



ICR620S-T16503 Professional

Lector62x

IMAGE-BASED CODE READERS

SICK
Sensor Intelligence.



Ordering information

| Type | Part no. |
|-----------------------------|----------|
| ICR620S-T16503 Professional | 1058623 |

Other models and accessories → www.sick.com/Lector62x



Detailed technical data

Features

| | |
|---------------------------|--|
| Focus | Teach auto focus |
| Sensor | CMOS matrix sensor, grayscale values |
| Sensor resolution | 752 px x 480 px (WVGA) |
| Internal lighting | Infrared |
| Light source | Illumination LEDs: invisible infrared light ($\lambda = 850 \pm 25$ nm) Feedback spot: visible green light ($\lambda = 525 \pm 15$ nm) Aiming laser: visible red light ($\lambda = 630 \dots 680$ nm) |
| MTBF | 75,000 h |
| LED class | 0 (IEC 62471:2006-07, EN 62471:2008-09) |
| Laser class | 1, complies with 21 CFR 1040.10 except for the tolerance according to "Laser Notice No. 50" from June 24, 2007 (IEC 60825-1:2014, EN 60825-1:2014) |
| Scanning frequency | 60 Hz, WVGA resolution |
| Code resolution | ≥ 0.1 mm ¹⁾ |
| Reading distance | 40 mm ... 1,500 mm ^{1) 2)} |
| Lens | Integrated |
| Focal length | 7 mm |

¹⁾ Valid for Data Matrix, PDF417, and 1D codes with good print quality.

²⁾ For details see reading field diagram.

Performance

| | |
|---|--|
| Readable code structures | 1D, 2D, Stacked |
| Bar code types | GS1-128 / EAN 128, UPC / GTIN / EAN, Interleaved 2 of 5, Pharmacode, GS1 DataBar, Code 39, Code 128, Codabar, Code 32, Code 93 |
| 2D code types | Data Matrix ECC200, GS1 Data-Matrix, PDF417, PDF417 Truncated, QR code |
| Code qualification | On the basis of ISO/IEC 16022, ISO/IEC 15415, ISO/IEC 15416, ISO/IEC 18004 |
| No. of codes per reading interval | 1 ... 50 |
| No. of characters per reading interval | 500 (for multiplexer function in CAN operation) |

| | |
|-------------------------------|--------|
| Internal image storage | 135 MB |
| Transport speed | 4 m/s |

Interfaces

| | |
|--------------------------------------|--|
| Ethernet | ✓, TCP/IP |
| Function | Host, AUX, OPC DA Server, FTP (image transmission) |
| Data transmission rate | 10/100 MBit/s |
| PROFINET | ✓ |
| Function | PROFINET Single Port, PROFINET Dual Port (optional via external connection module CDF600-2) |
| Data transmission rate | 10/100 MBit/s |
| EtherNet/IP™ | ✓ |
| Data transmission rate | 10/100 MBit/s |
| EtherCAT® | ✓ |
| Type of fieldbus integration | Optional over external fieldbus module CDF600 |
| Serial | ✓, RS-232, RS-422 |
| Function | Host, AUX |
| Data transmission rate | 0.3 kBaud ... 115.2 kBaud, AUX: 57.6 kBaud (RS-232) |
| CAN | ✓ |
| Function | SICK CAN sensor network CSN (master/slave, multiplexer/server) |
| Data transmission rate | 20 kbit/s ... 1 Mbit/s |
| CANopen | ✓ |
| Data transmission rate | 20 kbit/s ... 1 Mbit/s |
| PROFIBUS DP | ✓ |
| Type of fieldbus integration | Optional over external fieldbus module CDF600-2 |
| USB | ✓ |
| Remark | USB 2.0 |
| Switching inputs | 4 ("Sensor 1", "Sensor 2", 2 inputs via optional parameter storage CMC600 in CDB620/CDM420) |
| Switching outputs | 4 ("Result 1", "Result 2", 2 outputs via CMC and CDB620/CDM420 or "Result 1", "Result 2", "Result 3", "Result 4" when using the 17-wire cable with open cable end) |
| Reading pulse | Switching inputs, non-powered, serial interface, Ethernet, CAN, auto pulse, presentation mode |
| Optical indicators | 16 LEDs (5 x status display, 10 x LED bar graph, 1 green feedback spot) |
| Acoustic indicators | Beeper/buzzer (can be switched off, can be assigned a function to signal a result) |
| Operating elements | 2 buttons (choose and start/stop functions) |
| Configuration software | SOPAS ET |
| Memory card | Micro SD memory card (flash card) max. 32 GB, optional |
| Data storage and retrieval | Image and data storage via microSD memory card, internal storage and external FTP |
| Maximum encoder frequency | 300 Hz |
| External illumination control | Via digital output (max. 24 V trigger) |

Mechanics/electronics

| | |
|------------------------------|--|
| Electrical connection | 1 x M12, 17-pin male connector 1 x M12, 4-pin Ethernet female connector |
|------------------------------|--|

¹⁾ Swivel connector is 17.8 mm longer.

| | |
|-------------------------------|--|
| | Circular plug-in connector |
| Operating voltage | 10 V DC ... 30 V DC |
| Power consumption | Typ. 3 W |
| Output current | ≤ 100 mA |
| Housing | Aluminum die cast |
| Housing color | Light blue (RAL 5012) |
| Enclosure rating | IP65 (EN 60529 (1991-10), EN 60529/A2 (2002-02)) |
| Protection class | III |
| Electrical safety | EN 60950-1 (2006-04) / EN 60950-1/A11 (2009-03) |
| Weight | 170 g |
| Dimensions (L x W x H) | 71 mm x 43 mm x 35.6 mm ¹⁾ |

¹⁾ Swivel connector is 17.8 mm longer.

Ambient data

| | |
|--|---|
| Electromagnetic compatibility (EMC) | EN 61000-6-2 (2006-03) / EN 61000-6-2 (2009-05) |
| Vibration resistance | EN 60068-2-6:2008-02 |
| Shock resistance | EN 60068-2-27:2009-05 |
| Ambient operating temperature | 0 °C ... +50 °C |
| Storage temperature | -20 °C ... +70 °C |
| Permissible relative humidity | 90 %, Non-condensing |
| Ambient light immunity | 2,000 lx, on code |

Classifications

| | |
|-----------------------|----------|
| ECl@ss 5.0 | 27280103 |
| ECl@ss 5.1.4 | 27280103 |
| ECl@ss 6.0 | 27280103 |
| ECl@ss 6.2 | 27280103 |
| ECl@ss 7.0 | 27280103 |
| ECl@ss 8.0 | 27280103 |
| ECl@ss 8.1 | 27280103 |
| ECl@ss 9.0 | 27280103 |
| ETIM 5.0 | EC002550 |
| ETIM 6.0 | EC002550 |
| UNSPSC 16.0901 | 43211701 |

Dimensional drawing (Dimensions in mm (inch))

Lector62x Professional

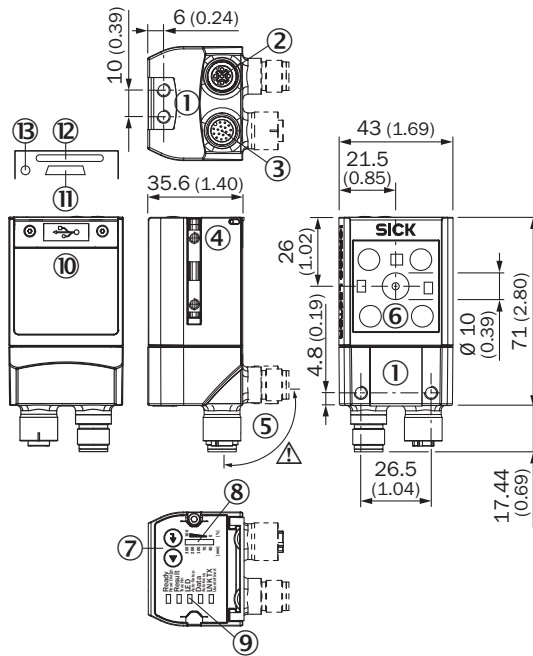

- ① M5 blind tapped holes, 5 mm deep (4 x), for mounting the sensor
- ② Ethernet connection
- ③ "Power/Serial Data/CAN/I/O" connection
- ④ Sliding nut M5, 5 mm deep (2 x), for mounting (as alternative)
- ⑤ Swivel connector unit
- ⑥ Reading field
- ⑦ Function button (2 x)
- ⑧ Bar graph display
- ⑨ LEDs for status display (2 levels), 5 x
- ⑩ Cover (flap)
- ⑪ "Micro USB" connection
- ⑫ Slot for microSD memory card
- ⑬ LED for microSD memory card

Reading field diagram

Working distance in mm (inch)

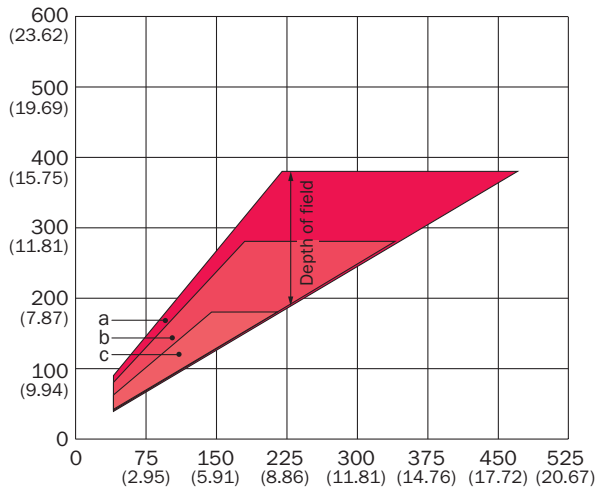

Focus position in mm (inch)

Resolution

- a: 1.00 mm (39.4 mil)
- b: 0.75 mm (29.5 mil)
- c: 0.50 mm (19.7 mil)

Working distance in mm (inch)

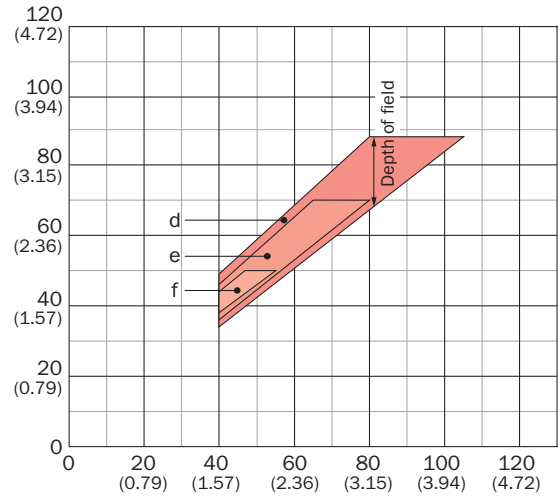

Focus position in mm (inch)

Resolution

- d: 0.25 mm (9.8 mil)
- e: 0.20 mm (7.9 mil)
- f: 0.15 mm (5.9 mil)

Field of view

Field of view

Field of view in mm² (sq inch)

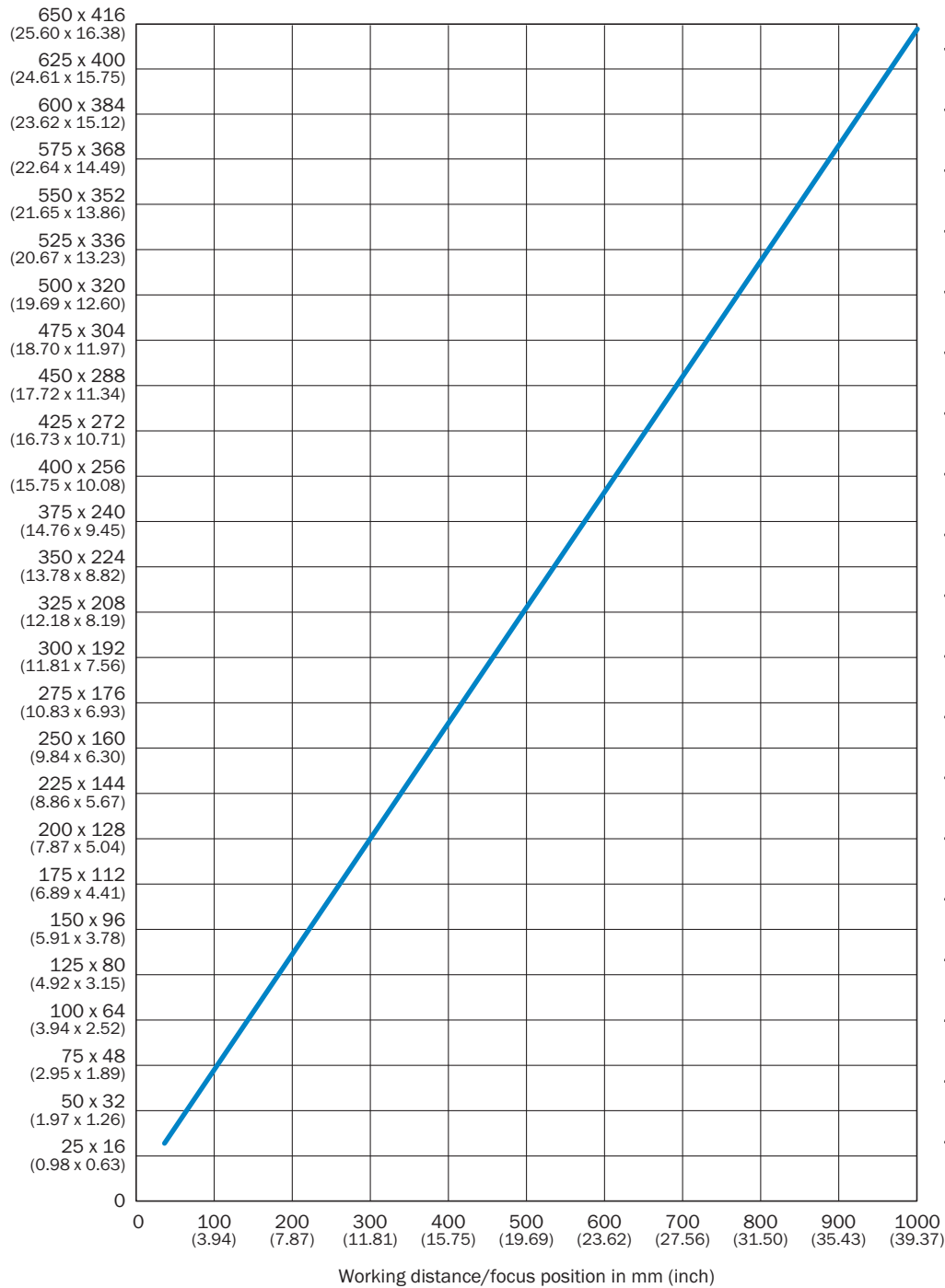









Min. resolution in mm (mil)

| 1D code | 2D code |
|------------|-------------|
| 1.9 (74.8) | 2.6 (102.4) |
| 1.8 (70.9) | 2.5 (98.4) |
| 1.7 (66.9) | 2.4 (94.5) |
| 1.6 (63.0) | 2.3 (90.6) |
| 1.5 (59.1) | 2.2 (86.6) |
| 1.4 (55.1) | 2.1 (82.7) |
| 1.3 (51.2) | 2.0 (78.7) |
| 1.2 (47.2) | 1.9 (74.8) |
| 1.1 (43.3) | 1.8 (70.9) |
| 1.0 (39.4) | 1.7 (66.9) |
| 0.9 (35.4) | 1.6 (63.0) |
| 0.8 (31.5) | 1.5 (59.1) |
| 0.7 (27.6) | 1.4 (55.1) |
| 0.6 (23.6) | 1.3 (51.2) |
| 0.5 (19.7) | 1.2 (47.2) |
| 0.4 (15.7) | 1.1 (43.3) |
| 0.3 (11.8) | 1.0 (39.4) |
| 0.2 (7.9) | 0.9 (35.4) |
| 0.1 (3.9) | 0.8 (31.5) |
| | 0.7 (27.6) |
| | 0.6 (23.6) |
| | 0.5 (19.7) |
| | 0.4 (15.7) |
| | 0.3 (11.8) |
| | 0.2 (7.9) |
| | 0.1 (3.9) |

f = 7 mm (ICR620S-T16503)

Recommended accessories

Other models and accessories → www.sick.com/Lector62x

| | Brief description | Further accessories | Type | Part no. |
|---|---|---------------------|--|----------|
| Mounting brackets and plates | | | | |
|  | Bracket with adapter board | | Mounting bracket | 2042902 |
| Plug connectors and cables | | | | |
|  | Head A: female connector, M12, 17-pin, straight Head B: male connector, D-Sub-HD, 15-pin, straight Cable: Power, serial, CAN, digital I/Os, shielded, 2 m | | Connection cable (male connector - female connector) | 2055419 |
|  | Head A: male connector, M12, 4-pin, D-coded Head B: male connector, M12, 4-pin, D-coded Cable: Ethernet, twisted pair, PUR, halogen-free, shielded, 2 m | | SSL-1204-G02ME | 6034420 |
|  | Head A: male connector, M12, 4-pin, straight, D-coded Head B: male connector, RJ45, 8-pin, straight Cable: Ethernet, twisted pair, PUR, halogen-free, shielded, 2 m | | SSL-2J04-G02ME | 6034414 |
|  | Head A: male connector, USB-A Head B: male connector, Micro-B Cable: USB 2.0, unshielded, 2 m | | USB cable | 6036106 |
| Modules | | | | |
|  | Small connection module for one sensor, 4 cable glands, base for CMC600 | Modules | CDB620-001 | 1042256 |
|  | Fieldbus proxy/gateway for connecting identification sensors to PROFIBUS-DP networks (PROFIBUS interface: 2 x M12, male connector/female connector, 5-pin) | | CDF600-2100 | 1058965 |
|  | Fieldbus proxy/gateway for connecting identification sensors to PROFIBUS-DP networks (PROFIBUS interface: 1 x D-Sub, female connector, 9-pin) | | CDF600-2103 | 1058966 |

SICK AT A GLANCE

SICK is one of the leading manufacturers of intelligent sensors and sensor solutions for industrial applications. A unique range of products and services creates the perfect basis for controlling processes securely and efficiently, protecting individuals from accidents and preventing damage to the environment.

We have extensive experience in a wide range of industries and understand their processes and requirements. With intelligent sensors, we can deliver exactly what our customers need. In application centers in Europe, Asia and North America, system solutions are tested and optimized in accordance with customer specifications. All this makes us a reliable supplier and development partner.

Comprehensive services complete our offering: SICK LifeTime Services provide support throughout the machine life cycle and ensure safety and productivity.

For us, that is “Sensor Intelligence.”

WORLDWIDE PRESENCE:

Contacts and other locations –www.sick.com