



# S30A-7011DB

S3000 Professional CMS

PRODUCT PORTFOLIO

**SICK**  
Sensor Intelligence.



### Ordering information

Type	Part no.
S30A-7011DB	1026402

The system plug has to be ordered separately!

Other models and accessories → [www.sick.de/S3000\\_Professional\\_CMS](http://www.sick.de/S3000_Professional_CMS)



### Detailed technical data

#### Features

Protective field range	7 m
Warning field range	49 m (20 m at 20 % reflectivity)
Distance measuring range	49 m
Number of field sets	8
Scan angle	190°
Resolution	30 mm, 40 mm, 50 mm, 70 mm, 150 mm, configurable
Angular resolution	0.5°, 0.25°, depending on range and resolution
Response time	60 ms <sup>1)</sup>
Protective field supplement	100 mm
Number of multiple samplings	2 ... 16, configurable
Delay of automatic reset	2 s ... 60 s, configurable

<sup>1)</sup> Depending on basic response time and multiple sampling.

#### Safety-related parameters

Type	Type 3 (IEC 61496)
Safety integrity level	SIL2 (IEC 61508), SILCL2 (EN 62061)
Category	Category 3 (EN ISO 13849)
Performance level	PL d (EN ISO 13849)
PFHd (mean probability of a dangerous failure per hour)	$8.0 \times 10^{-8}$ (EN ISO 13849)
T <sub>M</sub> (mission time)	20 years (EN ISO 13849)
Safe state in the event of a fault	At least one OSSD is in the OFF state.

#### Functions

External device monitoring (EDM)	✓
Simultaneous monitoring	✓
Static protective field switching	✓

Dynamic protective field switching	✓
Contour as a reference	✓
Integrated configuration memory	✓
Measured data output	✓
Expanded measured data output (CMS)	✓
Safe SICK device communication via EFI/SDL	✓

## Interfaces

Connection type	System plug with or without connecting cable
Configuration method	PC with CDS (Configuration and Diagnostic Software)
Configuration and diagnostics interface	RS-232
Transmission rate	9.6 kBaud, 19.2 kBaud, 38.4 kBaud
Data interface	RS-422
Transmission rate	≤ 500 kBaud
Safe SICK device communication via EFI/SDL	
Transmission rate	≤ 500 kBaud
Cable length	≤ 50 m
Conductor cross-section	0.34 mm <sup>2</sup>
Fieldbus, industrial network	
Integration via EFI gateways	CANopen, Ethernet TCP/IP, PROFIBUS DP, PROFIBUS PROFI-safe, PROFINET PROFI-safe <sup>1)</sup>

<sup>1)</sup> For a suitable EFI-gateway see modules and gateways in the accessory section of connection systems.

## Electrical data

Protection class	II (EN 50178)
Supply voltage $V_s$	24 V DC (16.8 V DC ... 28.8 V DC)
Power consumption	≤ 0.8 A <sup>1)</sup> ≤ 2.3 A <sup>2)</sup>
Inputs	
External device monitoring (EDM)	1
Reset/restart	1
Static control inputs	2 4
Dynamic control inputs (incremental encoder)	2
Outputs	
Safety outputs (OSSD)	2 x 500 mA
Diagnostic outputs	1 x 100 mA

<sup>1)</sup> At 24 V DC without output load.

<sup>2)</sup> At 24 V DC including maximum output load.

## Mechanical data

Dimensions (W x H x D)	155 mm x 185 mm x 160 mm
Weight	3.3 kg
Housing material	Aluminum die cast

<b>Housing color</b>	RAL 1021 (yellow)
<b>Front screen material</b>	Polycarbonat
<b>Front screen surface finish</b>	Outside with scratch-resistant coating

### Ambient data

<b>Enclosure rating</b>	IP 65 (EN 60529)
<b>Ambient operating temperature</b>	-10 °C ... +50 °C
<b>Storage temperature</b>	-25 °C ... +50 °C
<b>Vibration resistance</b>	5 g, 10 Hz ... 150 Hz (EN 61496-1, CLC/TS 61496-3)
<b>Shock resistance</b>	10 g, 16 ms (EN 61496-1, CLC/TS 61496-3)

### Other information





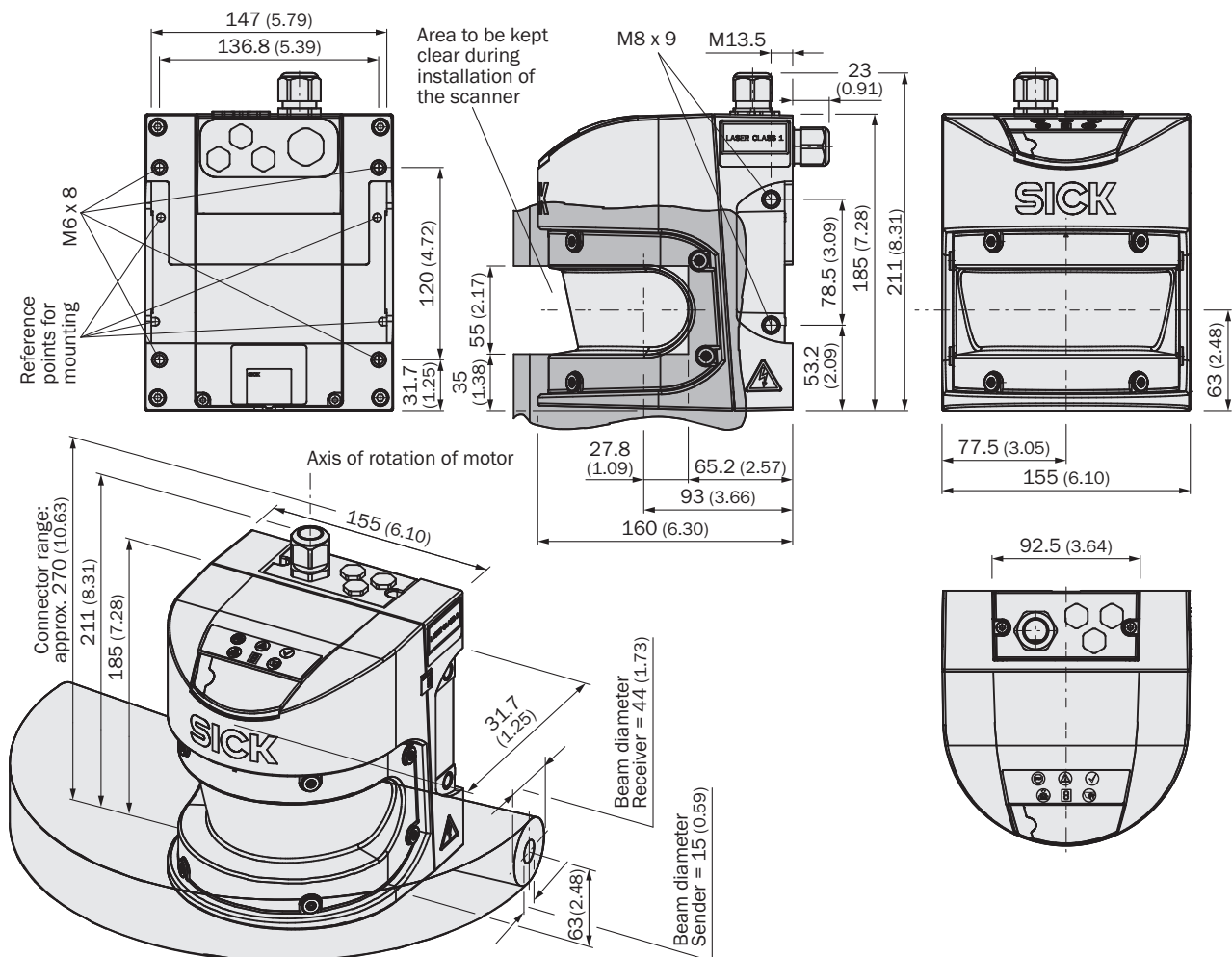

<b>Type of light</b>	Pulsed laser diode
<b>Wave length</b>	905 nm
<b>Reflectivity</b>	1.8 % ... > 1,000 %, reflectors
<b>Laser class</b>	1 (21 CFR 1040.10 and 1040.11, IEC 60825-1)

### Dimensional drawing (dimensions in mm (inch))



## Recommended accessories

Other models and accessories → [www.sick.de/S3000\\_Professional\\_CMS](http://www.sick.de/S3000_Professional_CMS)

	Brief description	Type	Part no.
<b>Mounting brackets and mounting plates</b>			
	1 piece, mounting bracket for direct mounting, from the rear, on wall or machine, not adjustable	Mounting kit 1	2015623
	1 piece, mounting bracket for rear mounting on wall or machine, adjustable longitudinal and lateral axes, only in conjunction with mounting kit 1 (2015623)	Mounting kit 2	2015624
	1 piece, mounting bracket for rear mounting on wall, floor, or machine, adjustable longitudinal and lateral axes, only in conjunction with mounting kit 1 (2015623) and 2 (2015624)	Mounting kit 3	2015625
	1 piece, Mounting bracket, heavy design, with protective hood, for floor mounting, adjustable longitudinal and lateral axes via alignment plate, adjustable height, steel, painted	Mounting kit heavy duty	2080350
<b>Plug connectors and cables</b>			
	Head A: Cable Head B: Cable Cable: PVC, shielded Fitting for EFI connections	EFI connecting cable	6029448
	Head A: male connector, M8, 4-pin, straight Head B: male connector, USB-A, straight Cable: PVC, unshielded, 2 m For connecting the configuration connection to the USB interface on the PC	DSL-8U04G02M025KM1	6034574
	Head A: male connector, M8, 4-pin, straight Head B: male connector, USB-A, straight Cable: PVC, unshielded, 10 m For connecting the configuration connection to the USB interface on the PC	DSL-8U04G10M025KM1	6034575
	Head A: system plug Cable: without cable Not for use with incremental encoders, integrated configuration memory	SX0A-A0000B	2023797

**Australia**

Phone +61 3 9457 0600  
1800 33 48 02 - tollfree  
E-Mail sales@sick.com.au

**Belgium/Luxembourg**

Phone +32 (0)2 466 55 66  
E-Mail info@sick.be

**Brasil**

Phone +55 11 3215-4900  
E-Mail marketing@sick.com.br

**Canada**

Phone +1 905 771 14 44  
E-Mail information@sick.com

**Česká republika**

Phone +420 2 57 91 18 50  
E-Mail sick@sick.cz

**China**

Phone +86 4000 121 000  
E-Mail info.china@sick.net.cn  
Phone +852-2153 6300  
E-Mail ghk@sick.com.hk

**Danmark**

Phone +45 45 82 64 00  
E-Mail sick@sick.dk

**Deutschland**

Phone +49 211 5301-301  
E-Mail info@sick.de

**España**

Phone +34 93 480 31 00  
E-Mail info@sick.es

**France**

Phone +33 1 64 62 35 00  
E-Mail info@sick.fr

**Great Britain**

Phone +44 (0)1727 831121  
E-Mail info@sick.co.uk

**India**

Phone +91-22-4033 8333  
E-Mail info@sick-india.com

**Israel**

Phone +972-4-6801000  
E-Mail info@sick-sensors.com

**Italia**

Phone +39 02 27 43 41  
E-Mail info@sick.it

**Japan**

Phone +81 (0)3 5309 2112  
E-Mail support@sick.jp

**Magyarország**

Phone +36 1 371 2680  
E-Mail office@sick.hu

**Nederland**

Phone +31 (0)30 229 25 44  
E-Mail info@sick.nl

**Norge**

Phone +47 67 81 50 00  
E-Mail sick@sick.no

**Österreich**

Phone +43 (0)22 36 62 28 8-0  
E-Mail office@sick.at

**Polska**

Phone +48 22 837 40 50  
E-Mail info@sick.pl

**România**

Phone +40 356 171 120  
E-Mail office@sick.ro

**Russia**

Phone +7-495-775-05-30  
E-Mail info@sick.ru

**Schweiz**

Phone +41 41 619 29 39  
E-Mail contact@sick.ch

**Singapore**

Phone +65 6744 3732  
E-Mail sales.gsg@sick.com

**Slovenija**

Phone +386 (0)1-47 69 990  
E-Mail office@sick.si

**South Africa**

Phone +27 11 472 3733  
E-Mail info@sickautomation.co.za

**South Korea**

Phone +82 2 786 6321/4  
E-Mail info@sickkorea.net

**Suomi**

Phone +358-9-25 15 800  
E-Mail sick@sick.fi

**Sverige**

Phone +46 10 110 10 00  
E-Mail info@sick.se

**Taiwan**

Phone +886-2-2375-6288  
E-Mail sales@sick.com.tw

**Türkiye**

Phone +90 (216) 528 50 00  
E-Mail info@sick.com.tr

**United Arab Emirates**

Phone +971 (0) 4 8865 878  
E-Mail info@sick.ae

**USA/México**

Phone +1(952) 941-6780  
1 800-325-7425 - tollfree  
E-Mail info@sickusa.com

More representatives and agencies  
at [www.sick.com](http://www.sick.com)