

Electrical Sector Solutions

# Volume 7: Logic Control, Operator Interface and Connectivity Solutions

**EATON**

*Powering Business Worldwide*

**Volume 1 – Residential and Light Commercial**

**1**

**Volume 2 – Commercial Distribution**

**2**

**Volume 3 – Power Distribution and Control Assemblies**

**3**

**Volume 4 – Circuit Protection**

**4**

**Volume 5 – Motor Control and Protection**

**5**

**Volume 6 – Solid-State Motor Control**

**6**

**Volume 7 – Logic Control, Operator Interface  
and Connectivity Solutions**

**7**

|  |                |
|--|----------------|
| <b>Tab 1 – Pushbuttons and Indicating Lights</b> .....                 | <b>V7-T1-1</b> |
| <b>Tab 2 – Stacklights</b> .....                                       | <b>V7-T2-1</b> |
| <b>Tab 3 – Control Relays and Timers</b> .....                         | <b>V7-T3-1</b> |
| <b>Tab 4 – PLC, I/O and Communications Products</b> .....              | <b>V7-T4-1</b> |
| <b>Tab 5 – Operator Interface Products</b> .....                       | <b>V7-T5-1</b> |
| <b>Tab 6 – Power Supplies</b> .....                                    | <b>V7-T6-1</b> |
| <b>Tab 7 – Industrial Control Transformers</b> .....                   | <b>V7-T7-1</b> |
| <b>Tab 8 – Terminal Blocks, Fuse Blocks<br/>and Fuse Holders</b> ..... | <b>V7-T8-1</b> |
| <b>Tab 9 – Connectivity Solutions</b> .....                            | <b>V7-T9-1</b> |
| <b>Appendix 1 – Eaton Terms &amp; Conditions</b> .....                 | <b>V7-A1-1</b> |
| <b>Appendix 2 – Catalog Parent Number Index</b> .....                  | <b>V7-A2-1</b> |
| <b>Appendix 3 – Alphabetical Product Index</b> .....                   | <b>V7-A3-1</b> |



## Dimensions, Weights and Ratings

Dimensions, weights and ratings given in this catalog **are approximate and should not be used for construction purposes**. Drawings containing exact dimensions are available upon request. All listed product specifications and ratings are subject to change without notice. Photographs are representative of production units.

## Terms and Conditions

All prices and discounts are subject to change without notice. When price changes occur, they are published in Eaton's *Price and Availability Digest* (PAD). All orders accepted by Eaton's Electrical Sector are subject to the general terms and conditions as set forth in Appendix 1—Eaton Terms & Conditions.

## Technical and Descriptive Publications

This catalog contains brief technical data for proper selection of products. Further information is available in the form of technical information publications and illustrated brochures. If additional product information is required, contact your local Eaton Products Distributor, call **1-800-525-2000** or visit our website at **www.eaton.com**.

## Compliance with Nuclear Regulation 10 CFR 21

Eaton products are sold as commercial grade products not intended for application in facilities or activities licensed by the United States Nuclear Regulatory Commission for atomic purposes, under 10 CFR 21. Further certification will be required for use of these products in a safety-related application in any nuclear facility licensed by the U.S. Nuclear Regulatory Commission.

## WARNING

The installation and use of Eaton products should be in accordance with the provisions of the U.S. National Electrical Code® and/or other local codes or industry standards that are pertinent to the particular end use. Installation or use not in accordance with these codes and standards could be hazardous to personnel and/or equipment.

These catalog pages do not purport to cover all details or variations in equipment, nor to provide for every possible contingency to be met in connection with installation, operation or maintenance. Should further information be desired or should particular problems arise which are not covered sufficiently for the purchaser's purposes, the matter should be referred to the local Eaton Products Distributor or Sales Office. The contents of this catalog shall not become part of or modify any prior or existing agreement, commitment or relationship. The sales contract contains the entire obligation of Eaton's Electrical Sector. The warranty contained in the contract between the parties is the sole warranty of Eaton. Any statements contained herein do not create new warranties or modify the existing warranty.



Powering Business Worldwide

**Eaton is a global leader in power distribution, power quality, control and automation, and monitoring products.**

At Eaton, we believe a reliable, efficient and safe power system is the foundation of every successful enterprise. Through innovative technologies, cutting-edge products and our highly skilled services team, we empower businesses around the world to achieve a powerful advantage.

In addition, Eaton is committed to creating and maintaining powerful customer relationships built on a foundation of excellence. From the products we manufacture to our dedicated customer service and support, we know what's important to you.

## Solutions

Eaton takes the complexity out of power systems management with a holistic and strategic approach, leveraging our industry-leading technology, solutions and services. We focus on the following three areas in all we do:

- Reliability—maintain the appropriate level of power continuity without disruption or unexpected downtime
- Efficiency—minimize energy usage, operating costs, equipment footprint and environmental impact
- Safety—identify and mitigate electrical hazards to protect what you value most

## Using the Eaton Catalog Library

As we grow, it becomes increasingly difficult to include all products in one or two comprehensive catalogs. Knowing that each user has their specific needs, we have created a library of catalogs for our products that when complete, will contain 15 volumes. Since the volumes will continuously be a work in progress and updated, each volume will stand alone. Refer to our volume directory, MZ08100001E, for a quick glance of where to look for the products you need. The 15 volumes include:

- Volume 1—Residential and Light Commercial (CA08100002E)
- Volume 2—Commercial Distribution (CA08100003E)
- Volume 3—Power Distribution and Control Assemblies (CA08100004E)
- Volume 4—Circuit Protection (CA08100005E)
- Volume 5—Motor Control and Protection (CA08100006E)
- Volume 6—Solid-State Motor Control (CA08100007E)
- Volume 7—Logic Control, Operator Interface and Connectivity Solutions (CA08100008E)
- Volume 8—Sensing Solutions (CA08100010E)
- Volume 9—Original Equipment Manufacturer (CA08100011E)
- Volume 10—Enclosed Control (CA08100012E)
- Volume 11—Vehicle and Commercial Controls (CA08100013E)
- Volume 12—Aftermarket, Renewal Parts and Life Extension Solutions (CA08100014E)
- Volume 13—Counters, Timers and Tachometers (CA08100015E)—Available in electronic format only
- Volume 14—Fuses (CA08100016E)—Available in electronic format only
- Volume 15—Solar Inverters and Electrical Balance of System (CA08100018E)

These volumes are not all-inclusive of every product, but they are meant to be an overview of our product lines. For our full range of product solutions and additional product information, consult [Eaton.com/electrical](http://Eaton.com/electrical) and other catalogs and product guides in our literature library. These references include:

- The Consulting Application Guide (CA08104001E)
- The Eaton Power Quality Product Guide (COR01FYA)

If you don't have the volume that contains the product or information that you are looking for, not to worry. You can access every volume of the catalog library at [Eaton.com/electrical](http://Eaton.com/electrical) in the Literature Library.

By installing our Automatic Tab Updater (ATU), you can be sure you always have the most recent version of each volume and tab.

## Icons



### Green Leaf

Eaton Green Solutions are products, systems or solutions that represent Eaton benchmarks for environmental performance. The green leaf symbol is our promise that the solution has been reviewed and documented as offering exceptional, industry-leading environmental benefits to customers, consumers and our communities. Though all of Eaton's products and solutions are designed to meet or exceed applicable government standards related to protecting the environment, our products with the Green Leaf designation further provide "exceptional environmental benefit".



### Learn Online

When you see the Learn Online icon, go to [Eaton.com/electrical](http://Eaton.com/electrical) and search for the product or training page. There you will find 100-level training courses, podcasts, webcasts or games and puzzles to learn more.



### Drawings Online

When you see the Drawings Online icon, go to [Eaton.com/electrical](http://Eaton.com/electrical) and find the products page. There you will find a tab that includes helpful product drawings and illustrations.

## Contact Us

If you need additional help, you can find contact information under the Customer Care heading of [Eaton.com/electrical](http://Eaton.com/electrical).

**10250T Pushbuttons**



**M22 Modular Pushbuttons**



|             |  |                  |
|-------------|--|------------------|
| <b>1.1</b>  | <b>Toggle Switches—E10</b>                                       |                  |
|             | Product Description .....  | <b>V7-T1-2</b>   |
|             | Product Selection .....  | <b>V7-T1-4</b>   |
| <b>1.2</b>  | <b>Environmentally Sealed Toggle Switches—E10E</b>               |                  |
|             | Product Description .....  | <b>V7-T1-8</b>   |
|             | Product Selection .....  | <b>V7-T1-9</b>   |
| <b>1.3</b>  | <b>Pushbutton Control Stations—Assembled</b>                     |                  |
|             | Product Description .....  | <b>V7-T1-14</b>  |
|             | Product Selection .....  | <b>V7-T1-16</b>  |
| <b>1.4</b>  | <b>16.2 mm Pushbuttons—RMQ-16</b>                                |                  |
|             | Product Selection Guide .....                                    | <b>V7-T1-31</b>  |
|             | Product Selection .....  | <b>V7-T1-32</b>  |
| <b>1.5</b>  | <b>22.5 mm Modular Pushbuttons—M22</b>                           |                  |
|             | Product Selection Guide .....                                    | <b>V7-T1-48</b>  |
|             | Product Selection .....  | <b>V7-T1-53</b>  |
| <b>1.6</b>  | <b>22.5 mm Compact Pushbuttons—C22</b>                           |                  |
|             | Product Selection Guide .....                                    | <b>V7-T1-139</b> |
|             | Product Selection .....  | <b>V7-T1-141</b> |
| <b>1.7</b>  | <b>30.5 mm Square Multifunction Watertight/Oiltight—E30</b>      |                  |
|             | Product Description .....  | <b>V7-T1-164</b> |
|             | Product Selection .....  | <b>V7-T1-166</b> |
| <b>1.8</b>  | <b>30.5 mm Heavy-Duty Watertight/Oiltight—10250T</b>             |                  |
|             | Product Description .....  | <b>V7-T1-182</b> |
|             | Product Selection .....  | <b>V7-T1-186</b> |
| <b>1.9</b>  | <b>30.5 mm Corrosion Resistant Watertight/Oiltight—E34</b>       |                  |
|             | Product Description .....  | <b>V7-T1-254</b> |
|             | Product Selection .....  | <b>V7-T1-260</b> |
| <b>1.10</b> | <b>30.5 mm Watertight/Oiltight—HT800</b>                         |                  |
|             | Product Description .....  | <b>V7-T1-296</b> |
|             | Product Selection .....  | <b>V7-T1-298</b> |
| <b>1.11</b> | <b>30.5 mm Class I Division 2 Hazardous Locations—10250T/E34</b> |                  |
|             | Product Description .....  | <b>V7-T1-321</b> |
|             | Product Selection .....  | <b>V7-T1-324</b> |





## Product Description

The E10 switches from Eaton's Electrical Sector are intended for general purpose light industrial use. Designed for retrofit and OEM applications.

## Features

### General Purpose Toggles

- Various circuit functions include maintained and momentary
- Poles include from single-pole single-throw to four-pole double-throw
- Spade, screw, and solder terminations available
- Numerous ratings
- Short 11/32 in and tall 15/32 in bat lever available
- Standard 15/32–32 thd.
- Hardware furnished assembled

## Contents

### Description

|   | <i>Page</i>    |
|---|----------------|
| Toggle Switches—E10                         |                |
| Standards and Certifications . . . . .      | <b>V7-T1-3</b> |
| Catalog Number Selection . . . . .          | <b>V7-T1-3</b> |
| Product Selection                           |                |
| Toggle Switches . . . . .                   | <b>V7-T1-4</b> |
| Hesitation Switches . . . . .               | <b>V7-T1-5</b> |
| Pushbuttons . . . . .                       | <b>V7-T1-5</b> |
| Accessories . . . . .                       | <b>V7-T1-5</b> |
| Technical Data and Specifications . . . . . | <b>V7-T1-6</b> |
| Circuit Diagrams . . . . .                  | <b>V7-T1-6</b> |
| Dimensions . . . . .                        | <b>V7-T1-7</b> |

### Heavy-Duty Hesitation Switches

- One-hole panel mount
- Three position switch offers unique positive center stop feature to assure lever cannot be thrown from one side through the center OFF position without stopping
  - Design feature is a major acceptance for motor reversing and speed control applications
- Prevents motor damage resulting from high current generation by counter EMF of the armature at the time of reversing
- Known as anti-plugging, hesitation, positive stop or positive off switch

### Non-Illuminated AC Rated Pushbuttons

- One-hole panel mount
- Medium-duty
- Spade and screw terminations available
- Various bushing lengths and button extensions
- Numerous ampere ratings with horsepower ratings

### Standards and Certifications

- UL Recognized
- CSA—File No. LR40068



### Catalog Number Selection

Catalog Number Selection is for illustrative purposes only and not to be used to create new catalog numbers.

#### Toggle Switches—E10 Series

Not to be used for ordering purposes

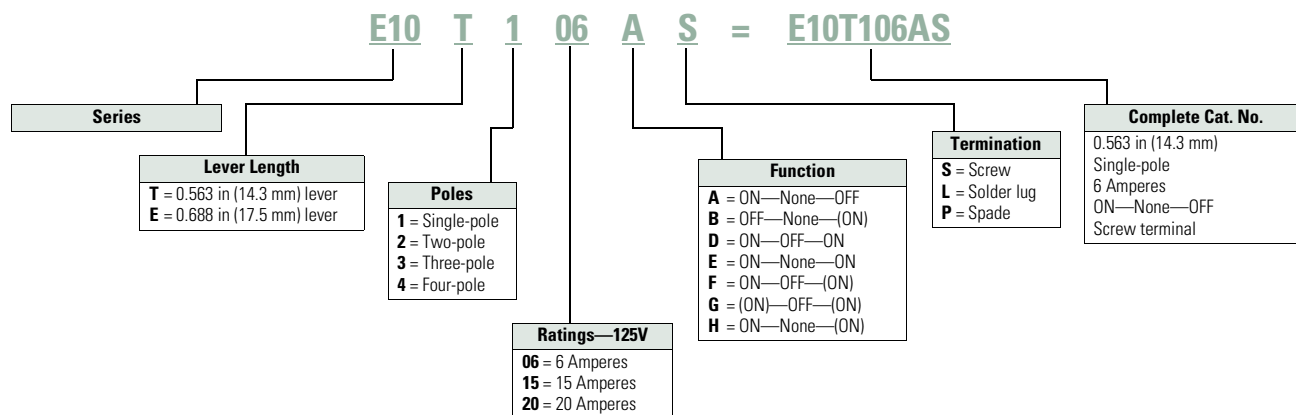





## Product Selection

### Toggle Switches

#### E10 Series—AC Rated—Minimum Order Quantity 10 Pieces

|   | Nominal AC Ratings |         |          | Poles and Throw ① | Function—Circuit with Lever In |                 |                      | Screw Terminal Catalog Number | 0.250 in (6.4 mm) Spade Terminal Catalog Number | Solder Lug Catalog Number |
|---|--------------------|---------|----------|-------------------|--------------------------------|-----------------|----------------------|-------------------------------|---|---------------------------|
|   | Amperes 125V       | hp 250V | hp 50V   |                   | UP Position                    | CENTER Position | DOWN Position—Keyway |                               |   |                           |
| <b>Single-Pole</b>  |                    |         |          |                   |                                |                 |                      |                               |   |                           |
|    | <b>Single-Pole</b> |         |          |                   |                                |                 |                      |                               |   |                           |
|   | 6                  | 3       | —        | 1 P.S.T.          | ON                             | None            | OFF                  | E10T106AS                     | E10T106AP                                       | E10T106AL                 |
|   | 15                 | 10      | 3/4      |                   |                                |                 |                      | E10T115AS                     | E10T115AP                                       | E10T115AL                 |
|   | 20                 | 10      | 3/4      |                   |                                |                 |                      | E10E120AS                     | E10E120AP                                       | E10E120AL                 |
|   | 6                  | 3       | —        | 1 P.D.T.          | ON                             | OFF             | ON                   | E10T106DS                     | E10T106DP                                       | —                         |
|   | 15                 | 10      | 3/4      |                   |                                |                 |                      | E10T115DS                     | E10T115DP                                       | E10T115DL                 |
|   | 20                 | 10      | 3/4      |                   |                                |                 |                      | E10E120DS                     | —   | —                         |
|   | 6                  | 3       | —        | 1 P.D.T.          | ON                             | None            | ON                   | E10T106ES                     | —   | —                         |
|   | 15                 | 10      | 3/4      |                   |                                |                 |                      | E10T115ES                     | E10T115EP                                       | E10T115EL                 |
|   | 20                 | 10      | 3/4      |                   |                                |                 |                      | E10E120ES                     | —   | —                         |
|   | —                  | 10      | 1/2      | 1 P.S.T.          | OFF                            | None            | (ON)                 | E10T115BS                     | E10T115BP                                       | —                         |
|   |                    |         |          | 1 P.D.T.          | ON                             | OFF             | (ON)                 | E10T115FS                     | E10T115FP                                       | —                         |
|   |                    |         |          | 1 P.D.T.          | ON                             | None            | (ON)                 | E10T115HS                     | E10T115HP                                       | —                         |
|   |                    |         | 1 P.D.T. | (ON)              | OFF                            | (ON)            | E10T115GS            | E10T115GP                     | —   |                           |
| <b>Two-Pole</b>   |                    |         |          |                   |                                |                 |                      |                               |   |                           |
|   | <b>Two-Pole</b>    |         |          |                   |                                |                 |                      |                               |   |                           |
|   | 6                  | 3       | —        | 2 P.S.T.          | ON                             | None            | OFF                  | E10T206AS                     | E10T206AP                                       | —                         |
|   | 15                 | 10      | 3/4      |                   |                                |                 |                      | E10T215AS                     | E10T215AP                                       | E10T215AL                 |
|   | 20                 | 10      | 3/4      |                   |                                |                 |                      | E10E220AS                     | E10E220AP                                       | E10E220AL                 |
|   | 6                  | 3       | —        | 2 P.D.T.          | ON                             | OFF             | ON                   | E10T206DS                     | E10T206DP                                       | —                         |
|   | 15                 | 10      | 3/4      |                   |                                |                 |                      | E10T215DS                     | E10T215DP                                       | E10T215DL                 |
|   | 20                 | 10      | 3/4      |                   |                                |                 |                      | E10E220DS                     | E10E220DP                                       | —                         |
|   | 6                  | 3       | —        | 2 P.D.T.          | ON                             | None            | ON                   | E10T206ES                     | —   | —                         |
|   | 15                 | 10      | 3/4      |                   |                                |                 |                      | E10T215ES                     | E10T215EP                                       | E10T215EL                 |
|   | 20                 | 10      | 3/4      |                   |                                |                 |                      | E10E220ES                     | —   | —                         |
|   | 15                 | 10      | 1/2      | 2 P.S.T.          | OFF                            | None            | (ON)                 | E10T215BS                     | —   | —                         |
|   |                    |         |          | 2 P.D.T.          | ON                             | None            | (ON)                 | E10T215HS                     | E10T215HP                                       | —                         |
|   |                    |         |          | 2 P.D.T.          | (ON)                           | OFF             | (ON)                 | E10T215GS                     | E10T215GP                                       | —                         |
| <b>Three-Pole</b>   |                    |         |          |                   |                                |                 |                      |                               |   |                           |
|  | <b>Three-Pole</b>  |         |          |                   |                                |                 |                      |                               |   |                           |
|   | 15                 | 10      | 3/4      | 3 P.S.T.          | ON                             | None            | OFF                  | E10E315AS                     | E10E315AP                                       | —                         |
|   |                    |         |          | 3 P.D.T.          | ON                             | OFF             | ON                   | E10E315DS                     | E10E315DP                                       | E10E315DL                 |
|   |                    |         | 3 P.D.T. | ON                | None                           | ON              | E10E315ES            | E10E315EP                     | E10E315EL                                       |                           |
| <b>Four-Pole</b>  |                    |         |          |                   |                                |                 |                      |                               |   |                           |
|  | <b>Four-Pole</b>   |         |          |                   |                                |                 |                      |                               |   |                           |
|   | 15                 | 10      | 3/4      | 4 P.S.T.          | ON                             | None            | OFF                  | E10E415AS                     | —   | E10E415AL                 |
|   |                    |         |          | 4 P.D.T.          | ON                             | OFF             | ON                   | E10E415DS                     | —   | E10E415DL                 |
|   |                    |         | 4 P.D.T. | ON                | None                           | ON              | E10E415ES            | —                             | E10E415EL                                       |                           |

**Note**

① See Circuit Diagrams on Page V7-T1-6.

### Hesitation Switches

Heavy-Duty Hesitation Switch



#### E10 Series—Special Purpose—Minimum Order Quantity 10 Pieces

| Nominal Ratings |         |         |         | Function—Circuit with Lever In... |             |                 |                      |          | Poles and Throw ① | Screw Terminal Catalog Number |
|-----------------|---------|---------|---------|-----------------------------------|-------------|-----------------|----------------------|----------|-------------------|-------------------------------|
| Amperes         |         | hp      |         | Operation                         | UP Position | CENTER Position | DOWN Position—Keyway |          |                   |                               |
| 28 Vdc          | 125 Vac | 250 Vac | 250 Vac |                                   |             |                 |                      |          |                   |                               |
| 15              | 15      | 10      | 3/4     | Maintained                        | ON          | OFF             | ON                   | 2 P.D.T. | <b>E10E215SS</b>  |                               |
|                 |         |         |         |                                   |             |                 |                      | 3 P.D.T. | <b>E10E315SS</b>  |                               |
|                 |         |         |         |                                   |             |                 |                      | 4 P.D.T. | <b>E10E415SS</b>  |                               |

### Pushbuttons

One-Hole Mounted Medium-Duty, Mom. Contact



#### E10 Series—Minimum Order Quantity 10 Pieces

| Nominal Ratings |            |             |         | Poles and Throw ① | Contacts | Bushing Length in (mm) Dim. "A" | Button Extension in (mm) Dim. "B" | Typical Maximum Operating Force | Screw Terminal Catalog Number        | Spade Terminal 0.250 in (6.4 mm) Catalog Number |
|-----------------|------------|-------------|---------|-------------------|----------|---------------------------------|-----------------------------------|---------------------------------|--------------------------------------|---|
| Amperes         |            | hp          |         |                   |          |                                 |                                   |                                 |                                      |   |
| 125 Vac NO      | 250 Vac NC | 125–250V NO | 250V NC |                   |          |                                 |                                   |                                 |                                      |   |
| 6               | —          | 3           | —       | 1 P.S.T.          | NO       | 0.69 (17.5)<br>0.34 (8.6)       | 0.53 (13.5)<br>0.25 (6.4)         | 0.9 lbs                         | <b>E10P106RS</b><br><b>E10P106JS</b> | <b>E10P106RP</b><br>—                           |
| 15              | —          | 10          | —       | 1 P.S.T.          | NO       | 0.69 (17.5)<br>0.34 (8.6)       | 0.53 (13.5)<br>0.25 (6.4)         | 0.9 lbs                         | <b>E10P115RS</b><br><b>E10P115JS</b> | <b>E10P115RP</b><br>—                           |
| 15              | 10         | 10          | 5       | 1/4 ②             | NO, NC   | 0.69 (17.5)                     | 0.53 (13.5)                       | 1.0 lbs                         | <b>E10P115LS</b>                     | —   |

### Accessories

#### Toggle Switches Accessories—Minimum Order Quantity 100 Pieces

| Description                                    | Material/Notes                | Catalog Number  |
|--|-------------------------------|-----------------|
| Hexagon locknut                                | Zinc-chromate treated steel   | <b>E10TA101</b> |
| Knurled face nut                               | Zinc-chromate treated steel   | <b>E10TA102</b> |
| Internal tooth lockwasher                      | Cadmium plated steel          | <b>E10TA103</b> |
| Terminal screws                                | #6-32 x 3/16 in binding head  | <b>E10TA201</b> |
| Spade terminal adapter—0.250 in (6.4 mm)       | Assembles to screw terminals  | <b>E10TA202</b> |
| ON-OFF indicating plate—vertical orientation   | Burnished nickel finish steel | <b>E10TA301</b> |
| OFF-ON indicating plate—horizontal orientation | Burnished nickel finish steel | <b>E10TA302</b> |

E10TA104

|                                   |                 |
|-----------------------------------|-----------------|
| Flip-up guard for toggle switches | <b>E10TA104</b> |
|-----------------------------------|-----------------|



E10TA105

|                                  |                 |
|----------------------------------|-----------------|
| Fixed shroud for toggle switches | <b>E10TA105</b> |
|----------------------------------|-----------------|



#### Notes

Interlock mechanism prevents operation of lever through the center position until pressure is momentarily relieved. Designed for control and protection of reversing motors.

① See Circuit Diagrams on **Page V7-T1-6**.

② Rated 1/4 hp at 125V, 1/2 hp at 250V.

## Technical Data and Specifications

### Toggle Switches

| Description     | Specification   |
|-----------------|---|
| AC ratings      | 6–20A, 125 Vac<br>3–10A, 250 Vac<br>Max. 3/4 hp at 250 Vac  |
| DC ratings      | 6–20A, 28 Vdc   |
| Electrical life | 6,000 cycles make/break at switch ampere rating   |
| Operation       | Slow make/slow break mechanism with butt action for AC and low voltage DC applications<br>Maintained and momentary contacts       |
| Poles/throws    | 1 through 4, single and double throw  |
| Mounting        | One hole with threaded 0.468 in-32 bushing and 0.068 x 0.035 in (1.7 x 0.9 mm) deep keyway that serves as anti-rotational feature |
| Lever lengths   | 0.563 in (14.3 mm) or 0.688 in (17.5 mm), bright nickel plated  |
| Terminals       | Screw, 0.250 in (6.4 mm) spade and solder lug   |

### Hesitation Switches

| Description  | Specification  |
|--------------|--|
| Operation    | Slow make/slow break mechanism with butt action for AC and low voltage DC applications; maintained contacts; ideal for reversing motor applications; interlock mechanism prevents operation of lever through center position until manual pressure is momentarily relieved |
| AC ratings   | 15A, 125 Vac<br>10A, 250 Vac<br>Max. 3/4 hp at 250 Vac   |
| DC ratings   | 15A, 28 Vdc  |
| Poles/throws | 2, 3 and 4, double throw only  |
| Mounting     | Single-pole with threaded 0.468 in-32 bushing and 0.068 x 0.049 in (1.7 x 1.2 mm) deep keyway  |
| Lever length | 0.687 in (17.4 mm), stainless steel  |
| Terminals    | Screw  |

### Pushbutton Actuators

| Description       | Specification   |
|-------------------|---|
| AC ratings        | 6–15A, 125 Vac (NO)<br>3–10A, 250 Vac (NO)<br>Max. 1/3 hp at 125/250 Vac  |
| Operation         | Slow make/slow break mechanism<br>Normally open contacts  |
| Poles/throws      | Single, single and double throw   |
| Mounting          | One hole with 0.468 in-32 threaded bushing and 0.068 x 0.035 in (1.7 x 0.9 mm) deep keyway<br>Two bushing heights: 11/16 in (17.5 mm) and 11/32 in (8.7 mm) |
| Button extensions | 17/32 in (13.5 mm) and 1/4 in (6.4 mm), bright nickel plated  |
| Terminals         | Screw   |

## Circuit Diagrams

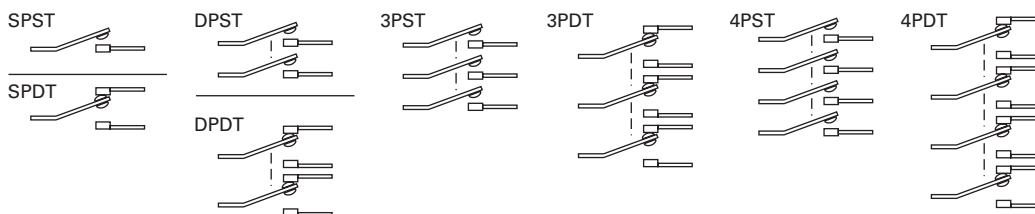

### Dimensions

Approximate Dimensions in Inches (mm)

#### Toggle Switch Dimensions

| No. of Poles | Operation                | Bushing Length<br>A | Lever Length<br>B | Screw Terminals |                |                | Spade Terminals |                |                | Solder Lug     |                |                |
|--------------|--------------------------|---------------------|-------------------|-----------------|----------------|----------------|-----------------|----------------|----------------|----------------|----------------|----------------|
|              |                          |                     |                   | C               | D              | E              | C <sup>Ⓢ</sup>  | D              | E              | C              | D              | E              |
| 1            | Momentary and maintained | 0.47<br>(11.9)      | 0.56<br>(14.2)    | 1.00<br>(25.4)  | 1.17<br>(29.7) | 0.63<br>(16.0) | 1.13<br>(28.7)  | 1.13<br>(28.7) | 0.63<br>(16.0) | 1.00<br>(25.4) | 1.13<br>(28.7) | 0.63<br>(16.0) |
| 2            | Maintained               | 0.47<br>(11.9)      | 0.56<br>(14.2)    | 1.06<br>(26.9)  | 1.31<br>(33.3) | 0.75<br>(19.1) | 1.19<br>(30.2)  | 1.31<br>(33.3) | 0.75<br>(19.1) | 1.06<br>(26.9) | 1.31<br>(33.3) | 0.75<br>(19.1) |
|              | Momentary                | 0.47<br>(11.9)      | 0.56<br>(14.2)    | 1.25<br>(31.8)  | 1.31<br>(33.3) | 0.75<br>(19.1) | 1.31<br>(33.3)  | 1.31<br>(33.3) | 0.75<br>(19.1) | 1.25<br>(31.8) | 1.31<br>(33.3) | 0.75<br>(19.1) |
| 3            | Maintained               | 0.47<br>(11.9)      | 0.69<br>(17.5)    | 1.27<br>(32.3)  | 1.34<br>(34.0) | 1.44<br>(36.6) | 1.37<br>(34.8)  | 1.34<br>(34.0) | 1.44<br>(36.6) | 1.23<br>(31.2) | 1.34<br>(34.0) | 1.44<br>(36.6) |
| 4            | Maintained               | 0.47<br>(11.9)      | 0.69<br>(17.5)    | 1.20<br>(30.5)  | 1.30<br>(33.0) | 1.40<br>(35.6) | 1.30<br>(33.0)  | 1.34<br>(34.0) | 1.40<br>(35.6) | 1.23<br>(31.2) | 1.34<br>(34.0) | 1.44<br>(36.6) |

#### Toggle Switch

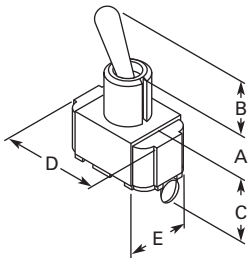

#### Hesitation Switch

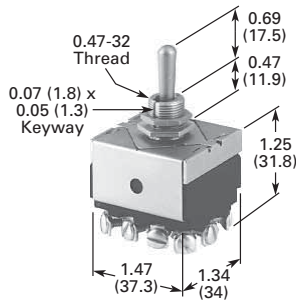

#### Pushbutton Actuator

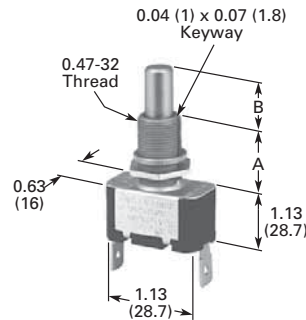

### Accessories

#### E10TA101 Hexagon Locknut

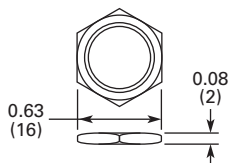

#### E10TA102 Knurled Face Nut

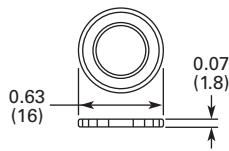

#### E10TA301 ON-OFF Indicating Plate—Vertical Orientation

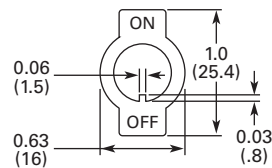

#### E10TA302 ON-OFF Indicating Plate—Horizontal Orientation



#### Note

Ⓢ Spade terminal adapters are used on 6 ampere and momentary screw terminal switches, adding 0.42 in (10.7 mm) to dimension C.



### Product Description

Designed for general purpose and OEM applications, this line of toggle switches provides a high IP68 rating for demanding environments.

### Features

#### Molded-In Screw Terminal

- Completely sealed against dust, moisture and other contaminants
- One-hole mounted bushing for easy installation
- Multi-circuits offered
- Two- and three-position with maintained and momentary action
- Molded-in terminal inserts and terminals numbers
- Single- and two-pole circuitry

#### Econoswitch

- Environmentally sealed
- Single- and two-pole circuitry
- One-hole mounting for easy installation
- Multi-circuits
- Two- and three-position with maintained and momentary action
- Three types of termination offered as standard

### Contents

#### Description

|   | <i>Page</i>     |
|---|-----------------|
| Environmentally Sealed Toggle Switches—E10E |                 |
| Product Selection                           |                 |
| Molded-In Screw Terminal . . . . .          | <b>V7-T1-9</b>  |
| Econoswitch . . . . .                       | <b>V7-T1-9</b>  |
| Switch Guard . . . . .                      | <b>V7-T1-9</b>  |
| Technical Data and Specifications . . . . . | <b>V7-T1-10</b> |
| Dimensions . . . . .                        | <b>V7-T1-11</b> |

#### Switch Guard

- For use with two-position switch
- Cover closure transfers switch toggle lever to OFF position
- One-hole mounted mounting style
- Cover is molded out of red thermoset molding material
- Guard cover is spring-loaded to either close or lock in open position
- Prevents accidental operation at switches

#### Options

**Note:** Contact your local Eaton Sales Representative for more information.

- Non-UL Recognized devices
  - Alternate toggle levers
  - Locking toggle levers
  - Rocker buttons
- Special mounting hardware
- Mounting hardware furnished assembled
- Terminal screws furnished assembled
- Special circuits
- Panel seal, part number 32-341
- Spade terminal adapters available

### Standards and Certifications

- UL—File number E15346; Guide card number is WOYR2
- CSA—LR40068, class number 6241







#### UL and CSA Nominal Ratings

| Catalog Number         | 125 Vac | 250 Vac |
|------------------------|---------|---------|
| <b>Amperes</b>         |         |         |
| <b>E10E118xx</b>       | 18      | 9       |
| <b>E10E218xx</b>       | 18      | 9       |
| <b>Single-Phase hp</b> |         |         |
| <b>E10E118xx</b>       | 1/4     | 1/2     |
| <b>E10E218xx</b>       | 1/2     | 1       |
| <b>Three-Phase hp</b>  |         |         |
| <b>E10E118xx</b>       | —       | —       |
| <b>E10E218xx</b>       | —       | —       |

### Product Selection





#### Molded-In Screw Terminal

##### E10E Series—Molded-In Screw Terminal

|   | Nominal AC Ratings |      |                 |      |                | Circuit with Lever Position   |   |   | Catalog Number   |
|---|--------------------|------|-----------------|------|----------------|---|---|---|------------------|
|   | Amperes            |      | Single-Phase hp |      | Three-Phase hp | Up  | Center  | Down (Keyway)   |                  |
|   | 125V               | 250V | 125V            | 250V | 125/250V       |  |  |  |                  |
| <b>Single-Pole</b>  | <b>Single-Pole</b> |      |                 |      |                |   |   |   |                  |
|  | 18                 | 9    | 1/4             | 1/2  | —              | ON  | OFF   | ON  | <b>E10E118DM</b> |
|   |                    |      |                 |      |                | ON  | NONE  | OFF   | <b>E10E118AM</b> |
|   |                    |      |                 |      |                | ON  | NONE  | ON  | <b>E10E118EM</b> |
| <b>Two-Pole</b>   | <b>Two-Pole</b>    |      |                 |      |                |   |   |   |                  |
|  | 18                 | 9    | 1/2             | 1    | —              | ON  | OFF   | ON  | <b>E10E218DM</b> |
|   |                    |      |                 |      |                | ON  | NONE  | OFF   | <b>E10E218AM</b> |
|   |                    |      |                 |      |                | ON  | NONE  | ON  | <b>E10E218EM</b> |

#### Econoswitch

##### E10E Series—Econoswitch

|   | Current Ratings—Amperes |           |                |                |                       |                |                | Circuit with Lever Position   |   |  | Screw Terminal Catalog Number | Solder Lug Terminal Catalog Number | Spade Terminal Catalog Number |
|---|-------------------------|-----------|----------------|----------------|-----------------------|----------------|----------------|---|---|--|-------------------------------|------------------------------------|-------------------------------|
|   | Type of Operation       | 28 Vdc    |                |                | 115 Vac, 60 or 400 Hz |                |                | Up  | Center  | Down (Keyway)  |                               |                                    |                               |
|   |                         | Lamp Load | Resistive Load | Inductive Load | Lamp Load             | Resistive Load | Inductive Load |  |  |  |                               |                                    |                               |
| <b>Single-Pole</b>  | <b>Single-Pole</b>      |           |                |                |                       |                |                |   |   |  |                               |                                    |                               |
|  | Maintained              | 5         | 20             | 15             | 3                     | 15             | 10             | ON  | OFF   | ON   | <b>E10E118DS</b>              | <b>E10E118DL</b>                   | <b>E10E118DP</b>              |
|   | Maintained              | 5         | 20             | 15             | 3                     | 15             | 10             | ON  | NONE  | OFF  | <b>E10E118AS</b>              | <b>E10E118AL</b>                   | <b>E10E118AP</b>              |
|   | Maintained              | 5         | 20             | 15             | 3                     | 15             | 10             | ON  | NONE  | ON   | <b>E10E118ES</b>              | <b>E10E118EL</b>                   | <b>E10E118EP</b>              |
|   | Momentary               | 4         | 15             | 10             | 2                     | 15             | 7              | ON <sup>Ⓢ</sup>   | OFF   | ON <sup>Ⓢ</sup>  | <b>E10E118GS</b>              | <b>E10E118GL</b>                   | <b>E10E118GP</b>              |
|   | Momentary               | 4         | 15             | 10             | 2                     | 15             | 7              | OFF   | NONE  | ON <sup>Ⓢ</sup>  | <b>E10E118BS</b>              | <b>E10E118BL</b>                   | <b>E10E118BP</b>              |
| <b>Two-Pole</b>   | <b>Two-Pole</b>         |           |                |                |                       |                |                |   |   |  |                               |                                    |                               |
|  | Maintained              | 7         | 20             | 15             | 4                     | 15             | 15             | ON  | OFF   | ON   | <b>E10E218DS</b>              | <b>E10E218DL</b>                   | <b>E10E218DP</b>              |
|   | Maintained              | 7         | 20             | 15             | 4                     | 15             | 15             | ON  | NONE  | OFF  | <b>E10E218AS</b>              | <b>E10E218AL</b>                   | <b>E10E218AP</b>              |
|   | Maintained              | 7         | 20             | 15             | 4                     | 15             | 15             | ON  | NONE  | ON   | <b>E10E218ES</b>              | <b>E10E218EL</b>                   | <b>E10E218EP</b>              |
|   | Momentary               | 5         | 18             | 10             | 2                     | 11             | 8              | ON <sup>Ⓢ</sup>   | OFF   | ON <sup>Ⓢ</sup>  | <b>E10E218GS</b>              | <b>E10E218GL</b>                   | <b>E10E218GP</b>              |
|   | Momentary               | 5         | 18             | 10             | 2                     | 11             | 8              | OFF   | NONE  | ON <sup>Ⓢ</sup>  | <b>E10E218BS</b>              | <b>E10E218BL</b>                   | <b>E10E218BP</b>              |

#### Switch Guard

##### Switch Guard

##### E10E Series—Switch Guard



|              | Catalog Number  |
|--------------|-----------------|
| Switch Guard | <b>E10TA104</b> |

**Note**

Ⓢ Momentary contact.

**Technical Data and Specifications****E10E Series—Molded-In Screw Terminal**

| <b>Description</b>          | <b>Specification</b>  |
|-----------------------------|---|
| Watertight seal             | Per MIL-STD-108E and designed to meet IP68  |
| Thermoset molding materials | Meet flame retardant requirements   |
| Temperature range           | –50° to 150°F (–46° to 66°C)  |
| Life                        | 20,000 operations at rated load; 40,000 operations mechanical life;<br>6,000 operations at hp ratings per UL and CSA requirements |
| Bushings                    | 15/32 in-32 thread  |

**E10E Series—Econoswitch**

| <b>Description</b> | <b>Specification</b>  |
|--------------------|---|
| Watertight seal    | Per MIL-STD-108E and designed to meet IP68  |
| Type of terminal   | Screws—6-32 UNC-22A<br>Solder lug—0.125 in (3.17 mm) dia. hole<br>Spade—0.250 in (6.35 mm) x 0.032 in (0.81 mm) thick |
| Life               | 50,000 operations at rated load; 100,000 operations mechanical life   |
| Temperature range  | –50° to 150°F (–46° to 66°C)  |

### Dimensions

Approximate Dimensions in Inches (mm)

#### Single-Pole Molded-In Screw Terminal E10E Series

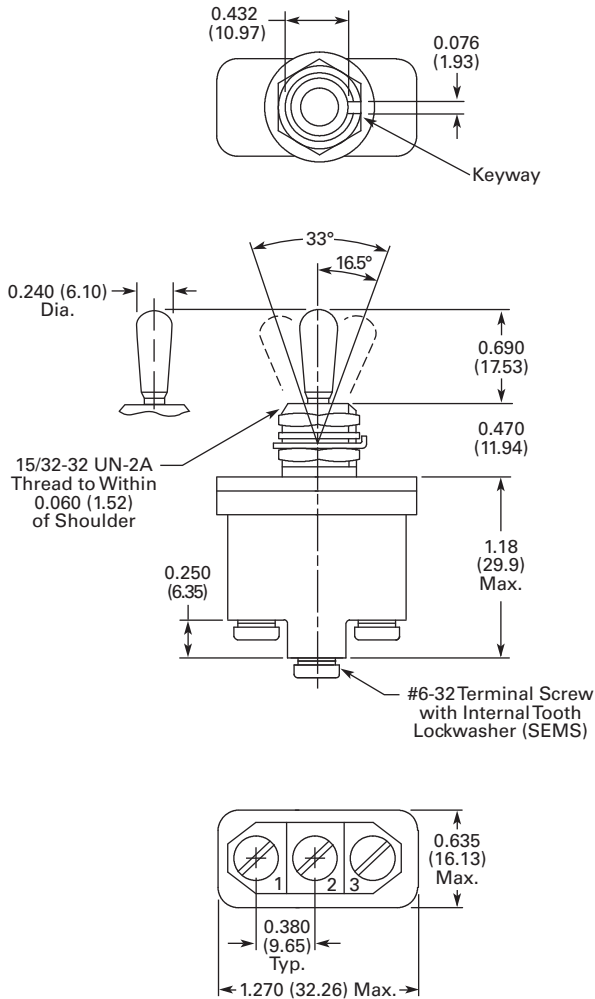

#### Two-Pole Molded-In Screw Terminal E10E Series

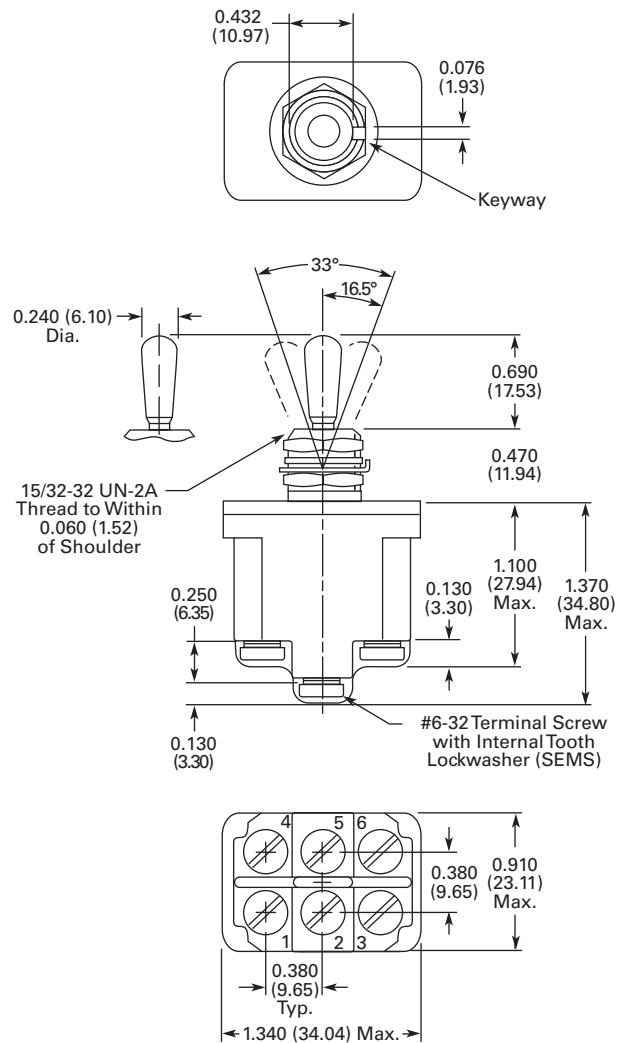

#### Toggle Switch Panel Cutout

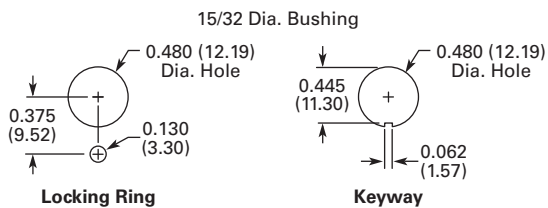



# 1.2

## Pushbuttons and Indicating Lights

### Environmentally Sealed Toggle Switches—E10E

1

Approximate Dimensions in Inches (mm)

#### Single-Pole Econoswitch E10E Series

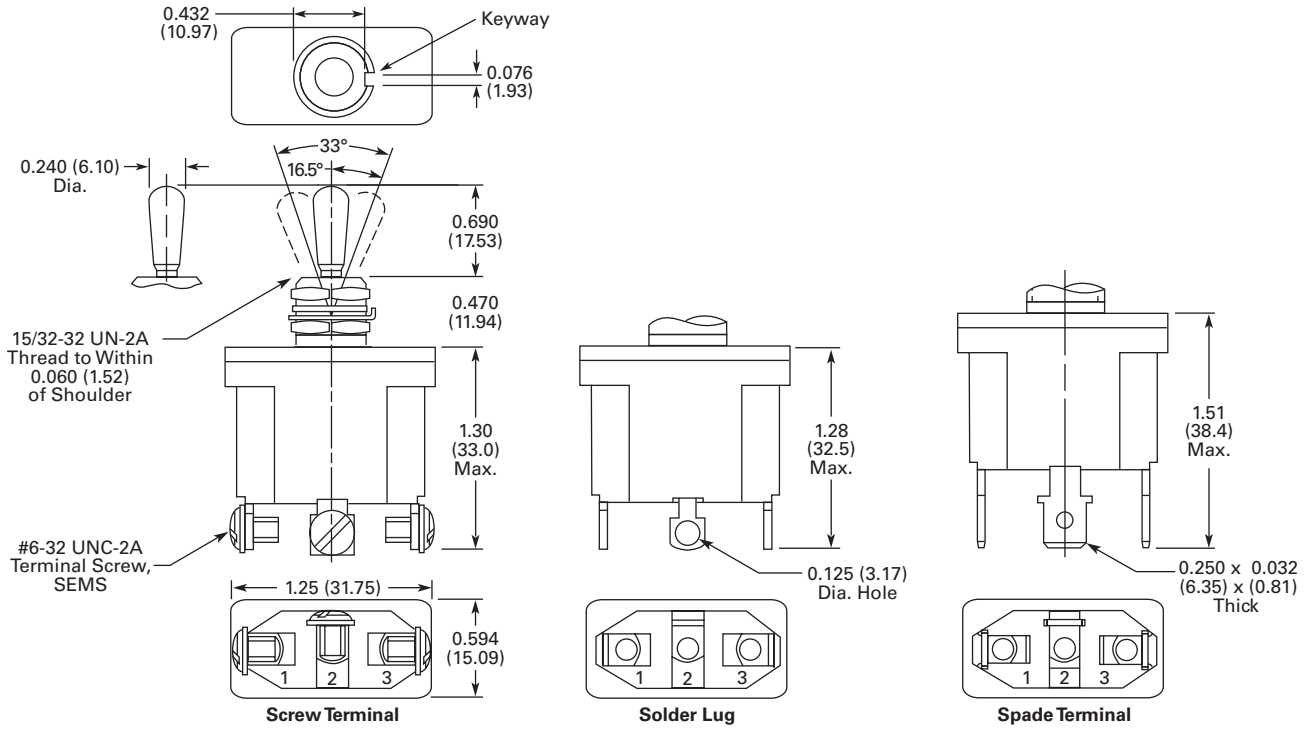

#### Two-Pole Econoswitch E10E Series

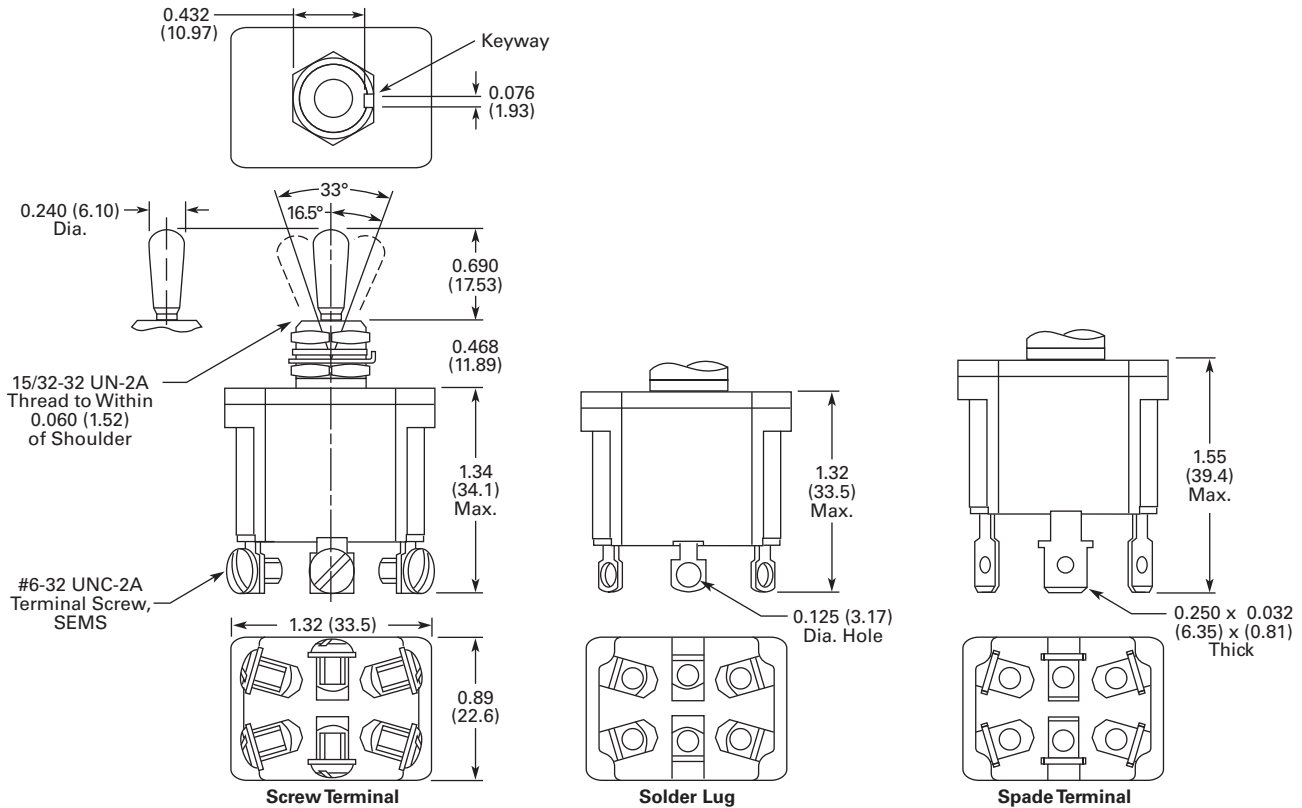

Approximate Dimensions in Inches (mm)

**Switch Guard**

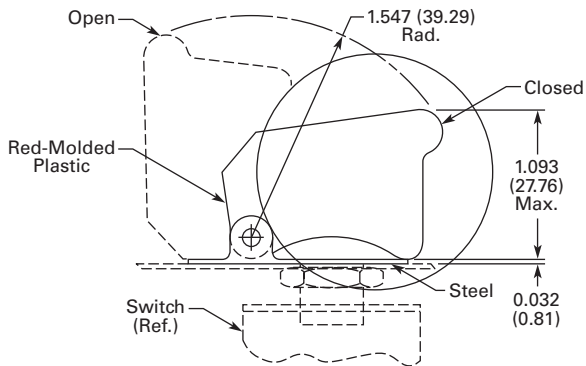
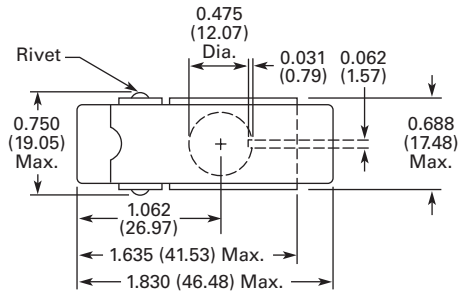
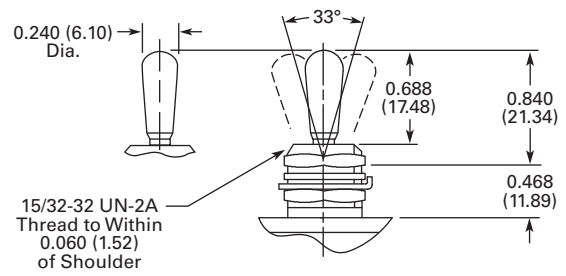

Pushbutton Control Stations



### Contents

| <i>Description</i>   | <i>Page</i>     |
|--|-----------------|
| Pushbutton Control Stations—Assembled  |                 |
| Features . . . . .   | <b>V7-T1-15</b> |
| Product Selection  |                 |
| M22 Assembled Control Stations . . . . .   | <b>V7-T1-16</b> |
| Commercial Control Stations . . . . .  | <b>V7-T1-17</b> |
| General Purpose Control Stations . . . . .   | <b>V7-T1-18</b> |
| Special Purpose Control Stations . . . . .   | <b>V7-T1-19</b> |
| 10250H Series Heavy-Duty Control Stations . . . . .                                  | <b>V7-T1-20</b> |
| 10250T Series Heavy-Duty 30.5 mm Control Stations . . . . .                          | <b>V7-T1-21</b> |
| Class I Division 2 10250T Series Heavy-Duty 30.5 mm Control Stations . . . . .       | <b>V7-T1-22</b> |
| Class I Division 2 E34 Series Corrosion Resistant 30.5 mm Control Stations . . . . . | <b>V7-T1-23</b> |
| Accessories . . . . .  | <b>V7-T1-23</b> |
| Custom Assembled Stations  |                 |
| Specification Form . . . . .   | <b>V7-T1-24</b> |
| Renewal Parts . . . . .  | <b>V7-T1-26</b> |
| Technical Data and Specifications . . . . .  | <b>V7-T1-28</b> |
| Dimensions . . . . .   | <b>V7-T1-28</b> |

### Product Description

#### M22 Assembled Control Stations

- M22 series operators
- Available in horizontal and vertical configurations
- Impact resistant polycarbonate enclosures
- Optional yellow covers
- Base mounting contact blocks and light units for quick wiring and vibration resistance

#### Commercial Control Stations

- 10250T series operators
- Full front label
- Specific function labels on front of enclosure

#### General Purpose Control Stations

- Construction grade
- General purpose wall mount
- Popular with contractors
- UL (NEMA) Type 1

#### Special Purpose Control Stations

- Standard grade
- Polyester enclosure
- UL (NEMA) Type 3, 3R, 4, 4X, 13

#### 10250H Series Heavy-Duty Control Stations

- 10250H Series operators
- Dark brown polyester enclosure
- Protective rubber gaskets provide NEMA 3S rating on pushbuttons
- Top and bottom 3/4 in NPT conduit entrances
- Includes alternate legend plates and spare mounting screws

#### 10250T Series Heavy-Duty 30.5 mm Control Stations

- 10250T Series operators
- ASA 61 gray die-cast zinc enclosures
- Surface or flush mounting
- Single 3/4 in NPT conduit entrance on one and two element stations
- Single 1 in NPT conduit entrance on three element stations

#### Class I Division 2 10250T Series Heavy-Duty 30.5 mm Control Stations

- 10250T Series operators
- Factory sealed contact blocks
- Die-cast, polyester or stainless steel enclosures
- Approved for NEC Class I Division 2, Groups B, C and D or Class I Zone 2 Group IIB plus Hydrogen type hazardous locations

#### Class I Division 2 E34 Series Corrosion Resistant 30.5 mm Control Stations

- E34 Series operators
- Factory sealed contact blocks
- Die-cast, polyester or stainless steel enclosures
- Approved for NEC Class I Division 2 Groups B, C and D or Class I Zone 2 Group IIB plus Hydrogen type hazardous locations

## Features

### M22 Assembled Control Stations

- IP66, UL (NEMA) Type 4X, 13
- Impact resistant polycarbonate enclosures
- Optional yellow cover
- 25% smaller depth than most competitor enclosures
- Base mounting contact blocks and light units for faster wiring and vibration resistance

### Commercial Control Stations

- ASA 61 gray die-cast zinc enclosures
- Pre-assembled and labeled for functions such as “Fuel Shut-Off”
- Great for commercial applications

### General Purpose Control Stations

- Construction grade
- General purpose wall mount
- Popular with contractors
- UL (NEMA) Type 1

### Special Purpose Control Stations

- Standard grade
- Polyester enclosure
- UL (NEMA) Type 3, 3R, 4, 4X, 13

### 10250H Series Heavy-Duty Control Stations

- Industrial grade
- Extra heavy-duty
- Polyester enclosure
- Booted buttons
- Outdoor installation
- UL (NEMA) Type 3, 3R, 3S, 4, 4X, 12, 13

### 10250T Series Heavy-Duty 30.5 mm Control Stations

- 30.5 mm operators
- Industrial grade
- Zinc die cast enclosure
- Popular with industrial end users
- UL (NEMA) Type 4, 4X, 12, 13

### Class I Division 2 Control Stations

- Available with 10250T or E34 30.5 mm operators
- Zinc die cast, polyester or stainless steel enclosures
- Factory-sealed contact blocks
- Popular with industrial end users
- UL (NEMA) Type 4, 4X, 12, 13
- NEC Class I Division 2 Groups B, C and D

## Product Selection

### M22 Assembled Control Stations



#### One Element Control Stations

| Orientation | Description   | Color | ①     | Inscription | Enclosure Cover Color | Catalog Number |
|-------------|---|-------|-------|-------------|-----------------------|----------------|
| Horizontal  | 40 mm mushroom head push-pull emergency stop operator                         | Red   | NC    | —           | Yellow                | M22-C1-M1H     |
| Horizontal  | 40 mm illuminated mushroom head push-pull emergency stop operator, 85–264 Vac | Red   | NO-NC | —           | Yellow                | M22-C1-M2H     |
| Horizontal  | 40 mm mushroom head twist-to-release emergency stop operator                  | Red   | NC    | —           | Yellow                | M22-C1-M3H     |
| Horizontal  | 40 mm mushroom head key-release emergency stop operator                       | Red   | NC    | —           | Yellow                | M22-C1-M4H     |
| Horizontal  | Flush pushbutton  | Green | NO    | ①           | Gray                  | M22-C1-M5H     |
| Horizontal  | Flush pushbutton  | Green | NO    | START       | Gray                  | M22-C1-M6H     |
| Horizontal  | Extended pushbutton   | Red   | NC    | ⊙           | Gray                  | M22-C1-M7H     |
| Horizontal  | Extended pushbutton   | Red   | NC    | STOP        | Gray                  | M22-C1-M8H     |
| Horizontal  | Key-operated selector switch, two-position maintained                         | —     | NO    | OFF-ON      | Gray                  | M22-C1-M9H     |
| Horizontal  | Knob type selector switch, three-position maintained                          | —     | 2NO   | HAND 0 AUTO | Gray                  | M22-C1-M10H    |
| Horizontal  | Double pushbutton   | Green | NO    | START       | Gray                  | M22-C1-M11H    |
|             |   | Red   | NC    | STOP        |                       |                |

#### Two Element Control Stations

| Orientation | Element 1 Description | Color | ①  | Inscription | Element 2 Description | Color | ①  | Inscription | Enclosure Cover Color | Catalog Number |
|-------------|-----------------------|-------|----|-------------|-----------------------|-------|----|-------------|-----------------------|----------------|
| Horizontal  | Extended pushbutton   | Red   | NC | ⊙           | Flush pushbutton      | Green | NO | ①           | Gray                  | M22-C2-M1H     |
| Vertical    | Flush pushbutton      | Green | NO | START       | Extended pushbutton   | Red   | NC | STOP        | Gray                  | M22-C2-M2V     |
| Vertical    | Flush pushbutton      | Black | NO | FORWARD     | Flush pushbutton      | Black | NO | REVERSE     | Gray                  | M22-C2-M3V     |

#### Three Element Control Stations

| Orientation | Element 1 Description | Color | ①          | Inscription | Element 2 Description | Color | ①          | Inscription | Element 3 Description | Color | ①  | Inscription | Enclosure Cover Color | Catalog Number |
|-------------|-----------------------|-------|------------|-------------|-----------------------|-------|------------|-------------|-----------------------|-------|----|-------------|-----------------------|----------------|
| Horizontal  | Extended pushbutton   | Red   | NC         | ⊙           | Indicating light      | White | 85–264 Vac | —           | Flush pushbutton      | Green | NO | ①           | Gray                  | M22-C3-M1H     |
| Vertical    | Indicating light      | White | 85–264 Vac | —           | Flush pushbutton      | Green | NO         | START       | Extended pushbutton   | Red   | NC | STOP        | Gray                  | M22-C3-M2V     |
| Horizontal  | Flush pushbutton      | Green | NO         | ①           | Extended pushbutton   | Red   | NC         | ⊙           | Flush pushbutton      | Green | NO | Ⓜ           | Gray                  | M22-C3-M3H     |
| Vertical    | Flush pushbutton      | Black | NO         | OPEN        | Extended pushbutton   | Red   | NC         | STOP        | Flush pushbutton      | Black | NO | CLOSE       | Gray                  | M22-C3-M4V     |
| Vertical    | Flush pushbutton      | Black | NO         | FORWARD     | Flush pushbutton      | Red   | NC         | STOP        | Flush pushbutton      | Black | NO | REVERSE     | Gray                  | M22-C3-M5V     |
| Vertical    | Flush pushbutton      | Black | NO         | UP          | Flush pushbutton      | Red   | NC         | STOP        | Flush pushbutton      | Black | NO | DOWN        | Gray                  | M22-C3-M6V     |

#### Notes

For assembled control stations not found in this selection, please contact the Eaton Technical Resource Center at 1-877-ETN CARE (386-2273) or TRC@eaton.com.

① Contact block configuration.

**Commercial Control Stations**



**Key Specifications**

- 30.5 mm (10250T series) operators
- ASA 61 gray die-cast zinc enclosures
- Industrial grade
- UL® Type 4, 4X, 12, 13
- Single 3/4 in NPT conduit entrance
- Dimensions—in (mm)
  - Enclosure: 3.88 W x 4.00 H x 3.00 D (98.6 x 101.6 x 76.3)
  - Operator: 1.63 D (to enclosure) x 1.50 diameter (41.4 x 38.1)

**What is included?**

Eaton’s pre-assembled, enclosed emergency stop pushbutton stations include an operator, an enclosure, contact blocks and a variety of unique labels. Each label has white lettering on a red background indicating the function and red lettering on a white background indicating the operator type.

**Available Catalog Numbers**

| Catalog Number <sup>①</sup> | Operator  | Enclosure Color | Label                           |
|-----------------------------|-----------|-----------------|---------------------------------|
| 10250T5B62-S101             | Push-Pull | Gray            | EMERGENCY STOP                  |
| 10250T5B62-S102             | Push-Pull | Gray            | EMERGENCY SHUT-OFF              |
| 10250T5B62-S103             | Push-Pull | Gray            | EMERGENCY GENERATOR STOP        |
| 10250T5B62-S104             | Push-Pull | Gray            | EMERGENCY HVAC SHUT-DOWN        |
| 10250T5B62-S105             | Push-Pull | Gray            | EMERGENCY ELECTRICAL DISCONNECT |
| 10250T5B62-S106             | Push-Pull | Gray            | EMERGENCY BOILER SHUT-DOWN      |
| 10250T5B62-S107             | Push-Pull | Gray            | EMERGENCY CHILLER STOP          |
| 10250T5B62-S108             | Push-Pull | Gray            | EMERGENCY FUEL SHUT-OFF         |
| 10250T5B62-S109             | Push-Pull | Gray            | EMERGENCY REFRIGERATION STOP    |
| 10250T5B62-S110             | Push-Pull | Gray            | EMERGENCY POWER OFF             |
| 10250T5B62-S111             | Push-Pull | Gray            | EMERGENCY GAS SHUT-OFF          |
| 10250T5B62-S112             | Push-Pull | Gray            | EMERGENCY VENTILATION SHUT-DOWN |
| 10250T5B62-S113             | Push-Pull | Gray            | GENERATOR                       |

**Additional Contact Blocks**

(Sold Separately)





















| Catalog Number | Circuit Configuration |
|----------------|-----------------------|
| 10250T51       | 1NC                   |
| 10250T53       | 1NO                   |
| 10250T1        | NO-NC                 |
| 10250T3        | 2NC                   |
| 10250T2        | 2NO                   |

**Note**

① Includes 1NO-1NC contact block.

## General Purpose Control Stations

### Type N Control Stations—UL (NEMA) Type 1

|   | Contact Symbol  | Button Type/Color                         | Legends           | Catalog Number      |
|---|---|---|-------------------|---------------------|
| <b>Single Button Station for Padlock Attachment Padlock attachment</b><br> | <b>One Element Enclosure Type</b>   |   |                   |                     |
|   |    | Flush/green                               | START             | <b>10250H5100</b>   |
|   |    | Flush/red                                 | STOP              | <b>10250H5101</b>   |
|   |    | Extended/red                              | STOP              | <b>10250H5104</b>   |
|   |    | Palm operated/black                       | None              | <b>10250H89</b> ②   |
| <b>Selector Switch</b><br>   |    | Three-position selector switch/black knob | RUN/OFF/AUTO      | <b>10250H289</b> ②  |
|   | <b>Two Element Enclosure Type</b>   |   |                   |                     |
| <b>Two Button Station</b><br>   |    | Flush/red                                 | START/STOP        | <b>10250H5200</b>   |
|   |    | Flush/green extended/red                  | START/STOP        | <b>10250H5207</b>   |
|   |  | Flush/black (all)                         | RAISE/LOWER       | <b>10250H5201</b>   |
|   |   |   | FOR/REV           | <b>10250H5202</b>   |
|   |   |   | OPEN/CLOSE        | <b>10250H5203</b>   |
|   |   |   | UP/DOWN           | <b>10250H5204</b>   |
|   |   |   | HIGH/LOW          | <b>10250H5205</b>   |
|   |   | FAST/SLOW                                 | <b>10250H5208</b> |                     |
| <b>Three Button Station</b><br>  | <b>Three Element Enclosure Type</b>   |   |                   |                     |
|   |  | Flush/black (all)                         | FOR/REV/STOP      | <b>10250H5300</b>   |
|   |  |   | UP/DOWN/STOP      | <b>10250H5301</b>   |
|   |  |   | RAISE/LOWER/STOP  | <b>10250H5302</b>   |
|   |   |   | OPEN/CLOSE/STOP   | <b>10250H5303</b>   |
|   | FAST/SLOW/STOP  |   | <b>10250H5304</b> |                     |
| <b>Three Button Station with Indicating Light</b><br>                    |  | 110/220V neon indicating light            | START/STOP        |                     |
|   |  | Clear—flush/green; flush/red              |                   | <b>10250H5310</b>   |
|   |  | Red—flush/green; flush/red                |                   | <b>10250ED853</b>   |
|   |  | Amber—flush/green; flush/red              |                   | <b>10250ED853-2</b> |

#### Notes

- ① Padlock attachment (10250H5110) must be purchased separately.
- ② Round button.

### Type N Control Stations—Open Type Construction (No Cover)

| Contact Symbol                    | Button Type/Color                         | Legends      | Catalog Number    |
|-----------------------------------|---|--------------|-------------------|
| <b>Selector Switch</b>            |   |              |                   |
| <b>One Element Enclosure Type</b> |   |              |                   |
|                                   | Three-position selector switch/black knob | RUN/OFF/AUTO | <b>10250H2538</b> |
| <b>Two Button Station</b>         |   |              |                   |
| <b>Two Element Enclosure Type</b> |   |              |                   |
|                                   | Flush/green                               | START/STOP   | <b>10250H2747</b> |
|                                   | Flush/black (all) mech. interlocked       | None ①       | <b>10250H2544</b> |

### Special Purpose Control Stations

#### Special Purpose Control Stations—UL (NEMA) Type 3, 3R, 4, 4X, 13

| Contact Symbol                     | Feature             | Legends    | Catalog Number    |
|------------------------------------|---------------------|------------|-------------------|
| <b>10250H_</b>                     |                     |            |                   |
| <b>One Element Pushbutton Type</b> |                     |            |                   |
|                                    | Flush               | START      | <b>10250H2738</b> |
|                                    |                     | STOP       | <b>10250H658</b>  |
|                                    | With lock hasp      | STOP       | <b>10250H665</b>  |
| <b>10250H_</b>                     |                     |            |                   |
| <b>Two Element Pushbutton Type</b> |                     |            |                   |
|                                    | Flush               | START/STOP | <b>10250H364</b>  |
|                                    | With lock hasp      | START/STOP | <b>10250H671</b>  |
|                                    | Buttons interlocked | FAST/SLOW  | <b>10250ED664</b> |
|                                    |                     | FOR/REV    | <b>10250H2740</b> |
|                                    |                     | UP/DOWN    | <b>10250H2741</b> |
|                                    |                     | OPEN/CLOSE | <b>10250H2742</b> |



**Note**

① No legend on buttons. Specify any standard legend.







#### 10250H Series Heavy-Duty Control Stations

##### Type H Control Stations—UL (NEMA) Type 3, 3S, 4, 4X, 12, 13

| Element Type   | Feature        | Circuit                                     | Assembled Legend Plate | Unassembled Alternate Legend Plate | Catalog Number                                 |                   |
|--|----------------|---|------------------------|------------------------------------|--|-------------------|
| <b>10250H_ One Element</b>   |                |   |                        |                                    |  |                   |
|   | Pushbuttons    | Without padlock hasp                        | 1NO-1NC                | JOG                                | START<br>STOP<br>RUN                           | <b>10250H1881</b> |
|  |                | With padlock hasp                           | 1NC                    | STOP                               | —  | <b>10250H4239</b> |
| Knob selector switch   | Two-position   | 1NO-1NC                                     | OFF/ON                 | —                                  | <b>10250H4526</b>                              |                   |
|  | Three-position | 1NO-1NC                                     | MAN/OFF/AUTO           | —                                  | <b>10250H4527</b>                              |                   |
| <b>10250H_ Two Element</b>   |                |   |                        |                                    |  |                   |
|   | Pushbuttons    | Standard                                    | 1NO-2NC                | START/STOP                         | —  | <b>10250H1884</b> |
|  |                |   | 2NO-2NC                | RAISE/LOWER                        | FORWARD<br>REVERSE<br>OPEN<br>CLOSE            | <b>10250H1885</b> |
|  |                | Standard and standard with padlock hasp     | 1NO-2NC                | START/STOP                         | —  | <b>10250H4240</b> |
| <b>10250H_ Three Element</b>   |                |   |                        |                                    |  |                   |
|  | Pushbuttons    | Standard                                    | 2NO-3NC                | FOR/REV/STOP                       | START    OPEN                                  | <b>10250H1890</b> |
|  |                | Two standard and standard with padlock hasp |                        |                                    | JOG    CLOSE<br>RAISE    FAST<br>LOWER    SLOW | <b>10250H4241</b> |
| Indicating light and pushbuttons   | 120V           | Light-red lens and two plain                | 1NO-2NC                | MOTOR RUNNING START/STOP           | —  | <b>10250H1913</b> |

### 10250T Series Heavy-Duty 30.5 mm Control Stations

#### Complete Assembled Stations—UL (NEMA) Type 4, 4X, 12, 13

| Element Type <sup>①</sup>   | Features  | Contact Block(s)                              | Legend           | Surface Mounting Catalog Number | Flush Mounting <sup>②</sup> Catalog Number |                   |
|---|---|---|------------------|---------------------------------|--|-------------------|
| <b>Break Glass Station</b>  |   |   |                  |                                 |  |                   |
|    | Break glass station <sup>③</sup>                    | Gray enclosure                                | NC (logic level) | EMERG. OFF                      | <b>10250TGS</b>                            | —                 |
|   |   | Red enclosure                                 |                  |                                 | <b>10250TGR</b>                            | —                 |
| <b>One Element</b>  |   |   |                  |                                 |  |                   |
|    | Pushbutton  | Standard                                      | NO-NC            | START                           | <b>10250T3516</b>                          | <b>10250T3573</b> |
|   |   |   | NC               | STOP                            | <b>10250T3518</b>                          | <b>10250T3575</b> |
|   |   |   | NO-NC            | None                            | <b>10250T3540</b>                          | <b>10250T3597</b> |
|   |   | Mushroom head                                 | NO-NC            | START                           | <b>10250T3517</b>                          | <b>10250T3574</b> |
|   |   | NC  | STOP             | <b>10250T3519</b>               | <b>10250T3576</b>                          |                   |
|   |   | With lock hasp <sup>④</sup>                   | NC               | STOP                            | <b>10250T3520</b>                          | <b>10250T3577</b> |
|   | Selector switch                                     | Two-position black knob                       | NO-NC            | OFF/ON                          | <b>10250T3523</b>                          | <b>10250T3580</b> |
|   |   | Three-position black knob                     | 2NO              | MAN/OFF/AUTO                    | <b>10250T3524</b>                          | <b>10250T3581</b> |
| Push-pull three-position  | Momentary red button                                | 2NC   | START/STOP       | <b>10250T3545</b>               | <b>10250T3602</b>                          |                   |
| <b>Two Element</b>  |   |   |                  |                                 |  |                   |
|   | Pushbuttons   | Standard                                      | 1NO-2NC          | START/STOP                      | <b>10250T3525</b>                          | <b>10250T3582</b> |
|   |   |   | 2NO-2NC          | RAISE/LOWER                     | <b>10250T3672</b>                          | <b>10250T3673</b> |
|   |   |   | 2NO-2NC          | None                            | <b>10250T3541</b>                          | <b>10250T3598</b> |
|   |   | With lock hasp <sup>④</sup>                   | 1NO-2NC          | START/STOP                      | <b>10250T3542</b>                          | <b>10250T3599</b> |
|   |   | Standard and mushroom head                    | 1NO-2NC          | START/STOP                      | <b>10250T3526</b>                          | <b>10250T3583</b> |
|   |   | Standard with maintained contact <sup>⑤</sup> | NO-NC<br>Plus NC | START/STOP                      | <b>10250T3528</b>                          | <b>10250T3585</b> |
| <b>Three Element</b>  |   |   |                  |                                 |  |                   |
|  | Pushbuttons   | Standard                                      | 2NO-3NC          | FOR, REV, STOP                  | <b>10250T3532</b>                          | <b>10250T3589</b> |
|   |   |   | 2NO-3NC          | UP, DOWN, STOP                  | <b>10250T3615</b>                          | —                 |
|   |   |   | 2NO-3NC          | OPEN, CLOSE, STOP               | <b>10250T3614</b>                          | —                 |
|   |   |   | 2NO-3NC          | None, None, STOP                | <b>10250T3543</b>                          | <b>10250T3600</b> |
|   |   | Two standard and with lock hasp               | 2NO-3NC          | None, None, STOP                | <b>10250T3544</b>                          | <b>10250T3601</b> |
|   | Indicating light (transformer type) and pushbuttons | Red lens — 120V                               | 1NO-2NC          | MOTOR RUN, START/STOP           | <b>10250T3536</b>                          | <b>10250T3593</b> |
|   |   | Red lens — 240V                               |                  |                                 | <b>10250T3537</b>                          | <b>10250T3594</b> |
|   |   | Red lens — 480V                               |                  |                                 | <b>10250T3538</b>                          | <b>10250T3595</b> |
| Red lens — 600V   |   |   |                  | <b>10250T3539</b>               | <b>10250T3596</b>                          |                   |

#### Break Glass Operator <sup>⑥</sup>



#### Break Glass Kit











| Description                               | Catalog Number  |
|---|-----------------|
| Operator with hammer and five glass discs | <b>10250TBG</b> |
| Glass discs only (5)                      | <b>10250TGL</b> |

#### Notes

- ① Stop buttons are red—all others are black.
- ② NEMA 4–13, if properly mounted on a flat surface. Consists of front plate, legend, operator and contact blocks.
- ③ Break glass stations will not function with Normally Open contact blocks.
- ④ Lock is 10250TA2.
- ⑤ Uses deep cover instead of shallow cover. Switch component is 10250TA67—mechanically interlocked operators.
- ⑥ Shown assembled to contact block (contact block supplied separately).

#### Class I Division 2 10250T Series Heavy-Duty 30.5 mm Control Stations

#### Complete Assembled Stations— UL (NEMA) Type 4, 4X, 12, 13; NEC Class I Division 2, Groups B, C and D

| Contact Symbol  | Button Type/Color                 | Legend Marking                  | Die Cast Enclosure Catalog Number | Polyester Molded Enclosure Catalog Number | Stainless Steel Enclosure Catalog Number |
|---|-----------------------------------|---------------------------------|-----------------------------------|---|--|
| <b>10250T7007</b>   |                                   |                                 |                                   |   |  |
| <b>Single Pushbutton</b>  |                                   |                                 |                                   |   |  |
|    | Flush/green                       | START                           | 10250T7003                        | 10250T7003P                               | 10250T7003S                              |
|    | Extended/red                      | STOP                            | 10250T7005                        | 10250T7005P                               | 10250T7005S                              |
|   | Alum. jumbo mushroom/red          | EMER. STOP<br>(engraved button) | 10250T7007                        | 10250T7007P                               | 10250T7007S                              |
|   | Flush/black                       | No legend                       | 10250T7009                        | 10250T7009P                               | 10250T7009S                              |
| <b>10250T7023P</b>  |                                   |                                 |                                   |   |  |
| <b>Two Pushbuttons</b>  |                                   |                                 |                                   |   |  |
|    | Flush/green                       | START                           | 10250T7023                        | 10250T7023P                               | 10250T7023S                              |
|    | Extended/red                      | STOP                            |                                   |   |  |
| Each Button   | Flush/black                       | No legend                       | 10250T7025                        | 10250T7025P                               | 10250T7025S                              |
|   | Flush/black                       | No legend                       |                                   |   |  |
| <b>10250T7033S</b>  |                                   |                                 |                                   |   |  |
| <b>Single Pilot Light—Two Pushbuttons</b>   |                                   |                                 |                                   |   |  |
|    | 120 Vac red                       | No legend                       | 10250T7033                        | 10250T7033P                               | 10250T7033S                              |
|    | Flush/green                       | START                           |                                   |   |  |
|    | Extended/red                      | STOP                            |                                   |   |  |
| Each Button   | 120 Vac red                       | No legend                       | 10250T7035                        | 10250T7035P                               | 10250T7035S                              |
|   | Flush/black                       |                                 |                                   |   |  |
|   | Flush/black                       |                                 |                                   |   |  |
| <b>Three-Position Selector Switch</b>   |                                   |                                 |                                   |   |  |
|  | Maintained knob/black             | HAND/OFF/AUTO                   | 10250T7011                        | 10250T7011P                               | 10250T7011S                              |
|  | Maintained knob/black             | No legend                       | 10250T7013                        | 10250T7013P                               | 10250T7013S                              |
| <b>Single Pushbutton Maintained</b>   |                                   |                                 |                                   |   |  |
|  | Push-pull with jumbo mushroom/red | EMER. STOP<br>(engraved button) | 10250T7019                        | 10250T7019P                               | 10250T7019S                              |
| Pull  | O                                 | X                               |                                   |   |  |
| Push  | X                                 | O                               |                                   |   |  |
|   |                                   |                                 |                                   |   |  |

### Class I Division 2 E34 Series Corrosion Resistant 30.5 mm Control Stations

E34EX\_



#### Complete Assembled Stations— UL (NEMA) Type 4, 4X, 12, 13; NEC Class I Division 2, Groups B, C and D

| Contact Symbol                        | Button Type/Color                 | Legend Marking                  | Die Cast Enclosure Catalog Number | Polyester Molded Enclosure Catalog Number | Stainless Steel Enclosure Catalog Number |
|---------------------------------------|-----------------------------------|---------------------------------|-----------------------------------|---|--|
| <b>Single Pushbutton</b>              |                                   |                                 |                                   |   |  |
| 1NO                                   | Flush/green                       | START                           | E34EX7003                         | E34EX7003P                                | E34EX7003S                               |
| 1NC                                   | Extended/red                      | STOP                            | E34EX7005                         | E34EX7005P                                | E34EX7005S                               |
|                                       | Alum. jumbo mushroom/red          | EMER. STOP<br>(engraved button) | E34EX7007                         | E34EX7007P                                | E34EX7007S                               |
|                                       | Flush/black                       | No legend                       | E34EX7009                         | E34EX7009P                                | E34EX7009S                               |
| <b>Two Pushbuttons</b>                |                                   |                                 |                                   |   |  |
| 1NO                                   | Flush/green                       | START                           | E34EX7023                         | E34EX7023P                                | E34EX7023S                               |
| 1NC                                   | Extended/red                      | STOP                            |                                   |   |  |
| Each Button                           | Flush/black                       | No legend                       | E34EX7025                         | E34EX7025P                                | E34EX7025S                               |
|                                       | Flush/black                       | No legend                       |                                   |   |  |
| <b>Three-Position Selector Switch</b> |                                   |                                 |                                   |   |  |
| 2NO                                   | Maintained knob/black             | HAND/OFF/AUTO                   | E34EX7011                         | E34EX7011P                                | E34EX7011S                               |
| 2NC                                   | Maintained knob/black             | No legend                       | E34EX7013                         | E34EX7013P                                | E34EX7013S                               |
| <b>Single Pushbutton Maintained</b>   |                                   |                                 |                                   |   |  |
| Pull Push<br>O X 1NO<br>X O 1NC       | Push-pull with jumbo mushroom/red | EMER. STOP<br>(engraved button) | E34EX7019                         | E34EX7019P                                | E34EX7019S                               |

## Accessories

Padlock Attachment



#### Type N Control Stations

| Description  | Catalog Number |
|--|----------------|
| Padlock attachment—For field assembly on square button type (except extended button types) | 10250H5110     |

**Note**

Use NEMA 4X 10250T operators where exposed to ultraviolet light, see **Page V7-T1-22**.

#### 1 Custom Assembled Stations Specification Form

##### Ordering Instructions

###### Step 1

Copy this ordering guide from catalog.

###### Step 2

Specify 10250T or E34 pushbutton lines in the corresponding box on the following page.

|                                  |  |
|----------------------------------|--|
| 10250T                           | <b>Pages</b><br>V7-T1-182 to V7-T1-253 |
| E34                              | <b>Pages</b><br>V7-T1-254 to V7-T1-295 |
| 10250T and E34<br>Class I Div. 2 | <b>Pages</b><br>V7-T1-321 to V7-T1-361 |

###### Step 3

Check back of panel dimensions—specify single or double depth enclosure in the corresponding box on the following page.

###### Step 4

Specify enclosure catalog number and price in the corresponding box on the following page. Enclosures can be found on **Pages V7-T1-116, V7-T1-233 and V7-T1-283**. For pricing, reference the most recent PAD or VISTA-line.

###### Step 5

Specify catalog numbers for desired operator, legend plate, light unit, accessory and contact block(s) for each location in the enclosure in the corresponding box on the following page. (See position locations on this page.)

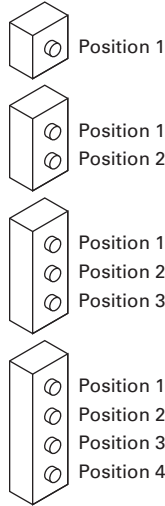

##### Position Locations

###### Step 6

For non-standard legends, specify legend desired, letter size and location on the layout sketches on the following page. For limitations see **Page V7-T1-232**. For pricing, use the blank legend catalog number and "STAMP" Suffix (Ex.: **10250TS36STAMP**) and reference the most recent PAD or VISTA-line.

Example: 10250TS36

Special Legend for Position # \_\_\_\_\_

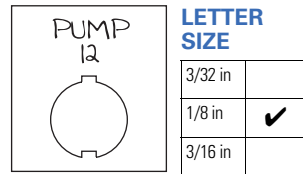

###### Step 7

Fax Sheet 2 of this form to Eaton's TRC, Technical Resource Center, at 828-651-0549 to the attention of—**Custom Stations Order** or email to TRC@eaton.com.

Within a few days you will receive a confirmation fax with the custom station part number and price.

###### Step 8

Place your order over the VISTA System.

##### For Selector and Roto-Push Operators

###### 10250T or E34

For single contact blocks or 1NO-1NC contact blocks, the mounting position of contacts must be specified. For example: If a 1NO-1NC contact block is required, specify if NO is to be mounted in Top A position or Bottom B position.



To — **Eaton's TRC, Custom Station Order**  
**(828) 651-0549 FAX, or email to TRC@eaton.com**

| FACTORY USE ONLY |  |
|------------------|--|
| Part Number      |  |
| Product Code     |  |
| Suffix           |  |
| Date             |  |
| Engineer         |  |

From — Customer Name \_\_\_\_\_  
 Customer Contact \_\_\_\_\_  
 Phone Number \_\_\_\_\_  
 Fax Number \_\_\_\_\_  
 Email Address \_\_\_\_\_

**Step 2)**

**10250T**    **STD**    **Class I Division 2**  
**E34**    **STD**    **Class I Division 2**

**Step 3)** ✓

|                        |  |
|------------------------|--|
| Single Depth Enclosure |  |
| Double Depth Enclosure |  |

**Step 4)**

| Enclosure Catalog Number | Price |
|--------------------------|-------|
|                          |       |

**Step 5)**

| Position | Operator | Price U.S. \$ | Light Unit | Price U.S. \$ | Contact Block | Price U.S. \$ | A/L | B/R | Contact Block | Price U.S. \$ | A/L | B/R | Total Price |
|----------|----------|---------------|------------|---------------|---------------|---------------|-----|-----|---------------|---------------|-----|-----|-------------|
| 1        |          |               |            |               |               |               |     |     |               |               |     |     |             |
| 2        |          |               |            |               |               |               |     |     |               |               |     |     |             |
| 3        |          |               |            |               |               |               |     |     |               |               |     |     |             |
| 4        |          |               |            |               |               |               |     |     |               |               |     |     |             |

| Position | Legend Plate | Price U.S. \$ | Lens or Caps | Price U.S. \$ | Accessory | Price U.S. \$ | Total Price |
|----------|--------------|---------------|--------------|---------------|-----------|---------------|-------------|
| 1        |              |               |              |               |           |               |             |
| 2        |              |               |              |               |           |               |             |
| 3        |              |               |              |               |           |               |             |
| 4        |              |               |              |               |           |               |             |

|               |
|---------------|
| <b>Total:</b> |
|               |

**10% Adder  
for Assembled Stations**

**Step 6) Non-standard Legends**

Special Legend for Position # \_\_\_\_\_

Special Legend for Position # \_\_\_\_\_

Special Legend for Position # \_\_\_\_\_

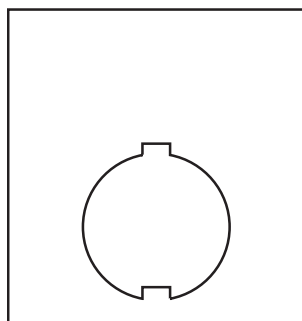

**LETTER SIZE** ✓

|                    |  |
|--------------------|--|
| 3/32 inch (2.4 mm) |  |
| 1/8 inch (3.2 mm)  |  |
| 3/16 inch (4.8 mm) |  |

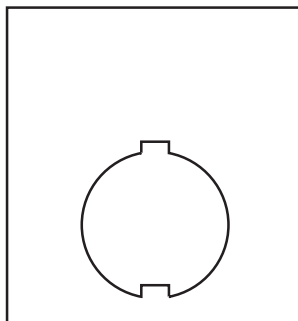

**LETTER SIZE** ✓

|                    |  |
|--------------------|--|
| 3/32 inch (2.4 mm) |  |
| 1/8 inch (3.2 mm)  |  |
| 3/16 inch (4.8 mm) |  |

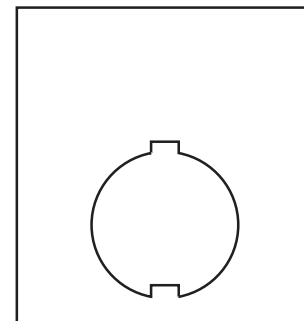

**LETTER SIZE** ✓

|                    |  |
|--------------------|--|
| 3/32 inch (2.4 mm) |  |
| 1/8 inch (3.2 mm)  |  |
| 3/16 inch (4.8 mm) |  |

#### 1

### Renewal Parts

#### Type N Renewal Parts

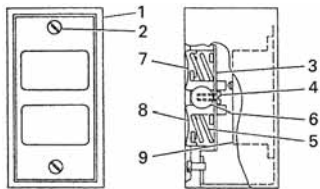

One and Two Element Station

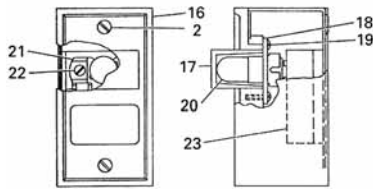

One Element Indicating Light

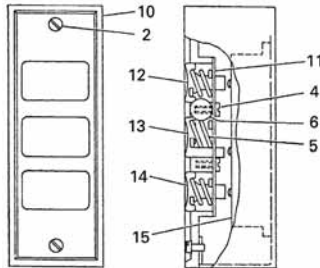

Three Element Station

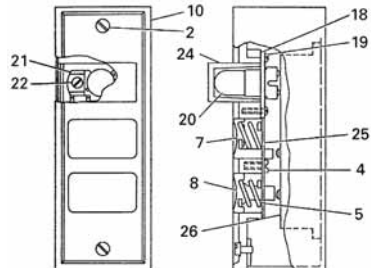

Two Element Station with Indicating Light



Open Type Two Element

#### Assembled Stations—Type N

| Item No.                     | Description                           | No. Req. | Part Number |
|------------------------------|---------------------------------------|----------|-------------|
| <b>Type N—Square Buttons</b> |                                       |          |             |
| 1                            | Cover                                 | 1        |             |
|                              | Two element                           |          | 49-3524     |
|                              | One element—top button                |          | 49-3524-2   |
|                              | One element—bottom button             |          | 49-3524-3   |
| 2                            | Cover screw                           | 2        | 11-2168     |
| 3                            | Pushbutton support bracket            | 1        | 79-6649     |
| 4                            | Pushbutton support bracket screw      | 1        | 11-2090     |
| 5                            | Pushbutton spring                     | 2        | 69-2571     |
| 6                            | Disc (when used—two element assembly) | 2        | 16-1960     |
| 7                            | Pushbutton—top position               | 1        |             |
|                              | START/green                           |          | 53-1169-3   |
|                              | RAISE/black                           |          | 53-1169-66  |
|                              | FORWARD/black                         |          | 53-1169-7   |
|                              | OPEN/black                            |          | 53-1169-9   |
|                              | UP/blank                              |          | 53-1169-11  |
|                              | Blank/green                           |          | 53-1169     |
| 8                            | Pushbutton—bottom position            | 1        |             |
|                              | STOP/red                              |          | 53-1202-2   |
|                              | Extended STOP/red                     |          | 53-1202-5   |
|                              | REVERSE/black                         |          | 53-1169-8   |
|                              | CLOSE/black                           |          | 53-1169-10  |
|                              | DOWN/black                            |          | 53-1169-12  |
|                              | LOWER/black                           |          | 53-1169-6   |
|                              | Blank/red                             |          | 53-1202     |

| Item No.                                | Description                | No. Req. | Part Number |
|---|----------------------------|----------|-------------|
| <b>Type N—Square Buttons, continued</b> |                            |          |             |
| 9                                       | Pushbutton element         | 1        |             |
|   | 1NO-1NC                    |          | 86-2588     |
|   | 2NO                        |          | 86-2588-2   |
|   | 1NO                        |          | 86-2588-3   |
|   | 1NC                        |          | 86-2588-4   |
| 10                                      | Cover                      | 1        | 49-3464     |
| 11                                      | Pushbutton support bracket | 1        | 79-6650     |
| 12                                      | Pushbutton—top position    | 1        |             |
|   | FORWARD/black              |          | 53-1170-7   |
|   | UP/black                   |          | 53-1170-4   |
|   | RAISE/black                |          | 53-1170-5   |
|   | OPEN/black                 |          | 53-1170-9   |
|   | FAST/black                 |          | 53-1170-6   |
| 13                                      | Pushbutton middle position | 1        |             |
|   | REVERSE/black              |          | 53-1169-15  |
|   | DOWN/black                 |          | 53-1169-18  |
|   | LOWER/black                |          | 53-1169-16  |
|   | CLOSE/black                |          | 53-1169-17  |
|   | SLOW/black                 |          | 53-1169-13  |
| 14                                      | Pushbutton—bottom position | 1        |             |
|   | STOP/red                   |          | 53-1201-2   |
| 15                                      | Pushbutton element         | 1        |             |
|   | 2NO-3NC                    |          | 86-2593     |
| 16                                      | Cover                      | 1        | 49-3524-4   |

### Assembled Stations—Type N, continued

| Item No.                                | Description                | No. Req. | Part Number |
|---|----------------------------|----------|-------------|
| <b>Type N—Square Buttons, continued</b> |                            |          |             |
| 17                                      | Lens                       | 1        |             |
|   | Clear                      |          | 28-494      |
|   | Red                        |          | 28-887-2    |
|   | Amber                      |          | 28-887-3    |
| 18                                      | Shield                     | 1        | 73-1337     |
| 19                                      | Shield screws              | 4        | 11-2012     |
| 20                                      | Lamp (neon NE48)           | 1        | 28-494      |
| 21                                      | Lamp receptacle            | 1        | 28-902      |
| 22                                      | Lamp receptacle screw      | 1        | 911-330F1   |
| 23                                      | Pilot light terminal base  | 1        | 86-2586     |
| 24                                      | Lens                       | 1        |             |
|   | Clear                      |          | 28-887      |
|   | Red                        |          | 28-887-2    |
|   | Amber                      |          | 28-887-3    |
| 25                                      | Pushbutton support bracket | 1        | 79-6650-2   |
| 26                                      | Pushbutton element         | 1        |             |
|   | 1NO-1NC                    |          | 86-2594     |

| Item No.                    | Description                          | No. Req. | Part Number |
|-----------------------------|--------------------------------------|----------|-------------|
| <b>Type N—Round Buttons</b> |                                      |          |             |
| Similar to 27               | Pushbutton assembly and element for: |          |             |
|                             | 10250H289                            | 1        | 10250H2538  |
|                             | 10250H364                            | 1        | 86-353      |
|                             | 10250H685                            | 1        | 86-353-8    |
|                             | 10250H665                            | 1        | 86-353-8    |
|                             | 10250H671                            | 1        | 86-353      |
|                             | 10250H2738                           | 1        | 86-353-3    |
|                             | 10250H2740                           | 1        | 86-356      |
|                             | 10250H2741                           | 1        | 86-356      |
|                             | 10250H2742                           | 1        | 86-356      |

### Type H Renewal Parts

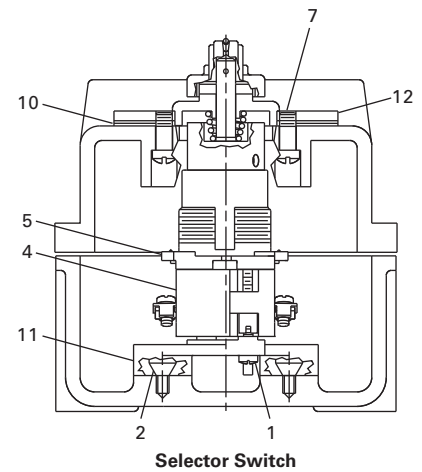
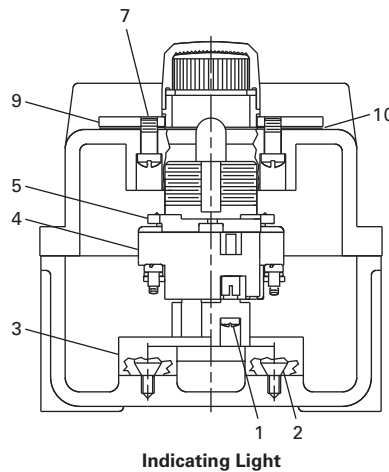
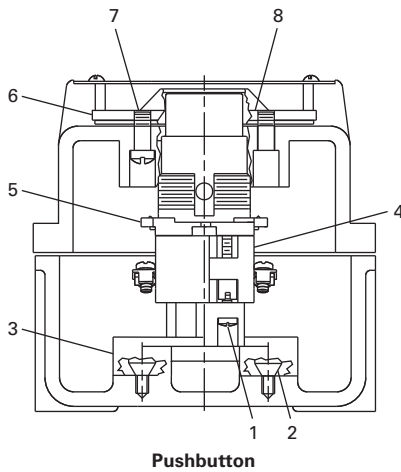

### Assembled Stations—Type H

| Item No.                         | Description     | No. Req.                         | Part Number |
|----------------------------------|-----------------|----------------------------------|-------------|
| <b>Type H—Assembled Stations</b> |                 |                                  |             |
| 1                                | Screw           | 2                                | 11-4654     |
| 2                                | Screw           | 2                                | 11-5719     |
| 3                                | Base            | 1                                | 17-16560    |
| 4                                | Contact blocks  | See Page V7-T1-235               |             |
| 5                                | 10250T operator | See Pages V7-T1-188 to V7-T1-225 |             |
| 6                                | Mounting plate  | 1                                | 17-19524    |

| Item No.                         | Description    | No. Req. | Part Number |
|----------------------------------|----------------|----------|-------------|
| <b>Type H—Assembled Stations</b> |                |          |             |
| 7                                | Screw          | 4        | 11-953      |
| 8                                | Diaphragm      | 1        | 32-253-2    |
| 9                                | Mounting plate | 1        | 17-19522    |
| 10                               | Gasket         | 1        | 32-254      |
| 11                               | Base           | 1        | 17-16561    |
| 12                               | Mounting plate | 1        | 17-19523    |



## Technical Data and Specifications

### Ratings

#### Maximum Ampere Ratings for Type N Control Stations

| Description                           | Volts AC |     |      |     | Volts DC |     |     |
|---------------------------------------|----------|-----|------|-----|----------|-----|-----|
|                                       | 110      | 220 | 440  | 550 | 120      | 240 | 600 |
| Make and emergency interrupt capacity | 30       | 15  | 7.5  | 6   | 1.0      | 0.5 | 0.1 |
| Normal load break                     | 3        | 1.5 | 0.75 | 0.6 | 1.0      | 0.5 | 0.1 |
| Continuous current                    | 10       | 10  | 10   | 10  | 10       | 10  | 10  |

#### Maximum Ampere Ratings for Type H Control Stations

| Description                           | Volts AC 50/60 Hz |      |      |      | Volts DC |      |
|---------------------------------------|-------------------|------|------|------|----------|------|
|                                       | 120               | 240  | 480  | 600  | 125      | 250  |
| Make and emergency interrupt capacity | 60                | 30   | 15   | 12   | 1.1      | 0.55 |
| Normal load break                     | 6                 | 3    | 1.5  | 1.2  | 1.1      | 0.55 |
| Continuous amperes                    | 10                | 10   | 10   | 10   | 10       | 10   |
| Voltamperes —                         |                   |      |      |      |          |      |
| Make and emergency interrupt capacity | 7200              | 7200 | 7200 | 7200 | 138      | 138  |
| Normal load break                     | 720               | 720  | 720  | 720  | 138      | 138  |

### Dimensions

Approximate Dimensions in Inches (mm)

#### Type N Control Stations

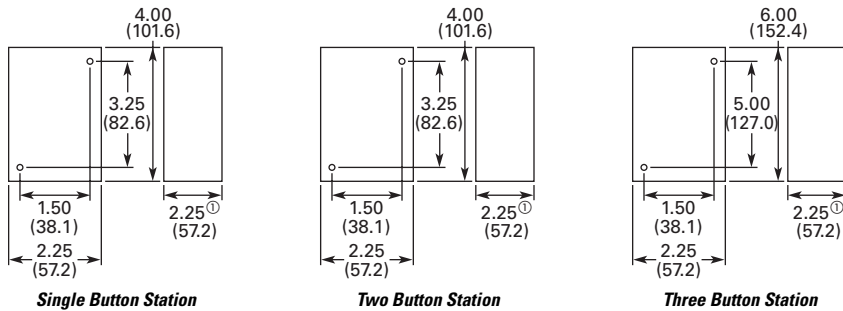

#### Special Purpose Control Stations

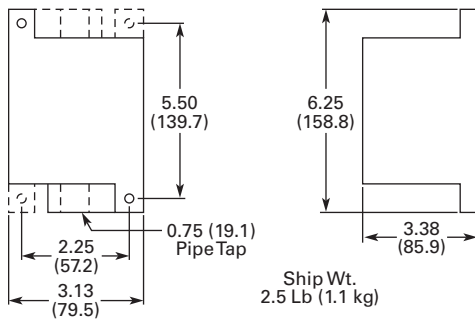

#### Note

⊙ 2.38 (60.5) for neon indicating light.

Approximate Dimensions in Inches (mm)

### Type H Control Stations

#### NEMA Type 3, 3R, 3S, 4, 4X, 13

| No. of Elements | Dimensions   |               |              |
|-----------------|--------------|---------------|--------------|
|                 | Wide         | High          | Deep         |
| 1 and 2         | 4.50 (114.3) | 8.25 (209.6)  | 4.50 (114.3) |
| 3               | 4.50 (114.3) | 10.75 (273.1) | 4.25 (108.0) |

### 10250T and E34

#### Approximate Enclosure Dimensions

| Number of Elements     | Surface Mounting Dimensions in In (mm) |               |             | Mounting D  | Mounting E    | Conduit Entrance |
|------------------------|--|---------------|-------------|-------------|---------------|------------------|
|                        | Wide A                                 | High B        | Deep C      |             |               |                  |
| <b>Cast</b>            |  |               |             |             |               |                  |
| 1                      | 3.88 (98.6)                            | 4.00 (101.6)  | 3.00 (76.3) | 2.69 (68.3) | 3.25 (82.6)   | 3/4              |
| 2                      | 3.88 (98.6)                            | 5.88 (149.4)  | 3.00 (76.3) | 2.69 (68.3) | 5.13 (130.3)  | 3/4              |
| 3                      | 3.88 (98.6)                            | 7.75 (196.9)  | 3.00 (76.3) | 2.69 (68.3) | 7.00 (177.8)  | 1                |
| 4                      | 33.88 (98.6)                           | 9.63 (244.6)  | 3.00 (76.3) | 2.69 (68.3) | 8.88 (225.6)  | 1                |
| <b>Polyester</b>       |  |               |             |             |               |                  |
| 1                      | 3.81 (96.8)                            | 6.63 (168.4)  | 3.38 (85.9) | 2.94 (74.7) | 4.88 (124.0)  | ①                |
| 2                      | 3.81 (96.8)                            | 6.63 (168.4)  | 3.38 (85.9) | 2.94 (74.7) | 4.88 (124.0)  | ①                |
| 3                      | 3.81 (96.8)                            | 8.88 (225.6)  | 3.38 (85.9) | 2.94 (74.7) | 7.13 (181.1)  | ①                |
| 4                      | 3.81 (96.8)                            | 6.63 (168.4)  | 3.38 (85.9) | 2.94 (74.7) | 4.88 (124.0)  | ①                |
| <b>Stainless Steel</b> |  |               |             |             |               |                  |
| 1                      | 3.00 (76.2)                            | 3.50 (88.9)   | 3.00 (76.2) | 1.50 (38.1) | 4.25 (108.0)  | ①                |
| 2                      | 3.50 (88.9)                            | 6.75 (171.5)  | 3.00 (76.2) | 1.50 (38.1) | 7.50 (190.5)  | ①                |
| 3                      | 3.50 (88.9)                            | 9.00 (228.6)  | 3.00 (76.2) | 1.50 (38.1) | 9.00 (228.6)  | ①                |
| 4                      | 3.50 (88.9)                            | 11.25 (285.8) | 3.00 (76.2) | 1.50 (38.1) | 12.00 (304.8) | ①                |

#### Note

① No conduit entrance holes provided. Drill as required.

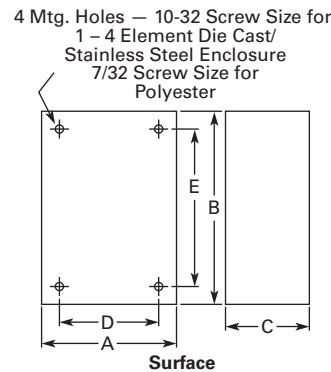

16.2 mm Pushbuttons—RMQ-16



### Contents

| <i>Description</i>   | <i>Page</i>     |
|--|-----------------|
| 16.2 mm Pushbuttons—RMQ-16   |                 |
| Product Selection Guide . . . . .                                  | <b>V7-T1-31</b> |
| Pushbuttons—Non-Illuminated and Illuminated . . . . .              | <b>V7-T1-32</b> |
| Indicating Lights . . . . .  | <b>V7-T1-34</b> |
| Emergency Stops . . . . .  | <b>V7-T1-35</b> |
| Selector Switches—Non-Illuminated, Illuminated and Keyed . . . . . | <b>V7-T1-36</b> |
| Accessories . . . . .  | <b>V7-T1-40</b> |
| Technical Data and Specifications . . . . .                        | <b>V7-T1-43</b> |
| Dimensions . . . . .   | <b>V7-T1-45</b> |

### Product Overview

#### Product Description

The RMQ-16 pushbutton line offers a wide array of functional and attractively designed illuminated and non-illuminated pushbuttons, selector switches, emergency stops and indicating lights. The illuminated line is offered with either incandescent or LED. RMQ-16 devices are designed with two front-of-panel operator sizes. The 18 x 18 mm or 25 x 25 mm square operators can help the user achieve over three times the information density compared with 22 mm ranges.

#### Features

- *Wide product breadth:* RMQ-16 offers illuminated and non-illuminated pushbuttons, keyed, non-keyed, and illuminated selector switches, emergency stops, and a large variety of accessories
- *Custom laser etching:* Hundreds of standard markings available in addition to infinite possible custom images with laser etching
- *High durability:* Pushbuttons and selector switches rated for 3 million mechanical operations
- *High information density:* Square operators (18 mm or 25 mm) allow for side-by-side mounting and achieve over three times the information density of typical 22 mm installations

#### Standards and Certifications

- UL Listed
- CSA Certified
- IEC/EN 60947-5 VDE-0660
- IP65



**Product Selection Guide**

**Pushbuttons**

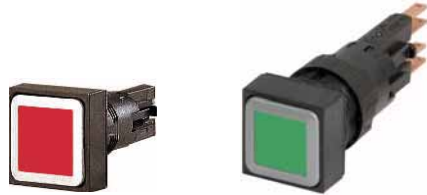

|                          |                      |                      |
|--------------------------|----------------------|----------------------|
| <b>Description</b>       | Non-Illuminated      | Illuminated          |
| <b>Product Selection</b> | <b>Page V7-T1-32</b> | <b>Page V7-T1-33</b> |

**Indicating Lights**



|                          |                      |                      |
|--------------------------|----------------------|----------------------|
| <b>Description</b>       | Flush                | Extended             |
| <b>Product Selection</b> | <b>Page V7-T1-34</b> | <b>Page V7-T1-34</b> |

**Emergency Stops**



|                          |                      |                      |
|--------------------------|----------------------|----------------------|
| <b>Description</b>       | Non-Illuminated      | Illuminated          |
| <b>Product Selection</b> | <b>Page V7-T1-35</b> | <b>Page V7-T1-35</b> |

**Selector Switches**



|                          |                      |                      |                      |
|--------------------------|----------------------|----------------------|----------------------|
| <b>Description</b>       | Non-Illuminated      | Illuminated          | Keyed                |
| <b>Product Selection</b> | <b>Page V7-T1-36</b> | <b>Page V7-T1-37</b> | <b>Page V7-T1-38</b> |

#### 1 Pushbuttons—Non-Illuminated and Illuminated

##### Catalog Number Selection

Catalog Number Selection is for illustrative purposes only and not to be used to create new catalog numbers.

##### Pushbuttons—Non-Illuminated and Illuminated

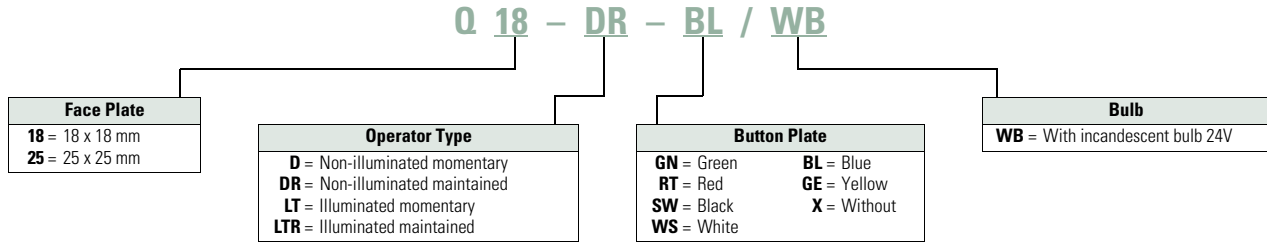

##### Product Selection

###### Non-Illuminated Pushbuttons

- Momentary or maintained
- Customizable laser etched pushbutton operators
- 18 mm or 25 mm square operator
- 3 million mechanical operations
- IEC/EN 60947-5
- IP65

###### Q18-D-GN



##### Non-Illuminated Pushbuttons

| Type       | Button Color | Catalog Number   |                  |
|------------|--------------|------------------|------------------|
|            |              | 18 x 18 mm       | 25 x 25 mm       |
| Momentary  | Green        | <b>Q18D-GN</b>   | <b>Q25D-GN</b>   |
|            | Red          | <b>Q18D-RT</b>   | <b>Q25D-RT</b>   |
|            | Black        | <b>Q18D-SW</b>   | <b>Q25D-SW</b>   |
|            | White        | <b>Q18D-WS</b>   | <b>Q25D-WS</b>   |
|            | Blue         | <b>Q18D-BL</b>   | <b>Q25D-BL</b>   |
|            | Yellow       | <b>Q18D-GE</b>   | <b>Q25D-GE</b>   |
|            | Without      | <b>Q18D-X</b> ①  | <b>Q25D-X</b> ①  |
| Maintained | Green        | <b>Q18DR-GN</b>  | <b>Q25DR-GN</b>  |
|            | Red          | <b>Q18DR-RT</b>  | <b>Q25DR-RT</b>  |
|            | Black        | <b>Q18DR-SW</b>  | <b>Q25DR-SW</b>  |
|            | White        | <b>Q18DR-WS</b>  | <b>Q25DR-WS</b>  |
|            | Blue         | <b>Q18DR-BL</b>  | <b>Q25DR-BL</b>  |
|            | Yellow       | <b>Q18DR-GE</b>  | <b>Q25DR-GE</b>  |
|            | Without      | <b>Q18DR-X</b> ① | <b>Q25DR-X</b> ① |

###### Note

① To order separate button plates, see **Page V7-T1-42**.

### Illuminated Pushbuttons

- Momentary or maintained
- LED or incandescent
- 18 mm or 25 mm square operator
- 3 million mechanical operations
- IEC/EN 60947-5
- IP65

#### Q18-LT-GE



### Illuminated Pushbuttons Without Bulb <sup>①</sup>

| Type       | Button Color | Catalog Number <sup>②</sup> |                  |
|------------|--------------|-----------------------------|------------------|
|            |              | 18 x 18 mm                  | 25 x 25 mm       |
| Momentary  | Green        | <b>Q18LT-GN</b>             | <b>Q25LT-GN</b>  |
|            | Red          | <b>Q18LT-RT</b>             | <b>Q25LT-RT</b>  |
|            | Black        | <b>Q18LT-SW</b>             | <b>Q25LT-SW</b>  |
|            | White        | <b>Q18LT-WS</b>             | <b>Q25LT-WS</b>  |
|            | Blue         | <b>Q18LT-BL</b>             | <b>Q25LT-BL</b>  |
|            | Yellow       | <b>Q18LT-GE</b>             | <b>Q25LT-GE</b>  |
| Maintained | Green        | <b>Q18LTR-GN</b>            | <b>Q25LTR-GN</b> |
|            | Red          | <b>Q18LTR-RT</b>            | <b>Q25LTR-RT</b> |
|            | Black        | <b>Q18LTR-SW</b>            | <b>Q25LTR-SW</b> |
|            | White        | <b>Q18LTR-WS</b>            | <b>Q25LTR-WS</b> |
|            | Blue         | <b>Q18LTR-BL</b>            | <b>Q25LTR-BL</b> |
|            | Yellow       | <b>Q18LTR-GE</b>            | <b>Q25LTR-GE</b> |

#### Notes

<sup>①</sup> To order with incandescent 24V bulb, insert a **/WB** at the end of the catalog number. Example, Q18LT-GN/**WB**.

<sup>②</sup> For a complete selection of incandescent 24V bulbs and LEDs, see **Page V7-T1-40**.

#### 1

### Indicating Lights

#### Catalog Number Selection

Catalog Number Selection is for illustrative purposes only and not to be used to create new catalog numbers.

#### Indicating Lights—Flush and Extended

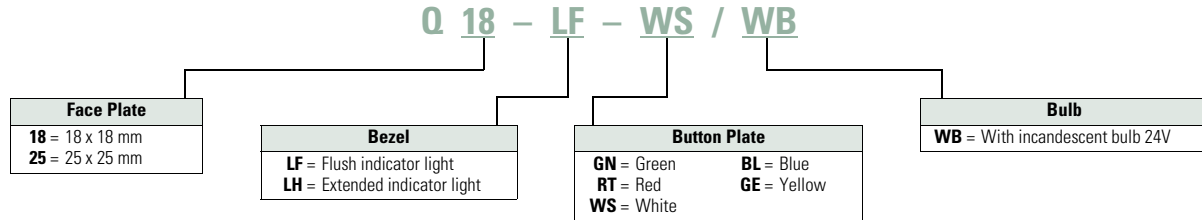



#### Product Selection

##### Indicating Lights

- LED or incandescent
- Flush and extended lenses
- 18 mm or 25 mm square operator
- 3 million mechanical operations
- IEC/EN 60947-5
- IP65

#### Indicating Lights Without Bulb <sup>①</sup>

|   | Type     | Button Color | Catalog Number <sup>②</sup> |                 |
|---|----------|--------------|-----------------------------|-----------------|
|   |          |              | 18 x 18 mm                  | 25 x 25 mm      |
| <b>Q18-LF-GE</b><br>  | Flush    | Green        | <b>Q18LF-GN</b>             | <b>Q25LF-GN</b> |
|   |          | Red          | <b>Q18LF-RT</b>             | <b>Q25LF-RT</b> |
|   |          | White        | <b>Q18LF-WS</b>             | <b>Q25LF-WS</b> |
|   |          | Blue         | <b>Q18LF-BL</b>             | <b>Q25LF-BL</b> |
|   |          | Yellow       | <b>Q18LF-GE</b>             | <b>Q25LF-GE</b> |
| <b>Q18-LH-BL</b><br> | Extended | Green        | <b>Q18LH-GN</b>             | <b>Q25LH-GN</b> |
|   |          | Red          | <b>Q18LH-RT</b>             | <b>Q25LH-RT</b> |
|   |          | White        | <b>Q18LH-WS</b>             | <b>Q25LH-WS</b> |
|   |          | Blue         | <b>Q18LH-BL</b>             | <b>Q25LH-BL</b> |
|   |          | Yellow       | <b>Q18LH-GE</b>             | <b>Q25LH-GE</b> |

#### Notes

- <sup>①</sup> To order with incandescent 24V bulb, insert a /WB at the end of the catalog number. Example, Q18-LF-GN/WB.  
<sup>②</sup> For a complete selection of incandescent 24V bulbs and LEDs, see **Page V7-T1-40**.

### Emergency Stops

#### Catalog Number Selection

Catalog Number Selection is for illustrative purposes only and not to be used to create new catalog numbers.

#### Emergency Stops—Non-Illuminated and Illuminated

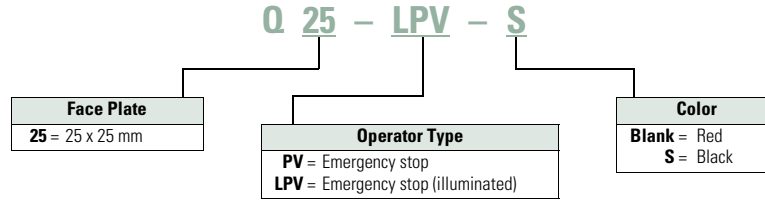

### Product Selection

#### Emergency Stops

- Push/pull operation
- Illuminated or non-illuminated
- Emergency stop (red) or Machine stop (black) available
- Suitable for use in safety applications
- IEC/EN 60947-5
- IP65

#### Q25PV



#### Emergency Stops—Non-Illuminated

| Button Color | Catalog Number |
|--------------|----------------|
| Red          | <b>Q25PV</b>   |
| Black        | <b>Q25PV-S</b> |

#### Q25LPV



#### Emergency Stops—Illuminated <sup>①</sup>

| Button Color | Catalog Number  |
|--------------|-----------------|
| Red          | <b>Q25LPV</b>   |
| Black        | <b>Q25LPV-S</b> |

#### Note

<sup>①</sup> Includes built-in multiple LED 24 Vdc.



#### 1

### Selector Switches—Non-Illuminated, Illuminated and Keyed

#### Catalog Number Selection

Catalog Number Selection is for illustrative purposes only and not to be used to create new catalog numbers.

#### Selector Switches—Non-Illuminated

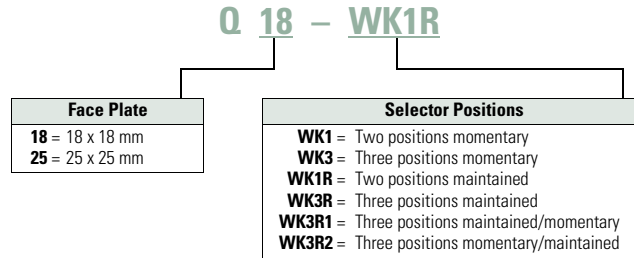

#### Product Selection

##### Non-Illuminated Selector Switches

- Momentary or maintained
- 18 mm or 25 mm square operator
- VS Anti-rotation feature
- 3 million mechanical operations
- IP65

**Q18WK1**



#### Selector Switches—Non-Illuminated

| Function             | Position | Switch Position | Catalog Number  |                 |
|----------------------|----------|-----------------|-----------------|-----------------|
|                      |          |                 | 18 x 18 mm      | 25 x 25 mm      |
| Momentary            | 2        |                 | <b>Q18WK1</b>   | <b>Q25WK1</b>   |
| Maintained           |          |                 | <b>Q18WK1R</b>  | <b>Q25WK1R</b>  |
| Momentary            | 3        |                 | <b>Q18WK3</b>   | <b>Q25WK3</b>   |
| Maintained           |          |                 | <b>Q18WK3R</b>  | <b>Q25WK3R</b>  |
| Maintained/momentary |          |                 | <b>Q18WK3R1</b> | <b>Q25WK3R1</b> |
| Momentary/maintained |          |                 | <b>Q18WK3R2</b> | <b>Q25WK3R2</b> |

### Catalog Number Selection

Catalog Number Selection is for illustrative purposes only and not to be used to create new catalog numbers.

### Selector Switches—Illuminated

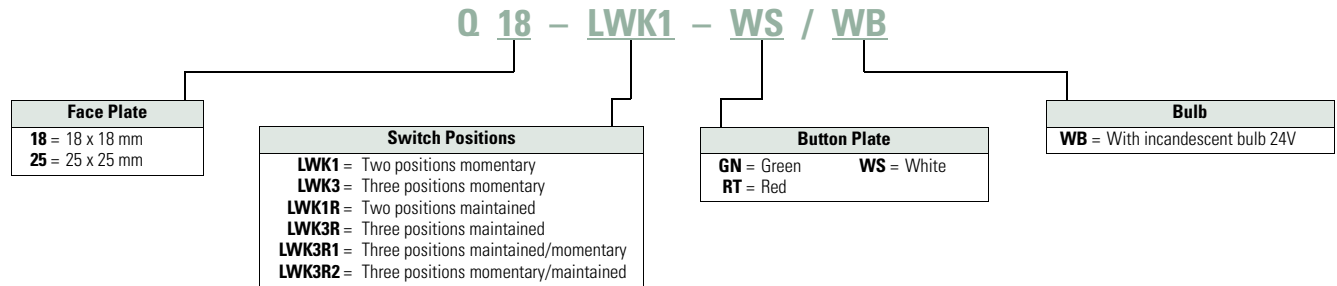

### Product Selection

#### Illuminated Selector Switches

- LED or incandescent
- Momentary or maintained
- 18 mm or 25 mm square operator
- VS Anti-rotation feature
- 3 million mechanical operations
- IP65

#### Q18LWK1-GN



### Selector Switches—Illuminated without Bulb ①

| Function                 | Position | Button Color | Switch Position | Catalog Number ②    |                     |
|--------------------------|----------|--------------|-----------------|---------------------|---------------------|
|                          |          |              |                 | 18 x 18 mm          | 25 x 25 mm          |
| Momentary                | 2        | Green        |                 | <b>Q18LWK1-GN</b>   | <b>Q25LWK1-GN</b>   |
|                          |          | Red          |                 | <b>Q18LWK1-RT</b>   | <b>Q25LWK1-RT</b>   |
|                          |          | White        |                 | <b>Q18LWK1-WS</b>   | <b>Q25LWK1-WS</b>   |
| Maintained               |          | Green        |                 | <b>Q18LWK1R-GN</b>  | <b>Q25LWK1R-GN</b>  |
|                          |          | Red          |                 | <b>Q18LWK1R-RT</b>  | <b>Q25LWK1R-RT</b>  |
|                          |          | White        |                 | <b>Q18LWK1R-WS</b>  | <b>Q25LWK1R-WS</b>  |
| Momentary                | 3        | Green        |                 | <b>Q18LWK3-GN</b>   | <b>Q25LWK3-GN</b>   |
|                          |          | Red          |                 | <b>Q18LWK3-RT</b>   | <b>Q25LWK3-RT</b>   |
|                          |          | White        |                 | <b>Q18LWK3-WS</b>   | <b>Q25LWK3-WS</b>   |
| Maintained               |          | Green        |                 | <b>Q18LWK3R-GN</b>  | <b>Q25LWK3R-GN</b>  |
|                          |          | Red          |                 | <b>Q18LWK3R-RT</b>  | <b>Q25LWK3R-RT</b>  |
|                          |          | White        |                 | <b>Q18LWK3R-WS</b>  | <b>Q25LWK3R-WS</b>  |
| Maintained/<br>momentary |          | Green        |                 | <b>Q18LWK3R1-GN</b> | <b>Q25LWK3R1-GN</b> |
|                          |          | Red          |                 | <b>Q18LWK3R1-RT</b> | <b>Q25LWK3R1-RT</b> |
|                          |          | White        |                 | <b>Q18LWK3R1-WS</b> | <b>Q25LWK3R1-WS</b> |
| Momentary/<br>maintained |          | Green        |                 | <b>Q18LWK3R2-GN</b> | <b>Q25LWK3R2-GN</b> |
|                          |          | Red          |                 | <b>Q18LWK3R2-RT</b> | <b>Q25LWK3R2-RT</b> |
|                          |          | White        |                 | <b>Q18LWK3R2-WS</b> | <b>Q25LWK3R2-WS</b> |

#### Notes

- ① To order with incandescent 24V bulb, insert a /WB at the end of the catalog number. Example, Q18LWK1-GN/WB.
- ② For a complete selection of incandescent 24V bulbs and LEDs, see Page V7-T1-40.

# 1.4

## Pushbuttons and Indicating Lights

### 16.2 mm Pushbuttons—RMQ-16

1

#### Catalog Number Selection

Catalog Number Selection is for illustrative purposes only and not to be used to create new catalog numbers.

#### Keyed Selector Switches—Two- and Three-Position

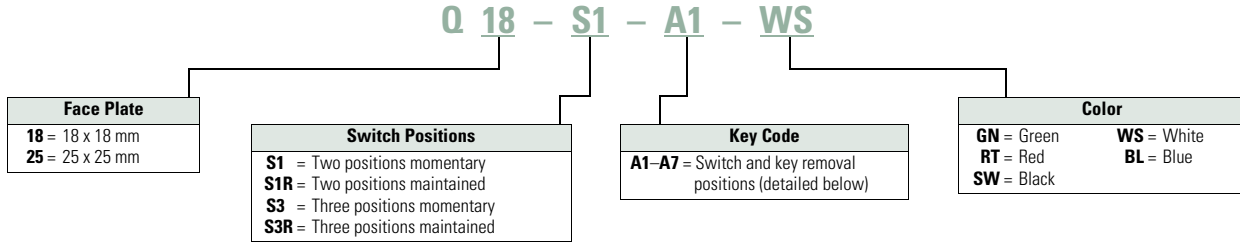

#### Product Selection

##### Keyed Selector Switches

- 5 color options
- Momentary or maintained
- 18 mm or 25 mm square operator
- VS Anti-rotation feature
- 3 million mechanical operations
- IP65

Q18S1



#### Keyed Selector Switches—Two-Position

| Function   | Button Color | Switch Position | Key Removal Position ① | Catalog Number   |                  |
|------------|--------------|-----------------|------------------------|------------------|------------------|
|            |              |                 |                        | 18 x 18 mm       | 25 x 25 mm       |
| Momentary  | Black        |                 | 0                      | <b>Q18S1</b>     | <b>Q25S1</b>     |
| Maintained | Black        |                 | 0                      | <b>Q18S1R</b>    | <b>Q25S1R</b>    |
| Maintained | Black        |                 | 0                      | <b>Q18S1R-A1</b> | <b>Q25S1R-A1</b> |

#### Keyed Selector Switches—Three-Position

| Function             | Button Color | Switch Position | Key Removal Position ① | Catalog Number   |                  |
|----------------------|--------------|-----------------|------------------------|------------------|------------------|
|                      |              |                 |                        | 18 x 18 mm       | 25 x 25 mm       |
| Momentary            | Black        |                 | 0                      | <b>Q18S3</b>     | <b>Q25S3</b>     |
| Maintained           |              |                 | 0, II                  | <b>Q18S3R</b>    | <b>Q25S3R</b>    |
| Maintained           |              |                 | 0                      | <b>Q18S3R-A1</b> | <b>Q25S3R-A1</b> |
|                      |              |                 | I, 0                   | <b>Q18S3R-A2</b> | <b>Q25S3R-A2</b> |
|                      |              |                 | 0, II                  | <b>Q18S3R-A3</b> | <b>Q25S3R-A3</b> |
| Maintained/momentary |              |                 | I, 0                   | <b>Q18S3R-A4</b> | <b>Q25S3R-A4</b> |
|                      |              |                 | 0                      | <b>Q18S3R-A5</b> | <b>Q25S3R-A5</b> |
| Momentary/maintained |              |                 | 0, II                  | <b>Q18S3R-A6</b> | <b>Q25S3R-A6</b> |
|                      |              |                 | 0                      | <b>Q18S3R-A7</b> | <b>Q25S3R-A7</b> |

##### Note

- ① I = Key is removed at the left.
- 0 = Key is removed at the center.
- II = Key is removed at the right.

**Q18S1-BL**

**Keyed Selector Switches, Multicolor—Two-Position**



| Function   | Button Color | Switch Position | Key Removal Position ① | Catalog Number   |                  |
|------------|--------------|-----------------|------------------------|------------------|------------------|
|            |              |                 |                        | 18 x 18 mm       | 25 x 25 mm       |
| Momentary  | Green        |                 | 0                      | <b>Q18S1-GN</b>  | <b>Q25S1-GN</b>  |
|            | Red          |                 |                        | <b>Q18S1-RT</b>  | <b>Q25S1-RT</b>  |
|            | White        |                 |                        | <b>Q18S1-WS</b>  | <b>Q25S1-WS</b>  |
|            | Blue         |                 |                        | <b>Q18S1-BL</b>  | <b>Q25S1-BL</b>  |
| Maintained | Green        |                 | 0                      | <b>Q18S1R-GN</b> | <b>Q25S1R-GN</b> |
|            | Red          |                 |                        | <b>Q18S1R-RT</b> | <b>Q25S1R-RT</b> |
|            | White        |                 |                        | <b>Q18S1R-WS</b> | <b>Q25S1R-WS</b> |
|            | Blue         |                 |                        | <b>Q18S1R-BL</b> | <b>Q25S1R-BL</b> |

**Q18S3-RT**

**Keyed Selector Switches, Multicolor—Three-Position**



| Function   | Button Color | Switch Position | Key Removal Position ① | Catalog Number   |                  |
|------------|--------------|-----------------|------------------------|------------------|------------------|
|            |              |                 |                        | 18 x 18 mm       | 25 x 25 mm       |
| Momentary  | Green        |                 | 0                      | <b>Q18S3-GN</b>  | <b>Q25S3-GN</b>  |
|            | Red          |                 |                        | <b>Q18S3-RT</b>  | <b>Q25S3-RT</b>  |
|            | White        |                 |                        | <b>Q18S3-WS</b>  | <b>Q25S3-WS</b>  |
|            | Blue         |                 |                        | <b>Q18S3-BL</b>  | <b>Q25S3-BL</b>  |
| Maintained | Green        |                 | 0, II                  | <b>Q18S3R-GN</b> | <b>Q25S3R-GN</b> |
|            | Red          |                 |                        | <b>Q18S3R-RT</b> | <b>Q25S3R-RT</b> |
|            | White        |                 |                        | <b>Q18S3R-WS</b> | <b>Q25S3R-WS</b> |
|            | Blue         |                 |                        | <b>Q18S3R-BL</b> | <b>Q25S3R-BL</b> |

**Note**

- ① I = Key is removed at the left.
- 0 = Key is removed at the center.
- II = Key is removed at the right.

## Accessories

E10



### Contact Elements

| Feature             | Catalog Number |
|---------------------|----------------|
| Normally open (N/O) | E10            |

E01



|                       |     |
|-----------------------|-----|
| Normally closed (N/C) | E01 |
|-----------------------|-----|

SRA10



### Screw Adapter

| Feature               | Catalog Number |
|-----------------------|----------------|
| Normally open (N/O)   | SRA10          |
| Normally closed (N/C) | SRA01          |
| Lamp sockets          | SRAL           |

WBGL6



### Incandescent 24V Bulbs

| Voltage | Current | Color | Catalog Number |
|---------|---------|-------|----------------|
| 6V      | 1W      | White | WBGL6          |
| 12V     |         |       | WBGL12         |
| 24–28V  |         |       | WBGL24         |

WBLED-GN6



### LEDs (AC/DC)

| Voltage                  | Current   | Color  | Catalog Number |
|--------------------------|-----------|--------|----------------|
| <b>Multiple Chip LED</b> |           |        |                |
| 6V                       | 45 mA     | Green  | WBLED-GN6      |
| 12V                      | 24 mA     |        | WBLED-GN12     |
| 6V                       | 45 mA     | Red    | WBLED-RT6      |
| 12V                      | 24 mA     |        | WBLED-RT12     |
| 6V                       | 45 mA     | Yellow | WBLED-GE6      |
| 12V                      | 24 mA     |        | WBLED-GE12     |
| <b>Single Chip LED</b> ① |           |        |                |
| 18–30V                   | 7–12.5 mA | Green  | LEDWB-G        |
|                          |           | Red    | LEDWB-R        |
|                          |           | White  | LEDWB-W        |
|                          |           | Blue   | LEDWB-B        |
|                          |           | Yellow | LEDWB-Y        |

ISH2,8



### Insulated Ferrule

| Description       | Catalog Number |
|-------------------|----------------|
| Insulated ferrule | ISH2,8         |

R16-MS



### Combination Box Spanner

| Description        | Catalog Number |
|--------------------|----------------|
| Mounting ring tool | 16-MS          |

VS



### Anti-Rotation Tab

| Description | Catalog Number |
|-------------|----------------|
| Guard ring  | VS             |

E8-SW



### Housing

| Description             | Color | Catalog Number |
|-------------------------|-------|----------------|
| Surface mount enclosure | White | I8             |
| Flush mount panel       | White | E8             |
|                         | Black | E8-SW          |

Q18BS



### Blanking Plug

| Size       | Catalog Number |
|------------|----------------|
| 18 x 18 mm | Q18BS          |
| 25 x 25 mm | Q25BS          |

Q25AGR



### Cover Plate

| Size       | Color | Catalog Number |
|------------|-------|----------------|
| 25 x 38 mm | Black | Q25AS          |
|            | Gray  | Q25AGR         |

#### Note

① Positive pole to X1. Integral suppressor circuit up to 1000V.

### Q2SQ25

#### Insert Plate

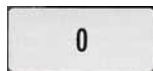

| Size       |       | Catalog Number |
|------------|-------|----------------|
| 10 x 22 mm | BLANK | <b>Q2SQ25</b>  |

### Q25TS-X

#### Legend Plate



| Size       | Color | Catalog Number  |
|------------|-------|-----------------|
| 25 x 38 mm | Black | <b>Q25TS-X</b>  |
|            | Gray  | <b>Q25TGR-X</b> |

### Q25TS\_

#### Legend Plate—Complete



| Size    | Etching     | Catalog Number   |
|---------|-------------|------------------|
| 25 x 38 | START       | <b>Q25TS-111</b> |
|         | STOP        | <b>Q25TS-110</b> |
|         | FAULT       | <b>Q25TS-250</b> |
|         | HAND 0 AUTO | <b>Q25TS-197</b> |
|         | MAN 0 AUTO  | <b>Q25TS-397</b> |
|         | 0           | <b>Q25TS-10</b>  |
|         | I           | <b>Q25TS-11</b>  |
|         | 0 I         | <b>Q25TS-90</b>  |
|         | I 0 II      | <b>Q25TS-93</b>  |

### SQT11

#### Emergency Stop Labels



| Type   | Feature     | Catalog Number |
|--------|-------------|----------------|
| Square | 4 Languages | <b>SQT11</b>   |
|        | Blank       | <b>SQT-GE</b>  |

### SRT11



|        |             |               |
|--------|-------------|---------------|
| Circle | 4 Languages | <b>SRT11</b>  |
|        | Blank       | <b>SRT-GE</b> |

#### Extra Keys

### ES16



#### Codes for Extra Keys

| Color | Catalog Number |
|-------|----------------|
| Green | <b>ES16-GN</b> |
| Red   | <b>ES16-RT</b> |
| Black | <b>ES16</b>    |
| White | <b>ES16-WS</b> |
| Blue  | <b>ES16-BL</b> |

**Button Plates**



**Button Plates**

| Type       | Color  | Etching            | Catalog Number     |
|------------|--------|--------------------|--------------------|
| 18 x 18 mm | Black  | —                  | <b>01TQ18</b>      |
|            |        | CUSTOM             | <b>01TQ18-ETCH</b> |
|            |        |                    | <b>21TQ18</b>      |
|            |        |                    | <b>19TQ18</b>      |
|            | White  | —                  | <b>02TQ18</b>      |
|            |        | CUSTOM             | <b>02TQ18-ETCH</b> |
|            |        |                    | <b>20TQ18</b>      |
|            | Green  | —                  | <b>03TQ18</b>      |
|            |        | CUSTOM             | <b>03TQ18-ETCH</b> |
|            |        |                    | <b>11TQ18</b>      |
|            | Red    | —                  | <b>04TQ18</b>      |
|            |        | CUSTOM             | <b>04TQ18-ETCH</b> |
|            |        |                    | <b>10TQ18</b>      |
|            | Yellow | —                  | <b>05TQ18</b>      |
|            |        | CUSTOM             | <b>05TQ18-ETCH</b> |
|            | Blue   | —                  | <b>06TQ18</b>      |
| CUSTOM     |        | <b>06TQ18-ETCH</b> |                    |

| Type       | Color  | Etching            | Catalog Number     |
|------------|--------|--------------------|--------------------|
| 25 x 25 mm | Black  | —                  | <b>01TQ25</b>      |
|            |        | CUSTOM             | <b>01TQ25-ETCH</b> |
|            |        |                    | <b>21TQ25</b>      |
|            |        |                    | <b>19TQ25</b>      |
|            | White  | —                  | <b>02TQ25</b>      |
|            |        | "STOP"             | <b>112TQ25</b>     |
|            |        | "ON"               | <b>221TQ25</b>     |
|            | White  | —                  | <b>02TQ25</b>      |
|            |        | CUSTOM             | <b>02TQ25-ETCH</b> |
|            |        |                    | <b>20TQ25</b>      |
|            | Green  | —                  | <b>03TQ25</b>      |
|            |        | CUSTOM             | <b>03TQ25-ETCH</b> |
|            |        | "START"            | <b>111TQ25</b>     |
|            |        |                    | <b>11TQ25</b>      |
|            | Red    | —                  | <b>04TQ25</b>      |
|            |        | CUSTOM             | <b>04TQ25-ETCH</b> |
| "STOP"     |        | <b>110TQ25</b>     |                    |
|            |        | <b>10TQ25</b>      |                    |
| Yellow     | —      | <b>05TQ25</b>      |                    |
|            | CUSTOM | <b>05TQ25-ETCH</b> |                    |
|            | "OFF"  | <b>217TQ25</b>     |                    |
| Blue       | —      | <b>06TQ25</b>      |                    |
|            | CUSTOM | <b>06TQ25-ETCH</b> |                    |

**Instructions for Ordering Laser Incriptions**

1. Identify part number to be inscribed.
2. Pick symbol from library and identify suffix code associated with the symbol.
3. Order part number already listed in the catalog with -ETCH suffix.
4. When placing an order by fax or Vistaline on the web, reference order item number and indicate appropriate symbol code or desired text.

**Example**

To order a 25 mm green flush button plate with the inscription AUTO HAND:

Order Catalog Number **03TQ25-ETCH**.

AUTO HAND inscription is found on **Page V7-T1-133** in the M22 Symbols Library, suffix code is **X91**.

In the order notes, reference item number and suffix **X91**.

**Note:** For a complete list of available symbols, see **Pages V7-T1-130 to V7-T1-136**, M22 Symbols Library.

## Technical Data and Specifications

## RMQ-16

| Description  | Unit              | Specification<br>Contact Elements  | Illuminated Pushbutton<br>Operators (Maintained)                               | Illuminated Selector<br>Switches     | Indicating Lights                 |
|--|-------------------|--|--|--------------------------------------|-----------------------------------|
| <b>General Technical Data</b>  |                   |  |  |                                      |                                   |
| Standards  |                   |  |  | UL, CSA, IEC/EN 60 947, VDE 0660, CE |                                   |
| Lifespan, mechanical (operations)  | x 10 <sup>5</sup> | 100  | 30 (3)   | 3                                    | —                                 |
| Maximum operating frequency  | Ops/h             | 3600   | 3600 (1800)  | 1800                                 | —                                 |
| Operating force  | N                 | 3  | 4  | —                                    | —                                 |
| Operating torque   | Nm                |  | —  | ≤ 0.2                                | —                                 |
| Degree of protection to IEC/EN 60 529  |                   | IP20 with ISH2,8   | IP65   | IP65                                 | IP65                              |
| Climatic proofing  |                   |  | Damp heat, constant, to IEC 60 068-2-3/Damp heat, cyclical, to IEC 60 068-2-30 |                                      |                                   |
| Ambient temperature  |                   |  |  |                                      |                                   |
| Open   | °C                | –25 to 60  | –25 to 60  | –25 to 60                            | –25 to 60                         |
| Enclosed   | °C                | –25 to 40  | –25 to 40  | –25 to 40                            | –25 to 40                         |
| Mounting position  |                   | As required  | As required  | As required                          | As required                       |
| Mechanical shock resistance to IEC 60 068-2-27 (half-sinusoidal shock, duration 11 ms) | g                 | 40   | 40   | 40                                   | 40                                |
| Terminal capacity (min./max.)  | mm <sup>2</sup>   | 0.5/1.0  | 0.5/1.0  | 0.5/1.0                              | 0.5/1.0                           |
| Blade terminal   |                   |  | 2.8 mm x 0.8 mm to DIN 46 244  |                                      |                                   |
| Ferrule  |                   |  | 2.8 mm x 0.8 mm to DIN 46 247 and IEC 60 760                                   |                                      |                                   |
| Dimensions   |                   | See <a href="#">Page V7-T1-45</a>  | See <a href="#">Page V7-T1-45</a>  | See <a href="#">Page V7-T1-45</a>    | See <a href="#">Page V7-T1-45</a> |
| <b>Contacts</b>  |                   |  |  |                                      |                                   |
| Rated impulse withstand voltage $U_{imp}$  | V                 | 4000   | 800  | 800                                  | 800                               |
| Rated insulation voltage $U_i$   | V                 | 250  | 250  | 250                                  | 250                               |
| Overvoltage category/pollution degree  |                   | III/3  | III/3  | III/3                                | III/3                             |
| Rated operational voltage $U_e$ (max.)   | V                 | 250  | 24   | 24                                   | 24                                |
| Rated operational current $I_e$ (max.)   | A                 | 4  | —  | —                                    | —                                 |
| Control circuit reliability at   |                   |  |  |                                      |                                   |
| 24 Vdc/5 mA (Fault probability Hr)   |                   |  | <10 <sup>-7</sup> , <1 fault in 10 <sup>7</sup> operations                     |                                      |                                   |
| 5 Vdc/1 mA (Fault probability Hr)  |                   |  | <5 x 10 <sup>-6</sup> , < fault in 5 x 10 <sup>6</sup> operations              |                                      |                                   |
| Use of insulated ferrule ISH 2.8   |                   |  |  |                                      |                                   |
| From $U_e$   |                   | >24 Vac/dc recommended   | >24 Vac/dc recommended   | >24 Vac/dc recommended               | >24 Vac/dc recommended            |
| From $U_e$   |                   |  | >50 Vac or 120 Vdc is mandatory, even on unused blade terminals                |                                      |                                   |
| Maximum short-circuit protective device  |                   |  |  |                                      |                                   |
| Fuseless   | Type              | FAZ-B6   | —  | —                                    | —                                 |
| Fuse   | A gG/gL           | 10   | —  | —                                    | —                                 |
| <b>Switching Capacity</b>  |                   |  |  |                                      |                                   |
| Rated operational current $I_e$  |                   |  |  |                                      |                                   |
| AC-15  |                   |  |  |                                      |                                   |
| 24V  | A                 | 4  | —  | —                                    | —                                 |
| 48V  | A                 | 4  | —  | —                                    | —                                 |
| 110V   | A                 | 4  | —  | —                                    | —                                 |
| 230V   | A                 | 4  | —  | —                                    | —                                 |
| DC-13  |                   |  |  |                                      |                                   |
| 24V  | A                 | 3  | —  | —                                    | —                                 |
| 42V  | A                 | 1.0  | —  | —                                    | —                                 |
| 60V  | A                 | 0.8  | —  | —                                    | —                                 |
| 110V   | A                 | 0.5  | —  | —                                    | —                                 |
| 220V   | A                 | 0.2  | —  | —                                    | —                                 |
| UL/CSA Data  |                   |  |  |                                      |                                   |
|  |                   | UL listed File No. E 29 184, Guide No. NKCR/CSA certified File No. 46 552 Class No. 321103 |  |                                      |                                   |
| Blade terminal   |                   | 0.110 x 0.032 in   | 0.110 x 0.032 in   | 0.110 x 0.032 in                     | 0.110 x 0.032 in                  |
| Fast-on connector  |                   | 0.110 x 0.032 in AMP #60 197-1, 62 050-1 or equivalent                                     |  |                                      |                                   |
| Rated voltage maximum AC   | Vac               | 300  | 24   | 24                                   | 24                                |
| Contact rating code AC   | E10/E01           | C300/Q300  | —  | —                                    | —                                 |
| Thermal continuous test current  | A                 | 2.5  | —  | —                                    | —                                 |
| Rated voltage maximum DC   | Vdc               | 300  | —  | —                                    | —                                 |
| Contact rating code DC   | E10/E01           | C300/R300  | —  | —                                    | —                                 |
| Thermal continuous test current  | A                 | 2.5  | —  | —                                    | —                                 |



# 1.4

## Pushbuttons and Indicating Lights

### 16.2 mm Pushbuttons—RMQ-16

1

#### RMQ-16, continued

| Description  | Unit              | Specification                     |                   |                        | Emergency Stop Operators  | Emergency Stop Operators (Illuminated) ① |
|--|-------------------|-----------------------------------|-------------------|------------------------|---|--|
|  |                   | Pushbutton Operators (Maintained) | Selector Switches | Key-Released Operators |   |  |
| <b>General Technical Data</b>  |                   |                                   |                   |                        |   |  |
| Standards  |                   |                                   |                   |                        | UL, CSA, IEC/EN 60 947, VDE 0660, CE  |  |
| Lifespan, mechanical (operations)  | x 10 <sup>5</sup> | 30 (3)                            | 3                 | 3                      | 0.5   | 0.5                                      |
| Maximum operating frequency  | Ops/h             | 3600 (1800)                       | 1800              | 1800                   | 600   | 600                                      |
| Operating force  | N                 | 4                                 | —                 | —                      | 25  | 25                                       |
| Operating torque   | Nm                | —                                 | ≤ 0.2             | ≤ 0.4                  | —   | —  |
| Degree of protection to IEC/EN 60 529  |                   | IP65                              | IP65              | IP65                   | IP65  | IP65                                     |
| Climatic proofing  |                   |                                   |                   |                        | Damp heat, constant, to IEC 60 068-2-3<br>Damp heat, cyclical, to IEC 60 068-2-30 |  |
| Ambient temperature  |                   |                                   |                   |                        |   |  |
| Open   | °C                | –25 to 60                         | –25 to 60         | –25 to 60              | –25 to 60   | –25 to 60                                |
| Enclosed   | °C                | –25 to 40                         | –25 to 40         | –25 to 40              | –25 to 40   | –25 to 40                                |
| Mounting position  |                   | As required                       | As required       | As required            | As required   | As required                              |
| Mechanical shock resistance to IEC 60 068-2-27 (half-sinusoidal shock, duration 11 ms) | g                 | 40                                | 40                | 40                     | 40  | 40                                       |
| Terminal capacity (min./max.)  | mm <sup>2</sup>   | —                                 | —                 | —                      | —   | 0.5/1.0                                  |
| Blade terminal   |                   | —                                 | —                 | —                      | —   | 2.8 x 0.8 mm                             |
| Ferrule  |                   | —                                 | —                 | —                      | —   | 2.8 x 0.8 mm                             |
| Dimensions   |                   | See Page V7-T1-45                 | See Page V7-T1-45 | See Page V7-T1-45      | See Page V7-T1-45   | See Page V7-T1-45                        |

#### Lifespan, Electrical AC-15 to IEC/EN 60 947-5-1 at 230V

$I_e$  = Rated operational current

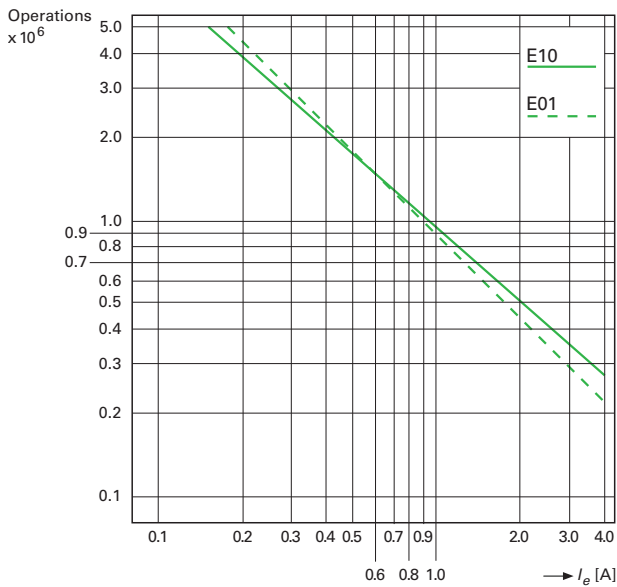

#### Note

① See illuminated selector switches on Page V7-T1-37 for contact values.

**Dimensions**

Approximate Dimensions in mm [in]

**Actuating and Indicator Elements**

**Square Style**

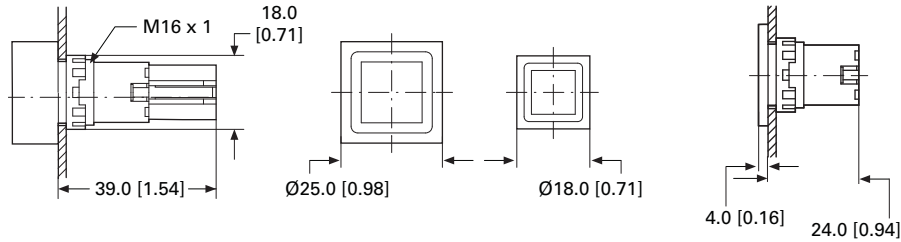

**Q...D-\_, Q...DR-\_**

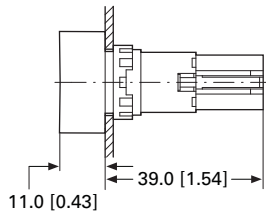

**Q...S\_**

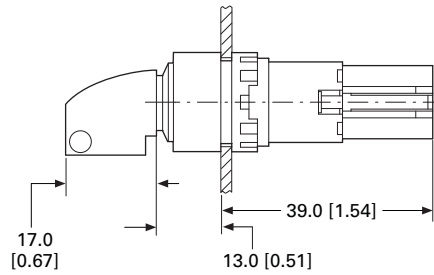

**Q...WK\_**

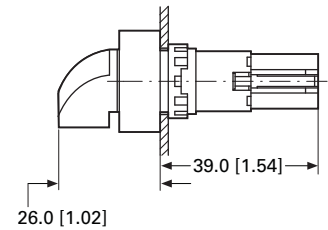

**Q...LT-\_, Q...LTR-\_, Q...LF-\_**

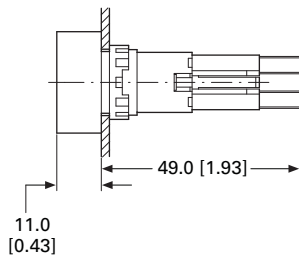

**Q...LH-\_**

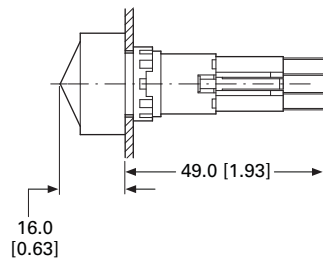

**Q...LWK\_**

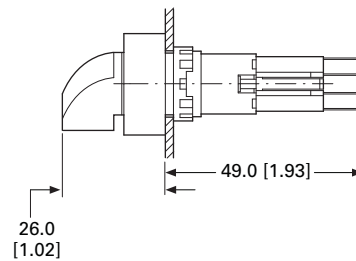

**Q25PV\_ , Q25LPV\_**

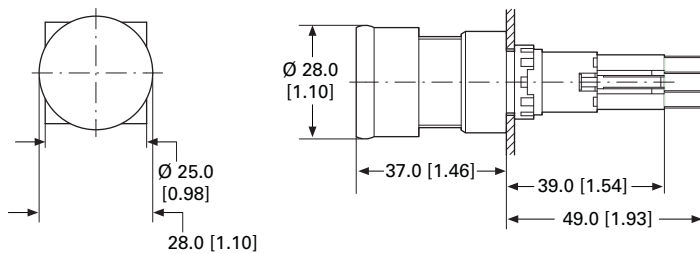

# 1.4

## Pushbuttons and Indicating Lights

### 16.2 mm Pushbuttons—RMQ-16

1

Approximate Dimensions in mm [in]

#### Front Fixing

Q18, Q25, E89, SRA, VS, M16

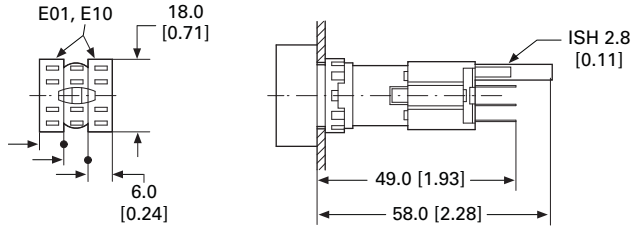

#### Drilling Dimensions

##### Drilling

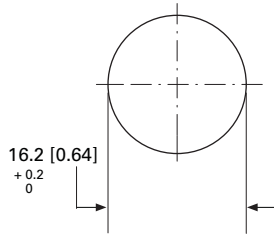

#### Grid Dimension to IEC/EN 60947

##### Q25

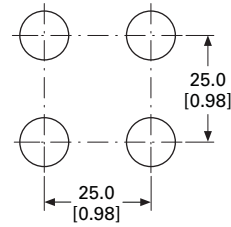

#### Minimum Grid Spacing Dimension

##### Q18

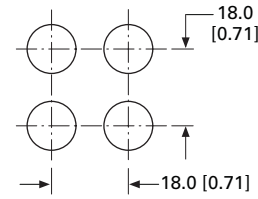

#### Mounting Distance

##### Mounting

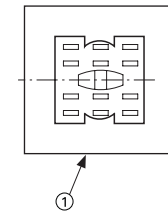

#### RMQ Screw Adapter

##### SRA\_

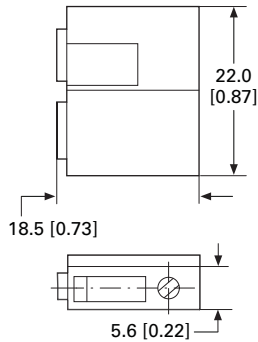

#### Anti-Rotation Feature

##### VS

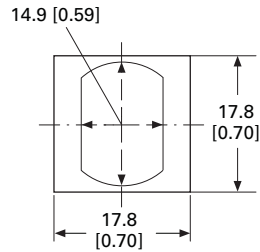

#### RMQ-16 Label Mount

##### Q25TS\_

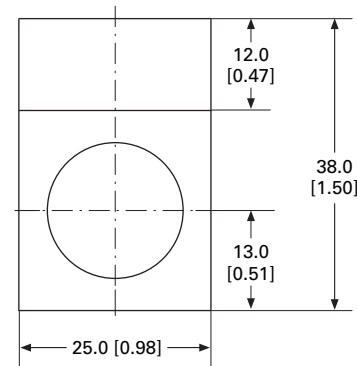

#### Blanking Plates

##### Q25AS

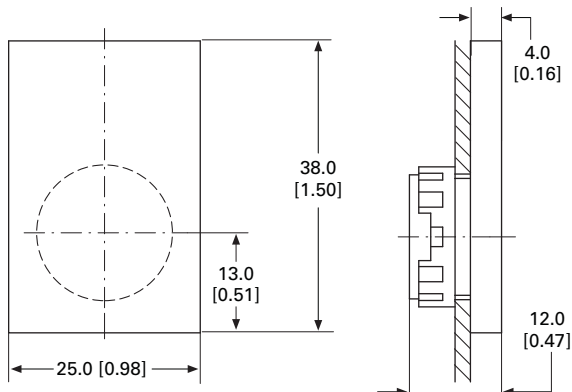

#### Note

① Exposed conductive part (metal).

22.5 mm Modular Pushbuttons—M22



**Product Description**

Eaton’s M22 industrial heavy-duty pushbutton line offers a wide array of functional, attractive and ergonomically designed illuminated and non-illuminated pushbuttons, selector switches, push-pulls, alternate action and twist-to-release operators. The complete illuminated line is only offered in LED light units to ensure high-quality brightness and up to 100,000 hours of LED illumination. M22 operators are available with either a silver or black nylon colored or chrome metal bezel. The space-saving modular construction of the M22 line makes on-the-job assembly fast and simplifies the stocking of both components and complete devices.

**NEW**

Eaton has expanded M22 pilot devices with a metal bezel option. The new M22M pushbutton is an elegant chrome metal bezel that is attractive, durable and rugged for heavy-duty environments. M22M devices are configurable and complement components within the M22 line.

**Highly Modular and Versatile Line**

- Field convertible functions (pushbuttons and selector switches), maintained to momentary
- Customizable laser engraving capabilities

**LED Indicators**

- 100,000 hours of life in high-vibration environments
- Lenses specifically designed for LED illumination

**Rugged Design**

- Most pushbutton operators and contact blocks exceed 5 million mechanical operations
- All components have IP66 rating, and some carry IP67 and IP69K for washdown environment; see **Page V7-T1-119** for further technical data

**Innovative Technologies**

- ASi communicating devices
- Palm switches

**Contents**

**Description**

**Page**

|   |                  |
|---|------------------|
| 22.5 mm Modular Pushbuttons—M22             |                  |
| Product Selection Guide . . . . .           | <b>V7-T1-48</b>  |
| Accessories . . . . .                       | <b>V7-T1-111</b> |
| Coding Adapter Guide . . . . .              | <b>V7-T1-118</b> |
| Technical Data and Specifications . . . . . | <b>V7-T1-119</b> |
| Dimensions . . . . .                        | <b>V7-T1-123</b> |
| Symbols Library. . . . .                    | <b>V7-T1-129</b> |



**Standards and Certifications**

All operators and components are IEC/EN 60947 VDE 0660.

All operators carry an IP66 rating with some rated for washdown environment with IP67 and IP69K.

All pushbuttons, emergency-stops, indicating lights, potentiometers and selector switches carry NEMA 4X, 13.

Marine classification societies: Bureau Veritas (BV), Germanischer Lloyd (GL), and Lloyd’s Register of Shipping (LR) approved.



#### 1

### Features

- Field convertible pushbuttons and mushroom operators from maintained to momentary status
- Field convertible selector switches from momentary to maintained operation and vice versa
- LED offering only for all illuminated operators
- Laser engraved pushbuttons, lenses and enclosures
- Heavy-duty construction with a minimum of IP66 and UL NEMA® type 4X / 13 on front of panel operators. Many operators even carry IP67 and IP69K, for the toughest applications
- Silver, black or chrome metal bezel now available
- Snap-lock contact blocks and light units for front or base mounting
- Notched hole mounting with anti-rotation tab and central nut mounting on each operator
- Over 5 million mechanical operations and 1.6 million electrical (reference specification sheet)
- Direct opening action normally closed contacts
- Unique and innovative offerings, such as four-way pushbuttons and USB/ RJ45 bulkhead interfaces
- Screw or spring-cage terminals

### Benefits

- Modular construction makes assembly fast and simplifies stocking of components and complete devices
- Field convertibility of operator status for pushbuttons and selector switches helps distributors and customers reduce inventory and increase functionality
- LED offering only for improved brightness quality and up to 100,000 hours of operation
- Plastic construction is corrosion resistant. Operators are designed for rugged environments, ideal for washdown applications (reference each operator's IP ratings and IEC/EN 60529 for ingress protection definition)
- Anti-rotation tab saves installation time and prevents operator rotation
- High mechanical and electrical life allows for use in tough and challenging applications
- Laser inscription capabilities allow for high-quality, wear-resistant markings
- All normally closed (NC) contacts are direct opening action, i.e., NC contacts are physically forced open by direct linkage with the pushbutton operator in the unlikely event of contact weld
- Some M22 operators are capable of communication via ASi protocol
- M22 offers USB and RJ45 connections

### Product Selection Guide

#### Pushbuttons



|                          |                                   |                                 |                                 |                                 |                                   |                                 |                                 |                                 |
|--------------------------|-----------------------------------|---------------------------------|---------------------------------|---------------------------------|-----------------------------------|---------------------------------|---------------------------------|---------------------------------|
| <b>Description</b>       | Non-illuminated, flush            |                                 | Non-illuminated, extended       |                                 | Illuminated, flush                |                                 | Illuminated, extended           |                                 |
| <b>Operator</b>          | Momentary                         | Maintained                      | Momentary                       | Maintained                      | Momentary                         | Maintained                      | Momentary                       | Maintained                      |
| <b>Product Selection</b> | <b>Pages V7-T1-53 to V7-T1-55</b> | <b>Pages V7-T1-56, V7-T1-57</b> | <b>Pages V7-T1-58, V7-T1-59</b> | <b>Pages V7-T1-60, V7-T1-61</b> | <b>Pages V7-T1-63 to V7-T1-65</b> | <b>Pages V7-T1-66, V7-T1-67</b> | <b>Pages V7-T1-68, V7-T1-69</b> | <b>Pages V7-T1-70, V7-T1-71</b> |

#### Indicating Lights



|                          |                                 |                                 |
|--------------------------|---------------------------------|---------------------------------|
| <b>Description</b>       | Flat                            | Conical                         |
| <b>Product Selection</b> | <b>Pages V7-T1-72, V7-T1-73</b> | <b>Pages V7-T1-72, V7-T1-73</b> |

### Emergency Stops



|                          |                      |                      |                      |                       |
|--------------------------|----------------------|----------------------|----------------------|-----------------------|
| <b>Description</b>       | Non-illuminated      | Illuminated          | Key release          | Mechanical indication |
| <b>Product Selection</b> | <b>Page V7-T1-75</b> | <b>Page V7-T1-75</b> | <b>Page V7-T1-76</b> | <b>Page V7-T1-76</b>  |

### Selector Switches



|                          |                                 |                                 |                                   |                                   |
|--------------------------|---------------------------------|---------------------------------|-----------------------------------|-----------------------------------|
| <b>Description</b>       | Non-illuminated knob type       | Non-illuminated rotary type     | Illuminated                       | Key-operated                      |
| <b>Product Selection</b> | <b>Pages V7-T1-80, V7-T1-81</b> | <b>Pages V7-T1-82, V7-T1-83</b> | <b>Pages V7-T1-85 to V7-T1-87</b> | <b>Pages V7-T1-88 to V7-T1-91</b> |

### Mushroom Head Pushbuttons



|                          |                                 |                                 |
|--------------------------|---------------------------------|---------------------------------|
| <b>Description</b>       | Non-illuminated                 | Non-illuminated                 |
| <b>Operator</b>          | Momentary                       | Maintained                      |
| <b>Product Selection</b> | <b>Pages V7-T1-94, V7-T1-95</b> | <b>Pages V7-T1-96, V7-T1-97</b> |

### Double Pushbuttons



|                          |                                       |   |                                    |
|--------------------------|---------------------------------------|---|------------------------------------|
| <b>Description</b>       | Extended pushbuttons and center light | Flush top and center light, extended bottom | Flush pushbuttons and center light |
| <b>Operator</b>          | Momentary                             | Momentary                                   | —                                  |
| <b>Product Selection</b> | <b>Page V7-T1-99</b>                  | <b>Page V7-T1-100</b>                       | <b>Page V7-T1-100</b>              |

#### Four-Way Pushbuttons



|                          |                                |                                |
|--------------------------|--------------------------------|--------------------------------|
| <b>Description</b>       | Non-interlocked                | Interlocked                    |
| <b>Operator</b>          | Momentary                      | Maintained                     |
| <b>Product Selection</b> | <a href="#">Page V7-T1-103</a> | <a href="#">Page V7-T1-103</a> |

#### Joysticks



|                          |                                |
|--------------------------|--------------------------------|
| <b>Description</b>       | Joysticks                      |
| <b>Product Selection</b> | <a href="#">Page V7-T1-104</a> |

#### Potentiometers



|                          |                                |
|--------------------------|--------------------------------|
| <b>Description</b>       | Potentiometers                 |
| <b>Product Selection</b> | <a href="#">Page V7-T1-106</a> |

#### Acoustic Devices



|                          |                                |
|--------------------------|--------------------------------|
| <b>Description</b>       | Acoustic devices               |
| <b>Product Selection</b> | <a href="#">Page V7-T1-106</a> |

#### Through-the-Door Operators



|                          |                                |
|--------------------------|--------------------------------|
| <b>Description</b>       | Through-the-door operators     |
| <b>Product Selection</b> | <a href="#">Page V7-T1-107</a> |

#### Bulkhead Interfaces



|                          |                                |
|--------------------------|--------------------------------|
| <b>Description</b>       | Bulkhead interfaces            |
| <b>Product Selection</b> | <a href="#">Page V7-T1-107</a> |

#### ASi Adapter Modules



|                          |                                |
|--------------------------|--------------------------------|
| <b>Description</b>       | ASi adapter modules            |
| <b>Product Selection</b> | <a href="#">Page V7-T1-108</a> |

#### Palm Switches



|                          |                                |
|--------------------------|--------------------------------|
| <b>Description</b>       | Palm switches                  |
| <b>Product Selection</b> | <a href="#">Page V7-T1-109</a> |

#### Assembled Control Stations



|                          |                               |
|--------------------------|-------------------------------|
| <b>Description</b>       | Assembled control stations    |
| <b>Product Selection</b> | <a href="#">Page V7-T1-16</a> |

M22\_



### Point-of-Purchase Units

| Color | Type                                      | Contact Configuration <sup>①</sup> | Catalog Number              |
|-------|---|------------------------------------|-----------------------------|
| Black | Flush momentary                           | NO/NC                              | <b>M22-D-S-K11-P</b>        |
| Red   | Extended momentary                        | NO/NC                              | <b>M22-DH-R-K11-P</b>       |
| Green | Flush momentary                           | NO/NC                              | <b>M22-D-G-K11-P</b>        |
| Red   | Ext. illuminated (12–30V) momentary       | NO/NC                              | <b>M22-DLH-R-K11-R-P</b>    |
| Red   | Ext. illuminated (85–264V) momentary      | NO/NC                              | <b>M22-DLH-R-K11-230R-P</b> |
| White | Flush illuminated (12–30V) maintained     | NO/NC                              | <b>M22-DRL-W-K11-W-P</b>    |
| White | Flush illuminated (85–264V) maintained    | NO/NC                              | <b>M22-DRL-W-K11-230W-P</b> |
| Red   | Indicating light (12–30V)                 | —                                  | <b>M22-L-R-R-P</b>          |
| Green | Indicating light (12–30V)                 | —                                  | <b>M22-L-G-G-P</b>          |
| Red   | Indicating light (85–264V)                | —                                  | <b>M22-L-R-230R-P</b>       |
| Green | Indicating light (85–264 Vac)             | —                                  | <b>M22-L-G-230G-P</b>       |
| Red   | Twist-to-release E-stop                   | 1NO/2NC                            | <b>M22-PVT-K12-P</b>        |
| Red   | Illuminated (12–30V) push-pull E-stop     | 1NO/2NC                            | <b>M22-PVL-K12-R-P</b>      |
| Red   | Illuminated (85–264V) push-pull E-stop    | 1NO/2NC                            | <b>M22-PVL-K12-230R-P</b>   |
| —     | Two-position maintained V selector switch | NO/NC                              | <b>M22-WKV-K11-P</b>        |
| —     | Three-position momentary selector switch  | NO/NC                              | <b>M22-WK3-K22-P</b>        |

**Note**

① All NC contact blocks are positively driven contact. ⊖



**Pushbuttons—Non-Illuminated and Illuminated**



**Contents**

**Description**

**Page**

|   |                 |
|---|-----------------|
| Pushbuttons—Non-Illuminated and Illuminated     |                 |
| Non-Illuminated, Flush, Momentary . . . . .     | <b>V7-T1-53</b> |
| Non-Illuminated, Flush, Maintained . . . . .    | <b>V7-T1-56</b> |
| Non-Illuminated, Extended, Momentary . . . . .  | <b>V7-T1-58</b> |
| Non-Illuminated, Extended, Maintained . . . . . | <b>V7-T1-60</b> |
| Illuminated, Flush, Momentary . . . . .         | <b>V7-T1-63</b> |
| Illuminated, Flush, Maintained . . . . .        | <b>V7-T1-66</b> |
| Illuminated, Extended, Momentary . . . . .      | <b>V7-T1-68</b> |
| Illuminated, Extended, Maintained . . . . .     | <b>V7-T1-70</b> |

**Pushbuttons—Non-Illuminated and Illuminated**

**Product Description**

Eaton’s M22 pushbutton line is a complete, modular and versatile offering. From field-convertible maintained operators to customizable laser engraved buttons, the M22 pushbutton line provides endless opportunity for flexibility and reduced inventory. Each operator type provides options for ordering as complete or component parts allowing for a perfect fit for each application. All of this flexibility comes in a very rugged design.

**Features**

- Field convertible from maintained to momentary (available on maintained pushbuttons only)
- Customizable laser engraving on all buttons
- LED offering only for improved brightness quality and up to 100,000 hours of operation
- More than five million mechanical operations on momentary and 1 million on maintained pushbuttons
- Modular construction makes assembly fast and simplifies stocking of components and complete devices
- Capable of communicating via ASi protocol with ASi adapter modules

**Protection Type**

- IP67, IP69K
- NEMA 4X, 13

### Catalog Number Selection

Catalog Number Selection is for illustrative purposes only and not to be used to create new catalog numbers.

#### Non-Illuminated Pushbuttons

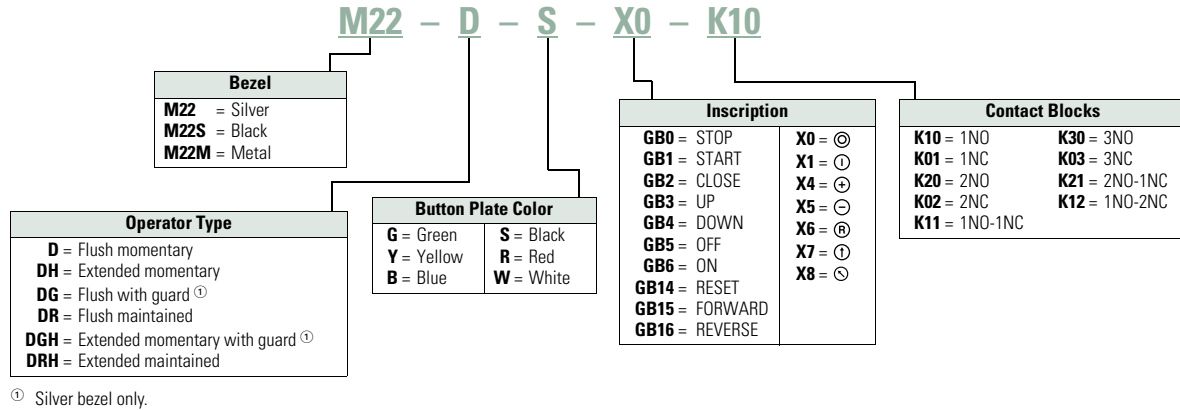

### Product Selection

#### Non-Illuminated Pushbuttons, Flush, Momentary

##### M22-D-G-K10



##### M22S-D-G-K10



##### M22M-D-G-K10



#### Complete Devices

| Button Color | Contact Block Configuration ① | Silver Bezel Catalog Number | Black Bezel Catalog Number | Metal Bezel Catalog Number |
|--------------|-------------------------------|-----------------------------|----------------------------|----------------------------|
| Black        | NO                            | M22-D-S-K10                 | M22S-D-S-K10               | M22M-D-S-K10               |
|              | NC                            | M22-D-S-K01                 | M22S-D-S-K01               | M22M-D-S-K01               |
|              | 2NO                           | M22-D-S-K20                 | M22S-D-S-K20               | M22M-D-S-K20               |
|              | 2NC                           | M22-D-S-K02                 | M22S-D-S-K02               | M22M-D-S-K02               |
|              | 1NO-1NC                       | M22-D-S-K11                 | M22S-D-S-K11               | M22M-D-S-K11               |
| Red          | NO                            | M22-D-R-K10                 | M22S-D-R-K10               | M22M-D-R-K10               |
|              | NC                            | M22-D-R-K01                 | M22S-D-R-K01               | M22M-D-R-K01               |
|              | 2NO                           | M22-D-R-K20                 | M22S-D-R-K20               | M22M-D-R-K20               |
|              | 2NC                           | M22-D-R-K02                 | M22S-D-R-K02               | M22M-D-R-K02               |
|              | 1NO-1NC                       | M22-D-R-K11                 | M22S-D-R-K11               | M22M-D-R-K11               |
| Green        | NO                            | M22-D-G-K10                 | M22S-D-G-K10               | M22M-D-G-K10               |
|              | NC                            | M22-D-G-K01                 | M22S-D-G-K01               | M22M-D-G-K01               |
|              | 2NO                           | M22-D-G-K20                 | M22S-D-G-K20               | M22M-D-G-K20               |
|              | 2NC                           | M22-D-G-K02                 | M22S-D-G-K02               | M22M-D-G-K02               |
|              | 1NO-1NC                       | M22-D-G-K11                 | M22S-D-G-K11               | M22M-D-G-K11               |

**Note**

① All NC contact blocks are positively driven contact. ⊖

1

## Non-Illuminated Pushbuttons, Flush, Momentary

M22-D-G

Operators Only <sup>①</sup>

| Button Color | Inscription | Silver Bezel Catalog Number | Black Bezel Catalog Number   | Metal Bezel Catalog Number   |
|--------------|-------------|-----------------------------|------------------------------|------------------------------|
| Black        | —           | M22-D-S                     | M22S-D-S                     | M22M-D-S                     |
| Red          | —           | M22-D-R                     | M22S-D-R                     | M22M-D-R                     |
|              | STOP        | M22-D-R-GB0                 | M22S-D-R-GB0                 | —                            |
|              | ⊙           | M22-D-R-X0                  | M22S-D-R-X0                  | M22M-D-R-X0                  |
| Green        | —           | M22-D-G                     | M22S-D-G                     | M22M-D-G                     |
|              | START       | M22-D-G-GB1                 | M22S-D-G-GB1                 | M22M-D-G-GB1                 |
|              | ①           | M22-D-G-X1                  | M22S-D-G-X1                  | M22M-D-G-X1                  |
| White        | —           | M22-D-W                     | M22S-D-W                     | M22M-D-W                     |
| Blue         | —           | M22-D-B                     | M22S-D-B                     | M22M-D-B                     |
| Yellow       | —           | M22-D-Y                     | M22S-D-Y                     | M22M-D-Y                     |
| —            | —           | M22-D-X-SRSG <sup>②</sup>   | M22S-D-X-SRSG <sup>②</sup>   | M22M-D-X-SRSG <sup>②</sup>   |
|              | —           | M22-D-X-SWRGYB <sup>③</sup> | M22S-D-X-SWRGYB <sup>③</sup> | M22M-D-X-SWRGYB <sup>③</sup> |

M22S-D-G



M22M-D-G



M22-DG-G



## Silver Guarded

| Button Color | Inscription | Silver Bezel Catalog Number  |
|--------------|-------------|------------------------------|
| Black        | —           | M22-DG-S                     |
| Red          | —           | M22-DG-R                     |
| Green        | —           | M22-DG-G                     |
| White        | —           | M22-DG-W                     |
| Blue         | —           | M22-DG-B                     |
| Yellow       | —           | M22-DG-Y                     |
| —            | —           | M22-DG-X-SRSG <sup>②</sup>   |
|              | —           | M22-DG-X-SWRGYB <sup>③</sup> |

## Notes

- <sup>①</sup> Includes contact block mounting adapter.  
<sup>②</sup> Buttonless operator comes with three color buttons (black, red, green).  
<sup>③</sup> Buttonless operator comes with all six color buttons (black, white, red, green, yellow, blue).

Non-Illuminated Pushbuttons, Flush, Momentary

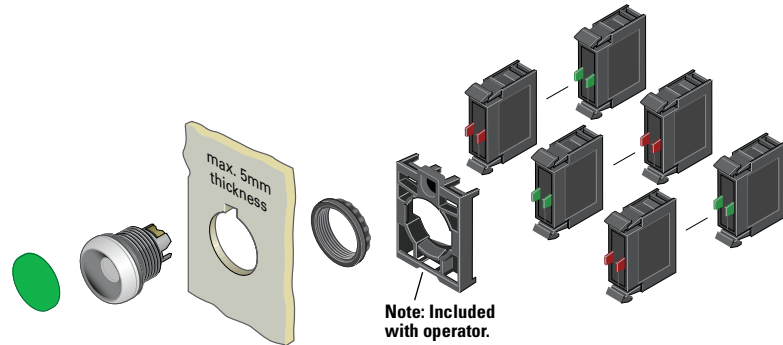

Components

M22-XD-G



Button Plates ①

| Color                                  | Inscription | Catalog Number  |
|--|-------------|-----------------|
| Black                                  | —           | M22-XD-S ②      |
|  | Custom      | M22-XD-S-ETCH ③ |
|  | STOP        | M22-XD-S-GB0    |
|  | START       | M22-XD-S-GB1    |
|  | CLOSE       | M22-XD-S-GB2    |
|  | UP          | M22-XD-S-GB3    |
|  | DOWN        | M22-XD-S-GB4    |
|  | OFF         | M22-XD-S-GB5    |
|  | ON          | M22-XD-S-GB6    |
|  | TEST        | M22-XD-S-GB9    |
|  | FORWARD     | M22-XD-S-GB15   |
|  | REVERSE     | M22-XD-S-GB16   |
|  | RAISE       | M22-XD-S-GB17   |
|  | LOWER       | M22-XD-S-GB18   |
|  | ⊙           | M22-XD-S-X0     |
|  | ⓪           | M22-XD-S-X1     |
|  | Ⓛ           | M22-XD-S-X2     |
|  | ⊕           | M22-XD-S-X4     |
| ⊖                                      | M22-XD-S-X5 |                 |
| Ⓛ                                      | M22-XD-S-X7 |                 |
| Red                                    | —           | M22-XD-R ②      |
|  | Custom      | M22-XD-R-ETCH ③ |
|  | STOP        | M22-XD-R-GB0    |
|  | OFF         | M22-XD-R-GB5    |
|  | ⊙           | M22-XD-R-X0     |
| Green                                  | —           | M22-XD-G ②      |
|  | Custom      | M22-XD-G-ETCH ③ |
|  | START       | M22-XD-G-GB1    |
|  | ON          | M22-XD-G-GB6    |
| Blue                                   | ⓪           | M22-XD-G-X1     |
|  | —           | M22-XD-B ②      |
|  | Custom      | M22-XD-B-ETCH ③ |
|  | RESET       | M22-XD-B-GB14   |
| White                                  | Ⓡ           | M22-XD-B-X6     |
|  | —           | M22-XD-W ②      |
|  | Custom      | M22-XD-W-ETCH ③ |
|  | START       | M22-XD-W-GB1    |
| Yellow                                 | ⓪           | M22-XD-W-X1     |
|  | —           | M22-XD-Y ②      |
| Black, red, green                      | Custom      | M22-XD-Y-ETCH ③ |
|  | —           | M22-XD-SRG      |
| Black, white, red, green, yellow, blue | —           | M22-XD-SWRGYB   |

M22-D-X



M22S-D-X



M22M-D-X



Buttonless Operator

| Silver Bezel Catalog Number ④ | Black Bezel Catalog Number ④ | Metal Bezel Catalog Number ④ |
|-------------------------------|------------------------------|------------------------------|
| M22-D-X                       | M22S-D-X                     | M22M-D-X                     |

M22-DG-X



Silver Guarded

| Silver Bezel Catalog Number ④ |
|-------------------------------|
| M22-DG-X                      |

M22-K10



Contact Blocks ①

| Terminal Type | Contact Configuration ⑤ | Catalog Number |
|---------------|-------------------------|----------------|
| Screw         | NO                      | M22-K10        |
|               | NO, early-make          | M22-K10P       |
|               | NC                      | M22-K01        |
|               | NC, late-break          | M22-K01D       |
| Spring-cage   | NO                      | M22-CK10       |
|               | NC                      | M22-CK01       |
|               | NC, late-break          | M22-CK01D      |
|               | 2NO                     | M22-CK20       |
|               | 2NC                     | M22-CK02       |
|               | NO-NC                   | M22-CK11       |

Notes

- ① For complete listing of available button plates and contact blocks, see Accessories, Pages V7-T1-111 to V7-T1-116.
- ② Minimum order quantity of (10).
- ③ When ordering, specify inscription per catalog number suffix from the Symbols Library (see Pages V7-T1-129 to V7-T1-136) into the Order Notes. For example, M22-XD-S-ETCH; Order Notes: Mark with symbol X91, Line item #\_.
- ④ Includes contact block mounting adapter.
- ⑤ All NC contact blocks are positively driven contact. ⊖

#### 1

#### Non-Illuminated Pushbuttons, Flush, Maintained <sup>①</sup>

M22-DR-S



M22S-DR-S



M22M-DR-S



#### Operators Only <sup>②</sup>

| Button Color | Silver Bezel<br>Catalog Number | Black Bezel<br>Catalog Number | Metal Bezel<br>Catalog Number |
|--------------|--------------------------------|-------------------------------|-------------------------------|
| Black        | M22-DR-S                       | M22S-DR-S                     | M22M-DR-S                     |
| Red          | M22-DR-R                       | M22S-DR-R                     | M22M-DR-R                     |
| Green        | M22-DR-G                       | M22S-DR-G                     | M22M-DR-G                     |
| White        | M22-DR-W                       | M22S-DR-W                     | M22M-DR-W                     |
| Blue         | M22-DR-B                       | M22S-DR-B                     | M22M-DR-B                     |
| Yellow       | M22-DR-Y                       | M22S-DR-Y                     | M22M-DR-Y                     |
| ③            | M22-DR-X-SRG                   | M22S-DR-X-SRG                 | M22M-DR-X-SRG                 |
| ④            | M22-DR-X-SWRGYB                | M22S-DR-X-SWRGYB              | M22M-DR-X-SWRGYB              |

#### Notes

- ① Maintained pushbuttons can be converted in the field to momentary operation by switching the locking ring, which is accessible through the side of the operator body.
- ② Includes contact block mounting adapter.
- ③ Buttonless operator comes with three color buttons (black, red, green).
- ④ Buttonless operator comes with all six color buttons (black, white, red, green, yellow, blue).

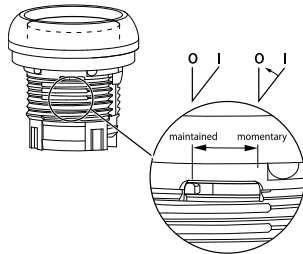

**Note:** This pilot device features a selectable function switch that enables the device to be set to either maintained or momentary operation.

### Non-Illuminated Pushbuttons, Flush, Maintained <sup>①</sup>

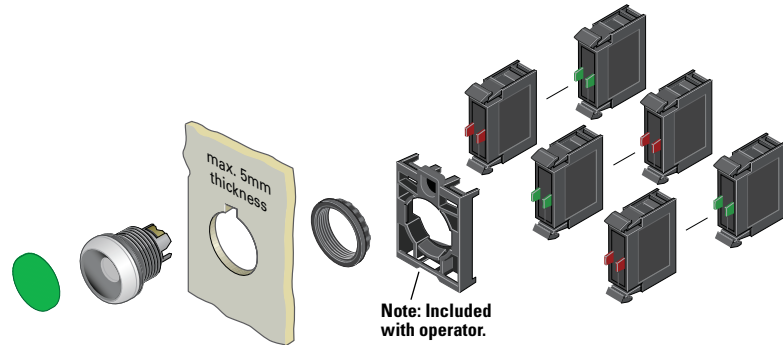

### Components

#### M22-XD-S



#### Button Plates <sup>②</sup>

| Color                                  | Inscription | Catalog Number             |
|--|-------------|----------------------------|
| Black                                  | —           | M22-XD-S <sup>③</sup>      |
|  | Custom      | M22-XD-S-ETCH <sup>④</sup> |
|  | STOP        | M22-XD-S-GB0               |
|  | START       | M22-XD-S-GB1               |
|  | CLOSE       | M22-XD-S-GB2               |
|  | UP          | M22-XD-S-GB3               |
|  | DOWN        | M22-XD-S-GB4               |
|  | OFF         | M22-XD-S-GB5               |
|  | ON          | M22-XD-S-GB6               |
|  | TEST        | M22-XD-S-GB9               |
|  | FORWARD     | M22-XD-S-GB15              |
|  | REVERSE     | M22-XD-S-GB16              |
|  | RAISE       | M22-XD-S-GB17              |
|  | LOWER       | M22-XD-S-GB18              |
|  | ⊙           | M22-XD-S-X0                |
|  | ⓪           | M22-XD-S-X1                |
|  | Ⓛ           | M22-XD-S-X2                |
|  | +           | M22-XD-S-X4                |
| −                                      | M22-XD-S-X5 |                            |
| Ⓛ                                      | M22-XD-S-X7 |                            |
| Red                                    | —           | M22-XD-R <sup>③</sup>      |
|  | Custom      | M22-XD-R-ETCH <sup>④</sup> |
|  | STOP        | M22-XD-R-GB0               |
|  | OFF         | M22-XD-R-GB5               |
|  | ⊙           | M22-XD-R-X0                |
|  | ⓪           | M22-XD-R-X1                |
| Green                                  | —           | M22-XD-G <sup>③</sup>      |
|  | Custom      | M22-XD-G-ETCH <sup>④</sup> |
|  | START       | M22-XD-G-GB1               |
|  | ON          | M22-XD-G-GB6               |
|  | ⓪           | M22-XD-G-X1                |
| Blue                                   | —           | M22-XD-B <sup>③</sup>      |
|  | Custom      | M22-XD-B-ETCH <sup>④</sup> |
|  | RESET       | M22-XD-B-GB14              |
|  | Ⓜ           | M22-XD-B-X6                |
| White                                  | —           | M22-XD-W <sup>③</sup>      |
|  | Custom      | M22-XD-W-ETCH <sup>④</sup> |
|  | START       | M22-XD-W-GB1               |
| Yellow                                 | ⓪           | M22-XD-W-X1                |
|  | —           | M22-XD-Y <sup>③</sup>      |
| Black, red, green                      | —           | M22-XD-S-ETCH <sup>④</sup> |
|  | —           | M22-XD-SRG                 |
| Black, white, red, green, yellow, blue | —           | M22-XD-SWRGYB              |

#### M22-DR-X



#### M22S-DR-X



#### M22M-DR-X



#### Buttonless Operator

| Silver Bezel Catalog Number <sup>⑤</sup> | Black Bezel Catalog Number <sup>⑤</sup> | Metal Bezel Catalog Number <sup>⑤</sup> |
|--|---|---|
| M22-DR-X                                 | M22S-DR-X                               | M22M-DR-X                               |

#### M22-K10



#### Contact Blocks <sup>②</sup>

| Terminal Type | Contact Configuration <sup>⑥</sup> | Catalog Number |
|---------------|------------------------------------|----------------|
| Screw         | NO                                 | M22-K10        |
|               | NO, early-make                     | M22-K10P       |
|               | NC                                 | M22-K01        |
|               | NC, late-break                     | M22-K01D       |
| Spring-cage   | NO                                 | M22-CK10       |
|               | NC                                 | M22-CK01       |
|               | NC, late-break                     | M22-CK01D      |
|               | 2NO                                | M22-CK20       |
|               | 2NC                                | M22-CK02       |
|               | NO-NC                              | M22-CK11       |

#### Notes

- ① Maintained pushbuttons can be converted in the field to momentary operation by switching the locking ring, which is accessible through the side of the operator body.
- ② For complete listing of available button plates and contact blocks, see Accessories, Pages V7-T1-111 to V7-T1-116.
- ③ Minimum order quantity of (10).
- ④ When ordering, specify inscription per catalog number suffix from the Symbols Library (see Pages V7-T1-129 to V7-T1-136) into the Order Notes. For example, M22-XD-S-ETCH; Order Notes: Mark with symbol X91, Line item #\_.
- ⑤ Includes contact block mounting adapter.
- ⑥ All NC contact blocks are positively driven contact. ⊖

#### 1 Non-Illuminated Pushbuttons, Extended, Momentary

M22-DH-R-K10



M22S-DH-R-K10



M22M-DH-R-K10



#### Complete Devices

| Button Color | Contact Block Configuration <sup>①</sup> | Silver Bezel Catalog Number | Black Bezel Catalog Number | Metal Bezel Catalog Number |
|--------------|--|-----------------------------|----------------------------|----------------------------|
| Red          | NO                                       | M22-DH-R-K10                | M22S-DH-R-K10              | M22M-DH-R-K10              |
|              | NC                                       | M22-DH-R-K01                | M22S-DH-R-K01              | M22M-DH-R-K01              |
|              | 2NO                                      | M22-DH-R-K20                | M22S-DH-R-K20              | M22M-DH-R-K20              |
|              | 2NC                                      | M22-DH-R-K02                | M22S-DH-R-K02              | M22M-DH-R-K02              |
|              | 1NO-1NC                                  | M22-DH-R-K11                | M22S-DH-R-K11              | M22M-DH-R-K11              |

M22-DGH-R-K10



#### Silver Guarded

| Button Color | Contact Block Configuration <sup>①</sup> | Silver Bezel Catalog Number |
|--------------|--|-----------------------------|
| Red          | NO                                       | M22-DGH-R-K10               |
|              | NC                                       | M22-DGH-R-K01               |
|              | 2NO                                      | M22-DGH-R-K20               |
|              | 2NC                                      | M22-DGH-R-K02               |
|              | 1NO-1NC                                  | M22-DGH-R-K11               |

M22-DH-R



M22S-DH-R



M22M-DH-R



#### Operators Only <sup>②</sup>

| Button Color | Inscription | Silver Bezel Catalog Number | Black Bezel Catalog Number | Metal Bezel Catalog Number |
|--------------|-------------|-----------------------------|----------------------------|----------------------------|
| Black        | —           | M22-DH-S                    | M22S-DH-S                  | M22M-DH-S                  |
| Red          | —           | M22-DH-R                    | M22S-DH-R                  | M22M-DH-R                  |
|              | STOP        | M22-DH-R-GB0                | M22S-DH-R-GB0              | M22M-DH-R-GB0              |
|              | ⊙           | M22-DH-R-X0                 | M22S-DH-R-X0               | M22M-DH-R-X0               |
| Green        | —           | M22-DH-G                    | M22S-DH-G                  | M22M-DH-G                  |
| White        | —           | M22-DH-W                    | M22S-DH-W                  | M22M-DH-W                  |
| Blue         | —           | M22-DH-B                    | M22S-DH-B                  | M22M-DH-B                  |
| Yellow       | —           | M22-DH-Y                    | M22S-DH-Y                  | M22M-DH-Y                  |
| ③            | —           | M22-DH-X-SRGR               | M22S-DH-X-SRGR             | M22M-DH-X-SRGR             |
| ④            | —           | M22-DH-X-SWRGRYB            | M22S-DH-X-SWRGRYB          | M22M-DH-X-SWRGRYB          |

M22-DGH-R-K10



#### Silver Guarded

| Button Color | Inscription | Silver Bezel Catalog Number |
|--------------|-------------|-----------------------------|
| Black        | —           | M22-DGH-S                   |
| Red          | —           | M22-DGH-R                   |
|              | STOP        | M22-DGH-R-GB0               |
|              | ⊙           | M22-DGH-R-X0                |
| Green        | —           | M22-DGH-G                   |
| White        | —           | M22-DGH-W                   |
| Blue         | —           | M22-DGH-B                   |
| Yellow       | —           | M22-DGH-Y                   |

#### Notes

- ① All NC contact blocks are positively driven contact. ⊖
- ② Includes contact block mounting adapter.
- ③ Buttonless operator comes with three color buttons (black, red, green).
- ④ Buttonless operator comes with all six color buttons (black, white, red, green, yellow, blue).

Non-Illuminated Pushbuttons, Extended, Momentary

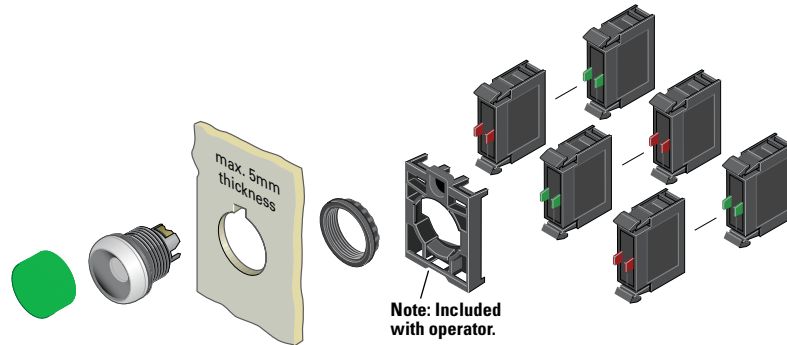

Components

M22-XDH-R



Button Plates ①

| Color                                  | Inscription  | Catalog Number   |
|--|--------------|------------------|
| Black                                  | —            | M22-XDH-S ②      |
|  | Custom       | M22-XDH-S-ETCH ③ |
|  | STOP         | M22-XDH-S-GB0    |
|  | START        | M22-XDH-S-GB1    |
|  | CLOSE        | M22-XDH-S-GB2    |
|  | UP           | M22-XDH-S-GB3    |
|  | DOWN         | M22-XDH-S-GB4    |
|  | OFF          | M22-XDH-S-GB5    |
|  | ON           | M22-XDH-S-GB6    |
|  | TEST         | M22-XDH-S-GB9    |
|  | FORWARD      | M22-XDH-S-GB15   |
|  | REVERSE      | M22-XDH-S-GB16   |
|  | RAISE        | M22-XDH-S-GB17   |
|  | LOWER        | M22-XDH-S-GB18   |
|  | ⊙            | M22-XDH-S-X0     |
|  | ①            | M22-XDH-S-X1     |
|  | ②            | M22-XDH-S-X2     |
|  | +            | M22-XDH-S-X4     |
| −                                      | M22-XDH-S-X5 |                  |
| ①                                      | M22-XDH-S-X7 |                  |
| Red                                    | —            | M22-XDH-R ②      |
|  | Custom       | M22-XDH-R-ETCH ③ |
|  | STOP         | M22-XDH-R-GB0    |
|  | OFF          | M22-XDH-R-GB5    |
|  | ⊙            | M22-XDH-R-X0     |
| Green                                  | —            | M22-XDH-G ②      |
|  | Custom       | M22-XDH-G-ETCH ③ |
|  | START        | M22-XDH-G-GB1    |
|  | ON           | M22-XDH-G-GB6    |
|  | ①            | M22-XDH-G-X1     |
| Blue                                   | —            | M22-XDH-B ②      |
|  | Custom       | M22-XDH-B-ETCH ③ |
|  | RESET        | M22-XDH-B-GB14   |
|  | Ⓜ            | M22-XDH-B-X6     |
| White                                  | —            | M22-XDH-W ②      |
|  | Custom       | M22-XDH-W-ETCH ③ |
|  | START        | M22-XDH-W-GB1    |
|  | ①            | M22-XDH-W-X1     |
| Yellow                                 | —            | M22-XDH-Y ②      |
|  | Custom       | M22-XDH-Y-ETCH ③ |
| Black, red, green                      | —            | M22-XDH-SRG      |
| Black, white, red, green, yellow, blue | —            | M22-XDH-SWRGYB   |

M22-D-X



M22S-D-X



M22M-D-X



M22-DG-X



M22-K10



Buttonless Operator

| Silver Bezel Catalog Number ④ | Black Bezel Catalog Number ④ | Metal Bezel Catalog Number ④ |
|-------------------------------|------------------------------|------------------------------|
| M22-D-X                       | M22S-D-X                     | M22M-D-X                     |

Silver Guarded

| Silver Bezel Catalog Number ④ |
|-------------------------------|
| M22-DG-X                      |

Contact Blocks ①

| Terminal Type | Contact Configuration ⑤ | Catalog Number |
|---------------|-------------------------|----------------|
| Screw         | NO                      | M22-K10        |
|               | NO, early-make          | M22-K10P       |
|               | NC                      | M22-K01        |
| Spring-cage   | NC, late-break          | M22-K01D       |
|               | NO                      | M22-CK10       |
|               | NC                      | M22-CK01       |
|               | NC, late-break          | M22-CK01D      |
|               | 2NO                     | M22-CK20       |
|               | 2NC                     | M22-CK02       |
|               | NO-NC                   | M22-CK11       |

Notes

- ① For complete listing of available button plates and contact blocks, see Accessories, Pages V7-T1-111 to V7-T1-116.
- ② Minimum order quantity of (10).
- ③ When ordering, specify inscription per catalog number suffix from the Symbols Library (see Pages V7-T1-129 to V7-T1-136) into the Order Notes. For example, M22-XDH-S-ETCH; Order Notes: Mark with symbol X91, Line item # \_.
- ④ Includes contact block mounting adapter.
- ⑤ All NC contact blocks are positively driven contact. ⊖



#### 1 Non-Illuminated Pushbuttons, Extended, Maintained <sup>①</sup>

##### Operators Only <sup>②</sup>

M22-DRH-W



M22S-DRH-W



M22M-DRH-W



| Button Color | Silver Bezel Catalog Number | Black Bezel Catalog Number | Metal Bezel Catalog Number |
|--------------|-----------------------------|----------------------------|----------------------------|
| Black        | M22-DRH-S                   | M22S-DRH-S                 | M22M-DRH-S                 |
| Red          | M22-DRH-R                   | M22S-DRH-R                 | M22M-DRH-R                 |
| Green        | M22-DRH-G                   | M22S-DRH-G                 | M22M-DRH-G                 |
| White        | M22-DRH-W                   | M22S-DRH-W                 | M22M-DRH-W                 |
| Blue         | M22-DRH-B                   | M22S-DRH-B                 | M22M-DRH-B                 |
| Yellow       | M22-DRH-Y                   | M22S-DRH-Y                 | M22M-DRH-Y                 |
| ③            | M22-DRH-X-SRG               | M22S-DRH-X-SRG             | M22M-DRH-X-SRG             |
| ④            | M22-DRH-X-SWRGYB            | M22S-DRH-X-SWRGYB          | M22M-DRH-X-SWRGYB          |

#### Notes

- ① Maintained pushbuttons can be converted in the field to momentary operation by switching the locking ring, which is accessible through the side of the operator body.
- ② Includes contact block mounting adapter.
- ③ Buttonless operator comes with three color buttons (black, red, green).
- ④ Buttonless operator comes with all six color buttons (black, white, red, green, yellow, blue).

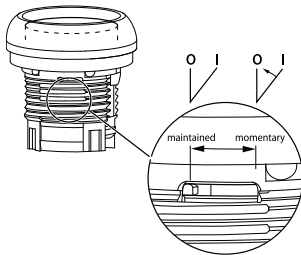

**Note:** This pilot device features a selectable function switch that enables the device to be set to either maintained or momentary operation.

### Non-Illuminated Pushbuttons, Extended, Maintained <sup>①</sup>

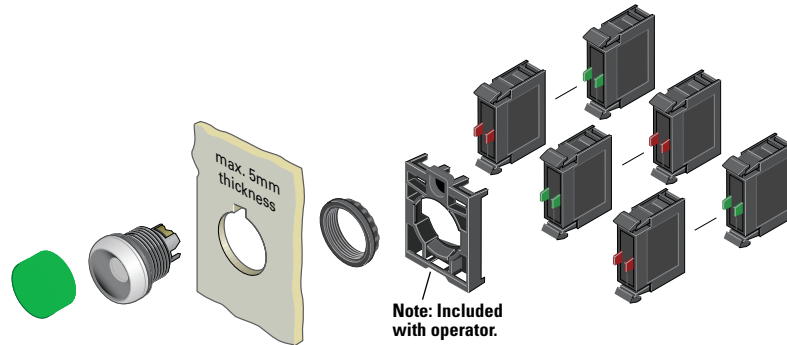

### Components

#### M22-XDH-W



#### Button Plates <sup>②</sup>

| Color                                  | Inscription  | Catalog Number              |
|--|--------------|-----------------------------|
| Black                                  | —            | M22-XDH-S <sup>③</sup>      |
|  | Custom       | M22-XDH-S-ETCH <sup>④</sup> |
|  | STOP         | M22-XDH-S-GB0               |
|  | START        | M22-XDH-S-GB1               |
|  | CLOSE        | M22-XDH-S-GB2               |
|  | UP           | M22-XDH-S-GB3               |
|  | DOWN         | M22-XDH-S-GB4               |
|  | OFF          | M22-XDH-S-GB5               |
|  | ON           | M22-XDH-S-GB6               |
|  | TEST         | M22-XDH-S-GB9               |
|  | FORWARD      | M22-XDH-S-GB15              |
|  | REVERSE      | M22-XDH-S-GB16              |
|  | RAISE        | M22-XDH-S-GB17              |
|  | LOWER        | M22-XDH-S-GB18              |
|  | ⊙            | M22-XDH-S-X0                |
|  | ①            | M22-XDH-S-X1                |
|  | ②            | M22-XDH-S-X2                |
|  | ⊕            | M22-XDH-S-X4                |
| ⊖                                      | M22-XDH-S-X5 |                             |
| ①                                      | M22-XDH-S-X7 |                             |
| Red                                    | —            | M22-XDH-R <sup>③</sup>      |
|  | Custom       | M22-XDH-R-ETCH <sup>④</sup> |
|  | STOP         | M22-XDH-R-GB0               |
|  | OFF          | M22-XDH-R-GB5               |
|  | ⊙            | M22-XDH-R-X0                |
|  | ①            | M22-XDH-R-X1                |
| Green                                  | —            | M22-XDH-G <sup>③</sup>      |
|  | Custom       | M22-XDH-G-ETCH <sup>④</sup> |
|  | START        | M22-XDH-G-GB1               |
|  | ON           | M22-XDH-G-GB6               |
|  | ①            | M22-XDH-G-X1                |
| Blue                                   | —            | M22-XDH-B <sup>③</sup>      |
|  | Custom       | M22-XDH-B-ETCH <sup>④</sup> |
|  | RESET        | M22-XDH-B-GB14              |
|  | Ⓜ            | M22-XDH-B-X6                |
| White                                  | —            | M22-XDH-W <sup>③</sup>      |
|  | Custom       | M22-XDH-W-ETCH <sup>④</sup> |
|  | START        | M22-XDH-W-GB1               |
|  | ①            | M22-XDH-W-X1                |
| Yellow                                 | —            | M22-XDH-Y <sup>③</sup>      |
|  | Custom       | M22-XDH-Y-ETCH <sup>④</sup> |
| Black, red, green                      | —            | M22-XDH-SRG                 |
| Black, white, red, green, yellow, blue | —            | M22-XDH-SWRGYB              |

#### M22-DR-X



#### M22S-DR-X



#### M22M-DR-X



#### Buttonless Operator

| Silver Bezel Catalog Number <sup>⑤</sup> | Black Bezel Catalog Number <sup>⑤</sup> | Metal Bezel Catalog Number <sup>⑤</sup> |
|--|---|---|
| M22-DR-X                                 | M22S-DR-X                               | M22M-DR-X                               |

#### M22-K10



#### Contact Blocks <sup>②</sup>

| Terminal Type | Contact Configuration <sup>⑥</sup> | Catalog Number |
|---------------|------------------------------------|----------------|
| Screw         | NO                                 | M22-K10        |
|               | NO, early-make                     | M22-K10P       |
|               | NC                                 | M22-K01        |
|               | NC, late-break                     | M22-K01D       |
| Spring-cage   | NO                                 | M22-CK10       |
|               | NC                                 | M22-CK01       |
|               | NC, late-break                     | M22-CK01D      |
|               | 2NO                                | M22-CK20       |
|               | NO-NC                              | M22-CK11       |

#### Notes

- ① Maintained pushbuttons can be converted in the field to momentary operation by switching the locking ring, which is accessible through the side of the operator body.
- ② For complete listing of available button plates and contact blocks, see Accessories, Pages V7-T1-111 to V7-T1-116.
- ③ Minimum order quantity of (10).
- ④ When ordering, specify inscription per catalog number suffix from the Symbols Library (see Pages V7-T1-129 to V7-T1-136) into the Order Notes. For example, M22-XDH-S-ETCH; Order Notes: Mark with symbol X91, Line item # \_.
- ⑤ Includes contact block mounting adapter.
- ⑥ All NC contact blocks are positively driven contact. ⊖

#### 1

### Catalog Number Selection

Catalog Number Selection is for illustrative purposes only and not to be used to create new catalog numbers.

#### Illuminated Pushbuttons

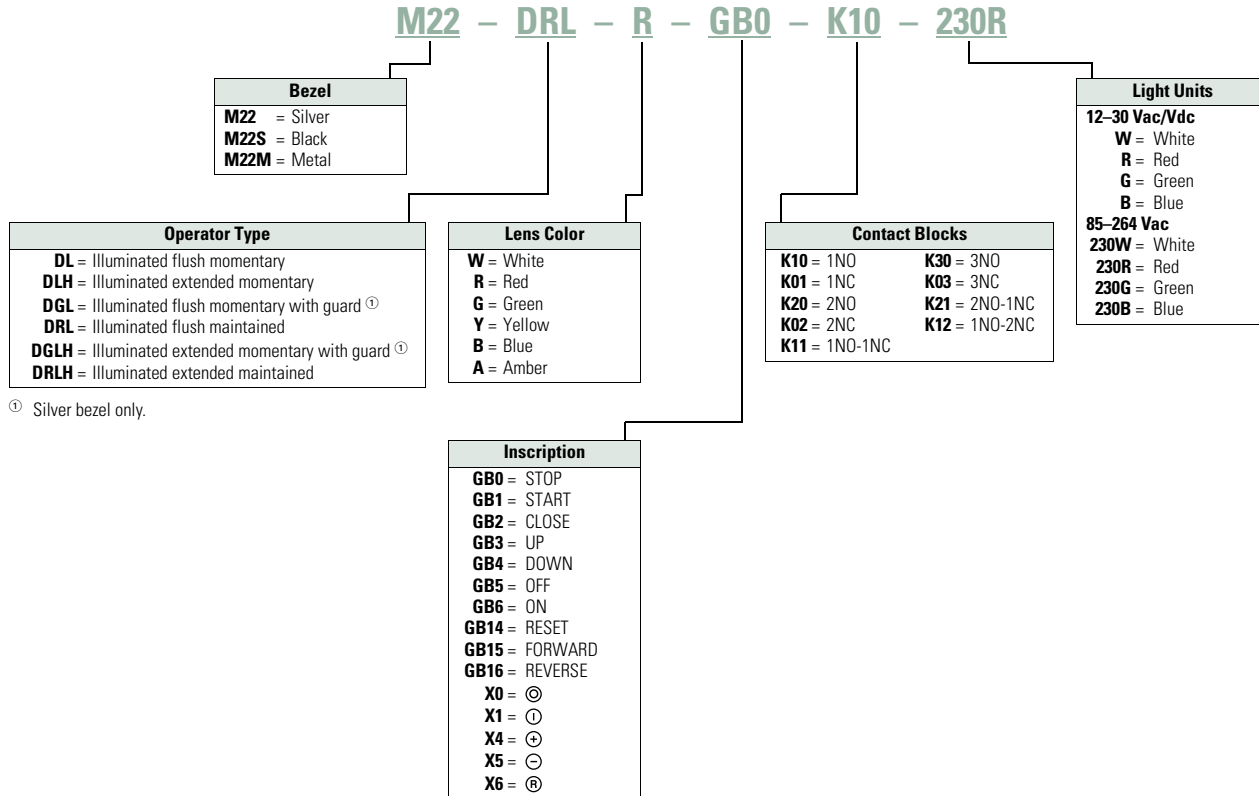

**Product Selection**

**Illuminated Pushbuttons, Flush, Momentary**

**M22-DL-G-K01-G**



**Complete Devices**

| Button Color    | Contact Block Configuration <sup>①</sup> | Light Unit Voltage | Silver Bezel Catalog Number | Black Bezel Catalog Number | Metal Bezel Catalog Number |
|-----------------|--|--------------------|-----------------------------|----------------------------|----------------------------|
| Red             | NC                                       | 12–30 Vac/Vdc      | M22-DL-R-K01-R              | M22S-DL-R-K01-R            | M22M-DL-R-K01-R            |
|                 | NC                                       | 85–264 Vac         | M22-DL-R-K01-230R           | M22S-DL-R-K01-230R         | M22M-DL-R-K01-230R         |
|                 | 2NC                                      | 12–30 Vac/Vdc      | M22-DL-R-K02-R              | M22S-DL-R-K02-R            | M22M-DL-R-K02-R            |
|                 | 2NC                                      | 85–264 Vac         | M22-DL-R-K02-230R           | M22S-DL-R-K02-230R         | M22M-DL-R-K02-230R         |
| Green           | 1NO/1NC                                  | 12–30 Vac/Vdc      | M22-DL-R-K11-R              | M22S-DL-R-K11-R            | M22M-DL-R-K11-R            |
|                 | 1NO/1NC                                  | 85–264 Vac         | M22-DL-R-K11-230R           | M22S-DL-R-K11-230R         | M22M-DL-R-K11-230R         |
|                 | NO                                       | 12–30 Vac/Vdc      | M22-DL-G-K10-G              | M22S-DL-G-K10-G            | M22M-DL-G-K10-G            |
|                 | NO                                       | 85–264 Vac         | M22-DL-G-K10-230G           | M22S-DL-G-K10-230G         | M22M-DL-G-K10-230G         |
| M22M-DL-G-K01-G | 2NO                                      | 12–30 Vac/Vdc      | M22-DL-G-K20-G              | M22S-DL-G-K20-G            | M22M-DL-G-K20-G            |
|                 | 2NO                                      | 85–264 Vac         | M22-DL-G-K20-230G           | M22S-DL-G-K20-230G         | M22M-DL-G-K20-230G         |
|                 | 1NO/1NC                                  | 12–30 Vac/Vdc      | M22-DL-G-K11-G              | M22S-DL-G-K11-G            | M22M-DL-G-K11-G            |
|                 | 1NO/1NC                                  | 85–264 Vac         | M22-DL-G-K11-230G           | M22S-DL-G-K11-230G         | M22M-DL-G-K11-230G         |
| White           | NO                                       | 12–30 Vac/Vdc      | M22-DL-W-K10-W              | M22S-DL-W-K10-W            | —                          |
|                 | NO                                       | 85–264 Vac         | M22-DL-W-K10-230W           | M22S-DL-W-K10-230W         | M22M-DL-W-K10-230W         |
|                 | 2NO                                      | 12–30 Vac/Vdc      | M22-DL-W-K20-W              | M22S-DL-W-K20-W            | —                          |
|                 | 2NO                                      | 85–264 Vac         | M22-DL-W-K20-230W           | M22S-DL-W-K20-230W         | M22M-DL-W-K20-230W         |
|                 | 1NO/1NC                                  | 12–30 Vac/Vdc      | M22-DL-W-K11-W              | M22S-DL-W-K11-W            | —                          |
|                 | 1NO/1NC                                  | 85–264 Vac         | M22-DL-W-K11-230W           | M22S-DL-W-K11-230W         | M22M-DL-W-K11-230W         |

**Note**

<sup>①</sup> All NC contact blocks are positively driven contact. ⊖

1

#### Illuminated Pushbuttons, Flush, Momentary

M22-DL-G



M22S-DL-G



M22M-DL-G



M22-DGL-G



#### Operators Only <sup>Ⓢ</sup>

| Button Color | Silver Bezel<br>Catalog Number | Black Bezel<br>Catalog Number | Metal Bezel<br>Catalog Number |
|--------------|--------------------------------|-------------------------------|-------------------------------|
| Red          | <b>M22-DL-R</b>                | <b>M22S-DL-R</b>              | <b>M22M-DL-R</b>              |
| Green        | <b>M22-DL-G</b>                | <b>M22S-DL-G</b>              | <b>M22M-DL-G</b>              |
| White        | <b>M22-DL-W</b>                | <b>M22S-DL-W</b>              | <b>M22M-DL-W</b>              |
| Blue         | <b>M22-DL-B</b>                | <b>M22S-DL-B</b>              | <b>M22M-DL-B</b>              |
| Yellow       | <b>M22-DL-Y</b>                | <b>M22S-DL-Y</b>              | <b>M22M-DL-Y</b>              |
| Amber        | <b>M22-DL-A</b>                | <b>M22S-DL-A</b>              | <b>M22M-DL-A</b>              |

#### Silver Guarded

| Button Color | Silver Bezel<br>Catalog Number |
|--------------|--------------------------------|
| Red          | <b>M22-DGL-R</b>               |
| Green        | <b>M22-DGL-G</b>               |
| White        | <b>M22-DGL-W</b>               |
| Blue         | <b>M22-DGL-B</b>               |
| Yellow       | <b>M22-DGL-Y</b>               |

**Note**

<sup>Ⓢ</sup> Includes contact block mounting adapter.

### Illuminated Pushbuttons, Flush, Momentary

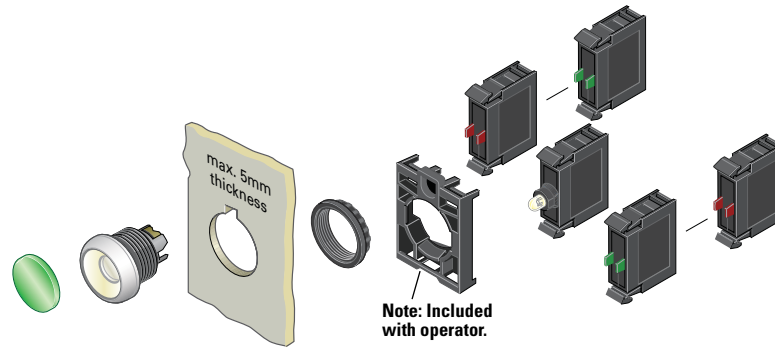

### Components

#### M22-XDL-G



#### Button Lenses ①

| Color  | Inscription | Catalog Number   |
|--------|-------------|------------------|
| Red    | —           | M22-XDL-R ②      |
|        | Custom      | M22-XDL-R-ETCH ③ |
|        | STOP        | M22-XDL-R-GB0    |
|        | OFF         | M22-XDL-R-GB5    |
|        | Ⓞ           | M22-XDL-R-X0     |
| Green  | —           | M22-XDL-G ②      |
|        | Custom      | M22-XDL-G-ETCH ③ |
|        | START       | M22-XDL-G-GB1    |
|        | ON          | M22-XDL-G-GB6    |
|        | Ⓛ           | M22-XDL-G-X1     |
| Blue   | —           | M22-XDL-B ②      |
|        | Custom      | M22-XDL-B-ETCH ③ |
|        | RESET       | M22-XDL-B-GB14   |
| White  | Ⓡ           | M22-XDL-B-X6     |
|        | —           | M22-XDL-W ②      |
| Yellow | Custom      | M22-XDL-W-ETCH ③ |
|        | —           | M22-XDL-Y ②      |
| Amber  | Custom      | M22-XDL-Y-ETCH ③ |
|        | —           | M22-XDL-A        |
|        | Custom      | M22-XDL-A-ETCH   |

#### M22-LED-W



#### Light Units ①

| Terminal Type | LED Color | Light Unit Voltage | Catalog Number |
|---------------|-----------|--------------------|----------------|
| Screw         | White     | 12–30 Vac/Vdc      | M22-LED-W      |
|               | Red       |                    | M22-LED-R      |
|               | Green     |                    | M22-LED-G      |
|               | Blue      |                    | M22-LED-B      |
| Screw         | White     | 85–264 Vac         | M22-LED230-W   |
|               | Red       |                    | M22-LED230-R   |
|               | Green     |                    | M22-LED230-G   |
|               | Blue      |                    | M22-LED230-B   |

#### M22-K10



#### Contact Blocks ①

| Terminal Type | Contact Configuration ⑤ | Catalog Number |
|---------------|-------------------------|----------------|
| Screw         | NO                      | M22-K10        |
|               | NO, early-make          | M22-K10P       |
|               | NC                      | M22-K01        |
|               | NC, late-break          | M22-K01D       |
| Spring-cage   | NO                      | M22-CK10       |
|               | NC                      | M22-CK01       |
|               | NC, late-break          | M22-CK01D      |
|               | 2NO                     | M22-CK20       |
|               | 2NC                     | M22-CK02       |
|               | NO-NC                   | M22-CK11       |

#### M22-DL-X



#### Buttonless Operator

| Silver Bezel Catalog Number ④ | Black Bezel Catalog Number ④ | Metal Bezel Catalog Number ④ |
|-------------------------------|------------------------------|------------------------------|
| M22-DL-X                      | M22S-DL-X                    | M22M-DL-X                    |

#### M22S-DL-X



#### M22M-DL-X



#### M22-DGL-X



#### Silver Guarded

| Silver Bezel Catalog Number ④ |
|-------------------------------|
| M22-DGL-X                     |

#### Notes

- ① For complete listing of available button lenses, light units and contact blocks, see Accessories, **Pages V7-T1-111 to V7-T1-116**.
- ② Minimum order quantity of (10).
- ③ When ordering, specify inscription per catalog number suffix from the Symbols Library (see **Pages V7-T1-129 to V7-T1-136**) into the Order Notes. For example, M22-XDL-R-ETCH; Order Notes: Mark with symbol X91, Line item #\_.
- ④ Includes contact block mounting adapter.
- ⑤ All NC contact blocks are positively driven contact. ⊖

1

#### Illuminated Pushbuttons, Flush, Maintained <sup>②</sup>

##### M22-DRL-W-K10-W



##### M22S-DRL-W-K10-W



##### M22M-DRL-W-K10-W



#### Complete Devices

| Button Color | Contact Block Configuration <sup>①</sup> | Light Unit Voltage | Silver Bezel Catalog Number | Black Bezel Catalog Number | Metal Bezel Catalog Number |
|--------------|--|--------------------|-----------------------------|----------------------------|----------------------------|
| White        | NO                                       | 12–30 Vac/Vdc      | M22-DRL-W-K10-W             | M22S-DRL-W-K10-W           | M22M-DRL-W-K10-W           |
|              | NO                                       | 85–264 Vac         | M22-DRL-W-K10-230W          | M22S-DRL-W-K10-230W        | M22M-DRL-W-K10-230W        |
|              | NC                                       | 12–30 Vac/Vdc      | M22-DRL-W-K01-W             | M22S-DRL-W-K01-W           | M22M-DRL-W-K01-W           |
|              | NC                                       | 85–264 Vac         | M22-DRL-W-K01-230W          | M22S-DRL-W-K01-230W        | M22M-DRL-W-K01-230W        |
|              | 2NO                                      | 12–30 Vac/Vdc      | M22-DRL-W-K20-W             | M22S-DRL-W-K20-W           | M22M-DRL-W-K20-W           |
|              | 2NO                                      | 85–264 Vac         | M22-DRL-W-K20-230W          | M22S-DRL-W-K20-230W        | M22M-DRL-W-K20-230W        |
|              | 2NC                                      | 12–30 Vac/Vdc      | M22-DRL-W-K02-W             | M22S-DRL-W-K02-W           | M22M-DRL-W-K02-W           |
|              | 2NC                                      | 85–264 Vac         | M22-DRL-W-K02-230W          | M22S-DRL-W-K02-230W        | M22M-DRL-W-K02-230W        |
|              | 1NO/1NC                                  | 12–30 Vac/Vdc      | M22-DRL-W-K11-W             | M22S-DRL-W-K11-W           | M22M-DRL-W-K11-W           |
|              | 1NO/1NC                                  | 85–264 Vac         | M22-DRL-W-K11-230W          | M22S-DRL-W-K11-230W        | M22M-DRL-W-K11-230W        |

##### M22-DRL-W



##### M22S-DRL-W



##### M22M-DRL-W



#### Operators Only <sup>③</sup>

| Button Color | Silver Bezel Catalog Number | Black Bezel Catalog Number | Metal Bezel Catalog Number |
|--------------|-----------------------------|----------------------------|----------------------------|
| Red          | M22-DRL-R                   | M22S-DRL-R                 | M22M-DRL-R                 |
| Green        | M22-DRL-G                   | M22S-DRL-G                 | M22M-DRL-G                 |
| White        | M22-DRL-W                   | M22S-DRL-W                 | M22M-DRL-W                 |
| Blue         | M22-DRL-B                   | M22S-DRL-B                 | M22M-DRL-B                 |
| Yellow       | M22-DRL-Y                   | M22S-DRL-Y                 | M22M-DRL-Y                 |
| Amber        | M22-DRL-A                   | M22S-DRL-A                 | M22M-DRL-A                 |

#### Notes

- ① All NC contact blocks are positively driven contact. ⊖
- ② Maintained pushbuttons can be converted in the field to momentary operation by switching the locking ring, which is accessible through the side of the operator body.
- ③ Includes contact block mounting adapter.

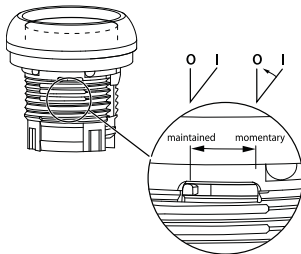

**Note:** This pilot device features a selectable function switch that enables the device to be set to either maintained or momentary operation.

### Illuminated Pushbuttons, Flush, Maintained <sup>①</sup>

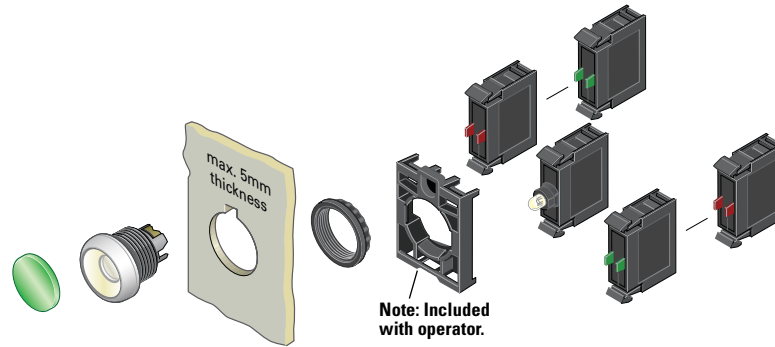

### Components

#### M22-XDL-W



#### Button Lenses <sup>②</sup>

| Color  | Inscription | Catalog Number                     |
|--------|-------------|------------------------------------|
| Red    | —           | <b>M22-XDL-R</b> <sup>③</sup>      |
|        | Custom      | <b>M22-XDL-R-ETCH</b> <sup>④</sup> |
|        | STOP        | <b>M22-XDL-R-GB0</b>               |
|        | OFF         | <b>M22-XDL-R-GB5</b>               |
|        | ⊙           | <b>M22-XDL-R-X0</b>                |
| Green  | —           | <b>M22-XDL-G</b> <sup>③</sup>      |
|        | Custom      | <b>M22-XDL-G-ETCH</b> <sup>④</sup> |
|        | START       | <b>M22-XDL-G-GB1</b>               |
|        | ON          | <b>M22-XDL-G-GB6</b>               |
|        | Ⓛ           | <b>M22-XDL-G-X1</b>                |
| Blue   | —           | <b>M22-XDL-B</b> <sup>③</sup>      |
|        | Custom      | <b>M22-XDL-B-ETCH</b> <sup>④</sup> |
|        | RESET       | <b>M22-XDL-B-GB14</b>              |
| White  | Ⓜ           | <b>M22-XDL-B-X6</b>                |
|        | Custom      | <b>M22-XDL-W-ETCH</b> <sup>④</sup> |
| Yellow | —           | <b>M22-XDL-Y</b> <sup>③</sup>      |
|        | Custom      | <b>M22-XDL-Y-ETCH</b> <sup>④</sup> |
| Amber  | —           | <b>M22-XDL-A</b>                   |
|        | Custom      | <b>M22-XDL-A-ETCH</b>              |

#### M22-LED-W



#### Light Units <sup>②</sup>

| Terminal Type | LED Color | Light Unit Voltage | Catalog Number      |
|---------------|-----------|--------------------|---------------------|
| Screw         | White     | 12–30 Vac/Vdc      | <b>M22-LED-W</b>    |
|               | Red       |                    | <b>M22-LED-R</b>    |
|               | Green     | <b>M22-LED-G</b>   |                     |
|               | Blue      | <b>M22-LED-B</b>   |                     |
| Screw         | White     | 85–264 Vac         | <b>M22-LED230-W</b> |
|               | Red       |                    | <b>M22-LED230-R</b> |
|               | Green     |                    | <b>M22-LED230-G</b> |
|               | Blue      |                    | <b>M22-LED230-B</b> |

#### M22-K10



#### Contact Blocks <sup>②</sup>

| Terminal Type | Contact Configuration <sup>⑤</sup> | Catalog Number   |
|---------------|------------------------------------|------------------|
| Screw         | NO                                 | <b>M22-K10</b>   |
|               | NO, early-make                     | <b>M22-K10P</b>  |
|               | NC                                 | <b>M22-K01</b>   |
|               | NC, late-break                     | <b>M22-K01D</b>  |
| Spring-cage   | NO                                 | <b>M22-CK10</b>  |
|               | NC                                 | <b>M22-CK01</b>  |
|               | NC, late-break                     | <b>M22-CK01D</b> |
|               | 2NO                                | <b>M22-CK20</b>  |
|               | 2NC                                | <b>M22-CK02</b>  |
|               | NO-NC                              | <b>M22-CK11</b>  |

#### M22-DRL-X



#### Buttonless Operator

| Silver Bezel Catalog Number <sup>⑤</sup> | Black Bezel Catalog Number <sup>⑤</sup> | Metal Bezel Catalog Number <sup>⑤</sup> |
|--|---|---|
| <b>M22-DRL-X</b>                         | <b>M22S-DRL-X</b>                       | <b>M22M-DRL-X</b>                       |

#### M22S-DRL-X



#### M22M-DRL-X



#### Notes

- ① Maintained pushbuttons can be converted in the field to momentary operation by switching the locking ring, which is accessible through the side of the operator body.
- ② For complete listing of available button lenses, light units and contact blocks, see Accessories, **Pages V7-T1-111 to V7-T1-116**.
- ③ Minimum order quantity of (10).
- ④ When ordering, specify inscription per catalog number suffix from the Symbols Library (see **Pages V7-T1-129 to V7-T1-136**) into the Order Notes. For example, M22-XDL-R-ETCH; Order Notes: Mark with symbol X91, Line item #\_.
- ⑤ Includes contact block mounting adapter.
- ⑥ All NC contact blocks are positively driven contact. ⊖



1

## Illuminated Pushbuttons, Extended, Momentary

M22-DLH-R-K11-R



M22S-DLH-R-K11-R



## Complete Devices

| Button Color | Contact Block Configuration <sup>①</sup> | Light Unit Voltage | Silver Bezel Catalog Number | Black Bezel Catalog Number | Metal Bezel Catalog Number |
|--------------|--|--------------------|-----------------------------|----------------------------|----------------------------|
| Red          | 1NO/1NC                                  | 12–30 Vac/Vdc      | M22-DLH-R-K11-R             | M22S-DLH-R-K11-R           | M22M-DLH-R-K11-R           |
|              | 1NO/1NC                                  | 85–264 Vac         | M22-DLH-R-K11-230R          | M22S-DLH-R-K11-230R        | M22M-DLH-R-K11-230R        |
| Green        | 2NO                                      | 12–30 Vac/Vdc      | M22-DLH-G-K20-G             | M22S-DLH-G-K20-G           | M22M-DLH-G-K20-G           |
|              | 2NO                                      | 85–264 Vac         | M22-DLH-G-K20-230G          | M22S-DLH-G-K20-230G        | M22M-DLH-G-K20-230G        |
| White        | 2NO                                      | 12–30 Vac/Vdc      | M22-DLH-W-K20-W             | M22S-DLH-W-K20-W           | M22M-DLH-W-K20-W           |
|              | 2NO                                      | 85–264 Vac         | M22-DLH-W-K20-230W          | M22S-DLH-W-K20-230W        | M22M-DLH-W-K20-230W        |

## Complete Press-to-Test Units

| Button Color | Light Unit Voltage | Silver Bezel Catalog Number | Black Bezel Catalog Number |
|--------------|--------------------|-----------------------------|----------------------------|
| Red          | 12–30 Vac/Vdc      | M22-T-R-R                   | M22S-T-R-R                 |
| Blue         |                    | M22-T-B-B                   | M22S-T-B-B                 |
| Yellow       |                    | M22-T-Y-W                   | M22S-T-Y-W                 |
| Green        |                    | M22-T-G-G                   | M22S-T-G-G                 |
| White        |                    | M22-T-W-W                   | M22S-T-W-W                 |
| Red          | 85–264 Vac         | M22-T-R-230R                | M22S-T-R-230R              |
| Blue         |                    | M22-T-R-230B                | M22S-T-B-230B              |
| Yellow       |                    | M22-T-Y-230W                | M22S-T-Y-230W              |
| Green        |                    | M22-T-G-230G                | M22S-T-G-230G              |
| White        |                    | M22-T-W-230W                | M22S-T-W-230W              |

Operators Only <sup>②</sup>

M22-DLH-R



M22S-DLH-R



M22M-DLH-R



| Button Color | Silver Bezel Catalog Number | Black Bezel Catalog Number | Metal Bezel Catalog Number |
|--------------|-----------------------------|----------------------------|----------------------------|
| Red          | M22-DLH-R                   | M22S-DLH-R                 | M22M-DLH-R                 |
| Green        | M22-DLH-G                   | M22S-DLH-G                 | M22M-DLH-G                 |
| White        | M22-DLH-W                   | M22S-DLH-W                 | M22M-DLH-W                 |
| Blue         | M22-DLH-B                   | M22S-DLH-B                 | M22M-DLH-B                 |
| Yellow       | M22-DLH-Y                   | M22S-DLH-Y                 | M22M-DLH-Y                 |
| Amber        | M22-DLH-A                   | M22S-DLH-A                 | M22M-DLH-A                 |

M22-DGLH-R



## Silver Guarded

| Button Color | Silver Bezel Catalog Number |
|--------------|-----------------------------|
| Red          | M22-DGLH-R                  |
| Green        | M22-DGLH-G                  |
| White        | M22-DGLH-W                  |
| Blue         | M22-DGLH-B                  |
| Yellow       | M22-DGLH-Y                  |

## Notes

- ① All NC contact blocks are positively driven contact.
- ② Includes contact block mounting adapter.

Illuminated Pushbuttons, Extended, Momentary

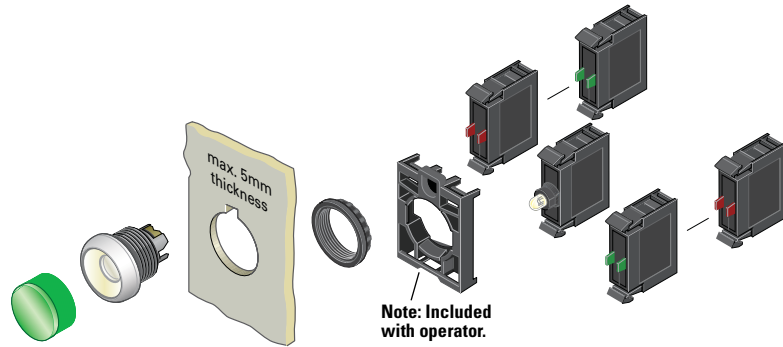

Components

M22-XDH-R



Button Lenses ①

| Color  | Inscription | Catalog Number    |
|--------|-------------|-------------------|
| Red    | —           | M22-XDLH-R ②      |
|        | Custom      | M22-XDLH-R-ETCH ③ |
|        | STOP        | M22-XDLH-R-GB0    |
|        | OFF         | M22-XDLH-R-GB5    |
|        | ⊙           | M22-XDLH-R-X0     |
| Green  | —           | M22-XDLH-G ②      |
|        | Custom      | M22-XDLH-G-ETCH ③ |
|        | START       | M22-XDLH-G-GB1    |
|        | ON          | M22-XDLH-G-GB6    |
|        | Ⓛ           | M22-XDLH-G-X1     |
|        | Blue        | —                 |
| Blue   | Custom      | M22-XDLH-B-ETCH ③ |
|        | RESET       | M22-XDLH-B-GB14   |
|        | Ⓡ           | M22-XDLH-B-X6     |
| White  | —           | M22-XDLH-W ②      |
|        | Custom      | M22-XDLH-W-ETCH ③ |
| Yellow | —           | M22-XDLH-Y ②      |
|        | Custom      | M22-XDLH-Y-ETCH ③ |
| Amber  | —           | M22-XDLH-A        |
|        | Custom      | M22-XDLH-A-ETCH   |

M22-LED-W



Light Units ①

| Terminal Type | LED Color | Light Unit Voltage | Catalog Number |
|---------------|-----------|--------------------|----------------|
| Screw         | White     | 12–30 Vac/Vdc      | M22-LED-W      |
|               | Red       |                    | M22-LED-R      |
|               | Green     |                    | M22-LED-G      |
|               | Blue      |                    | M22-LED-B      |
| Screw         | White     | 85–264 Vac         | M22-LED230-W   |
|               | Red       |                    | M22-LED230-R   |
|               | Green     |                    | M22-LED230-G   |
|               | Blue      |                    | M22-LED230-B   |

M22-K10



Contact Blocks ①

| Terminal Type | Contact Configuration ⑤ | Catalog Number |
|---------------|-------------------------|----------------|
| Screw         | NO                      | M22-K10        |
|               | NO, early-make          | M22-K10P       |
|               | NC                      | M22-K01        |
|               | NC, late-break          | M22-K01D       |
| Spring-cage   | NO                      | M22-CK10       |
|               | NC                      | M22-CK01       |
|               | NC, late-break          | M22-CK01D      |
|               | 2NO                     | M22-CK20       |
|               | 2NC                     | M22-CK02       |
|               | NO-NC                   | M22-CK11       |

M22-DL-X



Buttonless Operator

| Silver Bezel Catalog Number ④ | Black Bezel Catalog Number ④ | Metal Bezel Catalog Number ④ |
|-------------------------------|------------------------------|------------------------------|
| M22-DL-X                      | M22S-DL-X                    | M22M-DL-X                    |

M22S-DL-X



M22M-DL-X



M22-DGL-X



Silver Guarded

| Silver Bezel Catalog Number ④ |
|-------------------------------|
| M22-DGL-X                     |

Notes

- ① For complete listing of available button lenses, light units and contact blocks, see Accessories, Pages V7-T1-111 to V7-T1-116.
- ② Minimum order quantity of (10).
- ③ When ordering, specify inscription per catalog number suffix from the Symbols Library (see Pages V7-T1-129 to V7-T1-136) into the Order Notes. For example, M22-XDH-S-ETCH; Order Notes: Mark with symbol X91, Line item #...
- ④ Includes contact block mounting adapter.
- ⑤ All NC contact blocks are positively driven contact. ⊖

#### 1

#### Illuminated Pushbuttons, Extended, Maintained <sup>①</sup>

M22-DRLH-W



M22S-DRLH-W



M22M-DRLH-W



#### Operators Only <sup>②</sup>

| Button Color | Silver Bezel<br>Catalog Number | Black Bezel<br>Catalog Number | Metal Bezel<br>Catalog Number |
|--------------|--------------------------------|-------------------------------|-------------------------------|
| Red          | M22-DRLH-R                     | M22S-DRLH-R                   | M22M-DRLH-R                   |
| Green        | M22-DRLH-G                     | M22S-DRLH-G                   | M22M-DRLH-G                   |
| White        | M22-DRLH-W                     | M22S-DRLH-W                   | M22M-DRLH-W                   |
| Blue         | M22-DRLH-B                     | M22S-DRLH-B                   | M22M-DRLH-B                   |
| Yellow       | M22-DRLH-Y                     | M22S-DRLH-Y                   | M22M-DRLH-Y                   |
| Amber        | M22-DRLH-A                     | M22S-DRLH-A                   | M22M-DRLH-A                   |

#### Notes

- ① Maintained pushbuttons can be converted in the field to momentary operation by switching the locking ring, which is accessible through the side of the operator body.
- ② Includes contact block mounting adapter.

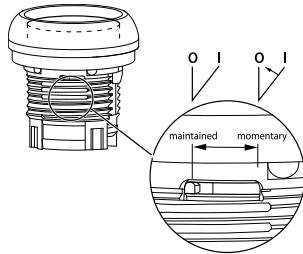

**Note:** This pilot device features a selectable function switch that enables the device to be set to either maintained or momentary operation.

Illuminated Pushbuttons, Extended, Maintained <sup>①</sup>

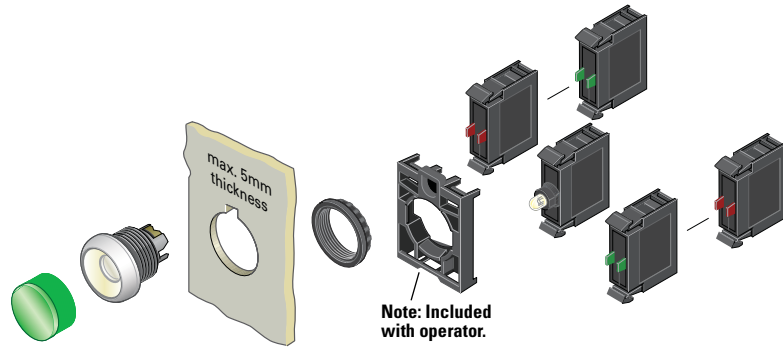

Components

M22-XDLH-W



Button Lenses <sup>②</sup>

| Color  | Inscription | Catalog Number               |
|--------|-------------|------------------------------|
| Red    | —           | M22-XDLH-R <sup>③</sup>      |
|        | Custom      | M22-XDLH-R-ETCH <sup>④</sup> |
|        | STOP        | M22-XDLH-R-GB0               |
|        | OFF         | M22-XDLH-R-GB5               |
|        | ⊙           | M22-XDLH-R-X0                |
| Green  | —           | M22-XDLH-G <sup>③</sup>      |
|        | Custom      | M22-XDLH-G-ETCH <sup>④</sup> |
|        | START       | M22-XDLH-G-GB1               |
|        | ON          | M22-XDLH-G-GB6               |
|        | Ⓜ           | M22-XDLH-G-X1                |
|        | Blue        | —                            |
| Blue   | Custom      | M22-XDLH-B-ETCH <sup>④</sup> |
|        | RESET       | M22-XDLH-B-GB14              |
|        | Ⓜ           | M22-XDLH-B-X6                |
| White  | —           | M22-XDLH-W <sup>③</sup>      |
|        | Custom      | M22-XDLH-W-ETCH <sup>④</sup> |
| Yellow | —           | M22-XDLH-Y <sup>③</sup>      |
|        | Custom      | M22-XDLH-Y-ETCH <sup>④</sup> |
| Amber  | —           | M22-XDLH-A                   |
|        | Custom      | M22-XDLH-A-ETCH              |

M22-LED-W



Light Units <sup>②</sup>

| Terminal Type | LED Color | Light Unit Voltage | Catalog Number |
|---------------|-----------|--------------------|----------------|
| Screw         | White     | 12–30 Vac/Vdc      | M22-LED-W      |
|               | Red       |                    | M22-LED-R      |
|               | Green     |                    | M22-LED-G      |
|               | Blue      |                    | M22-LED-B      |
| Screw         | White     | 85–264 Vac         | M22-LED230-W   |
|               | Red       |                    | M22-LED230-R   |
|               | Green     |                    | M22-LED230-G   |
|               | Blue      |                    | M22-LED230-B   |

M22-K10



Contact Blocks <sup>②</sup>

| Terminal Type | Contact Configuration <sup>⑥</sup> | Catalog Number |
|---------------|------------------------------------|----------------|
| Screw         | NO                                 | M22-K10        |
|               | NO, early-make                     | M22-K10P       |
|               | NC                                 | M22-K01        |
|               | NC, late-break                     | M22-K01D       |
| Spring-cage   | NO                                 | M22-CK10       |
|               | NC                                 | M22-CK01       |
|               | NC, late-break                     | M22-CK01D      |
|               | 2NO                                | M22-CK20       |
|               | 2NC                                | M22-CK02       |
|               | NO-NC                              | M22-CK11       |

M22-DRL-X



Buttonless Operator

| Silver Bezel Catalog Number <sup>⑤</sup> | Black Bezel Catalog Number <sup>⑤</sup> | Metal Bezel Catalog Number <sup>⑤</sup> |
|--|---|---|
| M22-DRL-X                                | M22S-DRL-X                              | M22M-DRL-X                              |

M22S-DRL-X



M22M-DRL-X



Notes

- ① Maintained pushbuttons can be converted in the field to momentary operation by switching the locking ring, which is accessible through the side of the operator body.
- ② For complete listing of available button lenses, light units and contact blocks, see Accessories, Pages V7-T1-111 to V7-T1-116.
- ③ Minimum order quantity of (10).
- ④ When ordering, specify inscription per catalog number suffix from the Symbols Library (see Pages V7-T1-129 to V7-T1-136) into the Order Notes. For example, M22-XDLH-S-ETCH; Order Notes: Mark with symbol X91, Line item #\_.
- ⑤ Includes contact block mounting adapter.
- ⑥ All NC contact blocks are positively driven contact. ⊖

#### 1

### Indicating Lights

#### Product Description

Eaton's M22 indicating lights use the combination of a durable, bright LED unit and modern lenses designed specifically for this type of LED to create a bright and visible indicating light.

As with the pushbuttons, the indicating light lenses can be laser engraved. Indicating lights can be ordered as complete devices, including lens and LED unit, or as modular components.

#### Features

- Customizable laser engraving on all lenses
- LED offering only for improved brightness quality and up to 100,000 hours of operation
- Lenses designed specifically for LED illumination
- Modular construction makes assembly fast and simplifies stocking of components and complete devices
- Capable of communicating via ASi protocol with ASi adapter modules

#### Protection Type

- IP67, IP69K
- NEMA 4X, 13

### Catalog Number Selection

Catalog Number Selection is for illustrative purposes only and not to be used to create new catalog numbers.

#### Indicating Lights

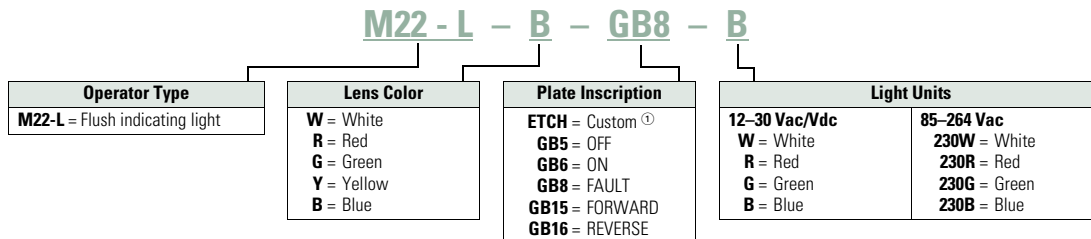

**Note:** Light unit should match color of lens. Use white light unit with yellow lens.

<sup>①</sup> When ordering, specify inscription per catalog number suffix from the Symbols Library (see **Pages V7-T1-129 to V7-T1-136**) into the Order Notes. For example, M22-L-B-ETCH; Order Notes: Mark with symbol X91, Line item #\_.

### Product Selection

#### Indicating Lights, Flush

##### M22-L-R-R



#### Complete Devices

| Lens Color | Light Color | Light Unit Voltage | Catalog Number      |
|------------|-------------|--------------------|---------------------|
| White      | White       | 12-30 Vac/Vdc      | <b>M22-L-W-W</b>    |
| Red        | Red         |                    | <b>M22-L-R-R</b>    |
| Green      | Green       |                    | <b>M22-L-G-G</b>    |
| Yellow     | White       |                    | <b>M22-L-Y-W</b>    |
| Blue       | Blue        |                    | <b>M22-L-B-B</b>    |
| Amber      | White       |                    | <b>M22-L-A-W</b>    |
| White      | White       | 85-264 Vac         | <b>M22-L-W-230W</b> |
| Red        | Red         |                    | <b>M22-L-R-230R</b> |
| Green      | Green       |                    | <b>M22-L-G-230G</b> |
| Yellow     | White       |                    | <b>M22-L-Y-230W</b> |
| Blue       | Blue        |                    | <b>M22-L-B-230B</b> |
| Amber      | White       |                    | <b>M22-L-A-230W</b> |

#### Operators Only <sup>①</sup>

##### M22-L-R



| Lens Color  | Catalog Number |
|-------------|----------------|
| <b>Flat</b> |                |
| White       | <b>M22-L-W</b> |
| Red         | <b>M22-L-R</b> |
| Green       | <b>M22-L-G</b> |
| Yellow      | <b>M22-L-Y</b> |
| Blue        | <b>M22-L-B</b> |
| Amber       | <b>M22-L-A</b> |

##### M22-LH-R



| Lens Color     | Catalog Number  |
|----------------|-----------------|
| <b>Conical</b> |                 |
| White          | <b>M22-LH-W</b> |
| Red            | <b>M22-LH-R</b> |
| Green          | <b>M22-LH-G</b> |
| Yellow         | <b>M22-LH-Y</b> |
| Blue           | <b>M22-LH-B</b> |
| Amber          | <b>M22-LH-A</b> |

#### Note

<sup>①</sup> Includes contact block mounting adapter.

### Indicating Lights, Flush

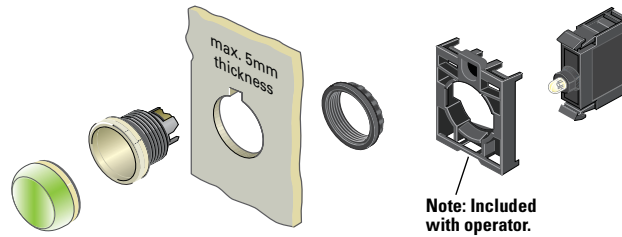

### Components

#### M22-XL-R



#### Lenses <sup>①</sup>

| Color          | Inscription | Catalog Number                    |
|----------------|-------------|-----------------------------------|
| <b>Flat</b>    |             |                                   |
| Red            | —           | <b>M22-XL-R</b> <sup>②</sup>      |
|                | Custom      | <b>M22-XL-R-ETCH</b> <sup>③</sup> |
|                | OFF         | <b>M22-XL-R-GB5</b>               |
| Green          | —           | <b>M22-XL-G</b> <sup>②</sup>      |
|                | Custom      | <b>M22-XL-G-ETCH</b> <sup>③</sup> |
|                | ON          | <b>M22-XL-G-GB6</b>               |
|                | REVERSE     | <b>M22-XL-G-GB16</b>              |
| Blue           | —           | <b>M22-XL-B</b> <sup>②</sup>      |
|                | Custom      | <b>M22-XL-B-ETCH</b> <sup>③</sup> |
|                | FAULT       | <b>M22-XL-B-GB8</b>               |
| White          | —           | <b>M22-XL-W</b> <sup>②</sup>      |
|                | Custom      | <b>M22-XL-W-ETCH</b> <sup>③</sup> |
|                | OFF         | <b>M22-XL-W-GB5</b>               |
|                | ON          | <b>M22-XL-W-GB6</b>               |
|                | FAULT       | <b>M22-XL-W-GB8</b>               |
| Yellow         | —           | <b>M22-XL-Y</b> <sup>②</sup>      |
|                | Custom      | <b>M22-XL-Y-ETCH</b> <sup>③</sup> |
| Amber          | —           | <b>M22-XL-A</b> <sup>②</sup>      |
|                | Custom      | <b>M22-XL-A-ETCH</b> <sup>③</sup> |
| <b>Conical</b> |             |                                   |
| Red            | —           | <b>M22-XLH-R</b>                  |
| Green          | —           | <b>M22-XLH-G</b>                  |
| Blue           | —           | <b>M22-XLH-B</b>                  |
| White          | —           | <b>M22-XLH-W</b>                  |
| Yellow         | —           | <b>M22-XLH-Y</b>                  |
| Amber          | —           | <b>M22-XLH-A</b>                  |

#### M22-LED-W



#### Light Units <sup>①④</sup>

| Terminal Type | LED Color | Light Unit Voltage | Catalog Number      |
|---------------|-----------|--------------------|---------------------|
| Screw         | White     | 12–30              | <b>M22-LED-W</b>    |
|               | Red       | Vac/Vdc            | <b>M22-LED-R</b>    |
|               | Green     |                    | <b>M22-LED-G</b>    |
|               | Blue      |                    | <b>M22-LED-B</b>    |
| Screw         | White     | 85–264             | <b>M22-LED230-W</b> |
|               | Red       | Vac                | <b>M22-LED230-R</b> |
|               | Green     |                    | <b>M22-LED230-G</b> |
|               | Blue      |                    | <b>M22-LED230-B</b> |

#### Notes

- ① For complete listing of available lenses and light units, see Accessories, **Pages V7-T1-111 to V7-T1-116**.
- ② Minimum order quantity of (10).
- ③ When ordering, specify inscription per catalog number suffix from the Symbols Library (see **Pages V7-T1-129 to V7-T1-136**) into the Order Notes. For example, M22-XL-R-ETCH; Order Notes: Mark with symbol X91, Line item #\_.
- ④ Select the same color LED element as lens color; for yellow and amber lenses, choose a white LED.

#### M22-L-X



#### Lensless Indicating Light

##### Catalog Number

M22-L-X

#### 1

### Emergency Stops

#### Product Description

Eaton's M22 emergency stops are a durable and reliable solution to a variety of e-stop applications. With standard push-pull, as well as twist-to-release and key-release, illuminated options and red or black operators, the M22 e-stop is a robust solution. As with all operators, they can be ordered as a ready to install complete device or as modular components for the perfect fit.

#### Features

- Push-pull and twist to release options available as well as illuminated and keyed release
- LED offering only for improved brightness quality and up to 100,000 hours of operation
- More than 100,000 mechanical operations
- Capable of communicating via ASi protocol with ASi adapter modules
- Suitable for use in safety applications up to Category-4 or Sil-3

#### Protection Type

- IP67, IP69K (IP66 key-release)
- NEMA 4X, 13

### Catalog Number Selection

Catalog Number Selection is for illustrative purposes only and not to be used to create new catalog numbers.

#### Emergency Stops

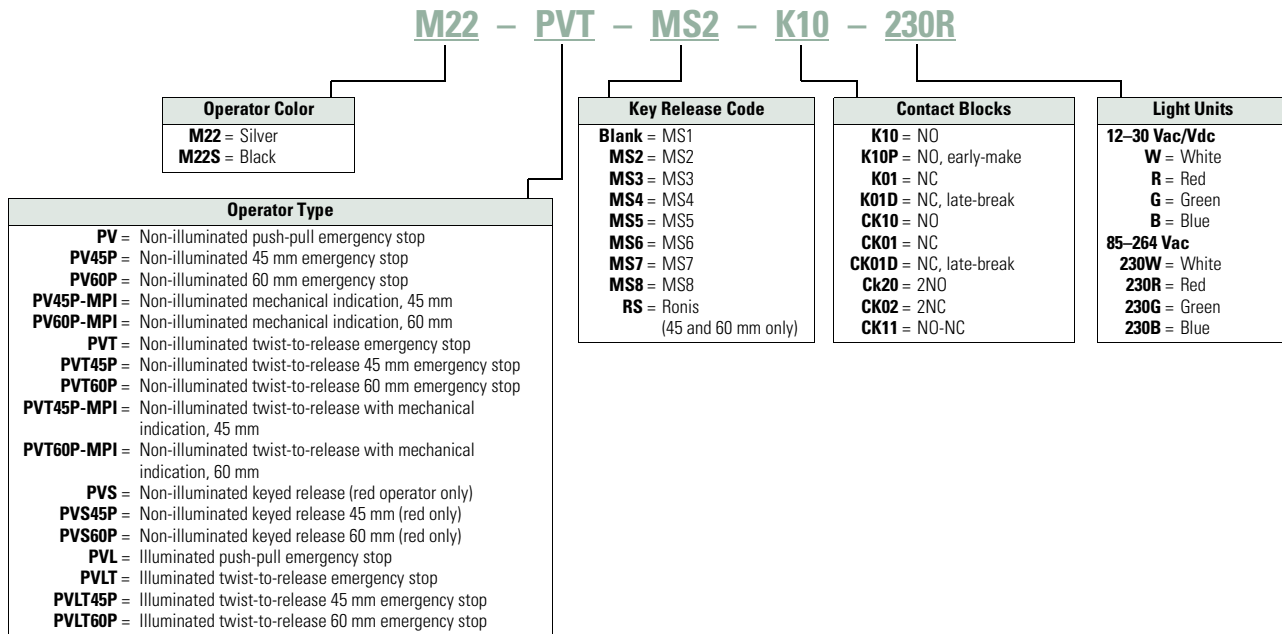

**Product Selection**

**Non-Illuminated and Illuminated Emergency Stops**

**Complete Devices**

| Type  | Button Color           | LED Color | Contact Block Configuration <sup>①</sup> | Light Unit Voltage       | Catalog Number |                       |                          |
|---|------------------------|-----------|--|--------------------------|----------------|-----------------------|--------------------------|
| <b>M22-PV-K01</b>   |                        |           |  |                          |                |                       |                          |
|  | <b>Non-Illuminated</b> |           |  |                          |                |                       |                          |
|   | Push-pull              | Red       | —  | NC                       | —              | <b>M22-PV-K01</b>     |                          |
|   |                        |           |  | 2NC                      |                | <b>M22-PV-K02</b>     |                          |
|   |                        |           |  | 1NO-2NC                  |                | <b>M22-PV-K12</b>     |                          |
|   | Twist-to-release       | Red       | —  | NC                       | —              | <b>M22-PVT-K01</b>    |                          |
|   |                        |           |  | 2NC                      |                | <b>M22-PVT-K02</b>    |                          |
|   |                        |           |  | 1NO-2NC                  |                | <b>M22-PVT-K12</b>    |                          |
|   | Key release            | Red       | —  | NC                       | —              | <b>M22-PVS-K01</b>    |                          |
|   |                        |           |  | 2NC                      |                | <b>M22-PVS-K02</b>    |                          |
| 1NO-2NC   |                        |           |  | <b>M22-PVS-K12</b>       |                |                       |                          |
| <b>M22-PVL-K01-R</b>  |                        |           |  |                          |                |                       |                          |
|  | <b>Illuminated</b>     |           |  |                          |                |                       |                          |
|   | Push-pull              | Red       | Red                                      | NC                       | 12–30 Vac/Vdc  | <b>M22-PVL-K01-R</b>  |                          |
|   |                        |           |  | 2NC                      |                | <b>M22-PVL-K02-R</b>  |                          |
|   |                        |           |  | 1NO-2NC                  |                | <b>M22-PVL-K12-R</b>  |                          |
|   |                        |           |  | NC                       |                | 85–264 Vac            | <b>M22-PVL-K01-230R</b>  |
|   |                        |           |  | 2NC                      |                |                       | <b>M22-PVL-K02-230R</b>  |
|   |                        |           |  | 1NO-2NC                  |                |                       | <b>M22-PVL-K12-230R</b>  |
|   | Twist-to-release       | Red       | Red                                      | NC                       | 12–30 Vac/Vdc  | <b>M22-PVLT-K01-R</b> |                          |
|   |                        |           |  | 2NC                      |                | <b>M22-PVLT-K02-R</b> |                          |
|   |                        |           |  | 1NO-2NC                  |                | <b>M22-PVLT-K12-R</b> |                          |
|   |                        |           |  | NC                       |                | 85–264 Vac            | <b>M22-PVLT-K01-230R</b> |
|   |                        |           |  | 2NC                      |                |                       | <b>M22-PVLT-K02-230R</b> |
| 1NO-2NC   |                        |           |  | <b>M22-PVLT-K12-230R</b> |                |                       |                          |

**Note**

<sup>①</sup> All NC contact blocks are positively driven contact. ⊖



#### Non-Illuminated and Illuminated Emergency Stops

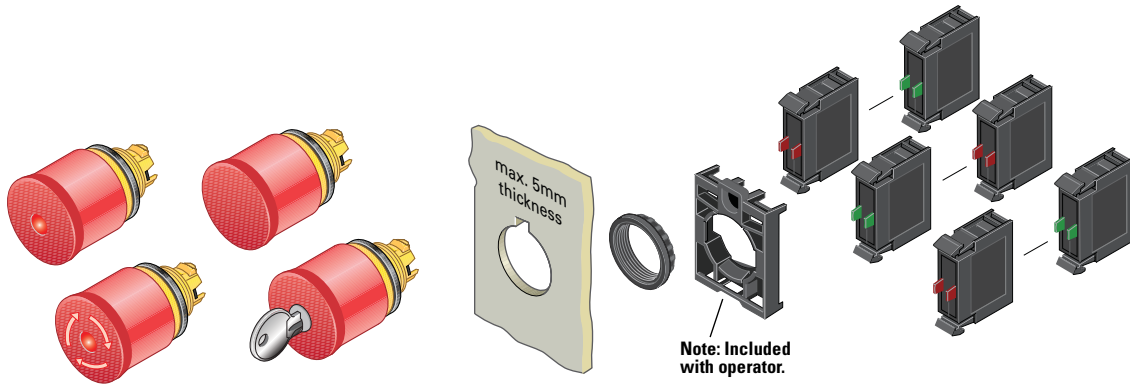

#### Components

##### M22-PVL



#### Push-Pull Emergency Stops

| Illumination/Indication | Actuator Size | Catalog Number       |
|-------------------------|---------------|----------------------|
| None                    | 35 mm         | <b>M22-PV</b>        |
|                         | 45 mm         | <b>M22-PV45P</b>     |
|                         | 60 mm         | <b>M22-PV60P</b>     |
| LED illumination        | 35 mm         | <b>M22-PVL</b>       |
|                         | 45 mm         | <b>M22-PVL45P</b>    |
|                         | 60 mm         | <b>M22-PVL60P</b>    |
| Mechanical indication   | 45 mm         | <b>M22-PV45P-MPI</b> |
|                         | 60 mm         | <b>M22-PV60P-MPI</b> |

##### M22-PVS60P-MS1



#### Key Release Emergency Stops ②

| Actuator Size | Key Code             | Catalog Number        |                       |
|---------------|----------------------|-----------------------|-----------------------|
| 35 mm         | MS1                  | <b>M22-PVS</b> ③      |                       |
|               | MS2                  | <b>M22-PVS-MS2</b>    |                       |
|               | MS3                  | <b>M22-PVS-MS3</b>    |                       |
|               | MS4                  | <b>M22-PVS-MS4</b>    |                       |
|               | MS5                  | <b>M22-PVS-MS5</b>    |                       |
|               | MS6                  | <b>M22-PVS-MS6</b>    |                       |
|               | MS7                  | <b>M22-PVS-MS7</b>    |                       |
|               | MS8                  | <b>M22-PVS-MS8</b>    |                       |
| 45 mm         | MS1                  | <b>M22-PVS45P</b>     |                       |
|               | MS2                  | <b>M22-PVS45P-MS2</b> |                       |
|               | MS3                  | <b>M22-PVS45P-MS3</b> |                       |
|               | MS4                  | <b>M22-PVS45P-MS4</b> |                       |
|               | MS5                  | <b>M22-PVS45P-MS5</b> |                       |
|               | MS6                  | <b>M22-PVS45P-MS6</b> |                       |
|               | MS7                  | <b>M22-PVS45P-MS7</b> |                       |
|               | MS8                  | <b>M22-PVS45P-MS8</b> |                       |
|               | Ronis                | <b>M22-PVS45P-RS</b>  |                       |
|               | 60 mm                | MS1                   | <b>M22-PVS60P</b>     |
|               |                      | MS2                   | <b>M22-PVS60P-MS2</b> |
|               |                      | MS3                   | <b>M22-PVS60P-MS3</b> |
|               |                      | MS4                   | <b>M22-PVS60P-MS4</b> |
|               |                      | MS5                   | <b>M22-PVS60P-MS5</b> |
|               |                      | MS6                   | <b>M22-PVS60P-MS6</b> |
|               |                      | MS7                   | <b>M22-PVS60P-MS7</b> |
| MS8           |                      | <b>M22-PVS60P-MS8</b> |                       |
| Ronis         | <b>M22-PVS60P-RS</b> |                       |                       |

##### M22-PVT45P-MPI



#### Twist-to-Release Emergency Stops

| Illumination/Indication | Actuator Size | Catalog Number        |
|-------------------------|---------------|-----------------------|
| None                    | 35 mm         | <b>M22-PVT</b>        |
|                         | 45 mm         | <b>M22-PVT45P</b>     |
|                         | 60 mm         | <b>M22-PVT60P</b>     |
| LED illumination        | 35 mm         | <b>M22-PVLT</b>       |
|                         | 45 mm         | <b>M22-PVLT45P</b>    |
|                         | 60 mm         | <b>M22-PVLT60P</b>    |
| Mechanical indication   | 45 mm         | <b>M22-PVT45P-MPI</b> |
|                         | 60 mm         | <b>M22-PVT60P-MPI</b> |

##### M22S-PVLT



#### Machine Stop Operators (Black) ①

| Illumination     | Type             | Actuator Size | Catalog Number   |
|------------------|------------------|---------------|------------------|
| Non-illuminated  | Push-pull        | 35 mm         | <b>M22S-PV</b>   |
|                  | Twist-to-release | 35 mm         | <b>M22S-PVT</b>  |
| LED illumination | Push-pull        | 35 mm         | <b>M22S-PVL</b>  |
|                  | Twist-to-release | 35 mm         | <b>M22S-PVLT</b> |

#### Notes

- ① Includes contact block mounting adapter.
- ② Key included. For identical locks and keys, use the same key code. One key is included with actuator; additional keys are available as accessories.
- ③ Includes Key Code MS1.

M22-K10



Contact Blocks ①

| Terminal Type | Mounting Location ② | Contact Configuration ③ | Catalog Number |
|---------------|---------------------|-------------------------|----------------|
| Screw         | Front               | NO                      | M22-K10        |
|               |                     | NO, early-make          | M22-K10P       |
|               |                     | NC                      | M22-K01        |
|               |                     | NC, late-break          | M22-K01D       |
|               |                     | SMCB, NC                | M22-K01SMC10   |
|               |                     | SMCB, 2NC               | M22-K02SMC10   |
| Base          | SMCB, NC            |                         | M22-KC01SMC10  |
|               |                     | SMCB, 2NC               | M22-KC02SMC10  |
| Spring-cage   | Front               | NO                      | M22-CK10       |
|               |                     | NC                      | M22-CK01       |
|               |                     | NC, late-break          | M22-CK01D      |
|               |                     | 2NO                     | M22-CK20       |
|               |                     | 2NC                     | M22-CK02       |
|               |                     | NO-NC                   | M22-CK11       |

M22-LED-W



Light Units ①

| Terminal Type | LED Color | Light Unit Voltage | Catalog Number |
|---------------|-----------|--------------------|----------------|
| Screw         | White     | 12–30 Vac/Vdc      | M22-LED-W      |
|               | Red       | 12–30 Vac/Vdc      | M22-LED-R      |
| Screw         | White     | 85–264 Vac         | M22-LED230-W   |
|               | Red       | 85–264 Vac         | M22-LED230-R   |
| Screw         | White     | 207–264 Vac        | M22-LED230H-W  |
|               | Red       | 207–264 Vac        | M22-LED230H-R  |





M22-ES-MS1



Extra Keys ④

| For Key Code | Catalog Number |
|--------------|----------------|
| MS1          | M22-ES-MS1     |
| MS2          | M22-ES-MS2     |
| MS3          | M22-ES-MS3     |
| MS4          | M22-ES-MS4     |
| MS5          | M22-ES-MS5     |
| MS6          | M22-ES-MS6     |
| MS7          | M22-ES-MS7     |
| MS8          | M22-ES-MS8     |

Accessories

| Description   | Voltage    | Catalog Number  |
|---|------------|-----------------|
| M22-XGPV<br>         | —          | M22-XGPV        |
| M22G-XGPV<br>        | —          | M22G-XGPV       |
| M22-MGTA<br>         | —          | M22-MGTA        |
| M22-PL-PV<br>        | —          | M22-PL-PV       |
| M22-XPV60-Y-120<br> | 24 Vac/Vdc | M22-XPV60-Y-24  |
|   | 120 Vac    | M22-XPV60-Y-120 |
|   | 230 Vac    | M22-XPV60-Y-230 |

Notes

- ① For complete listing of available contact blocks, see Accessories, Pages V7-T1-111 to V7-T1-116.
- ② Self-monitoring contact blocks (SMCB type) cannot be used with illuminated emergency stops.
- ③ All NC contact blocks are positively driven contact. ⊖
- ④ For use with key release operators only. One key included with operator.

**Selector Switches**



**Contents**

**Description**

**Page**

|                                    |                 |
|------------------------------------|-----------------|
| Selector Switches                  |                 |
| Non-Illuminated Switches . . . . . | <b>V7-T1-79</b> |
| Illuminated Switches . . . . .     | <b>V7-T1-84</b> |
| Key Operated . . . . .             | <b>V7-T1-88</b> |

**Selector Switches**

**Product Description**

Eaton’s M22 selector switch line offers an almost endless variety of options in maintained/momentary, key-removal and illuminated devices. The coding adapters used for maintained/momentary and key removal positions make the M22 stand out from competitive devices. By simply adding or removing a coding adapter from inside the operator, the end-user can change the function of the button. Operator options include standard knob, rotary head, illuminated and keyed versions. As with all operators, they can be ordered as a ready to install complete device or as modular components to meet application specific requirements.

**Features**

- Adding or removing coding adapters allows for field convertibility of maintained/momentary and key removal positions
- LED offering only for improved brightness quality and up to 100,000 hours of operation
- More than 100,000 mechanical operations
- Coding adapter options make assembly fast and simplify stocking of different configurations of selector switches
- Capable of communicating via ASi protocol with ASi adapter modules

**Protection Type**

- IP66
- NEMA 4X, 13

### Catalog Number Selection

Catalog Number Selection is for illustrative purposes only and not to be used to create new catalog numbers.

### Non-Illuminated Selector Switches

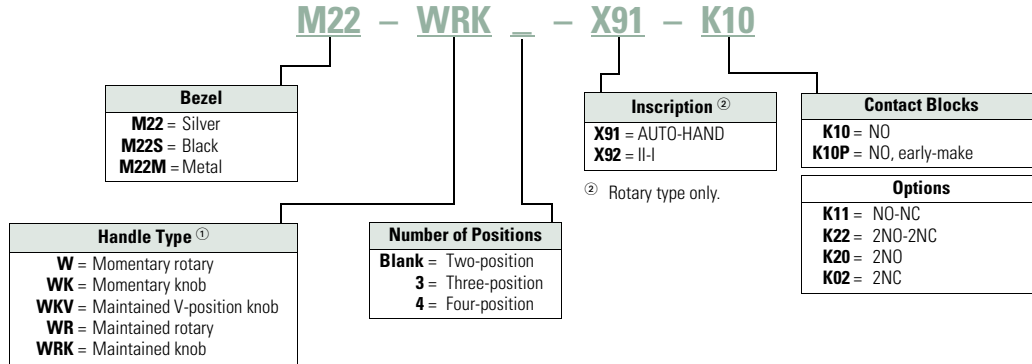

<sup>①</sup> All momentary selector switches can be converted in the field to maintained operation with the removal of a color-coded adapter.

# 1

## Product Selection

### Non-Illuminated Selector Switches



M22-WKV-K10



M22M-WKV-K10

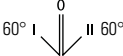

#### Complete Devices, Knob Type ①

| Type           | Switching Position  | Contact Block Configuration ② | Silver Bezel Catalog Number | Black Bezel Catalog Number | Metal Bezel Catalog Number |
|----------------|---|-------------------------------|-----------------------------|----------------------------|----------------------------|
| Two-position   | Maintained<br>   | NO                            | M22-WRK-K10                 | M22S-WRK-K10               | M22M-WRK-K10               |
|                |   | 1NO-1NC                       | M22-WRK-K11                 | M22S-WRK-K11               | M22M-WRK-K11               |
|                |   | 2NO-2NC                       | M22-WRK-K22                 | M22S-WRK-K22               | M22M-WRK-K22               |
| Two-position   | Maintained V<br> | NO                            | M22-WKV-K10                 | M22S-WKV-K10               | M22M-WKV-K10               |
|                |   | 1NO-1NC                       | M22-WKV-K11                 | M22S-WKV-K11               | M22M-WKV-K11               |
|                |   | 2NO-2NC                       | M22-WKV-K22                 | M22S-WKV-K22               | M22M-WKV-K22               |
| Three-position | Maintained<br>   | 2NO                           | M22-WRK3-K20                | M22S-WRK3-K20              | M22M-WRK3-K20              |
|                |   | 2NO-2NC                       | M22-WRK3-K22                | M22S-WRK3-K22              | M22M-WRK3-K22              |

#### Notes

- ① Includes contact block mounting adapter.
- ② All NC contact blocks are positively driven contact. ⊖

**Non-Illuminated Selector Switches**

**Components**





**M22-WK**



**Operators Only, Knob Type** ①

**M22M-WK**

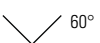
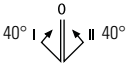
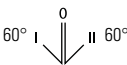
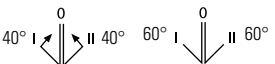

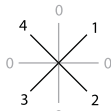
| Type           | Switching Position   | Silver Bezel Catalog Number   | Black Bezel Catalog Number | Metal Bezel Catalog Number |                  |
|----------------|--|---|----------------------------|----------------------------|------------------|
| Two-position   | Momentary ②<br>                     | <b>M22-WK</b>   | <b>M22S-WK</b>             | <b>M22M-WK</b>             |                  |
|                | Maintained<br>                      | <b>M22-WRK</b>  | <b>M22S-WRK</b>            | <b>M22M-WRK</b>            |                  |
|                | Maintained V<br>                    | <b>M22-WKV</b>  | <b>M22S-WKV</b>            | <b>M22M-WKV</b>            |                  |
| Three-position | Momentary ②<br>                     | <b>M22-WK3</b>  | <b>M22S-WK3</b>            | <b>M22M-WK3</b>            |                  |
|                | Maintained<br>                      | <b>M22-WRK3</b>   | <b>M22S-WRK3</b>           | <b>M22M-WRK3</b>           |                  |
|                | Maintained, return from left<br>   | <b>M22-WRK3-2</b>   | <b>M22S-WRK3-2</b>         | <b>M22M-WRK3-2</b>         |                  |
|                | Maintained, return from right<br> | <b>M22-WRK3-1</b>   | <b>M22S-WRK3-1</b>         | <b>M22M-WRK3-1</b>         |                  |
|                | Four-position  | Maintained<br> | <b>M22-WRK4</b>            | <b>M22S-WRK4</b>           | <b>M22M-WRK4</b> |

**Notes**

- ① Includes contact block mounting adapter.
- ② Momentary selector switches can be converted in the field to maintained operation with the removal of a color coded adapter. See **Page V7-T1-118**.

# 1

## Non-Illuminated Selector Switches

### Components

M22S-WR3-X94



#### Operators Only, Rotary Type ①

| Type           | Switching Position | Inscription     | Silver Bezel Catalog Number | Black Bezel Catalog Number | Metal Bezel Catalog Number |
|----------------|--------------------|-----------------|-----------------------------|----------------------------|----------------------------|
| Two-position   | Momentary ②        | I-O             | M22-W                       | M22S-W                     | M22M-W                     |
|                | Maintained         | I-O             | M22-WR                      | M22S-WR                    | M22M-WR                    |
|                |                    | Custom          | M22-WR-ETCH ③               | M22S-WR-ETCH ③             | M22M-WR-ETCH ③             |
|                |                    | AUTO-HAND       | M22-WR-X91                  | M22S-WR-X91                | M22M-WR-X91                |
|                |                    | II-I            | M22-WR-X92                  | M22S-WR-X92                | M22M-WR-X92                |
| Three-position | Momentary ②        | I-O-II          | M22-W3                      | M22S-W3                    | M22M-W3                    |
|                | Maintained         | I-O-II          | M22-WR3                     | M22S-WR3                   | M22M-WR3                   |
|                |                    | Custom          | M22-WR3-ETCH ③              | M22S-WR3-ETCH ③            | M22M-WR3-ETCH ③            |
|                |                    | AUTO-O-MAN      | M22-WR3-X94                 | M22S-WR3-X94               | M22M-WR3-X94               |
|                |                    |                 |                             |                            |                            |
| Four-position  | Maintained         | 0-1-0-2-0-3-0-4 | M22-WR4                     | M22S-WR4                   | M22M-WR4                   |

#### Notes

- ① Includes contact block mounting adapter.
- ② Momentary selector switches can be converted in the field to maintained operation with the removal of a color coded adapter. See [Page V7-T1-118](#).
- ③ When ordering, specify inscription per catalog number suffix from the Symbols Library (see [Pages V7-T1-129 to V7-T1-136](#)) into the Order Notes. For example, M22-WR3-ETCH; Order Notes: Mark with symbol X88, Line item #\_.

### Non-Illuminated Selector Switches

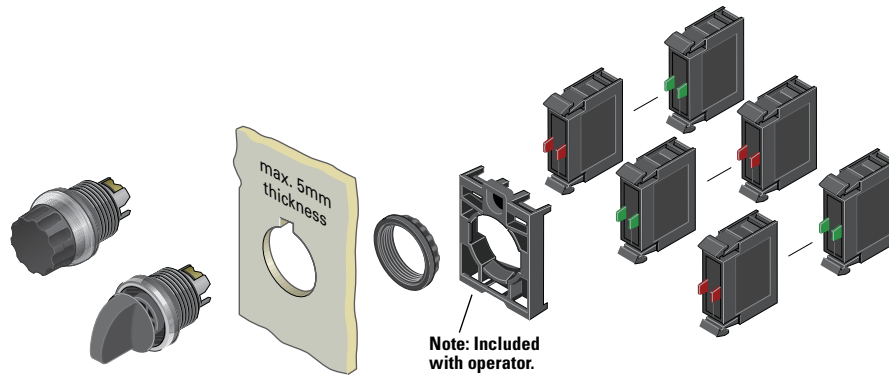

### Components





#### M22-K10



#### Contact Blocks <sup>①</sup>

| Terminal Type | Contact Configuration <sup>②</sup> | Catalog Number   |
|---------------|------------------------------------|------------------|
| Screw         | NO                                 | <b>M22-K10</b>   |
|               | NO, early-make                     | <b>M22-K10P</b>  |
|               | NC                                 | <b>M22-K01</b>   |
|               | NC, late-break                     | <b>M22-K01D</b>  |
| Spring-cage   | NO                                 | <b>M22-CK10</b>  |
|               | NC                                 | <b>M22-CK01</b>  |
|               | NC, late-break                     | <b>M22-CK01D</b> |
|               | 2NO                                | <b>M22-CK20</b>  |
|               | 2NC                                | <b>M22-CK02</b>  |
|               | NO-NC                              | <b>M22-CK11</b>  |

#### Accessories

|   | Description                       | Catalog Number  |
|---|-----------------------------------|-----------------|
|   | Plunger bridge <sup>③</sup>       | <b>M22-XW</b>   |
|   | Key cover                         | <b>M22-XWS</b>  |
|  | Key withdraw adapter <sup>④</sup> | <b>M22-XC-R</b> |
|  | Coding adapter                    | <b>M22-XC-Y</b> |
|  | Guard ring                        | <b>M22-XGWK</b> |

#### Notes

- ① For complete listing of available contact blocks, see Accessories, **Pages V7-T1-111 to V7-T1-116.**
- ② All NC contact blocks are positively driven contact. ⊖
- ③ Plunger needed to actuate center-mounted contact blocks. Used for non-illuminated three-position selector switches only.
- ④ Enables a keyed selector switch to be set to user-selected key withdraw position.



#### 1

### Catalog Number Selection

Catalog Number Selection is for illustrative purposes only and not to be used to create new catalog numbers.

#### Illuminated Selector Switches

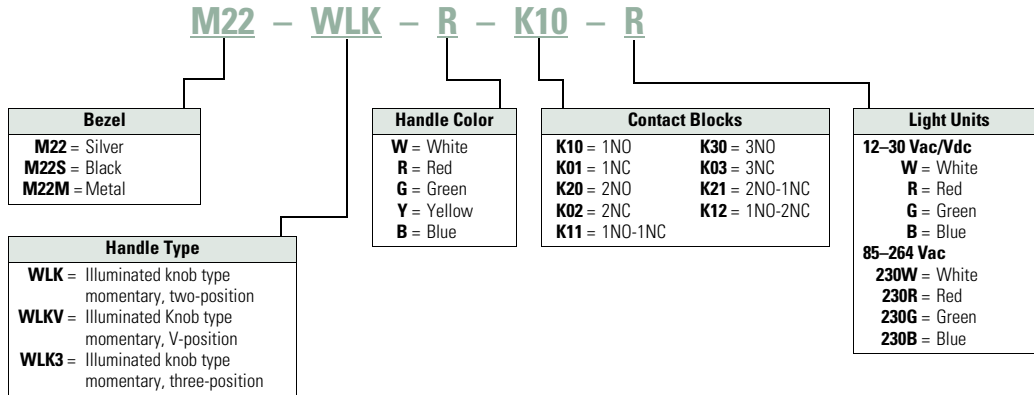

**Product Selection**



**Illuminated Selector Switches**

**Components**

M22-WLK-W

**Operators Only, Knob Type** <sup>①</sup>



| Type         | Switching Position  | Button Color | Silver Bezel Catalog Number | Black Bezel Catalog Number | Metal Bezel Catalog Number |
|--------------|---|--------------|-----------------------------|----------------------------|----------------------------|
| Two-position | Momentary <sup>②</sup><br> | White        | M22-WLK-W                   | M22S-WLK-W                 | M22M-WLK-W                 |
|              |   | Red          | M22-WLK-R                   | M22S-WLK-R                 | M22M-WLK-R                 |
|              |   | Green        | M22-WLK-G                   | M22S-WLK-G                 | M22M-WLK-G                 |
|              |   | Yellow       | M22-WLK-Y                   | M22S-WLK-Y                 | M22M-WLK-Y                 |
|              |   | Blue         | M22-WLK-B                   | M22S-WLK-B                 | M22M-WLK-B                 |
|              | Maintained<br>             | White        | M22-WRLK-W                  | M22S-WRLK-W                | M22M-WRLK-W                |
|              |   | Red          | M22-WRLK-R                  | M22S-WRLK-R                | M22M-WRLK-R                |
|              |   | Green        | M22-WRLK-G                  | M22S-WRLK-G                | M22M-WRLK-G                |
|              |   | Yellow       | M22-WRLK-Y                  | M22S-WRLK-Y                | M22M-WRLK-Y                |
|              |   | Blue         | M22-WRLK-B                  | M22S-WRLK-B                | M22M-WRLK-B                |
|              | Maintained V<br>           | White        | M22-WLKV-W                  | M22S-WLKV-W                | M22M-WLKV-W                |
|              |   | Red          | M22-WLKV-R                  | M22S-WLKV-R                | M22M-WLKV-R                |
|              |   | Green        | M22-WLKV-G                  | M22S-WLKV-G                | M22M-WLKV-G                |
|              |   | Yellow       | M22-WLKV-Y                  | M22S-WLKV-Y                | M22M-WLKV-Y                |
|              |   | Blue         | M22-WLKV-B                  | M22S-WLKV-B                | M22M-WLKV-B                |

**Notes**

- ① Includes contact block mounting adapter.
- ② Momentary selector switches can be converted in the field to maintained operation with the removal of a color coded adapter. See **Page V7-T1-118**.

# 1



## Illuminated Selector Switches

### Components

M22-WLK3-W

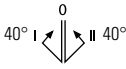
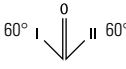

#### Operators Only, Knob Type <sup>①</sup>

| Type   | Switching Position   | Button Color  | Silver Bezel Catalog Number | Black Bezel Catalog Number | Metal Bezel Catalog Number |
|--|--|---------------|-----------------------------|----------------------------|----------------------------|
| Three-position   | Momentary <sup>②</sup><br>        | White         | M22-WLK3-W                  | M22S-WLK3-W                | M22M-WLK3-W                |
|  |  | Red           | M22-WLK3-R                  | M22S-WLK3-R                | M22M-WLK3-R                |
|  |  | Green         | M22-WLK3-G                  | M22S-WLK3-G                | M22M-WLK3-G                |
|  |  | Yellow        | M22-WLK3-Y                  | M22S-WLK3-Y                | M22M-WLK3-Y                |
|  |  | Blue          | M22-WLK3-B                  | M22S-WLK3-B                | M22M-WLK3-B                |
|  | Maintained<br>                    | White         | M22-WRLK3-W                 | M22S-WRLK3-W               | M22M-WRLK3-W               |
|  |  | Red           | M22-WRLK3-R                 | M22S-WRLK3-R               | M22M-WRLK3-R               |
|  |  | Green         | M22-WRLK3-G                 | M22S-WRLK3-G               | M22M-WRLK3-G               |
|  |  | Yellow        | M22-WRLK3-Y                 | M22S-WRLK3-Y               | M22M-WRLK3-Y               |
|  |  | Blue          | M22-WRLK3-B                 | M22S-WRLK3-B               | M22M-WRLK3-B               |
|  | Maintained, return from right<br> | White         | M22-WRLK3-1-W               | M22S-WRLK3-1-W             | M22M-WRLK3-1-W             |
|  |  | Red           | M22-WRLK3-1-R               | M22S-WRLK3-1-R             | M22M-WRLK3-1-R             |
| Green  |  | M22-WRLK3-1-G | M22S-WRLK3-1-G              | M22M-WRLK3-1-G             |                            |
| Yellow   |  | M22-WRLK3-1-Y | M22S-WRLK3-1-Y              | M22M-WRLK3-1-Y             |                            |
| Blue   |  | M22-WRLK3-1-B | M22S-WRLK3-1-B              | M22M-WRLK3-1-B             |                            |
| Maintained, return from left<br> | White  | M22-WRLK3-2-W | M22S-WRLK3-2-W              | M22M-WRLK3-2-W             |                            |
|  | Red  | M22-WRLK3-2-R | M22S-WRLK3-2-R              | M22M-WRLK3-2-R             |                            |
|  | Green  | M22-WRLK3-2-G | M22S-WRLK3-2-G              | M22M-WRLK3-2-G             |                            |
|  | Yellow   | M22-WRLK3-2-Y | M22S-WRLK3-2-Y              | M22M-WRLK3-2-Y             |                            |
|  | Blue   | M22-WRLK3-2-B | M22S-WRLK3-2-B              | M22M-WRLK3-2-B             |                            |

#### Notes

- <sup>①</sup> Includes contact block mounting adapter.
- <sup>②</sup> Momentary selector switches can be converted in the field to maintained operation with the removal of a color coded adapter. See [Page V7-T1-118](#).

**Illuminated Selector Switches**

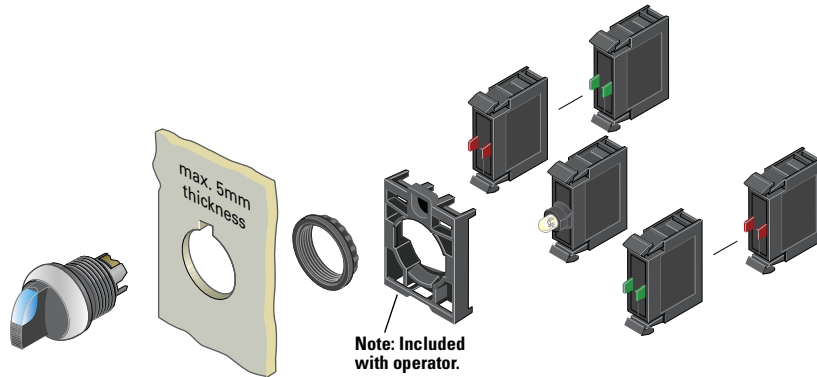

**M22-LED-W**



**Light Units** ①⑤

| Terminal Type | LED Color | Light Unit Voltage | Catalog Number      |
|---------------|-----------|--------------------|---------------------|
| Screw         | White     | 12–30<br>Vac/Vdc   | <b>M22-LED-W</b>    |
|               | Red       |                    | <b>M22-LED-R</b>    |
|               | Green     |                    | <b>M22-LED-G</b>    |
|               | Blue      |                    | <b>M22-LED-B</b>    |
| Screw         | White     | 85–264<br>Vac      | <b>M22-LED230-W</b> |
|               | Red       |                    | <b>M22-LED230-R</b> |
|               | Green     |                    | <b>M22-LED230-G</b> |
|               | Blue      |                    | <b>M22-LED230-B</b> |

**Accessories**

|                 | Description            | Catalog Number  |
|-----------------|------------------------|-----------------|
| <b>M22-XW</b>   | Plunger bridge ②       | <b>M22-XW</b>   |
| <b>M22-XWS</b>  | Key cover              | <b>M22-XWS</b>  |
| <b>M22-XC-R</b> | Key withdraw adapter ④ | <b>M22-XC-R</b> |
| <b>M22-XC-Y</b> | Coding adapter         | <b>M22-XC-Y</b> |
| <b>M22-XGWK</b> | Guard ring             | <b>M22-XGWK</b> |

**M22-K10**



**Contact Blocks** ①

| Terminal Type | Contact Configuration ③ | Catalog Number   |
|---------------|-------------------------|------------------|
| Screw         | NO                      | <b>M22-K10</b>   |
|               | NO, early-make          | <b>M22-K10P</b>  |
|               | NC                      | <b>M22-K01</b>   |
|               | NC, late-break          | <b>M22-K01D</b>  |
| Spring-cage   | NO                      | <b>M22-CK10</b>  |
|               | NC                      | <b>M22-CK01</b>  |
|               | NC, late-break          | <b>M22-CK01D</b> |
|               | 2NO                     | <b>M22-CK20</b>  |
|               | 2NC                     | <b>M22-CK02</b>  |
|               | NO-NC                   | <b>M22-CK11</b>  |

**Notes**

- ① For complete listing of available light units and contact blocks, see Accessories, **Pages V7-T1-111 to V7-T1-116.**
- ② Plunger needed to actuate center-mounted contact blocks. Used for non-illuminated three-position selector switches only.
- ③ All NC contact blocks are positively driven contact. ⊖
- ④ Enables a keyed selector switch to be set to user-selected key withdraw position.
- ⑤ Select the same color LED element as lens color; for yellow lens, choose a white LED.

#### 1

### Catalog Number Selection

Catalog Number Selection is for illustrative purposes only and not to be used to create new catalog numbers.

#### Key-Operated Selector Switches

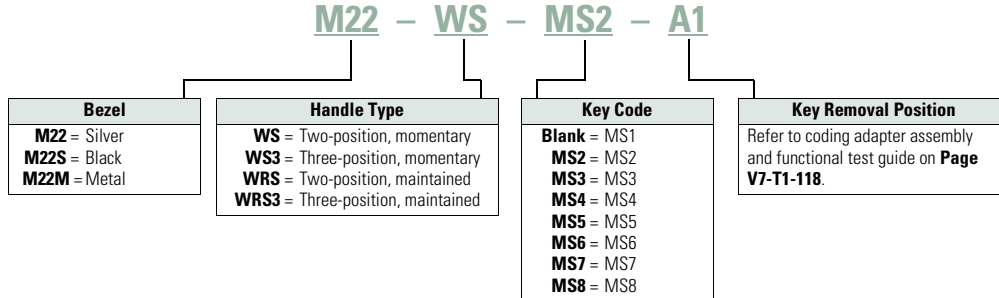

### Product Selection

#### Key-Operated Selector Switches <sup>①②</sup>

#### Components

##### M22-WS



#### Operators Only <sup>③</sup>

##### M22S-WRS



| Type         | Switching Position            | Key Removal Position                  | Key Code | Silver Bezel Catalog Number | Black Bezel Catalog Number | Metal Bezel Catalog Number |                     |
|--------------|-------------------------------|---------------------------------------|----------|-----------------------------|----------------------------|----------------------------|---------------------|
| Two-position | Momentary <sup>④</sup><br>40° | Return from right, key removable left | MS1      | <b>M22-WS</b>               | <b>M22S-WS</b>             | <b>M22M-WS</b>             |                     |
|              |                               |                                       | MS2      | <b>M22-WS-MS2</b>           | <b>M22S-WS-MS2</b>         | <b>M22M-WS-MS2</b>         |                     |
|              |                               |                                       | MS3      | <b>M22-WS-MS3</b>           | <b>M22S-WS-MS3</b>         | <b>M22M-WS-MS3</b>         |                     |
|              |                               |                                       | MS4      | <b>M22-WS-MS4</b>           | <b>M22S-WS-MS4</b>         | <b>M22M-WS-MS4</b>         |                     |
|              |                               |                                       | MS5      | <b>M22-WS-MS5</b>           | <b>M22S-WS-MS5</b>         | <b>M22M-WS-MS5</b>         |                     |
|              |                               |                                       | MS6      | <b>M22-WS-MS6</b>           | <b>M22S-WS-MS6</b>         | <b>M22M-WS-MS6</b>         |                     |
|              |                               |                                       | MS7      | <b>M22-WS-MS7</b>           | <b>M22S-WS-MS7</b>         | <b>M22M-WS-MS7</b>         |                     |
|              |                               |                                       | MS8      | <b>M22-WS-MS8</b>           | <b>M22S-WS-MS8</b>         | <b>M22M-WS-MS8</b>         |                     |
| Two-position | Maintained<br>40°             | Key removable left                    | MS1      | <b>M22-WRS-A1</b>           | <b>M22S-WRS-A1</b>         | <b>M22M-WRS-A1</b>         |                     |
|              |                               |                                       | MS2      | <b>M22-WRS-MS2-A1</b>       | <b>M22S-WRS-MS2-A1</b>     | <b>M22M-WRS-MS2-A1</b>     |                     |
|              |                               |                                       | MS3      | <b>M22-WRS-MS3-A1</b>       | <b>M22S-WRS-MS3-A1</b>     | <b>M22M-WRS-MS3-A1</b>     |                     |
|              |                               |                                       | MS4      | <b>M22-WRS-MS4-A1</b>       | <b>M22S-WRS-MS4-A1</b>     | <b>M22M-WRS-MS4-A1</b>     |                     |
|              |                               |                                       | MS5      | <b>M22-WRS-MS5-A1</b>       | <b>M22S-WRS-MS5-A1</b>     | <b>M22M-WRS-MS5-A1</b>     |                     |
|              |                               |                                       | MS6      | <b>M22-WRS-MS6-A1</b>       | <b>M22S-WRS-MS6-A1</b>     | <b>M22M-WRS-MS6-A1</b>     |                     |
|              |                               |                                       | MS7      | <b>M22-WRS-MS7-A1</b>       | <b>M22S-WRS-MS7-A1</b>     | <b>M22M-WRS-MS7-A1</b>     |                     |
|              |                               |                                       | MS8      | <b>M22-WRS-MS8-A1</b>       | <b>M22S-WRS-MS8-A1</b>     | <b>M22M-WRS-MS8-A1</b>     |                     |
|              | Key removable left/right      |                                       |          | MS1                         | <b>M22-WRS</b>             | <b>M22S-WRS</b>            | <b>M22M-WRS</b>     |
|              |                               |                                       |          | MS2                         | <b>M22-WRS-MS2</b>         | <b>M22S-WRS-MS2</b>        | <b>M22M-WRS-MS2</b> |
|              |                               |                                       |          | MS3                         | <b>M22-WRS-MS3</b>         | <b>M22S-WRS-MS3</b>        | <b>M22M-WRS-MS3</b> |
|              |                               |                                       |          | MS4                         | <b>M22-WRS-MS4</b>         | <b>M22S-WRS-MS4</b>        | <b>M22M-WRS-MS4</b> |
|              |                               |                                       |          | MS5                         | <b>M22-WRS-MS5</b>         | <b>M22S-WRS-MS5</b>        | <b>M22M-WRS-MS5</b> |
|              |                               |                                       |          | MS6                         | <b>M22-WRS-MS6</b>         | <b>M22S-WRS-MS6</b>        | <b>M22M-WRS-MS6</b> |
|              |                               |                                       |          | MS7                         | <b>M22-WRS-MS7</b>         | <b>M22S-WRS-MS7</b>        | <b>M22M-WRS-MS7</b> |
|              |                               |                                       |          | MS8                         | <b>M22-WRS-MS8</b>         | <b>M22S-WRS-MS8</b>        | <b>M22M-WRS-MS8</b> |

#### Notes

- ① Includes one key.
- ② Key removal positions can be modified in the field using coding adapters; see chart on **Page V7-T1-118**.
- ③ Includes contact block mounting adapter.
- ④ Momentary selector switches can be converted in the field to maintained operation with the removal of a color coded adapter. See **Page V7-T1-118**.

**Key-Operated Selector Switches** ①②

**Components**

M22-WS3-X93

**Operators Only, continued** ③



M22M-WS3-X93

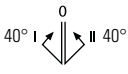
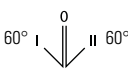

| Type                       | Switching Position   | Key Removal Position                         | Key Code       | Silver Bezel Catalog Number   | Black Bezel Catalog Number      | Metal Bezel Catalog Number |
|----------------------------|--|--|----------------|---|---------------------------------|----------------------------|
| Three-position             | Momentary ④<br> | Return from left/right, key removable center | MS1            | M22-WS3   | M22S-WS3                        | M22M-WS3                   |
|                            |  |  | MS2            | M22-WS3-MS2   | M22S-WS3-MS2                    | M22M-WS3-MS2               |
|                            |  |  | MS3            | M22-WS3-MS3   | M22S-WS3-MS3                    | M22M-WS3-MS3               |
|                            |  |  | MS4            | M22-WS3-MS4   | M22S-WS3-MS4                    | M22M-WS3-MS4               |
|                            |  |  | MS5            | M22-WS3-MS5   | M22S-WS3-MS5                    | M22M-WS3-MS5               |
|                            |  |  | MS6            | M22-WS3-MS6   | M22S-WS3-MS6                    | M22M-WS3-MS6               |
|                            |  |  | MS7            | M22-WS3-MS7   | M22S-WS3-MS7                    | M22M-WS3-MS7               |
|                            |  |  | MS8            | M22-WS3-MS8   | M22S-WS3-MS8                    | M22M-WS3-MS8               |
|                            |  |  | Three-position | Maintained<br> | Key removable left/center/right | MS1                        |
| MS2                        | M22-WRS3-MS2-A1  | M22S-WRS3-MS2-A1                             |                |   |                                 | M22M-WRS3-MS2-A1           |
| MS3                        | M22-WRS3-MS3-A1  | M22S-WRS3-MS3-A1                             |                |   |                                 | M22M-WRS3-MS3-A1           |
| MS4                        | M22-WRS3-MS4-A1  | M22S-WRS3-MS4-A1                             |                |   |                                 | M22M-WRS3-MS4-A1           |
| MS5                        | M22-WRS3-MS5-A1  | M22S-WRS3-MS5-A1                             |                |   |                                 | M22M-WRS3-MS5-A1           |
| MS6                        | M22-WRS3-MS6-A1  | M22S-WRS3-MS6-A1                             |                |   |                                 | M22M-WRS3-MS6-A1           |
| MS7                        | M22-WRS3-MS7-A1  | M22S-WRS3-MS7-A1                             |                |   |                                 | M22M-WRS3-MS7-A1           |
| MS8                        | M22-WRS3-MS8-A1  | M22S-WRS3-MS8-A1                             |                |   |                                 | M22M-WRS3-MS8-A1           |
| Key removable center/left  | MS1  | M22-WRS3-A2                                  |                |   | M22S-WRS3-A2                    | M22M-WRS3-A2               |
|                            | MS2  | M22-WRS3-MS2-A2                              |                |   | M22S-WRS3-MS2-A2                | M22M-WRS3-MS2-A2           |
|                            | MS3  | M22-WRS3-MS3-A2                              |                |   | M22S-WRS3-MS3-A2                | M22M-WRS3-MS3-A2           |
|                            | MS4  | M22-WRS3-MS4-A2                              |                |   | M22S-WRS3-MS4-A2                | M22M-WRS3-MS4-A2           |
|                            | MS5  | M22-WRS3-MS5-A2                              |                |   | M22S-WRS3-MS5-A2                | M22M-WRS3-MS5-A2           |
|                            | MS6  | M22-WRS3-MS6-A2                              |                |   | M22S-WRS3-MS6-A2                | M22M-WRS3-MS6-A2           |
|                            | MS7  | M22-WRS3-MS7-A2                              |                |   | M22S-WRS3-MS7-A2                | M22M-WRS3-MS7-A2           |
|                            | MS8  | M22-WRS3-MS8-A2                              |                |   | M22S-WRS3-MS8-A2                | M22M-WRS3-MS8-A2           |
| Key removable center/right | MS1  | M22-WRS3-A3                                  |                |   | M22S-WRS3-A3                    | M22M-WRS3-A3               |
|                            | MS2  | M22-WRS3-MS2-A3                              |                |   | M22S-WRS3-MS2-A3                | M22M-WRS3-MS2-A3           |
|                            | MS3  | M22-WRS3-MS3-A3                              |                |   | M22S-WRS3-MS3-A3                | M22M-WRS3-MS3-A3           |
|                            | MS4  | M22-WRS3-MS4-A3                              |                |   | M22S-WRS3-MS4-A3                | M22M-WRS3-MS4-A3           |
|                            | MS5  | M22-WRS3-MS5-A3                              |                |   | M22S-WRS3-MS5-A3                | M22M-WRS3-MS5-A3           |
|                            | MS6  | M22-WRS3-MS6-A3                              |                |   | M22S-WRS3-MS6-A3                | M22M-WRS3-MS6-A3           |
|                            | MS7  | M22-WRS3-MS7-A3                              |                |   | M22S-WRS3-MS7-A3                | M22M-WRS3-MS7-A3           |
|                            | MS8  | M22-WRS3-MS8-A3                              |                |   | M22S-WRS3-MS8-A3                | M22M-WRS3-MS8-A3           |
| Key removable left/right   | MS1  | M22-WRS3                                     |                |   | M22S-WRS3                       | M22M-WRS3                  |
|                            | MS2  | M22-WRS3-MS2                                 |                |   | M22S-WRS3-MS2                   | M22M-WRS3-MS2              |
|                            | MS3  | M22-WRS3-MS3                                 |                |   | M22S-WRS3-MS3                   | M22M-WRS3-MS3              |
|                            | MS4  | M22-WRS3-MS4                                 |                |   | M22S-WRS3-MS4                   | M22M-WRS3-MS4              |
|                            | MS5  | M22-WRS3-MS5                                 |                |   | M22S-WRS3-MS5                   | M22M-WRS3-MS5              |
|                            | MS6  | M22-WRS3-MS6                                 |                |   | M22S-WRS3-MS6                   | M22M-WRS3-MS6              |
|                            | MS7  | M22-WRS3-MS7                                 |                |   | M22S-WRS3-MS7                   | M22M-WRS3-MS7              |
|                            | MS8  | M22-WRS3-MS8                                 |                |   | M22S-WRS3-MS8                   | M22M-WRS3-MS8              |

**Notes**

- ① Includes one key.
- ② Key removal positions can be modified in the field using coding adapters; see chart on **Page V7-T1-118**.
- ③ Includes contact block mounting adapter.
- ④ Momentary selector switches can be converted in the field to maintained operation with the removal of a color coded adapter. See **Page V7-T1-118**.

## Key-Operated Selector Switches <sup>①②</sup>

### Components

M22-WS3-X93



M22M-WS3-X93

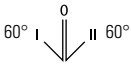
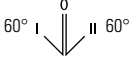

### Operators Only, continued <sup>③</sup>

| Type           | Switching Position   | Key Removal Position                         | Key Code        | Silver Bezel Catalog Number | Black Bezel Catalog Number | Metal Bezel Catalog Number |
|----------------|--|--|-----------------|-----------------------------|----------------------------|----------------------------|
| Three-position | Maintained<br>  | Return from left, key removable center       | MS1             | M22-WRS3-A7                 | M22S-WRS3-A7               | M22M-WRS3-A7               |
|                |  |  | MS2             | M22-WRS3-MS2-A7             | M22S-WRS3-MS2-A7           | M22M-WRS3-MS2-A7           |
|                |  |  | MS3             | M22-WRS3-MS3-A7             | M22S-WRS3-MS3-A7           | M22M-WRS3-MS3-A7           |
|                |  |  | MS4             | M22-WRS3-MS4-A7             | M22S-WRS3-MS4-A7           | M22M-WRS3-MS4-A7           |
|                |  |  | MS5             | M22-WRS3-MS5-A7             | M22S-WRS3-MS5-A7           | M22M-WRS3-MS5-A7           |
|                |  |  | MS6             | M22-WRS3-MS6-A7             | M22S-WRS3-MS6-A7           | M22M-WRS3-MS6-A7           |
|                |  |  | MS7             | M22-WRS3-MS7-A7             | M22S-WRS3-MS7-A7           | M22M-WRS3-MS7-A7           |
|                |  |  | MS8             | M22-WRS3-MS8-A7             | M22S-WRS3-MS8-A7           | M22M-WRS3-MS8-A7           |
|                | Return from left, key removable center/right   | MS1  | M22-WRS3-A6     | M22S-WRS3-A6                | M22M-WRS3-A6               |                            |
|                |  | MS2  | M22-WRS3-MS2-A6 | M22S-WRS3-MS2-A6            | M22M-WRS3-MS2-A6           |                            |
|                |  | MS3  | M22-WRS3-MS3-A6 | M22S-WRS3-MS3-A6            | M22M-WRS3-MS3-A6           |                            |
|                |  | MS4  | M22-WRS3-MS4-A6 | M22S-WRS3-MS4-A6            | M22M-WRS3-MS4-A6           |                            |
|                |  | MS5  | M22-WRS3-MS5-A6 | M22S-WRS3-MS5-A6            | M22M-WRS3-MS5-A6           |                            |
|                |  | MS6  | M22-WRS3-MS6-A6 | M22S-WRS3-MS6-A6            | M22M-WRS3-MS6-A6           |                            |
|                |  | MS7  | M22-WRS3-MS7-A6 | M22S-WRS3-MS7-A6            | M22M-WRS3-MS7-A6           |                            |
|                |  | MS8  | M22-WRS3-MS8-A6 | M22S-WRS3-MS8-A6            | M22M-WRS3-MS8-A6           |                            |
| Three-position | Maintained<br> | Return from right, key removable left/center | MS1             | M22-WRS3-A4                 | M22S-WRS3-A4               | M22M-WRS3-A4               |
|                |  |  | MS2             | M22-WRS3-MS2-A4             | M22S-WRS3-MS2-A4           | M22M-WRS3-MS2-A4           |
|                |  |  | MS3             | M22-WRS3-MS3-A4             | M22S-WRS3-MS3-A4           | M22M-WRS3-MS3-A4           |
|                |  |  | MS4             | M22-WRS3-MS4-A4             | M22S-WRS3-MS4-A4           | M22M-WRS3-MS4-A4           |
|                |  |  | MS5             | M22-WRS3-MS5-A4             | M22S-WRS3-MS5-A4           | M22M-WRS3-MS5-A4           |
|                |  |  | MS6             | M22-WRS3-MS6-A4             | M22S-WRS3-MS6-A4           | M22M-WRS3-MS6-A4           |
|                |  |  | MS7             | M22-WRS3-MS7-A4             | M22S-WRS3-MS7-A4           | M22M-WRS3-MS7-A4           |
|                |  |  | MS8             | M22-WRS3-MS8-A4             | M22S-WRS3-MS8-A4           | M22M-WRS3-MS8-A4           |
|                | Return from right, key removable center  | MS1  | M22-WRS3-A5     | M22S-WRS3-A5                | M22M-WRS3-A5               |                            |
|                |  | MS2  | M22-WRS3-MS2-A5 | M22S-WRS3-MS2-A5            | M22M-WRS3-MS2-A5           |                            |
|                |  | MS3  | M22-WRS3-MS3-A5 | M22S-WRS3-MS3-A5            | M22M-WRS3-MS3-A5           |                            |
|                |  | MS4  | M22-WRS3-MS4-A5 | M22S-WRS3-MS4-A5            | M22M-WRS3-MS4-A5           |                            |
|                |  | MS5  | M22-WRS3-MS5-A5 | M22S-WRS3-MS5-A5            | M22M-WRS3-MS5-A5           |                            |
|                |  | MS6  | M22-WRS3-MS6-A5 | M22S-WRS3-MS6-A5            | M22M-WRS3-MS6-A5           |                            |
|                |  | MS7  | M22-WRS3-MS7-A5 | M22S-WRS3-MS7-A5            | M22M-WRS3-MS7-A5           |                            |
|                |  | MS8  | M22-WRS3-MS8-A5 | M22S-WRS3-MS8-A5            | M22M-WRS3-MS8-A5           |                            |

#### Notes

- ① Includes one key.
- ② Key removal positions can be modified in the field using coding adapters; see chart on [Page V7-T1-118](#).
- ③ Includes contact block mounting adapter.

### Key-Operated Selector Switches

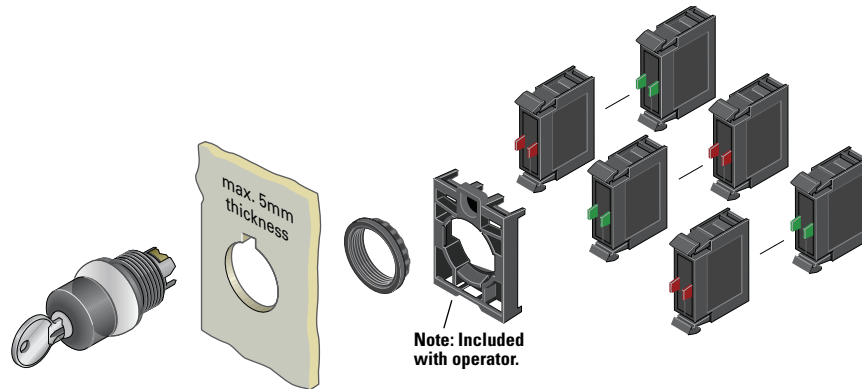

### Components

#### M22-K10



#### Contact Blocks <sup>①</sup>

| Terminal Type | Contact Configuration <sup>②</sup> | Catalog Number |
|---------------|------------------------------------|----------------|
| Screw         | NO                                 | M22-K10        |
|               | NO, early-make                     | M22-K10P       |
|               | NC                                 | M22-K01        |
|               | NC, late-break                     | M22-K01D       |
| Spring-cage   | NO                                 | M22-CK10       |
|               | NC                                 | M22-CK01       |
|               | NC, late-break                     | M22-CK01D      |
|               | 2NO                                | M22-CK20       |
|               | 2NC                                | M22-CK02       |
|               | NO-NC                              | M22-CK11       |





#### M22-ES-MS1



#### Extra Keys

| Key Code | Catalog Number |
|----------|----------------|
| MS1      | M22-ES-MS1     |
| MS2      | M22-ES-MS2     |
| MS3      | M22-ES-MS3     |
| MS4      | M22-ES-MS4     |
| MS5      | M22-ES-MS5     |
| MS6      | M22-ES-MS6     |
| MS7      | M22-ES-MS7     |
| MS8      | M22-ES-MS8     |

#### Accessories

|   | Description                       | Catalog Number |
|---|-----------------------------------|----------------|
| M22-XW<br>    | Plunger bridge <sup>③</sup>       | M22-XW         |
| M22-XWS<br>   | Key cover                         | M22-XWS        |
| M22-XC-R<br> | Key withdraw adapter <sup>④</sup> | M22-XC-R       |
| M22-XC-Y<br> | Coding adapter                    | M22-XC-Y       |
| M22-XGWK<br> | Guard ring                        | M22-XGWK       |

#### Notes

- ① For complete listing of available contact blocks, see Accessories, Pages V7-T1-111 to V7-T1-116.
- ② All NC contact blocks are positively driven contact. ⊖
- ③ Plunger needed to actuate center-mounted contact blocks. Used for non-illuminated three-position selector switches only.
- ④ Enables a keyed selector switch to be set to user-selected key withdraw position.



## 1

**Mushroom Head Pushbuttons****Product Description**

Eaton's M22 mushroom head operators are a durable and unique way to include standard pushbutton functionality. Like the standard pushbutton line, the maintained pushbuttons are field convertible to momentary. They also offer laser engraving and a robust five million mechanical operations on the standard momentary operator. As with all operators, they can be ordered as a ready to install complete device or as modular components.

**Features**

- Field convertible from maintained to momentary (available on maintained pushbuttons only)
- Customizable laser engraving on all buttons
- More than five million mechanical operations on momentary and one million on maintained pushbuttons
- Modular construction makes assembly fast and simplifies stocking of components and complete devices
- Capable of communicating via ASi protocol with ASi adapter modules

**Protection Type**

- IP67, IP69K
- NEMA 4X, 13

**Catalog Number Selection**

Catalog Number Selection is for illustrative purposes only and not to be used to create new catalog numbers.

**Mushroom Head Pushbuttons**

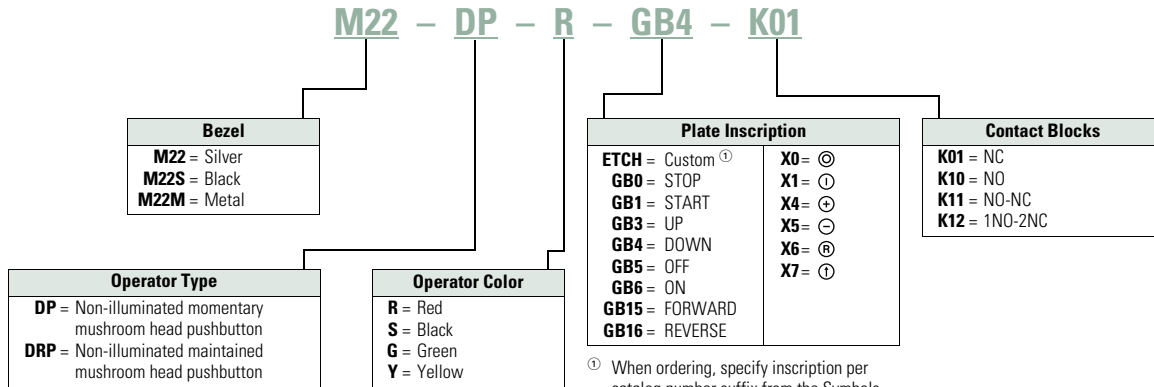

<sup>①</sup> When ordering, specify inscription per catalog number suffix from the Symbols Library (see **Pages V7-T1-129 to V7-T1-136**) into the Order Notes. For example, M22-DP-R-ETCH; Order Notes: Mark with symbol X91, Line item #\_.

#### 1

### Product Selection

#### Mushroom Head Pushbuttons, Momentary <sup>①</sup>

M22-DP-R-K01



M22S-DP-R-K01



M22M-DP-R-K01



#### Complete Devices

| Button Color | Contact Block Configuration <sup>②</sup> | Silver Bezel Catalog Number | Black Bezel Catalog Number | Metal Bezel Catalog Number |
|--------------|--|-----------------------------|----------------------------|----------------------------|
| Red          | NC                                       | M22-DP-R-K01                | M22S-DP-R-K01              | M22M-DP-R-K01              |
|              | 2NC                                      | M22-DP-R-K02                | M22S-DP-R-K02              | M22M-DP-R-K02              |
|              | 1NO-2NC                                  | M22-DP-R-K12                | M22S-DP-R-K12              | M22M-DP-R-K12              |
|              | 1NO-1NC                                  | M22-DP-R-K11                | M22S-DP-R-K11              | M22M-DP-R-K11              |

M22-DP-G



M22S-DP-G



M22M-DP-G



#### Operators Only <sup>②</sup>

| Button Color | Silver Bezel Catalog Number | Black Bezel Catalog Number | Metal Bezel Catalog Number |
|--------------|-----------------------------|----------------------------|----------------------------|
| Black        | M22-DP-S                    | M22S-DP-S                  | M22M-DP-S                  |
| Red          | M22-DP-R                    | M22S-DP-R                  | M22M-DP-R                  |
| Green        | M22-DP-G                    | M22S-DP-G                  | M22M-DP-G                  |
| Yellow       | M22-DP-Y                    | M22S-DP-Y                  | M22M-DP-Y                  |

#### Notes

- ① 35 mm diameter mushroom head button.
- ② Includes contact block mounting adapter.

### Non-Illuminated Mushroom Head Pushbuttons, Momentary <sup>①</sup>

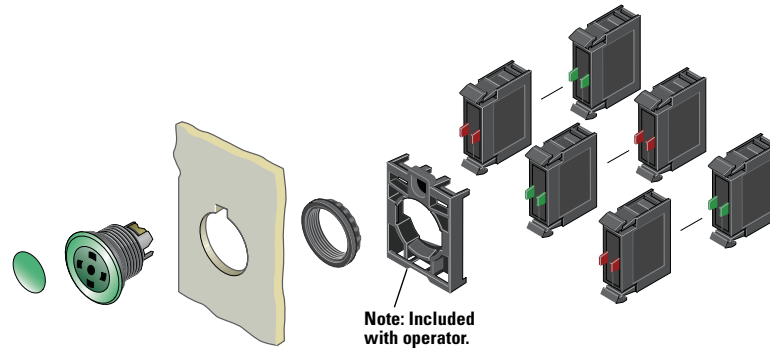

### Components

#### M22-XDP-G



#### Mushroom Head Plates

| Color  | Inscription | Catalog Number              |
|--------|-------------|-----------------------------|
| Black  | —           | M22-XDP-S <sup>②</sup>      |
|        | Custom      | M22-XDP-S-ETCH <sup>③</sup> |
|        | STOP        | M22-XDP-S-GB0               |
|        | START       | M22-XDP-S-GB1               |
|        | FORWARD     | M22-XDP-S-GB15              |
|        | REVERSE     | M22-XDP-S-GB16              |
|        | UP          | M22-XDP-S-GB3               |
|        | DOWN        | M22-XDP-S-GB4               |
|        | OFF         | M22-XDP-S-GB5               |
|        | ON          | M22-XDP-S-GB6               |
|        | ⊙           | M22-XDP-S-X0                |
|        | ①           | M22-XDP-S-X1                |
|        | +           | M22-XDP-S-X4                |
|        | −           | M22-XDP-S-X5                |
|        | ①           | M22-XDP-S-X7                |
| Red    | —           | M22-XDP-R <sup>②</sup>      |
|        | Custom      | M22-XDP-R-ETCH <sup>③</sup> |
|        | STOP        | M22-XDP-R-GB0               |
|        | OFF         | M22-XDP-R-GB5               |
|        | ⊙           | M22-XDP-R-X0                |
| Green  | —           | M22-XDP-G <sup>②</sup>      |
|        | Custom      | M22-XDP-G-ETCH <sup>③</sup> |
|        | START       | M22-XDP-G-GB1               |
|        | ON          | M22-XDP-G-GB6               |
|        | ⊙           | M22-XDP-G-X0                |
| White  | —           | M22-XDP-W <sup>②</sup>      |
|        | Custom      | M22-XDP-W-ETCH <sup>③</sup> |
|        | —           | M22-XDP-Y <sup>②</sup>      |
| Yellow | —           | M22-XDP-Y <sup>②</sup>      |
|        | Custom      | M22-XDP-Y-ETCH <sup>③</sup> |

#### M22-DP-G-X



#### Insertless Mushroom Head Operators

| Bezel  | Color  | Catalog Number |
|--------|--------|----------------|
| Silver | Black  | M22-DP-S-X     |
|        | Red    | M22-DP-R-X     |
|        | Green  | M22-DP-G-X     |
|        | Yellow | M22-DP-Y-X     |
| Black  | Black  | M22S-DP-S-X    |
|        | Red    | M22S-DP-R-X    |
|        | Green  | M22S-DP-G-X    |
| Metal  | Black  | M22M-DP-S-X    |
|        | Red    | M22M-DP-R-X    |
|        | Green  | M22M-DP-G-X    |
|        | Yellow | M22M-DP-Y-X    |

#### M22-K10



#### Contact Blocks <sup>④</sup>

| Terminal Type | Contact Configuration <sup>⑤</sup> | Catalog Number |
|---------------|------------------------------------|----------------|
| Screw         | NO                                 | M22-K10        |
|               | NO, early-make                     | M22-K10P       |
|               | NC                                 | M22-K01        |
|               | NC, late-break                     | M22-K01D       |
| Spring-cage   | NO                                 | M22-CK10       |
|               | NC                                 | M22-CK01       |
|               | NC, late-break                     | M22-CK01D      |
|               | 2NO                                | M22-CK20       |
|               | 2NC                                | M22-CK02       |
|               | NO-NC                              | M22-CK11       |

#### Notes

- ① 35 mm diameter mushroom head button.
- ② Minimum order quantity of (10).
- ③ When ordering, specify inscription per catalog number suffix from the Symbols Library (see **Pages V7-T1-129 to V7-T1-136**) into the Order Notes. For example, M22-XDP-S-ETCH; Order Notes: Mark with symbol X91, Line item #\_.
- ④ For complete listing of available contact blocks, see Accessories, **Pages V7-T1-111 to V7-T1-116**.
- ⑤ All NC contact blocks are positively driven contact. ⊖

#### 1

### Product Selection

#### Non-Illuminated Mushroom Head Pushbuttons, Maintained <sup>① ②</sup>

M22-DRP-R-K01



M22S-DRP-R-K01



M22M-DRP-R-K01



#### Complete Devices

| Button Color | Contact Block Configuration <sup>②</sup> | Silver Bezel Catalog Number | Black Bezel Catalog Number | Metal Bezel Catalog Number |
|--------------|--|-----------------------------|----------------------------|----------------------------|
| Red          | NC                                       | M22-DRP-R-K01               | M22S-DRP-R-K01             | M22M-DRP-R-K01             |
|              | 2NC                                      | M22-DRP-R-K02               | M22S-DRP-R-K02             | M22M-DRP-R-K02             |
|              | 1NO-2NC                                  | M22-DRP-R-K12               | M22S-DRP-R-K12             | M22M-DRP-R-K12             |
|              | 1NO-1NC                                  | M22-DRP-R-K11               | M22S-DRP-R-K11             | M22M-DRP-R-K11             |

M22-DRP-G



M22S-DRP-G



M22M-DRP-G



#### Operators Only

| Button Color | Silver Bezel Catalog Number | Black Bezel Catalog Number | Metal Bezel Catalog Number |
|--------------|-----------------------------|----------------------------|----------------------------|
| Black        | M22-DRP-S                   | M22S-DRP-S                 | M22M-DRP-S                 |
| Red          | M22-DRP-R                   | M22S-DRP-R                 | M22M-DRP-R                 |
| Green        | M22-DRP-G                   | M22S-DRP-G                 | M22M-DRP-G                 |
| Yellow       | M22-DRP-Y                   | M22S-DRP-Y                 | M22M-DRP-Y                 |

#### Notes

- ① 35 mm diameter mushroom head button.
- ② Maintained pushbuttons can be converted in the field to momentary operation by switching the locking ring, which is accessible through the side of the operator body.
- ③ All NC contact blocks are positively driven contact. ⊖

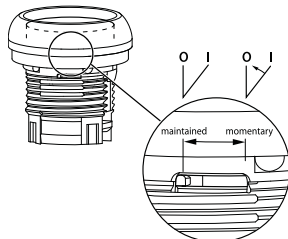

**Note:** This pilot device features a selectable function switch that enables the device to be set to either maintained or momentary operation.

**Non-Illuminated Mushroom Head Pushbuttons, Maintained** ①②

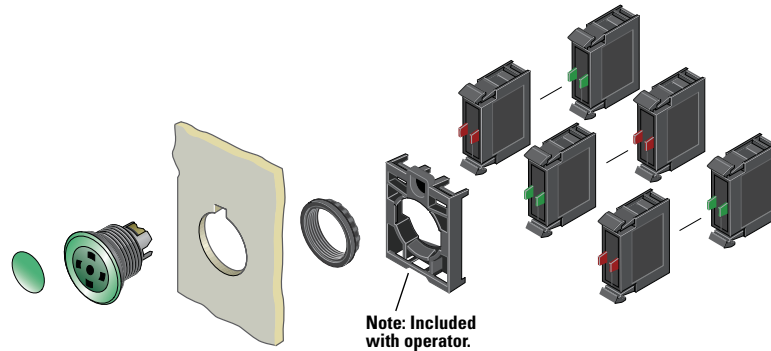

**Components**

**M22-XDP-G**



**Mushroom Head Plates** ③

| Color  | Inscription | Catalog Number          |
|--------|-------------|-------------------------|
| Black  | —           | <b>M22-XDP-S</b> ③      |
|        | Custom      | <b>M22-XDP-S-ETCH</b> ④ |
|        | STOP        | <b>M22-XDP-S-GB0</b>    |
|        | START       | <b>M22-XDP-S-GB1</b>    |
|        | FORWARD     | <b>M22-XDP-S-GB15</b>   |
|        | REVERSE     | <b>M22-XDP-S-GB16</b>   |
|        | UP          | <b>M22-XDP-S-GB3</b>    |
|        | DOWN        | <b>M22-XDP-S-GB4</b>    |
|        | OFF         | <b>M22-XDP-S-GB5</b>    |
|        | ON          | <b>M22-XDP-S-GB6</b>    |
|        | ⊙           | <b>M22-XDP-S-X0</b>     |
|        | ①           | <b>M22-XDP-S-X1</b>     |
|        | +           | <b>M22-XDP-S-X4</b>     |
|        | −           | <b>M22-XDP-S-X5</b>     |
|        | Ⓜ           | <b>M22-XDP-S-X7</b>     |
| Red    | —           | <b>M22-XDP-R</b> ③      |
|        | Custom      | <b>M22-XDP-R-ETCH</b> ④ |
|        | STOP        | <b>M22-XDP-R-GB0</b>    |
|        | OFF         | <b>M22-XDP-R-GB5</b>    |
|        | ⊙           | <b>M22-XDP-R-X0</b>     |
| Green  | —           | <b>M22-XDP-G</b> ③      |
|        | Custom      | <b>M22-XDP-G-ETCH</b> ④ |
|        | START       | <b>M22-XDP-G-GB1</b>    |
|        | ON          | <b>M22-XDP-G-GB6</b>    |
|        | ⊙           | <b>M22-XDP-G-X0</b>     |
| White  | —           | <b>M22-XDP-W</b> ③      |
|        | Custom      | <b>M22-XDP-W-ETCH</b> ④ |
| Yellow | —           | <b>M22-XDP-Y</b> ③      |
|        | Custom      | <b>M22-XDP-Y-ETCH</b> ④ |

**M22-DRP-G-X**



**Insertless Mushroom Head Operators**

| Bezel  | Color  | Catalog Number      |
|--------|--------|---------------------|
| Silver | Black  | <b>M22-DRP-S-X</b>  |
|        | Red    | <b>M22-DRP-R-X</b>  |
|        | Green  | <b>M22-DRP-G-X</b>  |
|        | Yellow | <b>M22-DRP-Y-X</b>  |
| Black  | Black  | <b>M22S-DRP-S-X</b> |
|        | Red    | <b>M22S-DRP-R-X</b> |
|        | Green  | <b>M22S-DRP-G-X</b> |
|        | Yellow | <b>M22S-DRP-Y-X</b> |
| Metal  | Black  | <b>M22M-DRP-S-X</b> |
|        | Red    | <b>M22M-DRP-R-X</b> |
|        | Green  | <b>M22M-DRP-G-X</b> |
|        | Yellow | <b>M22M-DRP-Y-X</b> |

**M22-K10**



**Contact Blocks** ⑤

| Terminal Type | Contact Configuration | Catalog Number   |
|---------------|-----------------------|------------------|
| Screw         | NO                    | <b>M22-K10</b>   |
|               | NO, early-make        | <b>M22-K10P</b>  |
|               | NC                    | <b>M22-K01</b>   |
|               | NC, late-break        | <b>M22-K01D</b>  |
| Spring-cage   | NO                    | <b>M22-CK10</b>  |
|               | NC                    | <b>M22-CK01</b>  |
|               | NC, late-break        | <b>M22-CK01D</b> |
|               | 2NO                   | <b>M22-CK20</b>  |
|               | 2NC                   | <b>M22-CK02</b>  |
|               | NO-NC                 | <b>M22-CK11</b>  |

**Notes**

- ① 35 mm diameter mushroom head button.
- ② Maintained pushbuttons can be converted in the field to momentary operation by switching the locking ring, which is accessible through the side of the operator body.
- ③ Minimum order quantity of (10).
- ④ When ordering, specify inscription per catalog number suffix from the Symbols Library (see **Pages V7-T1-129 to V7-T1-136**) into the Order Notes. For example, M22-XDP-S-ETCH; Order Notes: Mark with symbol X91, Line item #\_.
- ⑤ For complete listing of available button plates and contact blocks, see Accessories, **Pages V7-T1-111 to V7-T1-116**.
- ⑥ All NC contact blocks are positively driven contact. ⊖

#### 1

### Double Pushbuttons

#### Product Description

Eaton's M22 double pushbutton line is perfect for applications such as motor and pump starting, as well as anytime space is limited. In addition to the two buttons that fit in one 22 mm hole is the integrated white indicating light between them. These three operators allow for multiple functions to occur in a single space. Green/red, black/white and black/black color options along with laser engraving allow for further custom applications.

#### Features

- Flush and extended, as well as color options allow for the perfect combination button
- Integrated indicating light adds even more functionality in one standard 22 mm hole
- Customizable laser engraving on all buttons
- LED offering only for improved brightness quality and up to 100,000 hours of operation
- More than 200,000 mechanical operations
- Capable of communicating via ASi protocol with ASi adapter modules

#### Protection Type

- IP66
- NEMA 4X, 13

### Catalog Number Selection

Catalog Number Selection is for illustrative purposes only and not to be used to create new catalog numbers.

#### Double Pushbuttons

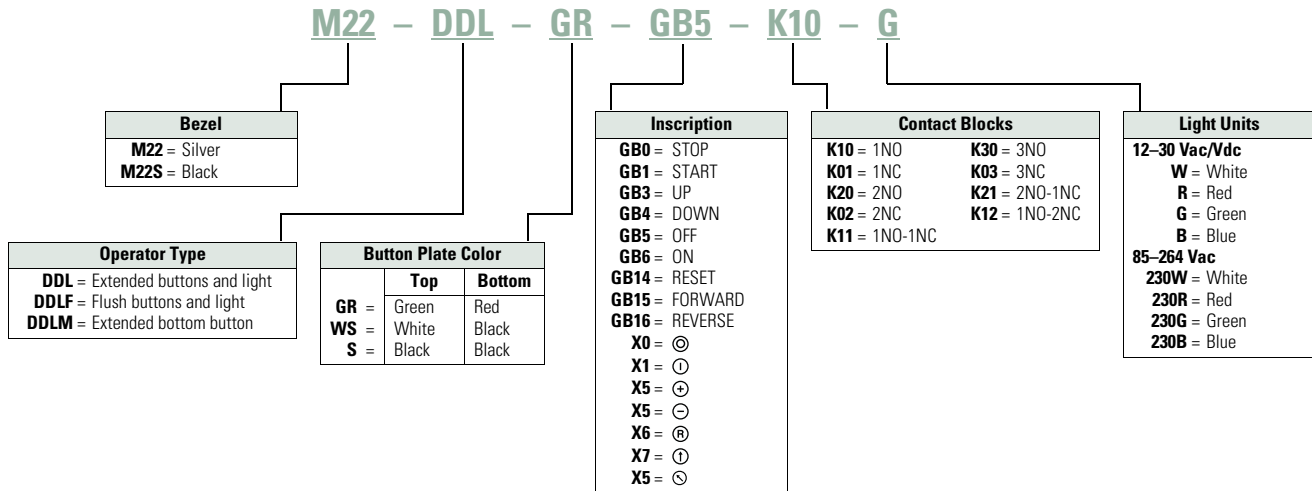



**Product Selection**

**Components**

**Double Pushbuttons, Extended Pushbuttons and Center Light, Momentary**

**Operators Only** <sup>①</sup>

|  | Bezel  | Color Top | Bottom | Inscription Top         | Bottom | Catalog Number                       |
|--|--------|-----------|--------|-------------------------|--------|--------------------------------------|
|  <p><b>M22-DDL-GR-GB1-GB0</b></p> | Silver | Green     | Red    | —                       | —      | <b>M22-DDL-GR</b>                    |
|  |        |           |        | Custom                  | Custom | <b>M22-DDL-GR-ETCH</b> <sup>②</sup>  |
|  |        |           |        | Ⓜ                       | Ⓜ      | <b>M22-DDL-GR-X1-X0</b>              |
|  |        |           |        | START                   | STOP   | <b>M22-DDL-GR-GB1-GB0</b>            |
|  |        |           |        | —                       | —      | <b>M22-DDL-WS</b>                    |
|  |        |           |        | Custom                  | Custom | <b>M22-DDL-WS-ETCH</b> <sup>②</sup>  |
|  |        | White     | Black  | —                       | —      | <b>M22-DDL-WS-X1-X0</b>              |
|  |        |           |        | Ⓜ                       | Ⓜ      | <b>M22-DDL-WS-GB1-GB0</b>            |
|  |        |           |        | START                   | STOP   | <b>M22-DDL-WS-GB1-GB0</b>            |
|  |        |           |        | —                       | —      | <b>M22-DDL-S</b>                     |
|  |        |           |        | Custom                  | Custom | <b>M22-DDL-S-ETCH</b> <sup>②</sup>   |
|  |        |           |        | —                       | —      | <b>M22-DDL-S-X4-X5</b>               |
|  <p><b>M22S-DDL-GR-X1-X0</b></p>  | Black  | Green     | Red    | Ⓜ                       | Ⓜ      | <b>M22S-DDL-S-X7-X7</b>              |
|  |        |           |        | —                       | —      | <b>M22S-DDL-GR</b>                   |
|  |        |           |        | Custom                  | Custom | <b>M22S-DDL-GR-ETCH</b> <sup>②</sup> |
|  |        |           |        | Ⓜ                       | Ⓜ      | <b>M22S-DDL-GR-X1-X0</b>             |
|  |        |           |        | START                   | STOP   | <b>M22S-DDL-GR-GB1-GB0</b>           |
|  |        |           |        | —                       | —      | <b>M22S-DDL-WS</b>                   |
|  |        | White     | Black  | —                       | —      | <b>M22S-DDL-WS</b>                   |
|  |        |           |        | Custom                  | Custom | <b>M22S-DDL-WS-ETCH</b> <sup>②</sup> |
|  |        |           |        | Ⓜ                       | Ⓜ      | <b>M22S-DDL-WS-X1-X0</b>             |
|  |        |           |        | START                   | STOP   | <b>M22S-DDL-WS-GB1-GB0</b>           |
|  |        |           |        | —                       | —      | <b>M22S-DDL-S</b>                    |
|  |        |           |        | Custom                  | Custom | <b>M22S-DDL-S-ETCH</b> <sup>②</sup>  |
| Black  | Black  | —         | —      | <b>M22S-DDL-S-X4-X5</b> |        |                                      |
|  |        | +         | —      | <b>M22S-DDL-S-X4-X5</b> |        |                                      |
|  |        | Ⓜ         | Ⓜ      | <b>M22S-DDL-S-X7-X7</b> |        |                                      |



**Notes**

- ① Includes contact block mounting adapter.
- ② When ordering, specify inscription per catalog number suffix from the Symbols Library (see **Pages V7-T1-129 to V7-T1-136**) into the Order Notes. For example, M22-DDL-S-ETCH; Order Notes: Mark with symbol X91, Line item #\_.





## Double Pushbuttons, Flush Top Pushbuttons and Center Light, Momentary

Operators Only <sup>①</sup>

|  | Bezel  | Color Top | Bottom | Inscription Top           | Bottom | Catalog Number                        |
|--|--------|-----------|--------|---------------------------|--------|---------------------------------------|
| <b>M22-DDLF-GR</b><br>        | Silver | Green     | Red    | —                         | —      | <b>M22-DDLF-GR</b>                    |
|  |        |           |        | Custom                    | Custom | <b>M22-DDLF-GR-ETCH</b> <sup>②</sup>  |
|  |        | White     | Black  | —                         | —      | <b>M22-DDLF-WS</b>                    |
|  |        |           |        | Custom                    | Custom | <b>M22-DDLF-WS-ETCH</b> <sup>②</sup>  |
|  |        | Green     | Red    | ①                         | ⊙      | <b>M22-DDLF-GR-X1-X0</b>              |
| White  | Black  | ①         | ⊙      | <b>M22-DDLF-WS-X1-X0</b>  |        |                                       |
| <b>M22S-DDLF-GR-X1-X0</b><br> | Black  | Green     | Red    | —                         | —      | <b>M22S-DDLF-GR</b>                   |
|  |        |           |        | Custom                    | Custom | <b>M22S-DDLF-GR-ETCH</b> <sup>②</sup> |
|  |        | White     | Black  | —                         | —      | <b>M22S-DDLF-WS</b>                   |
|  |        |           |        | Custom                    | Custom | <b>M22S-DDLF-WS-ETCH</b> <sup>②</sup> |
|  |        | Green     | Red    | ①                         | ⊙      | <b>M22S-DDLF-GR-X1-X0</b>             |
| White  | Black  | ①         | ⊙      | <b>M22S-DDLF-WS-X1-X0</b> |        |                                       |

## Double Pushbuttons, Flush Top Pushbutton and Center Light, Extended Bottom Pushbutton, Momentary

Operators Only <sup>①</sup>

|  | Bezel  | Color Top | Bottom | Inscription Top           | Bottom | Catalog Number                        |
|--|--------|-----------|--------|---------------------------|--------|---------------------------------------|
| <b>M22-DDLM-GR</b><br>         | Silver | Green     | Red    | —                         | —      | <b>M22-DDLM-GR</b>                    |
|  |        |           |        | Custom                    | Custom | <b>M22-DDLM-GR-ETCH</b> <sup>②</sup>  |
|  |        | White     | Black  | —                         | —      | <b>M22-DDLM-WS</b>                    |
|  |        |           |        | Custom                    | Custom | <b>M22-DDLM-WS-ETCH</b> <sup>②</sup>  |
|  |        | Green     | Red    | ①                         | ⊙      | <b>M22-DDLM-GR-X1-X0</b>              |
| White  | Black  | ①         | ⊙      | <b>M22-DDLM-WS-X1-X0</b>  |        |                                       |
| <b>M22S-DDLM-GR-X1-X0</b><br> | Black  | Green     | Red    | —                         | —      | <b>M22S-DDLM-GR</b>                   |
|  |        |           |        | Custom                    | Custom | <b>M22S-DDLM-GR-ETCH</b> <sup>②</sup> |
|  |        | White     | Black  | —                         | —      | <b>M22S-DDLM-WS</b>                   |
|  |        |           |        | Custom                    | Custom | <b>M22S-DDLM-WS-ETCH</b> <sup>②</sup> |
|  |        | Green     | Red    | ①                         | ⊙      | <b>M22S-DDLM-GR-X1-X0</b>             |
| White  | Black  | ①         | ⊙      | <b>M22S-DDLM-WS-X1-X0</b> |        |                                       |

**Notes**

<sup>①</sup> Includes contact block mounting adapter.

<sup>②</sup> When ordering, specify inscription per catalog number suffix from the Symbols Library (see **Pages V7-T1-129 to V7-T1-136**) into the Order Notes. For example, M22-DDLM-GR-ETCH; Order Notes: Mark with symbol X91, Line item #\_.

Double Pushbuttons

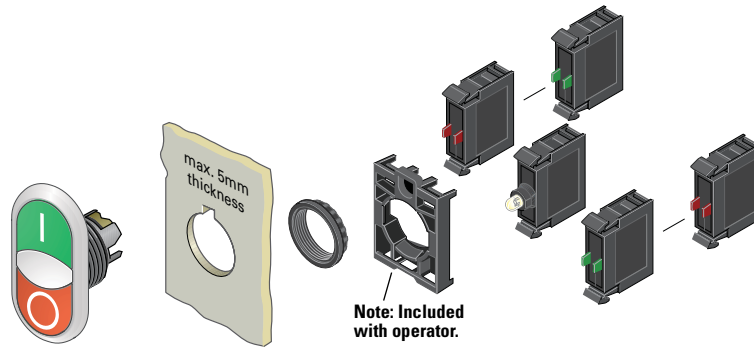

M22-LED-W



Light Units <sup>①</sup>

| Terminal Type | LED Color | Light Unit Voltage | Catalog Number      |
|---------------|-----------|--------------------|---------------------|
| Screw         | White     | 12–30 Vac/Vdc      | <b>M22-LED-W</b>    |
|               |           | 85–264 Vac         | <b>M22-LED230-W</b> |

M22-K10



Contact Blocks <sup>①</sup>

| Terminal Type | Contact Configuration <sup>②</sup> | Catalog Number   |
|---------------|------------------------------------|------------------|
| Screw         | NO                                 | <b>M22-K10</b>   |
|               | NO, early-make                     | <b>M22-K10P</b>  |
|               | NC                                 | <b>M22-K01</b>   |
|               | NC, late-break                     | <b>M22-K01D</b>  |
| Spring-cage   | NO                                 | <b>M22-CK10</b>  |
|               | NC                                 | <b>M22-CK01</b>  |
|               | NC, late-break                     | <b>M22-CK01D</b> |
|               | 2NO                                | <b>M22-CK20</b>  |
|               | 2NC                                | <b>M22-CK02</b>  |
|               | NO-NC                              | <b>M22-CK11</b>  |

Notes

- ① For complete listing of available light units and contact blocks, see Accessories, Pages V7-T1-111 to V7-T1-116.
- ② All NC contact blocks are positively driven contact. ⊖

#### 1

### Four-Way Pushbuttons

#### Product Description

Eaton's M22 four-way pushbutton is a truly unique offering. A four-way pushbutton offers four different buttons mounted in a single 22 mm hole. This is ideal not only for an application with limited space, but also directional applications (when ordered with the four arrow engraving option). Another unique option is the interlocked version, which prevents two opposite buttons from being actuated at the same time.

#### Features

- Four buttons in one operator allows for increased functionality in limited space
- Optional interlocking option, which prevents two buttons from being actuated at the same time
- Customizable laser engraving on all buttons for directional or other applications
- Capable of communicating via ASi protocol with ASi adapter modules

#### Protection Type

- IP66

### Catalog Number Selection

Catalog Number Selection is for illustrative purposes only and not to be used to create new catalog numbers.

#### Four-Way Pushbuttons

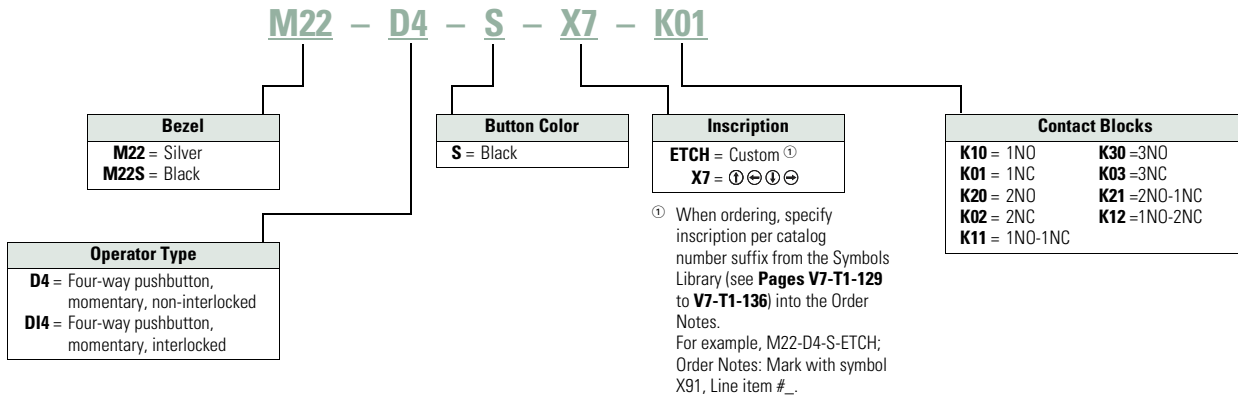

### Product Selection

#### Four-Way Pushbuttons, Momentary

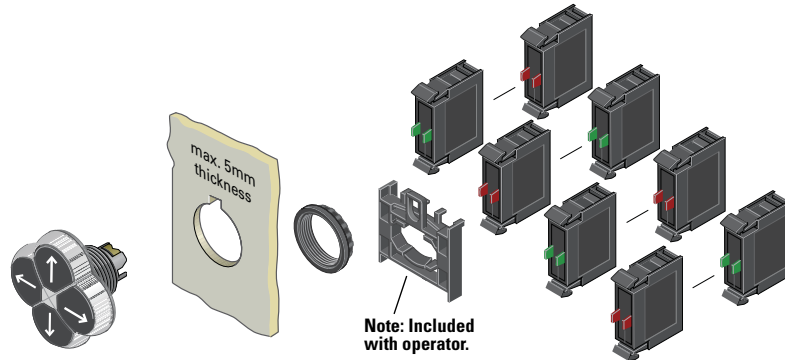

### Components

#### M22-D4-S-X7



#### Operators Only ①

| Type            | Bezel  | Color | Inscription        | Catalog Number           |
|-----------------|--------|-------|--------------------|--------------------------|
| Non-interlocked | Silver | Black | —                  | <b>M22-D4-S</b>          |
|                 |        |       | Custom             | <b>M22-D4-S-ETCH</b> ③   |
|                 |        |       | Directional arrows | <b>M22-D4-S-X7</b>       |
|                 | Black  | Black | —                  | <b>M22S-D4-S</b>         |
|                 |        |       | Custom             | <b>M22S-D4-S-ETCH</b> ③  |
|                 |        |       | Directional arrows | <b>M22S-D4-S-X7</b>      |
| Interlocked     | Silver | Black | —                  | <b>M22-DI4-S</b>         |
|                 |        |       | Custom             | <b>M22-DI4-S-ETCH</b> ③  |
|                 |        |       | Directional arrows | <b>M22-DI4-S-X7</b>      |
|                 | Black  | Black | —                  | <b>M22S-DI4-S</b>        |
|                 |        |       | Custom             | <b>M22S-DI4-S-ETCH</b> ③ |
|                 |        |       | Directional arrows | <b>M22S-DI4-S-X7</b>     |

#### M22-K10



#### Contact Blocks ②

| Terminal Type | Contact Configuration ④ | Catalog Number   |
|---------------|-------------------------|------------------|
| Screw         | NO                      | <b>M22-K10</b>   |
|               | NO, early-make          | <b>M22-K10P</b>  |
|               | NC                      | <b>M22-K01</b>   |
|               | NC, late-break          | <b>M22-K01D</b>  |
| Spring-cage   | NO                      | <b>M22-CK10</b>  |
|               | NC                      | <b>M22-CK01</b>  |
|               | NC, late-break          | <b>M22-CK01D</b> |
|               | 2NO                     | <b>M22-CK20</b>  |
|               | 2NC                     | <b>M22-CK02</b>  |
|               | NO-NC                   | <b>M22-CK11</b>  |

#### Notes

- ① Includes contact block mounting adapter.
- ② For complete listing of available contact blocks, see Accessories, **Pages V7-T1-111 to V7-T1-116**.
- ③ When ordering, specify inscription per catalog number suffix from the Symbols Library (see **Pages V7-T1-129 to V7-T1-136**) into the Order Notes.  
For example, M22-D4-S-ETCH; Order Notes: Mark with symbol X91, Line item #\_.
- ④ All NC contact blocks are positively driven contact. (⊖)

#### 1

### Joysticks

#### Product Description

Eaton's M22 joystick line comes in a wide variety of options. From vertical and horizontal two-position switches to the maintained four-position, these operators fit a variety of applications. An additional option, two switch points, allows for eight isolated circuits to be actuated individually on a single operator.

#### Features

- Available in four-position and two-position
- Two switch point option allows for two contacts in each direction (up to eight total contacts in one operator)
- Capable of communicating via ASi protocol with ASi adapter modules

#### Protection Type

- IP66

### Product Selection

#### Joysticks

#### Components

M22-WJ2H



M22M-WJ2H



#### Operators <sup>①</sup>

| Number of Directions    | Switching Position | Silver Bezel Catalog Number | Black Bezel Catalog Number | Metal Bezel Catalog Number |
|-------------------------|--------------------|-----------------------------|----------------------------|----------------------------|
| Two-position horizontal | Momentary          | M22-WJ2H                    | M22S-WJ2H                  | M22M-WJ2H                  |
| Two switch points       |                    | M22-WJ2H-2P                 | M22S-WJ2H-2P               | M22M-WJ2H-2P               |
| Two-position horizontal | Maintained         | M22-WRJ2H                   | M22S-WRJ2H                 | M22M-WRJ2H                 |
| Two-position vertical   | Momentary          | M22-WJ2V                    | M22S-WJ2V                  | M22M-WJ2V                  |
| Two switch points       |                    | M22-WJ2V-2P                 | M22S-WJ2V-2P               | M22M-WJ2V-2P               |
| Two-position vertical   | Maintained         | M22-WRJ2V                   | M22S-WRJ2V                 | M22M-WRJ2V                 |
| Four-position           | Momentary          | M22-WJ4                     | M22S-WJ4                   | M22M-WJ4                   |
| Two switch points       |                    | M22-WJ4-2P                  | M22S-WJ4-2P                | M22M-WJ4-2P                |
| Four-position           | Maintained         | M22-WRJ4                    | M22S-WRJ4                  | M22M-WRJ4                  |

#### Note

<sup>①</sup> Includes contact block mounting adapter.

### Joysticks

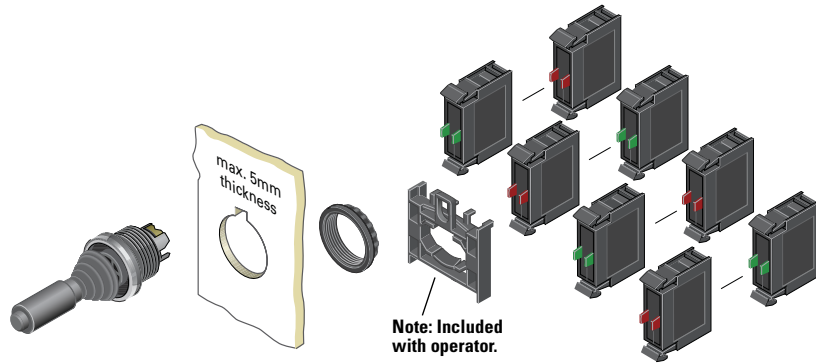

#### M22-K10



#### Contact Blocks <sup>①②</sup>

| Terminal Type | Contact Configuration <sup>③</sup> | Catalog Number |
|---------------|------------------------------------|----------------|
| Screw         | NO                                 | M22-K10        |
|               | NO, early-make                     | M22-K10P       |
|               | NC                                 | M22-K01        |
|               | NC, late-break                     | M22-K01D       |
| Spring-cage   | NO                                 | M22-CK10       |
|               | NC                                 | M22-CK01       |
|               | NC, late-break                     | M22-CK01D      |
|               | 2NO                                | M22-CK20       |
|               | 2NC                                | M22-CK02       |
|               | NO-NC                              | M22-CK11       |

#### Notes

- ① Includes contact block mounting adapter.
- ② For complete listing of available contact blocks, see Accessories, Pages V7-T1-111 to V7-T1-116.
- ③ All NC contact blocks are positively driven contact. ⊖

#### Joystick with Double Contact

The joystick allows the control of up to four directions of movement on machines. Different variants of the joystick have two/four-positions and other variants have two settings for each position. This allows, for example, two-speed settings for each direction. For this application, a standard normally open contact and an early-make contact are fitted in series. Momentary contact and latching contact versions are available.

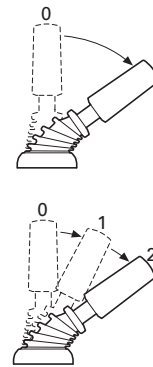

## Potentiometers

### Product Description

Eaton's M22 potentiometers allow for a ready to use operator in a conveniently sized package. M22 potentiometers include the resistive element, instead of just a knob, and a built in legend surrounding the knob. The slim design, with integrated contacts and the range of resistances available, allows for a quick install.

### Features

- Scale markings on the knob allows the operator to be used without an additional legend plate
- Oversized knob option available
- Slim design allows for space saving and simple wiring and installation

### Protection Type

- IP66
- NEMA 4X, 13

## Product Selection

### Potentiometers

#### M22-R10K



#### M22M-R10K



### Complete Devices

| Bezel          | Resistance Rk        | Catalog Number       |
|----------------|----------------------|----------------------|
| Silver         | 1                    | <b>M22-R1K</b>       |
|                | 4.7                  | <b>M22-R4K7</b>      |
|                | 10                   | <b>M22-R10K</b>      |
|                | 47                   | <b>M22-R47K</b>      |
|                | 100                  | <b>M22-R100K</b>     |
| Black          | 470                  | <b>M22-R470K</b>     |
|                | 1                    | <b>M22S-R1K</b>      |
|                | 4.7                  | <b>M22S-R4K7</b>     |
|                | 10                   | <b>M22S-R10K</b>     |
|                | 47                   | <b>M22S-R47K</b>     |
| Metal          | 100                  | <b>M22S-R100K</b>    |
|                | 470                  | <b>M22S-R470K</b>    |
|                | 1                    | <b>M22M-R1K</b>      |
|                | 4.7                  | <b>M22M-R4K7</b>     |
|                | 10                   | <b>M22M-R10K</b>     |
| Oversized Knob | 47                   | <b>M22M-R47K</b>     |
|                | 100                  | <b>M22M-R100K</b>    |
|                | 470                  | <b>M22M-R470K</b>    |
|                | 1                    | <b>M22-R1K-RH</b>    |
|                | 4.7                  | <b>M22-R4K7-RH</b>   |
| Silver         | 10                   | <b>M22-R10K-RH</b>   |
|                | 47                   | <b>M22-R47K-RH</b>   |
|                | 100                  | <b>M22-R100K-RH</b>  |
|                | 470                  | <b>M22-R470K-RH</b>  |
|                | 1                    | <b>M22S-R1K-RH</b>   |
| Black          | 4.7                  | <b>M22S-R4K7-RH</b>  |
|                | 10                   | <b>M22S-R10K-RH</b>  |
|                | 47                   | <b>M22S-R47K-RH</b>  |
|                | 100                  | <b>M22S-R100K-RH</b> |
|                | 470                  | <b>M22S-R470K-RH</b> |
| Metal          | 1                    | <b>M22M-R1K-RH</b>   |
|                | 4.7                  | <b>M22M-R4K7-RH</b>  |
|                | 10                   | <b>M22M-R10K-RH</b>  |
|                | 47                   | <b>M22M-R47K-RH</b>  |
|                | 100                  | <b>M22M-R100K-RH</b> |
| 470            | <b>M22M-R470K-RH</b> |                      |

## Acoustic Devices

### Product Description

Eaton's M22 acoustic devices are a simple and aesthetic way to add a buzzer or indicator to any application. Fitting in the same 22 mm hole, these devices can be ordered in continuous or pulsed tone and with or without the IP40 enclosure.

### Features

- Continuous or pulsed tone available
- 83 dB / 10 cm decibel rating
- Slim design allows for space saving and simple wiring and installation

### Protection Type

- IP40
- NEMA 12

## Product Selection

### Acoustic Devices

#### M22-AMC-XAM



### Complete Devices

| Description   | Decibel Rating | Catalog Number      |
|---|----------------|---------------------|
| Indicator with buzzer, black continuous tone, 18–30 Vac/Vdc | 83 dB/10 cm    | <b>M22-AMC-XAM</b>  |
| Indicator with buzzer, black pulsed tone, 18–30 Vac/Vdc     | 83 dB/10 cm    | <b>M22-AMC-XAMP</b> |

#### M22-XAM



### Buzzers

| Description                                 | Decibel Rating | Catalog Number  |
|---|----------------|-----------------|
| Indicator without buzzer, black             | 83 dB/10 cm    | <b>M22-AMC</b>  |
| Buzzer only, continuous tone, 18–30 Vac/Vdc | 83 dB/10 cm    | <b>M22-XAM</b>  |
| Buzzer only, pulsed tone, 18–30 Vac/Vdc     | 83 dB/10 cm    | <b>M22-XAMP</b> |

## Through-the-Door Operators

### Product Description

Eaton's M22 through-the-door operators use the same familiar flush pushbutton look with the addition of a cut-to-length rod that allows for a simple reset operator.

### Features

- Customizable laser engraving on all buttons
- More than five million mechanical operations
- Pushrod can be cut to length

### Protection Type

- IP67, IP69K
- NEMA 4X, 13

## Product Selection

### Through-the-Door Operators <sup>①</sup>

#### M22-DZ-B-X6



#### Complete Devices

| Color | Inscription | Catalog Number       |
|-------|-------------|----------------------|
| Blue  | —           | <b>M22-DZ-B</b>      |
|       | RESET       | <b>M22-DZ-B-GB14</b> |
|       | Ⓡ           | <b>M22-DZ-B-X6</b>   |
| Red   | —           | <b>M22-DZ-R</b>      |
|       | Ⓢ           | <b>M22-DZ-R-X0</b>   |
|       | STOP        | <b>M22-DZ-R-GB0</b>  |

#### M22-DZ-X



#### Buttonless Operator

| Bezel  | Catalog Number   |
|--------|------------------|
| Silver | <b>M22-DZ-X</b>  |
| Metal  | <b>M22M-DZ-X</b> |

#### M22-XD-B



#### Button Plates <sup>②</sup>

| Color | Inscription | Catalog Number               |
|-------|-------------|------------------------------|
| Blue  | —           | <b>M22-XD-B</b> <sup>③</sup> |
|       | RESET       | <b>M22-XD-B-GB14</b>         |
|       | Ⓡ           | <b>M22-XD-B-X6</b>           |
| Red   | —           | <b>M22-XD-R</b> <sup>③</sup> |
|       | Ⓢ           | <b>M22-XD-R-X0</b>           |
|       | STOP        | <b>M22-XD-R-GB0</b>          |

## Bulkhead Interfaces

### Product Description

Eaton's M22 bulkhead interfaces are another unique offering in the M22 line. This device allows for a secure connection to any USB or RJ45 connected device within an enclosure or panel. With an IP65 rating when closed, these devices are not only convenient, but robust and reliable.

### Features

- Convenient and safe way to make a data connection to inside of the panel without opening the panel door

### Protection Type

- IP65 when closed, IP20 when connected

## Product Selection

### Bulkhead Interfaces

#### M22-USB-SA



#### USB Socket <sup>④⑤</sup>

Used for USB connection plug IP65 when closed, IP20 when connected.

| Bezel  | Catalog Number    |
|--------|-------------------|
| Silver | <b>M22-USB-SA</b> |

#### M22-RJ45-SA



#### RJ45 Socket <sup>⑥</sup>

Used for RJ45 Ethernet connection IP65 when closed, IP20 when connected.

| Bezel  | Catalog Number     |
|--------|--------------------|
| Silver | <b>M22-RJ45-SA</b> |

### Notes

- <sup>①</sup> The pushrod is 3.24 in long and can be cut to length.
- <sup>②</sup> Any combination of plate color and inscription is available.
- <sup>③</sup> Minimum order quantity of (10).
- <sup>④</sup> USB interface is complete with 2-ft-long USB cable.
- <sup>⑤</sup> USB interface is UL Listed, CSA approved and USB 3.0.
- <sup>⑥</sup> RJ45 interface is an eight-wire connector.



## 1

**ASi Adapter Modules****Product Description**

Eaton's M22 ASi adapter modules add functionality to every operator in the M22 line. These devices can be connected to any operator that uses contact blocks or LED units. The simple snap-on design allows for a quick integration of an entire application of operators to a communicating network.

**Features**

- Allows compatible operators to communicate on an ASi network
- Not only can the status of a contact block be read, but LEDs can be illuminated by an ASi adapter
- ASi adapters simply clip on to the back of the contact blocks and LEDs
- Insulation displacement connectors allow for installation of adapters without any tools
- Two integrated LEDs indicate status of communications

**Protection Type**

- IP20

**Product Selection****ASi Adapter Modules****M22-ASi****Complete Devices**

| Description                                 | Catalog Number    |
|---|-------------------|
| ASi adapter module                          | <b>M22-ASi</b>    |
| ASi adapter module for base mounting        | <b>M22-ASi-C</b>  |
| ASi adapter module for E-stop               | <b>M22-ASi-S</b>  |
| ASi adapter module for E-stop base mounting | <b>M22-ASi-CS</b> |

**Palm Switches**

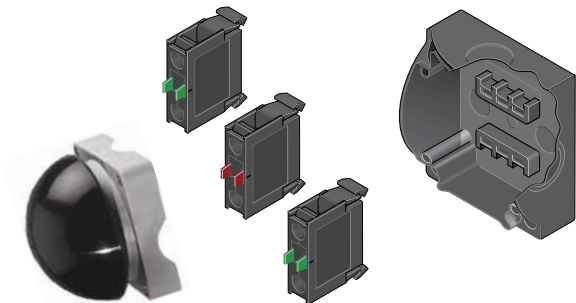

**Product Description**

Eaton’s M22 palm switches are an oversized button that mount directly to an enclosure base. This allows for a standalone button that can be mounted anywhere. The enclosure uses base-mounted contact blocks, which allows for quick wiring and mounting. The palm switches come in momentary or maintained versions. As with other M22 operators, the palm switches are available as complete devices, including the enclosure and contact blocks or as modular components.

**Features**

- Oversized operator in black, red and yellow color options
- Button integrated directly into an enclosure
- Base mounting contact blocks allow for simple wiring and installation
- More than one million mechanical operations on momentary and 100,000 on maintained operators

**Protection Type**

- IP67, IP69K
- NEMA 4X, 13

**Catalog Number Selection**

Catalog Number Selection is for illustrative purposes only and not to be used to create new catalog numbers.

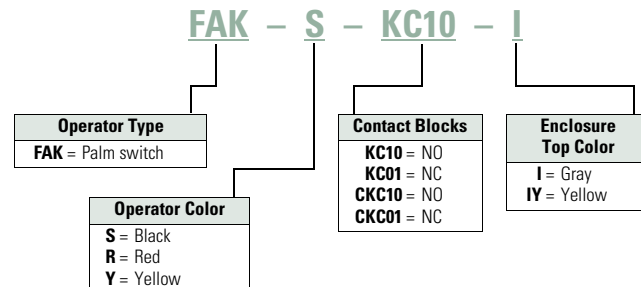

**Palm Switches, Type 4X/13 Enclosure**



**Product Selection**

**Complete Devices**

**Operator, Base and Contact Blocks** ①

| Button Color  | Contact Block Configuration ② | Catalog Number |                        |
|---|-------------------------------|----------------|------------------------|
| <b>FAK-S-KC11-I</b>   |                               |                |                        |
| <b>Momentary</b>  |                               |                |                        |
|   | Black                         | 1NO-1NC        | <b>FAK-S-KC11-I</b>    |
|   | Red                           | 1NO-1NC        | <b>FAK-R-KC11-I</b>    |
|   | Yellow                        | 1NO-1NC        | <b>FAK-Y-KC11-I</b>    |
| <b>FAK-R-V-KC01-IY</b>  |                               |                |                        |
| <b>Maintained</b>   |                               |                |                        |
|  | Red                           | NC             | <b>FAK-R-V-KC01-IY</b> |
|   |                               | 2NC            | <b>FAK-R-V-KC02-IY</b> |
|   |                               | 1NO-2NC        | <b>FAK-R-V-KC12-IY</b> |
|   |                               | 1NO-1NC        | <b>FAK-R-V-KC11-IY</b> |

**Notes**

① For complete listing of available contact blocks, see Accessories, Pages V7-T1-111 to V7-T1-116.

② All NC contact blocks are positively driven contact. ⊖

#### 1

#### Components

##### FAK-S



#### Operators Only

| Type       | Button Color | Catalog Number   |
|------------|--------------|------------------|
| Momentary  | Black        | <b>FAK-S</b>     |
|            | Red          | <b>FAK-R</b>     |
|            | Yellow       | <b>FAK-Y</b>     |
| Maintained | Red          | <b>FAK-R-V-Y</b> |

##### FAK-IU



#### Palm Switch Enclosure Base

##### Catalog Number

**FAK-IU**

##### M22-KC10



#### Contact Blocks <sup>①</sup>

| Terminal Type | Contact Configuration <sup>②</sup> | Catalog Number   |
|---------------|------------------------------------|------------------|
| Screw         | NO                                 | <b>M22-KC10</b>  |
|               | NC                                 | <b>M22-KC01</b>  |
| Spring-cage   | NO                                 | <b>M22-CKC10</b> |
|               | NC                                 | <b>M22-CKC01</b> |

#### Notes

<sup>①</sup> For complete listing of available contact blocks, see Accessories, **Pages V7-T1-111 to V7-T1-116**.

<sup>②</sup> All NC contact blocks are positively driven contact. 

Accessories

M22-XD-S



M22-XDH-R



M22-XDP-G



Button Plates

| Color                                  | Inscription | Catalog Number<br>Flush Pushbutton | Catalog Number<br>Extended Pushbutton | Catalog Number<br>Mushroom Head Button |
|--|-------------|------------------------------------|---------------------------------------|--|
| Black                                  | —           | M22-XD-S                           | M22-XDH-S                             | M22-XDP-S                              |
| White                                  | —           | M22-XD-W                           | M22-XDH-W                             | M22-XDP-W                              |
| Red                                    | —           | M22-XD-R                           | M22-XDH-R                             | M22-XDP-R                              |
| Green                                  | —           | M22-XD-G                           | M22-XDH-G                             | M22-XDP-G                              |
| Yellow                                 | —           | M22-XD-Y                           | M22-XDH-Y                             | M22-XDP-Y                              |
| Blue                                   | —           | M22-XD-B                           | M22-XDH-B                             | —                                      |
| Black, white, red, green, yellow, blue | —           | M22-XD-SWRGYB                      | M22-XDH-SWRGYB                        | —                                      |
| Black, red, green                      | —           | M22-XD-SRG                         | M22-XDH-SRG                           | —                                      |
| Black                                  | Custom      | M22-XD-S-ETCH                      | M22-XDH-S-ETCH                        | M22-XDP-S-ETCH                         |
| White                                  | Custom      | M22-XD-W-ETCH                      | M22-XDH-W-ETCH                        | M22-XDP-W-ETCH                         |
| Red                                    | Custom      | M22-XD-R-ETCH                      | M22-XDH-R-ETCH                        | M22-XDP-R-ETCH                         |
| Green                                  | Custom      | M22-XD-G-ETCH                      | M22-XDH-G-ETCH                        | M22-XDP-G-ETCH                         |
| Yellow                                 | Custom      | M22-XD-Y-ETCH                      | M22-XDH-Y-ETCH                        | M22-XDP-Y-ETCH                         |
| Blue                                   | Custom      | M22-XD-B-ETCH                      | M22-XDH-B-ETCH                        | —                                      |
| Black                                  | STOP        | M22-XD-S-GB0                       | M22-XDH-S-GB0                         | M22-XDP-S-GB0                          |
| Red                                    | STOP        | M22-XD-R-GB0                       | M22-XDH-R-GB0                         | M22-XDP-R-GB0                          |
| Black                                  | START       | M22-XD-S-GB1                       | M22-XDH-S-GB1                         | M22-XDP-S-GB1                          |
| White                                  | START       | M22-XD-W-GB1                       | M22-XDH-W-GB1                         | —                                      |
| Green                                  | START       | M22-XD-G-GB1                       | M22-XDH-G-GB1                         | M22-XDP-G-GB1                          |
| Black                                  | CLOSE       | M22-XD-S-GB2                       | M22-XDH-S-GB2                         | —                                      |
| Black                                  | UP          | M22-XD-S-GB3                       | M22-XDH-S-GB3                         | M22-XDP-S-GB3                          |
| Black                                  | DOWN        | M22-XD-S-GB4                       | M22-XDH-S-GB4                         | M22-XDP-S-GB4                          |
| Black                                  | OFF         | M22-XD-S-GB5                       | M22-XDH-S-GB5                         | M22-XDP-S-GB5                          |
| Red                                    | OFF         | M22-XD-R-GB5                       | M22-XDH-R-GB5                         | M22-XDP-R-GB5                          |
| Black                                  | ON          | M22-XD-S-GB6                       | M22-XDH-S-GB6                         | M22-XDP-S-GB6                          |
| Green                                  | ON          | M22-XD-G-GB6                       | M22-XDH-G-GB6                         | M22-XDP-G-GB6                          |
| Black                                  | TEST        | M22-XD-S-GB9                       | M22-XDH-S-GB9                         | —                                      |
| Blue                                   | RESET       | M22-XD-B-GB14                      | M22-XDH-B-GB14                        | —                                      |
| Black                                  | FORWARD     | M22-XD-S-GB15                      | M22-XDH-S-GB15                        | M22-XDP-S-GB15                         |
| Black                                  | REVERSE     | M22-XD-S-GB16                      | M22-XDH-S-GB16                        | M22-XDP-S-GB16                         |
| Black                                  | RAISE       | M22-XD-S-GB17                      | M22-XDH-S-GB17                        | —                                      |
| Black                                  | LOWER       | M22-XD-S-GB18                      | M22-XDH-S-GB18                        | —                                      |
| Black                                  | ⊙           | M22-XD-S-X0                        | M22-XDH-S-X0                          | M22-XDP-S-X0                           |
| Red                                    | ⊙           | M22-XD-R-X0                        | M22-XDH-R-X0                          | M22-XDP-R-X0                           |
| Green                                  | ⊙           | —                                  | —                                     | M22-XDP-G-X0                           |
| Black                                  | ①           | M22-XD-S-X1                        | M22-XDH-S-X1                          | M22-XDP-S-X1                           |
| White                                  | ①           | M22-XD-W-X1                        | M22-XDH-W-X1                          | —                                      |
| Green                                  | ①           | M22-XD-G-X1                        | M22-XDH-G-X1                          | M22-XDP-G-X1                           |
| Black                                  | ②           | M22-XD-S-X2                        | M22-XDH-S-X2                          | —                                      |
| Green                                  | ②           | M22-XD-G-X2                        | M22-XDH-G-X2                          | —                                      |
| Black                                  | +           | M22-XD-S-X4                        | M22-XDH-S-X4                          | M22-XDP-S-X4                           |
| Black                                  | −           | M22-XD-S-X5                        | M22-XDH-S-X5                          | M22-XDP-S-X5                           |
| Blue                                   | Ⓜ           | M22-XD-B-X6                        | M22-XDH-B-X6                          | —                                      |
| Black                                  | ①           | M22-XD-S-X7                        | M22-XDH-S-X7                          | M22-XDP-S-X7                           |
| Black                                  | ①           | M22-XD-S-X8                        | M22-XDH-S-X8                          | —                                      |
| Black                                  | See ① below | M22-XD-S-X9                        | M22-XDH-S-X9                          | —                                      |
| Black                                  | See ① below | M22-XD-S-X10                       | M22-XDH-S-X10                         | —                                      |
| Black                                  | See ① below | M22-XD-S-X11                       | M22-XDH-S-X11                         | —                                      |
| Black                                  | See ① below | M22-XD-S-X12                       | M22-XDH-S-X12                         | —                                      |
| Black                                  | See ① below | M22-XD-S-X13                       | M22-XDH-S-X13                         | —                                      |
| Black                                  | See ① below | M22-XD-S-X14                       | M22-XDH-S-X14                         | —                                      |
| Black                                  | See ① below | M22-XD-S-X15                       | M22-XDH-S-X15                         | —                                      |
| Black                                  | See ① below | M22-XD-S-X16                       | M22-XDH-S-X16                         | —                                      |
| Black                                  | See ① below | M22-XD-S-X17                       | M22-XDH-S-X17                         | —                                      |

Note

① Refer to the Symbols Library, (see Pages V7-T1-129 to V7-T1-136), for symbol image.

1

#### M22-XDLH-W



#### M22-XDL-G



#### Button Lenses

| Color  | Inscription | Catalog Number Flush  | Catalog Number Extended | Color | Inscription | Catalog Number Flush  | Catalog Number Extended |
|--------|-------------|-----------------------|-------------------------|-------|-------------|-----------------------|-------------------------|
| White  | —           | <b>M22-XDL-W</b>      | <b>M22-XDLH-W</b>       | Blue  | Custom      | <b>M22-XDL-B-ETCH</b> | <b>M22-XDLH-B-ETCH</b>  |
| Red    | —           | <b>M22-XDL-R</b>      | <b>M22-XDLH-R</b>       | Red   | STOP        | <b>M22-XDL-R-GB0</b>  | <b>M22-XDLH-R-GB0</b>   |
| Green  | —           | <b>M22-XDL-G</b>      | <b>M22-XDLH-G</b>       | Green | START       | <b>M22-XDL-G-GB1</b>  | <b>M22-XDLH-G-GB1</b>   |
| Yellow | —           | <b>M22-XDL-Y</b>      | <b>M22-XDLH-Y</b>       | Red   | OFF         | <b>M22-XDL-R-GB5</b>  | <b>M22-XDLH-R-GB5</b>   |
| Blue   | —           | <b>M22-XDL-B</b>      | <b>M22-XDLH-B</b>       | Green | ON          | <b>M22-XDL-G-GB6</b>  | <b>M22-XDLH-G-GB6</b>   |
| White  | Custom      | <b>M22-XDL-W-ETCH</b> | <b>M22-XDLH-W-ETCH</b>  | Blue  | RESET       | <b>M22-XDL-B-GB14</b> | <b>M22-XDLH-B-GB14</b>  |
| Red    | Custom      | <b>M22-XDL-R-ETCH</b> | <b>M22-XDLH-R-ETCH</b>  | Red   | Ⓢ           | <b>M22-XDL-R-X0</b>   | <b>M22-XDLH-R-X0</b>    |
| Green  | Custom      | <b>M22-XDL-G-ETCH</b> | <b>M22-XDLH-G-ETCH</b>  | Green | Ⓛ           | <b>M22-XDL-G-X1</b>   | <b>M22-XDLH-G-X1</b>    |
| Yellow | Custom      | <b>M22-XDL-Y-ETCH</b> | <b>M22-XDLH-Y-ETCH</b>  | Blue  | Ⓡ           | <b>M22-XDL-B-X6</b>   | <b>M22-XDLH-B-X6</b>    |

#### Mounting Adapters

| Description                    | Catalog Number |
|--------------------------------|----------------|
| Contact block mounting adapter | <b>M22-A</b>   |

#### M22-A



#### M22-A4



|  |               |
|--|---------------|
| Contact block mounting adapter, four-position (for use with four-way pushbuttons, joysticks and four-position selector switches only). | <b>M22-A4</b> |
|--|---------------|

#### M22-LS



|  |               |
|--|---------------|
| Allows mounting of M22 pushbuttons to LS-Titan limit switch bodies (for the full LS-Titan catalog section, see <b>PG08301004E</b> ). | <b>M22-LS</b> |
|--|---------------|

#### M22-K10



#### Contact Blocks

| Mounting Location  | Terminal Type | Contact Configuration <sup>①</sup> | Package Qty. | Catalog Number       |   |                 |
|--------------------|---------------|------------------------------------|--------------|----------------------|---|-----------------|
| Front              | Screw         | NO                                 | 1            | <b>M22-K10</b>       |   |                 |
|                    |               | NO                                 | 25           | <b>M22-K10-B25</b>   |   |                 |
|                    |               | NO                                 | 100          | <b>M22-K10-B100</b>  |   |                 |
|                    |               | NO, early-make                     | 1            | <b>M22-K10P</b>      |   |                 |
|                    |               | NC                                 | 1            | <b>M22-K01</b>       |   |                 |
|                    |               | NC                                 | 25           | <b>M22-K01-B25</b>   |   |                 |
|                    |               | NC                                 | 100          | <b>M22-K01-B100</b>  |   |                 |
|                    |               | NC, late-break                     | 1            | <b>M22-K01D</b>      |   |                 |
|                    |               | SMCB, NC                           | 1            | <b>M22-K01SMC10</b>  |   |                 |
|                    |               | SMCB, 2NC                          | 1            | <b>M22-K02SMC10</b>  |   |                 |
| Base               |               | NO                                 | 1            | <b>M22-KC10</b>      |   |                 |
|                    |               | NO                                 | 25           | <b>M22-KC10-B25</b>  |   |                 |
|                    |               | NO                                 | 100          | <b>M22-KC10-B100</b> |   |                 |
|                    |               | NC                                 | 1            | <b>M22-KC01</b>      |   |                 |
|                    |               | NC                                 | 25           | <b>M22-KC01-B25</b>  |   |                 |
|                    |               | NC                                 | 100          | <b>M22-KC01-B100</b> |   |                 |
|                    |               | SMCB, NC                           | 1            | <b>M22-KC01SMC10</b> |   |                 |
|                    |               | SMCB, 2NC                          | 1            | <b>M22-KC02SMC10</b> |   |                 |
|                    |               | Front                              | Spring-cage  | NO                   | 1 | <b>M22-CK10</b> |
|                    |               |                                    |              | NC                   | 1 | <b>M22-CK01</b> |
| NC, late-break     | 1             |                                    |              | <b>M22-CK01D</b>     |   |                 |
| 2NO <sup>②</sup>   | 1             |                                    |              | <b>M22-CK20</b>      |   |                 |
| 2NC <sup>②</sup>   | 1             |                                    |              | <b>M22-CK02</b>      |   |                 |
| NO-NC <sup>②</sup> | 1             |                                    |              | <b>M22-CK11</b>      |   |                 |
| Base               |               | NO                                 | 1            | <b>M22-CKC10</b>     |   |                 |
|                    |               | NC                                 | 1            | <b>M22-CKC01</b>     |   |                 |

#### Notes

<sup>①</sup> All NC contact blocks are positively driven contact. Ⓢ

<sup>②</sup> Not stackable.

### M22-LED-W



### Light Units

| Terminal Type | Mounting Location | LED Color   | Light Unit Voltage | Catalog Number |             |
|---------------|-------------------|-------------|--------------------|----------------|-------------|
| Screw         | Front             | White       | 12–30 Vac/Vdc      | M22-LED-W      |             |
|               |                   | Red         |                    | M22-LED-R      |             |
|               |                   | Green       |                    | M22-LED-G      |             |
|               |                   | Blue        |                    | M22-LED-B      |             |
|               |                   | White       | 85–264 Vac         | M22-LED230-W   |             |
|               |                   | Red         |                    | M22-LED230-R   |             |
|               |                   | Green       |                    | M22-LED230-G   |             |
|               |                   | Blue        |                    | M22-LED230-B   |             |
|               |                   | White       | 207–264 Vac        | M22-LED230H-W  |             |
|               |                   | Red         |                    | M22-LED230H-R  |             |
|               |                   | Green       |                    | M22-LED230H-G  |             |
|               |                   | Blue        |                    | M22-LED230H-B  |             |
|               | Base              | White       | 12–30 Vac/Vdc      | M22-LEDC-W     |             |
|               |                   |             |                    | M22-LEDC-R     |             |
|               |                   |             |                    | M22-LEDC-G     |             |
|               |                   |             |                    | M22-LEDC-B     |             |
|               |                   | 85–264 Vac  | M22-LEDC230-W      |                |             |
|               |                   |             | M22-LEDC230-R      |                |             |
|               |                   |             | M22-LEDC230-G      |                |             |
|               |                   |             | M22-LEDC230-B      |                |             |
|               |                   | 207–264 Vac | M22-LEDC230H-W     |                |             |
|               |                   |             | M22-LEDC230H-R     |                |             |
|               |                   |             | M22-LEDC230H-G     |                |             |
|               |                   |             | M22-LEDC230H-B     |                |             |
| Spring-cage   | Front             | White       | 12–30 Vac/Vdc      | M22-CLED-W     |             |
|               |                   | Red         |                    | M22-CLED-R     |             |
|               |                   | Green       |                    | M22-CLED-G     |             |
|               |                   | Blue        |                    | M22-CLED-B     |             |
|               |                   | White       | 85–264 Vac         | M22-CLED230-W  |             |
|               |                   | Red         |                    | M22-CLED230-R  |             |
|               |                   | Green       |                    | M22-CLED230-G  |             |
|               |                   | Blue        |                    | M22-CLED230-B  |             |
|               |                   | Base        | White              | 12–30 Vac/Vdc  | M22-CLEDC-W |
|               |                   |             |                    |                | M22-CLEDC-R |
|               |                   |             |                    |                | M22-CLEDC-G |
|               |                   |             |                    |                | M22-CLEDC-B |
|               | 85–264 Vac        |             | M22-CLEDC230-W     |                |             |
|               |                   |             | M22-CLEDC230-R     |                |             |
|               |                   |             | M22-CLEDC230-G     |                |             |
|               |                   |             | M22-CLEDC230-B     |                |             |

### M22-XLED60



### LED Resistor and Test Elements

| Terminal Type | Mounting Location | Element Type           | Voltage        | Catalog Number |
|---------------|-------------------|------------------------|----------------|----------------|
| Screw         | Front             | Resistor <sup>①②</sup> | 42–60 Vac/Vdc  | M22-XLED60     |
|               |                   |                        | 220 Vdc        | M22-XLED220    |
|               |                   | Test                   | 12–240 Vac/Vdc | M22-XLED-T     |
|               |                   |                        | 85–264 Vac     | M22-XLED230-T  |

#### Notes

- ① Resistor units to be used with 12–30V light units.
- ② Refer to **IL04716002E** for use of resistor elements in series for higher DC voltage.

#### Legend Plate Holders and Inserts, Pushbuttons and Double Pushbuttons <sup>②</sup>

**M22S-ST-X**



**M22-XST-GB0**



| Description  | Inscription | Catalog Number                   |
|--|-------------|----------------------------------|
| Legend plate holder, without legend plate insert, for pushbuttons        | —           | <b>M22S-ST-X</b>                 |
| Legend plate holder, without legend plate insert, for double pushbuttons | —           | <b>M22S-STDD-X</b>               |
| Legend plate insert  | —           | <b>M22-XST</b>                   |
|  | Custom      | <b>M22-XST-ETCH</b> <sup>①</sup> |
|  | STOP        | <b>M22-XST-GB0</b>               |
|  | START       | <b>M22-XST-GB1</b>               |
|  | OFF         | <b>M22-XST-GB5</b>               |
|  | ON          | <b>M22-XST-GB6</b>               |
|  | RUN         | <b>M22-XST-GB7</b>               |
|  | FAULT       | <b>M22-XST-GB8</b>               |
|  | OFF ON      | <b>M22-XST-GB10</b>              |
|  | MAN. AUTO   | <b>M22-XST-GB11</b>              |
|  | MAN. O AUTO | <b>M22-XST-GB12</b>              |
|  | HAND AUTO   | <b>M22-XST-D11</b>               |
|  | HAND O AUTO | <b>M22-XST-D12</b>               |
|  | 1           | <b>M22-XST-X52</b>               |
|  | 2           | <b>M22-XST-X53</b>               |
|  | 0 I         | <b>M22-XST-X88</b>               |
|  | 0 - I       | <b>M22-XST-X89</b>               |
|  | I O II      | <b>M22-XST-X93</b>               |

**Notes**

<sup>①</sup> When ordering, specify inscription per catalog number suffix from the Symbols Library (see **Pages V7-T1-129 to V7-T1-136**) into the Order Notes.

For example, M22-XD-S-ETCH; Order Notes: Mark with symbol X91, Line item # \_\_.







<sup>②</sup> Legend plates are IP66 and NEMA 4X/13.

**Example**

To order a legend plate for a pushbutton with non-standard markings (FORWARD):

1. Select legend plate holder—M22S-ST-X.
2. Select legend plate insert—M22-XST-ETCH.
3. Select FORWARD from the Symbols Library, **Pages V7-T1-129 to V7-T1-136**, identified by GB15 suffix.
4. Indicate on the order form in the order notes—suffix GB15, line item # \_\_\_\_ .

### Legend Plates, Complete ②



|   | Description                                     | Inscription  | Catalog Number  |                                  |
|---|---|--|---|----------------------------------|
| <b>M22S-ST-GB0</b><br> | For use with pushbuttons and indicating lights  | Legend plate holder with insert  | STOP <b>M22S-ST-GB0</b>   |                                  |
|   |   |  | START <b>M22S-ST-GB1</b>  |                                  |
|   |   |  | OFF <b>M22S-ST-GB5</b>  |                                  |
|   |   |  | ON <b>M22S-ST-GB6</b>   |                                  |
|   |   |  | RUN <b>M22S-ST-GB7</b>  |                                  |
|   |   |  | FAULT <b>M22S-ST-GB8</b>  |                                  |
|   |   |  | 1 <b>M22S-ST-X52</b>  |                                  |
|   |   |  | 2 <b>M22S-ST-X53</b>  |                                  |
|   |   | Selector switches  |   | OFF ON <b>M22S-ST-GB10</b>       |
|   |   |  |   | MAN. AUTO <b>M22S-ST-GB11</b>    |
|   | MAN. 0 AUTO <b>M22S-ST-GB12</b>                 |  |   |                                  |
|   | HAND AUTO <b>M22S-ST-D11</b>                    |  |   |                                  |
|   | HAND 0 AUTO <b>M22S-ST-D12</b>                  |  |   |                                  |
|   | 0 I <b>M22S-ST-X88</b>                          |  |   |                                  |
|   | 0 - I <b>M22S-ST-X89</b>                        |  |   |                                  |
|   | I 0 II <b>M22S-ST-X93</b>                       |  |   |                                  |
| <b>M22-XZK</b><br>     | Emergency-stop operators                        |  | Rectangular yellow legend plate                                   | — <b>M22-XZK</b>                 |
|   |   |  |   | Custom <b>M22-XZK-ETCH ①</b>     |
|   |   |  | EMERGENCY-STOP <b>M22-XZK-GB99</b>                                |                                  |
| <b>M22-XYK</b><br>    | Emergency-stop operators                        | Square yellow legend plate   | — <b>M22-XYK</b>  |                                  |
|   |   |  | — <b>M22-XYK-ETCH ①</b>   |                                  |
|   |   |  | EMERGENCY-STOP four-language <b>M22-XYK1</b>                      |                                  |
|   |   |  | EMERGENCY-STOP (top and bottom) <b>M22-XYK5</b>                   |                                  |
|   |   | <b>M22-XBK1</b><br> | Emergency-stop operators  | Round yellow legend plate, 90 mm |
|   | Custom <b>M22-XBK-ETCH ①</b>                    |  |   |                                  |
|   | EMERGENCY-STOP four-language <b>M22-XBK1</b>    |  |   |                                  |
|   | EMERGENCY-STOP (top and bottom) <b>M22-XBK5</b> |  |   |                                  |
| <b>M22-XBK1</b><br>  | Emergency-stop operators                        |  |   | Round yellow legend plate, 60 mm |
|   |   |  | Custom <b>M22-XBK-ETCH ①</b>                                      |                                  |
|   |   |  | EMERGENCY-STOP four-language <b>M22-XBK1</b>                      |                                  |
|   |   |  | EMERGENCY-STOP (top and bottom) <b>M22-XBK5</b>                   |                                  |
|   |   | <b>M22-XCK1</b><br> | Four-way pushbutton, joystick and four-position selector switches | Silver square legend plate       |
|   | Custom <b>M22-XCK-ETCH ①</b>                    |  |   |                                  |
|   | Four directional arrows <b>M22-XCK1</b>         |  |   |                                  |
|   | 0-1-0-2-0-3-0-4 <b>M22-XCK2</b>                 |  |   |                                  |
|   | Two directional arrows <b>M22-XCK3</b>          |  |   |                                  |

#### Notes

- ① When ordering, specify inscription per catalog number suffix from the Symbols Library (see **Pages V7-T1-129 to V7-T1-136**) into the Order Notes. For example, M22-XD-S-ETCH; Order Notes: Mark with symbol X91, Line item #\_.
- ② Legend plates are IP66 and NEMA 4X/13.



**Surface Mounting Enclosures** <sup>①</sup>

| Description  | Catalog Number    |
|--|-------------------|
| <b>M22-IY1-PG</b><br> | <b>M22-IY1-PG</b> |
| Yellow top, black base for emergency-stop operators  |                   |
| <b>M22-IY-PG</b><br>  |                   |
| One-element enclosure  | <b>M22-I1-PG</b>  |
| Two-element enclosure  | <b>M22-I2-PG</b>  |
| Three-element enclosure  | <b>M22-I3-PG</b>  |
| Four-element enclosure   | <b>M22-I4-PG</b>  |
| Six-element enclosure  | <b>M22-I6-PG</b>  |
| M20 connecting screw   | <b>M22-XI</b>     |
| M20 cord grip  | <b>V-M20</b>      |





**Flush Mounting Plates, Aluminum**

| Finish                                    | Rating | Catalog Number |
|---|--------|----------------|
| <b>One Hole</b>                           |        |                |
| Yellow paint for emergency-stop operators | —      | <b>M22-EY1</b> |
| Gray anodized                             | IP65   | <b>M22-E1</b>  |
| <b>Two Holes</b>                          |        |                |
| Gray anodized                             | IP65   | <b>M22-E2</b>  |
| <b>Three Holes</b>                        |        |                |
| Gray anodized                             | IP65   | <b>M22-E3</b>  |
| <b>Four Holes</b>                         |        |                |
| Gray anodized                             | IP65   | <b>M22-E4</b>  |
| <b>Five Holes</b>                         |        |                |
| Gray anodized                             | IP65   | <b>M22-E5</b>  |
| <b>Six Holes</b>                          |        |                |
| Anodized                                  | IP40   | <b>M22-E6</b>  |

**Shrouds, Plastic**

| Description  | Rating | Catalog Number |
|--|--------|----------------|
| <b>M22-H1</b><br> |        |                |
| One-element  | IP55   | <b>M22-H1</b>  |
| Two-element  | IP55   | <b>M22-H2</b>  |
| Three-element  | IP55   | <b>M22-H3</b>  |
| Four-element   | IP40   | <b>M22-H4</b>  |
| Five-element   | IP40   | <b>M22-H5</b>  |
| Six-element  | IP40   | <b>M22-H6</b>  |
| Mounting plate   | —      | <b>M22-XE5</b> |
| Plaster keys for flush mounting  | —      | <b>M22-UPE</b> |





**Selector Switch Accessories**

| Description  | Catalog Number  |
|--|-----------------|
| <b>M22-XW</b><br>   | <b>M22-XW</b>   |
| Plunger bridge <sup>②</sup>  |                 |
| <b>M22-XWS</b><br>  | <b>M22-XWS</b>  |
| Key cover  |                 |
| <b>M22-XC-R</b><br> | <b>M22-XC-R</b> |
| Key withdraw adapter <sup>③</sup>  |                 |
| <b>M22-XC-Y</b><br> | <b>M22-XC-Y</b> |
| Coding adapter   |                 |
| <b>M22-XGWK</b><br> | <b>M22-XGWK</b> |
| Guard ring   |                 |

**Notes**

- ① Requires use of base mounted contact blocks.
- ② Plunger needed to actuate center-mounted contact blocks. Used for non-illuminated three-position selector switches only.
- ③ Enables a keyed selector switch to be set to user-selected key withdraw position.

### Emergency Stop Operator Accessories

|  | Description       | Voltage    | Catalog Number         |
|--|-------------------|------------|------------------------|
|   | Yellow guard ring | —          | <b>M22-XGPV</b>        |
|   | Gray guard ring   | —          | <b>M22G-XGPV</b>       |
|   | Rectangular guard | —          | <b>M22-MGTA</b>        |
|   | Sealing shroud    | —          | <b>M22-PL-PV</b>       |
|  | Illuminated ring  | 24 Vac/Vdc | <b>M22-XPV60-Y-24</b>  |
|  |                   | 120 Vac    | <b>M22-XPV60-Y-120</b> |
|  |                   | 230 Vac    | <b>M22-XPV60-Y-230</b> |

### Blanking Plugs

| M22-B   | Color | Catalog Number |
|---|-------|----------------|
|  | Gray  | <b>M22-B</b>   |
|   | Black | <b>M22S-B</b>  |

### Mounting Accessories

|  | Description                       | Catalog Number  |
|--|-----------------------------------|-----------------|
|  | Telescopic clip with top-hat rail | <b>M22-TC</b>   |
|  | Telescopic clip                   | <b>M22-TA</b>   |
|  | Telescopic clip extension         | <b>M22-TCV</b>  |
|   | DIN rail mounting adapter         | <b>M22-IVS</b>  |
|   | Mounting ring                     | <b>M22-GR</b>   |
|   | Mounting ring tool                | <b>M22-MS</b>   |
|  | Adapter ring set for 30 mm holes  | <b>M22S-R30</b> |

### Protective Diaphragm

| M22-T-D and M22-T-DD   | For Use with ...                        | Catalog Number  |
|--|---|-----------------|
|  | Flush pushbuttons and indicating lights | <b>M22-T-D</b>  |
|  | Double pushbuttons                      | <b>M22-T-DD</b> |

### Dust Covers

| M22-ADC4  | Description                                   | Catalog Number  |
|---|---|-----------------|
|  | Contact block dust cover                      | <b>M22-XKDP</b> |
|   | Operator dust cover, max three contact blocks | <b>M22-ADC</b>  |
|   | Operator dust cover, max four contact blocks  | <b>M22-ADC4</b> |

### Kits

| Description   | Catalog Number |
|---|----------------|
| Includes one each: M22-XW, M22-XC-R, M22-XC-Y, M22S-B, M22-A, M22-XD-SWRGYB | <b>M22-KT1</b> |

## Coding Adapter Guide

### Selector Switches

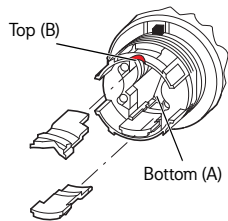

#### Two-Position Selector Switch

| Top (B) | Bottom (A) | Catalog Number  | Function   |
|---------|------------|-----------------|------------|
|         |            | M22(S)-W(L)(K)  | Momentary  |
|         |            | M22(S)-WR(L)(K) | Maintained |

#### Three-Position Selector Switch

| Top (B) | Bottom (A) | Catalog Number     | Function Left | Right      |
|---------|------------|--------------------|---------------|------------|
|         |            | M22(S)-W(L)(K)3    | Momentary     | Momentary  |
|         |            | M22(S)-WR(L)(K)3   | Maintained    | Maintained |
|         |            | M22(S)-WR(L)(K)3-1 | Maintained    | Momentary  |
|         |            | M22(S)-WR(L)(K)3-2 | Momentary     | Maintained |

#### Two-Position Key-Operated Selector Switch

| Top (B) | Bottom (A) | Catalog Number | Center Key Withdraw | Right Function | Key Withdraw |
|---------|------------|----------------|---------------------|----------------|--------------|
|         |            | M22(S)-WS      | Yes                 | Momentary      | No           |
|         |            | M22(S)-WRS     | Yes                 | Maintained     | Yes          |
|         |            | M22(S)-WRS-A1  | Yes                 | Maintained     | No           |

#### Three-Position Key-Operated Selector Switch

| Top (B) | Bottom (A) | Catalog Number | Left Function | Key Withdraw | Center Key Withdraw | Right Function | Key Withdraw |
|---------|------------|----------------|---------------|--------------|---------------------|----------------|--------------|
|         |            | M22(S)-WS3     | Momentary     | No           | Yes                 | Momentary      | No           |
|         |            | M22(S)-WRS3    | Maintained    | Yes          | Yes                 | Maintained     | Yes          |
|         |            | M22(S)-WRS3-A1 | Maintained    | No           | Yes                 | Maintained     | No           |
|         |            | M22(S)-WRS3-A2 | Maintained    | Yes          | Yes                 | Maintained     | No           |
|         |            | M22(S)-WRS3-A3 | Maintained    | No           | Yes                 | Maintained     | Yes          |
|         |            | M22(S)-WRS3-A4 | Maintained    | Yes          | Yes                 | Momentary      | No           |
|         |            | M22(S)-WRS3-A5 | Maintained    | No           | Yes                 | Momentary      | No           |
|         |            | M22(S)-WRS3-A6 | Momentary     | No           | Yes                 | Maintained     | Yes          |
|         |            | M22(S)-WRS3-A7 | Momentary     | No           | Yes                 | Maintained     | No           |

## Technical Data and Specifications

### Pushbuttons, Indicating Lights, Selector Switches and Emergency-Stop Operators

| Description   |              | Momentary Pushbuttons   | Maintained Pushbuttons                 | Indicating Lights, Buzzers and Potentiometers                         | Emergency-Stop Operators               | Selector Switches                      | Key-Operated Operators                 | Double Pushbuttons                     |
|---|--------------|---|--|---|--|--|--|--|
| <b>General</b>  |              |   |  |   |  |  |  |  |
| Standards   |              | IEC/EN 60947<br>VDE 0660<br>UL #E29184  | IEC/EN 60947<br>VDE 0660<br>UL #E29184 | IEC/EN 60947<br>VDE 0660<br>UL #E29184                                | IEC/EN 60947<br>VDE 0660<br>UL #340491 | IEC/EN 60947<br>VDE 0660<br>UL #E29184 | IEC/EN 60947<br>VDE 0660<br>UL #E29184 | IEC/EN 60947<br>VDE 0660<br>UL #E29184 |
| Lifespan, mechanical  | Operations   | x 10 <sup>6</sup>   | >5                                     | >1  | —                                      | >0.1                                   | >0.1                                   | >0.2                                   |
| Operating frequency   | Operations/h |   | ≥3600                                  | ≥1800   | —                                      | ≥600                                   | ≥2000                                  | ≥3600                                  |
| Actuating force   | n            |   | ≥5                                     | ≥5  | —                                      | ≥50                                    | —                                      | ≥5                                     |
| Operating torque (screw terminals)  | Nm           |   | —                                      | —   | —                                      | ≥0.3                                   | ≥0.5                                   | —                                      |
| <b>Protection Type</b>  |              |   |  |   |  |  |  |  |
| IP  |              | IP67, IP69K   | IP67, IP69K                            | Indicating lights: IP67, 69K<br>Buzzers: IP40<br>Potentiometers: IP66 | IP67, IP69K                            | IP66                                   | IP66                                   | IP66                                   |
| UL type   |              | 4X, 13  | 4X, 13                                 | Indicating lights: 4X/13<br>Buzzers: 12<br>Potentiometers: 4X/13      | 4X, 13                                 | 4X, 13                                 | 4X, 13                                 | 4X, 13                                 |
| Climatic proofing   |              | Damp heat, constant, according to IEC 60068-2-78<br>Damp heat, cyclical to IEC 60068-2-30 |  |   |  |  |  |  |
| Ambient temperature, operating  |              | °F<br>(°C)  | –13 to 158<br>(–25 to 70)              | –13 to 158<br>(–25 to 70)   | –13 to 158<br>(–25 to 70)              | –13 to 158<br>(–25 to 70)              | –13 to 158<br>(–25 to 70)              | –13 to 158<br>(–25 to 70)              |
| Mounting position   |              |   | As required                            | As required   | As required                            | As required                            | As required                            | As required                            |
| Mechanical shock resistance to IEC 60068-2-27 shock duration 11 ms, half-sinusoidal |              | g   | >30                                    | >30   | >30                                    | >50                                    | >30                                    | >30                                    |
| <b>Terminal Capacities</b>  |              |   |  |   |  |  |  |  |
| Solid   |              | AWG   | —                                      | —   | 20-16                                  | —                                      | —                                      | —                                      |
|   |              | mm <sup>2</sup>   | —                                      | —   | 0.5–1.5                                | —                                      | —                                      | —                                      |
| Stranded  |              | AWG   | —                                      | —   | 20-16                                  | —                                      | —                                      | —                                      |
|   |              | mm <sup>2</sup>   | —                                      | —   | 0.5–1.5                                | —                                      | —                                      | —                                      |
| <b>Contacts</b>   |              |   |  |   |  |  |  |  |
| Rated impulse withstand voltage   |              | U <sub>imp</sub>  | Vac                                    | —   | 4000                                   | —                                      | —                                      | —                                      |
| Rated insulation voltage  |              | U <sub>i</sub>  | V                                      | —   | 2500                                   | —                                      | —                                      | —                                      |
| Overvoltage category/pollution degree   |              |   | —                                      | —   | III/3                                  | —                                      | —                                      | —                                      |

## Contact Blocks and Light Units

| Description   |              |                   | Contact Blocks  | LED Light Units                        |
|---|--------------|-------------------|---|--|
| <b>General</b>  |              |                   |   |  |
| Standards   |              |                   | IEC/EN 60947<br>VDE 0660<br>UL #E29184  | IEC/EN 60947<br>VDE 0660<br>UL #E29184 |
| Lifespan, mechanical  | Operations   | $\times 10^6$     | >5  | —                                      |
| Operating frequency   | Operations/h |                   | $\geq 3600$   | —                                      |
| Actuating force   | n            |                   | $\geq 5$  | —                                      |
| Operating torque (screw terminals)  | Nm           |                   | $\leq 0.8$  | —                                      |
| <b>Protection Type</b>  |              |                   |   |  |
| IP  |              |                   | IP20  | IP20                                   |
| UL type   |              |                   | —   | —                                      |
| Climatic proofing   |              |                   | Damp heat, constant, according to IEC 60068-2-78<br>Damp heat, cyclical to IEC 60068-2-30 |  |
| Ambient temperature, operating  |              | °F (°C)           | –13 to 158 (–25 to 70)  | –13 to 158 (–25 to 70)                 |
| Mounting position   |              |                   | As required   | As required                            |
| Mechanical shock resistance to IEC 60068-2-27 shock duration 11 ms, half-sinusoidal |              | g                 | >30   | >30                                    |
| <b>Terminal Capacities</b>  |              |                   |   |  |
| Solid   |              | AWG               | 18–14   | 18–14                                  |
|   |              | mm <sup>2</sup>   | 0.75–2.5  | 0.75–2.5                               |
| Stranded  |              | AWG               | 20–14   | 20–14                                  |
|   |              | mm <sup>2</sup>   | 0.5–2.5   | 0.5–2.5                                |
| <b>Contacts</b>   |              |                   |   |  |
| Rated impulse withstand voltage   | $U_{imp}$    | Vac               | 6000  | 6000                                   |
| Rated insulation voltage  | $U_i$        | V                 | 500   | 500                                    |
| Overvoltage category/<br>pollution degree   |              |                   | III/3   | III/3                                  |
| NEMA contact ratings  |              |                   | A600, Q300  | —                                      |
| Current draw  |              |                   | —   | 5–15 mA                                |
| <b>Control Circuit Reliability</b>  |              |                   |   |  |
| at 24 Vdc/5 mA  | $H_f$        | Fault probability | $<10^{-7}$ , <1 fault in $10^7$ operations  | —                                      |
| at 5 Vdc/1 mA   | $H_f$        | Fault probability | $<5 \times 10^{-6}$ , <1 fault in $5 \times 10^6$ operations                              | —                                      |
| <b>Max. Short-Circuit Protective Device</b>   |              |                   |   |  |
| Fuse  | gG/gL        | A                 | 10  | —                                      |
| <b>Switching Capacity</b>   |              |                   |   |  |
| <b>Rated Operational Current</b>  |              |                   |   |  |
| AC-15   |              |                   |   |  |
| 115V  | $I_e$        | A                 | 6   | —                                      |
| 230V  | $I_e$        | A                 | 6   | —                                      |
| 400V  | $I_e$        | A                 | 4   | —                                      |
| 500V  | $I_e$        | A                 | 2   | —                                      |
| DC-13   |              |                   |   |  |
| 24V   | $I_e$        | A                 | 3   | —                                      |
| 42V   | $I_e$        | A                 | 1.7   | —                                      |
| 60V   | $I_e$        | A                 | 1.2   | —                                      |
| 110V  | $I_e$        | A                 | 0.6   | —                                      |
| 220V  | $I_e$        | A                 | 0.3   | —                                      |
| <b>Lifespan, Electrical</b>   |              |                   |   |  |
| AC-15   |              |                   |   |  |
| 230V/0.5A   | Operations   | $\times 10^6$     | 1.6   | —                                      |
| 230V/1.0A   | Operations   | $\times 10^6$     | 1   | —                                      |
| 230V/3.0A   | Operations   | $\times 10^6$     | 0.7   | —                                      |
| DV-13   |              |                   |   |  |
| 12V/2.8A  | Operations   | $\times 10^6$     | 1.2   | —                                      |

**Contact Element Note:** >200 Vac/60 Hz: –25/55°C

**Palm Switches**

| Description  |                              | Momentary  | Maintained               | FAK-R-V-KC11-I           |
|--|------------------------------|--|--------------------------|--------------------------|
| <b>General</b>   |                              |  |                          |                          |
| Standards  |                              | IEC/EN 60947<br>VDE 0660   | IEC/EN 60947<br>VDE 0660 | IEC/EN 60947<br>VDE 0660 |
| Lifespan, mechanical   | Operations x 10 <sup>6</sup> | >1   | >0.1                     | >0.1                     |
| Operating frequency  | Operations/h                 | ≥3600  | ≥600                     | ≥600                     |
| Actuating force  | n                            | 20–40  | 40–60                    | 15–25                    |
| Operating torque   | Nm                           | —  | —                        | —                        |
| Degree of protection, IEC/EN 60529   | IP                           | IP67, IP69K  | IP67, IP69K              | IP65                     |
|  | UL Type                      | 4X, 13   | 4X, 13                   | 4X, 13                   |
| Climatic proofing  |                              | Damp heat, constant, to IEC 60068-2-78<br>Damp heat, cyclic, to IEC 60068-2-30 |                          |                          |
| Ambient temperature, operating   | °F (°C)                      | –73 to 104 (–25 to 40)   | –73 to 104 (–25 to 40)   | –73 to 104 (–25 to 40)   |
| Mounting position  |                              | As required  |                          |                          |
| Mechanical shock resistance to IEC 60068-2-27<br>shock duration 11 ms, half-sinusoidal | g                            | >15  | >15                      | >15                      |

**ASi Adapter Modules**

| Description                                       |         | M22-ASI  | M22-ASI-C  |
|---|---------|--|--|
| <b>General</b>                                    |         |  |  |
| Standards   |         | IEC/EN 60947,<br>DIN EN 50295  | IEC/EN 60947,<br>DIN EN 50295  |
| Radio interference suppression                    |         | EN 55011,<br>EN 55022  | EN 55011,<br>EN 55022  |
| Limit value class                                 |         | —  | —  |
| Protection type                                   |         | IP20   | IP00   |
| Climatic proofing                                 |         | Damp heat, constant, to IEC 60068-2-78, cyclical, to IEC 60068-2-30  |  |
| Ambient temperature, operating                    | °F (°C) | –13 to 131 (–25 to 55)   | –13 to 131 (–25 to 55)   |
| Shock resistance shock duration 11 ms             | g       | >30  | >30  |
| Vibration to IEC 60068-2-27<br>(amplitude 1 mm)   | Hz      | —  | —  |
| Dimensions  | mm      | —  | —  |
| Weight  | kg      | —  | —  |
| Mounting  |         | Front mounting   | Front mounting   |
| Mounting position                                 |         | As required  | As required  |
| <b>Power Supply</b>                               |         |  |  |
| Rated voltage to AS-interface specification       | Vdc     | 26.5–31.6  | 26.5–31.6  |
| Connection technique                              |         | Yellow plug-in terminal as insulation piercing terminal  | Two cables onboard   |
| Power supply                                      |         | Completely from the AS-interface cable   |  |
| Addressing  |         | Via connection to AS-interface cable   |  |
| Total power consumption of the AS-interface       | mA      | ≥40  | ≥40  |
| AS-interface                                      |         | —  | —  |
| Rated operational current at full load            | mA      | —  | —  |
| Rated operational current when idle (no I, O set) | mA      | —  | —  |
| Status LEDs                                       |         | POWER AS-interface cable:<br>green LED on the rear side of the element<br>ERROR AS-interface, AS-interface master failure: red LED on the rear side of the element | POWER AS-interface cable:<br>green LED on the board<br>ERROR AS-interface, AS-interface master failure: red LED on the board |

## ASI-S Adapter Modules

| Description                                     |         | M22-ASI-S  | M22-ASI-CS   |
|---|---------|--|--|
| <b>Inputs</b>                                   |         |  |  |
| Inputs, protected against short-circuit         | Number  | Two (normally 22V/5 mA)  | Two (normally 22V/5 mA)  |
| Voltage range                                   | Vdc     | —  | —  |
| Rated current per input                         | mA      | —  | —  |
| High signal level                               | V       | —  | —  |
| Low signal                                      | mA      | —  | —  |
| Length of connecting cables                     | cm      | —  | —  |
| <b>Outputs</b>                                  |         |  |  |
| Outputs, protected against short-circuit        | Number  | One (normally 19V/8 mA)  | One (normally 19V/8 mA)  |
| Voltage range                                   | Vdc     | —  | —  |
| <b>Max. Current Carrying Capacity</b>           |         |  |  |
| All outputs                                     |         | —  | —  |
| ∑ three external outputs                        |         | —  | —  |
| Length of connecting cables                     | cm      | —  | —  |
| Profile   |         | S-3.A.E  | S-3.A.E  |
| Specification                                   |         | 2.1  | 2.1  |
| Addresses                                       | Number  | 62   | 62   |
| <b>Emergency-Stop Circuits</b>                  |         |  |  |
| Connection of the AS-interface line             |         | Yellow plug terminal with insulation piercing  | Two cables on the circuit board  |
| Power supply                                    |         | Complete from AS-interface, cable 26.5–31.6 Vdc  | Complete from AS-interface, cable 26.5–31.6 Vdc  |
| Fixing  |         | Front mounted  | Base mounted   |
| Addressing                                      |         | Via AS-interface cable   | Via AS-interface cable   |
| Max. total current                              | A       | 45 mA  | 45 mA  |
| Ambient temperature, operating                  | °F (°C) | –13 to 131 (–25 to 55)   | –13 to 131 (–25 to 55)   |
| Shock resistance                                |         | 30g/11 ms as per IEC 60068-2-27  | 30g/11 ms as per IEC 60068-2-27  |
| Protection type                                 |         | IP20   | IP00   |
| Climatic proofing                               |         | Damp heat, constant, to IEC 60068-2-78, cyclical, to IEC 60068-2-30                      | Damp heat, constant, to IEC 60068-2-78, cyclical, to IEC 60068-2-30                      |
| Mounting position                               |         | As required  | As required  |
| Standards                                       |         | EN 50178<br>EN 50 295  | EN 50178<br>EN 50 295  |
| Inputs  |         | Two-channel input (22V/5 mA) (moduled by code sequence) (two break contact sets M22-K01) | Two-channel input (22V/5 mA) (moduled by code sequence) (two break contact sets M22-K01) |
| Outputs   |         | One output, typically 19V/8 mA, short-circuit proof                                      | One output, typically 19V/8 mA, short-circuit proof                                      |
| <b>Status Displays</b>                          |         |  |  |
| Power, AS-interface cable                       |         | Green LED on the back  | Green LED on the back  |
| AS-interface error, AS-interface master failure |         | Red LED on the back  | Red LED on the back  |
| Profile   |         | S-7.B.E  | S-7.B.E  |

**Dimensions**

Approximate Dimensions in Inches (mm)

**Operators and Indicating Lights**

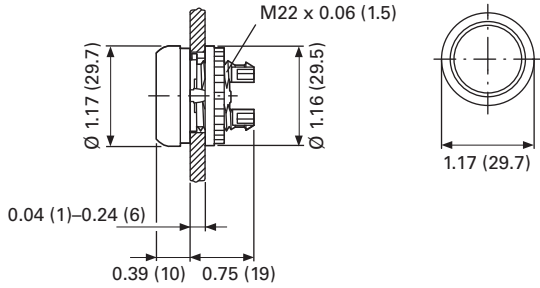

**Pushbuttons**

**M22...-D-**

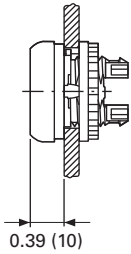

**M22...-DH-**

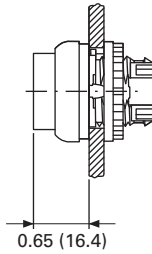

**M22-DG(L)-**

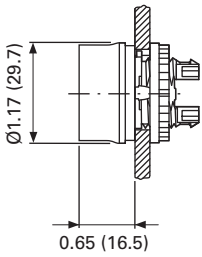

**M22...-DD-**

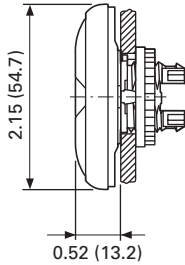

**M22-D, Base Mounted**

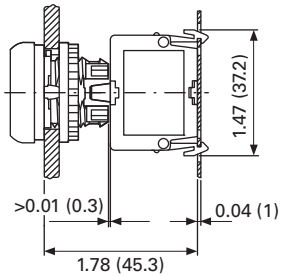

**Selector Switches Operators**

**M22...-W-**

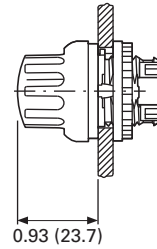

**M22...-WL-**

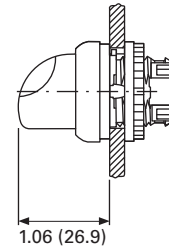

**Key-Operated Selector Switches**

**M22...-W(R)S-**

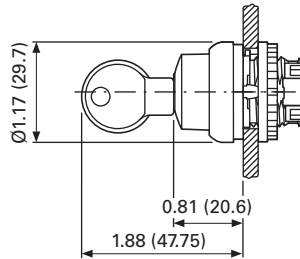

**Indicating Light**

**M22-L**

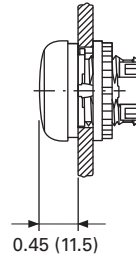



# 1.5

## Pushbuttons and Indicating Lights

### 22.5 mm Modular Pushbuttons—M22

1

Approximate Dimensions in Inches (mm)

#### Illuminated Pushbuttons

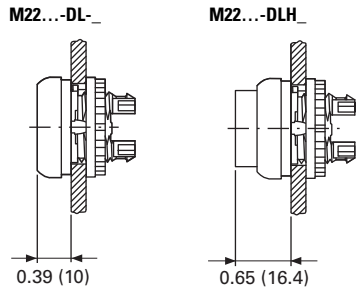

#### Mushroom Head Pushbutton

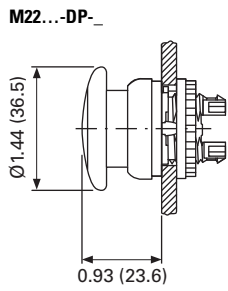

#### Emergency-Stop Operators

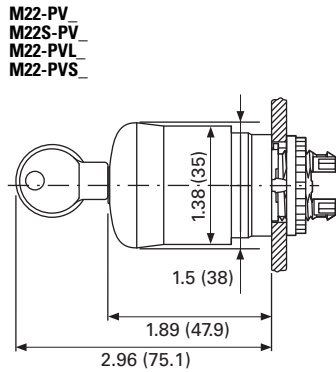

#### Potentiometer

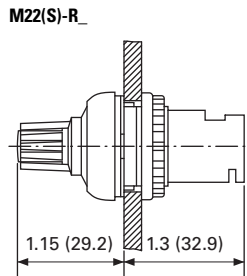

#### Contact Block Mounting Adapter

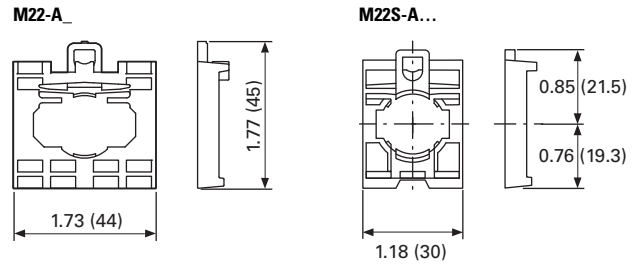

#### Front Mounted Centering Adapter

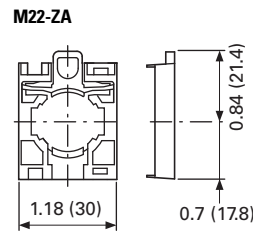

#### Front Mounted Indicating Light

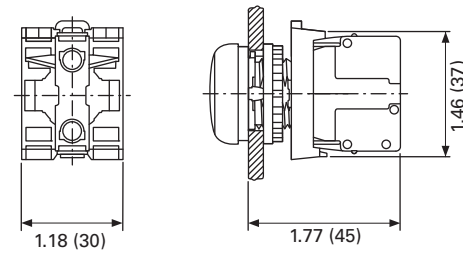

#### Pushbutton, Complete Devices

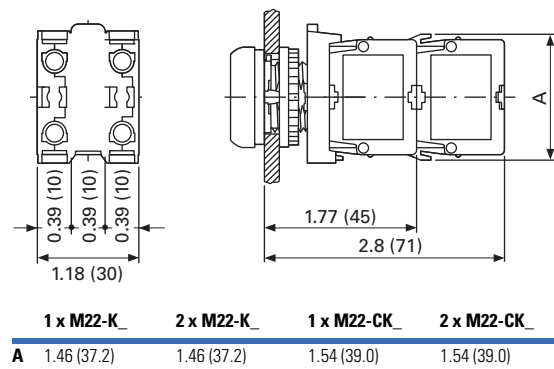

Approximate Dimensions in Inches (mm)

### DIN-Rail Mounting Adapter

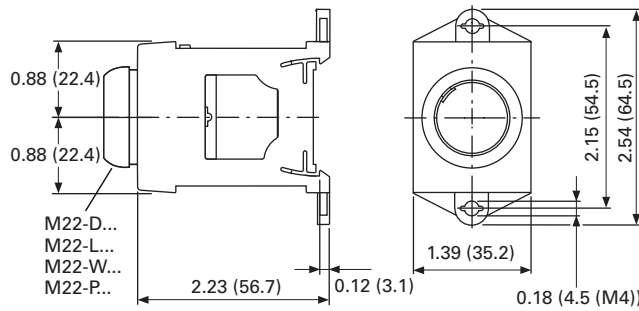

### Pushbuttons and Indicating Lights with M22-TC Telescopic Clip and M22-TVC Extension

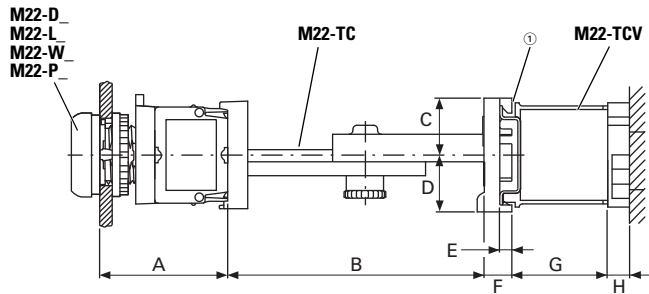

| A            | B                     | C            | D            | E             | F            | G           | H            |
|--------------|-----------------------|--------------|--------------|---------------|--------------|-------------|--------------|
| 1.77<br>(45) | 2.36–3.94<br>(60–100) | 0.79<br>(20) | 0.79<br>(20) | 0.18<br>(4.5) | 0.39<br>(10) | 154<br>(39) | 0.39<br>(10) |

① Top-hat rail to IEC/EN 60715.

### Palm Switches

FAK\_

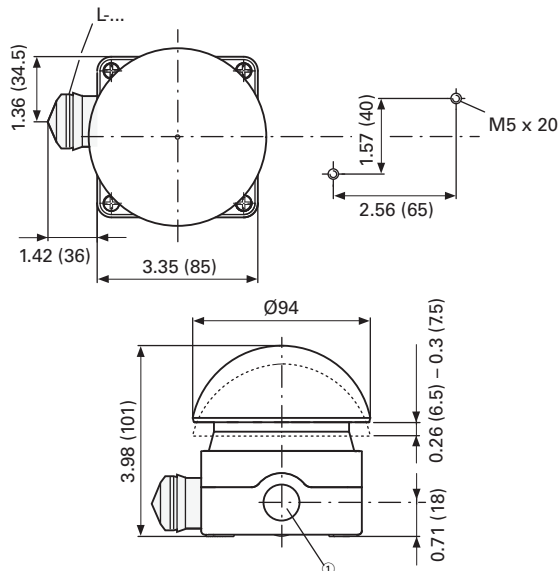

① 3 x M20 lateral, 1 x M16 in bottom.

### Front Mounted Mounting Plate

M22-E\_

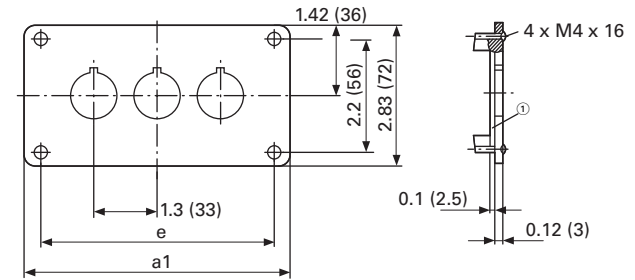

| Catalog Number | a1         | e          |
|----------------|------------|------------|
| M22-E(Y) ①     | 2.83 (72)  | 2.21 (56)  |
| M22-E2         | 4.13 (105) | 3.50 (89)  |
| M22-E3         | 5.43 (138) | 4.80 (122) |

| Catalog Number | a1         | e          |
|----------------|------------|------------|
| M22-E4         | 6.73 (171) | 6.10 (155) |
| M22-E5         | 8.03 (204) | 7.40 (188) |
| M22-E6         | 9.33 (237) | 8.70 (221) |

### Base Mounted Surface Mounting Enclosure

M22-I\_

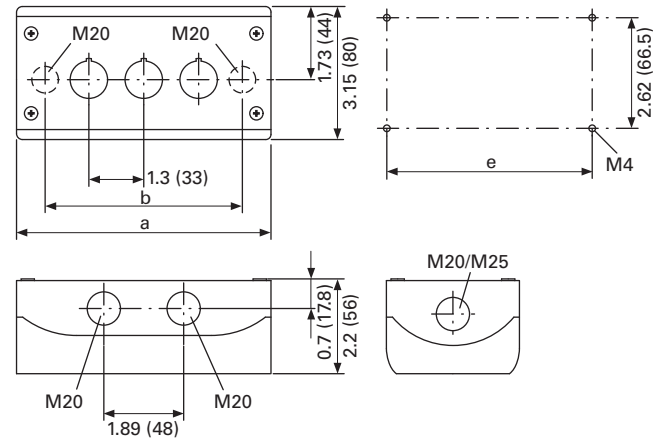

| Catalog Number | Mounting Locations | a               | b               | e               | Cable Entries           |
|----------------|--------------------|-----------------|-----------------|-----------------|-------------------------|
| M22-I(Y)1      | 1                  | 2.83<br>(72.0)  | 1.68<br>(42.6)  | 2.30<br>(58.5)  | 2 x M16 3 x M20 2 x M25 |
| M22-I2         | 2                  | 4.72<br>(120.0) | 3.37<br>(85.6)  | 4.19<br>(106.5) | 2 x M20 3 x M20 2 x M25 |
| M22-I3         | 3                  | 6.02<br>(153.0) | 4.67<br>(118.6) | 5.49<br>(139.5) | 2 x M20 2 x M25 4 x M20 |
| M22-I4         | 4                  | 7.32<br>(186.0) | 5.97<br>(151.6) | 6.79<br>(172.5) | 2 x M20 2 x M25 4 x M20 |
| M22-I6         | 6                  | 9.92<br>(252.0) | 8.57<br>(217.6) | 9.39<br>(238.5) | 2 x M20 2 x M25 4 x M20 |

# 1.5

## Pushbuttons and Indicating Lights

### 22.5 mm Modular Pushbuttons—M22

1

Approximate Dimensions in Inches (mm)

#### Covers

##### M22-H\_

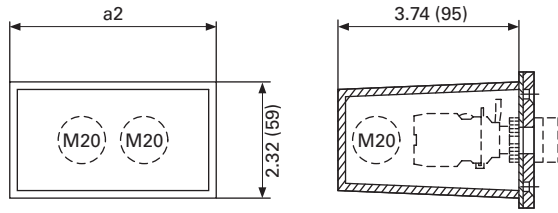

| Catalog Number | a2         | Cable Entry | Style     |
|----------------|------------|-------------|-----------|
| M22-H1         | 1.65 (42)  | 3 x M20     | One-piece |
| M22-H2         | 2.95 (75)  | 4 x M20     |           |
| M22-H3         | 4.25 (108) | 4 x M20     |           |
| M22-H4         | 5.55 (141) | 4 x M20     | Split     |
| M22-H5         | 6.85 (174) | 5 x M20     |           |
| M22-HE6        | 8.15 (207) | 6 x M20     |           |

#### Connecting Screw

##### M22-XI

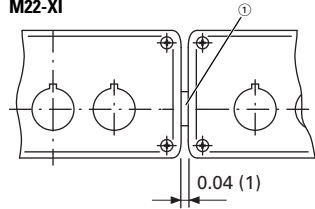

① Gasket.

#### Shroud with Plaster Keys

##### M22-UPE

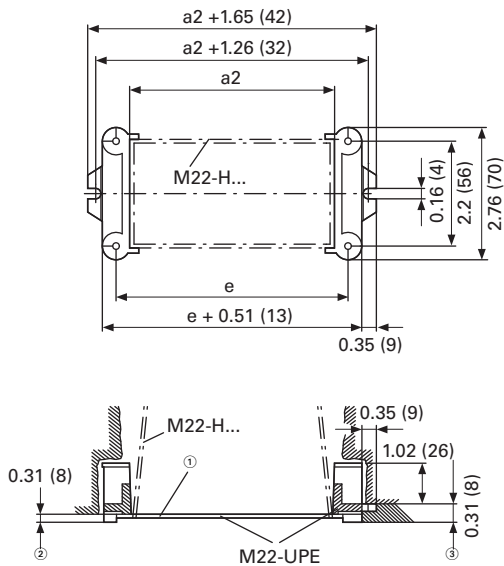

- ② Box for closing off when plastering.
- ③ Plaster thickness less than 8 mm.
- ④ Plaster thickness more than 8 mm.

#### Legend Plates

##### M22S-ST\_

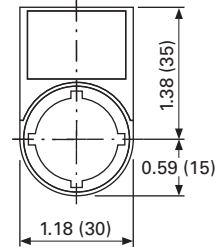

##### M22S-STDD-X

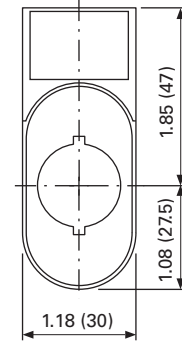

#### Mounting Hole with Lug Slot

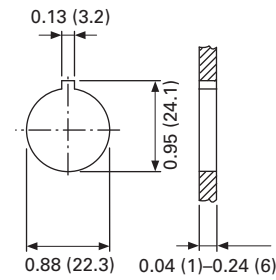

#### USB Socket

Approximate Dimensions in Inches (mm)

### Grid Dimension to IEC/EN 60947

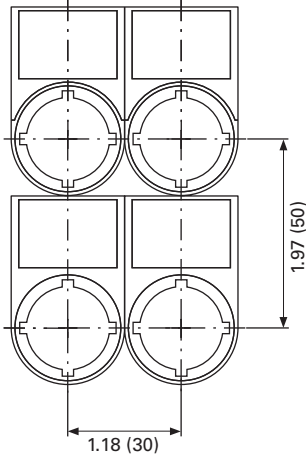

### Grid Dimension for Various Combinations

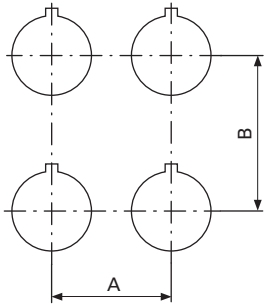

### Pushbutton Diaphragm

Pushbutton diaphragm cannot be combined with label mount.

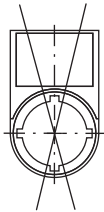

| Catalog Number                 | A ≥         | B ≥         |
|--------------------------------|-------------|-------------|
| <b>M22(S)-_ (IEC/EN 60947)</b> | 1.18 (30.0) | 1.97 (50.0) |
| <b>RMQ-Titan min.</b>          | 1.18 (30.0) | 1.58 (40.0) |
| <b>M22-D_ + M22-T-D</b>        | 1.30 (33.0) | 1.58 (40.0) |
| <b>M22-D(R)P_</b>              | 1.50 (38.0) | 1.58 (40.0) |
| <b>M22-PV_</b>                 | 1.50 (38.0) | 1.58 (40.0) |
| <b>M22-PV(L) + M22-PL-PV</b>   | 1.89 (48.0) | 2.20 (56.0) |
| <b>M22-PV(L)(S_) + M22-D_</b>  | 1.30 (33.0) | 1.58 (40.0) |
| <b>M22-DDL_</b>                | 1.18 (30.0) | 2.17 (55.0) |
| <b>M22-DDL_ + M22-T-DD</b>     | 1.30 (33.0) | 2.28 (58.0) |
| <b>M22-ST_</b>                 | 1.18 (30.0) | 1.97 (50.0) |
| <b>M22-STDD_</b>               | 1.18 (30.0) | 2.95 (75.0) |
| <b>M22-CK_</b>                 | 1.18 (30.0) | 1.77 (45.0) |
| <b>M22-CLED_</b>               | 1.18 (30.0) | 1.77 (45.0) |
| <b>M22-XAK_</b>                | 3.54 (90.0) | 3.54 (90.0) |
| <b>M22-XZK_</b>                | 1.30 (33.0) | 2.04 (52.0) |
| <b>M22-XBK_</b>                | 2.36 (60.0) | 2.36 (60.0) |
| <b>M22-XYK_</b>                | 1.97 (50.0) | 1.97 (50.0) |
| <b>M22-D4</b>                  | 2.17 (55.0) | 2.17 (55.0) |
| <b>M22-WR...4</b>              | 1.97 (50.0) | 1.97 (50.0) |
| <b>M22-W...J4</b>              | 1.97 (50.0) | 1.97 (50.0) |

### Grid Dimension for M22-DD\_

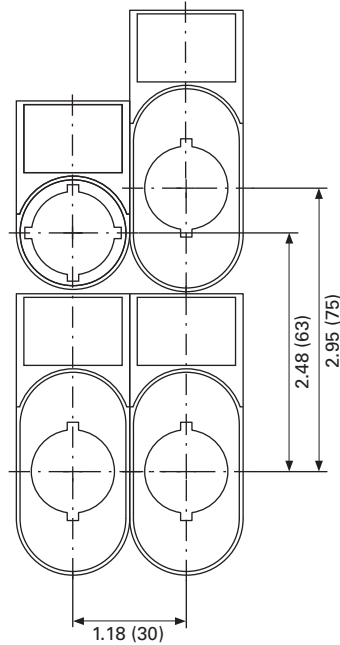

### Grid Dimension for M22-DDL\_

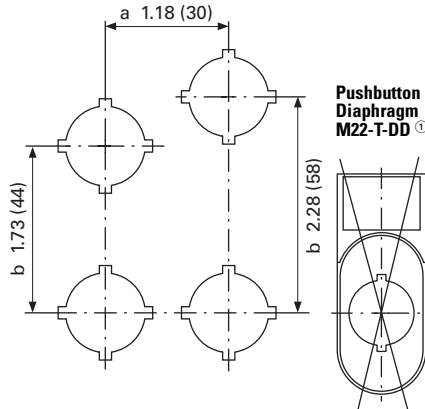

① Pushbutton diaphragm cannot be combined with label mount.

### Emergency Stop Sealing Cover

#### M22-PL-PV

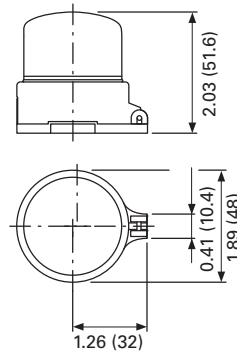

# 1.5

## Pushbuttons and Indicating Lights

### 22.5 mm Modular Pushbuttons—M22

1

Approximate Dimensions in Inches (mm)

#### Blanking Plugs

M22...B-<sub>-</sub>

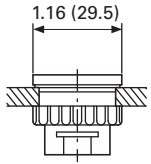

#### Pushbutton Diaphragm

M22-T-D

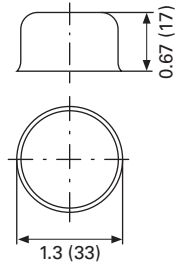

M22-T-D

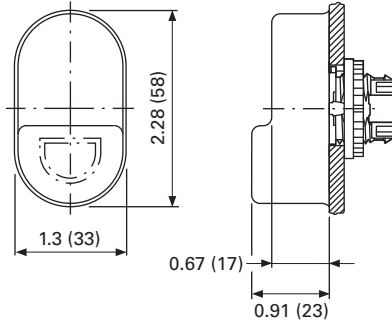

#### Guard Ring

M22-XGWK

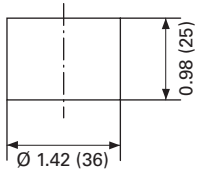

M22-XGPV

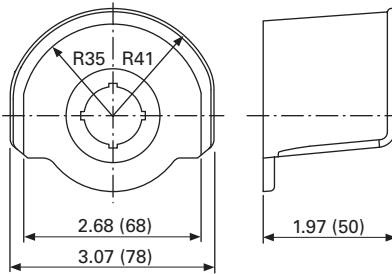

#### Key Cover

M22-XWS

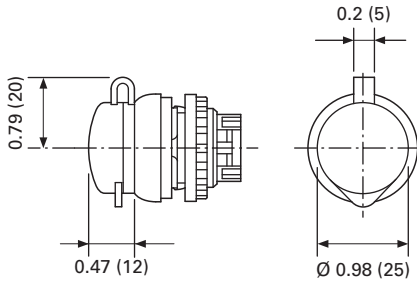

#### Emergency Stop Legend Plate

M22-XAK-<sub>-</sub>

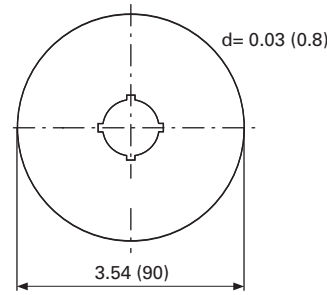

M22-X(Y)ZK-<sub>-</sub>

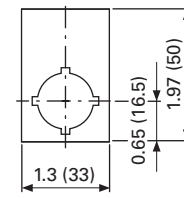

M22-XBK-<sub>-</sub>

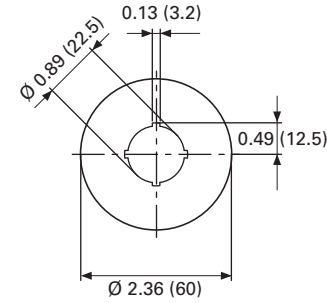

M22-XYK-<sub>-</sub>

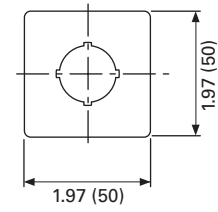

#### Joystick

M22...W...J-<sub>-</sub>

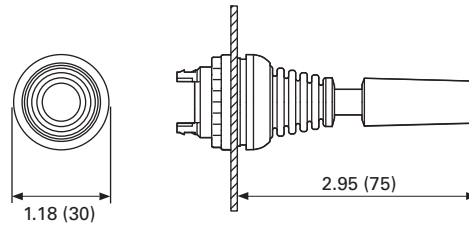

#### Four-Way Pushbutton

M22...D...4-<sub>-</sub>

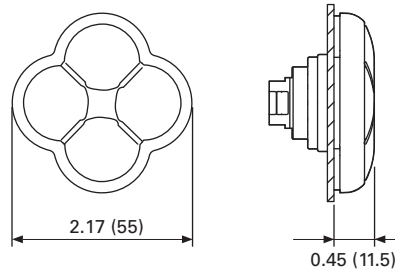

## Symbols Library

### Instructions for Ordering Laser Inscriptions

1. Identify part number to be inscribed.
2. Pick symbol from library and identify suffix code associated with the symbol.
3. Order part number already listed in the catalog with -ETCH suffix.
4. When placing an order by fax or Vistaline on the Web, reference order item number and indicate appropriate suffix code.

### Example

To order a green flush button plate with the inscription AUTO HAND:

Order Catalog Number: M22-XD-G-ETCH (see **Page V7-T1-55**).

AUTO HAND inscription is found on **Page V7-T1-133** in the Symbols Library, suffix code is X91.

In the order notes, reference item number and suffix X91.

Letter height 3 mm: max. three lines, max. 12 characters per line.

Letter height 5 mm: max. two lines, max. eight characters per line.

**Note:** For symbols or text not found in the Symbols Library, please contact the Eaton Technical Resource Center at 1-877-ETN CARE (386-2273) or TRC@eaton.com.

**Letter Height Specifications:** ≤ five characters; letter height = 0.197 in (5 mm). > five characters; letter height = 0.118 in (3 mm).

**Text—English**

| Inscription | Catalog Number Suffix |
|-------------|-----------------------|
| STOP        | GB0                   |
| START       | GB1                   |
| CLOSE       | GB2                   |
| UP          | GB3                   |
| DOWN        | GB4                   |
| OFF         | GB5                   |
| ON          | GB6                   |
| RUN         | GB7                   |
| FAULT       | GB8                   |
| TEST        | GB9                   |
| OFF ON      | GB10                  |
| MAN. AUTO   | GB11                  |
| MAN. 0 AUTO | GB12                  |
| RESET       | GB14                  |
| FORWARD     | GB15                  |
| REVERSE     | GB16                  |
| RAISE       | GB17                  |

**Text—German**

| Inscription    | Catalog Number Suffix |
|----------------|-----------------------|
| LOWER          | GB18                  |
| LEFT           | GB19                  |
| RIGHT          | GB20                  |
| BRAKE          | GB21                  |
| HIGH           | GB22                  |
| LOW            | GB23                  |
| FAST           | GB24                  |
| SLOW           | GB25                  |
| FASTER         | GB26                  |
| SLOWER         | GB27                  |
| OPEN           | GB32                  |
| PROG           | GB62                  |
| CALL           | GB63                  |
| OCCUPIED       | GB64                  |
| BYPASS<br>0 1  | GB65                  |
| BYPASS<br>UP   | GB66                  |
| EMERGENCY-STOP | GB99                  |

| Inscription | Catalog Number Suffix |
|-------------|-----------------------|
| Halt        | D0                    |
| Start       | D1                    |
| Zu          | D2                    |
| Auf         | D3                    |
| Ab          | D4                    |
| Aus         | D5                    |
| En          | D6                    |
| Betrieb     | D7                    |
| Störung     | D8                    |
| Prüfung     | D9                    |
| Aus Ein     | D10                   |
| HAND AUTO   | D11                   |
| HAND 0 AUTO | D12                   |
| Antrieb     | D13                   |
| Entsperren  | D14                   |
| Vorwärts    | D15                   |
| Rückwärts   | D16                   |
| Heben       | D17                   |
| Senken      | D18                   |
| Links       | D19                   |
| Rechts      | D20                   |
| Bremsen     | D21                   |
| Hoch        | D22                   |
| Niedrig     | D23                   |
| Schnell     | D24                   |

| Inscription             | Catalog Number Suffix |
|-------------------------|-----------------------|
| Langsam                 | D25                   |
| HAND                    | D28                   |
| AUTO                    | D29                   |
| Einrichten              | D30                   |
| Tippen                  | D31                   |
| Öffnen                  | D32                   |
| Steuerspannung          | D33                   |
| Start<br>Automatik      | D34                   |
| Lampentest              | D35                   |
| Phasenkontrolle         | D36                   |
| Alarm                   | D37                   |
| Alarm - Reset           | D38                   |
| Sammelstörung           | D39                   |
| Quittieren              | D40                   |
| Quittierung             | D41                   |
| Steuerung<br>Ein        | D42                   |
| Steuerung<br>Aus        | D43                   |
| Störung<br>quittieren   | D44                   |
| FÜHLER<br>int. ext.     | D72                   |
| HEIZUNG<br>1 2          | D73                   |
| AUS-<br>BLASEN          | D74                   |
| SOLLWERT<br>int. ext.   | D75                   |
| Not-Aus                 | D99                   |
| Not - Aus<br>quittieren | D100                  |

**Text Size: 3 mm**—Max. eight characters in first line; 10 characters in second line; eight characters in third line.



**Text Size: 5 mm**—Max. five characters per line.



**Letter Height Specifications:** ≤ five characters; letter height = 0.197 in (5 mm). > five characters; letter height = 0.118 in (3 mm).

**Text—French**

| Inscription     | Catalog Number Suffix |
|-----------------|-----------------------|
| ARRÊT           | F0                    |
| MARCHE          | F1                    |
| FERMÉ           | F2                    |
| MONTÉE          | F3                    |
| DESCENTE        | F4                    |
| ARRÊT           | F5                    |
| MARCHE          | F6                    |
| EN SERVICE      | F7                    |
| PANNE           | F8                    |
| ESSAI           | F9                    |
| ARRÊT MARCHÉ    | F10                   |
| MAN. AUTO       | F11                   |
| MAN. 0 AUTO     | F12                   |
| REARM.          | F14                   |
| AVANT           | F15                   |
| ARRIÈRE         | F16                   |
| MONTER          | F17                   |
| DESCENDRE       | F18                   |
| GAUCHE          | F19                   |
| DROITE          | F20                   |
| DEFAULT         | F67                   |
| SOUS TENSION    | F68                   |
| ARRÊT D'URGENCE | F99                   |

**Text—Swedish**

| Inscription   | Catalog Number Suffix |
|---------------|-----------------------|
| STOPP         | S0                    |
| START         | S1                    |
| STÄNG         | S2                    |
| UPP           | S3                    |
| NED           | S4                    |
| FRÅN          | S5                    |
| TILL          | S6                    |
| KÖR           | S7                    |
| FEL           | S8                    |
| PROV          | S9                    |
| FRÅN TILL     | S10                   |
| MAN. AUTO     | S11                   |
| MAN. 0 AUTO   | S12                   |
| ÅTERSTÄLLNING | S14                   |
| FRAM          | S15                   |
| BACK          | S16                   |
| ÖKA           | S17                   |
| MINSKA        | S18                   |
| VÄNSTER       | S19                   |
| HÖGER         | S20                   |
| BROMS         | S21                   |
| HÖG           | S22                   |
| LÅG           | S23                   |
| ÖPPNA         | S32                   |
| IN            | S45                   |
| UT            | S46                   |
| NÖDSTOPP      | S99                   |

**Symbols**

| Inscription | Catalog Number Suffix | Inscription | Catalog Number Suffix |
|-------------|-----------------------|-------------|-----------------------|
|             | X0                    |             | X13                   |
|             | X1                    |             | X14                   |
|             | X2                    |             | X15                   |
|             | X3                    |             | X16                   |
|             | X4                    |             | X17                   |
|             | X5                    |             | X18                   |
|             | X6                    |             | X19                   |
|             | X7                    |             | X20                   |
|             | X8                    |             | X21                   |
|             | X9                    |             | X22                   |
|             | X10                   |             | X23                   |
|             | X11                   |             | X24                   |
|             | X12                   |             | X25                   |

**Text Size: 3 mm**—Max. eight characters in first line; 10 characters in second line; eight characters in third line.



**Text Size: 5 mm**—Max. five characters per line.

















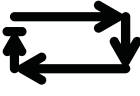
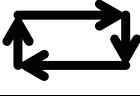







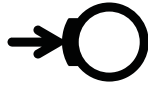

# 1.5

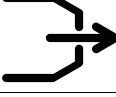





## Pushbuttons and Indicating Lights



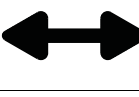









### 22.5 mm Modular Pushbuttons—M22

1

| Inscription   | Catalog Number Suffix |
|---|-----------------------|
|    | X26                   |
|    | X27                   |
|    | X28                   |
|    | X29                   |
|    | X30                   |
|    | X31                   |
|   | X32                   |
|  | X33                   |
|  | X34                   |
|  | X35                   |
|  | X36                   |
|  | X37                   |
|  | X38                   |
|  | X39                   |

| Inscription   | Catalog Number Suffix |
|---|-----------------------|
|    | X40                   |
|    | X41                   |
|    | X42                   |
|    | X43                   |
|    | X44                   |
|    | X45                   |
|  | X46                   |
|  | X47                   |
|  | X48                   |
|  | X49                   |
|  | X50                   |
| 0   | X51                   |
| 1   | X52                   |
| 2   | X53                   |

| Inscription   | Catalog Number Suffix |
|---|-----------------------|
| 3   | X54                   |
| 4   | X55                   |
| 5   | X56                   |
| 6   | X57                   |
| 7   | X58                   |
| 8   | X59                   |
| 9   | X60                   |
|  | X61                   |
|  | X62                   |
|  | X63                   |
|  | X64                   |
|  | X65                   |
|  | X66                   |
|  | X67                   |

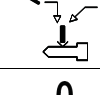
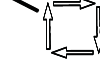
| Inscription   | Catalog Number Suffix |
|---|-----------------------|
|    | X68                   |
|    | X69                   |
|    | X70                   |
|    | X71                   |
|    | X72                   |
|    | X73                   |
|  | X74                   |
|  | X75                   |
|  | X76                   |
|  | X77                   |
|  | X78                   |
|  | X79                   |
|  | X80                   |
|  | X81                   |

Text Size: 3 mm—Max. eight characters in first line; 10 characters in second line; eight characters in third line.



Text Size: 5 mm—Max. five characters per line.



| Inscription        | Catalog Number Suffix | Inscription | Catalog Number Suffix | Inscription | Catalog Number Suffix | Inscription | Catalog Number Suffix |
|--------------------|-----------------------|-------------|-----------------------|-------------|-----------------------|-------------|-----------------------|
|                    | X82                   |             | X104                  |             | X118                  |             | X132                  |
|                    | X83                   |             | X105                  |             | X119                  |             | X133                  |
|                    | X88                   |             | X106                  |             | X120                  |             | X134                  |
|                    | X89                   |             | X107                  |             | X121                  |             | X135                  |
|                    | X90                   |             | X108                  |             | X122                  |             | X136                  |
| <b>AUTO HAND</b>   | X91                   |             | X109                  |             | X123                  |             | X137                  |
|                    | X92                   |             | X110                  |             | X124                  |             | X138                  |
|                    | X93                   |             | X111                  |             | X125                  |             | X139                  |
| <b>Auto 0 Man.</b> | X94                   |             | X112                  |             | X126                  |             | X140                  |
|                    | X95                   |             | X113                  |             | X127                  |             | X141                  |
|                    | X100                  |             | X114                  |             | X128                  |             | X142                  |
|                    | X101                  |             | X115                  |             | X129                  |             | X143                  |
|                    | X102                  |             | X116                  |             | X130                  |             | X144                  |
|                    | X103                  |             | X117                  |             | X131                  |             | X145                  |

**Text Size: 3 mm**—Max. eight characters in first line; 10 characters in second line; eight characters in third line.



**Text Size: 5 mm**—Max. five characters per line.













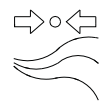



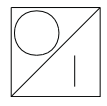
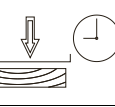

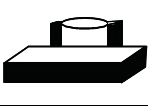
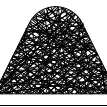
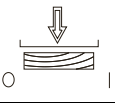

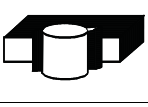
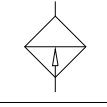

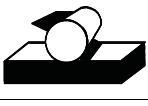
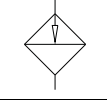
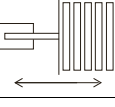

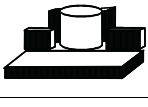
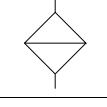
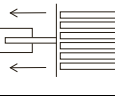

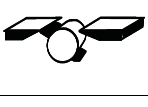
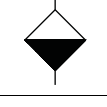
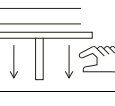

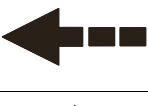
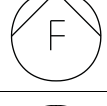
# 1.5

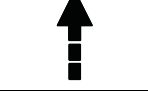
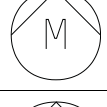
## Pushbuttons and Indicating Lights

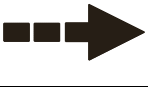
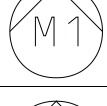
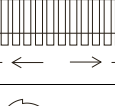
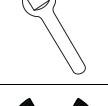
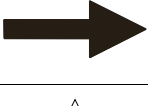
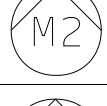
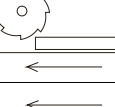
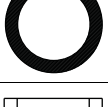
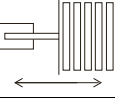
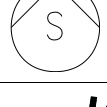
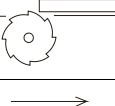
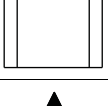
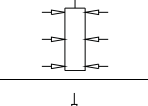
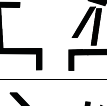
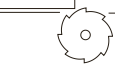
### 22.5 mm Modular Pushbuttons—M22

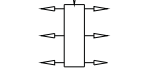
1











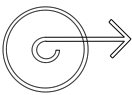



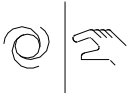

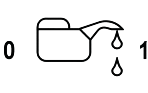
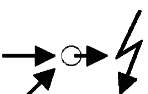



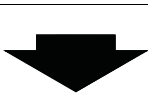

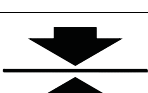

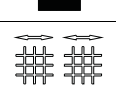
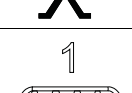







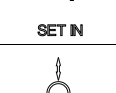





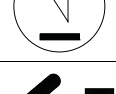
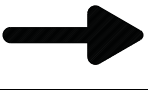

| Inscription   | Catalog Number Suffix | Inscription   | Catalog Number Suffix | Inscription   | Catalog Number Suffix | Inscription   | Catalog Number Suffix |
|---|-----------------------|---|-----------------------|---|-----------------------|---|-----------------------|
|    | X146                  |    | X160                  |    | X174                  |    | X188                  |
|    | X147                  |    | X161                  |    | X175                  |    | X189                  |
|    | X148                  |    | X162                  |    | X176                  |    | X190                  |
|    | X149                  |    | X163                  |    | X177                  |    | X191                  |
|    | X150                  |    | X164                  |    | X178                  |    | X192                  |
|    | X151                  |    | X165                  |    | X179                  |    | X193                  |
|   | X152                  |   | X166                  |   | X180                  |   | X194                  |
|  | X153                  |  | X167                  |  | X181                  |  | X195                  |
|  | X154                  |  | X168                  |  | X182                  |  | X196                  |
|  | X155                  |  | X169                  |  | X183                  |  | X197                  |
|  | X156                  |  | X170                  |  | X184                  |  | X198                  |
|  | X157                  |  | X171                  |  | X185                  |  | X199                  |
|  | X158                  |  | X172                  |  | X186                  |  | X200                  |
|  | X159                  |  | X173                  |  | X187                  |  | X201                  |

**Text Size: 3 mm**—Max. eight characters in first line; 10 characters in second line; eight characters in third line.



**Text Size: 5 mm**—Max. five characters per line.

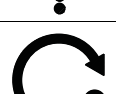

| Inscription   | Catalog Number Suffix | Inscription   | Catalog Number Suffix | Inscription   | Catalog Number Suffix | Inscription   | Catalog Number Suffix |
|---|-----------------------|---|-----------------------|---|-----------------------|---|-----------------------|
|    | X202                  |    | X216                  |    | X230                  |    | X244                  |
|    | X203                  |    | X217                  |    | X231                  |    | X245                  |
| L 1   | X204                  |    | X218                  |    | X232                  |    | X246                  |
| L 2   | X205                  |    | X219                  |    | X233                  |    | X247                  |
| L 3   | X206                  |    | X220                  |    | X234                  |    | X248                  |
| ↑ A   | X207                  |    | X221                  |    | X235                  |    | X249                  |
| ↓ A   | X208                  |   | X222                  |   | X236                  |   | X250                  |
| ↓ B   | X209                  |  | X223                  |  | X237                  |  | X251                  |
| ↑ B   | X210                  |  | X224                  |  | X238                  |  | X252                  |
| I   | X211                  |  | X225                  |  | X239                  |  | X253                  |
| II  | X212                  |  | X226                  |  | X240                  |  | X254                  |
| III   | X213                  |  | X227                  |  | X241                  |  | X255                  |
|  | X214                  |  | X228                  |  | X242                  |  | X256                  |
|  | X215                  |  | X229                  |  | X243                  |  | X257                  |
|   |                       |  |                       |  |                       |  |                       |

Text Size: 3 mm—Max. eight characters in first line; 10 characters in second line; eight characters in third line.



Text Size: 5 mm—Max. five characters per line.















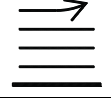

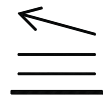

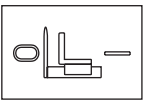





# 1.5

## Pushbuttons and Indicating Lights

### 22.5 mm Modular Pushbuttons—M22

1

| Inscription  | Catalog Number Suffix | Inscription   | Catalog Number Suffix | Inscription  | Catalog Number Suffix | Inscription  | Catalog Number Suffix |
|--|-----------------------|---|-----------------------|--|-----------------------|--|-----------------------|
|   | X258                  |  | X265                  | CHEM II  | X272                  |   | X279                  |
|   | X259                  |  | X266                  | CHEM III   | X273                  |   | X280                  |
|   | X260                  |  | X267                  |   | X274                  | OUT OF SERVICE   | X281                  |
|   | X261                  |  | X268                  |   | X275                  |   | X282                  |
|   | X262                  |  | X269                  | CONTI  | X276                  |   | X283                  |
|   | X263                  |  | X270                  | CUT  | X277                  |   | X284                  |
|  | X264                  | CHEM I  | X271                  |   | X278                  |  | X285                  |
|  |                       |   |                       |  |                       |  |                       |

Text Size: 3 mm—Max. eight characters in first line; 10 characters in second line; eight characters in third line.



Text Size: 5 mm—Max. five characters per line.



22.5 mm Compact Pushbuttons—C22



**Contents**

| <i>Description</i>                                    | <i>Page</i> |
|---|-------------|
| 22.5 mm Compact Pushbuttons—C22                       |             |
| Product Selection Guide . . . . .                     | V7-T1-139   |
| Pushbuttons—Non-Illuminated and Illuminated . . . . . | V7-T1-140   |
| Indicating Lights . . . . .                           | V7-T1-149   |
| Emergency Stops . . . . .                             | V7-T1-151   |
| Selector Switches . . . . .                           | V7-T1-154   |
| Technical Data and Specifications . . . . .           | V7-T1-159   |
| Dimensions . . . . .                                  | V7-T1-161   |

**Product Overview**

**Product Description**

Eaton’s C22 compact pushbutton line offers an industry leading array of functional, attractive, and ergonomically designed “all-in-one” illuminated and non-illuminated pushbuttons, selector switches, emergency stops and indicating lights. The complete illuminated line is only offered in LED light units to ensure high-quality brightness and up to 100,000 hours of LED illumination. C22 operators are available with either a silver or black bezel and share the exact same front of the panel look and feel as Eaton’s M22 line. The C22’s compact, “all-in-one” design with the contact block(s) and operators integral provides the user with a simple solution.

**Wide Product Breadth**

- In addition to the standard compact offering of indicating lights and pushbuttons, Eaton’s C22 offers keyed and non-keyed operators and emergency stops
- Hundreds of styles with standard laser etch markings with the ability to use custom M22 laser etched buttons in conjunction with C22 buttonless operators

**LED Indicators**

- 100,000 hours of life in high-vibration environments
- Lenses specifically designed for LED illumination

**Rugged Design**

- Pushbuttons (momentary) rated for 5 million mechanical operations and selector switches (non-keyed) rated for 1 million mechanical operations
- All components have IP65 rating, and some carry IP67 and IP69K for wash-down environment

**Standards and Certifications**

All operators are IEC/EN 60947 VDE 0660, UL Listed, and CSA Certified.

All operators carry an IP65, IP66, IP67 or IP69K rating.

All products carry ratings of NEMA 1, 3R, 4X, 12 and 13



## 1

**Features**

- Field convertible maintained pushbuttons from maintained to momentary
- Field convertible selector switches from momentary to maintained operation and vice versa
- LED offering only for all illuminated operators
- Laser engraved pushbuttons and lenses
- Heavy-duty construction with a minimum of IP65 and UL NEMA® Type 4X/13 on front of panel operators. Many operators even carry IP67 and IP69K, for the toughest applications
- Silver or black colored nylon bezels
- Notched hole mounting with anti-rotation tab and central nut mounting on each operator
- Pushbuttons (momentary) rated for 5 million mechanical operations and selector switches (non-keyed) rated for 1 million mechanical operations
- Unique compact offerings, including keyed and non-keyed operators and emergency stops

**Benefits**

- Compact, “all-in-one” operator and contact block design simplifies product selection, inventory, and installation
- Field convertibility of pushbuttons and selector switches helps distributors and customers reduce inventory and increase functionality
- LED offering only for improved brightness quality and up to 100,000 hours of operation
- Plastic construction is corrosion resistant
- Operators are designed for rugged environments, ideal for wash-down applications (reference each operator’s IP ratings for ingress protection definition)
- Anti-rotation tab saves installation time and prevents operator rotation
- High mechanical and electrical life allows for use in tough and challenging applications
- Laser inscription capabilities allow for high quality, wear-resistant markings
- By having a compact design emergency stop, the C22 design eliminates the need for self-monitoring contact blocks

**Product Selection Guide**

**Pushbuttons**



|                          |                                |                                |                                |                                |                                |                                |                                |                                |
|--------------------------|--------------------------------|--------------------------------|--------------------------------|--------------------------------|--------------------------------|--------------------------------|--------------------------------|--------------------------------|
| <b>Description</b>       | Non-illuminated, flush         |                                | Non-illuminated, extended      |                                | Illuminated, flush             |                                | Illuminated, extended          |                                |
| <b>Operator</b>          | Momentary                      | Maintained                     | Momentary                      | Maintained                     | Momentary                      | Maintained                     | Momentary                      | Maintained                     |
| <b>Product Selection</b> | <a href="#">Page V7-T1-141</a> | <a href="#">Page V7-T1-142</a> | <a href="#">Page V7-T1-143</a> | <a href="#">Page V7-T1-144</a> | <a href="#">Page V7-T1-145</a> | <a href="#">Page V7-T1-146</a> | <a href="#">Page V7-T1-147</a> | <a href="#">Page V7-T1-148</a> |

**Indicating Lights**



|                          |                                |
|--------------------------|--------------------------------|
| <b>Description</b>       | Indicating lights              |
| <b>Product Selection</b> | <a href="#">Page V7-T1-150</a> |

**Emergency Stops**



|                          |                                |                                |
|--------------------------|--------------------------------|--------------------------------|
| <b>Description</b>       | Twist release                  | Keyed-release                  |
| <b>Product Selection</b> | <a href="#">Page V7-T1-152</a> | <a href="#">Page V7-T1-152</a> |

**Selector Switches**



|                          |                                |                                |
|--------------------------|--------------------------------|--------------------------------|
| <b>Description</b>       | Non-illuminated, knob type     | Key-operated                   |
| <b>Product Selection</b> | <a href="#">Page V7-T1-155</a> | <a href="#">Page V7-T1-156</a> |



**Pushbuttons—Non-Illuminated and Illuminated****Pushbuttons—Non-Illuminated and Illuminated****Product Description**

Eaton's C22 Compact Pushbuttons are a complete line of monoblock type pushbuttons with the contact blocks, mounting adapter, and operator all-in-one. The C22 pushbuttons offer the same look and feel as their modular counterpart, the M22. They also carry many of the same rugged ratings and options, such as laser etching, field convertibility, and LED technology.

**Note:** For additional accessories, please see **Pages V7-T1-111 to V7-T1-117**, 22.5 mm Modular Pushbuttons—M22 Accessories.

**Features**

- Field convertible maintained pushbuttons from maintained to momentary
- LED offering only for improved brightness quality and up to 100,000 hours of operation
- Laser engraved pushbuttons and lenses
- Pushbuttons (momentary) rated for 5 million mechanical operations

**Contents****Description****Page**

|   |                  |
|---|------------------|
| Pushbuttons—Non-Illuminated and Illuminated |                  |
| Non-Illuminated, Flush, Momentary           | <b>V7-T1-141</b> |
| Non-Illuminated, Flush, Maintained          | <b>V7-T1-142</b> |
| Non-Illuminated, Extended, Momentary        | <b>V7-T1-143</b> |
| Non-Illuminated, Extended, Maintained       | <b>V7-T1-144</b> |
| Illuminated, Flush, Momentary               | <b>V7-T1-145</b> |
| Illuminated, Flush, Maintained              | <b>V7-T1-146</b> |
| Illuminated, Extended, Momentary            | <b>V7-T1-147</b> |
| Illuminated, Extended, Maintained           | <b>V7-T1-148</b> |
| Indicating Lights                           | <b>V7-T1-149</b> |
| Emergency Stops                             | <b>V7-T1-151</b> |
| Selector Switches                           | <b>V7-T1-154</b> |
| Technical Data and Specifications           | <b>V7-T1-159</b> |
| Dimensions                                  | <b>V7-T1-161</b> |

**Protection Type**

- IP67/IP69K
- NEMA 4X, 13

### Catalog Number Selection

Catalog Number Selection is for illustrative purposes only and not to be used to create new catalog numbers.

#### Non-Illuminated Pushbuttons

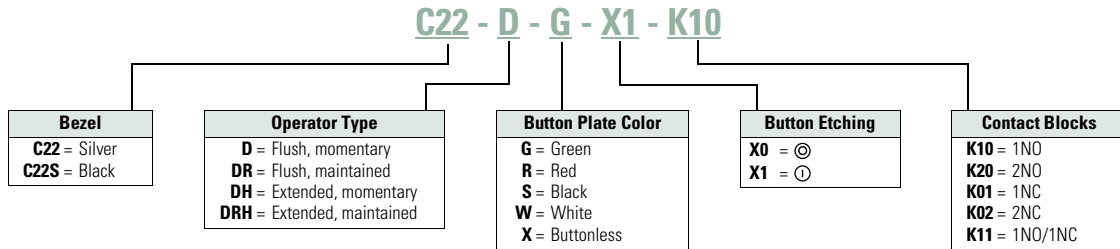

### Product Selection

#### Non-Illuminated, Flush, Momentary

##### C22(S)-D-\_\_ Non-Illuminated Pushbuttons, Flush, Momentary



| Button Color | Button Etching | Contact Block Configuration | Silver Bezel Catalog Number | Black Bezel Catalog Number |              |
|--------------|----------------|-----------------------------|-----------------------------|----------------------------|--------------|
| Green        | —              | 1NO                         | C22-D-G-K10                 | C22S-D-G-K10               |              |
|              |                | 2NO                         | C22-D-G-K20                 | C22S-D-G-K20               |              |
|              |                | 1NO/1NC                     | C22-D-G-K11                 | C22S-D-G-K11               |              |
|              | X1             | 1NO                         | C22-D-G-X1-K10              | C22S-D-G-X1-K10            |              |
|              |                | 2NO                         | C22-D-G-X1-K20              | C22S-D-G-X1-K20            |              |
|              |                | 1NO/1NC                     | C22-D-G-X1-K11              | C22S-D-G-X1-K11            |              |
| Red          | —              | 1NC                         | C22-D-R-K01                 | C22S-D-R-K01               |              |
|              |                | 2NC                         | C22-D-R-K02                 | C22S-D-R-K02               |              |
|              |                | 1NO/1NC                     | C22-D-R-K11                 | C22S-D-R-K11               |              |
|              | X0             | 1NC                         | C22-D-R-X0-K01              | C22S-D-R-X0-K01            |              |
|              |                | 2NC                         | C22-D-R-X0-K02              | C22S-D-R-X0-K02            |              |
|              |                | 1NO/1NC                     | C22-D-R-X0-K11              | C22S-D-R-X0-K11            |              |
| Black        | —              | 1NC                         | C22-D-S-K01                 | C22S-D-S-K01               |              |
|              |                | 2NC                         | C22-D-S-K02                 | C22S-D-S-K02               |              |
|              |                | 1NO/1NC                     | C22-D-S-K11                 | C22S-D-S-K11               |              |
|              | X0             | 1NC                         | C22-D-S-X0-K01              | C22S-D-S-X0-K01            |              |
|              |                | 2NC                         | C22-D-S-X0-K02              | C22S-D-S-X0-K02            |              |
|              |                | 1NO/1NC                     | C22-D-S-X0-K11              | C22S-D-S-X0-K11            |              |
| White        | —              | 1NO                         | C22-D-W-K10                 | C22S-D-W-K10               |              |
|              |                | 2NO                         | C22-D-W-K20                 | C22S-D-W-K20               |              |
|              |                | 1NO/1NC                     | C22-D-W-K11                 | C22S-D-W-K11               |              |
|              | X1             | 1NO                         | C22-D-W-X1-K10              | C22S-D-W-X1-K10            |              |
|              |                | 2NO                         | C22-D-W-X1-K20              | C22S-D-W-X1-K20            |              |
|              |                | 1NO/1NC                     | C22-D-W-X1-K11              | C22S-D-W-X1-K11            |              |
| Buttonless   | —              | 1NO                         | C22-D-X-K10                 | C22S-D-X-K10               |              |
|              |                | 2NO                         | C22-D-X-K20                 | C22S-D-X-K20               |              |
|              |                | 1NC                         | C22-D-X-K01                 | C22S-D-X-K01               |              |
|              | —              | 2NC                         | C22-D-X-K02                 | C22S-D-X-K02               |              |
|              |                | —                           | 1NO/1NC                     | C22-D-X-K11                | C22S-D-X-K11 |

# 1.6

## Pushbuttons and Indicating Lights

### 22.5 mm Compact Pushbuttons—C22

1

#### Non-Illuminated, Flush, Maintained

C22(S)-DR-



#### Non-Illuminated Pushbuttons, Flush, Maintained

| Button Color | Button Etching | Contact Block Configuration | Silver Bezel Catalog Number | Black Bezel Catalog Number |
|--------------|----------------|-----------------------------|-----------------------------|----------------------------|
| Green        | —              | 1NO                         | C22-DR-G-K10                | C22S-DR-G-K10              |
|              | —              | 2NO                         | C22-DR-G-K20                | C22S-DR-G-K20              |
|              | —              | 1NO/1NC                     | C22-DR-G-K11                | C22S-DR-G-K11              |
|              | X1             | 1NO                         | C22-DR-G-X1-K10             | C22S-DR-G-X1-K10           |
|              | X1             | 2NO                         | C22-DR-G-X1-K20             | C22S-DR-G-X1-K20           |
|              | X1             | 1NO/1NC                     | C22-DR-G-X1-K11             | C22S-DR-G-X1-K11           |
| Red          | —              | 1NC                         | C22-DR-R-K01                | C22S-DR-R-K01              |
|              | —              | 2NC                         | C22-DR-R-K02                | C22S-DR-R-K02              |
|              | —              | 1NO/1NC                     | C22-DR-R-K11                | C22S-DR-R-K11              |
|              | X0             | 1NC                         | C22-DR-R-X0-K01             | C22S-DR-R-X0-K01           |
|              | X0             | 2NC                         | C22-DR-R-X0-K02             | C22S-DR-R-X0-K02           |
|              | X0             | 1NO/1NC                     | C22-DR-R-X0-K11             | C22S-DR-R-X0-K11           |
| Black        | —              | 1NC                         | C22-DR-S-K01                | C22S-DR-S-K01              |
|              | —              | 2NC                         | C22-DR-S-K02                | C22S-DR-S-K02              |
|              | —              | 1NO/1NC                     | C22-DR-S-K11                | C22S-DR-S-K11              |
|              | X0             | 1NC                         | C22-DR-S-X0-K01             | C22S-DR-S-X0-K01           |
|              | X0             | 2NC                         | C22-DR-S-X0-K02             | C22S-DR-S-X0-K02           |
|              | X0             | 1NO/1NC                     | C22-DR-S-X0-K11             | C22S-DR-S-X0-K11           |
| White        | —              | 1NO                         | C22-DR-W-K10                | C22S-DR-W-K10              |
|              | —              | 2NO                         | C22-DR-W-K20                | C22S-DR-W-K20              |
|              | —              | 1NO/1NC                     | C22-DR-W-K11                | C22S-DR-W-K11              |
|              | X1             | 1NO                         | C22-DR-W-X1-K10             | C22S-DR-W-X1-K10           |
|              | X1             | 2NO                         | C22-DR-W-X1-K20             | C22S-DR-W-X1-K20           |
|              | X1             | 1NO/1NC                     | C22-DR-W-X1-K11             | C22S-DR-W-X1-K11           |
| Buttonless   | —              | 1NO                         | C22-DR-X-K10                | C22S-DR-X-K10              |
|              | —              | 2NO                         | C22-DR-X-K20                | C22S-DR-X-K20              |
|              | —              | 1NC                         | C22-DR-X-K01                | C22S-DR-X-K01              |
|              | —              | 2NC                         | C22-DR-X-K02                | C22S-DR-X-K02              |
|              | —              | 1NO/1NC                     | C22-DR-X-K11                | C22S-DR-X-K11              |

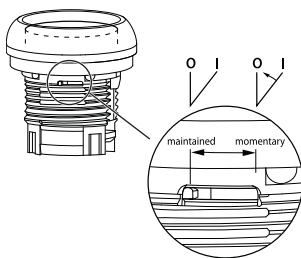

**Note:** Maintained pushbuttons can be converted in the field to momentary operation by switching the locking ring, which is accessible through the side of the operator body.

**Non-Illuminated, Extended, Momentary**

C22(S)-DH-



**Non-Illuminated Pushbuttons, Extended, Momentary**

| Button Color | Button Etching | Contact Block Configuration | Silver Bezel Catalog Number | Black Bezel Catalog Number |
|--------------|----------------|-----------------------------|-----------------------------|----------------------------|
| Green        | —              | 1NO                         | C22-DH-G-K10                | C22S-DH-G-K10              |
|              | —              | 2NO                         | C22-DH-G-K20                | C22S-DH-G-K20              |
|              | —              | 1NO/1NC                     | C22-DH-G-K11                | C22S-DH-G-K11              |
|              | X1             | 1NO                         | C22-DH-G-X1-K10             | C22S-DH-G-X1-K10           |
|              | X1             | 2NO                         | C22-DH-G-X1-K20             | C22S-DH-G-X1-K20           |
|              | X1             | 1NO/1NC                     | C22-DH-G-X1-K11             | C22S-DH-G-X1-K11           |
| Red          | —              | 1NC                         | C22-DH-R-K01                | C22S-DH-R-K01              |
|              | —              | 2NC                         | C22-DH-R-K02                | C22S-DH-R-K02              |
|              | —              | 1NO/1NC                     | C22-DH-R-K11                | C22S-DH-R-K11              |
|              | X0             | 1NC                         | C22-DH-R-X0-K01             | C22S-DH-R-X0-K01           |
|              | X0             | 2NC                         | C22-DH-R-X0-K02             | C22S-DH-R-X0-K02           |
|              | X0             | 1NO/1NC                     | C22-DH-R-X0-K11             | C22S-DH-R-X0-K11           |
| Black        | —              | 1NC                         | C22-DH-S-K01                | C22S-DH-S-K01              |
|              | —              | 2NC                         | C22-DH-S-K02                | C22S-DH-S-K02              |
|              | —              | 1NO/1NC                     | C22-DH-S-K11                | C22S-DH-S-K11              |
|              | X0             | 1NC                         | C22-DH-S-X0-K01             | C22S-DH-S-X0-K01           |
|              | X0             | 2NC                         | C22-DH-S-X0-K02             | C22S-DH-S-X0-K02           |
|              | X0             | 1NO/1NC                     | C22-DH-S-X0-K11             | C22S-DH-S-X0-K11           |
| White        | —              | 1NO                         | C22-DH-W-K10                | C22S-DH-W-K10              |
|              | —              | 2NO                         | C22-DH-W-K20                | C22S-DH-W-K20              |
|              | —              | 1NO/1NC                     | C22-DH-W-K11                | C22S-DH-W-K11              |
|              | X1             | 1NO                         | C22-DH-W-X1-K10             | C22S-DH-W-X1-K10           |
|              | X1             | 2NO                         | C22-DH-W-X1-K20             | C22S-DH-W-X1-K20           |
|              | X1             | 1NO/1NC                     | C22-DH-W-X1-K11             | C22S-DH-W-X1-K11           |

# 1.6

## Pushbuttons and Indicating Lights

### 22.5 mm Compact Pushbuttons—C22

1

#### Non-Illuminated, Extended, Maintained

C22(S)-DRH\_

#### Non-Illuminated Pushbuttons, Extended, Maintained



| Button Color | Button Etching | Contact Block Configuration | Silver Bezel Catalog Number | Black Bezel Catalog Number |
|--------------|----------------|-----------------------------|-----------------------------|----------------------------|
| Green        | —              | 1NO                         | C22-DRH-G-K10               | C22S-DRH-G-K10             |
|              | —              | 2NO                         | C22-DRH-G-K20               | C22S-DRH-G-K20             |
|              | —              | 1NO/1NC                     | C22-DRH-G-K11               | C22S-DRH-G-K11             |
|              | X1             | 1NO                         | C22-DRH-G-X1-K10            | C22S-DRH-G-X1-K10          |
|              | X1             | 2NO                         | C22-DRH-G-X1-K20            | C22S-DRH-G-X1-K20          |
|              | X1             | 1NO/1NC                     | C22-DRH-G-X1-K11            | C22S-DRH-G-X1-K11          |
| Red          | —              | 1NC                         | C22-DRH-R-K01               | C22S-DRH-R-K01             |
|              | —              | 2NC                         | C22-DRH-R-K02               | C22S-DRH-R-K02             |
|              | —              | 1NO/1NC                     | C22-DRH-R-K11               | C22S-DRH-R-K11             |
|              | X0             | 1NC                         | C22-DRH-R-X0-K01            | C22S-DRH-R-X0-K01          |
|              | X0             | 2NC                         | C22-DRH-R-X0-K02            | C22S-DRH-R-X0-K02          |
|              | X0             | 1NO/1NC                     | C22-DRH-R-X0-K11            | C22S-DRH-R-X0-K11          |
| Black        | —              | 1NC                         | C22-DRH-S-K01               | C22S-DRH-S-K01             |
|              | —              | 2NC                         | C22-DRH-S-K02               | C22S-DRH-S-K02             |
|              | —              | 1NO/1NC                     | C22-DRH-S-K11               | C22S-DRH-S-K11             |
|              | X0             | 1NC                         | C22-DRH-S-X0-K01            | C22S-DRH-S-X0-K01          |
|              | X0             | 2NC                         | C22-DRH-S-X0-K02            | C22S-DRH-S-X0-K02          |
|              | X0             | 1NO/1NC                     | C22-DRH-S-X0-K11            | C22S-DRH-S-X0-K11          |
| White        | —              | 1NO                         | C22-DRH-W-K10               | C22S-DRH-W-K10             |
|              | —              | 2NO                         | C22-DRH-W-K20               | C22S-DRH-W-K20             |
|              | —              | 1NO/1NC                     | C22-DRH-W-K11               | C22S-DRH-W-K11             |
|              | X1             | 1NO                         | C22-DRH-W-X1-K10            | C22S-DRH-W-X1-K10          |
|              | X1             | 2NO                         | C22-DRH-W-X1-K20            | C22S-DRH-W-X1-K20          |
|              | X1             | 1NO/1NC                     | C22-DRH-W-X1-K11            | C22S-DRH-W-X1-K11          |

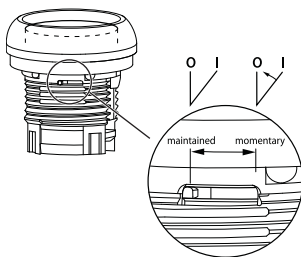

**Note:** Maintained pushbuttons can be converted in the field to momentary operation by switching the locking ring, which is accessible through the side of the operator body.

**Catalog Number Selection**

Catalog Number Selection is for illustrative purposes only and not to be used to create new catalog numbers.

**Illuminated Pushbuttons**

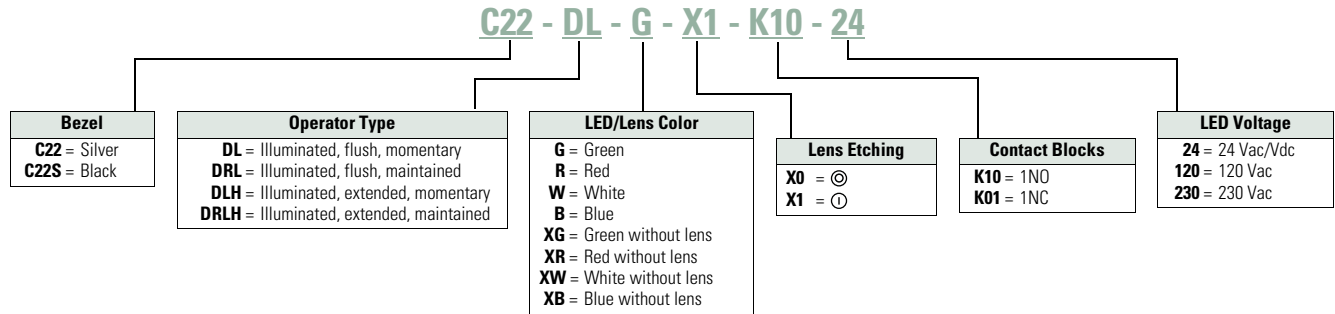

**Product Selection**

**Illuminated, Flush, Momentary**

**C22(S)-DL- Illuminated Pushbuttons, Flush, Momentary**



| LED Color | Button Color | Voltage    | Button Etching | Contact Block Configuration | Silver Bezel Catalog Number | Black Bezel Catalog Number |
|-----------|--------------|------------|----------------|-----------------------------|-----------------------------|----------------------------|
| Green     | Green        | 24 Vac/Vdc | —              | 1NO                         | C22-DL-G-K10-24             | C22S-DL-G-K10-24           |
|           |              | 120 Vac    | —              | 1NO                         | C22-DL-G-K10-120            | C22S-DL-G-K10-120          |
|           |              | 230 Vac    | —              | 1NO                         | C22-DL-G-K10-230            | C22S-DL-G-K10-230          |
|           |              | 24 Vac/Vdc | X1             | 1NO                         | C22-DL-G-X1-K10-24          | C22S-DL-G-X1-K10-24        |
|           |              | 120 Vac    | X1             | 1NO                         | C22-DL-G-X1-K10-120         | C22S-DL-G-X1-K10-120       |
|           |              | 230 Vac    | X1             | 1NO                         | C22-DL-G-X1-K10-230         | C22S-DL-G-X1-K10-230       |
|           | Buttonless   | 24 Vac/Vdc | —              | 1NO                         | C22-DL-XG-K10-24            | C22S-DL-XG-K10-24          |
|           |              | 120 Vac    | —              | 1NO                         | C22-DL-XG-K10-120           | C22S-DL-XG-K10-120         |
|           |              | 230 Vac    | —              | 1NO                         | C22-DL-XG-K10-230           | C22S-DL-XG-K10-230         |
|           |              | 24 Vac/Vdc | X0             | 1NC                         | C22-DL-R-X0-K01-24          | C22S-DL-R-K01-24           |
|           |              | 120 Vac    | —              | 1NC                         | C22-DL-R-K01-120            | C22S-DL-R-K01-120          |
|           |              | 230 Vac    | —              | 1NC                         | C22-DL-R-K01-230            | C22S-DL-R-K01-230          |
| Red       | Red          | 24 Vac/Vdc | —              | 1NO                         | C22-DL-W-K10-24             | C22S-DL-W-K10-24           |
|           |              | 120 Vac    | —              | 1NO                         | C22-DL-W-K10-120            | C22S-DL-W-K10-120          |
|           |              | 230 Vac    | —              | 1NO                         | C22-DL-W-K10-230            | C22S-DL-W-K10-230          |
|           |              | 24 Vac/Vdc | X1             | 1NO                         | C22-DL-W-X1-K10-24          | C22S-DL-W-X1-K10-24        |
|           |              | 120 Vac    | X1             | 1NO                         | C22-DL-W-X1-K10-120         | C22S-DL-W-X1-K10-120       |
|           |              | 230 Vac    | X1             | 1NO                         | C22-DL-W-X1-K10-230         | C22S-DL-W-X1-K10-230       |
|           | Buttonless   | 24 Vac/Vdc | —              | 1NC                         | C22-DL-XR-K01-24            | C22S-DL-XR-K01-24          |
|           |              | 120 Vac    | —              | 1NC                         | C22-DL-XR-K01-120           | C22S-DL-XR-K01-120         |
|           |              | 230 Vac    | —              | 1NC                         | C22-DL-XR-K01-230           | C22S-DL-XR-K01-230         |
|           |              | 24 Vac/Vdc | X0             | 1NC                         | C22-DL-R-X0-K01-24          | C22S-DL-R-X0-K01-24        |
|           |              | 120 Vac    | —              | 1NC                         | C22-DL-R-X0-K01-120         | C22S-DL-R-X0-K01-120       |
|           |              | 230 Vac    | —              | 1NC                         | C22-DL-R-X0-K01-230         | C22S-DL-R-X0-K01-230       |
| White     | White        | 24 Vac/Vdc | —              | 1NO                         | C22-DL-B-K10-24             | C22S-DL-B-K10-24           |
|           |              | 120 Vac    | —              | 1NO                         | C22-DL-B-K10-120            | C22S-DL-B-K10-120          |
|           |              | 230 Vac    | —              | 1NO                         | C22-DL-B-K10-230            | C22S-DL-B-K10-230          |
|           |              | 24 Vac/Vdc | X0             | 1NC                         | C22-DL-R-X0-K01-24          | C22S-DL-R-X0-K01-24        |
|           |              | 120 Vac    | X0             | 1NC                         | C22-DL-R-X0-K01-120         | C22S-DL-R-X0-K01-120       |
|           |              | 230 Vac    | X0             | 1NC                         | C22-DL-R-X0-K01-230         | C22S-DL-R-X0-K01-230       |
|           | Buttonless   | 24 Vac/Vdc | —              | 1NC                         | C22-DL-XB-K10-24            | C22S-DL-XB-K10-24          |
|           |              | 120 Vac    | —              | 1NC                         | C22-DL-XB-K10-120           | C22S-DL-XB-K10-120         |
|           |              | 230 Vac    | —              | 1NC                         | C22-DL-XB-K10-230           | C22S-DL-XB-K10-230         |
|           |              | 24 Vac/Vdc | X0             | 1NC                         | C22-DL-R-X0-K01-24          | C22S-DL-R-X0-K01-24        |
|           |              | 120 Vac    | —              | 1NC                         | C22-DL-R-X0-K01-120         | C22S-DL-R-X0-K01-120       |
|           |              | 230 Vac    | —              | 1NC                         | C22-DL-R-X0-K01-230         | C22S-DL-R-X0-K01-230       |
| Blue      | Blue         | 24 Vac/Vdc | —              | 1NO                         | C22-DL-B-K10-24             | C22S-DL-B-K10-24           |
|           |              | 120 Vac    | —              | 1NO                         | C22-DL-B-K10-120            | C22S-DL-B-K10-120          |
|           |              | 230 Vac    | —              | 1NO                         | C22-DL-B-K10-230            | C22S-DL-B-K10-230          |
|           |              | 24 Vac/Vdc | X0             | 1NC                         | C22-DL-R-X0-K01-24          | C22S-DL-R-X0-K01-24        |
|           |              | 120 Vac    | X0             | 1NC                         | C22-DL-R-X0-K01-120         | C22S-DL-R-X0-K01-120       |
|           |              | 230 Vac    | X0             | 1NC                         | C22-DL-R-X0-K01-230         | C22S-DL-R-X0-K01-230       |
|           | Buttonless   | 24 Vac/Vdc | —              | 1NO                         | C22-DL-XB-K10-24            | C22S-DL-XB-K10-24          |
|           |              | 120 Vac    | —              | 1NO                         | C22-DL-XB-K10-120           | C22S-DL-XB-K10-120         |
|           |              | 230 Vac    | —              | 1NO                         | C22-DL-XB-K10-230           | C22S-DL-XB-K10-230         |
|           |              | 24 Vac/Vdc | X0             | 1NC                         | C22-DL-R-X0-K01-24          | C22S-DL-R-X0-K01-24        |
|           |              | 120 Vac    | —              | 1NC                         | C22-DL-R-X0-K01-120         | C22S-DL-R-X0-K01-120       |
|           |              | 230 Vac    | —              | 1NC                         | C22-DL-R-X0-K01-230         | C22S-DL-R-X0-K01-230       |

# 1.6

## Pushbuttons and Indicating Lights

### 22.5 mm Compact Pushbuttons—C22

1

#### Illuminated, Flush, Maintained

C22(S)-DRL\_

#### Illuminated Pushbuttons, Flush, Maintained



| LED Color | Button Color | Voltage    | Contact Block Configuration | Silver Bezel Catalog Number | Black Bezel Catalog Number |
|-----------|--------------|------------|-----------------------------|-----------------------------|----------------------------|
| Green     | Green        | 24 Vac/Vdc | 1NO                         | C22-DRL-G-K10-24            | C22S-DRL-G-K10-24          |
|           |              | 120 Vac    | 1NO                         | C22-DRL-G-K10-120           | C22S-DRL-G-K10-120         |
|           |              | 230 Vac    | 1NO                         | C22-DRL-G-K10-230           | C22S-DRL-G-K10-230         |
|           | Buttonless   | 24 Vac/Vdc | 1NO                         | C22-DRL-XG-K10-24           | C22S-DRL-XG-K10-24         |
|           |              | 120 Vac    | 1NO                         | C22-DRL-XG-K10-120          | C22S-DRL-XG-K10-120        |
|           |              | 230 Vac    | 1NO                         | C22-DRL-XG-K10-230          | C22S-DRL-XG-K10-230        |
| Red       | Red          | 24 Vac/Vdc | 1NC                         | C22-DRL-R-K01-24            | C22S-DRL-R-K01-24          |
|           |              | 120 Vac    | 1NC                         | C22-DRL-R-K01-120           | C22S-DRL-R-K01-120         |
|           |              | 230 Vac    | 1NC                         | C22-DRL-R-K01-230           | C22S-DRL-R-K01-230         |
|           | Buttonless   | 24 Vac/Vdc | 1NC                         | C22-DRL-XR-K01-24           | C22S-DRL-XR-K01-24         |
|           |              | 120 Vac    | 1NC                         | C22-DRL-XR-K01-120          | C22S-DRL-XR-K01-120        |
|           |              | 230 Vac    | 1NC                         | C22-DRL-XR-K01-230          | C22S-DRL-XR-K01-230        |
| White     | White        | 24 Vac/Vdc | 1NO                         | C22-DRL-W-K10-24            | C22S-DRL-W-K10-24          |
|           |              | 120 Vac    | 1NO                         | C22-DRL-W-K10-120           | C22S-DRL-W-K10-120         |
|           |              | 230 Vac    | 1NO                         | C22-DRL-W-K10-230           | C22S-DRL-W-K10-230         |
|           | Buttonless   | 24 Vac/Vdc | 1NO                         | C22-DRL-XW-K10-24           | C22S-DRL-XW-K10-24         |
|           |              | 120 Vac    | 1NO                         | C22-DRL-XW-K10-120          | C22S-DRL-XW-K10-120        |
|           |              | 230 Vac    | 1NO                         | C22-DRL-XW-K10-230          | C22S-DRL-XW-K10-230        |
| Blue      | Blue         | 24 Vac/Vdc | 1NO                         | C22-DRL-B-K10-24            | C22S-DRL-B-K10-24          |
|           |              | 120 Vac    | 1NO                         | C22-DRL-B-K10-120           | C22S-DRL-B-K10-120         |
|           |              | 230 Vac    | 1NO                         | C22-DRL-B-K10-230           | C22S-DRL-B-K10-230         |
|           | Buttonless   | 24 Vac/Vdc | 1NO                         | C22-DRL-XB-K10-24           | C22S-DRL-XB-K10-24         |
|           |              | 120 Vac    | 1NO                         | C22-DRL-XB-K10-120          | C22S-DRL-XB-K10-120        |
|           |              | 230 Vac    | 1NO                         | C22-DRL-XB-K10-230          | C22S-DRL-XB-K10-230        |

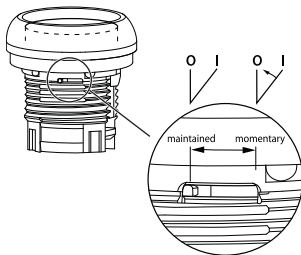

**Note:** Maintained pushbuttons can be converted in the field to momentary operation by switching the locking ring, which is accessible through the side of the operator body.

**Illuminated, Extended, Momentary**

C22(S)-DLH\_

**Illuminated Pushbuttons, Extended, Momentary**



| LED Color | Button Color | Voltage    | Button Etching | Contact Block Configuration | Silver Bezel Catalog Number | Black Bezel Catalog Number |
|-----------|--------------|------------|----------------|-----------------------------|-----------------------------|----------------------------|
| Green     | Green        | 24 Vac/Vdc | —              | 1NO                         | C22-DLH-G-K10-24            | C22S-DLH-G-K10-24          |
|           |              | 120 Vac    | —              | 1NO                         | C22-DLH-G-K10-120           | C22S-DLH-G-K10-120         |
|           |              | 230 Vac    | —              | 1NO                         | C22-DLH-G-K10-230           | C22S-DLH-G-K10-230         |
|           |              | 24 Vac/Vdc | X1             | 1NO                         | C22-DLH-G-X1-K10-24         | C22S-DLH-G-X1-K10-24       |
|           |              | 120 Vac    | X1             | 1NO                         | C22-DLH-G-X1-K10-120        | C22S-DLH-G-X1-K10-12       |
|           |              | 230 Vac    | X1             | 1NO                         | C22-DLH-G-X1-K10-230        | C22S-DLH-G-X1-K10-23       |
|           |              | 24 Vac/Vdc | —              | 1NC                         | C22-DLH-R-K01-24            | C22S-DLH-R-K01-24          |
|           |              | 120 Vac    | —              | 1NC                         | C22-DLH-R-K01-120           | C22S-DLH-R-K01-120         |
|           |              | 230 Vac    | —              | 1NC                         | C22-DLH-R-K01-230           | C22S-DLH-R-K01-230         |
| Red       | Red          | 24 Vac/Vdc | X0             | 1NC                         | C22-DLH-R-X0-K01-24         | C22S-DLH-R-X0-K01-24       |
|           |              | 120 Vac    | X0             | 1NC                         | C22-DLH-R-X0-K01-120        | C22S-DLH-R-X0-K01-12       |
|           |              | 230 Vac    | X0             | 1NC                         | C22-DLH-R-X0-K01-230        | C22S-DLH-R-X0-K01-23       |
|           |              | 24 Vac/Vdc | —              | 1NO                         | C22-DLH-W-K10-24            | C22S-DLH-W-K10-24          |
|           |              | 120 Vac    | —              | 1NO                         | C22-DLH-W-K10-120           | C22S-DLH-W-K10-120         |
|           |              | 230 Vac    | —              | 1NO                         | C22-DLH-W-K10-230           | C22S-DLH-W-K10-230         |
| White     | White        | 24 Vac/Vdc | X1             | 1NO                         | C22-DLH-W-X1-K10-24         | C22S-DLH-W-X1-K10-24       |
|           |              | 120 Vac    | X1             | 1NO                         | C22-DLH-W-X1-K10-120        | C22S-DLH-W-X1-K10-12       |
|           |              | 230 Vac    | X1             | 1NO                         | C22-DLH-W-X1-K10-230        | C22S-DLH-W-X1-K10-23       |
|           |              | 24 Vac/Vdc | —              | 1NO                         | C22-DLH-B-K10-24            | C22S-DLH-B-K10-24          |
|           |              | 120 Vac    | —              | 1NO                         | C22-DLH-B-K10-120           | C22S-DLH-B-K10-120         |
|           |              | 230 Vac    | —              | 1NO                         | C22-DLH-B-K10-230           | C22S-DLH-B-K10-230         |
| Blue      | Blue         | 24 Vac/Vdc | —              | 1NO                         | C22-DLH-B-K10-24            | C22S-DLH-B-K10-24          |
|           |              | 120 Vac    | —              | 1NO                         | C22-DLH-B-K10-120           | C22S-DLH-B-K10-120         |
|           |              | 230 Vac    | —              | 1NO                         | C22-DLH-B-K10-230           | C22S-DLH-B-K10-230         |



# 1.6

## Pushbuttons and Indicating Lights

### 22.5 mm Compact Pushbuttons—C22

1

#### Illuminated, Extended, Maintained

C22(S)-DRLH-

#### Illuminated Pushbuttons, Flush Extended, Maintained



| LED Color | Button Color | Voltage    | Button Etching | Contact Block Configuration | Silver Bezel Catalog Number | Black Bezel Catalog Number |
|-----------|--------------|------------|----------------|-----------------------------|-----------------------------|----------------------------|
| Green     | Green        | 24 Vac/Vdc | —              | 1NO                         | C22-DRLH-G-K10-24           | C22S-DRLH-G-K10-24         |
|           |              | 120 Vac    | —              | 1NO                         | C22-DRLH-G-K10-120          | C22S-DRLH-G-K10-120        |
|           |              | 230 Vac    | —              | 1NO                         | C22-DRLH-G-K10-230          | C22S-DRLH-G-K10-230        |
|           |              | 24 Vac/Vdc | X1             | 1NO                         | C22-DRLH-G-X1-K10-24        | C22S-DRLH-G-X1-K10-24      |
|           |              | 120 Vac    | X1             | 1NO                         | C22-DRLH-G-X1-K10-120       | C22S-DRLH-G-X1-K10-120     |
|           |              | 230 Vac    | X1             | 1NO                         | C22-DRLH-G-X1-K10-230       | C22S-DRLH-G-X1-K10-230     |
| Red       | Red          | 24 Vac/Vdc | —              | 1NC                         | C22-DRLH-R-K01-24           | C22S-DRLH-R-K01-24         |
|           |              | 120 Vac    | —              | 1NC                         | C22-DRLH-R-K01-120          | C22S-DRLH-R-K01-120        |
|           |              | 230 Vac    | —              | 1NC                         | C22-DRLH-R-K01-230          | C22S-DRLH-R-K01-230        |
|           |              | 24 Vac/Vdc | X0             | 1NC                         | C22-DRLH-R-X0-K01-24        | C22S-DRLH-R-X0-K01-24      |
|           |              | 120 Vac    | X0             | 1NC                         | C22-DRLH-R-X0-K01-120       | C22S-DRLH-R-X0-K01-120     |
|           |              | 230 Vac    | X0             | 1NC                         | C22-DRLH-R-X0-K01-230       | C22S-DRLH-R-X0-K01-230     |
| White     | White        | 24 Vac/Vdc | —              | 1NO                         | C22-DRLH-W-K10-24           | C22S-DRLH-W-K10-24         |
|           |              | 120 Vac    | —              | 1NO                         | C22-DRLH-W-K10-120          | C22S-DRLH-W-K10-120        |
|           |              | 230 Vac    | —              | 1NO                         | C22-DRLH-W-K10-230          | C22S-DRLH-W-K10-230        |
|           |              | 24 Vac/Vdc | X1             | 1NO                         | C22-DRLH-W-X1-K10-24        | C22S-DRLH-W-X1-K10-24      |
|           |              | 120 Vac    | X1             | 1NO                         | C22-DRLH-W-X1-K10-120       | C22S-DRLH-W-X1-K10-120     |
|           |              | 230 Vac    | X1             | 1NO                         | C22-DRLH-W-X1-K10-230       | C22S-DRLH-W-X1-K10-230     |
| Blue      | Blue         | 24 Vac/Vdc | —              | 1NO                         | C22-DRLH-B-K10-24           | C22S-DRLH-B-K10-24         |
|           |              | 120 Vac    | —              | 1NO                         | C22-DRLH-B-K10-120          | C22S-DRLH-B-K10-120        |
|           |              | 230 Vac    | —              | 1NO                         | C22-DRLH-B-K10-230          | C22S-DRLH-B-K10-230        |

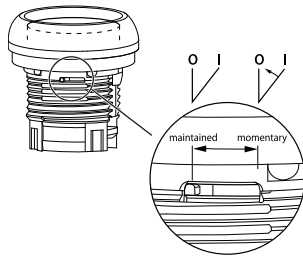

**Note:** Maintained pushbuttons can be converted in the field to momentary operation by switching the locking ring, which is accessible through the side of the operator body.

**Indicating Lights**



**Contents**

| <i><b>Description</b></i>                         | <i><b>Page</b></i> |
|---|--------------------|
| Pushbuttons—Non-Illuminated and Illuminated ..... | <b>V7-T1-140</b>   |
| Indicating Lights                                 |                    |
| Catalog Number Selection .....                    | <b>V7-T1-150</b>   |
| Product Selection .....                           | <b>V7-T1-150</b>   |
| Emergency Stops .....                             | <b>V7-T1-151</b>   |
| Selector Switches .....                           | <b>V7-T1-154</b>   |
| Technical Data and Specifications .....           | <b>V7-T1-159</b>   |
| Dimensions .....                                  | <b>V7-T1-161</b>   |

**Indicating Lights**

**Product Description**

C22 indicating lights use a combination of a durable, bright LED unit and modern lenses designed specifically for this type of LED to create a bright and visible indicating light. As with the pushbuttons, the indicating light lenses can be laser etched, simply order without lens and order M22/C22 custom etched lenses to attach.

**Note:** For additional accessories, please see **Pages V7-T1-111 to V7-T1-117**, 22.5 mm Modular Pushbuttons—M22 Accessories.

**Features**

- LED offering only for improved brightness quality and up to 100,000 hours of operation
- Lenses specifically designed for LED illumination
- Lenses capable of being laser etched for custom solutions that last

**Protection Type**

- IP67/IP69K
- NEMA 4X, 13

#### 1

### Catalog Number Selection

Catalog Number Selection is for illustrative purposes only and not to be used to create new catalog numbers.

#### Indicating Lights

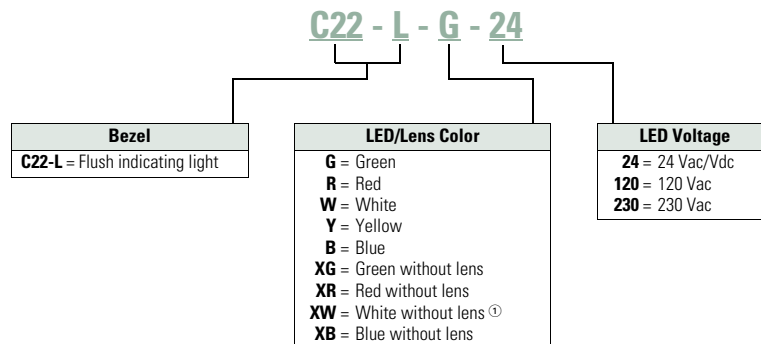

### Product Selection

#### Indicating Lights

C22-L-

#### Indicating Lights



| Lens Color   | LED Color | Voltage    | Catalog Number      |
|--------------|-----------|------------|---------------------|
| Green        | Green     | 24 Vac/Vdc | <b>C22-L-G-24</b>   |
|              |           | 120 Vac    | <b>C22-L-G-120</b>  |
|              |           | 230 Vac    | <b>C22-L-G-230</b>  |
| Red          | Red       | 24 Vac/Vdc | <b>C22-L-R-24</b>   |
|              |           | 120 Vac    | <b>C22-L-R-120</b>  |
|              |           | 230 Vac    | <b>C22-L-R-230</b>  |
| White        | White     | 24 Vac/Vdc | <b>C22-L-W-24</b>   |
|              |           | 120 Vac    | <b>C22-L-W-120</b>  |
|              |           | 230 Vac    | <b>C22-L-W-230</b>  |
| Yellow       | White     | 24 Vac/Vdc | <b>C22-L-Y-24</b>   |
|              |           | 120 Vac    | <b>C22-L-Y-120</b>  |
|              |           | 230 Vac    | <b>C22-L-Y-230</b>  |
| Blue         | Blue      | 24 Vac/Vdc | <b>C22-L-B-24</b>   |
|              |           | 120 Vac    | <b>C22-L-B-120</b>  |
|              |           | 230 Vac    | <b>C22-L-B-230</b>  |
| Without Lens | Green     | 24 Vac/Vdc | <b>C22-L-XG-24</b>  |
|              |           | 120 Vac    | <b>C22-L-XG-120</b> |
|              |           | 230 Vac    | <b>C22-L-XG-230</b> |
|              | Red       | 24 Vac/Vdc | <b>C22-L-XR-24</b>  |
|              |           | 120 Vac    | <b>C22-L-XR-120</b> |
|              |           | 230 Vac    | <b>C22-L-XR-230</b> |
|              | White     | 24 Vac/Vdc | <b>C22-L-XW-24</b>  |
|              |           | 120 Vac    | <b>C22-L-XW-120</b> |
|              |           | 230 Vac    | <b>C22-L-XW-230</b> |
|              | Blue      | 24 Vac/Vdc | <b>C22-L-XB-24</b>  |
|              |           | 120 Vac    | <b>C22-L-XB-120</b> |
|              |           | 230 Vac    | <b>C22-L-XB-230</b> |

**Note**

⊙ Use white LED for both white and yellow lenses.

### Emergency Stops



### Contents

| <i>Description</i>                                | <i>Page</i>      |
|---|------------------|
| Pushbuttons—Non-Illuminated and Illuminated ..... | <b>V7-T1-140</b> |
| Indicating Lights .....                           | <b>V7-T1-149</b> |
| Emergency Stops                                   |                  |
| Non-Illuminated, Twist-Release .....              | <b>V7-T1-152</b> |
| Non-Illuminated, Keyed-Release .....              | <b>V7-T1-152</b> |
| Selector Switches .....                           | <b>V7-T1-154</b> |
| Technical Data and Specifications .....           | <b>V7-T1-159</b> |
| Dimensions .....                                  | <b>V7-T1-161</b> |

## Emergency Stops

### Product Description

C22 emergency stops are a durable and reliable solution to a variety of e-stop applications. This compact e-stop, available as twist-to-release and keyed-release, is a simple product that eliminates the need for self-monitoring contact blocks, all while still meeting almost all of the industry safety standards.

**Note:** For additional accessories, please see **Pages V7-T1-111 to V7-T1-117**, 22.5 mm Modular Pushbuttons—M22 Accessories.

### Features

- Available in both twist-release and keyed-release with either 45 mm or 60 mm operators

### Protection Type

- Twist-Release
  - IP67/IP69K
- Keyed-Release
  - IP66
- NEMA 4X, 13

# 1.6

## Pushbuttons and Indicating Lights

### 22.5 mm Compact Pushbuttons—C22

1

#### Catalog Number Selection

Catalog Number Selection is for illustrative purposes only and not to be used to create new catalog numbers.

#### Emergency Stops

### C22 - PVS45P - MS1 - K01

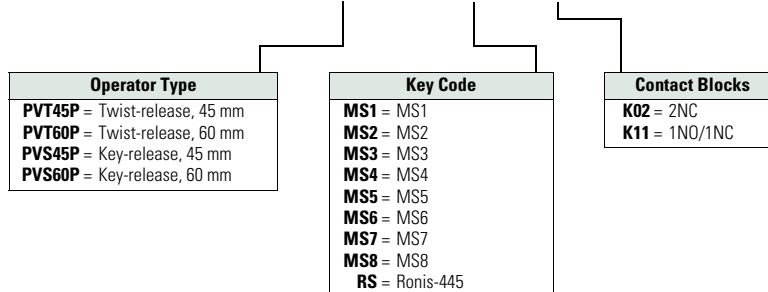

#### Product Selection

##### Non-Illuminated, Twist-Release

C22-PVT\_

##### Non-Illuminated Emergency Stops, Twist-Release



| Release Method | Operator Size | Contact Block Configuration | Catalog Number |
|----------------|---------------|-----------------------------|----------------|
| Twist-release  | 45 mm         | 2NC                         | C22-PVT45P-K02 |
|                |               | 1NO/1NC                     | C22-PVT45P-K11 |
|                | 60 mm         | 2NC                         | C22-PVT60P-K02 |
|                |               | 1NO/1NC                     | C22-PVT60P-K11 |

##### Non-Illuminated, Keyed-Release

C22-PVS\_

##### Non-Illuminated Emergency Stops, Keyed-Release



| Release Method | Operator Size | Key Code          | Contact Block Configuration | Catalog Number     |
|----------------|---------------|-------------------|-----------------------------|--------------------|
| Keyed-release  | 45 mm         | MS1               | 2NC                         | C22-PVS45P-MS1-K02 |
|                |               |                   | 1NO/1NC                     | C22-PVS45P-MS1-K11 |
|                |               | MS2               | 2NC                         | C22-PVS45P-MS2-K02 |
|                |               |                   | 1NO/1NC                     | C22-PVS45P-MS2-K11 |
|                |               | MS3               | 2NC                         | C22-PVS45P-MS3-K02 |
|                |               |                   | 1NO/1NC                     | C22-PVS45P-MS3-K11 |
|                |               | MS4               | 2NC                         | C22-PVS45P-MS4-K02 |
|                |               |                   | 1NO/1NC                     | C22-PVS45P-MS4-K11 |
|                |               | MS5               | 2NC                         | C22-PVS45P-MS5-K02 |
|                |               |                   | 1NO/1NC                     | C22-PVS45P-MS5-K11 |
|                |               | MS6               | 2NC                         | C22-PVS45P-MS6-K02 |
|                |               |                   | 1NO/1NC                     | C22-PVS45P-MS6-K11 |
|                |               | MS7               | 2NC                         | C22-PVS45P-MS7-K02 |
|                |               |                   | 1NO/1NC                     | C22-PVS45P-MS7-K11 |
|                |               | MS8               | 2NC                         | C22-PVS45P-MS8-K02 |
|                |               |                   | 1NO/1NC                     | C22-PVS45P-MS8-K11 |
| Ronis          | 2NC           | C22-PVS45P-RS-K02 |                             |                    |
|                | 1NO/1NC       | C22-PVS45P-RS-K11 |                             |                    |

C22-PVS\_

**Non-Illuminated Emergency Stops, Keyed-Release, continued**



| Release Method | Operator Size | Key Code                 | Contact Block Configuration | Catalog Number            |
|----------------|---------------|--------------------------|-----------------------------|---------------------------|
| Keyed-release  | 60 mm         | MS1                      | 2NC                         | <b>C22-PVS60P-MS1-K02</b> |
|                |               |                          | 1NO/1NC                     | <b>C22-PVS60P-MS1-K11</b> |
|                |               | MS2                      | 2NC                         | <b>C22-PVS60P-MS2-K02</b> |
|                |               |                          | 1NO/1NC                     | <b>C22-PVS60P-MS2-K11</b> |
|                |               | MS3                      | 2NC                         | <b>C22-PVS60P-MS3-K02</b> |
|                |               |                          | 1NO/1NC                     | <b>C22-PVS60P-MS3-K11</b> |
|                |               | MS4                      | 2NC                         | <b>C22-PVS60P-MS4-K02</b> |
|                |               |                          | 1NO/1NC                     | <b>C22-PVS60P-MS4-K11</b> |
|                |               | MS5                      | 2NC                         | <b>C22-PVS60P-MS5-K02</b> |
|                |               |                          | 1NO/1NC                     | <b>C22-PVS60P-MS5-K11</b> |
|                |               | MS6                      | 2NC                         | <b>C22-PVS60P-MS6-K02</b> |
|                |               |                          | 1NO/1NC                     | <b>C22-PVS60P-MS6-K11</b> |
|                |               | MS7                      | 2NC                         | <b>C22-PVS60P-MS7-K02</b> |
|                |               |                          | 1NO/1NC                     | <b>C22-PVS60P-MS7-K11</b> |
|                |               | MS8                      | 2NC                         | <b>C22-PVS60P-MS8-K02</b> |
|                |               |                          | 1NO/1NC                     | <b>C22-PVS60P-MS8-K11</b> |
| Ronis          | 2NC           | <b>C22-PVS60P-RS-K02</b> |                             |                           |
|                | 1NO/1NC       | <b>C22-PVS60P-RS-K11</b> |                             |                           |

# 1.6

## Pushbuttons and Indicating Lights

### 22.5 mm Compact Pushbuttons—C22

1

#### Selector Switches



#### Selector Switches

##### Product Description

With over 20 variations of operation and 8 varieties of key codes, the C22 line offers a very complete line of selector switches.

**Note:** For additional accessories, please see **Pages V7-T1-111 to V7-T1-117**, 22.5 mm Modular Pushbuttons—M22 Accessories.

##### Features

- Selector switch (non-keyed) rated for 1 million mechanical operations
- Momentary selector switches are field convertible from momentary to maintained

#### Contents

##### Description

|   | <i>Page</i>      |
|---|------------------|
| Pushbuttons—Non-Illuminated and Illuminated ..... | <b>V7-T1-140</b> |
| Indicating Lights .....                           | <b>V7-T1-149</b> |
| Emergency Stops .....                             | <b>V7-T1-151</b> |
| Selector Switches                                 |                  |
| Non-Illuminated, Knob Type .....                  | <b>V7-T1-155</b> |
| Non-Illuminated, Key Operated .....               | <b>V7-T1-156</b> |
| Technical Data and Specifications .....           | <b>V7-T1-159</b> |
| Dimensions .....                                  | <b>V7-T1-161</b> |

##### Protection Type

- IP65
- NEMA 4X, 13

**Catalog Number Selection**

Catalog Number Selection is for illustrative purposes only and not to be used to create new catalog numbers.

**Selector Switches—Non-Keyed**

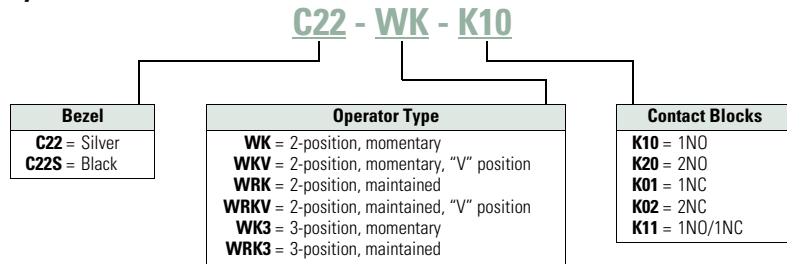

**Product Selection**

**Non-Illuminated, Knob Type**

C22(S)-WK- /  
C22(S)-WRK\_



**Non-Illuminated Selector Switches, Knob Type**

| Type              | Switching Position | Contact Block Configuration | Silver Bezel Catalog Number | Black Bezel Catalog Number |               |
|-------------------|--------------------|-----------------------------|-----------------------------|----------------------------|---------------|
| Two-position      | Momentary<br>40°   | 1NO                         | C22-WK-K10                  | C22S-WK-K10                |               |
|                   |                    | 2NO                         | C22-WK-K20                  | C22S-WK-K20                |               |
|                   |                    | 1NC                         | C22-WK-K01                  | C22S-WK-K01                |               |
|                   |                    | 2NC                         | C22-WK-K02                  | C22S-WK-K02                |               |
|                   |                    | 1NO/1NC                     | C22-WK-K11                  | C22S-WK-K11                |               |
|                   |                    | Momentary<br>60°            | 1NO                         | C22-WKV-K10                | C22S-WKV-K10  |
|                   | 2NO                |                             | C22-WKV-K20                 | C22S-WKV-K20               |               |
|                   | 1NC                |                             | C22-WKV-K01                 | C22S-WKV-K01               |               |
|                   | 2NC                |                             | C22-WKV-K02                 | C22S-WKV-K02               |               |
|                   | 1NO/1NC            |                             | C22-WKV-K11                 | C22S-WKV-K11               |               |
|                   | Maintained         |                             | 40°                         | 1NO                        | C22-WRK-K10   |
|                   |                    | 2NO                         |                             | C22-WRK-K20                | C22S-WRK-K20  |
| 1NC               |                    | C22-WRK-K01                 |                             | C22S-WRK-K01               |               |
| 2NC               |                    | C22-WRK-K02                 |                             | C22S-WRK-K02               |               |
| 1NO/1NC           |                    | C22-WRK-K11                 |                             | C22S-WRK-K11               |               |
| 60°               |                    | 1NO                         |                             | C22-WRKV-K10               | C22S-WRKV-K10 |
|                   |                    | 2NO                         | C22-WRKV-K20                | C22S-WRKV-K20              |               |
|                   |                    | 1NC                         | C22-WRKV-K01                | C22S-WRKV-K01              |               |
|                   |                    | 2NC                         | C22-WRKV-K02                | C22S-WRKV-K02              |               |
|                   |                    | 1NO/1NC                     | C22-WRKV-K11                | C22S-WRKV-K11              |               |
|                   |                    | Three-position              | Momentary<br>40°            | 2NO                        | C22-WK3-K20   |
| 2NC               |                    |                             |                             | C22-WK3-K02                | C22S-WK3-K02  |
| 1NO/1NC           | C22-WK3-K11        |                             |                             | C22S-WK3-K11               |               |
| Maintained<br>60° | 2NO                |                             | C22-WRK3-K20                | C22S-WRK3-K20              |               |
|                   | 2NC                |                             | C22-WRK3-K02                | C22S-WRK3-K02              |               |
|                   | 1NO/1NC            |                             | C22-WRK3-K11                | C22S-WRK3-K11              |               |

**Note:** Momentary selector switches can be field converted to maintained.



#### 1

### Catalog Number Selection

Catalog Number Selection is for illustrative purposes only and not to be used to create new catalog numbers.

#### Selector Switches—Keyed

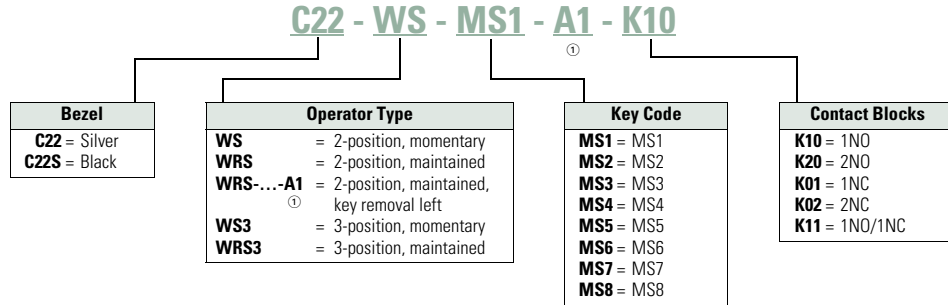

#### Non-Illuminated, Key Operated

C22(S)-WS-MS\_

#### Non-Illuminated Selector Switches, Key Operated





| Position     | Type                                     | Key Code       | Contact Block Configuration | Silver Bezel Catalog Number | Black Bezel Catalog Number |
|--------------|--|----------------|-----------------------------|-----------------------------|----------------------------|
| Two-position | Momentary<br>key removal left<br><br>40° | MS1            | 1NO                         | C22-WS-MS1-K10              | C22S-WS-MS1-K10            |
|              |  |                | 2NO                         | C22-WS-MS1-K20              | C22S-WS-MS1-K20            |
|              |  |                | 1NC                         | C22-WS-MS1-K01              | C22S-WS-MS1-K01            |
|              |  |                | 2NC                         | C22-WS-MS1-K02              | C22S-WS-MS1-K02            |
|              |  |                | 1NO/1NC                     | C22-WS-MS1-K11              | C22S-WS-MS1-K11            |
|              |  | MS2            | 1NO                         | C22-WS-MS2-K10              | C22S-WS-MS2-K10            |
|              |  |                | 2NO                         | C22-WS-MS2-K20              | C22S-WS-MS2-K20            |
|              |  |                | 1NC                         | C22-WS-MS2-K01              | C22S-WS-MS2-K01            |
|              |  |                | 2NC                         | C22-WS-MS2-K02              | C22S-WS-MS2-K02            |
|              |  |                | 1NO/1NC                     | C22-WS-MS2-K11              | C22S-WS-MS2-K11            |
|              |  | MS3            | 1NO                         | C22-WS-MS3-K10              | C22S-WS-MS3-K10            |
|              |  |                | 2NO                         | C22-WS-MS3-K20              | C22S-WS-MS3-K20            |
|              |  |                | 1NC                         | C22-WS-MS3-K01              | C22S-WS-MS3-K01            |
|              |  |                | 2NC                         | C22-WS-MS3-K02              | C22S-WS-MS3-K02            |
|              |  |                | 1NO/1NC                     | C22-WS-MS3-K11              | C22S-WS-MS3-K11            |
|              |  | MS4            | 1NO                         | C22-WS-MS4-K10              | C22S-WS-MS4-K10            |
|              |  |                | 2NO                         | C22-WS-MS4-K20              | C22S-WS-MS4-K20            |
|              |  |                | 1NC                         | C22-WS-MS4-K01              | C22S-WS-MS4-K01            |
|              |  |                | 2NC                         | C22-WS-MS4-K02              | C22S-WS-MS4-K02            |
|              |  |                | 1NO/1NC                     | C22-WS-MS4-K11              | C22S-WS-MS4-K11            |
| MS5          | 1NO                                      | C22-WS-MS5-K10 | C22S-WS-MS5-K10             |                             |                            |
|              | 2NO                                      | C22-WS-MS5-K20 | C22S-WS-MS5-K20             |                             |                            |
|              | 1NC                                      | C22-WS-MS5-K01 | C22S-WS-MS5-K01             |                             |                            |
|              | 2NC                                      | C22-WS-MS5-K02 | C22S-WS-MS5-K02             |                             |                            |
|              | 1NO/1NC                                  | C22-WS-MS5-K11 | C22S-WS-MS5-K11             |                             |                            |

**Note:** Momentary selector switches can be field converted to maintained.

C22(S)-WRS-MS\_

Non-Illuminated Selector Switches, Key Operated, continued



| Position                | Type  | Key Code | Contact Block Configuration | Silver Bezel Catalog Number | Black Bezel Catalog Number |
|-------------------------|---|----------|-----------------------------|-----------------------------|----------------------------|
| Two-position, continued | Momentary<br>key removal left<br> 40°        | MS6      | 1NO                         | C22-WS-MS6-K10              | C22S-WS-MS6-K10            |
|                         |   |          | 2NO                         | C22-WS-MS6-K20              | C22S-WS-MS6-K20            |
|                         |   |          | 1NC                         | C22-WS-MS6-K01              | C22S-WS-MS6-K01            |
|                         |   |          | 2NC                         | C22-WS-MS6-K02              | C22S-WS-MS6-K02            |
|                         |   |          | 1NO/1NC                     | C22-WS-MS6-K11              | C22S-WS-MS6-K11            |
|                         |   | MS7      | 1NO                         | C22-WS-MS7-K10              | C22S-WS-MS7-K10            |
|                         |   |          | 2NO                         | C22-WS-MS7-K20              | C22S-WS-MS7-K20            |
|                         |   |          | 1NC                         | C22-WS-MS7-K01              | C22S-WS-MS7-K01            |
|                         |   |          | 2NC                         | C22-WS-MS7-K02              | C22S-WS-MS7-K02            |
|                         |   |          | 1NO/1NC                     | C22-WS-MS7-K11              | C22S-WS-MS7-K11            |
|                         |   | MS8      | 1NO                         | C22-WS-MS8-K10              | C22S-WS-MS8-K10            |
|                         |   |          | 2NO                         | C22-WS-MS8-K20              | C22S-WS-MS8-K20            |
|                         |   |          | 1NC                         | C22-WS-MS8-K01              | C22S-WS-MS8-K01            |
|                         |   |          | 2NC                         | C22-WS-MS8-K02              | C22S-WS-MS8-K02            |
|                         |   |          | 1NO/1NC                     | C22-WS-MS8-K11              | C22S-WS-MS8-K11            |
| Two-position            | Maintained<br>key removal left/right<br> 40° | MS1      | 1NO                         | C22-WRS-MS1-K10             | C22S-WRS-MS1-K10           |
|                         |   |          | 2NO                         | C22-WRS-MS1-K20             | C22S-WRS-MS1-K20           |
|                         |   |          | 1NC                         | C22-WRS-MS1-K01             | C22S-WRS-MS1-K01           |
|                         |   |          | 2NC                         | C22-WRS-MS1-K02             | C22S-WRS-MS1-K02           |
|                         |   |          | 1NO/1NC                     | C22-WRS-MS1-K11             | C22S-WRS-MS1-K11           |
|                         |   | MS2      | 1NO                         | C22-WRS-MS2-K10             | C22S-WRS-MS2-K10           |
|                         |   |          | 2NO                         | C22-WRS-MS2-K20             | C22S-WRS-MS2-K20           |
|                         |   |          | 1NC                         | C22-WRS-MS2-K01             | C22S-WRS-MS2-K01           |
|                         |   |          | 2NC                         | C22-WRS-MS2-K02             | C22S-WRS-MS2-K02           |
|                         |   |          | 1NO/1NC                     | C22-WRS-MS2-K11             | C22S-WRS-MS2-K11           |
|                         |   | MS3      | 1NO                         | C22-WRS-MS3-K10             | C22S-WRS-MS3-K10           |
|                         |   |          | 2NO                         | C22-WRS-MS3-K20             | C22S-WRS-MS3-K20           |
|                         |   |          | 1NC                         | C22-WRS-MS3-K01             | C22S-WRS-MS3-K01           |
|                         |   |          | 2NC                         | C22-WRS-MS3-K02             | C22S-WRS-MS3-K02           |
|                         |   |          | 1NO/1NC                     | C22-WRS-MS3-K11             | C22S-WRS-MS3-K11           |

**Note:** Momentary selector switches can be field converted to maintained.

1

C22(S)-WRS...-MS1\_

#### Non-Illuminated Selector Switches, Key Operated, continued



| Position                | Type  | Key Code        | Contact Block Configuration | Silver Bezel Catalog Number | Black Bezel Catalog Number |
|-------------------------|---|-----------------|-----------------------------|-----------------------------|----------------------------|
| Two-position, continued | Maintained<br>key removal left/right<br><br>40°<br> | MS4             | 1NO                         | C22-WRS-MS4-K10             | C22S-WRS-MS4-K10           |
|                         |   |                 | 2NO                         | C22-WRS-MS4-K20             | C22S-WRS-MS4-K20           |
|                         |   |                 | 1NC                         | C22-WRS-MS4-K01             | C22S-WRS-MS4-K01           |
|                         |   |                 | 2NC                         | C22-WRS-MS4-K02             | C22S-WRS-MS4-K02           |
|                         |   |                 | 1NO/1NC                     | C22-WRS-MS4-K11             | C22S-WRS-MS4-K11           |
|                         |   | MS5             | 1NO                         | C22-WRS-MS5-K10             | C22S-WRS-MS5-K10           |
|                         |   |                 | 2NO                         | C22-WRS-MS5-K20             | C22S-WRS-MS5-K20           |
|                         |   |                 | 1NC                         | C22-WRS-MS5-K01             | C22S-WRS-MS5-K01           |
|                         |   |                 | 2NC                         | C22-WRS-MS5-K02             | C22S-WRS-MS5-K02           |
|                         |   |                 | 1NO/1NC                     | C22-WRS-MS5-K11             | C22S-WRS-MS5-K11           |
|                         | MS6   | 1NO             | C22-WRS-MS6-K10             | C22S-WRS-MS6-K10            |                            |
|                         |   | 2NO             | C22-WRS-MS6-K20             | C22S-WRS-MS6-K20            |                            |
|                         |   | 1NC             | C22-WRS-MS6-K01             | C22S-WRS-MS6-K01            |                            |
|                         |   | 2NC             | C22-WRS-MS6-K02             | C22S-WRS-MS6-K02            |                            |
|                         |   | 1NO/1NC         | C22-WRS-MS6-K11             | C22S-WRS-MS6-K11            |                            |
|                         | MS7   | 1NO             | C22-WRS-MS7-K10             | C22S-WRS-MS7-K10            |                            |
|                         |   | 2NO             | C22-WRS-MS7-K20             | C22S-WRS-MS7-K20            |                            |
|                         |   | 1NC             | C22-WRS-MS7-K01             | C22S-WRS-MS7-K01            |                            |
|                         |   | 2NC             | C22-WRS-MS7-K02             | C22S-WRS-MS7-K02            |                            |
|                         |   | 1NO/1NC         | C22-WRS-MS7-K11             | C22S-WRS-MS7-K11            |                            |
| MS8                     | 1NO   | C22-WRS-MS7-K10 | C22S-WRS-MS7-K10            |                             |                            |
|                         | 2NO   | C22-WRS-MS7-K20 | C22S-WRS-MS7-K20            |                             |                            |
|                         | 1NC   | C22-WRS-MS7-K01 | C22S-WRS-MS7-K01            |                             |                            |
|                         | 2NC   | C22-WRS-MS7-K02 | C22S-WRS-MS7-K02            |                             |                            |
|                         | 1NO/1NC   | C22-WRS-MS7-K11 | C22S-WRS-MS7-K11            |                             |                            |
| Two-position            | Maintained<br>key removal left<br><br>40°<br>       | MS1             | 1NO                         | C22-WRS-MS1-A1-K10          | C22S-WRS-MS1-A1-K10        |
|                         |   |                 | 2NO                         | C22-WRS-MS1-A1-K20          | C22S-WRS-MS1-A1-K20        |
|                         |   |                 | 1NC                         | C22-WRS-MS1-A1-K01          | C22S-WRS-MS1-A1-K01        |
|                         |   |                 | 2NC                         | C22-WRS-MS1-A1-K02          | C22S-WRS-MS1-A1-K02        |
|                         |   |                 | 1NO/1NC                     | C22-WRS-MS1-A1-K11          | C22S-WRS-MS1-A1-K11        |
| Three Position          | Momentary<br>Key Removal Center<br><br>40°<br>      | MS1             | 2NO                         | C22-WRS3-MS1-K20            | C22S-WRS3-MS1-K20          |
|                         |   |                 | 2NC                         | C22-WRS3-MS1-K02            | C22S-WRS3-MS1-K02          |
|                         |   |                 | 1NO/1NC                     | C22-WRS3-MS1-K11            | C22S-WRS3-MS1-K11          |
|                         | Maintained<br>Key Removal Left/Right<br><br>60°<br> | MS1             | 2NO                         | C22-WRS3-MS1-K20            | C22S-WRS3-MS1-K20          |
|                         |   |                 | 2NC                         | C22-WRS3-MS1-K02            | C22S-WRS3-MS1-K02          |
|                         |   |                 | 1NO/1NC                     | C22-WRS3-MS1-K11            | C22S-WRS3-MS1-K11          |

**Note:** Momentary selector switches can be field converted to maintained.

**Technical Data and Specifications**

**22.5 mm Compact Pushbuttons—C22**

| Description   | Unit                         | Pushbutton Actuators<br>Illuminated Pushbuttons C22                            |   | Indicator<br>Lights C22 | Selector Switch<br>Actuators C22 | Key-Operated<br>Buttons C22   | Emergency Stop/<br>Emergency Switching<br>OFF Pushbuttons C22 |
|---|------------------------------|--|---|-------------------------|----------------------------------|---|---|
|   |                              | Momentary  | Maintained  |                         |                                  |   |   |
| <b>General</b>  |                              |  |   |                         |                                  |   |   |
| Standards   |                              | IEC/EN 60947 VDE 0660  |   |                         |                                  |   |   |
| Lifespan, mechanical  | Operations x 10 <sup>6</sup> | 5  | 1   | —                       | 1                                | 0.1   | 0.05  |
| Operating frequency   | Operations/h                 | ≥3600  | ≥3600   | —                       | ≥2000                            | ≥100  | ≥300  |
| Actuating force   | N                            | ≥5   | ≥5  | —                       | —                                | —   | ≥50   |
| Operating torque  | Nm                           | —  | —   | —                       | ≥0.3                             | ≥0.5  | —   |
| Terminal screw tightening torque  | Nm                           | 0.8  | 0.8   | 0.8                     | 0.8                              | 0.8   | 0.8   |
| Threaded ring tightening torque   | Nm                           | 2  | 2   | 2                       | 2                                | 2   | 2   |
| Protection type   |                              | IP67, IP69K  | IP67, IP69K   | IP67, IP69K             | IP65                             | IP66  | IP67, IP69K   |
| Climatic proofing   |                              | Damp heat, constant, to IEC 60068-2-78<br>Damp heat, cyclic, to IEC 60068-2-30 |   |                         |                                  |   |   |
| Ambient temperature   |                              |  |   |                         |                                  |   |   |
| Open  | °C                           | –25° to 70°  | –25° to 70°   | –25° to 70°             | –25° to 70°                      | –25° to 70°   | –25° to 70°   |
| Storage   | °C                           | –30° to 80°  | –30° to 80°   | –30° to 80°             | –30° to 80°                      | –30° to 80°   | –30° to 80°   |
| Mounting position   |                              | As required  | As required   | As required             | As required                      | As required   | As required   |
| Mechanical shock resistance to IEC 60068-2-27 Shock duration 11 ms, half-sinusoidal | g                            | 30   | 30  | 30                      | 30                               | 30  | 30  |
| Terminal capacities   |                              |  |   |                         |                                  |   |   |
| Solid   | mm <sup>2</sup>              | 2 x 0.5–1.5  | 2 x 0.5–1.5   | 2 x 0.5–1.5             | 2 x 0.5–1.5                      | 2 x 0.5–1.5   | 2 x 0.5–1.5   |
| Flexible with ferrule   | mm <sup>2</sup>              | 2 x 0.5–1.5  | 2 x 0.5–1.5   | 2 x 0.5–1.5             | 2 x 0.5–1.5                      | 2 x 0.5–1.5   | 2 x 0.5–1.5   |
| <b>Contacts</b>   |                              |  |   |                         |                                  |   |   |
| Rated impulse withstand voltage   | U <sub>imp</sub>             | Vac  | 4000  | 4000                    | 4000                             | 4000  | 4000  |
| Rated insulation voltage  | U <sub>i</sub>               | V  | 250   | 250                     | 250                              | 250   | 250   |
| Overvoltage category/pollution degree   |                              |  | III/3   | III/3                   | III/3                            | III/3   | III/3   |
| Control circuit reliability   |                              |  |   |                         |                                  |   |   |
| at 5 Vdc/1 mA   | H <sub>F</sub>               | Fault probability  | Values follow   | Values follow           | —                                | Values follow   | Values follow   |
| at 17 Vdc/7 mA  | H <sub>F</sub>               | Fault probability  | N/O contact: statistically determined 1 failure per 17 x 10 <sup>6</sup> operations<br>N/C contact: statistically determined 1 failure per 0.9 x 10 <sup>6</sup> operations |                         | —                                | N/O contact: statistically determined 1 failure per 17 x 10 <sup>6</sup> operations<br>N/C contact: statistically determined 1 failure per 0.9 x 10 <sup>6</sup> operations |   |
| at 24 Vdc/5 mA  | H <sub>F</sub>               | Fault probability  | Values follow   | Values follow           | —                                | Values follow   | Values follow   |
| Max. short-circuit protective device  |                              |  |   |                         |                                  |   |   |
| Fuse  | gG/gL                        | A  | 10  | 10                      | —                                | 10  | 10  |

# 1.6

## Pushbuttons and Indicating Lights

### 22.5 mm Compact Pushbuttons—C22

1

#### 22.5 mm Compact Pushbuttons—C22, continued

| Description               | Unit       | Push-button Actuators |                        | Indicator Lights C22 | Selector Switch Actuators C22 | Key-Operated Buttons C22 | Emergency Stop/ Emergency Switching OFF Pushbuttons C22 |
|---------------------------|------------|-----------------------|------------------------|----------------------|-------------------------------|--------------------------|---|
|                           |            | Illuminated Momentary | Illuminated Maintained |                      |                               |                          |   |
| <b>Switching Capacity</b> |            |                       |                        |                      |                               |                          |   |
| Rated operational current |            |                       |                        |                      |                               |                          |   |
| AC-15                     |            |                       |                        |                      |                               |                          |   |
| 24V                       | $I_e$      | A                     | 4                      | 4                    | —                             | 4                        | 4   |
| 110V                      | $I_e$      | A                     | 2                      | 2                    | —                             | 2                        | 2   |
| 230V                      | $I_e$      | A                     | 1.5                    | 1.5                  | —                             | 1.5                      | 1.5   |
| DC-13                     |            |                       |                        |                      |                               |                          |   |
| 24V                       | $I_e$      | A                     | 3                      | 3                    | —                             | 3                        | 3   |
| 60V                       | $I_e$      | A                     | 1                      | 1                    | —                             | 1                        | 1   |
| 110V                      | $I_e$      | A                     | 0.6                    | 0.6                  | —                             | 0.6                      | 0.6   |
| 220V                      | $I_e$      | A                     | 0.3                    | 0.3                  | —                             | 0.3                      | 0.3   |
| Lifespan, electrical      |            |                       |                        |                      |                               |                          |   |
| AC-15                     |            |                       |                        |                      |                               |                          |   |
| 230V/0.5A                 | Operations | $\times 10^6$         | 0.4                    | 0.4                  | —                             | 0.4                      | 0.4   |
| 230V/1.0A                 |            | $\times 10^6$         | 0.6                    | 0.6                  | —                             | 0.6                      | 0.6   |

#### Contact Travel

##### Contact Travel Diagram

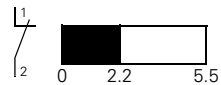
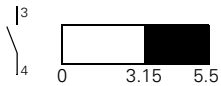

■ Contact closed

□ Contact open

**Dimensions**

Approximate Dimensions in mm [in]

**Illuminated Pushbuttons**

*Flat*

**C22(S)-DRL\_/C22(S)-DL\_**

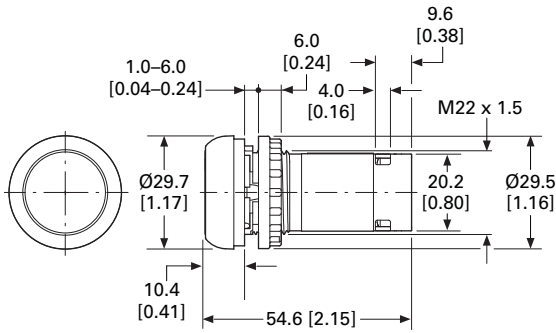

*Extended*

**C22(S)-DRLH\_/C22(S)-DLH\_**

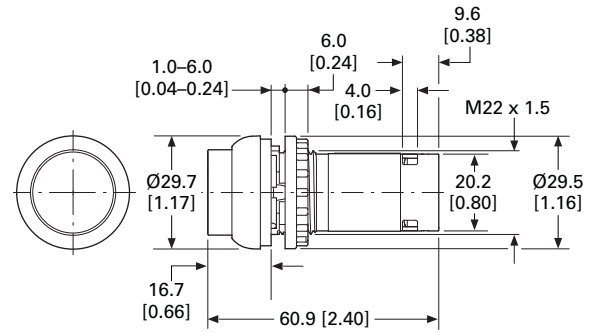

**Pushbutton Actuators**

*Flat*

**C22(S)-DR\_/C22(S)-D\_**

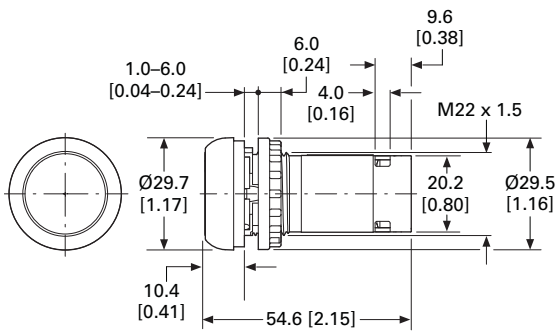

*Extended*

**C22(S)-DRH\_/C22(S)-DH\_**

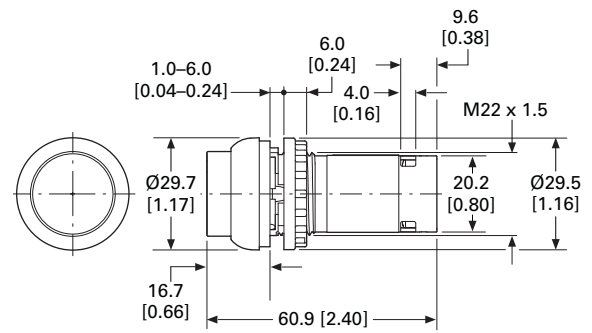

**Indicating Lights**

*Flat*

**C22-L\_**

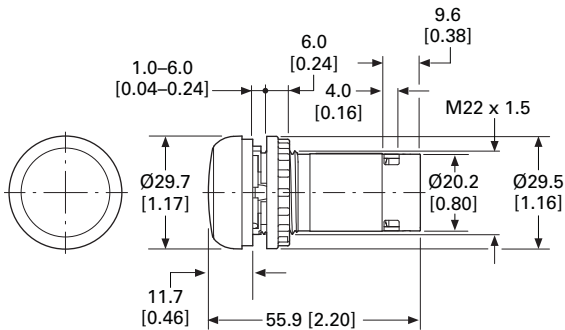

# 1.6

## Pushbuttons and Indicating Lights

### 22.5 mm Compact Pushbuttons—C22

#### 1 Approximate Dimensions in mm [in] Emergency Stop/Emergency Switching OFF Pushbuttons

C22-PVT45P\_

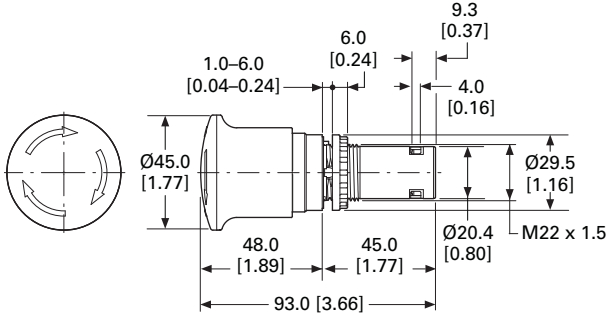

C22-PVT60P\_

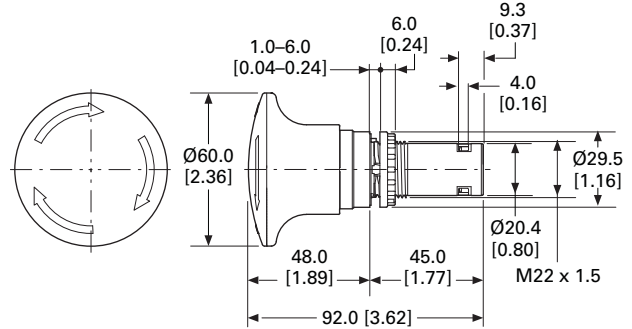

C22-PVT45P-MS\_

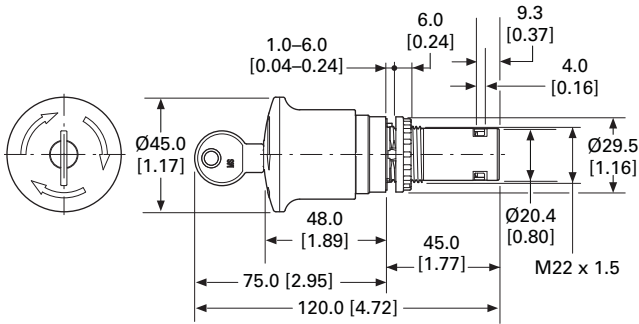

C22-PVT45P-RS\_

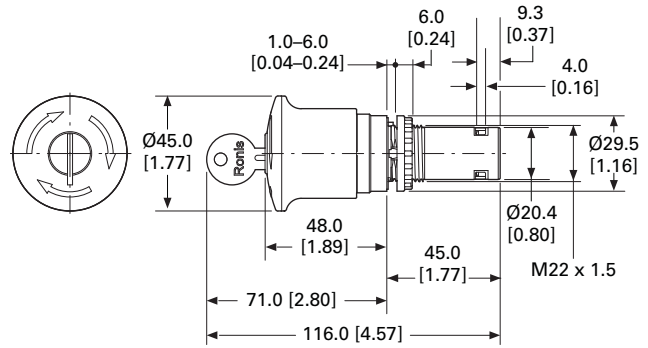

C22-PVT60P-MS\_

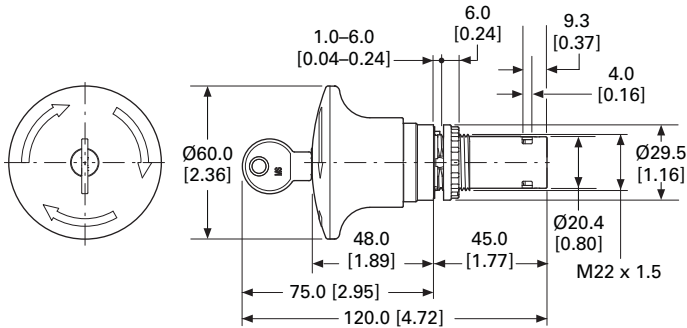

C22-PVT60P-RS\_

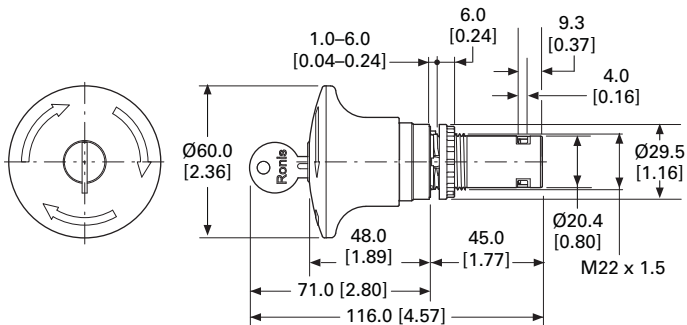

Approximate Dimensions in mm [in]

**Selector Switch Actuators**

**C22(S)-W(R)K\_**

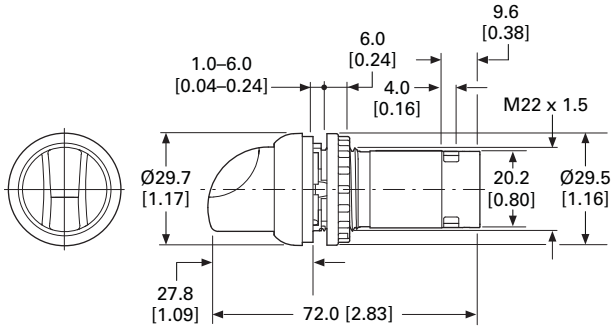

**Selector Switch Actuators/V Position**

**C22(S)-W(R)KV\_**

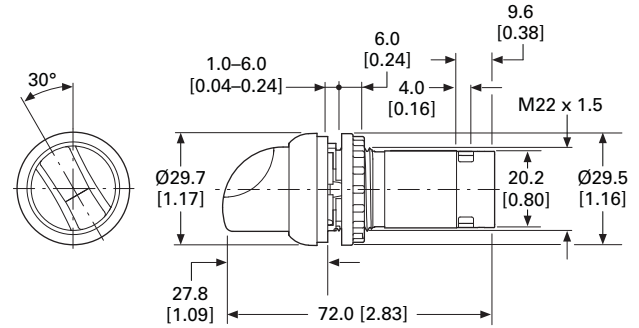

**Key Operated Actuators**

**C22(S)-WS(3)-MS\_/C22(S)-WRS(3)-MS\_**

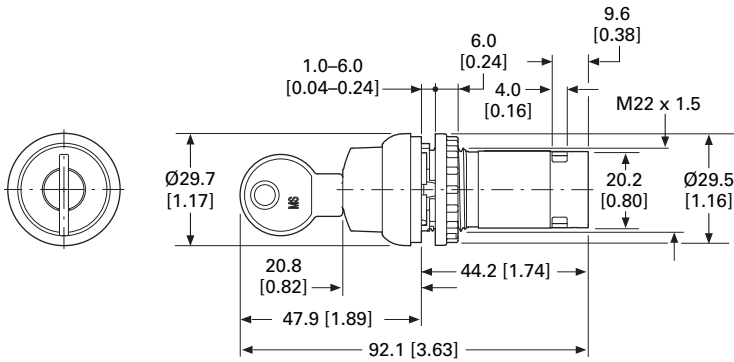

**C22(S)-WS(3)-RS\_/C22(S)-WRS(3)-RS\_**

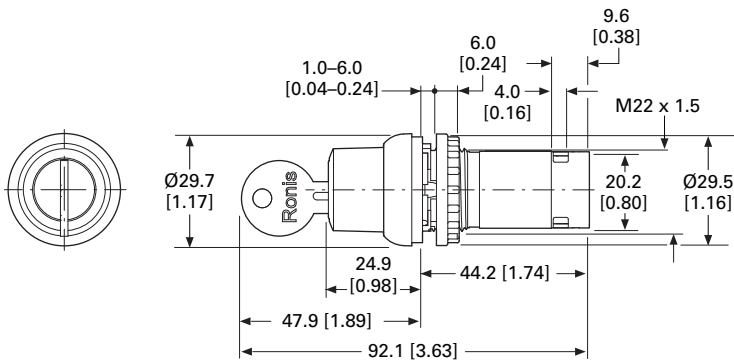



## 30.5 mm Square Multifunction Watertight/Oiltight—E30



### Product Description

The E30 industrial pushbutton and indicating light line from Eaton's Electrical Sector features a wide selection of square, multifunction operators which conveniently mount in a standard 30.5 mm (1-13/64 in) diameter panel hole. Up to six input and indicating functions can be grouped into a single operating head, saving valuable panel space. Attractive square operator styling, coupled with custom legending of colored buttons and lenses and many special function accessories, makes E30 components ideally suited for use on control consoles and for a variety of industrial OEM applications.

### Features

Type E30 control units consist of a basic operator with one or more buttons and lenses and contact block selection dependent on the specific operator configuration.

- **Pushbutton operators** will accommodate up to four single depth stackable contact blocks behind each operating button, up to eight circuits maximum.
- **Indicating lights** are supplied complete with either a transformer light unit up to 600 Vac supply line voltage or full voltage light unit up to 120 Vac/Vdc supply line voltage.
- **Combination pushbutton with indicating light** operators are supplied complete with a transformer or full voltage unit. Contact blocks must be ordered separately, up to four circuits maximum.

### Contents

| <i>Description</i>                                   | <i>Page</i>      |
|--|------------------|
| 30.5 mm Square Multifunction Watertight/Oiltight—E30 |                  |
| Product Identification . . . . .                     | <b>V7-T1-165</b> |
| Product Selection                                    |                  |
| Operators . . . . .                                  | <b>V7-T1-166</b> |
| Operator Components . . . . .                        | <b>V7-T1-169</b> |
| Accessories . . . . .                                | <b>V7-T1-175</b> |
| Options . . . . .                                    | <b>V7-T1-176</b> |
| Replacement Parts . . . . .                          | <b>V7-T1-179</b> |
| Technical Data and Specifications . . . . .          | <b>V7-T1-180</b> |
| Dimensions . . . . .                                 | <b>V7-T1-181</b> |

### Standards and Certifications

- UL Listed—File No. E131568
- CSA Certified—File No. LR68551



### Ingress Protection

- Single and dual indicating lights
  - UL (NEMA) Type 1, 2, 3, 3R, 3S, 4, 4X, 12, 13
- All other operators
  - UL (NEMA) Type 3, 3R, 4, 4X, 12, 13

### Product Identification

#### 30.5 mm Square Multifunction Watertight/Oiltight

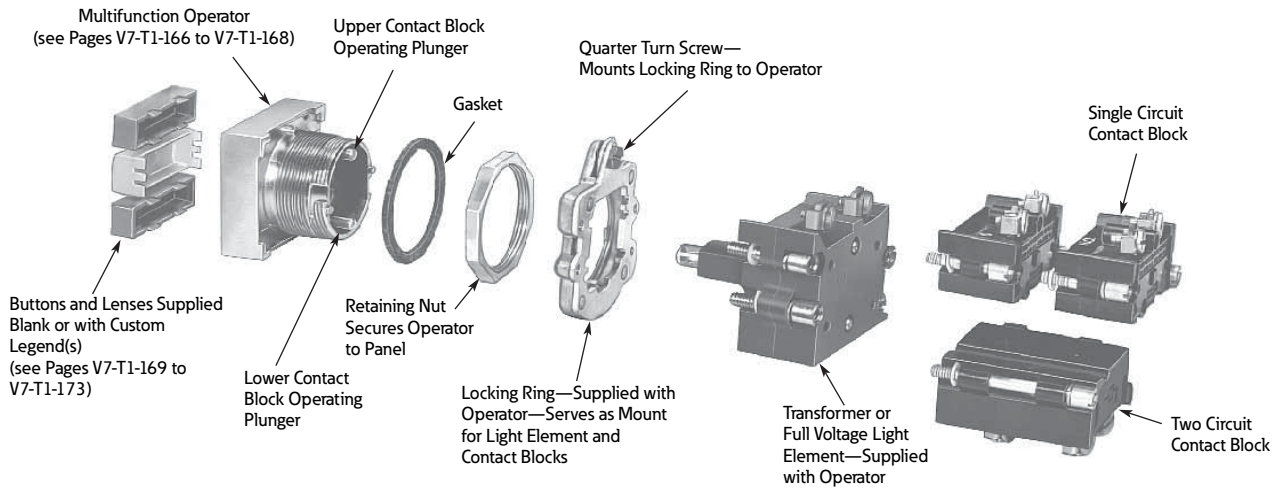

## Product Selection

### Operators

#### When Ordering a Complete E30 Control Unit Specify

| Catalog Number of ...     | Ordering Example (E30AB) |         |
|---------------------------|--------------------------|---------|
| Operator                  | E30KB130                 | “START” |
| Button(s)                 | E30KB231                 | “STOP”  |
| Contact block(s)          | E30KLA1                  | 1NO     |
| Accessories (if required) | E30KLA2                  | 1NC     |

#### Square Multifunction Operators

UL (NEMA) Type 3, 3R, 4, 4X, 12, 13

#### Single Button Operator



Shown with Extended Button

#### Single Button Operator/without Button (Order Button Separately)

| Button Type Required <sup>①</sup>   | Operation | Special Features | Catalog Number |
|---|-----------|------------------|----------------|
|  | Momentary | —                | <b>E30AA</b>   |

#### Two Button Operator



Shown with Extended Buttons

#### Two Button Operator/without Buttons (Order Buttons Separately)

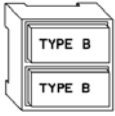
| Button Types Required <sup>①</sup>  | Operation                 |                        | Special Features          | Catalog Number             |
|---|---------------------------|------------------------|---------------------------|----------------------------|
|   | Top Button                | Bottom Button          |                           |                            |
|  | Momentary                 | Momentary              | —                         | <b>E30AB</b>               |
|   | Momentary                 | Momentary              | With mechanical interlock | <b>E30AC</b>               |
|   | Maintained (all contacts) | Release (all contacts) | —                         | <b>E30AD</b> <sup>②</sup>  |
|   | Maintained (all contacts) | Release (all contacts) | With mechanical interlock | <b>E30AP</b> <sup>②③</sup> |

#### Two Button Operator



Shown with Long Release Bar

#### Two Button Operator with Long (OFF) Release Bar—Includes OFF Bar/Button (Order Other Buttons Separately)

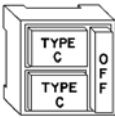
| Button Types Required <sup>④⑤</sup>   | Operation                 |                                   | Special Features                                 | Catalog Number            |
|---|---------------------------|-----------------------------------|--|---------------------------|
|   | Top Button                | Bottom Button                     |  |                           |
|  | Maintained                | Maintained                        | —  | <b>E30AF</b>              |
|   | Maintained                | Maintained                        | With mechanical interlock                        | <b>E30AG</b>              |
|   | Maintained                | Momentary                         | With mechanical interlock                        | <b>E30AH</b>              |
|   | Maintained (all contacts) | Maintained (bottom contacts only) | Top button operates both top and bottom contacts | <b>E30AK</b> <sup>⑥</sup> |



#### Notes

- ① Order from table on **Page V7-T1-169**.
- ② Limited to two single circuit, one double circuit 600V or two 120V (E30KLA9) contact blocks behind each button.
- ③ Buttons are interlocked so that one of the two is maintained at all times. Depressing the other button releases the maintained button and maintains the depressed button.
- ④ Operators are supplied as standard with red extended bar(s) marked “OFF” as shown in sketch. For other colors or markings, contact your nearest Eaton Distributor or call our Customer Service Center 1-800-356-1243. For replacement of standard red release bar, order **E30KR100**.
- ⑤ Order from table on **Page V7-T1-170**.
- ⑥ Limited to two single circuit, one double circuit 600V or two 120V (E30KLA9) contact blocks behind each button.

### Square Multifunction Operators and Indicating Lights

UL (NEMA) Type 3, 3R, 4, 4X, 12, 13

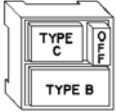
#### Two Button Operator with (OFF) Release—Includes OFF Bar/Button(s) (Order Other Buttons Separately)

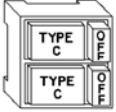
| Two Button Operator   | Button Types Required <sup>①②</sup>   | Operation                 |                           | Special Features                        | Catalog Number |
|---|---|---------------------------|---------------------------|---|----------------|
|   |   | Top Button                | Bottom Button             |   |                |
|  <p><i>Shown with Release Bar for Top Button</i></p>   |  | Maintained                | Momentary                 | Release bar for top button              | <b>E30AL</b>   |
|  <p><i>Shown with Release Bars for Each Button</i></p> |  | Maintained                | Maintained                | Individual release bars for each button | <b>E30AN</b>   |
|   |   | Maintained with interlock | Maintained with interlock | Individual release bars for each button | <b>E30AM</b>   |

#### Single Indicating Light Unit/without Lens (Order Lens Separately)

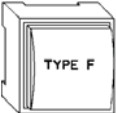
| Single Indicating Light Unit   | Lens Type Required <sup>③</sup>   | Type of Light Element Transformer (60/50 Hertz AC) |                          |                | Full Voltage (60/50 Hertz AC or DC) |                          |                |              |
|--|---|--|--------------------------|----------------|-------------------------------------|--------------------------|----------------|--------------|
|  |   | Voltage  | Lamp Number <sup>④</sup> | Catalog Number | Voltage                             | Lamp Number <sup>④</sup> | Catalog Number |              |
|  |   |  |                          |                |                                     |                          |                |              |
|  <p><i>Shown with Lens</i></p> |  | 120  | #259                     | <b>E30BA</b>   | 24                                  | 24PSB                    | <b>E30BJ</b>   |              |
|  |   |  |                          |                |                                     | 120                      | 120PSB         | <b>E30BM</b> |

#### Dual Indicating Light Unit/without Lenses (Order Lenses Separately)

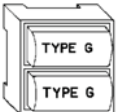
| Dual Indicating Light Unit  | Lens Types Required <sup>⑤</sup>  | Type of Light Element Transformer (60/50 Hertz AC) |                          |                | Full Voltage (60/50 Hertz AC or DC) |                          |                |              |
|---|---|--|--------------------------|----------------|-------------------------------------|--------------------------|----------------|--------------|
|   |   | Voltage  | Lamp Number <sup>④</sup> | Catalog Number | Voltage                             | Lamp Number <sup>④</sup> | Catalog Number |              |
|   |   |  |                          |                |                                     |                          |                |              |
|  <p><i>Shown with Lens</i></p> |  | 120  | 6PSB                     | <b>E30CA</b>   | 24                                  | 24PSB                    | <b>E30CJ</b>   |              |
|   |   |  |                          |                |                                     | 120                      | 120PSB         | <b>E30CM</b> |

#### Notes

- ① Order from table on **Page V7-T1-170**.
- ② Operators are supplied as standard with red extended release bar(s) marked "OFF" as shown in sketch. For other colors or markings, contact your nearest Eaton Distributor or call our Customer Service Center 1-800-356-1243. For replacement of standard red release bar, order **E30KR101**.
- ③ Order from table on **Page V7-T1-171**.
- ④ Light units will also accept LED lamps. For LED part numbers, see table on **Page V7-T1-179**.
- ⑤ Order from table on **Page V7-T1-172**.

1

UL (NEMA) Type 3, 3R, 4, 4X, 12, 13

#### Single Button Operator and Indicating Light



Shown with Button and Lens

#### Single Button Operator with Indicating Light/without Button or Lens (Order Button and Lens Separately)

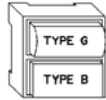
| Button and Lens Types Required ①  | Operation (Bottom Button) | Type of Light Element Transformer (60/50 Hertz AC) |               |                | Full Voltage (60/50 Hertz AC or DC) |               |                |
|---|---------------------------|--|---------------|----------------|-------------------------------------|---------------|----------------|
|   |                           | Voltage  | Lamp Number ② | Catalog Number | Voltage                             | Lamp Number ② | Catalog Number |
|  | Momentary                 | 120  | 6PSB          | <b>E30DA</b>   | 24                                  | 24PSB         | <b>E30DX3</b>  |
|   |                           | 120  | 120PSB        | <b>E30DF</b>   |                                     |               |                |

#### Single Button Operator with Release Bar and Indicating Light



Shown with Button and Lens

#### Single Button Operator with (OFF) Release Bar and Indicating Light—Includes OFF Bar/Button (Order Other Button and Lens Separately)

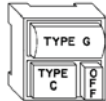
| Button and Lens Types Required ①  | Operation (Bottom Button) | Type of Light Element Transformer (60/50 Hertz AC) |               |                | Full Voltage (60/50 Hertz AC or DC) |               |                |
|---|---------------------------|--|---------------|----------------|-------------------------------------|---------------|----------------|
|   |                           | Voltage  | Lamp Number ② | Catalog Number | Voltage                             | Lamp Number ② | Catalog Number |
|  | Maintained                | 120  | 6PSB          | <b>E30DG</b>   | 24                                  | 24PSB         | <b>E30DX13</b> |
|   |                           | 120  | 120PSB        | <b>E30DM</b>   |                                     |               |                |

#### Two Button Operator with Indicating Light



Shown with Button and Lens

#### Two Button Operator with Indicating Light/without Buttons or Lens (Order Buttons and Lens Separately)

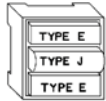
| Button and Lens Types Required ④  | Button Operation         | Type of Light Element Transformer (60/50 Hertz AC) |               |                | Full Voltage (60/50 Hertz AC or DC) |               |                |
|---|--------------------------|--|---------------|----------------|-------------------------------------|---------------|----------------|
|   |                          | Voltage  | Lamp Number ② | Catalog Number | Voltage                             | Lamp Number ② | Catalog Number |
|  | Momentary                | 120  | 6PSB          | <b>E30EA</b>   | 24                                  | 24PSB         | <b>E30EX3</b>  |
|   |                          | 120  | 120PSB        | <b>E30EF</b>   |                                     |               |                |
|   | Momentary with interlock | 120  | 6PSB          | <b>E30EG</b>   | 24                                  | 24PSB         | <b>E30EX13</b> |
|   |                          | 120  | 120PSB        | <b>E30EM</b>   |                                     |               |                |

#### Two Button Operator with Dual Indicating Lights



Shown with Button and Lens

#### Two Button Operator with Dual Indicating Lights/without Buttons and Lens

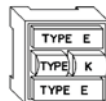
| Button and Lens Types Required ①  | Button Operation | Type of Light Element Transformer (60/50 Hertz AC) |               |                | Full Voltage (60/50 Hertz AC or DC) |               |                |
|---|------------------|--|---------------|----------------|-------------------------------------|---------------|----------------|
|   |                  | Voltage  | Lamp Number ② | Catalog Number | Voltage                             | Lamp Number ② | Catalog Number |
|  | Momentary        | 120  | 6PSB          | <b>E30JA</b>   | 24                                  | 24PSB         | <b>E30JX3</b>  |
|   |                  | 120  | 120PSB        | <b>E30JF</b>   |                                     |               |                |

#### Notes

- ① Order from tables on **Pages V7-T1-169 to V7-T1-173**.
- ② Light units will also accept LED lamps. For LED part numbers, see table on **Page V7-T1-179**.
- ③ Operators are supplied as standard with red extended release bar(s) marked "OFF" as shown in sketch. For other colors or markings, contact your nearest Eaton Distributor or call our Customer Service Center 1-800-356-1243. For replacement of standard red release bar, order **E30KR101**.
- ④ Order from tables on **Pages V7-T1-171 and V7-T1-172**.

### Operator Components

#### Operating Buttons Only

##### Type A Extended Button

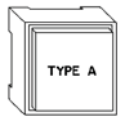

##### Type A Buttons with Standard Markings <sup>①</sup>

| Button Application  | Color | Marking     | Extended Button Catalog Number | Short Button Catalog Number | Color  | Marking | Extended Button Catalog Number | Short Button Catalog Number |
|---|-------|-------------|--------------------------------|-----------------------------|--------|---------|--------------------------------|-----------------------------|
|  | Black | Blank       | E30KA100                       | E30KA150                    | Green  | START   | E30KA330                       | E30KA380                    |
|   |       | START       | —                              | E30KA180                    | Yellow | Blank   | E30KA400                       | E30KA450                    |
|   | Red   | Blank       | E30KA200                       | E30KA250                    | White  | Blank   | E30KA500                       | E30KA550                    |
|   |       | EMERG. STOP | E30KA204                       | —                           | Gray   | Blank   | E30KA600                       | E30KA650                    |
|   |       | OFF         | E30KA218                       | E30KA268                    | Brown  | Blank   | E30KA700                       | E30KA750                    |
|   |       | STOP        | E30KA231                       | E30KA281                    | Orange | Blank   | E30KA800                       | E30KA950                    |
|   | Green | Blank       | E30KA300                       | E30KA350                    | Blue   | Blank   | E30KA900                       | E30KA950                    |

##### Type B Extended Button

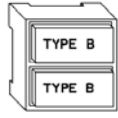

##### Type B Buttons with Standard Markings <sup>②</sup>

| Button Application  | Color    | Marking  | Extended Button Catalog Number | Short Button Catalog Number | Color       | Marking  | Extended Button Catalog Number | Short Button Catalog Number |          |
|---|----------|----------|--------------------------------|-----------------------------|-------------|----------|--------------------------------|-----------------------------|----------|
|  | Black    | Blank    | E30KB100                       | E30KB150                    | Black       | REVERSE  | E30KB125                       | E30KB175                    |          |
|   |          | AUTO     | E30KB101                       | E30KB151                    |             | RUN      | E30KB126                       | E30KB176                    |          |
|   |          | CLOSE    | E30KB102                       | E30KB152                    |             | SLOW     | E30KB128                       | E30KB178                    |          |
|   |          | DOWN     | E30KB103                       | E30KB153                    |             | START    | E30KB130                       | E30KB180                    |          |
|   |          | FAST     | E30KB105                       | E30KB155                    |             | TEST     | E30KB132                       | E30KB182                    |          |
|   |          | FORWARD  | E30KB107                       | E30KB157                    |             | UP       | E30KB134                       | E30KB184                    |          |
|   |          | HIGH     | E30KB109                       | E30KB159                    |             | Red      | Blank                          | E30KB200                    | E30KB250 |
|   |          | IN       | E30KB110                       | E30KB160                    | EMERG. STOP |          | E30KB204                       | —                           |          |
|   |          | INCH     | E30KB111                       | E30KB161                    | OFF         |          | E30KB218                       | E30KB268                    |          |
|   |          | JOG      | E30KB112                       | E30KB162                    | STOP        |          | E30KB231                       | E30KB281                    |          |
|   |          | JOG FOR. | E30KB113                       | E30KB163                    | Green       |          | Blank                          | E30KB300                    | E30KB350 |
|   |          | JOG REV. | E30KB114                       | E30KB164                    |             |          | START                          | E30KB330                    | E30KB380 |
|   |          | LOW      | E30KB115                       | E30KB165                    |             |          | Yellow                         | Blank                       | E30KB400 |
|   |          | LOWER    | E30KB116                       | E30KB166                    | White       | Blank    | E30KB500                       | E30KB550                    |          |
|   |          | MAN      | E30KB117                       | E30KB167                    |             | AUTO     | E30KB501                       | —                           |          |
|   |          | ON       | E30KB119                       | E30KB169                    |             | HAND     | E30KB508                       | —                           |          |
|   |          | OPEN     | E30KB120                       | E30KB170                    | Gray        | Blank    | E30KB600                       | E30KB650                    |          |
| OUT   | E30KB121 | E30KB171 | Brown                          | Blank                       | E30KB700    | E30KB750 |                                |                             |          |
| RAISE   | E30KB122 | E30KB172 | Orange                         | Blank                       | E30KB800    | E30KB850 |                                |                             |          |
| RESET   | E30KB124 | E30KB174 | Blue                           | Blank                       | E30KB900    | E30KB950 |                                |                             |          |

#### Notes

- ① Use with operator E30AA, legend characters 3/16 in (4.8 mm) high.
- ② Use with operators E30AB thru AE, AL and DA thru DF, legend characters 3/16 in (4.8 mm) high.

1

## Type C Extended Button

Type C Buttons with Standard Markings <sup>Ⓢ</sup>

| Button Application | Color           | Marking         | Extended Button Catalog Number | Short Button Catalog Number | Color           | Marking         | Extended Button Catalog Number | Short Button Catalog Number |                 |
|--------------------|-----------------|-----------------|--------------------------------|-----------------------------|-----------------|-----------------|--------------------------------|-----------------------------|-----------------|
|                    | Black           | Blank           | <b>E30KC100</b>                | <b>E30KC150</b>             | Black           | RESET           | <b>E30KC124</b>                | <b>E30KC174</b>             |                 |
|                    |                 | AUTO            | <b>E30KC101</b>                | <b>E30KC151</b>             |                 | REVERSE         | <b>E30KC125</b>                | <b>E30KC175</b>             |                 |
|                    |                 | CLOSE           | <b>E30KC102</b>                | <b>E30KC152</b>             |                 | RUN             | <b>E30KC126</b>                | <b>E30KC176</b>             |                 |
|                    |                 | DOWN            | <b>E30KC103</b>                | <b>E30KC153</b>             |                 | SLOW            | <b>E30KC128</b>                | <b>E30KC178</b>             |                 |
|                    |                 | FAST            | <b>E30KC105</b>                | <b>E30KC155</b>             |                 | START           | <b>E30KC130</b>                | <b>E30KC180</b>             |                 |
|                    |                 | FORWARD         | <b>E30KC107</b>                | <b>E30KC157</b>             |                 | TEST            | <b>E30KC132</b>                | <b>E30KC182</b>             |                 |
|                    |                 | HAND            | <b>E30KC108</b>                | <b>E30KC158</b>             |                 | UP              | <b>E30KC134</b>                | <b>E30KC184</b>             |                 |
|                    |                 | HIGH            | <b>E30KC109</b>                | <b>E30KC159</b>             |                 | Red             | Blank                          | <b>E30KC200</b>             | <b>E30KC250</b> |
|                    |                 | IN              | <b>E30KC110</b>                | <b>E30KC160</b>             |                 |                 | OFF                            | <b>E30KC218</b>             | —               |
|                    |                 | INCH            | <b>E30KC111</b>                | <b>E30KC161</b>             |                 |                 | STOP                           | <b>E30KC231</b>             | <b>E30KC281</b> |
|                    |                 | JOG             | <b>E30KC112</b>                | <b>E30KC162</b>             |                 | Green           | Blank                          | <b>E30KC300</b>             | <b>E30KC350</b> |
|                    |                 | JOG FOR.        | <b>E30KC113</b>                | <b>E30KC163</b>             |                 |                 | START                          | <b>E30KC330</b>             | <b>E30KC380</b> |
|                    |                 | JOG REV.        | <b>E30KC114</b>                | <b>E30KC164</b>             |                 | Yellow          | Blank                          | <b>E30KC400</b>             | <b>E30KC450</b> |
|                    |                 | LOW             | <b>E30KC115</b>                | <b>E30KC165</b>             |                 |                 | Blank                          | <b>E30KC500</b>             | <b>E30KC550</b> |
| LOWER              | <b>E30KC116</b> | <b>E30KC166</b> | Gray                           | Blank                       | <b>E30KC600</b> | <b>E30KC650</b> |                                |                             |                 |
| MAN                | <b>E30KC117</b> | <b>E30KC167</b> | Brown                          | Blank                       | <b>E30KC700</b> | <b>E30KC750</b> |                                |                             |                 |
| ON                 | <b>E30KC119</b> | <b>E30KC169</b> |                                | Blank                       | <b>E30KC800</b> | <b>E30KC850</b> |                                |                             |                 |
| OPEN               | <b>E30KC120</b> | <b>E30KC170</b> | Orange                         | Blank                       | <b>E30KC900</b> | <b>E30KC950</b> |                                |                             |                 |
| OUT                | <b>E30KC121</b> | <b>E30KC171</b> |                                | Blue                        | Blank           | <b>E30KC900</b> | <b>E30KC950</b>                |                             |                 |
| RAISE              | <b>E30KC122</b> | <b>E30KC172</b> |                                |                             |                 |                 |                                |                             |                 |

**Note**

<sup>Ⓢ</sup> Use with operators E30AF thru AK, AL thru AM and DG thru DM, legend characters 1/8 in (3.2 mm) high.

### Operating Buttons and Lens Only

#### Standard Color Buttons and Lens Marking ①

**Black lettering** on — White, Amber, Yellow and Clear.

**White lettering** on — Green, Red, Blue, Brown, Black, Orange and Gray.

#### Type E Button



#### Type E Buttons with Standard Markings ②

| Button Application | Color           | Marking  | Extended Button Catalog Number | Color           | Marking | Extended Button Catalog Number |                 |
|--------------------|-----------------|----------|--------------------------------|-----------------|---------|--------------------------------|-----------------|
|                    | Black           | Blank    | <b>E30KE100</b>                | Black           | RESET   | <b>E30KE124</b>                |                 |
|                    |                 | CLOSE    | <b>E30KE102</b>                |                 | REVERSE | <b>E30KE125</b>                |                 |
|                    |                 | DOWN     | <b>E30KE103</b>                |                 | RUN     | <b>E30KE126</b>                |                 |
|                    |                 | FAST     | <b>E30KE105</b>                |                 | SLOW    | <b>E30KE128</b>                |                 |
|                    |                 | FORWARD  | <b>E30KE107</b>                |                 | START   | <b>E30KE130</b>                |                 |
|                    |                 | HIGH     | <b>E30KE109</b>                |                 | TEST    | <b>E30KE132</b>                |                 |
|                    |                 | IN       | <b>E30KE110</b>                |                 | UP      | <b>E30KE134</b>                |                 |
|                    |                 | INCH     | <b>E30KE111</b>                |                 | Red     | Blank                          | <b>E30KE200</b> |
|                    |                 | JOG      | <b>E30KE112</b>                |                 |         | OFF                            | <b>E30KE218</b> |
|                    |                 | JOG FOR. | <b>E30KE113</b>                |                 |         | STOP                           | <b>E30KE231</b> |
|                    |                 | JOG REV. | <b>E30KE114</b>                |                 | Green   | Blank                          | <b>E30KE300</b> |
|                    |                 | LOW      | <b>E30KE115</b>                |                 |         | START                          | <b>E30KE330</b> |
|                    |                 | LOWER    | <b>E30KE116</b>                |                 | Yellow  | Blank                          | <b>E30KE400</b> |
|                    |                 | ON       | <b>E30KE119</b>                |                 | White   | Blank                          | <b>E30KE500</b> |
|                    |                 | OPEN     | <b>E30KE120</b>                | Gray            | Blank   | <b>E30KE600</b>                |                 |
|                    |                 | OUT      | <b>E30KE121</b>                | Brown           | Blank   | <b>E30KE700</b>                |                 |
| PHASE              | <b>E30KE122</b> | Orange   | Blank                          | <b>E30KE800</b> |         |                                |                 |
|                    |                 | Blue     | Blank                          | <b>E30KE900</b> |         |                                |                 |

#### Type F Lens



#### Type F Lenses with Standard Markings ③

| Button Application | Color | Marking    | Catalog Number | Color | Marking | Catalog Number |                |
|--------------------|-------|------------|----------------|-------|---------|----------------|----------------|
|                    | Red   | Blank      | <b>E30KF10</b> | Green | OFF     | <b>E30KF22</b> |                |
|                    |       | MOTOR RUN  | <b>E30KF11</b> |       | Amber   | Blank          | <b>E30KF30</b> |
|                    |       | ON         | <b>E30KF12</b> | Blue  |         | Blank          | <b>E30KF40</b> |
|                    |       | POWER ON   | <b>E30KF13</b> |       | Clear   | Blank          | <b>E30KF50</b> |
|                    | Green | Blank      | <b>E30KF20</b> | White |         | Blank          | <b>E30KF60</b> |
|                    |       | MOTOR STOP | <b>E30KF21</b> |       |         |                |                |
|                    |       | MOTOR RUN  | <b>E30KF23</b> |       |         |                |                |

#### Notes

- ① For lenses with special markings or with standard markings but in a different color, refer to instructions on **Pages V7-T1-176 to V7-T1-178.**
- ② Use with operators E30EA thru EM, FA thru FM and JA thru JM, legend characters 1/8 in (3.2 mm) high.
- ③ Use with operators E30BA thru BY, legend characters 3/16 in (4.8 mm) high.



#### Operating Lens Only

#### Standard Color Buttons and Lens Marking ①

**Black lettering** on — White, Amber, Yellow and Clear.

**White lettering** on — Green, Red, Blue, Brown, Black, Orange and Gray.

#### Type G Lens



#### Type G Lenses with Standard Markings ②

| Lens Application | Color      | Marking        | Catalog Number | Color | Marking        | Catalog Number |
|------------------|------------|----------------|----------------|-------|----------------|----------------|
|                  |            |                |                |       |                |                |
|                  | Red        | Blank          | <b>E30KG10</b> | Green | OFF            | <b>E30KG22</b> |
|                  |            | MOTOR RUN      | <b>E30KG11</b> |       | READY          | <b>E30KG23</b> |
|                  |            | ON             | <b>E30KG12</b> | Amber | Blank          | <b>E30KG30</b> |
|                  |            | POWER ON       | <b>E30KG13</b> |       | Blue           | Blank          |
| Green            | Blank      | <b>E30KG20</b> | Clear          | Blank | <b>E30KG50</b> |                |
|                  | MOTOR RUN  | <b>E30KG24</b> | White          | Blank | <b>E30KG60</b> |                |
|                  | MOTOR STOP | <b>E30KG21</b> |                |       |                |                |

#### Type J Lens



#### Type J Lenses with Standard Markings ③

| Lens Application | Color      | Marking        | Catalog Number | Color | Marking        | Catalog Number |
|------------------|------------|----------------|----------------|-------|----------------|----------------|
|                  |            |                |                |       |                |                |
|                  | Red        | Blank          | <b>E30KJ10</b> | Green | OFF            | <b>E30KJ22</b> |
|                  |            | MOTOR RUN      | <b>E30KJ11</b> |       | ON             | <b>E30KJ24</b> |
|                  |            | ON             | <b>E30KJ12</b> | Amber | Blank          | <b>E30KJ30</b> |
|                  |            | POWER ON       | <b>E30KJ13</b> |       | Blue           | Blank          |
|                  |            | MOTOR STOP     | <b>E30KJ14</b> | Clear | Blank          | <b>E30KJ50</b> |
| Green            | Blank      | <b>E30KJ20</b> | White          | Blank | <b>E30KJ60</b> |                |
|                  | MOTOR STOP | <b>E30KJ21</b> |                |       |                |                |
|                  | MOTOR RUN  | <b>E30KJ23</b> |                |       |                |                |

#### Type K Lenses



#### Type K Lenses with Standard Markings (Sold in Pairs Only) ④

| Lens Application | Color          |                 | Marking        |                 | Catalog Number |
|------------------|----------------|-----------------|----------------|-----------------|----------------|
|                  | Left Hand Lens | Right Hand Lens | Left Hand Lens | Right Hand Lens |                |
|                  | Red            | Red             | ON             | ON              | <b>E30KK12</b> |
|                  |                | Green           | ON             | OFF             | <b>E30KK13</b> |
|                  | Green          | Green           | OFF            | OFF             | <b>E30KK22</b> |
|                  |                | Red             | OFF            | ON              | <b>E30KK23</b> |

#### Notes

- ① For lenses with special markings or with standard markings but in a different color, refer to instructions on **Pages V7-T1-176 to V7-T1-178**.
- ② Use with operators E30CA thru CM and DA thru DM, legend characters 3/16 in (4.8 mm) high except MOTOR RUN, POWER ON and MOTOR STOP are 1/8 in (3.2 mm) high.
- ③ Use with operators E30EA thru EM, FA thru FM and GA thru GM, legend characters 1/8 in (3.2 mm) high.
- ④ Use with operators E30JA thru JW, legend characters 1/8 in (3.2 mm) high

**Type K Lenses**



**Type K Lenses—Blank (Sold in Pairs Only)**

| Color          |                 |                | Color          |                 |                |
|----------------|-----------------|----------------|----------------|-----------------|----------------|
| Left Hand Lens | Right Hand Lens | Catalog Number | Left Hand Lens | Right Hand Lens | Catalog Number |
| Red            | Red             | <b>E30KK10</b> | Blue           | Red             | <b>E30KK41</b> |
|                | Green           | <b>E30KK11</b> |                | Green           | <b>E30KK42</b> |
|                | Amber           | <b>E30KK17</b> |                | Amber           | <b>E30KK43</b> |
|                | Blue            | <b>E30KK14</b> |                | Blue            | <b>E30KK40</b> |
|                | Clear           | <b>E30KK15</b> |                | Clear           | <b>E30KK45</b> |
|                | White           | <b>E30KK16</b> |                | White           | <b>E30KK46</b> |
| Green          | Red             | <b>E30KK21</b> | Clear          | Red             | <b>E30KK51</b> |
|                | Green           | <b>E30KK20</b> |                | Green           | <b>E30KK52</b> |
|                | Amber           | <b>E30KK27</b> |                | Amber           | <b>E30KK53</b> |
|                | Blue            | <b>E30KK24</b> |                | Blue            | <b>E30KK54</b> |
|                | Clear           | <b>E30KK25</b> |                | Clear           | <b>E30KK50</b> |
|                | White           | <b>E30KK26</b> |                | White           | <b>E30KK56</b> |
| Amber          | Red             | <b>E30KK31</b> | White          | Red             | <b>E30KK61</b> |
|                | Green           | <b>E30KK32</b> |                | Green           | <b>E30KK62</b> |
|                | Amber           | <b>E30KK30</b> |                | Amber           | <b>E30KK63</b> |
|                | Blue            | <b>E30KK34</b> |                | Blue            | <b>E30KK64</b> |
|                | Clear           | <b>E30KK35</b> |                | Clear           | <b>E30KK65</b> |
|                | White           | <b>E30KK36</b> |                | White           | <b>E30KK60</b> |

#### Contact Blocks

**Standard Contact Blocks**—Molded, phenolic construction. Enclosed silver contacts with reliability “nibs” that improve the reliability of switching performance under dry circuit, corrosive atmosphere and fine dust conditions. For more extreme conditions, the logic level contact blocks described below are recommended.

**Logic Level Contact Blocks**—Feature palladium contacts. Palladium, which is more inert than gold, is well suited for voltages and currents approaching zero. When mounted in an enclosure rated for highly corrosive environments, logic level contact blocks can be used where exposure to chemicals may cause failure to other types of materials.

#### Mounting Limitations

See the contact block mounting limitations for Type E30 pushbutton and combination pushbutton and light operators on this page. Mounting positions 1 thru 8 indicate single depth contact blocks. Each of these positions can represent either a single circuit 600 volt block or a two-circuit 120 volt block. The two-circuit 600 volt block requires two of the numbered positions shown.

#### Mounting Positions

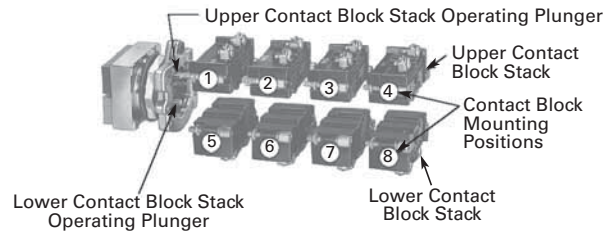

| Catalog Number of Operator    | Contact Blocks Can Be Mounted in Positions Listed Below |             |
|-------------------------------|---|-------------|
|                               | Upper Stack   | Lower Stack |
| E30AA thru E30AM <sup>①</sup> | 1-2-3-4   | 5-6-7-8     |
| E30BA thru E30CM              | None  | None        |
| E30DA thru E30DM              | None  | 5-6-7-8     |
| E30EA thru E30GM              | 2-3-4   | 6-7-8       |
| E30JA thru E30JM              | 3-4   | 7-8         |

#### Contact Block Type <sup>②</sup>

Single Circuit, Screw Terminals



Two Circuit, Screw Terminals



Two Circuit, Quick Connect Terminals



120 Vac Only—Two Circuit



#### Contact Block Selection











| Circuit                                | Pressure Terminals<br>Standard<br>Catalog Number | Logic Level<br>Catalog Number | Quick Connect Terminals <sup>③</sup><br>Standard<br>Catalog Number |
|--|--|-------------------------------|--|
|  |  |                               |  |
| <b>600 Vac, 250 Vdc—Single Circuit</b> |  |                               |  |
| 1NO                                    | E30KLA1  | E30KLAE1                      | E30KLB1  |
| 1NC                                    | E30KLA2  | E30KLAE2                      | E30KLB2  |
| <b>600 Vac, 250 Vdc—Two Circuit</b>    |  |                               |  |
| 1NO-1NC                                | E30KLA3  | E30KLAE3                      | E30KLB3  |
| 2NO                                    | E30KLA4  | E30KLAE4                      | E30KLB4  |
| 2NC                                    | E30KLA5  | E30KLAE5                      | E30KLB5  |
| <b>Special Contact Operation</b>       |  |                               |  |
| 1NO-1NC<br>Overlapping                 | E30KLA6 <sup>④</sup>                             | —                             | E30KLB6 <sup>④</sup>   |
| 2NO<br>(One early closing)             | E30KLA7 <sup>④</sup>                             | —                             | E30KLB7 <sup>④</sup>   |
| 2NC<br>(One late opening)              | E30KLA8  | —                             | E30KLB8  |
| <b>120 Vac Only—Two Circuit</b>        |  |                               |  |
| 1NO-1NC                                | E30KLA9 <sup>⑤</sup>                             | —                             | E30KLB9 <sup>⑤</sup>   |

#### Notes

- ① Except operator E30AD, AJ or AK which will accommodate contact blocks 1, 2, 5 and 6 only. (See Mounting Positions above.)
- ② Individually boxed contact blocks master packed 10 per carton.
- ③ Supplied with non-stacking screws. Limited to 2 contact blocks mounted in positions 1 and 5.
- ④ Do not use with maintained operators.
- ⑤ Contacts must be same polarity.

### Accessories

#### Accessories

|   | Description  | Color/Type   | Catalog Number   |
|---|--|--|--|
| <b>E30KR_</b><br>    | <b>Collar</b> —Snap on mounting for assembly in the field. Permits color coding of operator heads. Size: 1-19/32 x 1-19/32 x 9/16 in.  | Black  | <b>E30KR1</b>  |
|   |  | Red  | <b>E30KR2</b>  |
|   |  | Green  | <b>E30KR3</b>  |
|   |  | Yellow   | <b>E30KR4</b>  |
|   |  | White  | <b>E30KR5</b>  |
|   |  | Gray   | <b>E30KR6</b>  |
|   |  | Orange   | <b>E30KR8</b>  |
|   |  | Blue   | <b>E30KR9</b>  |
|   |  | Brown  | <b>E30KR10</b>   |
|   |  | <b>E30KT_</b><br> <p><i>Full Shroud</i></p>  <p><i>Half Shroud</i></p> | <b>Shroud</b> —Similar to collar above except for extension above the face of button to prevent accidental actuation of button. Half shroud with an extension on only half the collar may be positioned to protect top or bottom button. |
| Half shroud (gray)  | <b>E30KT7</b>  |  |  |
| <b>E30KR3_</b><br>  | <b>Guard</b> —Two collars deep, removable slide prevents accidental operation. White slide can be marked with grease pencil.   | Red with white slide   | <b>E30KR31</b>   |
|   |  | Red with clear slide   | <b>E30KR32</b>   |
| <b>E30KR30</b><br> | <b>Terminal Block</b> —2 terminals, each will accommodate 2-wire terminations.   |  | <b>E30KR30</b>   |
| <b>E30KT_</b><br>  | <b>Padlock Attachment</b> for locking single button and bottom button of multi-function operators in the depressed position. Locks NC contacts open or early closing NO contacts closed. Cannot be used in conjunction with collar, shroud or boot.                      | Short button   | <b>E30KT1</b>  |
|   |  | Extended button  | <b>E30KT2</b>  |
| <b>E30KT3</b><br>  | <b>Transparent Boot</b> —Guards against ingress of foreign material and freezing rain. <b>Note:</b> If this boot is used in conjunction with operator types AD or AE, an extended type button must be used in the top position and a short button in the lower position. |  | <b>E30KT3</b> ①  |
| <b>E30KT_</b><br>  | <b>Square Hole Plug</b> —  | Gray enameled  | <b>E30KT4</b>  |
|   |  | Stainless steel  | <b>E30KT5</b>  |
| <b>E30KV1</b><br>  | <b>Lamp and Lens Removal Tool</b> —Will not fit Cat. No. E30B light units listed on <b>Page V7-T1-167</b> .  |  | <b>E30KV1</b>  |
| <b>E22CW</b><br>   | <b>Octagonal Wrench</b> for mounting operators to panel.   |  | <b>E22CW</b>   |
| <b>E30KV2</b><br>  | <b>Button and Lens Removal Tool</b>  |  | <b>E30KV2</b>  |

**Note**

① Color coordinating collars, padlock attachments or legend plates cannot be used with operators equipped with a transparent boot.

### Options

#### Markings and Legend Plates

##### Buttons or Lenses with Non-Standard Horizontal Markings

Markings not listed as Standard Markings below are considered non-standard. If more than one marking is required on a button or lens, order non-standard markings.

##### Ordering Instructions

- Specify catalog number of blank button or lens of desired color, plus suffix "STAMP" for non-standard or "STD" for standard markings in order notes. See **Pages V7-T1-169 to V7-T1-173**.
- Specify size, legend desired and location in order notes by alphas as shown in example.
- Do not exceed maximum number of legend characters per line.

##### Ordering Example

Green Type B button to be marked with non-standard legend "ALL ELEVATORS DOWN."

Catalog No.: **E30KB300STAMP**  
 Letter Size: 1/8 in  
 Pos. A—ALL  
 Pos. C—ELEVATORS  
 Pos. F—DOWN

##### How to Use the Legend Location Figure

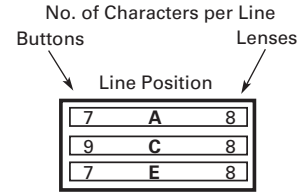

#### Legend Locations

Type A buttons and Type F lenses

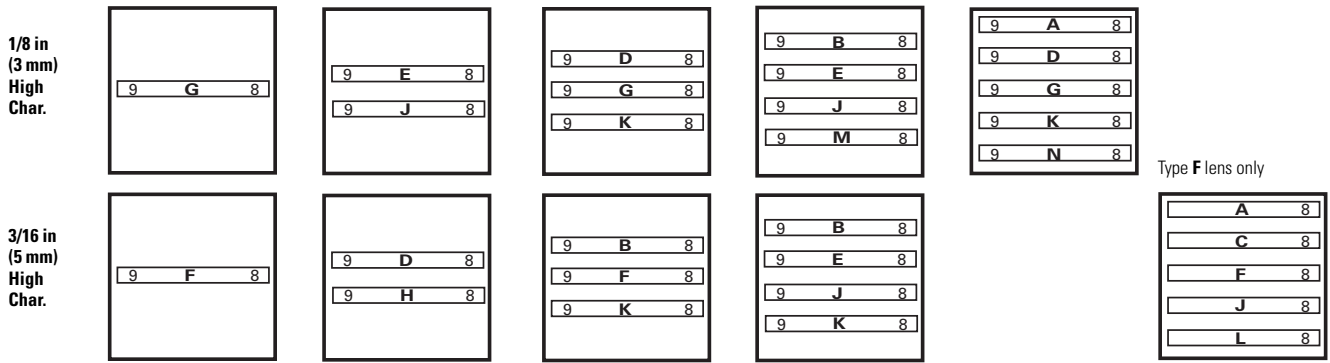

Type B buttons and Type G lenses

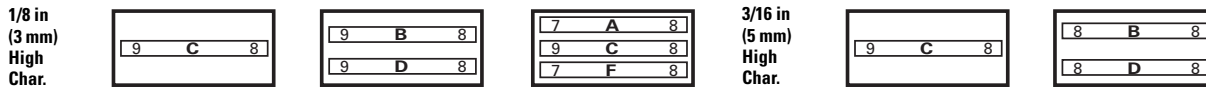

Type C buttons



Type D buttons

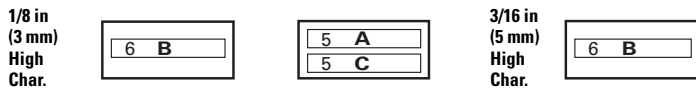

Type K buttons

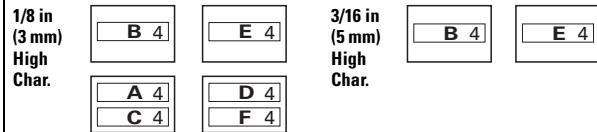

Type E buttons and Type J lenses

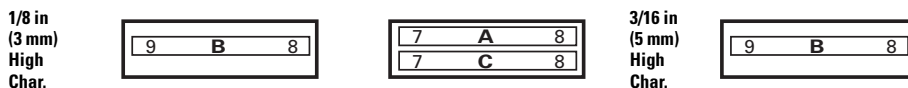

#### Standard Markings

|       |             |      |          |          |      |       |         |       |           |            |
|-------|-------------|------|----------|----------|------|-------|---------|-------|-----------|------------|
| AUTO  | EMERG. STOP | HAND | INCH     | JOG REV. | MAN. | OPEN  | RESET   | SLOW  | TEST      | MOTOR STOP |
| CLOSE | FAST        | HIGH | JOG      | LOW      | OFF  | OUT   | REVERSE | START | UP        | POWER ON   |
| DOWN  | FORWARD     | IN   | JOG FOR. | LOWER    | ON   | RAISE | RUN     | STOP  | MOTOR RUN | READY      |

### Legend Arrangements and Legend Locations

Legend plates  
E30KM1 or KM11

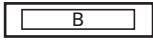

Legend plates  
E30KM4 or KM14

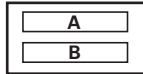

Legend plates  
E30KM3 or KM13

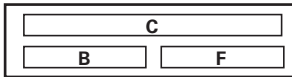
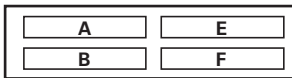
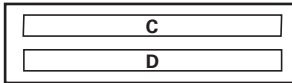

Legend plates  
E30KM5 or KM15

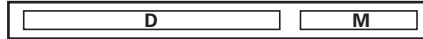
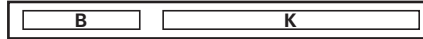
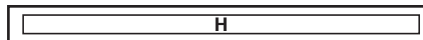

Legend plates  
E30KM2 or KM12

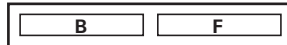
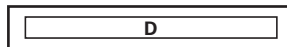

Legend plates  
E30KM6 or KM16

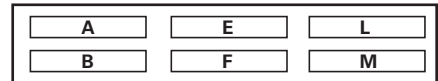
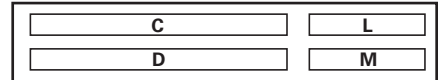
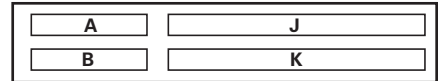
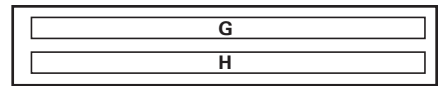

### Legend Plates E30KN76 or KN76B

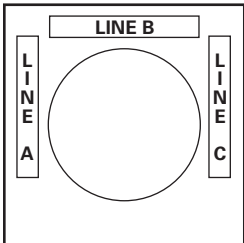

Legend plates  
E30KN76 or KN76B  
1/8 in character  
size only with a maximum  
of six characters.

### Maximum Number and Size of Permissible Legend Characters of Custom Stamped Legend Plates

| Type     | No. of Lines | Size and Maximum Number of Characters Per Line |               |                |                  |               |                |                  |               |                |
|----------|--------------|--|---------------|----------------|------------------|---------------|----------------|------------------|---------------|----------------|
|          |              | One Span                                       |               |                | Two Span         |               |                | Three Span       |               |                |
|          |              | 3/32 in (2.5 mm)                               | 1/8 in (3 mm) | 3/16 in (5 mm) | 3/32 in (2.5 mm) | 1/8 in (3 mm) | 3/16 in (5 mm) | 3/32 in (2.5 mm) | 1/8 in (3 mm) | 3/16 in (5 mm) |
| Standard | 1            | 13   | 10            | 10             | 30               | 22            | 22             | 47               | 34            | 34             |
| Large    | 1            | 13   | 10            | 10             | 30               | 23            | 23             | 47               | 36            | 36             |
|          | 2            | 13   | 10            | 10             | 30               | 23            | 23             | 47               | 36            | 36             |

Characters available for non-standard markings  
3/32 in (2.5 mm)—1/8 in (3 mm)—3/16 in (5 mm)

|  |                |                            |
|--|----------------|----------------------------|
| <b>A B C D E F G H I J K L M N O P Q R S T U V W X Y Z</b> | <b>. / — ,</b> | <b>1 2 3 4 5 6 7 8 9 0</b> |
|--|----------------|----------------------------|

#### 1 Buttons or Lenses with Non-Standard Vertical Markings

##### Ordering Instructions

- Specify catalog number of blank button or lens of desired color, selected from listings on **Pages V7-T1-169 to V7-T1-173**.
- Specify size, legend desired, location and state “vertically marked” in order notes.

**Note:** Specify either 1/8 or 3/16 in (3.2 or 4.8 mm) character height. Do not exceed maximum number of characters as outlined in table below.

##### Ordering Example:

Green Type K button to be marked with “RUN” “ON.”

Catalog No.: **E30KK20STAMP**  
 Letter Size: 3/16 in (4.8 mm)  
 Vertically Marked  
 Pos. B—RUN  
 Pos. E—ON

##### Maximum Number of Characters

| Description | Type | Maximum Number of Characters |                  |
|-------------|------|------------------------------|------------------|
|             |      | 1/8 in (3.2 mm)              | 3/16 in (4.8 mm) |
| Buttons     | A    | 7                            | 5                |
|             | B    | 7                            | 5                |
|             | C    | 4                            | 3                |
|             | D    | 5                            | 3                |
|             | E    | 7                            | 5                |
| Lenses      | F    | 7                            | 5                |
|             | G    | 7                            | 5                |
|             | J    | 7                            | 5                |
|             | K    | 3                            | 2                |

##### Legend Plates

Legend plates for Type E30 compact pushbutton and indicating light operators hook directly onto the operator and are clamped in place when the operator locking nut behind the panel is secured.

Two and three span plates are designed for use where two or more operators are mounted adjacent to each other **on minimum horizontal mounting centers**. These legend plates mount in the same manner as single span units.

##### When Ordering Legend Plates with Markings



- Catalog number of blank legend plate
- Insert the following in order notes:
  - Legends required
  - Size of characters—3/32, 1/8, 3/16 in (2.4, 3.2, 4.8 mm)
  - Positions of legends on one line standard and two line large legend plates by alphas as shown in sketches on following page.

##### Ordering Example:

Three span legend plate to be marked “MASTER CONTROL”, “STATION A” and “STATION B.”

Catalog No.: **E30KM3STAMP**  
 Letter Size: 1/8 in (3.2 mm)  
 Pos. C—MASTER CONTROL  
 Pos. B—STATION A  
 Pos. F—STATION B

##### Blank Legend Plates and Legend Plates with Markings

| Type  | One Span Catalog Number |
|---|-------------------------|
| <b>Black</b>  |                         |
| Standard— One Span  | Standard                |
|   | <b>E30KM1</b>           |
| Large—One Span  | Large                   |
|  | <b>E30KM4</b>           |

## Replacement Parts

### Replacement Light Units for E30 Components

| Voltage<br>AC and DC                              | Part Numbers—Receptacles without Lamps |                          |                                   |                                 |                               |
|---|--|--------------------------|-----------------------------------|---------------------------------|-------------------------------|
|   | Single<br>Indicating Light             | Dual<br>Indicating Light | Single Light<br>Single Pushbutton | Single Light<br>Dual Pushbutton | Dual Light<br>Dual Pushbutton |
| <b>Full Voltage Type</b>                          |  |                          |                                   |                                 |                               |
| 6V  | 57-2579-3A                             | 57-2568A                 | 57-2568A                          | 57-2579-3A                      | 57-2567                       |
| 12V   | 57-2579-3A                             | 57-2568A                 | 57-2568A                          | 57-2579-3A                      | 57-2567                       |
| 18/24V  | 57-2579-3A                             | 57-2568A                 | 57-2568A                          | 57-2579-3A                      | 57-2567                       |
| 28V   | 57-2579-3A                             | 57-2568A                 | 57-2568A                          | 57-2579-3A                      | 57-2567                       |
| 32V   | 57-2579-3A                             | 57-2568-2A               | 57-2568-2A                        | —                               | 57-2567                       |
| 48V   | 57-2579-3A                             | 57-2568A                 | 57-2568A                          | 57-2579-3A                      | 57-2567                       |
| 120V  | 57-2579-3A                             | 57-2568A                 | 57-2568A                          | 57-2579-3A                      | 57-2567                       |
| <b>Transformer Type</b>                           |  |                          |                                   |                                 |                               |
| 120V  | 42-2672A                               | 42-2663A                 | 42-2663A                          | 42-2671A                        | 42-2664A                      |
| 208V  | 42-2672-2A                             | 42-2663-2A               | 42-2663-2A                        | 42-2671-2A                      | 42-2664-2A                    |
| 240V  | 42-2672-3A                             | 42-2663-3A               | 42-2663-3A                        | 42-2671-3A                      | 42-2664-3A                    |
| 380V  | 42-2672-4A                             | 42-2663-4A               | 42-2663-4A                        | 42-2671-4A                      | 42-2664-4A                    |
| 480V  | 42-2672-5A                             | 42-2663-5A               | 42-2663-5A                        | 42-2671-5A                      | 42-2664-5A                    |
| 600V  | 42-2672-6A                             | 42-2663-6A               | 42-2663-6A                        | 42-2671-6A                      | 42-2664-6A                    |
| <b>Description and Part Numbers—Related Parts</b> |  |                          |                                   |                                 |                               |
| Inner lens  | 28-1008                                | 28-1010                  | 28-1010                           | 28-1010                         | 28-1010                       |
| Retaining nut                                     | 15-1885                                | 15-1885                  | 15-1885                           | 15-1885                         | 15-1885                       |
| Gasket  | 16-2092                                | 16-2092                  | 16-2092                           | 16-2092                         | 16-2092                       |
| Locking ring                                      | 52-1116                                | 52-1116                  | 52-1116                           | 52-1116                         | 52-1116                       |

### Replacement Lamps for E30 Illuminated Operators

| Mfg. Lamp Type | Voltage | Base Style   | Application                      | Part Number |
|----------------|---------|--------------|----------------------------------|-------------|
| 6PSB           | 6V      | T2 slide     | E30 transformer and full voltage | 28-1022     |
| 12PSB          | 12V     | T2 slide     | E30 full voltage                 | 28-1025     |
| 24PSB          | 24V     | T2 slide     | E30 full voltage                 | 28-1026     |
| 28PSB          | 28V     | T2 slide     | E30 full voltage                 | 28-1027     |
| 48PSB          | 48V     | T2 slide     | E30 full voltage                 | 28-1028     |
| 60PSB          | 60V     | T2 slide     | E30 full voltage                 | 28-1598     |
| 120PSB         | 120V    | T2 slide     | E30 full voltage                 | 28-1029     |
| #259           | 6.3V    | T3-1/4 wedge | E30 single transformer           | 28-949      |

### Replacement Lamps—Incandescent and LED

| Lamp<br>Voltage | Incandescent Lamps            |               |                        | LED Lamps           |            |            |            |
|-----------------|-------------------------------|---------------|------------------------|---------------------|------------|------------|------------|
|                 | Manufacturer's<br>Part Number | Base<br>Style | Eaton's<br>Part Number | Eaton's Part Number |            |            |            |
|                 |                               |               |                        | Red                 | Green      | Yellow     | Blue ①     |
| 6               | 6PSB                          | T2 slide      | 28-1022                | 35-1523             | 35-1523-2  | 35-1523-3  | 35-1523-17 |
| 12              | 12PSB                         | T2 slide      | 28-1025                | 35-1523-11          | 35-1523-12 | 35-1523-13 | 35-1523-18 |
| 24              | 24PSB                         | T2 slide      | 28-1026                | 35-1523-4           | 35-1523-5  | 35-1523-6  | 35-1523-19 |
| 28              | 28PSB                         | T2 slide      | 28-1027                | 35-1523-4           | 35-1523-5  | 35-1523-6  | 35-1523-19 |
| 48              | 48PSB                         | T2 slide      | 28-1028                | 35-1523-14          | 35-1523-15 | 35-1523-16 | 35-1523-20 |
| 120             | 120PSB                        | T2 slide      | 28-1029                | 35-1523-7           | 35-1523-8  | 35-1523-9  | 35-1523-21 |

**Note**

① E30 blue LED bulbs may not provide sufficient intensity for some applications.



## Technical Data and Specifications

### Operator Specifications

| Description               | Specification  |
|---------------------------|--|
| <b>Climate Conditions</b> |  |
| Operating                 | −20° to 150°F (−29° to 65°C)   |
| <b>Terminals</b>          |  |
| Light units               | Terminals are saddle clamp type for 2 stranded or solid wires up to 12 AWG (4.0 mm <sup>2</sup> )<br>Torque—7 lb-in (0.8 Nm)   |
| Contact block             | Terminals are saddle clamp type for 2 stranded or solid wires up to 12 AWG (4.0 mm <sup>2</sup> )<br>Torque—7 lb-in (0.8 Nm)   |
| <b>Materials</b>          |  |
| Operator                  | Zinc base die casting with a copper-nickel-chrome plated finish<br>Withstands the 200 hr. salt spray test in accordance with MIL Spec. QQ-M-151A and NEMA 4X testing.  |
| Internal parts            | Including shafts, washers and springs, are made of stainless steel   |
| Buttons and lenses        | Colorfast, wear resistant, molded acetal resin   |
| Contact blocks            | Made of molded, heat resistant, mineral filled phenolic<br>Contact block plungers are molded of nylon filled phenolic<br>Contacts are silver   |
| Reliability nibs          | These nibs combine a scrubbing action with high pressure density when the contacts are closed<br>They push through particles and films found on contact surfaces in industrial environments<br>Reliability nibs self-adjust to the application—dry circuit, normal or heavy-duty |

### Reliability Nibs



## Electrical Ratings

### Contact Blocks

#### Meet or Exceed NEMA Contact Rating Designation A600 and P300

| Description                                     | Vac A600 |      |      |      | Vdc P300 |      |      |
|---|----------|------|------|------|----------|------|------|
|   | 120V     | 240V | 480V | 600V | 24/28V   | 125V | 250V |
| Make and emergency interrupting capacity (Amps) | 60       | 30   | 15   | 12   | 5.73     | 1.1  | 0.55 |
| Normal load break (Amps)                        | 6        | 3    | 1.5  | 1.2  | 5.73     | 1.1  | 0.55 |
| Continuous current (Amps)                       | 10       | 10   | 10   | 10   | 5        | 5    | 5    |

- UL A600/P300 nominal connect 10A
- 1NO, 1NC, 2NO, 2NC, 1NO-1NC, early make, late break and overlapping configurations
- Mechanical positive drive operation on NC contacts
- Palladium alloy contact for logic level or highly corrosive environments

### Maximum Ratings for Logic Level and Hostile Atmosphere Application

| Description     | Specification     |
|-----------------|-------------------|
| Maximum amperes | 0.5A <sup>①</sup> |
| Maximum volts   | 120 Vac/Vdc       |

#### Note

<sup>①</sup> Logic level contact blocks are UL A600/P500 rated per table above.

### Light Unit

| Description                  | Specification                    |
|------------------------------|----------------------------------|
| <b>Bulbs—Average Life</b>    |                                  |
| Transformer type             | 20,000 hrs.                      |
| Resistor/direct voltage type | 2,500 hrs. min. at rated voltage |
| LED                          | 60,000 to 100,000 hrs.           |

**Dimensions**

Approximate Dimensions in Inches (mm)

**Pushbutton Operators**

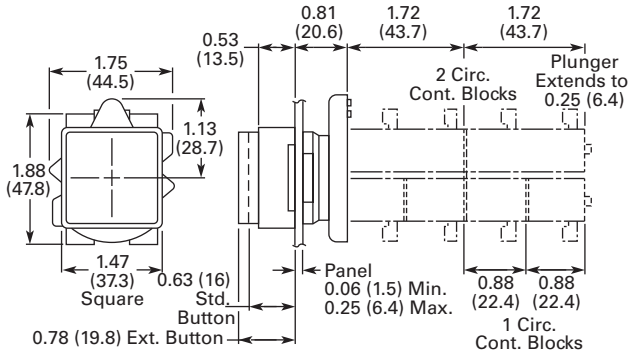

**Combination Pushbutton and Indicating Light Operators**

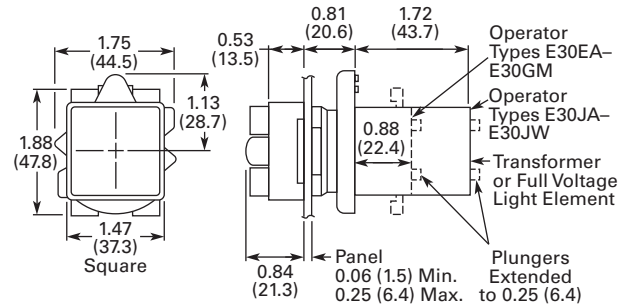

**Combination Pushbutton and Indicating Light Operators**

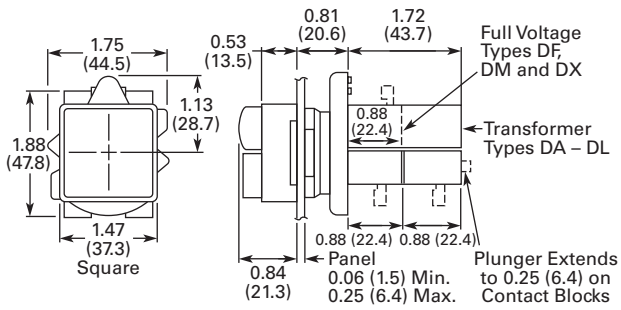

**Indicating Light Operators**

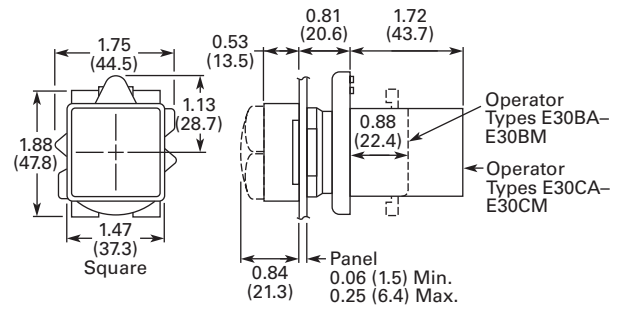

**Padlocking Attachment and Half Shroud E30KT7**

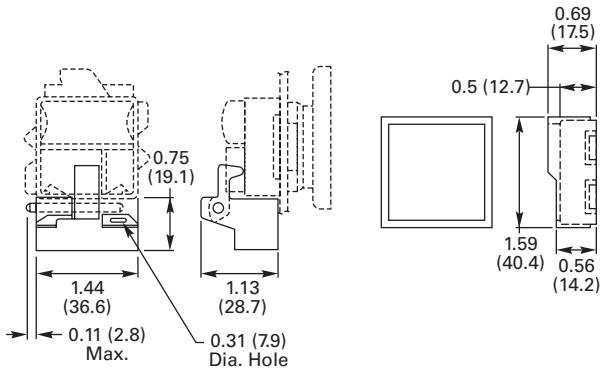

**Drilling Dimensions—Minimum Spacing <sup>①②</sup>**

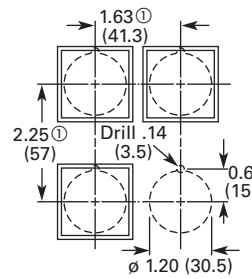

**Notes**

- ① Dimensions shown allow adequate space for the addition of one or two high legend plates and color coordinating collars.
- ② Locating nib hole or notch is 0.136 in (3.5 mm) drill. Alternate to drilling mounting holes use Greenlee Tool Co. punch (No. 730-S) to punch the hole and (No. 730-K) to punch the notch.

**Legend Plates**

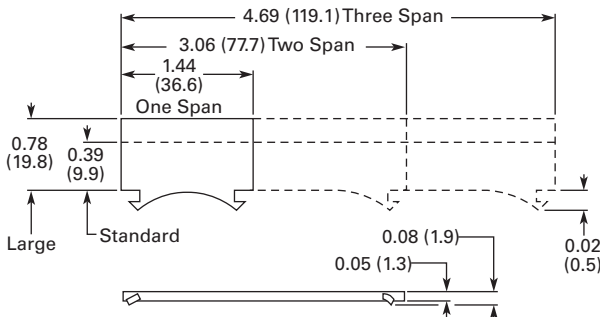



### Contents

| <i>Description</i>                            | <i>Page</i> |
|---|-------------|
| 30.5 mm Heavy-Duty Watertight/Oiltight—10250T |             |
| Product Overview                              | V7-T1-183   |
| Product Identification                        | V7-T1-183   |
| Catalog Number Selection                      | V7-T1-184   |
| Product Selection                             |             |
| Point-of-Purchase Packaging                   | V7-T1-186   |
| Non-Illuminated Momentary Pushbutton Units    | V7-T1-187   |
| Pushbuttons                                   | V7-T1-188   |
| Illuminated Momentary Pushbutton Units        | V7-T1-192   |
| Indicating Light Units                        | V7-T1-193   |
| Illuminated Pushbuttons and Indicating Lights | V7-T1-194   |
| Push-Pull Emergency Stop                      | V7-T1-196   |
| Illuminated Push-Pull Units                   | V7-T1-199   |
| Potentiometers                                | V7-T1-202   |
| Push-Pull Operators                           | V7-T1-203   |
| Selector Switch Units                         | V7-T1-207   |
| Selector Switch Selection                     | V7-T1-208   |
| Selector Switch Operators                     | V7-T1-211   |
| Illuminated Selector Switch Operators         | V7-T1-214   |
| Joystick Units                                | V7-T1-215   |
| Joysticks                                     | V7-T1-216   |
| Roto-Push Units                               | V7-T1-219   |
| Roto-Push Operators                           | V7-T1-220   |
| Accessories                                   | V7-T1-225   |
| Options                                       | V7-T1-230   |
| Replacement Parts                             | V7-T1-239   |
| Technical Data and Specifications             | V7-T1-241   |
| Dimensions                                    | V7-T1-244   |



Drawings  
Online

### Product Description

The 30.5 mm pushbutton line features a zinc die cast construction with chrome-plated housing and mounting nut. The same durable construction is also available with the corrosive resistant E34 line of pushbuttons. See E34 section on **Pages V7-T1-254 to V7-T1-288**.

### Features

- Heavy-duty zinc die cast construction
- Enclosed silver contacts with reliability nibs
- Diaphragm seals with drainage holes
- Grounding nibs on the operator casing

### Benefits

- Reliability nibs improve contact reliability even under dry circuit and fine dust conditions
- Drainage holes prevent buildup of liquid inside the operator which can prevent operation in freezing environments
- Grounding nibs bit through paint and other coatings to provide secure ground

### Application Description

#### Contact Operation

Slow make and break. All normally closed contacts have positive opening operation, i.e., normally closed contacts are forced open in the event of contact weld or spring breakage.

### Standards and Certifications

- CE EN 60947-5-1 and 60947-5-5
- UL 508—File No. 131568
- CSA C22.2 No. 14—File No. LR68551



### Ingress Protection

When mounted in similarly rated enclosure—

- Standard indicating lights
  - UL (NEMA) Type 1, 2, 3, 3R, 3S, 4, 4X, 12, 13
  - IEC IP65
- Most other operators
  - UL (NEMA) Type 1, 2, 3, 3R, 4, 4X, 12, 13
  - IEC IP65

**Product Overview**

**Reliability Nibs**

Eaton’s contact blocks feature enclosed silver contacts with pointed “reliability nibs” for reliable performance from logic level up to 600V. To ensure reliable switching, nibs bite through oxide which can form on silver contacts, eliminating the need for expensive logic level blocks for most applications.

**Reliability Nibs**

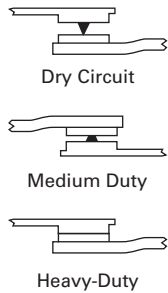

Reliability nibs improve performance in dry circuit, corrosive, fine dust and other contaminated atmospheres. Under normal environmental conditions, the minimum operational voltage is 5V and the minimum operational current is 1 mA, AC/DC. For operation under a wider range of environmental conditions, logic level contact blocks with inert palladium tipped contacts are recommended.

**Grounding Nibs**

10250T line operators have “grounding nibs”—four metal points on the operator casting designed to bite through most paints and other coatings on metal panels to enhance the ground connection when the operator is securely tightened.

**Grounding Nibs**

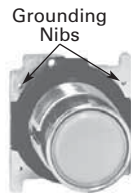

**Diaphragm Seal with Drainage Holes**

**Liquid Drainage**

Eaton’s pushbutton operators offer front of panel drainage via holes in the operator bushing. Hidden from view by the mounting nut, these holes prevent buildup of liquid inside the operator, which can prevent operation in freezing environments. The holes also provide a route for escaping liquid in high pressure washdowns, effectively relieving pressure from the internal diaphragm seal, ensuring reliable sealing in applications even beyond NEMA 4.

**Diaphragm Seal**

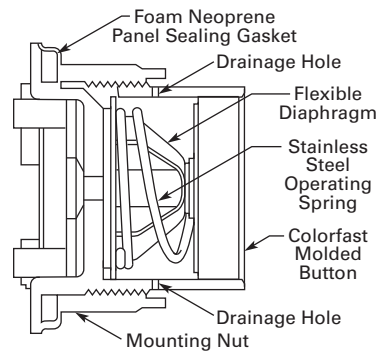

**Product Identification**

**30.5 mm Heavy-Duty Watertight/Oiltight—10250T Series**

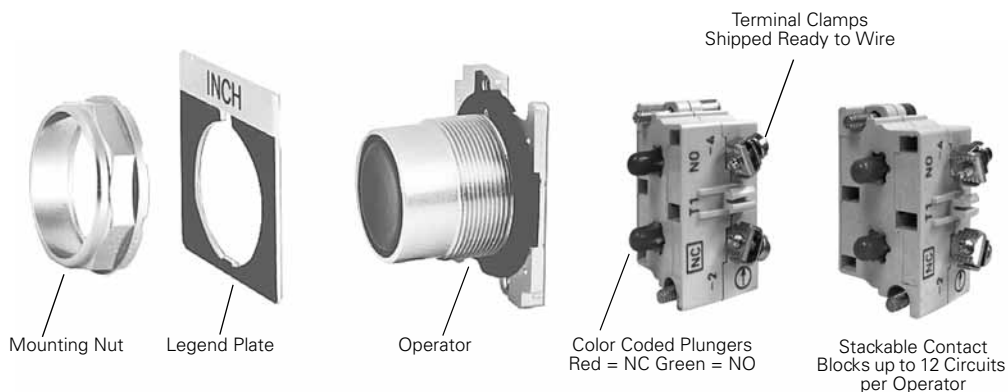

#### 1

### Catalog Number Selection

Catalog Number Selection is for illustrative purposes only and not to be used to create new catalog numbers.

#### Non-Illuminated Pushbuttons

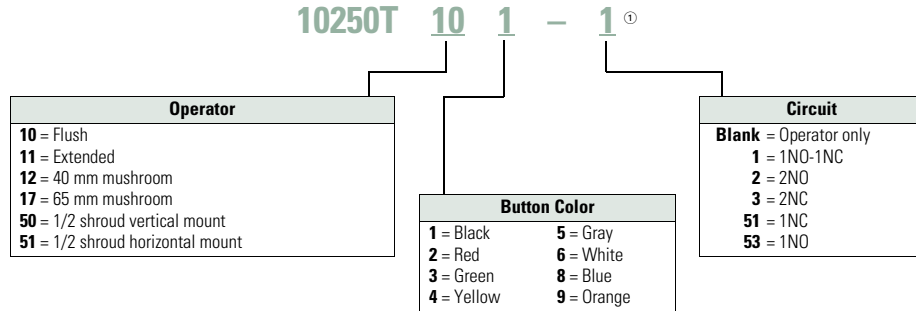

#### Illuminated and Non-Illuminated Push-Pulls

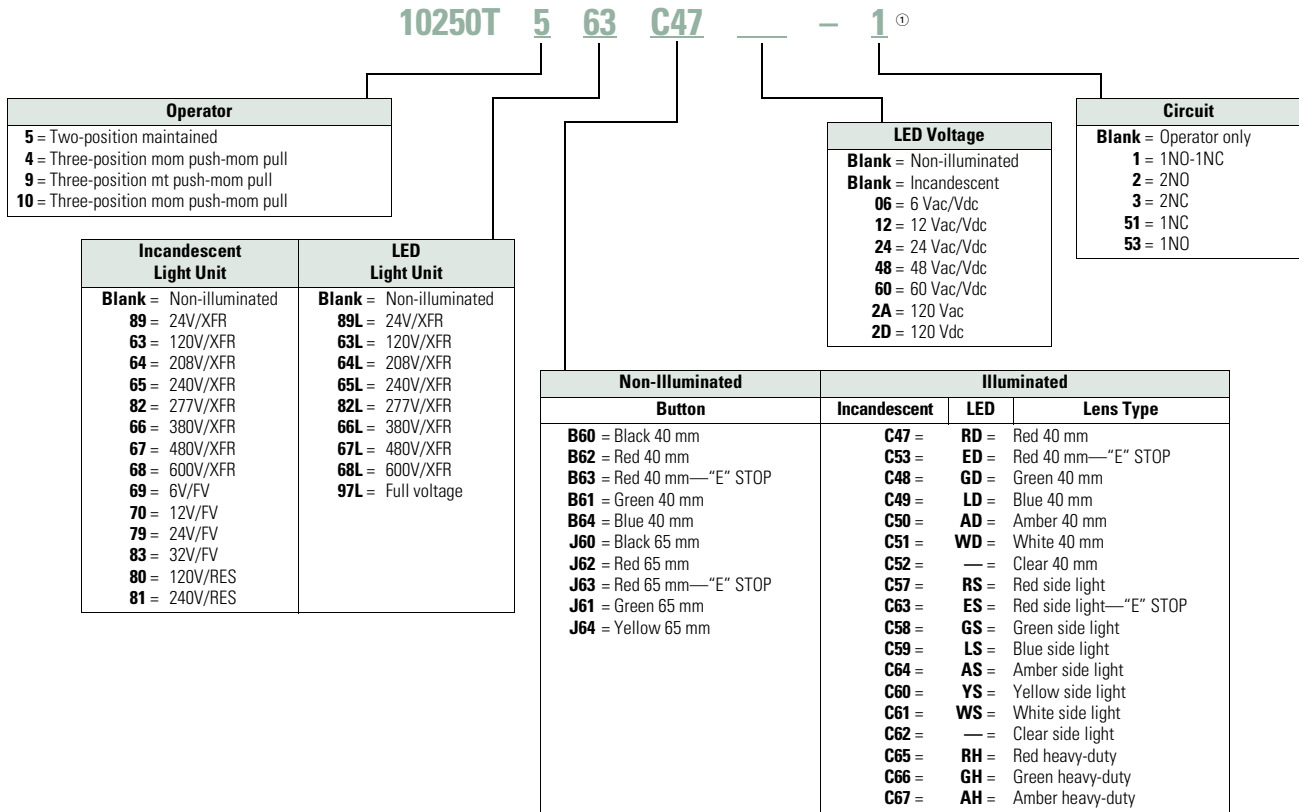

**Note**

① Add **X** at end of catalog number to receive parts assembled from factory.

Catalog Number Selection is for illustrative purposes only and not to be used to create new catalog numbers.

### Illuminated Pushbuttons

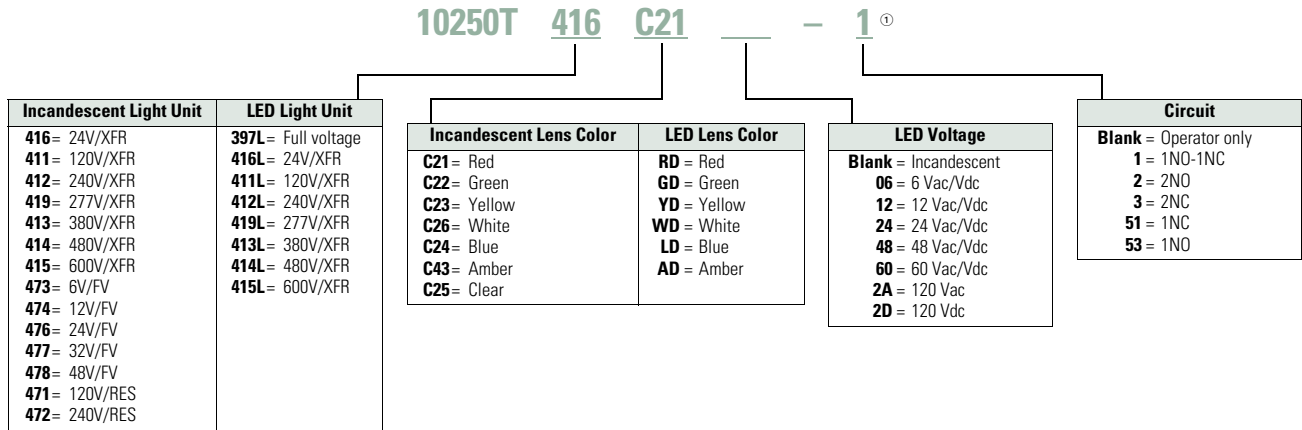

### Standard Indicating Lights, PresTest and Master Test

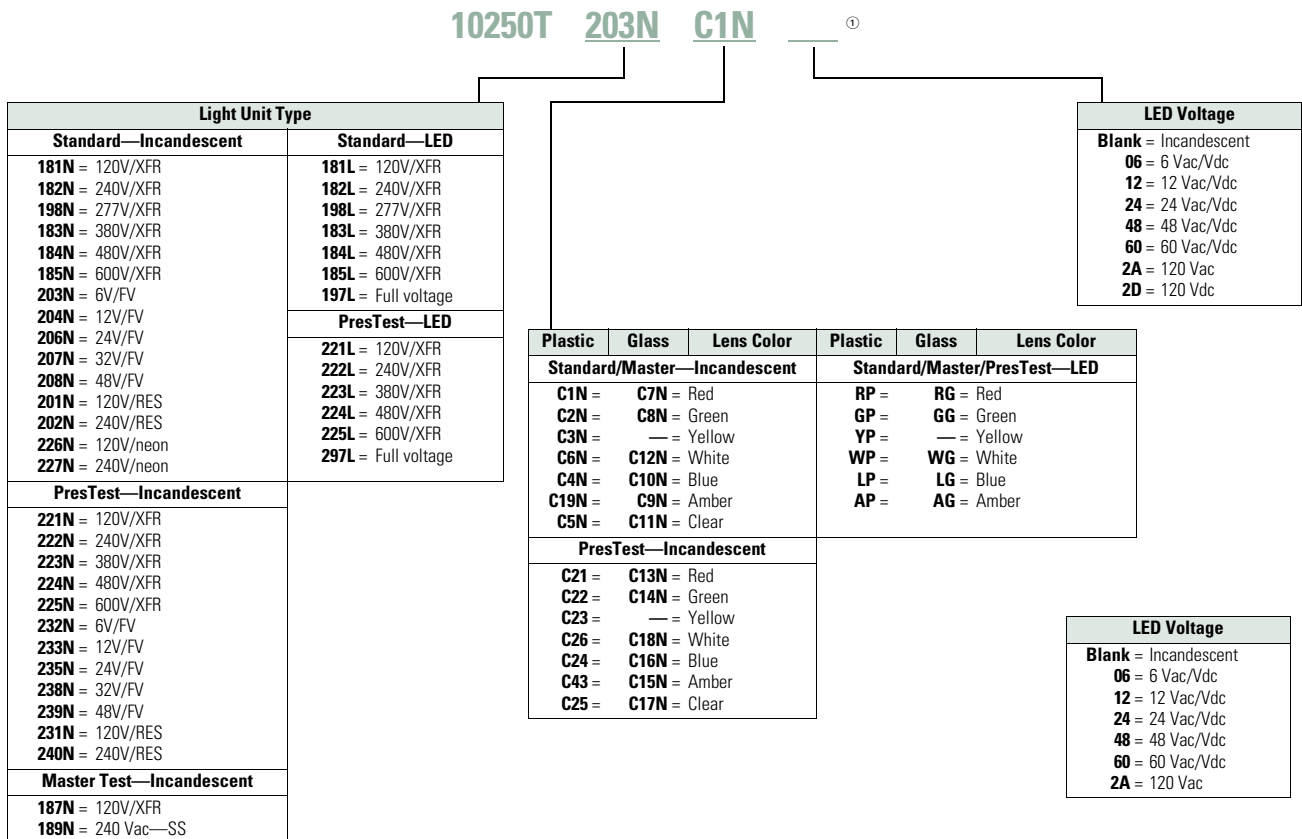

**Note**

① Add **X** at end of catalog number to receive parts assembled from factory.

## Product Selection

## Point-of-Purchase Packaging

Point-of-Purchase  
Packaged Pilot Device

## 10250T Point-of-Purchase Packaged Pilot Devices

| Product                                   | Description   | Catalog Number            |
|---|---|---------------------------|
| <b>Emergency Stop Operators</b>           |   |                           |
| Red non-illuminated push-pull             | 1NO-1NC contact block. Also includes two square engraved legend plates: EMERG. STOP and STOP.   | <b>10250T5B62-1-POP</b>   |
| Red mushroom pushbutton                   | 1NO-1NC contact block. Also includes two square engraved legend plates: EMERG. STOP and STOP.   | <b>10250T32R-POP</b>      |
| Red jumbo mushroom pushbutton             | Engraved EMERG. STOP with 1NO-1NC contact block.  | <b>10250T33-POP</b>       |
| <b>Momentary Pushbuttons</b>              |   |                           |
| Black flush pushbutton                    | 1NO-1NC contact block. Also includes two square engraved legend plates: START and JOG.  | <b>10250T30B-POP</b>      |
| Red extended pushbutton                   | 1NO-1NC contact block. Also includes one square engraved legend plate: STOP.  | <b>10250T31R-POP</b>      |
| <b>Indicating Lights</b>                  |   |                           |
| Red indicating light                      | Full voltage 24 Vac/Vdc with two extra lenses: Green and amber. Also includes two square engraved legend plates: RUN and JOG.                       | <b>10250T206NC1N-POP</b>  |
| Red indicating light                      | Resistor 120 Vac/Vdc with two extra lenses: Green and Amber. Also includes one square engraved legend plate: RUN and JOG.                           | <b>10250T34R-POP</b>      |
| <b>Illuminated Pushbuttons</b>            |   |                           |
| Red illuminating pushbutton               | Full voltage 24 Vac/Vdc with 1NO-1NC contact block and two extra lenses: Green and amber. Also includes one square engraved legend plate: POWER ON. | <b>10250T476C21-1-POP</b> |
| Red illuminating pushbutton               | Resistor 120 Vac/Vdc with 1NO-1NC contact block and two extra lenses: Green and amber. Also includes one square engraved legend plate: POWER ON.    | <b>10250T411C21-1-POP</b> |
| <b>Selector Switches</b>                  |   |                           |
| Black knob two-position selector switch   | 1NO-1NC contact block. Also includes three square engraved legend plates: OFF/ON, HAND/AUTO and RUN/JOG.  | <b>10250T20KB-POP</b>     |
| Black knob three-position selector switch | 2NO-2NC contact blocks. Also includes 1 square engraved legend plate: HAND/OFF/AUTO.  | <b>10250T22KB-POP</b>     |
| Black knob three-position selector switch | 1NO-1NC contact block. Also includes legend plate: HAND/OFF/AUTO  | <b>10250T21KB-POP</b>     |

### Non-Illuminated Momentary Pushbutton Units

UL (NEMA) Type 3, 3R, 4, 4X, 12, 13

#### Flush Button



#### Extended Button



#### Mushroom Button



#### Jumbo Mushroom



### Pushbutton Units—Flush, Extended, Mushroom Head or Jumbo Mushroom Head Operators

| Contact Type | Button Color             | Flush Button Catalog Number | Extended Button Catalog Number | Mushroom Button Catalog Number | Jumbo Mushroom <sup>①</sup> Catalog Number |
|--------------|--------------------------|-----------------------------|--------------------------------|--------------------------------|--|
| 1NO          | Black                    | 10250T23B                   | 10250T25B                      | 10250T26B                      | 10250T27B                                  |
|              | Red                      | 10250T23R                   | 10250T112-53                   | 10250T122-53                   | 10250T172-53                               |
|              | Green                    | 10250T23G                   | 10250T25G                      | 10250T26G                      | 10250T27G                                  |
|              | Yellow                   | 10250T23Y                   | 10250T25Y                      | 10250T26Y                      | 10250T27Y                                  |
|              | Red—Engraved EMERG. STOP | —                           | —                              | —                              | 10250T17213-53                             |
| 1NC          | Black                    | 10250T101-51                | 10250T111-51                   | 10250T121-51                   | 10250T171-51                               |
|              | Red                      | 10250T102-51                | 10250T25R                      | 10250T26R                      | 10250T27R                                  |
|              | Green                    | 10250T103-51                | 10250T113-51                   | 10250T123-51                   | 10250T173-51                               |
|              | Yellow                   | 10250T104-51                | 10250T120-51                   | 10250T124-51                   | 10250T174-51                               |
|              | Red—Engraved EMERG. STOP | —                           | —                              | —                              | 10250T29                                   |
| 1NO-1NC      | Black                    | 10250T30B                   | 10250T31B                      | 10250T32B                      | 10250T33B                                  |
|              | Red                      | 10250T30R                   | 10250T31R                      | 10250T32R                      | 10250T33R                                  |
|              | Green                    | 10250T30G                   | 10250T31G                      | 10250T32G                      | 10250T33G                                  |
|              | Yellow                   | 10250T30Y                   | 10250T31Y                      | 10250T32Y                      | 10250T33Y                                  |
|              | Red—Engraved EMERG. STOP | —                           | —                              | —                              | 10250T33                                   |
| 2NO          | Black                    | 10250T101-2                 | 10250T111-2                    | 10250T121-2                    | 10250T171-2                                |
|              | Red                      | 10250T102-2                 | 10250T112-2                    | 10250T122-2                    | 10250T172-2                                |
|              | Green                    | 10250T103-2                 | 10250T113-2                    | 10250T123-2                    | 10250T173-2                                |
|              | Yellow                   | 10250T104-2                 | 10250T120-2                    | 10250T124-2                    | 10250T174-2                                |
|              | Red—Engraved EMERG. STOP | —                           | —                              | —                              | 10250T17213-2                              |
| 2NC          | Black                    | 10250T101-3                 | 10250T111-3                    | 10250T121-3                    | 10250T171-3                                |
|              | Red                      | 10250T102-3                 | 10250T112-3                    | 10250T122-3                    | 10250T172-3                                |
|              | Green                    | 10250T103-3                 | 10250T113-3                    | 10250T123-3                    | 10250T173-3                                |
|              | Yellow                   | 10250T104-3                 | 10250T120-3                    | 10250T124-3                    | 10250T174-3                                |
|              | Red—Engraved EMERG. STOP | —                           | —                              | —                              | 10250T17213-3                              |

**Note**

① Anodized aluminum head is not suitable for use in ultraviolet light applications.









# 1

## Pushbuttons

UL (NEMA) Type 3, 3R, 4, 4X, 12, 13

### Momentary Pushbutton Operators, Non-illuminated

| Button   | Color   | Catalog Number       |                      |                  |                  |
|--|---|----------------------|----------------------|------------------|------------------|
|  |   | Vertical             | Horizontal           |                  |                  |
| <b>10250T10_</b><br>      | Flush button <sup>①</sup>   | Black                | <b>10250T101</b>     |                  |                  |
|  | Red   | <b>10250T102</b>     |                      |                  |                  |
|  | Green   | <b>10250T103</b>     |                      |                  |                  |
|  | Yellow  | <b>10250T104</b>     |                      |                  |                  |
|  | Gray  | <b>10250T105</b>     |                      |                  |                  |
|  | White   | <b>10250T106</b>     |                      |                  |                  |
|  | Blue  | <b>10250T108</b>     |                      |                  |                  |
|  | Orange  | <b>10250T109</b>     |                      |                  |                  |
| <b>10250T11_</b><br>      | Extended button   | Black                | <b>10250T111</b>     |                  |                  |
|  | Red   | <b>10250T112</b>     |                      |                  |                  |
|  | Green   | <b>10250T113</b>     |                      |                  |                  |
|  | Yellow  | <b>10250T120</b>     |                      |                  |                  |
|  | White   | <b>10250T116</b>     |                      |                  |                  |
|  | Blue  | <b>10250T118</b>     |                      |                  |                  |
|  | Orange  | <b>10250T119</b>     |                      |                  |                  |
|  | <b>10250T5_</b><br> | Half shrouded button | Black                | <b>10250T501</b> | <b>10250T511</b> |
| Red  |   |                      | <b>10250T502</b>     | <b>10250T512</b> |                  |
| Green  |   | <b>10250T503</b>     | <b>10250T513</b>     |                  |                  |
| Yellow   |   | <b>10250T504</b>     | <b>10250T514</b>     |                  |                  |
| Gray   |   | <b>10250T505</b>     | <b>10250T515</b>     |                  |                  |
| White  |   | <b>10250T506</b>     | <b>10250T516</b>     |                  |                  |
| Blue   |   | <b>10250T508</b>     | <b>10250T518</b>     |                  |                  |
| Orange   |   | <b>10250T509</b>     | <b>10250T519</b>     |                  |                  |
| <b>10250T12_</b><br>    |   | Mushroom button      | Black                | <b>10250T121</b> |                  |
|  |   |                      | Red                  | <b>10250T122</b> |                  |
|  | Green   |                      | <b>10250T123</b>     |                  |                  |
|  | Yellow  |                      | <b>10250T124</b>     |                  |                  |
|  | Blue  |                      | <b>10250T129</b>     |                  |                  |
| <b>10250T17_</b><br>    | Jumbo mushroom button <sup>②</sup>  | Black                | <b>10250T171</b>     |                  |                  |
|  |   | Red                  | <b>10250T172</b>     |                  |                  |
|  |   | Red (EMERG. STOP)    | <b>10250T17213</b>   |                  |                  |
|  |   | Green                | <b>10250T173</b>     |                  |                  |
|  |   | Yellow               | <b>10250T174</b>     |                  |                  |
| <b>10250ED1164_</b><br> | Low operating force—jumbo mushroom <sup>②③</sup>  | Black                | <b>10250ED1164-2</b> |                  |                  |
|  |   | Red                  | <b>10250ED1164-3</b> |                  |                  |
|  |   | Green                | <b>10250ED1164-4</b> |                  |                  |
|  |   | Yellow               | <b>10250ED1164-5</b> |                  |                  |
|  |   | Clear                | <b>10250ED1164</b>   |                  |                  |

**Note:** To order complete assembled unit using one composite catalog number, add contact block and legend plate suffix to the end of operator catalog number. Example: 10250T101-1TS33



**Operator**  
10250T101

+



**Contact Block**  
10250T1

+



**Legend Plate**  
10250TS33

#### Notes

- ① To order operator with factory assembled extended retaining nut, **10250TA12**, for thick panel applications, add suffix letter **E** to listed catalog number. Example: 10250T101E.
- ② Anodized aluminum head is not suitable for use in ultraviolet light applications.
- ③ Operating force—Standard = 2.4 lb; low force = 1.6 lb.

UL (NEMA) Type 3, 3R, 4, 4X, 12, 13

10250TA\_



### Mechanically Interlocked Pushbutton Operators

| Description                                 | Catalog Number         |
|---|------------------------|
| Black flush and green flush                 | 10250TA66              |
| Black flush and long red                    | 10250TA67              |
| Black flush and red mushroom head           | 10250TA68              |
| Black flush and lock-down red mushroom head | 10250TA69 <sup>①</sup> |
| Black flush and red jumbo mushroom head     | 10250TA76              |
| Green flush and long red                    | 10250TA72              |
| Black long and long red                     | 10250TA73              |
| Green flush and red mushroom head           | 10250TA77              |
| Green flush and black flush                 | 10250TA75              |

**Note**

<sup>①</sup> NC contacts must be mounted behind lock-down mushroom head operator to ensure lockout.

**Lockout Pushbutton Operators with Padlock Attachments**

UL (NEMA) Type 3, 3R, 4, 4X, 12, 13

The following pushbutton and mushroom operators include an integral padlock attachment for applications requiring lockout/tagout of specific machine functions. They are available in styles which allow locking of a button in the down position

(stopped position) or locking a button in the up position (to prevent starting). Select the **“Hand”** latch type which functions as a momentary pushbutton until the operator presses the button and moves the padlock attachment into position for

locking, or choose the **“Spring Loaded”** latch type where the padlock attachment springs into place when the button is pressed. Units accept a customer supplied 1/4 in padlock.

**10250TA16****Padlockable in the Down Position** ①

| Operator Type | Color             | Latch Type    | Catalog Number    |
|---------------|-------------------|---------------|-------------------|
| Flush head    | Red               | Hand          | <b>10250TA16</b>  |
| Mushroom head | Red               | Hand          | <b>10250TA42</b>  |
|               | Red               | Spring loaded | <b>10250TA45</b>  |
| Jumbo head ②  | Red               | Hand          | <b>10250TA52</b>  |
|               | Red               | Spring loaded | <b>10250TA55</b>  |
|               | Red (EMERG. STOP) | Spring loaded | <b>10250ED952</b> |

**Padlockable in the Up Position** ①**10250TA4\_**

| Operator Type | Color | Latch Type | Catalog Number   |
|---------------|-------|------------|------------------|
| Mushroom head | Black | Hand       | <b>10250TA41</b> |
|               | Green | Hand       | <b>10250TA43</b> |

**10250TA5\_**

|                       |        |      |                  |
|-----------------------|--------|------|------------------|
| Jumbo mushroom head ② | Black  | Hand | <b>10250TA51</b> |
|                       | Green  | Hand | <b>10250TA53</b> |
|                       | Yellow | Hand | <b>10250TA54</b> |

**Notes**

Hand attachment must be manually moved into place for locking. Spring loaded: when operator is pressed—attachment springs into place. Must be moved manually to release button.

① Operators can be latched down without a padlock. Padlock not included.

② Jumbo mushroom heads are not recommended for use in applications where exposure to ultraviolet light exists.

**Key Pushbutton Operator**

UL (NEMA) Type 3, 3R, 4, 4X, 12, 13

These devices incorporate an integral locking mechanism which enables locking units in various positions (**Locked Down**), locking units to

prevent operation (**Locked Up**) or setting unit to lock when the button is pressed (**Push to Lock**), requiring the key to be inserted to return to

normal operation. With the key in the center position, these operators function as a normal momentary pushbutton (**Free**).

**Replacement Keys or Dissimilar Locks for Key Operators Below**

Listed operators have identical locks and keys (Key Code H661) Catalog Number 10250ED824. For dissimilar lock and key combinations, see listing on **Page V7-T1-212**.

**Replacement Keys**

| Description                  | Catalog Number    |
|------------------------------|-------------------|
| Replacement keys (code H661) | <b>10250ED824</b> |

10250T43



**Key Pushbutton Operator**

Key Position and Pushbutton Operations



**Key Removal Positions**

**Vertical Mounting<sup>①</sup> Catalog Number**

**Three-Position**

|         |      |           |         |                  |
|---------|------|-----------|---------|------------------|
| Lock up | Free | Lock down | All     | <b>10250T430</b> |
| Lock up | Free | Lock down | L and R | <b>10250T431</b> |
| Lock up | Free | Lock down | C and R | <b>10250T432</b> |

**Two-Position**

|         |      |              |         |                  |
|---------|------|--------------|---------|------------------|
| Lock up | Free | —            | L and C | <b>10250T433</b> |
| Lock up | Free | —            | L       | <b>10250T434</b> |
| —       | Free | Lock down    | C and R | <b>10250T435</b> |
| —       | Free | Lock down    | R       | <b>10250T436</b> |
| —       | Free | Push to lock | C and R | <b>10250T437</b> |
| —       | Free | Push to lock | R       | <b>10250T438</b> |

**Latch-In, Twist-to-Release Operator**

UL (NEMA) Type 3, 3R, 4, 4X, 12, 13

10250ED1043-4



**Operator Only with Button**

| Description   | Catalog Number       |
|---|----------------------|
| Latch-in, twist-to-release operator with red mushroom head button | <b>10250ED1043-4</b> |

**Note**

① Horizontal mounting available on request.

#### 1

### Illuminated Momentary Pushbutton Units

UL (NEMA) Type 3, 3R, 4, 4X, 12, 13

- LED or incandescent
- Full voltage, resistor or transformer type
- Plastic lenses

#### 24V Full Voltage Illuminated Pushbutton



### Illuminated Pushbutton Units

| Type            | Voltage     | Color       | LED/Lamp Number   | Illuminated Pushbutton |                        |                    |
|-----------------|-------------|-------------|-------------------|------------------------|------------------------|--------------------|
|                 |             |             |                   | 1NO Catalog Number     | 1NO-1NC Catalog Number | 1NC Catalog Number |
| <b>LED Lamp</b> |             |             |                   |                        |                        |                    |
| Full voltage    | 24 Vac/Vdc  | Red         | Bayonet base      | 10250T397LRD24-53      | 10250T397LRD24-1       | 10250T397LRD24-51  |
|                 |             |             |                   | 10250T397LGD24-53      | 10250T397LGD24-1       | 10250T397LGD24-51  |
|                 |             |             |                   | 10250T397LAD24-53      | 10250T397LAD24-1       | 10250T397LAD24-51  |
|                 |             |             |                   | 10250T397LYD24-53      | 10250T397LYD24-1       | 10250T397LYD24-51  |
|                 |             |             |                   | 10250T397LLD24-53      | 10250T397LLD24-1       | 10250T397LLD24-51  |
|                 |             | 120 Vac/Vdc | Green             | 10250T397LWD24-53      | 10250T397LWD24-1       | 10250T397LWD24-51  |
|                 |             |             |                   | 10250T397LRD2A-53      | 10250T397LRD2A-1       | 10250T397LRD2A-51  |
|                 |             |             |                   | 10250T397LGD2A-53      | 10250T397LGD2A-1       | 10250T397LGD2A-51  |
|                 |             |             |                   | 10250T397LAD2A-53      | 10250T397LAD2A-1       | 10250T397LAD2A-51  |
|                 |             |             |                   | 10250T397LYD2A-53      | 10250T397LYD2A-2       | 10250T397LYD2A-51  |
|                 |             |             | Blue              | 10250T397LLD2A-53      | 10250T397LLD2A-1       | 10250T397LLD2A-51  |
|                 |             |             |                   | 10250T397LWD2A-53      | 10250T397LWD2A-1       | 10250T397LWD2A-51  |
|                 |             |             |                   | 10250T411LRD06-53      | 10250T411LRD06-1       | 10250T411LRD06-51  |
|                 |             |             |                   | 10250T411LGD06-53      | 10250T411LGD06-1       | 10250T411LGD06-51  |
|                 |             |             |                   | 10250T411LAD06-53      | 10250T411LAD06-1       | 10250T411LAD06-51  |
| Transformer     | 120 Vac     | Red         | 120MB             | 10250T411LYD06-53      | 10250T411LYD06-1       | 10250T411LYD06-51  |
|                 |             |             |                   | 10250T411LLD06-53      | 10250T411LLD06-1       | 10250T411LLD06-51  |
|                 |             |             |                   | 10250T411LWD06-53      | 10250T411LWD06-1       | 10250T411LWD06-51  |
|                 |             |             |                   | 10250T411LRD06-53      | 10250T411LRD06-1       | 10250T411LRD06-51  |
|                 |             |             |                   | 10250T411LGD06-53      | 10250T411LGD06-1       | 10250T411LGD06-51  |
|                 |             | Green       | 10250T411LAD06-53 | 10250T411LAD06-1       | 10250T411LAD06-51      |                    |
|                 |             |             | 10250T411LYD06-53 | 10250T411LYD06-1       | 10250T411LYD06-51      |                    |
|                 |             |             | 10250T411LLD06-53 | 10250T411LLD06-1       | 10250T411LLD06-51      |                    |
|                 |             |             | 10250T411LWD06-53 | 10250T411LWD06-1       | 10250T411LWD06-51      |                    |
|                 |             |             | 10250T476C21-53   | 10250T476C21-1         | 10250T476C21-51        |                    |
|                 |             |             | 10250T476C22-53   | 10250T476C22-1         | 10250T476C22-51        |                    |
|                 |             |             | 10250T476C43-53   | 10250T476C43-1         | 10250T476C43-51        |                    |
|                 |             |             | 10250T476C23-53   | 10250T476C23-1         | 10250T476C23-51        |                    |
|                 |             |             | 10250T476C24-53   | 10250T476C24-1         | 10250T476C24-51        |                    |
|                 |             |             | 10250T476C25-53   | 10250T476C25-1         | 10250T476C25-51        |                    |
| Resistor        | 120 Vac/Vdc | Red         | #757              | 10250T476C26-53        | 10250T476C26-1         | 10250T476C26-51    |
|                 |             |             |                   | 10250T471C21-53        | 10250T471C21-1         | 10250T471C21-51    |
|                 |             |             |                   | 10250T471C22-53        | 10250T471C22-1         | 10250T471C22-51    |
|                 |             |             |                   | 10250T471C43-53        | 10250T471C43-1         | 10250T471C43-51    |
|                 |             |             |                   | 10250T471C23-53        | 10250T471C23-1         | 10250T471C23-51    |
|                 |             | Green       | 10250T471C24-53   | 10250T471C24-1         | 10250T471C24-51        |                    |
|                 |             |             | 10250T471C25-53   | 10250T471C25-1         | 10250T471C25-51        |                    |
|                 |             |             | 10250T471C26-53   | 10250T471C26-1         | 10250T471C26-51        |                    |
|                 |             |             | 10250T75R ①       | 10250T76R ①            | 10250T77R ①            |                    |
|                 |             |             | 10250T75G ①       | 10250T76G ①            | 10250T77G ①            |                    |
|                 |             |             | 10250T75A ①       | 10250T76A ①            | 10250T77A ①            |                    |
|                 |             |             | 10250T75Y ①       | 10250T76Y ①            | 10250T77Y ①            |                    |
|                 |             |             | 10250T75B ①       | 10250T76B ①            | 10250T77B ①            |                    |
|                 |             |             | 10250T75C ①       | 10250T76C ①            | 10250T77C ①            |                    |
|                 |             |             | 10250T75W ①       | 10250T76W ①            | 10250T77W ①            |                    |
| Transformer     | 120 Vac     | Red         | #755              | 10250T75R ①            | 10250T76R ①            | 10250T77R ①        |
|                 |             |             |                   | 10250T75G ①            | 10250T76G ①            | 10250T77G ①        |
|                 |             |             |                   | 10250T75A ①            | 10250T76A ①            | 10250T77A ①        |
|                 |             |             |                   | 10250T75Y ①            | 10250T76Y ①            | 10250T77Y ①        |
|                 |             |             |                   | 10250T75B ①            | 10250T76B ①            | 10250T77B ①        |
|                 |             | Green       | 10250T75C ①       | 10250T76C ①            | 10250T77C ①            |                    |
|                 |             |             | 10250T75W ①       | 10250T76W ①            | 10250T77W ①            |                    |

#### Note

① For flashing module catalog number 10250TFL1, add suffix code **FM** to listed catalog number. Example: 10250T75R**FM**.

### Indicating Light Units ①

UL (NEMA) Type 3, 3R, 4, 4X, 12, 13

- LED or incandescent
- Full voltage, resistor or transformer type
- Standard and PresTest types
- Plastic lenses

PresTest—This device incorporates a press-to-test feature whereby depressing the lens disconnects the light from the source being

monitored and connects the lamp to a continuously energized circuit for immediate detection of faulty lamps.

24V Full Voltage Illuminated Light



120 Vac Transformer PresTest



### Indicating Light Units

| Type                     | Voltage     | Color          | LED/Lamp Number | Indicating Light Catalog Number | PresTest Catalog Number |                |               |
|--------------------------|-------------|----------------|-----------------|---------------------------------|-------------------------|----------------|---------------|
| <b>LED Lamp</b>          |             |                |                 |                                 |                         |                |               |
| Full voltage             | 24 Vac/Vdc  | Red            | Bayonet base    | 10250T197LRP24                  | 10250T297LRP24          |                |               |
|                          |             | Green          |                 | 10250T197LGP24                  | 10250T297LGP24          |                |               |
|                          |             | Amber          |                 | 10250T197LAP24                  | 10250T297LAP24          |                |               |
|                          |             | Yellow         |                 | 10250T197LYP24                  | 10250T297LYP24          |                |               |
|                          |             | Blue           |                 | 10250T197LLP24                  | 10250T297LLP24          |                |               |
|                          |             | White          |                 | 10250T197LWP24                  | 10250T297LWP24          |                |               |
|                          |             | 120 Vac        |                 | Red                             | 10250T197LRP2A          | 10250T297LRP2A |               |
|                          |             |                |                 | Green                           | 10250T197LGP2A          | 10250T297LGP2A |               |
|                          | Amber       |                | 10250T197LAP2A  | 10250T297LAP2A                  |                         |                |               |
|                          | Yellow      |                | 10250T197LYP2A  | 10250T297LYP2A                  |                         |                |               |
|                          | Blue        |                | 10250T197LLP2A  | 10250T297LLP2A                  |                         |                |               |
|                          | White       |                | 10250T197LWP2A  | 10250T297LWP2A                  |                         |                |               |
|                          | Transformer |                | 120 Vac         | Red                             | 10250T181LRP06          | 10250T221LRP06 |               |
|                          |             |                |                 | Green                           | 10250T181LGP06          | 10250T221LGP06 |               |
|                          |             | Amber          |                 | 10250T181LAP06                  | 10250T221LAP06          |                |               |
|                          |             | Yellow         |                 | 10250T181LYP06                  | 10250T221LYP06          |                |               |
| Blue                     |             | 10250T181LLP06 |                 | 10250T221LLP06                  |                         |                |               |
| White                    |             | 10250T181LWP06 |                 | 10250T221LWP06                  |                         |                |               |
| <b>Incandescent Lamp</b> |             |                |                 |                                 |                         |                |               |
| Full voltage             |             | 24 Vac/Vdc     |                 | Red                             | #757                    | 10250T206NC1N  | 10250T235NC21 |
|                          | Green       |                | 10250T206NC2N   | 10250T235NC22                   |                         |                |               |
|                          | Amber       |                | 10250T206NC19N  | 10250T235NC43                   |                         |                |               |
|                          | Yellow      |                | 10250T206NC3N   | 10250T235NC23                   |                         |                |               |
|                          | Blue        |                | 10250T206NC4N   | 10250T235NC24                   |                         |                |               |
|                          | Clear       |                | 10250T206NC5N   | 10250T235NC25                   |                         |                |               |
|                          | White       |                | 10250T206NC6N   | 10250T235NC26                   |                         |                |               |
|                          | Resistor    | 120 Vac/Vdc    | Red             | 120MB                           | 10250T201NC1N           | 10250T231NC21  |               |
|                          |             |                | Green           |                                 | 10250T201NC2N           | 10250T231NC22  |               |
|                          |             |                | Amber           |                                 | 10250T201NC19N          | 10250T231NC43  |               |
|                          |             |                | Yellow          |                                 | 10250T201NC3N           | 10250T231NC23  |               |
|                          |             |                | Blue            |                                 | 10250T201NC4N           | 10250T231NC24  |               |
|                          |             |                | Clear           |                                 | 10250T201NC5N           | 10250T231NC25  |               |
|                          |             |                | White           |                                 | 10250T201NC6N           | 10250T231NC26  |               |
| Transformer ②            | 120 Vac     | Red            | #755            | 10250T34R                       | 10250T74NR              |                |               |
|                          |             | Green          |                 | 10250T34G                       | 10250T74NG              |                |               |
|                          |             | Amber          |                 | 10250T34A                       | 10250T74NA              |                |               |
|                          |             | Yellow         |                 | 10250T34Y                       | 10250T74NY              |                |               |
|                          |             | Blue           |                 | 10250T34B                       | 10250T74NB              |                |               |
|                          |             | Clear          |                 | 10250T34C                       | 10250T74NC              |                |               |
|                          |             | White          |                 | 10250T34W                       | 10250T74NW              |                |               |

**Notes**

- ① Standard indicating lights are rated UL (NEMA) 3S as well.
- ② For flashing lamp add letter **F** to listed catalog number. Example: 10250T34RF.

**Illuminated Pushbuttons and Indicating Lights**

- LED or incandescent
- Full voltage, resistor or transformer type

**Illuminated Pushbutton****Operators without Lens****Indicating Light****PresTest****Master Test**

| Type  | Voltage | LED/Lamp Number | Illuminated Pushbutton Catalog Number | Indicating Light Catalog Number | PresTest Catalog Number | Master Test Catalog Number |
|---|---------|-----------------|---------------------------------------|---------------------------------|-------------------------|----------------------------|
| <b>Incandescent Unit</b>                    |         |                 |                                       |                                 |                         |                            |
| Full voltage AC/DC                          | 6       | #755            | <b>10250T473</b>                      | <b>10250T203N</b>               | <b>10250T232N</b>       | —                          |
|   | 12      | #756            | <b>10250T474</b>                      | <b>10250T204N</b>               | <b>10250T233N</b>       | —                          |
|   | 24      | #757            | <b>10250T476</b>                      | <b>10250T206N</b>               | <b>10250T235N</b>       | —                          |
|   | 32      | #1828           | <b>10250T477</b>                      | <b>10250T207N</b>               | <b>10250T238N</b>       | —                          |
|   | 48      | #1835           | <b>10250T478</b>                      | <b>10250T208N</b>               | <b>10250T239N</b>       | —                          |
| Resistor AC/DC <sup>②</sup>                 | 120     | 120MB           | <b>10250T471</b>                      | <b>10250T201N</b>               | <b>10250T231N</b>       | —                          |
|   | 240     | 120MB           | <b>10250T472</b>                      | <b>10250T202N</b>               | <b>10250T240N</b>       | —                          |
| Transformer AC only <sup>③</sup>            | 24      | #755            | <b>10250T416</b>                      | —                               | —                       | —                          |
|   | 120     |                 | <b>10250T411</b>                      | <b>10250T181N</b>               | <b>10250T221N</b>       | —                          |
|   | 240     |                 | <b>10250T422</b>                      | <b>10250T182N</b>               | <b>10250T222N</b>       | —                          |
|   | 277     |                 | <b>10250T419</b>                      | <b>10250T198N</b>               | —                       | —                          |
|   | 380     |                 | <b>10250T413</b>                      | <b>10250T183N</b>               | <b>10250T223N</b>       | —                          |
|   | 480     |                 | <b>10250T414</b>                      | <b>10250T184N</b>               | <b>10250T224N</b>       | —                          |
| Neon AC/DC <sup>④</sup>                     | 120     | NE51H-R22       | —                                     | <b>10250T226N</b>               | —                       | —                          |
|   | 240     | NE51H-R68       | —                                     | <b>10250T227N</b>               | —                       | —                          |
| Solid-state 50/60 Hz only                   | 120     | 120MB           | —                                     | —                               | —                       | <b>10250T189N</b>          |
| <b>LED (LEDs not included) <sup>①</sup></b> |         |                 |                                       |                                 |                         |                            |
| Full voltage                                | —       | Bayonet base    | <b>10250T397L</b>                     | <b>10250T197L</b>               | <b>10250T297L</b>       | —                          |
| Transformer AC only                         | 24      |                 | <b>10250T416L</b>                     | —                               | —                       | —                          |
|   | 120     |                 | <b>10250T411L</b>                     | <b>10250T181L</b>               | <b>10250T221L</b>       | —                          |
|   | 240     |                 | <b>10250T412L</b>                     | <b>10250T182L</b>               | <b>10250T222L</b>       | —                          |
|   | 277     |                 | <b>10250T419L</b>                     | <b>10250T198L</b>               | —                       | —                          |
|   | 380     |                 | <b>10250T413L</b>                     | <b>10250T183L</b>               | <b>10250T223L</b>       | —                          |
|   | 480     |                 | <b>10250T414L</b>                     | <b>10250T184L</b>               | <b>10250T224L</b>       | —                          |
|   | 600     |                 | <b>10250T415L</b>                     | <b>10250T185L</b>               | <b>10250T225L</b>       | —                          |

**Notes**

- <sup>①</sup> These units do not include lamps. Order LED separately to match lens color. See **Page V7-T1-239** for LED Selection and **Page V7-T1-185** for Catalog Numbering System.
- <sup>②</sup> Resistor units are not available for use with LEDs, choose either transformer or full voltage LED style.
- <sup>③</sup> For flashing lamp, add letter **F** to listed catalog number. Example: 10250T181NF.
- <sup>④</sup> Resistant to shock and vibration. For best illumination use amber, yellow or clear lens.

**Plastic**



### Indicating and Master Test Lenses

| Color  | Plastic Catalog Number | Glass Catalog Number |
|--------|------------------------|----------------------|
| Red    | 10250TC1N              | 10250TC7N            |
| Green  | 10250TC2N              | 10250TC8N            |
| Amber  | 10250TC19N             | 10250TC9N            |
| Yellow | 10250TC3N              | —                    |
| Blue   | 10250TC4N              | 10250TC10N           |
| Clear  | 10250TC5N              | 10250TC11N           |
| White  | 10250TC6N              | 10250TC12N           |

**Glass**



**10250TC2\_**



### Illuminated Pushbutton Lenses

| Color  | Catalog Number |
|--------|----------------|
| Red    | 10250TC21      |
| Green  | 10250TC22      |
| Yellow | 10250TC23      |
| Amber  | 10250TC43      |
| Blue   | 10250TC24      |
| Clear  | 10250TC25      |
| White  | 10250TC26      |

**Plastic**



### PresTest Lenses

| Color  | Plastic Catalog Number | Glass Catalog Number |
|--------|------------------------|----------------------|
| Red    | 10250TC21              | 10250TC13N           |
| Green  | 10250TC22              | 10250TC14N           |
| Amber  | 10250TC43              | 10250TC15N           |
| Yellow | 10250TC23              | —                    |
| Blue   | 10250TC24              | 10250TC16N           |
| Clear  | 10250TC25              | 10250TC17N           |
| White  | 10250TC26              | 10250TC18N           |

**Glass**





**1 Push-Pull Emergency Stops (Compliant with IEC 60947-5-5)**

UL (NEMA) Type 3, 3R, 4, 4X, 12, 13

- Two- and three-position
- Non-illuminated
- LONC contact block

**10250T579C47-71X****Two-Position Push-Pull Units****Operator Position** <sup>①</sup>

| Pull | Push | Button Type/Color                 | Lamp         | Type         | Voltage     | Catalog Number            |
|------|------|-----------------------------------|--------------|--------------|-------------|---------------------------|
| X    | 0    | 40 mm red—illuminated             | Incandescent | Transformer  | 120 Vac/Vdc | <b>10250T563C47-71X</b>   |
| X    | 0    | 40 mm red—illuminated EMERG. STOP | Incandescent | Transformer  | 120 Vac/Vdc | <b>10250T563C53-71X</b>   |
| X    | 0    | 40 mm red—illuminated EMERG. STOP | LED          | Transformer  | 120 Vac/Vdc | <b>10250T563LED06-71X</b> |
| X    | 0    | 40 mm red—illuminated             | Incandescent | Full voltage | 24 Vdc      | <b>10250T579C47-71X</b>   |
| X    | 0    | 40 mm red—illuminated EMERG. STOP | Incandescent | Full voltage | 24 Vdc      | <b>10250T579C53-71X</b>   |
| X    | 0    | 40 mm red—illuminated             | Incandescent | Resistor     | 120 Vac/Vdc | <b>10250T580C47-71X</b>   |
| X    | 0    | 40 mm red—illuminated EMERG. STOP | Incandescent | Resistor     | 120 Vac/Vdc | <b>10250T580C53-71X</b>   |
| X    | 0    | 40 mm red—illuminated             | Incandescent | Transformer  | 24 Vac      | <b>10250T589C47-71X</b>   |
| X    | 0    | 40 mm red—illuminated EMERG. STOP | Incandescent | Transformer  | 24 Vac      | <b>10250T589C53-71X</b>   |
| X    | 0    | 40 mm red—illuminated EMERG. STOP | LED          | Transformer  | 24 Vac      | <b>10250T589LED06-71X</b> |
| X    | 0    | 40 mm red—illuminated             | LED          | Transformer  | 24 Vac      | <b>10250T589LRD06-71X</b> |
| X    | 0    | 40 mm red—illuminated EMERG. STOP | LED          | Full voltage | 24 Vdc      | <b>10250T597LED24-71X</b> |
| X    | 0    | 40 mm red—illuminated EMERG. STOP | LED          | Full voltage | 120 Vac/Vdc | <b>10250T597LED2A-71X</b> |
| X    | 0    | 40 mm red—illuminated             | LED          | Full voltage | 24 Vdc      | <b>10250T597LRD24-71X</b> |
| X    | 0    | 40 mm red—illuminated             | LED          | Full voltage | 120 Vac/Vdc | <b>10250T597LRD2A-71X</b> |
| X    | 0    | 40 mm red                         | —            | —            | —           | <b>10250T5B62-71X</b>     |
| X    | 0    | 40 mm red—EMERG. STOP             | —            | —            | —           | <b>10250T5B63-71X</b>     |
| X    | 0    | 65 mm red                         | —            | —            | —           | <b>10250T5J62-71X</b>     |
| X    | 0    | 65 mm red—EMERG. STOP             | —            | —            | —           | <b>10250T5J63-71X</b>     |





**Note**

① X = closed circuit, 0 = open circuit.



UL (NEMA) Type 3, 3R, 4, 4X, 12, 13

### Two-Position Push-Pull Units

#### Operator Position <sup>①</sup>

|  | Pull | Push | Button Type/Color <sup>②</sup>  | Contact Type | Mounting Location |   | Catalog Number <sup>②</sup> |
|--|------|------|---|--------------|-------------------|---|-----------------------------|
|  |      |      |   |              | A                 | B |                             |
| <b>Two-Position Maintained Push, Maintained Pull</b>   |      |      |   |              |                   |   |                             |
| <br><b>10250T5B62-1X</b>  | 0    | X    | 40 mm/red   | 1NO          |                   |   | <b>10250T5B62-1X</b>        |
|  | X    | 0    |   | 1NC          |                   |   |                             |
| <br><b>10250T5B63-1X</b>  | 0    | X    | 40 mm engraved<br>EMERG. STOP/red   | 1NO          |                   |   | <b>10250T5B63-1X</b>        |
|  | X    | 0    |   | 1NC          |                   |   |                             |
| <br><b>10250T5J63-1X</b>  | 0    | X    | 65 mm aluminum engraved<br>EMERG. STOP/red  | 1NO          |                   |   | <b>10250T5J63-1X</b>        |
|  | X    | 0    |   | 1NC          |                   |   |                             |
| <br><b>10250ED1080-2</b> | 0    | X    | 65 mm aluminum engraved<br>EMERG. STOP/red<br><br>Special security<br>jumbo mushroom head | 1NO          |                   |   | <b>10250ED1080-2</b>        |
|  | X    | 0    |   | 1NC          |                   |   |                             |

### Button and Color Selection

|   | Color   | Suffix Code | Catalog Number   |
|---|---|-------------|------------------|
| <b>Standard</b><br>            | <b>Standard—40 mm</b>   |             |                  |
|   | Red   | <b>B62</b>  | <b>10250TB62</b> |
|   | Red (EMERG. STOP)   | <b>B63</b>  | <b>10250TB63</b> |
|   | Green   | <b>B61</b>  | <b>10250TB61</b> |
|   | Black   | <b>B60</b>  | <b>10250TB60</b> |
|   | Blue  | <b>B64</b>  | <b>10250TB64</b> |
| <b>Jumbo Mushroom Head</b><br> | <b>Jumbo Mushroom Head <sup>③</sup><br/>(Anodized) Aluminum—65 mm</b> |             |                  |
|   | Red   | <b>J62</b>  | <b>10250TJ62</b> |
|   | Red (EMERG. STOP)   | <b>J63</b>  | <b>10250TJ63</b> |
|   | Green   | <b>J61</b>  | <b>10250TJ61</b> |
|   | Black   | <b>J60</b>  | <b>10250TJ60</b> |
|   | Yellow  | <b>J64</b>  | <b>10250TJ64</b> |

#### Notes

- ① X = closed circuit, 0 = open circuit.
- ② To order different type or color buttons, substitute the underlined characters with appropriate suffix code from the table.  
Example: 10250T5B64-1X.
- ③ Anodized aluminum head is not suitable for use in ultraviolet light applications.

UL (NEMA) Type 3, 3R, 4, 4X, 12, 13

10250T\_

**Three-Position Push-Pull Units****Operator Position** <sup>①</sup>

| Pull                                   | Intermediate | Push | Button Type/Color <sup>②</sup>    | Contact Type | Mounting Location |   | Catalog Number <sup>②</sup> |
|--|--------------|------|-----------------------------------|--------------|-------------------|---|-----------------------------|
|  |              |      |                                   |              | A                 | B |                             |
| <b>Maintained Push, Momentary Pull</b> |              |      |                                   |              |                   |   |                             |
| X                                      | 0            | 0    | 40 mm/black                       | 1NC          |                   |   | <b>10250T9B60-3X</b>        |
| X                                      | X            | 0    | 40 mm/red                         | 1NC          |                   |   | <b>10250T9B62-3X</b>        |
|  |              |      | 40 mm engraved<br>EMERG. STOP/red |              |                   |   | <b>10250T9B63-3X</b>        |
| <b>Momentary Push, Momentary Pull</b>  |              |      |                                   |              |                   |   |                             |
| X                                      | 0            | 0    | 40 mm/black                       | 1NC          |                   |   | <b>10250T4B60-3X</b>        |
| X                                      | X            | 0    | 40 mm/red                         | 1NC          |                   |   | <b>10250T4B62-3X</b>        |
| 0                                      | 0            | X    | 40 mm/black                       | 1NO          |                   |   | <b>10250T10B60-1X</b>       |
| X                                      | 0            | 0    | 40 mm/red                         | 1NC          |                   |   | <b>10250T10B62-1X</b>       |

**Button and Color Selection**

| Color   | Suffix Code | Catalog Number   |
|---|-------------|------------------|
| <b>Standard—40 mm</b>   |             |                  |
| Red   | <b>B62</b>  | <b>10250TB62</b> |
| Red (EMERG. STOP)   | <b>B63</b>  | <b>10250TB63</b> |
| Green   | <b>B61</b>  | <b>10250TB61</b> |
| Black   | <b>B60</b>  | <b>10250TB60</b> |
| Blue  | <b>B64</b>  | <b>10250TB64</b> |
| <b>Jumbo Mushroom Head <sup>③</sup><br/>(Anodized) Aluminum—65 mm</b> |             |                  |
| Red   | <b>J62</b>  | <b>10250TJ62</b> |
| Red (EMERG. STOP)   | <b>J63</b>  | <b>10250TJ63</b> |
| Green   | <b>J61</b>  | <b>10250TJ61</b> |
| Black   | <b>J60</b>  | <b>10250TJ60</b> |
| Yellow  | <b>J64</b>  | <b>10250TJ64</b> |

**Notes**

<sup>①</sup> X = closed circuit, 0 = open circuit.

<sup>②</sup> To order different type or color buttons, substitute the underlined characters with appropriate suffix code from the table.  
Example: 10250T5B64-1X.

<sup>③</sup> Anodized aluminum head is not suitable for use in ultraviolet light applications.

**Standard****Jumbo Mushroom Head**

**Illuminated Push-Pull Units**

UL (NEMA) Type 3, 3R, 4, 4X, 12, 13

- LED or incandescent
- Full voltage, resistor or transformer type
- Two-position maintained

**Two-Position Push-Pull Operator**



**Two-Position Illuminated Maintained Push, Maintained Pull**

Operator Position ①

| Maintained—Pull | Maintained—Push | Lamp         | Type         | Voltage     | Contact Type | Mounting Location A      | Mounting Location B    | LED/Lamp Number | Red Standard Push-Pull Catalog Number ② |
|-----------------|-----------------|--------------|--------------|-------------|--------------|--------------------------|------------------------|-----------------|---|
| 0               | X               | LED          | Full Voltage | 24 Vac/Vdc  | 1NO          |                          |                        | Bayonet base    | <b>10250T597LRD24-1X</b>                |
| X               | 0               |              |              | 120 Vac/Vdc | 1NC          |                          |                        |                 | <b>10250T597LRD24A-1X</b>               |
|                 |                 |              | Transformer  | 24 Vac      |              | <b>10250T589LRD06-1X</b> |                        |                 |   |
|                 |                 |              |              | 120 Vac     |              | <b>10250T563LRD06-1X</b> |                        |                 |   |
| 0               | X               | Incandescent | Full voltage | 24 Vac/Vdc  | 1NO          |                          |                        | #757            | <b>10250T579C47-1X</b>                  |
| X               | 0               |              |              | 120 Vac/Vdc | 1NC          |                          |                        | 120MB           | <b>10250T580C47-1X</b>                  |
|                 |                 |              | Transformer  | 24 Vac      |              | #755                     | <b>10250T589C47-1X</b> |                 |   |
|                 |                 |              |              | 120 Vac     |              | <b>10250T563C47-1X</b>   |                        |                 |   |

**10250ED137\_**

**Jumbo Lens Illuminated E-Stops**







| Lamp | Button Type/Color  | Type         | Voltage    | Contact Type | Catalog Number     |
|------|--|--------------|------------|--------------|--------------------|
| LED  | Two-position illuminated maintained push/pull—<br>50 mm jumbo lens/red       | Full voltage | 24 Vac/Vdc | 1NO<br>1NC   | <b>10250ED1375</b> |
| LED  | Three-position illuminated momentary push/pull—<br>50 mm jumbo lens/red      | Full voltage | 24 Vac/Vdc | 1NC<br>1NC   | <b>10250ED1376</b> |
| LED  | Three-position illuminated momentary push/pull—<br>50 mm jumbo lens/red      | Full voltage | 24 Vac/Vdc | 1NO<br>1NC   | <b>10250ED1377</b> |
| LED  | Three-position illuminated maintained push/momentary pull—<br>50 mm lens/red | Full voltage |            | 1NO<br>1NC   | <b>10250ED1378</b> |

**Notes**

- ① X = closed circuit, 0 = open circuit.
- ② To order different type or color lens, substitute the underlined characters with appropriate suffix code from table on next page. Example: 10250T579C63-1X. For LEDs with different voltages see ordering example on **Page V7-T1-205**.

UL (NEMA) Type 3, 3R, 4, 4X, 12, 13

**Lens and Color Selection**

|   | Color   | Incandescent<br>Suffix Code | LED<br>Suffix Code | Catalog Number   |
|---|---|-----------------------------|--------------------|------------------|
| <b>Standard</b><br>                          | <b>Standard—40 mm</b>                                 |                             |                    |                  |
|   | Red   | <b>C47</b>                  | <b>RD</b>          | <b>10250TC47</b> |
|   | Red (EMERG. STOP)                                     | <b>C53</b>                  | <b>ED</b>          | <b>10250TC53</b> |
|   | Green   | <b>C48</b>                  | <b>GD</b>          | <b>10250TC48</b> |
|   | Blue  | <b>C49</b>                  | <b>LD</b>          | <b>10250TC49</b> |
|   | Amber   | <b>C50</b>                  | <b>AD</b>          | <b>10250TC50</b> |
|   | White   | <b>C51</b>                  | <b>WD</b>          | <b>10250TC51</b> |
|   | Clear   | <b>C52</b>                  | <b>CD</b>          | <b>10250TC52</b> |
| <b>Side-Lighted<br/>Aluminum</b><br>         | <b>Side-Lighted Aluminum—40 mm</b> <sup>①</sup>       |                             |                    |                  |
|   | Red   | <b>C57</b>                  | <b>RS</b>          | <b>10250TC57</b> |
|   | Red (EMERG. STOP)                                     | <b>C63</b>                  | <b>ES</b>          | <b>10250TC63</b> |
|   | Green   | <b>C58</b>                  | <b>GS</b>          | <b>10250TC58</b> |
|   | Blue  | <b>C59</b>                  | <b>LS</b>          | <b>10250TC59</b> |
|   | Amber   | <b>C64</b>                  | <b>AS</b>          | <b>10250TC64</b> |
|   | Yellow  | <b>C60</b>                  | <b>YS</b>          | <b>10250TC60</b> |
|   | White   | <b>C61</b>                  | <b>WS</b>          | <b>10250TC61</b> |
| Clear   | <b>C62</b>  | <b>CS</b>                   | <b>10250TC62</b>   |                  |
| <b>Aluminum Transparent<br/>Center</b><br> | <b>Aluminum Transparent Center—40 mm</b> <sup>①</sup> |                             |                    |                  |
|   | Red   | <b>C65</b>                  | <b>RH</b>          | <b>10250TC65</b> |
|   | Green   | <b>C66</b>                  | <b>GH</b>          | <b>10250TC66</b> |
| <b>Jumbo Lens</b><br>                      | <b>Jumbo Lens—50 mm</b>                               |                             |                    |                  |
|   | Red   | —                           | —                  | <b>10250TC77</b> |

**Note**

<sup>①</sup> Clear anodized aluminum and colored lens.

UL (NEMA) Type 3, 3R, 4, 4X, 12, 13

**Three-Position Push-Pull Operator**



**Three-Position Illuminated Momentary Push, Momentary Pull**

**Operator Position ①**

| Momentary—<br>Pull | Maintained—<br>Intermediate | Momentary—<br>Push | Lamp              | Type         | Voltage     | Contact<br>Type | Mounting Location |   | LED/<br>Lamp<br>Number | Red Standard<br>Push-Pull<br>Catalog Number ③ |                           |
|--------------------|-----------------------------|--------------------|-------------------|--------------|-------------|-----------------|-------------------|---|------------------------|---|---------------------------|
|                    |                             |                    |                   |              |             |                 | A                 | B |                        |   |                           |
| 0                  | 0                           | X                  | LED               | Full voltage | 24 Vac/Vdc  | 1NO             |                   |   | Bayonet<br>base        | <b>10250T1097LRD24-1X</b>                     |                           |
| X                  | 0                           | 0                  |                   |              | 120 Vac     | 1NC             |                   |   |                        | <b>10250T1097LRD2A-1X</b>                     |                           |
|                    |                             |                    |                   |              | Transformer | 24 Vac          |                   |   |                        |   | <b>10250T1089LRD06-1X</b> |
|                    |                             |                    |                   |              | 120 Vac     |                 |                   |   |                        | <b>10250T1063LRD06-1X</b>                     |                           |
| X                  | 0                           | 0                  | Incan-<br>descent | Full voltage | 24 Vac/Vdc  | 1NC             |                   |   | Bayonet<br>base        | <b>10250T497LRD24-3X</b>                      |                           |
| X                  | X                           | 0                  |                   |              | 120 Vac     | 1NC             |                   |   |                        | <b>10250T497LRD2A-3X</b>                      |                           |
|                    |                             |                    |                   |              | Transformer | 24 Vac          |                   |   |                        |   | <b>10250T489LRD06-3X</b>  |
|                    |                             |                    |                   |              | 120 Vac     |                 |                   |   |                        | <b>10250T463LRD06-3X</b>                      |                           |
| 0                  | 0                           | X                  | Incan-<br>descent | Full voltage | 24 Vac/Vdc  | 1NO             |                   |   | #757                   | <b>10250T1079C47-1X</b>                       |                           |
| X                  | 0                           | 0                  |                   |              | Resistor    | 120 Vac         |                   |   |                        | 1NC   | <b>10250T1080C47-1X</b>   |
|                    |                             |                    |                   |              | Transformer | 24 Vac          |                   |   |                        |   | <b>10250T1089C47-1X</b>   |
|                    |                             |                    |                   |              | 120 Vac     |                 |                   |   |                        | <b>10250T1063C47-1X</b>                       |                           |
| X                  | 0                           | 0                  | Incan-<br>descent | Full voltage | 24 Vac/Vdc  | 1NC             |                   |   | #757                   | <b>10250T479C47-3X</b>                        |                           |
| X                  | X                           | 0                  |                   |              | Resistor    | 120 Vac         |                   |   |                        | 1NC   | <b>10250T480C47-3X</b>    |
|                    |                             |                    |                   |              | Transformer | 24 Vac          |                   |   |                        |   | <b>10250T489C47-3X</b>    |
|                    |                             |                    |                   |              | 120 Vac     |                 |                   |   |                        | <b>10250T463C47-3X</b>                        |                           |

**Three-Position Push-Pull Operator**



**Three-Position Illuminated Maintained Push, Momentary Pull**

**Operator Position ①**

| Momentary—<br>Pull | Maintained—<br>Intermediate | Momentary—<br>Push | Lamp              | Type         | Voltage     | Contact<br>Type | Mounting Location |   | LED/<br>Lamp<br>Number | Red Standard<br>Push-Pull<br>Catalog Number ② |                          |
|--------------------|-----------------------------|--------------------|-------------------|--------------|-------------|-----------------|-------------------|---|------------------------|---|--------------------------|
|                    |                             |                    |                   |              |             |                 | A                 | B |                        |   |                          |
| X                  | 0                           | 0                  | LED               | Full voltage | 24 Vac/Vdc  | 1NC             |                   |   | Bayonet<br>base        | <b>10250T997LRD24-3X</b>                      |                          |
| X                  | X                           | 0                  |                   |              | 120 Vac     | 1NC             |                   |   |                        | <b>10250T997LRD2A-3X</b>                      |                          |
|                    |                             |                    |                   |              | Transformer | 24 Vac          |                   |   |                        |   | <b>10250T989LRD06-3X</b> |
|                    |                             |                    |                   |              | 120 Vac     |                 |                   |   |                        | <b>10250T963LRD06-3X</b>                      |                          |
| X                  | 0                           | 0                  | Incan-<br>descent | Full voltage | 24 Vac/Vdc  | 1NC             |                   |   | #757                   | <b>10250T979C47-3X</b>                        |                          |
| X                  | X                           | 0                  |                   |              | Resistor    | 120 Vac         |                   |   |                        | 1NC   | <b>10250T980C47-3X</b>   |
|                    |                             |                    |                   |              | Transformer | 24 Vac          |                   |   |                        |   | <b>10250T989C47-3X</b>   |
|                    |                             |                    |                   |              | 120 Vac     |                 |                   |   |                        | <b>10250T963C47-3X</b>                        |                          |

**Notes**

- ① X = closed circuit, 0 = open circuit.
- ② To order different type or color lens, substitute the underlined characters with appropriate suffix code from table on **Page V7-T1-200**. Example: 10250T1079C53-1X. For LEDs with different voltages see ordering example on **Page V7-T1-205**.
- ③ To order different type or color lens, substitute the underlined characters with appropriate suffix code from table on **Page V7-T1-200**. Example: 10250T979C53X. For LEDs with different voltages see ordering example on **Page V7-T1-205**.

**Potentiometers**

UL (NEMA) Type 3, 3R, 4, 4X, 12, 13

**Vertical or Horizontal  
One-Hole Mounting** ①**Potentiometer with Knob and Standard Dial Plate—Linear Type  $\pm 10\%$** 

| Potentiometer<br>Ohms  | Catalog Number   |
|--|------------------|
| <b>2 Watt (60V Max.) Single Potentiometer with Standard Aluminum Dial Plate</b> ②③ |                  |
| 1000   | <b>10250T331</b> |
| 2500   | <b>10250T332</b> |
| 5000   | <b>10250T338</b> |
| 10000  | <b>10250T333</b> |
| 25000  | <b>10250T334</b> |
| 50000  | <b>10250T335</b> |
| Operator only ④  | <b>10250T330</b> |
| Alternative—black plastic large legend with standard markings                      | <b>E34LP99</b>   |

**Notes**

- ① Shown with standard aluminum dial plate.
- ② Large dial plate with space for legend is available at no charge. To order, add suffix **36** to catalog number. Example: 10250T331**36**. To order separately, see footnote ③ below.
- ③ Large dial plate has space at top for 15 letters. 3/32 in high. For custom stamped legend plates, order legend plate as separate item **10250TR30** and specify stamping.
- ④ For use with commercially purchased potentiometers having shaft dimensions per dimension drawing on **Page V7-T1-249**.

### Push-Pull Operators

An illuminated push-pull pushbutton unit, arranged for one-hole mounting, can replace two pushbuttons and a pilot light or the non-illuminated form can replace two pushbuttons. These units are available in three basic types:

- **Maintained**—(Two-position). Maintains in the pulled or pushed position until manually actuated to the opposite mode.
- **Momentary**—(Three-position). Spring returns to an intermediate position when pulled or pushed and released.
- **Momentary Pull, Maintained Push**—(Three-position). Spring returns to intermediate position when pulled. Maintains in pushed position until manually returned to intermediate (ready to reset) position. Maintained stop holds circuit open and will prevent other series connected operators from starting the system.

The operators, buttons, contact blocks, etc., are offered as building block components that can be intermixed to satisfy many requirements. This minimizes the need for a varied and costly inventory.

### Two-Position Maintained Push-Pull ①



### Typical Applications

| Control                                   | Line—Diagram             | Operator                                   | Circuits                      | Operator Mode  |                |                          |               |  |  |  |
|---|--------------------------|--|-------------------------------|--|----------------|--------------------------|---------------|--|--|--|
| Three-wire three-position momentary       |                          | Momentary push and pull 10250T4            | 2NC contact block 10250T3     | <table border="0"> <tr> <td>START (mom.)</td> <td>Normal pos. (maint.)</td> <td>STOP (mom.)</td> </tr> <tr> <td></td> <td></td> <td></td> </tr> </table>         | START (mom.)   | Normal pos. (maint.)     | STOP (mom.)   |  |  |  |
| START (mom.)                              | Normal pos. (maint.)     | STOP (mom.)                                |                               |  |                |                          |               |  |  |  |
|   |                          |  |                               |  |                |                          |               |  |  |  |
| Two-wire two-position maintained          |                          | Maintained push and pull 10250T5           | 1NO-1NC contact block 10250T1 | <table border="0"> <tr> <td>START (maint.)</td> <td>No intermediate position</td> <td>STOP (maint.)</td> </tr> <tr> <td></td> <td></td> <td></td> </tr> </table> | START (maint.) | No intermediate position | STOP (maint.) |  |  |  |
| START (maint.)                            | No intermediate position | STOP (maint.)                              |                               |  |                |                          |               |  |  |  |
|   |                          |  |                               |  |                |                          |               |  |  |  |
| Three-wire momentary pull maintained push |                          | Maintained push and momentary pull 10250T9 | 2NC contact block 10250T3     | <table border="0"> <tr> <td>START (mom.)</td> <td>Normal pos. (maint.)</td> <td>STOP (maint.)</td> </tr> <tr> <td></td> <td></td> <td></td> </tr> </table>       | START (mom.)   | Normal pos. (maint.)     | STOP (maint.) |  |  |  |
| START (mom.)                              | Normal pos. (maint.)     | STOP (maint.)                              |                               |  |                |                          |               |  |  |  |
|   |                          |  |                               |  |                |                          |               |  |  |  |

### Notes

- A** and **B** circuits shown in the application illustrations are defined in the "Application Guide" on the following page.  
 ① Shown without button on lens.



#### 1

#### Application Guide

To assist in the selection of contact blocks, the sketch to the right shows pictorially by symbols **A** and **B** locations of contact circuits after assembly of contact blocks

and adapter to the operator. The table below shows the effect of the push and pull operations on either NO or NC contacts. (X = contact closed, O = contact open).

#### Contact Circuit Locations

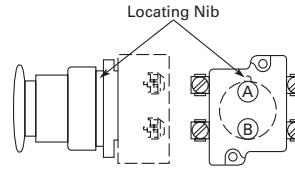

10250T579C47-71X

#### Push-Pull Operator Components



#### Operator Position and Circuit Arrangement

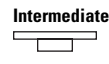

#### Contact Block Mounting Location

| Type of Operator                                    | Out—Pull |   | Intermediate             |   | In—Push |   | Contact Block ① | Catalog Number     |
|---|----------|---|--------------------------|---|---------|---|-----------------|--------------------|
|   | A        | B | A                        | B | A       | B |                 |                    |
| <b>Two-Position Operator without Lens</b>           |          |   |                          |   |         |   |                 |                    |
| Maintained push-pull                                | O        | O | No intermediate position |   | X       | X | 1NO             | <b>10250T5</b>     |
|   | X or     | X |                          |   | O or    | O | 1NC             |                    |
| Maintained push-pull with anti-theft jumbo mushroom | O        | O | No intermediate position |   | X       | X | 1NO             | <b>10250ED1080</b> |
|   | X or     | X |                          |   | O or    | O | 1NC             |                    |
|   | O        | O |                          |   | X       | X | 2NO             |                    |
|   | X        | X |                          |   | O       | O | 2NC             |                    |
| <b>Three-Position Operator without Lens</b>         |          |   |                          |   |         |   |                 |                    |
| Momentary push-pull                                 | O        | O | O                        | O | X       | O | 1NO             | <b>10250T4 ①</b>   |
|   | X or     | X | O or                     | X | O or    | O | 1NC             |                    |
|   | O        | O | O                        | O | X       | O | 2NO             |                    |
|   | X        | X | O                        | X | O       | O | 2NC             |                    |
| Maintained push-momentary pull                      | O        | O | O                        | O | X       | O | 1NO             | <b>10250T9 ①</b>   |
|   | X or     | X | O or                     | X | O or    | O | 1NC             |                    |
|   | O        | O | O                        | O | X       | O | 2NO             |                    |
|   | X        | X | O                        | X | O       | O | 2NC             |                    |
| Momentary push-pull                                 | O        | O | O                        | O | X       | X | 1NO             | <b>10250T10 ①</b>  |
|   | X or     | X | O or                     | O | O or    | O | 1NC             |                    |
|   | O        | O | O                        | O | X       | X | 2NO             |                    |
|   | X        | X | O                        | O | O       | O | 2ND             |                    |

#### Note

① Maximum of two blocks, four circuits. Special function contact blocks shown on **Page V7-T1-235** CANNOT be used with three-position push-pull operators 10250T4, 10250T9 or 10250T10.

### Push-Pull Light Units, Lenses and Buttons

#### Ordering Example with One Composite Number

Non-illuminated:

10250T5 + 10250TB62 + 10250T1 = **10250T5B62-1X**

Incandescent:

10250T5 + 10250TZ9 + 10250TC47 + 10250T1 = **10250T579C47-1X**

LED:

10250T5 + 10250T97L + 10250TC47 + Voltage code + 10250T1 = **10250T597LRD24-1X**

|               |               |
|---------------|---------------|
| 06—6 Vac/Vdc  | 60—60 Vac/Vdc |
| 12—12 Vac/Vdc | 2A—120 Vac    |
| 24—24 Vac/Vdc | 2D—120 Vdc    |
| 48—48 Vac/Vdc |               |





#### Light Units for Illuminated Push-Pull Devices

| Light Unit Type                         | Type         | Voltage         | LED/Lamp Number | Catalog Number   |                 |
|---|--------------|-----------------|-----------------|------------------|-----------------|
| LED<br>(LEDs not included) <sup>①</sup> | Full voltage | —               | Bayonet base    | <b>10250T97L</b> |                 |
|   | Transformer  | 24              |                 | <b>10250T89L</b> |                 |
|   | AC only      | 120             |                 | <b>10250T63L</b> |                 |
|   | 50/60 Hz     | 208             |                 | <b>10250T64L</b> |                 |
|   |              | 240             |                 | <b>10250T65L</b> |                 |
|   |              | 277             |                 | <b>10250T82L</b> |                 |
|   |              | 380             |                 | <b>10250T66L</b> |                 |
|   |              | 480             |                 | <b>10250T67L</b> |                 |
|   |              | 600             |                 | <b>10250T68L</b> |                 |
|   |              | Incandescent    |                 | Full voltage     | 6               |
| AC or DC                                |              |                 | 12              | <b>10250T70</b>  |                 |
|   | 24/28        |                 | <b>10250T79</b> |                  |                 |
|   | 32           |                 | <b>10250T83</b> |                  |                 |
|   | Resistor     |                 | 120             | 120MB            | <b>10250T80</b> |
| AC or DC                                | 240          |                 |                 | <b>10250T81</b>  |                 |
|   | Transformer  |                 | 24              | #755             | <b>10250T89</b> |
|   | AC only      |                 | 120             | <b>10250T63</b>  |                 |
|   | 50/60 Hz     |                 | 208             | <b>10250T64</b>  |                 |
|   |              |                 | 240             | <b>10250T65</b>  |                 |
|   |              | 277             | <b>10250T82</b> |                  |                 |
|   |              | 380             | <b>10250T66</b> |                  |                 |
|   |              | 480             | <b>10250T67</b> |                  |                 |
| 600                                     |              | <b>10250T68</b> |                 |                  |                 |



**Note**

① These units do not include lamps. Order LED separately to match lens color, see **Page V7-T1-239**.

## Alternate Lenses for Illuminated Push-Pull Devices

|   | Lens Color   | Incandescent Suffix Code | LED Suffix Code <sup>①</sup> | Catalog Number |
|---|--|--------------------------|------------------------------|----------------|
| <b>Standard</b><br>                            | <b>Standard</b>                                    |                          |                              |                |
|   | Red  | C47                      | RD                           | 10250TC47      |
|   | Red (EMERG. STOP)                                  | C53                      | ED                           | 10250TC53      |
|   | Green  | C48                      | GD                           | 10250TC48      |
|   | Blue   | C49                      | LD                           | 10250TC49      |
|   | Amber  | C50                      | AD                           | 10250TC50      |
|   | White  | C51                      | WD                           | 10250TC51      |
|   | Clear  | C52                      | CD                           | 10250TC52      |
| <b>Side-Lighted Anodized Aluminum Ring</b><br> | <b>Side-Lighted Anodized Aluminum Ring</b>         |                          |                              |                |
|   | Red  | C57                      | RS                           | 10250TC57      |
|   | Red (EMERG. STOP)                                  | C63                      | ES                           | 10250TC63      |
|   | Green  | C58                      | GS                           | 10250TC58      |
|   | Blue   | C59                      | LS                           | 10250TC59      |
|   | Amber  | C64                      | AS                           | 10250TC64      |
|   | Yellow   | C60                      | YS                           | 10250TC60      |
|   | White  | C61                      | WS                           | 10250TC61      |
|   | Clear  | C62                      | CS                           | 10250TC62      |
| <b>Heavy-Duty Aluminum</b><br>                | <b>Heavy-Duty Aluminum with Transparent Center</b> |                          |                              |                |
|   | Red  | C65                      | RH                           | 10250TC65      |
|   | Green  | C66                      | GH                           | 10250TC66      |
|   | Amber  | C67                      | AH                           | 10250TC67      |
|   | White  | C68                      | —                            | 10250TC68      |
| <b>Jumbo Lens</b><br>                        | <b>Jumbo Lens—50 mm</b>                            |                          |                              |                |
|   | Red  | —                        | —                            | 10250TC77      |

## Buttons for Non-Illuminated Push-Pull Devices

|   | Color   | Suffix Code | Catalog Number |
|---|---|-------------|----------------|
| <b>Standard</b><br>                                | <b>Standard</b>   |             |                |
|   | Red   | B62         | 10250TB62      |
|   | Red (EMERG. STOP)   | B63         | 10250TB63      |
|   | Green   | B61         | 10250TB61      |
|   | Black   | B60         | 10250TB60      |
|   | Blue  | B64         | 10250TB64      |
| <b>Jumbo Mushroom Head (Anodized) Aluminum</b><br> | <b>Jumbo Mushroom Head <sup>②</sup> (Anodized) Aluminum</b> |             |                |
|   | Red   | J62         | 10250TJ62      |
|   | Red (EMERG. STOP)   | J63         | 10250TJ63      |
|   | Green   | J61         | 10250TJ61      |
|   | Black   | J60         | 10250TJ60      |
|   | Yellow  | J64         | 10250TJ64      |

**Notes**

- <sup>①</sup> Suffix codes should only be used for assembling composite catalog numbers. To order lens above, order by catalog number.  
<sup>②</sup> Anodized aluminum head is not suitable for use in ultraviolet light applications.

**Legend Plates**

For a complete listing of available legend plates see **Pages V7-T1-230 to V7-T1-232**.

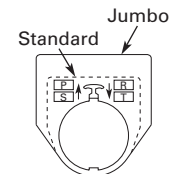

### Selector Switch Units

UL (NEMA) Type 3, 3R, 4, 4X, 12, 13

- Two-, three- and four-position maintained
- Non-illuminated and illuminated

#### Two-Position Maintained Switch



#### Two-Position Selector Switch

| Operator Position ① |   | Operator Action ② | Contact Type | Mounting Location |                   | Non-Illuminated             |                              | Illuminated—120V Transformer |                            |
|---------------------|---|-------------------|--------------|-------------------|-------------------|-----------------------------|------------------------------|------------------------------|----------------------------|
|                     |   |                   |              | A                 | B                 | Black Knob Catalog Number ③ | Black Lever Catalog Number ③ | Red Knob Catalog Number ③    | Red Lever Catalog Number ③ |
| X                   | 0 |                   | 1NC          |                   | <u>10250T20KB</u> | <u>10250T20LB</u>           | <u>10250ED1117-KR</u>        | <u>10250ED1117-LR</u>        |                            |
| 0                   | X |                   | 1NO          |                   |                   |                             |                              |                              |                            |

#### Three-Position Maintained Switch



#### Three-Position Selector Switch

| Operator Position ① |   |   | Operator Action ② | Contact Type | Mounting Location |                   | Non-Illuminated             |                              | Illuminated—120V Transformer |                            |
|---------------------|---|---|-------------------|--------------|-------------------|-------------------|-----------------------------|------------------------------|------------------------------|----------------------------|
|                     |   |   |                   |              | A                 | B                 | Black Knob Catalog Number ③ | Black Lever Catalog Number ③ | Red Knob Catalog Number ③    | Red Lever Catalog Number ③ |
| X                   | 0 | 0 |                   | 1NO          |                   | <u>10250T21KB</u> | <u>10250T21LB</u>           | <u>10250ED1117-2KR</u>       | <u>10250ED1117-2LR</u>       |                            |
| 0                   | 0 | X |                   | 1NO          |                   |                   |                             |                              |                              |                            |

#### Three-Position Maintained Switch



|   |   |   |  |              |  |                   |                   |                        |                        |
|---|---|---|--|--------------|--|-------------------|-------------------|------------------------|------------------------|
| X | 0 | 0 |  | 1NO          |  | <u>10250T22KB</u> | <u>10250T22LB</u> | <u>10250ED1117-3KR</u> | <u>10250ED1117-3LR</u> |
| 0 | X | 0 |  | 2NC (Series) |  |                   |                   |                        |                        |
| 0 | 0 | X |  | 1NO          |  |                   |                   |                        |                        |

#### Three-Position Maintained Switch



#### Four-Position Selector Switch

| Operator Position ① |   |   |   | Operator Action ② | Contact Type | Mounting Location |                   | Non-Illuminated             |                              | Illuminated—120V Transformer |                            |
|---------------------|---|---|---|-------------------|--------------|-------------------|-------------------|-----------------------------|------------------------------|------------------------------|----------------------------|
|                     |   |   |   |                   |              | A                 | B                 | Black Knob Catalog Number ③ | Black Lever Catalog Number ③ | Red Knob Catalog Number ③    | Red Lever Catalog Number ③ |
| X                   | 0 | 0 | 0 |                   | 1NC          |                   | <u>10250T46KB</u> | <u>10250T46LB</u>           | <u>10250ED1117-4KR</u>       | <u>10250ED1117-4LR</u>       |                            |
| 0                   | X | 0 | 0 |                   | 1NO          |                   |                   |                             |                              |                              |                            |
| 0                   | 0 | X | 0 |                   | 1NO          |                   |                   |                             |                              |                              |                            |
| 0                   | 0 | 0 | X |                   | 1NC          |                   |                   |                             |                              |                              |                            |

#### Color Selection

| Illuminated |             |       |             |       |             | Non-Illuminated |             |       |             |        |             |
|-------------|-------------|-------|-------------|-------|-------------|-----------------|-------------|-------|-------------|--------|-------------|
| Color       | Code Letter | Color | Code Letter | Color | Code Letter | Color           | Code Letter | Color | Code Letter | Color  | Code Letter |
| Red         | <b>R</b>    | White | <b>W</b>    | Amber | <b>A</b>    | Black           | <b>B</b>    | Green | <b>G</b>    | Blue   | <b>L</b>    |
| Green       | <b>G</b>    | Blue  | <b>B</b>    | Clear | <b>C</b>    | Red             | <b>R</b>    | White | <b>W</b>    | Orange | <b>O</b>    |

#### Notes

- ① X = closed circuit, 0 = open circuit.
- ② M = Maintained.
- ③ To order different type or color selector switch, substitute the underlined character with appropriate suffix code from the Color Selection table. Example: 10250T20KG.

#### 1

### Selector Switch Selection



#### Cam and Contact Block Selection

Selector switches in their varied forms (two-position, three-position and four-position) are a big factor contributing to the great flexibility of control that a well rounded line of “pushbuttons” can achieve. Because of their flexibility, they tend to cause difficulty with product selection and application. The following systematic approach should simplify that task.

Cam and contact block selection is better understood if you:

- Work with each incoming and outgoing wire/circuit separately.
- Recognize the terms NO and NC only identify the type of contact by its mode before mounting to the operator. The “X-O” table (Page V7-T1-210) shows how that contact will act after assembly to the operator with the selected cam shape. X = closed circuit, O = open circuit.

- Up to six NO or NC contacts may be mounted behind each plunger location for a total of twelve contacts. Single circuit contact blocks have only one plunger with the other side of the block “open.” Therefore, single circuit contact blocks transmit motion to blocks behind them only for the position containing the circuit.
- Each cam has two separate lobes, each of which operates one of the two contact block plungers independently of each other. Those are identified as position A (locating nib side) and position B (opposite of locating nib). The position designations give direction in selecting and mounting of the contact blocks.

#### Contact Circuit Locations

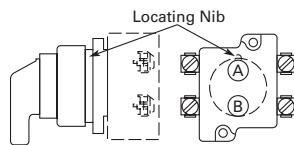

#### Systematic Approach

Application: **HAND-OFF-AUTO** selector switch. In this circuit, one incoming line is distributed to two other outgoing circuits by the switch. The two circuits can be looked at individually.

#### Step 1: Elementary Diagram.

Construct on paper, or in your mind, a simple elementary diagram of the switching scheme as follows:

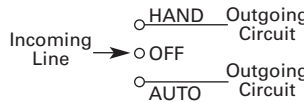

#### Step 2: “X-O” Pattern.

From the elementary diagram, you can construct an “X-O” diagram which describes when the contacts are to be closed (X) or open (O) in the various positions of the switch. The “X-O” for the **HAND** circuit looks like this:

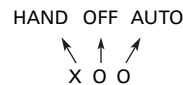

In this circuit, you want a contact closed on the left (HAND) but open in the center and right.

For the **AUTO** circuit, the “X-O” diagram would look like this:

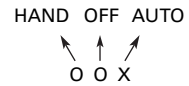

Putting them together, the complete “X-O” diagram is:



Once the “X-O” diagram has been generated the next step is to select the cam and contact block, or blocks, needed to perform the desired “X-O” functions. The selection tables on the following pages list the various types (shapes) of cams by number to choose from and the type of contact and position to achieve the function outlined in your “X-O” diagram.

### Step 3: Cam Selection.

The cam you select determines the operation of all contact blocks mounted to the operator. It is selected on the basis that it provides the simplest circuitry for the desired "X-O" diagram. The selection tables show all the "X-O" combinations. For the purpose of this example, the applicable portion of those tables is shown on this page.

Now to make the cam selection, make a simple worksheet such as:

|       | Cam 2       | Cam 3 |
|-------|-------------|-------|
| X O O | (A)NO-(B)NC | (A)NO |
| O O X | (B)NO       | (B)NO |

It becomes immediately obvious that cam 3 is the better choice for two reasons, (1) the series combination can be avoided making it simpler to wire, (2) only two contacts are required, which is less expensive than the three contacts required by cam 2.

### Step 4: Contact Block Selection.

Having selected the cam, contact block selection is simply a matter of gathering the A position and B position circuits into pairs which make up the most convenient contact block arrangement. If there is an imbalance in the number of circuits under A or B, then single circuit blocks must be selected for these leftover circuits.

Back to the worksheet, having selected cam 3 do this:



### Step 5: Selector Switch Operator.

Lastly, you have to choose from the many types of operators—knob and lever in various colors or keyed. Also what combinations of maintained and spring return functions are required. Selection of these operators can be found on **Page V7-T1-212**. For the example in step 4 you may want a three-position maintained black knob, cam 3—Catalog Number 10250T1323.

### The Complete Switch:

10250T1323 with one 10250T2 or, for one composite catalog number, 10250T21KB found on **Page V7-T1-207**.

### Diagrams

Circuits shown illustrate connections to obtain a selector switch circuit combination and are shown with their appropriate line diagrams. Field wiring of jumper connections required as shown.

X = Closed circuit  
O = Open circuit

### Wiring of Jumper Connections

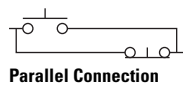

Four-position selector switches are limited to four contact blocks.

### Contact Blocks

For selection and number of available contact blocks per operator, see **Pages V7-T1-235 to V7-T1-238**.

### Example Selection Table

| No. | "X-O" Pattern | Cam Code #2 |          | Cam Code #3 |          |
|-----|---------------|-------------|----------|-------------|----------|
|     |               | Top A       | Bottom B | Top A       | Bottom B |
| 1   | X 0 0         |             |          |             | —        |
| 4   | 0 0 X         | —           |          | —           |          |

### Two-Position Selector Switch Contact Block Selection

| No. | Desired Circuit and Operator Position |   | Contact Blocks Required to Accomplish Circuit Function |                  |
|-----|---------------------------------------|---|--|------------------|
|     |                                       |   | Top Plunger A  | Bottom Plunger B |
| 1   | X                                     | 0 | or   |                  |
| 2   | 0                                     | X |  |                  |

### Note

① Wired in series.

# 1.8

## Pushbuttons and Indicating Lights

30.5 mm Heavy-Duty Watertight/Oiltight—10250T

### 1 Three-Position Switch—Cam and Contact Block Selection

| No. | Desired Circuit and Operator Position |   |   | Operator with Cam Code #2 |                  | Operator with Cam Code #3 |                  |
|-----|---------------------------------------|---|---|---------------------------|------------------|---------------------------|------------------|
|     |                                       |   |   | Mounting Location         |                  | Mounting Location         |                  |
|     |                                       |   |   | Top Plunger A             | Bottom Plunger B | Top Plunger A             | Bottom Plunger B |
| 1   | X                                     | 0 | 0 |                           |                  |                           |                  |
| 2   | X                                     | X | 0 |                           |                  |                           |                  |
| 3   | X                                     | 0 | X |                           |                  |                           |                  |
| 4   | 0                                     | 0 | X |                           |                  |                           |                  |
| 5   | 0                                     | X | X |                           |                  |                           |                  |
| 6   | 0                                     | X | 0 |                           |                  |                           |                  |

### Four-Position Switch—Contact Block Selection

| No. | Desired Circuit and Operator Position |   |   |   | Contact Blocks Required to Accomplish Circuit Function |                  | No. | Desired Circuit and Operator Position |                  |                   |                  | Contact Blocks Required to Accomplish Circuit Function |  |
|-----|---------------------------------------|---|---|---|--|------------------|-----|---------------------------------------|------------------|-------------------|------------------|--|--|
|     |                                       |   |   |   | Mounting Location                                      |                  |     | Mounting Location                     |                  | Mounting Location |                  |  |  |
|     |                                       |   |   |   | Top Plunger A  | Bottom Plunger B |     | Top Plunger A                         | Bottom Plunger B | Top Plunger A     | Bottom Plunger B |  |  |
| 1   | X                                     | 0 | 0 | 0 |  |                  | 10  | X                                     | 0                | X                 | 0                |  |  |
| 2   | 0                                     | X | 0 | 0 |  |                  |     |                                       |                  |                   |                  |  |  |
| 3   | 0                                     | 0 | X | 0 |  |                  | 11  | X                                     | X                | X                 | 0                |  |  |
| 4   | 0                                     | 0 | 0 | X |  |                  |     |                                       |                  |                   |                  |  |  |
| 5   | X                                     | 0 | 0 | X |  |                  | 12  | 0                                     | X                | X                 | X                |  |  |
| 6   | 0                                     | X | X | 0 |  |                  |     |                                       |                  |                   |                  |  |  |
| 7   | 0                                     | 0 | X | X |  |                  | 13  | X                                     | 0                | X                 | X                |  |  |
| 8   | X                                     | X | 0 | 0 |  |                  |     |                                       |                  |                   |                  |  |  |
| 9   | 0                                     | X | 0 | X |  |                  | 14  | X                                     | X                | 0                 | X                |  |  |

**Selector Switch Operators**

**Key Operators**

UL (NEMA) Type 3, 3R, 4, 4X, 12, 13

**Two-Position Maintained** <sup>①</sup>



**Key Operators with Cam**

| Positions                | Operator Action <sup>②</sup> | Cam Code <sup>③</sup> | Optional Key Removal Positions <sup>④</sup> | Vertical Mounting Catalog Number | Horizontal Mounting Catalog Number |
|--------------------------|------------------------------|-----------------------|---|----------------------------------|------------------------------------|
| Two-position—60° throw   |                              | 1                     | 1, 2, 3                                     | 10250T1511_                      | 10250T1611_                        |
|                          |                              | 1                     | 2   | 10250T1571_                      | 10250T1581_                        |
| Three-position—60° throw |                              | 2                     | 1-7   | 10250T1522_                      | 10250T1622_                        |
|                          |                              | 3                     |   | 10250T1523_                      | 10250T1623_                        |
|                          |                              | 2                     | 1, 4, 5                                     | 10250T1532_                      | 10250T1632_                        |
|                          |                              | 3                     |   | 10250T1533_                      | 10250T1633_                        |
|                          |                              | 2                     | 4   | 10250T1542_                      | 10250T1642_                        |
|                          |                              | 3                     |   | 10250T1543_                      | 10250T1643_                        |
| Four-position—40° throw  |                              | 2                     | 2, 4, 6                                     | 10250T1652_                      | 10250T1662_                        |
|                          |                              | 3                     |   | 10250T1653_                      | 10250T1663_                        |
|                          |                              | 7                     | 7   | 10250T1677_                      | 10250T1687_                        |

**Notes**

- ① Horizontal mount, key removal #1 keyed selector switch, cam 1 shown.
- ② M = Maintained. S = Spring return in direction of arrow (R).
- ③ For selection of the proper cam and contact block to obtain the proper circuit sequence, see selection instructions and tables on **Pages V7-T1-208, V7-T1-209 and V7-T1-210.**
- ④ Choose key removal position required for application from table on **Page V7-T1-212.** Add key removal code no. to listed catalog number. Example: 10250T15112.



#### Key Removal Positions

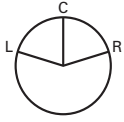

| Code Suffix | Key Removal Position |
|-------------|----------------------|
| 1           | Right only           |
| 2           | Left only            |
| 3           | Right and left       |
| 4           | Center only          |
| 5           | Right and center     |
| 6           | Left and center      |
| 7           | All positions        |

**Note:** Key removal in “spring return from” positions not recommended.

#### Replacement Keys or Dissimilar Locks for Key Operators

Operators listed on **Page V7-T1-212** have identical locks and keys (Key Code H661) Catalog Number 10250ED824. For dissimilar lock and key combinations, see listing on this page.

#### Replacement Key

| Description                  | Catalog Number |
|------------------------------|----------------|
| Replacement keys (code H661) | 10250ED824     |

#### Selector Switch Operators with Dissimilar Locks and Keys (UL [NEMA] 4, 4X and 13)

The locks in all key operators listed on **Pages V7-T1-191, V7-T1-212** and **V7-T1-349** are identical and use key code number H661. Two keys are supplied with every lock. For additional code number H661 keys, order **Catalog Number 10250ED824**. For others, order 10250ED1130 and designate lock number. When dissimilar locks for each operator or each group of operators are required, select from the lock and key combination listed below. **When Ordering Operator Only** or a complete control unit with a substitute lock, order from table below and add “except Lock and Key Code No. ...”

#### “H” Series Locks without Master Key—with Key Slot Cover

| Lock and Key Code Numbers |      |      |
|---------------------------|------|------|
| H501                      | H635 | H663 |
| H620                      | H639 | H675 |
| H621                      | H643 | H683 |
| H634                      | H654 | H688 |

#### “M” Series Locks with Master Key—with Key Slot Cover

| Lock and Key Code Numbers |      |      |      |
|---------------------------|------|------|------|
| MD1                       | MD14 | ME8  | MJ6  |
| MD2                       | MD15 | ME11 | MJ10 |
| MD3                       | MD16 | ME16 | MJ11 |
| MD4                       | MD19 | ME17 | MJ13 |
| MD5                       | MD20 | ME18 | MJ15 |
| MD7                       | ME2  | ME19 | MJ16 |
| MD9                       | ME3  | MJ1  | MD17 |
| MD10                      | ME5  | MJ3  |      |
| MD11                      | ME6  | MJ4  |      |
| MD13                      | ME7  | MJ5  |      |

#### Master Keys for Above Locks

| Application | Catalog Number |
|-------------|----------------|
| For code:   |                |
| MD1–MD20    | 10250ED825-3   |
| ME2–ME18    | 10250ED825-4   |
| MJ1–MJ16    | 10250ED825-5   |

#### Selector Switch Operators with Caps

UL (NEMA) Type 3, 3R, 4, 4X, 12, 13

#### Selector Switch Operators with Caps

| Positions                              | Operator Action <sup>②</sup> | Black Knob Selector Switch—Vertical Mounting <sup>③</sup> |                | Black Lever Selector Switch—Vertical Mounting <sup>③</sup> |                |            |
|--|------------------------------|---|----------------|--|----------------|------------|
|  |                              | Cam Code <sup>④</sup>                                     | Catalog Number | Cam Code <sup>④</sup>                                      | Catalog Number |            |
| Two-Position Maintained <sup>①</sup>   | Two-position—60° throw       |   | 1              | 10250T1311   | 1              | 10250T3011 |
|  |                              |   | 1              | 10250T1371   | 1              | 10250T3071 |
| Three-Position Maintained <sup>⑤</sup> | Three-position—60° throw     |   | 2              | 10250T1322   | 2              | 10250T3022 |
|  |                              |   | 3              | 10250T1323   | 3              | 10250T3023 |
|  |                              |   | 2              | 10250T1332   | 2              | 10250T3032 |
|  |                              |   | 3              | 10250T1333   | 3              | 10250T3033 |
|  |                              |   | 2              | 10250T1342   | 2              | 10250T3042 |
|  |                              |   | 3              | 10250T1343   | 3              | 10250T3043 |
|  |                              |   | 2              | 10250T1352   | 2              | 10250T3052 |
|  |                              |   | 3              | 10250T1353   | 3              | 10250T3053 |
| Four-position—40° throw                |                              | 7   | 10250T1367     | 7  | 10250T3067     |            |

#### Notes

- ① Black knob selector switch, cam 1 shown.
- ② M = Maintained. S = Spring return in direction of arrow.
- ③ Field convertible to horizontal mounting or order operator only and separate operator cap.
- ④ For selection of the proper cam and contact block to obtain the proper circuit sequence, see selection instructions and tables on **Pages V7-T1-208, V7-T1-209** and **V7-T1-210**.
- ⑤ Black lever selector switch, cam 3 shown.

### Selector Switch Operators without Caps

Operators can be ordered with caps assembled to them by adding the code number from the table on this page to the end of catalog number below.  
Example: 10250T4011**KB**

#### Two-Position Selector Switch Maintained



### Selector Switch Operators without Caps

| Positions                | Operator Action ① | Cam Code ② | Catalog Number    |
|--------------------------|-------------------|------------|-------------------|
| Two-position—60° throw   |                   | 1          | <b>10250T4011</b> |
|                          |                   | 1          | <b>10250T4081</b> |
| Three-position—60° throw |                   | 2          | <b>10250T4022</b> |
|                          |                   | 3          | <b>10250T4023</b> |
|                          |                   | 2          | <b>10250T4032</b> |
|                          |                   | 3          | <b>10250T4033</b> |
|                          |                   | 2          | <b>10250T4042</b> |
|                          |                   | 3          | <b>10250T4043</b> |
| Four-position—40° throw  |                   | 2          | <b>10250T4052</b> |
|                          |                   | 3          | <b>10250T4053</b> |
|                          |                   | 7          | <b>10250T4067</b> |
|                          |                   |            |                   |

#### Knob



#### Lever



#### Lever for Use with Maintained Operators



#### Coin Slot



### Operating Caps

| Color  | Knob Catalog and Code Number | Lever Catalog and Code Number | Color  | Lever ③ Catalog and Code Number | Coin Slot Catalog and Code Number |
|--------|------------------------------|-------------------------------|--------|---------------------------------|-----------------------------------|
| Black  | <b>10250TKB</b>              | <b>10250TLB</b>               | Black  | <b>10250TSB</b>                 | <b>10250TCB</b>                   |
| Red    | <b>10250TKR</b>              | <b>10250TLR</b>               | Red    | <b>10250TSR</b>                 | <b>10250TCR</b>                   |
| Green  | <b>10250TKG</b>              | <b>10250TLG</b>               | Green  | <b>10250TSG</b>                 | <b>10250TCG</b>                   |
| Yellow | <b>10250TKY</b>              | <b>10250TLY</b>               | Yellow | <b>10250TSY</b>                 | <b>10250TCY</b>                   |
| White  | <b>10250TKW</b>              | <b>10250TLW</b>               | White  | <b>10250TSW</b>                 | <b>10250TCW</b>                   |
| Gray   | <b>10250TKA</b>              | <b>10250TLA</b>               | Gray   | <b>10250TSA</b>                 | <b>10250TCA</b>                   |
| Blue   | <b>10250TKL</b>              | <b>10250TLL</b>               | Blue   | <b>10250TSL</b>                 | <b>10250TCL</b>                   |
| Orange | <b>10250TKD</b>              | <b>10250TLO</b>               | Orange | <b>10250TSO</b>                 | <b>10250TCO</b>                   |

#### Notes

- ① M = Maintained. S = Spring return in direction of arrow (R).
- ② For selection of the proper cam and contact block to obtain the proper circuit sequence, see selection instructions and tables on **Pages V7-T1-208, V7-T1-209 and V7-T1-210.**
- ③ Designed for added ingress protection. For use in maintained operators only.

#### 1

### Illuminated Selector Switch Operators

#### Illuminated Selector Switches without Caps

##### Two-Position Selector Switch Maintained



#### Operator without Knob or Lever

| Positions                | Operator Action ① | Transformer Type—50/60 Hz<br>6 Volt #755 Lamp |                   |                                  | Full Voltage Type—AC or DC ④<br>Lamps: 6V—#755, 12V—#756, 24V—#757,<br>48V—#1835, 120/240V—120MB |                   |                                  |
|--------------------------|-------------------|---|-------------------|----------------------------------|--|-------------------|----------------------------------|
|                          |                   | Cam Code ②                                    | Voltage           | Code Number and Catalog Number ③ | Cam Code ②   | Voltage           | Code Number and Catalog Number ③ |
| Two-position—60° throw   |                   | 1   | 24                | <b>10250T5961</b>                | 1  | 6                 | <b>10250T6201</b>                |
|                          |                   |   | 120               | <b>10250T5971</b>                |  | 12                | <b>10250T6211</b>                |
|                          |                   |   | 208               | <b>10250T6511</b>                |  | 24                | <b>10250T6221</b>                |
|                          |                   |   | 240               | <b>10250T5981</b>                |  | 48                | <b>10250T6231</b>                |
|                          |                   |   | 380               | <b>10250T5991</b>                |  | 120               | <b>10250T6361</b>                |
|                          |                   |   | 480               | <b>10250T6001</b>                |  | 240 ⑤             | <b>10250T6371</b>                |
|                          |                   |   | 600               | <b>10250T6011</b>                |  |                   |                                  |
| Three-position—60° throw |                   | + 2 or 3                                      | 24                | <b>10250T602_</b>                | + 2 or 3   | 6                 | <b>10250T624_</b>                |
|                          |                   |   | 120               | <b>10250T603_</b>                |  | 12                | <b>10250T625_</b>                |
|                          |                   |   | 208               | <b>10250T652_</b>                |  | 24                | <b>10250T626_</b>                |
|                          |                   |   | 240               | <b>10250T604_</b>                |  | 48                | <b>10250T627_</b>                |
|                          |                   |   | 380               | <b>10250T605_</b>                |  | 120               | <b>10250T638_</b>                |
|                          |                   |   | 480               | <b>10250T606_</b>                |  | 240 ⑤             | <b>10250T639_</b>                |
|                          |                   | 600   | <b>10250T607_</b> |                                  |  |                   |                                  |
|                          |                   | + 2 or 3                                      | 24                | <b>10250T654_</b>                | + 2 or 3   | 6                 | <b>10250T612_</b>                |
|                          |                   |   | 120               | <b>10250T620_</b>                |  | 12                | <b>10250T632_</b>                |
|                          |                   |   | 208               | <b>10250T655_</b>                |  | 24                | <b>10250T642_</b>                |
|                          |                   |   | 240               | <b>10250T656_</b>                |  | 48                | <b>10250T672_</b>                |
|                          |                   |   | 380               | <b>10250T657_</b>                |  | 120               | <b>10250T622_</b>                |
|                          |                   |   | 480               | <b>10250T658_</b>                |  | 240               | <b>10250T682_</b>                |
|                          |                   | 600   | <b>10250T659_</b> |                                  |  |                   |                                  |
|                          | + 2 or 3          | 24  | <b>10250T660_</b> | + 2 or 3                         | 6  | <b>10250T613_</b> |                                  |
|                          |                   | 120   | <b>10250T621_</b> |                                  | 12   | <b>10250T633_</b> |                                  |
|                          |                   | 208   | <b>10250T661_</b> |                                  | 24   | <b>10250T643_</b> |                                  |
|                          |                   | 240   | <b>10250T662_</b> |                                  | 48   | <b>10250T673_</b> |                                  |
|                          |                   | 380   | <b>10250T663_</b> |                                  | 120  | <b>10250T623_</b> |                                  |
|                          |                   | 480   | <b>10250T664_</b> |                                  | 240  | <b>10250T683_</b> |                                  |
|                          | 600               | <b>10250T665_</b>                             |                   |                                  |  |                   |                                  |
|                          | + 2 or 3          | 24  | <b>10250T614_</b> | + 2 or 3                         | 6  | <b>10250T628_</b> |                                  |
|                          |                   | 120   | <b>10250T615_</b> |                                  | 12   | <b>10250T629_</b> |                                  |
|                          |                   | 208   | <b>10250T653_</b> |                                  | 24   | <b>10250T630_</b> |                                  |
|                          |                   | 240   | <b>10250T616_</b> |                                  | 48   | <b>10250T631_</b> |                                  |
|                          |                   | 380   | <b>10250T617_</b> |                                  | 120  | <b>10250T640_</b> |                                  |
|                          |                   | 480   | <b>10250T618_</b> |                                  | 240 ⑤  | <b>10250T641_</b> |                                  |
|                          | 600               | <b>10250T619_</b>                             |                   |                                  |  |                   |                                  |
| Four-position—40° throw  |                   | 7   | 24                | <b>10250T6087</b>                | 7  | 6                 | <b>10250T6327</b>                |
|                          |                   |   | 120               | <b>10250T6097</b>                |  | 12                | <b>10250T6337</b>                |
|                          |                   |   | 208               | <b>10250T6547</b>                |  | 24                | <b>10250T6347</b>                |
|                          |                   |   | 240               | <b>10250T6107</b>                |  | 48                | <b>10250T6357</b>                |
|                          |                   |   | 380               | <b>10250T6117</b>                |  | 120               | <b>10250T6427</b>                |
|                          |                   |   | 480               | <b>10250T6127</b>                |  | 240 ⑤             | <b>10250T6437</b>                |
|                          |                   |   | 600               | <b>10250T6137</b>                |  |                   |                                  |

#### Notes

- ① M = Maintained. S = Spring return in direction of arrow (R).
- ② For selection of the proper cam and contact block, to obtain the proper circuit sequence, see selection tables on **Pages V7-T1-208, V7-T1-209 and V7-T1-210**.
- ③ Operator includes lens gasket and lens attachment screws.
- ④ Full voltage light units can be used at other than listed voltages by changing lamp. Replacement lamps are listed on **Page V7-T1-239**.
- ⑤ Resistor type. May generate excess heat if used in high density.

**Knob**



**Lever**



### Illuminated Knobs and Levers

| Color <sup>①</sup> | Knob Code Number and Catalog Number | Lever Code Number and Catalog Number |
|--------------------|-------------------------------------|--------------------------------------|
| Red                | 10250TER                            | 10250TFR                             |
| Green              | 10250TEG                            | 10250TFG                             |
| Yellow             | 10250TEA                            | 10250TFA                             |
| Blue               | 10250TEL                            | 10250TFL                             |
| Clear              | 10250TEC                            | 10250TFC                             |
| White              | 10250TEW                            | 10250TFW                             |
| Amber              | 10250TEM                            | 10250TFM                             |

### Joystick Units

**Two-Position Joystick**



### Joystick Units—UL (NEMA) Type 3, 3R, 4, 4X, 12, 13

**Operator Position <sup>②</sup>**

|   | Up | Center | Down | Operator Action <sup>③</sup> | Contact Type | Mounting Location |   | Two-Position Assembled Unit Catalog Number <sup>④</sup> |
|---|----|--------|------|------------------------------|--------------|-------------------|---|---|
|   |    |        |      |                              |              | A                 | B |   |
| X |    |        |      |                              | 1NC          |                   |   | 10250T452-3X  |
| 0 |    |        |      |                              | 1NC          |                   |   |   |

**Notes**

- ① Amber, clear and white lenses have a black arrow (pointer), red, green and blue lenses have a white arrow (pointer).
- ② X = closed circuit, 0 = open circuit.
- ③ M = Maintained. S = Spring return in direction of arrow (R).
- ④ Field convertible momentary to maintained or vice versa.

#### 1

### Joysticks

#### Two-Position Joystick Operators

The device mounts in the standard 30.5 mm mounting hole. Allow sufficient panel space for lever movement.

The maximum travel of the knob operator (full up to full down) is 2.2 in (24°) momentary, 2.5 in (30°) maintained, but ample space for lever operation must be allowed. These operators are field convertible from momentary to maintained operation or vice versa.

The use of NC contacts is preferred because they provide positive drive contact opening and a direct relationship between lever movement and affected terminal, i.e., up movement affects the top terminals.

#### Application Caution

Joystick operators are not recommended on certain DC applications above 24 Vdc which may involve lightly engaging the contacts (teasing) to achieve speed control, positioning, jogging, etc. Excessive arcing and deterioration of the contacts will occur.

#### Two-Position Joystick Operator



#### Two-Position Joystick Operators—UL (NEMA) Type 3, 3R, 4, 4X, 12, 13

| Contact Block Limitations   | Two-Position Operator Only—AC Applications Only Description <sup>①</sup> | Catalog Number    |
|---|--|-------------------|
| <b>Momentary Mode</b><br>4NC contact blocks max.<br>3NO contact blocks max. | Momentary up and down  | <b>10250T452</b>  |
|   | Maintained up—momentary down   | <b>10250T4521</b> |
|   | Maintained down—momentary up   | <b>10250T4522</b> |
| <b>Maintained Mode</b><br>2 contact blocks max.                             | Maintained up and down   | <b>10250T4525</b> |

#### Contact Block Operation and Selection

##### Handle Position <sup>②</sup>

| Up | Center | Down | Contact Block Type <sup>④</sup> | Mounting Location <sup>②③</sup> |          | Catalog Number               |
|----|--------|------|---------------------------------|---------------------------------|----------|------------------------------|
|    |        |      |                                 | Top A                           | Bottom B |                              |
|    |        |      | 1NC                             |                                 |          | <b>10250T51</b>              |
|    |        |      | 1NC                             |                                 |          | <b>10250T51</b>              |
|    |        |      | 2LONC (Series)                  |                                 |          | <b>10250T45</b>              |
|    |        |      | 1NC                             |                                 |          | <b>10250T3</b>               |
|    |        |      | 1NC                             |                                 |          | <b>10250T3</b>               |
|    |        |      | 1LONC                           |                                 |          | <b>10250T45</b>              |
|    |        |      | 1LONC                           |                                 |          | <b>10250T45</b>              |
|    |        |      | 1NC                             |                                 |          | <b>10250T44 <sup>⑤</sup></b> |
|    |        |      | 1NO                             |                                 |          | <b>10250T44 <sup>⑤</sup></b> |
|    |        |      | 1NC                             |                                 |          | <b>10250T44 <sup>⑤</sup></b> |
|    |        |      | 1NO                             |                                 |          | <b>10250T44 <sup>⑤</sup></b> |

#### A and B Mounting Location

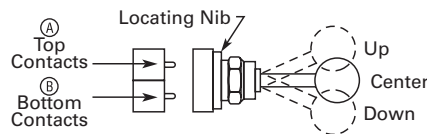

|   |  |   |
|---|--|---|
| <u>Up</u>   | <u>Center</u>  | <u>Down</u>   |
| NC Contact at Top Is Closed, NO at Bottom Is Closed | All NC and NO Contacts Are Open (1/2 Way), Late Opening NC Is Closed | NC Contact at Bottom Is Closed, NO at Top Is Closed |

#### Notes

- ① Field convertible momentary to maintained or vice versa. To expedite shipment of maintained types, order momentary operator 10250T452 which is a stocked device.
- ② Bolded circuit corresponds to "X-O" circuit selection. X = closed circuit, O = open circuit.
- ③ See above for "A" and "B" mounting location.
- ④ NO = normally open, NC = normally closed, LONC = late opening normally closed.
- ⑤ Four circuits in single block depth—rated 300V max.

### Four-Position Joystick Operators

The joystick operated control unit is intended for AC application only. For other use, see **Application** **Caution** on preceding page.

The panel area required for the four-position operator is equivalent to two standard pushbutton operators.

The latch holds the lever in the center position. The trigger latch must be released before lever can moved into any position.

**Four-Position Joystick Operator**



**Four-Position Joystick Operator with Latch**



### Four-Position Joystick Operators—UL (NEMA) Type 3, 3R, 4, 4X, 12, 13

| Contact Block Limitations                     | Description ①               | Catalog Number    |
|---|-----------------------------|-------------------|
| <b>Operator Only—AC Application Only</b>      |                             |                   |
| Four contact blocks max.—two in each position | Four-position—without latch | <b>10250T451_</b> |
|   | Four-position—with latch    | <b>10250T461_</b> |
| <b>Hole Plug</b>                              |                             |                   |
| Four contact blocks max.—two in each position | To plug unused hole         | <b>10250TA7</b>   |

### Field Conversion—Gate

The factory assembled four-position operator is assembled with a gate arranged for four handle positions.

#### Handle Positions



Four-Position Gate

Three additional gates, supplied with every operator, allow on the job conversion to three- or eight-position operation as illustrated.

### Two-, Three- or Eight-Position Operation

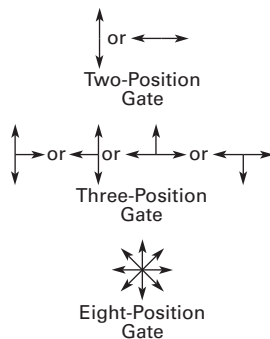

The eight-position gate controls the four functions shown as “Up,” “Down,” “Left” and “Right.” The remaining four diagonal positions each actuate two adjacent functions; for example, “Left Down” actuates both “Left” and “Down.” The operator may be arranged for spring return of handle to center position, or maintained in up to eight positions (see description of maintained position operator).

### Adjacent Functions

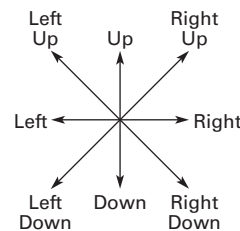

### Maintained Position

For maintained position (non-spring return), locate required maintained position or positions of operating lever and add appropriate suffix number to the catalog number selected from the table above.

### Maintained Positions

| Maintained Positions |      |      |       | Suffix Number |
|----------------------|------|------|-------|---------------|
| Up                   | Down | Left | Right |               |
| X                    | —    | —    | —     | <b>1</b>      |
| —                    | —    | —    | —     | <b>2</b>      |
| —                    | X    | —    | —     | <b>3</b>      |
| —                    | —    | X    | —     | <b>4</b>      |
| —                    | —    | —    | —     | <b>5</b>      |
| X                    | —    | X    | —     | <b>6</b>      |
| X                    | —    | —    | X     | <b>7</b>      |
| —                    | X    | X    | —     | <b>8</b>      |
| —                    | X    | —    | X     | <b>9</b>      |
| —                    | —    | X    | X     | <b>10</b>     |
| X                    | X    | X    | —     | <b>11</b>     |
| X                    | X    | —    | X     | <b>12</b>     |
| X                    | —    | X    | X     | <b>13</b>     |
| —                    | X    | X    | X     | <b>14</b>     |
| X                    | X    | X    | X     | <b>15</b>     |

On an eight-position gate, when an adjacent vertical and horizontal position are both maintained, the included diagonal position is also maintained.

**Note**

① Momentary operators—spring return to center. For maintained operators add suffix code from table on this page. Example: 10250T451**10**. Operator without latch, maintained in left and right positions.

#### 1

#### Contact Block Operation

Contact blocks mount directly to the back of the operator. For reliable operation, the maximum number of contact blocks that should be installed behind each operator lever is two (four total).

The figure below identifies the circuits activated by each of the eight possible lever positions. Contact block plungers 1, 2, 3, 4 are depressed (change state) when handle is in the position indicated by arrows below.

#### Circuit Activation

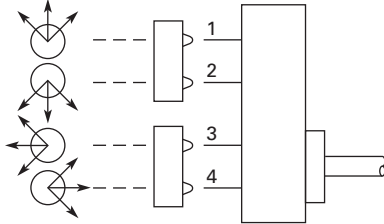

**Note:** Joystick in its resting state, center position, does not activate contact block plungers.

#### Ordering Example:

Suppose you are looking for a four-position momentary joystick without a latch and the following circuit arrangements. X = Closed Circuit, O = Open Circuit.

#### Example Circuit Arrangements

| Circuit | Up | Down | Left | Right |
|---------|----|------|------|-------|
| 1st     | X  | X    | X    | X     |
| 2nd     | X  | O    | O    | X     |

The contact blocks and their mounting locations would be as follows:

#### Example Contact Blocks and Locations

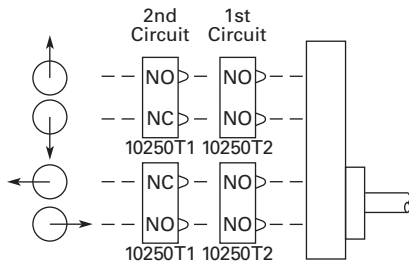

A complete bill of material for this example would include:

#### Example Order

| Qty. | Catalog Number |
|------|----------------|
| 1    | 10250T451      |
| 2    | 10250T2        |
| 2    | 10250T1        |

#### Blank Legend Plates for Joystick Operators

When ordering engraved legend plates, order by catalog number and insert the following into order notes:

- Legend required
- Size of characters: 3/16, 1/8, 3/32 in (4.8, 3.2, 2.4 mm)
- Location by letter (A–N)

Locations K and M can accommodate up to two lines horizontally; L and N up to two lines vertically.

Maximum number of characters:

- Horizontal  
3/16 in—13, 1/8 in—14, 3/32 in—19
- Vertical  
3/16 in—10, 1/8 in—13, 3/32 in—14

#### Ordering Example:

Two-position legend plate to be marked “UP” “DOWN.”

Catalog No. **10250TJ2S4STAMP**

Letter Size: 3/16 in (4.8 mm)

Pos. K—UP

Pos. M—DOWN

#### Two-Position

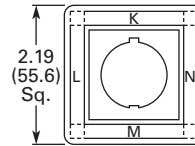

Catalog Number

Blank Plate

10250TJS3

Engraved Plate

10250TJS3STAMP

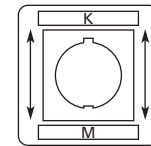

Catalog Number

|                |                |
|----------------|----------------|
| Blank Plate    | 10250TJS4      |
| Engraved Plate | 10250TJS4STAMP |

#### Four-Position

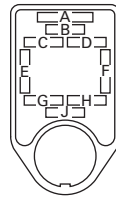

Catalog Number

Blank Plate

10250TJS1

Engraved Plate

10250TJS1STAMP

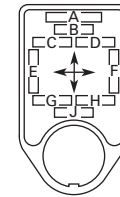

Catalog Number

|                |                |
|----------------|----------------|
| Blank Plate    | 10250TJS2      |
| Engraved Plate | 10250TJS2STAMP |

**Roto-Push Units**

**Two-Position Momentary**

Complete assembled two-position Roto-Push® Units are listed below. These operators have black flush buttons and are arranged for vertical mounting. Order legend plates separately.

**Mounting Location**

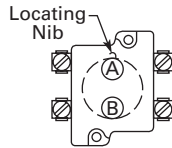

**Roto-Push—Black Flush Button**



**Roto-Push Units—UL (NEMA) Type 3, 3R, 4, 4X, 12, 13**

| Typical Applications<br>(Most Common Examples)                                    | Operator Position ① |           | Collar Right |           | Contact Type | Mounting Location |   | Catalog Number ② |
|---|---------------------|-----------|--------------|-----------|--------------|-------------------|---|------------------|
|   | Collar Left         | Depressed | Normal       | Depressed |              | A                 | B |                  |
| <b>Two-Position</b><br>FORWARD/REVERSE;<br>HIGH/LOW; OPEN/CLOSE;<br>UP/DOWN; etc. | Normal              | Depressed | Normal       | Depressed | 1NO          | A                 |   | 10250T2411-2     |
|   | 0                   | 0         | 0            | X         | 1NO          |                   | B |                  |
| JOG/RUN; MAN./AUTO;<br>etc.   | Normal              | Depressed | Normal       | Depressed | 1NO          | A                 |   | 10250T24111-2    |
|   | 0                   | X         | 0            | X         | 1NO          |                   | B |                  |
| RUN/JOG; START/JOG;<br>etc.   | Normal              | Depressed | Normal       | Depressed | 1NO          | A                 |   | 10250T24111-1    |
|   | X                   | X         | 0            | 0         | 1NC          |                   | B |                  |
| SAFE/RUN; etc.  | Normal              | Depressed | Normal       | Depressed | 1NO          | A                 |   | 10250T2415-2     |
|   | 0                   | 0         | 0            | X         | 1NO          |                   | B |                  |

**Two-Position Latched**

The two-position Roto-Push Latch Unit is fully assembled and only requires a legend plate for a great variety of applications. When the selector collar is in the extreme left position, the button is in the free or normal position and can be operated as a standard pushbutton. Rotating the collar to the

extreme right position automatically depresses and latches the button in the depressed position. The white filled groove in the button indicates the selector collar position. The selector collar has spring return to the left position except when in the extreme right latched position.

**Red Long**



**Rotates to a Latch-Out Mode**

| Color and Type of Button | Contact Block | Vertical Mounting Catalog Number |
|--------------------------|---------------|----------------------------------|
| Red long                 | 1NC           | 10250T72                         |
|                          | 2NC           | 10250T73                         |

**Notes**

- ① X = closed circuit, 0 = open circuit.
- ② Roto-Push assembled with contact blocks.



#### 1

### Roto-Push Operators

#### Roto-Push Components

A Roto-Push control unit combines the function of a pushbutton and a selector switch. The contacts are operated by the combined action of rotating the outer collar and pushing a button contained in the collar.

In selecting the cam and contact blocks for the listed function, the analysis involves considering the function with the collar rotated to the given position with the button free (designated as “N”) and then in that same position with the button depressed (designated “D”). This is done for each rotational position of the collar.

#### When Ordering Specify

- Catalog number of operator with cam code suffix from tables below and on following pages, Example: 10250T2411.
- Catalog number(s) for contact blocks and legend plates if required.
- To select the cam and contact blocks needed for two-position and three-position switches, use the tables on following pages.

#### Operator and Cam



#### Operator and Cam

| Color and Type of Button | Cam Code No. Select from Tables | Vertical Mounting Catalog and Code Number | Horizontal Mounting Catalog and Code Number |
|--------------------------|---------------------------------|---|---|
| Black flush              | + 1 to 18                       | 10250T241_                                | 10250T251_                                  |
| Red flush <sup>①</sup>   |                                 | 10250T242_                                | 10250T252_                                  |
| Green flush              |                                 | 10250T243_                                | 10250T253_                                  |
| Black long               |                                 | 10250T261_                                | 10250T271_                                  |
| Red long <sup>①</sup>    |                                 | 10250T262_                                | 10250T272_                                  |
| Green long               |                                 | 10250T263_                                | 10250T273_                                  |

#### Two-Position Roto-Push Operator—Rotates to a Latch-Out Mode Special Rotor Latch

This differs from the other Roto-Push operators in that as the collar is rotated to the right it depresses the button and releases the button when rotated left. But the button in the released position can be momentarily pushed independent of the collar or

its position. As the button is depressed by rotating the collar, the button also rotates and indicates its mode by a white line on the button face. This button can be used as an emergency stop or latched stop.

#### Special Roto Latch—Red Long Button











































#### Special Roto Latch—UL (NEMA) Type 3, 3R, 4, 4X, 12, 13

| Color and Type of Button | Vertical Mounting Catalog Number |
|--------------------------|----------------------------------|
| Red long                 | 10250T3213                       |
| Black long               | 10250T3214                       |

#### Note

<sup>①</sup> Not to be used for emergency stop application.

### Cam and Contact Block Selection for Two-Position Roto-Push

| Combination Number | Collar Position |   | Circuit Sequence <sup>①</sup> |   | Cam Code 1   | Cam Code 2   | Cam Code 3 | Cam Code 4   | Cam Code 5   | Cam Code 6   |
|--------------------|-----------------|---|-------------------------------|---|--|--|------------|--|--|--|
|                    | N               | D | N                             | D |  |  |            |  |  |  |
| 1                  | 0               | 0 | 0                             | X | A  NO   | A  NO   | —          | —  | A  NO   | —  |
| 2                  | 0               | 0 | X                             | 0 | —  | —  | —          | A  NO<br>B  NO     | A  NO<br>B  NO     | —  |
| 3                  | 0               | 0 | X                             | X | —  | —  | —          | —  | B  NO   | A  NO   |
| 4                  | 0               | X | 0                             | 0 | B  NO   | A  NO<br>B  NO     | —          | —  | —  | A  NO<br>B  NO     |
| 5                  | 0               | X | 0                             | X | A  NO<br>B  NO     | B  NO   | —          | A  NO   | —  | —  |
| 6                  | 0               | X | X                             | 0 | —  | —  | —          | —  | —  | —  |
| 7                  | 0               | X | X                             | X | —  | —  | A or B NO  | B  NO   | —  | B  NO   |
| 8                  | X               | 0 | 0                             | 0 | —  | —  | A or B NC  | B  NC   | —  | B  NC   |
| 9                  | X               | 0 | 0                             | X | —  | —  | —          | —  | —  | —  |
| 10                 | X               | 0 | X                             | 0 | A  NC<br>B  NC | B  NC   | —          | A  NC   | —  | —  |
| 11                 | X               | 0 | X                             | X | B  NC   | A  NO<br>B  NC | —          | —  | —  | A  NO<br>B  NC |
| 12                 | X               | X | 0                             | 0 | —  | —  | —          | —  | B  NC   | A  NC   |
| 13                 | X               | X | 0                             | 0 | —  | —  | —          | A  NO<br>B  NO | A  NO<br>B  NO | —  |
| 14                 | X               | X | X                             | 0 | A  NC   | A  NC   | —          | —  | A  NC   | —  |

### Series and Parallel Connections

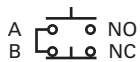

Series Connection



Parallel Connection

The connections are not made at the factory. They are illustrated in the selection table as requirements, but must be made on the job.

### Circuit Location

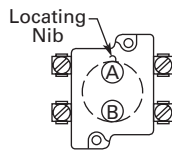

Letters "A" and "B" represent the locations which the two circuits of a contact block will occupy in relation to the locating nib of the operator.

### Note

① N = Button in free or normal position. D = Button depressed.

#### Cam and Contact Block Selection for Two-Position Roto-Push, continued

| Combination Number | Collar Position |   | Circuit Sequence ① |   | Cam Code 10 | Cam Code 11 | Cam Code 12 | Cam Code 13 | Cam Code 14 |   |
|--------------------|-----------------|---|--------------------|---|-------------|-------------|-------------|-------------|-------------|---|
|                    | N               | D | N                  | D |             |             |             |             |             |   |
| 15                 | 0               | 0 | 0                  | X | —           |             | —           | —           | —           |   |
| 16                 | 0               | 0 | X                  | 0 | —           |             | A           | A or B NC   | A           |   |
| 17                 | 0               | 0 | X                  | X | B           | B           | —           | —           | —           |   |
| 18                 | 0               | X | 0                  | 0 | A           |             | —           | —           | B           |   |
| 19                 | 0               | X | 0                  | X | —           | A           | B           | —           | —           |   |
| 20                 | 0               | X | X                  | 0 | —           | —           | —           | —           | A           |   |
| 21                 | 0               | X | X                  | X | A           | A           | A           | —           | —           |   |
| 22                 | X               | 0 | 0                  | 0 | A           | A           | A           | —           | —           |   |
| 23                 | X               | 0 | 0                  | X | —           | —           | —           | —           | A           |   |
| 24                 | X               | 0 | X                  | 0 | —           | A           | B           | —           | —           | — |
| 25                 | X               | 0 | X                  | X | A           | A           | —           | —           | B           |   |
| 26                 | X               | X | 0                  | 0 | B           | B           | —           | —           | —           | — |
| 27                 | X               | X | 0                  | 0 | —           | A           | A           | A or B NO   | A           |   |
| 28                 | X               | X | X                  | 0 | —           | A           | —           | —           | —           |   |

#### Series and Parallel Connections



Series Connection



Parallel Connection

The connections are not made at the factory. They are illustrated in the selection table as requirements, but must be made on the job.

**Note**

① N = Button in free or normal position. D = Button depressed.

#### Circuit Location

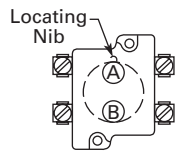

Letters “A” and “B” represent the locations which the two circuits of a contact block will occupy in relation to the locating nib of the operator.

### Cam and Contact Block Selection for Three-Position Roto-Push

| Combination Number | Collar Position               |   |   |   |   |   | Cam Code 7 | Cam Code 8 | Cam Code 9 | Cam Code 15 <sup>②</sup> | Cam Code 16 | Cam Code 17 | Cam Code 18 |
|--------------------|-------------------------------|---|---|---|---|---|------------|------------|------------|--------------------------|-------------|-------------|-------------|
|                    | Circuit Sequence <sup>①</sup> |   |   |   |   |   |            |            |            |                          |             |             |             |
|                    | N                             | D | N | D | N | D |            |            |            |                          |             |             |             |
| 1                  | 0                             | 0 | 0 | 0 | 0 | X |            |            | —          |                          |             | —           |             |
| 2                  | 0                             | 0 | 0 | 0 | X | X | —          | —          |            | —                        | —           |             | —           |
| 3                  | 0                             | 0 | 0 | X | 0 | 0 | —          | —          |            | —                        | —           | —           |             |
| 4                  | 0                             | 0 | 0 | X | 0 | X | —          | —          | —          | —                        | —           | —           |             |
| 5                  | 0                             | 0 | 0 | X | X | X | —          | —          |            | —                        | —           | —           | —           |
| 6                  | 0                             | 0 | X | X | 0 | 0 | —          |            | —          | —                        | —           | —           | —           |
| 7                  | 0                             | 0 | X | X | 0 | X | —          |            | —          | —                        | —           | —           | —           |
| 8                  | 0                             | 0 | X | X | X | 0 |            | —          | —          | —                        | —           | —           | —           |
| 9                  | 0                             | 0 | X | X | X | X |            | —          | —          | —                        | —           | —           | —           |
| 10                 | 0                             | X | 0 | 0 | 0 | 0 |            |            | —          |                          |             |             |             |
| 11                 | 0                             | X | 0 | 0 | 0 | X |            | —          | —          |                          |             | —           | —           |
| 12                 | 0                             | X | 0 | 0 | X | X | —          | —          | —          | —                        | —           |             | —           |
| 13                 | 0                             | X | 0 | X | 0 | 0 | —          | —          | —          | —                        | —           | —           |             |
| 14                 | 0                             | X | 0 | X | 0 | X | —          | —          | —          | —                        | —           | —           |             |
| 15                 | 0                             | X | X | X | 0 | 0 | —          |            | —          | —                        | —           | —           | —           |
| 16                 | 0                             | X | X | X | 0 | X | —          |            | —          | —                        | —           | —           | —           |
| 17                 | 0                             | X | X | X | X | X |            | —          | —          | —                        | —           | —           | —           |

#### Series and Parallel Connections

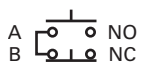

Series Connection



Parallel Connection

The connections are not made at the factory. They are illustrated in the selection table as requirements, but must be made on the job.

#### Circuit Location

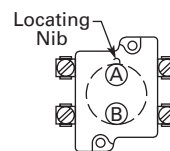

Letters "A" and "B" represent the locations which the two circuits of a contact block will occupy in relation to the locating nib of the operator.

#### Notes

① N = Button in free or normal position. D = Button depressed.

② Limited to 4 contact blocks. See Note on **Page V7-T1-236**.

#### Cam and Contact Block Selection for Three-Position Roto-Push, continued

| Combination Number | Circuit Sequence <sup>①</sup> |   |   |   |   |   | Cam Code 7 | Cam Code 8 <sup>②</sup> | Cam Code 9 | Cam Code 15 | Cam Code 16 | Cam Code 17 | Cam Code 18 |
|--------------------|-------------------------------|---|---|---|---|---|------------|-------------------------|------------|-------------|-------------|-------------|-------------|
|                    | N                             | D | N | D | N | D |            |                         |            |             |             |             |             |
| 18                 | X                             | 0 | 0 | 0 | 0 | 0 |            | —                       | —          | —           | —           | —           | —           |
| 19                 | X                             | 0 | 0 | 0 | X | X | —          | A                       | —          | —           | —           | —           | —           |
| 20                 | X                             | 0 | 0 | 0 | X | 0 | —          | A                       | —          | —           | —           | —           | —           |
| 21                 | X                             | 0 | X | X | 0 | 0 | —          | —                       | —          | —           | —           | A           | —           |
| 22                 | X                             | 0 | X | X | X | X | A          | A                       | —          | —           | A           | B           | A           |
| 23                 | X                             | 0 | X | X | X | 0 | A          | —                       | —          | —           | A           | —           | —           |
| 24                 | X                             | 0 | X | 0 | X | 0 | —          | —                       | —          | A           | —           | —           | A           |
| 25                 | X                             | 0 | X | 0 | X | X | —          | —                       | —          | A           | —           | —           | A           |
| 26                 | X                             | X | 0 | 0 | 0 | 0 | B          | —                       | A          | —           | —           | —           | —           |
| 27                 | X                             | X | 0 | 0 | 0 | X | A          | —                       | —          | —           | —           | —           | —           |
| 28                 | X                             | X | 0 | 0 | X | 0 | —          | B                       | —          | —           | —           | —           | —           |
| 29                 | X                             | X | 0 | 0 | X | X | —          | A                       | A          | —           | —           | —           | —           |
| 30                 | X                             | X | X | X | 0 | 0 | —          | —                       | B          | —           | —           | A           | —           |
| 31                 | X                             | X | X | X | X | 0 | A          | A                       | —          | —           | B           | —           | A           |
| 32                 | X                             | X | X | 0 | X | 0 | —          | —                       | —          | B           | —           | —           | B           |
| 33                 | X                             | X | X | 0 | X | X | —          | —                       | —          | A           | —           | —           | A           |

#### Series and Parallel Connections

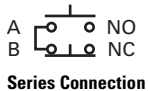

The connections are not made at the factory. They are illustrated in the selection table as requirements, but must be made on the job.

#### Circuit Location

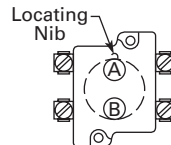

Letters "A" and "B" represent the locations which the two circuits of a contact block will occupy in relation to the locating nib of the operator.







#### Notes

- ① N = Button in free or normal position. D = Button depressed.
- ② Limited to 4 contact blocks. See Note on **Page V7-T1-236**.

### Accessories

Padlocks not included with padlocking attachments. For operators with built-in padlock attachment, see **Page V7-T1-190**.

#### Accessories

|   | Description   | Catalog Number |
|---|---|----------------|
| <b>Padlock Attachments</b>  |   |                |
|    | <b>10250TA2</b><br><b>Padlocking Attachment for Flush Pushbutton Operators</b><br>Permits locking NC contacts in open position with 1/4 in padlock. Will not lock NO contact.   | 10250TA2       |
|    | <b>10250TA26</b><br><b>Padlocking Attachment for Use with Extended Pushbutton</b><br>Permits locking NC contacts in open position with 1/4 in padlock.  | 10250TA26      |
|    | <b>10250TA36</b><br><b>Padlocking Cover Guard</b><br>Cover locked over flush button makes it unaccessible or on extended button locks NC contacts open. Takes 1/4 in shank size padlock.  | 10250TA36      |
|   | <b>10250TA38</b><br><b>Padlock Hasp or Flip-Up Guard</b><br>When used with a 1/4 in padlock, makes flush and long button and knob selector switch unaccessible, but not locked down. Without the padlock, it is a flip-up guard. Padlock hasp can be removed before assembly. | 10250TA38      |
|  | <b>10250TA63</b><br><b>Padlocking Attachment for Use with Flexible Weather Resistant Boot</b><br>Used on long button operators. Stainless steel. Use only for locking NC contacts open.   | 10250TA63      |
|  | <b>10250TA64</b><br><b>Padlock Attachment</b><br>For use with illuminated pushbuttons and maintained push-pull operators having standard button or lens only. Use 1/4 in padlock. Locks in down position only.  | 10250TA64      |
|  | <b>10250TA11</b><br><b>Padlocking Attachment for Non-Illuminated Knob Selector Switches</b><br>Provision for up to 5, 1/4 in padlocks.  | 10250TA11      |







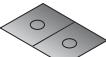

## Accessories, continued

|  | Description  | Catalog Number     |
|--|--|--------------------|
| <b>Shrouds and Guards</b>  |  |                    |
| <b>10250TA6</b><br>     | <b>Shroud for Mushroom Head Operator</b><br>Prevents accidental operation. (Not for push-pull operators.)  | <b>10250TA6</b>    |
| <b>10250TA12</b><br>    | <b>Extended Retaining Nut</b><br>Replaces standard nut and provides guard for flush head pushbutton operators.   | <b>10250TA12</b>   |
| <b>10250TA15</b><br>    | <b>Guard for Illuminated Pushbutton</b>  | <b>10250TA15</b>   |
| <b>10250TA56_</b><br>   | <b>Shroud</b><br>For jumbo mushroom head operator.   |                    |
|  | Gray   | <b>10250TA56</b>   |
|  | Yellow   | <b>10250TA56Y</b>  |
| <b>10250ED1241</b><br>  | <b>Half Shroud</b> —Yellow<br>For jumbo mushroom head operator.  | <b>10250ED1241</b> |
| <b>10250TA101</b><br> | <b>Fingerproof Shroud</b> —10 per package<br>Fits new style contact blocks and light units.  | <b>10250TA101</b>  |
| <b>Boots</b>   |  |                    |
| <b>10250TA_</b><br>   | <b>Flexible Weather Resistant Boot</b><br>For use with button operators (extended buttons preferred).<br>Temperature to –25°F (–32°C).<br>(See <b>Page V7-T1-229</b> for 10250TA96 Tightening Tool.) |                    |
|  | Black  | <b>10250TA3</b>    |
|  | Red  | <b>10250TA4</b> ①  |
|  | Green  | <b>10250TA10</b>   |
| <b>10250TA25</b><br>  | <b>Transparent Boot</b><br>For regular illuminated pushbutton operators and PresTest—<br>Temperature to –38°F (–39°C). ②   | <b>10250TA25</b>   |
| <b>10250TA4_</b><br>  | <b>Boot for Flush Pushbutton</b>   |                    |
|  | Clear  | <b>10250TA46</b>   |
|  | Black  | <b>10250TA47</b>   |
|  | Red  | <b>10250TA48</b>   |
|  | Green  | <b>10250TA49</b>   |

**Notes**

- ① Should not be used on flush button for STOP function.
- ② Not suitable for single contact block depth cast enclosure. Cover is too thick.

### Accessories, continued

|   | Description   | Catalog Number     |
|---|---|--------------------|
| <b>Hardware and Kits</b>  |   |                    |
| <b>10250TK3</b><br>    | <b>Thrust Washers</b> —<br>To meet Ford Motor Co. mounting specifications.  | <b>10250TK3</b>    |
| <b>10250TK5</b><br>    | <b>Contact Block Tape Seal</b> —<br>Seals plunger openings on last contact block. Order in multiples of 10 pieces.  | <b>10250TK5</b>    |
| <b>56-9337</b><br>     | <b>Selector Switch Operator Gasket</b> —<br>Seals out dust from getting in-between the cam and contact block plungers.<br>Supplied as standard with all selector switches.  | <b>56-9337</b>     |
| <b>10250TA3</b><br>    | <b>Special Retaining Nut</b> —<br>To accommodate thick panel:<br>Indicating lights  | <b>10250TA30</b>   |
|   | PresTest, pushbuttons and selector switches   | <b>10250TA31</b>   |
| <b>10250TA62</b><br>   | <b>Terminal Block</b> —<br>Two terminals, each will accommodate two wire terminations.  | <b>10250TA62</b>   |
| <b>10250TA8</b><br>  | <b>Spacer Ring</b> —<br>Used when legend plate is not required.   | <b>10250TA8</b>    |
| <b>10250TA79</b><br> | <b>Stacking Screw</b> —<br>Replaces transformer mounting screws on indicating light so terminal block 10250TA62 can be mounted to light to support and connect a series resistor.<br>This screw also fits all contact blocks. Order in multiples of 10. | <b>10250TA79</b>   |
| <b>10250TA2</b><br>  | <b>Base Mounting Spacers</b> ①—<br>Equivalent to contact block in depth<br>(one block deep).  | <b>10250TA22</b>   |
|   | Complete with screws, washers, etc.<br>(two block deep).  | <b>10250TA23</b>   |
| <b>10250TKG</b><br>  | <b>Grounding Kits</b> —<br>Kits consist of a ring connector and a #6 screw for mounting connector to rear of contact block mounting screw.<br>All components except standard indicating lights and PresTest indicating lights.                          | <b>10250TKG1</b>   |
|   | Standard indicating lights  | <b>10250TKG2</b> ② |
|   | PresTest indicating lights  | <b>10250TKG3</b> ② |
| <b>10250TA7</b><br>  | <b>Contact Block Terminal Jumpers</b> —<br>Available in multiples of 100 only.<br>Terminal to terminal—within block (short)   |                    |
|   | 100 per pkg.  | <b>10250TA70</b>   |
|   | 1000 per pkg.   | <b>10250TA70-2</b> |
|   | Terminal to terminal—block to block (long)  |                    |
|   | 100 per pkg.  | <b>10250TA71</b>   |
|   | 1000 per pkg.   | <b>10250TA71-2</b> |

#### Notes

- ① Component only. Not to be used for custom built (factory assembled) stations.
- ② Not suitable for single contact block depth cast enclosure. Cover is too thick.











## Accessories, continued

|  | Description  | Catalog Number      |
|--|--|---------------------|
| <b>Special Operators and Attachments</b>   |  |                     |
| <b>10250TA5</b><br>       | <b>Wobble Stick</b><br>Complete with retaining nut—fits standard button.   | <b>10250TA5</b>     |
| <b>10250TA14</b><br>      | <b>Lever Operator</b><br>For use with two vertically mounted flush pushbuttons.  | <b>10250TA14</b>    |
| <b>10250TA</b><br>        | <b>Maintained Contact Attachment Release Button Assembly</b> <sup>①</sup><br>Mechanically interlocks with another pushbutton and contact block (not included). Provides mode indication. Minimum hole centers 1.62 in (41.1 mm), maximum 2.313 in (58.8 mm). |                     |
|  | Black  | <b>10250TA17</b>    |
|  | Red  | <b>10250TA18</b>    |
|  | Green  | <b>10250TA19</b>    |
|  | Yellow   | <b>10250TA20</b>    |
|  | Same with Long Button—Black  | <b>10250TA39</b>    |
| <b>10250TA1</b><br>      | <b>Maintained Contact Attachment</b> <sup>①</sup><br>Mechanically interlocks two buttons and provides position indication for one. Use with two pushbutton operators and one or more contact blocks.   | <b>10250TA1</b>     |
| <b>10250TA13</b><br>    | <b>Roto-Push Lever Operator</b> —<br>Used to provide lever operation for Roto-Push operators.  | <b>10250TA13</b>    |
| <b>Special Light Modules</b>   |  |                     |
| <b>10250TA79</b><br>    | <b>Master Test (Dual Input) Module</b> —<br>Internal Form C relay suitable for either AC or DC applications. Total electrical isolation between monitored and test circuit. Fits all illuminated 10250T, E22, E30 and E34 devices.                           |                     |
|  | 48 Vdc   | <b>10250TMT8</b>    |
| <b>10250TFL</b><br>     | <b>Flasher Module</b> —<br>Changes any AC illuminated device to a controlled flashing light. Fits 10250T, E30 and E34 devices.   |                     |
|  | 24V  | <b>10250TFL2</b>    |
|  | 120V   | <b>10250TFL1</b>    |
| <b>10250ED986-4</b><br> | <b>Flashing Incandescent Lamp</b> —<br>For use with 120V transformer type or 6V full voltage type indicating lights including PresTest and most E29 devices.   | <b>10250ED986-4</b> |

**Note**

<sup>①</sup> Not suitable for single contact block depth cast enclosure. Cover is too thick.

### Accessories, continued

|   | Description   | Catalog Number    |
|---|---|-------------------|
| <b>Hole Plugs</b>   |   |                   |
|    | <b>10250TA7 Plug</b> —<br>For unused holes—steel, painted gray (stainless steel, use <b>E30KT5</b> , see <b>Page V7-T1-175</b> )          | <b>10250TA7</b>   |
| <b>Tools</b>  |   |                   |
|    | <b>10250TA95</b> Octagonal 10250T (notched to fit over selector switch lever), E29 and E30  | <b>10250TA95</b>  |
|    | <b>E22CW</b> E22, E30, E34 and octagonal 10250T (will not fit over selector switch levers)  | <b>E22CW</b>      |
|    | <b>10250TA96 Tool for Tightening Boots</b> —<br>Used to install boot Catalog Numbers 10250TA3, A4, A10 and A25.                           | <b>10250TA96</b>  |
|    | <b>10250TA102 10250T, E34 Allen Wrench</b> —<br>Used for removal of jumbo mushroom head.  | <b>10250TA102</b> |
|    | <b>10250TA74 Lamp Removal Tools</b> —<br>For transformer type illuminated pushbuttons, push-pull and selector switches.<br>Fits #12 lamp. | <b>10250TA74</b>  |
|  | <b>E30KV1</b> For full voltage and resistor type illuminated pushbuttons, push-pull and selector switches and E30.                        | <b>E30KV1</b>     |
|  | <b>E29KLT</b> Standard indicating lights. Fits #44, #755, #6S6 and #10S6.   | <b>E29KLT</b>     |

# 1

## Options

### Legend Plates

#### Legend Plates with Standard Markings

The legend plates listed below are sized for all standard commercial enclosures and Eaton’s cast enclosures. For vertical

spacing less than 1.75 in, replace the **S** in the catalog number with **MS**, or the **M** with **P** (except push-pull). No change in price. The smaller

size legend plates, “MS” or “P” size, have limited space for legend.

#### Square Legend Plate



#### 1/2 Round Legend Plate



#### For Pushbutton Operators and Indicating Lights—Standard

| Legend   | Color of Field | Square ①<br>Catalog Number | 1/2 Round<br>Catalog Number | Legend   | Color of Field | Square ①<br>Catalog Number | 1/2 Round<br>Catalog Number |
|--|----------------|----------------------------|-----------------------------|----------|----------------|----------------------------|-----------------------------|
| <b>Blank—see table on Page V7-T1-232.</b>              |                |                            |                             |          |                |                            |                             |
| <b>Letters on Legend Plates Below are 3/16 in High</b> |                |                            |                             |          |                |                            |                             |
| CLAMP  | Black          | 10250TS90                  | 10250TM90                   | OFF      | Red            | 10250TS24                  | 10250TM24                   |
| CLOSE  |                | 10250TS73                  | 10250TM11                   | ON       | Black          | 10250TS25                  | 10250TM25                   |
| DOWN   |                | 10250TS74                  | 10250TM12                   | OPEN     |                | 10250TS26                  | 10250TM26                   |
| EMERG. STOP  | Red            | 10250TS13                  | 10250TM13                   | OUT      |                | 10250TS27                  | 10250TM27                   |
| FAST   | Black          | 10250TS75                  | 10250TM14                   | POWER ON |                | 10250TS80                  | 10250TM80                   |
| FASTER   |                | 10250TS87                  | 10250TM87                   | RAISE    |                | 10250TS28                  | 10250TM28                   |
| FEEDER ON  |                | 10250TS94                  | 10250TM94                   | READY    |                | 10250TS86                  | 10250TM86                   |
| FEEDER OFF   |                | 10250TS95                  | 10250TM95                   | RESET    |                | 10250TS29                  | 10250TM29                   |
| FORWARD  |                | 10250TS15                  | 10250TM15                   | REVERSE  |                | 10250TS30                  | 10250TM30                   |
| HIGH   |                | 10250TS16                  | 10250TM16                   | RUN      |                | 10250TS31                  | 10250TM31                   |
| IN   |                | 10250TS17                  | 10250TM17                   | SAFE     |                | 10250TS85                  | 10250TM85                   |
| INCH   |                | 10250TS18                  | 10250TM18                   | SLOW     |                | 10250TS32                  | 10250TM32                   |
| JOG  |                | 10250TS19                  | 10250TM19                   | SLOWER   |                | 10250TS88                  | 10250TM88                   |
| JOG FOR.   |                | 10250TS20                  | 10250TM20                   | START    |                | 10250TS33                  | 10250TM33                   |
| JOG REV.   |                | 10250TS21                  | 10250TM21                   | STOP     | Red            | 10250TS34                  | 10250TM34                   |
| LOW  |                | 10250TS22                  | 10250TM22                   | TEST     | Black          | 10250TS83                  | 10250TM83                   |
| LOWER  |                | 10250TS23                  | 10250TM23                   | TRANSFER |                | 10250TS93                  | 10250TM93                   |
| LUBE-FAIL  |                | 10250TS92                  | 10250TM92                   | TRIP     |                | 10250TS84                  | 10250TM84                   |
| MOTOR RUN  |                | 10250TS81                  | 10250TM81                   | UNCLAMP  |                | 10250TS91                  | 10250TM91                   |
| MOTOR STOP   |                | 10250TS82                  | 10250TM82                   | UP       |                | 10250TS35                  | 10250TM35                   |

#### Blank Plastic Legend Plates—Square

| Color Lettering | Field             | Standard Catalog Number | Jumbo ②<br>Catalog Number | Extra Large Catalog Number |
|-----------------|-------------------|-------------------------|---------------------------|----------------------------|
| Black           | White or silver ③ | 10250TSP76              | 10250TLP76                | 10250TEP76                 |
| White           | Red or black ③    | 10250TSP77              | 10250TLP77                | 10250TEP77                 |

#### Notes

- ① Square legend plates have a satin aluminum field. Color is on lower portion.
- ② Cannot be used on cast enclosures except for top row. Suitable for most sheet metal enclosures.
- ③ If legend plate is to be engraved, specify field color required.

### Square Legend Plate



### 1/2 Round Legend Plate



### For Selector Switch and Roto-Push Operators—Standard Size

| Legend                                    | Color of Field | Square <sup>①</sup><br>Catalog Number | 1/2 Round<br>Catalog Number | Legend                                  | Color of Field | Square <sup>①</sup><br>Catalog Number | 1/2 Round<br>Catalog Number |
|---|----------------|---------------------------------------|-----------------------------|---|----------------|---------------------------------------|-----------------------------|
| <b>Blank—see table on Page V7-T1-232.</b> |                |                                       |                             |   |                |                                       |                             |
| <b>2-Position—5/32 in High Lettering</b>  |                |                                       |                             | <b>3-Position—1/8 in High Lettering</b> |                |                                       |                             |
| FOR. REV.                                 | Black          | 10250TS38                             | 10250TM38                   | AUTO OFF HAND                           | Black          | 10250TS49                             | 10250TM49                   |
| HAND AUTO                                 |                | 10250TS39                             | 10250TM39                   | FOR. OFF REV.                           |                | 10250TS50                             | 10250TM50                   |
| HIGH LOW                                  |                | 10250TS40                             | 10250TM40                   | FOR. SAFE REV.                          |                | 10250TS69                             | 10250TM69                   |
| JOG RUN                                   |                | 10250TS41                             | 10250TM41                   | HAND OFF AUTO                           |                | 10250TS51                             | 10250TM51                   |
| MAN. AUTO                                 |                | 10250TS67                             | 10250TM67                   | MAN. OFF AUTO                           |                | 10250TS68                             | 10250TM68                   |
| OFF ON                                    |                | 10250TS42                             | 10250TM42                   | OPEN OFF CLOSE                          |                | 10250TS53                             | 10250TM53                   |
| OPEN CLOSE                                |                | 10250TS43                             | 10250TM43                   | RUN SAFE JOG                            |                | 10250TS70                             | 10250TM70                   |
| RUN JOG                                   |                | 10250TS44                             | 10250TM44                   | UP OFF DOWN                             |                | 10250TS54                             | 10250TM54                   |
| SAFE RUN                                  |                | 10250TS45                             | 10250TM45                   | ON STOP SAFE                            | Red            | 10250TS71                             | 10250TM71                   |
| START JOG                                 |                | 10250TS46                             | 10250TM46                   |   |                |                                       |                             |
| START STOP                                |                | 10250TS47                             | 10250TM47                   |   |                |                                       |                             |
| UP DOWN                                   |                | 10250TS48                             | 10250TM48                   |   |                |                                       |                             |

### 70 mm Round—Plastic Legend Plate



### 45 mm and 70 mm Plastic—Round

| Color           | Lettering | Field                      | Catalog Number |
|-----------------|-----------|----------------------------|----------------|
| <b>45 mm</b>    |           |                            |                |
| Blank           |           | Yellow or red <sup>②</sup> | 10250TRP78     |
| <b>70 mm</b>    |           |                            |                |
| Blank           |           | Yellow or red <sup>②</sup> | 10250TRP76     |
| Red EMERG. STOP |           | Yellow                     | 10250TRP79     |

### For Push-Pull Units <sup>③</sup>

| Legend   | Color of Field | Square <sup>①</sup><br>Catalog Number | 1/2 Round<br>Catalog Number |
|--|----------------|---------------------------------------|-----------------------------|
| <b>Standard Size—Letters on Legend Plates Below are 3/32 in High</b> |                |                                       |                             |
| PULL START/PUSH STOP   | Green/red      | 10250TPP2                             | 10250TR2                    |
| PUSH ON/PULL OFF   | Black          | 10250TPP5                             | 10250TR5                    |
| PULL OPEN/PUSH CLOSE   | Black          | 10250TPP8                             | 10250TR8                    |
| PULL UP/PUSH DOWN  | Black          | 10250TPP11                            | 10250TR11                   |
| <b>Jumbo Size—Letters on Legend Plates Below are 1/8 in High</b>     |                |                                       |                             |
| PULL START/PUSH STOP   | Green/red      | 10250TPP3                             | 10250TR3                    |
| PULL ON/PUSH OFF   | Black          | 10250TPP6                             | 10250TR6                    |
| PULL OPEN/PUSH CLOSE   | Black          | 10250TPP9                             | 10250TR9                    |
| PULL UP/PUSH DOWN  | Black          | 10250TPP12                            | 10250TR12                   |

#### Notes

- ① Square legend plates have a satin aluminum field. Color is on lower portion.
- ② If legend plate is to be engraved, specify field color required.
- ③ All push-pull legend plates include the symbols ≠ ∅ in the center of the plate.

#### 1

#### Legend Plates with Non-Standard Markings

##### When Ordering Specify

- Catalog number of blank plate phase plus Suffix “STAMP”
- Insert the following into Order Notes: legend, letter size and locations (letters A–W)—combine letters for definitive locations as shown.

##### Ordering Example:

Catalog No.: **10250TS36STAMP**  
 Letter Size: 3/32 in (2.4 mm)  
 Pos. A—POWER HOUSE  
 Pos. B—START PUMP 1

##### Legend Characters Available

A B C D E F G H I J K L M N O  
 P Q R S T U V W X Y Z / - . , 1  
 2 3 4 5 6 7 8 9 0

Legend characters on black and red plates are white—on satin aluminum plates, characters are black.

##### Blackening Kit

Solution blackens aluminum exposed by engraving process. Must be applied immediately after engraving. 0.3 oz. bottle—sufficient for approximately 1100 legend plates.

Catalog Number: **10250TBK**

#### Legend Positions

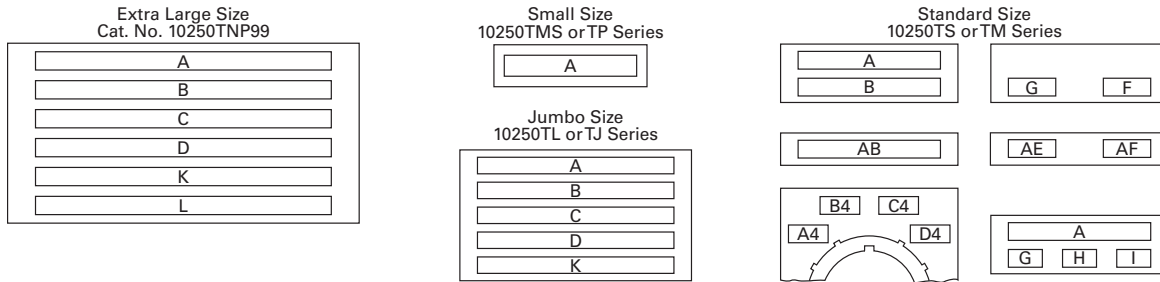

#### Blank and Custom Engraved Legend Plates

| Style               | Color       | Small Catalog Number | Standard Catalog Number | Jumbo <sup>②</sup> Catalog Number | Extra Large <sup>③</sup> Catalog Number | Four-Position Selector Switch      |                         | Push-Pull with Symbols <sup>①</sup> |                                   |
|---------------------|-------------|----------------------|-------------------------|-----------------------------------|---|------------------------------------|-------------------------|-------------------------------------|-----------------------------------|
|                     |             |                      |                         |                                   |   | Custom <sup>④</sup> Catalog Number | Standard Catalog Number | Standard Catalog Number             | Jumbo <sup>②</sup> Catalog Number |
| Square <sup>⑤</sup> | Black       | 10250TMS36           | 10250TS36               | 10250TL36                         | —                                       | 10250TS76                          | 10250TS72               | 10250PPP17                          | 10250PPP18                        |
|                     | Red         | 10250TMS37           | 10250TS37               | 10250TL37                         | —                                       | —                                  | —                       | —                                   | —                                 |
|                     | Green/red   | —                    | —                       | —                                 | —                                       | —                                  | —                       | 10250PPP20                          | 10250PPP21                        |
|                     | Satin alum. | —                    | —                       | —                                 | 10250TNP99                              | —                                  | —                       | —                                   | —                                 |
| 1/2 Round           | Black       | 10250TP36            | 10250TM36               | 10250TJ36                         | —                                       | —                                  | 10250TM72               | 10250TR17                           | 10250TR18                         |
|                     | Red         | 10250TP37            | 10250TM37               | 10250TJ37                         | —                                       | —                                  | —                       | —                                   | —                                 |
|                     | Green/red   | —                    | —                       | —                                 | —                                       | —                                  | —                       | 10250TR20                           | 10250TR21                         |
|                     | Satin alum. | —                    | 10250TM89               | 10250TJ89                         | —                                       | —                                  | —                       | —                                   | —                                 |

#### Maximum Characters per Legend Plate and Approximate Dimensions

| Top (Aluminum and Plastic) | Approximate Dimensions in Inches (mm) |             | Style     | Character Size 3/32 in High |                      | 1/8 in High     |                      | 3/16 in High    |                      |
|----------------------------|---------------------------------------|-------------|-----------|-----------------------------|----------------------|-----------------|----------------------|-----------------|----------------------|
|                            | Width                                 | Height      |           | Number of Lines             | Number of Characters | Number of Lines | Number of Characters | Number of Lines | Number of Characters |
| Small <sup>⑥</sup>         | 1.59 (40.4)                           | 1.59 (40.4) | Square    | 1                           | 17                   | —               | —                    | —               | —                    |
|                            |                                       |             | 1/2 Round | 1                           | 15                   | 1               | 12                   | 1               | 9                    |
| Standard and custom        | 1.75 (44.5)                           | 1.75 (44.5) | Square    | 2                           | 18                   | 2               | 13                   | 1               | 9                    |
|                            |                                       |             | 1/2 Round | 2                           | 15                   | 2               | 12                   | 1               | 9                    |
| Jumbo <sup>⑦</sup>         | 2.19 (55.6)                           | 2.19 (55.6) | Square    | 5                           | 23                   | 3               | 18                   | 2               | 12                   |
|                            |                                       |             | 1/2 Round | 5                           | 19                   | 4               | 15                   | 2               | 11                   |
| Extra large <sup>⑧</sup>   | 2.44 (62.0)                           | 2.44 (62.0) | Square    | 6                           | 25                   | 3               | 18                   | 3               | 12                   |



#### Notes

- <sup>①</sup> All push-pull legend plates include the symbols ≠ ∅ in the center of the plate.
- <sup>②</sup> Cannot be used on cast enclosures except for top row. Suitable for most sheet metal enclosures.
- <sup>③</sup> When used to meet Ford Motor Co. specifications, specify engraved legend. Cannot be used on standard cast or sheet metal enclosures.
- <sup>④</sup> Slightly larger than standard size for legends requiring more space—fits cast enclosures.
- <sup>⑤</sup> Square legend plates have a satin aluminum field. Color is on lower portion.
- <sup>⑥</sup> Recommended only when mounting on minimum centers (less than 1-3/4 in [44.5 mm] vertical centers).
- <sup>⑦</sup> Can be used on top row only of any enclosure.

### Enclosures

#### Die Cast, Polyester and Stainless Steel Enclosures

##### Enclosures (Case and Cover)—Surface Mounting <sup>①</sup>

|  | Number of Elements  | One Contact Block Depth Catalog Number | Two Contact Block Depth Catalog Number |
|--|---|--|--|
| <b>Die Cast Enclosure</b>  | <b>Die Cast Enclosure—In-Line <sup>②③④</sup> NEMA 4, 4X, 12, 13</b> |  |  |
|   | 1   | 10250TN1                               | 10250TN11                              |
|  | 2   | 10250TN2                               | 10250TN12                              |
|  | 3   | 10250TN3                               | 10250TN13                              |
|  | 4   | —                                      | 10250TN14                              |
| <b>Polyester Enclosure</b>   | <b>Polyester<sup>⑤</sup>—In-Line NEMA 3, 4X, 12</b>                 |  |  |
|   | 1   | —                                      | E34N51                                 |
|  | 2   | —                                      | E34N52                                 |
|  | 3   | —                                      | E34N53                                 |
|  | 4   | —                                      | E34N54                                 |
| <b>Stainless Steel Enclosure</b>   | <b>Stainless Steel <sup>④⑥</sup>—In-Line NEMA 4, 4X, 12</b>         |  |  |
|  | 1   | —                                      | 10250TN33                              |
|  | 2   | —                                      | 10250TN34                              |
|  | 3   | —                                      | 10250TN35                              |
|  | 4   | —                                      | 10250TN36                              |

Dimensions, see Page V7-T1-246.

### Mounting Instructions

Two-position joystick must be used with two contact block deep enclosures (maximum number of contact blocks = 1). Four-position joysticks cannot be used within these enclosures.

#### One and Two Contact Block Depth Enclosures



#### Enclosure Layouts

Top – For Vertical Mounting

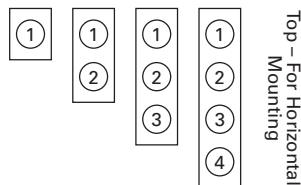

### Notes

- ① For spacing increments, see Page V7-T1-234.
- ② All die cast enclosures can be converted to base mounting of contact blocks, with spacers 10250TA22 or 10250TA23. See listing on Page V7-T1-227.
- ③ When used with E30 pushbuttons, only the one element enclosure can be used.
- ④ When used with resistor light units, only the 2 contact block depth enclosure can be used.
- ⑤ 14 gauge, type 304.

#### Die Cast and Stainless Steel—Flush Mount, Covers Only

##### Flush Mounting Covers



##### Covers Only—Flush Mounting

| Number of Elements                            | Catalog Number            | Catalog Number            |
|---|---------------------------|---------------------------|
| <b>Flush Die Cast Covers</b>                  |                           |                           |
|   | <b>In-Line Deep Cover</b> | <b>In-Line Flat Cover</b> |
| 1   | 10250TF11                 | 10250TF1                  |
| 2   | 10250TF12                 | 10250TF2                  |
| 3   | 10250TF13                 | 10250TF3                  |
| 4   | 10250TF14                 | 10250TF4                  |
| <b>In-Line Stainless Steel Flush Plates</b> ① |                           |                           |
|   | <b>With Pullbox</b>       | <b>Without Pullbox</b>    |
| 1   | 10250TS10                 | 10250TS1                  |
| 2   | 10250TS11                 | 10250TS2                  |
| 3   | 10250TS12                 | 10250TS3                  |
| 4   | 10250TS14                 | 10250TS4                  |
| <b>Dimensions, see Page V7-T1-247.</b>        |                           |                           |

#### Spacing Increments

Approximate Dimensions in Inches (mm)

| Type            | F           | G                | H           |
|-----------------|-------------|------------------|-------------|
| Die cast        | 2.44 (62.0) | 2.5 (63.5)       | 1.88 (47.8) |
| Polyester       | 1.88 (47.8) | Min. 2.13 (54.1) | 2.25 (57.2) |
| Stainless steel | 1.69 (42.9) | Min. 1.73 (43.9) | 2.25 (57.2) |

#### Spacing Increments for Enclosures

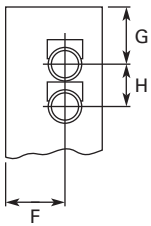

#### Enclosure Layouts

Top – For Vertical Mounting

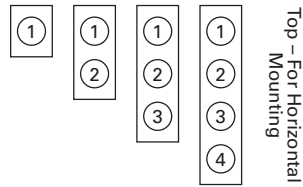

#### Note

① Not oiltight. NEMA 1 applications only.

### Contact Blocks

#### Standard Contact Blocks

- UL A600/P600 rated
- Color-coded plungers—red/green for NC/NO circuits
- Silver contact tips with “reliability nibs”
- Gray (opaque) or amber (translucent) housings
- Pressure plate or spade terminals
- Fingerproof shrouds (for pressure terminals only)

#### Logic Level Contact Blocks

- UL A600/P600 rated
- Color-coded plungers
- Inert palladium knife-blade contacts
- Gray (opaque) housings
- Pressure plate or spade terminals

#### Special Function Contact Blocks

- UL A600/P600 rated
- Color-coded plungers
- Silver contact tips with “reliability nibs”
- Gray (opaque) housings
- Pressure plate terminals only

#### Special Purpose Contact Block

- Maximum 300V rated
- Black plungers
- Silver contact tips with “reliability nibs”
- Black (opaque) housings
- Pressure plate terminals only
- Fingerproof shrouds not available

#### Reliability Nibs

Reliability nibs are the hallmark of Eaton’s contact blocks. A pointed silver nib on the contact tip ensures reliable switching from logic level (5V) up to 600V applications. Therefore standard contact blocks can be used for most logic level applications where the contacts are not exposed to any harsh environmental conditions.

#### Palladium Contacts

Palladium, which is more inert than gold, is well suited for voltages and currents approaching zero and is recommended for applications where environmental conditions are a factor.

#### Maximum Contact Block Mounting per Operator Type

| Operator                                 | Max. Stack |
|--|------------|
| Pushbuttons                              | 6          |
| Push-pull operators                      | 2          |
| Roto-push operators                      | 4          |
| Two- or three-position selector switches | 6          |
| Four-position selector switches          | 4          |
| Joysticks                                | 4          |



## 10250T1



## Contact Blocks

| Symbol                                      | Circuit   | Description <sup>①</sup>   | Standard                         | Spade Terminal <sup>②</sup> | Logic Level                      | Spade Terminal <sup>②</sup> |
|---|-----------|--|----------------------------------|-----------------------------|----------------------------------|-----------------------------|
|   |           |  | Pressure Terminal Catalog Number | Catalog Number              | Pressure Terminal Catalog Number | Catalog Number              |
|   | 1NC       | Stack up to six blocks (six circuits) unless otherwise noted.  | <b>10250T51</b>                  | <b>10250T59</b>             | <b>10250T51E</b>                 | <b>10250T59E</b>            |
|   | 1NO       | Stack up to six blocks (six circuits) unless otherwise noted.  | <b>10250T53</b>                  | <b>10250T60</b>             | <b>10250T53E</b>                 | <b>10250T60E</b>            |
|   | NO-NC     | Stack up to six blocks (12 circuits) unless otherwise noted.   | <b>10250T1</b>                   | <b>10250T40</b>             | <b>10250T1E</b>                  | <b>10250T40E</b>            |
|   | 2NC       | Stack up to six blocks (12 circuits) unless otherwise noted.   | <b>10250T3</b>                   | <b>10250T42</b>             | <b>10250T3E</b>                  | <b>10250T42E</b>            |
|   | 2NO       | Stack up to six blocks (12 circuits) unless otherwise noted.   | <b>10250T2</b>                   | <b>10250T41</b>             | <b>10250T2E</b>                  | <b>10250T41E</b>            |
| <b>Special Function Blocks <sup>③</sup></b> |           |  |                                  |                             |                                  |                             |
|   | LONC      | Late opening NC. Stack up to six blocks (six circuits) unless otherwise noted.                       | <b>10250T71 <sup>③</sup></b>     | —                           | <b>10250T71E <sup>③</sup></b>    | —                           |
|   | ECNO-NC   | Early closing NO and standard NC. Stack up to six blocks unless otherwise noted.                     | <b>10250T47 <sup>③④</sup></b>    | —                           | <b>10250T47E <sup>③</sup></b>    | —                           |
|   | ECNO-NO   | Early closing NO and standard NO. Stack up to four blocks unless otherwise noted.                    | <b>10250T57 <sup>③④</sup></b>    | —                           | <b>10250T57E <sup>③</sup></b>    | —                           |
|   | 2LONC     | Two late opening NC contacts. Stack up to six blocks unless otherwise noted.                         | <b>10250T45 <sup>③</sup></b>     | —                           | <b>10250T45E <sup>③</sup></b>    | —                           |
|   | LONC-ECNO | Overlapping contacts. Stack up to four blocks unless otherwise noted.                                | <b>10250T55 <sup>③④</sup></b>    | —                           | <b>10250T55E <sup>③</sup></b>    | —                           |
| <b>Special Purpose Blocks <sup>⑤</sup></b>  |           |  |                                  |                             |                                  |                             |
|   | 2NO-2NC   | Four circuits in single block depth. Rated 300V max. Stack up to four blocks unless otherwise noted. | <b>10250T44 <sup>⑤</sup></b>     | —                           |                                  |                             |

**Notes**

- <sup>①</sup> All 10250T contact blocks shown are suitable for use on standard 10250T and E34 operators. These contact blocks are not suitable for Class I Division 2 type 10250T or E34 devices.
- <sup>②</sup> Contact blocks with spade terminals are limited to a maximum of one contact block per operator and minimum spacing between devices is 2.5 in (63.5 mm). Not suitable for use in 10250T or E34 enclosures. Also available in amber housing. Not available with fingerproof shrouds.
- <sup>③</sup> Special function contact blocks are not suitable for use with roto-push operators, three-position push-pull operators, or four-position selector switches.
- <sup>④</sup> ECNO contact blocks are not suitable for use with two-position joysticks or when operators are used with padlock attachments.
- <sup>⑤</sup> Special purpose 10250T44 contact blocks are not suitable on selector switches or roto-push operators. Okay to use with three-position push-pull operators only on low voltage (30V or less) circuits. Fingerproof shrouds not available.

10250T1CP



### Contact Blocks with Fingerproof Shrouds

| Symbol                                      | Circuit   | Description <sup>①</sup>  | Standard Pressure Terminal <sup>②</sup> Catalog Number | Logic Level Pressure Terminal <sup>②</sup> Catalog Number |
|---|-----------|---|--|---|
| Blank No Plunger                            | 1NC       | Stack up to six blocks (six circuits) unless otherwise noted.                     | <b>10250T51P</b>                                       | <b>10250T51EP</b>   |
| Blank No Plunger                            | 1NO       | Stack up to six blocks (six circuits) unless otherwise noted.                     | <b>10250T53P</b>                                       | <b>10250T53EP</b>   |
| Blank No Plunger                            | NO-NC     | Stack up to six blocks (12 circuits) unless otherwise noted.                      | <b>10250T1P</b>  | <b>10250T1EP</b>  |
| Blank No Plunger                            | 2NC       | Stack up to six blocks (12 circuits) unless otherwise noted.                      | <b>10250T3P</b>  | <b>10250T3EP</b>  |
| Blank No Plunger                            | 2NO       | Stack up to six blocks (12 circuits) unless otherwise noted.                      | <b>10250T2P</b>  | <b>10250T2EP</b>  |
| <b>Special Function Blocks <sup>③</sup></b> |           |   |  |   |
| Blank No Plunger                            | LONC      | Late opening NC. Stack up to six blocks (six circuits) unless otherwise noted.    | <b>10250T71P <sup>④</sup></b>                          | <b>10250T71EP <sup>④</sup></b>                            |
| Blank No Plunger                            | ECNO-NC   | Early closing NO and standard NC. Stack up to six blocks unless otherwise noted.  | <b>10250T47P <sup>③④</sup></b>                         | <b>10250T47EP <sup>④</sup></b>                            |
| Blank No Plunger                            | ECNO-NO   | Early closing NO and standard NO. Stack up to four blocks unless otherwise noted. | <b>10250T57P <sup>③④</sup></b>                         | <b>10250T57EP <sup>④</sup></b>                            |
| Blank No Plunger                            | 2LONC     | Two late opening NC contacts. Stack up to six blocks unless otherwise noted.      | <b>10250T45P <sup>④</sup></b>                          | <b>10250T45EP <sup>④</sup></b>                            |
| Blank No Plunger                            | LONC-ECNO | Overlapping contacts. Stack up to four blocks unless otherwise noted.             | <b>10250T55P <sup>③④</sup></b>                         | <b>10250T55EP <sup>④</sup></b>                            |

**Notes**

- ① All 10250T contact blocks shown are suitable for use on standard 10250T and E34 operators. These contact blocks are not suitable for Class I Division 2 type 10250T or E34 devices.
- ② To order contact blocks with translucent amber housing, change suffix P to **CP** in catalog number e.g. 10250T51**CP**.
- ③ ECNO contact blocks are not suitable for use with two-position joysticks or when operators are used with padlock attachments.
- ④ Special function contact blocks are not suitable for use with roto-push operators, three-position push-pull operators, or four-position selector switches.

10250T1C



#### Amber Contact Blocks

| Symbol                                      | Circuit                  | Description <sup>①</sup>  | Standard   | Spade Terminal              | Logic Level                                      | Spade Terminal              |
|---|--------------------------|---|--|-----------------------------|--|-----------------------------|
|   |                          |   | Pressure Terminal <sup>②</sup><br>Catalog Number | Catalog Number <sup>③</sup> | Pressure Terminal <sup>②</sup><br>Catalog Number | Catalog Number <sup>③</sup> |
|   | Blank No Plunger<br>1NC  | Stack up to six blocks (six circuits) unless otherwise noted.                     | <b>10250T51C</b>                                 | <b>10250T59C</b>            | <b>10250T51EC</b>                                | <b>10250T59EC</b>           |
|   | Blank No Plunger<br>1NO  | Stack up to six blocks (six circuits) unless otherwise noted.                     | <b>10250T53C</b>                                 | <b>10250T60C</b>            | <b>10250T53EC</b>                                | <b>10250T60EC</b>           |
|   | NO-NC                    | Stack up to six blocks (12 circuits) unless otherwise noted.                      | <b>10250T1C</b>                                  | <b>10250T40C</b>            | <b>10250T1EC</b>                                 | <b>10250T40EC</b>           |
|   | 2NC                      | Stack up to six blocks (12 circuits) unless otherwise noted.                      | <b>10250T3C</b>                                  | <b>10250T42C</b>            | <b>10250T3EC</b>                                 | <b>10250T42EC</b>           |
|   | 2NO                      | Stack up to six blocks (12 circuits) unless otherwise noted.                      | <b>10250T2C</b>                                  | <b>10250T41C</b>            | <b>10250T2EC</b>                                 | <b>10250T41EC</b>           |
| <b>Special Function Blocks <sup>③</sup></b> |                          |   |  |                             |  |                             |
|   | Blank No Plunger<br>LONC | Late opening NC. Stack up to six blocks (six circuits) unless otherwise noted.    | <b>10250T71C <sup>④</sup></b>                    | —                           | <b>10250T71EC <sup>④</sup></b>                   | —                           |
|   | ECNO-NC                  | Early closing NO and standard NC. Stack up to six blocks unless otherwise noted.  | <b>10250T47C <sup>④⑤</sup></b>                   | —                           | <b>10250T47EC <sup>④</sup></b>                   | —                           |
|   | ECNO-NO                  | Early closing NO and standard NO. Stack up to four blocks unless otherwise noted. | <b>10250T57C <sup>④⑤</sup></b>                   | —                           | <b>10250T57EC <sup>④</sup></b>                   | —                           |
|   | 2LONC                    | Two late opening NC contacts. Stack up to six blocks unless otherwise noted.      | <b>10250T45C <sup>④</sup></b>                    | —                           | <b>10250T45EC <sup>④</sup></b>                   | —                           |
|   | LONC-ECNO                | Overlapping contacts. Stack up to four blocks unless otherwise noted.             | <b>10250T55C <sup>④⑤</sup></b>                   | —                           | <b>10250T55EC <sup>④</sup></b>                   | —                           |

**Notes**

- ① All 10250T contact blocks shown are suitable for use on standard 10250T and E34 operators. These contact blocks are not suitable for Class I Division 2 type 10250T or E34 devices.
- ② To order amber contact blocks with fingerproof shrouds, change suffix to **CP** in the catalog number e.g. 10250T51**CP**. Not available with spade terminals.
- ③ Contact blocks with spade terminals are limited to a maximum of one contact block per operator and minimum spacing between devices is 2.5 in (63.5 mm). Not suitable for use in 10250T or E34 enclosures. Also available in amber housing. Not available with fingerproof shrouds.
- ④ Special function contact blocks are not suitable for use with roto-push operators, three-position push-pull operators, or four-position selector switches.
- ⑤ ECNO contact blocks are not suitable for use with two-position joysticks or when operators are used with padlock attachments.

### Replacement Parts

#### Replacement Lamps—For 10250T Illuminated Operators

| Mfg. Lamp Type | Voltage | Base Style      | Application                                   | Part Number  |
|----------------|---------|-----------------|---|--------------|
| 120MB          | 120V    | T 3-1/4 bayonet | 10250T resistor indicating light              | 28-3044      |
| #267           | 6.3V    | T 3-1/4 bayonet | 10250T flasher                                | 10250ED986-4 |
| #755           | 6.3V    | T 3-1/4 bayonet | 10250T transformer, PresTest and full voltage | 28-2202      |
| #756           | 12V     | T 3-1/4 bayonet | 10250T full voltage                           | 28-5184      |
| #757           | 24V     | T 3-1/4 bayonet | 10250T full voltage                           | 28-5185      |
| #1828          | 32V     | T 3-1/4 bayonet | 10250T full voltage                           | 28-5186      |
| #1835          | 55V     | T 3-1/4 bayonet | 10250T resistor                               | 28-5187      |
| NE48           | 120V    | T 4-1/2 bayonet | 10250T neon                                   | 28-494       |
| NE51H-R22      | 120V    | T 3-1/4 bayonet | 10250T neon                                   | 28-3754      |
| NE51H-R68      | 240V    | T 3-1/4 bayonet | 10250T neon                                   | 28-3755      |

#### Standard LED Lamp



#### Replacement LED Lamps—For 10250T, E34 and E22 Units

| Voltage | Color  | Continuous AC/DC Catalog Number | Flashing AC Catalog Number | DC Catalog Number |
|---------|--------|---------------------------------|----------------------------|-------------------|
| 6–12V   | Red    | E22LED612RN                     | E22LED006RAF               | E22LED006RDF      |
|         | Orange | E22LED612ON                     | E22LED006OAF               | E22LED006ODF      |
|         | Yellow | E22LED612YN                     | E22LED006YAF               | E22LED006YDF      |
|         | Green  | E22LED612GN                     | E22LED006GAF               | E22LED006GDF      |
|         | Blue   | E22LED612BN                     | E22LED006BAF               | E22LED006BDF      |
|         | White  | E22LED612WN                     | E22LED006WAF               | E22LED006WDF      |
| 24V     | Red    | E22LED024RN                     | E22LED024RAF               | E22LED024RDF      |
|         | Orange | E22LED024ON                     | E22LED024OAF               | E22LED024ODF      |
|         | Yellow | E22LED024YN                     | E22LED024YAF               | E22LED024YDF      |
|         | Green  | E22LED024GN                     | E22LED024GAF               | E22LED024GDF      |
|         | Blue   | E22LED024BN                     | E22LED024BAF               | E22LED024BDF      |
|         | White  | E22LED024WN                     | E22LED024WAF               | E22LED024WDF      |
| 48V     | Red    | E22LED048RN                     | E22LED048RAF               | E22LED048RDF      |
|         | Orange | E22LED048ON                     | E22LED048OAF               | E22LED048ODF      |
|         | Yellow | E22LED048YN                     | E22LED048YAF               | E22LED048YDF      |
|         | Green  | E22LED048GN                     | E22LED048GAF               | E22LED048GDF      |
|         | Blue   | E22LED048BN                     | E22LED048BAF               | E22LED048BDF      |
|         | White  | E22LED048WN                     | E22LED048WAF               | E22LED048WDF      |
| 60V     | Red    | E22LED060RN                     | E22LED060RAF               | E22LED060RDF      |
|         | Orange | E22LED060ON                     | E22LED060OAF               | E22LED060ODF      |
|         | Yellow | E22LED060YN                     | E22LED060YAF               | E22LED060YDF      |
|         | Green  | E22LED060GN                     | E22LED060GAF               | E22LED060GDF      |
|         | Blue   | E22LED060BN                     | E22LED060BAF               | E22LED060BDF      |
|         | White  | E22LED060WN                     | E22LED060WAF               | E22LED060WDF      |
| 120V    | Red    | E22LED120RN                     | E22LED120RAF               | E22LED120RDF      |
|         | Orange | E22LED120ON                     | E22LED120OAF               | E22LED120ODF      |
|         | Yellow | E22LED120YN                     | E22LED120YAF               | E22LED120YDF      |
|         | Green  | E22LED120GN                     | E22LED120GAF               | E22LED120GDF      |
|         | Blue   | E22LED120BN                     | E22LED120BAF               | E22LED120BDF      |
|         | White  | E22LED120WN                     | E22LED120WAF               | E22LED120WDF      |

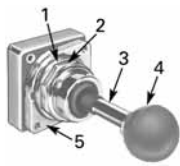

**Two-Position Joystick Operator**



**Flush Head Pushbutton Operator**

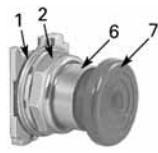

**Mushroom Head Pushbutton Operator**



**Mushroom Head Operator with Padlock Attachment**

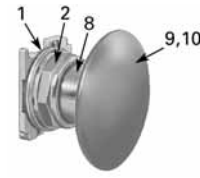

**Jumbo Mushroom Head Operator**

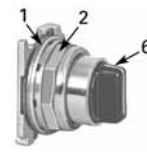

**Knob-Operated Selector Switch Operator**

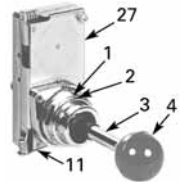

**Four-Position Joystick Operator (without Latch)**



**Illuminated Pushbutton Operator**



**Full Voltage, Resistor and Transformer Type Illuminated Selector Switch**



**Transformer Type Indicating Light**

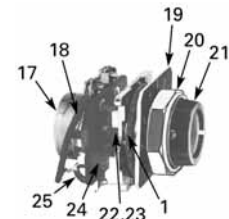

**Potentiometers**

#### 10250T Style Operator Replacement Parts

| Item No. | Description   | No. Req. | Part Number   |
|----------|---|----------|---------------|
| 1        | Gasket  | 1        | 16-1548       |
| 2        | Mounting nut  | 1        | 15-1530       |
| 3        | Handle  | 1        | 24-5045       |
| 4        | Knob  | 1        | 53-3157       |
|          | Knob (not shown) for joystick operator with latch                             | 1        | 53-3159       |
| 5        | Common gate (supplied with operator)  | 2        | 16-3400       |
| 6        | Set screw (#6-32 x 0.250 in long hollow hex)                                  | 2        | 11-2014       |
| 7        | Mushroom head button (includes [2] Item 6)                                    | 1        | As Req. Below |
|          | Black   | —        | 53-1317       |
|          | Red   | —        | 53-1317-2     |
|          | Yellow  | —        | 53-1317-3     |
|          | Green   | —        | 53-1317-4     |
|          | Blue  | —        | 53-1317-22    |
| 8        | Set screw (#10-32 x 0.250 in long hollow hex)                                 | 2        | 11-544        |
| 9        | Jumbo mushroom head button (aluminum—includes [2] Item 8)                     | 1        | As Req. Below |
|          | Red   | —        | 53-1317-9     |
|          | Black   | —        | 53-1317-10    |
|          | Yellow  | —        | 53-1317-11    |
|          | Green   | —        | 53-1317-12    |
| 10       | Jumbo mushroom head button (aluminum—red EMERG. STOP) does not include Item 8 | 1        | 53-1349-18    |
| 11       | Position gate:  |          |               |
|          | Two-position  | 1        | 54-7278       |
|          | Three-position  | 1        | 54-7173       |
|          | Four-position   | 1        | 54-12278      |
|          | Eight-position  | 1        | 54-12279      |
| 12       | Mounting screw (#6-32 x 0.710 in long)  | 2        | 10250TA79     |
|          | Washer  | 2        | 16-2038       |
| 13       | Terminal screw and lug (captives)   | Req.     | 80-5502KIT    |

| Item No. | Description  | No. Req. | Part Number   |
|----------|--|----------|---------------|
| 14       | Gasket (supplied with basic unit)  | 1        | 32-803        |
| 15       | Round head screw (#4-40 x 0.344 in long) (supplied with basic unit)          | 2        | 11-4553       |
| 16       | Mounting screw   | 2        | 11-1632       |
| 17       | Simple potentiometer (does not include items 18, 28 or 29)                   | 1        | As Req. Below |
|          | 1,000 ohms   | —        | 41-782-2      |
|          | 2,500 ohms   | —        | 41-782-3      |
|          | 5,000 ohms   | —        | 41-782-10     |
|          | 10,000 ohms  | —        | 41-782-4      |
|          | 25,000 ohms  | —        | 41-782-5      |
|          | 50,000 ohms  | —        | 41-782-6      |
| 18       | Connector (includes screw and lug)   | 2        | 25-1851       |
| 19       | Indicating plate   | 1        | As Req. Above |
|          | Standard size (without legend)   | —        | 30-4460       |
|          | Large size (specify legend)  | —        | 10250TR30     |
| 20       | Retaining nut  | 1        | 15-1547       |
| 21       | Knob   | 1        | 53-1314       |
|          | Socket set screw (#6-32 x 0.250 in long)                                     | 2        | 11-2014       |
| 22       | Coupling   | 1        | 29-3749-2     |
| 23       | Set screw (#6-32 x 0.188 in long)  | 1        | 11-1199       |
| 24       | Spacer   | 2        | 56-1066-18    |
| 25       | Connector (includes screw and lug)   | 1        | 25-1851-2     |
| 26       | Mounting nut   | 1        | 15-1938       |
| 27       | Four-position joystick operating mechanism (complete)                        | 1        | 24-6565       |
| 28       | Four-position joystick operating mechanism (not shown) (with latch) complete | 1        | 24-6565-2     |
| 29       | Spring loaded latch  | 1        | 52-1214-2     |
| 30       | Hand operated latch  | 1        | 52-913-3      |

## Technical Data and Specifications

### Mechanical Ratings

| Description                      | Specification                     |
|----------------------------------|-----------------------------------|
| <b>Frequency of Operation</b>    |                                   |
| All pushbuttons                  | 6000 operations/hr.               |
| Key and lever selection switches | 3000 operations/hr.               |
| Auto-latch devices               | 1200 operations/hr.               |
| <b>Life</b>                      |                                   |
| Pushbuttons                      | 10 x 10 <sup>6</sup> operations   |
| Contact blocks                   | 10 x 10 <sup>6</sup> operations   |
| PresTest units                   | 10 x 10 <sup>6</sup> operations   |
| Lever and key selector switches  | 0.25 x 10 <sup>6</sup> operations |
| Twist to release pushbuttons     | 0.3 x 10 <sup>6</sup> operations  |
| <b>Shock Resistance</b>          |                                   |
| Duration                         | 20 ms ≥5g                         |

### General Specifications

| Description  | Specification   |
|--|---|
| <b>Climate Conditions</b>                              |   |
| Operating temperature                                  | 1° to 150°F (–17° to 66°C)  |
| Storage temperature                                    | –40° to 176°F (–40° to 80°C)  |
| Altitude   | 6,562 ft (2,000m)   |
| Humidity   | Max. 95% RH at 60°C   |
| <b>Terminals</b>                                       |   |
| Marking  | NC-NO on the contact block to meet the NEMA requirements. Dual marking system 1–2 for normally closed, 3–4 for normally open to meet BS5472 (Cenelec EN50 005). |
| Clamps   | Terminals are saddle clamp type for 1 x 22 AWG (0.34 mm <sup>2</sup> ) to 2 x 14 AWG (2.5 mm <sup>2</sup> ) conductors  |
| Torque   | 7 lb-in (0.8 Nm)  |
| Degree of protection against direct electrical contact | IP2X with fingerproof shroud  |
| <b>Light Units</b>                                     |   |
| Transformers   | Will withstand short-circuit for 1 hour per IEC 60997-5-1   |
| Bulbs—average life:                                    |   |
| Transformer type                                       | 20,000 hrs.   |
| Resistor/direct voltage type                           | 2500 hrs. minimum at rated voltage  |
| LED  | 60,000 to 100,000 hrs.  |

#### Electrical Ratings

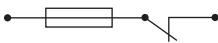
| Description   | Specification  |
|---|--|
| Insulation  | $U_i = 660 \text{ Vac or Vdc}$   |
| Thermal   | $I_{th} = 10\text{A}$  |
| <b>Short Circuit Coordination to IEC/EN 60947-5-1</b>                             |  |
| Rated conditional short circuit current   | 1 kA   |
| Fuse type   | GE power controls TIA 10, red spot type gG, 10A, 660 Vac, 460 Vdc, BS88-2, IEC 60269-2-1 |
|  |  |
| UL rating   | A600, P600   |
| AC load life duty cycle 1200 operations/hour                                      |  |
| 10A   | 110V pf 0.4— $1 \times 10^6$ operations  |
| 5A  | 250V pf 0.4— $1 \times 10^6$ operations  |
| 2A  | 600V pf 0.4— $1 \times 10^6$ operations  |
| Switching capacity  |  |
| AC 15 rated make/break ( $11 \times I_b$ at $1.1 \times U_b$ )                    |  |
| 6A  | 120V pf 0.3  |
| 4A  | 240V pf 0.3  |
| 2A  | 660V pf 0.3  |
| DC13 rated make/break ( $1.1 \times I_b$ at $1.1 \times U_b$ )                    |  |
| 1.0A  | 125V L/R $\geq 0.95$ at 300 ms   |
| 0.55A   | 250V L/R $\geq 0.95$ at 300 ms   |
| 0.1A  | 660V L/R $\geq 0.95$ at 300 ms   |
| 10A   | 110V pure resistive  |
| Maximum ratings for logic level and hostile atmosphere application                |  |
| Maximum amperes   | 0.5A   |
| Maximum volts   | 120 Vac/Vdc  |

#### Electrical Ratings—Contact Block

| Description   | 50 Vac or 60 Hz |      |      |      | Vdc   |     |      |
|---|-----------------|------|------|------|-------|-----|------|
|   | 120             | 240  | 480  | 600  | 24/28 | 125 | 250  |
| <b>Meet or Exceed NEMA Rating Designations A600, A300 and B300 for AC and P600 for DC</b> |                 |      |      |      |       |     |      |
| Make and emerg. interrupting capacity (amp)   | 60              | 30   | 15   | 12   | 5.7   | 1.1 | 0.55 |
| Normal load break (amp)   | 6               | 3    | 1.5  | 1.2  | 5.7   | 1.1 | 0.55 |
| Thermal current (amp)   | 10              | 10   | 10   | 10   | 5.0   | 5.0 | 5.0  |
| Voltamperes:  |                 |      |      |      |       |     |      |
| Make and emerg. interrupting capacity   | 7200            | 7200 | 7200 | 7200 | 138   | 138 | 138  |
| Normal load break   | 720             | 720  | 720  | 720  | 138   | 138 | 138  |

### Mounting Options

#### Panel Thickness

- Minimum: 0.06 in (1.6 mm)
- Maximum: 0.25 in (8 mm) including legend plate
- Maximum can be increased to 0.375 in (15.9 mm) using optional retaining nut
  - Indicating light: 10250TA30
  - Pushbutton/selector switch: 10250TA31

### Mounting Matrix

| Legend Plate | Dimensions in Inches (mm) |             |             |             |
|--------------|---------------------------|-------------|-------------|-------------|
|              | A                         | B           | C           | D           |
| Small        | 1.63 (41.3)               | 2.25 (57.2) | 2.25 (57.2) | 1.63 (41.3) |
| Medium       | 1.75 (44.5)               | 2.25 (57.2) | 2.25 (57.2) | 1.75 (44.5) |
| Large        | 2.25 (57.2)               | 2.25 (57.2) | 2.25 (57.2) | 2.25 (57.2) |

### Mounting Options in Inches (mm)

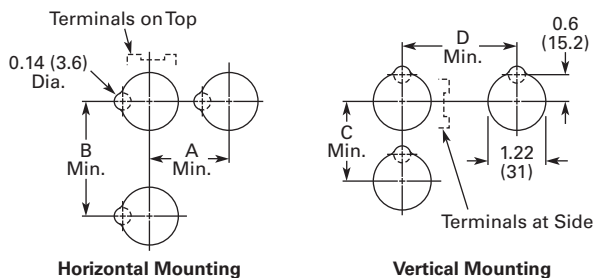

Horizontal mounting means terminals are located top and bottom of contact block. Vertical mounting means terminals are left and right of contact block. This allows close spacing of adjacent operators with easy access to terminals.

Locating nib hole or notch is 0.14 in (3.6 mm) #29 drill.

### Drilling Dimensions in Inches (mm)

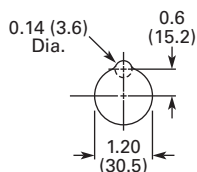



# 1.8

## Pushbuttons and Indicating Lights

30.5 mm Heavy-Duty Watertight/Oiltight—10250T

### 1

#### Dimensions

Approximate Dimensions in Inches (mm)

##### Mechanically Interlocked Pushbutton Operators

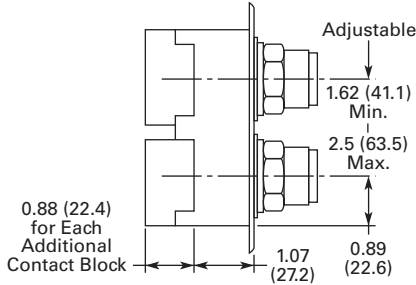

##### Lockout Pushbutton Operator Padlockable in the Down Position

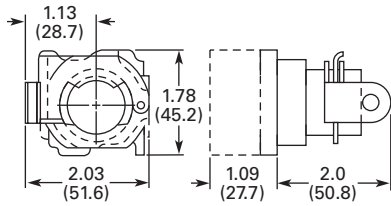

##### Lockout Pushbutton Operator Padlockable in the Up Position—Mushroom Head

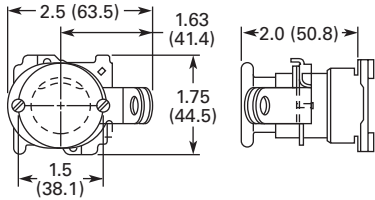

##### Lockout Pushbutton Operator Padlockable in the Up Position—Jumbo Mushroom Head

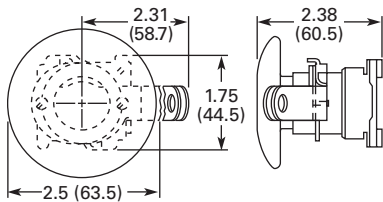

##### Potentiometer

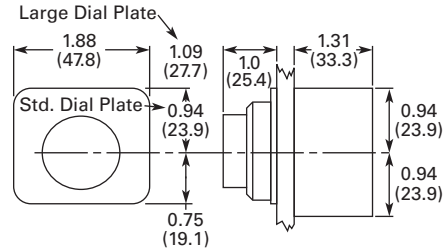

| Potentiometer          | A           | B           | C           |
|------------------------|-------------|-------------|-------------|
| 2 watt single          | 1.31 (33.3) | 0.94 (23.9) | 0.94 (23.9) |
| 25 watt—up to 25 mohms | 2.38 (60.5) | 1.19 (30.2) | 0.81 (20.6) |
| 50 mohms               | 2.56 (65.0) | 1.69 (42.9) | 1.25 (31.8) |

##### Two-Position Joystick Operator

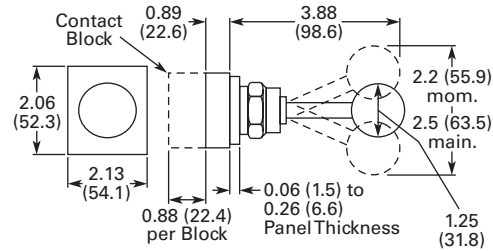

##### Four-Position Joystick Operator

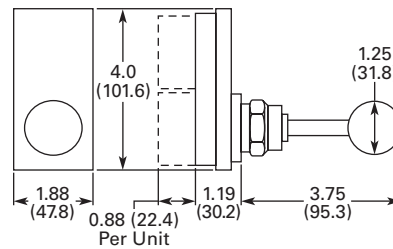

Approximate Dimensions in Inches (mm)

### Key Operated Pushbutton Operator

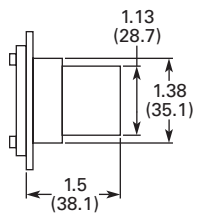

### Operator and Cam

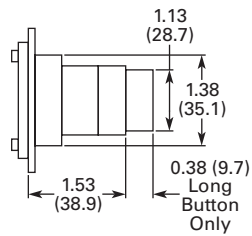

### Latch-In, Twist-to-Release Operator Only with Button

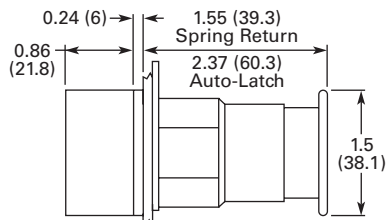

### Special Rotor Latch

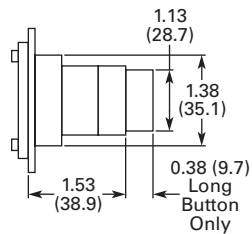

1

Approximate Dimensions in Inches (mm)

#### Surface Mounting

##### Die Cast, Polyester and Stainless Steel Enclosures

4 Mtg. Holes — 10-32 Screw Size for  
1 – 4 Element Die Cast/  
Stainless Steel Enclosure  
7/32 Screw Size for  
Polyester

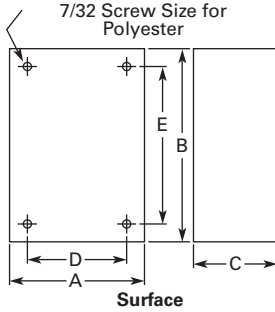

| Number of Elements     | Element Arrangement | Wide A      | High B        | Deep C                   | Mounting D  | E             | Conduit Entrance |
|------------------------|---------------------|-------------|---------------|--------------------------|-------------|---------------|------------------|
| <b>Die Cast</b>        |                     |             |               |                          |             |               |                  |
| 1                      | In-line             | 3.88 (98.6) | 4.00 (101.6)  | 3.00 (76.3) <sup>①</sup> | 2.69 (68.3) | 3.25 (82.6)   | 3/4              |
| 2                      |                     | 3.88 (98.6) | 5.88 (149.4)  | 3.00 (76.3) <sup>①</sup> | 2.69 (68.3) | 5.13 (130.3)  |                  |
| 3                      |                     | 3.88 (98.6) | 7.75 (196.9)  | 3.00 (76.3) <sup>①</sup> | 2.69 (68.3) | 7.00 (177.8)  | 1                |
| 4                      |                     | 3.88 (98.6) | 9.63 (244.6)  | 3.00 (76.3) <sup>①</sup> | 2.69 (68.3) | 8.88 (225.6)  |                  |
| <b>Polyester</b>       |                     |             |               |                          |             |               |                  |
| 1                      | In-line             | 3.81 (96.8) | 6.63 (168.4)  | 3.38 (85.9)              | 2.94 (74.7) | 4.88 (124.0)  | ②                |
| 2                      |                     | 3.81 (96.8) | 6.63 (168.4)  | 3.38 (85.9)              | 2.94 (74.7) | 4.88 (124.0)  |                  |
| 3                      |                     | 3.81 (96.8) | 8.88 (225.6)  | 3.38 (85.9)              | 2.94 (74.7) | 7.13 (181.1)  |                  |
| 4                      |                     | 3.81 (96.8) | 11.13 (282.7) | 3.38 (85.9)              | 2.94 (74.7) | 9.38 (238.3)  |                  |
| <b>Stainless Steel</b> |                     |             |               |                          |             |               |                  |
| 1                      | In-line             | 3.00 (76.2) | 3.50 (88.9)   | 3.00 (76.2)              | 1.50 (38.1) | 4.25 (108.0)  | ②                |
| 2                      |                     | 3.50 (88.9) | 6.75 (171.5)  | 3.00 (76.2)              | 1.50 (38.1) | 7.50 (190.5)  |                  |
| 3                      |                     | 3.50 (88.9) | 9.00 (228.6)  | 3.00 (76.2)              | 1.50 (38.1) | 9.00 (228.6)  |                  |
| 4                      |                     | 3.50 (88.9) | 11.25 (285.8) | 3.00 (76.2)              | 1.50 (38.1) | 12.00 (304.8) |                  |

#### Notes

- ① Depth given is for two contact block deep stations. One contact block deep stations subtract 3/4 in (19.1 mm).
- ② No conduit entrance holes provided. Drill as required.

Approximate Dimensions in Inches (mm)

### Flush Mounting

#### Die Case and Stainless Steel Covers Only

4 Mtg. Holes - 10-32 Screw Size  
for 1-11 Element Encl, 1/4-20  
Screw Size for 12 Element  
and Larger

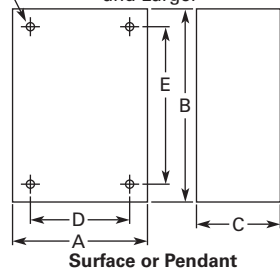

| Number of Elements     | Wide A       | High B        | Deep C                   | Mounting D  | E            |
|------------------------|--------------|---------------|--------------------------|-------------|--------------|
| <b>Die Cast</b>        |              |               |                          |             |              |
| 1                      | 3.88 (98.6)  | 4.00 (101.6)  | 0.25 (6.4) <sup>②</sup>  | 3.50 (88.9) | 3.63 (92.2)  |
| 2                      | 3.88 (98.6)  | 5.88 (149.4)  | 0.25 (6.4) <sup>②</sup>  | 3.50 (88.9) | 5.50 (139.7) |
| 3                      | 3.88 (98.6)  | 7.75 (196.9)  | 0.25 (6.4) <sup>②</sup>  | 3.50 (88.9) | 6.00 (152.4) |
| 4                      | 3.88 (98.6)  | 9.63 (244.6)  | 0.25 (6.4) <sup>②</sup>  | 3.50 (88.9) | 9.25 (235.0) |
| <b>Stainless Steel</b> |              |               |                          |             |              |
| 1                      | 5.00 (127.0) | 5.00 (127.0)  | 2.50 (63.5) <sup>②</sup> | 3.25 (82.6) | 1.88 (47.8)  |
| 2                      | 5.00 (127.0) | 6.88 (174.8)  | 2.50 (63.5) <sup>②</sup> | 3.25 (82.6) | 3.63 (92.2)  |
| 3                      | 5.00 (127.0) | 8.63 (219.2)  | 2.50 (63.5) <sup>②</sup> | 3.25 (82.6) | 5.50 (139.7) |
| 4                      | 5.00 (127.0) | 10.50 (266.7) | 2.50 (63.5) <sup>②</sup> | 3.25 (82.6) | 7.25 (184.2) |

#### Notes

- ① Depth given includes pull box.
- ② Depth given is for flat cover. Deep cover is 3/4 in (19.1 mm) deeper.

# 1.8

## Pushbuttons and Indicating Lights

30.5 mm Heavy-Duty Watertight/Oiltight—10250T

1

Approximate Dimensions in Inches (mm)

### Flush and Long Pushbutton Half Shroud

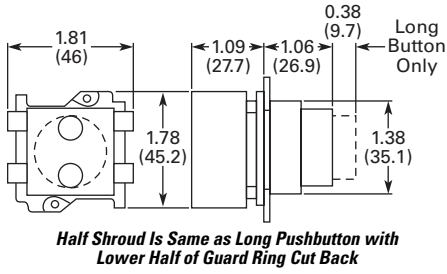

### Push-Pull Switch

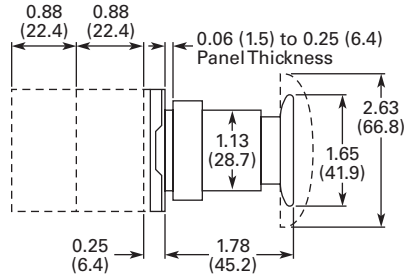

### Mushroom and Jumbo Head Pushbutton

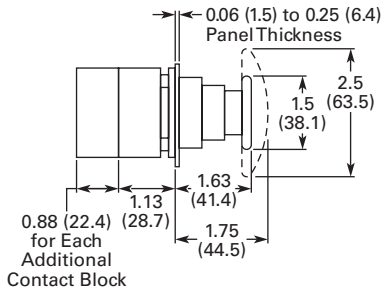

### Flush Pushbutton Operator with Padlock Attachment

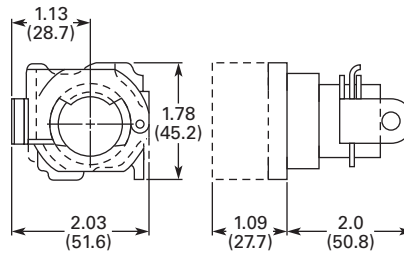

### Pushbutton with Cylinder Lock

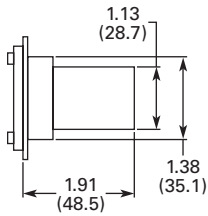

### Mushroom Head Pushbutton Operator with Padlock Attachment

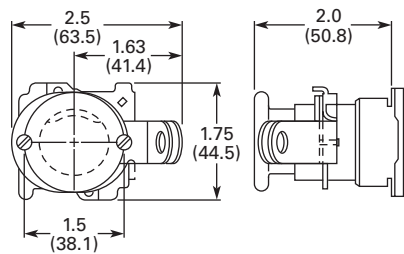

### Illuminated Pushbutton

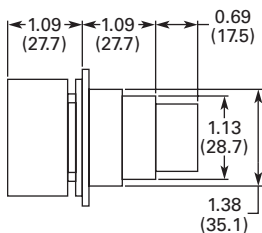

### Indicating Light—Transformer Type

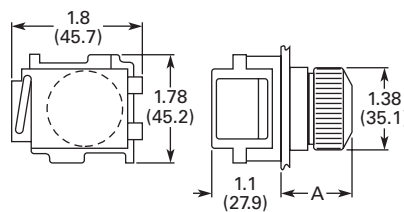

Approximate Dimensions in Inches (mm)

### PresTest Indicating Light—Transformer Type

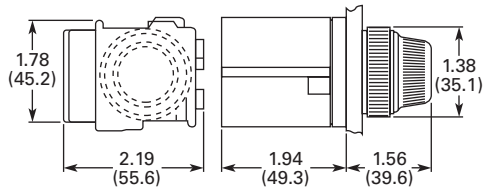

### PresTest Indicating Light—Resistor Type

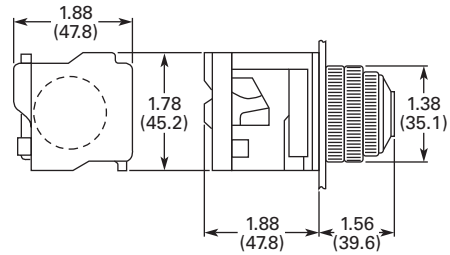

### Jumbo Mushroom Head Pushbutton Operator with Padlock Attachment

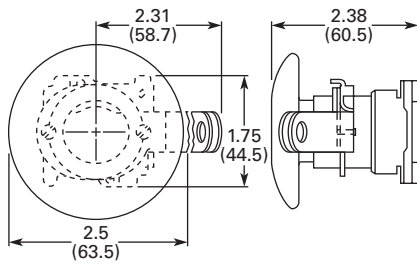

### Master Test Indicating Light

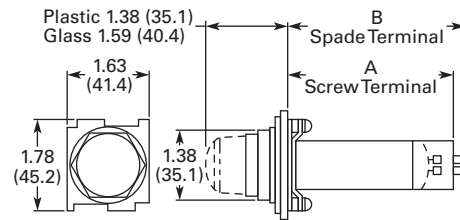

| Description      | B            | C            |
|------------------|--------------|--------------|
| Relay type       | 4.38 (111.2) | 4.28 (108.7) |
| Solid-state type | 2.94 (74.7)  | 2.88 (73.2)  |

### Indicating Light—Resistor and Neon Type

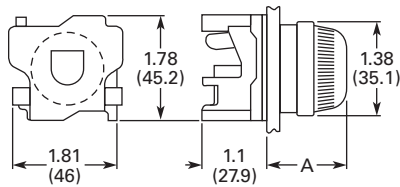

| Lens    | A           |
|---------|-------------|
| Plastic | 1.38 (35.1) |
| Glass   | 1.56 (39.6) |

### Potentiometer Shaft

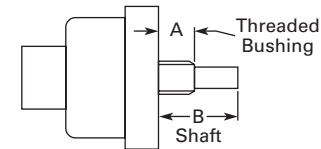

### Shaft Dimensions of Potentiometer That C-H Operator Will Accept

| Operator Catalog Number | A                                    | B                                   |
|-------------------------|--------------------------------------|-------------------------------------|
| 10250T330               | 0.38 (9.7) dia. x<br>0.38 (9.7) long | 0.25 (6.4) dia. x<br>0.63 (16) long |

# 1.8

## Pushbuttons and Indicating Lights

### 30.5 mm Heavy-Duty Watertight/Oiltight—10250T

1

Approximate Dimensions in Inches (mm)

#### Coin Operated Selector Switch

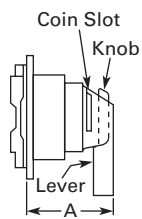

| Operator  | Dim. A      |
|-----------|-------------|
| Knob      | 1.38 (35.1) |
| Lever     | 1.50 (38.1) |
| Coin slot | 1.38 (35.1) |

#### Key Operated Selector Switch

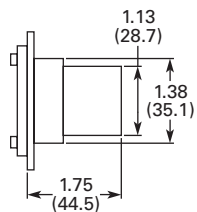

#### Illuminated Selector Switch

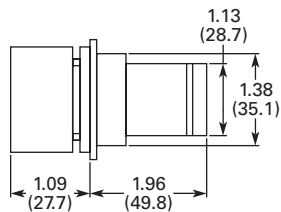

#### Roto-Push

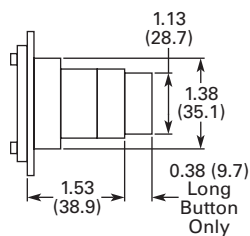

#### Wobble Stick Catalog No. 10250TA5

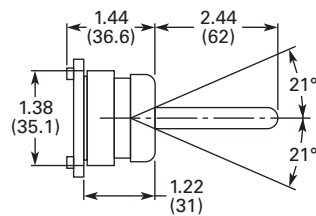

#### Lever Operator—For Use with Two Vertically Mounted Flush Pushbuttons Catalog No. 10250TA14

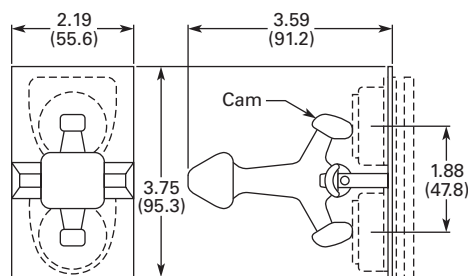

#### Flexible Boot—For Protecting Flush or Long Pushbutton Catalog No. 10250TA3 Typical

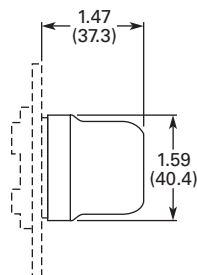

#### Transparent Flexible Boot—For Illuminated Pushbutton Catalog No. 10250TA25

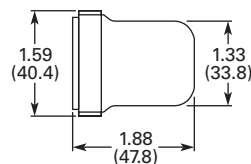

Approximate Dimensions in Inches (mm)

**Padlock Attachment—For Knob Selector Switch  
Catalog No. 10250TA11**

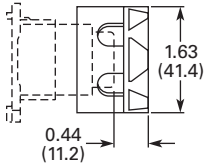

**Padlock Attachment—For Flush Pushbutton  
Catalog No. 10250TA2**

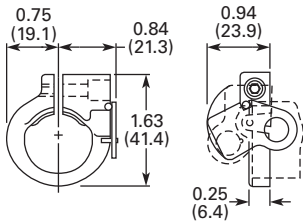

**Padlock Attachment—For Extended Pushbutton  
Catalog No. 10250TA26**

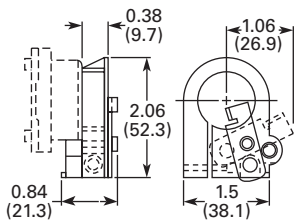

**Maintained Pushbutton  
Catalog No. 10250TA66 Typical**

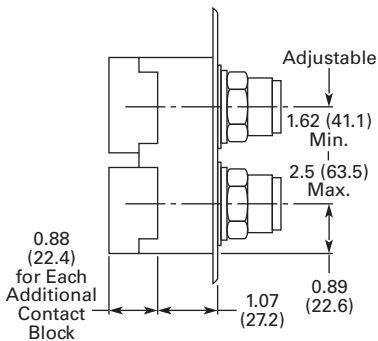

**Maintained Contact Attachment  
Catalog No. 10250TA17 Typical**

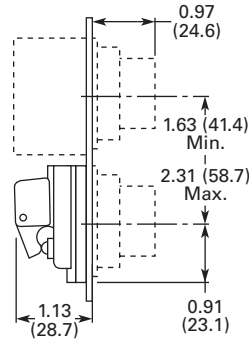

**Padlock Cover Guard for Flush Pushbutton  
Catalog No. 10250TA36**

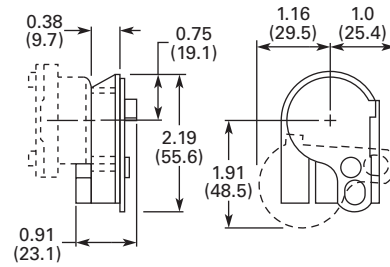

**Padlock Attachment for Maintained Push-Pull Operator  
Catalog No. 10250TA64**

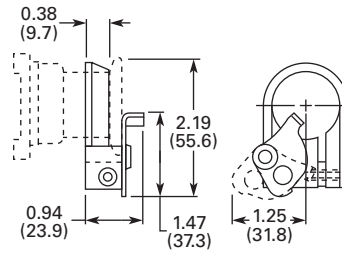

**Protecting Shroud for Jumbo Mushroom Head Button  
Catalog No. 10250TA56**

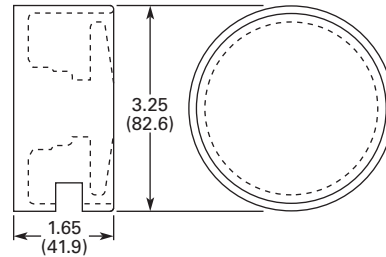



# 1.8

## Pushbuttons and Indicating Lights

30.5 mm Heavy-Duty Watertight/Oiltight—10250T

1

Approximate Dimensions in Inches (mm)

### Protecting Shroud for Mushroom Head Button Catalog No. 10250TA6

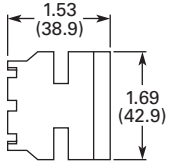

### Extended Retaining Nut Catalog No. 10250TA12

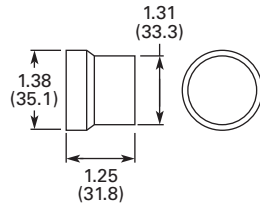

### Panel Drilling and Minimum Spacing

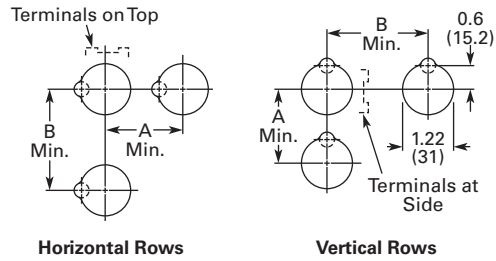

### Protecting Shroud for Illuminated Pushbutton Catalog No. 10250TA15

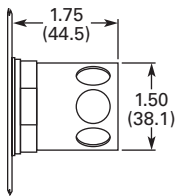

### Lever for Roto-Push Operator Catalog No. 10250TA13

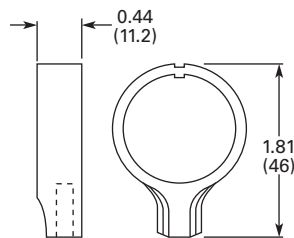

### Padlock Hasp or Flip-Up Guard Catalog No. 10250TA38

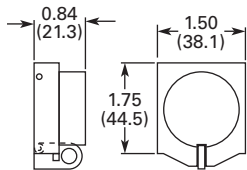

| Legend<br>Plate                         | A<br>Min.   | B<br>Min.   |
|---|-------------|-------------|
| <b>1 or 2 Circuit Contact Blocks</b>    |             |             |
| Small or none                           | 1.63 (41.4) | 2.25 (57.2) |
| Standard                                | 1.75 (44.5) | 2.25 (57.2) |
| Jumbo <sup>①</sup>                      | 2.25 (57.2) | 2.25 (57.2) |
| Extra large                             | 2.50 (63.5) | 2.60 (66.0) |
| <b>4 Circuit Contact Block 10250T44</b> |             |             |
| Small or none                           | 1.88 (47.8) | 2.25 (57.2) |
| Standard                                | 1.88 (47.8) | 2.25 (57.2) |
| Jumbo <sup>①</sup>                      | 2.25 (57.2) | 2.25 (57.2) |
| Extra large                             | 2.50 (63.5) | 2.60 (66.0) |

#### Notes

Locating nib hole or notch is 1.36–1.4 in (34.5–35.6 mm) #29 drill.

<sup>①</sup> If jumbo plates are to be placed one above the other vertically, add 0.13 (3.3) to minimum dimensions listed.

Approximate Dimensions in Inches (mm)

### Multiple Button Guard

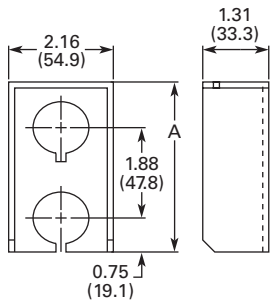

| Number of Elements | A             |
|--------------------|---------------|
| 2                  | 4.0 (101.6)   |
| 3                  | 5.88 (149.4)  |
| 4                  | 7.88 (200.2)  |
| 7                  | 13.38 (339.9) |

### Chain Hook Bracket

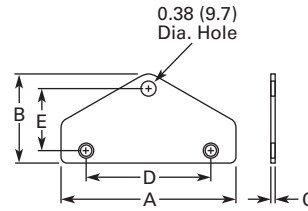

| Enclosure Size (No. of Elements) | Wide A      | High B      | Deep C     | Mounting D  | E           |
|----------------------------------|-------------|-------------|------------|-------------|-------------|
| 2, 3 and 4                       | 3.75 (95.3) | 1.94 (49.3) | 0.13 (3.3) | 2.69 (68.3) | 1.38 (35.1) |
| 6 and 7                          | 4.0 (101.6) | 2.19 (55.6) | 0.13 (3.3) | 2.88 (73.2) | 1.63 (41.4) |

### Master Test Module, Flasher Module and Legend Plate

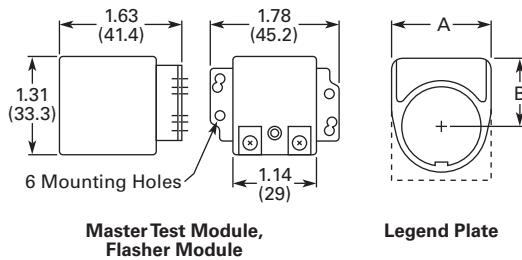

| Legend Plate                   | A               | B             |
|--------------------------------|-----------------|---------------|
| <b>1/2 Round Legend Plates</b> |                 |               |
| Small                          | 1.56 (39.6)     | 0.91 (23.1)   |
| Standard                       | 1.59 (40.4)     | 1.07 (27.2)   |
| Jumbo                          | 2.06 (52.3)     | 1.53 (38.9)   |
| <b>Square Legend Plates</b>    |                 |               |
| Small                          | 1.59 (40.4) sq. | 0.90 (22.9)   |
| Standard                       | 1.75 (44.5) sq. | 1.06 (26.9) ① |
| Jumbo                          | 2.19 (55.6) sq. | 1.50 (38.1)   |
| Extra large                    | 2.44 (62.0) sq. | 1.63 (41.4)   |

#### Notes

Locating nib hole or notch is 1.36–1.4 in (34.5–35.6 mm) #29 drill.

① For plastic legend plate, Dimension B is 1.12 (28.4).

## 30.5 mm Corrosion Resistant Watertight/Oiltight—E34



### Product Description

Eaton's E34 Series 30.5 mm pushbutton line features the same rugged die cast construction of our 10250T line with an additional two-layer 100% solid thermosetting cathodic epoxy coating. This coating provides a flat black smooth, consistent, corrosion resistant surface that has passed a demanding 600 hour salt spray test. (The industry standard for this 4X test requires only 200 hours.)

### Features

- Epoxy-coated metal operators
- Corrosion resistant
- Integral ground screw terminal on operators
- FDA approved for sanitary chemical resistance requirements

## Contents

### Description

### Page

#### 30.5 mm Corrosion Resistant Watertight/Oiltight—E34

|                                       |           |
|---------------------------------------|-----------|
| Product Overview                      | V7-T1-255 |
| Product Identification                | V7-T1-256 |
| Catalog Number Selection              | V7-T1-257 |
| Ordering Complete Devices             | V7-T1-259 |
| Product Selection                     |           |
| Non-Illuminated Momentary             |           |
| Pushbutton Units                      | V7-T1-260 |
| Plastic Lens Indicating Light Units   | V7-T1-260 |
| Pushbuttons                           | V7-T1-261 |
| Illuminated Pushbuttons and           |           |
| Indicating Lights                     | V7-T1-262 |
| Push-Pull Units                       | V7-T1-264 |
| Illuminated Push-Pull Units           | V7-T1-265 |
| Potentiometers                        | V7-T1-267 |
| Push-Pull Operators                   | V7-T1-268 |
| Selector Switch Units                 | V7-T1-272 |
| Selector Switch Selection             | V7-T1-273 |
| Selector Switch Operators             | V7-T1-276 |
| Key Operators                         | V7-T1-276 |
| Illuminated Selector Switch Operators | V7-T1-278 |
| Accessories                           | V7-T1-279 |
| Options                               | V7-T1-281 |
| Replacement Parts                     | V7-T1-287 |
| Technical Data and Specifications     | V7-T1-289 |
| Dimensions                            | V7-T1-292 |

### Standards and Certifications

- CE EN60947-5-1 and 60947-5-5
- UL 508—File No. E131568
- CSA C22.2 No. 14—File No. LR68551
- FDA 3-A Sanitary Standards



### Ingress Protection

When mounted in similarly rated enclosure—

- Standard indicating lights
  - UL (NEMA) Type 1, 2, 3, 3R, 3S, 4, 4X, 12, 13
  - IEC IP65
- All other operators
  - UL (NEMA) Type 1, 2, 3, 3R, 4, 4X, 12, 13
  - IEC IP65

### Product Overview

#### Ultraviolet Light

E34 cathodic coating is not recommended for use in applications where exposure to ultraviolet light exists—use NEMA 4X 10250T operators.

#### Reliability Nibs

Eaton’s contact blocks feature enclosed silver contacts with pointed “reliability nibs” for reliable performance from logic level up to 600V. To ensure reliable switching, nibs bite through oxide which can form on silver contacts, eliminating the need for expensive logic level blocks for most applications.

#### Reliability Nibs

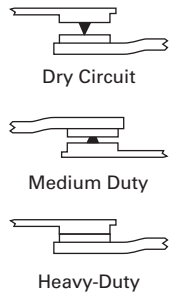

#### Diaphragm Seal with Drainage Holes

##### Liquid Drainage

Eaton’s pushbutton operators offer front of panel drainage via holes in the operator bushing. Hidden from view by the mounting nut, these holes prevent buildup of liquid inside the operator, which can prevent operation in freezing environments. The holes also provide a route for escaping liquid in high pressure washdowns, effectively relieving pressure from the internal diaphragm seal, ensuring reliable sealing in applications even beyond NEMA 4.

##### Diaphragm Seal

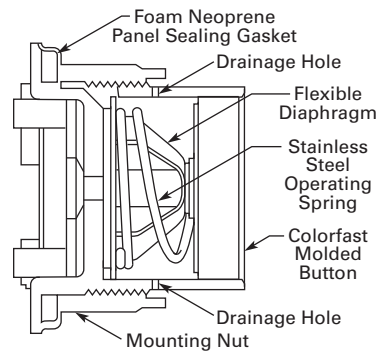

#### 1

#### Product Identification

#### 30.5 mm Corrosion Resistant Watertight/Oiltight—E34 Series

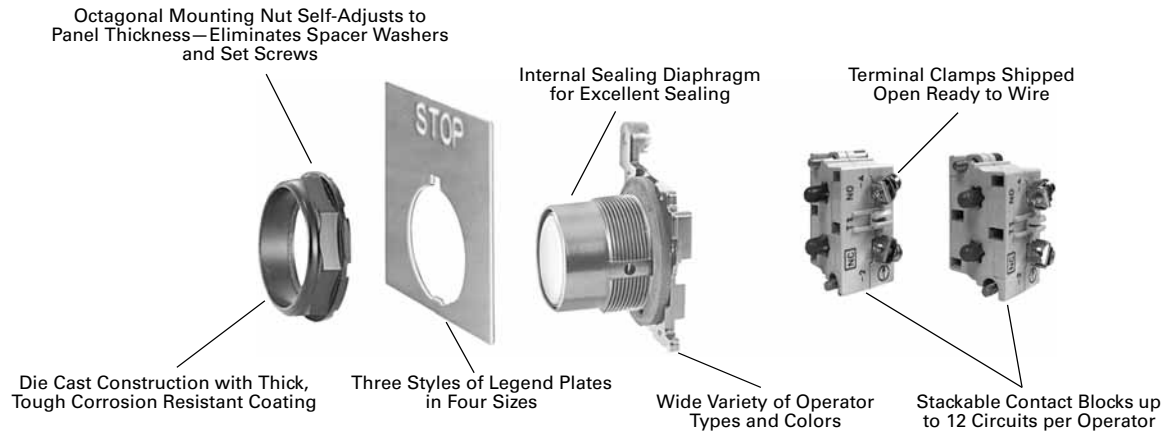

### Catalog Number Selection

Catalog Number Selection is for illustrative purposes only and not to be used to create new catalog numbers.

### Non-Illuminated Pushbuttons

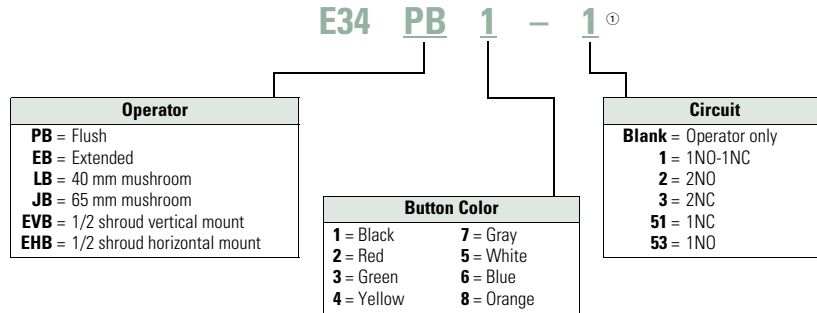

### Illuminated and Non-Illuminated Push-Pulls

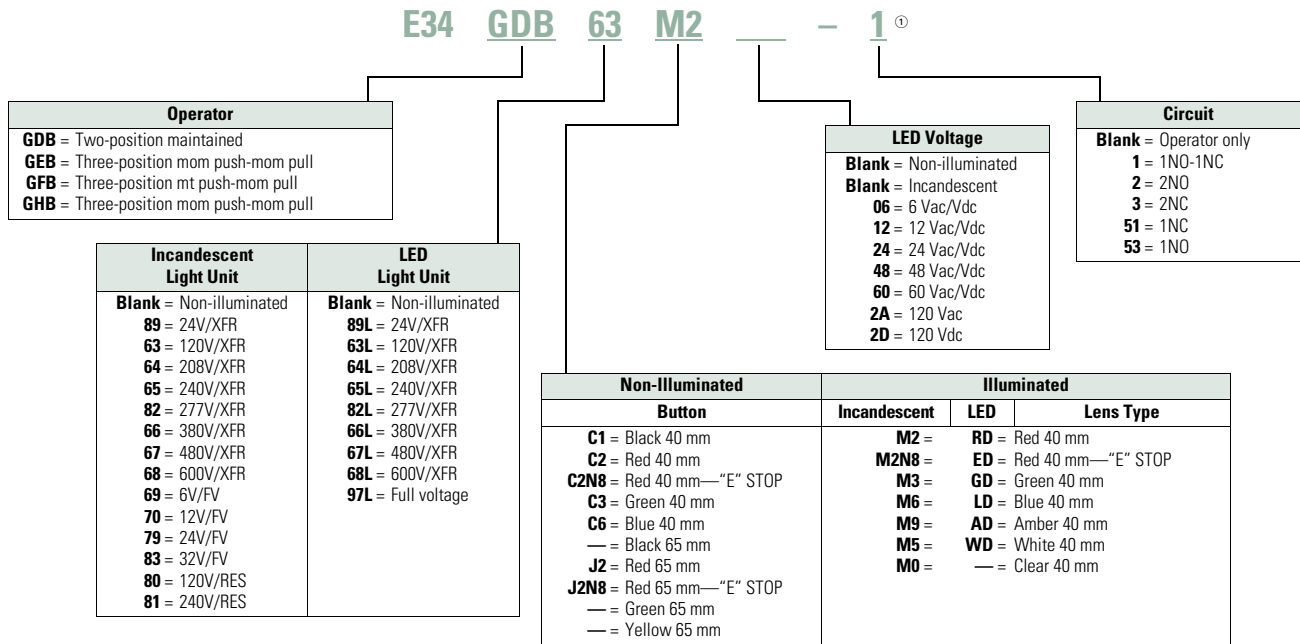

**Note**

① Add **X** at end of catalog number to receive parts assembled from factory.

Catalog Number Selection is for illustrative purposes only and not to be used to create new catalog numbers.

#### Illuminated Pushbuttons

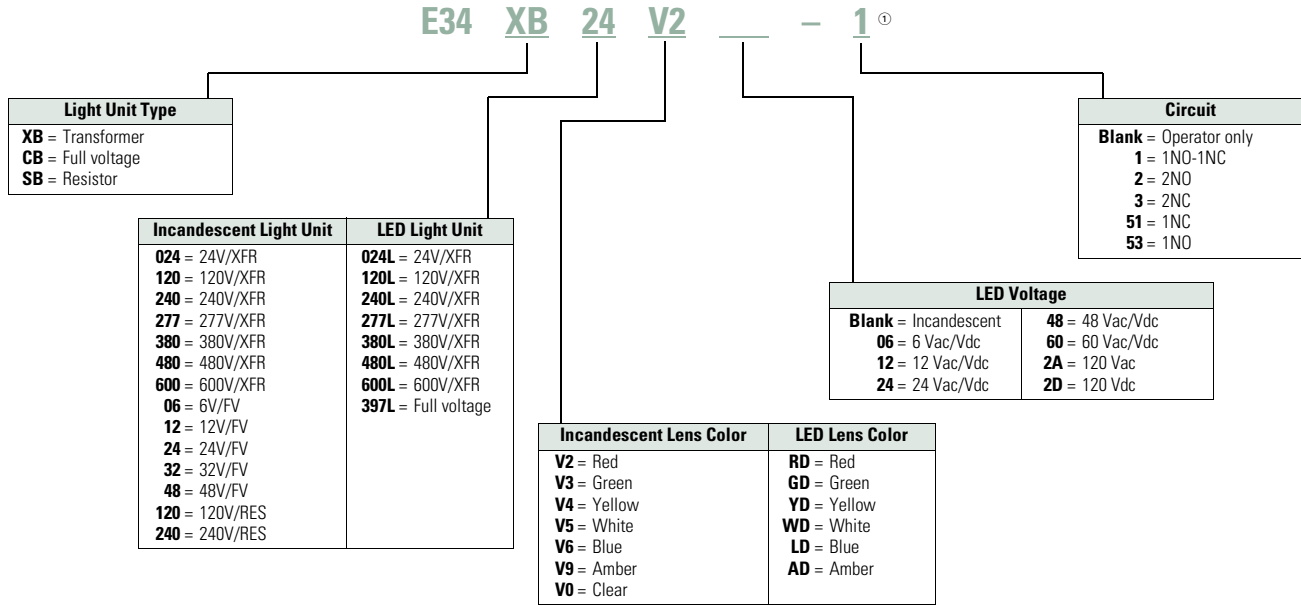

#### Standard Indicating Lights, PresTest and Master Test

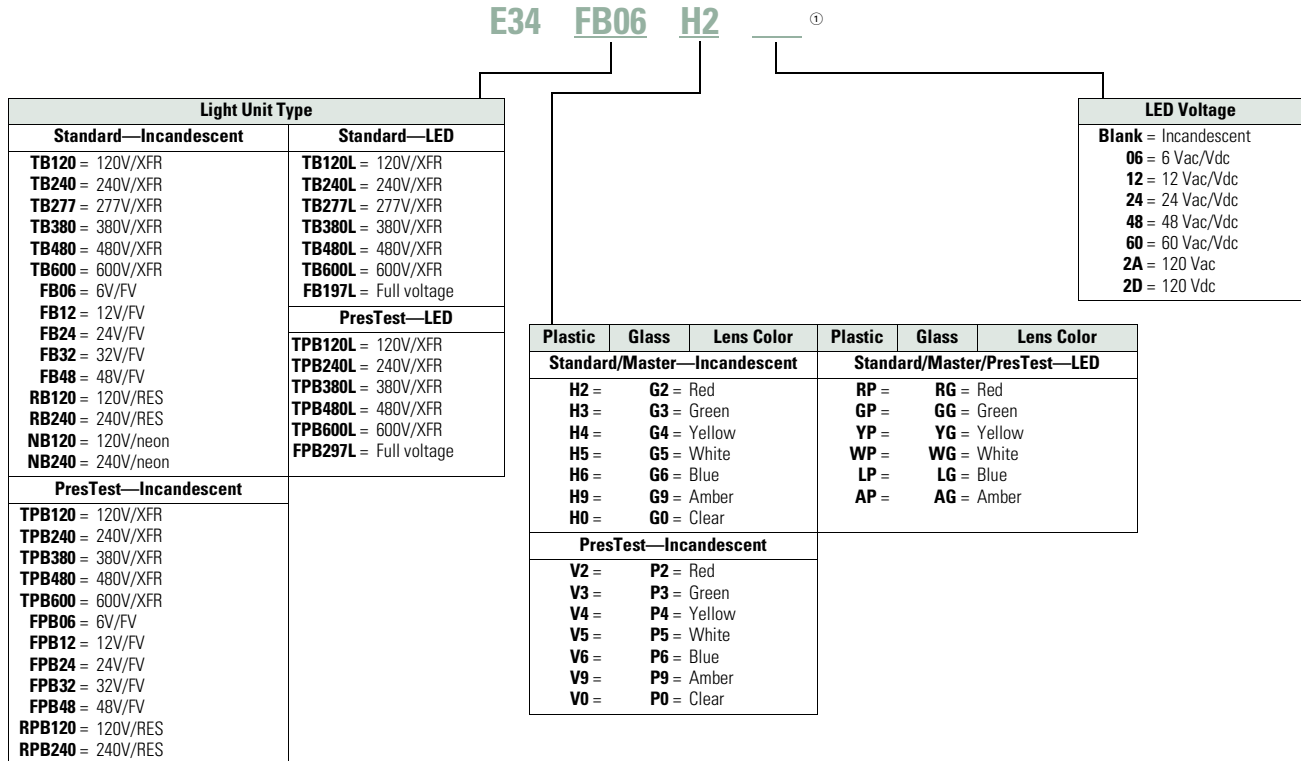

**Note**  
<sup>①</sup> Add **X** at end of catalog number to receive parts assembled from factory.

Catalog Number Selection is for illustrative purposes only and not to be used to create new catalog numbers.

### Ordering Complete Devices

Complete E34 pushbuttons, indicating lights and/or selector switch operators including contact block(s) and legend plate can be ordered using a single composite catalog number. The

individually packaged components will be shipped unassembled in a single overpack carton marked with the composite catalog number.

### Ordering Example

Illuminated Pushbutton Device—Catalog Number E34XB120V2-153SP90

For a complete Catalog Number breakdown, see **Pages V7-T1-257 to V7-T1-258.**

### For Complete E34 Device Ordering

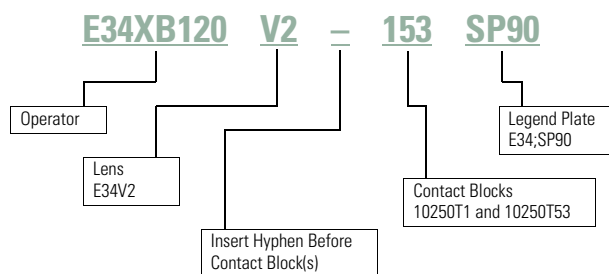



## Product Selection

### Non-Illuminated Momentary Pushbutton Units

UL (NEMA) Type 3, 3R, 4, 4X, 12, 13

#### Flush Button



#### Extended Button



#### Mushroom Button



#### Jumbo Mushroom



### Pushbutton Units

| Contact Type | Button Color             | Flush Button Catalog Number | Extended Button Catalog Number | Mushroom Button Catalog Number | Jumbo Mushroom <sup>①</sup> Catalog Number |
|--------------|--------------------------|-----------------------------|--------------------------------|--------------------------------|--|
| 1NO          | Black                    | E34PB1-53X                  | E34EB1-53X                     | E34LB1-53X                     | E34JB1-53X                                 |
|              | Red                      | E34PB2-53X                  | E34EB2-53X                     | E34LB2-53X                     | E34JB2-53X                                 |
|              | Green                    | E34PB3-53X                  | E34EB3-53X                     | E34LB3-53X                     | E34JB3-53X                                 |
|              | Red—Engraved EMERG. STOP | —                           | —                              | —                              | E34JB2N8-53X                               |
| 1NC          | Black                    | E34PB1-51X                  | E34EB1-51X                     | E34LB1-51X                     | E34JB1-51X                                 |
|              | Red                      | E34PB2-51X                  | E34EB2-51X                     | E34LB2-51X                     | E34JB2-51X                                 |
|              | Green                    | E34PB3-51X                  | E34EB3-51X                     | E34LB3-51X                     | E34JB3-51X                                 |
|              | Red—Engraved EMERG. STOP | —                           | —                              | —                              | E34JB2N8-51X                               |
| 1NO-1NC      | Black                    | E34PB1-1X                   | E34EB1-1X                      | E34LB1-1X                      | E34JB1-1X                                  |
|              | Red                      | E34PB2-1X                   | E34EB2-1X                      | E34LB2-1X                      | E34JB2-1X                                  |
|              | Green                    | E34PB3-1X                   | E34EB3-1X                      | E34LB3-1X                      | E34JB3-1X                                  |
|              | Red—Engraved EMERG. STOP | —                           | —                              | —                              | E34JB2N8-1X                                |

### Plastic Lens Indicating Light Units

UL (NEMA) Type 3, 3R, 4, 4X, 12, 13

#### 24V Full Voltage Indicating Light



### Indicating Light Units

| Type                     | Voltage             | Color | LED/Lamp Number | Indicating Light <sup>①</sup> Catalog Number |
|--------------------------|---------------------|-------|-----------------|--|
| <b>LED Lamp</b>          |                     |       |                 |  |
| Full voltage             | 24 Vac/Vdc          | Red   | Bayonet base    | E34FB197LRP24                                |
|                          |                     | Green |                 | E34FB197LGP24                                |
|                          |                     | Amber |                 | E34FB197LAP24                                |
|                          | 120 Vac             | Red   |                 | E34FB197LRP2A                                |
|                          |                     | Green |                 | E34FB197LGP2A                                |
|                          |                     | Amber |                 | E34FB197LAP2A                                |
| <b>Incandescent Lamp</b> |                     |       |                 |  |
| Full voltage             | 24 Vac/Vdc          | Red   | #757            | E34FB24H2X                                   |
|                          |                     | Green |                 | E34FB24H3X                                   |
|                          |                     | Amber |                 | E34FB24H9X                                   |
| Resistor                 | 120 Vac/Vdc         | Red   | 120MB           | E34RB120H2X                                  |
|                          |                     | Green |                 | E34RB120H3X                                  |
|                          |                     | Amber |                 | E34RB120H9X                                  |
| Transformer              | 120 Vac<br>50/60 Hz | Red   | #755            | E34TB120H2X                                  |
|                          |                     | Green |                 | E34TB120H3X                                  |
|                          |                     | Amber |                 | E34TB120H9X                                  |

#### Notes





Use NEMA 4X 10250T operators where exposed to ultraviolet light, see **Pages V7-T1-182 to V7-T1-253**.

① Anodized aluminum head—may not be suitable for some corrosive environments.

### Pushbuttons

UL (NEMA) Type 3, 3R, 4, 4X, 12, 13

#### Momentary Pushbutton Operators, Non-Illuminated

| Button   | Color  | Catalog Number             |                 |                   |
|--|--|----------------------------|-----------------|-------------------|
| <b>E34PB_</b><br>   | Flush button   | Black                      | <b>E34PB1</b>   |                   |
|  | Red  |                            | <b>E34PB2</b>   |                   |
|  | Green  |                            | <b>E34PB3</b>   |                   |
|  | Yellow   |                            | <b>E34PB4</b>   |                   |
|  | White  |                            | <b>E34PB5</b>   |                   |
|  | Blue   |                            | <b>E34PB6</b>   |                   |
|  | Gray   |                            | <b>E34PB7</b>   |                   |
|  | Orange   |                            | <b>E34PB8</b>   |                   |
| <b>E34EB_</b><br>   | Extended button  | Black                      | <b>E34EB1</b>   |                   |
|  | Red  |                            | <b>E34EB2</b>   |                   |
|  | Green  |                            | <b>E34EB3</b>   |                   |
|  | Yellow   |                            | <b>E34EB4</b>   |                   |
|  | White  |                            | <b>E34EB5</b>   |                   |
|  | Blue   |                            | <b>E34EB6</b>   |                   |
|  | Gray   |                            | <b>E34EB7</b>   |                   |
|  | Orange   |                            | <b>E34EB8</b>   |                   |
| <b>E34EHB_</b><br> | Half shrouded button   |                            | <b>Vertical</b> | <b>Horizontal</b> |
|  |  | Black                      | <b>E34EVB1</b>  | <b>E34EHB1</b>    |
|  | Red  | <b>E34EVB2</b>             | <b>E34EHB2</b>  |                   |
|  | Green  | <b>E34EVB3</b>             | <b>E34EHB3</b>  |                   |
|  | Yellow   | <b>E34EVB4</b>             | <b>E34EHB4</b>  |                   |
|  | White  | <b>E34EVB5</b>             | <b>E34EHB5</b>  |                   |
|  | Blue   | <b>E34EVB6</b>             | <b>E34EHB6</b>  |                   |
|  | Gray   | <b>E34EVB7</b>             | <b>E34EHB7</b>  |                   |
|  | Orange   | <b>E34EVB8</b>             | <b>E34EHB8</b>  |                   |
|  | <b>E34LB_</b><br> | Mushroom button            | Black           | <b>E34LB1</b>     |
| Red  |  |                            | <b>E34LB2</b>   |                   |
| Green  |  |                            | <b>E34LB3</b>   |                   |
| Yellow   |  |                            | <b>E34LB4</b>   |                   |
| Blue   |  |                            | <b>E34LB6</b>   |                   |
| <b>E34JB_</b><br> | Anodized aluminum jumbo mushroom button <sup>①</sup>   | Black                      | <b>E34JB1</b>   |                   |
|  |  | Red                        | <b>E34JB2</b>   |                   |
|  |  | Red (Engraved EMERG. STOP) | <b>E34JB2N8</b> |                   |
|  |  | Green                      | <b>E34JB3</b>   |                   |
|  |  | Yellow                     | <b>E34JB4</b>   |                   |

**Notes**

Use NEMA 4X 10250T operators where exposed to ultraviolet light, see **Pages V7-T1-182 to V7-T1-253**.

① Anodized aluminum head—may not be suitable for some corrosive environments.

#### Illuminated Pushbuttons and Indicating Lights

##### Illuminated Pushbutton



##### Indicating Light



##### PresTest



#### Operators without Lens

| Type                                  | Voltage | Lamp Number  | Illuminated Pushbutton Catalog Number | Indicating Light Catalog Number | PresTest Catalog Number |
|---------------------------------------|---------|--------------|---------------------------------------|---------------------------------|-------------------------|
| <b>LED Lamp (LEDs not included) ①</b> |         |              |                                       |                                 |                         |
| Full voltage                          | —       | Bayonet base | <b>E34CB497L</b>                      | <b>E34FB197L</b>                | <b>E34FPB297L</b>       |
| Transformer AC only                   | 24      |              | <b>E34XB024L</b>                      | —                               | —                       |
|                                       | 120     |              | <b>E34XB120L</b>                      | <b>E34TB120L</b>                | <b>E34TPB120L</b>       |
|                                       | 240     |              | <b>E34XB240L</b>                      | <b>E34TB240L</b>                | <b>E34TPB240L</b>       |
|                                       | 277     |              | <b>E34XB277L</b>                      | <b>E34TB277L</b>                | —                       |
|                                       | 380     |              | <b>E34XB380L</b>                      | <b>E34TB380L</b>                | <b>E34TPB380L</b>       |
|                                       | 480     |              | <b>E34XB480L</b>                      | <b>E34TB480L</b>                | <b>E34TPB480L</b>       |
|                                       | 600     |              | <b>E34XB600L</b>                      | <b>E34TB600L</b>                | <b>E34TPB600L</b>       |
| <b>Incandescent Lamp</b>              |         |              |                                       |                                 |                         |
| Full voltage AC/DC                    | 6       | #755         | <b>E34CB06</b>                        | <b>E34FB06</b>                  | <b>E34FPB06</b>         |
|                                       | 12      | #756         | <b>E34CB12</b>                        | <b>E34FB12</b>                  | <b>E34FPB12</b>         |
|                                       | 24      | #757         | <b>E34CB24</b>                        | <b>E34FB24</b>                  | <b>E34FPB24</b>         |
|                                       | 32      | #1828        | <b>E34CB32</b>                        | <b>E34FB32</b>                  | <b>E34FPB32</b>         |
|                                       | 48      | #1835        | <b>E34CB48</b>                        | <b>E34FB48</b>                  | <b>E34FPB48</b>         |
| Resistor AC/DC ②                      | 120     | 120MB        | <b>E34SB120</b>                       | <b>E34RB120</b>                 | <b>E34RPB120</b>        |
|                                       | 240     |              | <b>E34SB240</b>                       | <b>E34RB240</b>                 | <b>E34RPB240</b>        |
| Transformer AC only                   | 24      | #755         | <b>E34XB024</b>                       | —                               | —                       |
|                                       | 120     |              | <b>E34XB120</b>                       | <b>E34TB120</b>                 | <b>E34TPB120</b>        |
|                                       | 240     |              | <b>E34XB240</b>                       | <b>E34TB240</b>                 | <b>E34TPB240</b>        |
|                                       | 277     |              | <b>E34XB277</b>                       | <b>E34TB277</b>                 | —                       |
|                                       | 380     |              | <b>E34XB380</b>                       | <b>E34TB380</b>                 | <b>E34TPB380</b>        |
|                                       | 480     |              | <b>E34XB480</b>                       | <b>E34TB480</b>                 | <b>E34TPB480</b>        |
|                                       | 600     |              | <b>E34XB600</b>                       | <b>E34TB600</b>                 | <b>E34TPB600</b>        |
| Neon AC/DC                            | 120     | NE51H-R-22   | —                                     | <b>E34NB120</b>                 | —                       |
|                                       | 240     | NE51H-4-68   | —                                     | <b>E34NB240</b>                 | —                       |

#### Notes

Use NEMA 4X 10250T operators where exposed to ultraviolet light, see **Pages V7-T1-182 to V7-T1-253**.

① These units do not include lamps. Order LED separately to match lens color, see **Page V7-T1-239** for LED Selection and **Pages V7-T1-257 to V7-T1-258** for Catalog Numbering Selection.

② Resistor units are not available for use with LEDs, choose either transformer or full voltage LED style.

**Plastic**



### Indicating Light Lens

| Color  | Plastic Catalog Number | Glass <sup>①</sup> Catalog Number |
|--------|------------------------|-----------------------------------|
| Red    | E34H2                  | E34G2                             |
| Green  | E34H3                  | E34G3                             |
| Yellow | E34H4                  | E34G4                             |
| White  | E34H5                  | E34G5                             |
| Blue   | E34H6                  | E34G6                             |
| Ambler | E34H9                  | E34G9                             |
| Clear  | E34H0                  | E34G0                             |

**Glass**



**E34V\_**



### Illuminated Pushbutton Lens

| Color  | Catalog Number |
|--------|----------------|
| Red    | E34V2          |
| Green  | E34V3          |
| Yellow | E34V4          |
| White  | E34V5          |
| Blue   | E34V6          |
| Ambler | E34V9          |
| Clear  | E34V0          |

**Plastic**



### PresTest Lens

| Color  | Plastic Catalog Number | Glass <sup>①</sup> Catalog Number |
|--------|------------------------|-----------------------------------|
| Red    | E34V2                  | E34P2                             |
| Green  | E34V3                  | E34P3                             |
| Yellow | E34V4                  | E34P4                             |
| White  | E34V5                  | E34P5                             |
| Blue   | E34V6                  | E34P6                             |
| Ambler | E34V9                  | E34P9                             |
| Clear  | E34V0                  | E34P0                             |

**Glass**



**Note**

① Glass lens has black anodized aluminum bezel.

#### 1

#### Push-Pull Units

UL (NEMA) Type 3, 3R, 4, 4X, 12, 13

- Two- and three-position
- Non-illuminated

#### Two-Position Push-Pull Unit



#### Two-Position Push-Pull Units, Non-Illuminated

##### Operator Position ①

| Pull                                    | Push | Button Type/Color ②                        | Contact Type | Mounting Location |   | Catalog Number       |
|---|------|--|--------------|-------------------|---|----------------------|
|   |      |  |              | A                 | B |                      |
| <b>Maintained Push, Maintained Pull</b> |      |  |              |                   |   |                      |
| 0                                       | X    | 40 mm/red                                  | 1NO          |                   |   | <b>E34GDBC2-1X</b>   |
| X                                       | 0    | 40 mm engraved<br>EMERG. STOP/red          | 1NC          |                   |   | <b>E34GDBC2N8-1X</b> |
|   |      | 65 mm aluminum engraved<br>EMERG. STOP/red |              |                   |   | <b>E34GDBJ2N8-1X</b> |

#### Three-Position Push-Pull Unit



#### Three-Position Push-Pull Units, Non-Illuminated

##### Operator Position ①

| Pull                                   | Intermediate | Push | Button Type/Color ②               | Contact Type | Mounting Location |   | Catalog Number       |
|--|--------------|------|-----------------------------------|--------------|-------------------|---|----------------------|
|  |              |      |                                   |              | A                 | B |                      |
| <b>Maintained Push, Momentary Pull</b> |              |      |                                   |              |                   |   |                      |
| X                                      | 0            | 0    | 40 mm/black                       | 1NC          |                   |   | <b>E34GFBC1-3X</b>   |
| X                                      | X            | 0    | 40 mm/red                         | 1NC          |                   |   | <b>E34GFBC2-3X</b>   |
|  |              |      | 40 mm engraved<br>EMERG. STOP/red |              |                   |   | <b>E34GFBC2N8-3X</b> |
| <b>Momentary Push, Momentary Pull</b>  |              |      |                                   |              |                   |   |                      |
| X                                      | 0            | 0    | 40 mm/black                       | 1NC          |                   |   | <b>E34GEBc1-3X</b>   |
| X                                      | X            | 0    | 40 mm/red                         | 1NC          |                   |   | <b>E34GEBc2-3X</b>   |
| 0                                      | 0            | X    | 40 mm/black                       | 1NO          |                   |   | <b>E34GHBC1-1X</b>   |
| X                                      | 0            | 0    | 40 mm/red                         | 1NC          |                   |   | <b>E34GHBC2-1X</b>   |

#### Button and Color Selection

| Color  | Suffix Code | Catalog Number |
|--|-------------|----------------|
| <b>Standard—40 mm</b>                                  |             |                |
| Black  | <b>C1</b>   | <b>E34C1</b>   |
| Red  | <b>C2</b>   | <b>E34C2</b>   |
| Red (EMERG. STOP)                                      | <b>C2N8</b> | <b>E34C2N8</b> |
| Green  | <b>C3</b>   | <b>E34C3</b>   |
| Blue   | <b>C6</b>   | <b>E34C6</b>   |
| <b>Jumbo Mushroom Head ③ (Anodized) Aluminum—65 mm</b> |             |                |
| Red  | <b>J2</b>   | <b>E34J2</b>   |
| Red (EMERG. STOP)                                      | <b>J2N8</b> | <b>E34J2N8</b> |

#### Notes

Use NEMA 4X 10250T operators where exposed to ultraviolet light, see **Pages V7-T1-182 to V7-T1-253**.

① X = closed circuit, 0 = open circuit.

② To order different type or color buttons, substitute the underlined characters with appropriate suffix code from the table. Example: E34GDBCC6-1X.

③ Anodized aluminum may not be suitable for use on some corrosive applications.

### Illuminated Push-Pull Units

UL (NEMA) Type 3, 3R, 4, 4X, 12, 13

- Two-position maintained
- Illuminated

#### Illuminated Push-Pull Unit



#### Two-Position Illuminated Maintained Push, Maintained Pull

Operator Position ①

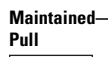

| Maintained—<br>Pull | Maintained—<br>Intermediate | Lamp              | Type         | Voltage     | Contact<br>Type | Mounting Location |   | LED/Lamp<br>Number      | Red Standard<br>Push-Pull<br>Catalog Number ② |                      |
|---------------------|-----------------------------|-------------------|--------------|-------------|-----------------|-------------------|---|-------------------------|---|----------------------|
|                     |                             |                   |              |             |                 | A                 | B |                         |   |                      |
| 0<br>X              | X<br>0                      | LED               | Full voltage | 24 Vac/Vdc  | 1NO             |                   |   | Bayonet<br>base         | <b>E34GDB97LRD24-1X</b>                       |                      |
|                     |                             |                   |              | 120 Vac/Vdc | 1NC             |                   |   |                         | <b>E34GDB97LRD24A-1X</b>                      |                      |
|                     |                             |                   |              | Transformer | 24 Vac          |                   |   |                         | <b>E34GDB89LRD06-1X</b>                       |                      |
|                     |                             |                   |              | 120 Vac     |                 |                   |   | <b>E34GDB63LRD06-1X</b> |   |                      |
| 0<br>X              | X<br>0                      | Incan-<br>descent | Full voltage | 24 Vac/Vdc  | 1NO             |                   |   | #757                    | <b>E34GDB79M2-1X</b>                          |                      |
|                     |                             |                   |              | Resistor    | 120 Vac/Vdc     |                   |   | 1NC                     | 120MB   | <b>E34GDB80M2-1X</b> |
|                     |                             |                   |              | Transformer | 24 Vac          |                   |   | #755                    | <b>E34GDB89M2-1X</b>                          |                      |
|                     |                             |                   |              | 120 Vac     |                 |                   |   | <b>E34GDB63M2-1X</b>    |   |                      |

#### Standard



#### Lens and Color Selection

| Color            | Incandescent<br>Suffix Code | LED<br>Suffix Code | Catalog Number |
|------------------|-----------------------------|--------------------|----------------|
| <b>Standard</b>  |                             |                    |                |
| Red              | <b>M2</b>                   | <b>RD</b>          | <b>E34M2</b>   |
| Red (EMER. STOP) | <b>M2N8</b>                 | <b>ED</b>          | <b>E34M2N8</b> |
| Green            | <b>M3</b>                   | <b>GD</b>          | <b>E34M3</b>   |
| Blue             | <b>M6</b>                   | <b>LD</b>          | <b>E34M6</b>   |
| Amber            | <b>M9</b>                   | <b>AD</b>          | <b>E34M9</b>   |
| White            | <b>M5</b>                   | <b>WD</b>          | <b>E34M5</b>   |
| Clear            | <b>M0</b>                   | <b>CD</b>          | <b>E34M0</b>   |

#### Notes

Use NEMA 4X 10250T operators where exposed to ultraviolet light, see **Pages V7-T1-182 to V7-T1-253**.

① X = closed circuit, 0 = open circuit.

② To order different type or color lens, substitute the underlined characters with appropriate suffix code from Lens and Color Selection table above.  
Example: E34GDB79M3-1X. For LEDs with different voltages see ordering example on **Page V7-T1-271**.

1

UL (NEMA) Type 3, 3R, 4, 4X, 12, 13

- Three-position maintained
- Illuminated

**Illuminated Push-Pull Unit**



**Three-Position Illuminated Momentary Push, Momentary Pull**

**Operator Position ①**



| Operator Position ① |                         |                | Lamp         | Type         | Voltage      | Contact Type | Mounting Location |              | LED/Lamp Number         | Red Standard Push-Pull Catalog Number ② |                         |       |                      |
|---------------------|-------------------------|----------------|--------------|--------------|--------------|--------------|-------------------|--------------|-------------------------|---|-------------------------|-------|----------------------|
| Momentary—Pull      | Maintained—Intermediate | Momentary—Push |              |              |              |              | A                 | B            |                         |   |                         |       |                      |
| 0                   | 0                       | X              | LED          | Full voltage | 24 Vac/Vdc   | 1NO          |                   | Bayonet base | <b>E34GHB97LRD24-1X</b> |   |                         |       |                      |
| X                   | 0                       | 0              |              |              | 120 Vac      | 1NC          |                   |              |                         |   | <b>E34GHB97LRD2A-1X</b> |       |                      |
|                     |                         |                |              |              | Trans-former | 24 Vac       |                   |              |                         |   | <b>E34GHB89LRD06-1X</b> |       |                      |
|                     |                         |                |              |              | 120 Vac      |              |                   |              | <b>E34GHB63LRD06-1X</b> |   |                         |       |                      |
| X                   | 0                       | 0              | LED          | Full voltage | 24 Vac/Vdc   | 1NC          |                   | Bayonet base | <b>E34GEB97LRD24-3X</b> |   |                         |       |                      |
| X                   | X                       | 0              |              |              | 120 Vac      | 1NC          |                   |              |                         |   | <b>E34GEB97LRD2A-3X</b> |       |                      |
|                     |                         |                |              |              | Trans-former | 24 Vac       |                   |              |                         |   | <b>E34GEB89LRD06-3X</b> |       |                      |
|                     |                         |                |              |              | 120 Vac      |              |                   |              | <b>E34GEB63LRD06-3X</b> |   |                         |       |                      |
| 0                   | 0                       | X              | Incandescent | Full voltage | 24 Vac/Vdc   | 1NO          |                   | #757         | <b>E34GHB79M2-1X</b>    |   |                         |       |                      |
| X                   | 0                       | 0              |              |              | Resistor     | 120 Vac      |                   |              |                         | 1NC                                     |                         | 120MB | <b>E34GHB80M2-1X</b> |
|                     |                         |                |              |              | Trans-former | 24 Vac       |                   |              |                         |   |                         | #755  | <b>E34GHB89M2-1X</b> |
|                     |                         |                |              |              | 120 Vac      |              |                   |              | <b>E34GHB63M2-1X</b>    |   |                         |       |                      |
| X                   | 0                       | 0              | LED          | Full voltage | 24 Vac/Vdc   | 1NC          |                   | #757         | <b>E34GEB79M2-3X</b>    |   |                         |       |                      |
| X                   | X                       | 0              |              |              | Resistor     | 120 Vac      |                   |              |                         | 1NC                                     |                         | 120MB | <b>E34GEB80M2-3X</b> |
|                     |                         |                |              |              | Trans-former | 24 Vac       |                   |              |                         |   |                         | #755  | <b>E34GEB89M2-3X</b> |
|                     |                         |                |              |              | 120 Vac      |              |                   |              | <b>E34GEB63M2-3X</b>    |   |                         |       |                      |

**Notes**

Use NEMA 4X 10250T operators where exposed to ultraviolet light, see **Pages V7-T1-182 to V7-T1-253**.

① X = closed circuit, 0 = open circuit.

② To order different type or color lens, substitute the underlined characters with appropriate suffix code from Lens and Color Selection table on the bottom of **Page V7-T1-265**. Example: E34GEB79M3-3X. For LEDs with different voltages see ordering example on **Page V7-T1-271**.

UL (NEMA) Type 3, 3R, 4, 4X, 12, 13

- Three-position—maintained push, momentary pull
- Illuminated

### Illuminated Push-Pull Unit



### Three-Position Illuminated Maintained Push, Momentary Pull

#### Operator Position ①



| Momentary Pull | Maintained Intermediate | Maintained Push | Lamp         | Type         | Voltage    | Contact Type | Mounting Location |              | LED/Lamp Number | Red Standard Push-Pull Catalog Number ② |
|----------------|-------------------------|-----------------|--------------|--------------|------------|--------------|-------------------|--------------|-----------------|---|
|                |                         |                 |              |              |            |              | A                 | B            |                 |   |
| X              | 0                       | 0               | LED          | Full voltage | 24 Vac/Vdc | 1NC          | o   o             | Bayonet base |                 | <b>E34GFB97LRD24-3X</b>                 |
| X              | X                       | 0               |              |              | 120 Vac    | 1NC          |                   |              |                 |   |
|                |                         |                 |              |              | 24 Vac     |              |                   |              |                 | <b>E34GFB89LRD06-3X</b>                 |
|                |                         |                 |              | Trans-former | 120 Vac    |              |                   |              |                 | <b>E34GFB63LRD06-3X</b>                 |
| X              | 0                       | 0               | Incandescent | Full voltage | 24 Vac/Vdc | 1NC          | o   o             | #757         |                 | <b>E34GFB79M2-3X</b>                    |
| X              | X                       | 0               |              |              | 120 Vac    | 1NC          |                   |              |                 |   |
|                |                         |                 |              |              | 24 Vac     |              |                   |              | #755            | <b>E34GFB89M2-3X</b>                    |
|                |                         |                 |              |              | 120 Vac    |              |                   |              |                 | <b>E34GFB63M2-3X</b>                    |

### Vertical or Horizontal One-Hole Mounting ③



### Potentiometers

UL (NEMA) Type 3, 3R, 4, 4X, 12, 13

### Potentiometer with Knob and Standard Dial Plate—Linear Type ±10%

| Potentiometer Ohms   | Catalog Number    |
|--|-------------------|
| <b>2 Watt (60V Max.) Single Potentiometer with Standard Aluminum Dial Plate ④⑤</b> |                   |
| 1000   | <b>E34PDB1F1</b>  |
| 2500   | <b>E34PDB1F2</b>  |
| 5000   | <b>E34PDB1F5</b>  |
| 10000  | <b>E34PDB1F10</b> |
| 25000  | <b>E34PDB1F25</b> |
| 50000  | <b>E34PDB1F50</b> |
| Operator only ⑥  | <b>E34PDB1A0</b>  |
| Alternative—black plastic large legend with standard markings                      | <b>E34LP99</b>    |

Dimensions, see Page V7-T1-292.

#### Notes

Use NEMA 4X 10250T operators where exposed to ultraviolet light, see Pages V7-T1-182 to V7-T1-253.

① X = closed circuit, 0 = open circuit.

② To order different type or color lens, substitute the underlined characters with appropriate suffix code from table on the bottom of Page V7-T1-265.

Example: E34GFB79M3-3X. For LEDs with different voltages see ordering example on Page V7-T1-271.

③ Shown with standard aluminum dial plate.

④ Large dial plate with space for legend is available at no charge. To order, add suffix **36** to catalog number. Example: E34PDB1F1**36**. To order separately, see footnote ⑤ below.

⑤ Large dial plate has space at top for 15 letters. 3/32 in high. For custom stamped legend plates, order legend plate as separate item **10250TR30** and specify stamping.

⑥ For use with commercially purchased potentiometers having shaft dimensions per dimension drawing on Page V7-T1-244.



#### 1

#### Push-Pull Operators

An illuminated push-pull pushbutton unit, arranged for one-hole mounting, can replace two pushbuttons and a pilot light or the non-illuminated form can replace two pushbuttons. These units are available in three basic types:

- **Maintained**—(Two-position). Maintains in the pulled or pushed position until manually actuated to the opposite mode.
- **Momentary**—(Three-position). Spring returns to an intermediate position when pulled or pushed and released.

- **Momentary Pull, Maintained Push**—(Three-position). Spring returns to intermediate position when pulled. Maintains in pushed position until manually returned to intermediate (ready to reset) position. Maintained stop holds circuit open and will prevent other series connected operators from starting the system.

The operators, buttons, contact blocks, etc., are offered as building block components that can be intermixed to satisfy many requirements. This minimizes the need for a varied and costly inventory.

#### Application Guide

To assist in the selection of contact blocks, the sketch below shows pictorially by symbols **A** and **B** locations of contact circuits after assembly of contact blocks and adapter to the operator. The table below shows the effect of the push and pull operations on either NO or NC contacts. (X = contact closed, O = contact open).

#### Contact Circuit Locations

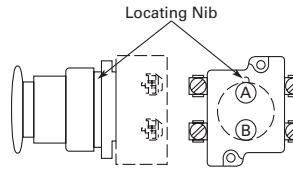

#### Two-Position Maint. Push-Pull ①



#### Push-Pull Operator Components

##### Operator Position and Circuit Arrangement



##### Contact Block Mounting Location

| Type of Operator                            | Out—Pull |   | Intermediate             |   | In—Push |   | Contact Block ② | Catalog Number  |
|---|----------|---|--------------------------|---|---------|---|-----------------|-----------------|
|   | A        | B | A                        | B | A       | B |                 |                 |
| <b>Two-Position Operator without Lens</b>   |          |   |                          |   |         |   |                 |                 |
| Maintained push-pull                        | O        | O | No intermediate position |   | X       | X | 1NO             | <b>E34GDB</b>   |
|   | X        | X |                          |   | O       | O | 1NC             |                 |
|   | O        | O |                          |   | X       | X | 2NO             |                 |
|   | X        | X |                          |   | O       | O | 2NC             |                 |
| <b>Three-Position Operator without Lens</b> |          |   |                          |   |         |   |                 |                 |
| Momentary push-pull                         | O        | O | O                        | O | X       | O | 1NO             | <b>E34GEB ②</b> |
|   | X        | X | O                        | X | O       | O | 1NC             |                 |
|   | O        | O | O                        | O | X       | O | 2NO             |                 |
|   | X        | X | O                        | X | O       | O | 2NC             |                 |
| Maintained push-momentary pull              | O        | O | O                        | O | X       | O | 1NO             | <b>E34GFB ②</b> |
|   | X        | X | O                        | X | O       | O | 1NC             |                 |
|   | O        | O | O                        | O | X       | O | 2NO             |                 |
|   | X        | X | O                        | X | O       | O | 2NC             |                 |
| Momentary push-pull                         | O        | O | O                        | O | X       | X | 1NO             | <b>E34GHB ②</b> |
|   | X        | X | O                        | O | O       | O | 1NC             |                 |
|   | O        | O | O                        | O | X       | X | 2NO             |                 |
|   | X        | X | O                        | O | O       | O | 2NC             |                 |

#### Notes

Use NEMA 4X 10250T operators where exposed to ultraviolet light, see **Pages V7-T1-182 to V7-T1-253**.

See Typical Applications on **Page V7-T1-203**.

① Shown without button on lens.

② Maximum of two blocks, four circuits. Special function contact blocks shown on **Page V7-T1-286** CANNOT be used with three-position push-pull operators E34GEB, E34GFB or E34GHB.

**Push-Pull Light Units, Lenses and Buttons**

**Ordering Example with One Composite Number**

Non-illuminated:

E34GDB + E34C2 + 10250T1 = **E34GDBC2-1X**

Incandescent:

E34GDB + 10250T79 + E34M2 + 10250T1 = **E34GDB79M2-1X**

LED:

E34GDB + 10250T97L + E34M2 + Voltage Code + 10250T1 = **E34GDB97LRD24-1X**

|               |               |
|---------------|---------------|
| 06—6 Vac/Vdc  | 60—60 Vac/Vdc |
| 12—12 Vac/Vdc | 2A—120 Vac    |
| 24—24 Vac/Vdc | 2D—120 Vdc    |
| 48—48 Vac/Vdc |               |

**Light Units for Illuminated Push-Pull Devices**

| Light Unit Type                    | Type   | Voltage      | LED/Lamp Number | Catalog Number           |
|------------------------------------|--|--------------|-----------------|--------------------------|
| LED<br>(LEDs not included) ①       | Full voltage<br>Transformer<br>AC only<br>50/60 Hz | —            | Bayonet<br>base | <b>10250T97L</b>         |
|                                    |  | 24           |                 | <b>10250T89L</b>         |
|                                    |  | 120          |                 | <b>10250T63L</b>         |
|                                    |  | 208          |                 | <b>10250T64L</b>         |
|                                    |  | 240          |                 | <b>10250T65L</b>         |
|                                    |  | 277          |                 | <b>10250T82L</b>         |
|                                    |  | 380          |                 | <b>10250T66L</b>         |
|                                    |  | 480          |                 | <b>10250T67L</b>         |
|                                    |  | 600          |                 | <b>10250T68L</b>         |
|                                    |  | Incandescent |                 | Full voltage<br>AC or DC |
| 12                                 | #756   |              | <b>10250T70</b> |                          |
| 24/28                              | #757   |              | <b>10250T79</b> |                          |
|                                    | #1828  |              | <b>10250T83</b> |                          |
|                                    |  |              |                 |                          |
| Resistor<br>AC or DC               | 120  |              | 120MB           | <b>10250T80</b>          |
|                                    | 240  |              |                 | <b>10250T81</b>          |
| Transformer<br>AC only<br>50/60 Hz | 24   |              | #755            | <b>10250T89</b>          |
|                                    | 120  |              |                 | <b>10250T63</b>          |
|                                    | 208  |              |                 | <b>10250T64</b>          |
|                                    | 240  |              |                 | <b>10250T65</b>          |
|                                    | 277  |              |                 | <b>10250T82</b>          |
|                                    | 380  |              |                 | <b>10250T66</b>          |
|                                    | 480  |              |                 | <b>10250T67</b>          |
|                                    | 600  |              |                 | <b>10250T68</b>          |
|                                    |  |              |                 |                          |

**Notes**

Use NEMA 4X 10250T operators where exposed to ultraviolet light, see **Pages V7-T1-182 to V7-T1-253**.

① These units do not include lamps. Order LED separately to match lens color from chart on **Page V7-T1-271**

## Buttons for Non-Illuminated Push-Pull Devices

| Color                      | Incandescent<br>Suffix Code | Catalog Number |
|----------------------------|-----------------------------|----------------|
| <b>Standard Button</b>     |                             |                |
| Black                      | <b>C1</b>                   | <b>E34C1</b>   |
| Red                        | <b>C2</b>                   | <b>E34C2</b>   |
| Red (EMERG. STOP)          | <b>C2N8</b>                 | <b>E34C2N8</b> |
| Green                      | <b>C3</b>                   | <b>E34C3</b>   |
| Blue                       | <b>C6</b>                   | <b>E34C6</b>   |
| <b>Jumbo Mushroom Head</b> |                             |                |
| Red ①                      | <b>J2</b>                   | <b>E34J2</b>   |
| Red (EMERG. STOP)          | <b>J2N8</b>                 | <b>E34J2N8</b> |

## E34M\_

## Alternate Lenses for Illuminated Push-Pull Devices

| Color             | Incandescent<br>Suffix Code | LED<br>Suffix Code ② | Catalog Number |
|-------------------|-----------------------------|----------------------|----------------|
| Red               | <b>M2</b>                   | <b>RD</b>            | <b>E34M2</b>   |
| Red (EMERG. STOP) | <b>M2N8</b>                 | <b>ED</b>            | <b>E34M2N8</b> |
| Green             | <b>M3</b>                   | <b>GD</b>            | <b>E34M3</b>   |
| Blue              | <b>M6</b>                   | <b>LD</b>            | <b>E34M6</b>   |
| Amber             | <b>M9</b>                   | <b>AD</b>            | <b>E34M9</b>   |
| White             | <b>M5</b>                   | <b>WD</b>            | <b>E34M5</b>   |
| Clear             | <b>M0</b>                   | —                    | <b>E34M0</b>   |

**Notes**

Use NEMA 4X 10250T operators where exposed to ultraviolet light, see **Pages V7-T1-182 to V7-T1-253**.

① Anodized aluminum may not be suitable for use on some corrosive applications.

② Suffix codes should only be used for assembling composite catalog numbers. To order lens, order by catalog number.

**Standard LED Lamp**



**LED Selection**

| Voltage   | Color  | Catalog Number |
|---|--------|----------------|
| 6 Vac/Vdc<br>suitable for<br>use with<br>transformers | Red    | E22LED006RN    |
|   | Orange | E22LED006ON    |
|   | Yellow | E22LED006YN    |
|   | Green  | E22LED006GN    |
|   | Blue   | E22LED006BN    |
| 12 Vac/Vdc  | White  | E22LED006WN    |
|   | Red    | E22LED012RN    |
|   | Orange | E22LED012ON    |
|   | Yellow | E22LED012YN    |
|   | Green  | E22LED012GN    |
| 24 Vac/Vdc  | Blue   | E22LED012BN    |
|   | White  | E22LED012WN    |
|   | Red    | E22LED024RN    |
|   | Orange | E22LED024ON    |
|   | Yellow | E22LED024YN    |
| 48 Vac/Vdc  | Green  | E22LED024GN    |
|   | Blue   | E22LED024BN    |
|   | White  | E22LED024WN    |
|   | Red    | E22LED048RN    |
|   | Orange | E22LED048ON    |
|   | Yellow | E22LED048YN    |
|   | Green  | E22LED048GN    |
|   | Blue   | E22LED048BN    |
|   | White  | E22LED048WN    |

| Voltage    | Color  | Catalog Number |
|------------|--------|----------------|
| 60 Vac/Vdc | Red    | E22LED060RN    |
|            | Orange | E22LED060ON    |
|            | Yellow | E22LED060YN    |
|            | Green  | E22LED060GN    |
|            | Blue   | E22LED060BN    |
| 120 Vac    | White  | E22LED060WN    |
|            | Red    | E22LED120RA    |
|            | Orange | E22LED120OA    |
|            | Yellow | E22LED120YA    |
|            | Green  | E22LED120GA    |
| 120 Vdc    | Blue   | E22LED120BA    |
|            | White  | E22LED120WA    |
|            | Red    | E22LED120RD    |
|            | Orange | E22LED120OD    |
|            | Yellow | E22LED120YD    |
|            | Green  | E22LED120GD    |
|            | Blue   | E22LED120BD    |
|            | White  | E22LED120WD    |

# 1

### Selector Switch Units





UL (NEMA) Type 3, 3R, 4, 4X, 12, 13

- Two-, three- and four-position—maintained
- Non-illuminated and illuminated

#### Two-Position Maint. Switch Knob















#### Two-Position Selector Switch

| Operator Position <sup>①</sup> |   | Operator Action <sup>②</sup>  | Contact Type | Mounting Location   |   | Cam Code | Non-Illuminated                        |   | Illuminated—120V Transformer         |                                       |
|--------------------------------|---|---|--------------|---|---|----------|--|---|--------------------------------------|---------------------------------------|
| X                              | O |   |              | A   | B   |          | Black Knob Catalog Number <sup>③</sup> | Black Lever Catalog Number <sup>③</sup> | Red Knob Catalog Number <sup>③</sup> | Red Lever Catalog Number <sup>③</sup> |
| X                              | O | M  | 1NC          |  |  | 1        | E34VFBK1-1X                            | E34VFB1-1X                              | E34VFB120ER-1X                       | E34VFB120FR-1X                        |
| O                              | X |   | 1NO          |  |  |          |  |   |                                      |                                       |

#### Three-Position Maint. Switch Knob













#### Three-Position Selector Switch

| Operator Position <sup>①</sup> |   |   | Operator Action <sup>②</sup>  | Contact Type | Mounting Location   |   | Cam Code | Non-Illuminated                        |   | Illuminated—120V Transformer         |                                       |
|--------------------------------|---|---|---|--------------|---|---|----------|--|---|--------------------------------------|---------------------------------------|
| X                              | O | O |   |              | A   | B   |          | Black Knob Catalog Number <sup>③</sup> | Black Lever Catalog Number <sup>③</sup> | Red Knob Catalog Number <sup>③</sup> | Red Lever Catalog Number <sup>③</sup> |
| X                              | O | O | M  | 1NO          |  |  | 3        | E34VHBK1-2X                            | E34VHBL1-2X                             | E34VHB120TER-2X                      | E34VHB120TFR-2X                       |
| O                              | O | X |   | 1NO          |  |  |          |  |   |                                      |                                       |
| X                              | O | O | M  | 1NO          |  |  | 3        | E34VHBK1-23X                           | E34VHBL1-23X                            | E34VHB120TER-23X                     | E34VHB120TFR-23X                      |
| O                              | X | O |   | 2NC (Series) |  |  |          |  |   |                                      |                                       |
| O                              | O | X |   | 1NO          |  |  |          |  |   |                                      |                                       |

#### Four-Position Maint. Switch Lever



#### Four-Position Selector Switch

| Operator Position <sup>①</sup> |   |   |   | Operator Action <sup>②</sup>  | Contact Type  | Mounting Location   |   | Cam Code     | Non-Illuminated                        |   | Illuminated—120V Transformer         |                                       |
|--------------------------------|---|---|---|---|---|---|---|--------------|--|---|--------------------------------------|---------------------------------------|
| X                              | O | O | O |   |   | A   | B   |              | Black Knob Catalog Number <sup>③</sup> | Black Lever Catalog Number <sup>③</sup> | Red Knob Catalog Number <sup>③</sup> | Red Lever Catalog Number <sup>③</sup> |
| X                              | O | O | O | M  | 1NC   |  |  | 7            | E34VTBK1-23X                           | E34VTBL1-23X                            | E34VRB120TER-23X                     | E34VRB120TFR-23X                      |
| O                              | X | O | O |   | 1NO   |  |  |              |  |   |                                      |                                       |
| O                              | O | X | O |   | 1NO   |  |  |              |  |   |                                      |                                       |
| O                              | O | O | X | 1NO   |  |  | 7   | E34VTBK1-23X | E34VTBL1-23X                           | E34VRB120TER-23X                        | E34VRB120TFR-23X                     |                                       |
| O                              | O | O | X | 1NC   |  |  |   |              |  |   |                                      |                                       |

#### Color Selection, Non-Illuminated

| Color  | Code Letter | Color  | Code Letter |
|--------|-------------|--------|-------------|
| Black  | 1           | White  | 5           |
| Red    | 2           | Blue   | 6           |
| Green  | 3           | Gray   | 7           |
| Yellow | 4           | Orange | 8           |

#### Notes

For Light Unit Voltage Suffix and Knobs, Levers tables, see **Page V7-T1-278**.

Use NEMA 4X 10250T operators where exposed to ultraviolet light, see **Pages V7-T1-182 to V7-T1-253**.

<sup>①</sup> X = closed circuit, O = open circuit.

<sup>②</sup> M = Maintained.

<sup>③</sup> To order different type or color selector switch, substitute the underlined character with appropriate suffix code from the Color Selection table. Example: E34VFBK2-X1.

### Selector Switch Selection



#### Cam and Contact Block Selection

Selector switches in their varied forms (two-position, three-position and four-position) are a big factor contributing to the great flexibility of control that a well rounded line of “pushbuttons” can achieve. Because of their flexibility, they tend to cause difficulty with product selection and application. The following systematic approach should simplify that task.

Cam and contact block selection is better understood if you:

- Work with each incoming and outgoing wire/circuit separately.
- Recognize the terms NO and NC only identify the type of contact by its mode before mounting to the operator. The “X-O” chart (Page V7-T1-275) shows how that contact will act after assembly to the operator with the selected cam shape. X = closed circuit, O = open circuit.

- Up to six NO or NC contacts may be mounted behind each plunger location for a total of twelve contacts. Single circuit contact blocks have only one plunger with the other side of the block “open.” Therefore, single circuit contact blocks transmit motion to blocks behind them only for the position containing the circuit.
- Each cam has two separate lobes, each of which operates one of the two contact block plungers independently of each other. Those are identified as position A (locating nib side) and position B (opposite of locating nib). The position designations give direction in selecting and mounting of the contact blocks.

#### Contact Circuit Locations

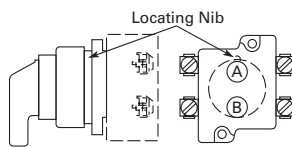

#### Systematic Approach

Application: **HAND-OFF-AUTO** selector switch. In this circuit, one incoming line is distributed to two other outgoing circuits by the switch. The two circuits can be looked at individually.

#### Step 1: Elementary Diagram.

Construct on paper, or in your mind, a simple elementary diagram of the switching scheme as follows:

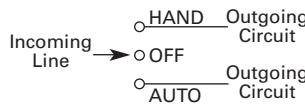

#### Step 2: “X-O” Pattern.

From the elementary diagram, you can construct an “X-O” diagram which describes when the contacts are to be closed (X) or open (O) in the various positions of the switch. The “X-O” for the **HAND** circuit looks like this:

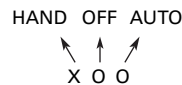

In this circuit, you want a contact closed on the left (HAND) but open in the center and right.

For the **AUTO** circuit, the “X-O” diagram would look like this:

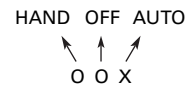

Putting them together, the complete “X-O” diagram is:



Once the “X-O” diagram has been generated, the next step is to select the cam and contact block, or blocks, needed to perform the desired “X-O” functions. The selection tables on the following pages list the various types (shapes) of cams by number to choose from and the type of contact and position to achieve the function outlined in your “X-O” diagram.

1

#### Step 3: Cam Selection.

The cam you select determines the operation of all contact blocks mounted to the operator. It is selected on the basis that it provides the simplest circuitry for the desired "X-O" diagram. The selection tables show all the "X-O" combinations. For the purpose of this example, the applicable portion of those tables is shown on this page.

Now to make the cam selection, make a simple worksheet such as:

|       | Cam 2       | Cam 3 |
|-------|-------------|-------|
| X O O | (A)NO-(B)NC | (A)NO |
| O O X | (B)NO       | (B)NO |

It becomes immediately obvious that cam 3 is the better choice for two reasons, (1) the series combination can be avoided making it simpler to wire, (2) only two contacts are required, which is less expensive than the three contacts required by cam 2.

#### Step 4: Contact Block Selection.

Having selected the cam, contact block selection is simply a matter of gathering the A position and B position circuits into pairs which make up the most convenient contact block arrangement. If there is an imbalance in the number of circuits under A or B, then single circuit blocks must be selected for these leftover circuits.

Back to the worksheet, having selected cam 3 do this:

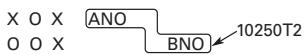

#### Step 5: Selector Switch Operator.

Lastly, you have to choose from the many types of operators—knob and lever in various colors or keyed. Also what combinations of maintained and spring return functions are required. Selection of these operators can be found on **Page V7-T1-276**. For the example in step 4, you may want a three-position maintained black knob, cam 3—Catalog Number E34VHBK1.

#### The Complete Switch:

E34VHBK1 with one 10250T2 or, for one composite catalog number, E34VHBK1-Y1 found on **Page V7-T1-273**.

#### Diagrams

Circuits shown illustrate connections to obtain a selector switch circuit combination and are shown with their appropriate line diagrams. Field wiring of jumper connections required as shown.

X = Closed circuit  
O = Open circuit

#### Wiring of Jumper Connections

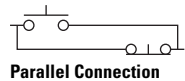

Four-position selector switches are limited to four contact blocks.

#### Contact Blocks

For selection and number of available contact blocks per operator, see **Page V7-T1-285**.

#### Example Selection Table

| No. | "X-O" Pattern | Cam Code #2 |          | Cam Code #3 |          |
|-----|---------------|-------------|----------|-------------|----------|
|     |               | Top A       | Bottom B | Top A       | Bottom B |
| 1   | X 0 0         |             |          |             | —        |
| 4   | 0 0 X         | —           |          | —           |          |

#### Two-Position Selector Switch Contact Block Selection

| No. | Desired Circuit and Operator Position |   | Contact Blocks Required to Accomplish Circuit Function |                  |
|-----|---------------------------------------|---|--|------------------|
|     |                                       |   | Top Plunger A  | Bottom Plunger B |
| 1   | X                                     | 0 |  | or               |
| 2   | 0                                     | X |  | or               |

#### Note

① Wired in series.

Three-Position Switch—Cam and Contact Block Selection

| No. | Desired Circuit and Operator Position |   |   | Contact Blocks Required to Accomplish Circuit Function<br>(Jumpers must be installed where indicated) |                  |                           |                  |
|-----|---------------------------------------|---|---|---|------------------|---------------------------|------------------|
|     |                                       |   |   | Operator with Cam Code #2   |                  | Operator with Cam Code #3 |                  |
|     |                                       |   |   | Mounting Location   |                  | Mounting Location         |                  |
|     |                                       |   |   | Top Plunger A   | Bottom Plunger B | Top Plunger A             | Bottom Plunger B |
| 1   | X                                     | 0 | 0 |   |                  |                           |                  |
| 2   | X                                     | X | 0 |   |                  |                           |                  |
| 3   | X                                     | 0 | X |   |                  |                           |                  |
| 4   | 0                                     | 0 | X |   |                  |                           |                  |
| 5   | 0                                     | X | X |   |                  |                           |                  |
| 6   | 0                                     | X | 0 |   |                  |                           |                  |

Four-Position Switch—Contact Block Selection

| No. | Desired Circuit and Operator Position |   |   |   | Contact Blocks Required to Accomplish Circuit Function |                  | No. | Desired Circuit and Operator Position |                  |               |                  | Contact Blocks Required to Accomplish Circuit Function |  |
|-----|---------------------------------------|---|---|---|--|------------------|-----|---------------------------------------|------------------|---------------|------------------|--|--|
|     |                                       |   |   |   | Mounting Location                                      |                  |     | Top Plunger A                         | Bottom Plunger B | Top Plunger A | Bottom Plunger B |  |  |
|     |                                       |   |   |   | Top Plunger A  | Bottom Plunger B |     |                                       |                  |               |                  |  |  |
| 1   | X                                     | 0 | 0 | 0 |  |                  | 10  | X                                     | 0                | X             | 0                |  |  |
| 2   | 0                                     | X | 0 | 0 |  |                  |     |                                       |                  |               |                  |  |  |
| 3   | 0                                     | 0 | X | 0 |  |                  | 11  | X                                     | X                | X             | 0                |  |  |
| 4   | 0                                     | 0 | 0 | X |  |                  |     |                                       |                  |               |                  |  |  |
| 5   | X                                     | 0 | 0 | X |  |                  | 12  | 0                                     | X                | X             | X                |  |  |
| 6   | 0                                     | X | X | 0 |  |                  |     |                                       |                  |               |                  |  |  |
| 7   | 0                                     | 0 | X | X |  |                  | 13  | X                                     | 0                | X             | X                |  |  |
| 8   | X                                     | X | 0 | 0 |  |                  |     |                                       |                  |               |                  |  |  |
| 9   | 0                                     | X | 0 | X |  |                  | 14  | X                                     | X                | 0             | X                |  |  |



# 1

## Selector Switch Operators

UL (NEMA) Type 3, 3R, 4, 4X, 12, 13

### Two-Position Knob Selector Switch



### Operators with Knob Assembled

| Positions                | Operator Action <sup>①</sup> | Black Knob Selector Switch—<br>Vertical Mounting <sup>②</sup> | Cam Code <sup>③</sup> | Catalog Number <sup>④</sup> |
|--------------------------|------------------------------|---|-----------------------|-----------------------------|
| Two-position—60° throw   |                              |   | 1                     | <u>E34VFBK1</u>             |
|                          |                              |   | 1                     | <u>E34VEBK1</u>             |
| Three-position—60° throw |                              |   | 2                     | <u>E34VGBK1</u>             |
|                          |                              |   | 3                     | <u>E34VHBK1</u>             |
|                          |                              |   | 2                     | <u>E34VJBK1</u>             |
|                          |                              |   | 3                     | <u>E34VKBK1</u>             |
|                          |                              |   | 2                     | <u>E34VLBK1</u>             |
|                          |                              |   | 3                     | <u>E34VMBK1</u>             |
| Four-position—40° throw  |                              |   | 2                     | <u>E34VNBK1</u>             |
|                          |                              |   | 3                     | <u>E34VPBK1</u>             |
| Four-position—40° throw  |                              |   | 7                     | <u>E34VTBK1</u>             |

## Key Operators

### Three-Position Keyed Selector Switch



### Key Operators with Cam and Cap

| Positions                | Operator Action <sup>①</sup> | Cam Code <sup>③</sup> | Key Removal Positions <sup>⑤</sup> | Vertical Mounting Catalog Number | Horiz. Mounting Catalog Number |
|--------------------------|------------------------------|-----------------------|------------------------------------|----------------------------------|--------------------------------|
| Two-position—60° throw   |                              | 1                     | 1, 2, 3                            | <u>E34KFB_</u>                   | <u>E34KFHB_</u>                |
|                          |                              | 1                     | 2                                  | <u>E34KEB_</u>                   | <u>E34KEHB_</u>                |
| Three-position—60° throw |                              | 2                     | 1–7                                | <u>E34KGB_</u>                   | <u>E34KGHB_</u>                |
|                          |                              | 3                     |                                    | <u>E34KHB_</u>                   | <u>E34KHGB_</u>                |
|                          |                              | 2                     | 1, 4, 5                            | <u>E34KJB_</u>                   | <u>E34KJHB_</u>                |
|                          |                              | 3                     |                                    | <u>E34KKB_</u>                   | <u>E34KKHB_</u>                |
|                          |                              | 2                     | 4                                  | <u>E34KLB_</u>                   | <u>E34KLHB_</u>                |
|                          |                              | 3                     |                                    | <u>E34KMB_</u>                   | <u>E34KMHB_</u>                |
| Four-position—40° throw  |                              | 2                     | 2, 4, 6                            | <u>E34KNB_</u>                   | <u>E34KNHB_</u>                |
|                          |                              | 3                     |                                    | <u>E34KPB_</u>                   | <u>E34KPHB_</u>                |
| Four-position—40° throw  |                              | 7                     | 7                                  | <u>E34KTB_</u>                   | <u>E34KTHB_</u>                |

### Notes

Use NEMA 4X 10250T operators where exposed to ultraviolet light, see **Pages V7-T1-182 to V7-T1-253**.

① M = Maintained. S = Spring return in direction of arrow (R).

② Field convertible to horizontal mounting.

③ For selection of the proper cam and contact block to obtain the proper circuit sequence, see selection instructions and tables on **Pages V7-T1-273 to V7-T1-275**.

④ For other colors of either the knob or lever, replace the underlined characters of the catalog number with the appropriate suffix code from Alternate Knob and Lever table on **Page V7-T1-277**. Example: E34VFBL2.

⑤ Choose key removal position required for application from table on **Page V7-T1-277**. Add key removal code number to listed catalog number. Example: E34KFB2.

### Key Removal Positions <sup>①</sup>

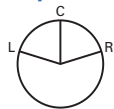

| Code Suffix | Key Removal Position |
|-------------|----------------------|
| 1           | Right only           |
| 2           | Left only            |
| 3           | Right and left       |
| 4           | Center only          |
| 6           | Left and center      |
| 7           | All positions        |

### Dissimilar Locks and Keys

Listed operators have identical locks and keys (Key Code H661), Catalog Number **10250ED824**. For dissimilar lock and key combinations, see **Page V7-T1-212**.

### Alternate Knobs and Levers for Operators <sup>②</sup>

E34K\_



E34L\_



E34A\_



| Color  | Knob        |                | Lever       |                | Lever Designed for Added Ingress Protection <sup>③</sup> |                |
|--------|-------------|----------------|-------------|----------------|--|----------------|
|        | Suffix Code | Catalog Number | Suffix Code | Catalog Number | Suffix Code  | Catalog Number |
| Black  | K1          | E34K1          | L1          | E34L1          | A1   | E34A1          |
| Red    | K2          | E34K2          | L2          | E34L2          | A2   | E34A2          |
| Green  | K3          | E34K3          | L3          | E34L3          | A3   | E34A3          |
| Yellow | K4          | E34K4          | L4          | E34L4          | A4   | E34A4          |
| White  | K5          | E34K5          | L5          | E34L5          | A5   | E34A5          |
| Blue   | K6          | E34K6          | L6          | E34L6          | A6   | E34A6          |
| Gray   | K7          | E34K7          | L7          | E34L7          | A7   | E34A7          |
| Orange | K8          | E34K8          | L8          | E34L8          | A8   | E34A8          |

#### Notes

- ① Key removal in “spring return from” positions not recommended.
- ② See operators on **Page V7-T1-276**.
- ③ For use on maintained operators only.

#### 1

### Illuminated Selector Switch Operators

120 Vac Transformer Selector Switch, Cam 1



#### Operator without Knob or Lever

| Positions                | Operator Action | Transformer Type—50/60 Hz<br>6V #755 Lamp<br>Catalog Number <sup>③④</sup> |                         | Full Voltage Type—AC or DC <sup>①</sup><br>Lamps—#755, #757, #1835, 120MB <sup>②</sup><br>Catalog Number <sup>④</sup> |                         |                         |
|--------------------------|-----------------|---|-------------------------|---|-------------------------|-------------------------|
|                          |                 | Cam Code 1 <sup>⑤</sup>   | Cam Code 2 <sup>⑤</sup> | Cam Code 3 <sup>⑤</sup>   | Cam Code 1 <sup>⑤</sup> | Cam Code 2 <sup>⑤</sup> |
| Two-position—60° throw   |                 | E34VFB_   |                         | E34SFB_   |                         |                         |
| Three-position—60° throw |                 | E34VGB_   | E34VHB_                 | E34SGB_   | E34SHB_                 |                         |
|                          |                 | E34VNB_ <sup>⑥</sup>  | E34VPB_ <sup>⑥</sup>    | E34SNB_ <sup>⑦</sup>  | E34SPB_ <sup>⑦</sup>    |                         |
|                          |                 | E34VJB_ <sup>⑥</sup>  | E34VKB_ <sup>⑥</sup>    | E34SJB_ <sup>⑦</sup>  | E34SKB_ <sup>⑦</sup>    |                         |
|                          |                 | E34VLB_   | E34VMB_                 | E34SLB_   | E34SMB_                 |                         |
| Four-position—40° throw  |                 | E34VRB_   | —                       | E34SRB_   | —                       |                         |

#### Knob



#### Lever



#### Knobs and Levers

| Color <sup>②</sup> | Knob Catalog Number and Code Number | Lever Catalog Number and Code Number |
|--------------------|-------------------------------------|--------------------------------------|
| Red                | 10250TER                            | 10250TFR                             |
| Green              | 10250TEG                            | 10250TFG                             |
| Yellow             | 10250TEA                            | 10250TFA                             |
| Blue               | 10250TEL                            | 10250TFL                             |
| Clear              | 10250TEC                            | 10250TFC                             |
| White              | 10250TEW                            | 10250TFW                             |
| Amber              | 10250TEM                            | 10250TFM                             |

#### Light Unit Voltage Suffix

Add to operator Catalog Number listed in table above.

#### Type of Light Unit

| Transformer Type<br>50/60 Hz |             | Full Voltage Type<br>AC or DC <sup>①</sup> |             |
|------------------------------|-------------|--|-------------|
| Voltage                      | Suffix Code | Voltage                                    | Suffix Code |
| 24                           | 024         | 6  | 06          |
| 120                          | 120         | 12   | 12          |
| 208                          | 208         | 24   | 24          |
| 240                          | 240         | 48   | 48          |
| 380                          | 380         | 120  | 120         |
| 480                          | 480         | 240 <sup>⑥</sup>                           | 240         |
| 600                          | 600         |  |             |

#### Notes

Use NEMA 4X 10250T operators where exposed to ultraviolet light, see **Pages V7-T1-182 to V7-T1-253**.

<sup>①</sup> Full voltage light units can be used at other than listed voltages by changing lamp. Replacement lamps are listed on **Page V7-T1-239**.

<sup>②</sup> 120MB lamps are used on both 120V and 240V operators.

<sup>③</sup> Operator includes lens gasket and lens attachment screws.

<sup>④</sup> Add suffix code for light unit voltage to listed catalog number from Light Unit Voltage Suffix table above.  
Example: For 24V transformer type light unit, order E34VFB024.

<sup>⑤</sup> For selection of the proper cam and contact block required to obtain a specific circuit sequence, see selection tables on **Pages V7-T1-273 to V7-T1-275**.

<sup>⑥</sup> 120 and 240V transformer only.

<sup>⑦</sup> 120 full voltage only.

<sup>⑧</sup> Resistor type. May generate excess heat if used in high density.

<sup>⑨</sup> Amber, clear and white lenses have a black arrow (R). Red, green and blue lenses have a white arrow (R).

### Accessories





#### Accessories

|   | Description  | Catalog Number   |
|---|--|--|
| <b>E34TA2</b><br>    | <b>Padlocking Attachment for Flush Pushbutton Operators.</b><br>Permits locking NC contacts in open position with 1/4 in padlock.<br>Will not lock NO contact. | <b>E34TA2</b>  |
| <b>10250TA_</b><br>  | <b>Flexible Weather Resistant Boot</b> for use with flush pushbutton operators.<br>Clear<br>Black<br>Red<br>Green  | <b>10250TA46</b><br><b>10250TA47</b><br><b>10250TA48</b><br><b>10250TA49</b> |
|   | <b>Flexible Weather Resistant Boot</b> for use with button operators (extended buttons preferred).<br>Black<br>Red<br>Green<br>Clear                           | <b>10250TA3</b><br><b>10250TA4</b> ①<br><b>10250TA10</b><br><b>10250TA85</b> |
|   | <b>Transparent Boot</b> for regular, illuminated pushbutton operators and PresTest.  | <b>10250TA25</b> ②   |
| <b>E34TA3_</b><br>  | <b>Special Retaining Nut</b> —to accommodate thick panel.<br>Indicating light<br>PresTest, pushbuttons and selector switches                                   | <b>E34TA30</b><br><b>E34TA31</b>   |
| <b>E34TA6</b><br>  | <b>Shroud for Mushroom Head Operator</b> —prevents accidental operation.<br>(Not for push-pull operators.)   | <b>E34TA6</b>  |
| <b>E34TA12</b><br> | <b>Extended Retaining Nut</b> —replaces standard nut and provides guard for flush type pushbutton operators.   | <b>E34TA12</b>   |
| <b>E34TA15</b><br> | <b>Guard for illuminated pushbutton</b>  | <b>E34TA15</b>   |
| <b>E34TA11</b><br> | <b>Padlocking Attachment</b> for non-illuminated knob selector switches—<br>accommodates up to five, 1/4 in padlocks.  | <b>E34TA11</b>   |

**Notes**

- ① Should not be used on flush button for STOP function.
- ② Not suitable for single contact block depth cast enclosure. Cover is too thick.

## Accessories, continued

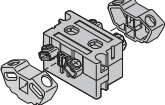
|   | Description  | Catalog Number     |
|---|--|--------------------|
| <b>E34TK3</b>   | <b>Thrust Washer</b> —To meet Ford Motor Company mounting specifications.  | <b>E34TK3</b>      |
|    |  |                    |
| <b>10250TA7_</b>  | <b>Contact Block Terminal Jumps</b> —Available in multiples of 100 only.   |                    |
|    | Terminal to terminal—within block (short):   |                    |
|   | 100 per package  | <b>10250TA70</b>   |
|   | 1000 per package   | <b>10250TA70-2</b> |
|   | Terminal to terminal—block to block (long):  |                    |
| 100 per package   | <b>10250TA71</b>   |                    |
| 1000 per package  | <b>10250TA71-2</b>   |                    |
| <b>10250TMT8</b>  | <b>Master Test (Dual Input) Module</b> —Internal Form C relay suitable for either AC or DC applications. Total electrical isolation between monitored and test circuit. Fits all illuminated 10250T, E22, E30 and E34 devices. |                    |
|    | 48 Vdc   | <b>10250TMT8</b>   |
|   |  |                    |
| <b>10250TFL_</b>  | <b>Flasher Module</b> —Internal Form C relay suitable for AC applications. One unit required for each operator in master test circuit.   |                    |
|   | 24 Vac   | <b>10250TFL2</b>   |
|   | 120 Vac  | <b>10250TFL1</b>   |
| <b>E22CW</b>  | <b>Panel Mounting Nut Wrench</b> —E22, E30, E34 and octagonal 10250T.  | <b>E22CW</b>       |
|  |  |                    |
| <b>10250TA101</b>   | <b>Fingerproof Shroud</b> —10 per package<br>Fits new style contact blocks and light units.  | <b>10250TA101</b>  |
|  |  |                    |

### Options

#### Legend Plates ①

##### Field Color

Legend plates can be supplied printed on black, red, silver or white field. To order legend printed on a color other than indicated—add

suffix code to the end of the catalog number as follows:

“R” for Red field;  
“W” for White field; or  
“S” for Silver field.

Example: E34SP26**R**—  
Standard plate with red field marked OPEN.

#### Standard

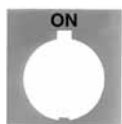

#### Jumbo



#### For Pushbutton Operators and Indicating Lights

| Legend   | Color of Field | Standard ② Catalog Number | Jumbo Catalog Number | Legend   | Color of Field | Standard ② Catalog Number | Jumbo Catalog Number |
|--|----------------|---------------------------|----------------------|----------|----------------|---------------------------|----------------------|
| <b>Letters on Legend Plates Below are 3/16 in High</b> |                |                           |                      |          |                |                           |                      |
| CLAMP  | Black          | E34SP90                   | E34LP90              | OFF      | Red            | E34SP24                   | E34LP24              |
| CLOSE  |                | E34SP73                   | E34LP73              | ON       | Black          | E34SP25                   | E34LP25              |
| DOWN   |                | E34SP74                   | E34LP74              | OPEN     |                | E34SP26                   | E34LP26              |
| EMERG. STOP  | Red            | E34SP13                   | E34LP13              | OUT      |                | E34SP27                   | E34LP27              |
| FAST   | Black          | E34SP75                   | E34LP75              | POWER ON |                | E34SP80                   | E34LP80              |
| FASTER   |                | E34SP87                   | E34LP87              | RAISE    |                | E34SP28                   | E34LP28              |
| FEEDER ON  |                | E34SP94                   | E34LP94              | READY    |                | E34SP86                   | E34LP86              |
| FEEDER OFF   |                | E34SP95                   | E34LP95              | RESET    |                | E34SP29                   | E34LP29              |
| FORWARD  |                | E34SP15                   | E34LP15              | REVERSE  |                | E34SP30                   | E34LP30              |
| HIGH   |                | E34SP16                   | E34LP16              | RUN      |                | E34SP31                   | E34LP31              |
| IN   |                | E34SP17                   | E34LP17              | SAFE     |                | E34SP85                   | E34LP85              |
| INCH   |                | E34SP18                   | E34LP18              | SLOW     |                | E34SP32                   | E34LP32              |
| JOG  |                | E34SP19                   | E34LP19              | SLOWER   |                | E34SP88                   | E34LP88              |
| JOG FOR.   |                | E34SP20                   | E34LP20              | START    |                | E34SP33                   | E34LP33              |
| JOG REV.   |                | E34SP21                   | E34LP21              | STOP     | Red            | E34SP34                   | E34LP34              |
| LOW  |                | E34SP22                   | E34LP22              | TEST     | Black          | E34SP83                   | E34LP83              |
| LOWER  |                | E34SP23                   | E34LP23              | TRANSFER |                | E34SP93                   | E34LP93              |
| LUBE-FAIL  |                | E34SP92                   | E34LP92              | TRIP     |                | E34SP84                   | E34LP84              |
| MOTOR RUN  |                | E34SP81                   | E34LP81              | UNCLAMP  |                | E34SP91                   | E34LP91              |
| MOTOR STOP   |                | E34SP82                   | E34LP82              | UP       |                | E34SP35                   | E34LP35              |

#### Blank Plastic Legend Plates—Square ③

| Color Lettering | Field Side 1 | Side 2 | Standard Catalog Number | Jumbo Catalog Number | Extra Large Catalog Number |
|-----------------|--------------|--------|-------------------------|----------------------|----------------------------|
| Black           | White        | Silver | 10250TSP76              | 10250TLP76           | 10250TEP76                 |
| White           | Red          | Black  | 10250TSP77              | 10250TLP77           | 10250TEP77                 |

#### Notes

- ① For dimensions, see **Page V7-T1-258**.
- ② 3/32 in high lettering.
- ③ Legend plates with non-standard markings or aluminum legend plates see 10250T listing on **Page V7-T1-232**.

1

## Standard

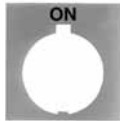

## Jumbo



## For Selector Switch Operators

| Legend                                     | Color of Field | Standard Catalog Number | Jumbo Catalog Number | Legend                                       | Color of Field | Standard Catalog Number | Jumbo Catalog Number |
|--|----------------|-------------------------|----------------------|--|----------------|-------------------------|----------------------|
| <b>Two-Position—3/16 in High Lettering</b> |                |                         |                      | <b>Three-Position—3/16 in High Lettering</b> |                |                         |                      |
| FOR. REV.                                  | Black          | <b>E34SP38</b>          | <b>E34LP38</b>       | AUTO OFF HAND                                | Black          | <b>E34SP49</b>          | <b>E34LP49</b>       |
| HAND AUTO                                  |                | <b>E34SP39</b>          | <b>E34LP39</b>       | FOR. OFF REV.                                |                | <b>E34SP50</b>          | <b>E34LP50</b>       |
| HIGH LOW                                   |                | <b>E34SP40</b>          | <b>E34LP40</b>       | FOR. SAFE REV.                               |                | <b>E34SP69</b>          | <b>E34LP69</b>       |
| JOG RUN                                    |                | <b>E34SP41</b>          | <b>E34LP41</b>       | HAND OFF AUTO                                |                | <b>E34SP51</b>          | <b>E34LP51</b>       |
| MAN. AUTO                                  |                | <b>E34SP67</b>          | <b>E34LP67</b>       | MAN. OFF AUTO                                |                | <b>E34SP68</b>          | <b>E34LP68</b>       |
| OFF ON                                     |                | <b>E34SP42</b>          | <b>E34LP42</b>       | OPEN OFF CLOSE                               |                | <b>E34SP53</b>          | <b>E34LP53</b>       |
| OPEN CLOSE                                 |                | <b>E34SP43</b>          | <b>E34LP43</b>       | RUN SAFE JOG                                 |                | <b>E34SP70</b>          | <b>E34LP70</b>       |
| RUN JOG                                    |                | <b>E34SP44</b>          | <b>E34LP44</b>       | UP OFF DOWN                                  |                | <b>E34SP54</b>          | <b>E34LP54</b>       |
| SAFE RUN                                   |                | <b>E34SP45</b>          | <b>E34LP45</b>       | ON STOP SAFE                                 |                | <b>E34SP71</b>          | <b>E34LP71</b>       |
| START JOG                                  |                | <b>E34SP46</b>          | <b>E34LP46</b>       |  |                |                         |                      |
| START STOP                                 |                | <b>E34SP47</b>          | <b>E34LP47</b>       |  |                |                         |                      |
| UP DOWN                                    |                | <b>E34SP48</b>          | <b>E34LP48</b>       |  |                |                         |                      |

## For Push-Pull Units

| Legend               | Color of Field | Standard <sup>①</sup> Catalog Number | Jumbo <sup>②</sup> Catalog Number |
|----------------------|----------------|--------------------------------------|-----------------------------------|
| PULL ON/PUSH OFF     | Black          | <b>E34PP5</b>                        | <b>E34R5</b>                      |
| PULL OPEN/PUSH CLOSE | Black          | <b>E34PP8</b>                        | <b>E34R8</b>                      |
| PULL UP/PUSH DOWN    | Black          | <b>E34PP11</b>                       | <b>E34R11</b>                     |

**Notes**



① 3/32 in (2.4 mm) high lettering.

② 1/8 in (3.2 mm) high lettering.

### Enclosures

#### Die Cast, Polyester and Stainless Steel Enclosures

##### Enclosures (Case and Cover)—Surface Mounting <sup>①</sup>

|  | Number of Elements   | One Contact Block Depth Catalog Number | Two Contact Block Depth Catalog Number |
|--|--|--|--|
| <b>Die Cast Enclosure</b><br>         | <b>Die Cast Enclosure—In-Line <sup>②③</sup> NEMA 4, 4X, 12, 13</b> |  |  |
|  | 1  | E34N1                                  | E34N11                                 |
|  | 2  | E34N2                                  | E34N12                                 |
|  | 3  | E34N3                                  | E34N13                                 |
|  | 4  | —                                      | E34N14                                 |
| <b>Polyester Enclosure</b><br>        | <b>Polyester—In-Line NEMA 3, 4X, 12</b>                            |  |  |
|  | 1  | —                                      | E34N51                                 |
|  | 2  | —                                      | E34N52                                 |
|  | 3  | —                                      | E34N53                                 |
|  | 4  | —                                      | E34N54                                 |
| <b>Stainless Steel Enclosure</b><br> | <b>Stainless Steel <sup>④</sup>—In-Line NEMA 4, 4X, 12</b>         |  |  |
|  | 1  | —                                      | 10250TN33                              |
|  | 2  | —                                      | 10250TN34                              |
|  | 3  | —                                      | 10250TN35                              |
|  | 4  | —                                      | 10250TN36                              |

Dimensions, see Page V7-T1-292.

### Mounting Instructions

These E34 Die Cast Enclosures feature a corrosion resistant coating identical to finish on the E34 operators except gray in color. Not for use in ultraviolet light applications.

#### One and Two Contact Block Depth Enclosures



One Contact Block Depth Enclosure

Two Contact Block Depth Enclosure

#### Enclosure Layouts

Top – For Vertical Mounting

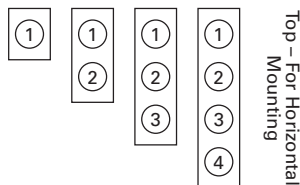

Top – For Horizontal Mounting

#### Notes

- ① For spacing increments, see Page V7-T1-284.
- ② All die cast enclosures can be converted to base mounting of contact blocks with spacers 10250TA22 or 10250TA23. See listing on Page V7-T1-227.
- ③ When used with E30 pushbuttons, only the one element enclosure can be used.
- ④ 14 gauge, type 304.



#### Die Cast and Stainless Steel—Flush Mount, Covers Only<sup>①</sup>

##### Flush Mounting Covers



##### Covers Only—Flush Mounting

| Number of Elements                                      | Catalog Number            | Catalog Number            |
|---|---------------------------|---------------------------|
| <b>Flush Die Cast Covers</b>                            |                           |                           |
|   | <b>In-Line Deep Cover</b> | <b>In-Line Flat Cover</b> |
| 1   | E34F11                    | E34F1                     |
| 2   | E34F12                    | E34F2                     |
| 3   | E34F13                    | E34F3                     |
| 4   | E34F14                    | E34F4                     |
| <b>In-Line Stainless Steel Flush Plates<sup>②</sup></b> |                           |                           |
|   | <b>With Pullbox</b>       | <b>Without Pullbox</b>    |
| 1   | 10250TS10                 | 10250TS1                  |
| 2   | 10250TS11                 | 10250TS2                  |
| 3   | 10250TS12                 | 10250TS3                  |
| 4   | 10250TS14                 | 10250TS4                  |

**Dimensions, see Page V7-T1-293.**

#### Spacing Increments

Approximate Dimensions in Inches (mm)

| Type            | F           | G                | H           |
|-----------------|-------------|------------------|-------------|
| Die cast        | 2.44 (62.0) | 2.5 (63.5)       | 1.88 (47.8) |
| Polyester       | 1.88 (47.8) | Min. 2.13 (54.1) | 2.25 (57.2) |
| Stainless steel | 1.69 (42.9) | Min. 1.73 (43.9) | 2.25 (57.2) |

#### Spacing Increments for Enclosures

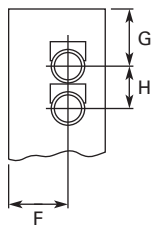

#### Enclosure Layouts

Top – For Vertical Mounting

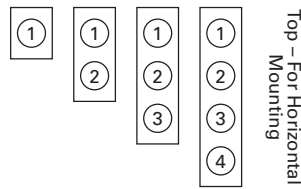

#### Notes

- <sup>①</sup> These E34 die cast covers feature a corrosion resistant coating identical to the finish on the E34 operators except gray in color.
- <sup>②</sup> Not oiltight. NEMA 1 applications only.

**Contact Blocks**

**Standard Contact Blocks**

- UL A600/P600 rated
- Color-coded plungers—red/green for NC/NO circuits
- Silver contact tips with “reliability nibs”
- Black (opaque) or amber (translucent) housings
- Pressure plate or spade terminals
- Fingerproof shrouds (for pressure terminals only)

**Logic Level Contact Blocks**

- UL A600/P600 rated
- Black plungers
- Inert palladium knife-blade contacts
- Black (opaque) housings
- Pressure plate or spade terminals
- Fingerproof shrouds not available

**Special Function Contact Blocks**

- UL A600/P600 rated
- Black plungers
- Silver contact tips with “reliability nibs”
- Black (opaque) housings
- Pressure plate terminals only
- Fingerproof shrouds not available

**Special Purpose Contact Block**

- Maximum 300V rated
- Black plungers
- Silver contact tips with “reliability nibs”
- Black (opaque) housings
- Pressure plate terminals only
- Fingerproof shrouds not available

**Reliability Nibs**

Reliability nibs are the hallmark of Eaton’s contact blocks. A pointed silver nib on the contact tip ensures reliable switching from logic level (5V) up to 600V applications. Therefore standard contact blocks can be used for most logic level applications where the contacts are not exposed to any harsh environmental conditions.

**Palladium Contacts**

Palladium, which is more inert than gold, is well suited for voltages and currents approaching zero and is recommended for applications where environmental conditions are a factor.

**Maximum Contact Block Mounting per Operator Type**

| Operator                                 | Max. Stack |
|--|------------|
| Pushbuttons                              | 6          |
| Push-pull operators                      | 2          |
| Roto-push operators                      | 4          |
| Two- or three-position selector switches | 6          |
| Four-position selector switches          | 4          |
| Joysticks                                | 4          |

10250T1



Contact Blocks

| Symbol                                      | Circuit   | Description <sup>①</sup>   | Standard                         | Spade Terminal <sup>②</sup> | Logic Level                      | Spade Terminal <sup>②</sup> |
|---|-----------|--|----------------------------------|-----------------------------|----------------------------------|-----------------------------|
|   |           |  | Pressure Terminal Catalog Number | Catalog Number              | Pressure Terminal Catalog Number | Catalog Number              |
|   | 1NC       | Stack up to six blocks (six circuits) unless otherwise noted.  | <b>10250T51</b>                  | <b>10250T59</b>             | <b>10250T51E</b>                 | <b>10250T59E</b>            |
|   | 1NO       | Stack up to six blocks (six circuits) unless otherwise noted.  | <b>10250T53</b>                  | <b>10250T60</b>             | <b>10250T53E</b>                 | <b>10250T60E</b>            |
|   | NO-NC     | Stack up to six blocks (12 circuits) unless otherwise noted.   | <b>10250T1</b>                   | <b>10250T40</b>             | <b>10250T1E</b>                  | <b>10250T40E</b>            |
|   | 2NC       | Stack up to six blocks (12 circuits) unless otherwise noted.   | <b>10250T3</b>                   | <b>10250T42</b>             | <b>10250T3E</b>                  | <b>10250T42E</b>            |
|   | 2NO       | Stack up to six blocks (12 circuits) unless otherwise noted.   | <b>10250T2</b>                   | <b>10250T41</b>             | <b>10250T2E</b>                  | <b>10250T41E</b>            |
| <b>Special Function Blocks <sup>③</sup></b> |           |  |                                  |                             |                                  |                             |
|   | LONC      | Late opening NC. Stack up to six blocks (six circuits) unless otherwise noted.                       | <b>10250T71 <sup>③</sup></b>     | —                           | <b>10250T71E <sup>③</sup></b>    | —                           |
|   | ECNO-NC   | Early closing NO and standard NC. Stack up to six blocks unless otherwise noted.                     | <b>10250T47 <sup>③④</sup></b>    | —                           | <b>10250T47E <sup>③</sup></b>    | —                           |
|   | ECNO-NO   | Early closing NO and standard NO. Stack up to four blocks unless otherwise noted.                    | <b>10250T57 <sup>③④</sup></b>    | —                           | <b>10250T57E <sup>③</sup></b>    | —                           |
|   | 2LONC     | Two late opening NC contacts. Stack up to six blocks unless otherwise noted.                         | <b>10250T45 <sup>③</sup></b>     | —                           | <b>10250T45E <sup>③</sup></b>    | —                           |
|   | LONC-ECNO | Overlapping contacts. Stack up to four blocks unless otherwise noted.                                | <b>10250T55 <sup>③④</sup></b>    | —                           | <b>10250T55E <sup>③</sup></b>    | —                           |
| <b>Special Purpose Blocks <sup>⑤</sup></b>  |           |  |                                  |                             |                                  |                             |
|   | 2NO-2NC   | Four circuits in single block depth. Rated 300V max. Stack up to four blocks unless otherwise noted. | <b>10250T44 <sup>⑤</sup></b>     | —                           |                                  |                             |

Notes

- ① All 10250T contact blocks shown are suitable for use on standard 10250T and E34 operators. These contact blocks are not suitable for Class I Division 2 type 10250T or E34 devices.
- ② Contact blocks with spade terminals are limited to a maximum of one contact block per operator and minimum spacing between devices is 2.5 in (63.5 mm). Not suitable for use in 10250T or E34 enclosures. Also available in amber housing. Not available with fingerproof shrouds.
- ③ Special function contact blocks are not suitable for use with roto-push operators, three-position push-pull operators, or four-position selector switches.
- ④ ECNO contact blocks are not suitable for use with two-position joysticks or when operators are used with padlock attachments.
- ⑤ Special purpose 10250T44 contact blocks are not suitable on selector switches or roto-push operators. Okay to use with three-position push-pull operators only on low voltage (30V or less) circuits.

10250T1CP



### Contact Blocks with Fingerproof Shrouds

| Symbol                                      | Circuit   | Description <sup>①</sup>  | Standard Pressure Terminal <sup>②</sup> Catalog Number | Logic Level Pressure Terminal <sup>②</sup> Catalog Number |
|---|-----------|---|--|---|
| Blank No Plunger                            | 1NC       | Stack up to six blocks (six circuits) unless otherwise noted.                     | <b>10250T51P</b>                                       | <b>10250T51EP</b>   |
| Blank No Plunger                            | 1NO       | Stack up to six blocks (six circuits) unless otherwise noted.                     | <b>10250T53P</b>                                       | <b>10250T53EP</b>   |
| Blank No Plunger                            | NO-NC     | Stack up to six blocks (12 circuits) unless otherwise noted.                      | <b>10250T1P</b>  | <b>10250T1EP</b>  |
| Blank No Plunger                            | 2NC       | Stack up to six blocks (12 circuits) unless otherwise noted.                      | <b>10250T3P</b>  | <b>10250T3EP</b>  |
| Blank No Plunger                            | 2NO       | Stack up to six blocks (12 circuits) unless otherwise noted.                      | <b>10250T2P</b>  | <b>10250T2EP</b>  |
| <b>Special Function Blocks <sup>③</sup></b> |           |   |  |   |
| Blank No Plunger                            | LONC      | Late opening NC. Stack up to six blocks (six circuits) unless otherwise noted.    | <b>10250T71P <sup>④</sup></b>                          | <b>10250T71EP <sup>④</sup></b>                            |
| Blank No Plunger                            | ECNO-NC   | Early closing NO and standard NC. Stack up to six blocks unless otherwise noted.  | <b>10250T47P <sup>③④</sup></b>                         | <b>10250T47EP <sup>④</sup></b>                            |
| Blank No Plunger                            | ECNO-NO   | Early closing NO and standard NO. Stack up to four blocks unless otherwise noted. | <b>10250T57P <sup>③④</sup></b>                         | <b>10250T57EP <sup>④</sup></b>                            |
| Blank No Plunger                            | 2LONC     | Two late opening NC contacts. Stack up to six blocks unless otherwise noted.      | <b>10250T45P <sup>④</sup></b>                          | <b>10250T45EP <sup>④</sup></b>                            |
| Blank No Plunger                            | LONC-ECNO | Overlapping contacts. Stack up to four blocks unless otherwise noted.             | <b>10250T55P <sup>③④</sup></b>                         | <b>10250T55EP <sup>④</sup></b>                            |

## Replacement Parts

### Replacement Lamps—For E34 Illuminated Operators

| Mfg. Lamp Type | Voltage | Base Style      | Application                                   | Part Number         |
|----------------|---------|-----------------|---|---------------------|
| 120MB          | 120V    | T 3-1/4 bayonet | 10250T resistor indicating light              | <b>28-3044</b>      |
| #267           | 6.3V    | T 3-1/4 bayonet | 10250T flasher                                | <b>10250ED986-4</b> |
| #755           | 6.3V    | T 3-1/4 bayonet | 10250T transformer, PresTest and full voltage | <b>28-2202</b>      |
| #756           | 12V     | T 3-1/4 bayonet | 10250T full voltage                           | <b>28-5184</b>      |
| #757           | 24V     | T 3-1/4 bayonet | 10250T full voltage                           | <b>28-5185</b>      |
| #1828          | 32V     | T 3-1/4 bayonet | 10250T full voltage                           | <b>28-5186</b>      |
| #1835          | 55V     | T 3-1/4 bayonet | 10250T resistor                               | <b>28-5187</b>      |
| NE48           | 120V    | T 4-1/2 bayonet | 10250T neon                                   | <b>28-494</b>       |
| NE51H-R22      | 120V    | T 3-1/4 bayonet | 10250T neon                                   | <b>28-3754</b>      |
| NE51H-R68      | 240V    | T 3-1/4 bayonet | 10250T neon                                   | <b>28-3755</b>      |

**Notes**

- ① All 10250T contact blocks shown are suitable for use on standard 10250T and E34 operators. These contact blocks are not suitable for Class I Division 2 type 10250T or E34 devices.
- ② To order contact blocks with translucent amber housing, change suffix P to **CP** in catalog number, e.g., 10250T51**CP**.
- ③ ECNO contact blocks are not suitable for use with two-position joysticks or when operators are used with padlock attachments.
- ④ Special function contact blocks are not suitable for use with roto-push operators, three-position push-pull operators, or four-position selector switches.



**Flush Head Pushbutton Operator**



**Mushroom Head Pushbutton Operator**



**Jumbo Mushroom Head Operator**

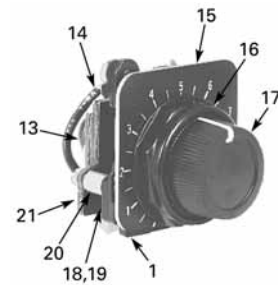

**Potentiometers**



**Illuminated Pushbutton Operator**



**Transformer Type Indicating Light**



**Knob-Operated Selector Switch Operator**

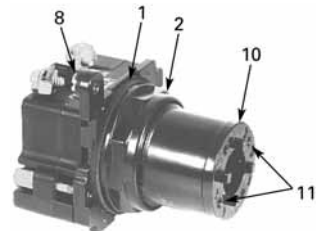

**Full Voltage, Resistor and Transformer Type Illuminated Selector Switch**

#### E34 Style Operator Replacement Parts

| Item No. | Description   | No. Req. | Part Number          |
|----------|---|----------|----------------------|
| 1        | Gasket  | 1        | 16-1548              |
| 2        | Mounting nut  | 1        | 15-1530-4            |
| 3        | Set screw (#6-32 x 0.250 in long hollow hex)                                  | 2        | 11-2014              |
| 4        | Mushroom head button (includes [2] item 5)                                    | 1        | <b>As Req. Below</b> |
|          | Black   | —        | 53-1317              |
|          | Red   | —        | 53-1317-2            |
|          | Yellow  | —        | 53-1317-3            |
|          | Green   | —        | 53-1317-4            |
|          | Blue  | —        | 53-1317-22           |
| 5        | Set screw (#10-32 x 0.250 in long hollow hex)                                 | 2        | 11-544               |
| 6        | Jumbo mushroom head button (aluminum—includes [2] item 5)                     | 1        | <b>As Req. Below</b> |
|          | Red   | —        | 53-1317-9            |
|          | Black   | —        | 53-1317-10           |
|          | Yellow  | —        | 53-1317-11           |
|          | Green   | —        | 53-1317-12           |
| 7        | Jumbo mushroom head button (aluminum—red EMERG. STOP) does not include item 5 | 1        | 53-1349-18           |
| 8        | Mounting screw (#6-32 x 0.710 in long)  | 2        | 10250TA79            |
|          | Washer  | 2        | 16-2038              |
| 9        | Terminal screw and lug (captive)  | Req.     | 80-5502              |
| 10       | Gasket (supplied with basic unit)   | 1        | 32-803               |
| 11       | Round head screw (#4-40 x 0.344 in long) (supplied with basic unit)           | 2        | 11-4553              |

| Item No. | Description  | No. Req. | Part Number          |
|----------|--|----------|----------------------|
| 12       | Mounting screw   | 2        | 11-1632              |
| 13       | Simple potentiometer (does not include items 18, 28 or 29) | 1        | <b>As Req. Below</b> |
|          | 1,000 ohms   | —        | 41-782-2             |
|          | 2,500 ohms   | —        | 41-782-3             |
|          | 5,000 ohms   | —        | 41-782-10            |
|          | 10,000 ohms  | —        | 41-782-4             |
|          | 25,000 ohms  | —        | 41-782-5             |
|          | 50,000 ohms  | —        | 41-782-6             |
| 14       | Connector (includes screw and lug)                         | 2        | 25-1851              |
| 15       | Indicating plate   | 1        | <b>As Req. Above</b> |
|          | Standard size (without legend)                             | —        | 30-4460              |
|          | Large size (specify legend)                                | —        | 10250TR30            |
| 16       | Retaining nut  | 1        | 15-1547-3            |
| 17       | Knob   | 1        | 53-1314              |
|          | Socket set screw (#6-32 x 0.250 in long)                   | 1        | 11-2014              |
| 18       | Coupling   | 1        | 11-2014<br>29-3749-2 |
| 19       | Set screw (#6-32 x 0.188 in long)                          | 1        | 11-1199              |
| 20       | Spacer   | 2        | 56-1066-18           |
| 21       | Connector (includes screw and lug)                         | 1        | 25-1851-2            |
| 22       | Mounting nut   | 1        | 15-1938-2            |

## Technical Data and Specifications

### Mechanical Ratings

| Description                     | Specification                     |
|---------------------------------|-----------------------------------|
| <b>Frequency of Operation</b>   |                                   |
| All pushbuttons                 | 6000 operations/hr.               |
| Key and lever selector switches | 3000 operations/hr.               |
| Auto-latch devices              | 1200 operations/hr.               |
| <b>Life</b>                     |                                   |
| Pushbuttons                     | 10 x 10 <sup>6</sup> operations   |
| Contact blocks                  | 10 x 10 <sup>6</sup> operations   |
| PresTest units                  | 10 x 10 <sup>6</sup> operations   |
| Lever and key selector switches | 0.25 x 10 <sup>6</sup> operations |
| Twist to release pushbuttons    | 0.3 x 10 <sup>6</sup> operations  |
| <b>Shock Resistance</b>         |                                   |
| Duration                        | 210 ms ≥5g                        |

### General Specifications

| Description  | Specification   |
|--|---|
| <b>Climate Conditions</b>                              |   |
| Operating temperature                                  | 1° to 150°F (–17° to 66°C)  |
| Storage temperature                                    | –40° to 176°F (–40° to 80°C)  |
| Altitude   | 6,562 ft (2,000m)   |
| Humidity   | Max. 95% RH at 60°C   |
| <b>Terminals</b>                                       |   |
| Marking  | NC-NO on the contact block to meet the NEMA requirements. Dual marking system 1–2 for normally closed, 3–4 for normally open to meet BS5472 (Cenelec EN50 005). |
| Clamps   | Terminals are saddle clamp type for 1 x 22 AWG (0.34 mm <sup>2</sup> ) to 2 x 14 AWG (2.5 mm <sup>2</sup> ) conductors  |
| Torque   | 7 lb-in (0.8 Nm)  |
| Degree of protection against direct electrical contact | IP2X with fingerproof shroud  |
| <b>Light Units</b>                                     |   |
| Transformers   | Will withstand short-circuit for 1 hour per IEC 60947-5-1   |
| Bulbs—average life:                                    |   |
| Transformer type                                       | 20,000 hrs.   |
| Resistor/direct voltage type                           | 2500 hrs. minimum at rated V  |
| LED  | 60,000 to 100,000 hrs.  |

#### Electrical Ratings

| Description   | Specification   |
|---|---|
| Insulation  | $U_i = 660 \text{ Vac or Vdc}$  |
| Thermal   | $I_{th} = 10\text{A}$   |
| <b>Short Circuit Coordination to IEC/EN 60947-5-1</b>                             |   |
| Rated conditional short circuit current   | 1 kA  |
| Fuse type   | GE power controls T1A 10, red spot type gG, 10A, 660 Vac, 460 Vdc, BS88-2, IEC 60269-2-1  |
|  |   |
| UL rating   | A600, P600  |
| AC load life duty cycle 1200 operations/hour                                      |   |
| 10A   | 110V pf 0.4— $1 \times 10^6$ operations   |
| 5A  | 250V pf 0.4— $1 \times 10^6$ operations   |
| 2A  | 600V pf 0.4— $1 \times 10^6$ operations   |
| Switching capacity  |   |
| AC 15 rated make/break ( $11 \times I_b$ at $1.1 \times U_b$ )                    |   |
| 6A  | 120V pf 0.3   |
| 4A  | 240V pf 0.3   |
| 2A  | 660V pf 0.3   |
| DC13 rated make/break ( $1.1 \times I_b$ at $1.1 \times U_b$ )                    |   |
| 1.0A  | 125V L/R $\geq 0.95$ at 300 ms  |
| 0.55A   | 250V L/R $\geq 0.95$ at 300 ms  |
| 0.1A  | 660V L/R $\geq 0.95$ at 300 ms  |
| 10A   | 110V pure resistive   |
| Maximum ratings for logic level and hostile atmosphere application                |   |
| Maximum amperes   | 0.5A  |
| Maximum volts   | 120 Vac/Vdc   |
| Low voltage switching   | Conical shaped points or “reliability nibs” improve performance in dry circuit, corrosive, fine dust and other contaminated atmospheres. Under normal environmental conditions, the minimum operational voltage is 5V and the minimum operational current is 1 mA, Vac/Vdc. |
| Contact operation   | Slow make and break. All normally closed contacts have positive opening operation, i.e., normally closed contacts are forced open in the event of contact weld or spring breakage.  |

#### Electrical Ratings—Contact Block

Meet or Exceed NEMA Rating Designations A600, A300 and B300 for AC and P600 for DC

| Description   | 50 Vac or 60 H |      |      |      | Vdc   |     |      |
|---|----------------|------|------|------|-------|-----|------|
|   | 120            | 240  | 480  | 600  | 24/28 | 125 | 250  |
| <b>Meet or Exceed NEMA Rating Designations A600, A300 and B300 for AC and P600 for DC</b> |                |      |      |      |       |     |      |
| Make and emerg. interrupting capacity (amp)   | 60             | 30   | 15   | 12   | 5.7   | 1.1 | 0.55 |
| Normal load break (amp)   | 6              | 3    | 1.5  | 1.2  | 5.7   | 1.1 | 0.55 |
| Thermal current (amp)   | 10             | 10   | 10   | 10   | 5.0   | 5.0 | 5.0  |
| Voltamperes:  |                |      |      |      |       |     |      |
| Make and emerg. interrupting capacity   | 7200           | 7200 | 7200 | 7200 | 138   | 138 | 138  |
| Normal load break   | 720            | 720  | 720  | 720  | 138   | 138 | 138  |

### Mounting Options

#### Panel Thickness

- Minimum: 0.06 in (1.6 mm)
- Maximum: 0.25 in (8 mm) including legend plate
- Maximum can be increased to 0.375 in (15.9 mm) using optional retaining nut
  - Indicating light: 10250TA30
  - Pushbutton/selector switch: 10250TA31

#### Mounting Matrix

| Legend Plate | Dimensions in Inches (mm) |             |             |             |
|--------------|---------------------------|-------------|-------------|-------------|
|              | A                         | B           | C           | D           |
| Small        | 1.63 (41.3)               | 2.25 (57.2) | 2.25 (57.2) | 1.63 (41.3) |
| Medium       | 1.75 (44.5)               | 2.25 (57.2) | 2.25 (57.2) | 1.75 (44.5) |
| Large        | 2.25 (57.2)               | 2.25 (57.2) | 2.25 (57.2) | 2.25 (57.2) |

#### Mounting Options in Inches (mm)

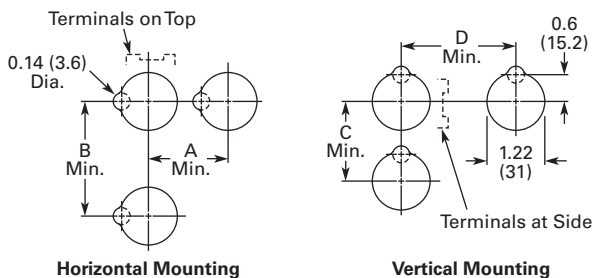

Horizontal mounting means terminals are located top and bottom of contact block. Vertical mounting means terminals are left and right of contact block. This allows close spacing of adjacent operators with easy access to terminals.

Locating nib hole or notch is 0.14 in (3.6 mm) #29 drill.

#### Drilling Dimensions in Inches (mm)

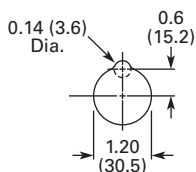



# 1

## Dimensions

Approximate Dimensions in Inches (mm)

### Potentiometer

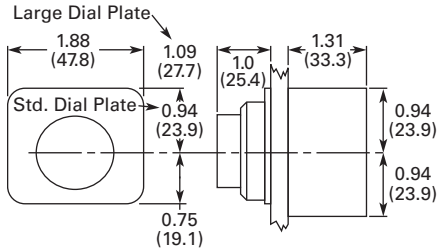

### Legend Plates

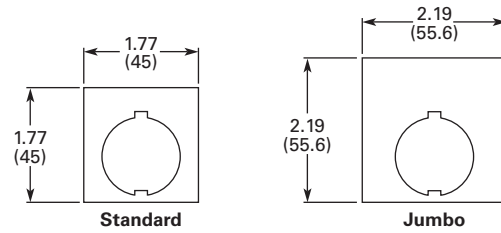

## Surface Mounting

### Die Cast, Polyester and Stainless Steel Enclosures

4 Mtg. Holes — 10-32 Screw Size for  
1 – 4 Element Die Cast/  
Stainless Steel Enclosure  
7/32 Screw Size for  
Polyester

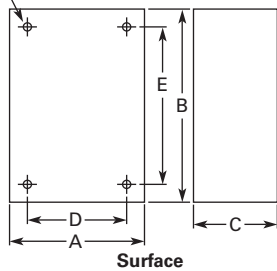

| Number of Elements     | Element Arrangement | Wide A      | High B        | Deep C                   | Mounting D  | E             | Conduit Entrance |
|------------------------|---------------------|-------------|---------------|--------------------------|-------------|---------------|------------------|
| <b>Die Cast</b>        |                     |             |               |                          |             |               |                  |
| 1                      | In-line             | 3.88 (98.6) | 4.00 (101.6)  | 3.00 (76.3) <sup>①</sup> | 2.69 (68.3) | 3.25 (82.6)   | 3/4              |
| 2                      |                     | 3.88 (98.6) | 5.88 (149.4)  | 3.00 (76.3) <sup>①</sup> | 2.69 (68.3) | 5.13 (130.3)  |                  |
| 3                      |                     | 3.88 (98.6) | 7.75 (196.9)  | 3.00 (76.3) <sup>①</sup> | 2.69 (68.3) | 7.00 (177.8)  | 1                |
| 4                      |                     | 3.88 (98.6) | 9.63 (244.6)  | 3.00 (76.3) <sup>①</sup> | 2.69 (68.3) | 8.88 (225.6)  |                  |
| <b>Polyester</b>       |                     |             |               |                          |             |               |                  |
| 1                      | In-line             | 3.81 (96.8) | 6.63 (168.4)  | 3.38 (85.9)              | 2.94 (74.7) | 4.88 (124.0)  | ②                |
| 2                      |                     | 3.81 (96.8) | 6.63 (168.4)  | 3.38 (85.9)              | 2.94 (74.7) | 4.88 (124.0)  |                  |
| 3                      |                     | 3.81 (96.8) | 8.88 (225.6)  | 3.38 (85.9)              | 2.94 (74.7) | 7.13 (181.1)  |                  |
| 4                      |                     | 3.81 (96.8) | 11.13 (282.7) | 3.38 (85.9)              | 2.94 (74.7) | 9.38 (238.3)  |                  |
| <b>Stainless Steel</b> |                     |             |               |                          |             |               |                  |
| 1                      | In-line             | 3.00 (76.2) | 3.50 (88.9)   | 3.00 (76.2)              | 1.50 (38.1) | 4.25 (108.0)  | ②                |
| 2                      |                     | 3.50 (88.9) | 6.75 (171.5)  | 3.00 (76.2)              | 1.50 (38.1) | 7.50 (190.5)  |                  |
| 3                      |                     | 3.50 (88.9) | 9.00 (228.6)  | 3.00 (76.2)              | 1.50 (38.1) | 9.00 (228.6)  |                  |
| 4                      |                     | 3.50 (88.9) | 11.25 (285.8) | 3.00 (76.2)              | 1.50 (38.1) | 12.00 (304.8) |                  |

### Notes

- ① Depth given is for two contact block deep stations. One contact block deep stations subtract 3/4 in (19.1 mm).
- ② No conduit entrance holes provided. Drill as required.

Approximate Dimensions in Inches (mm)

### Flush Mounting

#### Die Case and Stainless Steel Covers Only

4 Mtg. Holes - 10-32 Screw Size  
for 1-11 Element Encl, 1/4-20  
Screw Size for 12 Element  
and Larger

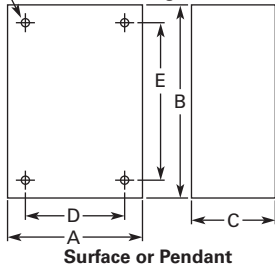

| Number of Elements     | Wide A       | High B        | Deep C        | Mounting D  | E            |
|------------------------|--------------|---------------|---------------|-------------|--------------|
| <b>Die Cast</b>        |              |               |               |             |              |
| 1                      | 3.88 (98.6)  | 4.00 (101.6)  | 0.25 (6.4) ①  | 3.50 (88.9) | 3.63 (92.2)  |
| 2                      | 3.88 (98.6)  | 5.88 (149.4)  | 0.25 (6.4) ①  | 3.50 (88.9) | 5.50 (139.7) |
| 3                      | 3.88 (98.6)  | 7.75 (196.9)  | 0.25 (6.4) ①  | 3.50 (88.9) | 6.00 (152.4) |
| 4                      | 3.88 (98.6)  | 9.63 (244.6)  | 0.25 (6.4) ①  | 3.50 (88.9) | 9.25 (235.0) |
| <b>Stainless Steel</b> |              |               |               |             |              |
| 1                      | 5.00 (127.0) | 5.00 (127.0)  | 2.50 (63.5) ② | 3.25 (82.6) | 1.88 (47.8)  |
| 2                      | 5.00 (127.0) | 6.88 (174.8)  | 2.50 (63.5) ② | 3.25 (82.6) | 3.63 (92.2)  |
| 3                      | 5.00 (127.0) | 8.63 (219.2)  | 2.50 (63.5) ② | 3.25 (82.6) | 5.50 (139.7) |
| 4                      | 5.00 (127.0) | 10.50 (266.7) | 2.50 (63.5) ② | 3.25 (82.6) | 7.25 (184.2) |

#### Notes

- ① Depth given is for flat cover. Deep cover is 3/4 in (19.1 mm) deeper.
- ② Depth given includes pull box.

# 1.9

## Pushbuttons and Indicating Lights

30.5 mm Corrosion Resistant Watertight/Oiltight—E34

1

Approximate Dimensions in Inches (mm)

### Padlocking Attachment for Flush Pushbutton Operators

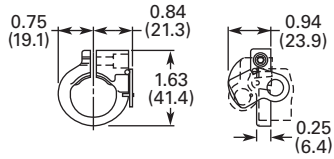

### Flexible Weather Resistant Boot

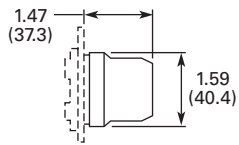

### Transparent Boot

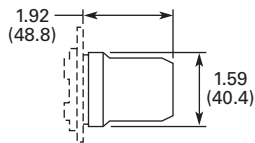

### Shroud for Mushroom Head Operator

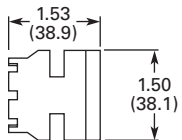

### Extended Retaining Nut

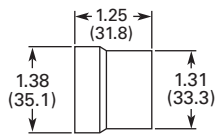

### Guard for Illuminated Pushbutton

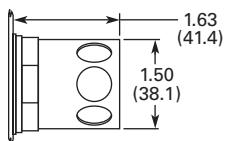

### Contact Block Terminal Jumps

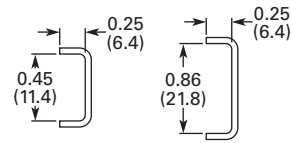

### Master Test Module and Flasher Module

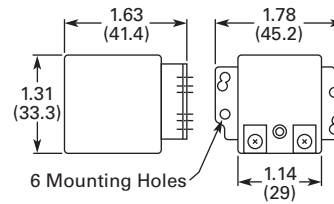

### Flush Pushbutton

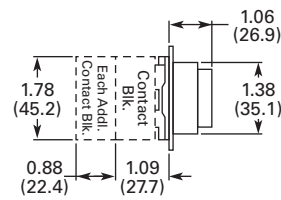

### Extended Pushbutton

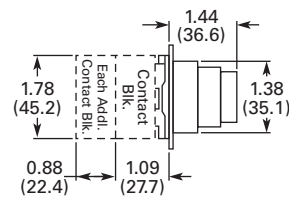

### Half Shroud Pushbutton

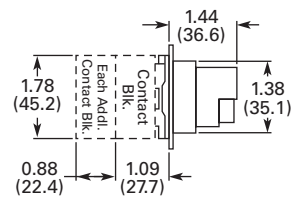

Approximate Dimensions in Inches (mm)

**Mushroom Pushbutton**

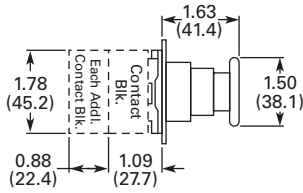

**Illuminated Pushbutton**

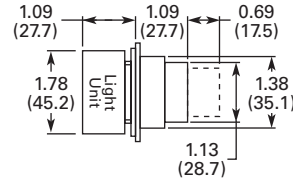

**Jumbo Mushroom Pushbutton**

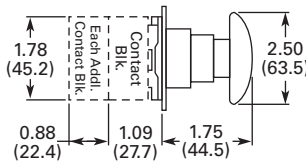

**Selector Switch**

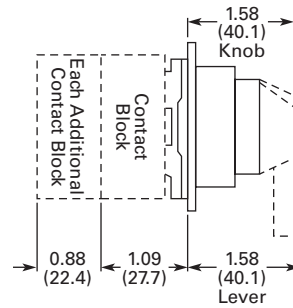

**Push-Pull Switch**

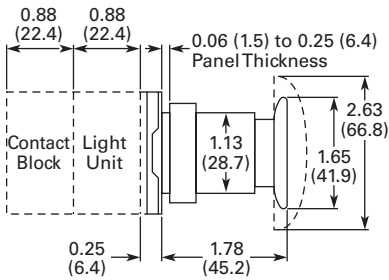

**Key Selector Switch**

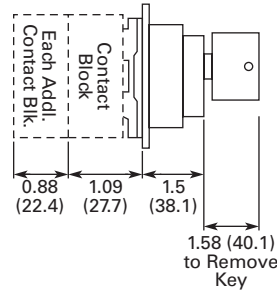

**Indicating Light**

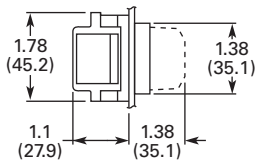

**Illuminated Selector Switch**

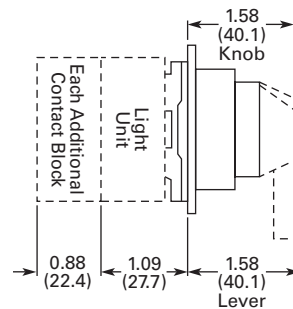

**PresTest Indicating Light**

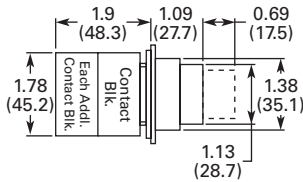



## Product Description

The HT800 Series from Eaton's Electrical Sector is a family of 30.5 mm pushbutton devices which includes momentary, illuminated and mushroom head pushbuttons, selector switches, indicating lights and push-pull switches. The HT800 devices have a familiar appearance found in most industrial applications and are suitable for replacement of several other manufacturers' 30.5 mm pushbutton devices.

## Features

- Anodized aluminum mounting rings
- Watertight double V-gasket seals
- Extended height bulbs
- Transparent housing contact blocks
- Color-coded contact blocks
- Gold-plated contacts (on low voltage contact block)
- Reliability ridge on movable contact
- Stackable screw-mounted contact blocks
- Contact blocks can be mounted in left/right or top/bottom positions
- Standard NC contact opens before NO contact closes (break before make operation)
- Bright and long lasting LED indicating lights in six colors
- Field convertible maintained selector switches—from two- to three-position and vice versa
- Field selectable knob/lever mounting positions—at any 22.5° increment

## Contents

### Description

| Description                                 | Page      |
|---|-----------|
| 30.5 mm Watertight/Oiltight—HT800           |           |
| Catalog Number Selection                    | V7-T1-297 |
| Product Selection                           |           |
| Momentary Pushbutton Units, Non-Illuminated | V7-T1-298 |
| Illuminated Pushbutton Units                | V7-T1-300 |
| Guarded Illuminated Pushbutton Units        | V7-T1-302 |
| Indicating Light Units                      | V7-T1-304 |
| Push-Pull Units                             | V7-T1-306 |
| Illuminated Push-Pull Units                 | V7-T1-307 |
| Selector Switch Units                       | V7-T1-308 |
| Selector Switch Contact Block Selection     | V7-T1-310 |
| Accessories                                 | V7-T1-311 |
| Options                                     | V7-T1-312 |
| Replacement Parts                           | V7-T1-315 |
| Technical Data and Specifications           | V7-T1-316 |
| Dimensions                                  | V7-T1-317 |

## Benefits

- Corrosion resistant NEMA 4X finish
- Watertight and oiltight NEMA 4, 13 ingress protection
- Increased side illumination of indicating lights and illuminated pushbuttons
- Easy visual inspection of contact conditions
- Easily identifiable NO (white) or NC (black) contact blocks
- Gold-plated contacts suitable for logic level circuits
- Reliability ridge penetrates contamination buildup on stationary contacts
- Left/right or top/bottom mounted contact blocks allow correct positioning in retrofit applications
- All-purpose selector switches are convertible and can rotate in 22.5° increments to suit panel layouts

## Standards and Certifications

- UL508 per File No. E131568
- CSA C22.2 No. 14 per File No. LR68551



## Ingress Protection

- UL (NEMA) Type 1, 2, 3, 3R, 4, 4X, 12 and 13 when mounted in similarly rated enclosures

**Catalog Number Selection**

Catalog Number Selection is for illustrative purposes only and not to be used to create new catalog numbers.

**HT800 Pushbuttons, Push-Pulls and Indicating Lights**

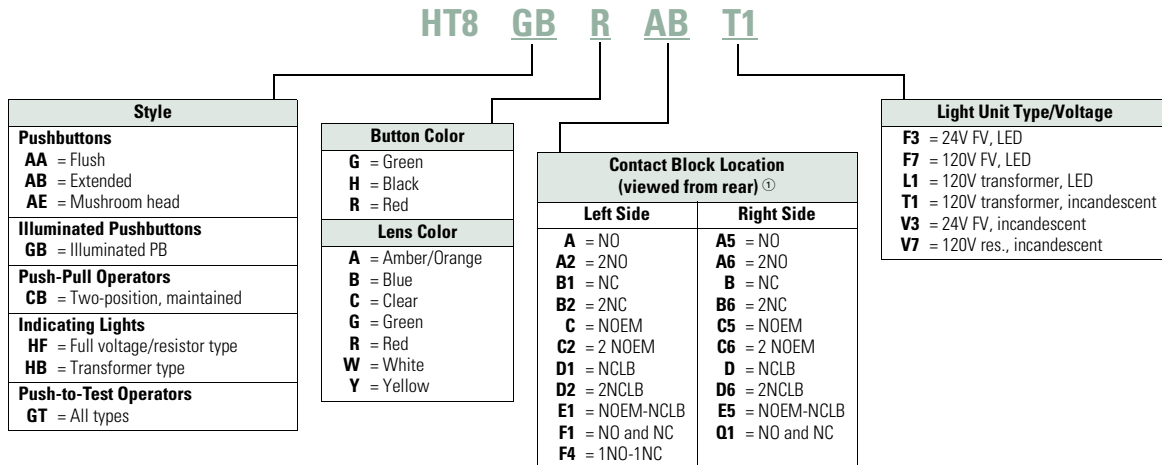

**HT800 Selector Switch**

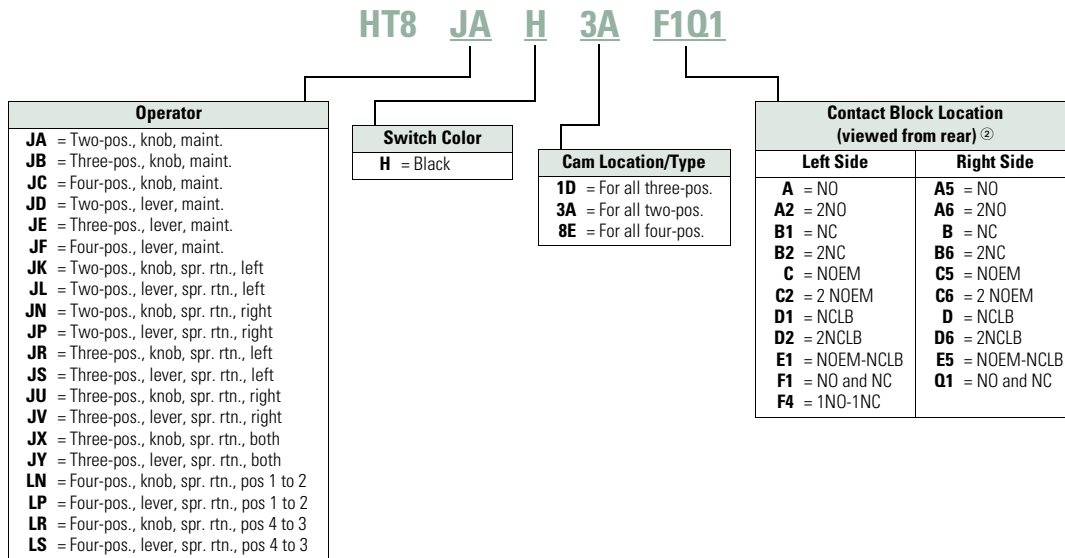

**Notes**

- ① Maximum of four contact blocks per side or a total of eight contact blocks recommended.
- ② Maximum of two contact blocks per side or a total of four contact blocks recommended.

**Product Selection****Momentary Pushbutton Units, Non-Illuminated**

UL (NEMA) Type 3, 3R, 4, 4X, 12 and 13

- Flush, extended or 40 mm mushroom head operators

**HT800 Pushbuttons****HT800 Pushbuttons—Point-of-Purchase Units**

| Description   | Catalog Number         |
|---|------------------------|
| Two-position maintained selector switch 1NO/1NC contact block, three square legend plates: OFF ON, MAN. AUTO, UP DOWN   | <b>HT8JAH3AAB-POP</b>  |
| Three-position maintained selector switch, black knob, 1NO/1NC contact block, three square legend plates: HAND OFF AUTO, FOR. OFF REV., OPEN OFF CLOSE                      | <b>HT8JBH1DAB-POP</b>  |
| Three-position selector switch, spring return from left and right, black knob, 1NO/1NC contact block, three square legend plates: UP OFF DOWN, FOR OFF REV., OPEN OFF CLOSE | <b>HT8JXH1DAB-POP</b>  |
| Red push-pull emergency stop, 1NO/1NC contact block, three square legend plates: STOP, EMERG. STOP, OFF   | <b>HT8CBRAB-POP</b>    |
| Illuminated push-pull maintained red pushbutton, 120V full voltage low profile LED, three square legend plates: STOP, EMERG. STOP, OFF                                      | <b>HT8FBRABFL7-POP</b> |
| Illuminated push-pull maintained red pushbutton, 24V full voltage low profile LED, three square legend plates: STOP, EMERG. STOP, OFF                                       | <b>HT8FBRABFL3-POP</b> |
| Green flush pushbutton, 1NO/1NC contact block, three square legend plates: START, ON, RUN   | <b>HT8AAGAB-POP</b>    |
| Black flush pushbutton, 1NO/1NC contact block, three square legend plates: RESET, JOG, OPEN   | <b>HT8AAHAB-POP</b>    |
| Red flush pushbutton, 1NO/1NC contact block, three square legend plates: STOP, CLOSE, OFF   | <b>HT8AARAB-POP</b>    |
| Red extended pushbutton, 1NO/1NC contact block, three square legend plates: STOP, CLOSE, OFF  | <b>HT8ABRAB-POP</b>    |
| Black extended pushbutton, 1NO/1NC contact block, three square legend plates: RESET, JOG, OPEN  | <b>HT8ABHAB-POP</b>    |
| Illuminated green pushbutton, 120V full voltage incandescent, 1NO/1NC contact block, three square legend plates: START, ON, RUN   | <b>HT8GBGABV7-POP</b>  |
| Illuminated green pushbutton, 24V full voltage incandescent, 1NO/1NC contact block, three square legend plates: START, ON, RUN  | <b>HT8GBGABV3-POP</b>  |

**Flush Head Operator**



**Extended Head Operator**



**40 mm Mushroom Head Operator**



**Momentary Contact Pushbutton Units, Non-Illuminated**

| Contact Type | Button Color | Flush Head Catalog Number | Extended Head Catalog Number | Mushroom Head (40 mm) Catalog Number |
|--------------|--------------|---------------------------|------------------------------|--------------------------------------|
| No contact   | Black        | HT8AAH                    | HT8ABH                       | HT8AEH                               |
|              | Red          | HT8AAR                    | HT8ABR                       | HT8AER                               |
|              | Green        | HT8AAG                    | HT8ABG                       | HT8AEG                               |
| 1NO          | Black        | HT8AAHA                   | HT8ABHA                      | HT8AEHA                              |
|              | Red          | HT8AARA                   | HT8ABRA                      | HT8AERA                              |
|              | Green        | HT8AAGA                   | HT8ABGA                      | HT8AEGA                              |
| 1NC          | Black        | HT8AAHB                   | HT8ABHB                      | HT8AEHB                              |
|              | Red          | HT8AARB                   | HT8ABRB                      | HT8AERB                              |
|              | Green        | HT8AAGB                   | HT8ABGB                      | HT8AEGB                              |
| 1NO-1NC      | Black        | HT8AAHAB                  | HT8ABHAB                     | HT8AEHAB                             |
|              | Red          | HT8AARAB                  | HT8ABRAB                     | HT8AERAB                             |
|              | Green        | HT8AAGAB                  | HT8ABGAB                     | HT8AEGAB                             |
| 2NO-2NC      | Black        | HT8AAHF1Q1                | HT8ABHF1Q1                   | HT8AEHF1Q1                           |
|              | Red          | HT8AARF1Q1                | HT8ABRF1Q1                   | HT8AERF1Q1                           |
|              | Green        | HT8AAGF1Q1                | HT8ABGF1Q1                   | HT8AEGF1Q1                           |



# 1

### Illuminated Pushbutton Units

UL (NEMA) Type 3, 3R, 4, 4X, 12 and 13

- Incandescent or LED
- Full voltage or transformer type
- 24V and 120V

#### Illuminated Pushbutton Operator



#### Illuminated Pushbuttons

| Type                     | Volts           | Lens Color       | Operator Only Catalog Number | 1NO Catalog Number | 1NC Catalog Number  | 1NO-1NC Catalog Number | 2NO-2NC Catalog Number |
|--------------------------|-----------------|------------------|------------------------------|--------------------|---------------------|------------------------|------------------------|
| <b>Incandescent Lamp</b> |                 |                  |                              |                    |                     |                        |                        |
| Full voltage             | 120 Vac/Vdc     | No lens ①        | <b>HT8GBFV</b>               | —                  | —                   | —                      | —                      |
|                          |                 | Red              | <b>HT8GBRV7</b>              | <b>HT8GBRAV7</b>   | <b>HT8GBRBV7</b>    | <b>HT8GBRABV7</b>      | <b>HT8GBRF1Q1V7</b>    |
|                          |                 | Green            | <b>HT8GBGV7</b>              | <b>HT8GBGAV7</b>   | <b>HT8GBGBV7</b>    | <b>HT8GBGABV7</b>      | <b>HT8GBGF1Q1V7</b>    |
|                          |                 | Amber            | <b>HT8GBAV7</b>              | <b>HT8GBAAV7</b>   | <b>HT8GBABV7</b>    | <b>HT8GBAABV7</b>      | <b>HT8GBAF1Q1V7</b>    |
|                          |                 | Clear            | <b>HT8GBCV7</b>              | <b>HT8GBCAV7</b>   | <b>HT8GBCBV7</b>    | <b>HT8GBCABV7</b>      | <b>HT8GBCF1Q1V7</b>    |
|                          |                 | White            | <b>HT8GBWV7</b>              | <b>HT8GBWAV7</b>   | <b>HT8GBWBV7</b>    | <b>HT8GBWABV7</b>      | <b>HT8GBWF1Q1V7</b>    |
|                          |                 | Yellow           | <b>HT8GBYV7</b>              | <b>HT8GBYAV7</b>   | <b>HT8GBYBV7</b>    | <b>HT8GBYABV7</b>      | <b>HT8GBYF1Q1V7</b>    |
|                          | Blue            | <b>HT8GBBV7</b>  | <b>HT8GBBAV7</b>             | <b>HT8GBBBV7</b>   | <b>HT8GBBABV7</b>   | <b>HT8GBBF1Q1V7</b>    |                        |
|                          | 24 Vac/Vdc      | No lens ①        | <b>HT8GBFV</b>               | —                  | —                   | —                      | —                      |
|                          |                 | Red              | <b>HT8GBRV3</b>              | <b>HT8GBRAV3</b>   | <b>HT8GBRBV3</b>    | <b>HT8GBRABV3</b>      | <b>HT8GBRF1Q1V3</b>    |
|                          |                 | Green            | <b>HT8GBGV3</b>              | <b>HT8GBGAV3</b>   | <b>HT8GBGBV3</b>    | <b>HT8GBGABV3</b>      | <b>HT8GBGF1Q1V3</b>    |
|                          |                 | Amber            | <b>HT8GBAV3</b>              | <b>HT8GBAAV3</b>   | <b>HT8GBABV3</b>    | <b>HT8GBAABV3</b>      | <b>HT8GBAF1Q1V3</b>    |
|                          |                 | Clear            | <b>HT8GBCV3</b>              | <b>HT8GBCAV3</b>   | <b>HT8GBCBV3</b>    | <b>HT8GBCABV3</b>      | <b>HT8GBCF1Q1V3</b>    |
|                          |                 | White            | <b>HT8GBWV3</b>              | <b>HT8GBWAV3</b>   | <b>HT8GBWBV3</b>    | <b>HT8GBWABV3</b>      | <b>HT8GBWF1Q1V3</b>    |
| Yellow                   |                 | <b>HT8GBYV3</b>  | <b>HT8GBYAV3</b>             | <b>HT8GBYBV3</b>   | <b>HT8GBYABV3</b>   | <b>HT8GBYF1Q1V3</b>    |                        |
| Transformer              | 120 Vac         | No lens ①        | <b>HT8GBT1</b>               | —                  | —                   | —                      | —                      |
|                          |                 | Red              | <b>HT8GBRT1</b>              | <b>HT8GBRAT1</b>   | <b>HT8GBRBT1</b>    | <b>HT8GBRABT1</b>      | <b>HT8GBRF1Q1T1</b>    |
|                          |                 | Green            | <b>HT8GBGT1</b>              | <b>HT8GBGAT1</b>   | <b>HT8GBGBT1</b>    | <b>HT8GBGABT1</b>      | <b>HT8GBGF1Q1T1</b>    |
|                          |                 | Amber            | <b>HT8GBAT1</b>              | <b>HT8GBAAT1</b>   | <b>HT8GBABT1</b>    | <b>HT8GBAABT1</b>      | <b>HT8GBAF1Q1T1</b>    |
|                          |                 | Clear            | <b>HT8GBCT1</b>              | <b>HT8GBCAT1</b>   | <b>HT8GBCBT1</b>    | <b>HT8GBCABT1</b>      | <b>HT8GBCF1Q1T1</b>    |
|                          |                 | White            | <b>HT8GBWT1</b>              | <b>HT8GBWAT1</b>   | <b>HT8GBWBT1</b>    | <b>HT8GBWABT1</b>      | <b>HT8GBWF1Q1T1</b>    |
|                          |                 | Yellow           | <b>HT8GBYT1</b>              | <b>HT8GBYAT1</b>   | <b>HT8GBYBT1</b>    | <b>HT8GBYABT1</b>      | <b>HT8GBYF1Q1T1</b>    |
| Blue                     | <b>HT8GBBT1</b> | <b>HT8GBBAT1</b> | <b>HT8GBBBT1</b>             | <b>HT8GBBABT1</b>  | <b>HT8GBBF1Q1T1</b> |                        |                        |

**Note**

① Light unit base operator without lens or bulb.

UL (NEMA) Type 3, 3R, 4, 4X, 12 and 13

**Illuminated Pushbutton Operator**



**Illuminated Pushbuttons, continued**

| Type         | Volts       | Lens Color | Operator Only Catalog Number | 1NO Catalog Number | 1NC Catalog Number | 1NO-1NC Catalog Number | 2NO-2NC Catalog Number |
|--------------|-------------|------------|------------------------------|--------------------|--------------------|------------------------|------------------------|
| <b>LED</b>   |             |            |                              |                    |                    |                        |                        |
| Full voltage | 120 Vac/Vdc | No lens ①  | <b>HT8GBFV</b>               | —                  | —                  | —                      | —                      |
|              |             | Red        | <b>HT8GBRF7</b>              | <b>HT8GBRAF7</b>   | <b>HT8GBRBF7</b>   | <b>HT8GBRABF7</b>      | <b>HT8GBRF1Q1F7</b>    |
|              |             | Green      | <b>HT8GBGF7</b>              | <b>HT8GBGAF7</b>   | <b>HT8GBGBF7</b>   | <b>HT8GBGABF7</b>      | <b>HT8GBGF1Q1F7</b>    |
|              |             | Amber      | <b>HT8GBAF7</b>              | <b>HT8GBAAF7</b>   | <b>HT8GBABF7</b>   | <b>HT8GBAABF7</b>      | <b>HT8GBAF1Q1F7</b>    |
|              |             | Clear      | <b>HT8GBCF7</b>              | <b>HT8GBCAF7</b>   | <b>HT8GBCBF7</b>   | <b>HT8GBCABF7</b>      | <b>HT8GBCF1Q1F7</b>    |
|              |             | White      | <b>HT8GBWF7</b>              | <b>HT8GBWAF7</b>   | <b>HT8GBWBF7</b>   | <b>HT8GBWABF7</b>      | <b>HT8GBWF1Q1F7</b>    |
|              |             | Yellow     | <b>HT8GBYF7</b>              | <b>HT8GBYAF7</b>   | <b>HT8GBYBF7</b>   | <b>HT8GBYABF7</b>      | <b>HT8GBYF1Q1F7</b>    |
|              |             | Blue       | <b>HT8GBBF7</b>              | <b>HT8GBBAF7</b>   | <b>HT8GBBBF7</b>   | <b>HT8GBBABF7</b>      | <b>HT8GBBF1Q1F7</b>    |
|              | 24 Vac/Vdc  | No lens ①  | <b>HT8GBFV</b>               | —                  | —                  | —                      | —                      |
|              |             | Red        | <b>HT8GBRF3</b>              | <b>HT8GBRAF3</b>   | <b>HT8GBRBF3</b>   | <b>HT8GBRABF3</b>      | <b>HT8GBRF1Q1F3</b>    |
|              |             | Green      | <b>HT8GBGF3</b>              | <b>HT8GBGAF3</b>   | <b>HT8GBGBF3</b>   | <b>HT8GBGABF3</b>      | <b>HT8GBGF1Q1F3</b>    |
|              |             | Amber      | <b>HT8GBAF3</b>              | <b>HT8GBAAF3</b>   | <b>HT8GBABF3</b>   | <b>HT8GBAABF3</b>      | <b>HT8GBAF1Q1F3</b>    |
|              |             | Clear      | <b>HT8GBCF3</b>              | <b>HT8GBCAF3</b>   | <b>HT8GBCBF3</b>   | <b>HT8GBCABF3</b>      | <b>HT8GBCF1Q1F3</b>    |
|              |             | White      | <b>HT8GBWF3</b>              | <b>HT8GBWAF3</b>   | <b>HT8GBWBF3</b>   | <b>HT8GBWABF3</b>      | <b>HT8GBWF1Q1F3</b>    |
|              |             | Blue       | <b>HT8GBBF3</b>              | <b>HT8GBBAF3</b>   | <b>HT8GBBBF3</b>   | <b>HT8GBBABF3</b>      | <b>HT8GBBF1Q1F3</b>    |
| Transformer  | 120 Vac     | No lens ①  | <b>HT8GBT1</b>               | —                  | —                  | —                      | —                      |
|              |             | Red        | <b>HT8GBRL1</b>              | <b>HT8GBRAL1</b>   | <b>HT8GBRBL1</b>   | <b>HT8GBRABL1</b>      | <b>HT8GBRF1Q1L1</b>    |
|              |             | Green      | <b>HT8GBGL1</b>              | <b>HT8GBGAL1</b>   | <b>HT8GBGBL1</b>   | <b>HT8GBGABL1</b>      | <b>HT8GBGF1Q1L1</b>    |
|              |             | Amber      | <b>HT8GBAL1</b>              | <b>HT8GBAAL1</b>   | <b>HT8GBABL1</b>   | <b>HT8GBAABL1</b>      | <b>HT8GBAF1Q1L1</b>    |
|              |             | Clear      | <b>HT8GBCL1</b>              | <b>HT8GBCAL1</b>   | <b>HT8GBCL1</b>    | <b>HT8GBCABL1</b>      | <b>HT8GBCF1Q1L1</b>    |
|              |             | White      | <b>HT8GBWL1</b>              | <b>HT8GBWAL1</b>   | <b>HT8GBWBL1</b>   | <b>HT8GBWABL1</b>      | <b>HT8GBWF1Q1L1</b>    |
|              |             | Yellow     | <b>HT8GBYL1</b>              | <b>HT8GBYAL1</b>   | <b>HT8GBYBL1</b>   | <b>HT8GBYABL1</b>      | <b>HT8GBYF1Q1L1</b>    |
|              |             | Blue       | <b>HT8GBBL1</b>              | <b>HT8GBBAL1</b>   | <b>HT8GBBBL1</b>   | <b>HT8GBBABL1</b>      | <b>HT8GBBF1Q1L1</b>    |

**Note**

① Light unit base operator without lens or bulb.

## 1

**Guarded Illuminated Pushbutton Units**

UL (NEMA) Type 3, 3R, 4, 4X, 12 and 13

- Incandescent or LED
- Full voltage or transformer type
- 24V and 120V

**Guarded Illuminated Pushbutton Operator****Guarded Illuminated Pushbuttons**

| Type                     | Volts           | Lens Color       | Operator Only Catalog Number | 1NO Catalog Number | 1NC Catalog Number  | 1NO-1NC Catalog Number | 2NO-2NC Catalog Number |
|--------------------------|-----------------|------------------|------------------------------|--------------------|---------------------|------------------------|------------------------|
| <b>Incandescent Lamp</b> |                 |                  |                              |                    |                     |                        |                        |
| Full voltage             | 120 Vac/Vdc     | No lens ①        | <b>HT8GDFV</b>               | —                  | —                   | —                      | —                      |
|                          |                 | Red              | <b>HT8GDRV7</b>              | <b>HT8GDRAV7</b>   | <b>HT8GDRBV7</b>    | <b>HT8GDRABV7</b>      | <b>HT8GDRF1Q1V7</b>    |
|                          |                 | Green            | <b>HT8GDGV7</b>              | <b>HT8GDGAV7</b>   | <b>HT8GDGBV7</b>    | <b>HT8GDGABV7</b>      | <b>HT8GDGF1Q1V7</b>    |
|                          |                 | Amber            | <b>HT8GDAV7</b>              | <b>HT8GDAAV7</b>   | <b>HT8GDABV7</b>    | <b>HT8GDAABV7</b>      | <b>HT8GDAF1Q1V7</b>    |
|                          |                 | Clear            | <b>HT8GDCV7</b>              | <b>HT8GDVAV7</b>   | <b>HT8GDGBV7</b>    | <b>HT8GDCAV7</b>       | <b>HT8GDCF1Q1V7</b>    |
|                          |                 | White            | <b>HT8GDWV7</b>              | <b>HT8GDWAV7</b>   | <b>HT8GDWBV7</b>    | <b>HT8GDWABV7</b>      | <b>HT8GDWF1Q1V7</b>    |
|                          |                 | Yellow           | <b>HT8GDYV7</b>              | <b>HT8GDYAV7</b>   | <b>HT8GDYBV7</b>    | <b>HT8GDYABV7</b>      | <b>HT8GDYF1Q1V7</b>    |
|                          | Blue            | <b>HT8GDBV7</b>  | <b>HT8GDBAV7</b>             | <b>HT8GDBBV7</b>   | <b>HT8GDBABV7</b>   | <b>HT8GDBF1Q1V7</b>    |                        |
|                          | 24 Vac/Vdc      | No lens ①        | <b>HT8GDFV</b>               | —                  | —                   | —                      | —                      |
|                          |                 | Red              | <b>HT8GDRV3</b>              | <b>HT8GDRAV3</b>   | <b>HT8GDRBV3</b>    | <b>HT8GDRABV3</b>      | <b>HT8GDRF1Q1V3</b>    |
|                          |                 | Green            | <b>HT8GDGV3</b>              | <b>HT8GDGAV3</b>   | <b>HT8GDGBV3</b>    | <b>HT8GDGABV3</b>      | <b>HT8GDGF1Q1V3</b>    |
|                          |                 | Amber            | <b>HT8GDAV3</b>              | <b>HT8GDAAV3</b>   | <b>HT8GDABV3</b>    | <b>HT8GDAABV3</b>      | <b>HT8GDAF1Q1V3</b>    |
|                          |                 | Clear            | <b>HT8GDCV3</b>              | <b>HT8GDVAV3</b>   | <b>HT8GDGBV3</b>    | <b>HT8GDCAV3</b>       | <b>HT8GDCF1Q1V3</b>    |
|                          |                 | White            | <b>HT8GDWV3</b>              | <b>HT8GDWAV3</b>   | <b>HT8GDWBV3</b>    | <b>HT8GDWABV3</b>      | <b>HT8GDWF1Q1V3</b>    |
| Yellow                   |                 | <b>HT8GDYV3</b>  | <b>HT8GDYAV3</b>             | <b>HT8GDYBV3</b>   | <b>HT8GDYABV3</b>   | <b>HT8GDYF1Q1V3</b>    |                        |
| Transformer              | 120 Vac         | No lens ①        | <b>HT8GDT1</b>               | —                  | —                   | —                      | —                      |
|                          |                 | Red              | <b>HT8GDRT1</b>              | <b>HT8GDRAT1</b>   | <b>HT8GDRBT1</b>    | <b>HT8GDRABT1</b>      | <b>HT8GDRF1Q1T1</b>    |
|                          |                 | Green            | <b>HT8GDGT1</b>              | <b>HT8GDGAT1</b>   | <b>HT8GDGBT1</b>    | <b>HT8GDGABT1</b>      | <b>HT8GDGF1Q1T1</b>    |
|                          |                 | Amber            | <b>HT8GDAT1</b>              | <b>HT8GDAAT1</b>   | <b>HT8GDABT1</b>    | <b>HT8GDAABT1</b>      | <b>HT8GDAF1Q1T1</b>    |
|                          |                 | Clear            | <b>HT8GDCT1</b>              | <b>HT8GDCAT1</b>   | <b>HT8GDGBT1</b>    | <b>HT8GDCABT1</b>      | <b>HT8GDCF1Q1T1</b>    |
|                          |                 | White            | <b>HT8GDWT1</b>              | <b>HT8GDWAT1</b>   | <b>HT8GDWBT1</b>    | <b>HT8GDWABT1</b>      | <b>HT8GDWF1Q1T1</b>    |
|                          |                 | Yellow           | <b>HT8GDYT1</b>              | <b>HT8GDYAT1</b>   | <b>HT8GDYBT1</b>    | <b>HT8GDYABT1</b>      | <b>HT8GDYF1Q1T1</b>    |
| Blue                     | <b>HT8GDBT1</b> | <b>HT8GDBAT1</b> | <b>HT8GDBBT1</b>             | <b>HT8GDBABT1</b>  | <b>HT8GDBF1Q1T1</b> |                        |                        |

**Note**

① Light unit base operator without lens or bulb.

UL (NEMA) Type 3, 3R, 4, 4X, 12 and 13

**Guarded Illuminated Pushbutton Operator**



**Guarded Illuminated Pushbuttons, continued**

| Type         | Volts           | Lens Color       | Operator Only Catalog Number | 1NO Catalog Number | 1NC Catalog Number  | 1NO-1NC Catalog Number | 2NO-2NC Catalog Number |
|--------------|-----------------|------------------|------------------------------|--------------------|---------------------|------------------------|------------------------|
| <b>LED</b>   |                 |                  |                              |                    |                     |                        |                        |
| Full voltage | 120 Vac/Vdc     | No lens ①        | <b>HT8GDFV</b>               | —                  | —                   | —                      | —                      |
|              |                 | Red              | <b>HT8GDRF7</b>              | <b>HT8GDRAF7</b>   | <b>HT8GDRBF7</b>    | <b>HT8GDRABF7</b>      | <b>HT8GDRF1Q1F7</b>    |
|              |                 | Green            | <b>HT8GDGF7</b>              | <b>HT8GDGAF7</b>   | <b>HT8GDGBF7</b>    | <b>HT8GDGABF7</b>      | <b>HT8GDGF1Q1F7</b>    |
|              |                 | Amber            | <b>HT8GDAF7</b>              | <b>HT8GDAAF7</b>   | <b>HT8GDABF7</b>    | <b>HT8GDAABF7</b>      | <b>HT8GDAF1Q1F7</b>    |
|              |                 | Clear            | <b>HT8GDCF7</b>              | <b>HT8GDCAF7</b>   | <b>HT8GDCBF7</b>    | <b>HT8GDCABF7</b>      | <b>HT8GDCF1Q1F7</b>    |
|              |                 | White            | <b>HT8GDWF7</b>              | <b>HT8GDWAF7</b>   | <b>HT8GDWBF7</b>    | <b>HT8GDWABF7</b>      | <b>HT8GDWF1Q1F7</b>    |
|              |                 | Yellow           | <b>HT8GDYF7</b>              | <b>HT8GDYAF7</b>   | <b>HT8GDYBF7</b>    | <b>HT8GDYABF7</b>      | <b>HT8GDYF1Q1F7</b>    |
|              | Blue            | <b>HT8GDBF7</b>  | <b>HT8GDBAF7</b>             | <b>HT8GDBBF7</b>   | <b>HT8GDBABF7</b>   | <b>HT8GDBF1Q1F7</b>    |                        |
|              | 24 Vac/Vdc      | No lens ①        | <b>HT8GDFV</b>               | —                  | —                   | —                      | —                      |
|              |                 | Red              | <b>HT8GDRF3</b>              | <b>HT8GDRAF3</b>   | <b>HT8GDRBF3</b>    | <b>HT8GDRABF3</b>      | <b>HT8GDRF1Q1F3</b>    |
|              |                 | Green            | <b>HT8GDGF3</b>              | <b>HT8GDGAF3</b>   | <b>HT8GDGBF3</b>    | <b>HT8GDGABF3</b>      | <b>HT8GDGF1Q1F3</b>    |
|              |                 | Amber            | <b>HT8GDAF3</b>              | <b>HT8GDAAF3</b>   | <b>HT8GDABF3</b>    | <b>HT8GDAABF3</b>      | <b>HT8GDAF1Q1F3</b>    |
|              |                 | Clear            | <b>HT8GDCF3</b>              | <b>HT8GDCAF3</b>   | <b>HT8GDCBF3</b>    | <b>HT8GDCABF3</b>      | <b>HT8GDCF1Q1F3</b>    |
|              |                 | White            | <b>HT8GDWF3</b>              | <b>HT8GDWAF3</b>   | <b>HT8GDWBF3</b>    | <b>HT8GDWABF3</b>      | <b>HT8GDWF1Q1F3</b>    |
| Yellow       |                 | <b>HT8GDYF3</b>  | <b>HT8GDYAF3</b>             | <b>HT8GDYBF3</b>   | <b>HT8GDYABF3</b>   | <b>HT8GDYF1Q1F3</b>    |                        |
| Blue         | <b>HT8GDBF3</b> | <b>HT8GDBAF3</b> | <b>HT8GDBBF3</b>             | <b>HT8GDBABF3</b>  | <b>HT8GDBF1Q1F3</b> |                        |                        |
| Transformer  | 120 Vac         | No lens ①        | <b>HT8GDT1</b>               | —                  | —                   | —                      | —                      |
|              |                 | Red              | <b>HT8GDRL1</b>              | <b>HT8GDRAL1</b>   | <b>HT8GDRBL1</b>    | <b>HT8GDRABL1</b>      | <b>HT8GDRF1Q1L1</b>    |
|              |                 | Green            | <b>HT8GDGL1</b>              | <b>HT8GDGAL1</b>   | <b>HT8GDGBL1</b>    | <b>HT8GDGABL1</b>      | <b>HT8GDGF1Q1L1</b>    |
|              |                 | Amber            | <b>HT8GDAL1</b>              | <b>HT8GDAAL1</b>   | <b>HT8GDABL1</b>    | <b>HT8GDAABL1</b>      | <b>HT8GDAF1Q1L1</b>    |
|              |                 | Clear            | <b>HT8GDCL1</b>              | <b>HT8GDCAL1</b>   | <b>HT8GDCBL1</b>    | <b>HT8GDCABL1</b>      | <b>HT8GDCF1Q1L1</b>    |
|              |                 | White            | <b>HT8GDWL1</b>              | <b>HT8GDWAL1</b>   | <b>HT8GDWBL1</b>    | <b>HT8GDWABL1</b>      | <b>HT8GDWF1Q1L1</b>    |
|              |                 | Yellow           | <b>HT8GDYL1</b>              | <b>HT8GDYAL1</b>   | <b>HT8GDYBL1</b>    | <b>HT8GDYABL1</b>      | <b>HT8GDYF1Q1L1</b>    |
|              |                 | Blue             | <b>HT8GDBL1</b>              | <b>HT8GDBAL1</b>   | <b>HT8GDBBL1</b>    | <b>HT8GDBABL1</b>      | <b>HT8GDBF1Q1L1</b>    |

**Note**

① Light unit base operator without lens or bulb.

#### 1

#### Indicating Light Units

UL (NEMA) Type 3, 3R, 4, 4X, 12 and 13

- Incandescent or LED
- Full voltage or transformer type
- Standard and PresTest types
- 24V and 120V

PresTest—This device incorporates a press-to-test feature whereby depressing the lens disconnects the light from the source

being monitored and connects the lamp to a continuously energized circuit for immediate detection of faulty lamps.

Indicating Light Unit



PresTest Light Unit



#### Indicating Light Units

| Type                | Volts               | Lens Color | Indicating Light Catalog Number | PresTest Catalog Number |                 |                 |
|---------------------|---------------------|------------|---------------------------------|-------------------------|-----------------|-----------------|
| <b>Incandescent</b> |                     |            |                                 |                         |                 |                 |
| Full voltage        | 120 Vac/Vdc         | No lens ①  | <b>HT8HFFV</b>                  | <b>HT8GTFV</b>          |                 |                 |
|                     |                     | Red        | <b>HT8HFRV7</b>                 | <b>HT8GTRV7</b>         |                 |                 |
|                     |                     | Green      | <b>HT8HFGV7</b>                 | <b>HT8GTGV7</b>         |                 |                 |
|                     |                     | Amber      | <b>HT8HFAV7</b>                 | <b>HT8GTAV7</b>         |                 |                 |
|                     |                     | Clear      | <b>HT8HFCV7</b>                 | <b>HT8GTCV7</b>         |                 |                 |
|                     |                     | White      | <b>HT8HFVV7</b>                 | <b>HT8GTWV7</b>         |                 |                 |
|                     |                     | Yellow     | <b>HT8HFYV7</b>                 | <b>HT8GTYV7</b>         |                 |                 |
|                     |                     | Blue       | <b>HT8HFBV7</b>                 | <b>HT8GTBV7</b>         |                 |                 |
|                     |                     | 24 Vac/Vdc | 24 Vac/Vdc                      | No lens ①               | <b>HT8HFFV</b>  | <b>HT8GTFV</b>  |
|                     |                     |            |                                 | Red                     | <b>HT8HFRV3</b> | <b>HT8GTRV3</b> |
|                     |                     |            |                                 | Green                   | <b>HT8HFGV3</b> | <b>HT8GTGV3</b> |
|                     |                     |            |                                 | Amber                   | <b>HT8HFAV3</b> | <b>HT8GTAV3</b> |
|                     |                     |            |                                 | Clear                   | <b>HT8HFCV3</b> | <b>HT8GTCV3</b> |
|                     |                     |            |                                 | White                   | <b>HT8HFVV3</b> | <b>HT8GTWV3</b> |
| Transformer         | 120 Vac<br>50/60 Hz | No lens ①  | <b>HT8HBT1</b>                  | <b>HT8GTT1</b>          |                 |                 |
|                     |                     | Red        | <b>HT8HBRT1</b>                 | <b>HT8GTRT1</b>         |                 |                 |
|                     |                     | Green      | <b>HT8HBGT1</b>                 | <b>HT8GTGT1</b>         |                 |                 |
|                     |                     | Amber      | <b>HT8HBAT1</b>                 | <b>HT8GTAT1</b>         |                 |                 |
|                     |                     | Clear      | <b>HT8HBCT1</b>                 | <b>HT8GTCT1</b>         |                 |                 |
|                     |                     | White      | <b>HT8HBWT1</b>                 | <b>HT8GTWT1</b>         |                 |                 |
|                     |                     | Yellow     | <b>HT8HBYT1</b>                 | <b>HT8GTYT1</b>         |                 |                 |
|                     |                     | Blue       | <b>HT8HBBT1</b>                 | <b>HT8GTBT1</b>         |                 |                 |

**Note**

① Light unit base operator without lens or bulb.

UL (NEMA) Type 3, 3R, 4, 4X, 12 and 13

**Indicating Light Unit**



**Indicating Light Units, continued**

**PresTest Light Unit**



| Type         | Volts               | Lens Color | Indicating Light Catalog Number | PresTest Catalog Number |
|--------------|---------------------|------------|---------------------------------|-------------------------|
| <b>LED</b>   |                     |            |                                 |                         |
| Full voltage | 120 Vac/Vdc         | No lens ①  | <b>HT8HFFV</b>                  | <b>HT8GTFV</b>          |
|              |                     | Red        | <b>HT8HFRF7</b>                 | <b>HT8GTRF7</b>         |
|              |                     | Green      | <b>HT8HFGF7</b>                 | <b>HT8GTGF7</b>         |
|              |                     | Amber      | <b>HT8HFAF7</b>                 | <b>HT8GTAF7</b>         |
|              |                     | Clear      | <b>HT8HFCF7</b>                 | <b>HT8GTCF7</b>         |
|              |                     | White      | <b>HT8HFWF7</b>                 | <b>HT8GTWF7</b>         |
|              |                     | Yellow     | <b>HT8HFVF7</b>                 | <b>HT8GTVF7</b>         |
|              |                     | Blue       | <b>HT8HBF7</b>                  | <b>HT8GTBF7</b>         |
|              | 24 Vac/Vdc          | No lens ①  | <b>HT8HFFV</b>                  | <b>HT8GTFV</b>          |
|              |                     | Red        | <b>HT8HFRF3</b>                 | <b>HT8GTRF3</b>         |
|              |                     | Green      | <b>HT8HFGF3</b>                 | <b>HT8GTGF3</b>         |
|              |                     | Amber      | <b>HT8HFAF3</b>                 | <b>HT8GTAF3</b>         |
|              |                     | Clear      | <b>HT8HFCF3</b>                 | <b>HT8GTCF3</b>         |
|              |                     | White      | <b>HT8HFWF3</b>                 | <b>HT8GTWF3</b>         |
|              |                     | Yellow     | <b>HT8HFVF3</b>                 | <b>HT8GTVF3</b>         |
|              |                     | Blue       | <b>HT8HBF3</b>                  | <b>HT8GTBF3</b>         |
| Transformer  | 120 Vac<br>50/60 Hz | No lens ①  | <b>HT8HBT1</b>                  | <b>HT8GTT1</b>          |
|              |                     | Red        | <b>HT8HBRL1</b>                 | <b>HT8GTRL1</b>         |
|              |                     | Green      | <b>HT8HBGL1</b>                 | <b>HT8GTGL1</b>         |
|              |                     | Amber      | <b>HT8HBAL1</b>                 | <b>HT8GTAL1</b>         |
|              |                     | Clear      | <b>HT8HBCL1</b>                 | <b>HT8GTCL1</b>         |
|              |                     | White      | <b>HT8HBWL1</b>                 | <b>HT8GTWL1</b>         |
|              |                     | Yellow     | <b>HT8HBYL1</b>                 | <b>HT8GTYL1</b>         |
|              |                     | Blue       | <b>HT8HBBL1</b>                 | <b>HT8GTBL1</b>         |

**Note**

① Light unit base operator without lens or bulb.

#### 1

#### Push-Pull Units

UL (NEMA) Type 3, 3R, 4, 4X, 12 and 13

- 40 mm mushroom head
- Two-position maintained
- Non-illuminated

#### Round Head Two-Position Push-Pull Unit



#### Flat Head Two-Position Push-Pull Unit



#### Two-Position Push-Pull, Maintained, Non-Illuminated

| Contact Type      | Operator Position—Maintained |    | Button Color | Round Head Mushroom Head Button Catalog Number | Flat Head Mushroom Head Button Catalog Number |
|-------------------|------------------------------|----|--------------|--|---|
|                   | Out                          | In |              |  |   |
| No contact        | —                            | —  | Black        | <b>HT8CBH</b>                                  | <b>HT8DBH</b>                                 |
|                   |                              |    | Red          | <b>HT8CBR</b>                                  | <b>HT8DBR</b>                                 |
|                   |                              |    | Green        | <b>HT8CBG</b>                                  | <b>HT8DBG</b>                                 |
| NO                | 0                            | X  | Black        | <b>HT8CBHA</b>                                 | <b>HT8DBHA</b>                                |
|                   |                              |    | Red          | <b>HT8CBRA</b>                                 | <b>HT8DBRA</b>                                |
|                   |                              |    | Green        | <b>HT8CBGA</b>                                 | <b>HT8DBGA</b>                                |
| NC                | X                            | 0  | Black        | <b>HT8CBHB</b>                                 | <b>HT8DBHB</b>                                |
|                   |                              |    | Red          | <b>HT8CBRB</b>                                 | <b>HT8DBRB</b>                                |
|                   |                              |    | Green        | <b>HT8CBGB</b>                                 | <b>HT8DBGB</b>                                |
| NO-NC             | 0                            | X  | Black        | <b>HT8CBHAB</b>                                | <b>HT8DBHAB</b>                               |
|                   | X                            | 0  | Red          | <b>HT8CBRAB</b>                                | <b>HT8DBRAB</b>                               |
|                   |                              |    | Green        | <b>HT8CBGAB</b>                                | <b>HT8DBGAB</b>                               |
| NCLB <sup>Ⓢ</sup> | X                            | 0  | Black        | <b>HT8CBHD1B</b>                               | <b>HT8DBHD1B</b>                              |
| NC                | X                            | 0  | Red          | <b>HT8CBRD1B</b>                               | <b>HT8DBRD1B</b>                              |
|                   |                              |    | Green        | <b>HT8CBGD1B</b>                               | <b>HT8DBGD1B</b>                              |
| NCLB <sup>Ⓢ</sup> | X                            | 0  | Black        | <b>HT8CBHD1D</b>                               | <b>HT8DBHD1D</b>                              |
| NCLB <sup>Ⓢ</sup> | X                            | 0  | Red          | <b>HT8CBRD1D</b>                               | <b>HT8DBRD1D</b>                              |
|                   |                              |    | Green        | <b>HT8CBGD1D</b>                               | <b>HT8DBGD1D</b>                              |

#### Note

<sup>Ⓢ</sup> NCLB = normally closed late break.

**Illuminated Push-Pull Units**

UL (NEMA) Type 3, 3R, 4, 4X, 12 and 13

- Incandescent or LED
- Full voltage or transformer type
- 24V and 120V

**Illuminated Push-Pull Unit**



**Illuminated Push-Pull Units**

| Type                     | Volts       | Lens Color | Operator Only Catalog Number | 1NO Catalog Number | 1NC Catalog Number | 1NO-1NC Catalog Number | 2NCLB Catalog Number |
|--------------------------|-------------|------------|------------------------------|--------------------|--------------------|------------------------|----------------------|
| <b>Incandescent Lamp</b> |             |            |                              |                    |                    |                        |                      |
| Full voltage             | 120 Vac/Vdc | Red        | HT8FBRV7                     | HT8FBRAV7          | HT8FBRBV7          | HT8FBRAV7              | HT8FBRD1DV7          |
|                          |             | Green      | HT8FBGV7                     | HT8FBGAV7          | HT8FBGBV7          | HT8FBGAV7              | HT8FBGD1DV7          |
|                          | 24 Vac/Vdc  | Red        | HT8FBRV3                     | HT8FBRAV3          | HT8FBRBV3          | HT8FBRAV3              | HT8FBRD1DV3          |
|                          |             | Green      | HT8FBGV3                     | HT8FBGAV3          | HT8FBGBV3          | HT8FBGAV3              | HT8FBGD1DV3          |
| Transformer              | 120 Vac     | Red        | HT8FBRT1                     | HT8FBRA1           | HT8FBRBT1          | HT8FBRA1               | HT8FBRD1DT1          |
|                          |             | Green      | HT8FBGT1                     | HT8FBGA1           | HT8FBGBT1          | HT8FBGA1               | HT8FBGD1DT1          |
| <b>LED Lamp</b>          |             |            |                              |                    |                    |                        |                      |
| Full voltage             | 120 Vac/Vdc | Red        | HT8FBRF7                     | HT8FBRAF7          | HT8FBRBF7          | HT8FBRAF7              | HT8FBRD1DF7          |
|                          |             | Green      | HT8FBGF7                     | HT8FBGAF7          | HT8FBGBF7          | HT8FBGAF7              | HT8FBGD1DF7          |
|                          | 24 Vac/Vdc  | Red        | HT8FBRF3                     | HT8FBRAF3          | HT8FBRBF3          | HT8FBRAF3              | HT8FBRD1DF3          |
|                          |             | Green      | HT8FBGF3                     | HT8FBGAF3          | HT8FBGBF3          | HT8FBGAF3              | HT8FBGD1DF3          |
| Transformer              | 120 Vac     | Red        | HT8FBRL1                     | HT8FBRAL1          | HT8FBRBL1          | HT8FBRAL1              | HT8FBRD1DL1          |
|                          |             | Green      | HT8FBGL1                     | HT8FBGAL1          | HT8FBGBL1          | HT8FBGAL1              | HT8FBGD1DL1          |

**Note:** Complete illuminated push-pull switches will not fit in a standard 3 in deep enclosure.

**Illuminated Push-Pull Units with Low Profile Light Units**

| Type                | Voltage     | Color | Fingersafe | Operator Only Catalog Number | 1NO Catalog Number | 1NC Catalog Number | 1NO-1NC Catalog Number | 2NCLB Catalog Number | 1NO-1NCLB Catalog Number |
|---------------------|-------------|-------|------------|------------------------------|--------------------|--------------------|------------------------|----------------------|--------------------------|
| <b>LED Lamp</b>     |             |       |            |                              |                    |                    |                        |                      |                          |
| Full voltage        | 120 Vac/Vdc | Red   | Yes        | HT8FBRFL7P                   | HT8FBRAFL7P        | HT8FBRBFL7P        | HT8FBRAFL7P            | HT8FBRD1DFL7P        | HT8FBRD1BFL7P            |
|                     |             | Red   | No         | HT8FBRFL7                    | HT8FBRAFL7         | HT8FBRBFL7         | HT8FBRAFL7             | HT8FBRD1DFL7         | HT8FBRD1BFL7             |
|                     | 24 Vac/Vdc  | Red   | Yes        | HT8FBRFL3P                   | HT8FBRAFL3P        | HT8FBRBFL3P        | HT8FBRAFL3P            | HT8FBRD1DFL3P        | HT8FBRD1BFL3P            |
|                     |             | Red   | No         | HT8FBRFL3                    | HT8FBRAFL3         | HT8FBRBFL3         | HT8FBRAFL3             | HT8FBRD1DFL3         | HT8FBRD1BFL3             |
| <b>Incandescent</b> |             |       |            |                              |                    |                    |                        |                      |                          |
| Full voltage        | 120 Vac/Vdc | Red   | Yes        | HT8FBRVL7P                   | HT8FBRAVL7P        | HT8FBRBVL7P        | HT8FBRAVL7P            | HT8FBRD1DVL7P        | HT8FBRD1BVL7P            |
|                     |             | Red   | No         | HT8FBRVL7                    | HT8FBRAVL7         | HT8FBRBVL7         | HT8FBRAVL7             | HT8FBRD1DVL7         | HT8FBRD1BVL7             |
|                     | 24 Vac/Vdc  | Red   | Yes        | HT8FBRVL3P                   | HT8FBRAVL3P        | HT8FBRBVL3P        | HT8FBRAVL3P            | HT8FBRD1DVL3P        | HT8FBRD1BVL3P            |
|                     |             | Red   | No         | HT8FBRVL3                    | HT8FBRAVL3         | HT8FBRBVL3         | HT8FBRAVL3             | HT8FBRD1DVL3         | HT8FBRD1BVL3             |



# 1

## Selector Switch Units

UL (NEMA) Type 3, 3R, 4, 4X, 12 and 13

- Two-, three- and four-position
- Non-illuminated

### Standard Knob Operator



### Standard Lever Operator



### Two-Position Selector Switch Units, Non-Illuminated

| Contact Type | Operator Position <sup>①</sup> |                  | Operating Mode <sup>②</sup> |   | Standard Black Knob Catalog Number | Standard Black Lever Catalog Number |
|--------------|--------------------------------|------------------|-----------------------------|---|------------------------------------|-------------------------------------|
|              |                                |                  |                             |   |                                    |                                     |
| No contacts  | —                              | —                | M                           | M | HT8JAH3A                           | HT8JDH3A                            |
|              |                                |                  | S                           | M | HT8JKH3A                           | HT8JLH3A                            |
|              |                                |                  | M                           | S | HT8JNH3A                           | HT8JPH3A                            |
| 1NO          | 0                              | X                | M                           | M | HT8JAH3AA5                         | HT8JDH3AA5                          |
|              |                                |                  | S                           | M | HT8JKH3AA5                         | HT8JLH3AA5                          |
|              |                                |                  | M                           | S | HT8JNH3AA5                         | HT8JPH3AA5                          |
| 2NO          | X<br>0                         | 0<br>X           | M                           | M | HT8JAH3AAA5                        | HT8JDH3AAA5                         |
|              |                                |                  | S                           | M | HT8JKH3AAA5                        | HT8JLH3AAA5                         |
|              |                                |                  | M                           | S | HT8JNH3AAA5                        | HT8JPH3AAA5                         |
| 2NO-2NC      | X<br>0<br>0<br>X               | 0<br>X<br>X<br>0 | M                           | M | HT8JAH3AF1Q1                       | HT8JDH3AF1Q1                        |
|              |                                |                  | S                           | M | HT8JKH3AF1Q1                       | HT8JLH3AF1Q1                        |
|              |                                |                  | M                           | S | HT8JNH3AF1Q1                       | HT8JPH3AF1Q1                        |

### Standard Knob Operator



### Standard Lever Operator



### Three-Position Selector Switch Units, Non-Illuminated

| Contact Type         | Operator Position <sup>①</sup> |                  |                  | Operating Mode <sup>②</sup> |   |   | Standard Black Knob Catalog Number | Standard Black Lever Catalog Number |
|----------------------|--------------------------------|------------------|------------------|-----------------------------|---|---|------------------------------------|-------------------------------------|
|                      |                                |                  |                  |                             |   |   |                                    |                                     |
| No contacts          | —                              | —                | —                | M                           | M | M | HT8JBH1D                           | HT8JEH1D                            |
|                      |                                |                  |                  | S                           | M | M | HT8JRH1D                           | HT8JSH1D                            |
|                      |                                |                  |                  | M                           | M | S | HT8JUH1D                           | HT8JVH1D                            |
|                      |                                |                  |                  | S                           | M | S | HT8JXH1D                           | HT8JYH1D                            |
| 2NO                  | X<br>0                         | 0<br>0           | 0<br>X           | M                           | M | M | HT8JBH1DAA5                        | HT8JEH1DAA5                         |
|                      |                                |                  |                  | S                           | M | M | HT8JRH1DAA5                        | HT8JSH1DAA5                         |
|                      |                                |                  |                  | M                           | M | S | HT8JUH1DAA5                        | HT8JVH1DAA5                         |
|                      |                                |                  |                  | S                           | M | S | HT8JXH1DAA5                        | HT8JYH1DAA5                         |
| 2NO-2NC <sup>③</sup> | X<br>0<br>0                    | 0<br>X<br>0      | 0<br>0<br>X      | M                           | M | M | HT8JBH1DF1Q1                       | HT8JEH1DF1Q1                        |
|                      |                                |                  |                  | S                           | M | M | HT8JRH1DF1Q1                       | HT8JSH1DF1Q1                        |
|                      |                                |                  |                  | M                           | M | S | HT8JUH1DF1Q1                       | HT8JVH1DF1Q1                        |
|                      |                                |                  |                  | S                           | M | S | HT8JXH1DF1Q1                       | HT8JYH1DF1Q1                        |
| 2NO-2NC              | X<br>0<br>0<br>X               | 0<br>X<br>0<br>X | X<br>X<br>X<br>0 | M                           | M | M | HT8JBH1DF1Q1                       | HT8JEH1DF1Q1                        |
|                      |                                |                  |                  | S                           | M | M | HT8JRH1DF1Q1                       | HT8JSH1DF1Q1                        |
|                      |                                |                  |                  | M                           | M | S | HT8JUH1DF1Q1                       | HT8JVH1DF1Q1                        |
|                      |                                |                  |                  | S                           | M | S | HT8JXH1DF1Q1                       | HT8JYH1DF1Q1                        |

#### Notes

① X = closed circuit, 0 = open circuit.

② M = Maintained, S = Momentary.

③ For OX0, NC contacts must be wired in series—see Three-Position Selector Switch table on Page V7-T1-310.

UL (NEMA) Type 3, 3R, 4, 4X, 12 and 13

Standard Knob Operator



**Four-Position Selector Switch Units, Non-Illuminated**

Standard Lever Operator



| Contact Type | Operator Position <sup>①</sup> |   |   |   | Operating Mode <sup>②</sup> |   |   |   | Standard Black Knob Catalog Number | Standard Black Lever Catalog Number |
|--------------|--------------------------------|---|---|---|-----------------------------|---|---|---|------------------------------------|-------------------------------------|
|              |                                |   |   |   |                             |   |   |   |                                    |                                     |
| No contacts  | —                              | — | — | — | M                           | M | M | M | <b>HT8JCH8E</b>                    | <b>HT8JFH8E</b>                     |
|              |                                |   |   |   | S                           | M | M | M | <b>HT8LNH8E</b>                    | <b>HT8LPH8E</b>                     |
|              |                                |   |   |   | M                           | M | M | S | <b>HT8LRH8E</b>                    | <b>HT8LSH8E</b>                     |
| 2NO-2NC      | X                              | 0 | 0 | 0 | M                           | M | M | M | <b>HT8JCH8EF1Q1</b>                | <b>HT8JFH8EF1Q1</b>                 |
|              | 0                              | X | 0 | 0 | S                           | M | M | M | <b>HT8LNH8EF1Q1</b>                | <b>HT8LPH8EF1Q1</b>                 |
|              | 0                              | 0 | X | 0 | S                           | M | M | M | <b>HT8LNH8EF1Q1</b>                | <b>HT8LPH8EF1Q1</b>                 |
|              | 0                              | 0 | 0 | X | M                           | M | M | S | <b>HT8LRH8EF1Q1</b>                | <b>HT8LSH8EF1Q1</b>                 |

**Notes**

- ① X = closed circuit, 0 = open circuit.
- ② M = Maintained, S = Momentary.







#### 1

### Selector Switch Contact Block Selection

#### For Two-, Three- and Four-Position Selector Switches









#### Two-Position Selector Switch (Cam Code 3A)

##### Operator Position

|   |  |  | Left  | or | Right   |
|---|---|---|---|----|---|
| X | 0   |   | <br>NO |    | <br>NC |
| 0 |   | X   | <br>NC |    | <br>NO |









#### Three-Position Selector Switch (Cam Code 1D)

##### Operator Position

|   |  |  |  | Left   | Right   |
|---|---|---|---|--|---|
| X | 0   | 0   |   | <br>NO  | —   |
| 0 |   | X   | 0   | <br>NC  | <br>NC   |
| 0 | 0   | 0   | X   | —  | <br>NO   |
| 0 |   | X   | X   | <br>NC | —   |
| X |   | X   | 0   | —  | <br>NC |









#### Four-Position Selector Switch (Cam Code 8E)

##### Operator Position

|   |  |  |  |  | Left  | Right  |
|---|---|---|---|---|---|--|
| X | 0   | 0   | 0   |   | <br>NO | —  |
| 0 |   | X   | 0   | 0   | <br>NC | —  |
| 0 | 0   | 0   | X   | 0   | —   | <br>NO |
| 0 | 0   | 0   | 0   | X   | —   | <br>NC |

**Accessories**

**HT800 Accessories**

|  | Description  | Catalog Number |
|--|--|----------------|
|  <p>HT8A15</p>      | <b>Illuminated Pushbutton Guard</b>  | HT8A15         |
|  <p>HT8WRENCH</p>   | <b>Wrench Tool</b>   | HT8WRENCH      |
|  <p>HT8LAMPTOOL</p> | <b>Lamp/Bulb Removal Tool</b>  | HT8LAMPTOOL    |
|  <p>HT8X1</p>       | <b>Thrust Washer (Anti-rotation)</b><br>(Included with every operator)                       | HT8X1          |
|  <p>HT8X2</p>      | <b>Trim Ring</b><br>(Included with every operator)   | HT8X2          |
|  <p>HT8X3</p>     | <b>Sealing/Spacer Washer</b><br>(Five included with every operator)                          | HT8X3          |
|  <p>HT8GR1</p>    | <b>Grounding Kit for Pushbuttons and Selector Switches</b><br>(Included with every operator) | HT8GR1         |
|  <p>HT8GR2</p>    | <b>Grounding Kit for Indicating Lights</b><br>(Included with indicating lights)              | HT8GR2         |

**Light Units**

| Light Unit  | Type         | Voltage     | Catalog Number |
|---|--------------|-------------|----------------|
|  | Full voltage | 24 Vac/Vdc  | HT8F3V3        |
|   |              | 120 Vac/Vdc | HT8F7V8        |
|   | Transformer  | 120 Vac     | HT8L1T1        |

## Options

### Legend Plates ①

#### Standard

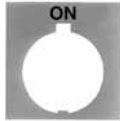

#### Jumbo



### For Pushbutton Operators and Indicating Lights

| Legend   | Color of Field | Standard Catalog Number | Jumbo Catalog Number | Legend   | Color of Field | Standard Catalog Number | Jumbo Catalog Number |
|--|----------------|-------------------------|----------------------|----------|----------------|-------------------------|----------------------|
| <b>Letters on Legend Plates Below are 3/16 in High</b> |                |                         |                      |          |                |                         |                      |
| CLAMP  | Black          | HT8SP90                 | HT8LP90              | OFF      | Red            | HT8SP24                 | HT8LP24              |
| CLOSE  |                | HT8SP73                 | HT8LP73              | ON       | Black          | HT8SP25                 | HT8LP25              |
| DOWN   |                | HT8SP74                 | HT8LP74              | OPEN     |                | HT8SP26                 | HT8LP26              |
| EMERG. STOP  |                | HT8SP13                 | HT8LP13              | OUT      |                | HT8SP27                 | HT8LP27              |
| FAST   |                | HT8SP75                 | HT8LP75              | POWER ON |                | HT8SP80                 | HT8LP80              |
| FASTER   |                | HT8SP87                 | HT8LP87              | RAISE    |                | HT8SP28                 | HT8LP28              |
| FEEDER ON  |                | HT8SP94                 | HT8LP94              | READY    |                | HT8SP86                 | HT8LP86              |
| FEEDER OFF   |                | HT8SP95                 | HT8LP95              | RESET    |                | HT8SP29                 | HT8LP29              |
| FORWARD  |                | HT8SP15                 | HT8LP15              | REVERSE  |                | HT8SP30                 | HT8LP30              |
| HIGH   |                | HT8SP16                 | HT8LP16              | RUN      |                | HT8SP31                 | HT8LP31              |
| IN   |                | HT8SP17                 | HT8LP17              | SAFE     |                | HT8SP85                 | HT8LP85              |
| INCH   |                | HT8SP18                 | HT8LP18              | SLOW     |                | HT8SP32                 | HT8LP32              |
| JOG  |                | HT8SP19                 | HT8LP19              | SLOWER   |                | HT8SP88                 | HT8LP88              |
| JOG FOR.   |                | HT8SP20                 | HT8LP20              | START    |                | HT8SP33                 | HT8LP33              |
| JOG REV.   |                | HT8SP21                 | HT8LP21              | STOP     | Red            | HT8SP34                 | HT8LP34              |
| LOW  |                | HT8SP22                 | HT8LP22              | TEST     | Black          | HT8SP83                 | HT8LP83              |
| LOWER  |                | HT8SP23                 | HT8LP23              | TRANSFER |                | HT8SP93                 | HT8LP93              |
| LUBE-FAIL  |                | HT8SP92                 | HT8LP92              | TRIP     |                | HT8SP84                 | HT8LP84              |
| MOTOR RUN  |                | HT8SP81                 | HT8LP81              | UNCLAMP  |                | HT8SP91                 | HT8LP91              |
| MOTOR STOP   |                | HT8SP82                 | HT8LP82              | UP       |                | HT8SP35                 | HT8LP35              |

#### Standard

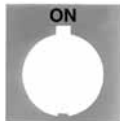

#### Jumbo



### For Selector Switch Operators

| Legend                                     | Color of Field | Standard Catalog Number | Jumbo Catalog Number | Legend                                       | Color of Field | Standard Catalog Number | Jumbo Catalog Number |
|--|----------------|-------------------------|----------------------|--|----------------|-------------------------|----------------------|
| <b>Two-Position—3/16 in High Lettering</b> |                |                         |                      | <b>Three-Position—3/16 in High Lettering</b> |                |                         |                      |
| FOR. REV.                                  | Black          | HT8SP38                 | HT8LP38              | AUTO OFF HAND                                | Black          | HT8SP49                 | HT8LP49              |
| HAND AUTO                                  |                | HT8SP39                 | HT8LP39              | FOR. OFF REV.                                |                | HT8SP50                 | HT8LP50              |
| HIGH LOW                                   |                | HT8SP40                 | HT8LP40              | FOR. SAFE REV.                               |                | HT8SP69                 | HT8LP69              |
| JOG RUN                                    |                | HT8SP41                 | HT8LP41              | HAND OFF AUTO                                |                | HT8SP51                 | HT8LP51              |
| MAN. AUTO                                  |                | HT8SP67                 | HT8LP67              | MAN. OFF AUTO                                |                | HT8SP68                 | HT8LP68              |
| OFF ON                                     |                | HT8SP42                 | HT8LP42              | OPEN OFF CLOSE                               |                | HT8SP53                 | HT8LP53              |
| OPEN CLOSE                                 |                | HT8SP43                 | HT8LP43              | RUN SAFE JOG                                 |                | HT8SP70                 | HT8LP70              |
| RUN JOG                                    |                | HT8SP44                 | HT8LP44              | UP OFF DOWN                                  |                | HT8SP54                 | HT8LP54              |
| SAFE RUN                                   |                | HT8SP45                 | HT8LP45              | ON STOP SAFE                                 |                | HT8SP71                 | HT8LP71              |
| START JOG                                  |                | HT8SP46                 | HT8LP46              |  |                |                         |                      |
| START STOP                                 |                | HT8SP47                 | HT8LP47              |  |                |                         |                      |
| UP DOWN                                    |                | HT8SP48                 | HT8LP48              |  |                |                         |                      |

### For Push-Pull Units

| Legend     | Color of Field | Standard ② Catalog Number | Jumbo ③ Catalog Number |
|------------|----------------|---------------------------|------------------------|
| ON/OFF     | Black          | HT8PP5                    | HT8R5                  |
| OPEN/CLOSE |                | HT8PP8                    | HT8R8                  |
| UP/DOWN    |                | HT8PP11                   | HT8R11                 |

### Blank Plastic Legend Plates—Square

| Legend | Color of Field | Standard Catalog Number | Jumbo Catalog Number |
|--------|----------------|-------------------------|----------------------|
| Black  | White/Silver   | HT8SP76                 | HT8LP76              |
| White  | Red/Black      | HT8SP77                 | HT8LP77              |

#### Notes

① For dimensions, see **Page V7-T1-320**.

② 3/32 in high lettering.

③ 1/8 in high lettering.

### Legend Plates with Non-Standard Markings

#### When Ordering Specify

- Catalog number of blank plate.
- Insert the following into Order Notes: legend, letter size and locations. See information below.

#### Ordering Example:

Catalog no.: **HT85P76STAMP**  
 Letter size: 3/32 in (2.4 mm)  
 Pos. A—POWER HOUSE  
 Pos. B—START PUMP 1

#### Legend Characters Available

A B C D E F G H I J K L M N O  
 P Q R S T U V W X Y Z / - . , 1  
 2 3 4 5 6 7 8 9 0

### Legend Positions

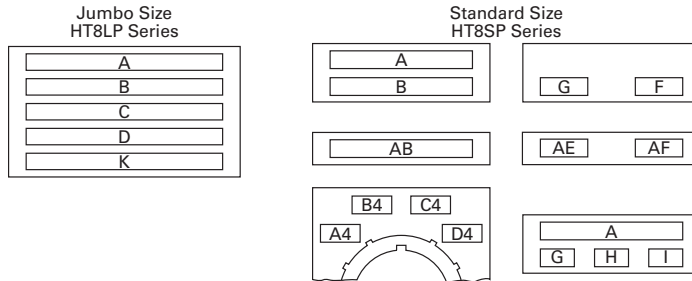

### Blank Plastic Legend Plates for Non-Standard Markings—Plastic

| Legend | Color of Field | Standard Catalog Number | Jumbo Catalog Number |
|--------|----------------|-------------------------|----------------------|
| Black  | White/Silver   | HT8SP76STAMP            | HT8LP76STAMP         |
| White  | Red/Black      | HT8SP77STAMP            | HT8LP77STAMP         |

### Maximum Characters per Legend Plate and Approximate Dimensions

| Top (Aluminum and Plastic) | Style  | Character Size |                      | 1/8 in High     |                      | 3/16 in High    |                      |
|----------------------------|--------|----------------|----------------------|-----------------|----------------------|-----------------|----------------------|
|                            |        | 3/32 in High   | Number of Characters | Number of Lines | Number of Characters | Number of Lines | Number of Characters |
| Standard                   | Square | 2              | 18                   | 2               | 13                   | 1               | 9                    |
| Jumbo ①                    | Square | 5              | 23                   | 3               | 18                   | 2               | 12                   |

#### Note

① Can be used on top row only of any enclosure.

## Contact Blocks

### NO Contact Block



### NC Contact Block



### Contact Blocks ①②

| Description/Function  | Contact Type | Without Guard Catalog Number | Fingerproof Catalog Number |
|---|--------------|------------------------------|----------------------------|
| Standard normally open contact  | NO           | <b>HT8A</b>                  | <b>HT8AP</b>               |
| Standard normally closed contact  | NC           | <b>HT8B</b>                  | <b>HT8BP</b>               |
| Normally open early make contact will make circuit before standard NO contact. DC ratings do not apply. | NOEM         | <b>HT8C</b>                  | <b>HT8CP</b>               |
| Normally closed late break contact will open after standard NC contact. DC ratings do not apply.        | NCLB         | <b>HT8D</b>                  | <b>HT8DP</b>               |
| Logic level, low voltage NO contact. Gold plated contacts.  | NO           | <b>HT8E</b>                  | <b>HT8EP</b>               |

### Contact Block Location (Viewed from Rear)

#### Suffix Codes ③④

| Left Side             | Right Side            |
|-----------------------|-----------------------|
| <b>A</b> = NO         | <b>A5</b> = NO        |
| <b>A2</b> = 2NO       | <b>A6</b> = 2NO       |
| <b>B1</b> = NC        | <b>B</b> = NC         |
| <b>B2</b> = 2NC       | <b>B6</b> = 2NC       |
| <b>C</b> = NOEM       | <b>C5</b> = NOEM      |
| <b>C2</b> = 2 NOEM    | <b>C6</b> = 2 NOEM    |
| <b>D1</b> = NCLB      | <b>D</b> = NCLB       |
| <b>D2</b> = 2 NCLB    | <b>D6</b> = 2 NCLB    |
| <b>E1</b> = NOEM-NCLB | <b>E5</b> = NOEM-NCLB |
| <b>F1</b> = NO and NC | <b>Q1</b> = NO and NC |
| <b>F4</b> = 1NO-1NC   |                       |

#### Notes

- ① See **Page V7-T1-316** for contact block electrical ratings.
- ② Maximum of four contact blocks per side or a total of eight contact blocks recommended.
- ③ Maximum of two contact blocks per side or a total of four contact blocks recommended.
- ④ Standard contact blocks without fingerproof protection.

**Replacement Parts**

**Replacement Bulbs and LEDs**

**Incandescent Bulb**



| Voltage             | Color | Catalog Number   |
|---------------------|-------|------------------|
| <b>Incandescent</b> |       |                  |
| 6V                  | —     | <b>HT8BULBV1</b> |
| 24V                 | —     | <b>HT8BULBV3</b> |
| 120V                | —     | <b>HT8BULBV7</b> |

**LED Bulb**



| Voltage  | Color        | Catalog Number   |
|--|--------------|------------------|
| <b>LED</b>   |              |                  |
| 6–12V<br>(For use with transformers with 6V secondary winding) | Red          | <b>HT8LEDRF1</b> |
|  | Green        | <b>HT8LEDGF1</b> |
|  | Amber/orange | <b>HT8LEDAF1</b> |
|  | White/clear  | <b>HT8LEDWF1</b> |
|  | Yellow       | <b>HT8LEDYF1</b> |
|  | Blue         | <b>HT8LEDBF1</b> |
| 24V  | Red          | <b>HT8LEDRF3</b> |
|  | Green        | <b>HT8LEDGF3</b> |
|  | Amber/orange | <b>HT8LEDAF3</b> |
|  | White/clear  | <b>HT8LEDWF3</b> |
|  | Yellow       | <b>HT8LEDYF3</b> |
|  | Blue         | <b>HT8LEDBF3</b> |
| 120V   | Red          | <b>HT8LEDRF7</b> |
|  | Green        | <b>HT8LEDGF7</b> |
|  | Amber/orange | <b>HT8LEDAF7</b> |
|  | White/clear  | <b>HT8LEDWF7</b> |
|  | Yellow       | <b>HT8LEDYF7</b> |
|  | Blue         | <b>HT8LEDBF7</b> |

**Replacement Lenses**

| Color  | Indicating Lights<br>Catalog Number | PresTest Lights<br>Illuminated Pushbuttons<br>Catalog Number |
|--------|-------------------------------------|--|
| Amber  | <b>HT8LA</b>                        | <b>HT8BA</b>   |
| Blue   | <b>HT8LB</b>                        | <b>HT8BB</b>   |
| Clear  | <b>HT8LC</b>                        | <b>HT8BC</b>   |
| Green  | <b>HT8LG</b>                        | <b>HT8BG</b>   |
| Red    | <b>HT8LR</b>                        | <b>HT8BR</b>   |
| White  | <b>HT8LW</b>                        | <b>HT8BW</b>   |
| Yellow | <b>HT8LY</b>                        | <b>HT8BY</b>   |



## Technical Data and Specifications

### HT800—Specifications

| Description                              | Specification  |
|--|--|
| <b>Mechanical Ratings</b>                |  |
| Frequency of operation                   |  |
| Pushbuttons                              | 6,000 operations per hour  |
| Selector switches                        | 3,000 operations per hour  |
| Push-pull operators                      | 3,000 operations per hour  |
| Mechanical endurance/life                |  |
| Pushbuttons                              | 10 x 10 <sup>6</sup> operations 6K ops/hr with 6 NO on left and 6 NC on right  |
| Selector switches                        | 250 x 10 <sup>3</sup> operations 3K ops/hr with 2 NO on left and 2 NC on right |
| Push-pull operators                      | 250 x 10 <sup>3</sup> operations 3K ops/hr with 6 NO on left and 6 NC on right |
| <b>Climatic Conditions</b>               |  |
| Operating temperature                    | 10° to 140°F (–12° to 60°C)  |
| Storage temperature                      | –40° to 176°F (–40° to 80°C)   |
| Altitude                                 | 6,562 ft (2,000m)  |
| Humidity                                 | 95% RH at 60°C   |
| <b>Terminals</b>                         |  |
| Contact blocks                           | #6-32 posidrive saddle clamp type, 1 x 16 AWG to 2 x 14 AWG, 12 in-lbs max.    |
| Light units                              | #6-32 posidrive saddle clamp type, 1 x 22 AWG to 2 x 14 AWG, 7 in-lbs max.     |
| <b>Electrical Ratings</b>                |  |
| Standard contact blocks UL (NEMA) rating | See table below.   |
| Logic level contact block power rating   | 5V 1 mA (minimum)<br>28V 500 mA (maximum)                                      |

### Electrical Ratings—HT800 Standard Contact Blocks, UL Rating

| Description/Function  | Contact Type | AC  | DC     | Catalog Number |
|---|--------------|---|--------|----------------|
| Standard normally open contact  | NO           | A600 ①                                    | P600 ② | <b>HT8A</b>    |
| Standard normally closed contact  | NC           | A600 ①                                    | P600 ② | <b>HT8B</b>    |
| Normally open early make contact will make circuit before standard NO contact. DC ratings do not apply. | NOEM         | A600 ①                                    | —      | <b>HT8C</b>    |
| Normally closed late break contact will open after standard NC contact. DC ratings do not apply.        | NCLB         | A600 ①                                    | —      | <b>HT8D</b>    |
| Logic level, low voltage NO contact. Gold plated contacts.  | NO           | 5V 1 mA (minimum)<br>28V 500 mA (maximum) |        | <b>HT8E</b>    |

### UL A600 and P600 Ratings

| Description                                 | 50 Vac or 60 Hz |      |      |      | Vdc ③ |       |       |
|---|-----------------|------|------|------|-------|-------|-------|
|   | 120             | 240  | 480  | 600  | 125   | 250   | 600   |
| Make and emerg. interrupting capacity (amp) | 60              | 30   | 15   | 12   | 1.1   | 0.55  | 0.2   |
| Normal load break (amp)                     | 6               | 3    | 1.5  | 1.2  | 1.1   | 0.55  | 0.2   |
| Thermal current (amp)                       | 10              | 10   | 10   | 10   | 5     | 5     | 5     |
| Voltamperes:                                |                 |      |      |      |       |       |       |
| Make and emerg. interrupting capacity       | 7200            | 7200 | 7200 | 7200 | 138 ④ | 138 ④ | 138 ④ |
| Normal load break                           | 720             | 720  | 720  | 720  | 138   | 138   | 138   |

#### Notes

- ① Heavy-duty.
- ② Standard-duty.
- ③ DC ratings do not apply to NOEM (Normally Open Early Make) and NCLB (Normal Closed Late Break) contact blocks HT8C and HT8D.
- ④ Maximum make or break volt-amperes at 300V or less.

### Dimensions

Approximate Dimensions in Inches (mm)

#### Momentary Pushbuttons—Non-Illuminated

Back, side and bottom views of pushbutton operator with attached contact blocks.

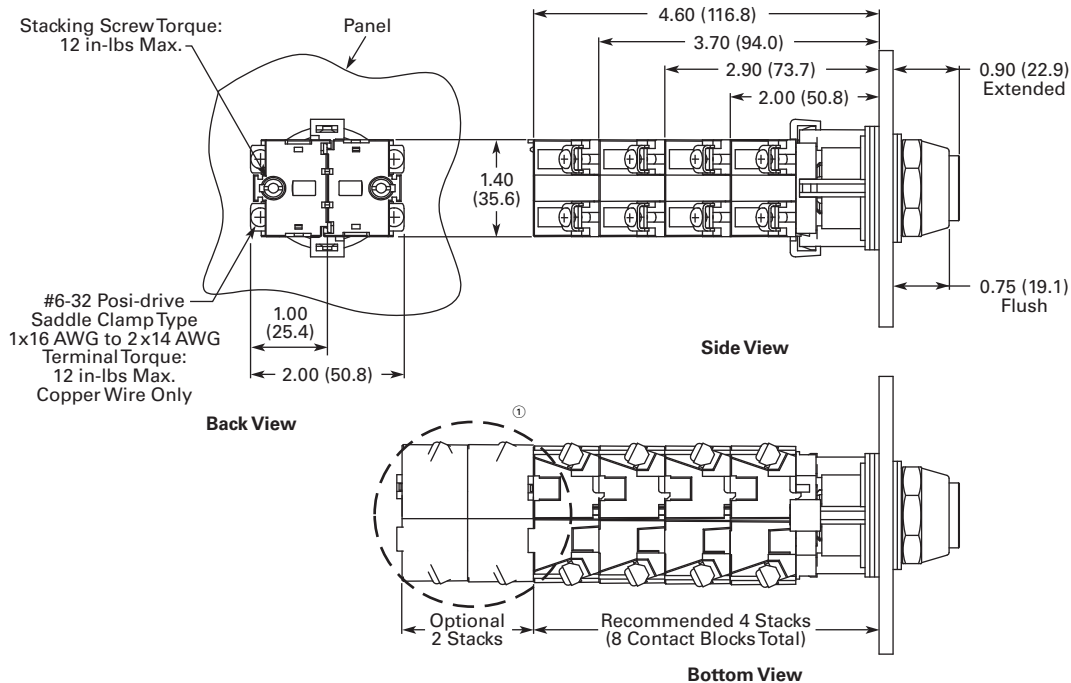

#### Illuminated Pushbuttons

Back, side and bottom views of pushbutton operator with attached contact blocks.

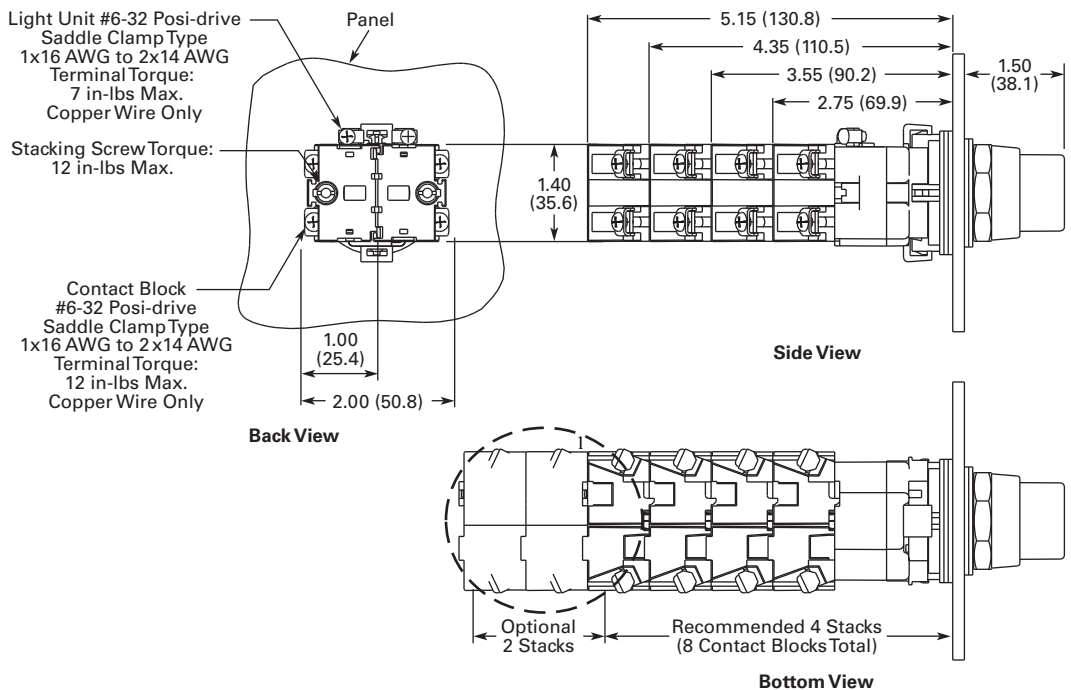

**Note**

① Recommended maximum of four tandem stacks of contact blocks behind operator. At users' discretion, two additional tandem stacks may be added.

# 1.10 Pushbuttons and Indicating Lights

## 30.5 mm Watertight/Oiltight—HT800

1

Approximate Dimensions in Inches (mm)

### Mushroom Head Pushbuttons and Round Head MRH Push-Pull Operators

Back, side and bottom views of mushroom head operator with attached contact blocks.

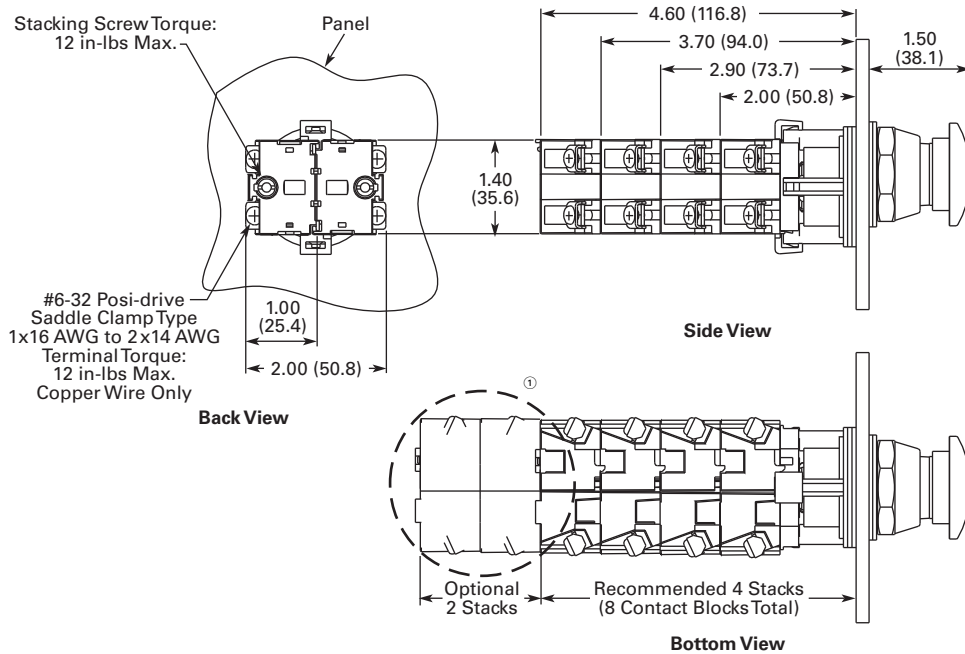

### Illuminated and Non-Illuminated Flat Head MRH Push-Pull Operators

Back, side and bottom views of push-pull operator with attached contact blocks.

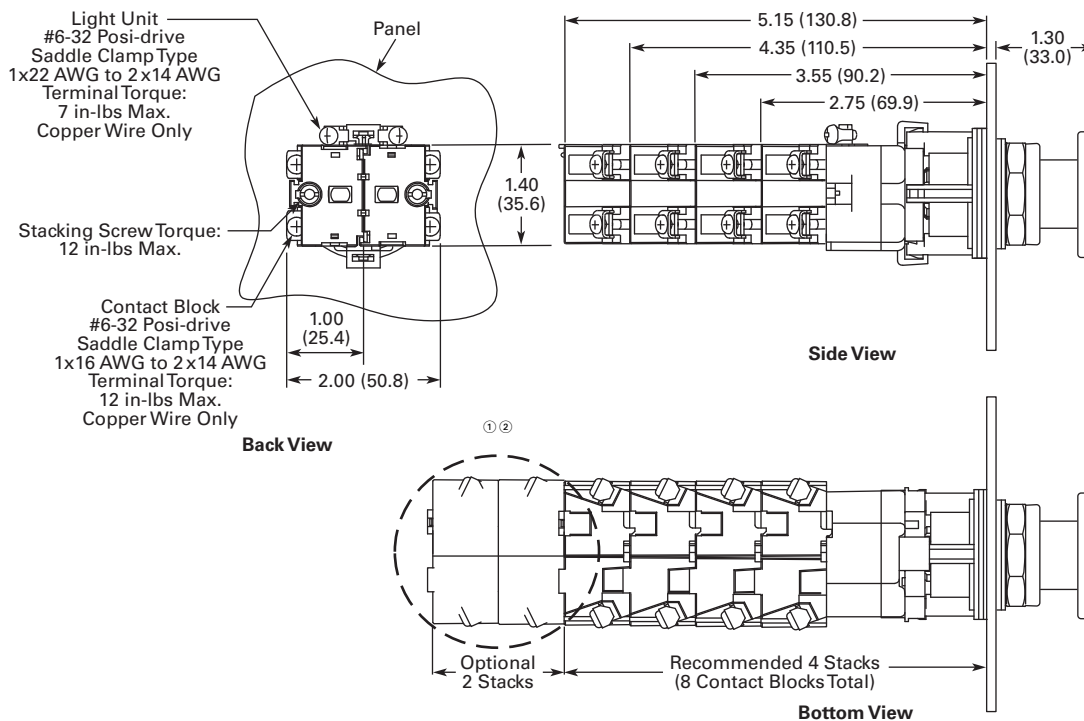

#### Notes

- ① Recommended maximum of four tandem stacks of contact blocks behind operator. At users' discretion, two additional tandem stacks may be added.
- ② Contact blocks mount directly to operator adaptor in non-illuminated version.

Approximate Dimensions in Inches (mm)

**Indicating Lights**

Back, side and bottom views of indicating light operator with attached contact blocks.

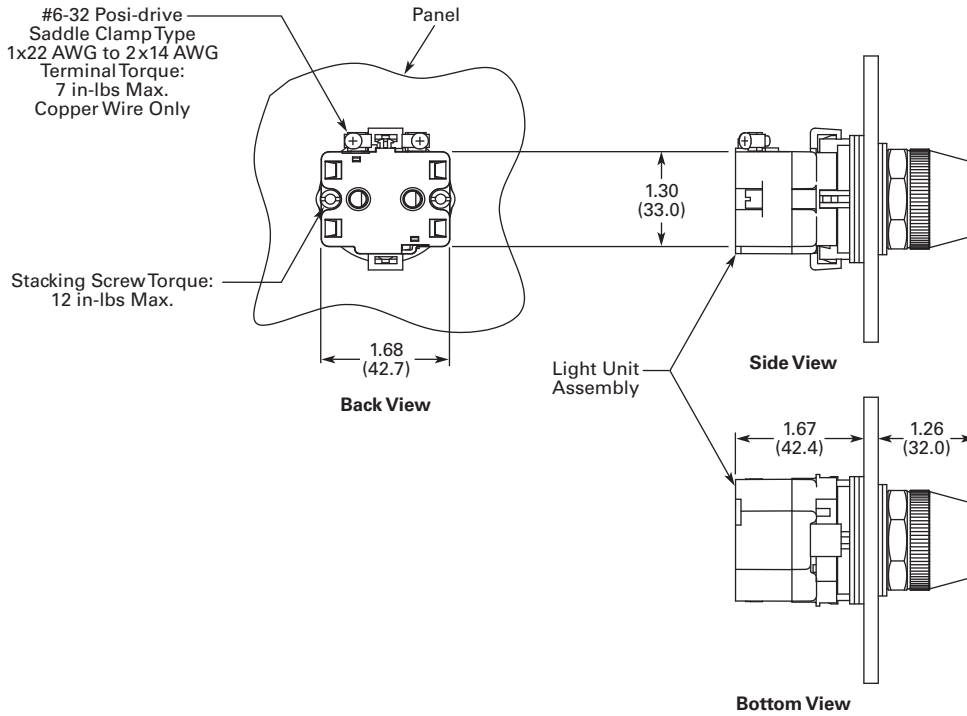

**Selector Switches**

Back, side and bottom views of selector switch operator with attached contact blocks.

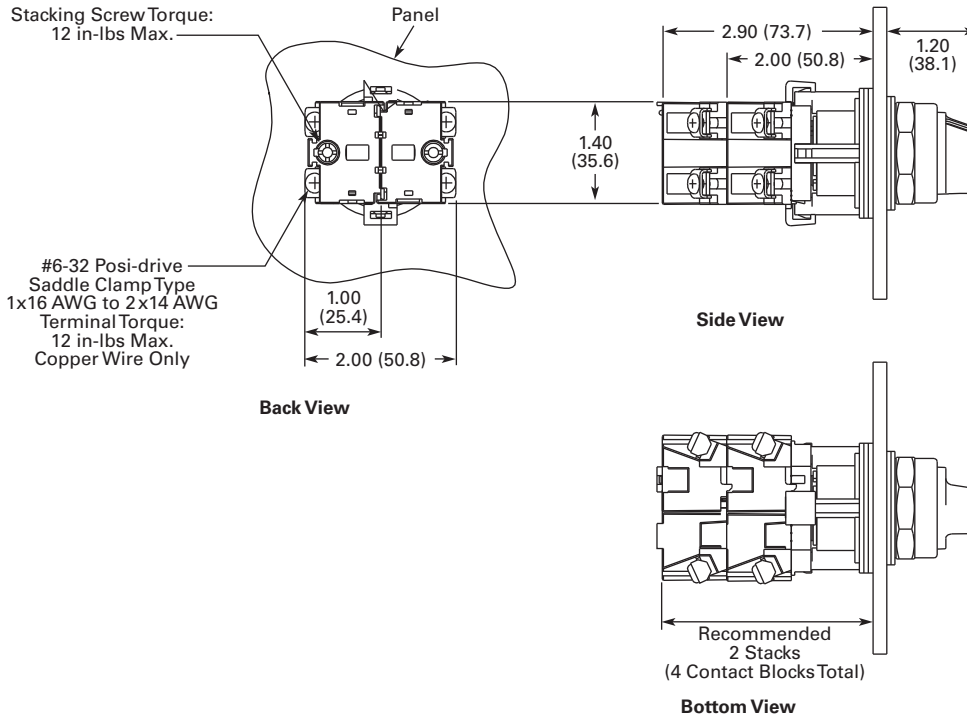

# 1.10 Pushbuttons and Indicating Lights

## 30.5 mm Watertight/Oiltight—HT800

1

Approximate Dimensions in Inches (mm)

### Mounting Matrix and Minimum Panel Spacing Requirements

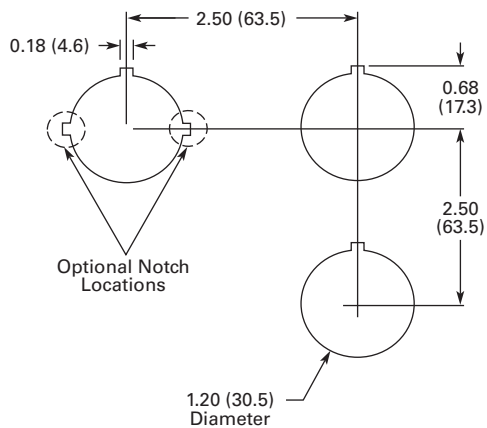

### Legend Plates

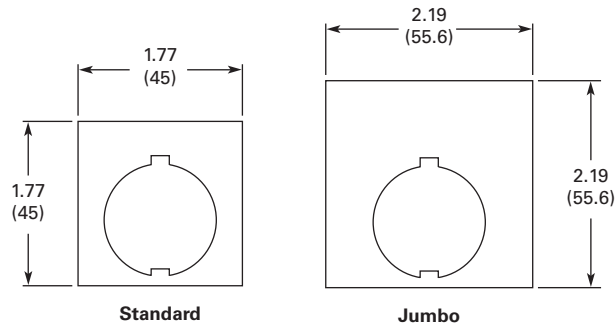

30.5 mm Class I Division 2 Hazardous Locations—10250T/E34



### Contents

| <i>Description</i>  | <i>Page</i>      |
|---|------------------|
| 30.5 mm Class I Division 2 Hazardous Locations—10250T/E34 |                  |
| Product Overview . . . . .                                | <b>V7-T1-322</b> |
| Product Identification . . . . .                          | <b>V7-T1-323</b> |
| Catalog Number Selection . . . . .                        | <b>V7-T1-323</b> |
| Product Selection   |                  |
| Momentary Pushbutton Units . . . . .                      | <b>V7-T1-324</b> |
| Non-Illuminated Pushbutton Units . . . . .                | <b>V7-T1-328</b> |
| Illuminated Pushbutton Units . . . . .                    | <b>V7-T1-330</b> |
| Guarded Illuminated Pushbutton Units . . . . .            | <b>V7-T1-331</b> |
| Indicating Light Units . . . . .                          | <b>V7-T1-332</b> |
| Illuminated Pushbuttons and Indicating Lights . . . . .   | <b>V7-T1-333</b> |
| Push-Pull Units . . . . .                                 | <b>V7-T1-335</b> |
| Illuminated Push-Pull Units . . . . .                     | <b>V7-T1-337</b> |
| Push-Pull Operators . . . . .                             | <b>V7-T1-340</b> |
| Selector Switch Units . . . . .                           | <b>V7-T1-344</b> |
| Selector Switch Selection . . . . .                       | <b>V7-T1-346</b> |
| Selector Switch Operators . . . . .                       | <b>V7-T1-349</b> |
| Illuminated Selector Switch Operators . . . . .           | <b>V7-T1-352</b> |
| Options . . . . .   | <b>V7-T1-354</b> |
| Technical Data and Specifications . . . . .               | <b>V7-T1-357</b> |
| Dimensions . . . . .                                      | <b>V7-T1-359</b> |
| Ratings . . . . .   | <b>V7-T1-360</b> |

### Product Description

#### All the Industry-Proven Quality of Eaton's 10250T and E34 Series of Logic Devices, plus Class I Division 2 Certification

The **10250T1H** consists of a normally open-normally closed factory sealed contact block that is UL Listed for use in Class I, Division 2, Groups B, C and D (NEC 500–503)—Class I, Zone 2, IIB + H2 (NEC 505) hazardous locations and is rated for both NEMA A600 and NEMA Q300. 10250T and E34 illuminated components have also been UL Listed for use in Class I, Division 2, Groups B, C and D (NEC 500–503)—Class I, Zone 2, IIB + H2 (NEC 505).

This, combined with the industry-proven Eaton 10250T 30.5 mm pushbutton line, offers a complete solution to Division 2 hazardous location requirements.

Single composite catalog numbers for complete assembled stations and operators for use in Division 2 hazardous locations are featured throughout this section.

### Features

- Factory sealed contact blocks
- Heavy-duty zinc die cast construction
- NEMA rated 1, 2, 3, 3R, 4, 4X, 12, 13
- Front-of-panel drainage holes
- Grounding nibs on the operator casing
- Solid thermosetting cathodic epoxy coating on E34
- Corrosion resistance in E34

### Benefits

- Pushbutton for hazardous locations
- Drainage holes prevent buildup of liquid inside the operator which can prevent operation in freezing environments
- Grounding nibs bite through paint and other coatings to provide secure ground
- Suitable for corrosive environments (E34 only)
- Earth terminal provides additional grounding point and allows for daisy chain grounding (E34 line)

### Standards and Certifications

- UL 508—File No. E131568
- UL 1604—File No. E10323
- CSA Certified C22.2 No.14—File No. LR 68551
- CSA Certified C22.2 No. 213-M1987—File No. LR 20713



### Ingress Protection

- Standard indicating lights
  - UL (NEMA) Type 3, 3R, 3S, 4, 4X, 12, 13
  - IEC IP65
- All other operators
  - UL (NEMA) Type 3, 3R, 4, 4X, 12, 13
  - IEC IP65

## Product Overview

### Operator

The 30.5 mm 10250T pushbutton line features a zinc die cast construction with chrome-plated housing and mounting nut.

Eaton's E34 Series 30.5 mm pushbutton line features the same rugged die cast construction of our 10250T line with an additional two-layer 100% solid thermosetting cathodic epoxy coating. This coating provides a flat black smooth, consistent, corrosion resistant surface that has passed a demanding 600 hour salt spray test. (The industry standard for this 4X test requires only 200 hours.)

### Ultraviolet Light

E34 epoxy coating is not recommended for use in applications where exposure to ultraviolet light exists—use NEMA 4X 10250T operators.

### Ratings

Our Class I Division 2 line of pushbuttons are UL Listed (NEMA type) 1, 2, 3, 3R, 4, 4X, 12 and 13. Our Class I Division 2 E34 line meets IEC 947-1 IP66 standards and the cathodic coating meets FDA 3A sanitary chemical resistance requirements. For a complete listing of all applicable ratings see **Pages V7-T1-357 to V7-T1-358.**

### 10250T Grounding Nibs

10250T line operators have "grounding nibs"—four metal points on the operator casting designed to bite through most paints and other coatings on metal panels to enhance the grounding connection when the operator is securely tightened.

### 10250T Grounding Nibs



### E34 Grounding Nibs

E34 line of operators is equipped with a ground screw terminal as part of its die cast construction. This earthing terminal provides an easily accessible point for grounding operators when used in a painted or nonmetallic enclosure and eliminates the need for extra kits when daisy chain grounding is required.

### E34 Grounding Nibs



### Diaphragm Seal with Drainage Holes

#### Liquid Drainage

Eaton's pushbutton operators offer front of panel drainage via holes in the operator bushing. Hidden from view by the mounting nut, these holes prevent buildup of liquid inside the operator, which can prevent operation in freezing environments. The holes also provide a route for escaping liquid in high pressure washdowns, effectively relieving pressure from the internal diaphragm seal, ensuring reliable sealing in applications even beyond NEMA 4.

### Diaphragm Seal

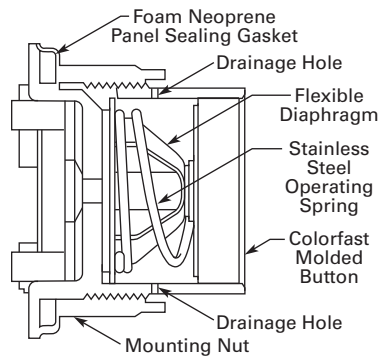

### Product Identification

#### 30.5 mm Class I Division 2 Hazardous Locations

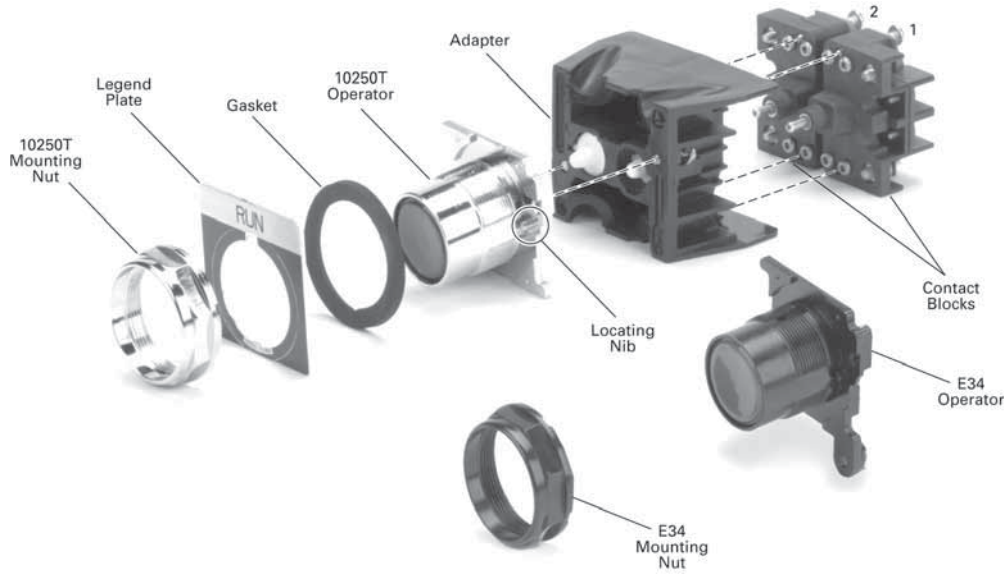

### Catalog Number Selection

Catalog Number Selection is for illustrative purposes only and not to be used to create new catalog numbers.

#### Non-Illuminated Assembled Operators

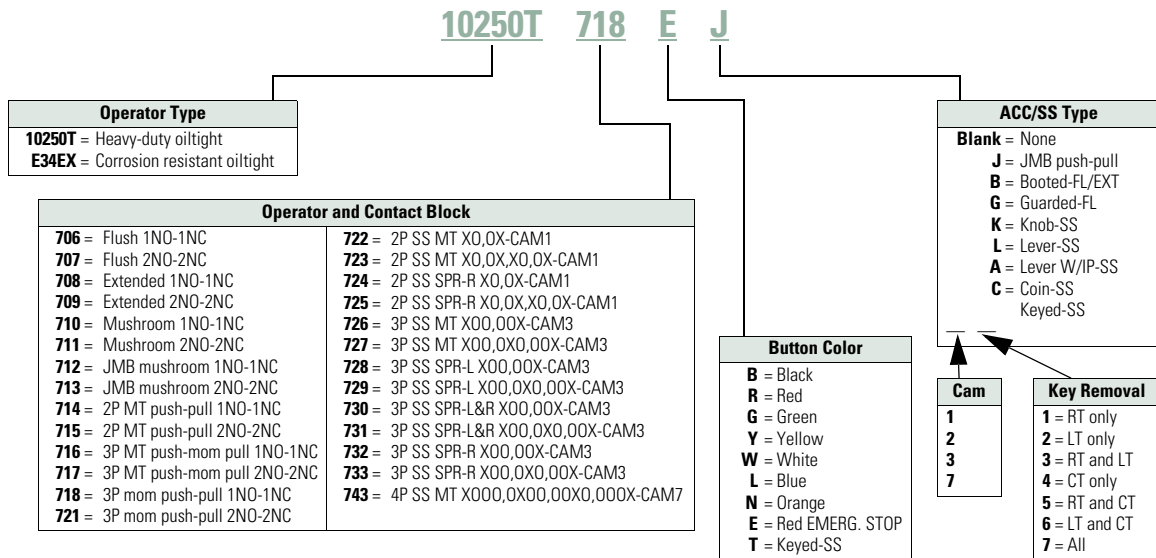



# 1

## Product Selection

### Momentary Pushbutton Units

UL (NEMA) Type 3, 3R, 4, 4X, 12, 13, NEC Class I Division 2, Groups B, C and D

#### 10250T Flush Button



#### E34 Flush Button



#### 10250T Extended Button



#### E34 Extended Button



### Non-Illuminated Flush and Extended Pushbuttons

| Contact Type | Button Color ① | Flush Button          |                    | Extended Button       |                    |                  |
|--------------|----------------|-----------------------|--------------------|-----------------------|--------------------|------------------|
|              |                | 10250T Catalog Number | E34 Catalog Number | 10250T Catalog Number | E34 Catalog Number |                  |
| 1NO-1NC      | Black          | <u>10250T706B</u>     | <u>E34EX706B</u>   | <u>10250T708B</u>     | <u>E34EX708B</u>   |                  |
|              | Red            | <u>10250T706R</u>     | <u>E34EX706R</u>   | <u>10250T708R</u>     | <u>E34EX708R</u>   |                  |
|              | Green          | <u>10250T706G</u>     | <u>E34EX706G</u>   | <u>10250T708G</u>     | <u>E34EX708G</u>   |                  |
|              | 2NO-2NC        | Black                 | <u>10250T707B</u>  | <u>E34EX707B</u>      | <u>10250T709B</u>  | <u>E34EX709B</u> |
|              |                | Red                   | <u>10250T707R</u>  | <u>E34EX707R</u>      | <u>10250T709R</u>  | <u>E34EX709R</u> |
|              |                | Green                 | <u>10250T707G</u>  | <u>E34EX707G</u>      | <u>10250T709G</u>  | <u>E34EX709G</u> |

### Color Selection

| Color  | Suffix Code | Color               | Suffix Code |
|--------|-------------|---------------------|-------------|
| Black  | <b>B</b>    | White               | <b>W</b>    |
| Red    | <b>R</b>    | Blue                | <b>L</b> ②  |
| Green  | <b>G</b>    | Orange ③            | <b>N</b>    |
| Yellow | <b>Y</b>    | Red (EMERG. STOP) ④ | <b>E</b>    |

#### Notes

Use NEMA 4X 10250T operators where exposed to ultraviolet light.

① To order different color guarded button, simply substitute the underlined character in catalog number with appropriate suffix code from Color Selection table above. Example: 10250T71Y.

② Blue not available on jumbo mushroom pushbutton.

③ Orange is only available on flush or extended pushbuttons.

④ Red with EMERG. STOP engraved on button head for jumbo mushroom pushbutton only.

UL (NEMA) Type 3, 3R, 4, 4X, 12, 13, NEC Class I Division 2, Groups B, C and D

**10250T Mushroom Button**



**E34 Mushroom Button**



**10250T Jumbo Mushroom Button**



**E34 Jumbo Mushroom Button**



### Non-Illuminated Mushroom and Jumbo Mushroom Pushbuttons

| Contact Type | Button Color <sup>①</sup> | Mushroom Button       | E34              | Jumbo Mushroom Button              | E34 <sup>②</sup> |
|--------------|---------------------------|-----------------------|------------------|------------------------------------|------------------|
|              |                           | 10250T Catalog Number | Catalog Number   | 10250T <sup>②</sup> Catalog Number | Catalog Number   |
| 1NO-1NC      | Black                     | <b>10250T710B</b>     | <b>E34EX710B</b> | <b>10250T712B</b>                  | <b>E34EX712B</b> |
|              | Red                       | <b>10250T710R</b>     | <b>E34EX710R</b> | <b>10250T712R</b>                  | <b>E34EX712R</b> |
|              | Green                     | <b>10250T710G</b>     | <b>E34EX710G</b> | <b>10250T712G</b>                  | <b>E34EX712G</b> |
| 2NO-2NC      | Black                     | <b>10250T711B</b>     | <b>E34EX711B</b> | <b>10250T713B</b>                  | <b>E34EX713B</b> |
|              | Red                       | <b>10250T711R</b>     | <b>E34EX711R</b> | <b>10250T713R</b>                  | <b>E34EX713R</b> |
|              | Green                     | <b>10250T711G</b>     | <b>E34EX711G</b> | <b>10250T713G</b>                  | <b>E34EX713G</b> |

### Color Selection

| Color  | Suffix Code | Color                          | Suffix Code           |
|--------|-------------|--------------------------------|-----------------------|
| Black  | <b>B</b>    | White                          | <b>W</b>              |
| Red    | <b>R</b>    | Blue                           | <b>L</b> <sup>③</sup> |
| Green  | <b>G</b>    | Orange <sup>④</sup>            | <b>N</b>              |
| Yellow | <b>Y</b>    | Red (EMERG. STOP) <sup>⑤</sup> | <b>E</b>              |

#### Notes

Use NEMA 4X 10250T operators where exposed to ultraviolet light.

<sup>①</sup> To order different color guarded button, simply substitute the underlined character in catalog number with appropriate suffix code from Color Selection table above. Example: 10250T710Y.

<sup>②</sup> Anodized aluminum head is not suitable for use in ultraviolet applications.

<sup>③</sup> Blue not available on jumbo mushroom pushbutton.

<sup>④</sup> Orange is only available on flush or extended pushbuttons.

<sup>⑤</sup> Red with EMERG. STOP engraved on button head for jumbo mushroom pushbutton only.

1

UL (NEMA) Type 3, 3R, 4, 4X, 12, 13, NEC Class I Division 2, Groups B, C and D

- Momentary contact
- Non-illuminated
- Booted or guarded

#### Booted Flush Button



#### Booted Extended Button



#### Guarded Extended Button



#### 10250T Pushbuttons Booted and Guarded

| Contact Type | Button Color | Booted Flush Button Catalog Number | Booted Extended Button Catalog Number | Guarded Extended Button <sup>①</sup> Catalog Number |
|--------------|--------------|------------------------------------|---------------------------------------|---|
| 1NO-1NC      | Black        | <b>10250T706BB</b>                 | <b>10250T708BB</b>                    | <b>10250T706BG</b>                                  |
|              | Red          | <b>10250T706RB</b> <sup>②</sup>    | <b>10250T708RB</b>                    | <b>10250T706RG</b>                                  |
|              | Green        | <b>10250T706GB</b>                 | <b>10250T708GB</b>                    | <b>10250T706GG</b>                                  |
| 2NO-2NC      | Black        | <b>10250T707BB</b>                 | <b>10250T709BB</b>                    | <b>10250T707BG</b>                                  |
|              | Red          | <b>10250T707RB</b> <sup>②</sup>    | <b>10250T709RB</b>                    | <b>10250T707RG</b>                                  |
|              | Green        | <b>10250T707GB</b>                 | <b>10250T709GB</b>                    | <b>10250T707GG</b>                                  |

#### Color Selection

| Color  | Suffix Code | Color  | Suffix Code |
|--------|-------------|--------|-------------|
| Black  | <b>B</b>    | White  | <b>W</b>    |
| Red    | <b>R</b>    | Blue   | <b>L</b>    |
| Green  | <b>G</b>    | Orange | <b>N</b>    |
| Yellow | <b>Y</b>    |        |             |

#### Notes

Use NEMA 4X 10250T operators where exposed to ultraviolet light.

<sup>①</sup> To order different color guarded button, simply substitute the underlined character in catalog number with appropriate suffix code from Color Selection table above. Example: 10250T706YG.

<sup>②</sup> Red booted flush pushbutton is not recommended for STOP function.

UL (NEMA) Type 3, 3R, 4, 4X, 12, 13, NEC Class I Division 2, Groups B, C and D

- Momentary contact
- Non-illuminated
- Booted or guarded

**Booted Flush Button**



**E34 Pushbuttons Booted and Guarded**

| Contact Type | Button Color | Booted Flush Button Catalog Number | Booted Extended Button Catalog Number | Guarded Extended Button <sup>①</sup> Catalog Number |
|--------------|--------------|------------------------------------|---------------------------------------|---|
| 1NO-1NC      | Black        | E34EX706BB                         | E34EX708BB                            | E34EX706BG  |
|              | Red          | E34EX706RB <sup>②</sup>            | E34EX708RB                            | E34EX706RG  |
|              | Green        | E34EX706GB                         | E34EX708GB                            | E34EX706GG  |
| 2NO-2NC      | Black        | E34EX707BB                         | E34EX709BB                            | E34EX707BG  |
|              | Red          | E34EX707RB <sup>②</sup>            | E34EX709RB                            | E34EX707RG  |
|              | Green        | E34EX707GB                         | E34EX709GB                            | E34EX707GG  |

**Booted Extended Button**



**Guarded Extended Button**



**Color Selection**

| Color  | Suffix Code | Color  | Suffix Code |
|--------|-------------|--------|-------------|
| Black  | <b>B</b>    | White  | <b>W</b>    |
| Red    | <b>R</b>    | Blue   | <b>L</b>    |
| Green  | <b>G</b>    | Orange | <b>N</b>    |
| Yellow | <b>Y</b>    |        |             |

**Notes**

Use NEMA 4X 10250T operators where exposed to ultraviolet light.

<sup>①</sup> To order different color guarded button, simply substitute the underlined character in catalog number with appropriate suffix code from Color Selection table above. Example: 10250T706YG.

<sup>②</sup> Red booted flush pushbutton is not recommended for STOP function.

#### 1

#### Non-Illuminated Pushbutton Units

UL (NEMA) Type 3, 3R, 4, 4X, 12, and 13

##### 10250T Flush Button



##### E34 Flush Button



##### 10250T Extended Button



##### E34 Extended Button



##### 10250T Half Shrouded Button



##### E34 Half Shrouded Button



#### Non-Illuminated Pushbuttons, Momentary Contact

| Color  | Flush Button                             |                          | Extended Button             |                          | Half Shrouded Button                    |                                 | E34                           |                                 |
|--------|--|--------------------------|-----------------------------|--------------------------|---|---------------------------------|-------------------------------|---------------------------------|
|        | 10250T <sup>①</sup><br>Catalog<br>Number | E34<br>Catalog<br>Number | 10250T<br>Catalog<br>Number | E34<br>Catalog<br>Number | 10250T<br>Vertical<br>Catalog<br>Number | Horizontal<br>Catalog<br>Number | Vertical<br>Catalog<br>Number | Horizontal<br>Catalog<br>Number |
| Black  | 10250T101                                | E34PB1                   | 10250T111                   | E34EB1                   | 10250T501                               | 10250T511                       | E34EVB1                       | E34EHB1                         |
| Red    | 10250T102                                | E34PB2                   | 10250T112                   | E34EB2                   | 10250T502                               | 10250T512                       | E34EVB2                       | E34EHB2                         |
| Green  | 10250T103                                | E34PB3                   | 10250T113                   | E34EB3                   | 10250T503                               | 10250T513                       | E34EVB3                       | E34EHB3                         |
| Yellow | 10250T104                                | E34PB4                   | 10250T120                   | E34EB4                   | 10250T504                               | 10250T514                       | E34EVB4                       | E34EHB4                         |
| Gray   | 10250T105                                | E34PB5                   | —                           | E34EB5                   | 10250T505                               | 10250T515                       | E34EVB5                       | E34EHB5                         |
| White  | 10250T106                                | E34PB6                   | 10250T116                   | E34EB6                   | 10250T506                               | 10250T516                       | E34EVB6                       | E34EHB6                         |
| Blue   | 10250T108                                | E34PB7                   | 10250T118                   | E34EB7                   | 10250T508                               | 10250T518                       | E34EVB7                       | E34EHB7                         |
| Orange | 10250T109                                | E34PB8                   | 10250T119                   | E34EB8                   | 10250T509                               | 10250T519                       | E34EVB8                       | E34EHB8                         |

#### Notes

Use NEMA 4X 10250T operators where exposed to ultraviolet light.

<sup>①</sup> To order operator with factory assembled extended retaining nut, 10250TA12, for thick panel applications, add suffix letter **E** to listed catalog number.

UL (NEMA) Type 3, 3R, 4, 4X, 12, and 13

**10250T Mushroom Button**



**Mushroom Head Non-Illuminated Pushbuttons, Momentary Contact**

| Color             | Mushroom Button       |                    | Anodized Aluminum Jumbo Mushroom Button |                                 |
|-------------------|-----------------------|--------------------|---|---------------------------------|
|                   | 10250T Catalog Number | E34 Catalog Number | 10250T <sup>①</sup> Catalog Number      | E34 <sup>②</sup> Catalog Number |
| Black             | 10250T121             | E34LB1             | 10250T171                               | E34JB1                          |
| Red               | 10250T122             | E34LB2             | 10250T172                               | E34JB2                          |
| Red (EMERG. STOP) | —                     | —                  | 10250T17213                             | E34JB2N8                        |
| Green             | 10250T123             | E34LB3             | 10250T173                               | E34JB3                          |
| Yellow            | 10250T124             | E34LB4             | 10250T174                               | E34JB4                          |
| Blue              | 10250T129             | E34LB6             | —                                       | —                               |

**E34 Mushroom Button**



**10250T Jumbo Mushroom Button**



**E34 Jumbo Mushroom Button**



**Notes**

- Use NEMA 4X 10250T operators where exposed to ultraviolet light.
- ① Anodized aluminum head is not suitable for use in ultraviolet light applications.
- ② Anodized aluminum head may not be suitable for some corrosive environments.

#### 1

### Illuminated Pushbutton Units

UL (NEMA) Type 3, 3R, 4, 4X, 12, 13, NEC Class I Division 2, Groups B, C and D

- Momentary contact
- Illuminated
- Plastic lenses

#### 10250T\_



#### E34EX\_



### Illuminated Pushbuttons

| Type                     | Voltage     | Color | Contact | 10250T LED/Lamp Number | Catalog Number ①     | E34 LED/Lamp Number   | Catalog Number ①    |
|--------------------------|-------------|-------|---------|------------------------|----------------------|-----------------------|---------------------|
| <b>LED Lamp</b>          |             |       |         |                        |                      |                       |                     |
| Full voltage             | 24 Vac/Vdc  | Red   | 1NO-1NC | Bayonet base           | <b>10250T828RD24</b> | Bayonet base          | <b>E34EX828RD24</b> |
|                          |             | Green |         |                        | <b>10250T828GD24</b> |                       | <b>E34EX828GD24</b> |
|                          |             | Amber |         |                        | <b>10250T828AD24</b> |                       | <b>E34EX828AD24</b> |
| Transformer              | 120 Vac     | Red   | 1NO-1NC |                        | <b>10250T828RD2A</b> |                       | <b>E34EX828RD2A</b> |
|                          |             | Green |         |                        | <b>10250T828GD2A</b> |                       | <b>E34EX828GD2A</b> |
|                          |             | Amber |         |                        | <b>10250T828AD2A</b> |                       | <b>E34EX828AD2A</b> |
| Transformer              | 120 Vac     | Red   | 1NO-1NC |                        | <b>10250T802RD06</b> | Bayonet base<br>6 Vac | <b>E34EX802RD06</b> |
|                          |             | Green |         |                        | <b>10250T802GD06</b> |                       | <b>E34EX802GD06</b> |
|                          |             | Amber |         |                        | <b>10250T802AD06</b> |                       | <b>E34EX802AD06</b> |
| <b>Incandescent Lamp</b> |             |       |         |                        |                      |                       |                     |
| Full voltage             | 24 Vac/Vdc  | Red   | 1NO-1NC | #757                   | <b>10250T818RD</b>   | #757                  | <b>E34EX818RD</b>   |
|                          |             | Green |         |                        | <b>10250T818GD</b>   |                       | <b>E34EX818GD</b>   |
|                          |             | Amber |         |                        | <b>10250T818AD</b>   |                       | <b>E34EX818AD</b>   |
| Resistor                 | 120 Vac/Vdc | Red   | 1NO-1NC | 120MB                  | <b>10250T824RD</b>   | 120MB                 | <b>E34EX824RD</b>   |
|                          |             | Green |         |                        | <b>10250T824GD</b>   |                       | <b>E34EX824GD</b>   |
|                          |             | Amber |         |                        | <b>10250T824AD</b>   |                       | <b>E34EX824AD</b>   |
| Transformer              | 120 Vac     | Red   | 1NO-1NC | #755                   | <b>10250T802RD</b>   | #755<br>6 Vac         | <b>E34EX802RD</b>   |
|                          |             | Green |         |                        | <b>10250T802GD</b>   |                       | <b>E34EX802GD</b>   |
|                          |             | Amber |         |                        | <b>10250T802AD</b>   |                       | <b>E34EX802AD</b>   |

#### 10250TC\_



#### E34V\_



### Lens Selection

| Color         | Suffix Code | Catalog Number   | Color      | Suffix Code | Catalog Number |
|---------------|-------------|------------------|------------|-------------|----------------|
| <b>10250T</b> |             |                  | <b>E34</b> |             |                |
| Red           | <b>R</b>    | <b>10250TC21</b> | Red        | <b>R</b>    | <b>E34V2</b>   |
| Green         | <b>G</b>    | <b>10250TC22</b> | Green      | <b>G</b>    | <b>E34V3</b>   |
| Yellow        | <b>Y</b>    | <b>10250TC23</b> | Yellow     | <b>Y</b>    | <b>E34V4</b>   |
| Amber         | <b>A</b>    | <b>10250TC43</b> | Amber      | <b>A</b>    | <b>E34V9</b>   |
| Blue          | <b>L</b>    | <b>10250TC24</b> | Blue       | <b>L</b>    | <b>E34V6</b>   |
| Clear         | <b>C</b>    | <b>10250TC25</b> | Clear      | <b>C</b>    | <b>E34V0</b>   |
| White         | <b>W</b>    | <b>10250TC26</b> | White      | <b>W</b>    | <b>E34V5</b>   |

#### Note

① To order different color lens, simply substitute the underlined character in the catalog number with appropriate suffix code from Lens Selection table above. Example: 10250T828YD24.

### Guarded Illuminated Pushbutton Units

UL (NEMA) Type 3, 3R, 4, 4X, 12, 13, NEC Class I Division 2, Groups B, C and D

- Momentary contact
- Guarded illuminated
- Plastic lenses

#### 10250T8\_



### Guarded Illuminated Pushbuttons

| Type                     | Voltage     | Color | Contact | 10250T LED/Lamp Number | Catalog Number ①     | E34 LED/Lamp Number | Catalog Number ①    |
|--------------------------|-------------|-------|---------|------------------------|----------------------|---------------------|---------------------|
| <b>LED Lamp</b>          |             |       |         |                        |                      |                     |                     |
| Full voltage             | 24 Vac/Vdc  | Red   | 1NO-1NC | Bayonet base           | <u>10250T828RG24</u> | Bayonet base        | <u>E34EX828RG24</u> |
|                          |             | Green |         |                        | 10250T828GG24        |                     | E34EX828GG24        |
|                          |             | Amber |         |                        | 10250T828AG24        |                     | E34EX828AG24        |
| Transformer              | 120 Vac     | Red   | 1NO-1NC |                        | <u>10250T828RG2A</u> |                     | <u>E34EX828RG2A</u> |
|                          |             | Green |         |                        | 10250T828GG2A        | E34EX828GG2A        |                     |
|                          |             | Amber |         |                        | 10250T828AG2A        | E34EX828AG2A        |                     |
| Transformer              | 120 Vac     | Red   | 1NO-1NC |                        | <u>10250T802RG06</u> |                     | <u>E34EX802RG06</u> |
|                          |             | Green |         |                        | 10250T802GG06        | E34EX802GG06        |                     |
|                          |             | Amber |         |                        | 10250T802AG06        | E34EX802AG06        |                     |
| <b>Incandescent Lamp</b> |             |       |         |                        |                      |                     |                     |
| Full voltage             | 24 Vac/Vdc  | Red   | 1NO-1NC | #757                   | <u>10250T818RG</u>   | #757                | <u>E34EX818RG</u>   |
|                          |             | Green |         |                        | 10250T818GG          |                     | E34EX818GG          |
|                          |             | Amber |         |                        | 10250T818AG          |                     | E34EX818AG          |
| Resistor                 | 120 Vac/Vdc | Red   | 1NO-1NC | 120MB                  | <u>10250T824RG</u>   | 120MB               | <u>E34EX824RG</u>   |
|                          |             | Green |         |                        | 10250T824GG          |                     | E34EX824GG          |
|                          |             | Amber |         |                        | 10250T824AG          |                     | E34EX824AG          |
| Transformer              | 120 Vac     | Red   | 1NO-1NC | #755                   | <u>10250T802RG</u>   | #755<br>6 Vac       | <u>E34EX802RG</u>   |
|                          |             | Green |         |                        | 10250T802GG          |                     | E34EX802GG          |
|                          |             | Amber |         |                        | 10250T802AG          |                     | E34EX802AG          |

#### E34EX8\_



#### 10250TC2\_



### Lens Selection

| Color         | Suffix Code | Catalog Number   | Color      | Suffix Code | Catalog Number |
|---------------|-------------|------------------|------------|-------------|----------------|
| <b>10250T</b> |             |                  | <b>E34</b> |             |                |
| Red           | <b>R</b>    | <u>10250TC21</u> | Red        | <b>R</b>    | <u>E34V2</u>   |
| Green         | <b>G</b>    | <u>10250TC22</u> | Green      | <b>G</b>    | <u>E34V3</u>   |
| Yellow        | <b>Y</b>    | <u>10250TC23</u> | Yellow     | <b>Y</b>    | <u>E34V4</u>   |
| Amber         | <b>A</b>    | <u>10250TC43</u> | Amber      | <b>A</b>    | <u>E34V9</u>   |
| Blue          | <b>L</b>    | <u>10250TC24</u> | Blue       | <b>L</b>    | <u>E34V6</u>   |
| Clear         | <b>C</b>    | <u>10250TC25</u> | Clear      | <b>C</b>    | <u>E34V0</u>   |
| White         | <b>W</b>    | <u>10250TC26</u> | White      | <b>W</b>    | <u>E34V5</u>   |

#### E34V\_



**Note**

① To order different color lens, simply substitute the underlined character in the catalog number with appropriate suffix code from Lens Selection table above. Example: 10250T828YD24.



# 1

## Indicating Light Units

UL (NEMA) Type 3, 3R, 3S, 4, 4X, 12, 13, NEC Class I Division 2, Groups B, C and D

- Standard
- Plastic lenses

### 10250T\_



### E34\_



## Indicating Lights

| Type            | Voltage                  | Color      | LED/Lamp Number        | 10250T Catalog Number ① | E34 Catalog Number ①  |                   |
|-----------------|--------------------------|------------|------------------------|-------------------------|-----------------------|-------------------|
| <b>LED Lamp</b> |                          |            |                        |                         |                       |                   |
| Full voltage    | 24 Vac/Vdc               | Red        | Bayonet base           | <u>10250T197HLRP24</u>  | <u>E34FB197HLRP24</u> |                   |
|                 |                          | Green      |                        | <u>10250T197HLGP24</u>  | <u>E34FB197HLGP24</u> |                   |
|                 |                          | Amber      |                        | <u>10250T197HLAP24</u>  | <u>E34FB197HLAP24</u> |                   |
|                 | 120 Vac                  | Red        | <u>10250T197HLRP2A</u> | <u>E34FB197HLRP2A</u>   |                       |                   |
|                 |                          | Green      | <u>10250T197HLGP2A</u> | <u>E34FB197HLGP2A</u>   |                       |                   |
|                 |                          | Amber      | <u>10250T197HLAP2A</u> | <u>E34FB197HLAP2A</u>   |                       |                   |
| Transformer     | 120 Vac                  | Red        |                        | <u>10250T181HLRP06</u>  | <u>E34TB120HLRP06</u> |                   |
|                 |                          | Green      |                        | <u>10250T181HLGP06</u>  | <u>E34TB120HLGP06</u> |                   |
|                 |                          | Amber      |                        | <u>10250T181HLAP06</u>  | <u>E34TB120HLAP06</u> |                   |
|                 | <b>Incandescent Lamp</b> |            |                        |                         |                       |                   |
|                 | Full voltage             | 24 Vac/Vdc | Red                    | #757                    | <u>10250T206HRP</u>   | <u>E34FB24HRP</u> |
|                 |                          |            | Green                  |                         | <u>10250T206HGP</u>   | <u>E34FB24HGP</u> |
| Amber           |                          |            |                        | <u>10250T206HAP</u>     | <u>E34FB24HAP</u>     |                   |
| Resistor        | 120 Vac/Vdc              | Red        | 120MB                  | <u>10250T201HRP</u>     | <u>E34RB120HRP</u>    |                   |
|                 |                          | Green      |                        | <u>10250T201HGP</u>     | <u>E34RB120HGP</u>    |                   |
|                 |                          | Amber      |                        | <u>10250T201HAP</u>     | <u>E34RB120HAP</u>    |                   |
| Transformer     | 120 Vac                  | Red        | #755                   | <u>10250T181HRP</u>     | <u>E34TB120HRP</u>    |                   |
|                 |                          | Green      |                        | <u>10250T181HGP</u>     | <u>E34TB120HGP</u>    |                   |
|                 |                          | Amber      |                        | <u>10250T181HAP</u>     | <u>E34TB120HAP</u>    |                   |

### Plastic



### Glass



## Lens Selection

| Color         | Plastic Suffix Code | Catalog Number | Glass Suffix Code | Catalog Number | Color      | Plastic Suffix Code | Catalog Number | Glass Suffix Code | Catalog Number |
|---------------|---------------------|----------------|-------------------|----------------|------------|---------------------|----------------|-------------------|----------------|
| <b>10250T</b> |                     |                |                   |                | <b>E34</b> |                     |                |                   |                |
| Red           | RP                  | 10250TC1N      | RG                | 10250TC7N      | Red        | RP                  | E34H2          | RG                | E34G2          |
| Green         | GP                  | 10250TC2N      | GG                | 10250TC8N      | Green      | GP                  | E34H3          | GG                | E34G3          |
| Amber         | AP                  | 10250TC19N     | AG                | 10250TC9N      | Amber      | AP                  | E34H9          | AG                | E34G9          |
| Yellow        | YP                  | 10250TC3N      | —                 | —              | Yellow     | YP                  | E34H4          | YG                | E34G4          |
| Blue          | LP                  | 10250TC4N      | LG                | 10250TC10N     | Blue       | LP                  | E34H6          | LG                | E34G6          |
| Clear         | CP                  | 10250TC5N      | CG                | 10250TC11N     | Clear      | CP                  | E34H0          | CG                | E34G0          |
| White         | WP                  | 10250TC6N      | WG                | 10250TC12N     | White      | WP                  | E34H5          | WG                | E34G5          |

### Notes

Use NEMA 4X 10250T operators where exposed to ultraviolet light.

① To order different color lens, simply substitute the underlined characters in the catalog number with appropriate suffix code from the Lens Selection table above.  
Example: 10250T201HYP.

**Illuminated Pushbuttons and Indicating Lights**

NEC Class I Division 2, Groups B, C and D

**Operators without Lenses**

**10250T Illuminated Pushbutton**



**E34 Illuminated Pushbutton**



**10250T Indicating Light**



**E34 Indicating Light**



| Type   | Voltage | LED/Lamp Number | Illuminated Pushbutton |                    | Indicating Light      |                    |
|--|---------|-----------------|------------------------|--------------------|-----------------------|--------------------|
|  |         |                 | 10250T Catalog Number  | E34 Catalog Number | 10250T Catalog Number | E34 Catalog Number |
| <b>LED Light Unit Type (LEDs not included) ①</b> |         |                 |                        |                    |                       |                    |
| Full voltage                                     | —       | Bayonet base    | <b>10250T397HL</b>     | <b>E34CB497HL</b>  | <b>10250T197HL</b>    | <b>E34FB197HL</b>  |
| Transformer AC only                              | 24      |                 | <b>10250T416HL</b>     | <b>E34XB024HL</b>  | —                     | —                  |
|  | 120     |                 | <b>10250T411HL</b>     | <b>E34XB120HL</b>  | <b>10250T181HL</b>    | <b>E34TB120HL</b>  |
|  | 240     |                 | <b>10250T412HL</b>     | <b>E34XB240HL</b>  | <b>10250T182HL</b>    | <b>E34TB240HL</b>  |
|  | 277     |                 | <b>10250T419HL</b>     | <b>E34XB277HL</b>  | <b>10250T198HL</b>    | <b>E34TB277HL</b>  |
|  | 380     |                 | <b>10250T413HL</b>     | <b>E34XB380HL</b>  | <b>10250T183HL</b>    | <b>E34TB380HL</b>  |
|  | 480     |                 | <b>10250T414HL</b>     | <b>E34XB480HL</b>  | <b>10250T184HL</b>    | <b>E34TB480HL</b>  |
|  | 600     |                 | <b>10250T415HL</b>     | <b>E34XB600HL</b>  | <b>10250T185HL</b>    | <b>E34TB600HL</b>  |
| <b>Incandescent Light Unit Type</b>              |         |                 |                        |                    |                       |                    |
| Full voltage AC/DC                               | 6       | #755            | <b>10250T473H</b>      | <b>E34CB06H</b>    | <b>10250T203H</b>     | <b>E34FB06H</b>    |
|  | 12      | #756            | <b>10250T474H</b>      | <b>E34CB12H</b>    | <b>10250T204H</b>     | <b>E34FB12H</b>    |
|  | 24      | #757            | <b>10250T476H</b>      | <b>E34CB24H</b>    | <b>10250T206H</b>     | <b>E34FB24H</b>    |
|  | 32      | #1828           | <b>10250T477H</b>      | <b>E34CB32H</b>    | <b>10250T207H</b>     | <b>E34FB32H</b>    |
|  | 48      | #1835           | <b>10250T478H</b>      | <b>E34CB48H</b>    | <b>10250T208H</b>     | <b>E34FB48H</b>    |
| Resistor ② AC/DC                                 | 120     | 120MB           | <b>10250T471H</b>      | <b>E34SB120H</b>   | <b>10250T201H</b>     | <b>E34RB120H</b>   |
|  | 240     | 120MB           | <b>10250T472H</b>      | <b>E34SB240H</b>   | <b>10250T202H</b>     | <b>E34RB240H</b>   |
| Transformer AC only                              | 24      | #755            | <b>10250T416H</b>      | <b>E34XB024H</b>   | —                     | —                  |
|  | 120     |                 | <b>10250T411H</b>      | <b>E34XB120H</b>   | <b>10250T181H</b>     | <b>E34TB120H</b>   |
|  | 240     |                 | <b>10250T412H</b>      | <b>E34XB240H</b>   | <b>10250T182H</b>     | <b>E34TB240H</b>   |
|  | 277     |                 | <b>10250T419H</b>      | <b>E34XB277H</b>   | <b>10250T198H</b>     | <b>E34TB277H</b>   |
|  | 380     |                 | <b>10250T413H</b>      | <b>E34XB380H</b>   | <b>10250T183H</b>     | <b>E34TB380H</b>   |
|  | 480     |                 | <b>10250T414H</b>      | <b>E34XB480H</b>   | <b>10250T184H</b>     | <b>E34TB480H</b>   |
|  | 600     |                 | <b>10250T415H</b>      | <b>E34XB600H</b>   | <b>10250T185H</b>     | <b>E34TB600H</b>   |
| Neon AC/DC                                       | 120     | NE51H-R-22      | —                      | —                  | <b>10250T226H</b>     | <b>E34NB120H</b>   |
|  | 240     | NE51H-4-68      | —                      | —                  | <b>10250T227H</b>     | <b>E34NB240H</b>   |

**Notes**

Use NEMA 4X 10250T operators where exposed to ultraviolet light.

① These units do not include lamps. Order LED separately to match lens color from the LED Selection table on **Page V7-T1-343**.

② Resistor units are not available for use with LEDs, choose either transformer or full voltage LED style.

#### Indicating Light Lenses

|   | Color        | 10250T<br>Catalog Number | E34<br>Catalog Number |  |
|---|--------------|--------------------------|-----------------------|--|
| <b>Plastic</b>                            |              |                          |                       |  |
| <br>10250TC_<br><br>E34H_                 | Red          | 10250TC1N                | E34H2                 |  |
|   | Green        | 10250TC2N                | E34H3                 |  |
|   | Amber        | 10250TC19N               | E34H9                 |  |
|   | Yellow       | 10250TC3N                | E34H4                 |  |
|   | Blue         | 10250TC4N                | E34H6                 |  |
|   | Clear        | 10250TC5N                | E34H0                 |  |
| <b>Glass</b><br><br>10250TC_<br><br>E34G_ | White        | 10250TC6N                | E34H5                 |  |
|   | <b>Glass</b> |                          |                       |  |
|   | Red          | 10250TC7N                | E34G2                 |  |
|   | Green        | 10250TC8N                | E34G3                 |  |
|   | Amber        | 10250TC9N                | E34G9                 |  |
|   | Yellow       | —                        | E34G4                 |  |
| Blue                                      | 10250TC10N   | E34G6                    |                       |  |
| Clear                                     | 10250TC11N   | E34G0                    |                       |  |
| White                                     | 10250TC12N   | E34G5                    |                       |  |

#### Illuminated Pushbutton Lenses

|                           | Color  | 10250T<br>Catalog Number | E34<br>Catalog Number |
|---------------------------|--------|--------------------------|-----------------------|
| <br>10250TC_<br><br>E34V_ | Red    | 10250TC21                | E34V2                 |
|                           | Green  | 10250TC22                | E34V3                 |
|                           | Yellow | 10250TC23                | E34V4                 |
|                           | Amber  | 10250TC43                | E34V9                 |
|                           | Blue   | 10250TC24                | E34V6                 |
|                           | Clear  | 10250TC25                | E34V0                 |
|                           | White  | 10250TC26                | E34V5                 |

### Push-Pull Units

UL (NEMA) Type 3, 3R, 4, 4X, 12, 13, NEC Class I Division 2, Groups B, C and D

- Two- and three-position
- Non-illuminated

10250T71\_

#### Two-Position Maintained Push, Maintained Pull



Operator Function (Position) ①

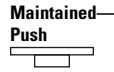
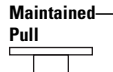

Contact Type

Mounting Location ①



Red Standard Push-Pull ②

10250T  
Catalog Number

E34  
Catalog Number

0  
X

X  
0

1NO  
1NC

10250T714R

E34EX714R

E34EX71\_



0  
X  
0  
X

X  
0  
X  
0

2NO  
2NC



10250T715R

E34EX715R

10250T71\_

#### Three-Position Maintained Push, Momentary Pull



Operator Function (Position) ①



Contact Type

Mounting Location ①



Red Standard Push-Pull ③

10250T  
Catalog Number

E34  
Catalog Number

0  
X

0  
0

X  
0

1NO  
1NC

10250T716R

E34EX716R

E34EX71\_



X  
X

0  
X

0  
0

1NC  
1NC



10250T717R

E34EX717R

#### Notes

① Bolded circuit corresponds to "X-0" circuit selection. X = closed circuit, 0 = open circuit.

② To order different type or color buttons, simply substitute underlined character with appropriate suffix code from the Button and Color Selection table on **Page V7-T1-336**. Example: 10250T714G.

③ To order different type or color buttons, simply substitute underlined character with appropriate suffix code from the Button and Color Selection table on **Page V7-T1-336**. Example: 10250T716G.

1

UL (NEMA) Type 3, 3R, 4, 4X, 12, 13, NEC Class I Division 2, Groups B, C and D

- Two- and three-position
- Non-illuminated

10250T7\_



E34EX7\_



### Three-Position Momentary Push, Momentary Pull

Operator Function (Position) ①

| Momentary—<br>Pull | Maintained—<br>Intermediate | Momentary—<br>Push | Contact<br>Type | Mounting Location ① |   | Red Standard Push-Pull ② |                       |
|--------------------|-----------------------------|--------------------|-----------------|---------------------|---|--------------------------|-----------------------|
|                    |                             |                    |                 | 1                   | 2 | 10250T<br>Catalog Number | E34<br>Catalog Number |
| 0<br>X             | 0<br>0                      | X<br>0             | 1NO<br>1NC      |                     |   | <b>10250T718R</b>        | <b>E34EX718R</b>      |
| X<br>X             | 0<br>X                      | 0<br>0             | 1NC<br>1NC      |                     |   | <b>10250T721R</b>        | <b>E34EX721R</b>      |

### Button and Color Selection

Standard



Jumbo Mushroom Head



| Color  | Suffix Code | 10250T Catalog Number | E34 Catalog Number |
|--|-------------|-----------------------|--------------------|
| <b>Standard</b>                                |             |                       |                    |
| Red  | <b>R</b>    | <b>10250TB62</b>      | <b>E34C2</b>       |
| Red (EMERG. STOP)                              | <b>E</b>    | <b>10250TB63</b>      | <b>E34C2N8</b>     |
| Green  | <b>G</b>    | <b>10250TB61</b>      | <b>E34C3</b>       |
| Black  | <b>B</b>    | <b>10250TB60</b>      | <b>E34C1</b>       |
| Blue   | <b>L</b>    | <b>10250TB64</b>      | <b>E34C6</b>       |
| <b>Jumbo Mushroom Head (Anodized) Aluminum</b> |             |                       |                    |
| Red  | <b>RJ</b>   | <b>10250TJ62</b>      | <b>E34J2</b>       |
| Red (EMERG. STOP)                              | <b>EJ</b>   | <b>10250TJ63</b>      | <b>E34J2N8</b>     |
| Green  | <b>GJ</b>   | <b>10250TJ61</b>      | —                  |
| Black  | <b>BJ</b>   | <b>10250TJ60</b>      | —                  |
| Yellow   | <b>YJ</b>   | <b>10250TJ64</b>      | —                  |

#### Notes

- ① Bolded circuit corresponds to "X-0" circuit selection. X = closed circuit, 0 = open circuit.  
 ② To order different type or color buttons, simply substitute underlined character with appropriate suffix code from the Button and Color Selection table above. Example: 10250T718G.

### Illuminated Push-Pull Units

UL (NEMA) Type 3, 3R, 4, 4X, 12, 13, NEC Class I Division 2, Groups B, C and D

- Two-position maintained
- Illuminated

#### 10250T8



#### E34EX8



### Two-Position Illuminated Maintained Push, Maintained Pull

Operator Function (Position) ①

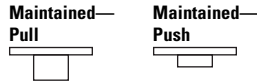

|                          |                 | Type         | Voltage    | Contact Type | Mounting Location ① | Red Standard Push-Pull ② |                     |
|--------------------------|-----------------|--------------|------------|--------------|---------------------|--------------------------|---------------------|
| Maintained Pull          | Maintained Push |              |            |              |                     | 10250T Catalog Number    | E34 Catalog Number  |
| <b>LED Lamp</b>          |                 |              |            |              |                     |                          |                     |
| 0                        | X               | Full voltage | 24 Vac/Vdc | 1NO          |                     | <b>10250T853RD24</b>     | <b>E34EX853RD24</b> |
| X                        | 0               |              | 120 Vac    | 1NC          |                     | <b>10250T853RD2A</b>     | <b>E34EX853RD2A</b> |
|                          |                 | Transformer  | 24 Vac     |              |                     | <b>10250T843RD06</b>     | <b>E34EX843RD06</b> |
|                          |                 |              | 120 Vac    |              |                     | <b>10250T844RD06</b>     | <b>E34EX844RD06</b> |
| <b>Incandescent Lamp</b> |                 |              |            |              |                     |                          |                     |
| 0                        | X               | Full voltage | 24 Vac/Vdc | 1NO          |                     | <b>10250T849RD</b>       | <b>E34EX849RD</b>   |
| X                        | 0               |              | Resistor   | 120 Vac/Vdc  |                     | 1NC                      | <b>10250T851RD</b>  |
|                          |                 | Transformer  | 24 Vac     |              |                     | <b>10250T843RD</b>       | <b>E34EX843RD</b>   |
|                          |                 |              | 120 Vac    |              |                     | <b>10250T844RD</b>       | <b>E34EX844RD</b>   |

### Lens and Color Selection

| Color                                      | 10250T      |                  | E34         |                |
|--|-------------|------------------|-------------|----------------|
|  | Suffix Code | Catalog Number   | Suffix Code | Catalog Number |
| <b>Standard</b>                            |             |                  |             |                |
| Red  | <b>RD</b>   | <b>10250TC47</b> | <b>RD</b>   | <b>E34M2</b>   |
| Red (EMERG. STOP)                          | <b>ED</b>   | <b>10250TC53</b> | <b>ED</b>   | <b>E34M2N8</b> |
| Green                                      | <b>GD</b>   | <b>10250TC48</b> | <b>GD</b>   | <b>E34M3</b>   |
| Blue                                       | <b>LD</b>   | <b>10250TC49</b> | <b>LD</b>   | <b>E34M6</b>   |
| Amber                                      | <b>AD</b>   | <b>10250TC50</b> | <b>AD</b>   | <b>E34M9</b>   |
| White                                      | <b>WD</b>   | <b>10250TC51</b> | <b>WD</b>   | <b>E34M5</b>   |
| Clear                                      | <b>CD</b>   | <b>10250TC52</b> | <b>CD</b>   | <b>E34M0</b>   |
| <b>Side-Lighted (Anodized) Aluminum</b>    |             |                  |             |                |
| Red  | <b>RS</b>   | <b>10250TC57</b> | —           | —              |
| Red (EMERG. STOP)                          | <b>ES</b>   | <b>10250TC63</b> | —           | —              |
| Green                                      | <b>GS</b>   | <b>10250TC58</b> | —           | —              |
| Blue                                       | <b>LS</b>   | <b>10250TC59</b> | —           | —              |
| Amber                                      | <b>AS</b>   | <b>10250TC64</b> | —           | —              |
| Yellow                                     | <b>YS</b>   | <b>10250TC60</b> | —           | —              |
| White                                      | <b>WS</b>   | <b>10250TC61</b> | —           | —              |
| Clear                                      | <b>CS</b>   | <b>10250TC62</b> | —           | —              |
| <b>HD Aluminum with Transparent Center</b> |             |                  |             |                |
| Red  | <b>RH</b>   | <b>10250TC65</b> | —           | —              |
| Green                                      | <b>GH</b>   | <b>10250TC66</b> | —           | —              |
| Amber                                      | <b>AH</b>   | <b>10250TC67</b> | —           | —              |

#### Notes

- ① Bolded circuit corresponds to “X-0” circuit selection. X = closed circuit, 0 = open circuit.
- ② To order different type or color lens, simply substitute the underlined characters with appropriate suffix code from the Lens and Color Selection table above. Example: 10250T851GS.

1

UL (NEMA) Type 3, 3R, 4, 4X, 12, 13, NEC Class I Division 2, Groups B, C and D

- Three-position—maintained push, momentary pull
- Illuminated

#### 10250T<sub>8</sub>



#### E34EX<sub>8</sub>



### Three-Position Illuminated Maintained Push, Momentary Pull

#### Operator Function (Position) ①



| Operator Function (Position) ① |                         |                 | Type         | Voltage     | Contact Type | Mounting Location ① |   | Red Standard Push-Pull ② |                      |                     |
|--------------------------------|-------------------------|-----------------|--------------|-------------|--------------|---------------------|---|--------------------------|----------------------|---------------------|
| Momentary—Pull                 | Maintained—Intermediate | Maintained—Push |              |             |              | 1                   | 2 | 10250T Catalog Number    | E34 Catalog Number   |                     |
| <b>LED Lamp</b>                |                         |                 |              |             |              |                     |   |                          |                      |                     |
| 0                              | 0                       | X               | Full voltage | 24 Vac/Vdc  | 1NO          |                     |   | <b>10250T864RD24</b>     | <b>E34EX864RD24</b>  |                     |
| X                              | 0                       | 0               |              | 120 Vac     | 1NC          |                     |   | <b>10250T864RD2A</b>     | <b>E34EX864RD2A</b>  |                     |
|                                |                         |                 |              | Transformer | 24 Vac       |                     |   |                          | <b>10250T854RD06</b> | <b>E34EX854RD06</b> |
|                                |                         |                 |              | 120 Vac     |              |                     |   | <b>10250T855RD06</b>     | <b>E34EX855RD06</b>  |                     |
| X                              | 0                       | 0               | Full voltage | 24 Vac/Vdc  | 1NC          |                     |   | <b>10250T875RD24</b>     | <b>E34EX875RD24</b>  |                     |
| X                              | X                       | 0               |              | 120 Vac     | 1NC          |                     |   | <b>10250T875RD2A</b>     | <b>E34EX875RD2A</b>  |                     |
|                                |                         |                 |              | Transformer | 24 Vac       |                     |   |                          | <b>10250T865RD06</b> | <b>E34EX865RD06</b> |
|                                |                         |                 |              | 120 Vac     |              |                     |   | <b>10250T866RD06</b>     | <b>E34EX866RD06</b>  |                     |
| <b>Incandescent Lamp</b>       |                         |                 |              |             |              |                     |   |                          |                      |                     |
| 0                              | 0                       | X               | Full voltage | 24 Vac/Vdc  | 1NO          |                     |   | <b>10250T860RD</b>       | <b>E34EX860RD</b>    |                     |
| X                              | 0                       | 0               |              | Resistor    | 120 Vac      |                     |   | 1NC                      | <b>10250T862RD</b>   | <b>E34EX862RD</b>   |
|                                |                         |                 |              | Transformer | 24 Vac       |                     |   |                          | <b>10250T854RD</b>   | <b>E34EX854RD</b>   |
|                                |                         |                 |              | 120 Vac     |              |                     |   | <b>10250T855RD</b>       | <b>E34EX855RD</b>    |                     |
| X                              | 0                       | 0               | Full voltage | 24 Vac/Vdc  | 1NC          |                     |   | <b>10250T871RD</b>       | <b>E34EX871RD</b>    |                     |
| X                              | X                       | 0               |              | Resistor    | 120 Vac      |                     |   | 1NC                      | <b>10250T873RD</b>   | <b>E34EX873RD</b>   |
|                                |                         |                 |              | Transformer | 24 Vac       |                     |   |                          | <b>10250T865RD</b>   | <b>E34EX865RD</b>   |
|                                |                         |                 |              | 120 Vac     |              |                     |   | <b>10250T866RD</b>       | <b>E34EX866RD</b>    |                     |

#### Notes

① Bolded circuit corresponds to “X-0” circuit selection. X = closed circuit, 0 = open circuit.

② To order different type or color lens, simply substitute the underlined characters with appropriate suffix code from the Lens and Color Selection table on the bottom of **Page V7-T1-337**. Example: 10250T862AS.

UL (NEMA) Type 3, 3R, 4, 4X, 12, 13, NEC Class I Division 2, Groups B, C and D

- Three-position—momentary
- Illuminated

**10250T<sub>8</sub>**



**E34EX<sub>8</sub>**



**Three-Position Illuminated Momentary Push, Momentary Pull**

Operator Function (Position) ①

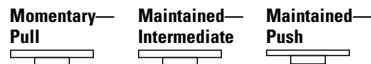

| Operator Function (Position) ① |                         |                 | Type         | Voltage     | Contact Type | Mounting Location ① |   | Red Standard Push-Pull ② |                     |                   |
|--------------------------------|-------------------------|-----------------|--------------|-------------|--------------|---------------------|---|--------------------------|---------------------|-------------------|
| Momentary Pull                 | Maintained Intermediate | Maintained Push |              |             |              | 1                   | 2 | 10250T Catalog Number    | E34 Catalog Number  |                   |
| <b>LED Lamp</b>                |                         |                 |              |             |              |                     |   |                          |                     |                   |
| 0                              | 0                       | X               | Full voltage | 24 Vac/Vdc  | 1NO          |                     |   | <b>10250T886RD24</b>     | <b>E34EX886RD24</b> |                   |
| X                              | 0                       | 0               |              | 120 Vac     | 1NC          |                     |   | <b>10250T886RD2A</b>     | <b>E34EX886RD2A</b> |                   |
|                                |                         |                 |              | Transformer | 24 Vac       |                     |   | <b>10250T876RD06</b>     | <b>E34EX876RD06</b> |                   |
|                                |                         |                 |              | 120 Vac     |              |                     |   | <b>10250T877RD06</b>     | <b>E34EX877RD06</b> |                   |
| X                              | 0                       | 0               | Full voltage | 24 Vac/Vdc  | 1NC          |                     |   | <b>10250T897RD24</b>     | <b>E34EX897RD24</b> |                   |
| X                              | X                       | 0               |              | 120 Vac     | 1NC          |                     |   | <b>10250T897RD2A</b>     | <b>E34EX897RD2A</b> |                   |
|                                |                         |                 |              | Transformer | 24 Vac       |                     |   | <b>10250T887RD06</b>     | <b>E34EX887RD06</b> |                   |
|                                |                         |                 |              | 120 Vac     |              |                     |   | <b>10250T888RD06</b>     | <b>E34EX888RD06</b> |                   |
| <b>Incandescent Lamp</b>       |                         |                 |              |             |              |                     |   |                          |                     |                   |
| 0                              | 0                       | X               | Full voltage | 24 Vac/Vdc  | 1NO          |                     |   | <b>10250T882RD</b>       | <b>E34EX882RD</b>   |                   |
| X                              | 0                       | 0               |              | Resistor    | 120 Vac      |                     |   | 1NC                      | <b>10250T884RD</b>  | <b>E34EX884RD</b> |
|                                |                         |                 |              | Transformer | 24 Vac       |                     |   |                          | <b>10250T876RD</b>  | <b>E34EX876RD</b> |
|                                |                         |                 |              | 120 Vac     |              |                     |   | <b>10250T877RD</b>       | <b>E34EX877RD</b>   |                   |
| X                              | 0                       | 0               | Full voltage | 24 Vac/Vdc  | 1NC          |                     |   | <b>10250T893RD</b>       | <b>E34EX893RD</b>   |                   |
| X                              | X                       | 0               |              | Resistor    | 120 Vac      |                     |   | 1NC                      | <b>10250T895RD</b>  | <b>E34EX895RD</b> |
|                                |                         |                 |              | Transformer | 24 Vac       |                     |   |                          | <b>10250T887RD</b>  | <b>E34EX887RD</b> |
|                                |                         |                 |              | 120 Vac     |              |                     |   | <b>10250T888RD</b>       | <b>E34EX888RD</b>   |                   |

**Notes**

- ① Bolded circuit corresponds to "X-0" circuit selection. X = closed circuit, 0 = open circuit.
- ② To order different type or color lens, simply substitute the underlined characters with appropriate suffix code from the Lens and Color Selection table on the bottom of **Page V7-T1-337**. Example: 10250T862AS.



#### 1

### Push-Pull Operators

An illuminated push-pull pushbutton unit, arranged for one-hole mounting, can replace two pushbuttons and a pilot light or the non-illuminated form can replace two pushbuttons. These units are available in three basic types:

- **Maintained**—(Two-position). Maintains in the pulled or pushed position until manually actuated to the opposite mode.
- **Momentary**—(Three-position). Spring returns to an intermediate position when pulled or pushed and released.

- **Momentary Pull, Maintained Push**—(Three-position). Spring returns to intermediate position when pulled. Maintains in pushed position until manually returned to intermediate (ready to reset) position. Maintained stop holds circuit open and will prevent other series connected operators from starting the system.

The operators, buttons, contact blocks, etc., are offered as building block components that can be intermixed to satisfy many requirements. This minimizes the need for a varied and costly inventory.

### Application Guide

To assist in the selection of contact blocks, the sketch below shows pictorially by symbols **1** and **2** locations of contact circuits after assembly of contact blocks and adapter to the operator. The table below shows the effect of the push and pull operations on either NO or NC contacts. (X = contact closed, O = contact open).

### Locating Nibs

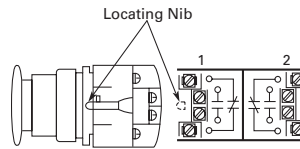

### 10250T\_ Push-Pull Operator Components



### E34G\_



### Operator Position and Circuit Arrangement



| Type of Operator                            | Contact Block       | Contact Block Mounting Location |   |                          |   | 10250T Catalog Number | E34 Catalog Number |         |
|---|---------------------|---------------------------------|---|--------------------------|---|-----------------------|--------------------|---------|
|   |                     | Out—Pull                        |   | Intermediate             |   |                       |                    | In—Push |
|   |                     | 1                               | 2 | 1                        | 2 | 1                     | 2                  |         |
| <b>Two-Position Operator without Lens</b>   |                     |                                 |   |                          |   |                       |                    |         |
| Maintained push-pull                        | 1NO                 | O                               | O | No intermediate position |   | 10250T5               | E34GDB             |         |
|   | 1NC                 | X                               | X |                          |   |                       |                    | O       |
|   | 2NO                 | O                               | O |                          |   | X                     | X                  |         |
|   | 2NC                 | X                               | X |                          |   | O                     | O                  |         |
| <b>Three-Position Operator without Lens</b> |                     |                                 |   |                          |   |                       |                    |         |
| Momentary push-pull                         | 1NO                 | O                               | O | O                        | O | 10250T4               | E34GEB             |         |
|   | 1NC                 | X                               | X | O                        | X |                       |                    | O       |
| Maintained push-momentary pull              | 2NO                 | O                               | O | O                        | O | 10250T9               | E34GFB             |         |
|   | 2NC                 | X                               | X | O                        | X |                       |                    | O       |
|   | Momentary push-pull | 1NO                             | O | O                        | O | O                     | 10250T10           | E34GHB  |
|   |                     | 1NC                             | X | X                        | O | O                     |                    |         |
| 2NO   |                     | O                               | O | O                        | O | X                     | X                  |         |
| 2NC   |                     | X                               | X | O                        | O | O                     | O                  |         |

### Note

Use NEMA 4X 10250T operators where exposed to ultraviolet light.

### Push-Pull Light Units, Lenses and Buttons

NEC Class I Division 2 Groups B, C and D

#### Light Units for Illuminated Push-Pull Devices

| Light Unit Type                    | Type                | Voltage      | LED/Lamp Number  | Catalog Number           |
|------------------------------------|---------------------|--------------|------------------|--------------------------|
| LED<br>(LEDs not included) ①       | Full voltage        | —            | Bayonet base     | <b>10250T97HL</b>        |
|                                    | Transformer         | 24           |                  | <b>10250T89HL</b>        |
|                                    | AC only<br>50/60 Hz | 120          |                  | <b>10250T63HL</b>        |
|                                    |                     | 208          |                  | <b>10250T64HL</b>        |
|                                    |                     | 240          |                  | <b>10250T65HL</b>        |
|                                    |                     | 277          |                  | <b>10250T82HL</b>        |
|                                    |                     | 380          |                  | <b>10250T66HL</b>        |
|                                    |                     | 480          |                  | <b>10250T67HL</b>        |
|                                    |                     | 600          |                  | <b>10250T68HL</b>        |
|                                    |                     | Incandescent |                  | Full voltage<br>AC or DC |
| 12                                 | #756                |              | <b>10250T70H</b> |                          |
| 24/28                              | #757                |              | <b>10250T79H</b> |                          |
| 32                                 | #1828               |              | <b>10250T83H</b> |                          |
| Resistor<br>AC or DC               | 120                 |              | 120MB            | <b>10250T80H</b>         |
|                                    | 240                 |              |                  | <b>10250T81H</b>         |
| Transformer<br>AC only<br>50/60 Hz | 24                  |              | #755             | <b>10250T89H</b>         |
|                                    | 120                 |              |                  | <b>10250T63H</b>         |
|                                    | 208                 |              |                  | <b>10250T64H</b>         |
|                                    | 240                 |              |                  | <b>10250T65H</b>         |
|                                    | 277                 |              |                  | <b>10250T82H</b>         |
|                                    | 380                 |              |                  | <b>10250T66H</b>         |
|                                    | 480                 |              |                  | <b>10250T67H</b>         |
|                                    | 600                 |              |                  | <b>10250T68H</b>         |

**Note**

① These units do not include lamps. Order LED separately to match lens color from table on [Page V7-T1-343](#).

#### Alternate Lenses for Illuminated Push-Pull Devices

##### Standard



| Color             | 10250T Catalog Number | E34 Catalog Number |
|-------------------|-----------------------|--------------------|
| <b>Standard</b>   |                       |                    |
| Red               | 10250TC47             | E34M2              |
| Red (EMERG. STOP) | 10250TC53             | E34M2N8            |
| Green             | 10250TC48             | E34M3              |
| Blue              | 10250TC49             | E34M6              |
| Amber             | 10250TC50             | E34M9              |
| White             | 10250TC51             | E34M5              |
| Clear             | 10250TC52             | E34M0              |

##### Side-Lighted (Anodized) Aluminum



| Color                                      | 10250T Catalog Number | E34 Catalog Number |
|--|-----------------------|--------------------|
| <b>Side-Lighted Anodized Aluminum Ring</b> |                       |                    |
| Red  | 10250TC57             | —                  |
| Red (EMERG. STOP)                          | 10250TC63             | —                  |
| Green                                      | 10250TC58             | —                  |
| Blue                                       | 10250TC59             | —                  |
| Amber                                      | 10250TC64             | —                  |
| Yellow                                     | 10250TC60             | —                  |
| White                                      | 10250TC61             | —                  |
| Clear                                      | 10250TC62             | —                  |

##### HD Aluminum with Transparent Center



| Color  | 10250T Catalog Number | E34 Catalog Number |
|--|-----------------------|--------------------|
| <b>Heavy-Duty Aluminum with Transparent Center</b> |                       |                    |
| Red  | 10250TC65             | —                  |
| Green  | 10250TC66             | —                  |
| Amber  | 10250TC67             | —                  |

#### Buttons for Non-Illuminated Push-Pull Devices

##### Standard



| Color             | 10250T Catalog Number | E34 Catalog Number |
|-------------------|-----------------------|--------------------|
| <b>Standard</b>   |                       |                    |
| Red               | 10250TB62             | E34C2              |
| Red (EMERG. STOP) | 10250TB63             | E34C2N8            |
| Green             | 10250TB61             | E34C3              |
| Black             | 10250TB60             | E34C1              |
| Blue              | 10250TB64             | E34C6              |

##### Jumbo Mushroom Head



| Color   | 10250T Catalog Number | E34 Catalog Number |
|---|-----------------------|--------------------|
| <b>Jumbo Mushroom Head (Anodized) Aluminum <sup>Ⓢ</sup></b> |                       |                    |
| Red   | 10250TJ62             | E34J2              |
| Red (EMERG. STOP)   | 10250TJ63             | E34J2N8            |
| Green   | 10250TJ61             | —                  |
| Black   | 10250TJ60             | —                  |
| Yellow  | 10250TJ64             | —                  |

#### Notes

Use NEMA 4X 10250T operators where exposed to ultraviolet light.

<sup>Ⓢ</sup> Anodized aluminum head is not suitable for use with ultraviolet light applications.

**Standard LED Lamp**



**LED Selection**

| Voltage   | Color  | Catalog Number |
|---|--------|----------------|
| 6 Vac/Vdc<br>suitable for<br>use with<br>transformers | Red    | E22LED006RN    |
|   | Orange | E22LED006ON    |
|   | Yellow | E22LED006YN    |
|   | Green  | E22LED006GN    |
|   | Blue   | E22LED006BN    |
|   | White  | E22LED006WN    |
| 12 Vac/Vdc  | Red    | E22LED012RN    |
|   | Orange | E22LED012ON    |
|   | Yellow | E22LED012YN    |
|   | Green  | E22LED012GN    |
|   | Blue   | E22LED012BN    |
|   | White  | E22LED012WN    |
| 24 Vac/Vdc  | Red    | E22LED024RN    |
|   | Orange | E22LED024ON    |
|   | Yellow | E22LED024YN    |
|   | Green  | E22LED024GN    |
|   | Blue   | E22LED024BN    |
|   | White  | E22LED024WN    |
| 48 Vac/Vdc  | Red    | E22LED048RN    |
|   | Orange | E22LED048ON    |
|   | Yellow | E22LED048YN    |
|   | Green  | E22LED048GN    |
|   | Blue   | E22LED048BN    |
|   | White  | E22LED048WN    |

| Voltage    | Color  | Catalog Number |
|------------|--------|----------------|
| 60 Vac/Vdc | Red    | E22LED060RN    |
|            | Orange | E22LED060ON    |
|            | Yellow | E22LED060YN    |
|            | Green  | E22LED060GN    |
|            | Blue   | E22LED060BN    |
|            | White  | E22LED060WN    |
| 120 Vac    | Red    | E22LED120RA    |
|            | Orange | E22LED120OA    |
|            | Yellow | E22LED120YA    |
|            | Green  | E22LED120GA    |
|            | Blue   | E22LED120BA    |
|            | White  | E22LED120WA    |
| 120 Vdc    | Red    | E22LED120RD    |
|            | Orange | E22LED120OD    |
|            | Yellow | E22LED120YD    |
|            | Green  | E22LED120GD    |
|            | Blue   | E22LED120BD    |
|            | White  | E22LED120WD    |

**Note**

For a complete listing of all LEDs available, see **Page V7-T1-239**.

#### 1

#### Selector Switch Units

UL (NEMA) Type 3, 3R, 4, 4X, 12, 13, NEC Class I Division 2, Groups B, C and D

- Two- and three-position
- Non-illuminated

#### 10250T72\_



#### E34EX72\_



#### Two-Position Selector Switch—Non-Illuminated

| Operator Position <sup>①</sup> |   | Operator Action <sup>②</sup> | Contact Type | Mounting Location <sup>①</sup> |   | Cam Code | Black Knob—Selector Switch <sup>③</sup> |                    |
|--------------------------------|---|------------------------------|--------------|--------------------------------|---|----------|---|--------------------|
|                                |   |                              |              | 1                              | 2 |          | 10250T Catalog Number                   | E34 Catalog Number |
| X                              | O |                              | 1NC<br>1NO   |                                |   | 1        | <b>10250T722BK</b>                      | <b>E34EX722BK</b>  |
| O                              | X |                              |              |                                |   |          | <b>10250T724BK</b>                      | <b>E34EX724BK</b>  |
| X                              | O |                              | 1NC<br>1NO   |                                |   | 1        | <b>10250T723BK</b>                      | <b>E34EX723BK</b>  |
| O                              | X |                              |              |                                |   |          | <b>10250T725BK</b>                      | <b>E34EX725BK</b>  |

#### 10250T\_



#### Three-Position Selector Switch—Non-Illuminated

| Operator Position <sup>①</sup> |   |   | Operator Action <sup>②</sup> | Contact Type                      | Mounting Location <sup>①</sup> |   | Cam Code | Black Knob—Selector Switch <sup>④</sup> |                    |
|--------------------------------|---|---|------------------------------|-----------------------------------|--------------------------------|---|----------|---|--------------------|
|                                |   |   |                              |                                   | 1                              | 2 |          | 10250T Catalog Number                   | E34 Catalog Number |
| X                              | O | O |                              | 1NO<br>1NO                        |                                |   | 3        | <b>10250T726BK</b>                      | <b>E34EX726BK</b>  |
| O                              | O | X |                              |                                   |                                |   |          | <b>10250T728BK</b>                      | <b>E34EX728BK</b>  |
|                                |   |   |                              |                                   |                                |   |          | <b>10250T730BK</b>                      | <b>E34EX730BK</b>  |
|                                |   |   |                              |                                   |                                |   |          | <b>10250T732BK</b>                      | <b>E34EX732BK</b>  |
| X                              | O | O |                              | 1NO<br>1NC-1NC<br>(Series)<br>1NO |                                |   | 3        | <b>10250T727BK</b>                      | <b>E34EX727BK</b>  |
| O                              | X | O |                              |                                   |                                |   |          | <b>10250T729BK</b>                      | <b>E34EX729BK</b>  |
| O                              | O | X |                              |                                   |                                |   |          | <b>10250T731BK</b>                      | <b>E34EX731BK</b>  |
|                                |   |   |                              |                                   |                                |   |          | <b>10250T733BK</b>                      | <b>E34EX733BK</b>  |

#### Notes

- ① Bolded circuit corresponds to "X-O" circuit selection. X = closed circuit, O = open circuit.
- ② M = Maintained. S = Spring return in direction of arrow (→).
- ③ To order different type or color selector switch, simply substitute the underlined characters with appropriate suffix code from the table on **Page V7-T1-345**.  
Example: 10250T722LL. For keyed selector switch, substitute the underlined characters with **T\_ (cam)+\_ (key removal position)**. Example: 10250T722T13.
- ④ To order different type or color selector switch, simply substitute the underlined characters with appropriate suffix code from the Switch and Color Selection table on **Page V7-T1-345**.  
Example: 10250T726LL. For keyed selector switch, substitute the underlined characters with **T\_ (cam)+\_ (key removal position)**. Example: 10250T726T13.

UL (NEMA) Type 3, 3R, 4, 4X, 12, 13, NEC Class I Division 2, Groups B, C and D

- Four-position maintained
- Non-illuminated

10250T743

### Four-Position Selector Switch—Non-Illuminated



E34EX743



#### Operator Position ①

|   |   |   |   |
|---|---|---|---|
|   |   |   |   |
| X | 0 | 0 | 0 |
| 0 | X | 0 | 0 |
| 0 | 0 | X | 0 |
| 0 | 0 | 0 | X |

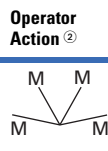

**Contact Type**

|     |
|-----|
| 1NC |
| 1NO |
| 1NO |
| 1NC |

#### Mounting Location ①

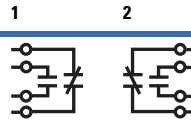

**Cam Code**

7

#### Black Knob—Selector Switch ③

| 10250T Catalog Number | E34 Catalog Number |
|-----------------------|--------------------|
| 10250T743BK           | E34EX743BK         |

#### Knob



#### Lever



#### Coin Slot ⑤



### Switch and Color Selection

| Color  | Knob Suffix Code | Lever Suffix Code | Lever ④ Suffix Code | Coin Slot ⑤ Suffix Code |
|--------|------------------|-------------------|---------------------|-------------------------|
| Black  | BK               | BL                | BA                  | BC                      |
| Red    | RK               | RL                | RA                  | RC                      |
| Green  | GK               | GL                | GA                  | GC                      |
| Yellow | YK               | YL                | YA                  | YC                      |
| White  | WK               | WL                | WA                  | WC                      |
| Gray   | AK               | AL                | AA                  | AC                      |
| Blue   | LK               | LL                | LA                  | LC                      |
| Orange | NK               | NL                | NA                  | NC                      |

### Key Operated Selection

| Number of Position | Operator Action ⑥ | Suffix and Removal Position |
|--------------------|-------------------|-----------------------------|
| 2                  | M M               | T1 + 1, 2, 3                |
|                    | M ← S             | T1 + 2                      |
| 3                  | M M M             | T3 + 1–7                    |
|                    | S → M M           | T3 + 1, 4, 5                |
|                    | S → M ← S         | T3 + 4                      |
|                    | M M ← S           | T3 + 2, 4, 6                |
| 4                  | MMMM              | T7 + 7                      |

### Key Removal Positions ⑦

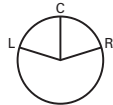

| Code Suffix | Key Removal Position |
|-------------|----------------------|
| 1           | Right only           |
| 2           | Left only            |
| 3           | Right and left       |
| 4           | Center only          |
| 6           | Left and center      |
| 7           | All positions        |

#### Notes

- ① Bolded circuit corresponds to “X-0” circuit selection. X = closed circuit, 0 = open circuit.
- ② M = Maintained.
- ③ To order different type or color selector switch, simply substitute the underlined characters with appropriate suffix code from the Switch and Color Selection table above. Example: 10250T743LL. For keyed selector switch, substitute the underlined characters with **T\_ (cam) + \_ (key removal position)**. Example: 10250T7431ZL.
- ④ Designed for added ingress protection. For use in maintained operators only.
- ⑤ 10250T only.
- ⑥ M = Maintained. S = Spring return in direction of arrow (→).
- ⑦ Key removal in “spring return from” positions not recommended.

#### 1

### Selector Switch Selection



10250T



E34

#### Cam and Contact Block Selection

Selector switches in their varied forms (two-position, three-position, and four-position) are a big factor contributing to the great flexibility of control that a well rounded line of “pushbuttons” can achieve. Because of their flexibility, they tend to cause difficulty with product selection and application. The following systematic approach should simplify that task.

Cam and contact block selection is better understood if you:

- Work with each incoming and outgoing wire/circuit separately.
- Recognize the terms NO and NC only identify the type of contact by its mode before mounting to the operator. The “X-O” table (Page V7-T1-348) shows how that contact will act after assembly to the operator with the selected cam shape. X = closed circuit, O = open circuit.

- One NO-NC contact block may be mounted behind each plunger of the mounting adapter for a total of four circuits.
- Each cam has two separate lobes, each of which operates one of the two contact block plungers independently of each other. Those are identified as position 1 (locating nib side) and position 2 (opposite of locating nib). The position designations give direction in selecting and mounting of the contact blocks.

#### Contact Circuit Locations

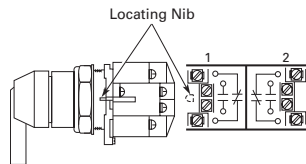

#### Systematic Approach

Application: **HAND-OFF-AUTO** selector switch. In this circuit, one incoming line is distributed to two other outgoing circuits by the switch. The two circuits can be looked at individually.

#### Step 1: Elementary Diagram.

Construct on paper, or in your mind, a simple elementary diagram of the switching scheme as follows:

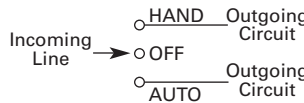

In this circuit, you want a contact closed on the left (HAND) but open in the center and right.

For the **AUTO** circuit, the “X-O” diagram would look like this:

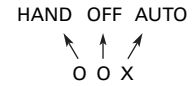

Putting them together, the complete “X-O” diagram is:



#### Step 2: “X-O” Pattern.

From the elementary diagram, you can construct an “X-O” diagram which describes when the contacts are to be closed (X) or open (O) in the various positions of the switch. The “X-O” for the **HAND** circuit looks like this:

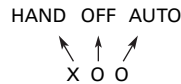

Once the “X-O” diagram has been generated, the next step is to select the cam and contact block, or blocks, needed to perform the desired “X-O” functions. The selection tables on the following pages list the various types (shapes) of cams by number to choose from and the type of contact and position to achieve the function outlined in your “X-O” diagram.

### Step 3: Cam Selection.

The cam you select determines the operation of all contact blocks mounted to the operator. It is selected on the basis that it provides the simplest circuitry for the desired "X-O" diagram. The selection tables show all the "X-O" combinations. For the purpose of this example, the applicable portion of those tables is shown on this page.

Now to make the cam selection, make a simple worksheet such as below. (1) or (2) = mounting location from chart above:

|       | Cam 2         | Cam 3 |
|-------|---------------|-------|
| X O O | (1)NO-(2)NC ① | (1)NO |
| O O X | (2)NO         | (2)NO |

It becomes obvious that cam 3 is the better choice because the series connection can be avoided, making it simpler to wire.

### Step 4: Contact Block Selection.

Having selected the cam, contact block selection is simply a matter of determining if you require one NO-NC contact block (Cat. No 10250T1H) or two. Given the limitations of the factory sealed contact block and the desired "X-O" application, you may have circuits that will not be needed—as seen here with the two additional NC circuits. (1) or (2) = mounting location from chart above.

| Qty | Catalog No. | Cam 3                      |
|-----|-------------|----------------------------|
| 2   | 10250TIH    | (1)NO (2)NC<br>(1)NC (2)NO |

### Step 5: Selector Switch Operator.

Lastly, you have to choose from the many types of operators—knob and lever in various colors or keyed. Also what combinations of maintained and spring return functions are required. Selection of these operators can be found on **Page V7-T1-349**. For the example in step 4, you may want a three-position maintained black knob, cam 3—Catalog Number 10250T1323 (or 34VHBK1).

**The Complete Switch:** 10250T1323 (or 34VHBK1) with two 10250T1H or for one composite catalog number—10250T726BK (or E34EX726BK) found on **Page V7-T1-344**.

### Diagrams

Circuits shown illustrate connections to obtain a selector circuit combination and are shown with their appropriate line diagrams in **BOLD**. Field wiring of jumper connections required as shown.

X = Closed circuit  
O = Open circuit

### Example Selection Table

| No. | Desired Circuit and Operator Position |   |   | Cam Code #2 Contact Blocks and Mounting Location |   | Cam Code #3 Contact Blocks and Mounting Location |   |
|-----|---------------------------------------|---|---|--|---|--|---|
|     |                                       |   |   | 1  | 2 | 1  | 2 |
| 1   | X                                     | O | O |  |   |  | — |
| 4   | O                                     | O | X | —  |   | —  |   |

**Note**

① Wired in series.



# 1.11

## Pushbuttons and Indicating Lights

30.5 mm Class I Division 2 Hazardous Locations—10250T/E34

1

### Two-Position Selector Switch

| Number | Desired Circuit and Operator Position |   | Cam Code #1 Contact Blocks and Mounting Location |   |
|--------|---------------------------------------|---|--|---|
|        |                                       |   | 1  | 2 |
| 1      | X                                     | 0 |  |   |
| 2      | 0                                     | X |  |   |

### Three-Position Selector Switch

| No. | Desired Circuit and Operator Position |   |   | Cam Code #2 Contact Blocks and Mounting Location |   | Cam Code #3 Contact Blocks and Mounting Location |   |
|-----|---------------------------------------|---|---|--|---|--|---|
|     |                                       |   |   | 1  | 2 | 1  | 2 |
| 1   | X                                     | 0 | 0 |  |   | —  | — |
| 2   | X                                     | X | 0 | —  |   | —  |   |
| 3   | X                                     | 0 | X |  | — |  | — |
| 4   | 0                                     | 0 | X | —  |   | —  |   |
| 5   | 0                                     | X | X |  |   | —  | — |
| 6   | 0                                     | X | 0 |  | — |  | — |

### Four-Position Selector Switch

| Number | Desired Circuit and Operator Position |   |   |   | Cam Code #7 Contact Blocks and Mounting Location |   |
|--------|---------------------------------------|---|---|---|--|---|
|        |                                       |   |   |   | 1  | 2 |
| 1      | X                                     | 0 | 0 | 0 |  | — |
| 2      | 0                                     | X | 0 | 0 | —  |   |
| 3      | 0                                     | 0 | X | 0 |  | — |
| 4      | 0                                     | 0 | 0 | X | —  |   |
| 5      | X                                     | 0 | 0 | X |  | — |
| 6      | 0                                     | X | X | 0 |  | — |
| 7      | 0                                     | 0 | X | X |  | — |
| 8      | X                                     | X | 0 | 0 |  | — |
| 9      | 0                                     | X | 0 | X | —  |   |
| 10     | X                                     | 0 | X | 0 |  | — |

### Selector Switch Operators

#### 10250T Selector Switch Operators with Caps

UL (NEMA) Type 3, 3R, 4, 4X, 12, 13

##### Black Knob Selector Switch



##### Black Lever Selector Switch



#### 10250T Selector Switch Operators with Caps

| Positions                | Operator Action <sup>①</sup> | Black Knob Selector Switch—<br>Vertical Mounting <sup>②</sup> |                | Black Lever Selector Switch—<br>Vertical Mounting <sup>②</sup> |                |
|--------------------------|------------------------------|---|----------------|--|----------------|
|                          |                              | Cam Code <sup>③</sup>   | Catalog Number | Cam Code <sup>③</sup>  | Catalog Number |
| Two-position—60° throw   |                              | 1   | 10250T1311     | 1  | 10250T3011     |
|                          |                              | 1   | 10250T1371     | 1  | 10250T3071     |
| Three-position—60° throw |                              | 2   | 10250T1322     | 2  | 10250T3022     |
|                          |                              | 3   | 10250T1323     | 3  | 10250T3023     |
|                          |                              | 2   | 10250T1332     | 2  | 10250T3032     |
|                          |                              | 3   | 10250T1333     | 3  | 10250T3033     |
|                          |                              | 2   | 10250T1342     | 2  | 10250T3042     |
|                          |                              | 3   | 10250T1343     | 3  | 10250T3043     |
| Four-position—40° throw  |                              | 2   | 10250T1352     | 2  | 10250T3052     |
|                          |                              | 3   | 10250T1353     | 3  | 10250T3053     |
| Four-position—40° throw  |                              | 7   | 10250T1367     | 7  | 10250T3067     |

##### Horizontal Mounting



#### 10250T Key Operators with Cam

| Positions                | Operator Action <sup>①</sup> | Cam Code <sup>③</sup> | Optional Key Removal Positions <sup>④</sup> | Vertical Mounting Catalog Number <sup>④</sup> | Horizontal Mounting Catalog Number <sup>④</sup> |
|--------------------------|------------------------------|-----------------------|---|---|---|
| Two-position—60° throw   |                              | 1                     | 1, 2, 3                                     | 10250T1511_                                   | 10250T1611_                                     |
|                          |                              | 1                     | 2   | 10250T1571_                                   | 10250T1581_                                     |
| Three-position—60° throw |                              | 2                     | 1-7   | 10250T1522_                                   | 10250T1622_                                     |
|                          |                              | 3                     |   | 10250T1523_                                   | 10250T1623_                                     |
|                          |                              | 2                     | 1, 4, 5                                     | 10250T1532_                                   | 10250T1632_                                     |
|                          |                              | 3                     |   | 10250T1533_                                   | 10250T1633_                                     |
|                          |                              | 2                     | 4   | 10250T1542_                                   | 10250T1642_                                     |
|                          |                              | 3                     |   | 10250T1543_                                   | 10250T1643_                                     |
| Four-position—40° throw  |                              | 2                     | 2, 4, 6                                     | 10250T1652_                                   | 10250T1662_                                     |
|                          |                              | 3                     |   | 10250T1653_                                   | 10250T1663_                                     |
| Four-position—40° throw  |                              | 7                     | 7   | 10250T1677_                                   | 10250T1687_                                     |

##### Key Removal Positions

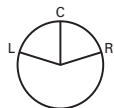

#### Key Removal Positions <sup>⑤</sup>

| Code Suffix | Key Removal Position | Code Suffix | Key Removal Position |
|-------------|----------------------|-------------|----------------------|
| 1           | Right only           | 5           | Right and center     |
| 2           | Left only            | 6           | Left and center      |
| 3           | Right and left       | 7           | All positions        |
| 4           | Center only          |             |                      |

##### Notes

- ① M = Maintained. S = Spring return in direction of arrow (→).
- ② Field convertible to horizontal mounting or order operator only and separate operator cap.
- ③ For selection of the proper cam and contact block to obtain the proper circuit sequence, see selection instructions and table on **Pages V7-T1-346 to V7-T1-348**.
- ④ Choose key removal position required for application from table above. Add key removal code no. to listed catalog number. Example: 10250T15112.
- ⑤ Key removal in “spring return from” positions not recommended.

#### Replacement Keys or Dissimilar Locks for Above Key Operators

Listed operators have identical locks and keys (Key Code H661) Catalog Number 10250ED824.

#### Replacement Keys

| Description                  | Catalog Number |
|------------------------------|----------------|
| Replacement keys (code H661) | 10250ED824     |

1

UL (NEMA) Type 3, 3R, 4, 4X, 12, 13

**Black Knob Selector Switch**



**E34 Selector Switch Operators with Knob Assembled**

**Black Knob Selector Switch—  
Vertical Mounting <sup>②</sup>**

| Positions                | Operator Action <sup>①</sup> | Cam Code <sup>③</sup> | Catalog Number <sup>④</sup> |
|--------------------------|------------------------------|-----------------------|-----------------------------|
| Two-position—60° throw   |                              | 1                     | <b>E34VFBK1</b>             |
|                          |                              | 1                     | <b>E34VEBK1</b>             |
| Three-position—60° throw |                              | 2                     | <b>E34VGBK1</b>             |
|                          |                              | 3                     | <b>E34VHBK1</b>             |
|                          |                              | 2                     | <b>E34VJBK1</b>             |
|                          |                              | 3                     | <b>E34VKBK1</b>             |
|                          |                              | 2                     | <b>E34VLBK1</b>             |
|                          |                              | 3                     | <b>E34VMBK1</b>             |
| Four-position—40° throw  |                              | 2                     | <b>E34VNBK1</b>             |
|                          |                              | 3                     | <b>E34VPBK1</b>             |
| Four-position—40° throw  |                              | 7                     | <b>E34VTBK1</b>             |

**E34KFB\_**



**E34 Key Operators with Cam and Cap**

| Positions                | Operator Action <sup>①</sup> | Cam Code <sup>③</sup> | Key Removal Positions <sup>⑤</sup> | Vertical Mounting Catalog Number | Horizontal Mounting Catalog Number |
|--------------------------|------------------------------|-----------------------|------------------------------------|----------------------------------|------------------------------------|
| Two-position—60° throw   |                              | 1                     | 1, 2, 3                            | <b>E34KFB_</b>                   | <b>E34KFHB_</b>                    |
|                          |                              | 1                     | 2                                  | <b>E34KEB_</b>                   | <b>E34KEHB_</b>                    |
| Three-position—60° throw |                              | 2                     | 1–7                                | <b>E34KGB_</b>                   | <b>E34KGHB_</b>                    |
|                          |                              | 3                     |                                    | <b>E34KHB_</b>                   | <b>E34KHGB_</b>                    |
|                          |                              | 2                     | 1, 4, 5                            | <b>E34KJB_</b>                   | <b>E34KJHB_</b>                    |
|                          |                              | 3                     |                                    | <b>E34KKB_</b>                   | <b>E34KKHB_</b>                    |
|                          |                              | 2                     | 4                                  | <b>E34KLB_</b>                   | <b>E34KLHB_</b>                    |
|                          |                              | 3                     |                                    | <b>E34KMB_</b>                   | <b>E34KMHB_</b>                    |
| Four-position—40° throw  |                              | 2                     | 2, 4, 6                            | <b>E34KNB_</b>                   | <b>E34KNHB_</b>                    |
|                          |                              | 3                     |                                    | <b>E34KPB_</b>                   | <b>E34KPHB_</b>                    |
| Four-position—40° throw  |                              | 7                     | 7                                  | <b>E34KTB_</b>                   | <b>E34KTHB_</b>                    |

**Notes**

Use NEMA 4X 10250T operators where exposed to ultraviolet light, see **Page V7-T1-349**.

① M = Maintained. S = Spring return in direction of arrow (→).

② Field convertible to horizontal mounting.

③ For selection of the proper cam and contact block to obtain the proper circuit sequence, see selection instructions and table on **Pages V7-T1-346 to V7-T1-348**.

④ For other colors of either knob or lever, replace the underlined characters of the catalog number with the appropriate suffix code from Alternate Knobs and Levers table on **Page V7-T1-351**. Example: E34VFBL2.

⑤ Choose key removal position required for application from table on **Page V7-T1-351**. Add key removal code no. to listed catalog number. Example: E34KFB2.

### Key Removal Positions

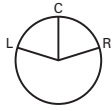

### Key Removal Positions

| Code Suffix | Key Removal Position | Code Suffix | Key Removal Position |
|-------------|----------------------|-------------|----------------------|
| 1           | Right only           | 5           | Right and center     |
| 2           | Left only            | 6           | Left and center      |
| 3           | Right and left       | 7           | All positions        |
| 4           | Center only          |             |                      |

### Knob



### Lever



### Lever for Added Ingress Protection



### Alternate Knobs and Levers for Operators <sup>①</sup>

| Color  | Knob        |                | Lever       |                | Lever Designed for Added Ingress Protection <sup>②</sup> |                |
|--------|-------------|----------------|-------------|----------------|--|----------------|
|        | Suffix Code | Catalog Number | Suffix Code | Catalog Number | Suffix Code  | Catalog Number |
| Black  | K1          | E34K1          | L1          | E34L1          | A1   | E34A1          |
| Red    | K2          | E34K2          | L2          | E34L2          | A2   | E34A2          |
| Green  | K3          | E34K3          | L3          | E34L3          | A3   | E34A3          |
| Yellow | K4          | E34K4          | L4          | E34L4          | A4   | E34A4          |
| White  | K5          | E34K5          | L5          | E34L5          | A5   | E34A5          |
| Blue   | K6          | E34K6          | L6          | E34L6          | A6   | E34A6          |
| Gray   | K7          | E34K7          | L7          | E34L7          | A7   | E34A7          |
| Orange | K8          | E34K8          | L8          | E34L8          | A8   | E34A8          |

#### Notes

- ① Key removal in “spring return from” positions not recommended.
- ② For use on maintained operators only.

# 1

## Illuminated Selector Switch Operators

Two-Position Maint. Selector Switch



### 10250T Illuminated Selector Switch Operator Only without Knob or Lever

| Position                 | Operator Action ① | Transformer Type—50/60 Hz<br>6V #755 Lamp |             |                           | Full Voltage Type—AC or DC ④ |             |                           |
|--------------------------|-------------------|---|-------------|---------------------------|------------------------------|-------------|---------------------------|
|                          |                   | Cam Code ③                                | Voltage     | Catalog and Code Number ② | Cam Code ③                   | Voltage     | Catalog and Code Number ② |
| Two-position—60° throw   |                   | 1   | 24          | 10250T5961H               | 1                            | 6           | 10250T6201H               |
|                          |                   |   | 120         | 10250T5971H               |                              | 12          | 10250T6211H               |
|                          |                   |   | 208         | 10250T6511H               |                              | 24          | 10250T6221H               |
|                          |                   |   | 240         | 10250T5981H               |                              | 48          | 10250T6231H               |
|                          |                   |   | 380         | 10250T5991H               |                              | 120         | 10250T6361H               |
|                          |                   |   | 480         | 10250T6001H               |                              | 240 ⑤       | 10250T6371H               |
|                          |                   |   | 600         | 10250T6011H               |                              |             |                           |
| Three-position—60° throw |                   | + 2 or 3                                  | 24          | 10250T602_H               | + 2 or 3                     | 6           | 10250T624_H               |
|                          |                   |   | 120         | 10250T603_H               |                              | 12          | 10250T625_H               |
|                          |                   |   | 208         | 10250T652_H               |                              | 24          | 10250T626_H               |
|                          |                   |   | 240         | 10250T604_H               |                              | 48          | 10250T627_H               |
|                          |                   |   | 380         | 10250T605_H               |                              | 120         | 10250T638_H               |
|                          |                   |   | 480         | 10250T607_H               |                              | 240 ⑤       | 10250T639_H               |
|                          |                   |   | 600         | 10250T607_H               |                              |             |                           |
|                          |                   | + 2 or 3                                  | 120         | 10250T620_H               | + 2 or 3                     | 120         | 10250T622_H               |
|                          |                   |   | 240         | 10250T656_H               |                              |             |                           |
|                          |                   |   |             |                           |                              |             |                           |
|                          |                   | + 2 or 3                                  | 120         | 10250T621_H               | + 2 or 3                     | 120         | 10250T623_H               |
|                          |                   |   | 240         | 10250T662_H               |                              |             |                           |
|                          |                   | + 2 or 3                                  | 24          | 10250T614_H               | + 2 or 3                     | 6           | 10250T628_H               |
|                          |                   |   | 120         | 10250T615_H               |                              | 12          | 10250T629_H               |
| 208                      |                   |   | 10250T653_H | 24                        |                              | 10250T630_H |                           |
| 240                      |                   |   | 10250T616_H | 48                        |                              | 10250T631_H |                           |
| 380                      |                   |   | 10250T617_H | 120                       |                              | 10250T640_H |                           |
| 480                      |                   |   | 10250T618_H | 240 ⑤                     |                              | 10250T641_H |                           |
| 600                      |                   |   | 10250T619_H |                           |                              |             |                           |
| Four-position—40° throw  |                   | 7   | 24          | 10250T6087H               | 7                            | 6           | 10250T6327H               |
|                          |                   |   | 120         | 10250T6097H               |                              | 12          | 10250T6337H               |
|                          |                   |   | 208         | 10250T6547H               |                              | 24          | 10250T6347H               |
|                          |                   |   | 240         | 10250T6107H               |                              | 48          | 10250T6357H               |
|                          |                   |   | 380         | 10250T6117H               |                              | 120         | 10250T6427H               |
|                          |                   |   | 480         | 10250T6127H               |                              | 240 ⑤       | 10250T6437H               |
|                          |                   |   | 600         | 10250T6137H               |                              |             |                           |

### Knob



### Lever



### Knobs and Levers

| Color ⑥ | Knob Catalog and Code Number | Lever Catalog and Code Number | Color ⑥ | Knob Catalog and Code Number | Lever Catalog and Code Number |
|---------|------------------------------|-------------------------------|---------|------------------------------|-------------------------------|
| Red     | 10250TER                     | 10250TFR                      | Clear   | 10250TEC                     | 10250TFC                      |
| Green   | 10250TEG                     | 10250TFG                      | White   | 10250TEW                     | 10250TFW                      |
| Yellow  | 10250TEA                     | 10250TFA                      | Amber   | 10250TEM                     | 10250TFM                      |
| Blue    | 10250TEL                     | 10250TFL                      |         |                              |                               |

#### Notes

- ① M = Maintained. S = Spring return in direction of arrow (→).
- ② For selection of the proper cam and contact block, to obtain the proper circuit sequence, see selection table on [Page V7-T1-348](#).
- ③ Operator includes lens gasket and lens attachment screws.
- ④ Full voltage light units can be used at other than listed voltages by changing lamp. Replacement lamps are listed on [Page V7-T1-239](#).
- ⑤ Resistor type. May generate excess heat if used in high density.
- ⑥ Amber, clear and white lenses have a black arrow (pointer), red, green and blue lenses have a white arrow (pointer).

120 Vac Transformer Selector Switch, Cam 1



### Illuminated Selector Switch Operator Only without Knob or Lever

| Positions                | Operator Action | Transformer Type—50/60 Hz<br>6V #755 Lamp<br>Catalog Number <sup>①②</sup> | Full Voltage Type—AC or DC <sup>③</sup><br>Lamps—#755, #757, #1835, 120MB <sup>④</sup><br>Catalog Number <sup>②</sup> |  |  |  |
|--------------------------|-----------------|---|---|--|--|--|
| Two-position—60° throw   |                 | <b>Cam Code 1</b> <sup>⑤</sup><br>E34VFB_H                                | <b>Cam Code 1</b> <sup>⑤</sup><br>E34SFB_H  |  |  |  |
| Three-position—60° throw |                 | <b>Cam Code 2</b> <sup>⑤</sup><br>E34VGB_H                                | <b>Cam Code 3</b> <sup>⑤</sup><br>E34VHB_H  | <b>Cam Code 2</b> <sup>⑤</sup><br>E34SGB_H | <b>Cam Code 3</b> <sup>⑤</sup><br>E34SHB_H |  |
|                          |                 | E34VNB_H <sup>⑥</sup>   | E34VPB_H <sup>⑥</sup>   | E34SNB_H <sup>⑦</sup>                      | E34SPB_H <sup>⑦</sup>                      |  |
|                          |                 | E34VJB_H <sup>⑥</sup>   | E34VKB_H <sup>⑥</sup>   | E34SJB_H <sup>⑦</sup>                      | E34SKB_H <sup>⑦</sup>                      |  |
|                          |                 | E34VLB_H  | E34VMB_H  | E34SLB_H                                   | E34SMB_H                                   |  |
|                          |                 | E34VRB_H  | —   | E34SRB_H                                   | —  |  |

#### Knob



#### Lever



#### Knobs and Levers

| Color <sup>④</sup> | Knob Catalog Number and Code Number | Lever Catalog Number and Code Number |
|--------------------|-------------------------------------|--------------------------------------|
| Red                | 10250TER                            | 10250TFR                             |
| Green              | 10250TEG                            | 10250TFG                             |
| Yellow             | 10250TEA                            | 10250TFA                             |
| Blue               | 10250TEL                            | 10250TFL                             |
| Clear              | 10250TEC                            | 10250TFC                             |
| White              | 10250TEW                            | 10250TFW                             |
| Amber              | 10250TEM                            | 10250TFM                             |

#### Light Unit Voltage Suffix

Add to operator catalog number listed in table above.

#### Type of Light Unit

| Transformer Type<br>50/60 Hz |             | Full Voltage Type<br>AC or DC <sup>③</sup> |             |
|------------------------------|-------------|--|-------------|
| Voltage                      | Suffix Code | Voltage                                    | Suffix Code |
| 24                           | 024         | 6  | 06          |
| 120                          | 120         | 12   | 12          |
| 208                          | 208         | 24   | 24          |
| 240                          | 240         | 48   | 48          |
| 380                          | 380         | 120  | 120         |
| 480                          | 480         | 240 <sup>⑥</sup>                           | 240         |
| 600                          | 600         |  |             |

#### Notes

Use NEMA 4X 10250T operators where exposed to ultraviolet light, see **Page V7-T1-352**.

- ① Operator includes lens gasket and lens attachment screws.
- ② Replace underscore with proper voltage suffix code from Light Unit Voltage Suffix table above. Example: three-position maintained with 120V transformer type light unit: E34VGB120H.
- ③ Full voltage light units can be used at other than listed voltages by changing lamp. Replacement lamps are listed on **Page V7-T1-239**.
- ④ 120MB lamps are used on both 120V and 240V operators.
- ⑤ For selection of the proper cam and contact block required to obtain a specific circuit sequence, see selection table on **Page V7-T1-348**.
- ⑥ 120 and 240V transformer only.
- ⑦ 120 full voltage only.
- ⑧ Resistor type. May generate excess heat if used in high density.
- ⑨ Amber, clear and white lenses have a black arrow (pointer). Red, green and blue lenses have a white arrow (pointer).

## 1

**Options****Contact Blocks and Mounting Adapters**

NEC Class I Division 2, Groups B, C and D

**Contact Block****Contact Block**

| Description  | Catalog Number  |
|--|-----------------|
| Class I Division 2 factory sealed contact block with 1NO-1NC | <b>10250T1H</b> |

**Dimensions**, see **Page V7-T1-359**.

**Mounting Adapter****Mounting Adapter**

| Description                            | Catalog Number  |
|--|-----------------|
| Mounting adapter for pushbuttons       | <b>10250TD2</b> |
| Mounting adapter for selector switches | <b>10250TD3</b> |

**Dimensions**, see **Page V7-T1-359**.

**Mounting Adapters with Contact Block(s)—Overpacked**

| Description                              | Catalog Number      |
|--|---------------------|
| Pushbutton adapter with 1NO-1NC          | <b>10250TD21H</b>   |
| Pushbutton adapter with 2 (1NO-1NC)      | <b>10250TD21H1H</b> |
| Selector switch adapter with 1NO-1NC     | <b>10250TD31H</b>   |
| Selector switch adapter with 2 (1NO-1NC) | <b>10250TD31H1H</b> |

### Mounting and Assembly

#### Panel Thickness

- Minimum: 0.06 in (1.6 mm)
- Maximum: 0.25 in (8 mm) including legend plate
- Maximum can be increased to 0.375 in (15.9 mm) using optional retaining nut
  - Indicating light: 10250TA30/E34TA30
  - Pushbutton/selector switch: 10250TA31/E34TA31

#### Mounting Matrix

| Legend Plate | Dimensions in Inches (mm) |             |             |             |
|--------------|---------------------------|-------------|-------------|-------------|
|              | A                         | B           | C           | D           |
| Small        | 2.87 (72.6)               | 2.25 (57.2) | 2.25 (57.2) | 2.87 (72.6) |
| Jumbo        | 2.87 (72.6)               | 2.32 (58.6) | 2.32 (58.6) | 2.87 (72.6) |
| Extra large  | 2.87 (72.6)               | 2.56 (65.2) | 2.52 (64.1) | 2.87 (72.6) |

#### Panel Spacing and Drilling

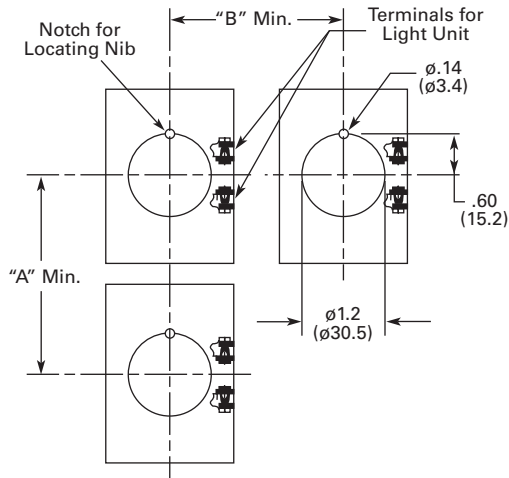

Drilling for One Hole Mounting and Dimensions for Minimum Spacing in Vertical Rows.

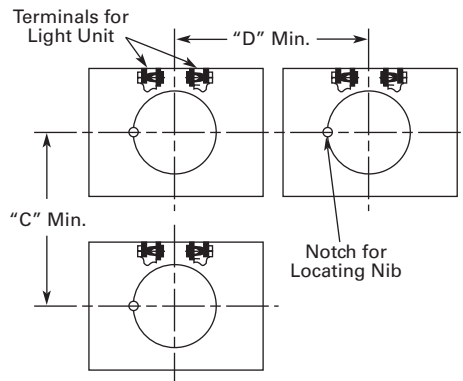

Drilling for One Hole Mounting and Dimensions for Minimum Spacing in Horizontal Rows.

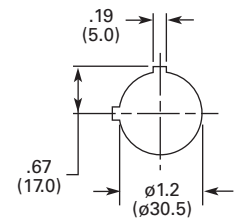

NOTE: Suitable for Use in This Alternate Mounting Hole.

#### Operator Assembly

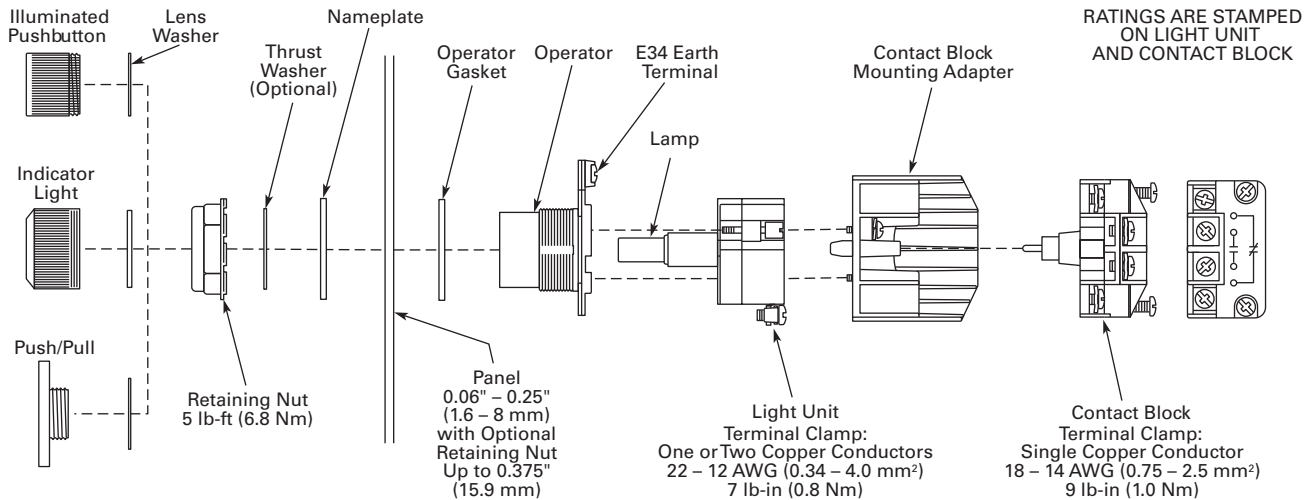





# 1

## Enclosures

### Die Cast, Polyester and Stainless Steel Enclosures

#### Enclosures (Case and Cover)—Surface Mounting <sup>①</sup>

|  | Number of Elements  | 10250T Catalog Number | E34 Catalog Number |
|--|---|-----------------------|--------------------|
| <b>Die Cast Enclosure</b>  | <b>Die Cast Enclosure—Deep Cover—In-Line NEMA 4, 4X, 12, 13</b> |                       |                    |
|   | 1   | 10250TN11             | E34N11             |
|  | 2   | 10250TN12             | E34N12             |
|  | 3   | 10250TN13             | E34N13             |
|  | 4   | 10250TN14             | E34N14             |
| <b>Polyester Enclosure</b>   | <b>Polyester—In-Line NEMA 3, 4X, 12</b>                         |                       |                    |
|   | 1   | —                     | E34N51             |
|  | 2   | —                     | E34N52             |
|  | 3   | —                     | E34N53             |
|  | 4   | —                     | E34N54             |
| <b>Stainless Steel Enclosure</b>   | <b>Stainless Steel <sup>②</sup>—In-Line NEMA 4, 4X, 12</b>      |                       |                    |
|  | 1   | —                     | 10250TN33          |
|  | 2   | —                     | 10250TN34          |
|  | 3   | —                     | 10250TN35          |
|  | 4   | —                     | 10250TN36          |

**Dimensions**, see **Page V7-T1-359**.

#### Notes

- <sup>①</sup> For spacing increments, see **Page V7-T1-234**.
- <sup>②</sup> 14 gauge, type 304.

#### Application Notes:

1. Operators need to be mounted in their horizontal orientation for all enclosures. For die cast enclosures remove locating nib on operators and use thrust washer (Catalog Number 10250TK3).
2. Polyester enclosures must be used when mounting illuminated operators.

#### Enclosure Layouts

Top – For Vertical Mounting

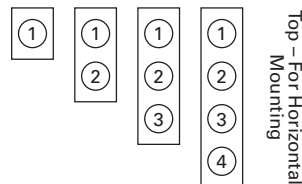

Top – For Horizontal Mounting

## Technical Data and Specifications

### Mechanical Ratings

| Description                     | Specification                     |
|---------------------------------|-----------------------------------|
| <b>Frequency of Operation</b>   |                                   |
| All pushbuttons                 | 6000 operations/hr.               |
| Key and lever selector switches | 3000 operations/hr.               |
| <b>Life</b>                     |                                   |
| Pushbuttons                     | 10 x 10 <sup>6</sup> operations   |
| Contact block                   | 10 x 10 <sup>6</sup> operations   |
| Key and lever selector switches | 0.25 x 10 <sup>6</sup> operations |
| <b>Shock Resistance</b>         |                                   |
| Duration/force                  | 20 ms ≥5g                         |

### Climatic Conditions

| Description           | Specification                |
|-----------------------|------------------------------|
| Operating temperature | 32° to 140°F (0° to 66°C)    |
| Storage temperature   | -40° to 176°F (-40° to 80°C) |
| Altitude              | 6,562 ft (2,000m)            |
| Humidity              | Max. 95% RH at 60°C          |

### Terminals

| Description  | Specification  |
|--|--|
| <b>Light Units</b>                                     |  |
| Clamps   | Terminals are saddle clamp type for 1 x 22 AWG (0.34 mm <sup>2</sup> ) to 2 x 14 AWG (4.0 mm <sup>2</sup> ) conductors           |
| Torque   | 7 lb-in (0.8 Nm)   |
| Degree of protection against direct electrical contact | IP2X with fingerproof shroud   |
| <b>Contact Blocks</b>                                  |  |
| Clamps   | Terminals are stainless steel saddle clamp type for 1 x 18–14 AWG (0.75–2.5 mm <sup>2</sup> ) solid or stranded copper conductor |
| Torque   | 9 lb-in (1.0 Nm) with size 2 Phillips screwdriver  |
| Degree of protection against direct electrical contact | IP2X with fingerproof shroud   |

### Electrical Ratings

| Description                  | Specification                      |
|------------------------------|------------------------------------|
| <b>Light Units</b>           |                                    |
| Bulbs—average life:          |                                    |
| Transformer type             | 20,000 hrs.                        |
| Resistor/direct voltage type | 2500 hrs. minimum at rated voltage |
| LED                          | 60,000 to 100,000 hrs.             |

**Electrical Ratings—Contact Block****Meet or Exceed NEMA Contact Rating Designations A600 and Q300**

| Description                                  | A600 (AC) |      |      |      | Q300 (DC) |      |
|--|-----------|------|------|------|-----------|------|
|  | 120V      | 240V | 480V | 600V | 125V      | 250V |
| Make and emerg. interrupting capacity (amps) | 60        | 30   | 15   | 12   | 0.55      | 0.27 |
| Normal load break (amps)                     | 6         | 3    | 1.5  | 1.2  | 0.55      | 0.27 |
| Thermal current (amps)                       | 10        | 10   | 10   | 10   | 2.5       | 2.5  |
| Voltamperes:                                 |           |      |      |      |           |      |
| Maximum make                                 | 7200      | 7200 | 7200 | 7200 | 69        | 69   |
| Maximum break                                | 720       | 720  | 720  | 720  | 69        | 69   |

**Temperature Codes**

All illuminated devices have operating temperatures below 100°C except for the following catalog numbers with temperature codes per NEC table 500.5(d) and UL 1604:

| 10250T                                 | E34       | Temp. Code |
|--|-----------|------------|
| 10250T201H                             | E34RB120H | T3C        |
| 10250T202H                             | E34RB240H | T3A        |
| 10250T471H                             | E34SB120H | TC3        |
| 10250T472H                             | E34SB240H | T3B        |
| 10250T80H                              | —         | T3C        |
| 10250T81H                              | —         | T3B        |
| All selector switches w/120 MB lamp    |           | T3C        |
| All illuminated devices with lamp 1835 |           | T4A        |

**Note:** For additional technical information, see Publication Number **TD.74.T.E.04**.

### Dimensions

Approximate Dimensions in Inches (mm)

#### Surface Mounting

##### Die Cast, Polyester and Stainless Steel Enclosures

4 Mtg. Holes — 10-32 Screw Size for  
1 – 4 Element Die Cast/  
Stainless Steel Enclosure  
7/32 Screw Size for  
Polyester

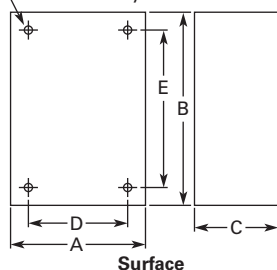

| Number of Elements     | Element Arrangement | Wide A      | High B        | Deep C      | Mounting D  | E             | Conduit Entrance |
|------------------------|---------------------|-------------|---------------|-------------|-------------|---------------|------------------|
| <b>Die Cast</b>        |                     |             |               |             |             |               |                  |
| 1                      | In-line             | 3.88 (98.6) | 4.00 (101.6)  | 3.00 (76.3) | 2.69 (68.3) | 3.25 (82.6)   | 3/4              |
| 2                      |                     | 3.88 (98.6) | 5.88 (149.4)  | 3.00 (76.3) | 2.69 (68.3) | 5.13 (130.3)  |                  |
| 3                      |                     | 3.88 (98.6) | 7.75 (196.9)  | 3.00 (76.3) | 2.69 (68.3) | 7.00 (177.8)  | 1                |
| 4                      |                     | 3.88 (98.6) | 9.63 (244.6)  | 3.00 (76.3) | 2.69 (68.3) | 8.88 (225.6)  |                  |
| <b>Polyester</b>       |                     |             |               |             |             |               |                  |
| 1                      | In-line             | 3.81 (96.8) | 6.63 (168.4)  | 3.38 (85.9) | 2.94 (74.7) | 4.88 (124.0)  | ①                |
| 2                      |                     | 3.81 (96.8) | 6.63 (168.4)  | 3.38 (85.9) | 2.94 (74.7) | 4.88 (124.0)  |                  |
| 3                      |                     | 3.81 (96.8) | 8.88 (225.6)  | 3.38 (85.9) | 2.94 (74.7) | 7.13 (181.1)  |                  |
| 4                      |                     | 3.81 (96.8) | 11.13 (282.7) | 3.38 (85.9) | 2.94 (74.7) | 9.38 (238.3)  |                  |
| <b>Stainless Steel</b> |                     |             |               |             |             |               |                  |
| 1                      | In-line             | 3.00 (76.2) | 3.50 (88.9)   | 3.00 (76.2) | 1.50 (38.1) | 4.25 (108.0)  | ①                |
| 2                      |                     | 3.50 (88.9) | 6.75 (171.5)  | 3.00 (76.2) | 1.50 (38.1) | 7.50 (190.5)  |                  |
| 3                      |                     | 3.50 (88.9) | 9.00 (228.6)  | 3.00 (76.2) | 1.50 (38.1) | 9.00 (228.6)  |                  |
| 4                      |                     | 3.50 (88.9) | 11.25 (285.8) | 3.00 (76.2) | 1.50 (38.1) | 12.00 (304.8) |                  |

#### Contact Block

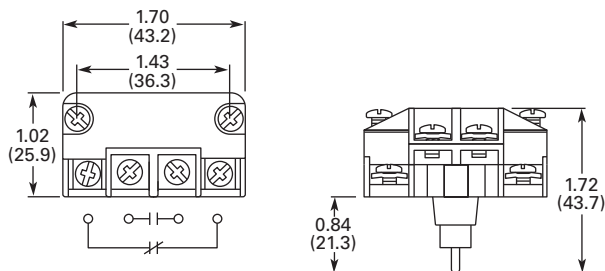

#### Mounting Adapter

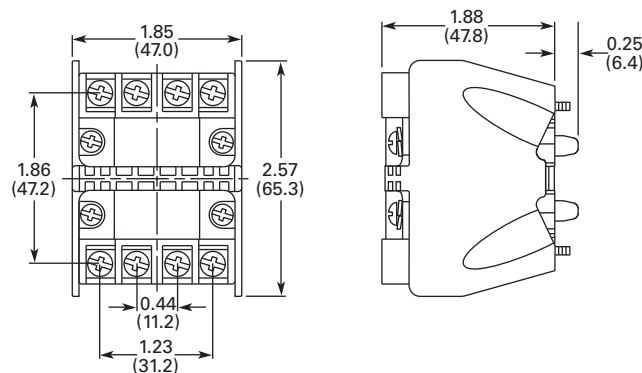

#### Note

① No conduit entrance holes provided. Drill as required.

### Ratings

#### Summary of NEC Article 500

The NEC Article 500 explains in great detail the requirements for the installation of wiring and electrical equipment in hazardous locations. The purpose of this summary is for general reference only, the National Electrical Code along with other applicable authorities having jurisdiction over the site should be the installer's guidelines when wiring or installing electrical equipment in any hazardous or potentially hazardous location.

#### Class I, Division 2 Definition

Class I, Division 2 covers hazardous locations where flammable gases, vapors or volatile liquids are handled either in a closed system, or confined within suitable enclosures, or where hazardous concentrations are normally prevented by positive mechanical ventilation. Areas adjacent to Division 1 locations, into which gases might occasionally flow, would also belong to Division 2 (NEC (500.5(b))).

#### Hazardous Location

Any area where there is the possibility of explosion and fire resulting from the presence of flammable vapors, liquids or gas, or combustible dust or fibers.

#### Summary of NEC Article 505

The NEC also classifies hazardous locations for flammable gases and vapors into zones under NEC 505. This system is more in line with the European Standards, CENELEC and IEC, with the major difference being that NEC 505 only classifies gases and vapors while CENELEC and IEC also include dusts.

### Summary of Classifications

#### NEC 500–503

| Class       | Division  | Group   |
|-------------|---|---|
| I. Gas      | 1. Hazard may exist—May exist in atmosphere under normal operating conditions   | A. Acetylene  |
|             |   | B. Hydrogen and manufactured gases containing 30% hydrogen by volume (e.g. butadiene, ethylene oxide, propylene oxide)                |
|             | 2. Potential hazard—May be present in atmosphere only under abnormal circumstances OR location adjacent to Class I, Division 1 location | C. Petrochemicals (e.g. carbon monoxide, ether, ethylene, hydrogen sulfide, morpholine, cyclopropane)                                 |
|             |   | D. Petrochemicals (e.g. gasoline, benzene, butane, propane, acetone, ammonia, vinyl chloride)   |
| II. Dust    | 1. Hazard may exist—May exist in atmosphere under normal operating conditions   | A. Acetylene  |
|             |   | B. Hydrogen and manufactured gases containing 30% hydrogen by volume (e.g. butadiene, ethylene oxide, propylene oxide)                |
|             |   | C. Petrochemicals (e.g. carbon monoxide, ether, ethylene, hydrogen sulfide, morpholine, cyclopropane)                                 |
|             | 2. Potential hazard—May be present in atmosphere only under abnormal circumstances  | D. Petrochemicals (e.g. gasoline, benzene, butane, propane, acetone, ammonia, vinyl chloride)   |
|             |   | E. Conductive and combustible dust (resistivity <math><10^9</math> ohm/cm) (metal dusts)  |
|             |   | F. Carbonaceous dusts (resistivity >math>10^2</math> ohms/cm but <math>\leq 10^8</math> ohms/cm) (e.g. carbon black, coke dust, coal) |
| III. Fibers | 1. Production areas   | G. Non-conductive combustible dust (resistivity >math>10^5</math> ohms/cm) (e.g. grain dust, flour, starch, sugar, plastics)          |
|             |   | F. Carbonaceous dusts (resistivity >math>10^2</math> ohms/cm but <math>\leq 10^8</math> ohms/cm) (e.g. carbon black, coke dust, coal) |
|             | 2. Handling and storage areas   | G. Non-conductive combustible dust (resistivity >math>10^5</math> ohms/cm) (e.g. grain dust, flour, starch, sugar, plastics)          |
|             |   | Easily ignitable fibers or flyings  |

#### NEC 505

| Class  | Zone   | Group   |
|--------|--|---|
| I. Gas | 0. Continuously present or present for long periods of time  | IIC. Acetylene, hydrogen or equivalent hazard   |
|        |  | IIB. Acetaldehyde, ethylene or equivalent hazard                                      |
|        |  | IIA. Acetone, ammonia, ethyl alcohol, gasoline, methane, propane or equivalent hazard |
|        | 1. Likely to exist under normal operating or maintenance conditions or adjacent to Zone 0                              | IIC. Acetylene, hydrogen or equivalent hazard   |
|        |  | IIB. Acetaldehyde, ethylene or equivalent hazard                                      |
|        |  | IIA. Acetone, ammonia, ethyl alcohol, gasoline, methane, propane or equivalent hazard |
|        | 2. Not likely to occur in normal operation and if they do occur will only exist for short period or adjacent to Zone 1 | IIC. Acetylene, hydrogen or equivalent hazard   |
|        |  | IIB. Acetaldehyde, ethylene or equivalent hazard                                      |
|        |  | IIA. Acetone, ammonia, ethyl alcohol, gasoline, methane, propane or equivalent hazard |

#### Note

For additional information on grouping of compounds, see NFPA 497M-1991 and NFPA 325-1994.

### Summary of Basic Methods Available for Class I, Division 2 Locations

| Method   | Features Configuration   | Advantages  | Disadvantages   |
|--|--|---|---|
| Factory sealed contact block                           | Closed-ended labyrinth contact block with an incendive circuit incapable of external ignition  | Higher continuous carrying amperages—up to 10A<br>Direct drive contacts—contacts can be forced open<br>Suitable for use in all enclosures<br>Best suited for motor control applications | May not be suitable for logic level circuits  |
| Hermetically sealed block                              | Reed switch sealed against an external atmosphere  | Suitable for low energy level circuits<br>Suitable for use in all enclosures  | Lower continuous carrying amperages are not suitable for motor control applications (typically 3A to 5A rated)<br>Contacts cannot be forced open<br>Permanent magnet attracts metallic dust and filings that can reduce the electrical creepage distance between live terminals |
| Explosion proof enclosures (Class I, Division 1 and 2) | Enclosures capable of withstanding an internal explosion while preventing external ignition. Enclosures designed for Class I, Division 1 can safely be used in Class I, Division 2 | Higher level of protection than required for Class I Division 2   | Higher material and installation costs<br>Conduit sealing is still required<br>Time consuming maintenance   |

#### Factory Sealed Contact Blocks

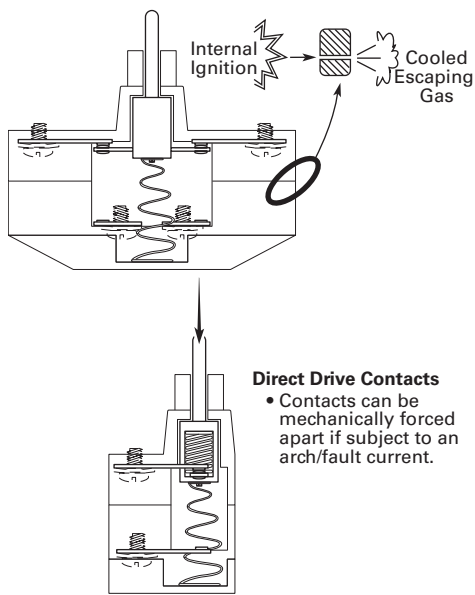

#### Hermetically Sealed Reed Contact Block

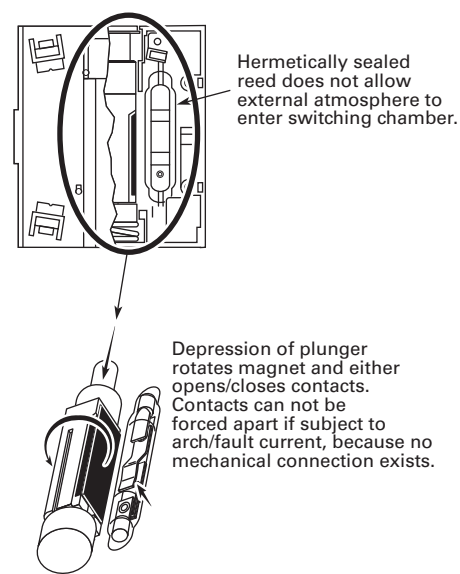

#### Explosion Proof Enclosure

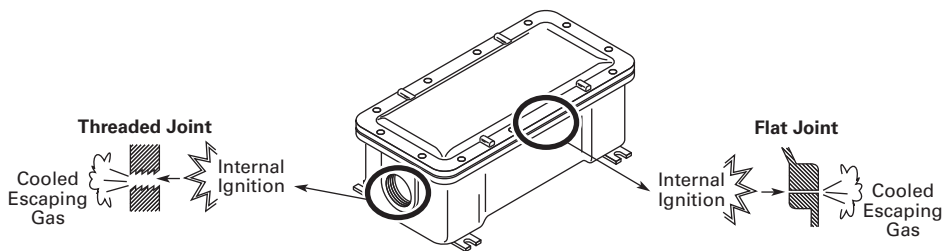

**SL Series Stacklights****E26 Series Stacklights****2.1 SL Series**

|   |          |
|---|----------|
| Product Description .....               | V7-T2-2  |
| Features .....                          | V7-T2-2  |
| Benefits .....                          | V7-T2-2  |
| Standards and Certifications .....      | V7-T2-2  |
| Product Overview .....                  | V7-T2-3  |
| Component Identification—SL7 .....      | V7-T2-4  |
| Product Selection—SL7 .....             | V7-T2-6  |
| Component Identification—SL4 .....      | V7-T2-12 |
| Product Selection—SL4 .....             | V7-T2-14 |
| Accessories .....                       | V7-T2-19 |
| Technical Data and Specifications ..... | V7-T2-20 |
| Dimensions .....                        | V7-T2-25 |

**2.2 E26 Series**

|   |          |
|---|----------|
| Product Description .....               | V7-T2-32 |
| Features .....                          | V7-T2-32 |
| Benefits .....                          | V7-T2-32 |
| Standards and Certifications .....      | V7-T2-32 |
| Product Identification .....            | V7-T2-33 |
| Catalog Number Selection .....          | V7-T2-34 |
| Product Selection .....                 | V7-T2-35 |
| Replacement Parts .....                 | V7-T2-40 |
| Technical Data and Specifications ..... | V7-T2-41 |
| Ratings .....                           | V7-T2-42 |
| Mounting Instructions .....             | V7-T2-43 |
| Dimensions .....                        | V7-T2-44 |

# 2.1

## Stacklights

### SL Series

Stacklights—SL Series

2



### Product Description

The new Eaton SL7 and SL4 stacklights provide reliable control over all key processes and machine availability. Now available in two sizes, 70 mm (SL7) and 40 mm (SL4), the new stacklights are engineered to keep you informed about potential material requirements, downtime and hazards. Modules are available in a wide selection of audible, illuminating and mounting options that are well suited to adapt to any industrial application.

### Highly Modular and Versatile Line

- Easily configurable components
- Simple bayonet mounting mechanism for quick assembly
- Flexible mounting and lighting options
- Volume-adjustable alarms

### Optimal Performance in Rugged Applications

- All elements have IP66 and UL Type 4/4X/13 ratings for protection against strong jets of water
- Bright and efficient LEDs with a lifespan of up to 100,000 hours
- High-performance LEDs for maximum illumination in direct sunlight
- Acoustic modules with up to 100 dB sound levels
- Operating temperatures: -22° to +140°F (-30° to +60°C)

### Contents

#### Description

|                                   | <i>Page</i>     |
|-----------------------------------|-----------------|
| SL Series                         |                 |
| Product Overview                  | <b>V7-T2-3</b>  |
| Component Identification—SL7      | <b>V7-T2-4</b>  |
| Product Selection—SL7             | <b>V7-T2-6</b>  |
| Component Identification—SL4      | <b>V7-T2-12</b> |
| Product Selection—SL4             | <b>V7-T2-14</b> |
| Accessories                       | <b>V7-T2-19</b> |
| Technical Data and Specifications | <b>V7-T2-20</b> |
| Dimensions                        | <b>V7-T2-25</b> |

### Features

- Six lens colors: red, amber, yellow, green, blue, white
- Continuous, flashing, strobe and multi-strobe lighting functions
- Mono-tone, dual-tone and multi-tone audible alarms
- LED or incandescent lighting options
- Control up to five modules on a single stack, 10 with dual-arm base
- 24V, 120 Vac and 230 Vac operating voltages

### Benefits

- Simplified twist-and-lock assembly, no tools required
- Compact components reduce inventory requirements and increase flexibility
- Versatile hardware for quick installation and minimized downtime
- New slim 40 mm size is ideal for applications with constrained space
- Lean automation with SmartWire-DT connectivity
- Ideal for indoor and outdoor usage

### Standards and Certifications

- UL 508—File No. E29184
- IEC/EN 60947-5-1
- CSA C22.2 No. 14-10
- CSA C22.2 No. 94-91
- CSA Class No. NKCR7





Product Overview

|                         | SL7  | SL4  |
|-------------------------|--|--|
| <b>Diameter</b>         | 70 mm  | 40 mm  |
|                         |   |    |
| <b>Acoustic Modules</b> | Page V7-T2-9   | Page V7-T2-16  |
|                         |   |    |
| <b>Light Modules</b>    | <p>Continuous light, LED: Page V7-T2-6</p> <p>Flashing light, LED: Page V7-T2-7</p> <p>Strobe light, LED: Page V7-T2-7</p> <p>Continuous light, high-performance LED: Page V7-T2-8</p> <p>Strobe light, high-performance LED: Page V7-T2-8</p> <p>Multi-strobe light, high-performance LED: Page V7-T2-8</p> <p>Continuous light, Incandescent: Page V7-T2-8</p> | <p>Continuous light, LED: Page V7-T2-16</p> <p>Flashing light, LED: Page V7-T2-15</p> <p>Strobe light, LED: Page V7-T2-15</p> <p>Multi-strobe light, LED: Page V7-T2-17</p> <p>Continuous light, Incandescent: Page V7-T2-17</p> |
|                         |    |  |
|                         |   |  |
| <b>Base Modules</b>     | Page V7-T2-10, V7-T2-11  | Page V7-T2-17  |
| <b>Accessories</b>      | Page V7-T2-19  | Page V7-T2-19  |

# 2.1

## Stacklights

SL Series

### Component Identification—SL7

2

#### Component Identification

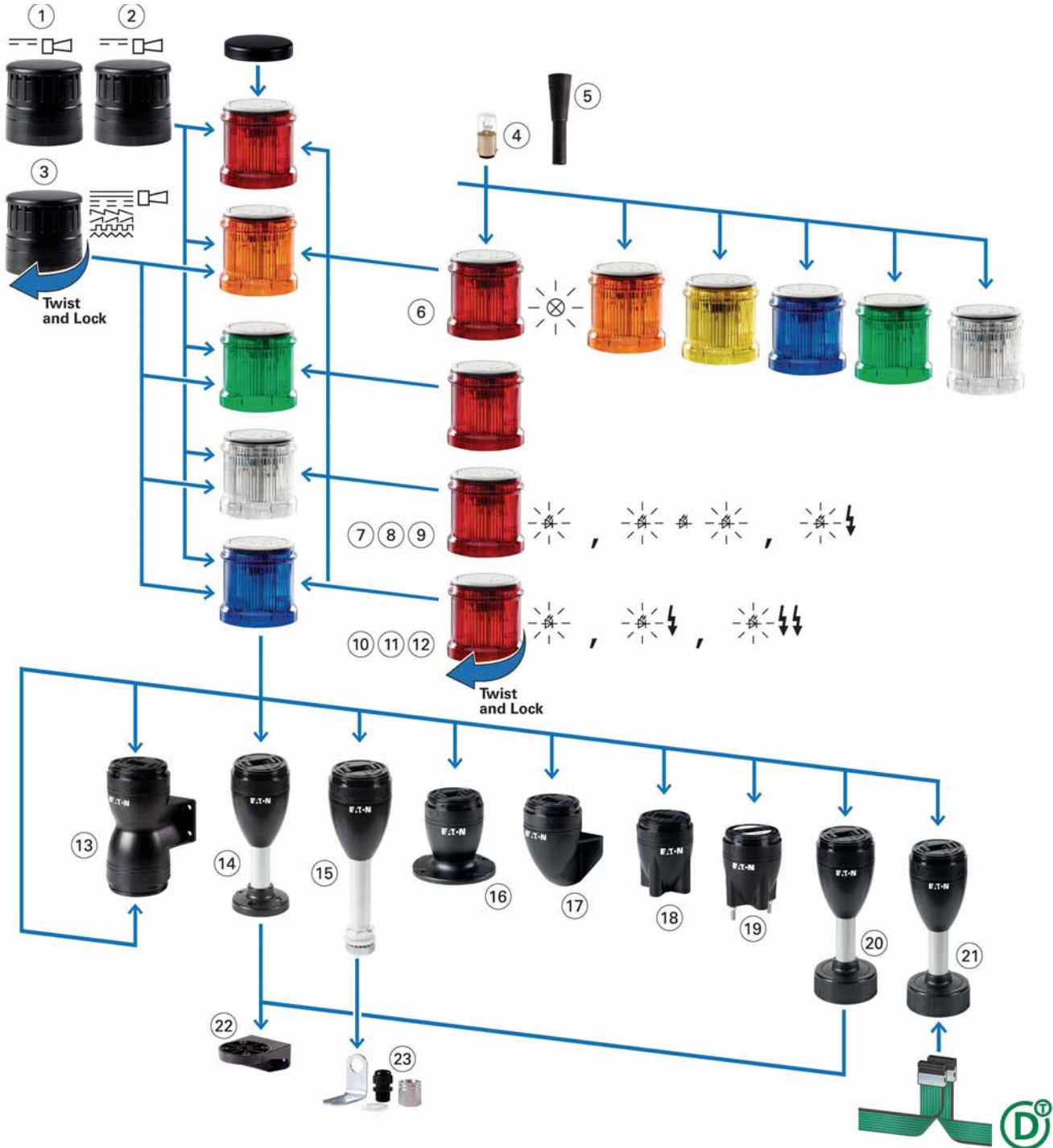

#### Light Modes

|              | Continuous | Flashing | Strobe | Multi-Strobe |
|--------------|------------|----------|--------|--------------|
| Incandescent |            | —        | —      | —            |
| LED          |            |          |        |              |

## SL7—Component Identification Descriptions

| Item   | Item Number | Description  | Page Reference |
|--|-------------|--|----------------|
| <b>Acoustic Modules</b>  |             |  |                |
| Easy mounting with bayonet mount, place at highest position<br>Sound pressure up to 100 dB, adjustable with internal potentiometer<br>Operating mode: 100% DF (duty factor)<br>Degree of protection: UL Type 4/4X/13, IP66<br>Operational voltages: 24 Vac/Vdc, 110/120 Vac, 230/240 Vac | 1           | Continuous tone or pulsed tone, adjustable with internal DIP switches<br>Frequency: 2800 Hz                            | V7-T2-9        |
|  | 2           | Continuous tone or pulsed tone; can be actuated externally; takes up to two inputs (two modules)<br>Frequency: 2800 Hz | V7-T2-9        |
|  | 3           | Multi-tone (eight tones) adjustable with internal DIP switch<br>Frequency 500–2700 Hz                                  | V7-T2-9        |
| <b>Incandescent Bulb</b>   | 4           | Accessory  | V7-T2-19       |
| <b>Tool for Replacing Incandescent Bulb</b>  | 5           | Accessory  | V7-T2-19       |
| <b>Light Modules</b>   |             |  |                |
| Easy mounting with bayonet mount, modules can be arranged in any order<br>Operating mode: 100% DF (duty factor)<br>Degree of protection: UL Type 4/4X/13, IP66<br>Max. 5 modules per stack or up to 10 via dual-arm base option  |             |  |                |
| <b>Light Module for Incandescent Bulb</b>  |             |  |                |
| Continuous light   | 6           | BA15d socket, without incandescent bulb  | V7-T2-7        |
| <b>Light Modules with LED</b>  |             |  |                |
| Continuous light   | 7           |  | V7-T2-6        |
| Flashing light   | 8           | Flashing frequency: 2 Hz   | V7-T2-7        |
| Strobe light   | 9           | Flashing frequency: 1.4 Hz   | V7-T2-7        |
| <b>Light Modules with High-Output LED</b>  |             |  |                |
| Continuous light   | 10          |  | V7-T2-8        |
| Strobe light   | 11          | High-performance LED, flashing frequency: 1.4 Hz   | V7-T2-8        |
| Strobe light, multi-strobe light   | 12          | High-performance LED, with various strobe sequences<br>Flashing frequency: 1–2.6 Hz                                    | V7-T2-8        |
| <b>Base Modules</b>  |             |  |                |
| Easy mounting with bayonet mount, includes cover plate, with spring-cage terminals<br>Degree of protection: UL Type 4/4X/13, IP66  |             |  |                |
| Base for mounting on both sides  | 13          | Max. 2 x 5 modules that can be actuated individually   | V7-T2-11       |
| Base with aluminum tube and plastic foot   | 14          | Aluminum tube 100 mm, 250 mm or 400 mm   | V7-T2-10       |
| Base with aluminum tube and threaded 1/2 in NPT  | 15          | Aluminum tube 100 mm, 250 mm or 400 mm   | V7-T2-10       |
| Base with external fixing holes  | 16          | —  | V7-T2-10       |
| Vertical base with bracket   | 17          | —  | V7-T2-11       |
| Base with internal (on the inside) fixing holes  | 18          | —  | V7-T2-10       |
| Base with built-in fixing screws (pre-assembled)   | 19          | —  | V7-T2-10       |
| Base with base adapter for slipping onto place (rapid mounting and wiring system)  | 20          | Aluminum tube 100 mm, 250 mm or 400 mm   | V7-T2-10       |
| Base with base adapter for slipping onto place (rapid mounting and wiring system) and SmartWire-DT™ connection   | 21          | Aluminum tube 100 mm   | V7-T2-10       |
| <b>Mounting Bracket</b>  |             |  |                |
| Bracket  | 22          | Accessory  | V7-T2-19       |
| Bracket  | 23          | Accessory, includes M20 cable gland  | V7-T2-19       |

# 2.1

## Stacklights

### SL Series

#### Product Selection—SL7

#### Complete Devices

2

SL7-100-L-R\_



#### Continuous Light, LED, UL Type 4/4X/13, IP66

| Rated Operational Voltage (U <sub>e</sub> V) | Number of Modules | Color           | Function | Standard Pack | Catalog Number             |
|--|-------------------|-----------------|----------|---------------|----------------------------|
| <b>Base Module with Foot and 100 mm Tube</b> |                   |                 |          |               |                            |
| 24 Vac/Vdc                                   | 2                 | Red/Green       |          | 1             | <b>SL7-100-L-RG-24LED</b>  |
|  | 3                 | Red/Amber/Green |          |               | <b>SL7-100-L-RAG-24LED</b> |

#### Light Module with LED

SL7-L\_



#### Continuous Light, UL Type 4/4X/13, IP66

| Rated Operational Voltage (U <sub>e</sub> V) | Color  | Function | Standard Pack | Catalog Number    |
|--|--------|----------|---------------|-------------------|
| 24 Vac/Vdc                                   | Blue   |          | 1             | <b>SL7-L24-B</b>  |
|  | Green  |          |               | <b>SL7-L24-G</b>  |
|  | Red    |          |               | <b>SL7-L24-R</b>  |
|  | White  |          |               | <b>SL7-L24-W</b>  |
|  | Yellow |          |               | <b>SL7-L24-Y</b>  |
|  | Amber  |          |               | <b>SL7-L24-A</b>  |
| 110/120 Vac                                  | Blue   |          | 1             | <b>SL7-L120-B</b> |
|  | Green  |          |               | <b>SL7-L120-G</b> |
|  | Red    |          |               | <b>SL7-L120-R</b> |
|  | White  |          |               | <b>SL7-L120-W</b> |
|  | Yellow |          |               | <b>SL7-L120-Y</b> |
|  | Amber  |          |               | <b>SL7-L120-A</b> |
| 230/240 Vac                                  | Blue   |          | 1             | <b>SL7-L230-B</b> |
|  | Green  |          |               | <b>SL7-L230-G</b> |
|  | Red    |          |               | <b>SL7-L230-R</b> |
|  | White  |          |               | <b>SL7-L230-W</b> |
|  | Yellow |          |               | <b>SL7-L230-Y</b> |
|  | Amber  |          |               | <b>SL7-L230-A</b> |

## Light Module with LED, continued

SL7-BL\_

## Flashing Light, UL Type 4/4X/13, IP66, 2 Hz



| Rated Operational Voltage (U <sub>e</sub> V) | Color       | Function | Standard Pack | Catalog Number |
|--|-------------|----------|---------------|----------------|
| 24 Vac/Vdc                                   | Blue        |          | 1             | SL7-BL24-B     |
|  | Green       |          |               | SL7-BL24-G     |
|  | Red         |          |               | SL7-BL24-R     |
|  | White       |          |               | SL7-BL24-W     |
|  | Yellow      |          |               | SL7-BL24-Y     |
|  | Amber       |          |               | SL7-BL24-A     |
|  | 110/120 Vac | Blue     |               |                |
| Green  |             |          | SL7-BL120-G   |                |
| Red  |             |          | SL7-BL120-R   |                |
| White  |             |          | SL7-BL120-W   |                |
| Yellow                                       |             |          | SL7-BL120-Y   |                |
| Amber  |             |          | SL7-BL120-A   |                |
| 230/240 Vac                                  |             | Blue     |               | 1              |
|  | Green       |          | SL7-BL230-G   |                |
|  | Red         |          | SL7-BL230-R   |                |
|  | White       |          | SL7-BL230-W   |                |
|  | Yellow      |          | SL7-BL230-Y   |                |
|  | Amber       |          | SL7-BL230-A   |                |

SL7-FL\_

## Strobe Light, UL Type 4/4X/13, IP66, 1.4 Hz



| Rated Operational Voltage (U <sub>e</sub> V) | Color       | Function | Standard Pack | Catalog Number |
|--|-------------|----------|---------------|----------------|
| 24 Vac/Vdc                                   | Blue        |          | 1             | SL7-FL24-B     |
|  | Green       |          |               | SL7-FL24-G     |
|  | Red         |          |               | SL7-FL24-R     |
|  | White       |          |               | SL7-FL24-W     |
|  | Yellow      |          |               | SL7-FL24-Y     |
|  | Amber       |          |               | SL7-FL24-A     |
|  | 110/120 Vac | Blue     |               |                |
| Green  |             |          | SL7-FL120-G   |                |
| Red  |             |          | SL7-FL120-R   |                |
| White  |             |          | SL7-FL120-W   |                |
| Yellow                                       |             |          | SL7-FL120-Y   |                |
| Amber  |             |          | SL7-FL120-A   |                |
| 230/240 Vac                                  |             | Blue     |               | 1              |
|  | Green       |          | SL7-FL230-G   |                |
|  | Red         |          | SL7-FL230-R   |                |
|  | White       |          | SL7-FL230-W   |                |
|  | Yellow      |          | SL7-FL230-Y   |                |
|  | Amber       |          | SL7-FL230-A   |                |

# 2.1

## Stacklights

### SL Series

2

#### SL7 Light Module with High-Output LED

SL7-L24-

##### Continuous Light, UL Type 4/4X/13, IP66



| Rated Operational Voltage (U <sub>e</sub> V)             | Color  | Function | Standard Pack | Catalog Number |
|--|--------|----------|---------------|----------------|
| <b>High-Performance LED for Maximum Signaling Effect</b> |        |          |               |                |
| 24 Vac/Vdc   | Blue   |          | 1             | SL7-L24-B-HP   |
|  | Green  |          |               | SL7-L24-G-HP   |
|  | Red    |          |               | SL7-L24-R-HP   |
|  | White  |          |               | SL7-L24-W-HP   |
|  | Yellow |          |               | SL7-L24-Y-HP   |
|  | Amber  |          |               | SL7-L24-A-HP   |

SL7-FL24-HP

##### Strobe Light, UL Type 4/4X/13, IP66



| Rated Operational Voltage (U <sub>e</sub> V)                     | Color  | Function | Standard Pack | Catalog Number |
|--|--------|----------|---------------|----------------|
| <b>High-Performance LED for Maximum Signaling Effect, 1.4 Hz</b> |        |          |               |                |
| 24 Vac/Vdc   | Blue   |          | 1             | SL7-FL24-B-HP  |
|  | Green  |          |               | SL7-FL24-G-HP  |
|  | Red    |          |               | SL7-FL24-R-HP  |
|  | White  |          |               | SL7-FL24-W-HP  |
|  | Yellow |          |               | SL7-FL24-Y-HP  |
|  | Amber  |          |               | SL7-FL24-A-HP  |

SL7-FL24-HPM

##### Multi-Strobe Light, UL Type 4/4X/13, IP66



| Rated Operational Voltage (U <sub>e</sub> V)                       | Color  | Function | Standard Pack | Catalog Number |
|--|--------|----------|---------------|----------------|
| <b>High-Performance LED for Maximum Signaling Effect, 1–2.6 Hz</b> |        |          |               |                |
| 24 Vac/Vdc   | Blue   |          | 1             | SL7-FL24-B-HPM |
|  | Green  |          |               | SL7-FL24-G-HPM |
|  | Red    |          |               | SL7-FL24-R-HPM |
|  | White  |          |               | SL7-FL24-W-HPM |
|  | Yellow |          |               | SL7-FL24-Y-HPM |
|  | Amber  |          |               | SL7-FL24-A-HPM |

#### SL7 Light Module for Incandescent Bulb

SL7-L-

##### Continuous Light, UL Type 4/4X/13, IP66

For incandescent bulb selection, see **Page V7-T2-19**.



| Rated Operational Voltage (U <sub>e</sub> V)                 | Color  | Function | Standard Pack | Catalog Number |
|--|--------|----------|---------------|----------------|
| <b>Without Light Elements, Incandescent Bulb, Maximum 7W</b> |        |          |               |                |
| <250 Vac/Vdc   | Blue   |          | 1             | SL7-L-B        |
|  | Green  |          |               | SL7-L-G        |
|  | Red    |          |               | SL7-L-R        |
|  | White  |          |               | SL7-L-W        |
|  | Yellow |          |               | SL7-L-Y        |
|  | Amber  |          |               | SL7-L-A        |

## SL7 Acoustic Modules

## SL7-AP\_

**Continuous Tone or Pulsed Tone, UL Type 4/4X/13, IP66** ①

Adjustable with internal DIP switches.

Sound pressure 100 dB, adjustable with internal potentiometer.  
f = 2800 Hz.

| Rated Operational Voltage (U <sub>e</sub> V) | Rated Operational Current (I <sub>e</sub> mA) | Color | Function | Sound Type | Standard Pack | Catalog Number |
|--|---|-------|----------|------------|---------------|----------------|
| 24 Vac/Vdc                                   | Maximum 92                                    | Black |          |            | 1             | SL7-AP24       |
| 110/120 Vac                                  | Maximum 41                                    | Black |          |            |               | SL7-AP120      |
| 230/240 Vac                                  | Maximum 43                                    | Black |          |            |               | SL7-AP230      |

## SL7-AP\_-E

**Continuous Tone or Pulsed Tone, External Actuation, UL Type 4/4X/13, IP66** ①

Assigned two inputs (two modules).

Sound pressure 100 dB, adjustable with internal potentiometer.  
f = 2800 Hz.

| Rated Operational Voltage (U <sub>e</sub> V) | Rated Operational Current (I <sub>e</sub> mA) | Color | Function | Sound Type | Standard Pack | Catalog Number |
|--|---|-------|----------|------------|---------------|----------------|
| 24 Vac/Vdc                                   | Maximum 92                                    | Black |          |            | 1             | SL7-AP24-E     |
| 110/120 Vac                                  | Maximum 41                                    | Black |          |            |               | SL7-AP120-E    |
| 230/240 Vac                                  | Maximum 43                                    | Black |          |            |               | SL7-AP230-E    |

## SL7-AP\_-M

**Multi-Tone; Eight Tones, UL Type 4/4X/13, IP66** ①

Adjustable with internal DIP switch.

Sound pressure 100 dB, adjustable with internal potentiometer.  
f = 500–2700 Hz.

| Rated Operational Voltage (U <sub>e</sub> V) | Rated Operational Current (I <sub>e</sub> mA) | Color | Function | Sound Type | Standard Pack | Catalog Number |
|--|---|-------|----------|------------|---------------|----------------|
| 24 Vac/Vdc                                   | Maximum 115                                   | Black |          |            | 1             | SL7-AP24-M     |
| 110/120 Vac                                  | Maximum 45                                    | Black |          |            |               | SL7-AP120-M    |
| 230/240 Vac                                  | Maximum 43                                    | Black |          |            |               | SL7-AP230-M    |

**Note**

① Place only at the highest position on a pole.

# 2.1





## Stacklights

### SL Series

#### SL7 Base Modules

2



#### For Horizontal Mounting—Includes Cover, Maximum 5 Modules

|  | Description   | Tube Length | Color      | Standard Pack | For use with ...                                    | Catalog Number      |
|--|---|-------------|------------|---------------|---|---------------------|
| <b>SL7-CB-__</b><br>    | Base with aluminum tube and plastic foot<br>Spring-loaded terminals             | 100 mm      | Black      | 1             | SL7-L-...   | <b>SL7-CB-100</b>   |
|  |   | 250 mm      | aluminum   |               | SL7-BL-...  | <b>SL7-CB-250</b>   |
|  |   | 400 mm      | color tube |               | SL7-FL-...<br>SL7-AP-...                            | <b>SL7-CB-400</b>   |
| <b>SL7-CB-T-__</b><br> | Base with aluminum tube and 3/4 in NPT threaded base<br>Spring-loaded terminals | 100 mm      | Black      | 1             | SL7-L-...   | <b>SL7-CB-T-100</b> |
|  |   | 250 mm      | aluminum   |               | SL7-BL-...  | <b>SL7-CB-T-250</b> |
|  |   | 400 mm      | color tube |               | SL7-FL-...<br>SL7-AP-...                            | <b>SL7-CB-T-400</b> |
| <b>SL7-CB-IMH</b><br> | Base with internal (on the inside) fixing holes<br>Spring-loaded terminals      | —           | Black      | 1             | SL7-L-...<br>SL7-BL-...<br>SL7-FL-...<br>SL7-AP-... | <b>SL7-CB-IMH</b>   |
| <b>SL7-CB-IMS</b><br> | Base with built-in (pre-assembled) fixing screws<br>Spring-loaded terminals     | —           | Black      | 1             | SL7-L-...<br>SL7-BL-...<br>SL7-FL-...<br>SL7-AP-... | <b>SL7-CB-IMS</b>   |
| <b>SL7-CB-EMH</b><br> | Base with external fixing holes<br>Spring-loaded terminals                      | —           | Black      | 1             | SL7-L-...<br>SL7-BL-...<br>SL7-FL-...<br>SL7-AP-... | <b>SL7-CB-EMH</b>   |



## SL7 Base Modules, continued

## For Horizontal Mounting—Includes Cover, Maximum 5 Modules, continued

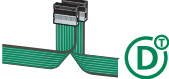
|   | Description   | Tube Length | Color      | Standard Pack | For use with ...                                    | Catalog Number     |
|---|---|-------------|------------|---------------|---|--------------------|
| <b>SL7-FMS_</b><br>  | Base with base adapter for slipping onto place (rapid mounting and wiring system)<br>Screw terminals  | 100 mm      | Black      | 1             | SL7-L-...   | <b>SL7-FMS-100</b> |
|   |   | 250 mm      | aluminum   |               | SL7-BL-...  | <b>SL7-FMS-250</b> |
|   |   | 400 mm      | color tube |               | SL7-FL-...<br>SL7-AP-...                            | <b>SL7-FMS-400</b> |
| <b>SL7-SWD</b><br><br> | Base with base adapter for slipping onto place (rapid mounting and wiring system)<br>Blade terminal SWD4-8MF2<br>Maximum 0.3A per module<br>External power supply connectable (24 Vdc)<br>Configurable with SWD-Assist (planning and ordering help) | 100 mm      | —          | 1             | SL7-L-...<br>SL7-BL-...<br>SL7-FL-...<br>SL7-AP-... | <b>SL7-SWD</b>     |

## For Vertical Mounting—Includes Cover, Maximum 5 Modules

|   | Description   | Color | Standard Pack | For use with ...                                    | Catalog Number   |
|---|---|-------|---------------|---|------------------|
| <b>SL7-CB-FW</b><br> | Vertical base with bracket<br>Spring-loaded terminals | Black | 1             | SL7-L-...<br>SL7-BL-...<br>SL7-FL-...<br>SL7-AP-... | <b>SL7-CB-FW</b> |

## For Mounting on Both Sides—Includes Cover, Maximum 2 x 5 Modules

|  | Description  | Color | Standard Pack | For use with ...                                    | Catalog Number  |
|--|--|-------|---------------|---|-----------------|
| <b>SL7-CB-D</b><br> | Base with external fixing holes<br>Spring-loaded terminals | Black | 1             | SL7-L-...<br>SL7-BL-...<br>SL7-FL-...<br>SL7-AP-... | <b>SL7-CB-D</b> |

# 2.1

## Stacklights

SL Series

### Component Identification—SL4

#### Component Identification

2

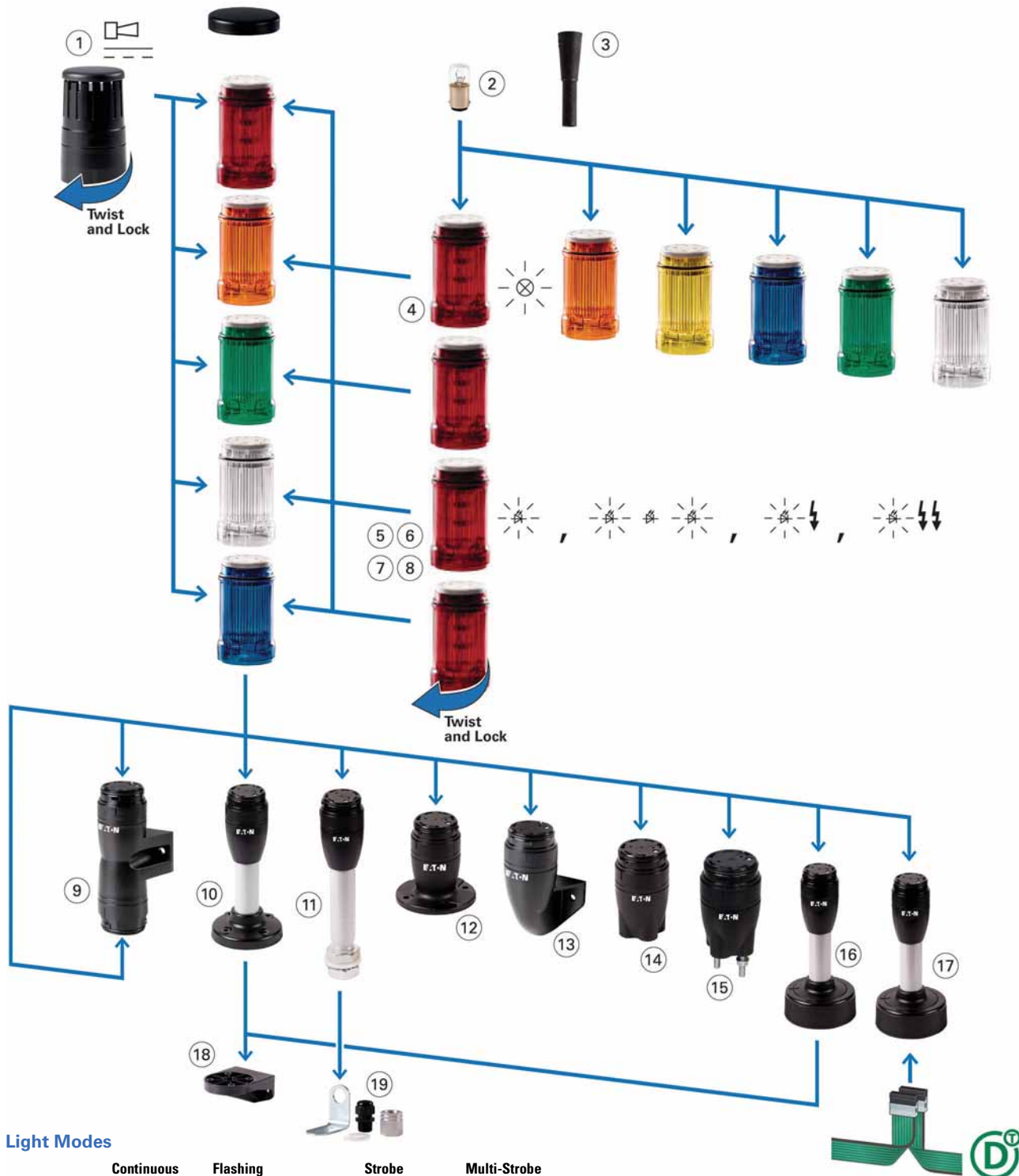

#### Light Modes

|              | Continuous | Flashing | Strobe | Multi-Strobe |
|--------------|------------|----------|--------|--------------|
| Incandescent |            | —        | —      | —            |
| LED          |            |          |        |              |

## SL4—Component Identification Descriptions

| Item   | Item Number | Description   | Page Reference |
|--|-------------|---|----------------|
| <b>Acoustic Modules</b>  |             |   |                |
| Sound pressure 80 dB, adjustable with internal potentiometer, frequency 4000 Hz<br>Easy mounting with bayonet mount, set up as highest module<br>Permanently integrated cover plate<br>Operating mode: 100% DF (duty factor)<br>Degree of protection: UL Type 4/4X/13, IP66                    | 1           | Continuous tone or pulsed tone, adjustable with internal DIP switches<br>Frequency: 2800 Hz | V7-T2-16       |
| <b>Incandescent Bulb</b>   | 2           | Accessory   | V7-T2-19       |
| <b>Tool for Replacing Incandescent Bulb</b>  | 3           | Accessory   | V7-T2-19       |
| <b>Light Modules</b>   |             |   |                |
| Easy mounting with bayonet mount, modules can be arranged in any order<br>Without light element (incandescent bulb with BA15d socket),<br>easy mounting with bayonet mount.<br>Operating mode: 100% DF (duty factor)<br>Flashing frequency 2 Hz<br>Degree of protection: UL Type 4/4X/13, IP66 |             |   |                |
| <b>Light Module for Incandescent Bulb</b>  |             |   |                |
| Continuous light   | 4           | BA15d socket, without incandescent bulb   | V7-T2-16       |
| <b>Light Modules with LED</b>  |             |   |                |
| Continuous light   | 5           |   | V7-T2-14       |
| Flashing light   | 6           | Flashing frequency: 2 Hz  | V7-T2-15       |
| Strobe light   | 7           | Flashing frequency: 1.4 Hz  | V7-T2-15       |
| Strobe light, multi-strobe light   | 8           | High-performance LED, with various strobe sequences<br>Flashing frequency: 1–2.6 Hz         | V7-T2-16       |
| <b>Base Modules</b>  |             |   |                |
| Easy mounting with bayonet mount, includes cover plate, with spring-cage terminals<br>Degree of protection: UL Type 4/4X/13, IP66  |             |   |                |
| Base for mounting on both sides  | 9           | Max. 2 x 5 modules that can be actuated individually  | V7-T2-17       |
| Base with aluminum tube and plastic foot   | 10          | Aluminum tube 100 mm, 250 mm or 400 mm  | V7-T2-17       |
| Base with aluminum tube and threaded 1/2 in NPT  | 11          | Aluminum tube 100 mm, 250 mm or 400 mm  | V7-T2-17       |
| Base with external fixing holes  | 12          | —   | V7-T2-17       |
| Vertical base with bracket   | 13          | —   | V7-T2-17       |
| Base with internal (on the inside) fixing holes  | 14          | —   | V7-T2-17       |
| Base with built-in fixing screws (pre-assembled)   | 15          | —   | V7-T2-17       |
| Base with base adapter for slipping onto place (rapid mounting and wiring system)  | 16          | Aluminum tube 100 mm, 250 mm or 400 mm  | V7-T2-17       |
| Base with base adapter for slipping onto place (rapid mounting and wiring system) and SmartWire-DT™ connection   | 17          | Aluminum tube 100 mm  | V7-T2-17       |
| <b>Mounting Bracket</b>  |             |   |                |
| Bracket  | 18          | Accessory   | V7-T2-19       |
| Bracket  | 19          | Accessory, includes M20 cable gland   | V7-T2-19       |

# 2.1

## Stacklights

### SL Series

#### Product Selection—SL4

2

#### Complete Devices

SL4-100-L-R\_



#### Continuous Light, LED, UL Type 4/4X/13, IP66

| Rated Operational Voltage (U <sub>e</sub> V) | Number of Modules | Color           | Function | Standard Pack | Catalog Number             |
|--|-------------------|-----------------|----------|---------------|----------------------------|
| <b>Base Module with Foot and 100 mm Tube</b> |                   |                 |          |               |                            |
| 24 Vac/Vdc                                   | 2                 | Red/Green       |          | 1             | <b>SL4-100-L-RG-24LED</b>  |
|  | 3                 | Red/Amber/Green |          |               | <b>SL4-100-L-RAG-24LED</b> |

#### Light Module with LED

SL4-L\_



#### Continuous Light, UL Type 4/4X/13, IP66

| Rated Operational Voltage (U <sub>e</sub> V) | Color  | Function | Standard Pack | Catalog Number    |
|--|--------|----------|---------------|-------------------|
| 24 Vac/Vdc                                   | Blue   |          | 1             | <b>SL4-L24-B</b>  |
|  | Green  |          |               | <b>SL4-L24-G</b>  |
|  | Red    |          |               | <b>SL4-L24-R</b>  |
|  | White  |          |               | <b>SL4-L24-W</b>  |
|  | Yellow |          |               | <b>SL4-L24-Y</b>  |
|  | Amber  |          |               | <b>SL4-L24-A</b>  |
| 110/120 Vac                                  | Blue   |          | 1             | <b>SL4-L120-B</b> |
|  | Green  |          |               | <b>SL4-L120-G</b> |
|  | Red    |          |               | <b>SL4-L120-R</b> |
|  | White  |          |               | <b>SL4-L120-W</b> |
|  | Yellow |          |               | <b>SL4-L120-Y</b> |
|  | Amber  |          |               | <b>SL4-L120-A</b> |
| 230/240 Vac                                  | Blue   |          | 1             | <b>SL4-L230-B</b> |
|  | Green  |          |               | <b>SL4-L230-G</b> |
|  | Red    |          |               | <b>SL4-L230-R</b> |
|  | White  |          |               | <b>SL4-L230-W</b> |
|  | Yellow |          |               | <b>SL4-L230-Y</b> |
|  | Amber  |          |               | <b>SL4-L230-A</b> |

## Light Module with LED, continued

SL4-BL\_

## Flashing Light, UL Type 4/4X/13, IP66, 2 Hz



| Rated Operational Voltage (U <sub>e</sub> V) | Color       | Function | Standard Pack | Catalog Number |
|--|-------------|----------|---------------|----------------|
| 24 Vac/Vdc                                   | Blue        |          | 1             | SL4-BL24-B     |
|  | Green       |          |               | SL4-BL24-G     |
|  | Red         |          |               | SL4-BL24-R     |
|  | White       |          |               | SL4-BL24-W     |
|  | Yellow      |          |               | SL4-BL24-Y     |
|  | Amber       |          |               | SL4-BL24-A     |
|  | 110/120 Vac | Blue     |               |                |
| Green  |             |          | SL4-BL120-G   |                |
| Red  |             |          | SL4-BL120-R   |                |
| White  |             |          | SL4-BL120-W   |                |
| Yellow                                       |             |          | SL4-BL120-Y   |                |
| Amber  |             |          | SL4-BL120-A   |                |
| 230/240 Vac                                  |             | Blue     |               | 1              |
|  | Green       |          | SL4-BL230-G   |                |
|  | Red         |          | SL4-BL230-R   |                |
|  | White       |          | SL4-BL230-W   |                |
|  | Yellow      |          | SL4-BL230-Y   |                |
|  | Amber       |          | SL4-BL230-A   |                |

SL4-FL\_

## Strobe Light, UL Type 4/4X/13, IP66, 1.4 Hz



| Rated Operational Voltage (U <sub>e</sub> V) | Color       | Function | Standard Pack | Catalog Number |
|--|-------------|----------|---------------|----------------|
| 24 Vac/Vdc                                   | Blue        |          | 1             | SL4-FL24-B     |
|  | Green       |          |               | SL4-FL24-G     |
|  | Red         |          |               | SL4-FL24-R     |
|  | White       |          |               | SL4-FL24-W     |
|  | Yellow      |          |               | SL4-FL24-Y     |
|  | Amber       |          |               | SL4-FL24-A     |
|  | 110/120 Vac | Blue     |               |                |
| Green  |             |          | SL4-FL120-G   |                |
| Red  |             |          | SL4-FL120-R   |                |
| White  |             |          | SL4-FL120-W   |                |
| Yellow                                       |             |          | SL4-FL120-Y   |                |
| Amber  |             |          | SL4-FL120-A   |                |
| 230/240 Vac                                  |             | Blue     |               | 1              |
|  | Green       |          | SL4-FL230-G   |                |
|  | Red         |          | SL4-FL230-R   |                |
|  | White       |          | SL4-FL230-W   |                |
|  | Yellow      |          | SL4-FL230-Y   |                |
|  | Amber       |          | SL4-FL230-A   |                |

# 2.1

## Stacklights

### SL Series

#### Light Module with LED, continued

2

SL4-FL24-\_-M



#### Multi-Strobe Light, UL Type 4/4X/13, IP66

| Rated Operational Voltage (U <sub>e</sub> V)                                      | Color  | Function | Standard Pack | Catalog Number      |
|---|--------|----------|---------------|---------------------|
| <b>LED for Effective Signaling Effect With Various Strobe Sequences, 1–2.6 Hz</b> |        |          |               |                     |
| 24 Vac/Vdc  | Blue   |          | 1             | <b>SL4-FL24-B-M</b> |
|   | Green  |          |               | <b>SL4-FL24-G-M</b> |
|   | Red    |          |               | <b>SL4-FL24-R-M</b> |
|   | White  |          |               | <b>SL4-FL24-W-M</b> |
|   | Yellow |          |               | <b>SL4-FL24-Y-M</b> |
|   | Amber  |          |               | <b>SL4-FL24-A-M</b> |

#### SL4 Light Module for Incandescent Bulb

SL4-L-\_-



#### Continuous Light, UL Type 4/4X/13, IP66

For incandescent bulb selection, see **Page V7-T2-19**.

| Rated Operational Voltage (U <sub>e</sub> V)                 | Color  | Function | Standard Pack | Catalog Number |
|--|--------|----------|---------------|----------------|
| <b>Without Light Elements, Incandescent Bulb, Maximum 4W</b> |        |          |               |                |
| <250 Vac/Vdc   | Blue   |          | 1             | <b>SL4-L-B</b> |
|  | Green  |          |               | <b>SL4-L-G</b> |
|  | Red    |          |               | <b>SL4-L-R</b> |
|  | White  |          |               | <b>SL4-L-W</b> |
|  | Yellow |          |               | <b>SL4-L-Y</b> |
|  | Amber  |          |               | <b>SL4-L-A</b> |

#### SL4 Acoustic Modules

SL4-AP-\_-



#### Continuous Tone or Pulsed Tone, UL Type 4/4X/13, IP66

Adjustable with internal DIP switches.



Sound pressure 80 dB, adjustable with internal potentiometer.

f = 4000 Hz.

| Rated Operational Voltage (U <sub>e</sub> V)         | Rated Operational Current (I <sub>e</sub> mA) | Color | Function | Sound Type | Standard Pack | Catalog Number   |
|--|---|-------|----------|------------|---------------|------------------|
| <b>Place only at the highest position on a pole.</b> |   |       |          |            |               |                  |
| 24 Vac/Vdc   | Maximum 39                                    | Black |          |            | 1             | <b>SL4-AP24</b>  |
| 110/120 Vac  | Maximum 21                                    | Black |          |            |               | <b>SL4-AP120</b> |
| 230/240 Vac  | Maximum 21                                    | Black |          |            |               | <b>SL4-AP230</b> |

## SL4 Base Modules

## For Horizontal Mounting—Includes Cover, Maximum 5 Modules

|   | Description   | Tube Length | Color      | Standard Pack | For use with ...                                    | Catalog Number       |
|---|---|-------------|------------|---------------|---|----------------------|
|    | Base with aluminum tube and plastic foot<br>Spring-loaded terminals             | 100 mm      | Black      | 1             | SL4-L-...   | <b>SL4-PIB-100</b>   |
|   |   | 250 mm      | aluminum   |               | SL4-BL-...  | <b>SL4-PIB-250</b>   |
|   |   |             | color tube |               | SL4-FL-...  | <b>SL4-PIB-400</b>   |
|   |   | 400 mm      |            |               | SL4-AP-...  |                      |
|    | Base with aluminum tube and 3/4 in NPT threaded base<br>Spring-loaded terminals | 100 mm      | Black      | 1             | SL4-L-...   | <b>SL4-PIB-T-100</b> |
|   |   | 250 mm      | aluminum   |               | SL4-BL-...  | <b>SL4-PIB-T-250</b> |
|   |   |             | color tube |               | SL4-FL-...  | <b>SL4-PIB-T-400</b> |
|   |   | 400 mm      |            |               | SL4-AP-...  |                      |
|  | Base with internal (on the inside) fixing holes<br>Spring-loaded terminals      | —           | Black      | 1             | SL4-L-...<br>SL4-BL-...<br>SL4-FL-...<br>SL4-AP-... | <b>SL4-PIB-IMH</b>   |
|  | Base with built-in (pre-assembled) fixing screws<br>Spring-loaded terminals     | —           | Black      | 1             | SL4-L-...<br>SL4-BL-...<br>SL4-FL-...<br>SL4-AP-... | <b>SL4-PIB-IMS</b>   |
|  | Base with external fixing holes<br>Spring-loaded terminals                      | —           | Black      | 1             | SL4-L-...<br>SL4-BL-...<br>SL4-FL-...<br>SL4-AP-... | <b>SL4-PIB-EMH</b>   |

# 2.1



## Stacklights

### SL Series

#### SL4 Base Modules, continued

2

#### For Horizontal Mounting—Includes Cover, Maximum 5 Modules, continued

| Description   | Tube Length | Color               | Standard Pack | For use with ...                                    | Catalog Number     |
|---|-------------|---------------------|---------------|---|--------------------|
| <b>SL4-FMS_</b><br><br>Base with base adapter for slipping onto place (rapid mounting and wiring system)<br>Screw terminals  | 100 mm      | Black               | 1             | SL4-L-...   | <b>SL4-FMS-100</b> |
|   | 250 mm      | aluminum color tube |               | SL4-BL-...<br>SL4-FL-...                            | <b>SL4-FMS-250</b> |
|   | 400 mm      |                     |               | SL4-AP-...  | <b>SL4-FMS-400</b> |
| <b>SL4-SWD</b><br><br> Base with base adapter for slipping onto place (rapid mounting and wiring system)<br>Blade terminal SWD4-8MF2<br>Maximum 0.3A per module<br>External power supply connectable (24 Vdc)<br>Configurable with SWD-Assist (planning and ordering help) | 100 mm      | —                   | 1             | SL4-L-...<br>SL4-BL-...<br>SL4-FL-...<br>SL4-AP-... | <b>SL4-SWD</b>     |

#### SL4-PIB-FW For Vertical Mounting—Includes Cover, Maximum 5 Modules

| Description  | Color | Standard Pack | For use with ...                                    | Catalog Number    |
|--|-------|---------------|---|-------------------|
| <b>SL4-PIB-FW</b><br><br>One-sided base with bracket<br>Spring-loaded terminals | Black | 1             | SL4-L-...<br>SL4-BL-...<br>SL4-FL-...<br>SL4-AP-... | <b>SL4-PIB-FW</b> |

#### SL4-PIB-D For Mounting on Both Sides—Includes Cover, Maximum 2 x 5 Modules

| Description   | Color | Standard Pack | For use with ...                                    | Catalog Number   |
|---|-------|---------------|---|------------------|
| <b>SL4-PIB-D</b><br><br>Base with external fixing holes<br>Spring-loaded terminals | Black | 1             | SL4-L-...<br>SL4-BL-...<br>SL4-FL-...<br>SL4-AP-... | <b>SL4-PIB-D</b> |



## Accessories

### SL7 and SL4 Series

#### Mounting Brackets

##### SL7/4-FW



#### Mounting Brackets for Vertical Mounting, Plastic

| Standard Pack | For Use With ...        | Catalog Number  |
|---------------|-------------------------|-----------------|
| 1             | SL4-PIB...<br>SL7-CB... | <b>SL7/4-FW</b> |

##### SL7/4-FW-T



#### M20 Cable Gland for Vertical Mounting, Metal (Includes Mounting Bracket)

| Standard Pack | For Use With ...            | Catalog Number    |
|---------------|-----------------------------|-------------------|
| 1             | SL4-PIB-T...<br>SL7-CB-T... | <b>SL7/4-FW-T</b> |

#### Incandescent Bulb Tool

##### SL7/4-BET



#### Tool for Replacing Incandescent Bulb

| Standard Pack | For Use With ...       | Catalog Number   |
|---------------|------------------------|------------------|
| 1             | SL7-L-...<br>SL4-L-... | <b>SL7/4-BET</b> |

#### Incandescent Bulbs

##### SL7 Series

##### SL7-L12



#### Incandescent Bulbs, Mounting: Ba15d

| Lifespan (h) | Rated Operational Voltage (U <sub>e</sub> V) | Power (Watts) | Standard Pack | For Use With ... | Catalog Number  |
|--------------|--|---------------|---------------|------------------|-----------------|
| 3000         | 12   | 5             | 1             | SL7-L-...        | <b>SL7-L12</b>  |
|              | 24   | 6.5           |               |                  | <b>SL7-L24</b>  |
|              | 120  | 7             |               |                  | <b>SL7-L120</b> |
|              | 230  | 6.5           |               |                  | <b>SL7-L230</b> |

##### SL4 Series

##### SL4-L12



#### Incandescent Bulbs, Mounting: Ba15d

| Lifespan (h) | Rated Operational Voltage (U <sub>e</sub> V) | Power (Watts) | Standard Pack | For Use With ... | Catalog Number  |
|--------------|--|---------------|---------------|------------------|-----------------|
| 3000         | 12   | 4             | 1             | SL4-L-...        | <b>SL4-L12</b>  |
|              | 24   |               |               |                  | <b>SL4-L24</b>  |
|              | 120  |               |               |                  | <b>SL4-L120</b> |
|              | 230  |               |               |                  | <b>SL4-L230</b> |

## Technical Data and Specifications

## 2

### SL7 Series

#### SL7 General Specifications

| Description   | Specification  |
|---|--|
| Standards   | IEC/EN 60947-5-1   |
| Lens color  | Blue, green, red, clear, yellow, amber   |
| Number of signal elements                           | Max. 5 with standard base<br>Max. 10 with base for mounting on both sides      |
| <b>Mechanical Ratings</b>                           |  |
| Shock (IEC 68-2-27)                                 | 11 ms, 15g   |
| Vibration (IEC 68-2-6)                              | 20 sweeps 10–150 Hz, 1g  |
| <b>Climate Conditions</b>                           |  |
| Climatic proofing                                   | Damp heat, constant, to IEC 60068-2-78<br>Damp heat, cyclic, to IEC 60069-2-30 |
| Operating temperature                               | –22° to +140°F (–30° to +60°C)   |
| Storage temperature                                 | –22° to +185°F (–30° to +85°C)   |
| <b>Environmental Ratings</b>                        |  |
| IEC degree of protection                            | UL Type 4/4X/13, IP66<br>IEC/EN 60529  |
| Protection type UL                                  | Type 4/4X/13   |
| <b>Materials</b>                                    |  |
| Cover   | Polycarbonate  |
| Lenses  | Polycarbonate  |
| Stacklight base                                     | Polycarbonate  |
| Tubes   | Aluminum   |
| <b>Terminal Capacity</b>                            |  |
| Solid or flexible conductor                         | 0.13–2.5 mm <sup>2</sup>   |
| Flexible with ferrule with plastic collar           | 0.25–1.5 mm <sup>2</sup><br>AWG 24–AWG 14                                      |
| <b>Contacts</b>                                     |  |
| Rated impulse withstand voltage (U <sub>imp</sub> ) | 4000 Vac   |
| Rated insulation voltage (U <sub>i</sub> )          | 250V   |
| Overvoltage category/pollution degree               | III/3  |

## SL7 Light Module Specifications

|                            | Unit | SL7-L-...-...  | SL7-BL-...-...   | SL7-FL-...-...   | SL7-L24-...-HP          | SL7-FL24-...-HP         | SL7-FL24-...-HPM        | SL7-L-...                           |
|----------------------------|------|--|--|--|-------------------------|-------------------------|-------------------------|-------------------------------------|
| Type of light              |      | Continuous light   | Flashing light   | Strobe light   | Continuous light        | Strobe light            | Multi-strobe light      | Continuous light                    |
| Light elements             |      | LED  | LED  | LED  | High-performance LED    | High-performance LED    | High-performance LED    | Incandescent bulb (max. 7W)         |
| Mounting                   |      | —  | —  | —  | —                       | —                       | —                       | Ba15d                               |
| Flashing/strobe frequency  |      | —  | 2 Hz   | 1.4 Hz   | —                       | 1.4 Hz                  | 1–2.6 Hz                | —                                   |
| Transmission angle         |      | 360°   | 360°   | 360°   | 360°                    | 360°                    | 360°                    | 360°                                |
| Leakage current            | A    | < 0.003  | < 0.003  | < 0.003  | < 0.003                 | < 0.003                 | < 0.003                 | < 0.003                             |
| Current-/power consumption |      |  |  |  |                         |                         |                         |                                     |
| 24 Vac/Vdc                 | A    | 0.049–0.054  | 0.058  | 0.130–0.135  | 0.170–0.200             | 0.260–0.265             | 0.260–0.265             | —                                   |
| 110/120 Vac                | A    | 0.028–0.031  | 0.028–0.030  | 0.010  | —                       | —                       | —                       | —                                   |
| 230/240 Vac                | A    | 0.027–0.028  | 0.030–0.031  | 0.010  | —                       | —                       | —                       | —                                   |
| Power consumption          |      | —  | —  | —  | —                       | —                       | —                       | Max. 7W with the specified voltages |
| Voltage levels             |      | 24 Vac/Vdc ± 10%<br>110/120 Vac ± 10%<br>230/240 Vac ± 10% | 24 Vac/Vdc ± 10%<br>110/120 Vac ± 10%<br>230/240 Vac ± 10% | 24 Vac/Vdc ± 10%<br>110/120 Vac ± 10%<br>230/240 Vac ± 10% | 18–30 Vdc/<br>18–26 Vac | 18–30 Vdc/<br>18–26 Vac | 18–30 Vdc/<br>18–26 Vac | Up to<br>250 Vac/Vdc                |
| Lifespan                   | h    | 100,000  | 100,000  | 100,000  | 50,000                  | 50,000                  | 50,000                  | 3000                                |
| Weight                     | g    | 80   | 80   | 80   | 80                      | 80                      | 80                      | 80                                  |

## SL7 Acoustic Module Specifications

|                                 | Unit | SL7-AP...  | SL7-AP...-E  | SL7-AP...-M  |
|---------------------------------|------|--|--|--|
| Type of tone                    |      | Continuous or pulsed tone                                  | Continuous or pulsed tone                                  | Continuous or pulsed tone<br>Eight types of sound          |
| Types of sound                  |      | Two versions,<br>table of sound types                      | Two versions,<br>table of sound types                      | Eight versions,<br>table of sound types                    |
| Sound setting                   |      | Internal; single-pole DIP                                  | Can be externally actuated                                 | Internal; three-pole DIP                                   |
| Sound pressure                  | dB   | Max.: 100<br>Min.: 88                                      | Max.: 100<br>Min.: 88                                      | Max.: 100<br>Min.: 88                                      |
| Sound pressure level adjustment |      | Built-in, potentiometer                                    | Built-in, potentiometer                                    | Built-in, potentiometer                                    |
| Transmission angle              |      | 360°   | 360°   | 360°   |
| Current-/power consumption      |      |  |  |  |
| 24 Vac/Vdc                      | A    | 0.092  | 0.092  | 0.115  |
| 110/120 Vac                     | A    | 0.041  | 0.041  | 0.045  |
| 230/240 Vac                     | A    | 0.043  | 0.043  | 0.043  |
| Voltage levels                  |      | 24 Vac/Vdc ± 10%<br>110/120 Vac ± 10%<br>230/240 Vac ± 10% | 24 Vac/Vdc ± 10%<br>110/120 Vac ± 10%<br>230/240 Vac ± 10% | 24 Vac/Vdc ± 10%<br>110/120 Vac ± 10%<br>230/240 Vac ± 10% |
| Weight                          | g    | 102  | 102  | 102  |

## SL7 Table of Sound Types

|             | Sound Type      | Frequency (Hz) | Diagram | Repeat Rate           | DIP Switch Position | Maximum Volume at 1M (dB) |
|-------------|-----------------|----------------|---------|-----------------------|---------------------|---------------------------|
| SL7-AP...   | Continuous tone | Approx. 2800   |         | —                     | —                   | 100                       |
|             | Pulsed tone     | Approx. 2800   |         | Approx. 2 Hz          | —                   | 100                       |
| SL7-AP...-E | Continuous tone | Approx. 2800   |         | —                     | —                   | 100                       |
|             | Pulsed tone     | Approx. 2800   |         | Approx. 2 Hz          | —                   | 100                       |
| SL7-AP...-M | Continuous tone | 2700           |         | —                     | ON                  | Tone 01 100               |
|             | Continuous tone | 1350           |         | —                     | ON                  | Tone 02 100               |
|             | Pulsed tone     | 2700           |         | 250 ms on, 250 ms off | ON                  | Tone 03 100               |
|             | Pulsed tone     | 1350           |         | 250 ms on, 250 ms off | ON                  | Tone 04 100               |
|             | Falling         | 1200–500       |         | 1 Hz                  | ON                  | Tone 05 98                |
|             | Rising          | 500–1200       |         | Rising 3s, 0.5s off   | ON                  | Tone 06 98                |
|             | Alternating     | 800–1000       |         | 2 Hz                  | ON                  | Tone 07 94                |
|             | rising/falling  | 500–1500       |         | 10 Hz                 | ON                  | Tone 08 94                |

**SL4 Series****SL4 General Specifications**

| <b>Description</b>                                  | <b>Specification</b>   |
|---|--|
| Standards   | IEC/EN 60947-5-1   |
| Lens color  | Blue, green, red, clear, yellow, orange  |
| Number of signal elements                           | Max. 5 with standard base<br>Max. 10 with base for mounting on both sides      |
| Mounting position                                   | As required  |
| <b>Mechanical Ratings</b>                           |  |
| Mechanical shock resistance                         | >15g according to IEC 60068-2-27<br>Shock duration 11 ms<br>Sinusoidal         |
| <b>Climate Conditions</b>                           |  |
| Climatic proofing                                   | Damp heat, constant, to IEC 60068-2-78<br>Damp heat, cyclic, to IEC 60069-2-30 |
| Ambient temperature                                 | -22°F to +140°F (-30°C to +60°C)   |
| <b>Environmental Ratings</b>                        |  |
| IEC degree of protection                            | UL Type 4/4X/13, IP66<br>IEC/EN 60529  |
| Protection type UL                                  | Type 4/4X/13   |
| <b>Materials</b>                                    |  |
| Enclosure   | Polycarbonate (PC), black  |
| Cap   | Polycarbonate (PC)   |
| <b>Terminal Capacity</b>                            |  |
| Solid or flexible conductor                         | 0.2–1.5 mm <sup>2</sup>  |
| Solid or flexible conductor, with ferrule           | 0.25–1.5 mm <sup>2</sup>   |
| Flexible with ferrule with plastic collar           | 0.25–0.75 mm <sup>2</sup><br>AWG 24–AWG 16                                     |
| <b>Contacts</b>                                     |  |
| Rated impulse withstand voltage (U <sub>imp</sub> ) | 4000 Vac   |
| Rated insulation voltage (U <sub>i</sub> )          | 250V   |
| Overvoltage category/pollution degree               | III/3  |

## SL4 Light Module Specifications

|                           | Unit | SL4-L...-...   | SL4-BL...-...  | SL4-FL...-...  | SL4-FL24...-M      | SL4-L...                               |
|---------------------------|------|--|--|--|--------------------|--|
| Type of light             |      | Continuous light   | Flashing light   | Strobe light   | Multi-strobe light | Continuous light                       |
| Light elements            |      | LED  | LED  | LED  | LED                | Incandescent bulb (max. 4W)            |
| Mounting                  |      | —  | —  | —  | —                  | Ba15d                                  |
| Flashing/strobe frequency |      | —  | 2 Hz   | 1.4 Hz   | 1–2.6 Hz           | —                                      |
| Transmission angle        |      | 360°   | 360°   | 360°   | 360°               | 360°                                   |
| Leakage current           | A    | < 0.003  | < 0.003  | < 0.003  | < 0.003            | < 0.003                                |
| Current/power consumption |      |  |  |  |                    |  |
| 24 Vac/Vdc                | A    | 0.022–0.033  | 0.028–0.036  | 0.035–0.065  | 0.048–0.068        | —                                      |
| 110/120 Vac               | A    | 0.030  | 0.030  | 0.10   | —                  | —                                      |
| 230/240 Vac               | A    | 0.030  | 0.030  | 0.10   | —                  | —                                      |
| Power consumption         |      | —  | —  | —  | —                  | Maximum 4W with the specified voltages |
| Voltage levels            |      | 24 Vac/Vdc ± 10%<br>110/120 Vac ± 10%<br>230/240 Vac ± 10% | 24 Vac/Vdc ± 10%<br>110/120 Vac ± 10%<br>230/240 Vac ± 10% | 24 Vac/Vdc ± 10%<br>110/120 Vac ± 10%<br>230/240 Vac ± 10% | 24 Vac/Vdc ± 10%   | Up to 250 Vac/Vdc                      |
| Lifespan                  | h    | 100,000  | 100,000  | 100,000  | 100,000            | 100,000                                |
| Weight                    | g    | 45   | 45   | 45   | 45                 | 45                                     |

## SL4 Acoustic Module Specifications

|   | Unit | SL4-AP...  |
|---|------|--|
| Type of tone                                  |      | Continuous or pulsed tone                                  |
| Types of sound                                |      | Two versions, table of sound types                         |
| Sound setting                                 |      | Internal; single-pole DIP                                  |
| Sound pressure                                | dB   | 80   |
| Sound pressure level adjustment               |      | —  |
| Sound pressure can be lowered to a minimum of |      | —  |
| Transmission angle                            |      | 360°   |
| Current/power consumption                     |      |  |
| 24 Vac/Vdc                                    | A    | 0.039  |
| 110/120 Vac                                   | A    | 0.021  |
| 230/240 Vac                                   | A    | 0.021  |
| Voltage levels                                |      | 24 Vac/Vdc ± 10%<br>110/120 Vac ± 10%<br>230/240 Vac ± 10% |
| Weight  | g    | 43   |

## SL4 Table of Sound Types

|           | Sound Type      | Frequency (Hz) | Diagram | Repeat Rate  | Maximum Volume at 1M (dB) |
|-----------|-----------------|----------------|---------|--------------|---------------------------|
| SL4-AP... | Continuous tone | Approx. 4000   | —       | —            | 80                        |
|           | Pulsed tone     | Approx. 4000   | — — —   | Approx. 2 Hz | 80                        |

**Dimensions**

Approximate Dimensions in Inches (mm)

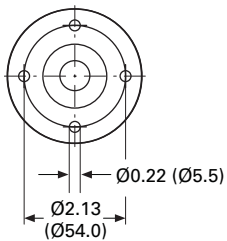
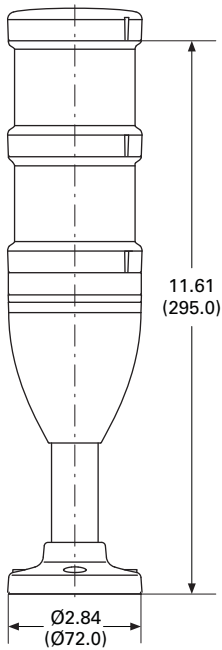
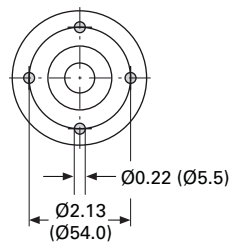
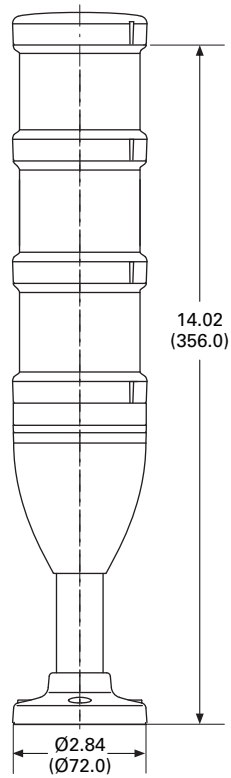
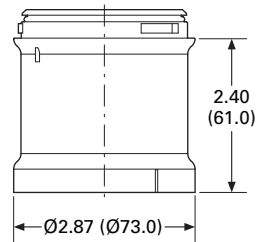
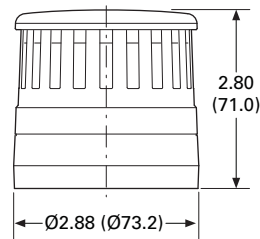
**SL7 Series****Complete Devices****SL7-100-L-RG-24LED****SL7-100-L-RYG-24LED****Light Modules****SL7-(B)(F)L...****Acoustic Modules****SL7-AP...**

# 2.1

## Stacklights

### SL Series

Approximate Dimensions in Inches (mm)

2

#### Basic Modules

##### SL7-CB-...

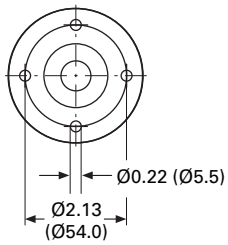
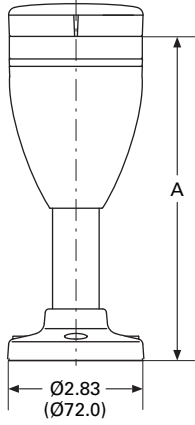

| Catalog Number | A             |
|----------------|---------------|
| SL7-CB-100     | 6.73 (171.0)  |
| SL7-CB-250     | 12.64 (321.0) |
| SL7-CB-400     | 18.54 (471.0) |

##### SL7-CB-T...

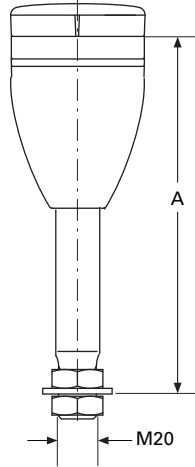

| Catalog Number | A             |
|----------------|---------------|
| SL7-CB-T-100   | 7.48 (190.0)  |
| SL7-CB-T-250   | 13.38 (340.0) |
| SL7-CB-T-400   | 19.29 (490.0) |

##### SL7-CB-D

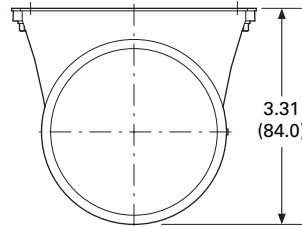
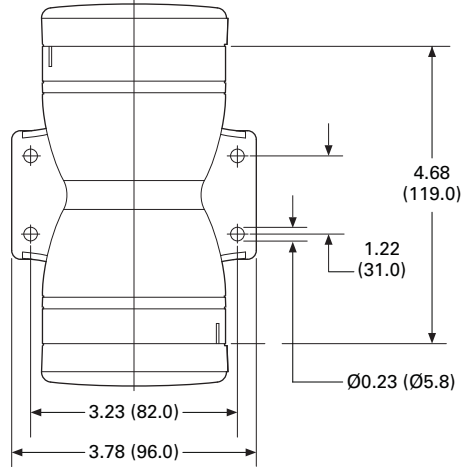

##### SL7-CB-EMH

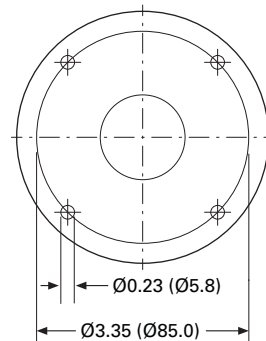
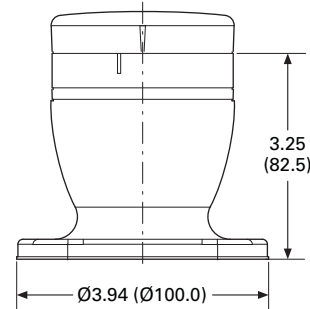

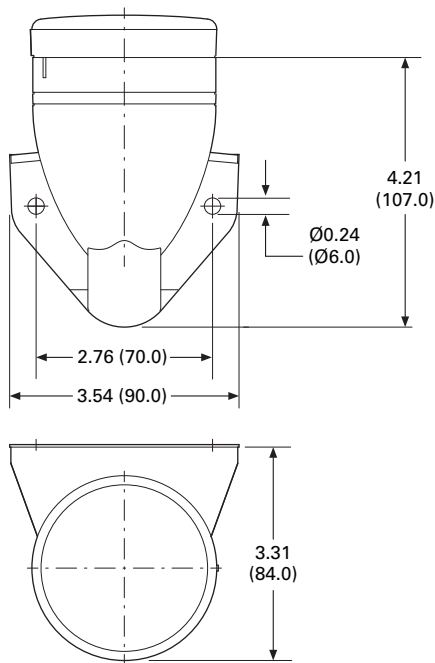
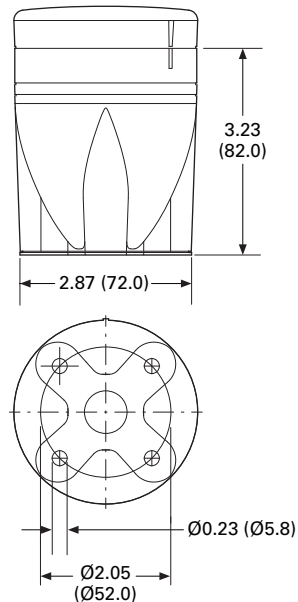
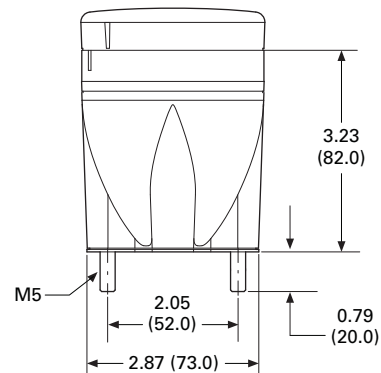
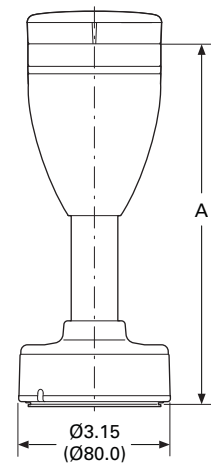
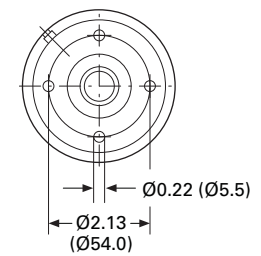
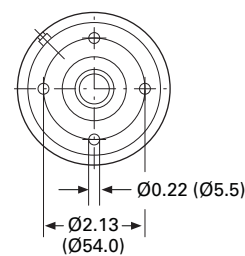
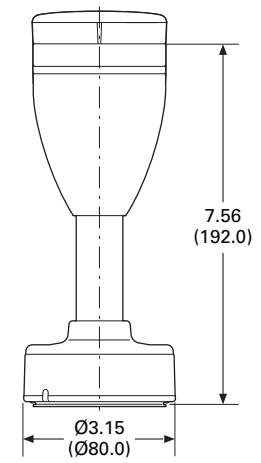

Approximate Dimensions in Inches (mm)

**SL7-CB-FW****SL7-CB-IMH****SL7-CB-IMS****SL7-FMS-...****SL7-SWD ①**

| Catalog Number | A             |
|----------------|---------------|
| SL7-FMS-100    | 7.55 (192.0)  |
| SL7-FMS-250    | 13.46 (342.0) |
| SL7-FMS-400    | 19.37 (192.0) |

**Note**

① For connecting to SmartWire-DT.

# 2.1

## Stacklights

### SL Series

Approximate Dimensions in Inches (mm)

2

#### SL4 Series

##### Complete Devices

###### SL4-100-L-RG-24LED

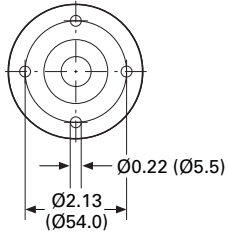
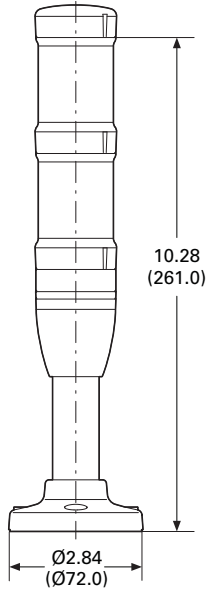

###### SL4-100-L-RYG-24LED

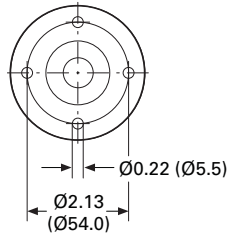
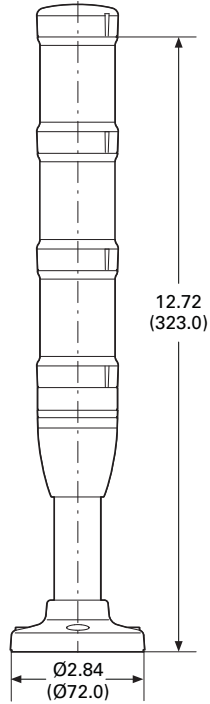

##### Light Modules

###### SL4-(B)(F)L...

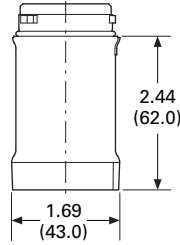

##### Acoustic Modules

###### SL4-AP...

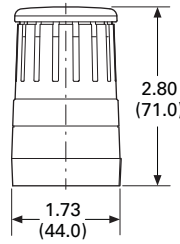

Approximate Dimensions in Inches (mm)

Basic Modules

SL4-PIB-...

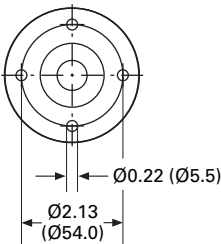
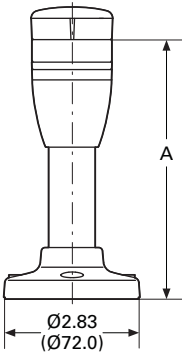

| Catalog Number | A             |
|----------------|---------------|
| SL4-PIB-100    | 3.53 (136.0)  |
| SL4-PIB-250    | 11.26 (286.0) |
| SL4-PIB-400    | 17.16 (436.0) |

SL4-PIB-T...

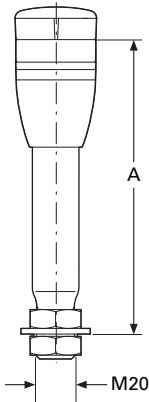

| Catalog Number | A             |
|----------------|---------------|
| SL4-PIB-T-100  | 5.90 (150.0)  |
| SL4-PIB-T-250  | 11.81 (300.0) |
| SL4-PIB-T-400  | 17.72 (450.0) |

SL4-PIB-D

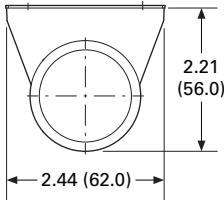
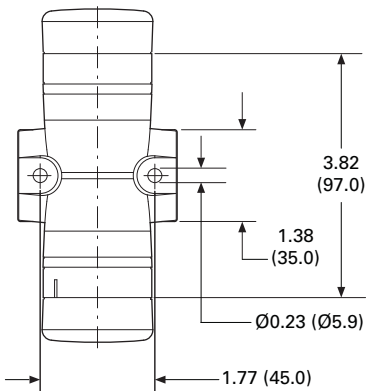

SL4-PIB-EMH

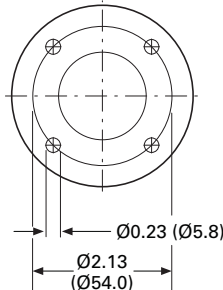
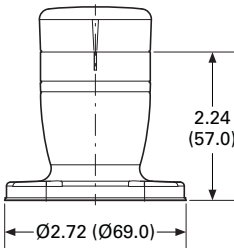

# 2.1

## Stacklights

### SL Series

Approximate Dimensions in Inches (mm)

2

#### SL4-PIB-FW

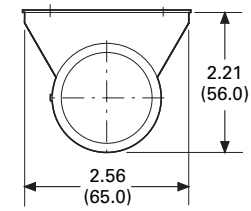
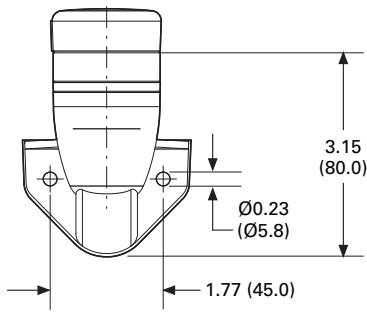

#### SL4-PIB-IMH

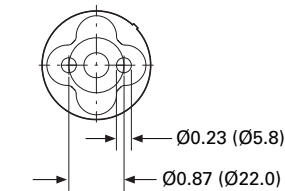
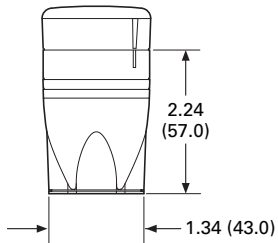

#### SL4-PIB-IMS

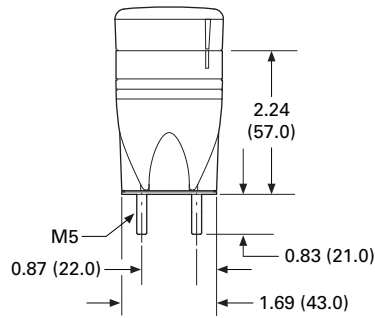

#### SL4-FMS-...

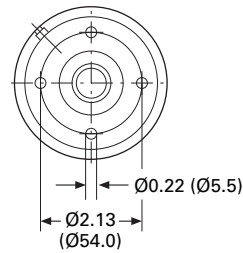
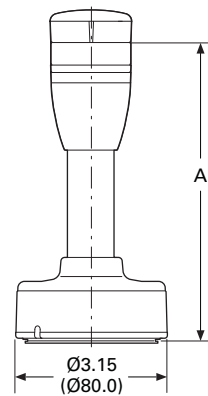

#### SL4-SWD<sup>①</sup>

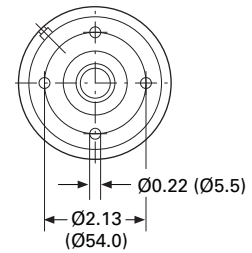
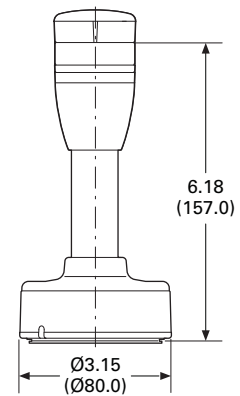

| Catalog Number | A             |
|----------------|---------------|
| SL4-FMS-100    | 6.18 (157.0)  |
| SL4-FMS-250    | 12.09 (307.0) |
| SL4-FMS-400    | 17.99 (457.0) |

**Note**

① For connecting to SmartWire-DT.

Approximate Dimensions in Inches (mm)

### Mounting Brackets

#### SL7/4-FW

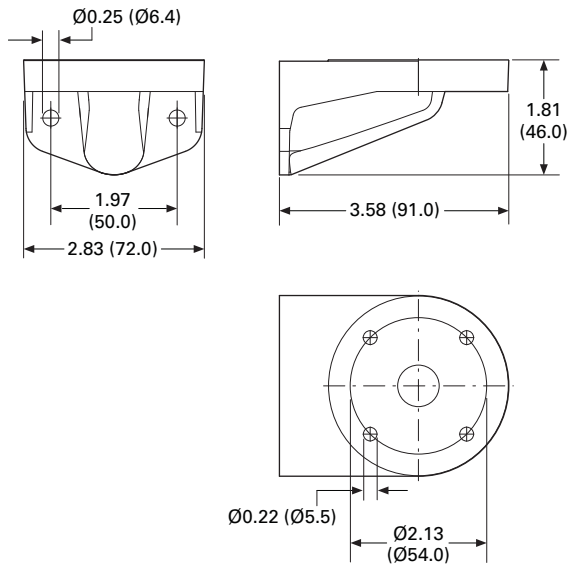

#### SL7/4-FW-T

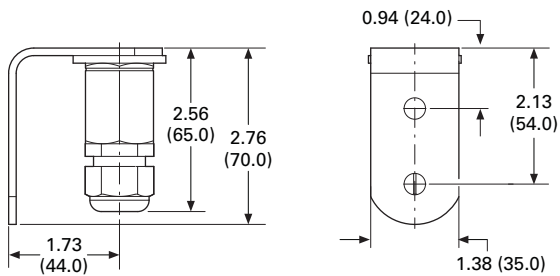

### Incandescent Bulbs

#### SL7-L12 and SL4-L12

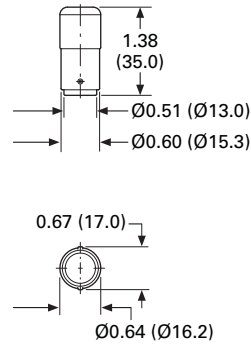

### Tool for Replacing Incandescent Bulb

#### SL7/4-BET

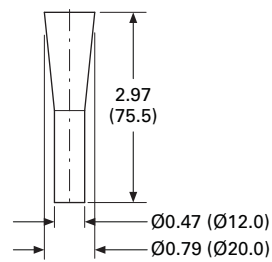

Stacklights—E26 Series

2



### Product Description

The E26 stacklight unit is a modular system that provides illuminated and audible status indication in all directions. Easily assembled plug-in modular units include constant, flashing and strobe light units, as well as mono-tonal, bi-tonal, intermittent audible alarms. Stacklights may be assembled in a variety of configurations, which are identified in the Maximum Configurations table on **Page V7-T2-33**. Several lamp, color and mounting options further enhance the stacklight's versatility.

### Features

- Modular construction
- Six lens colors
- Variety of lamp types and voltages
- Mono-tonal, bi-tonal and intermittent audible alarms

### Benefits

- Combination of visible and audible alarms
- Modular components reduce inventory requirements, increase flexibility
- Steady and flashing modes allow one light to signal multiple conditions
- No-tools assembly permits easy lamp replacement

### Standards and Certifications

- CE 60947-5-1
- UL 508—File No. E131568
- cUL C22.2 No. 14—File No. E131568



### Ingress Protection

- Stacklight base and light units: IP65, NEMA 4, 4X and 13
- Alarm units: IP20, NEMA 1

### Electrical Shock Protection

- Stacklight base and light unit: IP2X
- Alarm units: IPOX

### Contents

| <b>Description</b>                          | <b>Page</b>     |
|---|-----------------|
| E26 Series                                  |                 |
| Product Identification . . . . .            | <b>V7-T2-33</b> |
| Catalog Number Selection . . . . .          | <b>V7-T2-34</b> |
| Product Selection . . . . .                 | <b>V7-T2-35</b> |
| Replacement Parts . . . . .                 | <b>V7-T2-40</b> |
| Technical Data and Specifications . . . . . | <b>V7-T2-41</b> |
| Ratings . . . . .                           | <b>V7-T2-42</b> |
| Mounting Instructions . . . . .             | <b>V7-T2-43</b> |
| Dimensions . . . . .                        | <b>V7-T2-44</b> |

## Product Identification



### Standard Stacklight Base

For use with incandescent or standard LEDs for steady, non-flashing illumination or with flashing LEDs for flashing illumination. Bases include terminal block for wiring, stacklight cover and gasket. See **Page V7-T2-38**.



### Flashing Stacklight Base

Allows configuration of each light in the stack for either steady or 60 times per minute flashing illumination. Flashing circuit for use with incandescent lamps only. (Maximum allowable number of light modules is 2 at 12V, 4 at 24V and 6 at 48V and above.) See **Page V7-T2-38**.

For flashing LEDs use standard base with flashing LED light module.



### Light Modules

Available in a variety of colors for both incandescent lamps and LED lamps. To maximize illumination and light dispersion, incandescent units include an opal white diffuser while LED diffusers are clear. See **Page V7-T2-36**.



### Xenon Strobe

Sets are similar to standard lens/diffuser units, except each set consists of two lens units. The lower unit includes the electronics and is permanently fused to the upper unit which contains the Xenon lamp. Xenon units may be placed in any position in a complete stacklight unit. They will flash 60 times per minute when used with a standard or flashing base. See **Page V7-T2-36**.



### Alarms

May be fitted to the top of a complete stacklight unit or directly to the stacklight bases, if desired. Available in three versions, each with adjustable sound levels. See **Page V7-T2-39**.

## Complete Stacklight Modules



- Stacklights accept a maximum of six incandescent or LED light modules or two Xenon Flasher modules and can be mounted in any position on the stack.
- Alarm units are mounted in the top most position only.

## Maximum Configurations

| Incandescent or LED Modules | Xenon Modules | Alarm Modules | Max. Number of Modules |
|-----------------------------|---------------|---------------|------------------------|
| 6                           | —             | —             | 6                      |
| 5                           | —             | 1             | 6                      |
| 4                           | 1             | —             | 5                      |
| 3                           | 1             | 1             | 5                      |
| 2                           | 2             | —             | 4                      |
| 1                           | 2             | 1             | 4                      |

### Catalog Number Selection

#### Stacklight Catalog Numbering System

2

**E26X 9 KM L 39R W - V 4**

| Mounting Base <sup>①</sup> |                        |                       |
|----------------------------|------------------------|-----------------------|
| Code                       | Description            | Component Catalog No. |
| <b>W</b>                   | None (base mount)      | —                     |
| <b>4</b>                   | 3/4 in NPT hub, chrome | E26S104               |
| <b>8</b>                   | Standard three-hole    | E26S108               |
| <b>9</b>                   | Standard four-hole     | E26S109               |

| Extension Tube <sup>⑤</sup> |                        |                       |
|-----------------------------|------------------------|-----------------------|
| Code                        | Description            | Component Catalog No. |
| <b>W</b>                    | None (base mount)      | —                     |
| Gray Aluminum               |                        |                       |
| <b>HM</b>                   | 20 mm 3/4 in NPT       | E26BHM                |
| <b>JM</b>                   | 160 mm 3/4 in NPT      | E26BJM                |
| <b>KM</b>                   | 360 mm 3/4 in NPT      | E26BKM                |
| <b>MM</b>                   | 760 mm 3/4 in NPT      | E26BMM                |
| Black Aluminum              |                        |                       |
| <b>HU</b>                   | 20 mm 3/4 in NPT       | E26BHU                |
| <b>JU</b>                   | 160 mm 3/4 in NPT      | E26BJU                |
| <b>KU</b>                   | 360 mm 3/4 in NPT      | E26BKU                |
| <b>MU</b>                   | 760 mm 3/4 in NPT      | E26BMU                |
| <b>RU</b>                   | Right angle 3/4 in NPT | E26BRU                |

| Stacklight Base |                       |                                    |
|-----------------|-----------------------|------------------------------------|
| Code            | Description           | Component Catalog No. <sup>②</sup> |
| <b>L</b>        | Standard              | E26BL                              |
| <b>F</b>        | Flashing <sup>⑥</sup> | E26BF_                             |

| Alarm    |              |                                    |
|----------|--------------|------------------------------------|
| Code     | Description  | Component Catalog No. <sup>②</sup> |
| <b>W</b> | None         | —                                  |
| <b>Q</b> | Mono-tonal   | E26BQ_                             |
| <b>N</b> | Bi-tonal     | E26BN_                             |
| <b>P</b> | Intermittent | E26BP_                             |

| Voltage <sup>③</sup>   |             |
|------------------------|-------------|
| Code                   | Description |
| <b>V1</b>              | 12V         |
| <b>V2</b>              | 24V         |
| <b>V3</b>              | 48V         |
| <b>V4</b>              | 120V        |
| <b>V5</b> <sup>④</sup> | 240V        |

| Light Module |  |                                    |
|--------------|--|------------------------------------|
| Code         | Description  | Component Catalog No. <sup>②</sup> |
| <b>0</b>     | Clear incandescent                                   | E26B0_                             |
| <b>2</b>     | Red incandescent                                     | E26B2_                             |
| <b>3</b>     | Green incandescent                                   | E26B3_                             |
| <b>4</b>     | Yellow incandescent                                  | E26B4_                             |
| <b>6</b>     | Blue incandescent                                    | E26B6_                             |
| <b>9</b>     | Amber incandescent                                   | E26B9_                             |
| <b>W</b>     | White cluster LED with clear lens                    | E26BW_                             |
| <b>R</b>     | Red cluster LED with red lens                        | E26BR_                             |
| <b>G</b>     | Green cluster LED with green lens                    | E26BG_                             |
| <b>Y</b>     | Yellow cluster LED with yellow lens                  | E26BY_                             |
| <b>B</b>     | Blue cluster LED with blue lens                      | E26BB_                             |
| <b>A</b>     | Amber cluster LED with amber lens                    | E26BA_                             |
| <b>W1</b>    | White cylindrical LED with clear lens <sup>④</sup>   | E26BW1_                            |
| <b>R1</b>    | Red cylindrical LED with red lens <sup>④</sup>       | E26BR1_                            |
| <b>G1</b>    | Green cylindrical LED with green lens <sup>④</sup>   | E26BG1_                            |
| <b>Y1</b>    | Yellow cylindrical LED with yellow lens <sup>④</sup> | E26BY1_                            |
| <b>B1</b>    | Blue cylindrical LED with blue lens <sup>④</sup>     | E26BB1_                            |
| <b>A1</b>    | Amber cylindrical LED with amber lens <sup>④</sup>   | E26BA1_                            |
| <b>M</b>     | Flashing white cluster LED with clear lens           | E26BM_                             |
| <b>E</b>     | Flashing red cluster LED with red lens               | E26BE_                             |
| <b>U</b>     | Flashing green cluster LED with green lens           | E26BU_                             |
| <b>V</b>     | Flashing yellow cluster LED with yellow lens         | E26BV_                             |
| <b>K</b>     | Flashing blue cluster LED with blue lens             | E26BK_                             |
| <b>Z</b>     | Flashing amber cluster LED with amber lens           | E26BZ_                             |
| <b>X0</b>    | Xenon flasher with clear lens                        | E26BX0_                            |
| <b>X2</b>    | Xenon flasher with red lens                          | E26BX2_                            |
| <b>X3</b>    | Xenon flasher with green lens                        | E26BX3_                            |
| <b>X4</b>    | Xenon flasher with yellow lens                       | E26BX4_                            |
| <b>X6</b>    | Xenon flasher with blue lens                         | E26BX6_                            |
| <b>X9</b>    | Xenon flasher with amber lens                        | E26BX9_                            |

#### Voltage Codes

| Voltage Code | Incandescent Lamp | Cluster LED     | Cylindrical LED | Xenon Flasher | Flasher Base/Alarm |
|--------------|-------------------|-----------------|-----------------|---------------|--------------------|
| (Blank)      | No lamp supplied  | No LED supplied | No LED supplied | —             | —                  |
| <b>V1</b>    | 12 Vac/Vdc        | 12 Vac/Vdc      | 12 Vac/Vdc      | 12 Vac/Vdc    | 12 Vac/Vdc         |
| <b>V2</b>    | 24 Vac/Vdc        | 24 Vac/Vdc      | 24 Vac/Vdc      | 24 Vac/Vdc    | 24 Vac/Vdc         |
| <b>V3</b>    | 48 Vac/Vdc        | 48 Vac/Vdc      | 48 Vac/Vdc      | 48 Vac/Vdc    | 48 Vac/Vdc         |
| <b>V4</b>    | 120 Vac/Vdc       | 120 Vac         | 120 Vac         | 120 Vac       | 120 Vac/Vdc        |
| <b>V5</b>    | 240 Vac/Vdc       | 240 Vac         | —               | 240 Vac       | 240 Vac/Vdc        |

#### Notes

- ① Unless base mount is specified, an extension tube must be selected for a complete unit.
- ② Component catalog numbers for flashing bases, alarm units and light modules are incomplete and require the addition of a suffix code to specify the required voltage rating. See table above.
- ③ If no voltage is specified, assembled stacklight will be supplied without lamps or LEDs.
- ④ 240V not available for cylindrical LEDs.
- ⑤ For complete length (extension tube and base), see **Page V7-T2-39**.
- ⑥ Flashing base is for use with incandescent lamps.



## Product Selection

### Assembled Units

#### One-, Two- and Three-Light Assembled Stacklights

- Base mountable
- Incandescent or LED versions
- 24V and 120V versions

#### One-Light Unit Stacklight

| Volts AC/DC       | Alarm | First Level Color | Illumination Type      | Catalog Number       |
|-------------------|-------|-------------------|------------------------|----------------------|
| 24V               | None  | Red               | Incandescent—steady    | <b>E26XWWL2W-V2</b>  |
| 24V               | None  | Red               | Cylindrical LED—steady | <b>E26XWWLR1W-V2</b> |
| 24V               | None  | Green             | Incandescent—steady    | <b>E26XWWL3W-V2</b>  |
| 24V               | None  | Green             | Cylindrical LED—steady | <b>E26XWWLG1W-V2</b> |
| 24V               | None  | Amber             | Incandescent—steady    | <b>E26XWWL9W-V2</b>  |
| 24V               | None  | Amber             | Cylindrical LED—steady | <b>E26XWWLA1W-V2</b> |
| 120V              | None  | Red               | Incandescent—steady    | <b>E26XWWL2W-V4</b>  |
| 120V <sup>①</sup> | None  | Red               | Cylindrical LED—steady | <b>E26XWWLR1W-V4</b> |
| 120V              | None  | Green             | Incandescent—steady    | <b>E26XWWL3W-V4</b>  |
| 120V <sup>①</sup> | None  | Green             | Cylindrical LED—steady | <b>E26XWWLG1W-V4</b> |
| 120V              | None  | Amber             | Incandescent—steady    | <b>E26XWWL9W-V4</b>  |
| 120V <sup>①</sup> | None  | Amber             | Cylindrical LED—steady | <b>E26XWWLA1W-V4</b> |

#### Two-Light Unit Stacklight

| Volts AC/DC       | Alarm | First Level Color | Illumination Type      | Second Level Color | Illumination Type      | Catalog Number         |
|-------------------|-------|-------------------|------------------------|--------------------|------------------------|------------------------|
| 24V               | None  | Green             | Incandescent—steady    | Red                | Incandescent—steady    | <b>E26XWWL32W-V2</b>   |
| 24V               | None  | Green             | Cylindrical LED—steady | Red                | Cylindrical LED—steady | <b>E26XWWLG1R1W-V2</b> |
| 120V              | None  | Green             | Incandescent—steady    | Red                | Incandescent—steady    | <b>E26XWWL32W-V4</b>   |
| 120V <sup>①</sup> | None  | Green             | Cylindrical LED—steady | Red                | Cylindrical LED—steady | <b>E26XWWLG1R1W-V4</b> |

#### Three-Light Unit Stacklight

| Volts AC/DC       | Alarm | First Level Color | Illumination Type      | Second Level Color | Illumination Type      | Third Level Color | Illumination Type      | Catalog Number           |
|-------------------|-------|-------------------|------------------------|--------------------|------------------------|-------------------|------------------------|--------------------------|
| 24V               | None  | Green             | Incandescent—steady    | Amber              | Incandescent—steady    | Red               | Incandescent—steady    | <b>E26XWWL392W-V2</b>    |
| 24V               | None  | Green             | Cylindrical LED—steady | Amber              | Cylindrical LED—steady | Red               | Cylindrical LED—steady | <b>E26XWWLG1A1R1W-V2</b> |
| 120V              | None  | Green             | Incandescent—steady    | Amber              | Incandescent—steady    | Red               | Incandescent—steady    | <b>E26XWWL392W-V4</b>    |
| 120V <sup>①</sup> | None  | Green             | Cylindrical LED—steady | Amber              | Cylindrical LED—steady | Red               | Cylindrical LED—steady | <b>E26XWWLG1A1R1W-V4</b> |

#### Note

- <sup>①</sup> LED modules have very low current draw and should not be used with triac output devices like PLC triac output modules. It is recommended that dry contact outputs be used to switch 120 Vac modules.

### Light and Xenon Strobe Modules

2

- Light modules include lens diffusers which provide even illumination and eliminate hot spots.
- Xenon strobes emit a bright attention-getting white flashing light. Flash rate = 60/min.
- Xenon strobe modules occupy two positions in the stacklight assembly.

#### Light/LED Module



#### Xenon Strobe Module



### Light and Xenon Strobe Modules <sup>①</sup>

| LED/Lamp Voltage     | Lens Color | Incandescent Steady or Flashing Catalog Number | Cylindrical LED Steady Only Catalog Number | Cluster LED Steady Catalog Number | Cluster LED Flashing Catalog Number | Xenon Flashing Catalog Number |
|----------------------|------------|--|--|-----------------------------------|-------------------------------------|-------------------------------|
| Without bulb or LED  | Red        | E26B2  | E26B                                       | E26BR                             | E26BR                               | —                             |
|                      | Green      | E26B3  | E26BG                                      | E26BG                             | E26BG                               | —                             |
|                      | Yellow     | E26B4  | E26BY                                      | E26BY                             | E26BY                               | —                             |
|                      | Blue       | E26B6  | E26BB                                      | E26BB                             | E26BB                               | —                             |
|                      | Amber      | E26B9  | E26BA                                      | E26BA                             | E26BA                               | —                             |
|                      | Clear      | E26B0  | E26BW                                      | E26BW                             | E26BW                               | —                             |
| 12 Vac/Vdc           | Red        | E26B2V1  | E26BR1V1                                   | E26BRV1                           | E26BEV1                             | E26BX2V1                      |
|                      | Green      | E26B3V1  | E26BG1V1                                   | E26BGV1                           | E26BUV1                             | E26BX3V1                      |
|                      | Yellow     | E26B4V1  | E26BY1V1                                   | E26BYV1                           | E26BVV1                             | E26BX4V1                      |
|                      | Blue       | E26B6V1  | E26BB1V1                                   | E26BBV1                           | E26BKV1                             | E26BX6V1                      |
|                      | Amber      | E26B9V1  | E26BA1V1                                   | E26BAV1                           | E26BZV1                             | E26BX9V1                      |
|                      | Clear      | E26B0V1  | E26BW1V1                                   | E26BWW1                           | E26BMV1                             | E26BX0V1                      |
| 24 Vac/Vdc           | Red        | E26B2V2  | E26BR1V2                                   | E26BRV2                           | E26BEV2                             | E26BX2V2                      |
|                      | Green      | E26B3V2  | E26BG1V2                                   | E26BGV2                           | E26BUV2                             | E26BX3V2                      |
|                      | Yellow     | E26B4V2  | E26BY1V2                                   | E26BYV2                           | E26BVV2                             | E26BX4V2                      |
|                      | Blue       | E26B6V2  | E26BB1V2                                   | E26BBV2                           | E26BKV2                             | E26BX6V2                      |
|                      | Amber      | E26B9V2  | E26BA1V2                                   | E26BAV2                           | E26BZV2                             | E26BX9V2                      |
|                      | Clear      | E26B0V2  | E26BW1V2                                   | E26BWW2                           | E26BMV2                             | E26BX0V2                      |
| 48 Vac/Vdc           | Red        | E26B2V3  | E26BR1V3                                   | E26BRV3                           | E26BEV3                             | E26BX2V3                      |
|                      | Green      | E26B3V3  | E26BG1V3                                   | E26BGV3                           | E26BUV3                             | E26BX3V3                      |
|                      | Yellow     | E26B4V3  | E26BY1V3                                   | E26BYV3                           | E26BVV3                             | E26BX4V3                      |
|                      | Blue       | E26B6V3  | E26BB1V3                                   | E26BBV3                           | E26BKV3                             | E26BX6V3                      |
|                      | Amber      | E26B9V3  | E26BA1V3                                   | E26BAV3                           | E26BZV3                             | E26BX9V3                      |
|                      | Clear      | E26B0V3  | E26BW1V3                                   | E26BWW3                           | E26BMV3                             | E26BX0V3                      |
| 120 Vac <sup>②</sup> | Red        | E26B2V4  | E26BR1V4                                   | E26BRV4                           | E26BEV4                             | E26BX2V4                      |
|                      | Green      | E26B3V4  | E26BG1V4                                   | E26BGV4                           | E26BUV4                             | E26BX3V4                      |
|                      | Yellow     | E26B4V4  | E26BY1V4                                   | E26BYV4                           | E26BVV4                             | E26BX4V4                      |
|                      | Blue       | E26B6V4  | E26BB1V4                                   | E26BBV4                           | E26BKV4                             | E26BX6V4                      |
|                      | Amber      | E26B9V4  | E26BA1V4                                   | E26BAV4                           | E26BZV4                             | E26BX9V4                      |
|                      | Clear      | E26B0V4  | E26BW1V4                                   | E26BWW4                           | E26BMV4                             | E26BX0V4                      |
| 240 Vac <sup>②</sup> | Red        | E26B2V5  | —  | E26BRV5                           | E26BEV5                             | E26BX2V5                      |
|                      | Green      | E26B3V5  | —  | E26BGV5                           | E26BUV5                             | E26BX3V5                      |
|                      | Yellow     | E26B4V5  | —  | E26BYV5                           | E26BVV5                             | E26BX4V5                      |
|                      | Blue       | E26B6V5  | —  | E26BBV5                           | E26BKV5                             | E26BX6V5                      |
|                      | Amber      | E26B9V5  | —  | E26BAV5                           | E26BZV5                             | E26BX9V5                      |
|                      | Clear      | E26B0V5  | —  | E26BWW5                           | E26BMV5                             | E26BX0V5                      |

#### Notes

- ① Include lens, diffusers and lamps unless otherwise noted.
- ② Incandescent bulbs are AC/DC rated, LEDs are AC rated only.

## LEDs—Cylindrical or Cluster

Cylindrical  
Stacklight LED

## Cylindrical or Cluster LEDs

## Cluster LED



| Voltage     | Color       | Cylindrical LED<br>Steady Only<br>Catalog Number | Cluster LED<br>Steady<br>Catalog Number | Cluster LED<br>Flashing<br>Catalog Number |
|-------------|-------------|--|---|---|
| 12 Vac/Vdc  | Red         | E26S110  | E26S15                                  | E26S48                                    |
|             | Green       | E26S114  | E26S19                                  | E26S53                                    |
|             | Yellow      | E26S112  | E26S23                                  | E26S58                                    |
|             | Blue        | E26S115  | E26S27                                  | E26S63                                    |
|             | White       | E26S116  | E26S71                                  | E26S75                                    |
|             | Amber       | E26S111  | E26S79                                  | E26S84                                    |
|             | 24 Vac/Vdc  | Red  | E26S117                                 | E26S16                                    |
| Green       |             | E26S121  | E26S20                                  | E26S54                                    |
| Yellow      |             | E26S119  | E26S24                                  | E26S59                                    |
| Blue        |             | E26S122  | E26S28                                  | E26S64                                    |
| White       |             | E26S123  | E26S72                                  | E26S76                                    |
| Amber       |             | E26S118  | E26S80                                  | E26S85                                    |
| 48 Vac/Vdc  |             | Red  | E26S124                                 | E26S17                                    |
|             | Green       | E26S128  | E26S21                                  | E26S55                                    |
|             | Yellow      | E26S126  | E26S25                                  | E26S60                                    |
|             | Blue        | E26S129  | E26S29                                  | E26S65                                    |
|             | White       | E26S130  | E26S73                                  | E26S77                                    |
|             | Amber       | E26S125  | E26S81                                  | E26S86                                    |
|             | 120 Vac/Vdc | Red  | E26S138                                 | E26S18                                    |
| Green       |             | E26S142  | E26S22                                  | E26S56                                    |
| Yellow      |             | E26S140  | E26S26                                  | E26S61                                    |
| Blue        |             | E26S143  | E26S30                                  | E26S66                                    |
| White       |             | —  | E26S74                                  | E26S78                                    |
| Amber       |             | E26S139  | E26S82                                  | E26S87                                    |
| 240 Vac/Vdc |             | Red  | —                                       | E26S44                                    |
|             | Green       | —  | E26S45                                  | E26S57                                    |
|             | Yellow      | —  | E26S46                                  | E26S62                                    |
|             | Blue        | —  | E26S47                                  | E26S67                                    |
|             | White       | —  | E26S101                                 | E26S102                                   |
|             | Amber       | —  | E26S83                                  | E26S88                                    |

### Mounting Bases Components

#### Standard Base

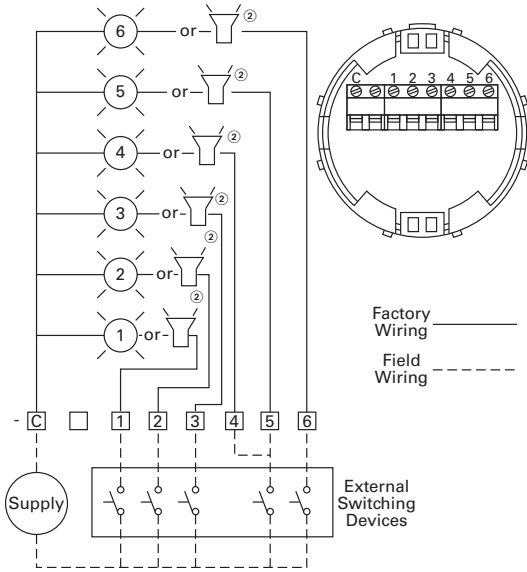

#### Flashing Base

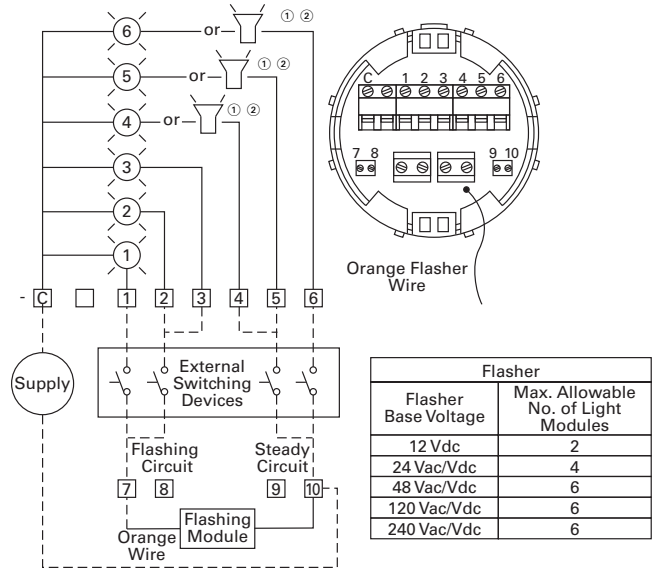

| Description  | Voltage                   | Catalog Number |
|--|---------------------------|----------------|
| <b>Standard Base</b>   |                           |                |
| For use with steady incandescent or steady/flashing LED                              | 12 Vac/Vdc to 240 Vac/Vdc | <b>E26BL</b>   |
| <b>Flashing Base</b>   |                           |                |
| Enables configuration of incandescent light modules for steady or flashing operation | 12 Vdc                    | <b>E26BFV1</b> |
|  | 24 Vac/Vdc                | <b>E26BFV2</b> |
|  | 48 Vac/Vdc                | <b>E26BFV3</b> |
|  | 120 Vac/Vdc               | <b>E26BFV4</b> |
|  | 240 Vac/Vdc               | <b>E26BFV5</b> |

### Mounting Bases and Hubs

| Description                              | Voltage | Catalog Number |
|--|---------|----------------|
| <b>Standard Three-Hole Mounting Base</b> |         |                |
| Standard three-hole mounting base        | —       | <b>E26S108</b> |
| <b>Standard Four-Hole Mounting Base</b>  |         |                |
| Standard four-hole mounting base         | —       | <b>E26S109</b> |
| <b>Myers Type Hub</b>                    |         |                |
| 3/4 in NPT threaded hub                  | —       | <b>E26S104</b> |

#### Notes

- ① Audible alarm units must be wired via the steady circuit on flashing base units.
- ② Audible alarm units can be wired in positions as shown but only one unit is permitted on each stack and unit must occupy the last or top mounting position.

## Alarm Units and Extension Tubes Components

E26B\_



## Audible Alarm Units-NEMA Type 1 (IP20) ①

| Description         | Voltage     | Catalog Number |
|---------------------|-------------|----------------|
| <b>Mono-Tonal</b>   |             |                |
| 4.5 mA              | 12 Vac/Vdc  | E26BQV1        |
| 12.6 mA             | 24 Vac/Vdc  | E26BQV2        |
| 9.4 mA              | 48 Vac/Vdc  | E26BQV3        |
| 11.5 mA             | 120 Vac/Vdc | E26BQV4        |
| 5.1 mA              | 240 Vac/Vdc | E26BQV5        |
| <b>Bi-Tonal</b>     |             |                |
| 4.5 mA              | 12 Vac/Vdc  | E26BNV1        |
| 12.6 mA             | 24 Vac/Vdc  | E26BNV2        |
| 9.4 mA              | 48 Vac/Vdc  | E26BNV3        |
| 11.5 mA             | 120 Vac/Vdc | E26BNV4        |
| 5.1 mA              | 240 Vac/Vdc | E26BNV5        |
| <b>Intermittent</b> |             |                |
| 4.5 mA              | 12 Vac/Vdc  | E26BPV1        |
| 12.6 mA             | 24 Vac/Vdc  | E26BPV2        |
| 9.4 mA              | 48 Vac/Vdc  | E26BPV3        |
| 11.5 mA             | 120 Vac/Vdc | E26BPV4        |
| 5.1 mA              | 240 Vac/Vdc | E26BPV5        |

## Extension Tubes

Extension Tube

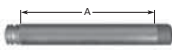

| Description                 | Voltage | Catalog Number |
|-----------------------------|---------|----------------|
| <b>Extension "A" ②</b>      |         |                |
| 0.79 in (20 mm) extension   | —       | E26BHM         |
| 6.30 in (160 mm) extension  | —       | E26BJM         |
| 14.17 in (360 mm) extension | —       | E26BKM         |
| 29.92 in (760 mm) extension | —       | E26BMM         |

Extension Tube

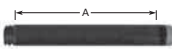

|                             |   |        |
|-----------------------------|---|--------|
| <b>Extension "A" ③</b>      |   |        |
| 0.79 in (20 mm) extension   | — | E26BHU |
| 6.30 in (160 mm) extension  | — | E26BJU |
| 14.17 in (360 mm) extension | — | E26BKU |
| 29.92 in (760 mm) extension | — | E26BMU |

E26BRU



|                            |   |        |
|----------------------------|---|--------|
| Right angle extension tube | — | E26BRU |
|----------------------------|---|--------|

## Notes

- ① Volume adjustment range: 64 dB to 90 dB typical current draw (mA).
- ② For use with standard mounting base or 3/4 in NPT threaded hub—gray aluminum.
- ③ For use with standard mounting base or 3/4 in NPT threaded hub—black aluminum.

### Replacement Parts

2

#### Stacklight Replacement Parts

| Description  | Notes   | Number in Diagram | Catalog Number       |
|--|---|-------------------|----------------------|
| Replacement cover  | Normally included with stacklight base                    | 1                 | E26S68               |
| Replacement lens O-ring                                      | Normally included with light modules                      | 2                 | E26S106 <sup>①</sup> |
| Replacement lenses   | Clear   | 3                 | E26S38               |
|  | Red   |                   | E26S39               |
|  | Green   |                   | E26S40               |
|  | Yellow  |                   | E26S41               |
|  | Blue  |                   | E26S42               |
|  | Amber   |                   | E26S43               |
| Replacement Xenon strobe dual high (does not include lenses) | 12 Vac/Vdc  | 4                 | E26S33               |
|  | 24 Vac/Vdc  |                   | E26S34               |
|  | 48 Vac/Vdc  |                   | E26S35               |
|  | 120 Vac   |                   | E26S36               |
|  | 240 Vac   |                   | E26S37               |
| Replacement diffusers  | White — normally supplied with incandescent light modules | 4                 | E26S31               |
|  | Clear — normally supplied with LED light modules          |                   | E26S32               |
| Replacement lamps <sup>②</sup>                               | 12V   | 5                 | E26S8                |
|  | 24V   |                   | E26S9                |
|  | 48V   |                   | E26S10               |
|  | 120V  |                   | E26S11               |
|  | 240V  |                   | E26S12               |
| Replacement extension tube O-rings                           | Normally included with extension tubes                    | 6                 | E26S107 <sup>③</sup> |
| Replacement mounting gasket <sup>④</sup>                     | Normally included with stacklight base                    | 7                 | E26S105              |
| Lamp removal tool  | For E26 and E22 incandescent lamps                        |                   | E22BA3               |

#### Typical Stacklight Assemblies

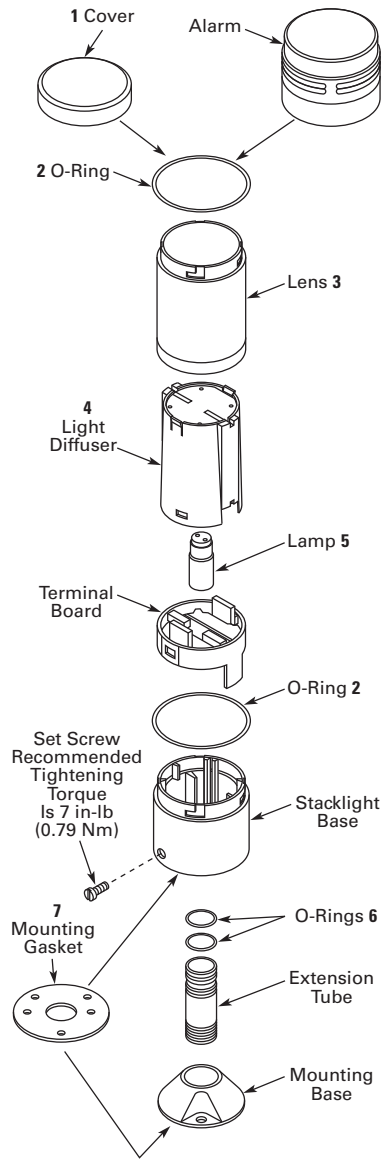

Typical Stacklight Assembly (Exploded View)

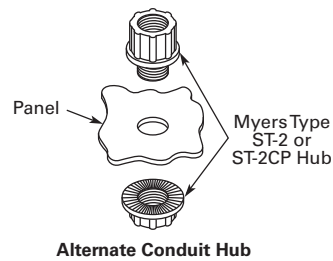

#### Notes

- ① Sold in packages of 5 pieces.
- ② For replacement LEDs, see table on **Page V7-T2-37**.
- ③ Sold in packages of 10 pieces.
- ④ Mounting gaskets have two sets of mounting holes—one set with center-to-center spacing of 1.75 in (44.5 mm) and another set with center-to-center spacing of 1.65 in (42 mm).

## Technical Data and Specifications

### General Specifications

| Description                                   | Specification  |
|---|--|
| <b>Mechanical Ratings</b>                     |  |
| Shock (IEC 68-2-27)                           | 11 ms, 15g   |
| Vibration (IEC 68-2-6)                        | 10 sweeps 10–150 Hz, 2g  |
| Bump (IEC 68-2-29)                            | 1000 pulses, 6 ms, 15g   |
| <b>Climate Conditions</b>                     |  |
| Operating                                     | Maximum 104°F (40°C) at 95% RH,<br>Temperature –4° to 140°F (–20° to 60°C)   |
| Storage                                       | Temperature –40° to 176°F (–40° to 80°C)   |
| <b>Materials</b>                              |  |
| Cover   | Polycarbonate  |
| Lenses  | Polycarbonate  |
| Stacklight base                               | Nylon  |
| Extension tubes                               | Aluminum   |
| Mounting base                                 | Zinc die cast  |
| <b>Terminals</b>                              |  |
| Single conductor                              | 14–30 AWG (2.5–0.05 mm <sup>2</sup> )  |
| Two conductors (same size)                    | 18–26 AWG (0.75–0.14 mm <sup>2</sup> )<br>Do not mix solid and stranded wire in the same terminal                            |
| Recommended tightening torque                 | 4.4–5.3 lb-in (0.5–0.6 Nm)   |
| <b>Electrical Ratings</b>                     |  |
| Insulation voltage (U <sub>i</sub> )          | 690V   |
| Operational voltage (U <sub>o</sub> )         | 250V   |
| Impulse withstand voltage (U <sub>imp</sub> ) | 1.5 kV   |
| <b>Bulb Specifications</b>                    |  |
| Incandescent lamp type                        | BA15d  |
| Maximum lamp wattage                          | 6W   |
| Bulbs—average life                            |  |
| Incandescent                                  | 7,000 to 12,000 hrs. (based on voltage)  |
| Xenon flasher                                 | 20,000 hrs.  |
| LED   | 60,000 to 100,000 hrs. (based on colors)   |
| <b>LED/Incandescent Comparison</b>            |  |
| Incandescent lamps                            | Average operating life of 7,000 hours<br>Each lamp can be used with any color lens<br>Low cost results in short term savings |
| LED lamps                                     | Average operating life of 60,000 to 100,000 hours<br>Low power consumption<br>Extended life results in long-term savings     |

## Ratings

Published theoretical lamp lives are based on ideal laboratory conditions and should be used for comparison only. Actual life may be shorter due to various application conditions.

2

### Stacklight Incandescent Application Data

| Type of Light | Lamp Used | Approximate Current, mA per Light | Theoretical Lamp Life, Hours as Applied |
|---------------|-----------|-----------------------------------|---|
| 12V           | BA15d     | 417                               | 7,000                                   |
| 24V           | BA15d     | 208                               | 7,000                                   |
| 48V           | BA15d     | 104                               | 7,000                                   |
| 110–140V      | BA15d     | 36–50                             | 7,000                                   |
| 220–260V      | BA15d     | 23–27                             | 12,000                                  |

### Xenon Flasher Application Data

| Type of Light | Lamp Used | Approximate Current, mA per Light | Theoretical Lamp Life, Hours as Applied |
|---------------|-----------|-----------------------------------|---|
| 12V           | DC        | 460 mA                            | 20,000                                  |
|               | AC        | 780 mA                            | 20,000                                  |
| 24V           | DC        | 190 mA                            | 20,000                                  |
|               | AC        | 320 mA                            | 20,000                                  |
| 48V           | DC        | 100 mA                            | 20,000                                  |
|               | AC        | 150 mA                            | 20,000                                  |
| 120V          | AC        | 60 mA <sup>①</sup>                | 20,000                                  |
| 240V          | AC        | 30 mA <sup>①</sup>                | 20,000                                  |

### LED Application Data

| Type of Light                             | Color  | Cluster LED Approximate Current, mA at Rated Volts | Cylindrical LED Approximate Current, mA at Rated Volts | Theoretical Lamp Life, Hours as Applied |
|---|--------|--|--|---|
| <b>Continuous/Flashing Stacklight LED</b> |        |  |  |   |
| 12 Vac/Vdc                                | Red    | 92   | 92   | 100,000                                 |
|   | Amber  | 92   | 92   | 100,000                                 |
|   | Yellow | 92   | 92   | 100,000                                 |
|   | Green  | 60   | 60   | 80,000                                  |
|   | Blue   | 60   | 60   | 60,000                                  |
|   | White  | 60   | 60   | 60,000                                  |
| 24 Vac/Vdc                                | Red    | 47   | 47   | 100,000                                 |
|   | Amber  | 47   | 47   | 100,000                                 |
|   | Yellow | 47   | 47   | 100,000                                 |
|   | Green  | 59   | 59   | 80,000                                  |
|   | Blue   | 59   | 59   | 60,000                                  |
|   | White  | 59   | 59   | 60,000                                  |
| 48 Vac/Vdc                                | Red    | 25   | 25   | 100,000                                 |
|   | Amber  | 25   | 25   | 100,000                                 |
|   | Yellow | 25   | 25   | 100,000                                 |
|   | Green  | 18   | 18   | 80,000                                  |
|   | Blue   | 31   | 31   | 60,000                                  |
|   | White  | 31   | 31   | 60,000                                  |
| 60 Vac/Vdc                                | Red    | 25   | 25   | 100,000                                 |
|   | Amber  | 25   | 25   | 100,000                                 |
|   | Yellow | 25   | 25   | 100,000                                 |
|   | Green  | 18   | 18   | 80,000                                  |
|   | Blue   | 17   | 17   | 60,000                                  |
|   | White  | 17   | 17   | 60,000                                  |
| 120 Vac/Vdc                               | Red    | 24   | 24   | 100,000                                 |
|   | Amber  | 24   | 24   | 100,000                                 |
|   | Yellow | 24   | 24   | 100,000                                 |
|   | Green  | 17   | 17   | 80,000                                  |
|   | Blue   | 16   | 16   | 60,000                                  |
|   | White  | 16   | 16   | 60,000                                  |

#### Note

<sup>①</sup> Represents average current draw, 1.6A peak for 120V and 0.8A peak at 240V.



## Mounting Instructions

Stacklight bases may be mounted without the use of an extension tube or mounting base. If additional height is required, choose

0.8–30 in (20–760 mm) extension tubes that fit between the mounting base and stacklight base. The extension tubes are threaded

with 3/4 in NPT threads, allowing for direct connection to conduit fittings or threaded holes without the use of a mounting base.

### Base Mounting

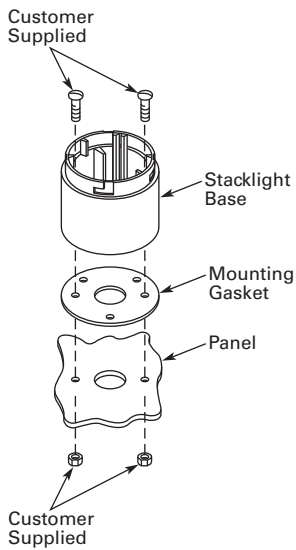

### Utilizing Extension Tube and Mounting Base

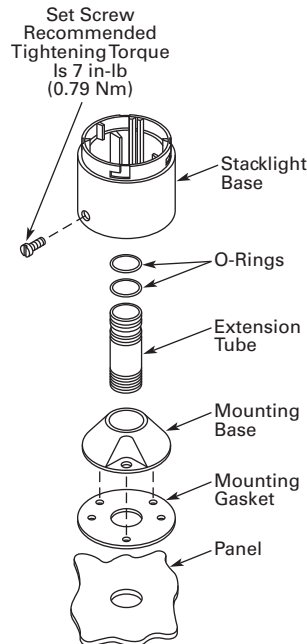

### Utilizing Extension Tube and 3/4 In (19.1 mm) Conduit Hub

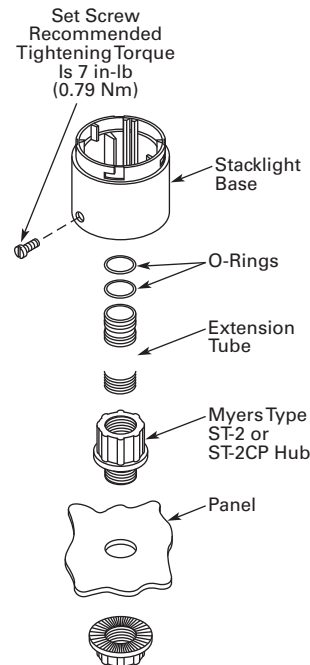

(Use Rubber-Jawed Pliers for Installation to Avoid Scratching the Black Anodized Coating)

## Mounting Dimensions

Approximate Dimensions in Inches (mm)

### Base Mounting

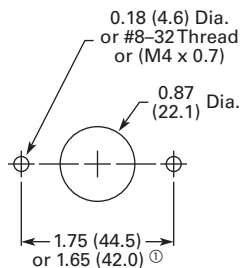

### Three-Hole Mounting for E26S108

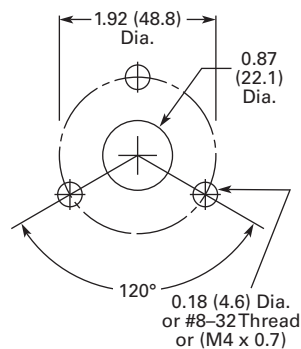

### Four-Hole Mounting for E26S109

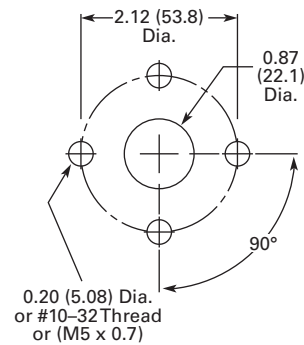

### Conduit Hub for E26S104—3/4 In (19.1 mm)

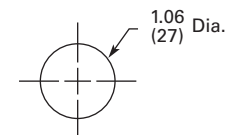

### Note

① Stacklight base and gasket are supplied as standard with two sets of base mount holes. One set with center-to-center spacing of 1.75 in (44.5 mm) and another set with center-to-center spacing of 1.65 in (42 mm).

### Dimensions

Approximate Dimensions in Inches (mm)

#### Standard and Flashing Bases ①

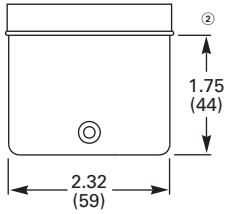

#### Alarm Units

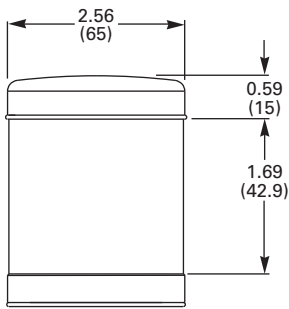

#### Assembled Extension Tubes

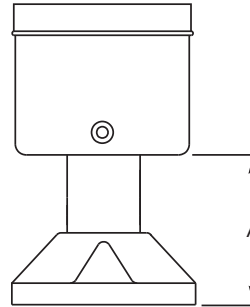

| Tube Extension | Height A    |
|----------------|-------------|
| 0.79 (20)      | 1.77 (45)   |
| 6.30 (160)     | 7.28 (185)  |
| 14.17 (360)    | 15.16 (385) |
| 29.92 (760)    | 30.91 (785) |

#### Right Angle Extension Tubes

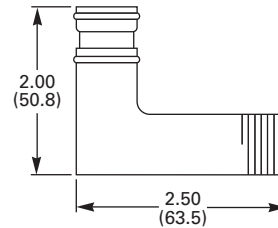

#### Notes

- ① Bases also suitable for mounting with extension tubes listed on [Page V7-T2-39](#).
- ② Mounting gasket and cover are supplied as standard with stacklight bases.

Approximate Dimensions in Inches (mm)

**One-Light Unit Stacklight**

**Standard**

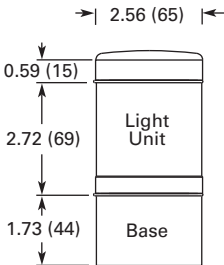

**With Alarm**

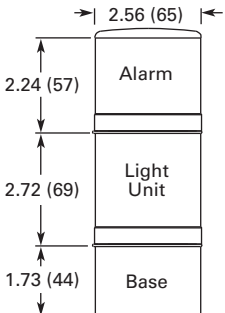

**With Xenon Flasher**

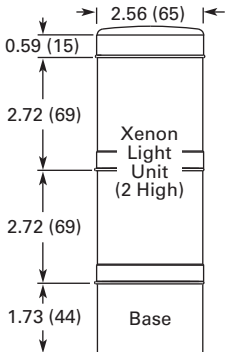

**Two-Light Unit Stacklight**

**Standard**

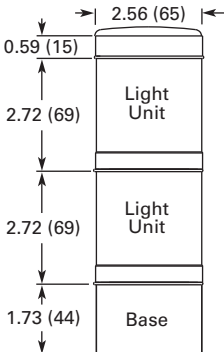

**With Alarm**

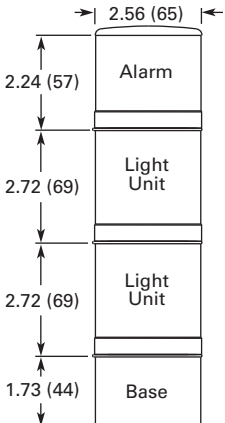

**With Xenon Flasher**

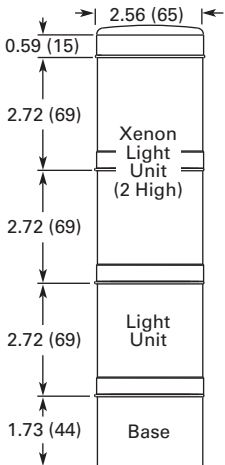

# 2.2

## Stacklights

### E26 Series

Approximate Dimensions in Inches (mm)

2

#### Three-Light Unit Stacklight

##### Standard

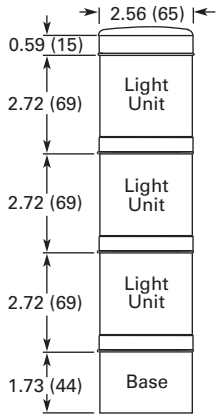

##### With Alarm

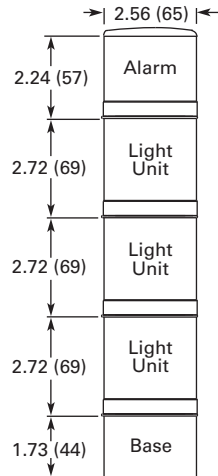

##### With Xenon Flasher

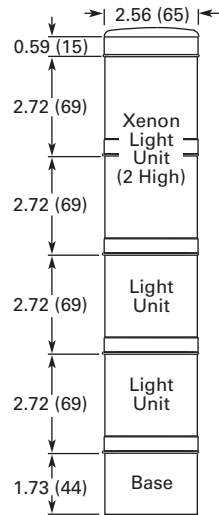

#### Light Modules

##### Standard

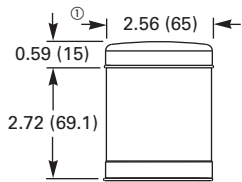

##### Xenon

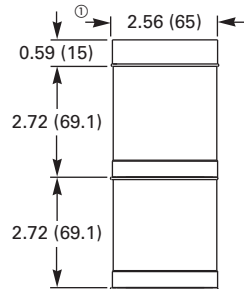

#### Note

① Cover included with stacklight base.

**easyRelay Programmable Relays**



**D1 Series General Purpose Relay**



**D96 Series Solid-State Relay**



**Universal TR Series Timing Relay**



**Safety Relay**



**3.1 Relay Products**

Control Relays and Timers Comparison ..... **V7-T3-2**

**3.2 XR Series Terminal Block Relays**

*Standard, OptoCoupler and High Current*  
Catalog Number Selection ..... **V7-T3-3**

**3.3 Programmable Relays**

*easy500, easy700, easy800, easy802/806 Relays and MFD-Titan Multi-Function Displays*  
Product Overview ..... **V7-T3-19**

**3.4 General Purpose Plug-In Relays**

*General Purpose Relays—D1, D2, D3, D4, D5, D7, D8 and D9 Series*  
Product Selection Guide ..... **V7-T3-49**

**3.5 General Purpose Open Style Relays**

*9575H Series 3000 Relay*  
9575H Series 3000—Type AA, AC and DC ..... **V7-T3-118**

**3.6 Solid-State Relays**

*D93, D96 and D99 Series*  
Product Overview ..... **V7-T3-122**

**3.7 Machine Tool Relays**

*D15, BF/BFD, AR/ARD and D26 Series*  
Product Overview ..... **V7-T3-141**

**3.8 Timing Relays**

*Universal TR, TR and TMR Series*  
Product Selection Guide ..... **V7-T3-167**

**3.9 Alternating Relays**

*D85 Series*  
Product Description ..... **V7-T3-188**

**3.10 Safety Relays**

*ESR5 Series*  
Product Description ..... **V7-T3-193**

**3.11 easySafety**

*ES4P Series*  
Product Description ..... **V7-T3-199**

# 3.1

## Control Relays and Timers

### Relay Product Overview

#### Relay Products

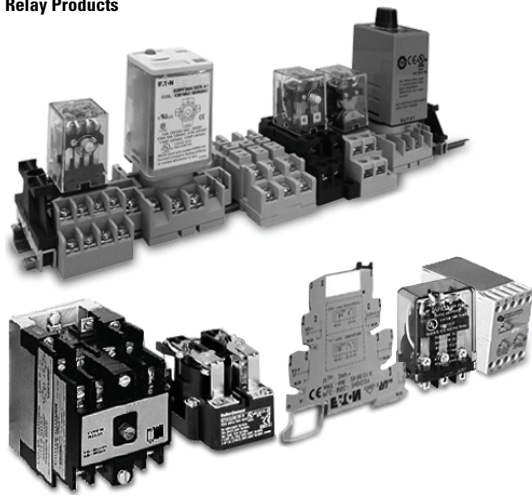

3

#### Contents

| <i>Description</i>                   | <i>Page</i>      |
|--------------------------------------|------------------|
| Terminal Block Relays .....          | <b>V7-T3-3</b>   |
| Programmable Relays .....            | <b>V7-T3-19</b>  |
| General Purpose Plug-In Relays ..... | <b>V7-T3-49</b>  |
| General Purpose Type AA Relays ..... | <b>V7-T3-118</b> |
| Solid-State Relays .....             | <b>V7-T3-122</b> |
| Machine Tool Relays .....            | <b>V7-T3-141</b> |
| Timing Relays .....                  | <b>V7-T3-167</b> |
| Alternating Relays .....             | <b>V7-T3-188</b> |
| Safety Relays .....                  | <b>V7-T3-193</b> |

### Control Relays and Timers Comparison

#### Selection Guide by Catalog Number Prefix

| Relays       | Type                            | Mounting                          | Contacts    | Maximum Amperage (AC) | RU | UL | CSA | CE | Page Number      |
|--------------|---------------------------------|-----------------------------------|-------------|-----------------------|----|----|-----|----|------------------|
| 9575H3       | General purpose                 | Panel mount                       | Fixed       | 40 A                  | —  | ■  | ■   | ■  | <b>V7-T3-119</b> |
| AR/ARD       | Machine tool                    | Panel mount                       | Convertible | 10 A                  | —  | ■  | ■   | —  | <b>V7-T3-154</b> |
| BF/BFD       | Machine tool                    | Panel mount                       | Fixed       | 10 A                  | ■  | —  | ■   | —  | <b>V7-T3-148</b> |
| D2RF         | Full featured plug-in           | DIN rail / panel mount            | Fixed       | 10 A                  | ■  | —  | ■   | ■  | <b>V7-T3-59</b>  |
| D2RR         | Standard plug-in                | DIN rail / panel mount / flange   | Fixed       | 10 A                  | ■  | —  | ■   | ■  | <b>V7-T3-59</b>  |
| D3RF         | Full featured plug-in           | DIN rail / panel mount            | Fixed       | 16 A                  | ■  | —  | ■   | ■  | <b>V7-T3-69</b>  |
| D3RR         | Standard plug-in                | DIN rail / panel mount            | Fixed       | 16 A                  | ■  | —  | ■   | ■  | <b>V7-T3-69</b>  |
| D4PR         | Standard plug-in                | DIN rail / panel mount            | Fixed       | 10 A                  | ■  | —  | ■   | ■  | <b>V7-T3-77</b>  |
| D5RF         | Full featured plug-in           | DIN rail / panel mount            | Fixed       | 16 A                  | ■  | —  | ■   | ■  | <b>V7-T3-82</b>  |
| D5RR         | Standard plug-in                | DIN rail / panel mount / PC board | Fixed       | 16 A                  | ■  | —  | ■   | ■  | <b>V7-T3-82</b>  |
| D7PF         | Full featured plug-in           | DIN rail / panel mount            | Fixed       | 20 A                  | ■  | —  | ■   | ■  | <b>V7-T3-91</b>  |
| D7PR         | Standard plug-in                | DIN rail / panel mount / flange   | Fixed       | 20 A                  | ■  | —  | ■   | ■  | <b>V7-T3-91</b>  |
| D8PR         | Standard plug-in                | DIN rail / panel mount / flange   | Fixed       | 30 A                  | ■  | —  | ■   | ■  | <b>V7-T3-104</b> |
| D9PR         | Standard plug-in                | Panel mounting                    | Fixed       | 25 A                  | ■  | —  | ■   | —  | <b>V7-T3-109</b> |
| D15          | Machine tool                    | DIN rail / panel mount            | Fixed       | 10 A                  | —  | ■  | ■   | ■  | <b>V7-T3-143</b> |
| D26          | Machine tool                    | Panel or channel mount            | Convertible | 10 A                  | —  | ■  | ■   | —  | <b>V7-T3-159</b> |
| D85          | Alternating relays              | DIN rail / panel mount            | Fixed       | 10 A                  | ■  | ■  | —   | ■  | <b>V7-T3-189</b> |
| D1RF         | Full featured plug-in           | DIN rail / panel mount            | Fixed       | 20 A                  | ■  | —  | ■   | ■  | <b>V7-T3-54</b>  |
| D1RR         | Standard plug-in                | DIN rail / panel mount            | Fixed       | 20 A                  | ■  | —  | ■   | ■  | <b>V7-T3-54</b>  |
| easyRelay    | Programmable relay              | DIN rail                          | Fixed       | 8 A                   | —  | ■  | ■   | ■  | <b>V7-T3-23</b>  |
| TMR5         | Timing relay (non-programmable) | DIN rail / panel mount            | Fixed       | 10 A                  | ■  | ■  | —   | ■  | <b>V7-T3-180</b> |
| TMR6         | Timing relay (non-programmable) | DIN rail / panel mount            | Fixed       | 10 A                  | ■  | ■  | —   | ■  | <b>V7-T3-184</b> |
| TR           | Timing relay (programmable)     | DIN rail / panel mount            | Fixed       | 10 A                  | —  | ■  | ■   | —  | <b>V7-T3-177</b> |
| Universal TR | Timing relay (programmable)     | DIN rail                          | Fixed       | 8 A                   | —  | ■  | ■   | ■  | <b>V7-T3-173</b> |
| XR           | Terminal block relay            | DIN rail                          | Fixed       | 6 A, 10 A             | ■  | —  | —   | ■  | <b>V7-T3-5</b>   |

### Terminal Block Relays



### Contents

#### Description

#### Terminal Block Relays

|  |                 |
|--|-----------------|
| Standard Terminal Block Relays .....     | <b>V7-T3-4</b>  |
| OptoCoupler Terminal Block Relays .....  | <b>V7-T3-12</b> |
| High Current Terminal Block Relays ..... | <b>V7-T3-15</b> |
| <b>XR</b> Series Accessories .....       | <b>V7-T3-18</b> |

#### Page

## Catalog Number Selection

### XR Series—Overview

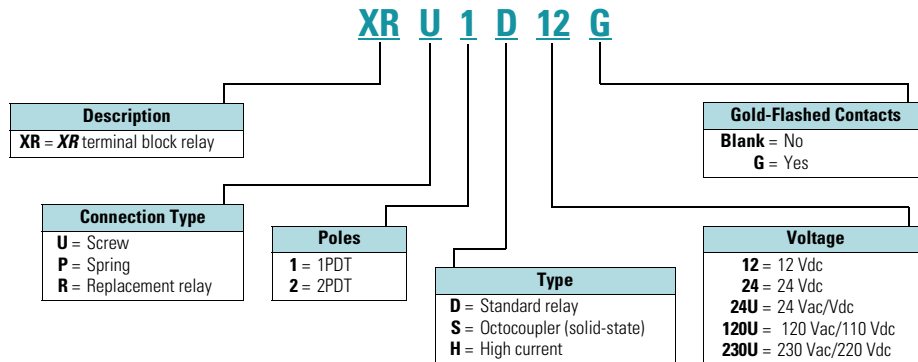

Standard Terminal Block Relay

3



### Contents

| <i>Description</i>                           | <i>Page</i>     |
|--|-----------------|
| Standard Terminal Block Relays               |                 |
| Product Selection . . . . .                  | <b>V7-T3-5</b>  |
| Technical Data and Specifications . . . . .  | <b>V7-T3-6</b>  |
| Electrical Schematics . . . . .              | <b>V7-T3-11</b> |
| Dimensions . . . . .                         | <b>V7-T3-11</b> |
| OptoCoupler Terminal Block Relays . . . . .  | <b>V7-T3-12</b> |
| High Current Terminal Block Relays . . . . . | <b>V7-T3-15</b> |
| <b>XR</b> Series Accessories . . . . .       | <b>V7-T3-18</b> |

### Standard Terminal Block Relays

#### Product Description

The **XR** Series Terminal Block Relays are ideal for applications that require a high switching capacity and long electrical service life. The relays are plug-in interfaces that connect to basic terminal blocks. The **XR** Series uses screw or spring-cage technology, as well as offers quick system wiring, superior safety features, clear labeling and a high level of modularity.

#### Application Description

Used in automation systems, electromechanical relays guarantee a safe connection between process I/O and electronic controls. The following functions are covered by relay coupling elements:

- Electrical isolation between the input and output circuits
- Independence of the type of switching current (AC and DC)
- High short-term overload resistance in the event of short circuits or voltage peaks
- Low switching losses
- Ease of operation

#### Features

- Pluggable relay allows for field replacement
- Functional plug-in bridges
- Choice of screw connections or spring-cage connection
- LED status indication
- DIN rail mount
- Only 6.2 mm wide for single-pole versions, 14 mm wide for double-pole
- All common input voltages between 12 Vdc to 120 Vac
- Gold-plated contacts available
- Equipped with a robust, miniature relay:
  - IP67 protection
  - Environmentally friendly, cadmium-free contact material
  - Easy, cost-effective installation and replacement using the engagement lever

#### Standards and Certifications

- cULus listed
- CE





## Product Selection

## XRU1D 24U



## Standard Terminal Block Relays

| Gold-Plated Contacts               | Rated Current | Supply Voltage  | Standard Pack | Catalog Number    |
|------------------------------------|---------------|-----------------|---------------|-------------------|
| <b>1PDT Screw Connection</b>       |               |                 |               |                   |
| No                                 | 6 A           | 12 Vdc          | 10            | <b>XRU1D12</b>    |
| No                                 | 6 A           | 120 Vac/110 Vdc | 10            | <b>XRU1D120U</b>  |
| Yes                                | 6 A           | 120 Vac/110 Vdc | 10            | <b>XRU1D120UG</b> |
| No                                 | 6 A           | 24 Vdc          | 10            | <b>XRU1D24</b>    |
| No                                 | 6 A           | 24 Vac/Vdc      | 10            | <b>XRU1D24U</b>   |
| Yes                                | 6 A           | 24 Vac/Vdc      | 10            | <b>XRU1D24UG</b>  |
| No                                 | 6 A           | 230 Vac/220 Vdc | 10            | <b>XRU1D230U</b>  |
| <b>1PDT Spring Cage Connection</b> |               |                 |               |                   |
| No                                 | 6 A           | 12 Vdc          | 10            | <b>XRP1D12</b>    |
| No                                 | 6 A           | 120 Vac/110 Vdc | 10            | <b>XRP1D120U</b>  |
| No                                 | 6 A           | 24 Vdc          | 10            | <b>XRP1D24</b>    |
| No                                 | 6 A           | 24 Vac/Vdc      | 10            | <b>XRP1D24U</b>   |
| No                                 | 6 A           | 230 Vac/220 Vdc | 10            | <b>XRP1D230U</b>  |
| <b>DPDT Screw Connection</b>       |               |                 |               |                   |
| No                                 | 6 A           | 12 Vdc          | 10            | <b>XRU2D12</b>    |
| No                                 | 6 A           | 120 Vac/110 Vdc | 10            | <b>XRU2D120U</b>  |
| No                                 | 6 A           | 24 Vdc          | 10            | <b>XRU2D24</b>    |
| No                                 | 6 A           | 24 Vac/Vdc      | 10            | <b>XRU2D24U</b>   |
| No                                 | 6 A           | 230 Vac/220 Vdc | 10            | <b>XRU2D230U</b>  |

## Standard Replacement Relays

| Gold-Plated Contacts | Rated Current | Supply Voltage <sup>①</sup> | Standard Pack | Catalog Number    |
|----------------------|---------------|-----------------------------|---------------|-------------------|
| <b>1PDT</b>          |               |                             |               |                   |
| No                   | 6 A           | 12 Vdc                      | 10            | <b>XRR1D12</b>    |
| No                   | 6 A           | 120 Vac/110 Vdc             | 10            | <b>XRR1D120U</b>  |
| Yes                  | 6 A           | 120 Vac/110 Vdc             | 10            | <b>XRR1D120UG</b> |
| No                   | 6 A           | 24 Vdc                      | 10            | <b>XRR1D24</b>    |
| Yes                  | 6 A           | 24 Vdc                      | 10            | <b>XRR1D24G</b>   |
| <b>DPDT</b>          |               |                             |               |                   |
| No                   | 6 A           | 12 Vdc                      | 10            | <b>XRR2D12</b>    |
| No                   | 6 A           | 120 Vac/110 Vdc             | 10            | <b>XRR2D120U</b>  |
| No                   | 6 A           | 24 Vdc                      | 10            | <b>XRR2D24</b>    |
| No                   | 6 A           | 230 Vac/220 Vdc             | 10            | <b>XRR2D230U</b>  |

**Note**

<sup>①</sup> Voltage is the rating at the base. It may not match the voltage on the specific replacement relay.

## Technical Data and Specifications

### Standard 1PDT Screw Connection Terminal Block Relays

| Catalog Number                                       | XRU1D12  | XRU1D24  | XRU1D24U                            | XRU1D120U                           |
|--|--|--|-------------------------------------|-------------------------------------|
| Replacement Relay                                    | XRR1D12  | XRR1D24  | XRR1D24                             | XRR1D120U                           |
| Input voltage  | 12 Vdc   | 24 Vdc   | 24 Vac/Vdc                          | 120 Vac/110 Vdc                     |
| <b>Connection Data</b>                               |  |  |                                     |                                     |
| Rigid solid AWG (mm <sup>2</sup> )                   | 26–14 (0.14–2.5)                               | 26–14 (0.14–2.5)                               | 26–14 (0.14–2.5)                    | 26–14 (0.14–2.5)                    |
| Flexible stranded AWG (mm <sup>2</sup> )             | 26–14 (0.14–2.5)                               | 26–14 (0.14–2.5)                               | 26–14 (0.14–2.5)                    | 26–14 (0.14–2.5)                    |
| <b>Input Data for 1PDT Screw Connection Versions</b> |  |  |                                     |                                     |
| Input voltage  | 12 Vdc   | 24 Vdc   | 24 Vac/Vdc                          | 120 Vac/110 Vdc                     |
| Permissible range                                    | See <b>Page V7-T3-10</b>                       | See <b>Page V7-T3-10</b>                       | See <b>Page V7-T3-10</b>            | See <b>Page V7-T3-10</b>            |
| Typical input current                                | 15.3 mA  | 9 mA   | 11 mA (24 Vac)/8.5 mA (24 Vdc)      | 3.5 mA (120 Vac)/3 mA (110 Vdc)     |
| Typical response time                                | 5 ms   | 5 ms   | 6 ms                                | 6 ms                                |
| Typical release time                                 | 8 ms   | 8 ms   | 15 ms                               | 15 ms                               |
| Input protection                                     | Polarity protection diode, free-wheeling diode | Polarity protection diode, free-wheeling diode | Bridge rectifier                    | Bridge rectifier                    |
| <b>Output Data</b>                                   |  |  |                                     |                                     |
| Contact type   | 1PDT   | 1PDT   | 1PDT                                | 1PDT                                |
| Contact material                                     | AgSnO  | AgSnO  | AgSnO                               | AgSnO                               |
| Max. switching voltage                               | 250 Vac/Vdc <sup>①</sup>                       | 250 Vac/Vdc <sup>①</sup>                       | 250 Vac/Vdc <sup>①</sup>            | 250 Vac/Vdc <sup>①</sup>            |
| Min. switching voltage                               | 12 Vac/Vdc                                     | 12 Vac/Vdc                                     | 12 Vac/Vdc                          | 12 Vac/Vdc                          |
| Limiting continuous current                          | 6 A  | 6 A  | 6 A                                 | 6 A                                 |
| Min. switching current                               | 10 mA  | 10 mA  | 10 mA                               | 10 mA                               |
| Min. switching power                                 | 120 mW   | 120 mW   | 120 mW                              | 120 mW                              |
| <b>Miscellaneous Data</b>                            |  |  |                                     |                                     |
| Ambient temp range                                   | –4 °F to +140 °F (–20 °C to +60 °C)            | –4 °F to +140 °F (–20 °C to +60 °C)            | –4 °F to +140 °F (–20 °C to +60 °C) | –4 °F to +140 °F (–20 °C to +60 °C) |
| Rated operating mode                                 | 100% operating factor                          | 100% operating factor                          | 100% operating factor               | 100% operating factor               |
| Inflammability class                                 | V0, in accordance with UL 94                   | V0, in accordance with UL 94                   | V0, in accordance with UL 94        | V0, in accordance with UL 94        |
| Mechanical service life                              | 2 x 10 <sup>7</sup> cycles                     | 2 x 10 <sup>7</sup> cycles                     | 2 x 10 <sup>7</sup> cycles          | 2 x 10 <sup>7</sup> cycles          |

#### Note

<sup>①</sup> The separating plate, XRAPLCEsk, should be installed for voltages greater than 250 V (L1, L2, L3) between identical terminal points of adjacent modules. Potential bridging is then possible with the XRAFBST bridge system.

## Standard 1PDT Screw Connection Terminal Block Relays with Gold Contacts

| Catalog Number  | XRU1D24UG                                | XRU1D120UG                               |
|---|--|--|
| Replacement Relay   | XRR1D24G                                 | XRR1D120UG                               |
| Input voltage   | 24 Vac/Vdc                               | 120 Vac/110 Vdc                          |
| <b>Connection Data</b>  |  |  |
| Rigid solid AWG (mm <sup>2</sup> )                                      | 26–14 (0.14–2.5)                         | 26–14 (0.14–2.5)                         |
| Flexible stranded AWG (mm <sup>2</sup> )                                | 26–14 (0.14–2.5)                         | 26–14 (0.14–2.5)                         |
| <b>Input Data for 1PDT Screw Connection Versions with Gold Contacts</b> |  |  |
| Input voltage   | 24 Vac/Vdc                               | 120 Vac/110 Vdc                          |
| Permissible range   | See <b>Page V7-T3-10</b>                 | See <b>Page V7-T3-10</b>                 |
| Typical input current   | 11 mA (24 Vac)/8.5 mA (24 Vdc)           | 3.5 mA (120 Vac)/3 mA (110 Vdc)          |
| Typical response time   | 6 ms                                     | 6 ms                                     |
| Typical release time  | 15 ms                                    | 15 ms                                    |
| Input protection  | Bridge rectifier                         | Bridge rectifier                         |
| <b>Output Data</b>  |  |  |
| Contact type  | 1PDT                                     | 1PDT                                     |
| Contact material  | AgSnO, gold plated <sup>①</sup>          | AgSnO, gold plated <sup>①</sup>          |
| Max. switching voltage  | 30 Vac/36 Vdc (250 Vac/Vdc) <sup>②</sup> | 30 Vac/36 Vdc (250 Vac/Vdc) <sup>②</sup> |
| Min. switching voltage  | 100 mV (12 Vac/Vdc) <sup>②</sup>         | 100 mV (12 Vac/Vdc) <sup>②</sup>         |
| Limiting continuous current   | 50 mA (6 A) <sup>②</sup>                 | 50 mA (6 A) <sup>②</sup>                 |
| Min. switching current  | 1 mA (10 mA) <sup>②</sup>                | 1 mA (10 mA) <sup>②</sup>                |
| Min. switching power  | 100 mW (120 mW) <sup>②</sup>             | 100 mW (120 mW) <sup>②</sup>             |
| <b>Miscellaneous Data</b>   |  |  |
| Ambient temp range  | –4 °F to +140 °F (–20 °C to +60 °C)      | –40 °F to +131 °F (–20 °C to +55 °C)     |
| Rated operating mode  | 100% operating factor                    | 100% operating factor                    |
| Inflammability class  | V0, in accordance with UL 94             | V0, in accordance with UL 94             |
| Mechanical service life   | 2 x 10 <sup>7</sup> cycles               | 2 x 10 <sup>7</sup> cycles               |

**Notes**

- <sup>①</sup> The separating plate, XRAPLCEsk, should be installed for voltages greater than 250 V (L1, L2, L3) between identical terminal points of adjacent modules. Potential bridging is then possible with the XRAFBST bridge system.
- <sup>②</sup> If the maximum values are exceeded, the gold layer is destroyed and the values in parentheses apply.

## Standard 1PDT Spring Cage Terminal Block Relays

| Catalog Number                                  | XRP1D12  | XRP1D24  | XRP1D24U                            | XRP1D120U                           |
|---|--|--|-------------------------------------|-------------------------------------|
| Replacement Relay                               | XRR1D12  | XRR1D24  | XRR1D24                             | XRR1D120U                           |
| Input voltage                                   | 12 Vdc   | 24 Vdc   | 24 Vac/Vdc                          | 120 Vac/110 Vdc                     |
| <b>Connection Data</b>                          |  |  |                                     |                                     |
| Rigid solid AWG (mm <sup>2</sup> )              | 26–14 (0.14–2.5)                               | 26–14 (0.14–2.5)                               | 26–14 (0.14–2.5)                    | 26–14 (0.14–2.5)                    |
| Flexible stranded AWG (mm <sup>2</sup> )        | 26–14 (0.14–2.5)                               | 26–14 (0.14–2.5)                               | 26–14 (0.14–2.5)                    | 26–14 (0.14–2.5)                    |
| <b>Input Data for 1PDT Spring Cage Versions</b> |  |  |                                     |                                     |
| Input voltage                                   | 12 Vdc   | 24 Vdc   | 24 Vac/Vdc                          | 120 Vac/110 Vdc                     |
| Permissible range                               | See <b>Page V7-T3-10</b>                       | See <b>Page V7-T3-10</b>                       | See <b>Page V7-T3-10</b>            | See <b>Page V7-T3-10</b>            |
| Typical input current                           | 15.3 mA  | 9 mA   | 11 mA (24 Vac)/8.5 mA (24 Vdc)      | 3.5 mA (120 Vac)/3 mA (110 Vdc)     |
| Typical response time                           | 5 ms   | 5 ms   | 6 ms                                | 6 ms                                |
| Typical release time                            | 8 ms   | 8 ms   | 15 ms                               | 15 ms                               |
| Input protection                                | Polarity protection diode, free-wheeling diode | Polarity protection diode, free-wheeling diode | Bridge rectifier                    | Bridge rectifier                    |
| <b>Output Data</b>                              |  |  |                                     |                                     |
| Contact type                                    | 1PDT   | 1PDT   | 1PDT                                | 1PDT                                |
| Contact material                                | AgSnO  | AgSnO  | AgSnO                               | AgSnO                               |
| Max. switching voltage                          | 250 Vac/Vdc <sup>①</sup>                       | 250 Vac/Vdc <sup>①</sup>                       | 250 Vac/Vdc <sup>①</sup>            | 250 Vac/Vdc <sup>①</sup>            |
| Min. switching voltage                          | 12 Vac/Vdc                                     | 12 Vac/Vdc                                     | 12 Vac/Vdc                          | 12 Vac/Vdc                          |
| Limiting continuous current                     | 6 A  | 6 A  | 6 A                                 | 6 A                                 |
| Min. switching current                          | 10 mA  | 10 mA  | 10 mA                               | 10 mA                               |
| Min. switching power                            | 120 mW   | 120 mW   | 120 mW                              | 120 mW                              |
| <b>Miscellaneous Data</b>                       |  |  |                                     |                                     |
| Ambient temp range                              | –4 °F to +140 °F (–20 °C to +60 °C)            | –4 °F to +140 °F (–20 °C to +60 °C)            | –4 °F to +140 °F (–20 °C to +60 °C) | –4 °F to +131 °F (–20 °C to +55 °C) |
| Rated operating mode                            | 100% operating factor                          | 100% operating factor                          | 100% operating factor               | 100% operating factor               |
| Inflammability class                            | V0, in accordance with UL 94                   | V0, in accordance with UL 94                   | V0, in accordance with UL 94        | V0, in accordance with UL 94        |
| Mechanical service life                         | 2 x 10 <sup>7</sup> cycles                     | 2 x 10 <sup>7</sup> cycles                     | 2 x 10 <sup>7</sup> cycles          | 2 x 10 <sup>7</sup> cycles          |

**Note**

<sup>①</sup> The separating plate, XRAPLCESK, should be installed for voltages greater than 250 V (L1, L2, L3) between identical terminal points of adjacent modules. Potential bridging is then possible with the XRAFBST bridge system.

## Standard DPDT Screw Connection Terminal Block Relays

| Catalog Number<br>Replacement Relay             | XRU2D12<br>XRR2D12                                | XRU2D24<br>XRR2D24                                | XRU2D24U<br>XRR2D24                 | XRU2D120U<br>XRR2D120U              |
|---|---|---|-------------------------------------|-------------------------------------|
| Input voltage                                   | 12 Vdc  | 24 Vdc  | 24 Vac/Vdc                          | 120 Vac/110 Vdc                     |
| <b>Connection Data</b>                          |   |   |                                     |                                     |
| Rigid solid AWG (mm <sup>2</sup> )              | 26–14 (0.14–2.5)                                  | 26–14 (0.14–2.5)                                  | 26–14 (0.14–2.5)                    | 26–14 (0.14–2.5)                    |
| Flexible stranded AWG (mm <sup>2</sup> )        | 26–14 (0.14–2.5)                                  | 26–14 (0.14–2.5)                                  | 26–14 (0.14–2.5)                    | 26–14 (0.14–2.5)                    |
| <b>Input Data for 1PDT Spring Cage Versions</b> |   |   |                                     |                                     |
| Input voltage                                   | 12 Vdc  | 24 Vdc  | 24 Vac/Vdc                          | 120 Vac/110 Vdc                     |
| Permissible range                               | See <b>Page V7-T3-10</b>                          | See <b>Page V7-T3-10</b>                          | See <b>Page V7-T3-10</b>            | See <b>Page V7-T3-10</b>            |
| Typical input current                           | 33 mA   | 18 mA   | 17.5 mA                             | 4.5 mA (120 Vac)/4.2 mA (110 Vdc)   |
| Typical response time                           | 8 ms  | 8 ms  | 8 ms                                | 7 ms                                |
| Typical release time                            | 10 ms   | 10 ms   | 10 ms                               | 10 ms                               |
| Input protection                                | Polarity protection diode,<br>free-wheeling diode | Polarity protection diode,<br>free-wheeling diode | Bridge rectifier                    | Bridge rectifier                    |
| <b>Output Data</b>                              |   |   |                                     |                                     |
| Contact type                                    | 2PDT  | Single contact, 2PDT                              | Single contact, 2PDT                | Single contact, 2PDT                |
| Contact material                                | AgNi  | AgNi  | AgNi                                | AgNi                                |
| Max. switching voltage                          | 250 Vac/Vdc <sup>①</sup>                          | 250 Vac/Vdc <sup>①</sup>                          | 250 Vac/Vdc <sup>①</sup>            | 250 Vac/Vdc <sup>①</sup>            |
| Min. switching voltage                          | 5 V   | 5 V   | 5 V                                 | 5 V                                 |
| Limiting continuous current                     | 6 A   | 6 A   | 6 A                                 | 6 A                                 |
| Max. inrush current                             | 15 A (300 ms)                                     | 15 A (300 ms)                                     | 15 A (300 ms)                       | 15 A (300 ms)                       |
| Min. switching current                          | 10 mA   | 10 mA   | 10 mA                               | 10 mA                               |
| Min. switching power                            | 50 mW   | 50 mW   | 50 mW                               | 50 mW                               |
| <b>General Data</b>                             |   |   |                                     |                                     |
| Ambient temp range                              | –4 °F to +140 °F (–20 °C to +60 °C)               | –4 °F to +140 °F (–20 °C to +60 °C)               | –4 °F to +140 °F (–20 °C to +60 °C) | –4 °F to +140 °F (–20 °C to +60 °C) |
| Rated operating mode                            | 100% operating factor                             | 100% operating factor                             | 100% operating factor               | 100% operating factor               |
| Inflammability class                            | V0, in accordance with UL 94                      | V0, in accordance with UL 94                      | V0, in accordance with UL 94        | V0, in accordance with UL 94        |
| Mechanical service life                         | 3 x 10 <sup>7</sup> cycles                        | 3 x 10 <sup>7</sup> cycles                        | 3 x 10 <sup>7</sup> cycles          | 3 x 10 <sup>7</sup> cycles          |

**Note**

<sup>①</sup> The separating plate, XRAPLCESK, should be installed for voltages greater than 250 V (L1, L2, L3) between identical terminal points of adjacent modules. Potential bridging is then possible with the XRFBST bridge system.

# 3.2

## Control Relays and Timers

### Terminal Block Relays

#### Permissible Range Diagrams

1PDT Relay Modules

#### Operating Range Voltage for 12 Vdc

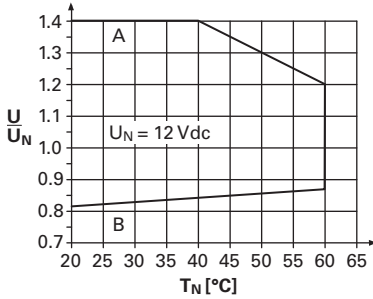

DPDT Relay Modules

#### Operating Range Voltage for 12 Vdc

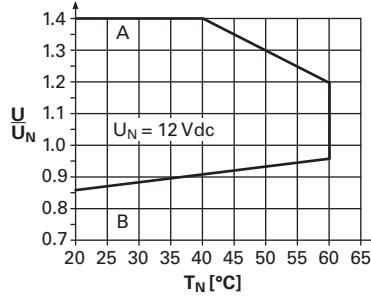

#### Operating Range Voltage for 120 Vac/110 Vdc

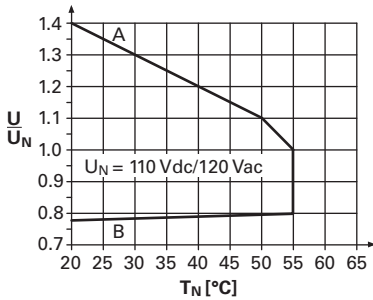

#### Operating Range Voltage for 120 Vac/110 Vdc

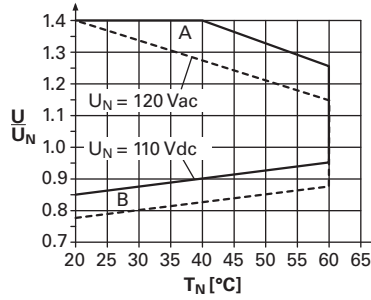

#### Operating Range Voltage for 24 Vdc

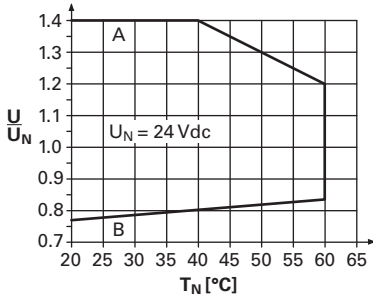

#### Operating Range Voltage for 24 Vdc

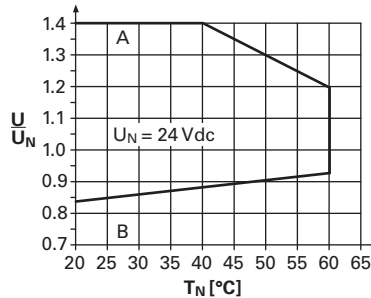

#### Operating Range Voltage for 24 Vac/Vdc

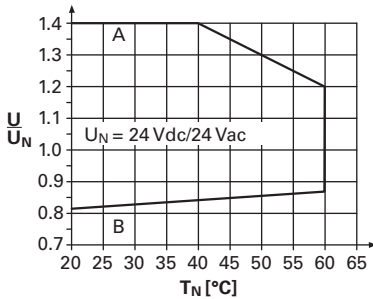

#### Operating Range Voltage for 24 Vac/Vdc

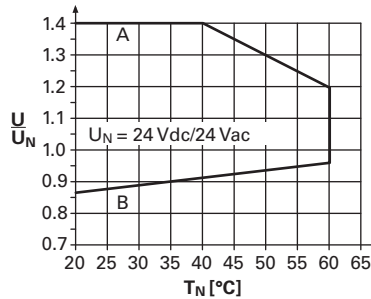

#### Notes

**General Conditions** — Direct alignment in the block, all devices 100% operating factor, horizontal or vertical mounting.

**Curve A** — Maximum permissible continuous operating voltage  $U_{max}$  with limiting continuous current on the contact side (see respective technical data).

**Curve B** — Minimum permissible relay operate voltage  $U_{op}$  after pre-excitation <sup>①</sup> (see respective technical data).

<sup>①</sup> Pre-excitation: Relay has been operated in a thermally steady state at the ambient temperature  $T_{ij}$  with nominal voltage  $U_N$  and limiting continuous current on the contact side (see respective technical data) (warm coil). After being switched off for a short time, the relay must reliably pick up again at  $U_{op}$ .

### Electrical Schematics

#### 1PDT Terminal Block Relays

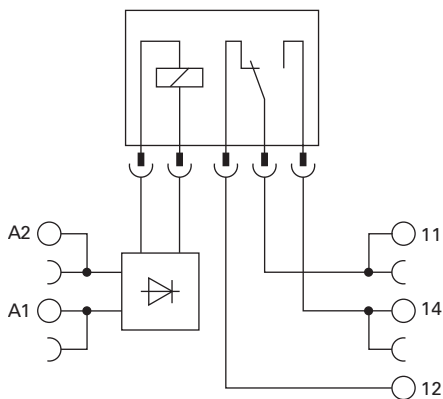

#### DPDT Terminal Block Relays

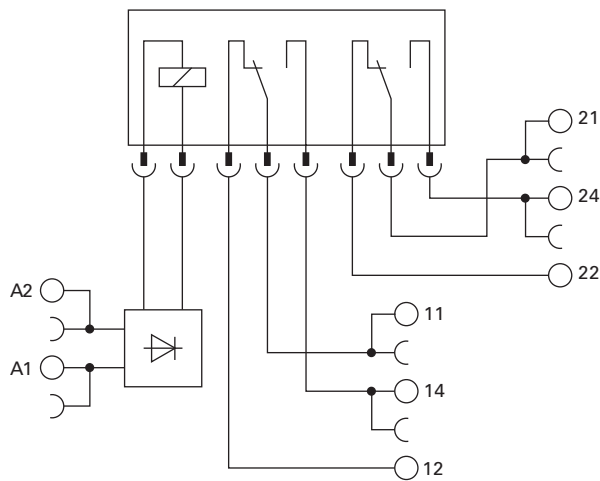

### Dimensions

Approximate Dimensions in Inches (mm)

#### Standard 1PDT Terminal Block Relays

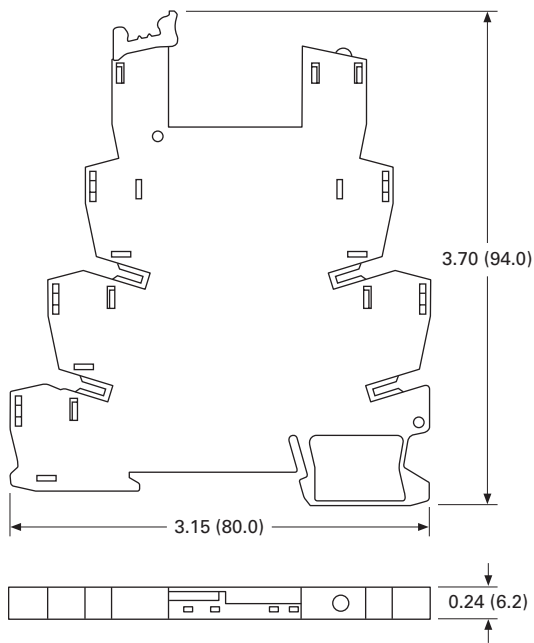

#### Standard DPDT Terminal Block Relays

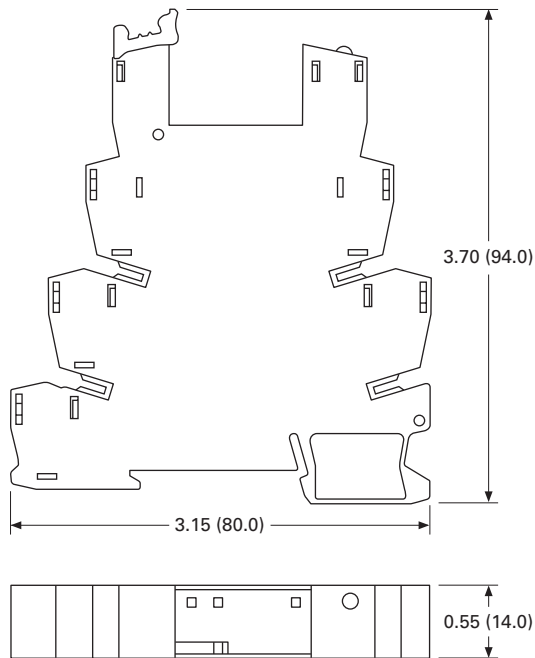

OptoCoupler Terminal Block Relay



### Contents

| <i><b>Description</b></i>                    | <i><b>Page</b></i> |
|--|--------------------|
| Standard Terminal Block Relays . . . . .     | <b>V7-T3-4</b>     |
| OptoCoupler Terminal Block Relays            |                    |
| Product Selection . . . . .                  | <b>V7-T3-13</b>    |
| Technical Data and Specifications . . . . .  | <b>V7-T3-13</b>    |
| Electrical Schematic . . . . .               | <b>V7-T3-14</b>    |
| Dimensions . . . . .                         | <b>V7-T3-14</b>    |
| High Current Terminal Block Relays . . . . . | <b>V7-T3-15</b>    |
| <b>XR</b> Series Accessories . . . . .       | <b>V7-T3-18</b>    |

### OptoCoupler Terminal Block Relays

#### Product Description

The **XR** Series OptoCoupler Terminal Block Relays can be used in all applications and consist of a pluggable miniature OptoCoupler and a basic terminal block. The **XR** Series uses screw or spring-cage technology, as well as offers quick system wiring, superior safety features, clear labeling and a high level of modularity.

#### Application Description

The **XR** Series OptoCoupler relays can be used as an input or output interface. They provide the typical reliability of OptoCouplers and are especially suited for high operating frequencies.

#### Features

- Pluggable relay allows for field replacement
- Functional plug-in bridges
- LED status indication
- DIN rail mount
- Only 6.2 mm wide
- Switching capacity up to 24 Vdc/3 A
- IP67-protected optical electronics
- Wear-resistant and bounce-free switching
- Insensitive to shock and vibration
- Integrated protection circuit
- Zero voltage switch at AC output

#### Standards and Certifications

- cULus listed
- CE





## Product Selection

## XRU1S24



## OptoCoupler Terminal Block Relays

| Rated Current | Supply Voltage  | Standard Pack | Catalog Number   |
|---------------|-----------------|---------------|------------------|
| 2 A           | 120 Vac/110 Vdc | 10            | <b>XRU1S120U</b> |
| 2 A           | 24 Vdc          | 10            | <b>XRU1S24</b>   |

## OptoCoupler Replacement Relays

| Rated Current | Supply Voltage <sup>①</sup> | Standard Pack | Catalog Number   |
|---------------|-----------------------------|---------------|------------------|
| 2 A           | 24 Vdc                      | 18            | <b>XRR1S24</b>   |
| 2 A           | 120 Vac/110 Vdc             | 10            | <b>XRR1S120U</b> |

## Technical Data and Specifications

## Pluggable Power OptoCoupler (Solid-State) Terminal Block Relays

| Catalog Number                                      | <b>XRU1S24</b>                                 | <b>XRU1S120U</b>                      |
|---|--|---------------------------------------|
| Replacement Relay                                   | <b>XRR1S24</b>                                 | <b>XRR1S120U</b>                      |
| Input voltage                                       | 24 Vdc   | 120 Vac/110 Vdc                       |
| <b>Connection Data</b>                              |  |                                       |
| Rigid solid AWG (mm <sup>2</sup> )                  | 26–14 (0.14–2.5)                               | 26–14 (0.14–2.5)                      |
| Flexible stranded AWG (mm <sup>2</sup> )            | 26–14 (0.14–2.5)                               | 26–14 (0.14–2.5)                      |
| <b>Input Data</b>                                   |  |                                       |
| Input voltage                                       | 24 Vdc   | 120 Vac/110 Vdc                       |
| Permissible range                                   | 0.8–1.2  | 0.8–1.1                               |
| Typical input current                               | 9 mA   | 4 mA                                  |
| Switching level 1 signal ("H")                      | ≥0.8   | ≥0.8                                  |
| Switching level 0 signal ("L")                      | ≤0.4   | ≤0.25                                 |
| Typical switch-on time                              | 20 μS  | 6 ms                                  |
| Typical turn-off time                               | 500 μS   | 10 ms                                 |
| Input protection                                    | Polarity protection diode, free-wheeling diode | Bridge rectifier                      |
| <b>Output Data</b>                                  |  |                                       |
| Max. switching voltage                              | 33 Vdc   | 33 Vdc                                |
| Min. switching voltage                              | 3 Vdc  | 3 Vdc                                 |
| Limiting continuous current                         | 3 A (See derating curve)                       | 3 A (See derating curve)              |
| Max. inrush current                                 | 15 A (10 ms)                                   | 15 A (10 ms)                          |
| Output circuit                                      | 2-conductor floating                           | 2-conductor floating                  |
| Output protection                                   | Polarity protection, surge protection          | Polarity protection, surge protection |
| Voltage drop at maximum limiting continuous current | ≤ 200 mV                                       | ≤ 200 mV                              |
| <b>General Data</b>                                 |  |                                       |
| Ambient temp range                                  | –4 °F to +140 °F (–20 °C to +60 °C)            | –4 °F to +140 °F (–20 °C to +60 °C)   |
| Rated operating mode                                | 100% operating factor                          | 100% operating factor                 |
| Inflammability class                                | V0, in accordance with UL 94                   | V0, in accordance with UL 94          |
| Mechanical service life                             | 2 x 10 <sup>7</sup> cycles                     | 2 x 10 <sup>7</sup> cycles            |

**Note**

<sup>①</sup> Voltage is the rating at the base. It may not match the voltage on the specific replacement relay.

# 3.2

## Control Relays and Timers

### Terminal Block Relays

3

#### Derating Curve OptoCoupler

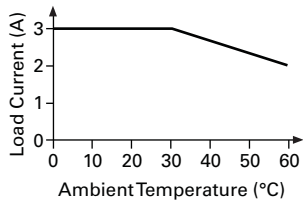

#### Electrical Schematic

##### Pluggable Power OptoCoupler (Solid-State) Terminal Block Relays

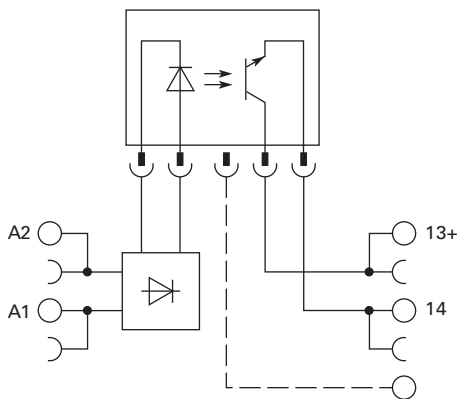

#### Dimensions

Approximate Dimensions in Inches (mm)

##### Pluggable Power OptoCoupler (Solid-State) Terminal Block Relays

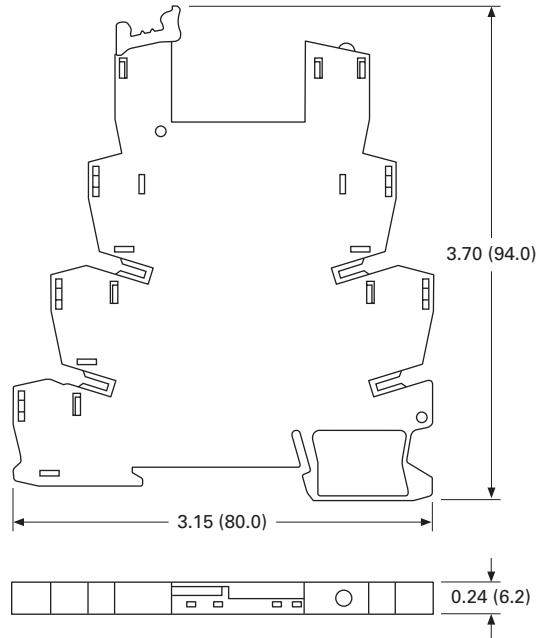

## High Current Terminal Block Relay



## Contents

| <b>Description</b>                          | <b>Page</b>     |
|---|-----------------|
| Standard Terminal Block Relays . . . . .    | V7-T3-4         |
| OptoCoupler Terminal Block Relays . . . . . | V7-T3-12        |
| High Current Terminal Block Relays          |                 |
| Product Selection . . . . .                 | V7-T3-16        |
| Technical Data and Specifications . . . . . | V7-T3-16        |
| Electrical Schematic . . . . .              | V7-T3-17        |
| Dimensions . . . . .                        | V7-T3-17        |
| <b>XR Series Accessories</b> . . . . .      | <b>V7-T3-18</b> |

## High Current Terminal Block Relays

## Product Description

The **XR** Series Relays include products designed to meet high continuous current and/or long electrical service life applications. The **XR** Series Relays are plug-in interfaces that connect to basic terminal blocks that use screw connection technology. Overall width is 14 mm.

## Application Description

These relays are best suited for applications that require higher continuous load currents than miniature relays can carry and switch. They can withstand inrush currents or brief overloads without damage, and allow for continuous load currents of up to 10 A. The **XR** Series Relay boasts an average service life of the contacts that is two or three times the normal life of a less powerful relay, resulting in service cost savings.

## Features

- 14 mm wide
- Pluggable relay allows for field replacement
- Convenient plug-in bridge system
- LED status indication
- DIN Rail Mount
- IP67-protected optical electronics
- Wear-resistant and bounce-free switching
- Insensitive to shock and vibration
- Integrated protection circuit
- Zero voltage switch at AC output
- Environmentally friendly, cadmium-free contact material
- Electrical isolation between input and output

## Standards and Certifications

- cULus listed
- CE



## Product Selection

## XRU1H24



## High Current Terminal Block Relays

| Rated Current | Supply Voltage  | Standard Pack | Catalog Number |
|---------------|-----------------|---------------|----------------|
| 10 A          | 12 Vdc          | 10            | XRU1H12        |
| 10 A          | 120 Vac/110 Vdc | 10            | XRU1H120U      |
| 10 A          | 24 Vdc          | 10            | XRU1H24        |
| 10 A          | 24 Vac/Vdc      | 10            | XRU1H24U       |

## High Current Replacement Relays

| Rated Current | Supply Voltage <sup>①</sup> | Standard Pack | Catalog Number |
|---------------|-----------------------------|---------------|----------------|
| 10 A          | 24 Vdc                      | 10            | XRR1H24        |
| 10 A          | 24 Vac/Vdc                  | 10            | XRR1H24U       |
| 10 A          | 12 Vdc                      | 10            | XRR1H12        |
| 10 A          | 120 Vac/110 Vdc             | 10            | XRR1H120U      |

## Technical Data and Specifications

## High Current Terminal Block Relays (1PDT)

| Catalog Number<br>Replacement Relay             | XRU1H12<br>XRR1H12                                | XRU1H24<br>XRR1H24                                | XRU1H24U<br>XRR1H24U                | XRU1H120U<br>XRR1H120U              |
|---|---|---|-------------------------------------|-------------------------------------|
| Input voltage                                   | 12 Vdc  | 24 Vdc  | 24 Vac/Vdc                          | 120 Vac/110 Vdc                     |
| <b>Connection Data</b>                          |   |   |                                     |                                     |
| Rigid solid AWG (mm <sup>2</sup> )              | 26–14 (0.14–2.5)                                  | 26–14 (0.14–2.5)                                  | 26–14 (0.14–2.5)                    | 26–14 (0.14–2.5)                    |
| Flexible stranded AWG (mm <sup>2</sup> )        | 26–14 (0.14–2.5)                                  | 26–14 (0.14–2.5)                                  | 26–14 (0.14–2.5)                    | 26–14 (0.14–2.5)                    |
| <b>Input Data for 1PDT Spring Cage Versions</b> |   |   |                                     |                                     |
| Input voltage                                   | 12 Vdc  | 24 Vdc  | 24 Vac/Vdc                          | 120 Vac/110 Vdc                     |
| Permissible range                               | See <b>Page V7-T3-10</b>                          | See <b>Page V7-T3-10</b>                          | See <b>Page V7-T3-10</b>            | See <b>Page V7-T3-10</b>            |
| Typical input current                           | 33 mA   | 18 mA   | 17.5 mA                             | 4.5 mA (120 Vac)/4.2 mA (110 Vdc)   |
| Typical response time                           | 8 ms  | 8 ms  | 8 ms                                | 7 ms                                |
| Typical release time                            | 10 ms   | 10 ms   | 10 ms                               | 10 ms                               |
| Input protection                                | Polarity protection diode,<br>free-wheeling diode | Polarity protection diode,<br>free-wheeling diode | Bridge rectifier                    | Bridge rectifier                    |
| <b>Output Data</b>                              |   |   |                                     |                                     |
| Contact type                                    | Single contact, 1PDT                              | Single contact, 1PDT                              | Single contact, 1PDT                | Single contact, 1PDT                |
| Contact material                                | AgNi  | AgNi  | AgNi                                | AgNi                                |
| Max. switching voltage                          | 250 Vac/Vdc <sup>②</sup>                          | 250 Vac/Vdc <sup>②</sup>                          | 250 Vac/Vdc <sup>②</sup>            | 250 Vac/Vdc <sup>②</sup>            |
| Min. switching voltage                          | 12 Vac/Vdc  | 12 Vac/Vdc  | 12 Vac/Vdc                          | 12 Vac/Vdc                          |
| Limiting continuous current                     | 10 A <sup>③</sup>                                 | 10 A <sup>③</sup>                                 | 10 A <sup>③</sup>                   | 10 A <sup>③</sup>                   |
| Max. inrush current                             | 30 A (300 ms)                                     | 30 A (300 ms)                                     | 30 A (300 ms)                       | 30 A (300 ms)                       |
| Min. switching current                          | 100 mA  | 100 mA  | 100 mA                              | 100 mA                              |
| Min. switching power                            | 1.2 W   | 1.2 W   | 1.2 W                               | 1.2 W                               |
| <b>Miscellaneous Data</b>                       |   |   |                                     |                                     |
| Ambient temp range                              | –4 °C to +140 °F (–20 °C to +60 °C)               | –4 °C to +140 °F (–20 °C to +60 °C)               | –4 °C to +140 °F (–20 °C to +60 °C) | –4 °C to +140 °F (–20 °C to +60 °C) |
| Rated operating mode                            | 100% operating factor                             | 100% operating factor                             | 100% operating factor               | 100% operating factor               |
| Inflammability class                            | V0, in accordance with UL 94                      | V0, in accordance with UL 94                      | V0, in accordance with UL 94        | V0, in accordance with UL 94        |
| Mechanical service life                         | 3 x 10 <sup>7</sup> cycles                        | 3 x 10 <sup>7</sup> cycles                        | 3 x 10 <sup>7</sup> cycles          | 3 x 10 <sup>7</sup> cycles          |

## Notes

- ① Voltage is the rating at the base. It may not match the voltage on the specific replacement relay.
- ② The separating plate, XRAPLCEsk, should be installed for voltages greater than 250 V (L1, L2, L3) between identical terminal points of adjacent modules. Potential bridging is then possible with the XRAFBST bridge system.
- ③ The current rating for the normally open contact (#14) is 10 A. The current rating for the normally closed contact (#12) is 6 A and can be increased to 10 A by bridging the two #12 contact connections.

### Electrical Schematic

#### High Current Terminal Block Relays

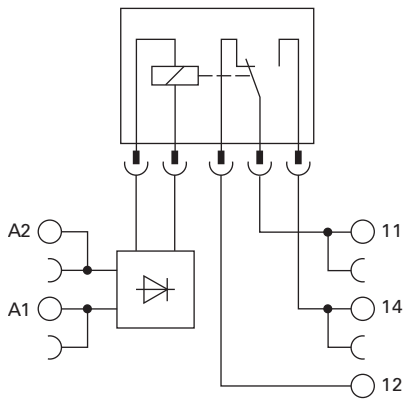

### Dimensions

Approximate Dimensions in Inches (mm)

#### High Current Terminal Block Relays

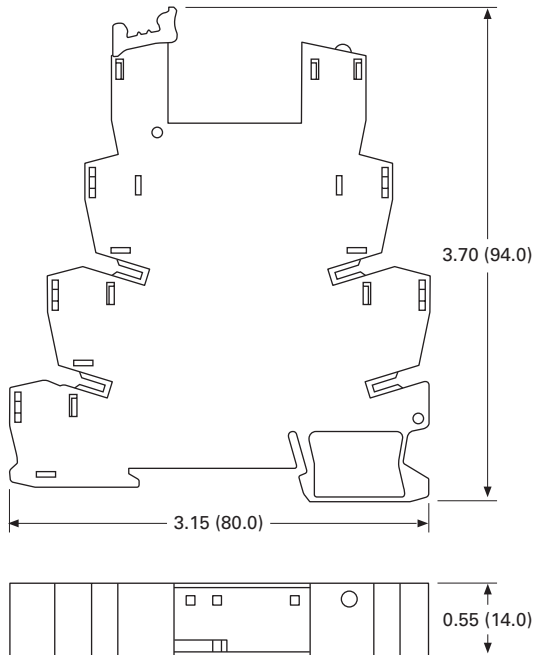

## XR Series Accessories

### Product Description

#### Power Terminal Block

#### Bridges



The XRAPLCESK power terminal block has the same shape as the relay modules and is used to feed in the bridging potentials. The nominal current is 32 A. When the total current is less than or equal to 6 A, supply can take place directly at the connecting terminal blocks of one of the connected relays.

#### End Cover

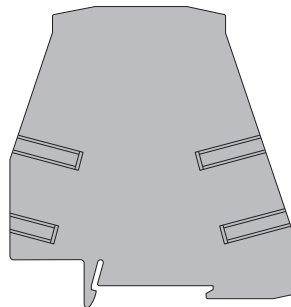

The XRAATPBK end cover is required at the start and stop of a relay strip. It can also be used for visual separation of groups of relays as well as separating relays with voltages greater than 250 V and separating neighboring bridges with different potentials. It is equipped with pre-scored break out points at the bridging positions so that individual bridges can be passed through as needed. It may also be necessary to use the end cover between adjacent relays when three phases (L1, L2, L3) are used on the contact side of the relay.

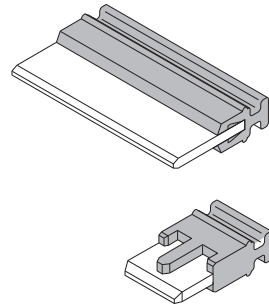

The XRAFBST colored, insulated plug-in bridge system reduces wiring time by up to 70% compared to conventionally wired relays. The XRAFBST2, 2-position bridges, are suited for bridging a smaller number of relays and total currents  $\leq 6$  A. When a circuit is supplied from both sides, the circuit can be opened at any point, allowing all other modules to continue being supplied at the same time. The XRAFBST500 allow up to 80 modules to be bridged at one time. If bridges with different potentials meet in neighboring modules, the end cover XRAATPBK should be used. All bridges are equipped with a groove for removal with a standard screwdriver.

### Product Selection

#### XR Series Accessories

| Color                             | Standard Pack | Catalog Number |
|-----------------------------------|---------------|----------------|
| <b>2-Position Snap-In Jumper</b>  |               |                |
| Red                               | 10            | XRAFBST2RD     |
| Blue                              | 10            | XRAFBST2BU     |
| Gray                              | 10            | XRAFBST2GY     |
| <b>80-Position Snap-In Jumper</b> |               |                |
| Red                               | 5             | XRAFBST500RD   |
| Blue                              | 5             | XRAFBST500BU   |
| Gray                              | 5             | XRAFBST500GY   |
| <b>Power Terminal Block</b>       |               |                |
| Gray                              | 5             | XRAPLCESK      |
| <b>End Cover</b>                  |               |                |
| Black                             | 5             | XRAATPBK       |

### Technical Data and Specifications

#### Power Terminal Block

| Description                              | Specification        |
|--|----------------------|
| <b>Connection Data</b>                   |                      |
| Rigid solid AWG (mm <sup>2</sup> )       | 24–10 (0.2–4)        |
| Flexible stranded AWG (mm <sup>2</sup> ) | 24–10 (0.2–4)        |
| <b>Miscellaneous Data</b>                |                      |
| Max. current                             | 32 A                 |
| Max. voltage                             | 250 Vac <sup>①</sup> |

#### Note

- <sup>①</sup> The separating plate, XRAPLCESK, should be installed for voltages greater than 250 V (L1, L2, L3) between identical terminal points of adjacent modules. Potential bridging is then possible with the XRAFBST bridge system.

## Programmable Relays



## Product Overview

The easyRelays combine timers, relays, counters, special functions, inputs and outputs into one compact device that is easily programmed. The easyRelay family of products provides an exceptional level of flexibility together with a substantial savings of commissioning time and effort.

The easyRelays are available in more than 35 styles that support from 12 I/O up to a network of up to 320 I/O points, providing the ideal solution for lighting, energy management, industrial control, irrigation, pump control, HVAC and home automation.

Once easyRelays are installed, changes are easily accomplished through front panel programming, eliminating the need to change wiring and minimizing downtime.

The easy802/806 relays are even more powerful than the easy800 series and include an integrated SmartWire-DT gateway. Conventional hardwiring to pushbuttons, selector switches, pilot devices and contactors can now be eliminated, allowing for a dramatic increase in panel wiring productivity. For more information on SmartWire-DT and how it can increase productivity, go to [www.eaton.com/smartwiredt](http://www.eaton.com/smartwiredt).

## Contents

## Description

## Page

|  |                 |
|--|-----------------|
| Programmable Relays  |                 |
| easy500/700/800 Programmable Relays . . . . .                | <b>V7-T3-20</b> |
| easy802/806 Programmable Relays with SmartWire-DT . . . . .  | <b>V7-T3-26</b> |
| easyRelay and MFD Expansion Modules . . . . .                | <b>V7-T3-30</b> |
| MFD-Titan Multi-Function Displays . . . . .                  | <b>V7-T3-33</b> |
| easyRelay Communication Modules . . . . .                    | <b>V7-T3-40</b> |
| easyRelay Power Supplies, Accessories and Software . . . . . | <b>V7-T3-43</b> |

## Application Description

The easyRelays excel in traditional applications where multiple relays, timers and pushbuttons are used. Applications span residential, commercial and industrial installations.

Typical control applications are:

- Lighting controls
- Duplex pump controls
- Water fountain controls
- Parking garage access controls
- Refrigeration control system
- Greenhouse temperature and ventilation controls
- Booster pump controls

See publication no. **AP05013001E** for the easyRelay application guide. Download from [www.eaton.com/easyrelays](http://www.eaton.com/easyrelays).

#### easy500/700/800 Programmable Relays



3

#### easy500/700/800 Programmable Relays

##### Product Description

Three families make up the easyRelay programmable relay product line. All models are available with and without displays. DIN rail mounted.

**easy500**—for controlling small applications with up to 12 input/output signals. Connectable to Ethernet.

**easy700**—for controlling medium-sized applications with 20 I/O points (expandable to 40 I/O points). Connectable to Ethernet and bus systems.

**easy800**—for controlling large-scale applications with 20 points, expandable to 40 points locally, and expandable using the easyNet network up to 320 I/O points. Connectable to Ethernet and bus systems.

The easyNet integrated network provides easy and inexpensive linking of up to eight easy800 devices over a distance of up to 1000 meters. Each easy800 device can run its own program, or be used as a distributed input/output module. Connect up to eight controllers with up to 40 I/O to obtain 320 I/O.

##### Standards

- CSA C22.2 No. 142-M1987
- CSA C22.2 No. 213-M1987
- EN 55011
- EN 50178
- EN 61131-2
- IEC EN 61000-4
- IEC 60068-2-6
- IEC 60068-2-27
- UL 508

##### Certifications

- UL
- CSA
- CE
- CSA Class I, Div. 2, Groups A, B, C, D; Temp. Code T3C
- C-Tick
- GOST-R
- Ukrain-GOST



##### Shipping Approvals

- Bureau Veritas
- Det Norske Veritas
- Germanischer Lloyd
- Lloyd's Register of Shipping

#### Contents

##### Description

| Description  | Page     |
|--|----------|
| easy500/700/800 Programmable Relays                |          |
| System Overview                                    | V7-T3-21 |
| Product Selection                                  | V7-T3-23 |
| Technical Data and Specifications                  | V7-T3-24 |
| Dimensions   | V7-T3-25 |
| easy802/806 Programmable Relays with SmartWire-DT  | V7-T3-26 |
| easyRelay and MFD Expansion Modules                | V7-T3-30 |
| MFD-Titan Multi-Function Displays                  | V7-T3-33 |
| easyRelay Communication Modules                    | V7-T3-40 |
| easyRelay Power Supplies, Accessories and Software | V7-T3-43 |

#### Catalog Number Selection

##### easy500/700/800

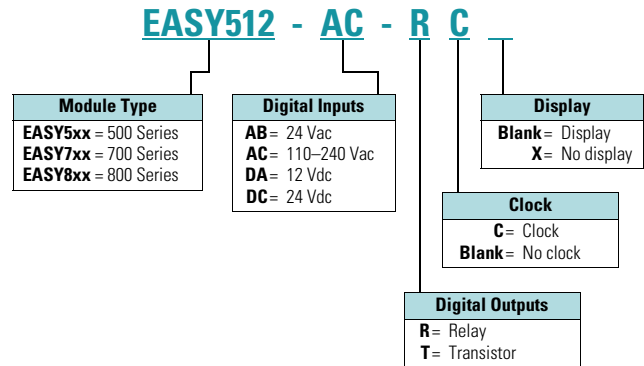

**Note:** Not all combinations are possible. See selection tables.



### System Overview

#### easy500/700 Programmable Relays

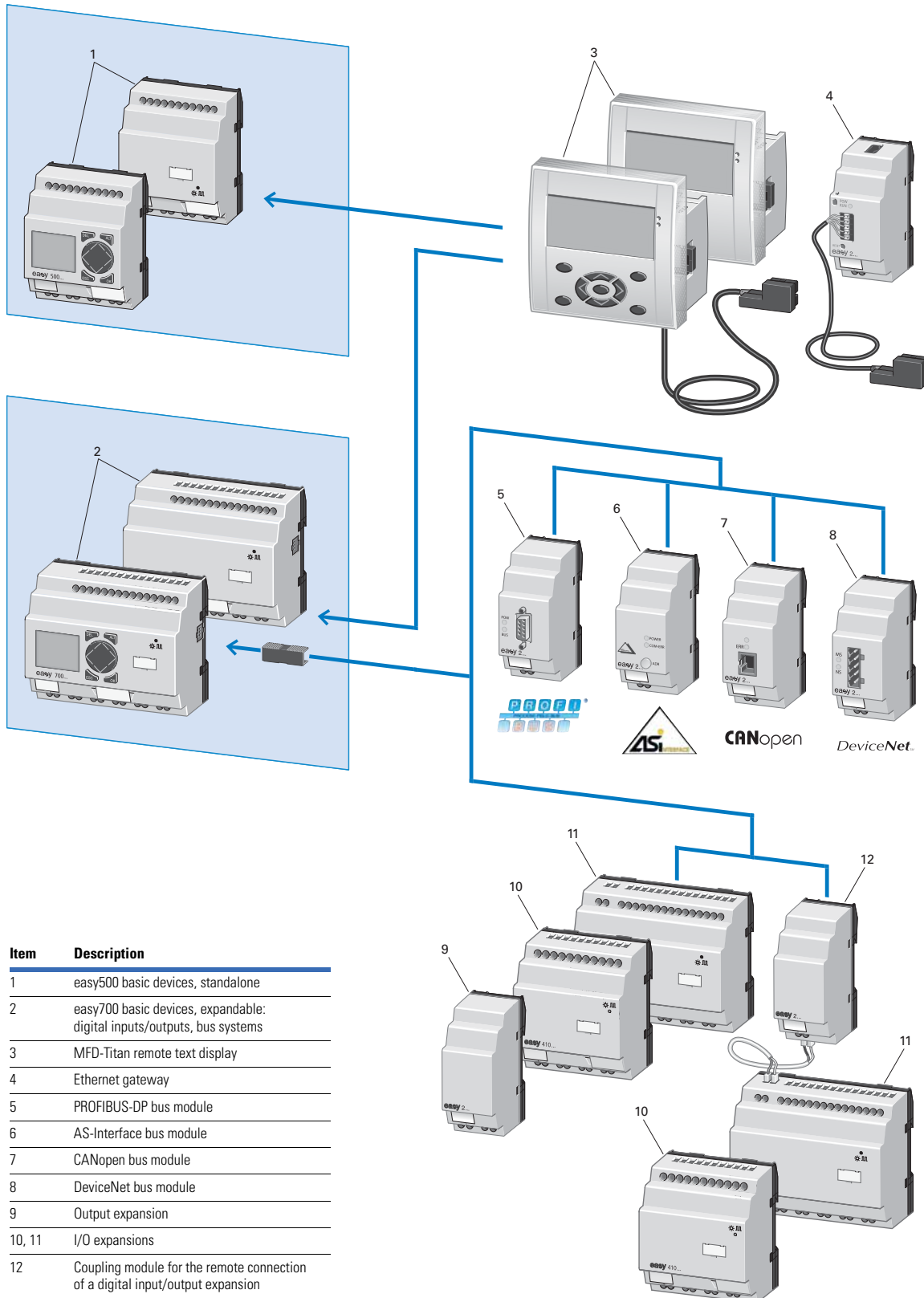

| Item   | Description   |
|--------|---|
| 1      | easy500 basic devices, standalone   |
| 2      | easy700 basic devices, expandable: digital inputs/outputs, bus systems        |
| 3      | MFD-Titan remote text display   |
| 4      | Ethernet gateway  |
| 5      | PROFIBUS-DP bus module  |
| 6      | AS-Interface bus module   |
| 7      | CANopen bus module  |
| 8      | DeviceNet bus module  |
| 9      | Output expansion  |
| 10, 11 | I/O expansions  |
| 12     | Coupling module for the remote connection of a digital input/output expansion |

# 3.3

## Control Relays and Timers

### Programmable Relays

#### easy800 Programmable Relay

3

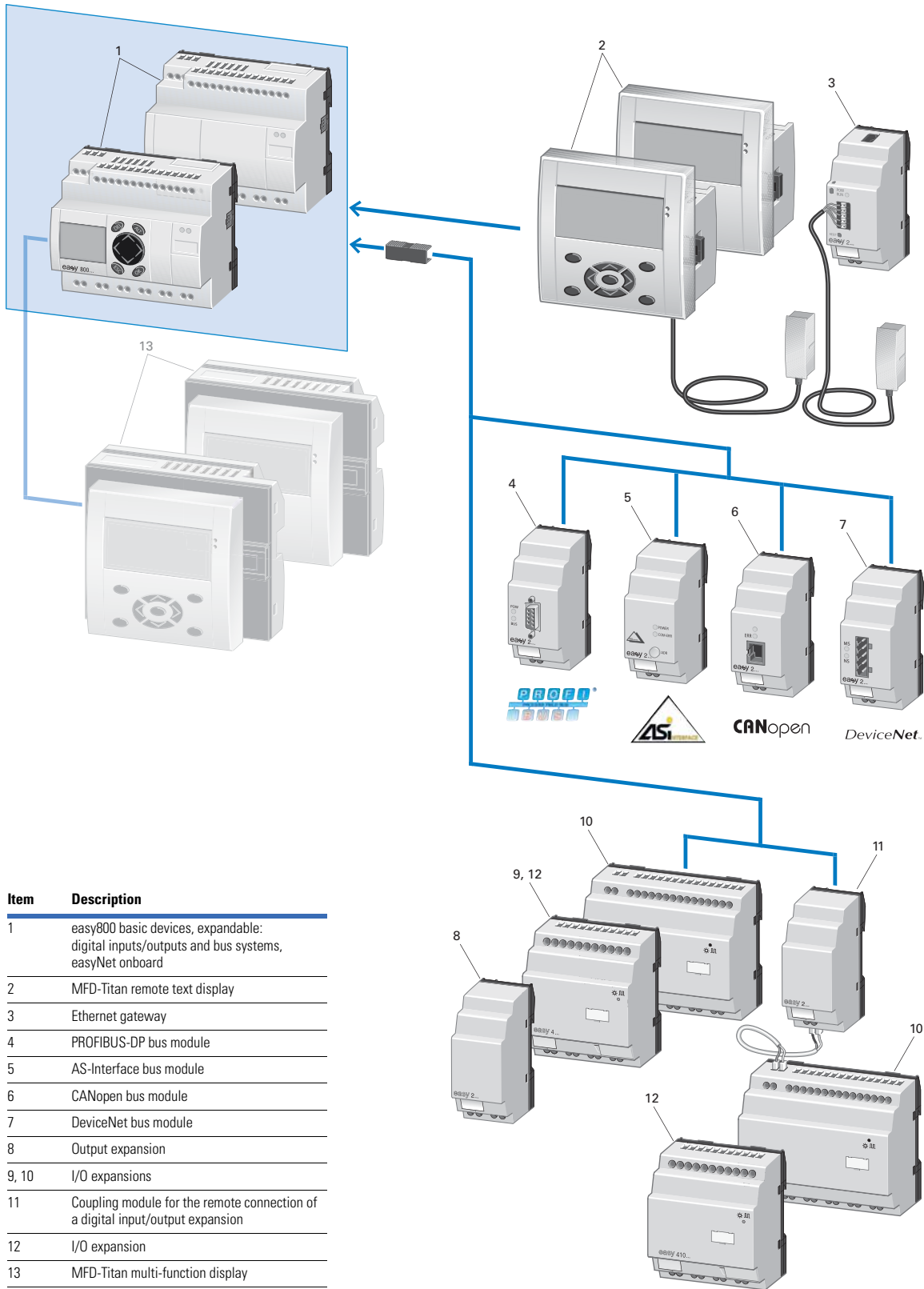

## Product Selection

## easy500—Display



## easy500 Programmable Relays (Standalone)

| Description       | Inputs |             |        |        |                     | Outputs |            | Catalog Number |
|-------------------|--------|-------------|--------|--------|---------------------|---------|------------|----------------|
|                   | 24 Vac | 110–240 Vac | 12 Vdc | 24 Vdc | Analog <sup>①</sup> | Relay   | Transistor |                |
| <b>Display</b>    |        |             |        |        |                     |         |            |                |
| 12 I/O, no clock  | —      | 8           | —      | —      | —                   | 4       | —          | EASY512-AC-R   |
|                   | —      | —           | —      | 8      | 2                   | 4       | —          | EASY512-DC-R   |
| 12 I/O, clock     | 8      | —           | —      | —      | 2                   | 4       | —          | EASY512-AB-RC  |
|                   | —      | 8           | —      | —      | —                   | 4       | —          | EASY512-AC-RC  |
|                   | —      | —           | 8      | —      | 2                   | 4       | —          | EASY512-DA-RC  |
|                   | —      | —           | —      | 8      | 2                   | 4       | —          | EASY512-DC-RC  |
|                   | —      | —           | —      | 8      | 2                   | —       | 4          | EASY512-DC-TC  |
| <b>No Display</b> |        |             |        |        |                     |         |            |                |
| 12 I/O, clock     | 8      | —           | —      | —      | 2                   | 4       | —          | EASY512-AB-RCX |
|                   | —      | 8           | —      | —      | —                   | 4       | —          | EASY512-AC-RCX |
|                   | —      | —           | 8      | —      | 2                   | 4       | —          | EASY512-DA-RCX |
|                   | —      | —           | —      | 8      | 2                   | 4       | —          | EASY512-DC-RCX |
|                   | —      | —           | —      | 8      | 2                   | —       | 4          | EASY512-DC-TCX |

## easy500—No Display



## easy700—Display



## easy700 Programmable Relays (Expandable and Networkable)

| Description       | Inputs |             |        |        |                     | Outputs |            | Catalog Number |
|-------------------|--------|-------------|--------|--------|---------------------|---------|------------|----------------|
|                   | 24 Vac | 110–240 Vac | 12 Vdc | 24 Vdc | Analog <sup>①</sup> | Relay   | Transistor |                |
| <b>Display</b>    |        |             |        |        |                     |         |            |                |
| 18 I/O, clock     | 12     | —           | —      | —      | 4                   | 6       | —          | EASY719-AB-RC  |
|                   | —      | 12          | —      | —      | —                   | 6       | —          | EASY719-AC-RC  |
|                   | —      | —           | 12     | —      | 4                   | 6       | —          | EASY719-DA-RC  |
|                   | —      | —           | —      | 12     | 4                   | 6       | —          | EASY719-DC-RC  |
| 20 I/O, clock     | —      | —           | —      | 12     | 4                   | —       | 8          | EASY721-DC-TC  |
| <b>No Display</b> |        |             |        |        |                     |         |            |                |
| 18 I/O, clock     | 12     | —           | —      | —      | 4                   | 6       | —          | EASY719-AB-RCX |
|                   | —      | 12          | —      | —      | —                   | 6       | —          | EASY719-AC-RCX |
|                   | —      | —           | 12     | —      | 4                   | 6       | —          | EASY719-DA-RCX |
|                   | —      | —           | —      | 12     | 4                   | 6       | —          | EASY719-DC-RCX |
| 20 I/O, clock     | —      | —           | —      | 12     | 4                   | —       | 8          | EASY721-DC-TCX |

## easy700—No Display



## easy800—Display



## easy800 Programmable Relays (Expandable and Networkable)

| Description       | Inputs      |        |                     | Outputs |            |        | Catalog Number |
|-------------------|-------------|--------|---------------------|---------|------------|--------|----------------|
|                   | 110–240 Vac | 24 Vdc | Analog <sup>①</sup> | Relay   | Transistor | Analog |                |
| <b>Display</b>    |             |        |                     |         |            |        |                |
| 18 I/O, clock     | 12          | —      | —                   | 6       | —          | —      | EASY819-AC-RC  |
|                   | —           | 12     | 4                   | 6       | —          | —      | EASY819-DC-RC  |
| 19 I/O, clock     | —           | 12     | 4                   | 6       | —          | 1      | EASY820-DC-RC  |
| 20 I/O, clock     | —           | 12     | 4                   | —       | 8          | —      | EASY821-DC-TC  |
| 21 I/O, clock     | —           | 12     | 4                   | —       | 8          | 1      | EASY822-DC-TC  |
| <b>No Display</b> |             |        |                     |         |            |        |                |
| 18 I/O, clock     | 12          | —      | —                   | 6       | —          | —      | EASY819-AC-RCX |
|                   | —           | 12     | 4                   | 6       | —          | —      | EASY819-DC-RCX |
| 19 I/O, clock     | —           | 12     | 4                   | 6       | —          | 1      | EASY820-DC-RCX |
| 20 I/O, clock     | —           | 12     | 4                   | —       | 8          | —      | EASY821-DC-TCX |
| 21 I/O, clock     | —           | 12     | 4                   | —       | 8          | 1      | EASY822-DC-TCX |

## easy800—No Display

**Note**

<sup>①</sup> Analog inputs optional. Use of analog inputs will result in a decrease in the same number of available digital inputs.

## Technical Data and Specifications

## easy500 Series

| Type  | EASY512-AB...  | EASY512-AC...                       | EASY512-DA...                       | EASY512-DC-R...                     | EASY512-DC-TC.                      |
|---|--|-------------------------------------|-------------------------------------|-------------------------------------|-------------------------------------|
| Supply voltage                                  | 24 Vac   | 100–240 Vac                         | 12 Vdc                              | 24 Vdc                              | 24 Vdc                              |
| Heat dissipation                                | 5 VA   | 5 VA                                | 2 W                                 | 2 W                                 | 2 W                                 |
| Continuous current outputs <sup>①</sup>         | 8 A  | 8 A                                 | 8 A                                 | 8 A                                 | 0.5 A                               |
| Short-circuit proof with power factor 1         | Line protection B16, 600 A   |                                     |                                     |                                     | —                                   |
| Short-circuit proof with power factor 0.7...0.7 | Line protection B16, 900 A   |                                     |                                     |                                     | —                                   |
| Mounting  | On 35 mm DIN rail or screw mounting with ZB4-101-GF1 mounting feet |                                     |                                     |                                     |                                     |
| Connection cables                               |  |                                     |                                     |                                     |                                     |
| Solid   | 0.2–4.0 mm <sup>2</sup> (AWG 22–12)                                | 0.2–4.0 mm <sup>2</sup> (AWG 22–12) | 0.2–4.0 mm <sup>2</sup> (AWG 22–12) | 0.2–4.0 mm <sup>2</sup> (AWG 22–12) | 0.2–4.0 mm <sup>2</sup> (AWG 22–12) |
| Flexible  | 0.2–2.5 mm <sup>2</sup> (AWG 22–12)                                | 0.2–2.5 mm <sup>2</sup> (AWG 22–12) | 0.2–2.5 mm <sup>2</sup> (AWG 22–12) | 0.2–2.5 mm <sup>2</sup> (AWG 22–12) | 0.2–2.5 mm <sup>2</sup> (AWG 22–12) |
| Degree of protection                            | IP20   | IP20                                | IP20                                | IP20                                | IP20                                |
| RFI suppression                                 | EN 55011, EN 55022 Class B, IEC 61000-6-1, 2, 3, 4                 |                                     |                                     |                                     |                                     |
| Ambient operating temperature                   | –25 °C to +55 °C   | –25 °C to +55 °C                    | –25 °C to +55 °C                    | –25 °C to +55 °C                    | –25 °C to +55 °C                    |
| Transport and storage temperature               | –40 °C to +70 °C   | –40 °C to +70 °C                    | –40 °C to +70 °C                    | –40 °C to +70 °C                    | –40 °C to +70 °C                    |
| Hazardous location                              | CSA Class I, Div. 2, Groups A, B, C, D; Temp. Code T3C             |                                     |                                     |                                     |                                     |

## easy700 Series

| Type  | EASY719-AB...  | EASY719-AC...                       | EASY719-DA...                       | EASY719-DC-RC...                    | EASY721-DC-TC.                      |
|---|--|-------------------------------------|-------------------------------------|-------------------------------------|-------------------------------------|
| Supply voltage                                  | 24 Vac   | 100–240 Vac                         | 12 Vdc                              | 24 Vdc                              | 24 Vdc                              |
| Heat dissipation                                | 7 VA   | 10 VA                               | 3.5 W                               | 3.5 W                               | 3.5 W                               |
| Continuous current outputs <sup>①</sup>         | 8 A  | 8 A                                 | 8 A                                 | 8 A                                 | 0.5 A                               |
| Short-circuit proof with power factor 1         | Line protection B16, 600 A   | Line protection B16, 600 A          | Line protection B16, 600 A          | Line protection B16, 600 A          | —                                   |
| Short-circuit proof with power factor 0.7...0.7 | Line protection B16, 900 A   | Line protection B16, 900 A          | Line protection B16, 900 A          | Line protection B16, 900 A          | —                                   |
| Mounting  | On 35 mm DIN rail or screw mounting with ZB4-101-GF1 mounting feet |                                     |                                     |                                     |                                     |
| Connection cables                               |  |                                     |                                     |                                     |                                     |
| Solid   | 0.2–4.0 mm <sup>2</sup> (AWG 22–12)                                | 0.2–4.0 mm <sup>2</sup> (AWG 22–12) | 0.2–4.0 mm <sup>2</sup> (AWG 22–12) | 0.2–4.0 mm <sup>2</sup> (AWG 22–12) | 0.2–4.0 mm <sup>2</sup> (AWG 22–12) |
| Flexible  | 0.2–2.5 mm <sup>2</sup> (AWG 22–12)                                | 0.2–2.5 mm <sup>2</sup> (AWG 22–12) | 0.2–2.5 mm <sup>2</sup> (AWG 22–12) | 0.2–2.5 mm <sup>2</sup> (AWG 22–12) | 0.2–2.5 mm <sup>2</sup> (AWG 22–12) |
| Degree of protection                            | IP20   | IP20                                | IP20                                | IP20                                | IP20                                |
| RFI suppression                                 | EN 55011, EN 55022 Class B, IEC 61000-6-1, 2, 3, 4                 |                                     |                                     |                                     |                                     |
| Ambient operating temperature                   | –25 °C to +55 °C   | –25 °C to +55 °C                    | –25 °C to +55 °C                    | –25 °C to +55 °C                    | –25 °C to +55 °C                    |
| Transport and storage temperature               | –40 °C to +70 °C   | –40 °C to +70 °C                    | –40 °C to +70 °C                    | –40 °C to +70 °C                    | –40 °C to +70 °C                    |
| Hazardous location                              | CSA Class I, Div. 2, Groups A, B, C, D; Temp. Code T3C             |                                     |                                     |                                     |                                     |

## easy800 Series

| Type  | EASY819-AC...  | EASY819-DC-RC...                    | EASY820-DC-RC...                    | EASY821-DC-TC...                    | EASY822-DC-TC.                      |
|---|--|-------------------------------------|-------------------------------------|-------------------------------------|-------------------------------------|
| Supply voltage                                  | 100–240 Vac  | 24 Vdc                              | 24 Vdc                              | 24 Vdc                              | 24 Vdc                              |
| Heat dissipation                                | 10 VA  | 3.4 W                               | 3.4 W                               | 3.4 W                               | 3.4 W                               |
| Continuous current outputs <sup>①</sup>         | 8 A  | 8 A                                 | 8 A                                 | 8 A                                 | 0.5 A                               |
| Short-circuit proof with power factor 1         | Line protection B16, 600 A   | Line protection B16, 600 A          | Line protection B16, 600 A          | Line protection B16, 600 A          | —                                   |
| Short-circuit proof with power factor 0.7...0.7 | Line protection B16, 900 A   | Line protection B16, 900 A          | Line protection B16, 900 A          | Line protection B16, 900 A          | —                                   |
| Mounting  | On 35 mm DIN rail or screw mounting with ZB4-101-GF1 mounting feet |                                     |                                     |                                     |                                     |
| Connection cables                               |  |                                     |                                     |                                     |                                     |
| Solid   | 0.2–4.0 mm <sup>2</sup> (AWG 22–12)                                | 0.2–4.0 mm <sup>2</sup> (AWG 22–12) | 0.2–4.0 mm <sup>2</sup> (AWG 22–12) | 0.2–4.0 mm <sup>2</sup> (AWG 22–12) | 0.2–4.0 mm <sup>2</sup> (AWG 22–12) |
| Flexible  | 0.2–2.5 mm <sup>2</sup> (AWG 22–12)                                | 0.2–2.5 mm <sup>2</sup> (AWG 22–12) | 0.2–2.5 mm <sup>2</sup> (AWG 22–12) | 0.2–2.5 mm <sup>2</sup> (AWG 22–12) | 0.2–2.5 mm <sup>2</sup> (AWG 22–12) |
| Degree of protection                            | IP20   | IP20                                | IP20                                | IP20                                | IP20                                |
| RFI suppression                                 | EN 55011, EN 55022 Class B, IEC 61000-6-1, 2, 3, 4                 |                                     |                                     |                                     |                                     |
| Ambient operating temperature                   | –25 °C to +55 °C   | –25 °C to +55 °C                    | –25 °C to +55 °C                    | –25 °C to +55 °C                    | –25 °C to +55 °C                    |
| Transport and storage temperature               | –40 °C to +70 °C   | –40 °C to +70 °C                    | –40 °C to +70 °C                    | –40 °C to +70 °C                    | –40 °C to +70 °C                    |
| Hazardous location                              | CSA Class I, Div. 2, Groups A, B, C, D; Temp. Code T3C             |                                     |                                     |                                     |                                     |

**Note**

<sup>①</sup> Relay = 8 A (10 A to UL) with resistive load, 3 A with inductive load. Transistor outputs = 0.5 A/24 Vdc, maximum four outputs switchable in parallel.

### Dimensions

Approximate Dimensions in Inches (mm)

#### easy500 Series, Drawing Number MD05013001E

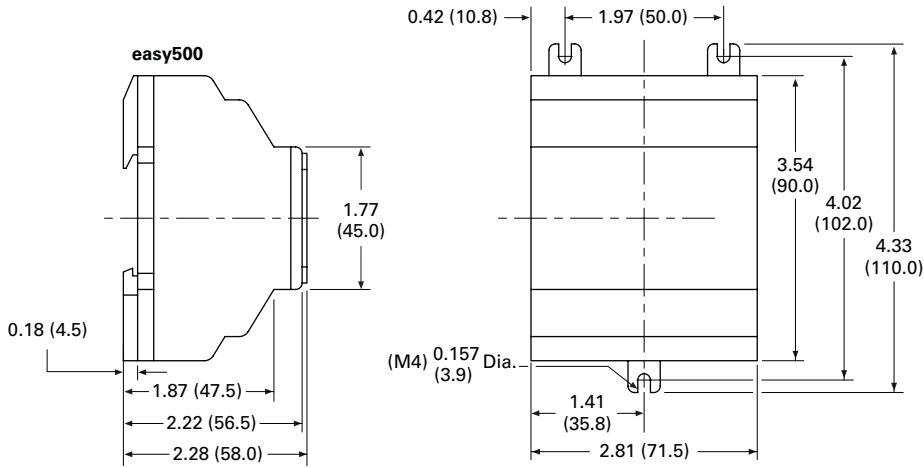

#### easy700 Series, Drawing Number MD05013002E

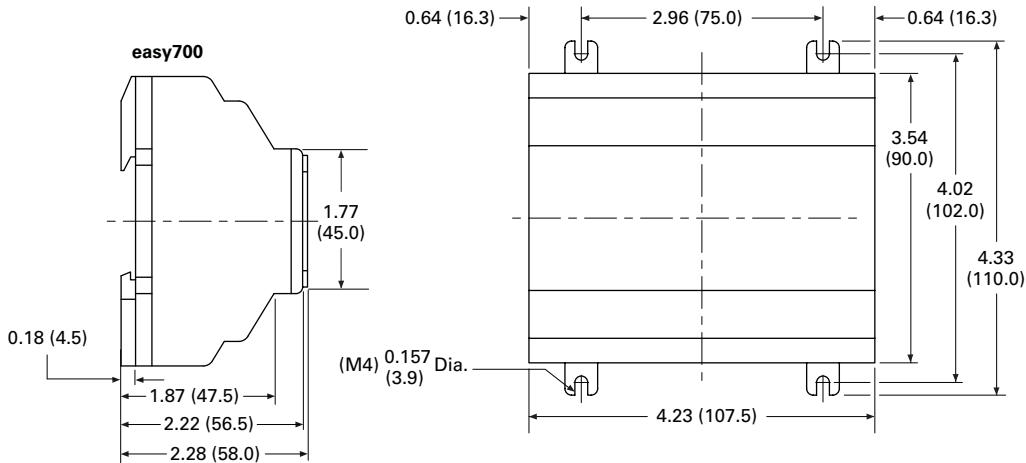

#### easy800 Series, Drawing Number MD05013003E

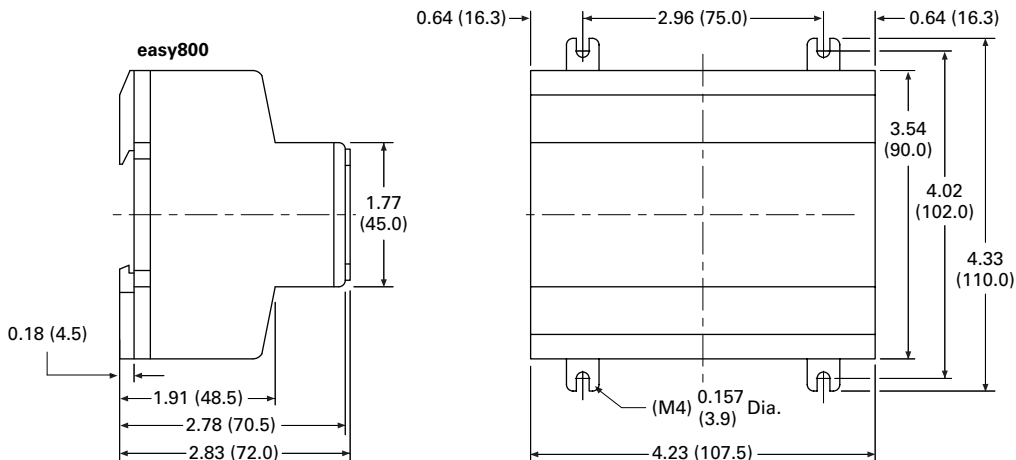

easy802/806 Programmable Relays with SmartWire-DT



### easy802/806 Programmable Relays with SmartWire-DT

#### Product Description

SmartWire-DT is a high-performance system that can be used to quickly and easily connect motor control components such as relays, contactors, pilot devices, manual motor protectors, soft starters ① and variable frequency drives ② as well as digital and analog input/output modules. On the new easy800 with integrated SmartWire-DT master, up to 99 SmartWire-DT devices in total with up to 166 inputs/outputs can be connected via the SmartWire-DT line. All required supply voltages, including those for bus devices as well as 24 Vdc for the contactors, are provided directly with the flat eight-pole SmartWire-DT bus line. This reduces wiring effort and troubleshooting and saves time and costs.

The easy802 features a POW power feeder for regulating power to the device as well as the SmartWire-DT devices. A second AUX power feeder provides the connected contactors with 24 Vdc. A separate 24 Vdc power supply is required to provide 24 Vdc power to the easy802 or easy806 controllers. The configuration of the SmartWire-DT devices is undertaken at a touch of the provided Configuration button. LEDs provide feedback on the connecting states on the device and the SmartWire-DT line. The serial interface serves for programming as well as for connection of a remote text display, touch panel or for connection to the Ethernet.

### Contents

#### Description

|  | <i>Page</i>     |
|--|-----------------|
| easy500/700/800 Programmable Relays . . . . .                | <b>V7-T3-20</b> |
| easy802/806 Programmable Relays with SmartWire-DT            |                 |
| Product Selection . . . . .                                  | <b>V7-T3-27</b> |
| Accessories. . . . .   | <b>V7-T3-27</b> |
| Technical Data and Specifications. . . . .                   | <b>V7-T3-28</b> |
| Dimensions. . . . .  | <b>V7-T3-29</b> |
| easyRelay and MFD Expansion Modules . . . . .                | <b>V7-T3-30</b> |
| MFD-Titan Multi-Function Displays . . . . .                  | <b>V7-T3-33</b> |
| easyRelay Communication Modules . . . . .                    | <b>V7-T3-40</b> |
| easyRelay Power Supplies, Accessories and Software . . . . . | <b>V7-T3-43</b> |

#### Note

① Soft starters and variable frequency drives will be available with direct SmartWire-DT connectivity in late 2013.

In addition to the functionality of the easy802, the easy806 also features four fast inputs (5 kHz). Two of the four inputs can also be configured as fast outputs (5 kHz) (transistor 24 Vdc, 0.1 A). In addition to the additional inputs/outputs on easy806, there is a connection option to the easyNet. Up to eight EASY806-DC-SWD controllers can be connected via easyNet, allowing up to 1360 inputs/outputs.

For more information on SmartWire-DT and related components, see **Tab 9** of this volume or go to [www.eaton.com/smawiredt](http://www.eaton.com/smawiredt).

#### Standards

- EN 50178
- IEC/EN 60947
- UL 508

#### Certifications

- cULus
- CE
- C-Tick



## Product Selection

Control relay for connection of SmartWire-DT and simultaneously for supply of power to the SmartWire-DT devices, such as switchgear and contactors.

### EASY802-DC-SWD



#### easy800 with SmartWire-DT

| Supply Voltage | Description                     | Catalog Number        |
|----------------|---------------------------------|-----------------------|
| 24 Vdc         | Control relay with SmartWire-DT | <b>EASY802-DC-SWD</b> |

### EASY806-DC-SWD



|        |   |                       |
|--------|---|-----------------------|
| 24 Vdc | Control relay with SmartWire-DT, four inputs, two of which can be used as outputs (transistor 24 Vdc, 0.1 A), easyNet onboard | <b>EASY806-DC-SWD</b> |
|--------|---|-----------------------|

## Remote Displays

Both the easy802 and easy806 controllers can be connected to a MFD remote display or a XV touch panel display with Galileo.

## Accessories

### MFD-80



#### Accessories—easy800

| Description                       | Catalog Number |
|-----------------------------------|----------------|
| MFD display, NEMA 4X indoor rated | <b>MFD-80</b>  |

### MFD-CP4



|  |                       |
|--|-----------------------|
| 24 Vdc power / communication module              | <b>MFD-CP4</b>        |
| easy802/806 to MFD-CP4 communication cable, 1.5m | <b>EU4A-RJ45-CAB2</b> |
| easy802/806 to XV HMI communication cable, 2m    | <b>EU4A-RJ45-CAB1</b> |

## Technical Data and Specifications

### easy802/806 Programmable Relays with SmartWire-DT

| Description  | Unit            | Specification                                      |
|--|-----------------|--|
| <b>Ambient Climatic Conditions</b>   |                 |  |
| Cold to IEC 60068-2-1, heat to IEC 60068-2-2, damp heat, constant, to IEC 60068-2-78; cyclical to IEC 60068-2-30; temperature change to IEC 68000-2-14 |                 |  |
| Operating ambient temperature  | °C (°F)         | –25 ° to +55 ° (–13 ° to +131 °)                   |
| Condensation   |                 | Prevent condensation by means of suitable measures |
| LCD display (reliable legible)   | °C (°F)         | 0 ° to +55 ° (32 ° to +131 °)                      |
| Storage  | °C (°F)         | –40 ° to +70 ° (–40 ° to +158 °)                   |
| Relative humidity, noncondensing (IEC EN 60068-2-30)   | %               | 5 to 95  |
| Air pressure (in operation)  | hPa             | 795 up to 1080                                     |
| <b>Ambient Mechanical Conditions</b>   |                 |  |
| Protection type EN 50178, IEC 60529, VBG4  |                 | IP20   |
| Vibrations (IEC EN 60068-2-6)  |                 |  |
| Constant amplitude: easy800-SWD; 3.5 mm  | Hz              | 5–8.4  |
| Constant acceleration: easy800-SWD; 1g   | Hz              | 8.4–150  |
| Mechanical shock resistance (IEC EN 60068-2-27) semi-sinusoidal 15g / 11 ms  | Shocks          | 18   |
| Drop (IEC EN 60068-2-31)   | Drop height     | mm 50  |
| Free fall, packaged (IEC EN 60068-2-32)  | m               | 0.3  |
| <b>Electromagnetic Compatibility (EMC)</b>   |                 |  |
| Electrostatic discharge (ESD), to IEC EN 61000-4-2   |                 |  |
| Air discharge  | kV              | 8  |
| Contact discharge  | kV              | 6  |
| Electromagnetic fields (RFI), to IEC EN 61000-4-3  |                 |  |
| 0.8–1.0 GHz  | V/m             | 10   |
| 1.4–2.0 GHz  | V/m             | 3  |
| 2.0–2.7 GHz  | V/m             | 1  |
| Radio interference suppression   |                 | EN 55011 Class B                                   |
| Burst, to IEC EN 61000-4-4   |                 |  |
| Supply cables  | kV              | 2  |
| Signal cables  | kV              | 2  |
| easyNet  | kV              | 2  |
| SWD-line   | kV              | 2  |
| Power pulses (surge), to IEC EN 61000-4-5 (supply cables, symmetrical)   | kV              | 1  |
| Radiated RFI, to IEC EN 61000-4-6  | V               | 10   |
| <b>Insulation Resistance</b>   |                 |  |
| Overvoltage category   |                 | III  |
| Pollution degree   |                 | 2  |
| Clearance in air and creepage distances  |                 | EN 50178, UL 508, CSA C22.2, No. 142               |
| Insulation resistance  |                 | EN 50178   |
| <b>Terminal Capacity</b>   |                 |  |
| Solid, minimum to maximum  | mm <sup>2</sup> | 0.2 to 1.5 (AWG 24–16)                             |
| Flexible with ferrule, minimum to maximum  | mm <sup>2</sup> | 0.2 to 1.5 (AWG 24–16)                             |
| <b>DC POW Rated Operational Voltage</b>  |                 |  |
| Rated value U <sub>e</sub>   | Vdc, (%)        | 24 DC (–15/+20)                                    |
| Permissible range ①  | Vdc             | 20.4–28.8  |
| Residual ripple  | %               | ≤ 5  |
| Protection against polarity reversal   |                 | Yes  |
| Input current  |                 |  |
| At rated operating voltage   | mA              | easy802: 500 / easy806: 900                        |
| Inrush current and duty factor   |                 | 12.5 A for 6 ms                                    |
| Voltage dips (IEC EN 61131-2)  | ms              | 10   |

#### Note

① Use power-feed modules if the cable length of the SWD line causes excessive voltage drop.



## easy802/806 Programmable Relays with SmartWire-DT, continued

| Description   | Unit     | Specification                      |
|---|----------|------------------------------------|
| Heat dissipation                                      |          |                                    |
| At 24 Vdc   | W        | easy802: max. 5 / easy806: max. 6  |
| Fuse  | A        | ≥ 3                                |
| Potential isolation (easy800-SWD)                     |          |                                    |
| To auxiliary ①  |          | Yes                                |
| To easyNet ①  |          | Yes                                |
| To serial interface                                   |          | Yes                                |
| To easyLink ①   |          | No                                 |
| To inputs ①   |          | No                                 |
| To outputs ①  |          | No                                 |
| To SWD ①  |          | No                                 |
| <b>DC AUX Rated Operational Voltage (easy800-SWD)</b> |          |                                    |
| Rated value $U_e$                                     | Vdc, (%) | 24 (-15/+20)                       |
| Permissible range $U_{AUX}$                           | Vdc      | 20.4–28.8                          |
| Residual ripple                                       | %        | ≤ 5                                |
| Input current ② (max.)                                | A        | 2 (UL) / 3 (CE)                    |
| Rated operational voltage of the 24 Vdc stations      | V        | $U_{AUX} - 0.3$ V                  |
| Protection against polarity reversal                  |          | Yes                                |
| Short-circuit strength                                |          | No                                 |
| Fuse  | A        | ≤ 2 (UL) external fuse with FAZ B2 |
| Heat dissipation                                      |          |                                    |
| At 24 Vdc   | W        | Normally 1                         |
| Potential isolation (easy800-SWD)                     |          |                                    |
| To POW power supply, inputs and outputs               |          | Yes                                |
| To PC interface (COM), easyNet                        |          | Yes                                |
| To SWD  |          | Yes                                |

**Notes**

① If present.

② If contactors with a higher total power consumption are connected, an EU5C-SWD-PF1 or EU5C-SWD-PF2 power-feed module must be used.

**Dimensions**

Approximate Dimensions in Inches (mm)

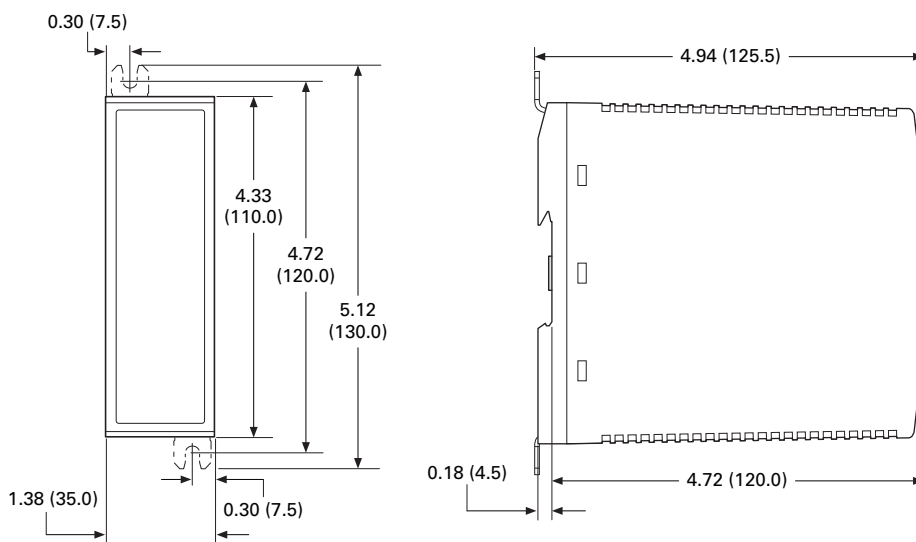
**easy802 and easy806 Controllers**

#### easyRelay Expansion Modules



#### Contents

| <i>Description</i>  | <i>Page</i>     |
|---|-----------------|
| easy500/700/800 Programmable Relays . . . . .                   | <b>V7-T3-20</b> |
| easy802/806 Programmable Relays<br>with SmartWire-DT . . . . .  | <b>V7-T3-26</b> |
| easyRelay and MFD Expansion Modules                             |                 |
| Product Selection . . . . .                                     | <b>V7-T3-31</b> |
| Technical Data and Specifications . . . . .                     | <b>V7-T3-31</b> |
| Dimensions . . . . .  | <b>V7-T3-32</b> |
| MFD-Titan Multi-Function Displays . . . . .                     | <b>V7-T3-33</b> |
| easyRelay Communication Modules . . . . .                       | <b>V7-T3-40</b> |
| easyRelay Power Supplies, Accessories<br>and Software . . . . . | <b>V7-T3-43</b> |

#### easyRelay and MFD Expansion Modules

##### Product Description

Expansion modules are available for increasing the input/output of the easy700/800 and MFD-Titan multi-function displays to 24 inputs and up to 16 outputs. Expansion modules can be mounted directly to the easy700 or easy800 relays or up to 98 ft (30m) away using coupling module EASY200-EASY.

##### Standards

- CSA C22.2 No. 142-M1987
- CSA C22.2 No. 213-M1987
- EN 55011
- EN 50178
- EN 61131-2
- IEC EN 61000-4
- IEC 60068-2-6
- IEC 60068-2-27
- UL 508

##### Certifications

- UL
- CSA
- CE
- CSA Class I, Div. 2, Groups A, B, C, D; Temp. Code T3C
- C-Tick
- GOST-R
- Ukrain-GOST



##### Shipping Approvals

- Bureau Veritas
- Det Norske Veritas
- Germanischer Lloyd
- Lloyd's Register of Shipping

## Product Selection

## EASY618\_



## Digital I/O Expansion Modules

Can be used via easyLink.

| Supply Voltage   | Digital Inputs | Outputs         |            | Catalog Number |
|--|----------------|-----------------|------------|----------------|
|  |                | Relay 10 A (UL) | Transistor |                |
| 100–240 Vac  | 12             | 6               | —          | EASY618-AC-RE  |
| 24 Vdc   | 12             | 6               | —          | EASY618-DC-RE  |
| 24 Vdc   | 12             | —               | 8          | EASY620-DC-TE  |
| 24 Vdc   | 6              | 4               | —          | EASY410-DC-RE  |
| 24 Vdc   | 6              | —               | 4          | EASY410-DC-TE  |
| 24 Vdc   | —              | 2               | —          | EASY202-RE     |
| For distributed connection of a digital input/output expansion at up to 98 ft (30m) distance |                |                 |            | EASY200-EASY   |

## EASY406\_



## Analog I/O Expansion Modules

Can be used via easyLink.

| Supply Voltage | Inputs          |                         | Digital Outputs |            | Analog Outputs | Catalog Number |
|----------------|-----------------|-------------------------|-----------------|------------|----------------|----------------|
|                | Digital/ Analog | Can Be Used for Digital | Relay 10 A (UL) | Transistor |                |                |
| 24 Vdc         | 1/2             | 2                       | —               | 2          | 1              | EASY406-DC-ME  |
| 24 Vdc         | 1/6             | 2                       | —               | 2          | 2              | EASY411-DC-ME  |

## Technical Data and Specifications

## easyRelay I/O Expansion Modules

| Type  | EASY202-RE   | EASY618-AC-RE                       | EASY618-DC-RE                       | EASY620-DC-TE                       | EASY200-EASY                        |
|---|--|-------------------------------------|-------------------------------------|-------------------------------------|-------------------------------------|
| Supply voltage                                  | —  | 100 – 240 Vac                       | 24 Vac                              | 24 Vac                              | —                                   |
| Heat dissipation                                | 1 W  | 10 VA                               | 4 W                                 | 4 W                                 | 1 W                                 |
| Continuous current outputs <sup>①</sup>         | 8 A  | 8 A                                 | 8 A                                 | 0.5 A                               | —                                   |
| Short-circuit proof with power factor 1         | Line protection<br>B16, 600 A                                      | Line protection<br>B16, 600 A       | Line protection<br>B16, 600 A       | Line protection<br>B16, 600 A       | —                                   |
| Short-circuit proof with power factor 0.7...0.7 | Line protection<br>B16, 900 A                                      | Line protection<br>B16, 900 A       | Line protection<br>B16, 900 A       | Line protection<br>B16, 900 A       | —                                   |
| Connection cables                               |  |                                     |                                     |                                     |                                     |
| Solid   | 0.2–4.0 mm <sup>2</sup> (AWG 22–12)                                | 0.2–4.0 mm <sup>2</sup> (AWG 22–12) | 0.2–4.0 mm <sup>2</sup> (AWG 22–12) | 0.2–4.0 mm <sup>2</sup> (AWG 22–12) | 0.2–4.0 mm <sup>2</sup> (AWG 22–12) |
| Flexible  | 0.2–2.5 mm <sup>2</sup> (AWG 22–12)                                | 0.2–2.5 mm <sup>2</sup> (AWG 22–12) | 0.2–2.5 mm <sup>2</sup> (AWG 22–12) | 0.2–2.5 mm <sup>2</sup> (AWG 22–12) | 0.2–2.5 mm <sup>2</sup> (AWG 22–12) |
| Degree of protection                            | IP20   | IP20                                | IP20                                | IP20                                | IP20                                |
| RFI suppression                                 | EN 55011, EN 55022 Class B, IEC 61000-6-1,2,3,4                    |                                     |                                     |                                     |                                     |
| Ambient operating temperature                   | –25 °C to +55 °C   | –25 °C to +55 °C                    | –25 °C to +55 °C                    | –25 °C to +55 °C                    | –25 °C to +55 °C                    |
| Transport and storage temperature               | –40 °C to +70 °C   | –40 °C to +70 °C                    | –40 °C to +70 °C                    | –40 °C to +70 °C                    | –40 °C to +70 °C                    |
| Certification, standards                        | EN 50178, IEC/EN 60947, UL, CSA                                    |                                     |                                     |                                     |                                     |
| Mounting  | On 35 mm DIN rail or screw mounting with ZB4-101-GF1 mounting feet |                                     |                                     |                                     |                                     |

# 3.3

## Control Relays and Timers

### Programmable Relays

#### Dimensions

Approximate Dimensions in Inches (mm)

#### easy600 Series, Drawing Number MD05013002E

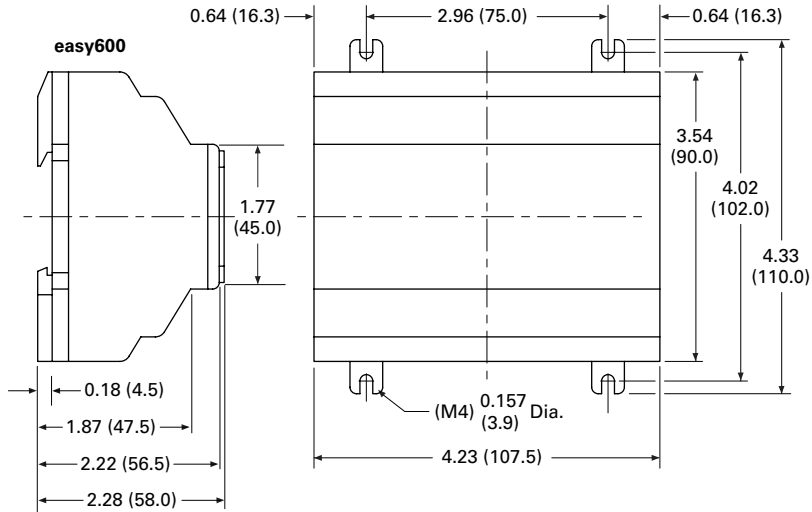

#### EASY202-RE/EASY200-EASY/EASY205-ASI Series, Drawing Number MD05013012E

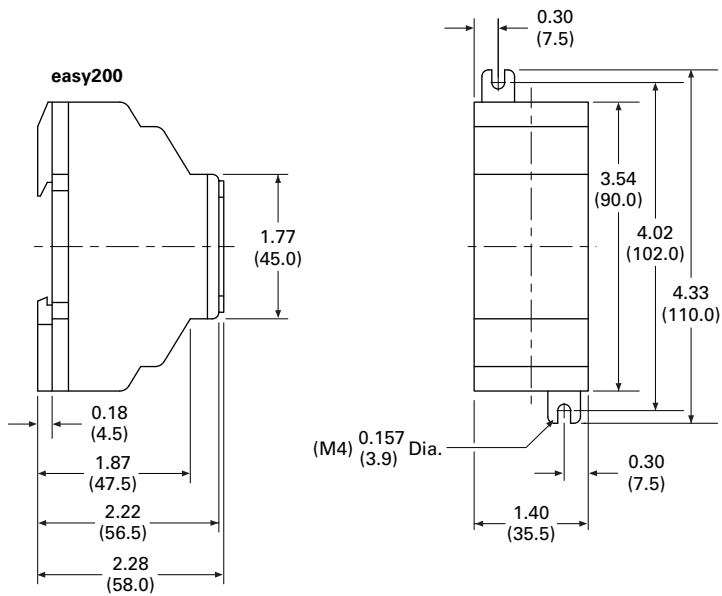

**MFD-Titan Multi-Function Displays****Contents**

| <b>Description</b>  | <b>Page</b>     |
|---|-----------------|
| easy500/700/800 Programmable Relays .....                   | <b>V7-T3-20</b> |
| easy802/806 Programmable Relays<br>with SmartWire-DT .....  | <b>V7-T3-26</b> |
| easyRelay and MFD Expansion Modules .....                   | <b>V7-T3-33</b> |
| MFD-Titan Multi-Function Displays                           |                 |
| System Overview .....                                       | <b>V7-T3-34</b> |
| Product Selection .....                                     | <b>V7-T3-35</b> |
| Accessories .....   | <b>V7-T3-36</b> |
| Technical Data and Specifications .....                     | <b>V7-T3-37</b> |
| Dimensions .....  | <b>V7-T3-38</b> |
| easyRelay Communication Modules .....                       | <b>V7-T3-40</b> |
| easyRelay Power Supplies, Accessories<br>and Software ..... | <b>V7-T3-43</b> |

**MFD-Titan Multi-Function Displays****Product Description**

The MFD-Titan multi-function displays can be used as remote text displays for easy500, easy700, easy800 and easy802/806 relays or can be configured as standalone or networked multi-function displays. As a multi-function display, the MFD-Titan combines the control functions of an easy800 with a door-mounted graphics display.

MFD-Titan multi-function display is comprised of three parts: display, controller and I/O modules. Match each piece to the needs of your application. If you need to both monitor and modify parameters within your application, choose the MFD-80-B display. The preprogrammed and user programmable buttons give you the capability to make small changes to the way your application is running, start or stop a process, or change your program completely. Select a controller with or without easyNet support, and with AC or DC power. Finally, add the MFD I/O module that best suits your application.

MFD-Titan—for controlling small applications that require graphic visualization and for large-scale applications with 20 points, expandable to 40 points locally, and expandable using the easyNet network up to 320 I/O points.

The MFD-Titan display can be linked to the easy500/700/800 models to provide an enhanced text based operator interface.

The easyNet integrated network provides easy and inexpensive linking of up to eight MFD-Titan devices over a distance of up to 1000 meters. Each MFD-Titan device can run its program, or be used as a distributed input/output module. Connect up to eight controllers with up to 40 I/O to obtain 320 I/O.

**Standards**

- CSA C22.2 No. 142-M1987
- CSA C22.2 No. 213-M1987
- EN 55011
- EN 50178
- EN 61131-2
- IEC EN 61000-4
- IEC 60068-2-6
- IEC 60068-2-27
- UL 508

**Certifications**

- UL
- CSA
- CE
- CSA Class I, Div. 2, Groups A, B, C, D; Temp. Code T3C
- C-Tick
- GOST-R
- Ukrain-GOST

**Shipping Approvals**

- Bureau Veritas
- Det Norske Veritas
- Germanischer Lloyd
- Lloyd's Register of Shipping

# 3.3

## Control Relays and Timers

### Programmable Relays

#### System Overview

#### MFD-Titan Multi-Function Display

3

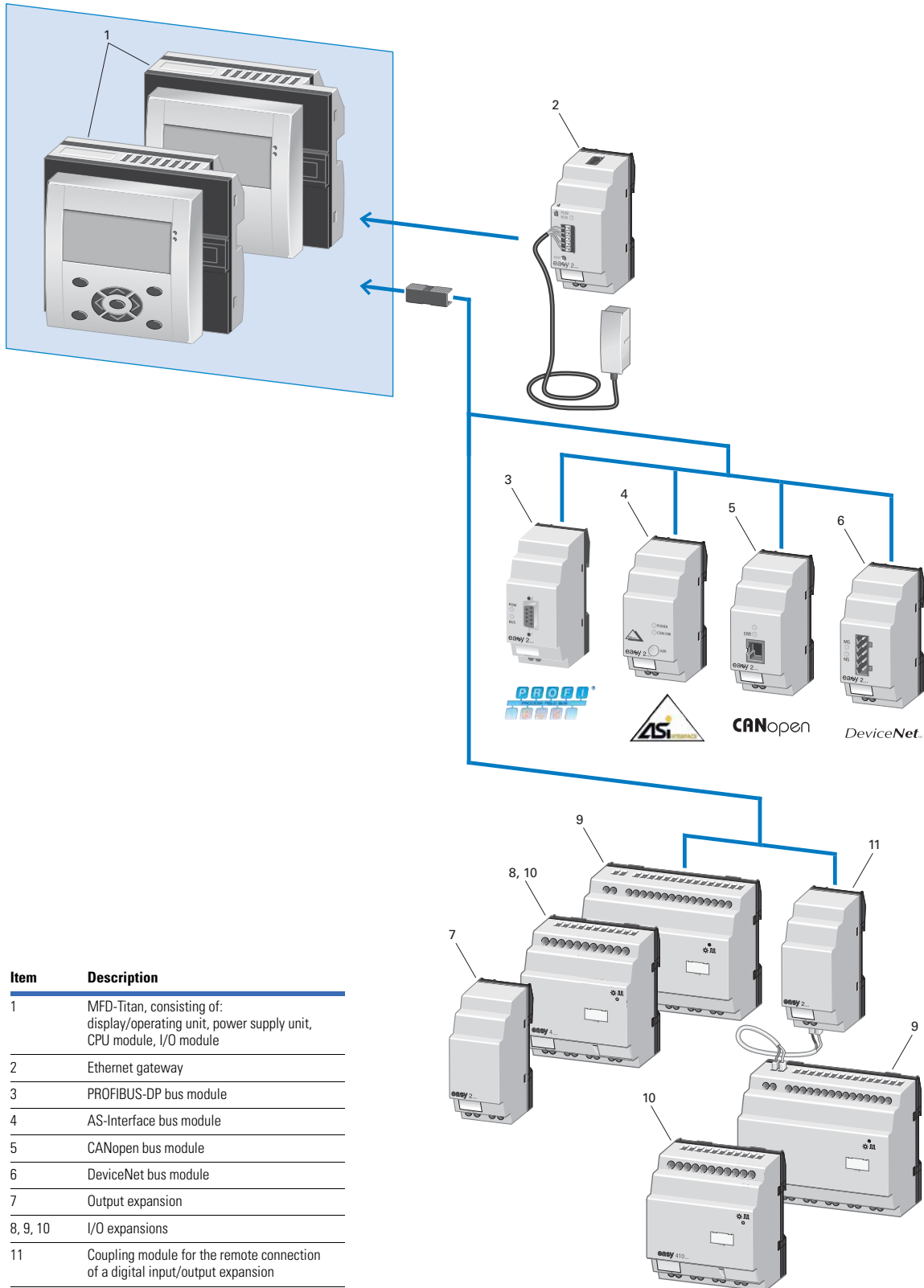

## Product Selection

## MFD-80-B



## MFD-Titan Display/Operator Units

Monochrome display 132 x 64 pixels with switchable backlight and removable front frame.

| Description                       | Keypad | Eaton Logo | Custom Engraving | Catalog Number         |
|-----------------------------------|--------|------------|------------------|------------------------|
| MFD display, NEMA 4X indoor rated | —      | —          | —                | <b>MFD-80-X</b>        |
| MFD display, NEMA 4X indoor rated | —      | ■          | —                | <b>MFD-80</b>          |
| MFD display, NEMA 4X indoor rated | —      | —          | ■                | <b>MFD-80-ETCH</b> ①   |
| MFD display with keypad ②         | ■      | —          | —                | <b>MFD-80-B-X</b>      |
| MFD display with keypad ②         | ■      | ■          | —                | <b>MFD-80-B</b>        |
| MFD display with keypad ②         | —      | —          | ■                | <b>MFD-80-B-ETCH</b> ① |

## MFD-CP4



## MFD-Titan Text/Graphics Display Power Module

For use with MFD-Titan displays for use as remote text/graphics display.

| Supply Voltage | Description   | Catalog Number        |
|----------------|---|-----------------------|
| 100–240 Vac    | AC power supply / communication module (no cable)           | <b>MFD-AC-CP4</b>     |
|                | AC module for easy500/700 relays and cable MFD-CP4-500-CAB5 | <b>MFD-AC-CP4-500</b> |
|                | AC module for easy800 relays and cable MFD-CP4-800-CAB5     | <b>MFD-AC-CP4-800</b> |
| 24 Vdc         | DC power supply / communication module (no cable)           | <b>MFD-CP4</b>        |
|                | DC module for easy500/700 relays and cable MFD-CP4-500-CAB5 | <b>MFD-CP4-500</b>    |
|                | DC module for easy800 relays and cable MFD-CP4-800-CAB5     | <b>MFD-CP4-800</b>    |

## MFD-CP



## MFD-Titan Controller Modules

For use with MFD-Titan display/operator units. Add MFD-Titan I/O modules as needed.

| Supply Voltage | Description   | Catalog Number       |
|----------------|---|----------------------|
| 100–240 Vac    | Program and screen memory                                   | <b>MFD-AC-CP8-ME</b> |
|                | Program and screen memory, with easyNet                     | <b>MFD-AC-CP8-NT</b> |
| 24 Vdc         | Program and screen memory                                   | <b>MFD-CP8-ME</b>    |
|                | Program and screen memory, with easyNet                     | <b>MFD-CP8-NT</b>    |
|                | Double program and screen memory (as MFD-CP8)               | <b>MFD-CP10-ME</b>   |
|                | Double program and screen memory (as MFD-CP8), with easyNet | <b>MFD-CP10-NT</b>   |

## Notes

- ① To order an MFD display with custom engraving, a marking file with the required text and/or graphics must be created as a Labeleditor ZIP file. The ZIP file has to be sent to the Eaton factory, and the name of the file must be referenced in the order notes section. To download the Labeleditor configuration software, please visit [www.eaton.com/software](http://www.eaton.com/software).
- ② To obtain a NEMA 4X indoor rating on MFD displays with keypads, use with a protective membrane cover MFD-XM-80.

#### MFD-R16



#### MFD-Titan I/O Modules

For use with MFD-Titan controller modules.

| Supply Voltage | Description | Inputs  |                     | Outputs |            |        | Catalog Number |
|----------------|-------------|---------|---------------------|---------|------------|--------|----------------|
|                |             | Digital | Analog <sup>①</sup> | Relay   | Transistor | Analog |                |
| 100–240 Vac    | 16 I/O      | 12      | —                   | 4       | —          | —      | MFD-AC-R16     |
|                |             | 12      | 4                   | 4       | —          | —      | MFD-R16        |
|                |             | 12      | 4                   | —       | 4          | —      | MFD-T16        |
| 24 Vdc         | 17 I/O      | 12      | 4                   | 4       | —          | 1      | MFD-RA17       |
|                |             | 12      | 4                   | —       | 4          | 1      | MFD-TA17       |

#### MFD-TP\_



#### MFD-Titan I/O Modules with Temperature Detection

For use with MFD-CP8\_ <sup>②</sup> and MFD-CP10\_ MFD-Titan controller modules.

| Supply Voltage | Inputs  |                        |       | Outputs         |            |        | Temperature Ranges                            | Catalog Number |
|----------------|---------|------------------------|-------|-----------------|------------|--------|---|----------------|
|                | Digital | Can Be Used For Analog | Pt100 | Relay 10 A (UL) | Transistor | Analog |   |                |
| 24 Vdc         | 6       | 2                      | 2     | —               | 4          | —      | –40 ° to +90 °C/0 ° to +250 °C/0 ° to +400 °C | MFD-TP12-PT-A  |
|                | 6       | 2                      | 2     | —               | 4          | —      | –200 ° to +200 °C/0 ° to +850 °C              | MFD-TP12-PT-B  |
|                | 6       | 2                      | —     | —               | 4          | —      | –40 ° to +90 °C/0 ° to +250 °C                | MFD-TP12-NI-A  |
|                | 6       | 2                      | 2     | —               | 4          | 1      | –40 ° to +90 °C/0 ° to +250 °C/0 ° to +400 °C | MFD-TAP13-PT-A |
|                | 6       | 2                      | 2     | —               | 4          | 1      | –200 ° to +200 °C/0 ° to +850 °C              | MFD-TAP13-PT-B |
|                | 6       | 2                      | —     | —               | 4          | 1      | –40 ° to +90 °C/0 ° to +250 °C                | MFD-TAP13-NI-A |

### Accessories

#### Miscellaneous Parts

| Description                                 | Catalog Number |
|---|----------------|
| MFD-Titan display protective membrane cover | MFD-XM-80      |
| MFD-Titan display protective plastic cover  | MFD-XS-80      |
| MFD-Titan display DIN rail mount kit        | MFD-TS-144     |

#### Notes

- ① Analog inputs optional. Use of analog inputs will result in a decrease in the same number of available digital inputs
- ② Version 8 and higher MFD-CP8\_ controllers are compatible with the temperature detection modules.



## Technical Data and Specifications

### MFD-80, MFD-CP4, MFD-CP8

| Type                              | MFD-80...  | MFD-CP4/CP8  |
|-----------------------------------|--|--|
| Connection cables                 |  |  |
| Solid                             | —  | 0.2–4.0 mm <sup>2</sup> (AWG 22–12)                    |
| Flexible                          | —  | 0.2–2.5 mm <sup>2</sup> (AWG 22–12)                    |
| Degree of protection              | IP65   | IP20   |
| RFI suppression                   | EN 55011, EN 55022 Class B, IEC 61000-6-1, 2, 3, 4     | EN 55011, EN 55022 Class B, IEC 61000-6-1, 2, 3, 4     |
| Ambient operating temperature     | Clearly legible at –5 °C to +50 °C                     | –25 °C to +55 °C                                       |
| Transport and storage temperature | –40 °C to +70 °C                                       | –40 °C to +70 °C                                       |
| Hazardous location                | CSA Class I, Div. 2, Groups A, B, C, D; Temp. Code T3C | CSA Class I, Div. 2, Groups A, B, C, D; Temp. Code T3C |

### MFD-Titan I/O Modules

| Type  | MFD-AC-R16                                      | MFD-R16                             | MFD-RA17                            | MFD-T16                             | MFD-TA17                            |
|---|---|-------------------------------------|-------------------------------------|-------------------------------------|-------------------------------------|
| Supply voltage                                  | Supply via MFD-CP8 module                       | Supply via MFD-CP8 module           | Supply via MFD-CP8 module           | Supply via MFD-CP8 module           | Supply via MFD-CP8 module           |
| Heat dissipation                                | 0.5 W   | 0.5 W                               | 0.5 W                               | 0.5 W                               | 0.5 W                               |
| Continuous current outputs <sup>①</sup>         | 8 A   | 8 A                                 | 8 A                                 | 0.5 A                               | 0.5 A                               |
| Short-circuit proof with power factor 1         | Line protection B16, 600 A                      | Line protection B16, 600 A          | Line protection B16, 600 A          | —                                   | —                                   |
| Short-circuit proof with power factor 0.7...0.7 | Line protection B16, 600 A                      | Line protection B16, 600 A          | Line protection B16, 600 A          | —                                   | —                                   |
| Connection cables                               |   |                                     |                                     |                                     |                                     |
| Solid   | 0.2–4.0 mm <sup>2</sup> (AWG 22–12)             | 0.2–4.0 mm <sup>2</sup> (AWG 22–12) | 0.2–4.0 mm <sup>2</sup> (AWG 22–12) | 0.2–4.0 mm <sup>2</sup> (AWG 22–12) | 0.2–4.0 mm <sup>2</sup> (AWG 22–12) |
| Flexible  | 0.2–2.5 mm <sup>2</sup> (AWG 22–12)             | 0.2–2.5 mm <sup>2</sup> (AWG 22–12) | 0.2–2.5 mm <sup>2</sup> (AWG 22–12) | 0.2–2.5 mm <sup>2</sup> (AWG 22–12) | 0.2–2.5 mm <sup>2</sup> (AWG 22–12) |
| Degree of protection                            | IP20  | IP20                                | IP20                                | IP20                                | IP20                                |
| RFI suppression                                 | EN 55011, EN 55022 Class B, IEC 61000-6-1,2,3,4 |                                     |                                     |                                     |                                     |
| Ambient operating temperature                   | –25 °C to +55 °C                                | –25 °C to +55 °C                    | –25 °C to +55 °C                    | –25 °C to +55 °C                    | –25 °C to +55 °C                    |
| Transport and storage temperature               | –40 °C to +70 °C                                | –40 °C to +70 °C                    | –40 °C to +70 °C                    | –40 °C to +70 °C                    | –40 °C to +70 °C                    |
| Mounting  | Snap fitted to MFD-CP8 module                   | Snap fitted to MFD-CP8 module       | Snap fitted to MFD-CP8 module       | Snap fitted to MFD-CP8 module       | Snap fitted to MFD-CP8 module       |

### MFD-CP4 and CP8 Communication Modules

| Type             | MFD-80...  | MFD-CP4-...           | MFD-CP8...  | MFD-AC-CP8... |
|------------------|--|-----------------------|---|---------------|
| Supply voltage   | Supply from -CP                                    | 24 Vdc                | 24 Vdc  | 100–240 Vac   |
| Heat dissipation | 3 W  | 1.5 W                 | 3 W   | 8 VA          |
| Mounting         | Front mounting in 2 x 22.5 mm Standard drill holes | Snap fitted to MFD-80 | Snap fitted to MFD-80 or on 35 mm DIN rail or screw mounting with ZB4-101-GF1 mounting feet |               |

#### Note

- <sup>①</sup> Relay = 8 A with resistive load, 3 A with inductive load.  
Transistor outputs = 0.5 A/24 Vdc, maximum four outputs switchable in parallel.

# 3.3

## Control Relays and Timers

### Programmable Relays

#### Dimensions

Approximate Dimensions in Inches (mm)

#### MFD-80 Series, Drawing Number MD05013005E

3

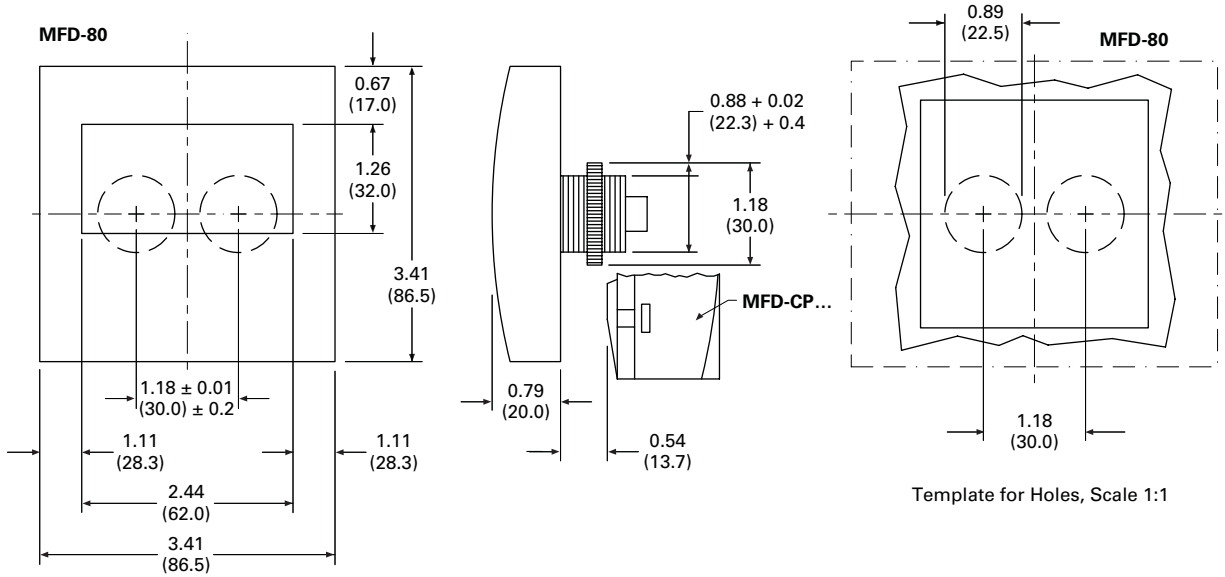

#### MFD-CP4, MFD-80 and MFD-CP4 Series Combined, Drawing Number MD013013E

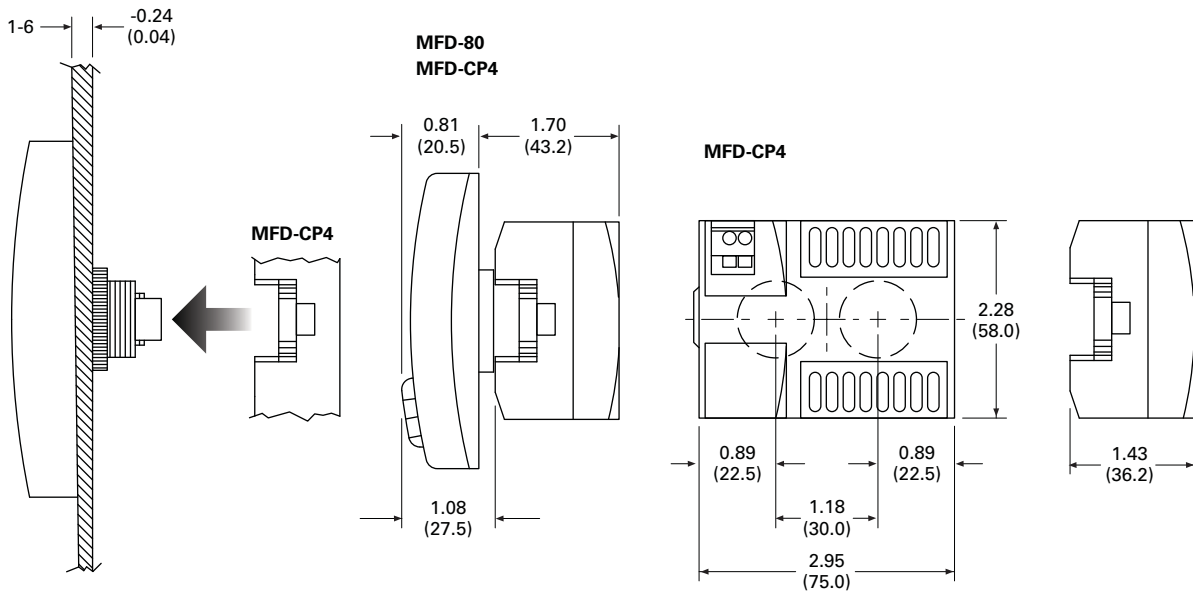

Approximate Dimensions in Inches (mm)

### MFD-CP8 Series, Drawing Number MD05013006E

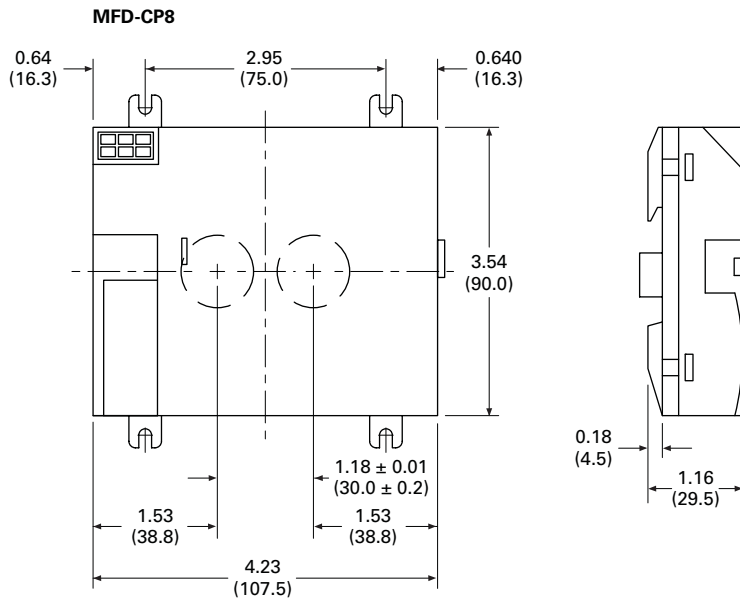

### MFD-R/MFD-T I/O Module, Drawing Number MD05013007E

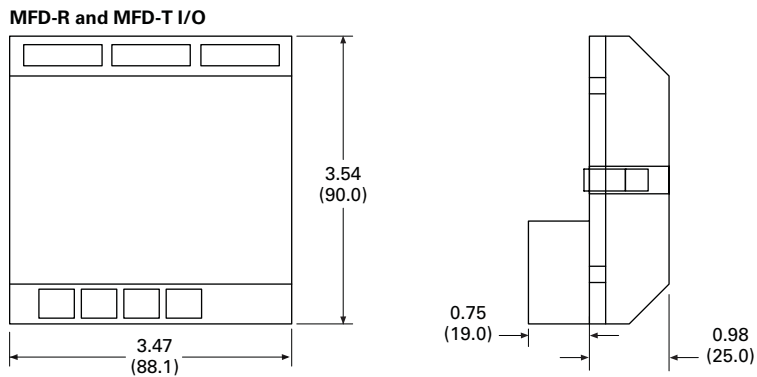

#### easyRelay Communication Modules



#### Contents

| <i>Description</i>  | <i>Page</i>     |
|---|-----------------|
| easy500/700/800 Programmable Relays . . . . .                   | <b>V7-T3-20</b> |
| easy802/806 Programmable Relays<br>with SmartWire-DT . . . . .  | <b>V7-T3-26</b> |
| easyRelay and MFD Expansion Modules . . . . .                   | <b>V7-T3-33</b> |
| MFD-Titan Multi-Function Displays . . . . .                     | <b>V7-T3-33</b> |
| easyRelay Communication Modules                                 |                 |
| Technical Data and Specifications . . . . .                     | <b>V7-T3-41</b> |
| Dimensions . . . . .  | <b>V7-T3-41</b> |
| easyRelay Power Supplies, Accessories<br>and Software . . . . . | <b>V7-T3-43</b> |

### easyRelay Communication Modules

#### Product Description

Four network modules are available for easily connecting to world-standard networks. The network modules can be used with the easy700/800 programmable relays and MFD-Titan multi-function displays.

Available communication modules support:

- DeviceNet
- PROFIBUS-DP
- AS-Interface
- CANopen

All modules operate exclusively as nodes on the given network.

#### Product Selection

The Ethernet gateway connects devices provided with an RS-232 serial interface with the Ethernet network. This gateway can be used with easy500 as well as easy700/800 relays and MFD-Titan displays.

#### EASY209-SE



#### Ethernet Gateway Module

| Description      |  | Catalog Number      |
|------------------|--|---------------------|
| Ethernet gateway | Serial interface easyRelay or MFD...CP8/CP10_ to Ethernet, for connecting to easyOPC server, easySoft or easyCom | <b>EASY209-SE</b> ① |

#### EASY204-DP



#### Network Interface Modules

| Description                                       |  | Catalog Number     |
|---|--|--------------------|
| DeviceNet interface module                        | Addresses available 0 to 63  | <b>EASY222-DN</b>  |
| PROFIBUS-DP interface module                      | Device addresses available 1 to 126  | <b>EASY204-DP</b>  |
| AS-Interface interface module with 4 in and 4 out | Device: 4 inputs, 4 outputs, 4 parameter bits<br>Addresses available 0 to 31 | <b>EASY205-ASI</b> |
| CANopen interface module                          | Addresses available 1 to 127   | <b>EASY221-CO</b>  |

#### Note

① To set up the Ethernet gateway, download the EASY209-SE configuration software at [www.eaton.com/easyrelays](http://www.eaton.com/easyrelays).

### Technical Data and Specifications

#### easy700/800/MFD Communication Interface Modules EASY204-DP, EASY205-ASI, EASY221-CO, EASY222-DN, EASY209-SE ①

| Description                       | Specification  |
|-----------------------------------|--|
| Supply voltage                    | 24 Vdc   |
| Heat dissipation ②                | 1 W  |
| Connection cables                 |  |
| Solid                             | 0.2–4.0 mm <sup>2</sup> (AWG 22–12)                                |
| Flexible                          | 0.2–2.5 mm <sup>2</sup> (AWG 22–12)                                |
| Degree of protection              | IP20   |
| RFI suppression                   | EN 55011, EN 55022 Class B, IEC 61000-6-1,2,3,4                    |
| Ambient operating temperature     | –25 °C to +55 °C   |
| Transport and storage temperature | –40 °C to +70 °C   |
| Certification, standards          | EN 50178, IEC/EN 60947, UL, CSA                                    |
| Mounting                          | On 35 mm DIN rail or screw mounting with ZB4-101-GF1 mounting feet |

#### Notes

- ① EASY209-SE is also compatible with easy500 programmable relays.
- ② EASY204-DP dissipates 2 W.

### Dimensions

Approximate Dimensions in Inches (mm)

#### EASY202-RE/EASY200-EASY/EASY205-ASI/ EASY209-SE Series, Drawing Number MD05013012E

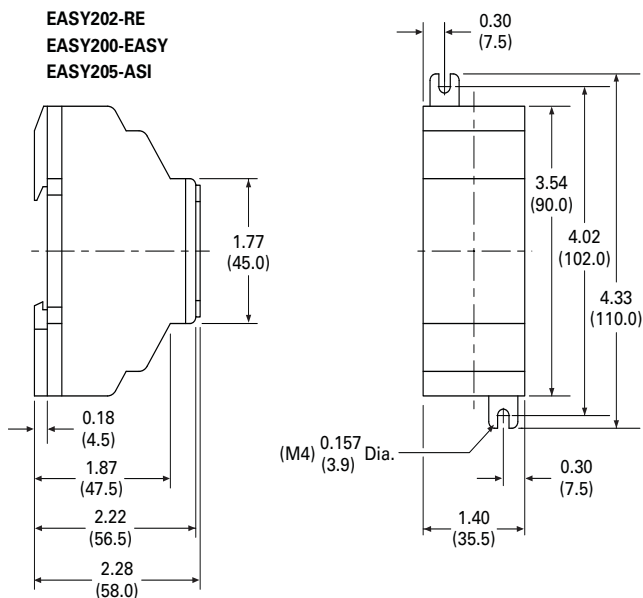

#### EASY221-CO/EASY222-DN Series, Drawing Number MD05013010E

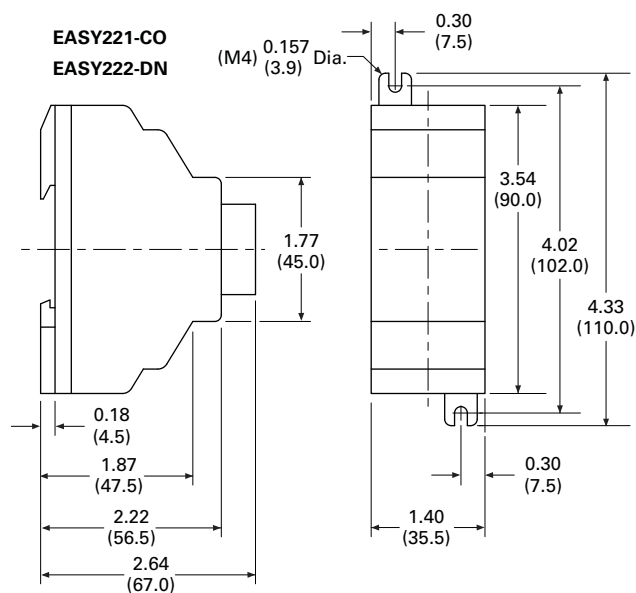

# 3.3

## Control Relays and Timers

### Programmable Relays

EASY204-DP Series,  
Drawing Number MD05013011E

3

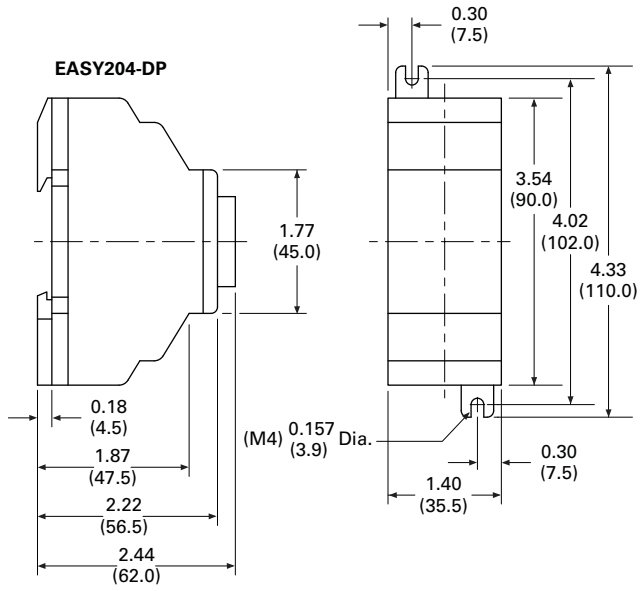

## easyRelay Power Supplies, Accessories and Software



## easyRelay Power Supplies, Accessories and Software

### Product Description

**Power Supplies**—12 Vdc and 24 Vdc power supplies for applications where only 100–240 Vac is available.

**Accessories**—Memory modules, cables and other components to complete your automation solutions.

**Software**—The easySoft software is used to program all of the easyRelays and MFD-Titan displays. The Windows®-based software provides straightforward circuit diagram input and editing and the diagrams can be displayed in the format desired. When easy800 and MFD-Titan controllers are connected using easyNet, all connected devices can be accessed and their programs loaded from a single controller.

easySoft includes an integrated offline simulation tool that allows users to test a circuit diagram before commissioning.

### Product Selection

Power supply units are primary switched-mode power supplies that are optimally suited for the easyRelay and easySafety product series in terms of functions and design. The new and high-performance power supply units support safe operation in plants and machines. They are simple and flexible in handling.

## Contents

| <i>Description</i>                                      | <i>Page</i>     |
|---|-----------------|
| easy500/700/800 Programmable Relays .....               | <b>V7-T3-20</b> |
| easy802/806 Programmable Relays with SmartWire-DT ..... | <b>V7-T3-26</b> |
| easyRelay and MFD Expansion Modules .....               | <b>V7-T3-30</b> |
| MFD-Titan Multi-Function Displays .....                 | <b>V7-T3-33</b> |
| easyRelay Communication Modules .....                   | <b>V7-T3-40</b> |
| easyRelay Power Supplies, Accessories and Software      |                 |
| Accessories .....                                       | <b>V7-T3-44</b> |
| Technical Data and Specifications .....                 | <b>V7-T3-46</b> |
| Wiring Diagram .....                                    | <b>V7-T3-46</b> |
| Dimensions .....  | <b>V7-T3-47</b> |

Fast diagnosis of the voltage output: continuous light on the LED—fault-free operation; flashing on the LED—short circuit or overload on voltage output.

- Suitable for worldwide use due to wide range input from 85 V to 264 Vac, 50/60 Hz
- Output voltages can be connected in parallel to increase power output or for redundant operation to achieve greater system availability
- Compliance with international standards and approvals

The primary switched-mode power supply units can be used everywhere:

- Safety extra low voltage (SELV to EN 60 950)
- Radio interference Class B to EN 55 011 and EN 55 022 for use in industrial and public networks

### EASY...-POW



### Power Supply Units

Rated input voltage 100–240 Vac, single-phase.

| Input Voltage Range | Rated Output Voltage | Output Voltage Setting Range | Rated Output Power | Rated Output Current | Catalog Number     |
|---------------------|----------------------|------------------------------|--------------------|----------------------|--------------------|
| 100–240 Vac         | 24 Vdc/12 Vdc        | —                            | 8 W                | 0.35 A/20 mA         | <b>EASY200-POW</b> |
|                     | 24 Vdc               | —                            | 30 W               | 1.25 A               | <b>EASY400-POW</b> |
|                     | 24 Vdc               | —                            | 60 W               | 2.5 A                | <b>EASY500-POW</b> |
|                     | 24 Vdc               | —                            | 100 W              | 4.2 A                | <b>EASY600-POW</b> |

#### Bluetooth Adapter

Conveniently commission and service machines and other equipment remotely.

- Simple communication with easy800 or MFD-Titan from outside loud and/or dangerous areas
- An 8-digit PIN security code prevents unauthorized remote access
- Simple recognition in Windows 7
- Full online functionality with easySoft-Pro V6.91 or higher
- Has all necessary radio type approvals for USA, Canada and Europe

#### EASY800-BLT-ADP



#### Bluetooth Adapter

| Description  | Catalog Number         |
|--|------------------------|
| easy800/MFD Bluetooth adapter  | <b>EASY800-BLT-ADP</b> |
| The Bluetooth adapter provides wireless connectivity to easySoft-Pro for easy programming download and upload. Use it with the easyRemote Display Android App for simple and fast access to your easy800 relays up to a distance of 10 meters. |                        |

#### Accessories

##### easySoft



#### Programming Software

| Description  | Catalog Number         |
|--|------------------------|
| Programming software for easy500/700   | <b>EASY-SOFT-BASIC</b> |
| Programming software for easy800, easy 802/806 and MFD-Titan includes SWD-Assist for configuration of the SmartWire-DT network | <b>EASY-SOFT-PRO</b>   |

#### EASY-USB-CAB



#### Programming Cables

| Description                                 | Catalog Number            |
|---|---------------------------|
| easy500/700 to PC programming cable—USB     | <b>EASY-USB-CAB</b>       |
| easy500/700 to PC programming cable—RS-232  | <b>EASY-PC-CAB</b>        |
| easy800/MFD to PC programming cable—RS-232  | <b>EASY800-PC-CAB</b>     |
| easy800/MFD to PC programming cable—USB     | <b>EASY800-USB-CAB</b>    |
| easy802/806 to PC programming cable—USB, 2m | <b>EU4A-RJ45-USB-CAB1</b> |

#### MFD-CP4-800-CAB5



#### Cables and Connectors

| Description   | Catalog Number          |
|---|-------------------------|
| easy500/700 to MFD-CP4 communication cable, 5m                                | <b>MFD-CP4-500-CAB5</b> |
| easy800 to MFD-CP4 communication cable, 5m                                    | <b>MFD-CP4-800-CAB5</b> |
| easy800 to MFD-CP8 communication cable, 2m                                    | <b>MFD-800-CAB</b>      |
| easy800 to MFD-CP8 communication cable, 5m                                    | <b>MFD-800-CAB5</b>     |
| easy800 modem, printer, programming cable                                     | <b>EASY800-MO-CAB</b>   |
| easy802/806 to MFD-CP4 communication cable, 1.5m                              | <b>EU4A-RJ45-CAB2</b>   |
| easy802/806 to XV HMI communication cable, 2m                                 | <b>EU4A-RJ45-CAB1</b>   |
| easy800/MFD easyNet cable, 0.3m networking cable                              | <b>EASY-NT-30</b>       |
| easy800/MFD easyNet cable, 0.8m networking cable                              | <b>EASY-NT-80</b>       |
| easy800/MFD easyNet cable, 1.5m networking cable                              | <b>EASY-NT-150</b>      |
| easy800/MFD easyNet cable (cable only, no connectors, see EASY-NT-RJ45), 100m | <b>EASY-NT-CAB</b>      |
| RJ45 network connectors for easyNet cable (EASY-NT-CAB), 10/pack              | <b>EASY-NT-RJ45</b>     |
| easy800/MFD network termination resistor, 2/pack                              | <b>EASY-NT-R</b>        |

#### EASY800-MO-CAB





**EASY-M-32K****EASY-M-256K****Memory Storage Modules**

| Description                            | Catalog Number     |
|--|--------------------|
| easy500/700 32K memory storage module  | <b>EASY-M-32K</b>  |
| easy800/MFD 256K memory storage module | <b>EASY-M-256K</b> |
| easy800/MFD 512K memory storage module | <b>EASY-M-512K</b> |

**Panel Window****Mounting Kit****Simulator****Miscellaneous Parts**

| Description  | Catalog Number           |
|--|--------------------------|
| easy500 panel window   | <b>SKF-FF4</b>           |
| easy700/800 panel window                                       | <b>SKF-FF6</b>           |
| easy500/700/800 panel window mounting kit to front mount units | <b>SKF-HA</b>            |
| High current input adapter, six-channel                        | <b>EASY256-HCI</b>       |
| Base to expander, interface connector                          | <b>EASY-LINK-DS</b>      |
| easy500 relay simulator  | <b>EASY412-DC-SIM-NA</b> |
| Mounting feet, 9/pack  | <b>ZB4-101-GF1</b>       |
| Grounding kit  | <b>ZB4-102-KS1</b>       |

#### Technical Data and Specifications

##### easyRelay Power Supplies

| Type                              | EASY200-POW  | EASY400-POW  |
|-----------------------------------|--|--|
| Supply voltage                    | 100–240 Vac  | 100–240 Vac  |
| Maximum range                     | 85–264 Vac   | 85–264 Vac   |
| Output voltage                    | 24 Vdc (±3%)   | 24 Vdc (±3%)                                       |
| Output current (rated value)      | 0.25 A   | 1.25 A   |
| Overcurrent limitation form       | 0.3 A  | 1.4 A  |
| Short-circuit proof (secondary)   | Yes  | Yes  |
| Overload proof                    | Yes  | Yes  |
| Potential isolation (prim./sec.)  | Yes, SELV, (to EN 600950, VDE 805)                                 | Yes, SELV, (to EN 600950, VDE 805)                 |
| Others                            | Additional output voltage 12 DC, 20 mA                             | Additional output voltage 12 DC, 20 mA             |
| Connection cables                 |  |  |
| Solid                             | 0.2–4.0 mm <sup>2</sup> (AWG 22–12)                                | 0.2–4.0 mm <sup>2</sup> (AWG 22–12)                |
| Flexible                          | 0.2–2.5 mm <sup>2</sup> (AWG 22–12)                                | 0.2–2.5 mm <sup>2</sup> (AWG 22–12)                |
| Degree of protection              | IP20   | IP20   |
| RFI suppression                   | EN 55011, EN 55022 Class B, IEC 61000-6-1, 2, 3, 4                 | EN 55011, EN 55022 Class B, IEC 61000-6-1, 2, 3, 4 |
| Ambient operating temperature     | –25 °C to +55 °C   | –25 °C to +55 °C                                   |
| Transport and storage temperature | –40 °C to +70 °C   | –40 °C to +70 °C                                   |
| Mounting                          | On 35 mm DIN rail or screw mounting with ZB4-101-GF1 mounting feet |  |

#### Wiring Diagram

##### EASY256-HCI

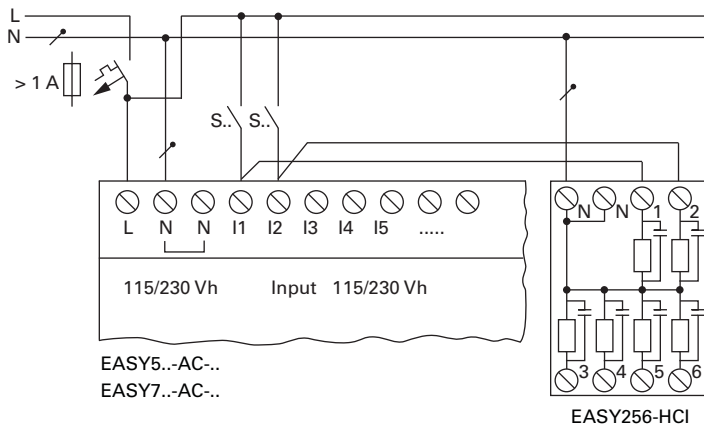

### Dimensions

Approximate Dimensions in Inches (mm)

#### EASY200-POW/EASY256-HCI and EASY400-POW Series, Drawing Number MD05013004E

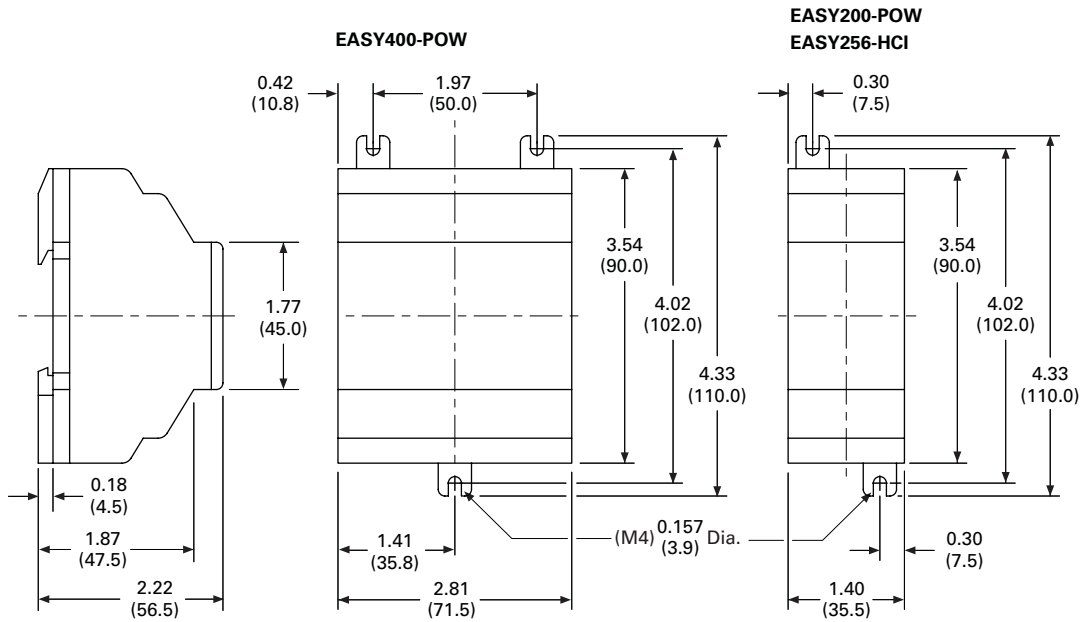

#### MFD-XS-80 and MFD-XM-80 Series, Drawing Number MD05013009E

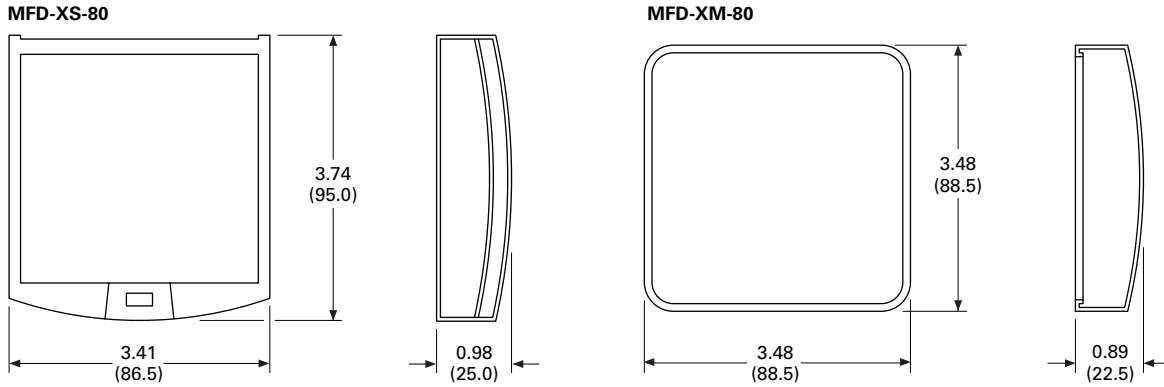

#### SKF-FF4 and SKF-FF6 Series, Drawing Number MD05013014E

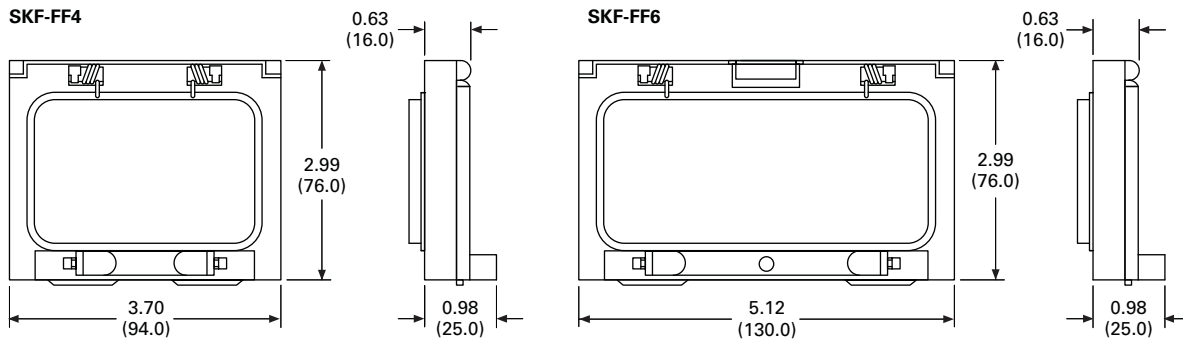

# 3.3

## Control Relays and Timers

### Programmable Relays

Approximate Dimensions in Inches (mm)

#### SKF-HA Series, Drawing Number MD05013015E

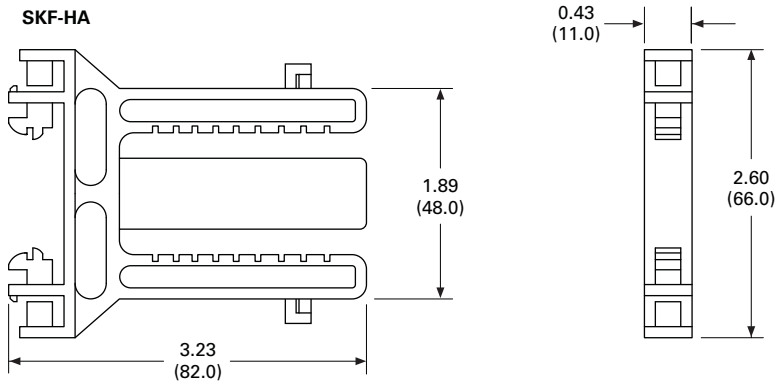

#### ZB4-101-GF1 Mounting Feet

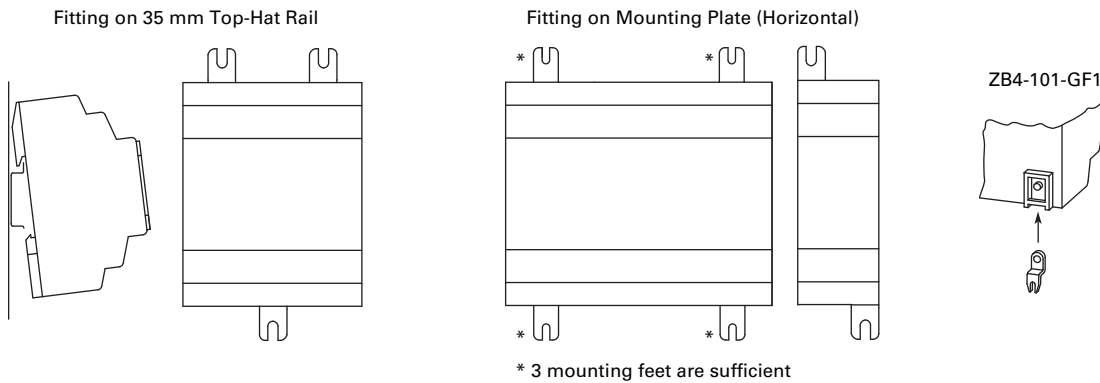

#### ZB4-102-KS1 Series— Grounding the Screen for Top-Hat Rail

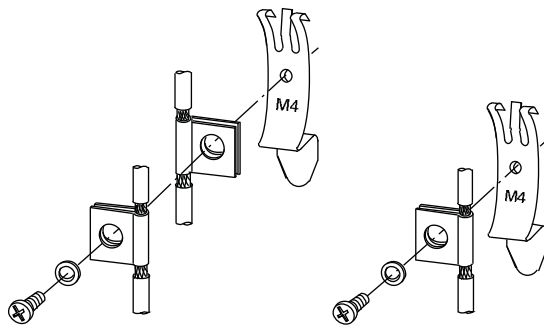

#### ZB4-102-KS1 Series— Grounding the Screen for Mounting Plate

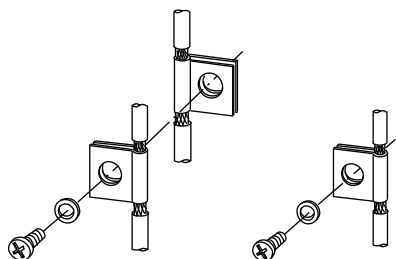

#### EASY412-DC-SIM-NA Series

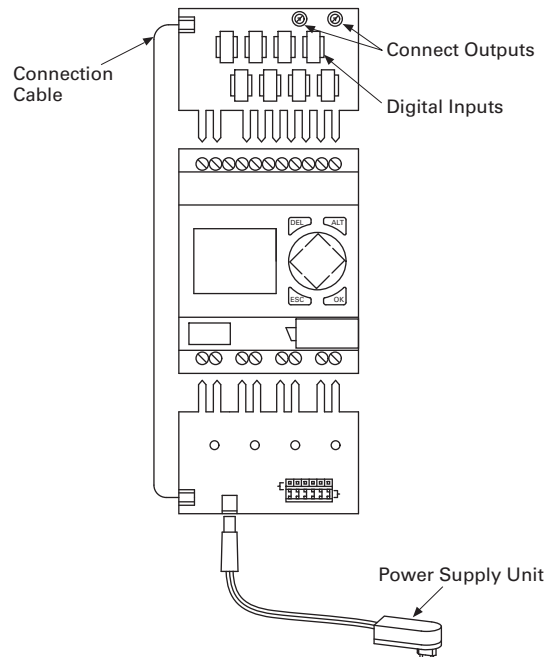

## General Purpose Plug-In Relay



## Contents

| <i>Description</i>         | <i>Page</i> |
|----------------------------|-------------|
| D1RR/D1RF Series . . . . . | V7-T3-53    |
| D2RR/D2RF Series . . . . . | V7-T3-57    |
| D3RR/D3RF Series . . . . . | V7-T3-67    |
| D4 Series . . . . .        | V7-T3-76    |
| D5RR/D5RF Series . . . . . | V7-T3-80    |
| D7PR/D7PF Series . . . . . | V7-T3-89    |
| D8 Series . . . . .        | V7-T3-103   |
| D9 Series . . . . .        | V7-T3-108   |
| Accessories . . . . .      | V7-T3-112   |

## Product Selection Guide

## General Purpose Relay Selection Characteristics

- Current rating: 1 A–30 A
- Contact arrangement: SPDT, DPDT, 3PDT, 4PDT, etc.
- Coil voltage: 6 V–240 Vac/ 6 V–110 Vdc
- Mounting options: socket, flange, DIN rail, panel
- Specifications: CSA, CE, IEC, NEMA, UL, etc.
- Other: physical dimensions, maximum voltage, mechanical/ electrical life, etc.

# 3.4

## Control Relays and Timers

### General Purpose Plug-In Relays

3

#### General Purpose Plug-In Relays

Relay Series

D1RR/D1RF

D2RR/D2RF

D3RR/D3RF



#### Approvals



**Note:** UL when used with the appropriate socket.



**Note:** UL when used with the appropriate socket.



**Note:** UL when used with the appropriate socket.

#### Features

|   |   |   |
|---|---|---|
| Polycarbonate cover                     | Polycarbonate cover                     | Polycarbonate cover                     |
| Indicator lamp and pushbutton available | Indicator lamp and pushbutton available | Indicator lamp and pushbutton available |
| Panel and DIN mounting                  | Panel, DIN and flange mounting          | Panel and DIN mounting                  |
|   | Latching                                |   |

#### Contact Data

| Configuration                     | SPDT         | DPDT         | 4PDT | DPDT         | 3PDT |
|-----------------------------------|--------------|--------------|------|--------------|------|
| Max. allowable load               | 15 A         | 12 A         | 6 A  | 10 A         | 10 A |
| Material                          | Silver alloy | Silver alloy |      | Silver alloy |      |
| Dielectric strength between poles | 1500 V       | 1500 V       |      | 1500 V       |      |

#### Coil Data

|             |              |              |                            |
|-------------|--------------|--------------|----------------------------|
| AC          | 6 to 240 Vac | 6 to 240 Vac | 6 to 240 Vac               |
| DC          | 6 to 110 Vdc | 6 to 110 Vdc | 6 to 110 Vdc               |
| Power       |              |              |                            |
| VA (Vac)    | 0.9 VA       | 1.2 VA       | 3 VA 1.4 W (D3RR and D3RF) |
| Watts (Vdc) | 0.7 W        | 0.9 W        | —                          |

#### General Data

|                       |                                      |                                      |                                      |
|-----------------------|--------------------------------------|--------------------------------------|--------------------------------------|
| Ambient temperature   |                                      |                                      |                                      |
| Storage               | −40 °F to +185 °F (−40 °C to +85 °C) | −40 °F to +185 °F (−40 °C to +85 °C) | −40 °F to +185 °F (−40 °C to +85 °C) |
| Operational           | −40 °F to +131 °F (−40 °C to +55 °C) | −40 °F to +131 °F (−40 °C to +55 °C) | −40 °F to +131 °F (−40 °C to +55 °C) |
| Response time         | 20 milliseconds                      | 20 milliseconds                      | 20 milliseconds                      |
| Life                  |                                      |                                      |                                      |
| Mechanical operations | 10 million                           | 10 million                           | 5 million (D3RR and D3RF)            |
| Electrical operations | 100,000                              | 200,000                              | 100,000                              |
| Page Numbers          | V7-T3-53 to V7-T3-56                 | V7-T3-57 to V7-T3-66                 | V7-T3-67 to V7-T3-75                 |

## General Purpose Plug-In Relays, continued

## Relay Series

D4



D5RR/D5RF



D7PR/D7PF



## Approvals



Note: UL when used with the appropriate socket.

Note: UL when used with the appropriate socket.

## Features

Polycarbonate cover

Polycarbonate cover

Polycarbonate cover

Indicator lamp available

Indicator lamp and pushbutton available

Indicator lamp and pushbutton available

Panel and DIN mounting

Panel, DIN and flange mounting

Panel and DIN mounting

Socket has built-in hold-down spring

## Contact Data

| Configuration       | SPDT            | DPDT           | DPDT         | 3PDT | DPDT         | 3PDT   | 4PDT   |
|---------------------|-----------------|----------------|--------------|------|--------------|--------|--------|
| Max. allowable load | 10 A at 250 Vac | 5 A at 240 Vac | 10 A         | 10 A | 15 A         | 15 A   | 15 A   |
| Material            | AgCdO           |                | Silver alloy |      | Silver alloy |        |        |
| Dielectric strength | 5000 V          |                | 1500 V       |      | 1500 V       | 2500 V | 2500 V |

## Coil Data

|             |              |  |              |  |              |        |        |
|-------------|--------------|--|--------------|--|--------------|--------|--------|
| AC          | 6 to 240 Vac |  | 6 to 240 Vac |  | 6 to 240 Vac |        |        |
| DC          | 6 to 110 Vdc |  | 6 to 110 Vdc |  | 6 to 110 Vdc |        |        |
| Power       |              |  |              |  |              |        |        |
| VA (Vac)    | 0.9 VA       |  | 3 VA         |  | 1.2 VA       | 1.5 VA | 1.5 VA |
| Watts (Vdc) | 0.5 W        |  | 1.4 W        |  | 0.9 W        | 1.4 W  | 1.5 W  |

## General Data

|                       |                                      |  |                                      |  |  |         |         |
|-----------------------|--------------------------------------|--|--------------------------------------|--|--|---------|---------|
| Ambient temperature   |                                      |  |                                      |  |  |         |         |
| Storage               | −40 °F to +158 °F (−40 °C to +70 °C) |  | −40 °F to +185 °F (−40 °C to +85 °C) |  | −40 °F to +185 °F (−40 °C to +85 °C)           |         |         |
| Operational           | −40 °F to +158 °F (−40 °C to +70 °C) |  | −40 °F to +131 °F (−40 °C to +55 °C) |  | −40 °F to +131 °F (−40 °C to +55 °C)           |         |         |
| Response time         | 15 milliseconds                      |  | 20 milliseconds                      |  | 20 milliseconds (30 milliseconds for latching) |         |         |
| Life                  |                                      |  |                                      |  |  |         |         |
| Mechanical operations | 10 million                           |  | 5 million                            |  | 10 million                                     |         |         |
| Electrical operations | 100,000                              |  | 100,000                              |  | 100,000  | 200,000 | 200,000 |

|              |                      |                      |                       |
|--------------|----------------------|----------------------|-----------------------|
| Page Numbers | V7-T3-76 to V7-T3-79 | V7-T3-80 to V7-T3-88 | V7-T3-89 to V7-T3-102 |
|--------------|----------------------|----------------------|-----------------------|

# 3.4

## Control Relays and Timers

### General Purpose Plug-In Relays

3

#### General Purpose Plug-In Relays, continued

Relay Series

D8

D9



#### Approvals



#### Features

Dust cover

Dust cover

Panel, DIN and flange mounting

Pushbutton available

Quick-connect and screw terminals

Panel mounting

Screw terminals

#### Contact Data

Configuration

4PST

SPST-NO

DPST-NO

NO

NC

Max. allowable load

30 A at  
220 Vac

25 A at  
220 Vac

25 A at  
220 Vac

8 A at  
220 Vac

Material

AgCdO

AgCdO

Dielectric strength

4000 V

4000 V

#### Coil Data

AC

6 to 240 Vac

24 to 240 Vac

DC

12 to 24 Vdc

12 to 110 Vdc

Power

VA (Vac)

2.5 VA

2.6 VA

Watts (Vdc)

1.9 W

2.0 W

#### General Data

Ambient temperature

Storage

-4 °F to +185 °F (-20 °C to +85 °C)

-13 °F to +140 °F (-25 °C to +60 °C)

Operational

-4 °F to +131 °F (-20 °C to +55 °C)

-13 °F to +140 °F (-25 °C to +60 °C)

Response time

30 milliseconds

50 milliseconds

Life

Mechanical operations

5 million

1 million

Electrical operations

100,000

100,000

Page Numbers

V7-T3-103 to V7-T3-107

V7-T3-108 to V7-T3-111



### D1 Series Relay



## D1RR/D1RF Series

### Product Description

The D1 Series of relay provides a compact single-pole relay capable of handling 15 A. Multiple feature and voltage options allow for the perfect fit for any application.

### Features

#### D1RR

- Compact relay capable of breaking relatively large load currents
- Panel and DIN rail mounting

#### D1RF

- The contact operation can be easily checked by Push-to-Test button
- Flag indicator shows relay status in manual or powered condition
- LED status lamp shows coil ON or OFF status—ideal for use in low light applications
- Push-to-Test button allows for manual operation of relay without the need for coil power
- Lock-down door holds pushbutton and contacts in the operate position when activated
- Finger-grip cover allows operator to remove relays from sockets easily
- ID tag/write label to identify relays in multiple-relay circuits
- Bipolar LED allows for reverse polarity applications

## Contents

### Description

|   | <i>Page</i>      |
|---|------------------|
| D1RR/D1RF Series                            |                  |
| Product Selection . . . . .                 | <b>V7-T3-54</b>  |
| Accessories . . . . .                       | <b>V7-T3-54</b>  |
| Technical Data and Specifications . . . . . | <b>V7-T3-55</b>  |
| Wiring Diagram . . . . .                    | <b>V7-T3-56</b>  |
| Dimensions . . . . .                        | <b>V7-T3-56</b>  |
| D2RR/D2RF Series . . . . .                  | <b>V7-T3-57</b>  |
| D3RR/D3RF Series . . . . .                  | <b>V7-T3-67</b>  |
| D4 Series . . . . .                         | <b>V7-T3-76</b>  |
| D5RR/D5RF Series . . . . .                  | <b>V7-T3-80</b>  |
| D7PR/D7PF Series . . . . .                  | <b>V7-T3-89</b>  |
| D8 Series . . . . .                         | <b>V7-T3-103</b> |
| D9 Series . . . . .                         | <b>V7-T3-108</b> |
| Accessories . . . . .                       | <b>V7-T3-112</b> |

### Standards and Certifications



When used with accompanying Eaton screw terminal socket.

### Catalog Number Selection

#### D1RF/D1RR Series

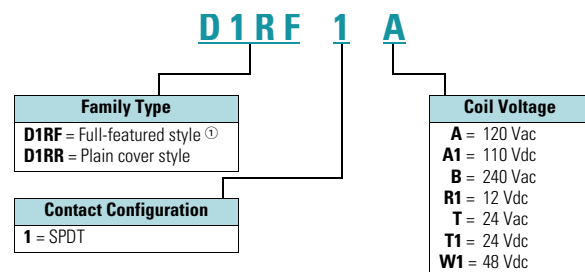

#### Note

① Full-featured, LED test button, flag indicator, lock-down door, finger-grip cover, ID tag.

# 3.4

## Control Relays and Timers

### General Purpose Plug-In Relays

3

#### Product Selection

#### D1RR/D1RF Relay/Socket Quick Reference

| Relay Type | Socket | Clip     | Module Type | ID Tag | Jumper |
|------------|--------|----------|-------------|--------|--------|
| D1RR1      | D1PAA  | PMC-1781 | B           | —      | —      |
| D1RF1      | D1PAA  | PMC-1781 | B           | —      | —      |

#### D1RF Series Relay



#### D1RR/D1RF Series

| Coil Voltage         | Contact Configuration | Coil Resistance (Ohms) | Catalog Number |
|----------------------|-----------------------|------------------------|----------------|
| <b>Full Featured</b> |                       |                        |                |
| 12 Vdc               | SPDT                  | 188                    | <b>D1RF1R1</b> |
| 24 Vac 50/60 Hz      | SPDT                  | 180                    | <b>D1RF1T</b>  |
| 24 Vdc               | SPDT                  | 750                    | <b>D1RF1T1</b> |
| 110 Vdc              | SPDT                  | 13,800                 | <b>D1RF1A1</b> |
| 120 Vac 50/60 Hz     | SPDT                  | 4430                   | <b>D1RF1A</b>  |
| 240 Vac 50/60 Hz     | SPDT                  | 15,720                 | <b>D1RF1B</b>  |
| <b>Plain Cover</b>   |                       |                        |                |
| 12 Vdc               | SPDT                  | 188                    | <b>D1RR1R1</b> |
| 24 Vdc               | SPDT                  | 750                    | <b>D1RR1T1</b> |
| 48 Vdc               | SPDT                  | 2600                   | <b>D1RR1W1</b> |
| 110 Vdc              | SPDT                  | 13,800                 | <b>D1RR1A1</b> |
| 120 Vac 50/60 Hz     | SPDT                  | 4430                   | <b>D1RR1A</b>  |
| 240 Vac              | SPDT                  | 15,270                 | <b>D1RR1B</b>  |

#### Accessories

#### D1RR/D1RF Sockets and Accessories

| Type                      | Module Size | Nominal Voltage (Max. for Sockets) | Nominal Current | Mounting Style | Wire Size                                  | Wire Connection | Standard Pack | Catalog Number    |
|---------------------------|-------------|------------------------------------|-----------------|----------------|--|-----------------|---------------|-------------------|
| Socket                    | B           | 300                                | 20              | Panel/DIN rail | 12 /14 (2) AWG, 4 /2.5 (2) mm <sup>2</sup> | Screw clamping  | 10            | <b>D1RAA</b> ①    |
| Flange mount adapter      | —           | —                                  | —               | Flange         | —  | —               | 25            | <b>PFC-D11</b>    |
| Metal spring clip         | —           | —                                  | —               | —              | —  | —               | 25            | <b>PMC-1781</b>   |
| Protection diode          | B           | 6 to 250 Vdc                       | —               | —              | —  | —               | 20            | <b>MOD-BD250</b>  |
| LED indicator             | B           | 24 Vac/Vdc                         | —               | —              | —  | —               | 20            | <b>MOD-BLG24</b>  |
|                           | B           | 120/240 Vac/Vdc                    | —               | —              | —  | —               | 20            | <b>MOD-BLG240</b> |
| MOV suppressor            | B           | 120 Vac/Vdc                        | —               | —              | —  | —               | 20            | <b>MOD-BMV120</b> |
|                           | B           | 24 Vac/Vdc                         | —               | —              | —  | —               | 20            | <b>MOD-BMV24</b>  |
|                           | B           | 240 Vac/Vdc                        | —               | —              | —  | —               | 20            | <b>MOD-BMV240</b> |
| Plastic DIN rail end stop | —           | —                                  | —               | —              | —  | —               | 25            | <b>PPF-P</b>      |

#### Note

① Protection Category (Finger Safe), EN 60529: IP20.

**Technical Data and Specifications****D1RF/D1RR Relay Specifications**

| Description  | D1RR                                     | D1RF  |
|--|--|---|
| <b>Contact Characteristics</b>                       |  |   |
| Contact rating                                       | 15 A                                     | 15 A  |
| Terminal style                                       | Plug-in                                  | Plug-in   |
| Contact materials                                    | Silver alloy                             | Silver alloy  |
| Maximum switching voltage                            | 300 V                                    | 300 V   |
| Switching current at voltage—resistive               | 20 A at 120 Vac 50/60 Hz                 | 20 A at 120 Vac 50/60 Hz  |
|  | 20 A at 277 Vac 50/60 Hz                 | 20 A at 277 Vac 50/60 Hz  |
|  | 20 A at 28 Vdc                           | 20 A at 28 Vdc  |
| Switching current at voltage                         | 1/2 hp at 120 Vac                        | 1/2 hp at 120 Vac   |
|  | 1 hp at 277 Vac                          | 1 hp at 277 Vac   |
| Pilot duty   | B300                                     | B300  |
| Minimum switching requirement                        | 100 mA at 5 Vdc (0.5 W)                  | 100 mA at 5 Vdc (0.5 W)   |
| <b>Coil Characteristics</b>                          |  |   |
| Operating range                                      |  |   |
| % of nominal (AC)                                    | 85 to 110%                               | 85 to 110%  |
| % of nominal (DC)                                    | 80 to 110%                               | 80 to 110%  |
| Average consumption                                  | 0.9 VA                                   | 0.9 VA  |
|  | 0.7 W                                    | 0.7 W   |
| Dropout voltage threshold                            | 15% (AC)                                 | 15% (AC)  |
|  | 10% (DC)                                 | 10% (DC)  |
| <b>Performance</b>                                   |  |   |
| Electrical life (UL 508) operations at rated current | 100,000 operations                       | 100,000 operations  |
| Mechanical life operations unpowered                 | 10,000,000 operations                    | 10,000,000 operations   |
| Response time  | 20 ms                                    | 20 ms   |
| Dielectric strength                                  |  |   |
| Between coil and contact Vac (rms)                   | 2500 V (rms)                             | 2500 V (rms)  |
| Between poles Vac (rms)                              | 1500 V (rms)                             | 1500 V (rms)  |
| <b>Environment</b>                                   |  |   |
| Ambient air temperature around the device            |  |   |
| Storage  | −40 °F to +131 °F (−40 °C to +55 °C)     | −40 °F to +131 °F (−40 °C to +55 °C)  |
| Operation  | −40 °F to +185 °F (−40 °C to +85 °C)     | −40 °F to +185 °F (−40 °C to +85 °C)  |
| Vibration resistance—operational                     | 3 g-n at 10–55 Hz                        | 3 g-n at 10–55 Hz   |
| Shock resistance                                     | 10 g-n                                   | 10 g-n  |
| Degree of protection                                 | IP40                                     | IP40  |
| <b>Features</b>                                      |  |   |
| Cover options  | Plain cover                              | Full featured   |
| Features   | Mechanical flag indicator (optional LED) | Locking pushbutton/<br>Bipolar LED/<br>Removable ID tag/<br>Mechanical flag indicator |
| Product certifications                               | RoHS/UL/CE/CSA                           | RoHS/UL/CE/CSA  |

# 3.4

## Control Relays and Timers

### General Purpose Plug-In Relays

#### Wiring Diagram

##### D1RF/D1RR

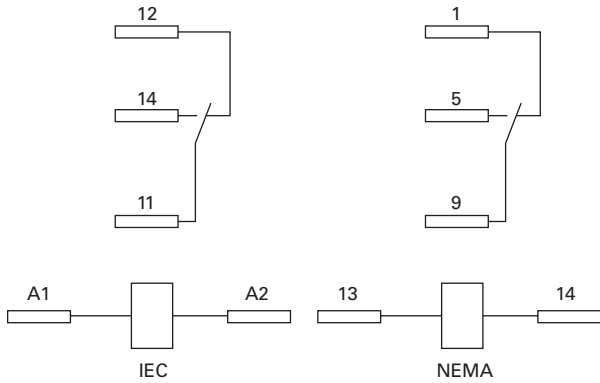

#### Dimensions

Approximate Dimensions in Inches (mm)

##### D1RF/D1RR

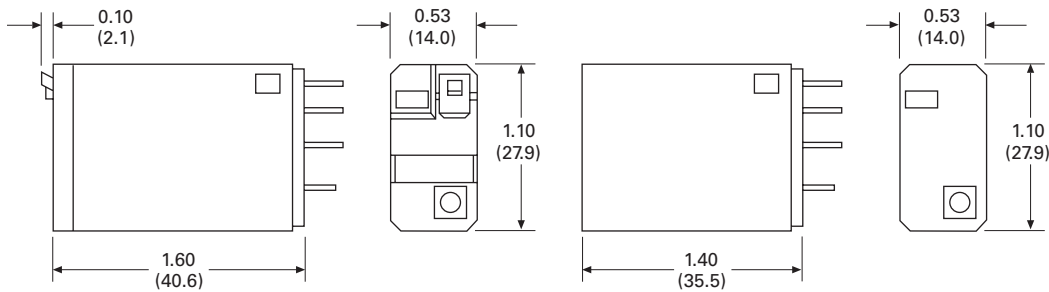

##### D1RAA

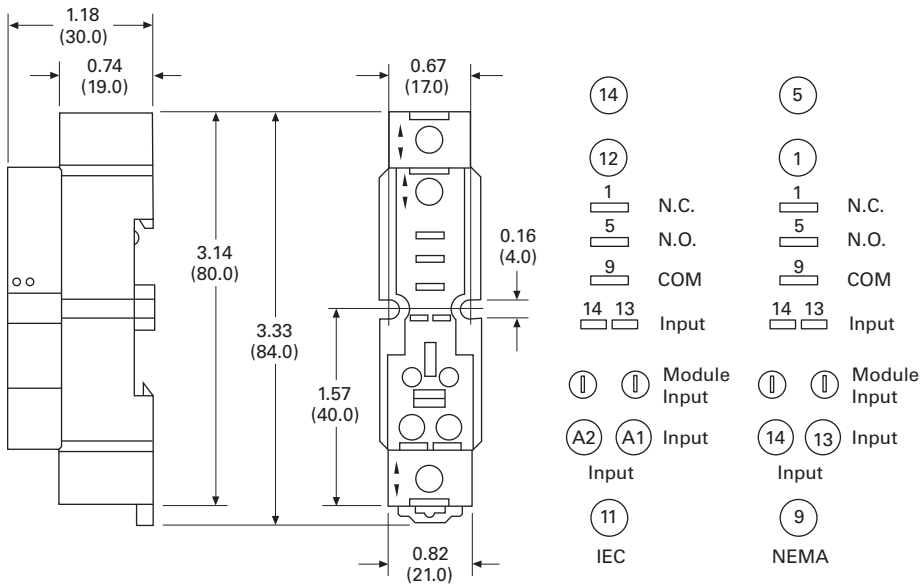

## D2 Series Relay



## D2RR/D2RF Series

## Product Description

The D2 Series is a compact line of relays with quick response time and long life. Available in DPDT and 4PDT configurations.

## Features

**D2RR**

- Ultra-high sensitivity relay with quick response
- High reliability, long life
- Panel, DIN rail and flange mounting
- Small size

## Contents

**Description**

|   | <b>Page</b>      |
|---|------------------|
| D1RR/D1RF Series . . . . .                  | <b>V7-T3-53</b>  |
| D2RR/D2RF Series                            |                  |
| Catalog Number Selection . . . . .          | <b>V7-T3-58</b>  |
| Product Selection . . . . .                 | <b>V7-T3-58</b>  |
| Accessories . . . . .                       | <b>V7-T3-60</b>  |
| Technical Data and Specifications . . . . . | <b>V7-T3-61</b>  |
| Wiring Diagrams . . . . .                   | <b>V7-T3-62</b>  |
| Dimensions . . . . .                        | <b>V7-T3-63</b>  |
| D3RR/D3RF Series . . . . .                  | <b>V7-T3-67</b>  |
| D4 Series . . . . .                         | <b>V7-T3-76</b>  |
| D5RR/D5RF Series . . . . .                  | <b>V7-T3-80</b>  |
| D7PR/D7PF Series . . . . .                  | <b>V7-T3-89</b>  |
| D8 Series . . . . .                         | <b>V7-T3-103</b> |
| D9 Series . . . . .                         | <b>V7-T3-108</b> |
| Accessories . . . . .                       | <b>V7-T3-112</b> |

## Standards and Certifications



 When used with accompanying Eaton screw terminal socket.

**D2RF**

- Flag indicator shows relay status in manual or powered condition
- Bipolar LED status lamp allows for reverse polarity applications
  - Shows coil ON or OFF status
  - Ideal in low light conditions
- Color-coded pushbutton identifies AC coils with red or DC coils with blue pushbuttons
  - Allows for manual operation of relay without the need for coil power
  - Ideal for field service personnel to test control circuits
- Lock-down door, when activated, holds pushbutton and contacts in the operate position
  - Excellent for analyzing circuit problems
- Finger-grip cover allows operator to remove relays from sockets more easily than conventional relays
- White plastic ID tag/write label used for identification of relays in multi-relay circuits

# 3.4

## Control Relays and Timers

### General Purpose Plug-In Relays

#### Catalog Number Selection

##### D2RF/D2RR ①

3

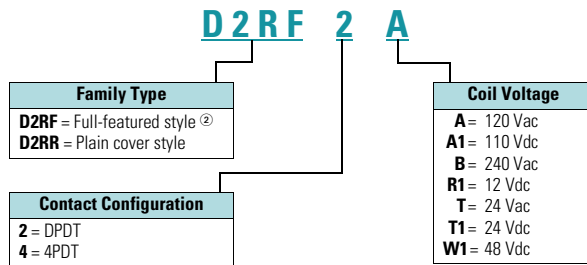

#### Product Selection

##### D2RF/D2RR Relay/Socket Quick Reference

| Relay Type   | Socket | Clip     | Module Type | ID Tag  | Jumper |
|--------------|--------|----------|-------------|---------|--------|
| D2RR2, D2RF2 | D2PAL  | PWC-D24  | B           | PWF-D2P | D2PJ1  |
|              |        | PQC-1782 | —           | —       | —      |
|              | D2PA6  | PQC-1342 | None        | —       | —      |
| D2RR4, D2RF4 | D2PAP  | PWC-D24  | B           | PWF-D2P | D2PJ1  |
|              |        | PQC-1782 | —           | —       | —      |
|              | D2PA7  | PWC-D24  | B           | —       | —      |
|              |        | PQC-1782 | B           | —       | —      |
|              | D2PA6  | PQC-1342 | None        | —       | —      |

#### Notes

- ① For deciphering catalog numbers. Do not use for ordering as not all combinations are readily available.
- ② Full-featured, LED test button, flag indicator, lock-down door, finger-grip cover, ID tag.

## D2RF Series Relay



## D2RF/D2RR Series

| Coil Voltage               | Contact Configuration | Coil Resistance (Ohms) | Catalog Number |
|----------------------------|-----------------------|------------------------|----------------|
| <b>Full Featured Style</b> |                       |                        |                |
| 12 Vdc                     | DPDT                  | 160                    | <b>D2RF2R1</b> |
| 24 Vac                     | DPDT                  | 180                    | <b>D2RF2T</b>  |
| 24 Vdc                     | DPDT                  | 650                    | <b>D2RF2T1</b> |
| 48 Vdc                     | DPDT                  | 2600                   | <b>D2RF2W1</b> |
| 110/125 Vdc                | DPDT                  | 11,000                 | <b>D2RF2A1</b> |
| 120 Vac                    | DPDT                  | 4430                   | <b>D2RF2A</b>  |
| 220/240 Vac                | DPDT                  | 15,720                 | <b>D2RF2B</b>  |
| 12 Vdc                     | 4PDT                  | 160                    | <b>D2RF4R1</b> |
| 24 Vac                     | 4PDT                  | 180                    | <b>D2RF4T</b>  |
| 24 Vdc                     | 4PDT                  | 650                    | <b>D2RF4T1</b> |
| 48 Vdc                     | 4PDT                  | 2600                   | <b>D2RF4W1</b> |
| 110/125 Vdc                | 4PDT                  | 11,000                 | <b>D2RF4A1</b> |
| 120 Vac                    | 4PDT                  | 4430                   | <b>D2RF4A</b>  |
| 220/240 Vac                | 4PDT                  | 15,720                 | <b>D2RF4B</b>  |
| <b>Plain Cover Style</b>   |                       |                        |                |
| 12 Vdc                     | DPDT                  | 160                    | <b>D2RR2R1</b> |
| 24 Vac                     | DPDT                  | 180                    | <b>D2RR2T</b>  |
| 24 Vdc                     | DPDT                  | 650                    | <b>D2RR2T1</b> |
| 120 Vac                    | DPDT                  | 4430                   | <b>D2RR2A</b>  |
| 220/240 Vac                | DPDT                  | 15,720                 | <b>D2RR2B</b>  |
| 12 Vdc                     | 4PDT                  | 160                    | <b>D2RR4R1</b> |
| 24 Vac                     | 4PDT                  | 180                    | <b>D2RR4T</b>  |
| 24 Vdc                     | 4PDT                  | 650                    | <b>D2RR4T1</b> |
| 110/125 Vdc                | 4PDT                  | 11,000                 | <b>D2RR4A1</b> |
| 120 Vac                    | 4PDT                  | 4430                   | <b>D2RR4A</b>  |
| 220/240 Vac                | 4PDT                  | 15,720                 | <b>D2RR4B</b>  |

# 3.4

## Control Relays and Timers

### General Purpose Plug-In Relays

#### Accessories

##### D2RF/D2RR Sockets and Accessories

3

| Type                      | Module Size | Nominal Voltage (Max. for Sockets) | Nominal Current | Mounting Style | Wire Size                                  | Wire Connection | Standard Pack | Catalog Number    |
|---------------------------|-------------|------------------------------------|-----------------|----------------|--|-----------------|---------------|-------------------|
| Socket                    | B           | 300                                | 12              | DIN rail/panel | 14/16 (2) AWG, 2.5/1.5 (2) mm <sup>2</sup> | Elevator        | 1             | <b>D2PAL</b> ①    |
|                           | None        | 300                                | 10              | DIN rail/panel | 12/14 (2) AWG, 4/2.5 (2) mm <sup>2</sup>   | Screw clamping  | 10            | <b>D2PA6</b>      |
|                           | B           | 300                                | 10              | DIN rail/panel | 14/16 (2) AWG, 2.5/1.5 (2) mm <sup>2</sup> | Elevator        | 1             | <b>D2PAP</b> ①    |
|                           | B           | 300                                | 10              | DIN rail/panel | 12/14 (2) AWG, 4/2.5 (2) mm <sup>2</sup>   | Screw clamping  | 10            | <b>D2PA7</b> ①    |
|                           | None        | 300                                | 10              | DIN rail/panel | 12/14 (2) AWG, 4/2.5 (2) mm <sup>2</sup>   | Screw clamping  | 5             | <b>D2PA4</b>      |
| Flange mount adapter      | —           | —                                  | —               | Flange         | —  | —               | 25            | <b>PFC-D2D72</b>  |
| Plastic ejector clip      | —           | —                                  | —               | —              | —  | —               | 10            | <b>PWC-D24</b>    |
| Metal spring clip         | —           | —                                  | —               | —              | —  | —               | 25            | <b>PQC-1782</b>   |
|                           | —           | —                                  | —               | —              | —  | —               | 25            | <b>PQC-1342</b>   |
| Hold-down spring          | —           | —                                  | —               | —              | —  | —               | 100           | <b>PYC-A1</b>     |
| Protection diode          | B           | 6 to 250 Vdc                       | —               | —              | —  | —               | 20            | <b>MOD-BD250</b>  |
| LED indicator             | B           | 24 Vac/Vdc                         | —               | —              | —  | —               | 20            | <b>MOD-BLG24</b>  |
|                           | B           | 120/240 Vac/Vdc                    | —               | —              | —  | —               | 20            | <b>MOD-BLG240</b> |
| MOV suppressor            | B           | 120 Vac/Vdc                        | —               | —              | —  | —               | 20            | <b>MOD-BMV120</b> |
|                           | B           | 24 Vac/Vdc                         | —               | —              | —  | —               | 20            | <b>MOD-BMV24</b>  |
|                           | B           | 240 Vac/Vdc                        | —               | —              | —  | —               | 20            | <b>MOD-BMV240</b> |
| Coil bus jumpers          | —           | —                                  | —               | —              | —  | —               | 10            | <b>D2PJ1</b>      |
| Plastic DIN rail end stop | —           | —                                  | —               | —              | —  | —               | 25            | <b>PPF-P</b>      |

**Note**

① Protection category (finger safe), EN 60529: IP20.



## Technical Data and Specifications

### D2RF/D2RR Relay Specifications

| Description  | D2RR2/D2RR4                          | D2RF  |
|--|--------------------------------------|---|
| <b>Contact Characteristics</b>                       |                                      |   |
| Contact rating                                       | 12 A / 6 A                           | 6 A   |
| Terminal style                                       | Plug-in                              | Plug-in   |
| Contact materials                                    | Silver alloy                         | Silver alloy  |
| Maximum switching voltage                            | 300 V                                | 300 V   |
| Switching current at voltage—resistive               | 10 A at 120 Vac<br>50/60 Hz          | 10 A at 277 Vac<br>50/60 Hz   |
|  | 8 A at 277 Vac<br>50/60 Hz           | 8 A at 120 Vac<br>50/60 Hz  |
|  | 8 A at 28 Vdc                        | 8 A at 28 Vdc   |
| Switching current at voltage                         | 1/3 hp at 120 Vac<br>1 hp at 277 Vac | 1/3 hp at 120 Vac<br>1 hp at 277 Vac  |
| Pilot duty   | B300                                 | B300  |
| Minimum switching requirement                        | 100 mA at 5 Vdc<br>(0.5 W)           | 100 mA at 5 Vdc<br>(0.5 W)  |
| <b>Coil Characteristics</b>                          |                                      |   |
| Operating range                                      |                                      |   |
| % of nominal (AC)                                    | 85 to 110%                           | 85 to 110%  |
| % of nominal (DC)                                    | 80 to 110%                           | 80 to 110%  |
| Average consumption                                  | 1.2 VA                               | 1.2 VA  |
|  | 0.9 W                                | 0.9 W   |
| Dropout voltage threshold                            | 15% (AC)                             | 15% (AC)  |
|  | 10% (DC)                             | 10% (DC)  |
| <b>Performance</b>                                   |                                      |   |
| Electrical life (UL 508) operations at rated current | 200,000                              | 200,000   |
| Mechanical life operations unpowered                 | 10,000,000                           | 10,000,000  |
| Response time  | 20 ms                                | 20 ms   |
| Dielectric strength                                  |                                      |   |
| Between coil and contact Vac (rms)                   | 1500 rms                             | 1500 rms  |
| Between poles Vac (rms)                              | 1500 rms                             | 1500 rms  |
| <b>Environment</b>                                   |                                      |   |
| Ambient air temperature around the device            |                                      |   |
| Operation  | −40 °F to +131 °F (−40 °C to +55 °C) | −40 °F to +131 °F (−40 °C to +55 °C)  |
| Storage  | −40 °F to +185 °F (−40 °C to +85 °C) | −40 °F to +185 °F (−40 °C to +85 °C)  |
| Vibration resistance—operational                     | 3 g-n at 10–55 Hz                    | 3 g-n at 10–55 Hz   |
| Shock resistance                                     | 10 g-n                               | 10 g-n  |
| Degree of protection                                 | IP40                                 | IP40  |
| <b>Features</b>                                      |                                      |   |
| Cover options  | Plain cover                          | Full featured   |
| Features   | Mechanical flag indicator            | Locking pushbutton/<br>Bipolar LED/<br>Removable ID tag/<br>Mechanical flag indicator |
| Product certifications                               | RoHS/UL/CE/CSA                       | RoHS/UL/CE/CSA  |

# 3.4

## Control Relays and Timers

### General Purpose Plug-In Relays

#### Wiring Diagrams

##### D2RF2/D2RR2

3

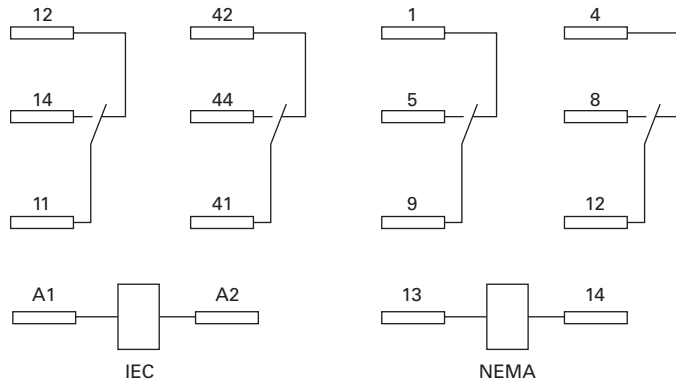

##### D2RF4/D2RR4

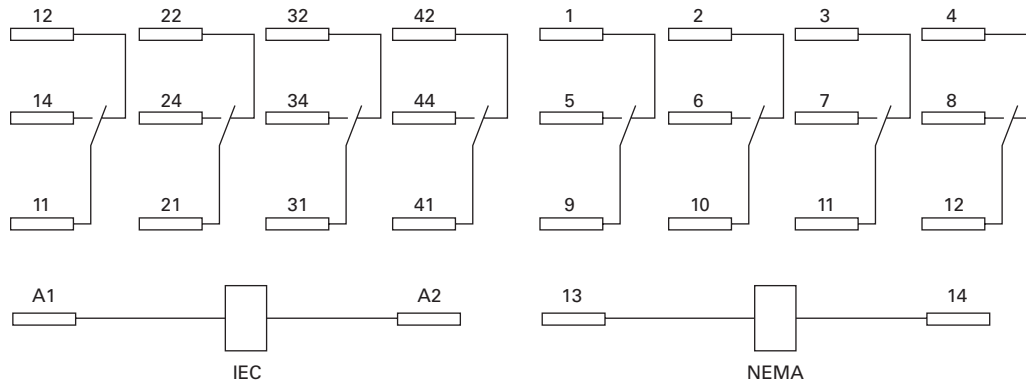

### Dimensions

Approximate Dimensions in Inches (mm)

#### D2RF2/D2RR2

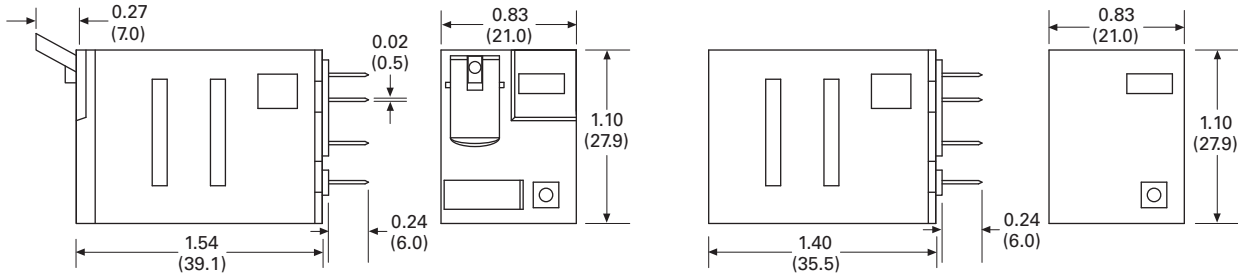

#### D2RF4/D2RR4

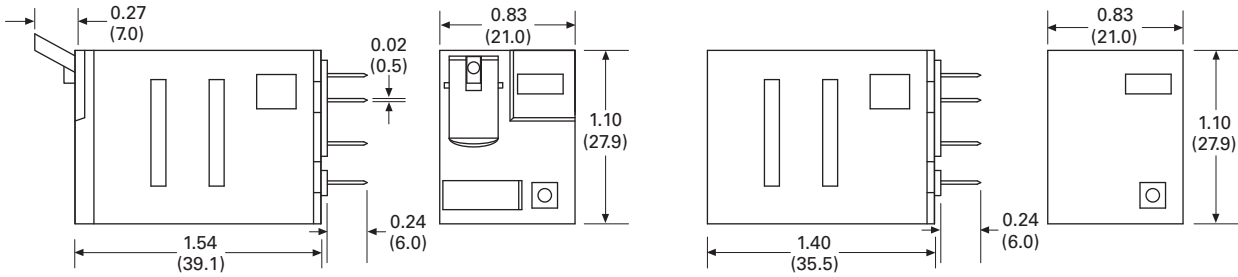

#### D2PA6

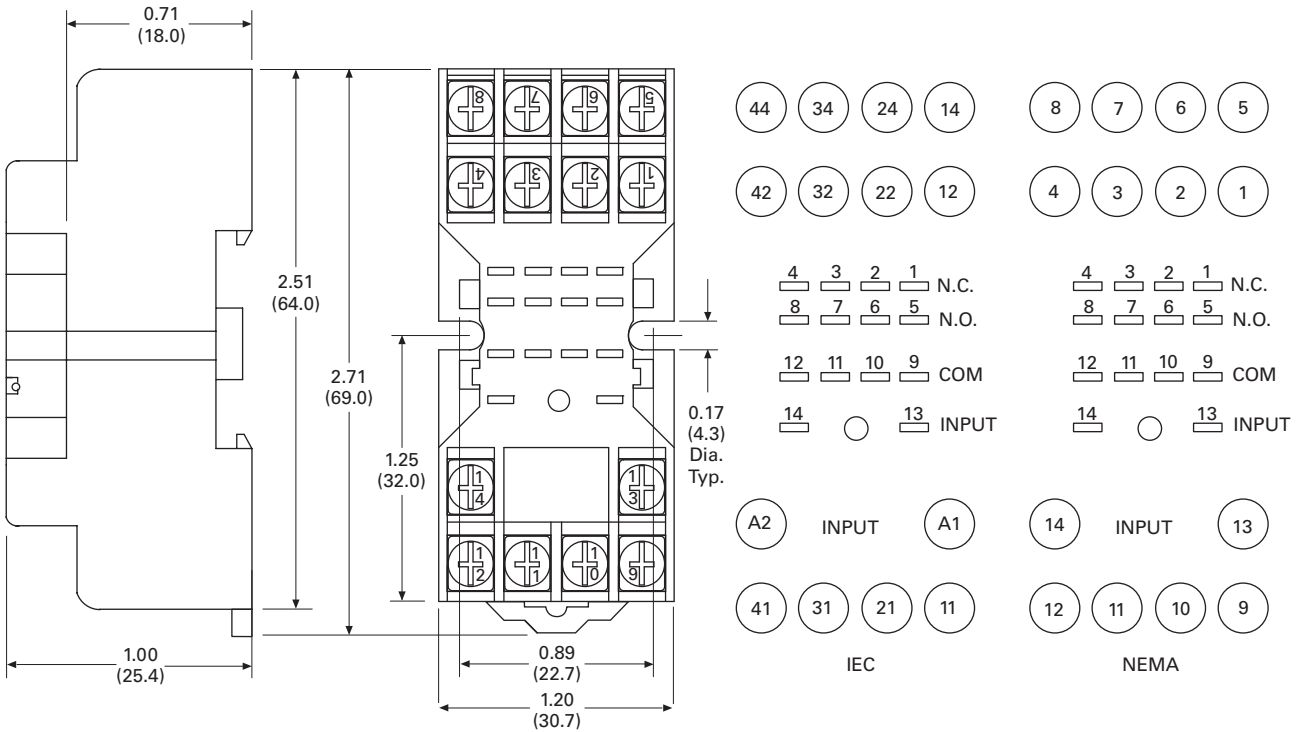

# 3.4

## Control Relays and Timers

### General Purpose Plug-In Relays

Approximate Dimensions in Inches (mm)

#### D2PA7

3

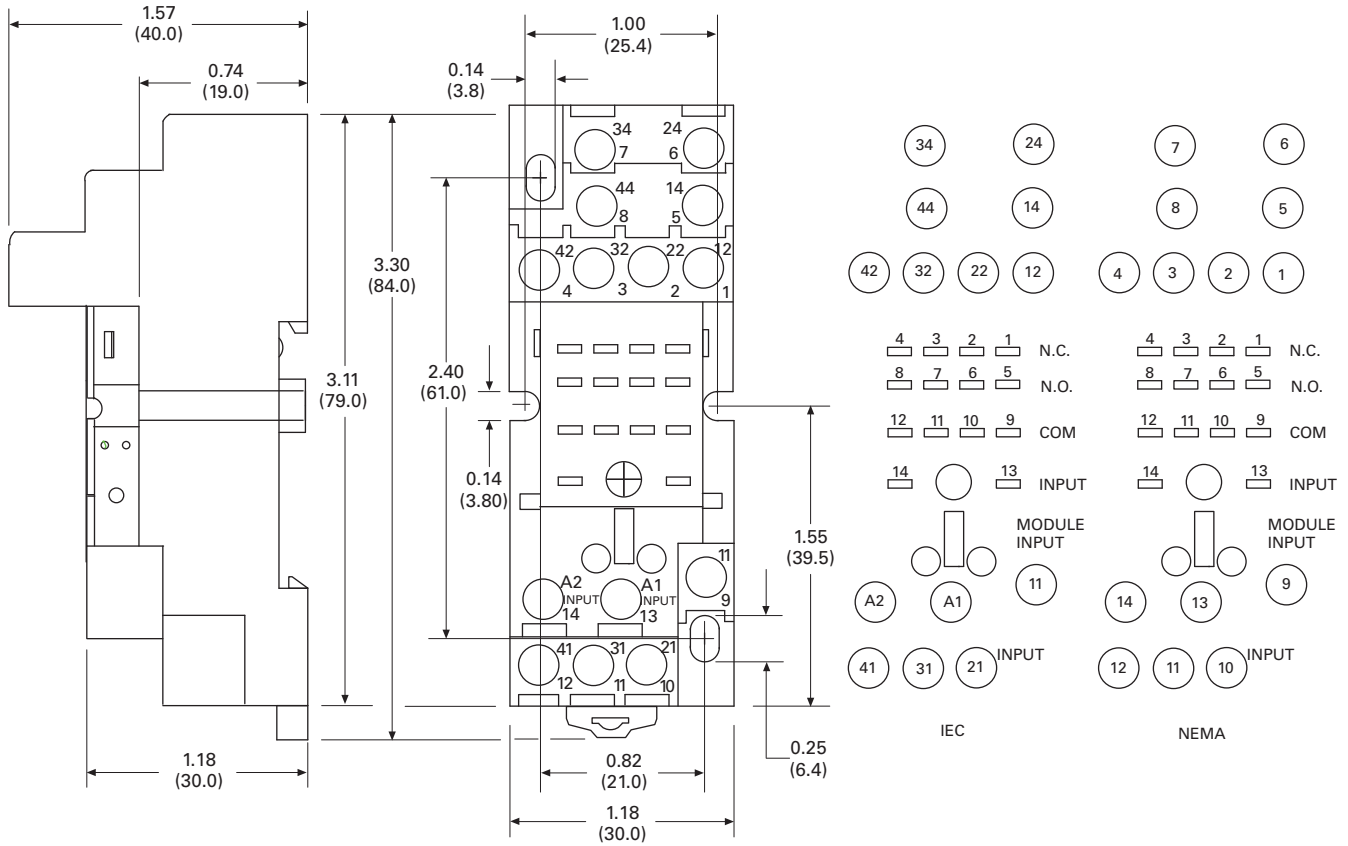

Approximate Dimensions in Inches (mm)

### D2PAP

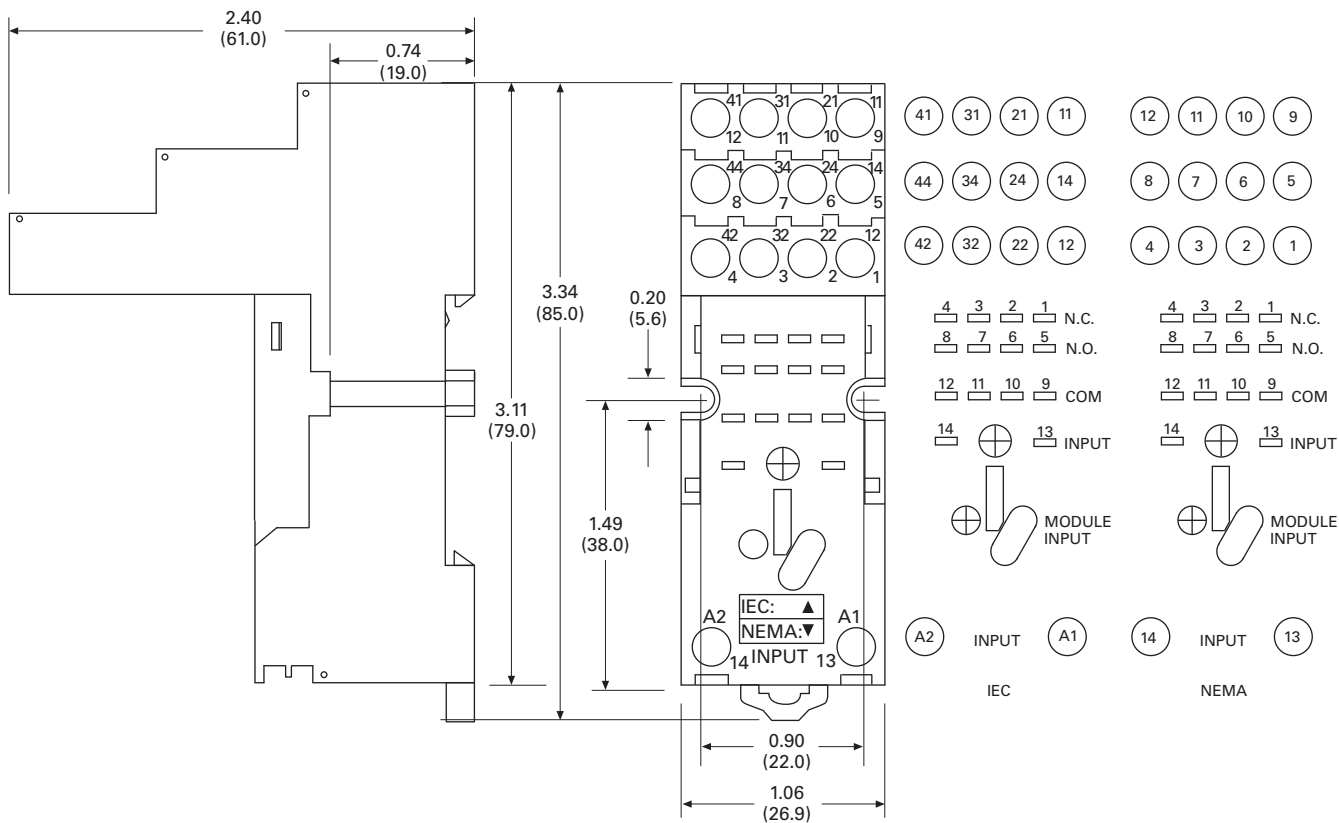

# 3.4

## Control Relays and Timers

### General Purpose Plug-In Relays

Approximate Dimensions in Inches (mm)

#### D2PAL

3

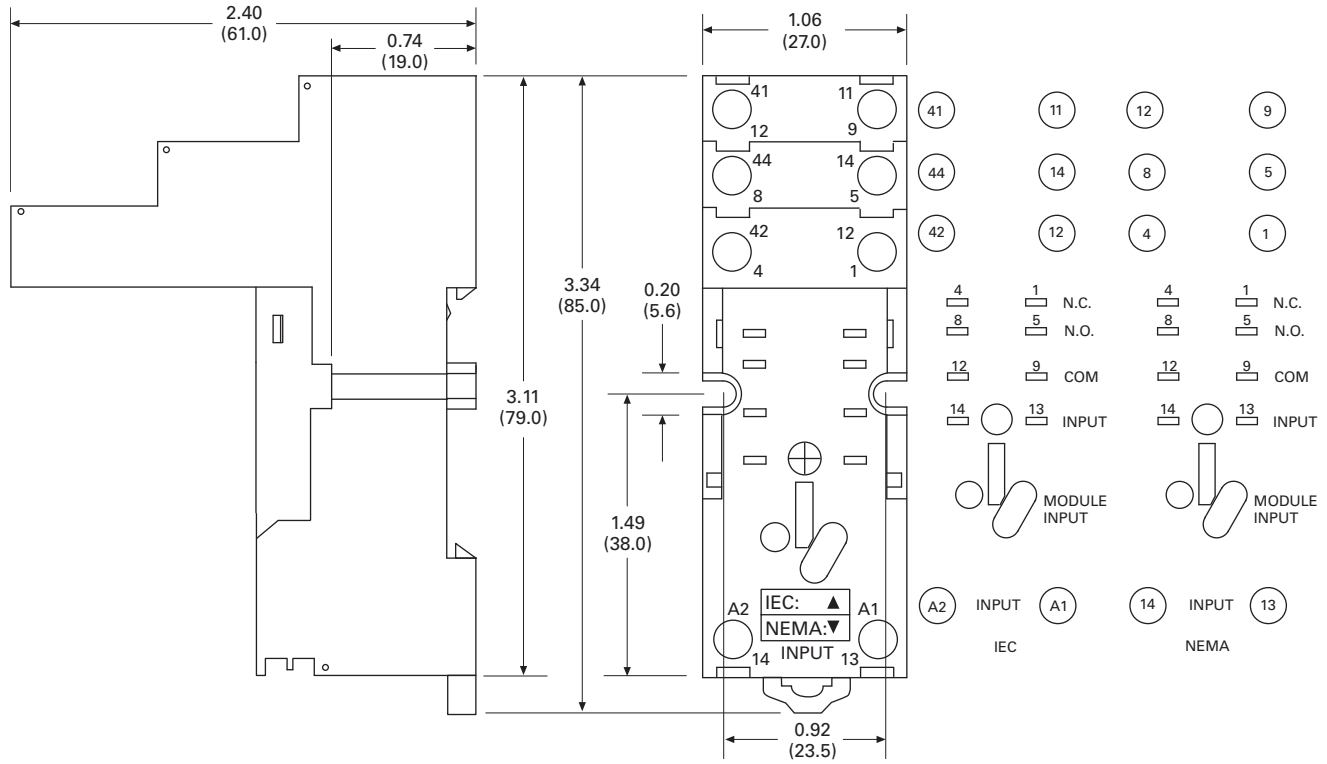

## D3 Series Relay



## D3RR/D3RF Series

## Product Description

The D3 Series of relays provides excellent functionality in a popular octal base design. Rigid pins and guide allow for quick and easy installation with little risk of damage.

## Features

**D3RR**

- Compact relay capable of breaking relatively large load currents
- Panel and DIN rail mounting
- 8- or 11-pin octal plug-in

## Contents

| <b>Description</b>                          | <b>Page</b> |
|---|-------------|
| D1RR/D1RF Series . . . . .                  | V7-T3-53    |
| D2RR/D2RF Series . . . . .                  | V7-T3-57    |
| D3RR/D3RF Series                            |             |
| Catalog Number Selection . . . . .          | V7-T3-68    |
| Product Selection . . . . .                 | V7-T3-68    |
| Accessories . . . . .                       | V7-T3-70    |
| Technical Data and Specifications . . . . . | V7-T3-71    |
| Dimensions . . . . .                        | V7-T3-72    |
| D4 Series . . . . .                         | V7-T3-76    |
| D5RR/D5RF Series . . . . .                  | V7-T3-80    |
| D7PR/D7PF Series . . . . .                  | V7-T3-89    |
| D8 Series . . . . .                         | V7-T3-103   |
| D9 Series . . . . .                         | V7-T3-108   |
| Accessories . . . . .                       | V7-T3-112   |

## Standards and Certifications



When used with accompanying Eaton screw terminal socket (for D3RF only)

**D3RF**

- The contact operation can be easily checked by Push-to-Test button
- Flag indicator shows relay status in manual or powered condition
- LED status lamp shows coil ON or OFF status—ideal for use in low light applications
- Push-to-Test button allows for manual operation of relay without the need for coil power
- Lock-down door holds pushbutton and contacts in the operate position when activated
- Finger-grip cover allows operator to remove relays from sockets easily
- ID tag/write label to identify relays in multiple-relay circuits
- Bipolar LED allows for reverse polarity applications

# 3.4

## Control Relays and Timers

### General Purpose Plug-In Relays

#### Catalog Number Selection

##### D3RR/D3RF Series ①

3

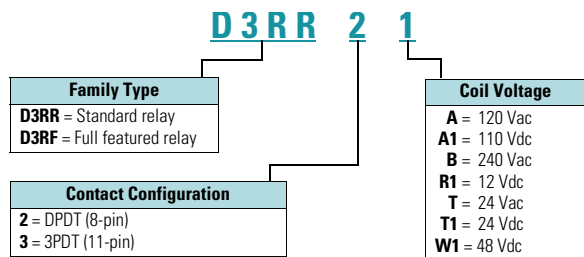

#### Product Selection

##### D3 Relay/Socket Quick Reference

| Relay Type   | Socket  | Clip     | Module Type | ID Tag   | Jumper |
|--------------|---------|----------|-------------|----------|--------|
| D3RR2, D3RF2 | D3PA6   | PQC-1332 | A           | —        | D3PJ1  |
|              | D3PAL8  | PQC-1351 | A           | PWF-D3D5 | —      |
|              | D3PA2   | PQC-1351 | None        | —        | —      |
| D3RR3, D3RF3 | D3PA7   | PQC-1332 | A           | —        | D3PJ1  |
|              | D3PAL11 | PQC-1351 | A           | PWF-D3D5 | —      |
|              | D3PA3   | PQC-1351 | None        | —        | —      |

#### Notes

① For deciphering catalog numbers. Do not use for ordering as not all combinations are readily available.



## D3 Series Relay



## D3RR/D3RF Series

| Coil Voltage               | Contact Configuration | Coil Resistance (Ohms) | Catalog Number |
|----------------------------|-----------------------|------------------------|----------------|
| <b>Full Featured Style</b> |                       |                        |                |
| 120 Vac                    | DPDT                  | 1700                   | <b>D3RF2A</b>  |
| 240 Vac                    | DPDT                  | 7200                   | <b>D3RF2B</b>  |
| 12 Vdc                     | DPDT                  | 120                    | <b>D3RF2R1</b> |
| 24 Vdc                     | DPDT                  | 470                    | <b>D3RF2T1</b> |
| 120 Vac                    | 3PDT                  | 1700                   | <b>D3RF3A</b>  |
| 220/240 Vac                | 3PDT                  | 7200                   | <b>D3RF3B</b>  |
| 24 Vac                     | 3PDT                  | 72                     | <b>D3RF3T</b>  |
| 24 Vdc                     | 3PDT                  | 470                    | <b>D3RF3T1</b> |
| <b>Plain Cover Style</b>   |                       |                        |                |
| 120 Vac                    | DPDT                  | 1700                   | <b>D3RR2A</b>  |
| 110/125 Vdc                | DPDT                  | 10,000                 | <b>D3RR2A1</b> |
| 220/240 Vac                | DPDT                  | 7200                   | <b>D3RR2B</b>  |
| 12 Vdc                     | DPDT                  | 120                    | <b>D3RR2R1</b> |
| 24 Vac                     | DPDT                  | 72                     | <b>D3RR2T</b>  |
| 24 Vdc                     | DPDT                  | 470                    | <b>D3RR2T1</b> |
| 48 Vdc                     | DPDT                  | 1800                   | <b>D3RR2W1</b> |
| 120 Vac                    | 3PDT                  | 1700                   | <b>D3RR3A</b>  |
| 110/125 Vdc                | 3PDT                  | 10,000                 | <b>D3RR3A1</b> |
| 220/240 Vac                | 3PDT                  | 7200                   | <b>D3RR3B</b>  |
| 12 Vdc                     | 3PDT                  | 120                    | <b>D3RR3R1</b> |
| 24 Vac                     | 3PDT                  | 72                     | <b>D3RR3T</b>  |
| 24 Vdc                     | 3PDT                  | 470                    | <b>D3RR3T1</b> |

# 3.4

## Control Relays and Timers

### General Purpose Plug-In Relays

#### Accessories

##### D3RR/D3RF Series Sockets and Accessories

3

| Type                      | Module Size | Nominal Voltage (Max. for Sockets) | Nominal Current | Mounting Style | Wire Size                                | Wire Connection | Standard Pack | Catalog Number              |
|---------------------------|-------------|------------------------------------|-----------------|----------------|--|-----------------|---------------|-----------------------------|
| Socket                    | A           | 300                                | 16              | DIN rail/panel | 12/14 (2) AWG, 4/2.5 (2) mm <sup>2</sup> | Screw clamping  | 1             | <b>D3PA6</b> <sup>①</sup>   |
|                           | A           | 300                                | 12              | DIN rail/panel | 12/14 (2) AWG, 4/2.5 (2) mm <sup>2</sup> | Elevator        | 10            | <b>D3PAL8</b> <sup>①</sup>  |
|                           | None        | 300/600                            | 15/10           | DIN rail/panel | 12/14 (2) AWG, 4/2.5 (2) mm <sup>2</sup> | Screw clamping  | 10            | <b>D3PA2</b>                |
|                           | A           | 600                                | 5               | DIN rail/panel | 12/14 (2) AWG, 4/2.5 (2) mm <sup>2</sup> | Screw clamping  | 1             | <b>D3PA7</b> <sup>①</sup>   |
|                           | A           | 300                                | 12              | DIN rail/panel | 12/14 (2) AWG, 4/2.5 (2) mm <sup>2</sup> | Elevator        | 10            | <b>D3PAL11</b> <sup>①</sup> |
|                           | None        | 300/600                            | 15/5            | DIN rail/panel | 12/14 (2) AWG, 4/2.5 (2) mm <sup>2</sup> | Screw clamping  | 10            | <b>D3PA3</b>                |
| Metal spring clip         | —           | —                                  | —               | —              | —  | —               | 25            | <b>PQC-1332</b>             |
|                           | —           | —                                  | —               | —              | —  | —               | 10            | <b>PQC-1351</b>             |
| Protection diode          | A           | 6 to 250 Vdc                       | —               | —              | —  | —               | 20            | <b>MOD-AD250</b>            |
| LED indicator             | A           | 24 Vac/Vdc                         | —               | —              | —  | —               | 20            | <b>MOD-ALG24</b>            |
|                           | A           | 120/240 Vac/Vdc                    | —               | —              | —  | —               | 20            | <b>MOD-ALG240</b>           |
| MOV suppressor            | A           | 120 Vac/Vdc                        | —               | —              | —  | —               | 20            | <b>MOD-AMV120</b>           |
|                           | A           | 24 Vac/Vdc                         | —               | —              | —  | —               | 20            | <b>MOD-AMV24</b>            |
|                           | A           | 240 Vac/Vdc                        | —               | —              | —  | —               | 20            | <b>MOD-AMV240</b>           |
| R/C suppressor            | A           | 6 to 24 Vac/Vdc                    | —               | —              | —  | —               | 20            | <b>MOD-RC24</b>             |
|                           | A           | 110 to 240 Vac/Vdc                 | —               | —              | —  | —               | 20            | <b>MOD-RC240</b>            |
| Write-on plastic labels   | —           | —                                  | —               | —              | —  | —               | 10            | <b>PWF-D3D5</b>             |
| Coil bus jumpers          | —           | —                                  | —               | —              | —  | —               | 10            | <b>D3PJ1</b>                |
| Plastic DIN rail end stop | —           | —                                  | —               | —              | —  | —               | 25            | <b>PPF-P</b>                |

#### Note

<sup>①</sup> Protection category (finger safe), EN 60529: IP20.

## Technical Data and Specifications

### D3RR/D3RF Series Relay Specifications

| Description  | D3RR                                 | D3RF  |
|--|--------------------------------------|---|
| <b>Contact Characteristics</b>                       |                                      |   |
| Contact rating                                       | 10 A                                 | 10 A  |
| Terminal style                                       | Octal                                | Octal   |
| Contact materials                                    | Silver alloy                         | Silver alloy  |
| Maximum switching voltage                            | 300 V                                | 300 V   |
| Switching current at voltage—resistive               | 16 A at 277 Vac<br>50/60 Hz          | 16 A at 277 Vac<br>50/60 Hz   |
|  | 16 A at 120 Vac<br>50/60 Hz          | 16 A at 120 Vac<br>50/60 Hz   |
|  | 16 A at 28 Vdc                       | 16 A at 28 Vdc  |
| Switching current at voltage                         | 1/2 hp at 240 Vac                    | 1/2 hp at 240 Vac   |
|  | 1/3 hp at 120 Vac                    | 1/3 hp at 120 Vac   |
| Pilot duty   | B300                                 | B300  |
| Minimum switching requirement                        | 100 mA at 5 Vdc<br>(0.5 W)           | 100 mA at 5 Vdc<br>(0.5 W)  |
| <b>Coil Characteristics</b>                          |                                      |   |
| Operating range                                      |                                      |   |
| % of nominal (AC)                                    | 85 to 110%                           | 85 to 110%  |
| % of nominal (DC)                                    | 80 to 110%                           | 80 to 110%  |
| Average consumption                                  | 3 VA                                 | 3 VA  |
|  | 1.4 W                                | 1.4 W   |
| Dropout voltage threshold                            | 15% (AC)                             | 15% (AC)  |
|  | 10% (DC)                             | 10% (DC)  |
| <b>Performance</b>                                   |                                      |   |
| Electrical life (UL 508) operations at rated current | 100,000 operations                   | 100,000 operations  |
| Mechanical life operations unpowered                 | 5,000,000 operations                 | 5,000,000 operations  |
| Response time  | 20 ms                                | 20 ms   |
| Dielectric strength                                  |                                      |   |
| Between coil and contact Vac (rms)                   | 1500 V (rms)                         | 1500 V (rms)  |
| Between poles Vac (rms)                              | 1500 V (rms)                         | 1500 V (rms)  |
| <b>Environment</b>                                   |                                      |   |
| Ambient air temperature around the device            |                                      |   |
| Storage  | −40 °F to +185 °F (−40 °C to +85 °C) | −40 °F to +185 °F (−40 °C to +85 °C)  |
| Operation  | −40 °F to +131 °F (−40 °C to +55 °C) | −40 °F to +131 °F (−40 °C to +55 °C)  |
| Vibration resistance—operational                     | 3 g-n at 10–55 Hz                    | 3 g-n at 10–55 Hz   |
| Shock resistance                                     | 10 g-n                               | 10 g-n  |
| Degree of protection                                 | IP40                                 | IP40  |
| <b>Features</b>                                      |                                      |   |
| Cover options  | Plain cover                          | Full Featured   |
| Features   | Mechanical flag indicator            | Bipolar LED/<br>Locking pushbutton/<br>Removable ID tag/<br>Mechanical flag indicator |
| Product certifications                               | RoHS/UL/CE/CSA                       | RoHS/UL/CE/CSA  |

# 3.4

## Control Relays and Timers

### General Purpose Plug-In Relays

#### Dimensions

Approximate Dimensions in Inches (mm)

3

#### D3RR2/D3RF2

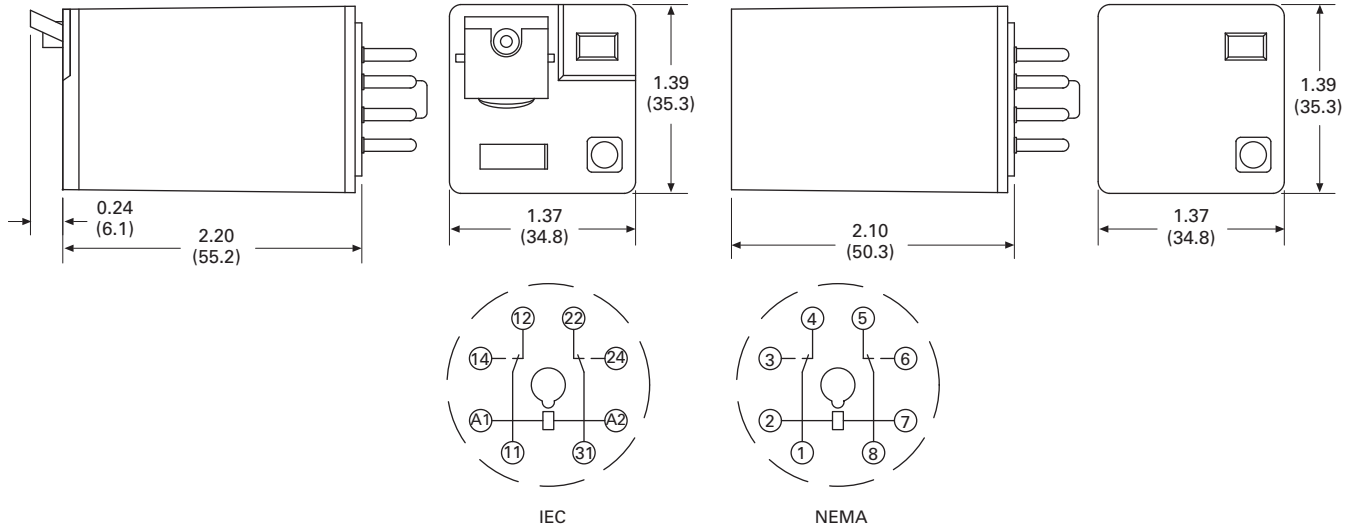

#### D3RR3/D3RF3

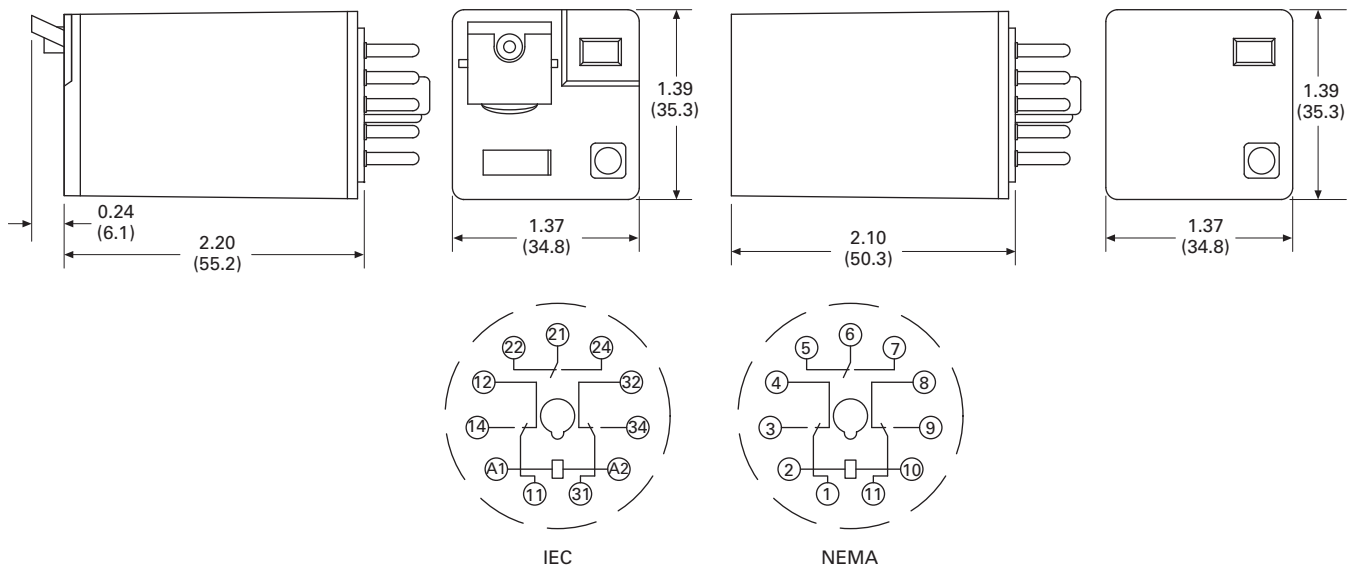

Approximate Dimensions in Inches (mm)

### D3PA2

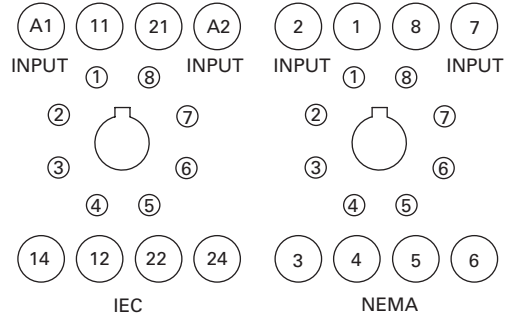
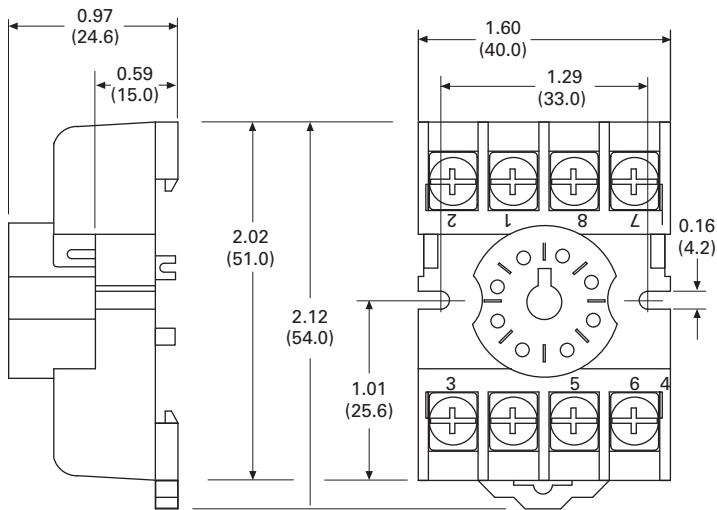

### D3PA3

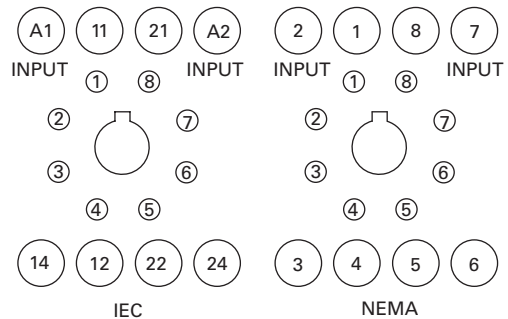
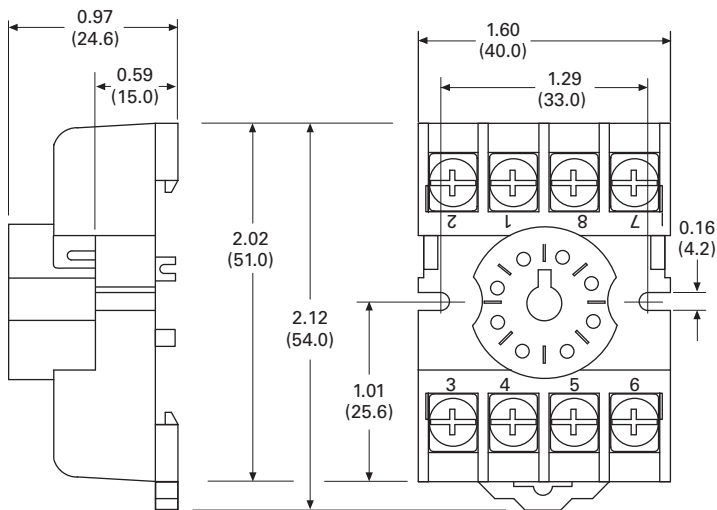
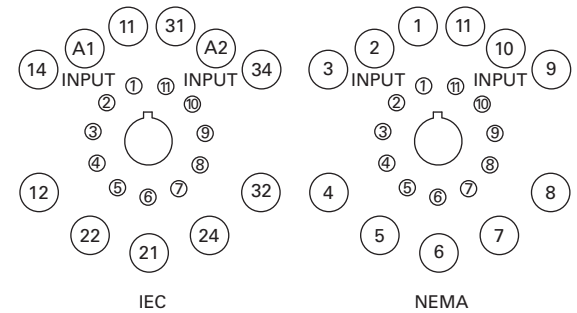
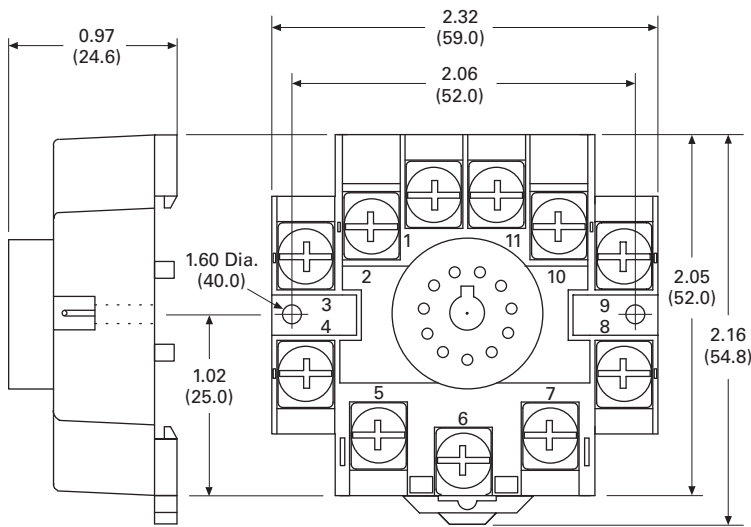

# 3.4

## Control Relays and Timers

### General Purpose Plug-In Relays

Approximate Dimensions in Inches (mm)

#### D3PA6

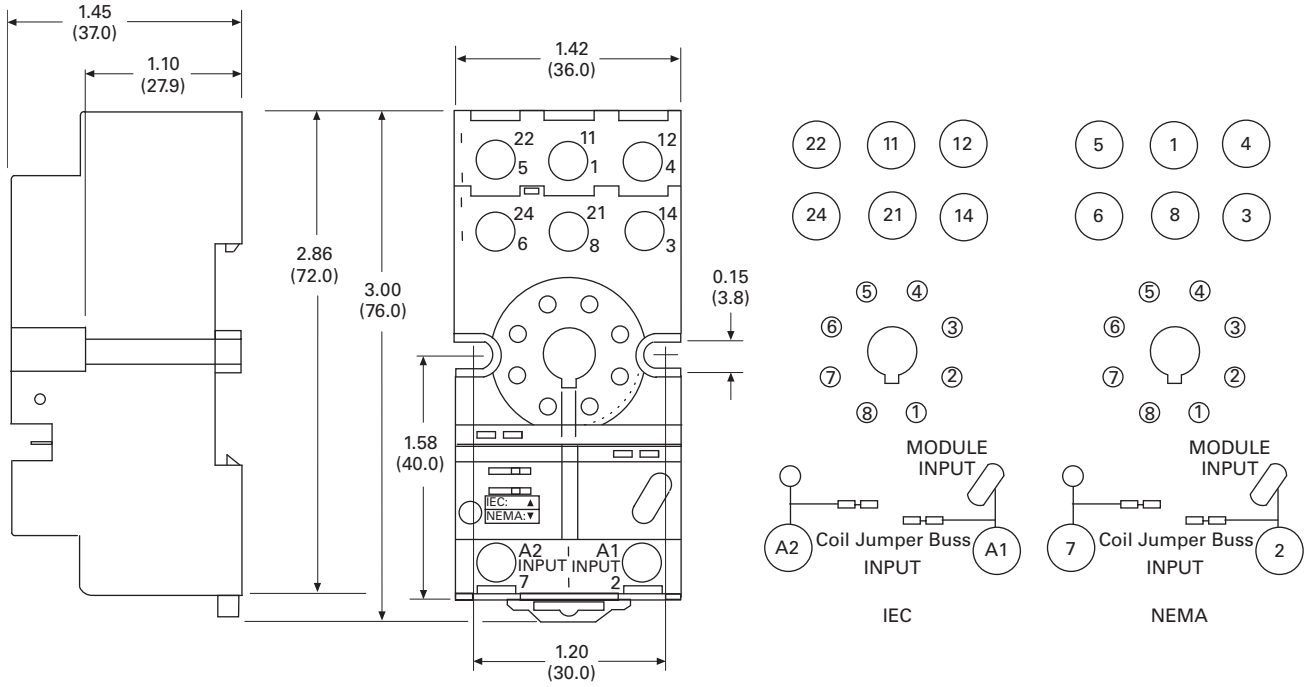

#### D3PA7

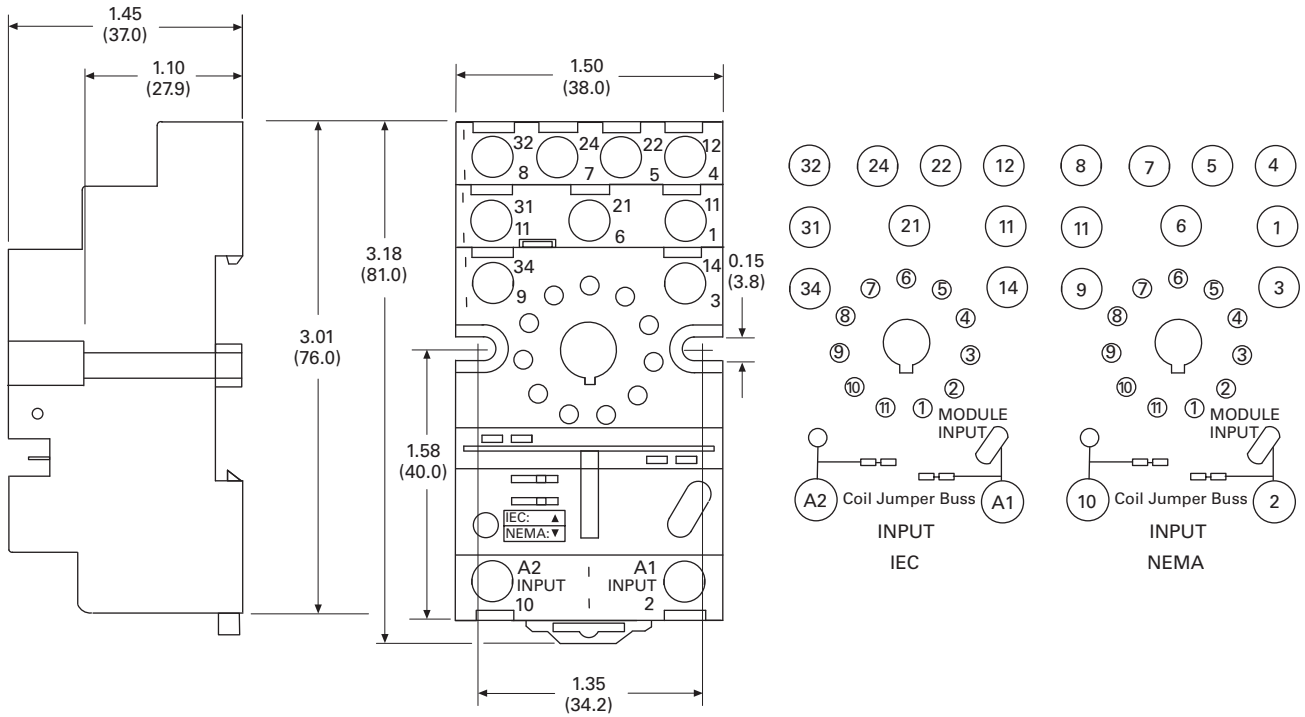

Approximate Dimensions in Inches (mm)

### D3PAL8

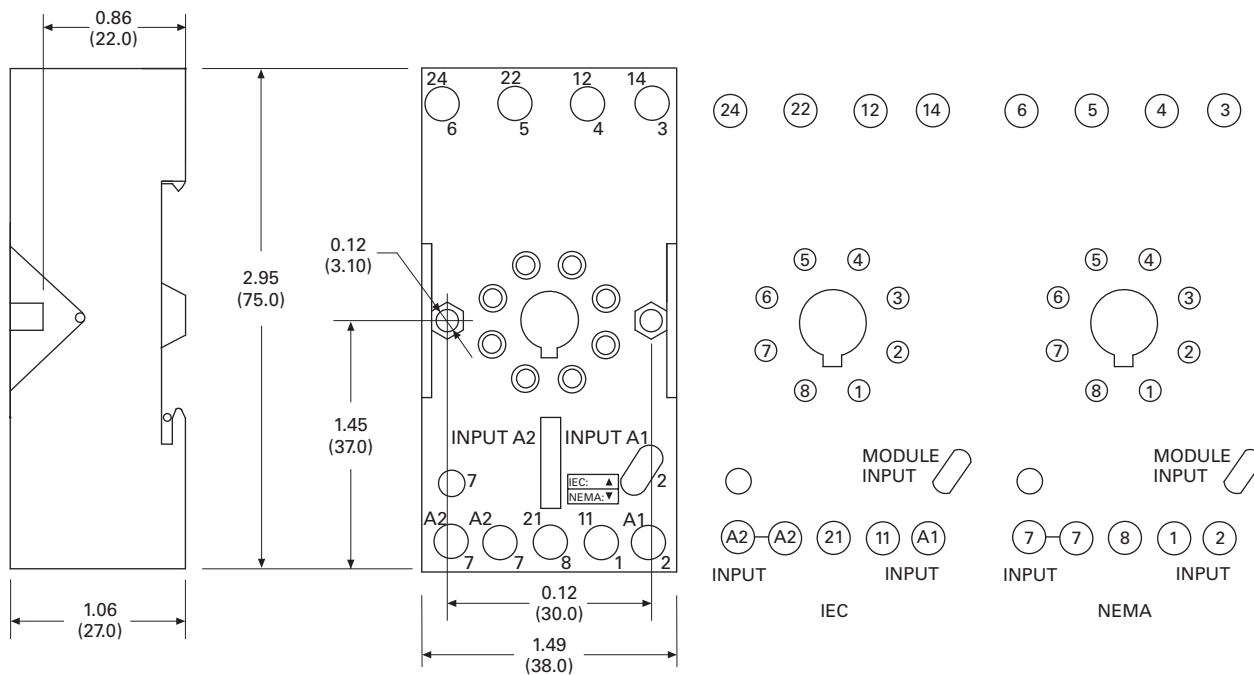

### D3PAL11

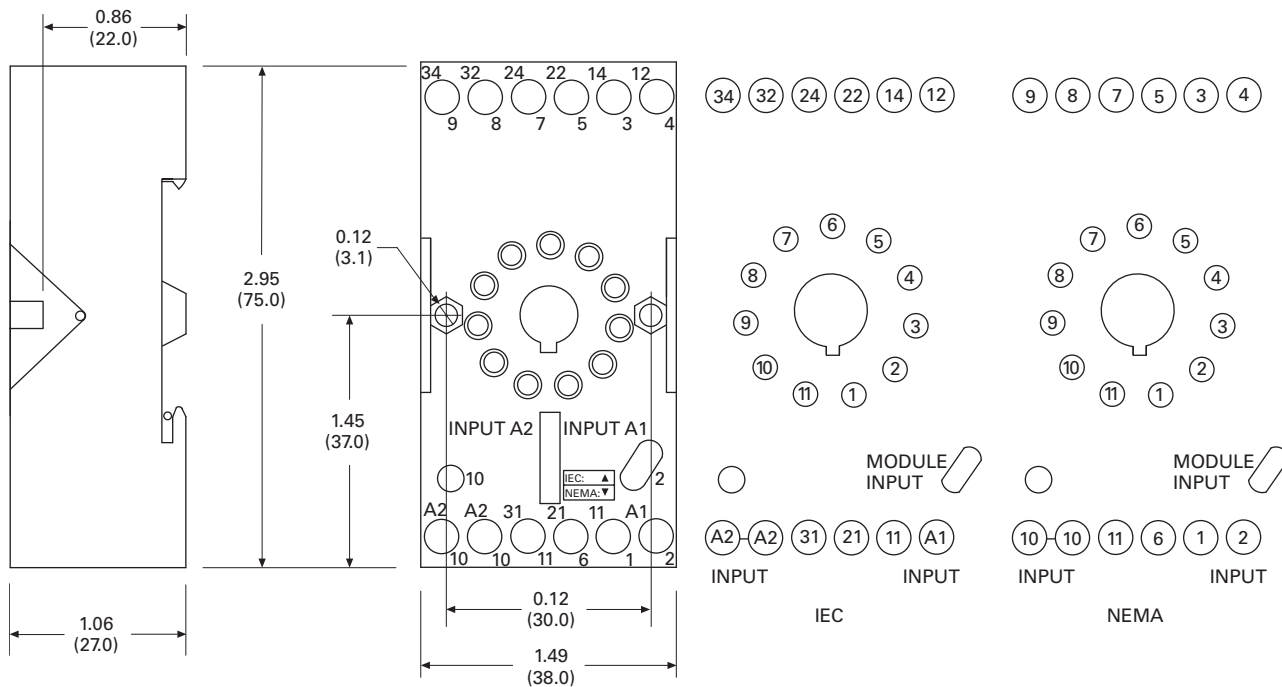

D4 Series Relay



### D4 Series

#### Product Description

The D4 Series is a slim-form relay designed to fit into tight spaces. The retaining clip is built in to the socket to provide easy and secure assembly.

#### Features

- Slim-styled power relay
- Socket has built-in hold-down clip
- Panel or DIN rail mounting

#### Standards and Certifications

File # E1491, E65657

File # LR701519



### Contents

| Description                            | Page      |
|--|-----------|
| D1RR/D1RF Series.....                  | V7-T3-53  |
| D2RR/D2RF Series.....                  | V7-T3-57  |
| D3RR/D3RF Series.....                  | V7-T3-67  |
| D4 Series                              |           |
| Technical Data and Specifications..... | V7-T3-78  |
| Dimensions.....                        | V7-T3-79  |
| D5RR/D5RF Series.....                  | V7-T3-80  |
| D7PR/D7PF Series.....                  | V7-T3-89  |
| D8 Series.....                         | V7-T3-103 |
| D9 Series.....                         | V7-T3-108 |
| Accessories.....                       | V7-T3-112 |

#### Catalog Number Selection

##### D4 Series ①

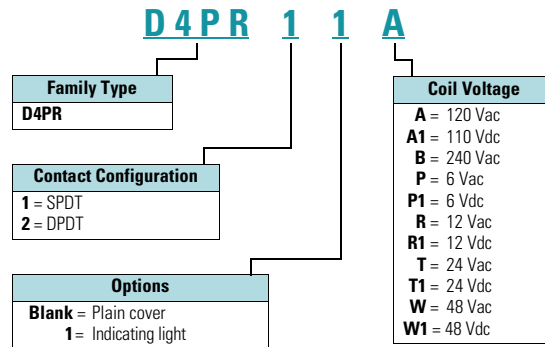

#### Product Selection

##### D4 Relay/Socket Quick Reference

| Relay Type | Socket | Hold-Down Clip |
|------------|--------|----------------|
| D4PR1      | D4PA1  | ②              |
| D4PR2      | D4PA2  | ②              |

#### Notes

- ① For deciphering catalog numbers. Do not use for ordering as not all combinations are readily available.
- ② Socket has built-in hold-down spring.



## D4 Series Relay



## D4 Series

| Voltage/Poles                     | Standard Pack | Catalog Number    |
|-----------------------------------|---------------|-------------------|
| <b>DIN Rail Sockets</b>           |               |                   |
| Single-pole                       | 10            | <b>D4PA1</b>      |
| Two-pole                          | 10            | <b>D4PA2</b>      |
| <b>SPDT with Indicating Light</b> |               |                   |
| 120 Vac                           | 1             | <b>D4PR11A</b>    |
| 110 Vdc                           | 1             | <b>D4PR11A1</b>   |
| 240 Vac                           | 1             | <b>D4PR11B</b>    |
| 6 Vac                             | 50            | <b>D4PR11P</b>    |
| 6 Vdc                             | 50            | <b>D4PR11P1</b>   |
| 12 Vac                            | 50            | <b>D4PR11R</b>    |
| 12 Vdc                            | 1             | <b>D4PR11R1</b>   |
| 24 Vac                            | 1             | <b>D4PR11T</b>    |
| 24 Vdc                            | 1             | <b>D4PR11T1</b>   |
| 48 Vdc                            | 50            | <b>D4PR11W1</b>   |
| <b>Standard SPDT</b>              |               |                   |
| 120 Vac                           | 1             | <b>D4PR1A</b>     |
| 110 Vdc                           | 50            | <b>D4PR1A1</b>    |
| 240 Vac                           | 50            | <b>D4PR1P</b>     |
| 6 Vac                             | 1             | <b>D4PR1P1</b>    |
| 6 Vdc                             | 50            | <b>D4PR1R</b>     |
| 12 Vac                            | 1             | <b>D4PR1R1</b>    |
| 12 Vdc                            | 1             | <b>D4PR1R1-A2</b> |
| 24 Vac                            | 1             | <b>D4PR1T</b>     |
| 24 Vdc                            | 1             | <b>D4PR1T1</b>    |
| 48 Vdc                            | 1             | <b>D4PR1W1</b>    |

| Voltage/Poles                     | Standard Pack | Catalog Number  |
|-----------------------------------|---------------|-----------------|
| <b>DPDT with Indicating Light</b> |               |                 |
| 120 Vac                           | 1             | <b>D4PR21A</b>  |
| 110 Vdc                           | 1             | <b>D4PR21A1</b> |
| 240 Vac                           | 1             | <b>D4PR21B</b>  |
| 6 Vac                             | 50            | <b>D4PR21P</b>  |
| 6 Vdc                             | 1             | <b>D4PR21P1</b> |
| 12 Vac                            | 50            | <b>D4PR21R</b>  |
| 12 Vdc                            | 1             | <b>D4PR21R1</b> |
| 24 Vac                            | 1             | <b>D4PR21T</b>  |
| 24 Vdc                            | 1             | <b>D4PR21T1</b> |
| 48 Vdc                            | 50            | <b>D4PR21W1</b> |
| <b>Standard DPDT</b>              |               |                 |
| 120 Vac                           | 1             | <b>D4PR2A</b>   |
| 110 Vdc                           | 50            | <b>D4PR2A1</b>  |
| 240 Vac                           | 50            | <b>D4PR2B</b>   |
| 6 Vac                             | 50            | <b>D4PR2P</b>   |
| 6 Vdc                             | 1             | <b>D4PR2P1</b>  |
| 12 Vac                            | 50            | <b>D4PR2R</b>   |
| 12 Vdc                            | 1             | <b>D4PR2R1</b>  |
| 24 Vac                            | 1             | <b>D4PR2T</b>   |
| 24 Vdc                            | 1             | <b>D4PR2T1</b>  |
| 48 Vdc                            | 1             | <b>D4PR2W1</b>  |

## Technical Data and Specifications

## D4 Series

3

| Description                                   | Resistive Load<br>(p.f. = 1) | Inductive Load<br>(p.f. = 0.4, L/R = 7 ms) |
|---|------------------------------|--|
| <b>D4PR1</b>                                  |                              |  |
| Rated load                                    | 250 Vac 10 A                 | 250 Vac 7.5 A                              |
|   | 30 Vdc 10 A                  | 30 Vdc 5 A                                 |
| Carry current                                 | 10 A                         | 10 A                                       |
| Max. operating voltage                        | 380 Vac/125 Vdc              | 380 Vac/125 Vdc                            |
| Max. operating current                        | 10 A                         | 10 A                                       |
| Contact material                              | AgCdO                        | AgCdO                                      |
| Max. switching capacity                       | 2500 VA                      | 1875 VA                                    |
|   | 300 W                        | 150 W                                      |
| Min. permissible load                         | 100 mA, 5 Vdc                | 100 mA, 5 Vdc                              |
| Pickup voltage (max.)                         | 80% AC/70% DC                | 80% AC/70% DC                              |
| Dropout voltage (min.)                        | 30% AC/15% DC                | 30% AC/15% DC                              |
| Voltage (max.)                                | 110%                         | 110%                                       |
| Mechanical life (min.)                        | 10,000,000 AC/20,000,000 DC  | 10,000,000 AC/20,000,000 DC                |
| Electrical life at all contact ratings (min.) | 100,000                      | 100,000                                    |
| Maximum hp ratings                            | 1/3 hp (125 Vac)             | 1/3 hp (125 Vac)                           |
|   | 1/2 hp (250 Vac)             | 1/2 hp (250 Vac)                           |
|   | 1/2 hp (277 Vac)             | 1/2 hp (277 Vac)                           |
| <b>D4PR2</b>                                  |                              |  |
| Rated load                                    | 240 Vac 5 A                  | 250 Vac 2 A                                |
|   | 30 Vdc 5 A                   | 30 Vdc 3 A                                 |
| Carry current                                 | 5 A                          | 5 A  |
| Max. operating voltage                        | 380 Vac/125 Vdc              | 380 Vac/125 Vdc                            |
| Max. operating current                        | 5 A                          | 5 A  |
| Contact material                              | AgCdO                        | AgCdO                                      |
| Max. switching capacity                       | 1250 VA                      | 500 VA                                     |
|   | 150 W                        | 90 W                                       |
| Min. permissible load                         | 10 mA, 5 Vdc                 | 10 mA, 5 Vdc                               |
| Pickup voltage (max.)                         | 80% AC/70% DC                | 80% AC/70% DC                              |
| Dropout voltage (min.)                        | 30% AC/15% DC                | 30% AC/15% DC                              |
| Voltage (max.)                                | 110%                         | 110%                                       |
| Mechanical life (min.)                        | 10,000,000 AC/20,000,000 DC  | 10,000,000 AC/20,000,000 DC                |
| Electrical life at all contact ratings (min.) | 100,000                      | 100,000                                    |
| Maximum hp ratings                            | 1/6 hp (120 Vac)             | 1/6 hp (120 Vac)                           |
|   | 1/3 hp (240 Vac)             | 1/3 hp (240 Vac)                           |
|   | 1/3 hp (265 Vac)             | 1/3 hp (265 Vac)                           |

### Dimensions

Approximate Dimensions in Inches (mm)

#### D4PR1

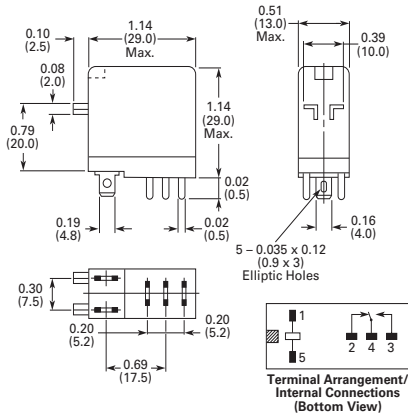

#### D4PR2

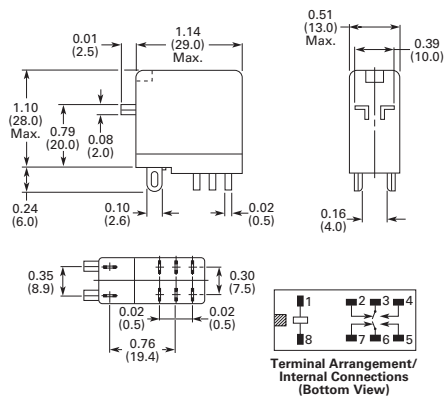

#### D4PA1

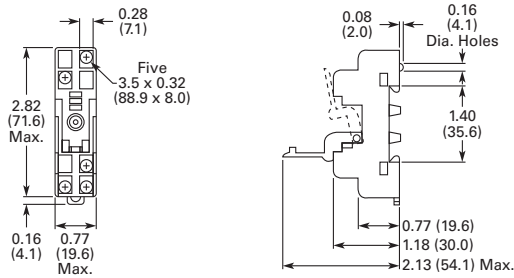

Terminal Arrangement

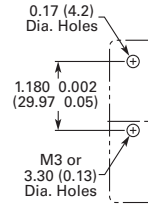

Mounting Holes

#### D4PA2

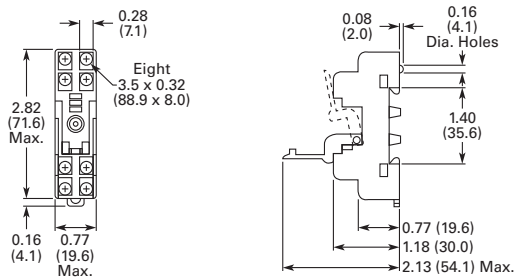

Terminal Arrangement

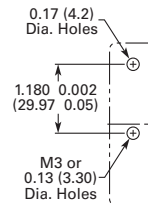

Mounting Holes

D5 Series Relay



### Contents

| <i><b>Description</b></i>              | <i><b>Page</b></i> |
|--|--------------------|
| D1RR/D1RF Series.....                  | <b>V7-T3-53</b>    |
| D2RR/D2RF Series.....                  | <b>V7-T3-57</b>    |
| D3RR/D3RF Series.....                  | <b>V7-T3-67</b>    |
| D4 Series.....                         | <b>V7-T3-76</b>    |
| D5RR/D5RF Series                       |                    |
| Catalog Number Selection.....          | <b>V7-T3-81</b>    |
| Product Selection.....                 | <b>V7-T3-81</b>    |
| Accessories.....                       | <b>V7-T3-83</b>    |
| Technical Data and Specifications..... | <b>V7-T3-84</b>    |
| Wiring Diagrams.....                   | <b>V7-T3-85</b>    |
| Dimensions.....                        | <b>V7-T3-86</b>    |
| D7PR/D7PF Series.....                  | <b>V7-T3-89</b>    |
| D8 Series.....                         | <b>V7-T3-103</b>   |
| D9 Series.....                         | <b>V7-T3-108</b>   |
| Accessories.....                       | <b>V7-T3-112</b>   |

### D5RR/D5RF Series

#### Product Description

The D5 Series is rated at 10 A and is available in full-featured and plain cover styles.

#### Features

##### **D5RR**

- Industrial rated 300 V, 10 A relay in two-pole and three-pole configurations
- Compact design can be panel or DIN rail mounted

##### **D5RF**

- Flag indicator shows relay status in manual or powered condition
- LED status lamp shows coil ON or OFF status—ideal for use in low light applications
- Push-to-Test button allows for manual operation of relay without the need for coil power
- Lock-down door holds pushbutton and contacts in the operate position when activated
- Finger-grip cover allows operator to remove relays from sockets easily
- ID tag/write label to identify relays in multiple-relay circuits
- Bipolar LED allows for reverse polarity applications

#### Standards and Certifications



 When used with accompanying Eaton screw terminal socket (D5RF only)

### Catalog Number Selection

#### D5 Series

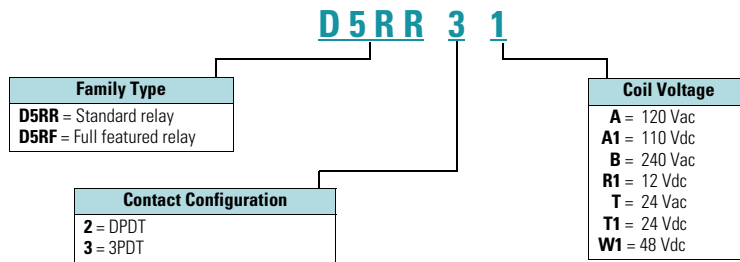

### Product Selection

#### D5 Relay/Socket Quick Reference

| Relay Type                    | Socket | Clip     | Module Type | ID Tag   | Jumper |
|-------------------------------|--------|----------|-------------|----------|--------|
| D5RR2, D5RF2,<br>D5RR3, D5RF3 | D5PAL  | PQC-1351 | A           | PWF-D3D5 | D3PJ1  |
|                               | D5PA2  | PQC-1351 | None        | —        | —      |
|                               | D5PA3L | PQC-1351 | None        | —        | —      |
|                               | D5PA3S | PQC-1351 | None        | —        | —      |

# 3.4

## Control Relays and Timers

### General Purpose Plug-In Relays

D5 Series Relay



#### D5 Series

| Coil Voltage             | Contact Configuration | Coil Resistance (Ohms) | Catalog Number |
|--------------------------|-----------------------|------------------------|----------------|
| <b>Full Featured</b>     |                       |                        |                |
| 120 Vac                  | DPDT                  | 1700                   | <b>D5RF2A</b>  |
| 110/125 Vdc              | DPDT                  | 10,000                 | <b>D5RF2A1</b> |
| 220/240 Vac              | DPDT                  | 7200                   | <b>D5RF2B</b>  |
| 12 Vdc                   | DPDT                  | 120                    | <b>D5RF2R1</b> |
| 24 Vac                   | DPDT                  | 72                     | <b>D5RF2T</b>  |
| 24 Vdc                   | DPDT                  | 470                    | <b>D5RF2T1</b> |
| 120 Vac                  | 3PDT                  | 1700                   | <b>D5RF3A</b>  |
| 110/125 Vdc              | 3PDT                  | 10,000                 | <b>D5RF3A1</b> |
| 220/240 Vac              | 3PDT                  | 7200                   | <b>D5RF3B</b>  |
| 12 Vdc                   | 3PDT                  | 120                    | <b>D5RF3R1</b> |
| 24 Vac                   | 3PDT                  | 72                     | <b>D5RF3T</b>  |
| 24 Vdc                   | 3PDT                  | 470                    | <b>D5RF3T1</b> |
| <b>Side Flange Cover</b> |                       |                        |                |
| 220/240 Vac              | DPDT                  | 7200                   | <b>D5RB2B</b>  |
| 12 Vdc                   | DPDT                  | 120                    | <b>D5RB2R1</b> |
| 24 Vac                   | DPDT                  | 72                     | <b>D5RB2T</b>  |
| 24 Vdc                   | DPDT                  | 470                    | <b>D5RB2T1</b> |
| <b>Plain Cover</b>       |                       |                        |                |
| 120 Vac                  | DPDT                  | 1700                   | <b>D5RR2A</b>  |
| 110/125 Vdc              | DPDT                  | 10,000                 | <b>D5RR2A1</b> |
| 220/240 Vac              | DPDT                  | 7200                   | <b>D5RR2B</b>  |
| 24 Vac                   | DPDT                  | 72                     | <b>D5RR2T</b>  |
| 24 Vdc                   | DPDT                  | 470                    | <b>D5RR2T1</b> |
| 120 Vac                  | 3PDT                  | 1700                   | <b>D5RR3A</b>  |
| 110/125 Vdc              | 3PDT                  | 10,000                 | <b>D5RR3A1</b> |
| 220/240 Vac              | 3PDT                  | 7200                   | <b>D5RR3B</b>  |
| 12 Vdc                   | 3PDT                  | 120                    | <b>D5RR3R1</b> |
| 24 Vac                   | 3PDT                  | 72                     | <b>D5RR3T</b>  |
| 24 Vdc                   | 3PDT                  | 470                    | <b>D5RR3T1</b> |

## Accessories

## D5 Sockets and Accessories

| Type                      | Module Size | Nominal Voltage (Max. for Sockets) | Nominal Current | Mounting Style | Wire Size                                 | Wire Connection | Standard Pack | Catalog Number    |
|---------------------------|-------------|------------------------------------|-----------------|----------------|---|-----------------|---------------|-------------------|
| Socket                    | A           | 300                                | 25              | DIN rail       | 10 /14 (2) AWG, 6/2.5 (2) mm <sup>2</sup> | Elevator        | 10            | <b>D5PAL</b> ①    |
|                           | None        | 300                                | 15              | DIN rail/panel | 12/14 (2) AWG, 4/2.5 (2) mm <sup>2</sup>  | Screw clamping  | 10            | <b>D5PA2</b>      |
|                           | None        | 300                                | 15              | Chassis        | (Output): 16 AWG, 1 mm <sup>2</sup>       | Solder          | 10            | <b>D5PA3L</b>     |
|                           | None        | 300                                | 15              | Chassis        | (Output): 16 AWG, 1 mm <sup>2</sup>       | Solder          | 10            | <b>D5PA3S</b>     |
| Metal spring clip         | —           | —                                  | —               | —              | —   | —               | 10            | <b>PQC-1351</b>   |
| Protection diode          | A           | 6 to 250 Vdc                       | —               | —              | —   | —               | 20            | <b>MOD-AD250</b>  |
| LED indicator             | A           | 24 Vac/Vdc                         | —               | —              | —   | —               | 20            | <b>MOD-ALG24</b>  |
|                           | A           | 120/240 Vac/Vdc                    | —               | —              | —   | —               | 20            | <b>MOD-ALG240</b> |
| MOV suppressor            | A           | 120 Vac/Vdc                        | —               | —              | —   | —               | 20            | <b>MOD-AMV120</b> |
|                           | A           | 24 Vac/Vdc                         | —               | —              | —   | —               | 20            | <b>MOD-AMV24</b>  |
|                           | A           | 240 Vac/Vdc                        | —               | —              | —   | —               | 20            | <b>MOD-AMV240</b> |
| R/C suppressor            | A           | 6 to 24 Vac/Vdc                    | —               | —              | —   | —               | 20            | <b>MOD-RC24</b>   |
|                           | A           | 110 to 240 Vac/Vdc                 | —               | —              | —   | —               | 20            | <b>MOD-RC240</b>  |
| Write-on plastic labels   | —           | —                                  | —               | —              | —   | —               | 10            | <b>PWF-D3D5</b>   |
| Coil bus jumpers          | —           | —                                  | —               | —              | —   | —               | 10            | <b>D3PJ1</b>      |
| Plastic DIN rail end stop | —           | —                                  | —               | —              | —   | —               | 25            | <b>PFP-P</b>      |

**Note**

① Protection category (finger safe), EN 60529: IP20.

## Technical Data and Specifications

### D5 Series

| Description  | D5RR  | D5RF  |
|--|---|---|
| <b>Contact Characteristics</b>                       |   |   |
| Contact rating                                       | 10 A  | 10 A  |
| Terminal style                                       | Plug-in                                     | Plug-in   |
| Contact materials                                    | Silver alloy                                | Silver alloy  |
| Maximum switching voltage                            | 300 V                                       | 300 V   |
| Switching current at voltage—resistive               |   |   |
|  | 16 A at 277 Vac 50/60 Hz                    | 16 A at 277 Vac 50/60 Hz  |
|  | 16 A at 120 Vac 50/60 Hz                    | 16 A at 120 Vac 50/60 Hz  |
|  | 16 A at 28 Vdc                              | 16 A at 28 Vdc  |
| Switching current at voltage                         | 1/2 hp at 240 Vac                           | 1/2 hp at 240 Vac   |
|  | 1/3 hp at 120 Vac                           | 1/3 hp at 120 Vac   |
| Pilot duty   | B300  | B300  |
| Minimum switching requirement                        | 100 mA at 5 Vdc (0.5 W)                     | 100 mA at 5 Vdc (0.5 W)   |
| <b>Coil Characteristics</b>                          |   |   |
| Operating range                                      |   |   |
| % of nominal (AC)                                    | 85 to 110%                                  | 85 to 110%  |
| % of nominal (DC)                                    | 80 to 110%                                  | 80 to 110%  |
| Average consumption                                  | 3 VA<br>1.4 W                               | 3 VA<br>1.4 W   |
| Drop-out voltage threshold                           | 10%/15% (AC)<br>10% (DC)                    | 10%/15% (AC)<br>10% (DC)  |
| <b>Performance</b>                                   |   |   |
| Electrical life (UL 508) operations at rated current | 100,000 operations                          | 100,000 operations  |
| Mechanical life operations unpowered                 | 5,000,000 operations                        | 5,000,000 operations  |
| Response time  | 20 ms                                       | 20 ms   |
| Dielectric strength                                  |   |   |
| Between coil and contact Vac (rms)                   | 1500 V (rms)                                | 1500 V (rms)  |
| Between poles Vac (rms)                              | 1500 V (rms)                                | 1500 V (rms)  |
| <b>Environment</b>                                   |   |   |
| Ambient air temperature around the device            |   |   |
| Storage  | −40 °F to +185 °F (−40 °C to +85 °C)        | −40 °F to +185 °F (−40 °C to +85 °C)  |
| Operation  | −40 °F to +131 °F (−40 °C to +55 °C)        | −40 °F to +131 °F (−40 °C to +55 °C)  |
| Vibration resistance—operational                     | 3 g-n at 10–55 Hz                           | 3 g-n at 10–55 Hz   |
| Shock resistance                                     | 10 g-n                                      | 10 g-n  |
| Degree of protection                                 | IP40  | IP40  |
| <b>Features</b>                                      |   |   |
| Cover options  | Flange/plain cover with LED                 | Full featured   |
| Features   | Mechanical flag indicator<br>(LED optional) | Bipolar LED/<br>Mechanical flag indicator/<br>Locking pushbutton/<br>Removable ID tag |
| Product certifications                               | RoHS/UL/CE/CSA                              | RoHS/UL/CE/CSA  |



### Wiring Diagrams

#### D5PA3L and D5PA3S

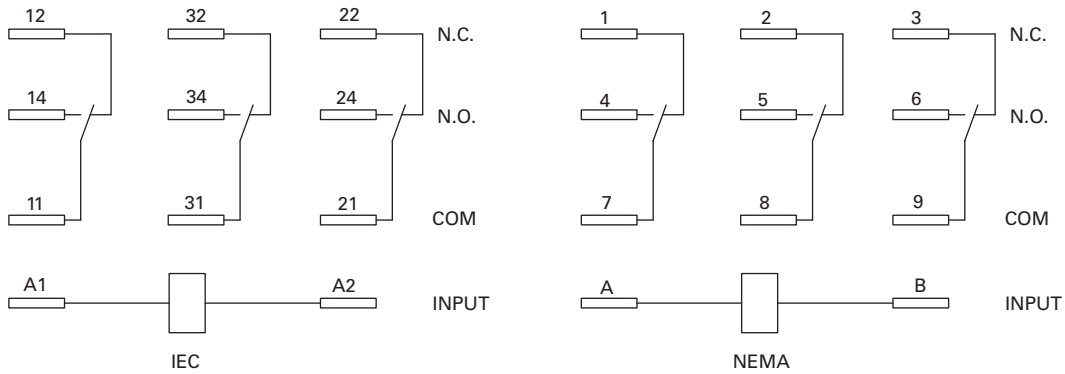

#### D5RR2/D5RF2 DPDT

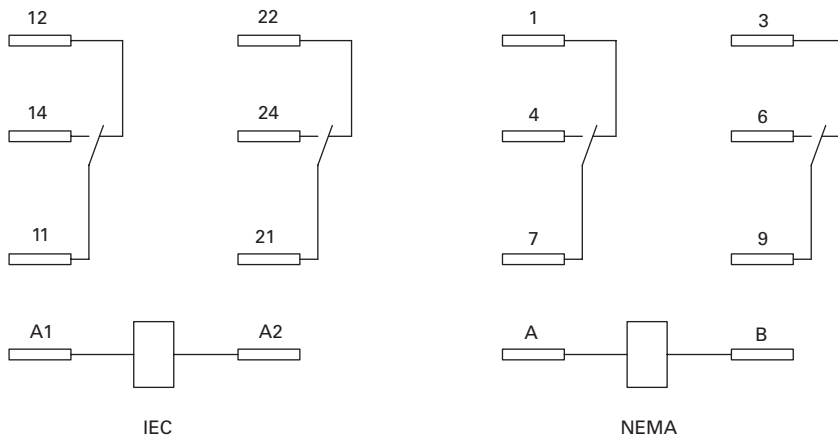

#### D5RR3/D5RF3 3PDT

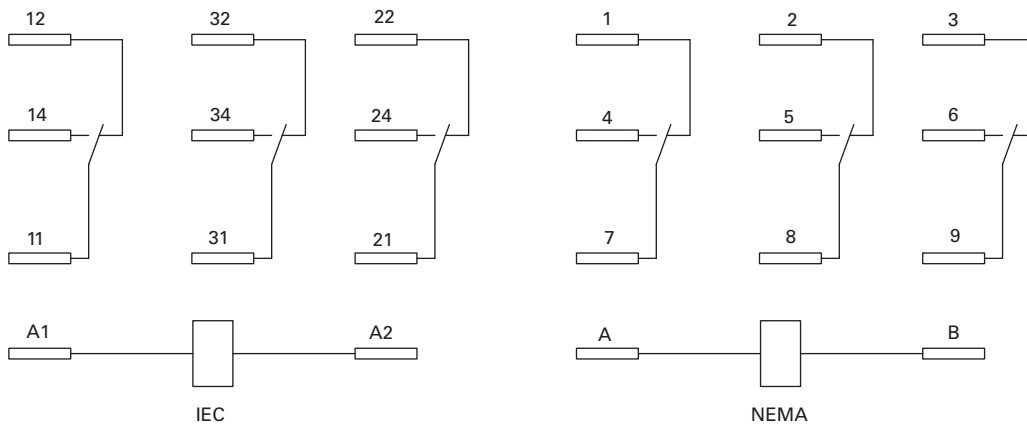

# 3.4

## Control Relays and Timers

### General Purpose Plug-In Relays

#### Dimensions

Approximate Dimensions in Inches (mm)

#### D5RR and D5RF

3

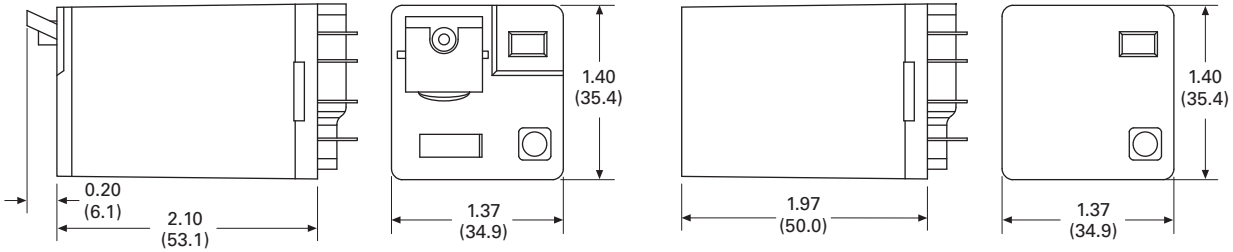

#### D5PA2

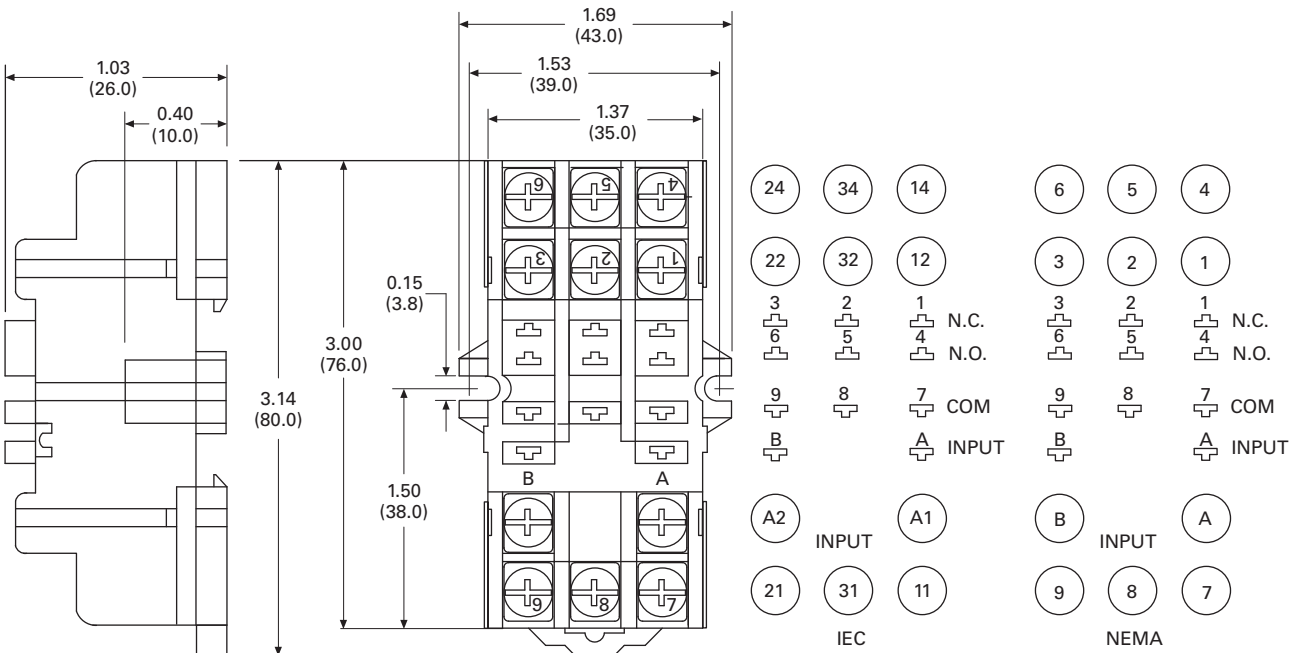

Approximate Dimensions in Inches (mm)

### D5PA3L and D5PA3S

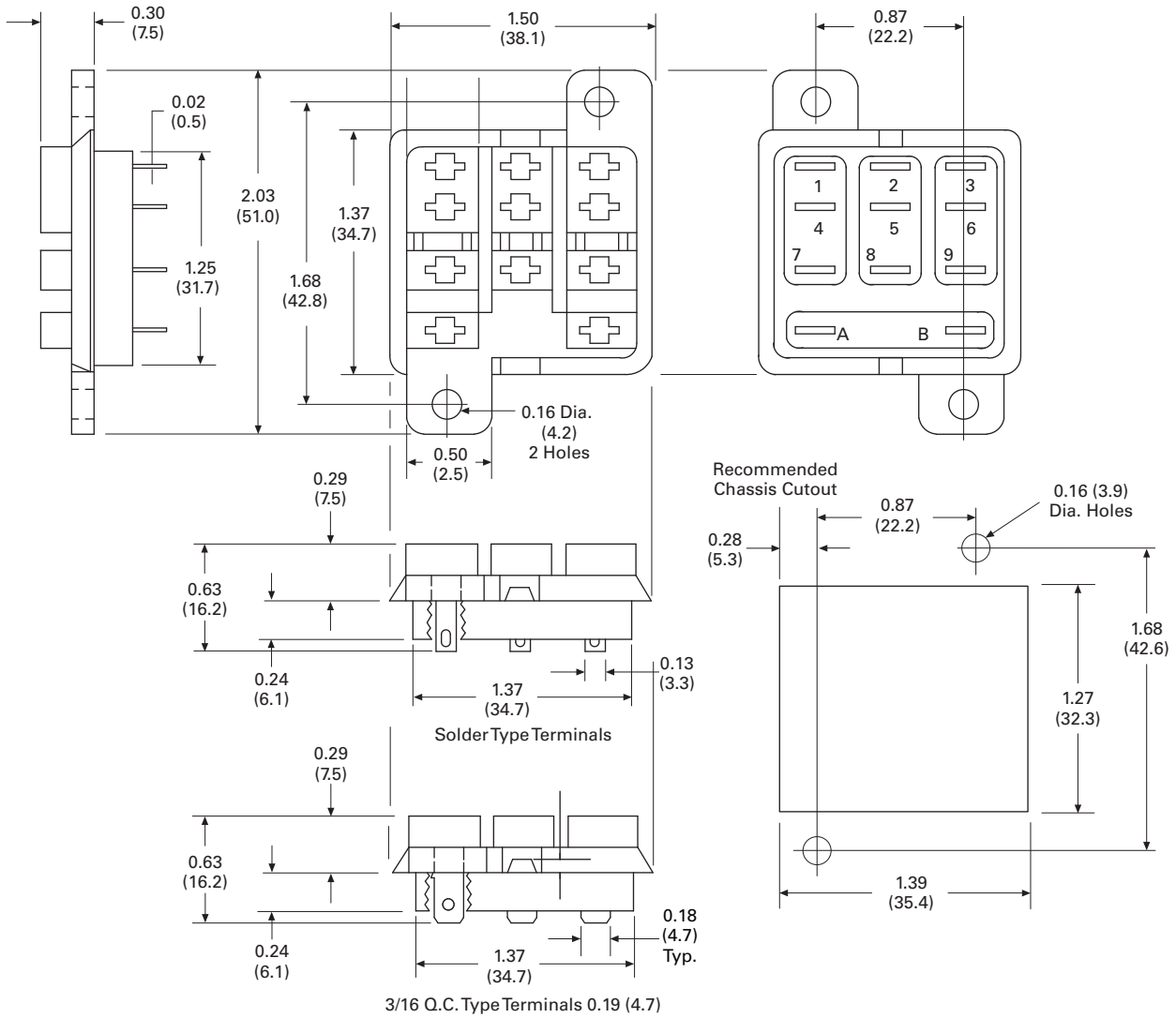

# 3.4

## Control Relays and Timers

### General Purpose Plug-In Relays

Approximate Dimensions in Inches (mm)

#### D5PAL

3

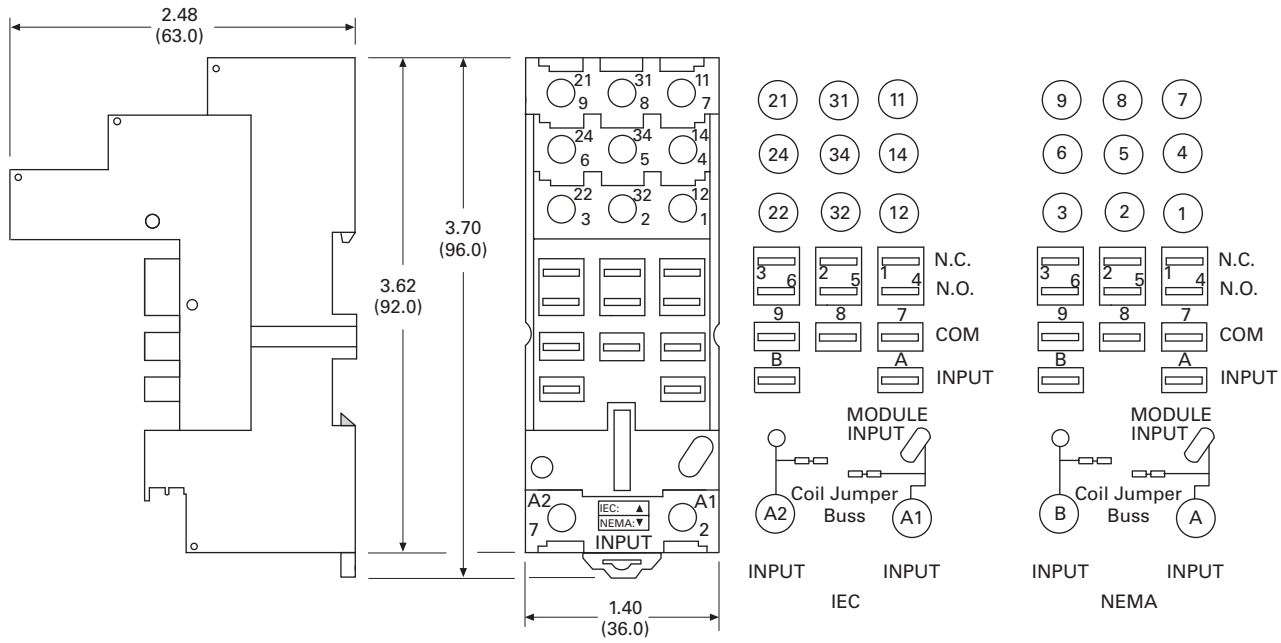

## D7 Series Relay



## D7PR/D7PF Series

## Product Description

The D7 Series is a cost-effective control relay with high dielectric strength and high current-carrying capacity.

## Features

**D7PR**

- Arc barrier equipped relay with high dielectric strength
- Panel and DIN rail mounting

## Contents

| <b>Description</b>                          | <b>Page</b> |
|---|-------------|
| D1RR/D1RF Series . . . . .                  | V7-T3-53    |
| D2RR/D2RF Series . . . . .                  | V7-T3-57    |
| D3RR/D3RF Series . . . . .                  | V7-T3-67    |
| D4 Series . . . . .                         | V7-T3-76    |
| D5RR/D5RF Series . . . . .                  | V7-T3-80    |
| D7PR/D7PF Series                            |             |
| Catalog Number Selection . . . . .          | V7-T3-90    |
| Product Selection . . . . .                 | V7-T3-90    |
| Accessories . . . . .                       | V7-T3-92    |
| Technical Data and Specifications . . . . . | V7-T3-93    |
| Wiring Diagrams . . . . .                   | V7-T3-95    |
| Dimensions . . . . .                        | V7-T3-96    |
| D8 Series . . . . .                         | V7-T3-103   |
| D9 Series . . . . .                         | V7-T3-108   |
| Accessories . . . . .                       | V7-T3-112   |

**D7PF**

- Flag indicator shows relay status in manual or powered condition
- Bipolar LED status lamp allows for reverse polarity applications
  - Shows coil ON or OFF status
  - Ideal in low light conditions
- Color-coded pushbutton identifies AC coils with red or DC coils with blue pushbuttons
  - Allows for manual operation of relay without the need for coil power
  - Ideal for field service personnel to test control circuits
- Lock-down door, when activated, holds pushbutton and contacts in the operate position
  - Excellent for analyzing circuit problems
- Finger-grip cover allows operator to remove relays from sockets more easily than conventional relays
- White plastic ID tag/write label used for identification of relays in multi-relay circuits

## Standards and Certifications

 File # E37317, E65657

 File # LR217017, LR217069



 RoHS COMPLIANT

# 3.4

## Control Relays and Timers

### General Purpose Plug-In Relays

#### Catalog Number Selection

##### D7 Series

3

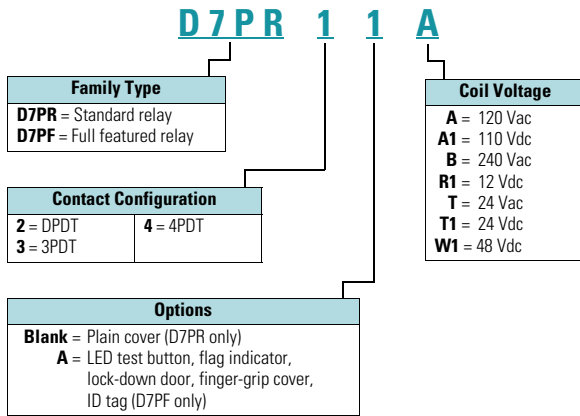

#### Product Selection

##### D7 Relay/Socket Quick Reference

| Relay Type   | Socket/Adapter | Clip      | Module Type | ID Tag | Jumper |
|--------------|----------------|-----------|-------------|--------|--------|
| D7PR2, D7PF2 | D7PAA          | PQC-1342  | B           | —      | —      |
|              |                | PQC-1349  | B           | —      | —      |
|              | D7PA9          | PQC-1342  | None        | —      | —      |
|              |                | PFC-D2D72 | —           | None   | —      |
| D7PR3, D7PF3 | D7PAB          | PQC-1783  | A           | —      | —      |
|              |                | PMC-1783  | A           | —      | —      |
|              | PFC-D73        | —         | None        | —      | —      |
| D7PR4, D7PF4 | D7PAD          | PQC-1784  | A           | —      | —      |
|              |                | PMC-1784  | A           | —      | —      |
|              | PFC-D74        | —         | None        | —      | —      |

## D7 Series Relay



## D7 Series

| Coil Voltage         | Contact Configuration | Coil Resistance (Ohms) | Catalog Number  |
|----------------------|-----------------------|------------------------|-----------------|
| <b>Full Featured</b> |                       |                        |                 |
| 120 Vac              | DPDT                  | 4430                   | <b>D7PF2AA</b>  |
| 110/125 Vdc          | DPDT                  | 11,000                 | <b>D7PF2AA1</b> |
| 220/240 Vac          | DPDT                  | 15,720                 | <b>D7PF2AB</b>  |
| 12 Vdc               | DPDT                  | 160                    | <b>D7PF2AR1</b> |
| 24 Vac               | DPDT                  | 180                    | <b>D7PF2AT</b>  |
| 24 Vdc               | DPDT                  | 650                    | <b>D7PF2AT1</b> |
| 24 Vac               | 3PDT                  | 103                    | <b>D7PF3AT</b>  |
| 24 Vdc               | 3PDT                  | 400                    | <b>D7PF3AT1</b> |
| 120 Vac              | 4PDT                  | 2220                   | <b>D7PF4AA</b>  |
| 110/125 Vdc          | 4PDT                  | 7340                   | <b>D7PF4AA1</b> |
| 240 Vac              | 4PDT                  | 9120                   | <b>D7PF4AB</b>  |
| 12 Vdc               | 4PDT                  | 96                     | <b>D7PF4AR1</b> |
| 24 Vac               | 4PDT                  | 84.5                   | <b>D7PF4AT</b>  |
| 24 Vdc               | 4PDT                  | 388                    | <b>D7PF4AT1</b> |
| 48 Vac               | 4PDT                  | 410                    | <b>D7PF4AW1</b> |
| <b>Plain Cover</b>   |                       |                        |                 |
| 120 Vac              | DPDT                  | 4430                   | <b>D7PR2A</b>   |
| 110/125 Vdc          | DPDT                  | 11,000                 | <b>D7PR2A1</b>  |
| 12 Vdc               | DPDT                  | 160                    | <b>D7PR2R1</b>  |
| 24 Vac               | DPDT                  | 180                    | <b>D7PR2T</b>   |
| 24 Vdc               | DPDT                  | 650                    | <b>D7PR2T1</b>  |
| 120 Vac              | 3PDT                  | 2770                   | <b>D7PR3A</b>   |
| 240 Vac              | 3PDT                  | 12,100                 | <b>D7PR3B</b>   |
| 12 Vdc               | 3PDT                  | 100                    | <b>D7PR3R1</b>  |
| 24 Vac               | 3PDT                  | 103                    | <b>D7PR3T</b>   |
| 24 Vdc               | 3PDT                  | 400                    | <b>D7PR3T1</b>  |
| 120 Vac              | 4PDT                  | 2220                   | <b>D7PR4A</b>   |
| 110/125 Vdc          | 4PDT                  | 7340                   | <b>D7PR4A1</b>  |
| 240 Vac              | 4PDT                  | 9120                   | <b>D7PR4B</b>   |
| 24 Vac               | 4PDT                  | 84.5                   | <b>D7PR4T</b>   |
| 24 Vdc               | 4PDT                  | 388                    | <b>D7PR4T1</b>  |

# 3.4

## Control Relays and Timers

### General Purpose Plug-In Relays

#### Accessories

##### D7 Sockets and Accessories

3

| Type                      | Module Size | Nominal Voltage (Max. for Sockets) | Nominal Current | Mounting Style | Wire Size                                | Wire Connection | Standard Pack   | Catalog Number    |
|---------------------------|-------------|------------------------------------|-----------------|----------------|--|-----------------|-----------------|-------------------|
| Socket                    | B           | 300                                | 16              | DIN rail/panel | 12/14 (2) AWG, 4/2.5 (2) mm <sup>2</sup> | Screw clamping  | —               | <b>D7PAA</b> ①    |
|                           | None        | 300                                | 10              | DIN rail/panel | 12/14 (2) AWG, 4/2.5 (2) mm <sup>2</sup> | Screw clamping  | 1               | <b>D7PA9</b>      |
|                           | A           | 300                                | 16              | DIN rail/panel | 12/14 (2) AWG, 4/2.5 (2) mm <sup>2</sup> | Screw clamping  | —               | <b>D7PAD</b> ①    |
|                           | A           | 300                                | 16              | DIN rail/panel | 12/14 (2) AWG, 4/2.5 (2) mm <sup>2</sup> | Screw clamping  | —               | <b>D7PAB</b> ①    |
| Flange mount adapter      | —           | —                                  | —               | Flange         | —  | —               | 25              | <b>PFC-D2D72</b>  |
|                           | —           | —                                  | —               | Flange         | —  | —               | 25              | <b>PFC-D73</b>    |
|                           | —           | —                                  | —               | Flange         | —  | —               | 25              | <b>PFC-D74</b>    |
| Metal spring clip         | —           | —                                  | —               | —              | —  | 25              | <b>PQC-1342</b> |                   |
| Plastic ID clip           | —           | —                                  | —               | —              | —  | 10              | <b>PQC-1349</b> |                   |
| Metal spring clip         | —           | —                                  | —               | —              | —  | 25              | <b>PQC-1784</b> |                   |
| Plastic ID clip           | —           | —                                  | —               | —              | —  | 10              | <b>PMC-1784</b> |                   |
| Hold-down spring          | —           | —                                  | —               | —              | —  | 25              | <b>PYC-B2</b>   |                   |
| Metal spring clip         | —           | —                                  | —               | —              | —  | 10              | <b>PQC-1783</b> |                   |
| Plastic ID clip           | —           | —                                  | —               | —              | —  | 10              | <b>PMC-1783</b> |                   |
| Protection diode          | A           | 6 to 250 Vdc                       | —               | —              | —  | —               | 20              | <b>MOD-AD250</b>  |
| LED indicator             | A           | 24 Vac/Vdc                         | —               | —              | —  | —               | 20              | <b>MOD-ALG24</b>  |
|                           | A           | 120/240 Vac/Vdc                    | —               | —              | —  | —               | 20              | <b>MOD-ALG240</b> |
| MOV suppressor            | A           | 120 Vac/Vdc                        | —               | —              | —  | —               | 20              | <b>MOD-AMV120</b> |
|                           | A           | 24 Vac/Vdc                         | —               | —              | —  | —               | 20              | <b>MOD-AMV24</b>  |
|                           | A           | 240 Vac/Vdc                        | —               | —              | —  | —               | 20              | <b>MOD-AMV240</b> |
| R/C suppressor            | A           | 6 to 24 Vac/Vdc                    | —               | —              | —  | —               | 20              | <b>MOD-RC24</b>   |
|                           | A           | 110 to 240 Vac/Vdc                 | —               | —              | —  | —               | 20              | <b>MOD-RC240</b>  |
| Protection diode          | B           | 6 to 250 Vdc                       | —               | —              | —  | —               | 20              | <b>MOD-BD250</b>  |
| LED indicator             | B           | 24 Vac/Vdc                         | —               | —              | —  | —               | 20              | <b>MOD-BLG24</b>  |
|                           | B           | 120/240 Vac/Vdc                    | —               | —              | —  | —               | 20              | <b>MOD-BLG240</b> |
| MOV suppressor            | B           | 120 Vac/Vdc                        | —               | —              | —  | —               | 20              | <b>MOD-BMV120</b> |
|                           | B           | 24 Vac/Vdc                         | —               | —              | —  | —               | 20              | <b>MOD-BMV24</b>  |
|                           | B           | 240 Vac/Vdc                        | —               | —              | —  | —               | 20              | <b>MOD-BMV240</b> |
| Plastic DIN rail end stop | —           | —                                  | —               | —              | —  | 25              | <b>PPF-P</b>    |                   |

**Note**

① Protection category (finger safe), EN 60529: IP20.



## Technical Data and Specifications

### D7PR Relay

| Description  | D7PR (DPDT)                                 | D7PR (3PDT)                                 | D7PR (4PDT)                                 |
|--|---|---|---|
| <b>Contact Characteristics</b>                       |   |   |   |
| Contact rating                                       | 15 A  | 15 A  | 15 A  |
| Terminal style                                       | Plug-in                                     | Plug-in                                     | Plug-in                                     |
| Contact materials                                    | Silver alloy                                | Silver alloy                                | Silver alloy                                |
| Maximum switching voltage                            | 300 V                                       | 300 V                                       | 300 V                                       |
| Switching current at voltage—resistive               | 15 A at 120 Vac 50/60 Hz                    | 15 A at 120 Vac 50/60 Hz                    | 15 A at 120 Vac 50/60 Hz                    |
|  | 12 A at 277 Vac 50/60 Hz                    | 12 A at 277 Vac 50/60 Hz                    | 12 A at 277 Vac 50/60 Hz                    |
|  | 10 A at 277 Vac 50/60 Hz                    | —   | —   |
|  | 12 A at 28 Vdc                              | 12 A at 28 Vdc                              | 12 A at 28 Vdc                              |
| Switching current at voltage                         | 1/2 hp at 120 Vac                           | 1/2 hp at 120 Vac                           | 1/2 hp at 120 Vac                           |
|  | 1 hp at 250 Vac                             | 3/4 hp at 250 Vac                           | 3/4 hp at 250 Vac                           |
| Pilot duty   | B300  | B300  | B300  |
| Minimum switching requirement                        | 100 mA at 5 Vdc (0.5 W)                     | 100 mA at 5 Vdc (0.5 W)                     | 100 mA at 5 Vdc (0.5 W)                     |
| <b>Coil Characteristics</b>                          |   |   |   |
| Operating range                                      |   |   |   |
| % of nominal (AC)                                    | 85 to 110%                                  | 85 to 110%                                  | 85 to 110%                                  |
| % of nominal (DC)                                    | 80 to 110%                                  | 80 to 110%                                  | 80 to 110%                                  |
| Average consumption                                  | 1.2 VA                                      | 1.5 VA                                      | 1.5 VA                                      |
|  | 0.9 W                                       | 1.4 W                                       | 1.5 W                                       |
| Dropout voltage threshold                            | 15% (AC)                                    | 15% (AC)                                    | 15% (AC)                                    |
|  | 10% (DC)                                    | 10% (DC)                                    | 10% (DC)                                    |
| <b>Performance</b>                                   |   |   |   |
| Electrical life (UL 508) operations at rated current | 100,000 operations                          | 200,000 operations                          | 200,000 operations                          |
| Mechanical life operations unpowered                 | 10,000,000 operations                       | 10,000,000 operations                       | 10,000,000 operations                       |
| Response time  | 20 ms                                       | 20 ms                                       | 20 ms                                       |
| Dielectric strength                                  |   |   |   |
| Between coil and contact Vac (rms)                   | 2500 V (rms)                                | 2500 V (rms)                                | 2500 V (rms)                                |
| Between poles Vac (rms)                              | 1500 V (rms)                                | 2500 V (rms)                                | 2500 V (rms)                                |
| <b>Environment</b>                                   |   |   |   |
| Ambient air temperature around the device            |   |   |   |
| Operation  | −40 °F to +131 °F<br>(−40 °C to +55 °C)     | −40 °F to +131 °F<br>(−40 °C to +55 °C)     | −40 °F to +131 °F<br>(−40 °C to +55 °C)     |
| Storage  | −40 °F to +185 °F<br>(−40 °C to +85 °C)     | −40 °F to +185 °F<br>(−40 °C to +85 °C)     | −40 °F to +185 °F<br>(−40 °C to +85 °C)     |
| Vibration resistance—operational                     | 3 g-n at 10–55 Hz                           | 3 g-n at 10–55 Hz                           | 3 g-n at 10–55 Hz                           |
| Shock resistance                                     | 10 g-n                                      | 10 g-n                                      | 10 g-n                                      |
| Degree of protection                                 | IP40  | IP40  | IP40  |
| <b>Features</b>                                      |   |   |   |
| Cover options  | Plain cover                                 | Plain cover                                 | Plain cover                                 |
| Features   | Mechanical flag indicator<br>(optional LED) | Mechanical flag indicator<br>(optional LED) | Mechanical flag indicator<br>(optional LED) |
| Product certifications                               | RoHS/UL/CE/CSA                              | RoHS/UL/CE/CSA                              | RoHS/UL/CE/CSA                              |

## D7PF Relay

| Description  | D7PF (DPDT)   | D7PF (3PDT)   | D7PF (4PDT)   |
|--|---|---|---|
| <b>Contact Characteristics</b>                       |   |   |   |
| Contact rating                                       | 15 A  | 15 A  | 15 A  |
| Terminal style                                       | Plug-in   | Plug-in   | Plug-in   |
| Contact materials                                    | Silver alloy  | Silver alloy  | Silver alloy  |
| Maximum switching voltage                            | 300 V   | 300 V   | 300 V   |
| Switching current at voltage—resistive               | 15 A at 120 Vac 50/60 Hz  | 15 A at 120 Vac 50/60 Hz  | 15 A at 120 Vac 50/60 Hz  |
|  | 12 A at 277 Vac 50/60 Hz  | 12 A at 277 Vac 50/60 Hz  | 12 A at 277 Vac 50/60 Hz  |
|  | 10 A at 277 Vac 50/60 Hz  | —   | —   |
|  | 12 A at 28 VDC  | 12 A at 28 Vdc  | 12 A at 28 Vdc  |
| Switching current at voltage                         | 1/2 hp at 120 Vac   | 3/4 hp at 250 Vac   | 1/2 hp at 120 Vac   |
|  | 1 hp at 250 Vac   | 1/2 hp at 120 Vac   | 3/4 hp at 250 Vac   |
| Pilot duty   | B300  | B300  | B300  |
| Minimum switching requirement                        | 100 mA at 5 Vdc (0.5 W)   | 100 mA at 5 Vdc (0.5 W)   | 100 mA at 5 Vdc (0.5 W)   |
| <b>Coil Characteristics</b>                          |   |   |   |
| Operating range                                      |   |   |   |
| % of nominal (AC)                                    | 85 to 110%  | 85 to 110%  | 85 to 110%  |
| % of nominal (DC)                                    | 80 to 110%  | 80 to 110%  | 80 to 110%  |
| Average consumption                                  | 1.2 VA  | 1.5 VA  | 1.5 VA  |
|  | 0.9 W   | 1.4 W   | 1.5 W   |
| Dropout voltage threshold                            | 15% (AC)  | 15% (AC)  | 15% (AC)  |
|  | 10% (DC)  | 10% (DC)  | 10% (DC)  |
| <b>Performance</b>                                   |   |   |   |
| Electrical life (UL 508) operations at rated current | 100,000 operations  | 200,000 operations  | 200,000 operations  |
| Mechanical life operations unpowered                 | 10,000,000 operations   | 10,000,000 operations   | 10,000,000 operations   |
| Response time  | 20 ms   | 20 ms   | 20 ms   |
| Dielectric strength                                  |   |   |   |
| Between coil and contact Vac (rms)                   | 2500 V (rms)  | 2500 V (rms)  | 2500 V (rms)  |
| Between poles Vac (rms)                              | 1500 V (rms)  | 2500 V (rms)  | 2500 V (rms)  |
| <b>Environment</b>                                   |   |   |   |
| Ambient air temperature around the device            |   |   |   |
| Operation  | −40 °F to +131 °F<br>(−40 ° to 55 °C)   | −40 °F to +131 °F<br>(−40 ° to 55 °C)   | −40 °F to +131 °F<br>(−40 ° to 55 °C)   |
| Storage  | −40 °F to +185 °F<br>(−40 ° to 85 °C)   | −40 °F to +185 °F<br>(−40 ° to 85 °C)   | −40 °F to +185 °F<br>(−40 ° to 85 °C)   |
| Vibration resistance—operational                     | 3 g-n at 10–55 Hz   | 3 g-n at 10–55 Hz   | 3 g-n at 10–55 Hz   |
| Shock resistance                                     | 10 g-n  | 10 g-n  | 10 g-n  |
| Degree of protection                                 | IP40  | IP40  | IP40  |
| <b>Features</b>                                      |   |   |   |
| Cover options  | Full featured   | Full featured   | Full featured   |
| Features   | Locking pushbutton/<br>Bipolar LED/<br>Removable ID tag/<br>Mechanical flag indicator | Locking pushbutton/<br>Bipolar LED/<br>Removable ID tag/<br>Mechanical flag indicator | Locking pushbutton/<br>Bipolar LED/<br>Removable ID tag/<br>Mechanical flag indicator |
| Product certifications                               | RoHS/UL/CE/CSA  | RoHS/UL/CE/CSA  | RoHS/UL/CE/CSA  |

### Wiring Diagrams

#### D7PR2/D7PF2

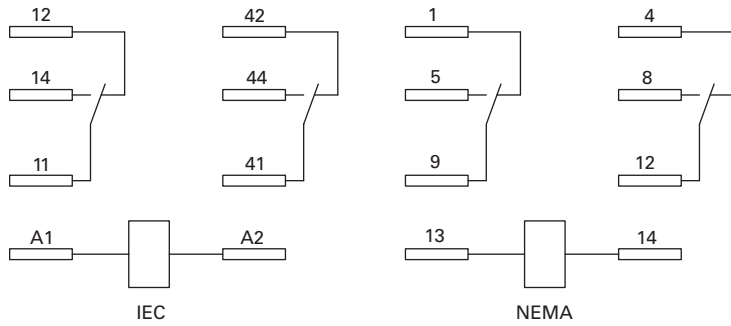

#### D7PR3/D7PF3

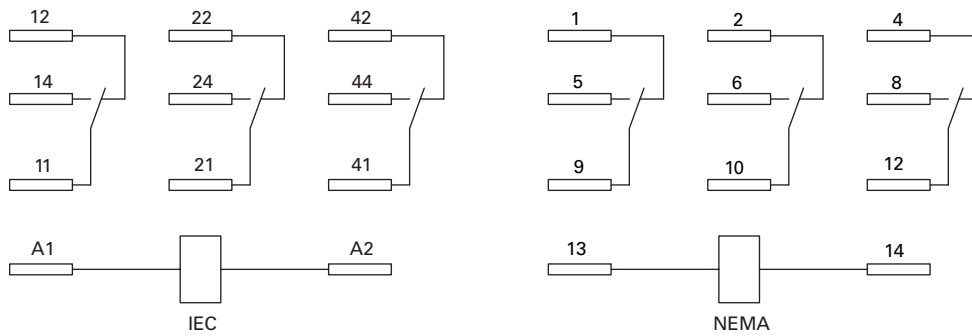

#### D7PR4/D7PF4

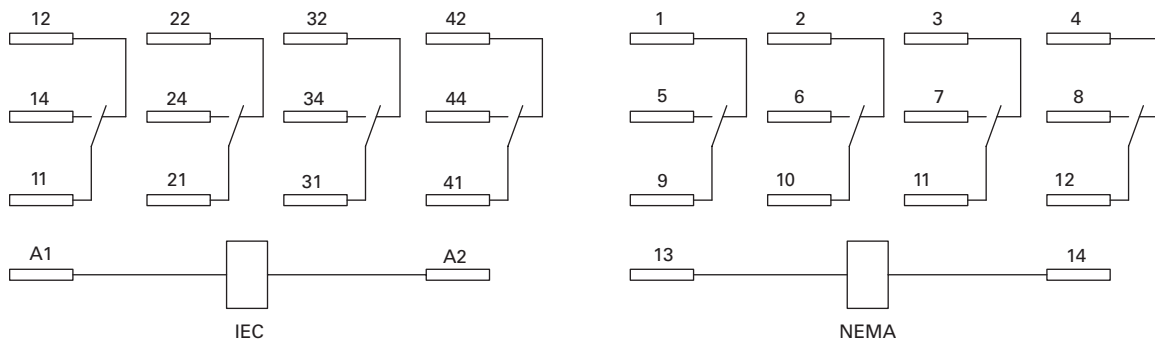

# 3.4

## Control Relays and Timers

### General Purpose Plug-In Relays

#### Dimensions

Approximate Dimensions in Inches (mm)

#### D7PR1/D7PF1

3

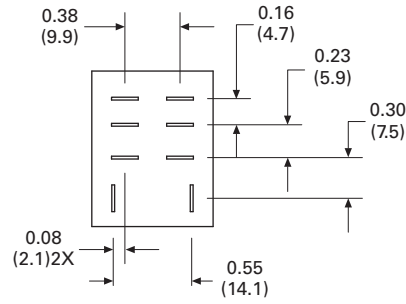
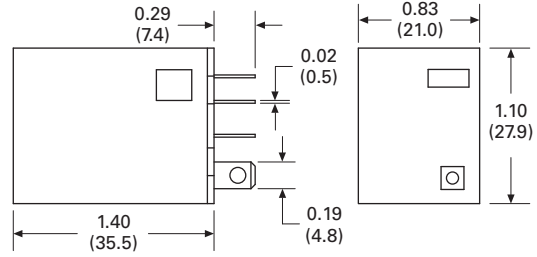
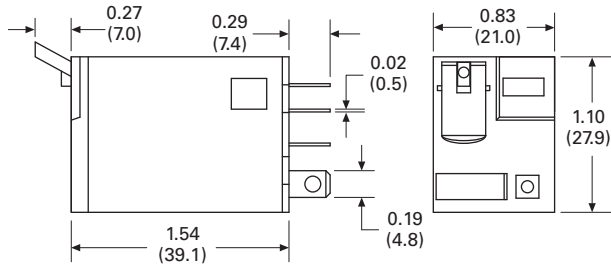

#### D7PR2/D7PF2

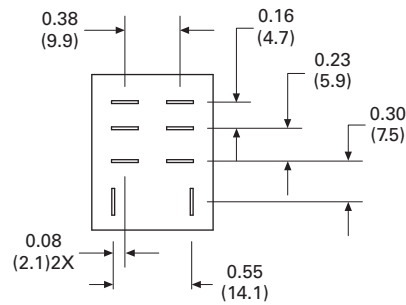
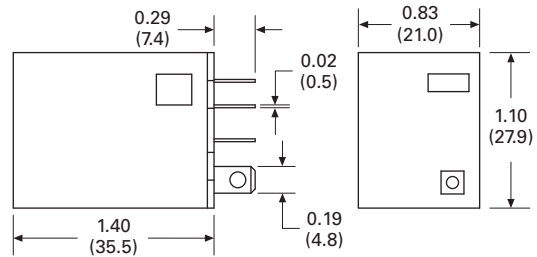
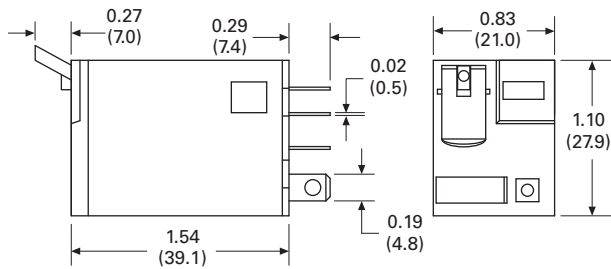

Approximate Dimensions in Inches (mm)

### D7PR3/D7PF3

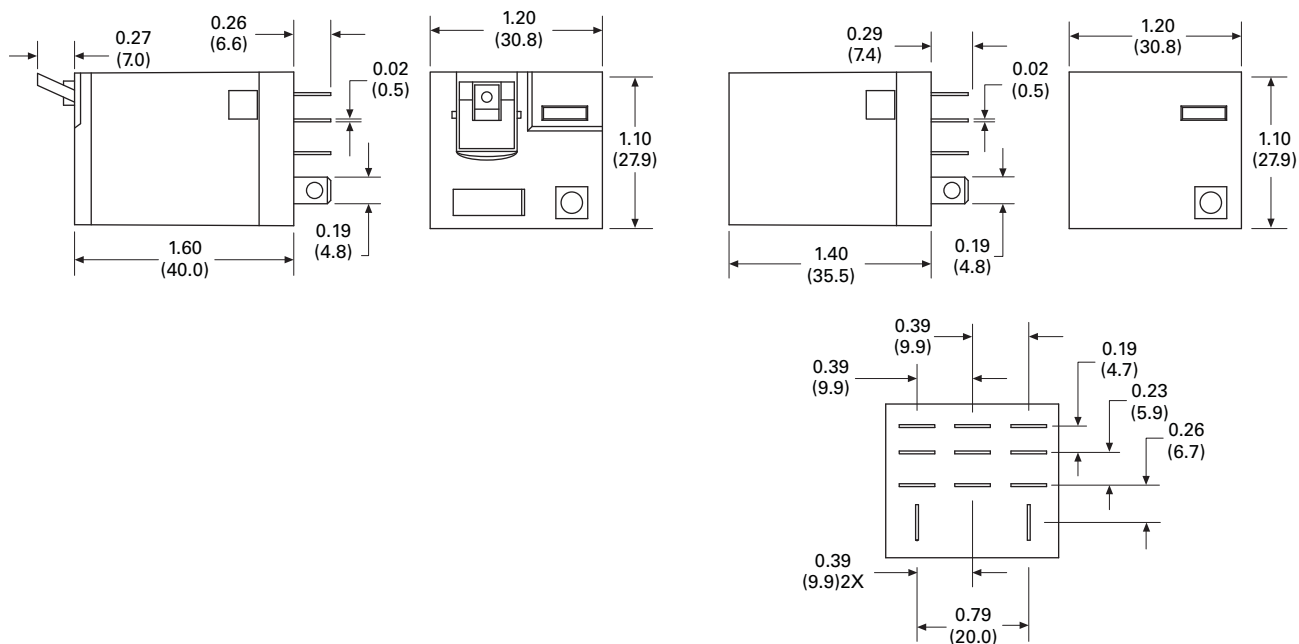

### D7PR4/D7PF4

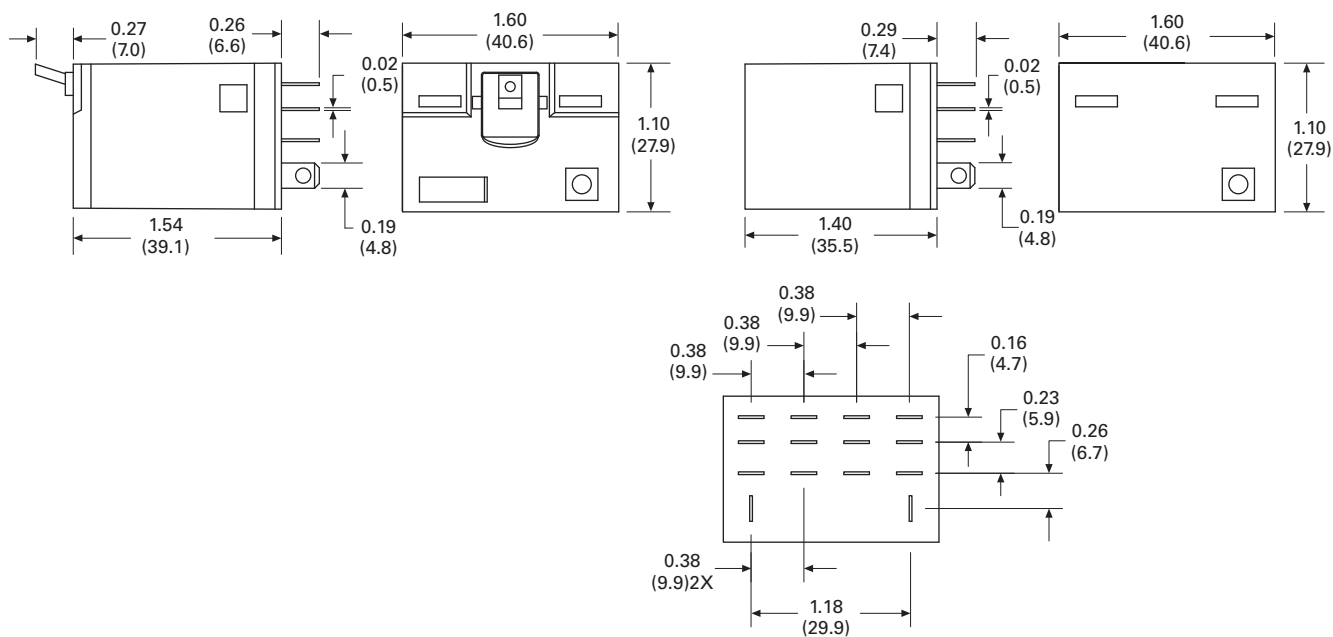

# 3.4

## Control Relays and Timers

### General Purpose Plug-In Relays

Approximate Dimensions in Inches (mm)

#### D7PA3

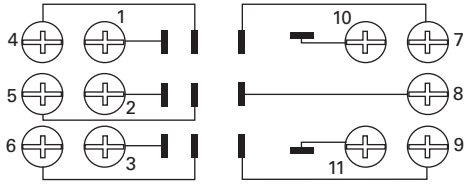

Wiring Diagram (Top View)

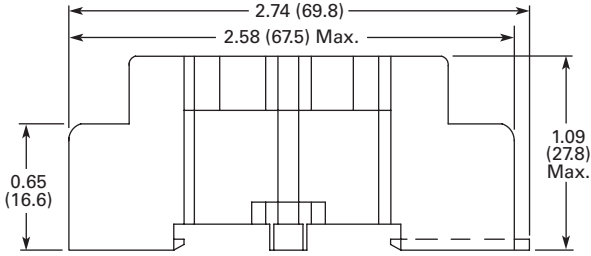

Combination Slotted/Phillips  
Head Screws 6-32 x 5/16"

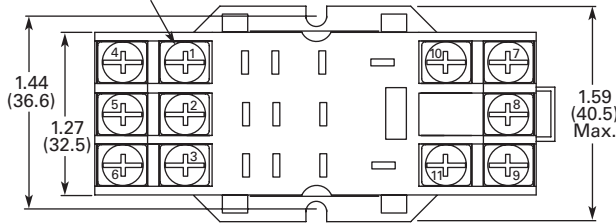

#### D7PA4

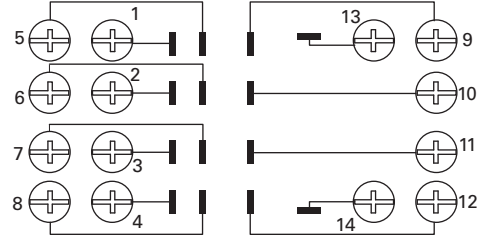

Wiring Diagram (Top View)

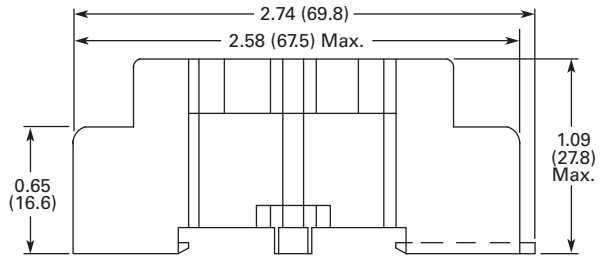

Combination Slotted/Phillips  
Head Screws 6-32 x 5/16"

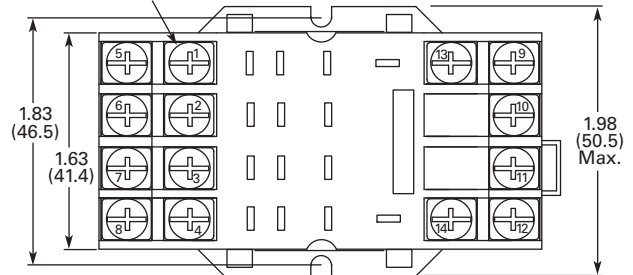

Approximate Dimensions in Inches (mm)

### D7PA9 Standard Mount

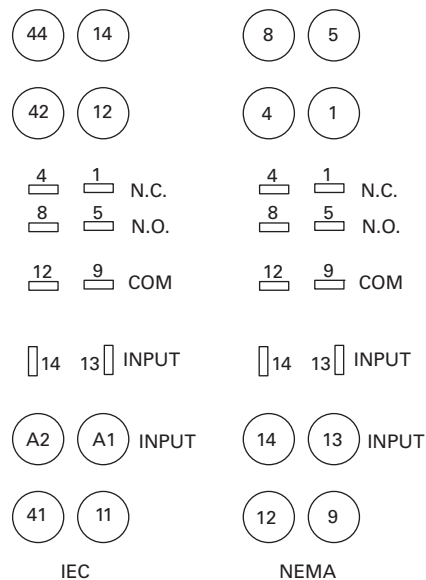
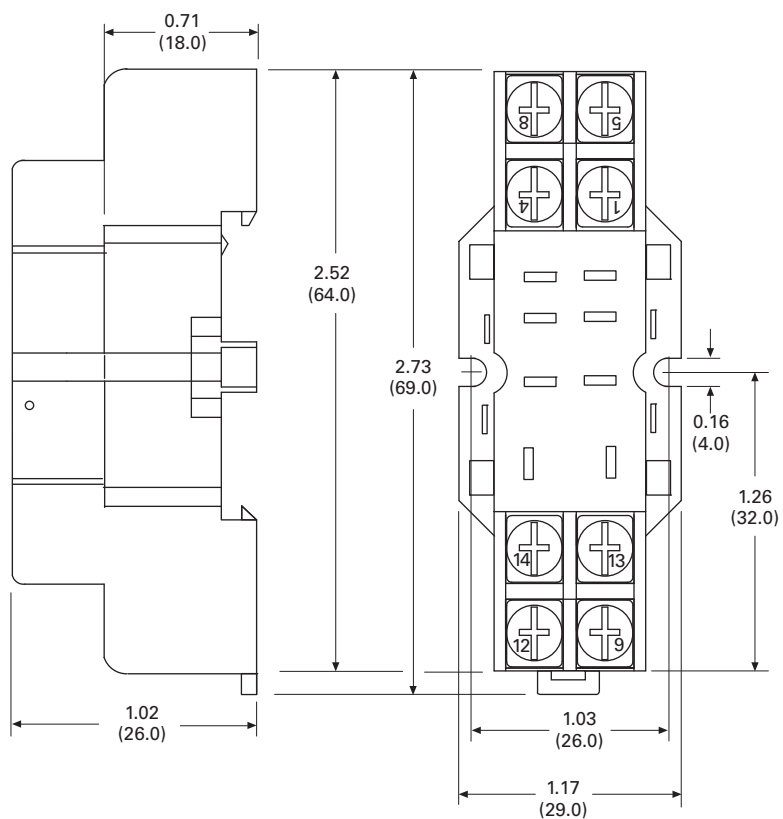

# 3.4

## Control Relays and Timers

### General Purpose Plug-In Relays

Approximate Dimensions in Inches (mm)

D7PAA

3

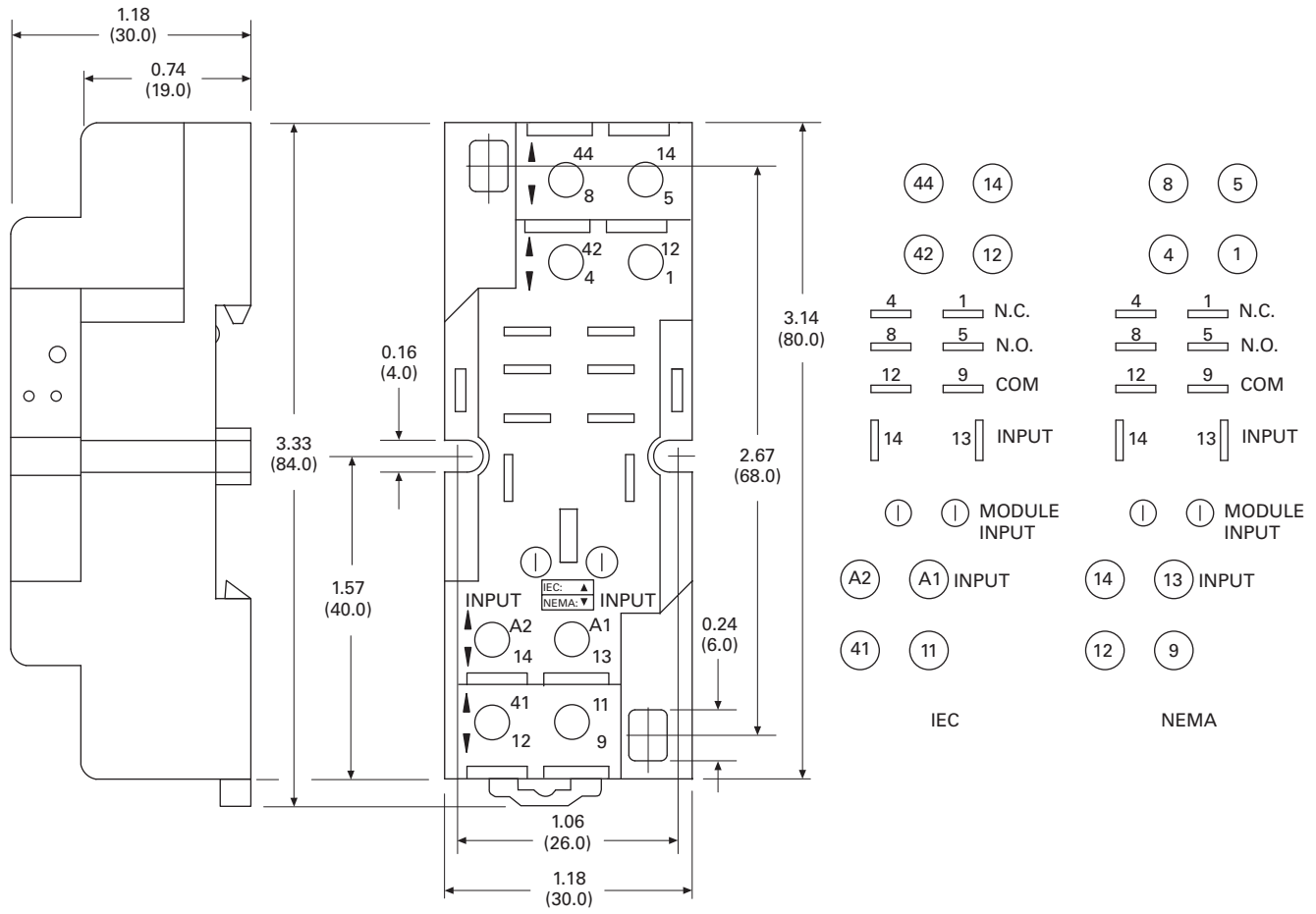



Approximate Dimensions in Inches (mm)

**D7PAB**

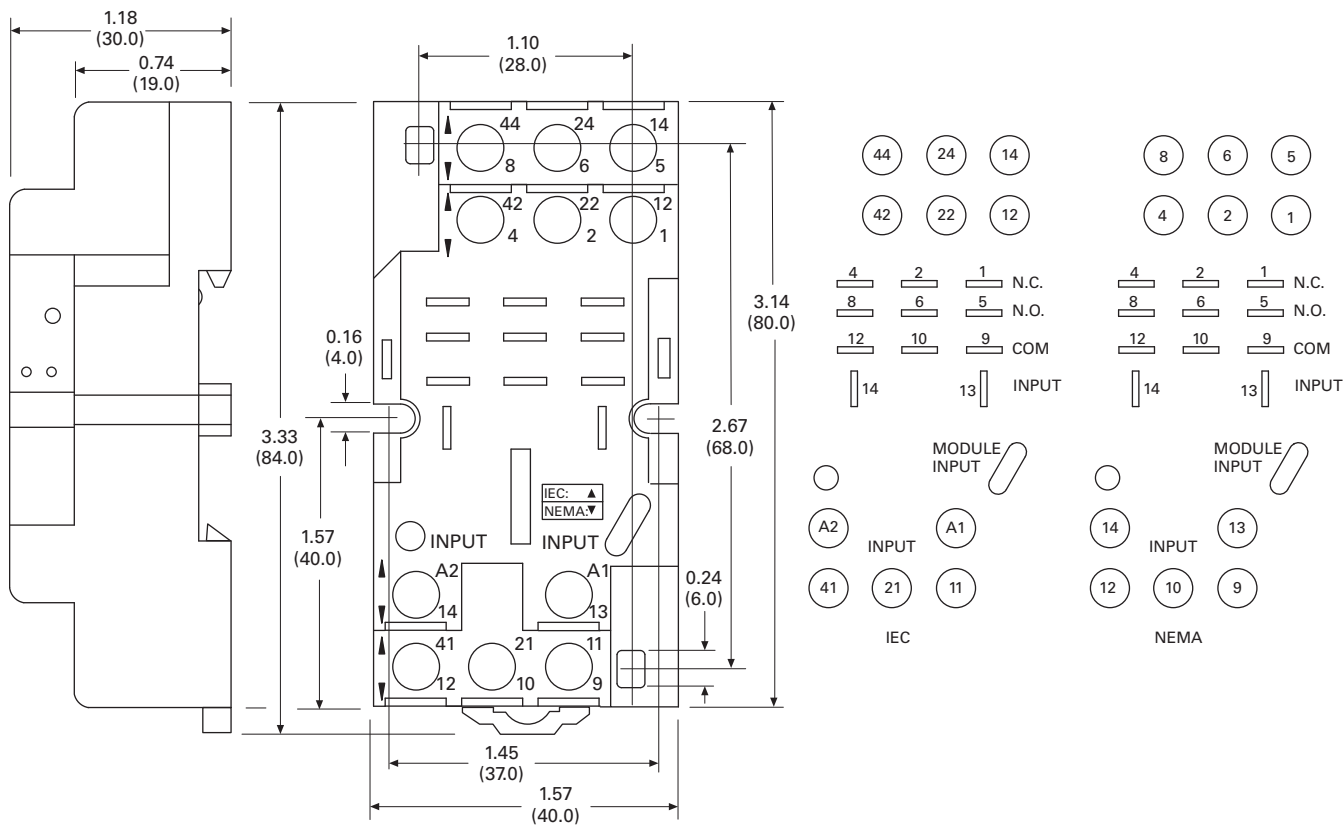

# 3.4

## Control Relays and Timers

### General Purpose Plug-In Relays

Approximate Dimensions in Inches (mm)

#### D7PAD

3

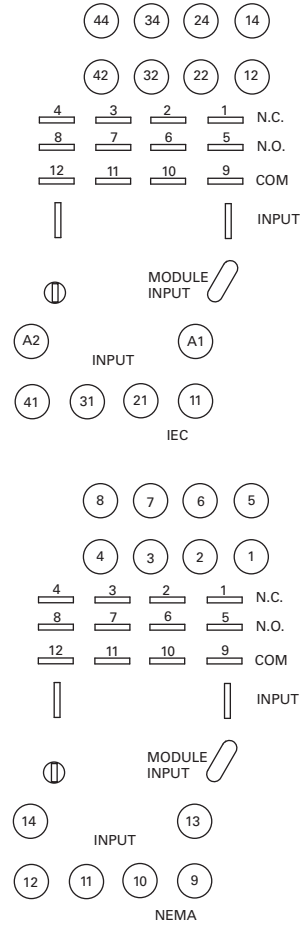
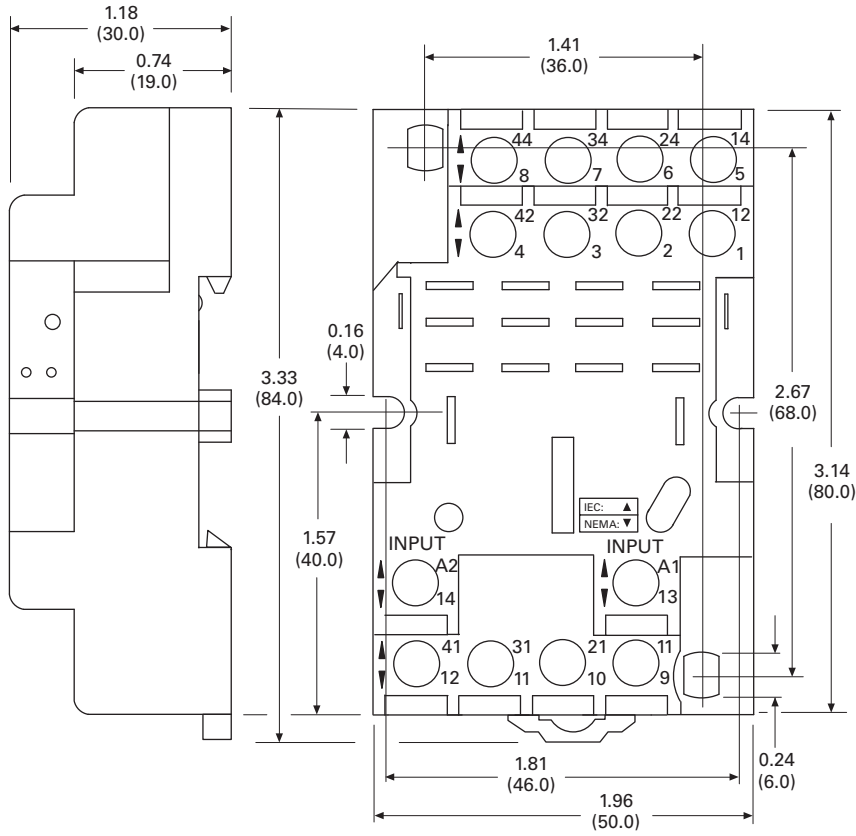

**D8 Series Relay****D8 Series****Product Description**

The D8 Series power relays are perfect for loads up to 30 A, with versions for flange mounting and e-clip mounting available.



**Features**

- Allows switching of 25 A and 30 A loads
- A high-capacity, high-withstand voltage relay compatible with momentary voltage drops
- No contact chattering for momentary voltage drops up to 50% of rated voltage
- UL Class B construction standard
- Wide-range AC-activated coil that handles 100 to 120 Vac at either 50 or 60 Hz
- Panel, DIN rail and flange mounting

**Contents****Description**

|   | <b>Page</b>      |
|---|------------------|
| D1RR/D1RF Series . . . . .                  | <b>V7-T3-53</b>  |
| D2RR/D2RF Series . . . . .                  | <b>V7-T3-57</b>  |
| D3RR/D3RF Series . . . . .                  | <b>V7-T3-67</b>  |
| D4 Series . . . . .                         | <b>V7-T3-76</b>  |
| D5RR/D5RF Series . . . . .                  | <b>V7-T3-80</b>  |
| D7PR/D7PF Series . . . . .                  | <b>V7-T3-89</b>  |
| D8 Series                                   |                  |
| Catalog Number Selection . . . . .          | <b>V7-T3-104</b> |
| Product Selection . . . . .                 | <b>V7-T3-104</b> |
| Technical Data and Specifications . . . . . | <b>V7-T3-105</b> |
| Dimensions . . . . .                        | <b>V7-T3-105</b> |
| D9 Series . . . . .                         | <b>V7-T3-108</b> |
| Accessories . . . . .                       | <b>V7-T3-112</b> |

**Standards and Certifications**

-  File # E1491
-  File # LR701520
- 

# 3.4

## Control Relays and Timers

### General Purpose Plug-In Relays

3

#### Catalog Number Selection

##### D8 Series ①

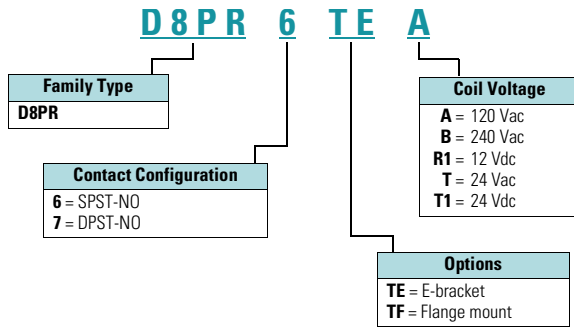

#### Product Selection

##### D8 Relay/Socket Quick Reference

| Relay Type | Mounting Bracket | Adapter Track/<br>Panel Mount | Front Connecting<br>Sockets Track/<br>Panel Mount |
|------------|------------------|-------------------------------|---|
| D8PR6TE    | D8PA5            | D8PA1                         | D8PA2   |
| D8PR7TE    | D8PA5            | D8PA1                         | D8PA2   |

##### D8 Series Relay



##### D8 Series ②

| Type                     | Standard Pack | Catalog Number   |
|--------------------------|---------------|------------------|
| <b>SPST E-Bracket</b>    |               |                  |
| Coil voltage             |               |                  |
| 24 Vac                   | 1             | <b>D8PR6TET</b>  |
| 24 Vdc                   | 1             | <b>D8PR6TET1</b> |
| <b>SPST Flange Mount</b> |               |                  |
| 120 Vac                  | 1             | <b>D8PR6TFA</b>  |
| 24 Vdc                   | 1             | <b>D8PR6TFT1</b> |
| <b>DPST E-Bracket</b>    |               |                  |
| Coil voltage             |               |                  |
| 120 Vac                  | 1             | <b>D8PR7TEA</b>  |
| <b>DPST Flange Mount</b> |               |                  |
| 120 Vac                  | 1             | <b>D8PR7TFA</b>  |
| 24 Vdc                   | 1             | <b>D8PR7TFT1</b> |
| <b>Sockets</b>           |               |                  |
| DIN rail adapter         | 10            | <b>D8PA1</b>     |
| Screw terminal adapter   | 10            | <b>D8PA2</b>     |
| Bracket adapter          | 10            | <b>D8PA5</b>     |
| <b>Accessory</b>         |               |                  |
| DIN rail end stop        | 100           | <b>PFP-M</b>     |

##### Notes

- ① For deciphering catalog numbers. Do not use for ordering as not all combinations are readily available.
- ② Additional coil voltages available—consult Sales Office or Customer Support Center.

### Technical Data and Specifications

#### Coil Resistance

| Coil Voltage | Ohms   | mA   |
|--------------|--------|------|
| 24 Vac       | 303    | 71   |
| 110/120 Vac  | 5260   | 20.4 |
| 220/240 Vac  | 21,000 | 10.2 |
| 12 Vdc       | 75     | 158  |
| 24 Vdc       | 303    | 79   |

#### D8 Relays

| Description                                   | D8PR6  | D8PR7  |
|---|--|--|
| Rated load                                    | 220 Vac 30 A                                 | 220 Vac 25 A                                 |
| Carry current                                 | 30 A   | 25 A   |
| Max. operating voltage                        | 250 Vac                                      | 250 Vac                                      |
| Max. switching current                        | 30 A   | 25 A   |
| Contact material                              | AgCdO  | AgCdO  |
| Max. switching capacity                       | 6600 VA                                      | 5500 VA                                      |
| Min. permissible load                         | 100 mA at 5 Vdc                              | 100 mA at 5 Vdc                              |
| Mechanical life (min.)                        | 5,000,000 operations                         | 5,000,000 operations                         |
| Electrical life at all contact ratings (min.) | 100,000 operations                           | 100,000 operations                           |
| Maximum hp ratings                            | 1-1/2 hp (120 Vac)<br>3 hp (240/265/277 Vac) | 1-1/2 hp (120 Vac)<br>3 hp (240/265/277 Vac) |

#### Coil Data

| Coil Voltage       | Must Operate | Must Release | Maximum Voltage |
|--------------------|--------------|--------------|-----------------|
| 24 Vdc/Vac, 12 Vdc | 75% maximum  | 15% minimum  | 110%            |
| 120 Vac            | 75 V         | 18 V         | 132 V           |
| 240 Vac            | 150 V        | 36 V         | 264 V           |

### Dimensions

Approximate Dimensions in Inches (mm)

#### D8PR6TF

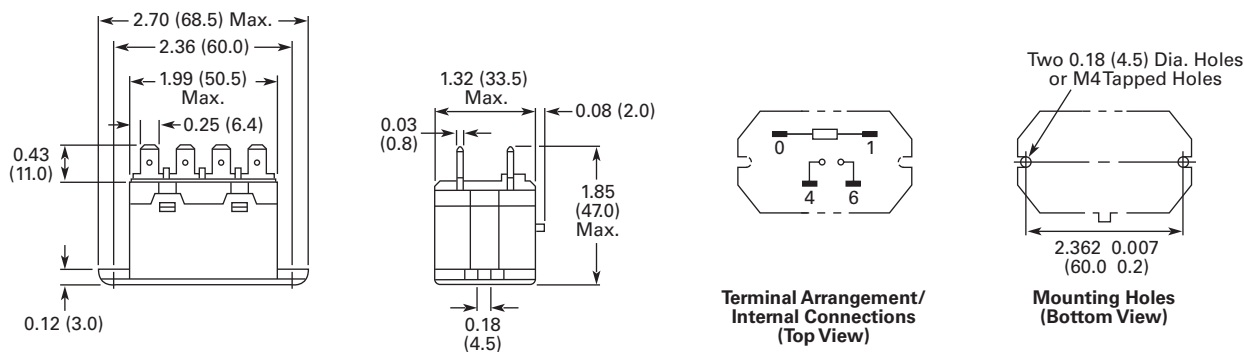

# 3.4

## Control Relays and Timers

### General Purpose Plug-In Relays

Approximate Dimensions in Inches (mm)

#### D8PR7TF

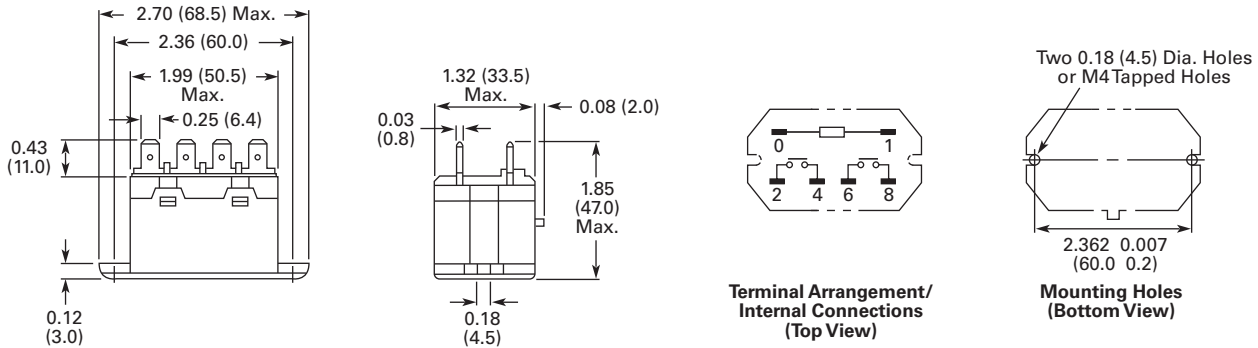

#### D8PR6TE with D8PA5 Bracket Attached

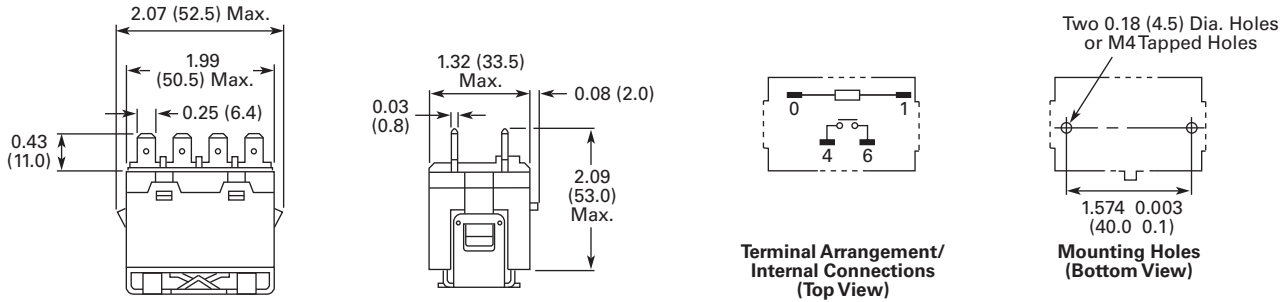

#### D8PR7TE with D8PA5 Bracket Attached

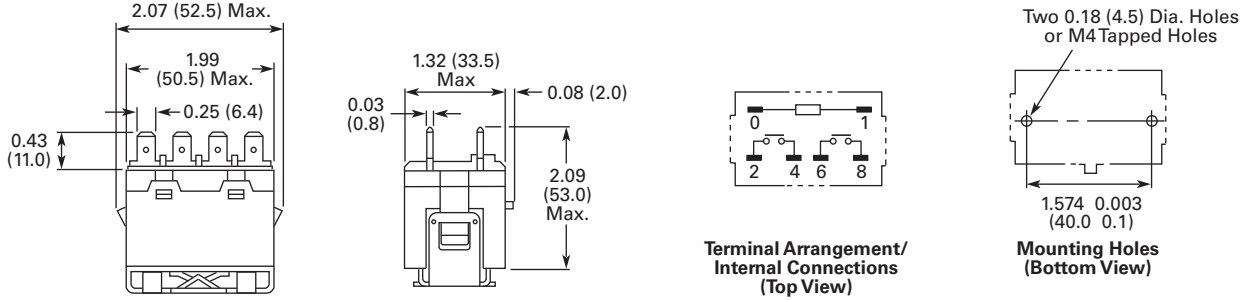

#### D8PA1

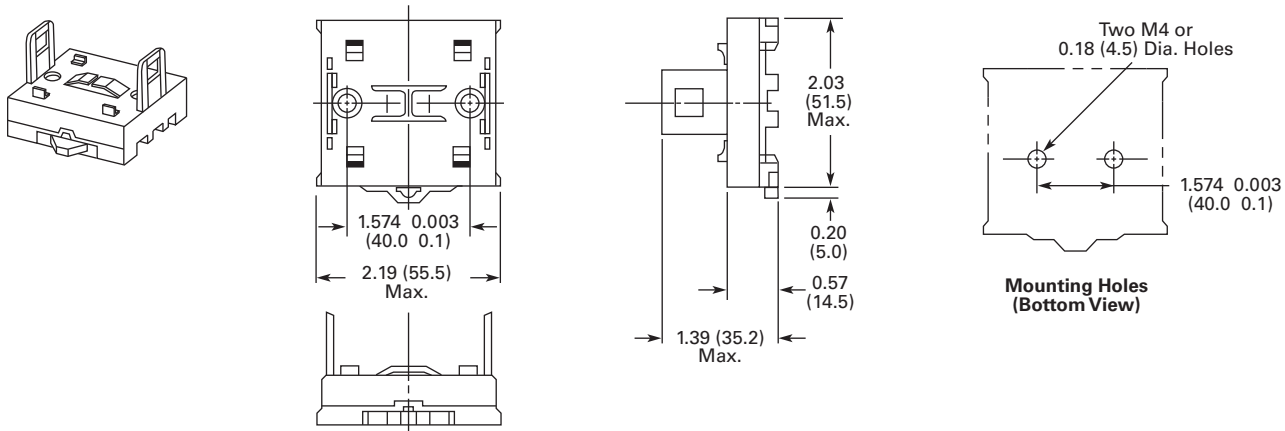

**Note:** Minimum spacing around relay = 0.20 inches (5 mm).

Approximate Dimensions in Inches (mm)

### D8PA2

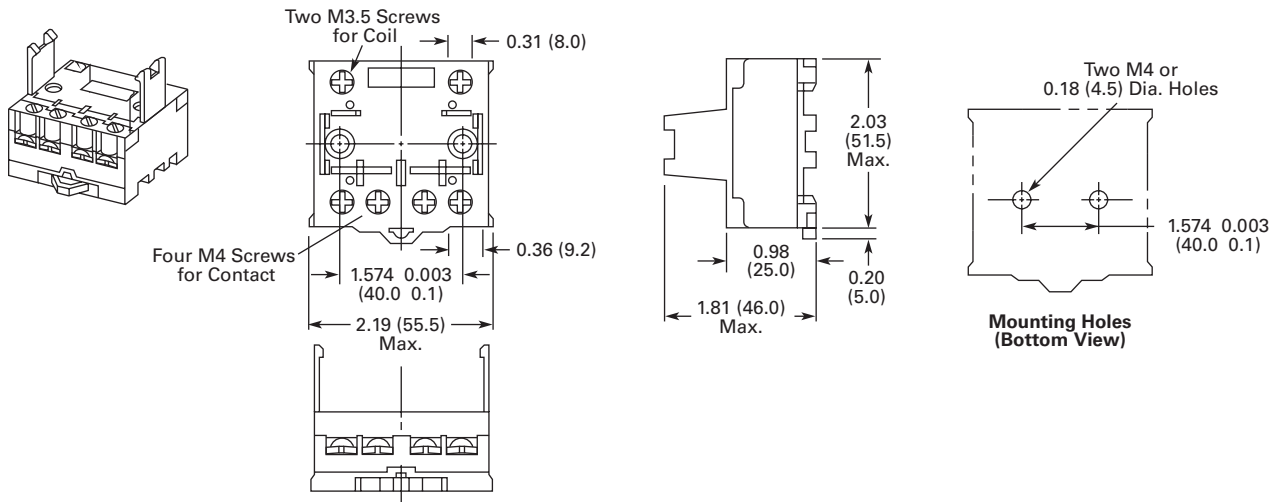

### D8PA5

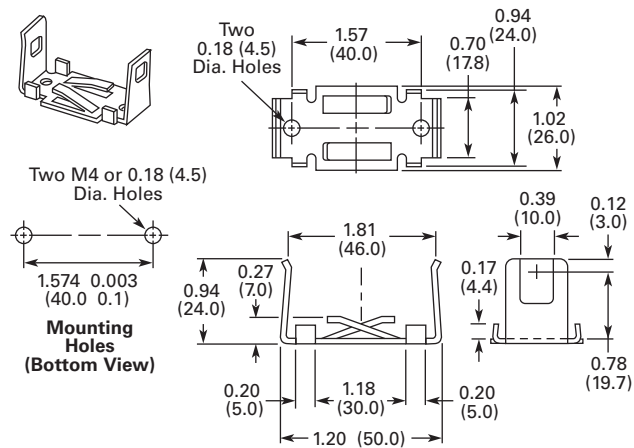

### PFP-M DIN Rail End Stop

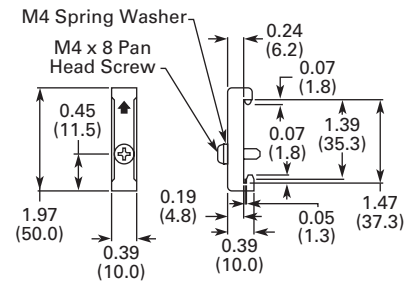

# 3.4

## Control Relays and Timers

### General Purpose Plug-In Relays

D9 Series Relay

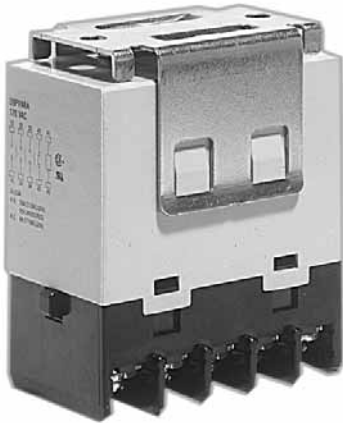

3

### Contents

| Description                            | Page      |
|--|-----------|
| D1RR/D1RF Series.....                  | V7-T3-53  |
| D2RR/D2RF Series.....                  | V7-T3-57  |
| D3RR/D3RF Series.....                  | V7-T3-67  |
| D4 Series.....                         | V7-T3-76  |
| D5RR/D5RF Series.....                  | V7-T3-80  |
| D7PR/D7PF Series.....                  | V7-T3-89  |
| D8 Series.....                         | V7-T3-103 |
| D9 Series                              |           |
| Product Selection.....                 | V7-T3-109 |
| Technical Data and Specifications..... | V7-T3-109 |
| Dimensions.....                        | V7-T3-110 |
| Accessories.....                       | V7-T3-112 |

### D9 Series

#### Product Description

The four-pole D9 Series is ideal for three-phase motor applications. Various contact configurations are available.

#### Features

- Ideal for three-phase motor control applications
- No contact chattering for momentary voltage drops up to 50% of rated voltage
- Push-to-Test button is a standard feature to check contact operation
- Mounting bracket is supplied with relay

#### Catalog Number Selection

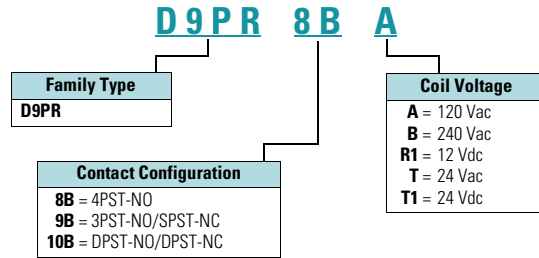

#### Standards and Certifications



File # E1491



File # LR701520



## Product Selection

### D9 Series

|                                    | Catalog Number  |                                    | Catalog Number   |
|------------------------------------|-----------------|------------------------------------|------------------|
| <b>4PST-NO Power Relay</b>         |                 | <b>DPST-NO/DPST-NC Power Relay</b> |                  |
| Coil voltage                       |                 | Coil voltage                       |                  |
| 24 Vac                             | <b>D9PR8BT</b>  | 24 Vac                             | <b>D9PR10BT</b>  |
| 120 Vac                            | <b>D9PR8BA</b>  | 120 Vac                            | <b>D9PR10BA</b>  |
| 240 Vac                            | <b>D9PR8BB</b>  | 24 Vac                             | <b>D9PR10BT1</b> |
| 24 Vdc                             | <b>D9PR8BT1</b> |                                    |                  |
| <b>3PST-NO/SPST-NC Power Relay</b> |                 |                                    |                  |
| 120 Vac                            | <b>D9PR9BA</b>  |                                    |                  |

## Technical Data and Specifications

### Coil Resistance

| Coil Voltage | Ohms | mA   | Coil Voltage | Ohms | mA  |
|--------------|------|------|--------------|------|-----|
| 24 Vac       | —    | 75   | 12 Vdc       | 72   | 167 |
| 120 Vac      | —    | 21.6 | 24 Vdc       | 288  | 83  |
| 240 Vac      | —    | 10.8 | 110 Vdc      | 6050 | 18  |

### D9PR Specifications

| Description                                   | NO Contacts<br>Resistive Load (p.f. = 1)   | NC Contacts<br>Resistive Load (p.f. = 1)   |
|---|--|--|
| Rated load                                    | 220 Vac 25 A<br>30 Vdc 25 A  | 220 Vac 8 A<br>30 Vdc 8 A  |
| Carry current                                 | 25 A   | 8 A  |
| Max. operating voltage                        | 250 Vac/125 Vdc  | 250 Vac/125 Vdc  |
| Max. switching current                        | 25 A   | 8 A  |
| Max. switching capacity                       | 5500 VA<br>750 W   | 1760 VA<br>240 W   |
| Min. permissible load                         | 100 mA at 24 Vdc   | 100 mA at 24 Vdc   |
| Mechanical life (min.)                        | 1,000,000 operations   | 1,000,000 operations   |
| Electrical life at all contact ratings (min.) | 100,000 operations   | 100,000 operations   |
| Maximum hp ratings                            | 1-1/2 hp (120 Vac)<br>3 hp (240/265/277 Vac)<br>Three-phase 3 hp (240/265/277 Vac) 30,000 cycles<br>Three-phase 5 hp (240/265/277 Vac) 30,000 cycles | 1-1/2 hp (120 Vac)<br>3 hp (240/265/277 Vac)<br>Three-phase 3 hp (240/265/277 Vac) 30,000 cycles<br>Three-phase 5 hp (240/265/277 Vac) 30,000 cycles |

# 3.4

## Control Relays and Timers

### General Purpose Plug-In Relays

3

#### Coil Data

| Coil Voltage                | Must Operate | Must Release | Maximum Voltage |
|-----------------------------|--------------|--------------|-----------------|
| 24 Vdc/Vac, 12 Vdc, 110 Vdc | 75% maximum  | 10% minimum  | 110%            |
| 120 Vac                     | 75 V         | 18 V         | 132 V           |
| 240 Vac                     | 150 V        | 36 V         | 264 V           |

#### Terminal Arrangements

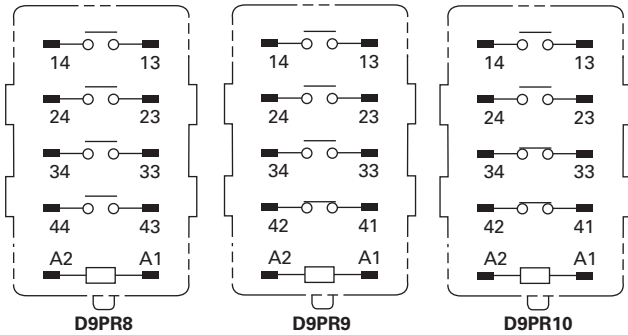

#### Dimensions

Approximate Dimensions in Inches (mm)

#### D9PR

##### Screw Terminal Brackets

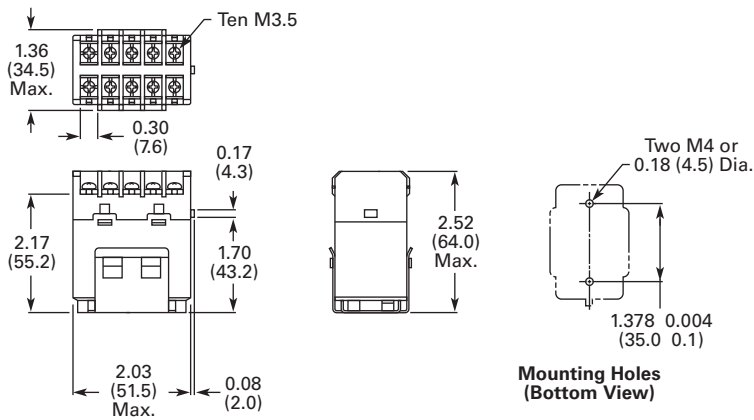

Mounting Holes  
(Bottom View)

Approximate Dimensions in Inches (mm)

### Mounting Bracket

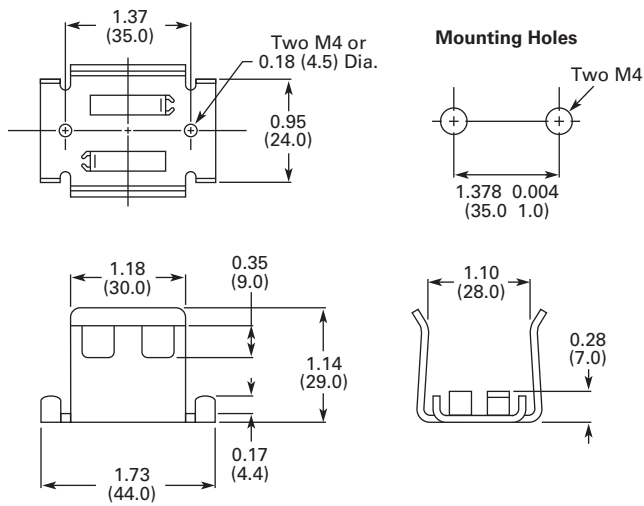

# 3.4

## Control Relays and Timers

### General Purpose Plug-In Relays

#### Accessories



3

#### Contents

| Description                     | Page      |
|---------------------------------|-----------|
| D1RR/D1RF Series                | V7-T3-53  |
| D2RR/D2RF Series                | V7-T3-57  |
| D3RR/D3RF Series                | V7-T3-67  |
| D4 Series                       | V7-T3-76  |
| D5RR/D5RF Series                | V7-T3-80  |
| D7PR/D7PF Series                | V7-T3-89  |
| D8 Series                       | V7-T3-103 |
| D9 Series                       | V7-T3-108 |
| Accessories                     |           |
| MOD Modules                     | V7-T3-113 |
| Relay Clips                     | V7-T3-114 |
| Coil Bus Jumpers                | V7-T3-116 |
| Write-On Plastic Labels/ID Tags | V7-T3-116 |
| Flange Mount Adapters           | V7-T3-117 |

#### Accessories

##### Accessories Selection Guide

Eaton offers a variety of simple-to-install relay accessories that allow you to customize the features of a relay system to meet your exact needs.

##### The MOD Module System

Eaton's plug-in modules are a simple way to add functionality to your relay without the hassle of messy wiring and additional mounting of external electronics. They are available in a variety of configurations to meet the needs of almost any application.

#### Circuit Diagrams

##### Diode Circuit

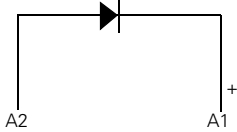

The diode module protects external drive circuitry from inductive voltages generated when removing coil voltages.

##### LED Circuit

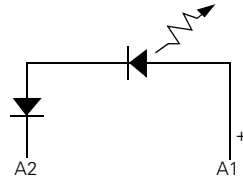

The LED status lamp verifies that power is being supplied to the coil. Ideal for both AC and DC applications. Polarity sensitive for DC applications.

##### RC Circuit

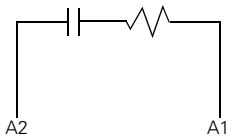

Snubs back EMF of relay coil.

##### Metal Oxide Varistor (MOV) Circuit

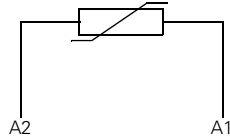

The MOV circuit protects by shunting potentially damaging electrical spikes away from the relay coil. Ideal for AC and DC applications.

#### System Diagrams



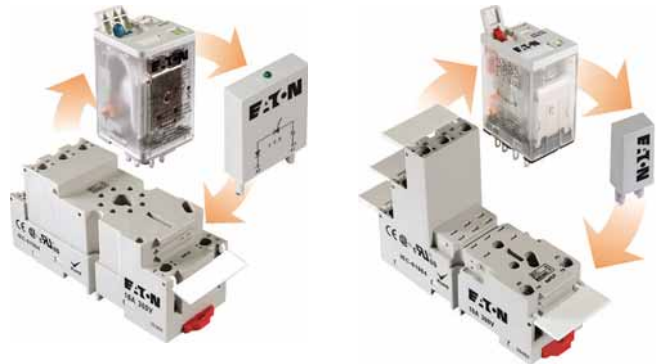



##### The MOD Module System



**MOD Modules**

Eaton's relay accessories provide a complete solution for add-on modules and identification tags.

**MOD Modules**

| Module Size   | Description           | Nominal Voltage              | Catalog Number   | Mating Sockets  |
|---|-----------------------|------------------------------|--|---|
| <b>MOD-AD250</b><br>   | A<br>Protection diode | 6–250 Vdc                    | <b>MOD-AD250</b>   | D3PA6, D3PAL8,<br>D3PA7, D3PAL11,<br>D5PAL, D7PAB,<br>D7PAD |
| <b>MOD-RC_</b><br>     | R/C suppressor        | 6–24 Vac<br>110–240 Vac      | <b>MOD-RC24</b><br><b>MOD-RC240</b>                        |   |
| <b>MOD-ALG_</b><br>    | LED indicator         | 24 Vac<br>120/240 Vac        | <b>MOD-ALG24</b><br><b>MOD-ALG240</b>                      |   |
| <b>MOD-AMV_</b><br>   | MOV suppressor        | 24 Vac<br>120 Vac<br>240 Vac | <b>MOD-AMV24</b><br><b>MOD-AMV120</b><br><b>MOD-AMV240</b> |   |
| <b>MOD-BD250</b><br> | B<br>Protection diode | 6–250 Vdc                    | <b>MOD-BD250</b>   | D1PAA, D2PAL,<br>D2PAP, D2PA7,<br>D7PAA                     |
| <b>MOD-BLG_</b><br>  | LED indicator         | 24 Vac<br>120/240 Vac        | <b>MOD-BLG24</b><br><b>MOD-BLG240</b>                      |   |
| <b>MOD-BMV_</b><br>  | MOV suppressor        | 24 Vac<br>120 Vac<br>240 Vac | <b>MOD-BMV24</b><br><b>MOD-BMV120</b><br><b>MOD-BMV240</b> |   |

# 3.4

## Control Relays and Timers

### General Purpose Plug-In Relays

3







#### Relay Clips

Eaton offers a variety of relay clips designed to improve the performance and functionality within an electrical panel.

#### Metal Hold-Down Clips

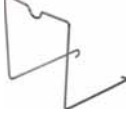
Metal hold-down clips, or spring clips, are ideal for use where high heat or humid conditions are a factor. These clips hold their shape and tension and are designed to withstand harsh environments. All clips are made of corrosion-resistant stainless steel.

#### Metal Hold-Down Clips

|   | Catalog Number  | Mating Sockets  | Mating Relays                          |
|---|-----------------|---|--|
|    | <b>PMC-1781</b> | D1PAA   | D1RR, D1RF                             |
|    | <b>PQC-1782</b> | D2PAL, D2PAP, D2PA7   | D2RR2, D2RF2, D2RR3, D2RF4             |
|    | <b>PQC-1342</b> | D2PA6, D7PAA, D7PA9   | D2RR4, D2RF4                           |
|   | <b>PQC-1332</b> | D3PA6, D3PA7  | D3RR2, D3RF2, D3RR3, D3RF3             |
|  | <b>PQC-1351</b> | D3PAL8, D3PA2, D3PAL11, D3PA3, D5PAL, D5PA2, D5PA3L, D5PA3S | D3RR2, D3RF2, D3RR3, D3RF4, D5RR, D5RF |
|  | <b>PQC-1783</b> | D7PAB   | D7PR1, D7PF1, D7PR2, D7PF3             |
|  | <b>PQC-1784</b> | D7PAD   | D7PR4, D7PF4                           |
|  | <b>PYC-B2</b>   | D7PA3, D7PA4  | D7PR1, D7PR2, D7PR4                    |

### Plastic Ejector/ Hold-Down Clips

These clips are great for applications where sockets are located in dense or tight areas. They allow for quick, safe and firm securing of relays in the sockets with the added benefit that the relay can be ejected with one finger. Plastic clips also aid in keeping operators' fingers away from live circuits. The optional snap-in identification tag allows for custom marking of sockets when used in multi-socket applications.

PWC-D24



### Plastic Ejector/Hold-Down Clips

| Catalog Number | Mating Sockets      | Mating Relays |
|----------------|---------------------|---------------|
| PWC-D24        | D2PAL, D2PAP, D2PA7 | D2RF2, D2RF4  |

### Plastic ID Clips

Plastic ID clips allow for easy circuit identification in multi-relay applications. They are designed for labeling and are not ideal for securing the relay in the socket.

PQC-1349



### Plastic ID Clips

| Catalog Number | Mating Sockets | Mating Relays |
|----------------|----------------|---------------|
| PQC-1349       | D7PAA          | D7PF1, D7PF2  |

PMC-1783



|          |       |              |
|----------|-------|--------------|
| PMC-1783 | D7PAB | D7PF1, D7PF2 |
|----------|-------|--------------|

PMC-1784



|          |       |       |
|----------|-------|-------|
| PMC-1784 | D7PAD | D7PF4 |
|----------|-------|-------|

# 3.4

## Control Relays and Timers

### General Purpose Plug-In Relays

3

#### Coil Bus Jumpers

Eaton's coil bus jumpers allow inputs to be bridged to adjacent sockets without additional wiring, making multi-relay connections quick and easy. The easy-to-install design requires no tools and can be complete in a matter of seconds.



#### System Diagrams

##### Coil Bus Jumpers ①



#### Write-On Plastic Labels/ID Tags

These convenient plastic labels snap easily onto the relay socket for clear identification in multi-relay panels. The hinged design makes wiring simple and allows for angular adjustment of the tag to improve readability in the panel. Marking with a standard permanent marker creates a smudge-free surface.

#### Coil Bus Jumpers

| Catalog Number | Mating Sockets      |
|----------------|---------------------|
| D2PJ1          | D2PAL, D2PAP        |
| D3PJ1          | D3PA6, D3PA7, D5PAL |

#### Write-On Plastic Labels/ID Tags

| Catalog Number | Mating Sockets         |
|----------------|------------------------|
| PWF-D2P        | D2PAL, D2PAP           |
| PWF-D3D5       | D3PAL8, D3PAL11, D5PAL |

#### Note

① Jumpers in photo are colored green to improve visibility, actual jumpers are black.



### Flange Mount Adapters

Eaton's relay flange mount adapters create a modular approach to flexible mounting options. Each low-cost adapter allows for panel mounting of a standard control relay and can eliminate the need for a socket.

### Unit with Flange Mount Adapter



### Flange Mount Adapters

|  | Catalog Number | Mating Relay      |
|--|----------------|-------------------|
|   | PFC-D11        | D1RF1, D1RR1      |
|   | PFC-D2D72      | D2P, D7PF2, D7PR2 |
|   | PFC-D73        | D7PF3, D7PR3      |
|  | PFC-D74        | D7PF4, D7PR4      |

9575H Series 3000 Relay



3

### 9575H Series 3000—Type AA, AC and DC

#### Product Description

Type AA panel-mounted relays are rated (each pole) 40 A up to 300 Vac, 50/60 Hz; 5 A at 480/600 Vac, 50/60 Hz and 40 A at 28 Vdc.

#### Application Description

9575H Series 3000 relays are ideal for applications when controlling smaller loads, such as single-phase motors.

### Contents

#### Description

9575H Series 3000—Type AA, AC and DC

|  |           |
|--|-----------|
| Product Selection . . . . .                | V7-T3-119 |
| Accessories. . . . .                       | V7-T3-119 |
| Technical Data and Specifications. . . . . | V7-T3-120 |
| Dimensions. . . . .                        | V7-T3-121 |

#### Page

#### Standards and Certifications

- UL listed, E1491
- CSA 41729
- CE: EN60947-4-1, EN60947-5-1



## Product Selection

### When Ordering, Specify

Catalog number and magnet coil code letter. Example: for DPDT relay with auxiliary

switch and a 120 V 50/60 Hz coil, order Catalog Number 9575H3A010.

### 9575H Series 3000 Relay



### Type AA Relays <sup>①</sup>

| Relay Style                                     | Catalog Number <sup>②</sup> |
|---|-----------------------------|
| Relay (DPDT)                                    | 9575H3_000                  |
| Relay with auxiliary switch                     | 9575H3_010                  |
| Relay with blowout magnets                      | 9575H3_100                  |
| Relay with auxiliary switch and blowout magnets | 9575H3_110                  |

### Coil Voltage Selection

| Coil Voltage    | Hz    | Suffix Code |
|-----------------|-------|-------------|
| <b>Volts AC</b> |       |             |
| 120             | 50/60 | A           |
| 240             | 50/60 | B           |
| 480/440         | 60/50 | C           |
| 600/550         | 60/50 | D           |
| 208             | 50/60 | E           |
| 277             | 50/60 | H           |
| 6               | 50/60 | J           |
| 12              | 50/60 | K           |
| 24              | 50/60 | L           |
| 48              | 50/60 | M           |
| <b>Volts DC</b> |       |             |
| 110             | —     | P           |
| 220             | —     | Q           |
| 6               | —     | R           |
| 12              | —     | S           |
| 24              | —     | T           |
| 48              | —     | W           |

## Accessories

### Enclosure <sup>③</sup>

| Description      | Catalog Number |
|------------------|----------------|
| NEMA 1 Enclosure | 9575H2449      |

### Notes

- ① There are no "repair parts" available for these relays.
- ② Underscore indicates missing code suffix for magnet coil—see Selection table above.
- ③ Only 9575H3 relays without an auxiliary switch should be mounted in the 9575H2449 enclosure.

#### Technical Data and Specifications

##### Relay Specifications

3

##### Coil

- Pull-in voltage: 80% DC coils, 85% AC coils of nominal voltage or less at 25°C
- Dropout voltage: 10% of nominal voltage or more at 25°C
- Coil resistance:  $\pm 10\%$  measured at 25°C
- Max. DC coil dissipation capability: 4 watts DC continuous at 25°C

##### Contacts

- Contact combination: DPDT
- Contact rating each pole (main contacts): Each pole rated 40 amps up to 300 Vac, 50/60 Hz, 5 amps at 480/600 Vac 50/60 Hz, 0.75 PF load. 1-1/2 hp motor load (each pole) at 120–600 Vac, 50/60 Hz. 2 hp motor load at 200–600 Vac, 50/60 Hz only when using both poles to switch both sides of load, 40 amps at 28 Vdc resistive load each pole. NEMA A 600 pilot duty 50/60 Hz
- Additional contact ratings for relays with blowout magnets: 10 A at 110 Vdc resistive, 4 A at 225 Vdc resistive, 2 A at 325 Vdc resistive. For inductive loads, contacts must be derated accordingly.
- Contact material: Silver cadmium oxide, gold flashed. 5/16 in (7.9 mm) diameter standard

##### Dielectric Withstanding Voltage

- Between open contacts: 1500  $V_{rms}$
- All other mutually insulated conductive elements: 2200  $V_{rms}$

##### Miscellaneous

- Coil terminals: 6–32 screws
- Contact terminals: 8–32 screws
- Main base material: Molded phenolic, UL recognized (QMFZ2)
- Weight (DPDT Relay): 11 oz (311 grams) approximately
- Weight (DPDT Relay with auxiliary switch) 14.5 oz (411 grams) approximately

##### Auxiliary Switch Specifications

- Contact combination: SPDT
- Contact rating: Auxiliary switch rated 10 amps at 125 or 250 Vac, resistive load; 1/4 hp at 125 or 250 Vac, motor load; 0.4 amps at 125 Vdc or 0.20 amps at 250 Vdc, resistive load; 3 amps at 125 Vac lamp load. All AC ratings are 50/60 Hz
- Dielectric withstanding voltage: 500 Vac rms between open contacts, 1500 Vac rms between all other mutually insulated conductive elements
- Terminals: 4–40 round head screws for auxiliary contacts standard

#### Average Operating Times (Milliseconds)

| Operation | DPDT Relay | DPDT Relay with Auxiliary Switch |
|-----------|------------|----------------------------------|
| Pickup    | 40         | 50                               |
| Dropout   | 35         | 35                               |

#### Temperature Ranges

| Temperature         | AC                | DC                |
|---------------------|-------------------|-------------------|
| Operating range     | -30 °C to +55 °C  | -30 °C to +55 °C  |
| Non-operating range | -30 °C to +100 °C | -30 °C to +100 °C |

### Dimensions

Approximate Dimensions in Inches (mm)

#### 9575H3 DPDT Relay

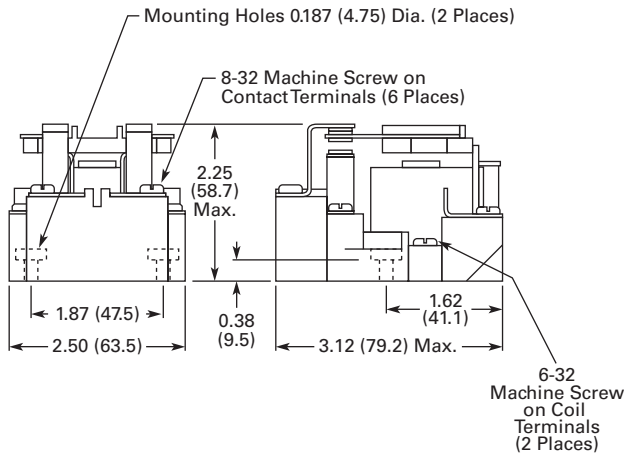

#### 9575H2449

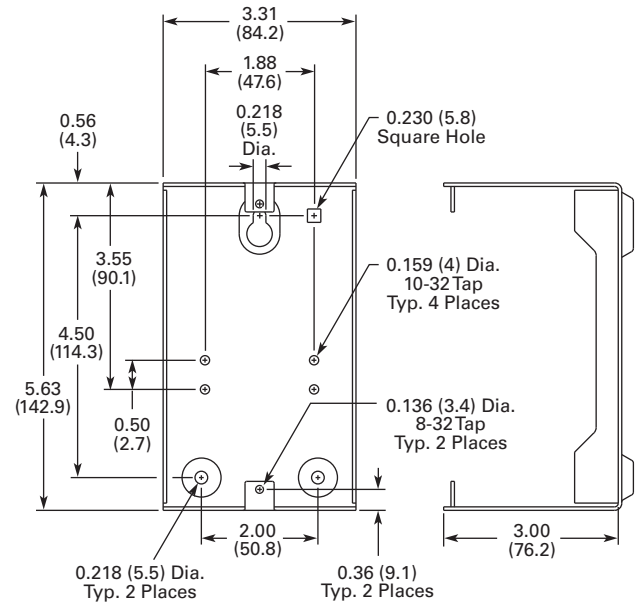

#### 9575H3 DPDT Relay with Auxiliary SPDT Switch

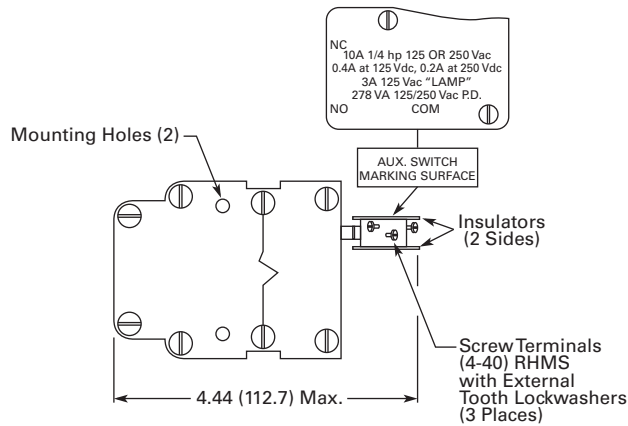
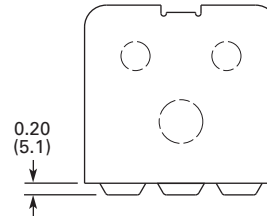
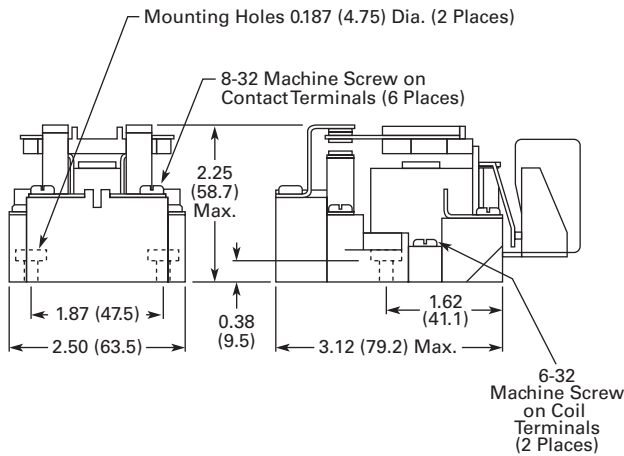

RELAY TOP VIEW

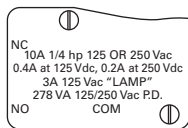

# 3.6

## Control Relays and Timers

### Solid-State Relays

3

#### Solid-State Relays



#### Contents

##### Description

Solid-State Relays

|                  |           |
|------------------|-----------|
| D93 Series ..... | V7-T3-123 |
| D96 Series ..... | V7-T3-130 |
| D99 Series ..... | V7-T3-135 |

##### Page

### Product Overview

### Catalog Number Selection

#### Solid-State Relays—D93, D96 and D99 Series

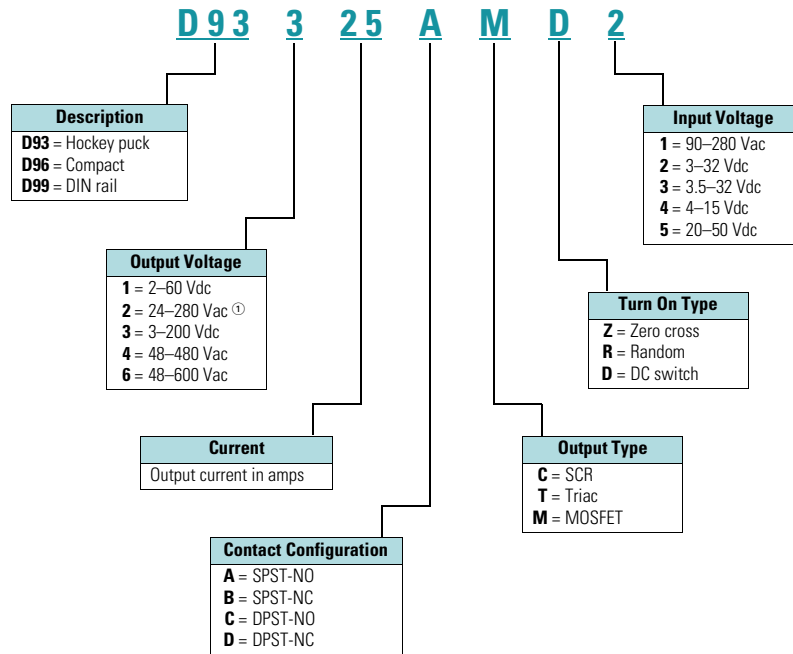

**Note**

① For D96208ACZ3, output voltage is 3–150 Vdc.

## D93 Series—Solid-State Relays



## Contents

| <b>Description</b>                      | <b>Page</b> |
|---|-------------|
| D93 Series                              |             |
| Product Selection .....                 | V7-T3-124   |
| Accessories .....                       | V7-T3-124   |
| Technical Data and Specifications ..... | V7-T3-125   |
| Dimensions .....                        | V7-T3-129   |
| D96 Series .....                        | V7-T3-130   |
| D99 Series .....                        | V7-T3-135   |

## D93 Series

## Product Description

Eaton's D93 series of solid-state relays is a line of heavy-duty industrial relays in the common "hockey puck" package. The removable, finger-safe cover and optional accessories make the D93 safe and easy to install in a variety of applications.

Models are available in a variety of input voltages and switch types up to 75 A.

## Application Description

A solid-state relay (SSR) can perform many applications that an electromechanical relay can perform. The SSR differs in that it has no moving mechanical parts within it and has some distinct advantages over an electromechanical relay.

When used correctly in the intended application, the SSR provides a high degree of reliability, a long service life, significantly reduced electromagnetic interference, fast response and high vibration resistance.

Applications for the SSR typically include equipment that requires high cycling rates, low acoustical or electrical noise, or high vibration resistance. Some examples are medical equipment, heating/cooling equipment, lighting control and pumps/compressors, among others.

## Features and Benefits

- All solid-state circuitry with no moving parts to wear
- Compact, panel mounting for flexible installation
- Isolated input and output terminals to protect the system from electrical noise
- Internal snubber circuitry to protect the SSR from transients

## Standards and Certifications

- UL/cUL recognized—UL 508
- CSA certified
- CE marked
- RoHS compliant



# 3.6

## Control Relays and Timers

### Solid-State Relays

#### Product Selection

D93210ACZ1

#### D93 Series

3



| Input Voltage | Output Voltage | Contact Configuration | Switching Type | Rated Current Load (Amps) | Catalog Number |
|---------------|----------------|-----------------------|----------------|---------------------------|----------------|
| 90–280 Vac    | 24–280 Vac     | SPST-NO               | Zero cross     | 10                        | D93210ACZ1     |
| 3–32 Vdc      | 24–280 Vac     | SPST-NO               | Zero cross     | 10                        | D93210ACZ2     |
| 3–32 Vdc      | 24–280 Vac     | SPST-NO               | Triac          | 10                        | D93210ATZ2     |
| 90–280 Vac    | 24–280 Vac     | SPST-NO               | Zero cross     | 25                        | D93225ACZ1     |
| 3–32 Vdc      | 24–280 Vac     | SPST-NO               | Zero cross     | 25                        | D93225ACZ2     |
| 3–32 Vdc      | 24–280 Vac     | SPST-NO               | Triac          | 25                        | D93225ATZ2     |
| 90–280 Vac    | 24–280 Vac     | SPST-NO               | Zero cross     | 40                        | D93240ACZ1     |
| 3–32 Vdc      | 24–280 Vac     | SPST-NO               | Zero cross     | 40                        | D93240ACZ2     |
| 3–32 Vdc      | 24–280 Vac     | SPST-NO               | Triac          | 40                        | D93240ATZ2     |
| 90–280 Vac    | 24–280 Vac     | SPST-NO               | Zero cross     | 50                        | D93250ACZ1     |
| 3–32 Vdc      | 24–280 Vac     | SPST-NO               | Zero cross     | 50                        | D93250ACZ2     |
| 90–280 Vac    | 24–280 Vac     | SPST-NO               | Zero cross     | 75                        | D93275ACZ1     |
| 3–32 Vdc      | 24–280 Vac     | SPST-NO               | Zero cross     | 75                        | D93275ACZ2     |
| 3–32 Vdc      | 3–200 Vdc      | SPST-NO               | MOSFET         | 12                        | D93312AMD2     |
| 3–32 Vdc      | 3–200 Vdc      | SPST-NO               | MOSFET         | 25                        | D93325AMD2     |
| 3–32 Vdc      | 3–200 Vdc      | SPST-NO               | MOSFET         | 40                        | D93340AMD2     |

#### Accessories

D93HS1



#### D93 Series—Heat Sink

Eaton's D93HS1 heat sink is specifically designed to be used with D93 solid-state relays. It is pre-drilled and tapped, and matches the heat dissipation requirements for relays up to 50 A.

#### Heat Sink Accessory

| Description | Catalog Number |
|-------------|----------------|
| Heat sink   | D93HS1         |

**Note:** Always ensure that all details of the application are considered when determining heat dissipation requirements, including ambient temperature. The D93 relays must be firmly mounted to the heat sink using a suitable thermally conductive grease or thermal transfer pad.

D93TP1



#### D93 Series—Thermal Transfer Pad

The D93TP1 is a self-adhesive transfer pad designed for use with Eaton's D93 solid-state relays. When used properly, it will adequately conduct the heat to a heat sink without the use of grease.



## Technical Data and Specifications

### D93 Series

| Description  | Units  | D93210ACZ1  | D93210ACZ2        | D93210ATZ2  | D93225ACZ1  | D93225ACZ2        | D93225ATZ2  |
|--|--------|-------------|-------------------|-------------|-------------|-------------------|-------------|
| <b>Output Characteristics</b>                      |        |             |                   |             |             |                   |             |
| Contact configuration                              |        | SPST-NO     | SPST-NO           | SPST-NO     | SPST-NO     | SPST-NO           | SPST-NO     |
| Switching device                                   |        | SCR         | SCR               | Triac       | SCR         | SCR               | Triac       |
| Current rating                                     | A      | 10          | 10                | 10          | 25          | 25                | 25          |
| Switching type                                     |        | Zero cross  | Zero cross        | Zero cross  | Zero cross  | Zero cross        | Zero cross  |
| Maximum rate of rise off state voltage (DV/DT)     | V/us   | 200         | 250               | 700         | 500         | 500               | 250         |
| Incandescent lamp ampere rating (rms)              | A      | 8           | 16                | 16          | 16          | 16                | 16          |
| Motor load rating (rms)                            | A      | 4.5         | 8                 | 8           | 8           | 8                 | 8           |
| Min. load current to maintain on                   | mA     | 50          | 120               | 250         | 120         | 120               | 120         |
| Non-repetitive surge current (1 cycle)             | A      | 83          | 250               | 1000        | 250         | 250               | 250         |
| Max. rms overload current (1 second)               | A      | 24          | 80                | 50          | 40          | 40                | 80          |
| Max. off state leakage current (rms)               | mA     | 8           | 10                | 10          | 8           | 10                | 10          |
| Peak blocking voltage                              | Vpk    | 600         | 300               | —           | 600         | 600               | —           |
| Typical on state voltage drop (rms)                | Vac    | 1.6         | 1.6               | 1.35        | 1.6         | 1.6               | 1.6         |
| Max. on state voltage drop (rms)                   | Vac    | 1.6         | 1.6               | 1.6         | 1.6         | 1.6               | 1.6         |
| Max. I <sup>2</sup> t for fusing (A <sup>2</sup> ) |        | 72          | 300               | 1700        | 312         | 250               | 300         |
| <b>Input Characteristics</b>                       |        |             |                   |             |             |                   |             |
| Must release voltage                               | V      | 10 AC       | 1 DC              | 10 AC       | 10 AC       | 1 DC              | 1 DC        |
| Typical input impedance                            | ohms   | 13k         | Current regulator | 16–25k      | 13k         | Current regulator | 1.5k        |
| Nominal input current at 5 Vdc or 240 Vac          | mA     | 20          | 2                 | 12          | 20          | 16                | 2           |
| Reverse polarity protection                        |        | NA          | Yes               | NA          | NA          | Yes               | Yes         |
| <b>Performance Characteristics</b>                 |        |             |                   |             |             |                   |             |
| Operating time (response time)                     |        |             |                   |             |             |                   |             |
| ON   | ms     | 8.3         | 8.3               | 8.3         | 8.3         | 8.3               | 8.3         |
| OFF  | ms     | 8.3         | 8.3               | 8.3         | 8.3         | 8.3               | 8.3         |
| Rated insulation voltage—input to input            | Vac    | 4000        | 4000              | 4000        | 4000        | 4000              | 4000        |
| Dielectric strength—terminal to chassis            | Vac    | 4000        | 4000              | 4000        | 4000        | 4000              | 4000        |
| <b>Environment</b>                                 |        |             |                   |             |             |                   |             |
| Product certifications                             |        | UR, CSA, CE | UR, CSA, CE       | UR, CSA, CE | UR, CSA, CE | UR, CSA, CE       | UR, CSA, CE |
| Ambient air temperature                            |        |             |                   |             |             |                   |             |
| Storage  | °C     | –40 to 100  | –40 to 100        | –40 to 100  | –40 to 100  | –40 to 100        | –40 to 100  |
| Operating  | °C     | –40 to 80   | –40 to 80         | –40 to 80   | –40 to 80   | –40 to 80         | –40 to 80   |
| Degree of protection                               |        | IP20        | IP20              | IP20        | IP20        | IP20              | IP20        |
| <b>Miscellaneous Characteristics</b>               |        |             |                   |             |             |                   |             |
| Thermal resistance (junction to case)              | °C/W   | 3.5         | 3.5               | 1.45        | 1.02        | 1.02              | 1.45        |
| Weight   | g (oz) | 100 (3.5)   | 100 (3.5)         | 100 (3.5)   | 100 (3.5)   | 100 (3.5)         | 100 (3.5)   |
| LED—input  |        | Green       | Green             | Green       | Green       | Green             | Green       |
| Input terminals                                    |        | M3.5        | M3.5              | M3.5        | M3.5        | M3.5              | M3.5        |
| Output terminals                                   |        | M4          | M4                | M4          | M4          | M4                | M4          |
| Terminal torque (max.)                             | Nm     | 1.0         | 1.0               | 1.0         | 1.0         | 1.0               | 1.0         |

# 3.6

## Control Relays and Timers

### Solid-State Relays

#### D93 Series, continued

| Description  | Units  | D93240ACZ1  | D93240ACZ2  | D93240ATZ2  | D93250ACZ1  | D93250ACZ2        |
|--|--------|-------------|-------------|-------------|-------------|-------------------|
| <b>Output Characteristics</b>                      |        |             |             |             |             |                   |
| Contact configuration                              |        | SPST-NO     | SPST-NO     | SPST-NO     | SPST-NO     | SPST-NO           |
| Switching device                                   |        | SCR         | SCR         | Triac       | SCR         | SCR               |
| Current rating                                     | A      | 40          | 40          | 40          | 50          | 50                |
| Switching type                                     |        | Zero cross  | Zero cross  | Zero cross  | Zero cross  | Zero cross        |
| Maximum rate of rise off state voltage (DV/DT)     | V/us   | 500         | 500         | 250         | 500         | 500               |
| Incandescent lamp ampere rating (rms)              | A      | 30          | 30          | 20          | 39          | 39                |
| Motor load rating (rms)                            | A      | 14          | 14          | 14          | 14          | 14                |
| Min. load current to maintain on                   | mA     | 250         | 250         | 50          | 250         | 250               |
| Non-repetitive surge current (1 cycle)             | A      | 625         | 625         | 250         | 520         | 520               |
| Max. rms overload current (1 second)               | A      | 80          | 80          | 80          | 100         | 100               |
| Max. off state leakage current (rms)               | mA     | 10          | 10          | 10          | 10          | 8                 |
| Peak blocking voltage                              | Vpk    | 600         | 600         | 600         | 600         | 600               |
| Typical on state voltage drop (rms)                | Vac    | 1.6         | 1.6         | 1.6         | 1.1         | 1.8               |
| Max. on state voltage drop (rms)                   | Vac    | 1.6         | 1.6         | 1.6         | 1.8         | 1.8               |
| Max. I <sup>2</sup> t for fusing (A <sup>2</sup> ) |        | 1250        | 1250        | 438         | 1250        | 1250              |
| <b>Input Characteristics</b>                       |        |             |             |             |             |                   |
| Must release voltage                               | V      | 10 AC       | 1 DC        | 1 DC        | 10 AC       | 1 DC              |
| Typical input impedance                            | ohms   | 13k         | ACL         | 1.5k        | 13k         | Current regulator |
| Nominal input current at 5 Vdc or 240 Vac          | mA     | 20          | 16          | 2           | 20          | 16                |
| Reverse polarity protection                        |        | N/A         | Yes         | Yes         | NA          | Yes               |
| <b>Performance Characteristics</b>                 |        |             |             |             |             |                   |
| Operating time (response time)                     |        |             |             |             |             |                   |
| ON   | ms     | 8.3         | 8.3         | 8.3         | 8.3         | 8.3               |
| OFF  | ms     | 8.3         | 8.3         | 8.3         | 8.3         | 8.3               |
| Rated insulation voltage—input to input            | Vac    | 4000        | 4000        | 4000        | 4000        | 4000              |
| Dielectric strength—terminal to chassis            | Vac    | 4000        | 4000        | 4000        | 4000        | 4000              |
| <b>Environment</b>                                 |        |             |             |             |             |                   |
| Product certifications                             |        | UR, CSA, CE | UR, CSA, CE | UR, CSA, CE | UR, CSA, CE | UR, CSA, CE       |
| Ambient air temperature                            |        |             |             |             |             |                   |
| Storage  | °C     | −40 to 100  | −40 to 100  | −40 to 100  | −40 to 100  | −40 to 100        |
| Operating  | °C     | −40 to 80   | −40 to 80   | −40 to 80   | −40 to 80   | −40 to 80         |
| Degree of protection                               |        | IP20        | IP20        | IP20        | IP20        | IP20              |
| <b>Miscellaneous Characteristics</b>               |        |             |             |             |             |                   |
| Thermal resistance (junction to case)              | °C/W   | 0.9         | 0.9         | 0.95        | 0.63        | 0.63              |
| Weight   | g (oz) | 100         | 100         | 100         | 135 (4.8)   | 135 (4.8)         |
| LED—input  |        | Green       | Green       | Green       | Green       | Green             |
| Input terminals                                    |        | M3.5        | M3.5        | M3.5        | M3.5        | M3.5              |
| Output terminals                                   |        | M6          | M6          | M6          | M6          | M6                |
| Terminal torque (max.)                             | Nm     | 1.0         | 1.0         | 1.0         | 1.0         | 1.0               |

## D93 Series, continued

| Description  | Units  | D93275ACZ1  | D93275ACZ2        | D93312AMD2   | D93325AMD2   | D93340AMD2   |
|--|--------|-------------|-------------------|--------------|--------------|--------------|
| <b>Output Characteristics</b>                      |        |             |                   |              |              |              |
| Contact configuration                              |        | SPST-NO     | SPST-NO           | SPST-NO      | SPST-NO      | SPST-NO      |
| Switching device                                   |        | SCR         | SCR               | MOSFET       | MOSFET       | MOSFET       |
| Current rating                                     | A      | 75          | 75                | 12           | 25           | 40           |
| Switching type                                     |        | Zero cross  | Zero cross        | DC switching | DC switching | DC switching |
| Maximum rate of rise off state voltage (DV/DT)     | V/us   | 500         | 500               | NA           | NA           | NA           |
| Incandescent lamp ampere rating (rms)              | A      | 39          | 39                | NA           | NA           | NA           |
| Motor load rating (rms)                            | A      | 25          | 25                | NA           | NA           | NA           |
| Min. load current to maintain on                   | mA     | 250         | 250               | 20           | 20           | 20           |
| Non-repetitive surge current (1 cycle)             | A      | 1150        | 1150              | 27           | 50           | 90           |
| Max. rms overload current (1 second)               | A      | 150         | 150               | NA           | NA           | NA           |
| Max. off state leakage current (rms)               | mA     | 10          | 10                | 8            | 8            | 8            |
| Peak blocking voltage                              | Vpk    | 600         | 600               | —            | —            | —            |
| Typical on state voltage drop (rms)                | Vac    | 1.8         | 1.8               | 1.6          | 1.6          | 1.6          |
| Max. on state voltage drop (rms)                   | Vac    | 1.8         | 1.8               | 2.83         | 2.83         | 2.83         |
| Max. I <sup>2</sup> t for fusing (A <sup>2</sup> ) |        | 5000        | 5000              | NA           | NA           | NA           |
| <b>Input Characteristics</b>                       |        |             |                   |              |              |              |
| Must release voltage                               | V      | 10 AC       | 1 DC              | 1 DC         | 1 DC         | 1 DC         |
| Typical input impedance                            | ohms   | 13k         | Current regulator | 1k           | 1k           | 1k           |
| Nominal input current at 5 Vdc or 240 Vac          | mA     | 20          | 16                | 10           | 10           | 10           |
| Reverse polarity protection                        |        | NA          | Yes               | No           | No           | No           |
| <b>Performance Characteristics</b>                 |        |             |                   |              |              |              |
| Operating time (response time)                     |        |             |                   |              |              |              |
| ON   | ms     | 8.3         | 8.3               | 300 μs       | 600 μs       | 600 μs       |
| OFF  | ms     | 8.3         | 8.3               | 1            | 2.6          | 2.6          |
| Rated insulation voltage—input to input            | Vac    | 4000        | 4000              | 4000         | 4000         | 4000         |
| Dielectric strength—terminal to chassis            | Vac    | 4000        | 4000              | 2500         | 2500         | 2500         |
| <b>Environment</b>                                 |        |             |                   |              |              |              |
| Product certifications                             |        | UR, CSA, CE | UR, CSA, CE       | UR, CSA, CE  | UR, CSA, CE  | UR, CSA, CE  |
| Ambient air temperature                            |        |             |                   |              |              |              |
| Storage  | °C     | –40 to 100  | –40 to 100        | –40 to 100   | –40 to 100   | –40 to 100   |
| Operating  | °C     | –40 to 80   | –40 to 80         | –40 to 80    | –40 to 80    | –40 to 80    |
| Degree of protection                               |        | IP20        | IP20              | IP20         | IP20         | IP20         |
| <b>Miscellaneous Characteristics</b>               |        |             |                   |              |              |              |
| Thermal resistance (junction to case)              | °C/W   | 0.6         | 0.63              | 1.06         | 1.06         | 0.63         |
| Weight   | g (oz) | 200         | 135 (4.8)         | 110 (3.9)    | 110 (3.9)    | 135 (4.8)    |
| LED—input  |        | Green       | Green             | Green        | Green        | Green        |
| Input terminals                                    |        | M3.5        | M3.5              | M3.5         | M3.5         | M3.5         |
| Output terminals                                   |        | M6          | M6                | M4           | M4           | M6           |
| Terminal torque (max.)                             | Nm     | 1.0         | 1.0               | 1.0          | 1.0          | 1.0          |

# 3.6

## Control Relays and Timers

### Solid-State Relays

3

#### Temperature Derating Curves

##### 10 Amp Styles

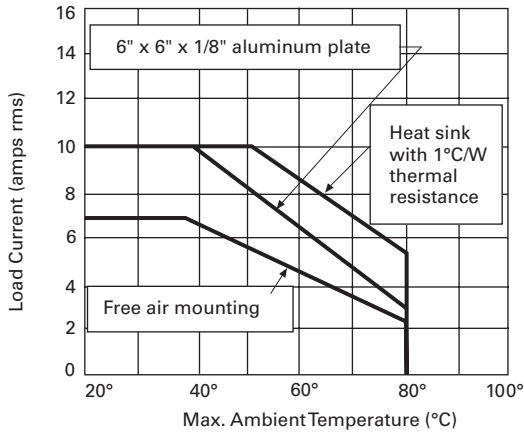

##### 40 and 50 Amp Styles

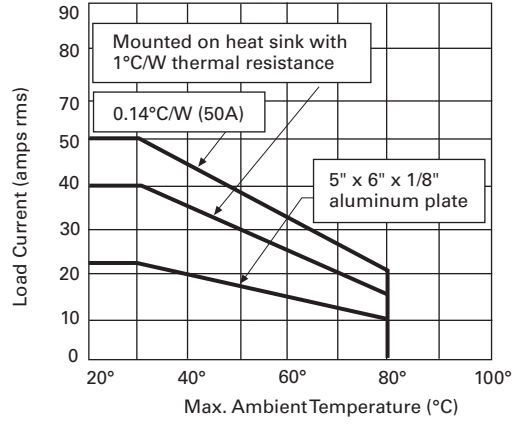

##### 25 Amp Styles

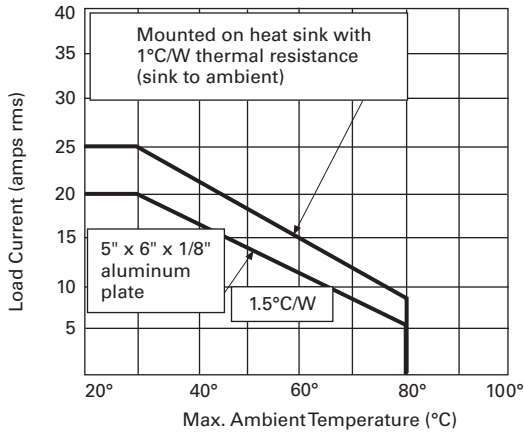

##### 75 Amp Styles

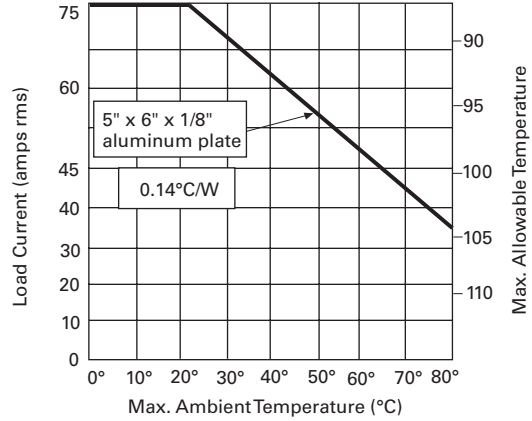

### Dimensions

Approximate Dimensions in Inches (mm)

#### D93 Series

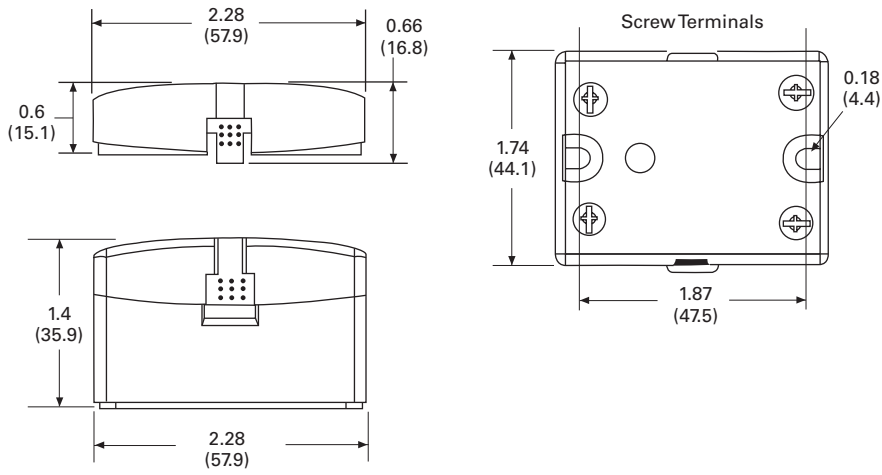

D96 Series—Solid-State Relays



### Contents

| <b>Description</b>                      | <b>Page</b>      |
|---|------------------|
| D93 Series .....                        | <b>V7-T3-123</b> |
| D96 Series                              |                  |
| Product Selection .....                 | <b>V7-T3-131</b> |
| Technical Data and Specifications ..... | <b>V7-T3-132</b> |
| Dimensions .....                        | <b>V7-T3-134</b> |
| D99 Series .....                        | <b>V7-T3-135</b> |

### D96 Series

#### Product Description

Eaton’s D96 series of solid-state relays is a technologically advanced set of electronic relays for tough applications and harsh environments. The compact 17.5 mm wide package with an integrated heat sink provides easy mounting in tight spaces.

#### Application Description

A solid-state relay (SSR) can perform many applications that an electromechanical relay can perform. The SSR differs in that it has no moving mechanical parts within it and has some distinct advantages over an electromechanical relay.

When used correctly in the intended application, the SSR provides a high degree of reliability, a long service life, significantly reduced electromagnetic interference, fast response and high vibration resistance.

Applications for the SSR typically include equipment that requires high cycling rates, low acoustical or electrical noise, or high vibration resistance. Some examples are medical equipment, heating/cooling equipment, lighting control and pumps/compressors, among others.

#### Features and Benefits

- All solid-state circuitry has no moving parts to wear
- Integral heat sink eliminates the need for added accessories and installation
- Flexible mounting allows DIN rail or panel mounting without additional hardware or tools
- Isolated input and output terminals protect the system from electrical noise
- Internal snubber circuitry protects the SSR from transients

#### Standards and Certifications

- UL/cUL listed—UL 508
- CSA certified
- CE marked
- RoHS compliant



## Product Selection

D96115ACZ3

## D96 Series



| Input Voltage | Output Voltage | Contact Configuration | Switching Type | Rated Current Load (Amps) | Catalog Number    |
|---------------|----------------|-----------------------|----------------|---------------------------|-------------------|
| 3.5–32 Vdc    | 3–50 Vdc       | SPST-NO               | DC switch      | 15                        | <b>D96115ACZ3</b> |
| 3.5–32 Vdc    | 3–150 Vdc      | SPST-NO               | DC switch      | 8                         | <b>D96208ACZ3</b> |
| 90–280 Vac    | 24–280 Vac     | SPST-NO               | Random         | 10                        | <b>D96210ACR1</b> |
| 3–32 Vdc      | 24–280 Vac     | SPST-NO               | Random         | 10                        | <b>D96210ACR2</b> |
| 90–280 Vac    | 24–280 Vac     | SPST-NO               | Zero cross     | 10                        | <b>D96210ACZ1</b> |
| 3–32 Vdc      | 24–280 Vac     | SPST-NO               | Zero cross     | 10                        | <b>D96210ACZ2</b> |
| 3–32 Vdc      | 24–280 Vac     | SPST-NC               | Random         | 10                        | <b>D96210BCR2</b> |
| 90–280 Vac    | 48–480 Vac     | SPST-NO               | Random         | 10                        | <b>D96410ACR1</b> |
| 3–32 Vdc      | 48–480 Vac     | SPST-NO               | Random         | 10                        | <b>D96410ACR2</b> |
| 90–280 Vac    | 48–480 Vac     | SPST-NO               | Zero cross     | 10                        | <b>D96410ACZ1</b> |
| 3–32 Vdc      | 48–480 Vac     | SPST-NO               | Zero cross     | 10                        | <b>D96410ACZ2</b> |
| 90–280 Vac    | 48–600 Vac     | SPST-NO               | Random         | 10                        | <b>D96610ACR1</b> |
| 90–280 Vac    | 48–600 Vac     | SPST-NO               | Zero cross     | 10                        | <b>D96610ACZ1</b> |
| 3–32 Vdc      | 48–600 Vac     | SPST-NO               | Zero cross     | 10                        | <b>D96610ACZ2</b> |

## Technical Data and Specifications

## D96 Series

3

| Description  | Units                  | D96210ACZ1  | D96210ACZ2        | D96210ACR1     | D96210ACR2     | D96115ACZ3        | D96208ACZ3        | D96210BCR2     |
|--|------------------------|-------------|-------------------|----------------|----------------|-------------------|-------------------|----------------|
| <b>Output Characteristics</b>                      |                        |             |                   |                |                |                   |                   |                |
| Contact configuration                              |                        | SPST-NO     | SPST-NO           | SPST-NO        | SPST-NO        | SPST-NO           | SPST-NO           | SPST-NC        |
| Switching device                                   |                        | SCR         | SCR               | SCR            | SCR            | MOSFET            | MOSFET            | SCR            |
| Current rating                                     | A                      | 10          | 10                | 10             | 10             | 15                | 8                 | 10             |
| Switching type                                     |                        | Zero cross  | Zero cross        | Random turn on | Random turn on | DC switching      | DC switching      | Random turn on |
| Maximum zero turn-on voltage (Vpk)                 | V                      | 35          | 35                | 35             | 35             | NA                | NA                | 35             |
| Maximum rate of rise off state voltage (DV/DT)     | V/us                   | 500         | 500               | 500            | 500            | NA                | NA                | 500            |
| Incandescent lamp ampere rating (rms)              | A                      | 8           | 8                 | 8              | 8              | NA                | NA                | 8              |
| Motor load rating (rms)                            | A                      | 4.5         | 4.5               | 4.5            | 4.5            | NA                | NA                | 4.5            |
| Min. load current to maintain on                   | mA                     | 50          | 50                | 50             | 50             | 20                | 20                | 50             |
| Non-repetitive surge current (1 cycle)             | A                      | 500         | 500               | 500            | 500            | 50                | 35                | 500            |
| Max. rms overload current (1 second)               | A                      | 24          | 24                | 24             | 24             | 24                | 17                | 24             |
| Max. off state leakage current (rms)               | mA                     | 10          | 10                | 10             | 10             | 10                | 10                | 10             |
| Typical on state voltage drop (rms)                | V                      | 1.25 AC     | 1.25 AC           | 1.25 AC        | 1.25 AC        | 1.25 DC           | 1.25 DC           | 1.25 AC        |
| Max. on state voltage drop (rms)                   | V                      | 1.6 AC      | 1.6 AC            | 1.6 AC         | 1.6 AC         | 1.6 DC            | 1.6 DC            | 1.6 AC         |
| Max. I <sup>2</sup> t for fusing (A <sup>2</sup> ) |                        | 1250        | 1250              | 1250           | 1250           | NA                | NA                | 1250           |
| <b>Input Characteristics</b>                       |                        |             |                   |                |                |                   |                   |                |
| Must release voltage                               | V                      | 10 AC       | 1 DC              | 10 AC          | 1 DC           | 1 DC              | 1 DC              | 1 DC           |
| Typical input impedance                            | ohms                   | 16–25k      | Current regulator | 16–25k         | ACL            | Current regulator | Current regulator | ACL            |
| Nominal input current at 5 Vdc or 240 Vac          | mA                     | 12          | 16                | 12             | 16             | 12                | 12                | 12             |
| Reverse polarity protection                        |                        | NA          | Yes               | NA             | Yes            | Yes               | Yes               | Yes            |
| <b>Performance Characteristics</b>                 |                        |             |                   |                |                |                   |                   |                |
| Operating time (response time)                     |                        |             |                   |                |                |                   |                   |                |
| ON   | ms                     | 40          | 8.3               | 8.3            | 8.3            | 5                 | 5                 | 8.3            |
| OFF  | ms                     | 80          | 8.3               | 8.3            | 8.3            | 5                 | 5                 | 8.3            |
| Rated insulation voltage—input to input            | Vac                    | 2500        | 2500              | 4000           | 4000           | 2500              | 2500              | 4000           |
| Dielectric strength—terminal to chassis            | Vac                    | 2500        | 2500              | 2500           | 2500           | 2500              | 2500              | 2500           |
| <b>Environment</b>                                 |                        |             |                   |                |                |                   |                   |                |
| Product certifications                             |                        | UL, CSA, CE | UL, CSA, CE       | UL, CSA, CE    | UL, CSA, CE    | UL, CSA, CE       | UL, CSA, CE       | UL, CSA, CE    |
| Ambient air temperature                            |                        |             |                   |                |                |                   |                   |                |
| Storage  | °C                     | –40 to 100  | –40 to 100        | –40 to 100     | –40 to 100     | –40 to 100        | –40 to 100        | –40 to 100     |
| Operating  | °C                     | –30 to 80   | –30 to 80         | –30 to 80      | –30 to 80      | –30 to 80         | –30 to 80         | –30 to 80      |
| Degree of protection                               |                        | IP20        | IP20              | IP20           | IP20           | IP20              | IP20              | IP20           |
| <b>Miscellaneous Characteristics</b>               |                        |             |                   |                |                |                   |                   |                |
| Thermal resistance (junction to case)              | °C/W                   | 0.66        | 0.66              | 0.66           | 0.66           | 0.66              | 0.66              | 0.66           |
| Integral heat sink                                 | °C/W                   | 4.0         | 4.0               | 4.0            | 4.0            | 4.0               | 4.0               | 4.0            |
| Weight   | g (oz)                 | 127 (4.1)   | 127 (4.1)         | 127 (4.1)      | 127 (4.1)      | 127 (4.1)         | 127 (4.1)         | 127 (4.1)      |
| LED—input  |                        | Green       | Green             | Green          | Green          | Green             | Green             | Green          |
| Terminal wire capacity                             | AWG (mm <sup>2</sup> ) | 14 (2.1)    | 14 (2.1)          | 14 (2.1)       | 14 (2.1)       | 14 (2.1)          | 14 (2.1)          | 14 (2.1)       |
| Terminal torque (max.)                             | in-lb (Nm)             | 7.1 (0.8)   | 7.1 (0.8)         | 7.1 (0.8)      | 7.1 (0.8)      | 7.1 (0.8)         | 7.1 (0.8)         | 7.1 (0.8)      |



**Temperature Derating Curves**

**8 Amp Style**

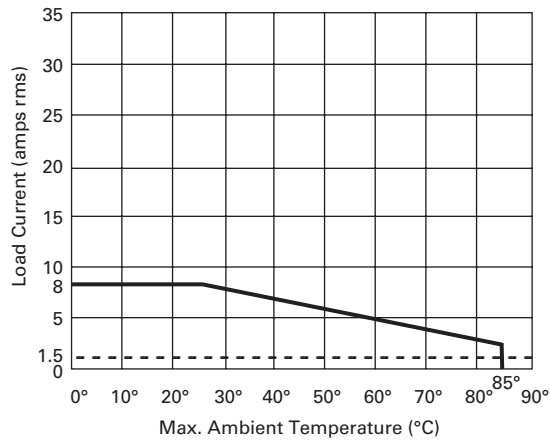

**15 Amp Style**

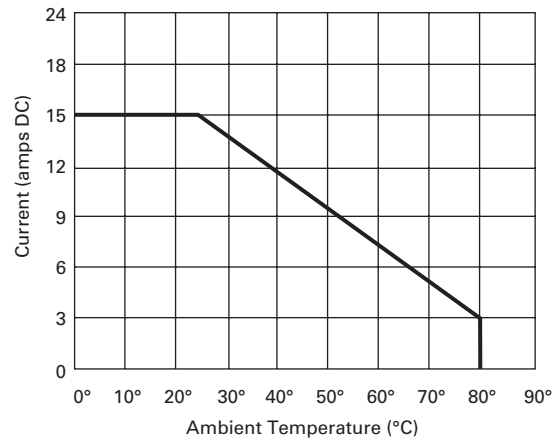

**10 Amp Style**

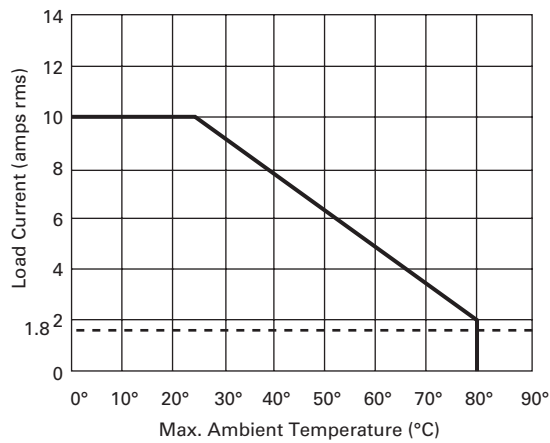

# 3.6

## Control Relays and Timers

### Solid-State Relays

#### Dimensions

Approximate Dimensions in Inches (mm)

#### D96 Series

3

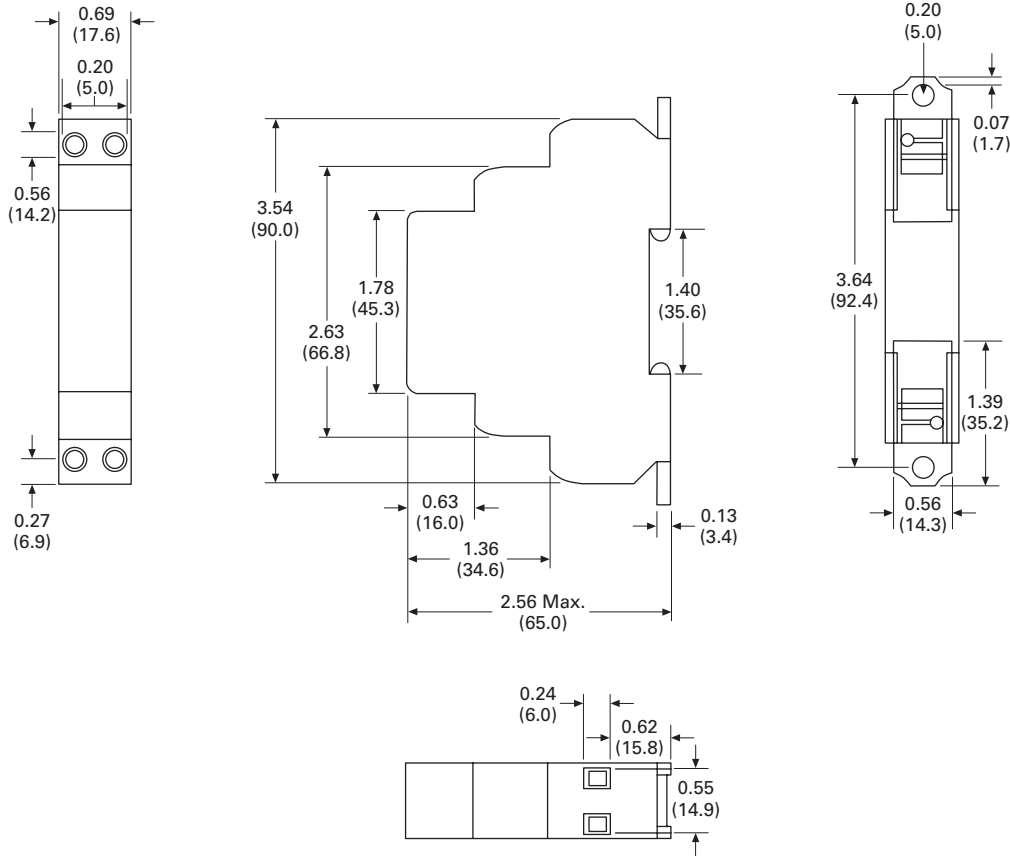

## D99 Series—Solid-State Relays



## D99 Series

## Product Description

Eaton's D99 series of solid-state relays is a line of heavy-duty industrial relays with an integrated heat sink. The attached metal hardware can be used for DIN rail or panel mounting.

Models are available in a variety of input voltages in 10 A, 25 A and 40 A sizes.

## Application Description

A solid-state relay (SSR) can perform many applications that an electromechanical relay can perform. The SSR differs in that it has no moving mechanical parts within it and has some distinct advantages over an electromechanical relay.

When used correctly in the intended application, the SSR provides a high degree of reliability, a long service life, significantly reduced electromagnetic interference, fast response and high vibration resistance.

Applications for the SSR typically include equipment that requires high cycling rates, low acoustical or electrical noise, or high vibration resistance. Some examples are medical equipment, heating/cooling equipment, lighting control and pumps/compressors, among others.

## Contents

| Description                             | Page      |
|---|-----------|
| D93 Series .....                        | V7-T3-123 |
| D96 Series .....                        | V7-T3-130 |
| D99 Series                              |           |
| Product Selection .....                 | V7-T3-136 |
| Technical Data and Specifications ..... | V7-T3-137 |
| Dimensions .....                        | V7-T3-140 |

## Features and Benefits

- All solid-state circuitry has no moving parts to wear
- Integral heat sink eliminates the need for added accessories and installation
- Flexible mounting allows DIN rail or panel mounting without additional hardware or tools
- Isolated input and output terminals protect the system from electrical noise
- Internal snubber circuitry protects the SSR from transients

## Standards and Certifications

- UL/cUL listed—UL 508
- CSA certified
- CE marked
- RoHS compliant



# 3.6

## Control Relays and Timers

### Solid-State Relays

#### Product Selection

D99210ACZ1

#### D99 Series

3



| Input Voltage | Output Voltage | Contact Configuration | Switching Type | Rated Current Load (Amps) | Catalog Number |
|---------------|----------------|-----------------------|----------------|---------------------------|----------------|
| 90–280 Vac    | 24–280 Vac     | SPST-NO               | Zero cross     | 10                        | D99210ACZ1     |
| 3–32 Vdc      | 24–280 Vac     | SPST-NO               | Zero cross     | 10                        | D99210ACZ2     |
| 90–280 Vac    | 24–280 Vac     | SPST-NO               | Zero cross     | 25                        | D99225ACZ1     |
| 3–32 Vdc      | 24–280 Vac     | SPST-NO               | Zero cross     | 25                        | D99225ACZ2     |
| 90–280 Vac    | 24–280 Vac     | SPST-NO               | Zero cross     | 40                        | D99240ACZ1     |
| 3–32 Vdc      | 24–280 Vac     | SPST-NO               | Zero cross     | 40                        | D99240ACZ2     |
| 90–280 Vac    | 48–600 Vac     | SPST-NO               | Zero cross     | 10                        | D99610ACZ1     |
| 3–32 Vdc      | 48–600 Vac     | SPST-NO               | Zero cross     | 10                        | D99610ACZ2     |
| 90–280 Vac    | 48–600 Vac     | SPST-NO               | Zero cross     | 25                        | D99625ACZ1     |
| 3–32 Vdc      | 48–600 Vac     | SPST-NO               | Zero cross     | 25                        | D99625ACZ2     |
| 90–280 Vac    | 48–600 Vac     | SPST-NO               | Zero cross     | 40                        | D99640ACZ1     |
| 3–32 Vdc      | 48–600 Vac     | SPST-NO               | Zero cross     | 40                        | D99640ACZ2     |

## Technical Data and Specifications

### D99 Series

| Description  | Units                  | D99210ACZ1  | D99210ACZ2        | D99225ACZ1  | D99225ACZ2        | D99240ACZ1  | D99240ACZ2        |
|--|------------------------|-------------|-------------------|-------------|-------------------|-------------|-------------------|
| <b>Output Characteristics</b>                      |                        |             |                   |             |                   |             |                   |
| Contact configuration                              |                        | SPST-NO     | SPST-NO           | SPST-NO     | SPST-NO           | SPST-NO     | SPST-NO           |
| Switching device                                   |                        | SCR         | SCR               | SCR         | SCR               | SCR         | SCR               |
| Current rating                                     | A                      | 10          | 10                | 25          | 25                | 40          | 40                |
| Switching type                                     |                        | Zero cross  | Zero cross        | Zero cross  | Zero cross        | Zero cross  | Zero cross        |
| Maximum zero turn-on voltage (Vpk)                 | V                      | 35          | 35                | 35          | 35                | 35          | 35                |
| Maximum rate of rise off state voltage (DV/DT)     | V/us                   | 500         | 200               | 500         | 500               | 500         | 500               |
| Incandescent lamp ampere rating (rms)              | A                      | 8           | 8                 | 16          | 16                | 20          | 20                |
| Motor load rating (rms)                            | A                      | 4.5         | 4.5               | 8           | 8                 | 14          | 14                |
| Min. load current to maintain on                   | mA                     | 50          | 50                | 120         | 120               | 250         | 250               |
| Non-repetitive surge current (1 cycle)             | A                      | 83          | 83                | 800         | 800               | 800         | 800               |
| Max. rms overload current (1 second)               | A                      | 24          | 24                | 40          | 40                | 100         | 100               |
| Max. off state leakage current (rms)               | mA                     | 10          | 10                | 10          | 10                | 10          | 10                |
| Typical on state voltage drop (rms)                | Vac                    | 1.25        | 1.25              | 1.35        | 1.35              | 1.6         | 1.6               |
| Max. on state voltage drop (rms)                   | Vac                    | 1.6         | 1.6               | 1.8         | 1.8               | 1.6         | 1.6               |
| Max. I <sup>2</sup> t for fusing (A <sup>2</sup> ) |                        | 83          | 83                | 3700        | 3700              | 3700        | 83                |
| <b>Input Characteristics</b>                       |                        |             |                   |             |                   |             |                   |
| Must release voltage                               | V                      | 10 AC       | 1 DC              | 10 AC       | 1 DC              | 10 AC       | 1 DC              |
| Typical input impedance                            | ohms                   | 16–25k      | Current regulator | 16–25k      | Current regulator | 13k         | Current regulator |
| Nominal input current at 5 Vdc or 240 Vac          | mA                     | 12          | 12                | 12          | 12                | 16          | 16                |
| Reverse polarity protection                        |                        | NA          | Yes               | NA          | Yes               | NA          | Yes               |
| <b>Performance Characteristics</b>                 |                        |             |                   |             |                   |             |                   |
| Operating time (response time)                     |                        |             |                   |             |                   |             |                   |
| ON   | ms                     | 8.3         | 8.3               | 8.3         | 8.3               | 8.3         | 10                |
| OFF  | ms                     | 8.3         | 8.3               | 8.3         | 8.3               | 8.3         | 10                |
| Rated insulation voltage—input to input            | Vac                    | 4000        | 4000              | 4000        | 4000              | 4000        | 4000              |
| Dielectric strength—terminal to chassis            | Vac                    | 4000        | 4000              | 4000        | 4000              | 4000        | 4000              |
| <b>Environment</b>                                 |                        |             |                   |             |                   |             |                   |
| Product certifications                             |                        | UL, CSA, CE | UL, CSA, CE       | UL, CSA, CE | UL, CSA, CE       | UL, CSA, CE | UL, CSA, CE       |
| Ambient air temperature                            |                        |             |                   |             |                   |             |                   |
| Storage  | °C                     | –40 to 100  | –40 to 100        | –40 to 100  | –40 to 100        | –40 to 100  | –40 to 100        |
| Operating  | °C                     | –30 to 80   | –30 to 80         | –30 to 80   | –30 to 80         | –30 to 80   | –30 to 80         |
| Degree of protection                               |                        | IP20        | IP20              | IP20        | IP20              | IP20        | IP20              |
| <b>Miscellaneous Characteristics</b>               |                        |             |                   |             |                   |             |                   |
| Thermal resistance (junction to case)              | °C/W                   | 1.5         | 1.5               | 1.5         | 0.43              | 1.5         | 0.43              |
| Integral heat sink                                 | °C/W                   | 2.2         | 2.2               | 2.2         | 2.2               | 2.2         | 2.2               |
| Weight   | g (oz)                 | 320 (11.3)  | 320 (11.3)        | 320 (11.3)  | 326 (11.5)        | 320 (11.3)  | 332 (11.7)        |
| LED—input  |                        | Green       | Green             | Green       | Green             | Green       | Green             |
| Terminal wire capacity                             | AWG (mm <sup>2</sup> ) | 8 (10)      | 8 (10)            | 8 (10)      | 8 (10)            | 8 (10)      | 8 (10)            |
| Terminal torque (max.)                             | in-lb (Nm)             | 12.5 (1.4)  | 12.5 (1.4)        | 12.5 (1.4)  | 12.5 (1.4)        | 12.5 (1.4)  | 12.5 (1.4)        |

# 3.6

## Control Relays and Timers

### Solid-State Relays

3

#### D99 Series, continued

| Description  | Units                  | D99610ACZ1  | D99610ACZ2        | D99625ACZ1  | D99625ACZ2        | D99640ACZ1  | D99640ACZ2        |
|--|------------------------|-------------|-------------------|-------------|-------------------|-------------|-------------------|
| <b>Output Characteristics</b>                      |                        |             |                   |             |                   |             |                   |
| Contact configuration                              |                        | SPST-NO     | SPST-NO           | SPST-NO     | SPST-NO           | SPST-NO     | SPST-NO           |
| Switching device                                   |                        | SCR         | SCR               | SCR         | SCR               | SCR         | SCR               |
| Current rating                                     | A                      | 10          | 10                | 25          | 10                | 40          | 40                |
| Switching type                                     |                        | Zero cross  | Zero cross        | Zero cross  | Zero cross        | Zero cross  | Zero cross        |
| Maximum zero turn-on voltage (V <sub>pk</sub> )    | V                      | 35          | 35                | 35          | 35                | 35          | 35                |
| Maximum rate of rise off state voltage (DV/DT)     | V/us                   | 200         | 200               | 700         | 700               | 500         | 500               |
| Incandescent lamp ampere rating (rms)              | A                      | 8           | 8                 | 16          | 16                | 20          | 20                |
| Motor load rating (rms)                            | A                      | 4.5         | 4.5               | 8           | 8                 | 14          | 14                |
| Min. load current to maintain on                   | mA                     | 80          | 80                | 250         | 250               | 250         | 250               |
| Non-repetitive surge current (1 cycle)             | A                      | 83          | 83                | 1000        | 1000              | 800         | 800               |
| Max. rms overload current (1 second)               | A                      | 24          | 24                | 50          | 50                | 100         | 100               |
| Max. off state leakage current (rms)               | mA                     | 10          | 10                | 10          | 10                | 10          | 10                |
| Typical on state voltage drop (rms)                | Vac                    | 1.25        | 1.25              | 1.35        | 1.35              | 1.6         | 1.6               |
| Max. on state voltage drop (rms)                   | Vac                    | 1.6         | 1.6               | 1.6         | 1.6               | 1.6         | 1.6               |
| Max. I <sup>2</sup> t for fusing (A <sup>2</sup> ) |                        | 83          | 83                | 1700        | 1700              | 3700        | 3700              |
| <b>Input Characteristics</b>                       |                        |             |                   |             |                   |             |                   |
| Must release voltage                               | V                      | 10 AC       | 1 DC              | 10 AC       | 1 DC              | 10 AC       | 1 DC              |
| Typical input impedance                            | ohms                   | 16–25k      | Current regulator | 16–25k      | Current regulator | 13k         | Current regulator |
| Nominal input current at 5 Vdc or 240 Vac          | mA                     | 12          | 16                | 12          | 16                | 16          | 16                |
| Reverse polarity protection                        |                        | NA          | Yes               | NA          | Yes               | NA          | Yes               |
| <b>Performance Characteristics</b>                 |                        |             |                   |             |                   |             |                   |
| Operating time (response time)                     |                        |             |                   |             |                   |             |                   |
| ON   | ms                     | 8.33        | 8.3               | 8.33        | 8.3               | 10          | 10                |
| OFF  | ms                     | 8.33        | 8.3               | 8.33        | 8.3               | 10          | 10                |
| Rated insulation voltage—input to input            | Vac                    | 4000        | 4000              | 4000        | 4000              | 4000        | 4000              |
| Dielectric strength—terminal to chassis            | Vac                    | 4000        | 4000              | 4000        | 4000              | 4000        | 4000              |
| <b>Environment</b>                                 |                        |             |                   |             |                   |             |                   |
| Product certifications                             |                        | UL, CSA, CE | UL, CSA, CE       | UL, CSA, CE | UL, CSA, CE       | UL, CSA, CE | UL, CSA, CE       |
| Ambient air temperature                            |                        |             |                   |             |                   |             |                   |
| Storage  | °C                     | –40 to 100  | –40 to 100        | –40 to 100  | –40 to 100        | –40 to 100  | –40 to 100        |
| Operating  | °C                     | –30 to 80   | –30 to 80         | –30 to 80   | –30 to 80         | –30 to 80   | –30 to 80         |
| Degree of protection                               |                        | IP20        | IP20              | IP20        | IP20              | IP20        | IP20              |
| <b>Miscellaneous Characteristics</b>               |                        |             |                   |             |                   |             |                   |
| Thermal resistance (junction to case)              | °C/W                   | 1.8         | 1.8               | 0.43        | 0.43              | 0.43        | 0.43              |
| Integral heat sink                                 | °C/W                   | 2.2         | 2.2               | 2.2         | 2.2               | 2.2         | 2.2               |
| Weight   | g (oz)                 | 320 (11.3)  | 321 (11.3)        | 326 (11.5)  | 326 (11.5)        | 332 (11.7)  | 332 (11.7)        |
| LED—input  |                        | Green       | Green             | Green       | Green             | Green       | Green             |
| Terminal wire capacity                             | AWG (mm <sup>2</sup> ) | 8 (10)      | 9 (10)            | 8 (10)      | 8 (10)            | 8 (10)      | 8 (10)            |
| Terminal torque (max.)                             | in-lb (Nm)             | 12.5 (1.4)  | 12.5 (1.4)        | 12.5 (1.4)  | 12.5 (1.4)        | 12.5 (1.4)  | 12.5 (1.4)        |

**Temperature Derating Curves**

**10 Amp Styles**

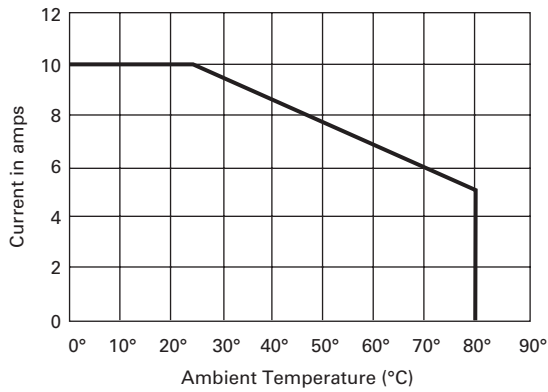

**40 Amp Styles**

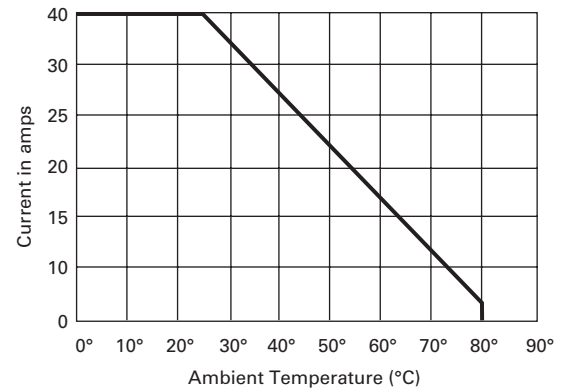

**25 Amp Styles**

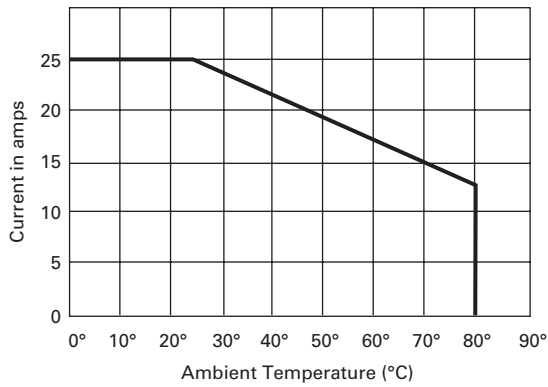

# 3.6

## Control Relays and Timers

### Solid-State Relays

#### Dimensions

Approximate Dimensions in Inches (mm)

#### D99 Series

3

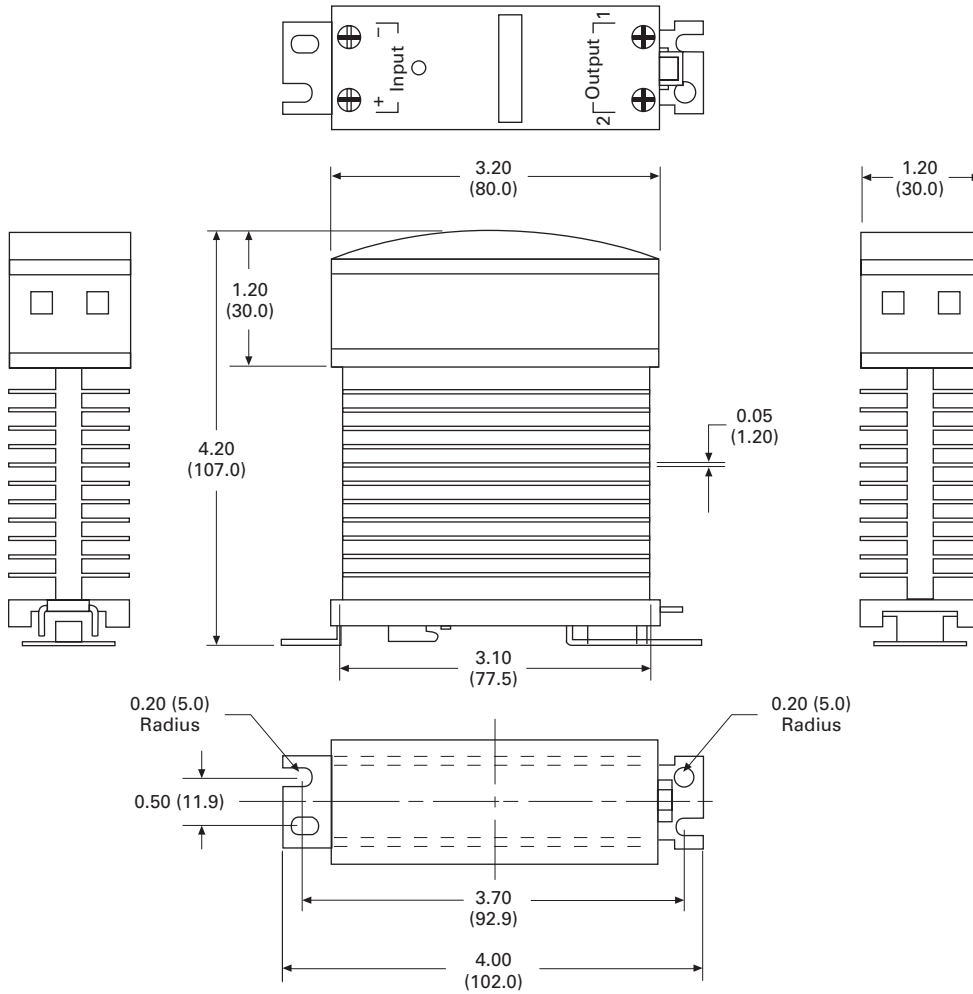



## Machine Tool Relays



### Product Overview

Eaton's machine tool relay offering includes a variety of NEMA type relays. Included in this are open style relays and relays with convertible or side-mount contacts. Also included in this family are a variety of accessories to match the application, including suppressors, timing contacts and enclosures. The relay coils are available in a variety of line and control level voltages.

### Contents

| <b>Description</b>  | <b>Page</b>      |
|---|------------------|
| Machine Tool Relays   |                  |
| D15 Series—Freedom 600 V Multipole . . . . .                                | <b>V7-T3-142</b> |
| BF/BFD Series—Fixed Contact<br>Industrial Control . . . . .                 | <b>V7-T3-147</b> |
| AR/ARD Series—Convertible Contact<br>Industrial Control . . . . .           | <b>V7-T3-153</b> |
| D26 Series—Type M, 600 Vac Multipole<br>with Convertible Contacts . . . . . | <b>V7-T3-158</b> |
| D26 Series—Type M, DC Multipole<br>with Convertible Contacts . . . . .      | <b>V7-T3-163</b> |

D15 Series—Freedom 600 V Multipole



### Contents

| <i>Description</i>                          | <i>Page</i> |
|---|-------------|
| D15 Series—Freedom 600 V Multipole          |             |
| Product Selection . . . . .                 | V7-T3-143   |
| Accessories . . . . .                       | V7-T3-144   |
| Technical Data and Specifications . . . . . | V7-T3-145   |
| Dimensions . . . . .                        | V7-T3-146   |
| BF/BFD Series—Fixed Contact                 |             |
| Industrial Control . . . . .                | V7-T3-147   |
| AR/ARD Series—Convertible Contact           |             |
| Industrial Control . . . . .                | V7-T3-153   |
| D26 Series—Type M, 600 Vac Multipole        |             |
| with Convertible Contacts . . . . .         | V7-T3-158   |
| D26 Series—Type M, DC Multipole             |             |
| with Convertible Contacts . . . . .         | V7-T3-163   |

### D15 Series—Freedom 600 V Multipole

#### Product Description

Contact poles on the D15 relay are of the fixed design and are not convertible. The basic four-pole relay will accept a front-mounted contact pole deck and/or side-mounted contact blocks (one per side). In addition, a side-mounted solid-state timer or a front-mounted pneumatic timer can be added to the relay. Only one front-mounted attachment can be added to the basic relay.

#### Application Description

Side-mounted contact blocks can be used to provide additional poles in applications where a pneumatic timer is installed on the front of the relay. They can also be used where panel depth is restricted.

The maximum number of contacts recommended per relay is eight, six of which can be NC. When a pneumatic timer is used, the maximum recommended number of NC contacts is three.

Relays with DC coils are supplied with a coil clearing NC contact mounted on the side of the relay.

#### Features and Benefits

- 600 V, 10 A continuous thermal current
- State indicator visually shows relay ON or OFF status
- Relay base has mounting holes on 35 x 60 mm centers, permitting direct replacement of competitive relays
- Relay also mounts on 35 mm DIN rail as standard
- Magnet coil has three terminals, permitting either top or diagonal wiring—easy to replace European or U.S. relays without changing wiring layout
- Contact pole terminals have captive, backed-out, self-lifting pressure plates with ± screws—reduced wiring time
- All terminals are shrouded or “finger-proofed” to reduce possibility of electrical shock

#### Standards and Certifications

- UL
- CSA certified

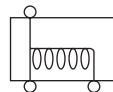



## Product Selection

### When Ordering, Specify

Catalog number and magnet coil code letter. Example: For a four-pole relay having 4NO contacts with a 120 V 60 Hz coil, order Catalog Number D15CR40**AB**.

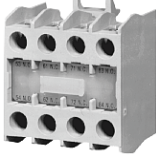
### Factory-Assembled Multipole Relays

|  | Number of Poles | Type of Contacts |    | Open Type Catalog Number <sup>①</sup> |
|--|-----------------|------------------|----|---------------------------------------|
|  |                 | NO               | NC |                                       |
| <br>D15CR40_B   | 4               | 4                | 0  | D15CR40_B                             |
|  |                 | 3                | 1  | D15CR31_B                             |
|  |                 | 2                | 2  | D15CR22_B                             |
|  |                 | 1                | 3  | D15CR13_B                             |
|  |                 | 0                | 4  | D15CR04_B                             |
| <br>D15CR60_B<br>(four-pole relay with two-pole front-mounted deck)   | 6               | 6                | 0  | D15CR60_B                             |
|  |                 | 5                | 1  | D15CR51_B                             |
|  |                 | 4                | 2  | D15CR42_B                             |
|  |                 | 3                | 3  | D15CR33_B                             |
|  |                 | 2                | 4  | D15CR24_B                             |
|  |                 | 1                | 5  | D15CR15_B <sup>②</sup>                |
|  |                 | 0                | 6  | D15CR06_B <sup>②</sup>                |
| <br>D15CR80_B<br>(four-pole relay with four-pole front-mounted deck) | 8               | 8                | 0  | D15CR80_B                             |
|  |                 | 7                | 1  | D15CR71_B                             |
|  |                 | 6                | 2  | D15CR62_B                             |
|  |                 | 5                | 3  | D15CR53_B                             |
|  |                 | 4                | 4  | D15CR44_B                             |
|  |                 | 3                | 5  | D15CR35_B <sup>②</sup>                |
|  |                 | 2                | 6  | D15CR26_B <sup>②</sup>                |

### Additional Contact Poles

| Description                            | Catalog Number |
|--|----------------|
| <b>Front Contact Pole Deck</b>         |                |
| 1NO-1NC                                | C320KGT3       |
| 2NO                                    | C320KGT4       |
| 2NC                                    | C320KGT5       |
| 1NO (early closing)–1NC (late opening) | C320KGT7       |
| 4NO                                    | C320KGT13      |
| 3NO-1NC                                | C320KGT14      |
| 2NO-2NC                                | C320KGT15      |
| 1NO-3NC                                | C320KGT16      |
| 4NC                                    | C320KGT17      |
| <b>Side-Mounted Contact Blocks</b>     |                |
| 1NO-1NC                                | C320KGS3       |
| 2NO                                    | C320KGS4       |
| 2NC                                    | C320KGS5       |
| 1NO (early closing)–1NC (late opening) | C320KGS7       |

### Notes

- ① Underscore indicates missing code suffix for magnet coil—see Magnet Coil Selection table above.
- ② Not all suffix codes available: consult Customer Support Center.

### Magnet Coil Selection

| AC Coils<br>Volts and Hertz | Code<br>Suffix | DC Coils<br>Volts | Code<br>Suffix |
|-----------------------------|----------------|-------------------|----------------|
| 120/60 or 110/50            | <b>A</b>       | 12                | <b>R1</b>      |
| 240/60 or 220/50            | <b>B</b>       | 24                | <b>T1</b>      |
| 480/60 or 440/50            | <b>C</b>       | 48                | <b>W1</b>      |
| 600/60 or 550/50            | <b>D</b>       | 120               | <b>A1</b>      |
| 208/60                      | <b>E</b>       |                   |                |
| 277/60                      | <b>H</b>       |                   |                |
| 208–240/60                  | <b>J</b>       |                   |                |
| 24/60                       | <b>T</b>       |                   |                |

#### Accessories

##### C320 Pneumatic Timer Attachment



##### Pneumatic Timer Attachment

| Timing Range      | Catalog Number |
|-------------------|----------------|
| 0.1 to 30 seconds | <b>C320TP1</b> |
| 10 to 180 seconds | <b>C320TP2</b> |

| Description | Maximum Ampere Ratings |            |            |            |
|-------------|------------------------|------------|------------|------------|
|             | Volts AC               |            |            |            |
|             | <b>120</b>             | <b>240</b> | <b>480</b> | <b>600</b> |
| Make        | 30                     | 15         | 7.5        | 6          |
| Break       | 3                      | 1.5        | 0.75       | 0.6        |

Attachment mounts on top of any Freedom Series relay (top-mounted auxiliary contacts can not be installed on device when timer is used). Timer unit has DPST

timed contacts—circuits in each pole must be the same polarity. Units are convertible from OFF to ON delay or vice-versa.

##### Finger Protection Shields

| Application | Catalog Number |
|-------------|----------------|
| D15         | <b>C320LS1</b> |

Snap-on shields for both contactors and starters provide IEC Type IP20

Finger Protection. Prevents accidental contact with line/load terminals.

##### Adhesive Dust Cover

| Description     | Catalog Number    |
|-----------------|-------------------|
| 25 to a package | <b>C320DSTCVR</b> |

These adhesive stickers come 25 to a package and provide extra protection from contaminants when applied to the sides of Freedom D15. Adhesive covers are easily

applied to side opening where auxiliaries are not installed and provide extra protection from metal filings and other debris.

##### Solid-State Timer



##### Solid-State ON DELAY Timer ①

| Timing Range       | Catalog Number ②③④  |
|--------------------|---------------------|
| 0.1 to 1.0 seconds | <b>C320TDN1_</b>    |
| 1 to 30 seconds    | <b>C320TDN30_</b>   |
| 30 to 300 seconds  | <b>C320TDN300_</b>  |
| 5 to 30 minutes    | <b>C320TDN3000_</b> |

This timer is designed to be **wired in series with the load** (typically a coil). When the START button is pushed (power applied to timer), the ON delay timing function starts. At the completion of the set timing period, timer and series wired load will both be energized.

##### C321MP1



##### Metal Mounting Plate

| Description          | Catalog Number |
|----------------------|----------------|
| Metal mounting plate | <b>C321MP1</b> |

Fits all D15 multipole relays.

##### DIN Rail



##### Mounting Channel (DIN Rail)

| Description    | Catalog Number    |
|----------------|-------------------|
| 1 meter length | <b>XBANS3575P</b> |

Designed for DIN rail mounting of Freedom Series relays.

##### C320TS2



##### Transient Suppressor Kits

| Description | Coil Voltage 50/60 Hz ⑤ | Catalog Number |
|-------------|-------------------------|----------------|
| Transient   | 24/120 V                | <b>C320TS1</b> |
| Suppressor  | 208/240 V               | <b>C320TS2</b> |
|             | 277/480 V               | <b>C320TS3</b> |

These kits limit high voltage transients produced in the control circuit when power is removed from the contactor or starter coil. There are three separate suppressors for use on 24–120 V, 208–240 V or 27–480 V coils respectively.

These devices mount directly to the coil terminals.

##### Notes

- ① Side mounted on Freedom Series NEMA 00–2, D15, IECA-K and C25D, C25E and C25F frame.
- ② Add operating voltage suffix to catalog number; **A** = 120 V, **B** = 240 V, **E** = 208 V.
- ③ Rated 0.5 ampere pilot duty—not to be used on larger contactors.
- ④ Terminal connections are quick connects only. Two per side.
- ⑤ Suppressor is compatible with coil voltages/ranges as shown, both 50 and 60 Hz.

### C320DC



### AC/DC Interface Module— Controller Coil Voltage Ranges

| Controller Catalog Number Prefix   | Controller Size or Rating | Coil Range Volts AC |
|------------------------------------|---------------------------|---------------------|
| AE16, AE17, AE56, AE57, CE15, CE55 | A-F                       | 24–240              |
|                                    | G-K                       | 48–240              |
|                                    | L-N                       | 110–240             |
| AN16, AN56, CN15, CN55             | 00–0                      | 24–240              |
|                                    | 1–2                       | 48–240              |
|                                    | 3                         | 110–240             |
| CN35                               | 10–30 A                   | 24–240              |
|                                    | 60 A                      | 48–240              |
|                                    | 100 A                     | 110–240             |

The Catalog Number C320DC Interface Module is an optically isolated solid-state switch that provides a means of operating AC coils with a 24 Vdc control signal. It acts as a space-saving interposing relay that can switch a specified 50/60 Hz AC source to the contactor or starter coil.

The module may be directly attached to the coil terminals of any Freedom Series contactor or starter—NEMA Sizes 00–3, D15, IEC Sizes A–N and lighting contactors 10–100 A. It also has

provisions for DIN rail mounting.

The module will operate coils within the voltage ranges shown in the table to the left.

#### Design Characteristics

- DC input: 24 V  $\pm$ 10% at mA nominal
- AC operating voltage: 24–240 Vac  $\pm$ 10% 50/60 Hz
- AC current rating: 10 A make (inrush), 1 A break (sealed)

### Typical Application—Solid-State Switch

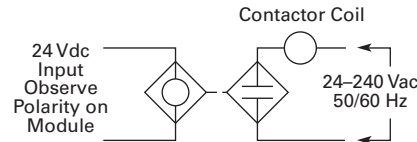

## Technical Data and Specifications

### Contact Ratings—NEMA A600

Continuous Thermal Rating: 10 A

| AC Volts | Make | Break |
|----------|------|-------|
| 120      | 60   | 6.0   |
| 240      | 30   | 3.0   |
| 480      | 15   | 1.5   |
| 600      | 12   | 1.2   |

### Contact Ratings—NEMA P300

Continuous Thermal Rating: 5 A

| DC Volts | Make/Break Amperes |
|----------|--------------------|
| 125      | 1.1                |
| 250      | 0.55               |

### Magnet Coil Data

| AC Voltage | Pickup VA | Watts | Sealed VA | Watts |
|------------|-----------|-------|-----------|-------|
| 12–600 V   | 80        | 49    | 7.5       | 2.4   |

| DC Voltage | Pickup Amps | Watts | Sealed VA | Watts |
|------------|-------------|-------|-----------|-------|
| 12         | 6.4         | 76.8  | 0.28      | 3.36  |
| 24         | 3.2         | 76.8  | 0.14      | 3.36  |
| 48         | 1.6         | 76.8  | 0.07      | 3.36  |
| 120        | 0.64        | 76.8  | 0.028     | 3.36  |

### Example of Terminal Marking with 2NO and 2NC Contacts

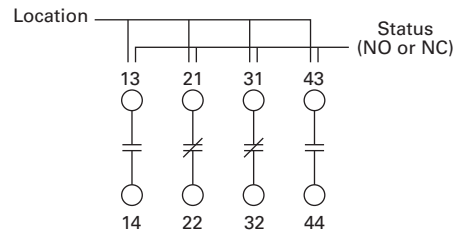

Relay terminals are identified by a two-digit number in accordance with International Standards approved by CENELEC (European Committee for Electrotechnical Standardization). The number is marked on the relay and is used to identify location and status of the contacts.

The first digit indicates the location of the contact on the relay. The numbering begins with 1 and continues without a break from left to right.

The second digit indicates the status of the contacts (NO or NC). Terminal marking 1 and 2 mean NC and 3 and 4 mean NO.

# 3.7

## Control Relays and Timers

### Machine Tool Relays

#### Dimensions

Approximate Dimensions in Inches (mm)

#### D15 Four-Pole Relay

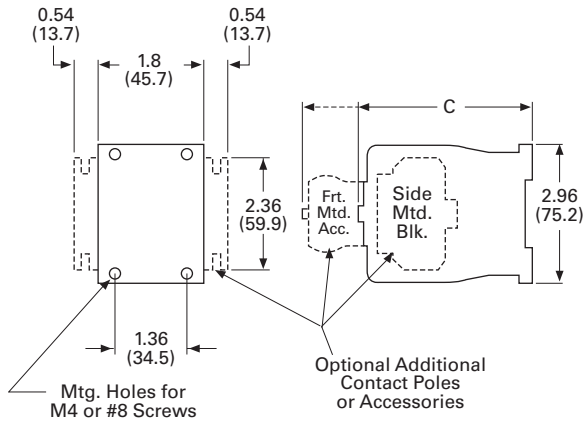

#### D15 Six- and Eight-Pole Relays

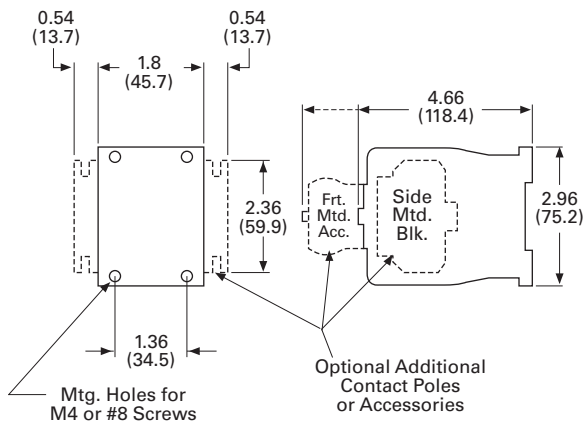

#### Dimensions and Shipping Weights

| Description                        | Dimension C  | Shipping Weights<br>Lbs (kg) |
|------------------------------------|--------------|------------------------------|
| Relay only                         | 3.30 (83.8)  | 1.3 (0.6)                    |
| Relay with timer attachment        | 5.55 (141.0) | 1.5 (0.7)                    |
| Relay with front contact pole deck | 4.66 (118.4) | 1.7 (0.8)                    |

**BF/BFD Series—Fixed Contact Industrial Control****BF/BFD Series—Fixed Contact Industrial Control****Product Description**

Type BF is AC operated, 300 V maximum, and the BFD is DC operated, 250 V. Fixed contact relays are available in any combination of NO and NC from two to 12 poles. BF and BFD relays have captive clamp terminals fully accessible from the front, a molded coil with low operating temperature and silver alloy contacts suitable for low voltage circuits.

**Features and Benefits****Wiring to Relay**

- In parallel with coil—one timed and up to 12 instantaneous contacts, or
- In series with coil—up to 12 timed contacts in one relay

**Permanent Magnet Latch**

- Field mountable on Catalog Number BF; factory installed on BFD
- Latch coil continuously rated
- Latch plunger adjustable for optimum performance

**Contents**

| <b>Description</b>   | <b>Page</b>      |
|--|------------------|
| D15 Series—Freedom 600 V Multipole . . . . .                             | <b>V7-T3-142</b> |
| BF/BFD Series—Fixed Contact Industrial Control                           |                  |
| Product Selection . . . . .  | <b>V7-T3-148</b> |
| Options . . . . .  | <b>V7-T3-150</b> |
| Technical Data and Specifications . . . . .                              | <b>V7-T3-151</b> |
| Dimensions . . . . .   | <b>V7-T3-152</b> |
| AR/ARD Series—Convertible Contact Industrial Control . . . . .           | <b>V7-T3-153</b> |
| D26 Series—Type M, 600 Vac Multipole with Convertible Contacts . . . . . | <b>V7-T3-158</b> |
| D26 Series—Type M, DC Multipole with Convertible Contacts . . . . .      | <b>V7-T3-163</b> |

**Standards and Certifications**

- UL recognized, UL File No. E19223 (AC relays only)
- CSA certified, File No. LR39402-6, LR28548-10, 11 (AC and DC relays)



#### Product Selection

##### When Ordering, Specify

- Catalog number of basic relay
- If a coil voltage other than listed is required, select the suffix code from the Coil Voltage table and substitute it for the last letter in the catalog number. Example: BF80**V** for a 110/60 AC coil

3

##### Type BF



##### Type BFD

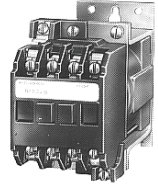

#### Complete Relay—Type BF and BFD, Two-, Three-, Four- and Six-Pole <sup>①</sup>

| Number of Poles | Type of Contact |             | BF 300 Vac Basic Relays<br>120/60, 110/50 AC Coil | BFD 250 Vdc Basic<br>Relays<br>120 DC Coil |
|-----------------|-----------------|-------------|---|--|
|                 | NO (Form A)     | NC (Form B) | Catalog Number                                    | Catalog Number                             |
| 2               | 2               | 0           | BF20F   | BFD20S                                     |
|                 | 1               | 1           | BF11F   | BFD11S                                     |
|                 | 0               | 2           | BF02F   | BFD02S                                     |
| 3               | 3               | 0           | BF30F   | BFD30S                                     |
|                 | 2               | 1           | BF21F   | BFD21S <sup>②</sup>                        |
|                 | 1               | 2           | BF12F   | BFD12S                                     |
|                 | 0               | 3           | BF03F   | BFD03S                                     |
| 4               | 4               | 0           | BF40F   | BFD40S                                     |
|                 | 3               | 1           | BF31F   | BFD31S                                     |
|                 | 2               | 2           | BF22F   | BFD22S                                     |
|                 | 1               | 3           | BF13F   | BFD13S                                     |
|                 | 0               | 4           | BF04F   | BFD04S                                     |
| 6               | 6               | 0           | BF60F   | BFD60S                                     |
|                 | 5               | 1           | BF51F   | BFD51S                                     |
|                 | 4               | 2           | BF42F   | BFD42S                                     |
|                 | 3               | 3           | BF33F   | BFD33S                                     |
|                 | 2               | 4           | BF24F   | BFD24S                                     |
|                 | 0               | 6           | BF06F   | BFD06S                                     |

#### Coil Voltage

| BF Coils |       |             |
|----------|-------|-------------|
| Volts AC | Hz    | Suffix Code |
| 12       | 60    | H           |
| 24       | 60    | I           |
| 48       | 60    | J           |
| 110      | 60    | V           |
| 110/120  | 50/60 | F           |
| 208      | 60    | K           |
| 220/240  | 50/60 | G           |
| 440      | 60    | C           |

| BFD Coils |             |
|-----------|-------------|
| Volts DC  | Suffix Code |
| 6         | C           |
| 12        | D           |
| 24        | L           |
| 38        | N           |
| 48        | M           |
| 72        | E           |
| 95        | B           |
| 120       | S           |
| 130       | U           |
| 240       | T           |

#### Notes

- <sup>①</sup> Relays listed above with equal number of NO and NC contact poles are specially priced—1NO and 1NC pole are supplied at no additional charge.
- <sup>②</sup> Consult Customer Support Center for availability.



**When Ordering, Specify**

- Catalog number of basic relay
- If a coil voltage other than listed is required, select the suffix code from the Coil Voltage table and substitute it for the last letter in the catalog number. Example: BF80**V** for a 110/60 AC coil

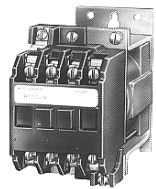
**Type BF****Type BFD****Complete Relay—Type BF and BFD, Eight-, 10- and 12-Pole** <sup>①</sup>

| Number of Poles | Type of Contact |             | BF 300 Vac Basic Relays<br>120/60, 110/50 AC Coil | BFD 250 Vdc Basic<br>Relays<br>120 DC Coil |
|-----------------|-----------------|-------------|---|--|
|                 | NO (Form A)     | NC (Form B) | Catalog Number                                    | Catalog Number                             |
| 8               | 8               | 0           | <b>BF80F</b>                                      | <b>BFD80S</b>                              |
|                 | 7               | 1           | <b>BF71F</b>                                      | <b>BFD71S</b>                              |
|                 | 6               | 2           | <b>BF62F</b>                                      | <b>BFD62S</b>                              |
|                 | 5               | 3           | <b>BF53F</b>                                      | <b>BFD53S</b>                              |
|                 | 4               | 4           | <b>BF44F</b>                                      | <b>BFD44S</b>                              |
|                 | 0               | 8           | <b>BF08F</b>                                      | <b>BFD08S</b>                              |
| 10              | 10              | 0           | <b>BF100F</b>                                     | <b>BFD100S</b>                             |
|                 | 8               | 2           | <b>BF82F</b>                                      | <b>BFD82S</b> <sup>②</sup>                 |
|                 | 7               | 3           | <b>BF73F</b> <sup>②</sup>                         | <b>BFD73S</b>                              |
|                 | 6               | 4           | <b>BF64F</b>                                      | <b>BFD64S</b>                              |
|                 | 5               | 5           | <b>BF55F</b>                                      | <b>BFD55S</b> <sup>②</sup>                 |
|                 | 4               | 6           | <b>BF46F</b>                                      | <b>BFD46S</b>                              |
|                 | 2               | 8           | <b>BF28F</b>                                      | <b>BFD28S</b>                              |
| 12              | 12              | 0           | <b>BF120F</b>                                     | <b>BFD120S</b>                             |
|                 | 8               | 4           | <b>BF84F</b>                                      | <b>BFD84S</b>                              |
|                 | 7               | 5           | <b>BF75F</b>                                      | <b>BFD75S</b>                              |
|                 | 6               | 6           | <b>BF66F</b>                                      | <b>BFD66S</b>                              |
|                 | 5               | 7           | <b>BF57F</b>                                      | <b>BFD57S</b>                              |
|                 | 4               | 8           | <b>BF48F</b>                                      | <b>BFD48S</b>                              |

**Coil Voltage**

| BF Coils |       |             |
|----------|-------|-------------|
| Volts AC | Hz    | Suffix Code |
| 12       | 60    | <b>H</b>    |
| 24       | 60    | <b>I</b>    |
| 48       | 60    | <b>J</b>    |
| 110      | 60    | <b>V</b>    |
| 110/120  | 50/60 | <b>F</b>    |
| 208      | 60    | <b>K</b>    |
| 220/240  | 50/60 | <b>G</b>    |
| 440      | 60    | <b>C</b>    |

| BFD Coils |             |
|-----------|-------------|
| Volts DC  | Suffix Code |
| 6         | <b>C</b>    |
| 12        | <b>D</b>    |
| 24        | <b>L</b>    |
| 38        | <b>N</b>    |
| 48        | <b>M</b>    |
| 72        | <b>E</b>    |
| 95        | <b>B</b>    |
| 120       | <b>S</b>    |
| 130       | <b>U</b>    |
| 240       | <b>T</b>    |

**Notes**

- <sup>①</sup> Relays listed above with equal number of NO and NC contact poles are specially priced—1NO and 1NC pole are supplied at no additional charge.
- <sup>②</sup> Consult Customer Support Center for availability.

# 3.7

## Control Relays and Timers

### Machine Tool Relays

3

Permanent Magnet Latch, Relay Mounted

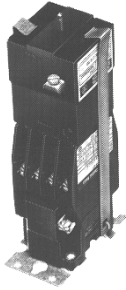

#### Permanent Magnet Latch

| Coil Volts       | Coil Hz | Catalog Number |
|------------------|---------|----------------|
| <b>AC Relays</b> |         |                |
| 24               | 60      | <b>BFMLI</b> ② |
| 48               | 60      | <b>BFMLJ</b> ② |
| 110/120          | 50/60   | <b>BFMLF</b>   |
| 220/240          | 50/60   | <b>BFMLG</b>   |
| <b>DC Relays</b> |         |                |
| 24               | —       | <b>BFMLL</b>   |
| 48               | —       | <b>BFMLM</b>   |
| 120              | —       | <b>BFMLS</b>   |
| 240              | —       | <b>BFMLT</b>   |

#### Options

##### FASTON Push-On Terminals

| Description  | Code Letter | Catalog Number |
|--|-------------|----------------|
| Insert letter <b>F</b> after relay type designation in listed catalog number. Example: BFF20F or BFDF20S | <b>F</b>    | —              |

##### Overlapping Contacts

| Description   | Code Letter | Catalog Number |
|---|-------------|----------------|
| NO contact closes before corresponding NC contact opens—supplied as NO/NC set(s). Insert letter <b>A</b> after relay type designation in listed catalog number. Example: BFA22F or BFDAF22S | <b>A</b>    | —              |

##### NEMA 1 Enclosure for Relay Types

| Description      | Code Letter | Catalog Number    |
|------------------|-------------|-------------------|
| BF, AR—all poles | —           | <b>4977D40G04</b> |
| BFD—4–8 poles    | —           | <b>4977D40G04</b> |
| ARD—4–8 poles    | —           | <b>4977D40G04</b> |

##### Notes

- ① For panel mount, add Suffix **F**.
- ② Consult Customer Support Center for availability.

## Technical Data and Specifications

### General Specifications

#### BF Relay Electrical Ratings—NEMA A300

| Volts | Maximum Current |      |       | Maximum VA |       |
|-------|-----------------|------|-------|------------|-------|
|       | Cont.           | Make | Break | Make       | Break |
| 120   | 10              | 60   | 6     | 7200       | 720   |
| 240   | 10              | 30   | 3     | 7200       | 720   |

#### Horsepower Ratings (UL Recognized)

| Phase | AC Volts |     | Volts | DC Rating—NEMA P300 |       |                         | Max. Make or Break (VA) |
|-------|----------|-----|-------|---------------------|-------|-------------------------|-------------------------|
|       | 115      | 230 |       | Maximum Current     | Break | Max. Make or Break (VA) |                         |
| 1     | 1/6      | 1/2 | 125   | 5.0                 | 1.1   | 1.1                     | 138                     |
| 3     | —        | 1   | 250   | 5.0                 | 0.55  | 0.55                    | 138                     |

#### Resistive Rating

|         |       |
|---------|-------|
| 125 Vdc | 3 A   |
| 250 Vdc | 1.5 A |

#### Coil Power Requirements

|    |                                |
|----|--------------------------------|
| AC | 72 VA open, 22 VA closed       |
| DC | 12 watts (nominal), 250 V max. |

### Permanent Magnet Latch Specifications

| Item                          | Specification  |
|-------------------------------|--|
| Unlatching power requirements | Open gap: 24 VA AC<br>Closed gap: 7 VA<br>Burden: 4 watts (AC) |

# 3.7

## Control Relays and Timers

### Machine Tool Relays

3

#### Contact Arrangements—BF and BFD Relays

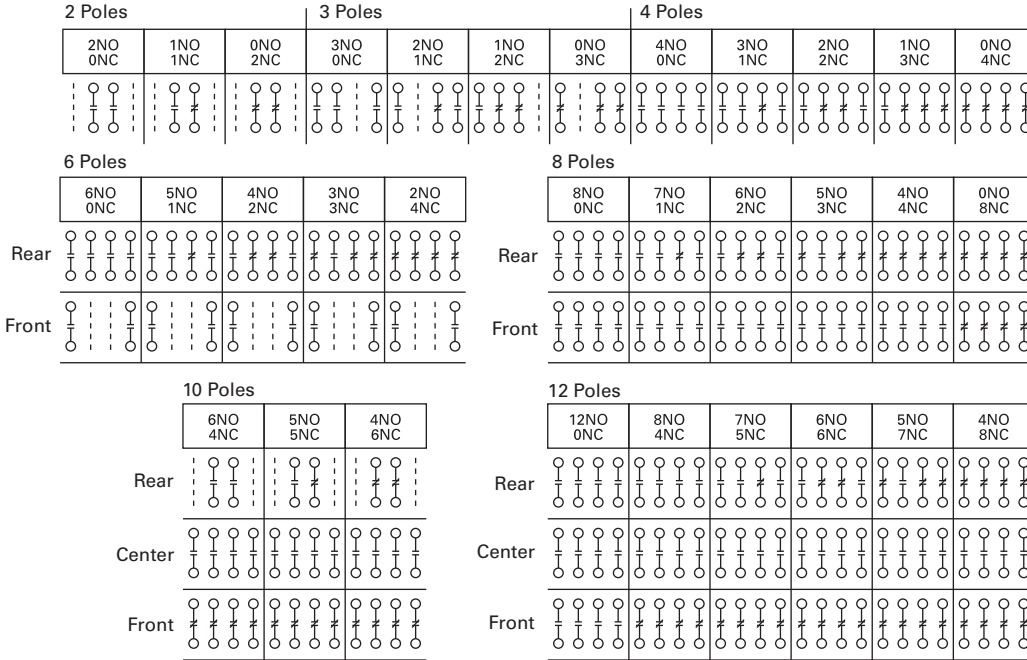

**Note:** NO = Normally Open NC = Normally Closed

#### Dimensions

Approximate Dimensions in Inches (mm)

#### BF Relay with Permanent Magnet Latch and Solid-State Timer

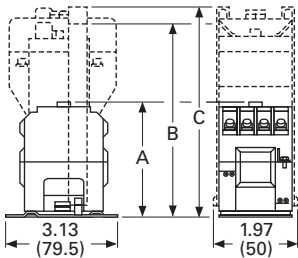

#### BFD Relay with Solid-State Timer

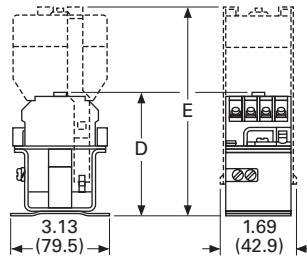

#### Enclosures—NEMA 1 for BF, BFD, AR and ARD

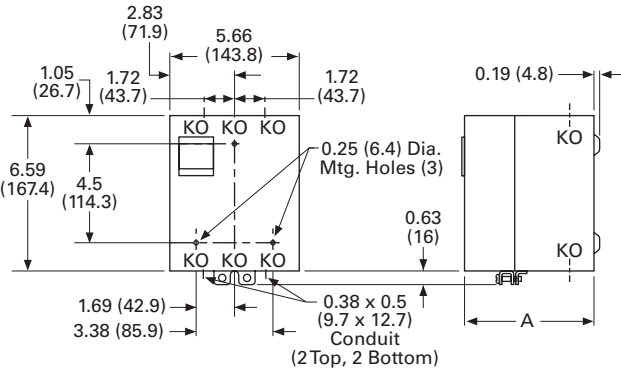

#### BF and BFD Relay Dimensions

| Number of Poles | A<br>BF Only | B<br>BF w/Latch | C<br>BF w/Timer | D<br>BFD Only | E<br>BFD w/Timer |
|-----------------|--------------|-----------------|-----------------|---------------|------------------|
| 4               | 3.22 (81.8)  | 6.22 (158.0)    | 5.88 (149.4)    | 4.03 (102.4)  | 7.06 (179.3)     |
| 8               | 4.19 (106.4) | 7.19 (182.6)    | 6.88 (174.8)    | 4.97 (126.2)  | 8.00 (203.2)     |
| 12              | 4.81 (122.2) | 7.81 (198.4)    | 7.50 (190.5)    | 5.63 (143.0)  | 8.66 (220.0)     |

#### NEMA 1 for BF, BFD, AR and ARD Dimensions

| Poles                             | Catalog Number     | A<br>NEMA 1  |
|-----------------------------------|--------------------|--------------|
| <b>Relays without Attachments</b> |                    |              |
| All                               | <b>BF, AR, ARD</b> | 5.34 (135.6) |
| 4 – 8                             | <b>BFD</b>         | 5.34 (135.6) |
| 10, 12                            | <b>BFD</b>         | 7.97 (202.4) |
| <b>Relays with Attachments</b>    |                    |              |
| All                               | <b>BF, AR, ARD</b> | 7.97 (202.4) |

## AR/ARD Series—Convertible Contact Industrial Control



## AR/ARD Series—Convertible Contact Industrial Control

## Product Description

The AR/ARD relays are electromechanical convertible contact relays. AR relays are AC devices and the ARD is for DC applications.

## Application Description

Type AR and ARD relays are designed for use on machine tools, process lines, conveyors and similar automatic and semi-automatic equipment.

## Features and Benefits

**Permanent Magnet Latch**

By energizing the relay coil, the latch attachment “sets” (when the base relay’s armature/crossbar assembly has closed) holding the relay ON, even after the relay coil has been de-energized. The clearing coil on the latch is energized to release the armature/crossbar assembly.

- Field mountable to four- and six-pole
- Latch plunger is adjustable
- Latch coil continuously rated
- Unlatching power requirements
  - Open gap: 24 VA
  - Closed gap: 7 VA
  - Burden: 4 watts AC, 6 watts DC

## Contents

| <b>Description</b>   | <b>Page</b>      |
|--|------------------|
| D15 Series—Freedom 600 V Multipole . . . . .                             | <b>V7-T3-142</b> |
| BF/BFD Series—Fixed Contact Industrial Control . . . . .                 | <b>V7-T3-147</b> |
| AR/ARD Series—Convertible Contact Industrial Control                     |                  |
| Product Selection . . . . .  | <b>V7-T3-154</b> |
| Accessories . . . . .  | <b>V7-T3-155</b> |
| Options . . . . .  | <b>V7-T3-155</b> |
| Technical Data and Specifications . . . . .                              | <b>V7-T3-156</b> |
| Dimensions . . . . .   | <b>V7-T3-157</b> |
| D26 Series—Type M, 600 Vac Multipole with Convertible Contacts . . . . . | <b>V7-T3-158</b> |
| D26 Series—Type M, DC Multipole with Convertible Contacts . . . . .      | <b>V7-T3-163</b> |

## Operation

AR relays are available in either four- or six-pole configurations. AR relays are easily converted to eight- or 10-poles simply by adding a four-pole deck. In addition, mechanical latch attachments are available with four- and six-pole relays.

Contacts are convertible from NO to NC, to provide any combination desired up to a maximum of 10. For the ARD, the number of poles cannot exceed **four** NC in any pole configuration. Wide spacing of contacts simplifies installation, contact testing and maintenance. Contacts are electrically and mechanically isolated from each other. Overlap contacts are also available in one or two sets. These contacts should be mounted in the center pole positions. AC and DC contact cartridges should not be used in the same relay.

## Standards and Certifications

- UL File No. E19223
- CSA File No. LR39402-6, LR54517 and LR54520



## Reference Information

- ART, ARTD: IL 14510, IL 14485

#### Product Selection

##### When Ordering, Specify

- Catalog number of basic relay with 120/60, 110/50 AC coil from AR/ARD Relays table.
- If a coil voltage other than listed is required, select the suffix code from the Coil Voltage table below and substitute it for the last letter in the catalog number. Example: AR64**V** for a 110/60 AC coil.

3

#### AR/ARD Relays



#### AR/ARD Relays

| Number of Poles | Contact |    |                | AR 600 Vac Relays<br>120/60, 110/50 AC Coil | ARD 600 Vdc Relays<br>120 DC Coil |
|-----------------|---------|----|----------------|---|-----------------------------------|
|                 | NO      | NC | Blank Cavities | Catalog Number                              | Catalog Number                    |
| 4               | 0       | 0  | 4              | AR4A  | ARD4S                             |
|                 | 2       | 0  | 2              | AR420A                                      | ARD420S                           |
|                 | 4       | 0  | 0              | AR440A                                      | ARD440S                           |
| 6               | 0       | 0  | 6              | AR6A  | ARD6S                             |
|                 | 4       | 0  | 2              | AR640A                                      | —                                 |
|                 | 6       | 0  | 0              | AR660A                                      | ARD660S                           |
| 8 <sup>①</sup>  | 6       | 0  | 2              | AR860A                                      | ARD860S <sup>②</sup>              |
|                 | 8       | 0  | 0              | AR880A                                      | ARD880S                           |
| 10 <sup>①</sup> | 10      | 0  | 0              | AR10100A                                    | ARD10100S                         |

#### Coil Voltage

| AR Coils |       |             | ARD Coils |             |
|----------|-------|-------------|-----------|-------------|
| Volts AC | Hz    | Suffix Code | Volts DC  | Suffix Code |
| 12       | 60    | F           | 12        | D           |
| 24       | 60    | I           | 24        | L           |
| 48       | 60    | G           | 48        | M           |
| 110      | 60    | V           | 95        | B           |
| 110/120  | 50/60 | A           | 120       | S           |
| 208      | 60    | B           | 130       | U           |
| 220/240  | 50/60 | W           | 240       | T           |
| 277      | 60    | C           |           |             |
| 380/440  | 50/60 | H           |           |             |
| 440/480  | 50/60 | X           |           |             |
| 550      | 60    | D           |           |             |
| 550/600  | 50/60 | E           |           |             |

#### Contact Cartridges—600 V

| Terminal Type        | Standard Contact Cartridge<br>Catalog Number <sup>③</sup> | Overlap Contact Cartridge<br>Catalog Number <sup>④</sup> |
|----------------------|---|--|
| <b>AC Cartridges</b> |   |  |
| With clamp terminals | ARC   | AROC   |
| With screw terminals | ARCR  | AROCR  |
| <b>DC Cartridges</b> |   |  |
| With clamp terminals | ARDC  | ARDOC  |
| With screw terminals | ARDCR   | ARDOCR   |

##### Notes

- ① Will not accept top-mounted latch or timers.
- ② Contact Customer Support Center for availability.
- ③ Standard cartridges are sold in cartons of four cartridges. Catalog number is for single cartridge.
- ④ Overlap contact cartridges are sold in sets of two cartridges. Catalog number is for sets of two.

### ARML Permanent Magnet Latch for AR/ARD Relays



### Permanent Magnet Latch

| Operating Volts                | Coil Hz | Catalog Number |
|--------------------------------|---------|----------------|
| <b>For AC Control Circuits</b> |         |                |
| 24                             | 60      | <b>ARMLI</b>   |
| 48                             | 60      | <b>ARMLG</b>   |
| 120                            | 60/50   | <b>ARMLA</b>   |
| 240                            | 60/50   | <b>ARMLW</b>   |
| <b>For DC Control Circuits</b> |         |                |
| 24                             | —       | <b>ARMLL</b>   |
| 48                             | —       | <b>ARMLM</b>   |
| 120                            | —       | <b>ARMLS</b>   |
| 240                            | —       | <b>ARMLT</b>   |

### Accessories

#### Four-Pole Top Deck Adder

- Increases contact capacity from four/six-poles to eight/10-poles
- Mounts on top of basic relay using three screws
- Will not interfere with wiring, testing or convertible cartridges
- Screw terminals for ring connectors available; to order, add Suffix **R** to catalog number listed below

#### Four-Pole Top Deck Adder



### Four-Pole Top Deck Adder

| No. of Poles                   | Contacts |    | Blank Cavities | Catalog Number |
|--------------------------------|----------|----|----------------|----------------|
|                                | NO       | NC |                |                |
| <b>With 600 Vac Cartridges</b> |          |    |                |                |
| 4                              | 2        | 0  | 2              | <b>ARA20</b>   |
|                                | 4        | 0  | 0              | <b>ARA40</b>   |
| <b>With 600 Vdc Cartridges</b> |          |    |                |                |
| 4                              | 2        | 0  | 2              | <b>ARDA20</b>  |
|                                | 4        | 0  | 0              | <b>ARDA40</b>  |

### Options

#### Convertible Contacts

| Description  | Code Letter | Catalog Number |
|--|-------------|----------------|
| AR and ARD relays listed are supplied with NO contacts that are easily converted to NC. If both NO and NC poles are required, order by catalog number. Example: four-pole relay with 1NO and 3NC contacts, order AR413A. | ①           | —              |

#### Screw Terminals

| Description   | Code Letter | Catalog Number |
|---|-------------|----------------|
| For ring-type connectors, add suffix <b>R</b> to the catalog number. Example: AR420 <b>AR</b> . | <b>R</b>    | —              |

### Surge Suppressor

#### ARSS Surge Suppressor for AR Relays



|                  | Catalog Number |
|------------------|----------------|
| Surge Suppressor | <b>ARSS</b>    |

#### Overlapping Contacts

| Description  | Code Letter             | Catalog Number |
|--|-------------------------|----------------|
| NO contact closes before corresponding NC contact opens — supplied as NO/NC sets of two cartridges. Insert letter <b>S</b> after relay type designation in listed catalog number. Example: AR402 <b>AS</b> . Specify the number of sets required: <b>S</b> for one set and <b>S2</b> for two sets. | <b>S</b> or <b>S2</b> ① | —              |

#### Note

① Consult Customer Support Center for availability.

## Technical Data and Specifications

### General

#### Contact Ratings—600 Vac Cartridge NEMA A600

| Volts | Maximum Current |      |       | Maximum VA |       |
|-------|-----------------|------|-------|------------|-------|
|       | Cont.           | Make | Break | Make       | Break |
| 120   | 10              | 60   | 6     | 7200       | 720   |
| 240   | 10              | 30   | 3     | 7200       | 720   |
| 480   | 10              | 15   | 1.5   | 7200       | 720   |
| 600   | 10              | 12   | 1.2   | 7200       | 720   |

#### DC Cartridges—NEMA P600

| Volts | Maximum Current |               | Maximum VA    |
|-------|-----------------|---------------|---------------|
|       | Continuous      | Make or Break | Make or Break |
| 125   | 5               | 1.10          | 138           |
| 250   | 5               | 0.55          | 138           |
| 600   | 5               | 0.20          | 138           |

#### Resistive Rating

|         |       |
|---------|-------|
| 125 Vdc | 3 A   |
| 250 Vdc | 1.5 A |

#### Coil Power Requirements

|    |                           |
|----|---------------------------|
| AC | 96 VA open, 14 VA closed  |
| DC | 14 watts open, 250 V max. |

| Voltage                | AR Relays | ARD Relays |
|------------------------|-----------|------------|
| Pickup voltage (max.)  | 85%       | 65%        |
| Dropout voltage (min.) | 60%       | 15%        |
| Voltage (max.)         | 110%      | 110%       |



### Dimensions

Approximate Dimensions in Inches (mm)

#### Four- and Six-Pole with Four-Pole Adder, Solid-State Timer and Mechanical Latch

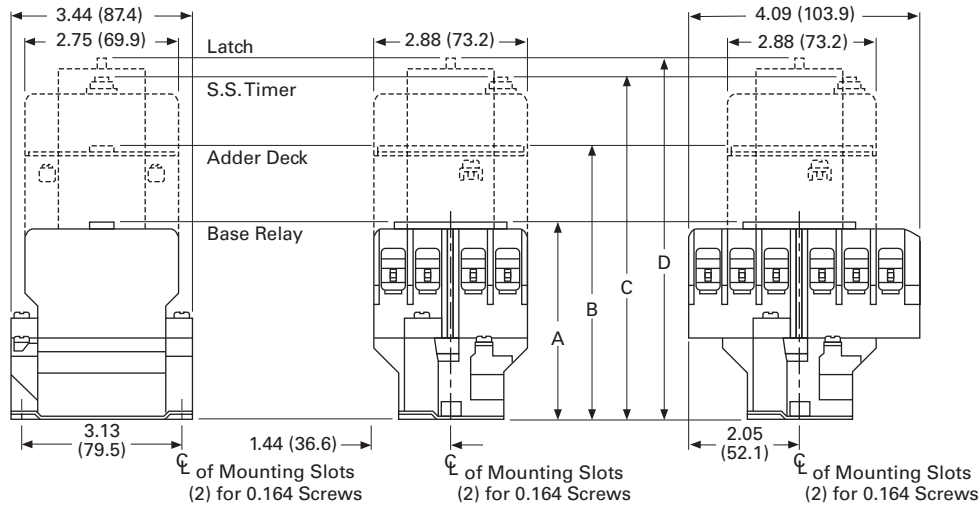

End View, 4- and 6-Pole

Side View, 4-Pole

Side View, 6-Pole

#### Four- and Six-Pole with Four-Pole Adder, Solid-State Timer and Mechanical Latch

| Relay Catalog Number | A<br>Four-, Six-Pole Relays | B<br>Relay Adder | C<br>Relay with Timer | D<br>Relay with Latch |
|----------------------|-----------------------------|------------------|-----------------------|-----------------------|
| AR                   | 3.56 (90.4)                 | 4.94 (125.5)     | 6.00 (152.4)          | 6.39 (162.3)          |
| ARD                  | 4.63 (117.6)                | 6.00 (152.4)     | 7.06 (179.3)          | 7.45 (189.2)          |

#### Enclosures—NEMA 1 for BF, BFD, AR and ARD

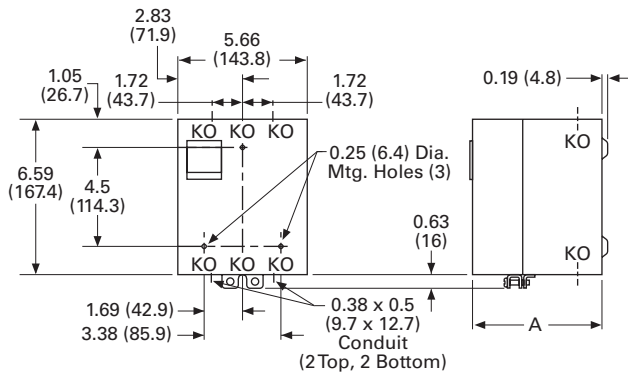

#### Enclosures—NEMA 1 for BF, BFD, AR and ARD

| Poles                             | Catalog Number | Dimension A<br>NEMA 1 |
|-----------------------------------|----------------|-----------------------|
| <b>Relays without Attachments</b> |                |                       |
| All                               | BF, AR, ARD    | 5.34 (135.6)          |
| 4-8                               | BFD            | 5.34 (135.6)          |
| 10, 12                            | BFD            | 7.97 (202.4)          |
| <b>Relays with Attachments</b>    |                |                       |
| All                               | BF, AR, ARD    | 7.97 (202.4)          |

D26 Series—Type M, 600 Vac Multipole with Convertible Contacts



### Contents

| <i>Description</i>  | <i>Page</i>      |
|---|------------------|
| D15 Series—Freedom 600 V Multipole . . . . .                        | <b>V7-T3-142</b> |
| BF/BFD Series—Fixed Contact Industrial Control. . . . .             | <b>V7-T3-147</b> |
| AR/ARD Series—Convertible Contact Industrial Control . . . . .      | <b>V7-T3-153</b> |
| D26 Series—Type M, 600 Vac Multipole with Convertible Contacts      |                  |
| Product Selection . . . . .   | <b>V7-T3-159</b> |
| Technical Data and Specifications . . . . .                         | <b>V7-T3-161</b> |
| Dimensions . . . . .  | <b>V7-T3-162</b> |
| D26 Series—Type M, DC Multipole with Convertible Contacts . . . . . | <b>V7-T3-163</b> |

### D26 Series—Type M, 600 Vac Multipole with Convertible Contacts

#### Product Description

Relays can be ordered as complete devices in any pole combination up to a maximum of 12NO or 8NC and 4NO poles, or can be assembled from components shown on **Page V7-T3-160**.

Relay base assembly (**D26MB**) will accept from 1 to 4 rear poles (**D26MPR**, **D26MPS** and/or **D26MPL**).

#### Features

Contact poles D26MPR and D26MPF in 2- through 8-pole relays are convertible NO to NC or vice versa. Simply reverse the terminal screws and rotate the unit pole 180° (in either direction).

#### Options

Adding a front deck, the total number of poles can be increased to 8, all convertible NO to NC.

Adding a **D26MF**, 4-pole fixed NO attachment, builds a 12-pole relay with 8 convertible poles and 4 fixed NO poles.

Relays with mechanical latch are available in any convertible pole combination up to eight poles maximum.

#### Standards and Certifications

- UL listed—Class No. NKCR2, File E1230(N)
- CSA certified—File LR353



**Normally Closed Contact**



**Normally Open Contact**

To obtain overlapping contacts, use **D26MPS** (NO early closing) and **D26MPL** (NC late opening) rear poles, in related circuits.

## Product Selection

### Complete AC Relays

When Ordering, Specify

- Catalog number and magnet coil suffix letter.
- Example: For a 4-pole relay having 4NO contacts, order Catalog Number **D26MR40**, with a 120 V, 60 Hz coil, order **D26MR40A**.
- For fast delivery and minimum inventory, it is recommended that component parts or complete relays with NO poles be ordered.

### 4-Pole Complete AC Relays—Open Type

| Number of Contacts | Type of Contact |             | Relay Only Catalog Number | Relay with Mechanical Latch Catalog Number |
|--------------------|-----------------|-------------|---------------------------|--|
|                    | NO (Form A)     | NC (Form B) |                           |  |
| 2                  | 2               | 0           | D26MR20                   | D26MR202                                   |
|                    | 1               | 1           | D26MR11                   | D26MR112                                   |
|                    | 0               | 2           | D26MR02                   | D26MR022                                   |
| 3                  | 3               | 0           | D26MR30                   | D26MR302                                   |
|                    | 2               | 1           | D26MR21                   | D26MR212                                   |
|                    | 1               | 2           | D26MR12                   | D26MR122                                   |
|                    | 0               | 3           | D26MR03                   | D26MR032                                   |
| 4                  | 4               | 0           | D26MR40                   | D26MR402                                   |
|                    | 3               | 1           | D26MR31                   | D26MR312                                   |
|                    | 2               | 2           | D26MR22                   | D26MR222                                   |
|                    | 1               | 3           | D26MR13                   | D26MR132                                   |
|                    | 0               | 4           | D26MR04                   | D26MR042                                   |
| 6 <sup>①</sup>     | 6               | 0           | D26MR60                   | D26MR602                                   |
|                    | 5               | 1           | D26MR51                   | D26MR512                                   |
|                    | 4               | 2           | D26MR42                   | D26MR422                                   |
|                    | 3               | 3           | D26MR33                   | D26MR332                                   |
|                    | 2               | 4           | D26MR24                   | D26MR242                                   |
|                    | 1               | 5           | D26MR15                   | D26MR152                                   |
|                    | 0               | 6           | D26MR06                   | D26MR062                                   |
|                    | 8 <sup>①</sup>  | 8           | 0                         | D26MR80                                    |
| 7                  |                 | 1           | D26MR71                   | D26MR712                                   |
| 6                  |                 | 2           | D26MR62                   | D26MR622                                   |
| 5                  |                 | 3           | D26MR53                   | D26MR532                                   |
| 4                  |                 | 4           | D26MR44                   | D26MR442                                   |
| 3                  |                 | 5           | D26MR35                   | D26MR352                                   |
| 2                  |                 | 6           | D26MR26                   | D26MR262                                   |
| 1                  |                 | 7           | D26MR17                   | D26MR172                                   |
| 0                  |                 | 8           | D26MR08                   | D26MR082                                   |



4-Pole with Latch



4-Pole with Pneumatic Timer Attachment



### Magnet Coil Selection

| Volts/Hertz         | Suffix Code | Volts/Hertz                   | Suffix Code |
|---------------------|-------------|-------------------------------|-------------|
| 120/60–110/50       | A           | 32/60 <sup>②</sup>            | V           |
| 240/60–220/50       | B           | 12/60 <sup>②</sup>            | R           |
| 208/60 <sup>②</sup> | E           | 6/60                          | P           |
| 24/60               | T           | 380/50 <sup>②</sup>           | L           |
| 277/60              | H           | 480/60 or 440/50              | C           |
|                     |             | 600/60 or 550/50 <sup>②</sup> | D           |

#### Notes

<sup>①</sup> **10- and 12-Poles:** The 6 and 8 contact relays (without mechanical latch only) listed above can be provided with four additional NO non-convertible contacts. Add suffix number **4** to above listed catalog number plus magnet coil suffix. Example: For a 12 contact relay, order **D26MR804A**.

<sup>②</sup> Consult Customer Support Center for availability.

# 3.7

## Control Relays and Timers

### Machine Tool Relays

3

#### Relay Component Parts Location

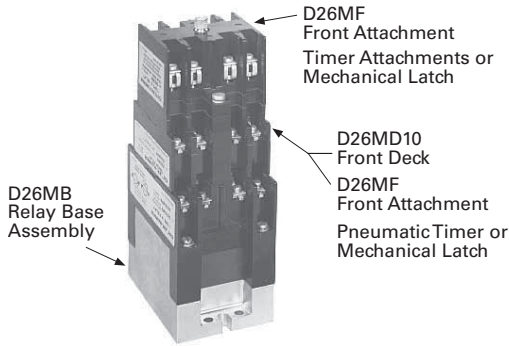

#### Relay with Pneumatic Timer Attachment Factory Installed (without Relay Contacts)

| Contact Positions <sup>①</sup> | Timer Operation | Catalog Number <sup>②</sup> |
|--------------------------------|-----------------|-----------------------------|
| 4                              | ON delay        | <b>D26MR005</b>             |
| 4                              | OFF delay       | <b>D26MR006</b>             |

The relays listed above will accept up to four catalog number D26MPR contacts (convertible—NO or NC) for instantaneous operation. Order contacts separately.

For additional information on timer attachment, see **Page V7-T3-161**.

For assembly of relays from component parts and relay accessories, see components tables below.

#### Rear Pole



#### Front Pole



#### Separate Contacts

| Description                             | Catalog Number  |
|---|-----------------|
| <b>Convertible Contacts</b>             |                 |
| Rear pole—NO                            | <b>D26MPR</b>   |
| Rear pole—NC                            | <b>D26MPR02</b> |
| Front pole—NO                           | <b>D26MPF</b>   |
| Front pole—NC                           | <b>D26MPF02</b> |
| Gold plated (for low power circuits)    |                 |
| Rear pole—NO                            | <b>D26MPR03</b> |
| Front pole—NO                           | <b>D26MPF03</b> |
| <b>Non-Convertible Contacts</b>         |                 |
| Rear pole NO early closing <sup>③</sup> | <b>D26MPS</b>   |
| Rear pole NC late opening <sup>③</sup>  | <b>D26MPL</b>   |

#### Relay Base Assembly



#### Relay Base Assembly (without Poles)

| Description         | Catalog Number            |
|---------------------|---------------------------|
| Relay base assembly | <b>D26MB</b> <sup>④</sup> |

Basic four-pole D26 relay without contacts. Provision for adding one to four poles

as needed, **D26MPR**, **D26MPL** and/or **D26MPS** rear pole type.

#### Rear Pole



#### Front Deck (Convertible Contact Poles)

| Description                | Catalog Number |
|----------------------------|----------------|
| <b>Front Deck with ...</b> |                |
| 1NO contact pole           | <b>D26MD10</b> |
| 2NO contact poles          | <b>D26MD20</b> |
| 4NO contact poles          | <b>D26MD40</b> |

Provides up to four additional front pole type D26MPF contacts. Convertible, NO to NC.

#### Four-Pole Front Attachment



#### Four-Pole Front Attachment (4NO Fixed Circuit)

| Description      | Catalog Number |
|------------------|----------------|
| Front attachment | <b>D26MF</b>   |

Can be added to any two- to eight-pole Type M, D26 relay to provide up to a 12-pole

relay. Four NO, non-convertible contacts are included in this assembly.

#### Notes

- ① Number of available instantaneous contact positions (order contacts separately—Catalog Number D26MPR).
- ② Consult Customer Support Center for availability.
- ③ To obtain overlapping contacts, these two special poles must be used in related circuits.
- ④ Add magnet coil suffix letter, see **Page V7-T3-159**. Example: D26MBA.

**Relay State Indicating Light****Relay State Indicating Light**

| Description       | Catalog Number |
|-------------------|----------------|
| 120 Vac, 50/60 Hz | D26MAP120      |
| 240 Vac, 50/60 Hz | D26MAP240      |

Light provided with leads and bracket for mounting on two-to 12-pole relays. May be

used to monitor state of magnet coil or relay contact operation.

**Pneumatic Timer Attachment****Pneumatic Timer Attachment**

| Description | Catalog Number |
|-------------|----------------|
| ON delay    | D26MTE         |
| OFF delay   | D26MTD         |

Attachment mounts on any 0-to four-pole D26 relay without latch. Timer unit has DPDT timed contacts (circuits in each pole must be the same polarity). Adjustable timing

range—0.1 to 180 seconds, repeat accuracy  $\pm 10\%$ . Units are convertible from OFF delay to ON delay or vice versa.

**Mounting Channel****Mounting Channel**

| Description                | Catalog Number |
|----------------------------|----------------|
| 10 in length for 4 relays  | D26MC4         |
| 20 in length for 8 relays  | D26MC8         |
| 30 in length for 12 relays | D26MC12        |
| 40 in length for 16 relays | D26MC16        |

Pre-spaced mounting for adjacent relay installation. Indexed for cutting to desired

length. Captive mounting screws provided in channel for easier installation.

**Technical Data and Specifications****General****Contact Ratings (Amperes) A600**

| AC Volts <sup>①</sup> | Make and Emergency Interrupting Capacity | Break | Continuous Thermal Rating |
|-----------------------|--|-------|---------------------------|
| 120                   | 60                                       | 6     | 10                        |
| 240                   | 30                                       | 3     | 10                        |
| 480                   | 15                                       | 1.5   | 10                        |
| 600                   | 12                                       | 1.2   | 10                        |

**Coil Power**

| Relay           | Watts  |        | VA     |        | Operating Time        |
|-----------------|--------|--------|--------|--------|-----------------------|
|                 | Inrush | Sealed | Inrush | Sealed | Range in Milliseconds |
| Two- to 12-pole | 95.0   | 9      | 155    | 22     | Pickup: 6–13          |
| Latch coil      | 18.5   | 11     | 41     | 17     | Dropout: 8–26         |

**Note**

<sup>①</sup> For DC contact ratings, see **Page V7-T3-165**.

**Manual Test Accessory****Manual Test Accessory**

| Description           | Catalog Number |
|-----------------------|----------------|
| Manual test accessory | D26MTA         |

Tool to manually hold relays in the energized position for circuitry testing on completed

panel. (10 per box, order in multiples of 10.)

**Transient Suppressor****Transient Suppressor**

| Description                      | Catalog Number |
|----------------------------------|----------------|
| Magnet coil transient suppressor | D26MAS1        |
| Latch coil transient suppressor  | D26MAS2        |

May be mounted on any 120 Vac relay magnet coil or latch coil or 120 Vdc latch coil—connects directly across coil terminals. All DC magnet coils have a built-in varistor for transient suppression.

Limits high voltage transients produced in the circuit when power is removed from the coil.

# 3.7

## Control Relays and Timers

### Machine Tool Relays

#### Dimensions

Approximate Dimensions in Inches (mm)

#### AC and DC D26 Relays

3

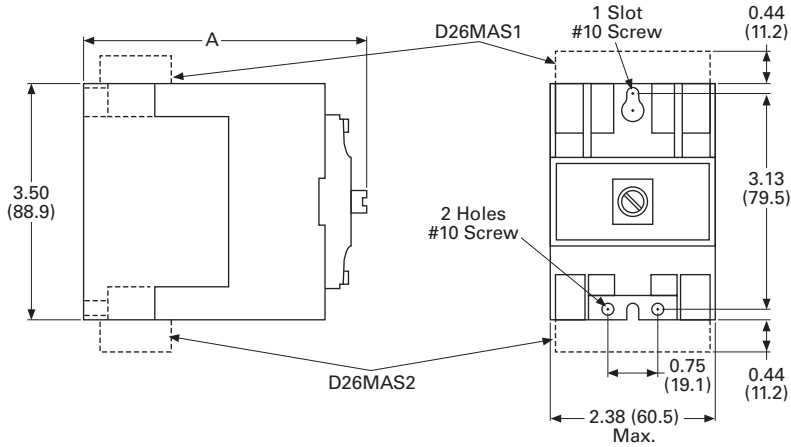

| AC Relay D26                    | DC Relay D26                    | Dimension A  | Ship. Wt. Lbs (kg) |
|---------------------------------|---------------------------------|--------------|--------------------|
| 1-4 poles                       | 1-3 poles                       | 4.00 (101.6) | 2.5 (1.1)          |
| 1-4 poles with timer D26 or D87 | 1-3 poles with timer D26 or D87 | 6.00 (152.4) | 3.3 (1.5)          |
| 1-4 poles with latch            | 1-2 poles with latch            | 6.13 (155.7) | 3.5 (1.6)          |
| 1-4 poles with D26MF            | 1-3 poles with D26MF            | 5.81 (147.6) | 2.8 (1.3)          |
| 5-8 poles                       | 4-7 poles                       | 5.25 (133.4) | 2.8 (1.3)          |
| 5-8 poles with timer D87        | 4-7 poles with timer D87        | 7.25 (184.2) | 3.5 (1.6)          |
| 5-8 poles with latch            | 3-6 poles with latch            | 7.31 (185.7) | 3.8 (1.7)          |
| 9-12 poles                      | 8-11 poles                      | 7.00 (177.8) | 3.0 (1.4)          |

#### Mounting Channel

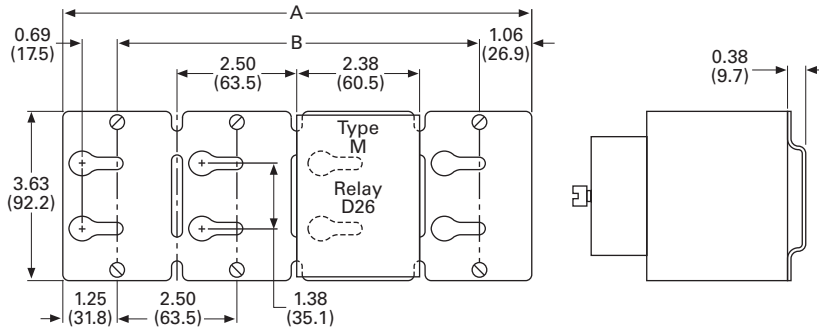

| Catalog Number | Dimension A | Dimension B  |
|----------------|-------------|--------------|
| D26MC16        | 40 (1016)   | 37.5 (952.5) |
| D26MC12        | 30 (762)    | 27.5 (698.5) |
| D26MC8         | 20 (508)    | 17.5 (444.5) |
| D26MC4         | 10 (254)    | 7.5 (190.5)  |

**Note:** Channel mounts through keyholes with #10 screws (two each end and one every fourth relay). Relays mount with screws captive in channel. All screws must be tightened firmly.

D26 Series—Type M, DC Multipole with Convertible Contacts



Contents

| Description  | Page      |
|--|-----------|
| D15 Series—Freedom 600 V Multipole . . . . .                             | V7-T3-142 |
| BF/BFD Series—Fixed Contact Industrial Control . . . . .                 | V7-T3-147 |
| AR/ARD Series—Convertible Contact Industrial Control . . . . .           | V7-T3-153 |
| D26 Series—Type M, 600 Vac Multipole with Convertible Contacts . . . . . | V7-T3-158 |
| D26 Series—Type M, DC Multipole with Convertible Contacts                |           |
| Product Selection . . . . .  | V7-T3-164 |
| Technical Data and Specifications . . . . .                              | V7-T3-165 |
| Dimensions . . . . .   | V7-T3-166 |

D26 Series—Type M, DC Multipole with Convertible Contacts

Product Description

Type M, DC multipole relays are physically and mechanically similar to the (D26) Type M AC relays described on Page V7-T3-159. They differ only in the electrical ratings and available pole combinations due to the use of a normally closed late opening, coil clearing contact, factory wired to the pickup winding of the magnet coil. (Contact is shown as L in figure to the right.) Magnet coil has built-in varistor for transient suppression.

The mechanically latched relay has one extra contact, normally open early closing, factory wired in series with the winding of the intermittent rated latch coil. (Contact is shown as S in figure to the right.)

**Component parts for these relays** are the same as those listed for the (D26) Type M AC relays on Page V7-T3-159, except for the Indicating Light, which is not applicable to a DC relay.

Contact poles D26MPR and D26MPF in 2- to 7-pole relays are convertible NO to NC or vice versa. Simply reverse the terminal screws and rotate the unit pole 180° (in either direction).

Latch Operation

With the latch coil de-energized, energizing the relay coil will pick up the relay and mechanically latch it in the pickup position. With the relay coil de-energized, energizing the latch coil will allow the relay to drop out.

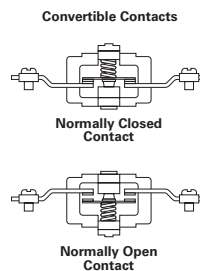

DC Type M Relay

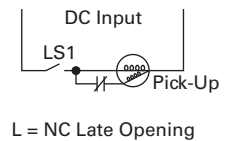

DC Type M Relay with Latch

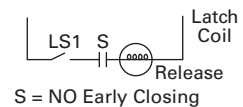
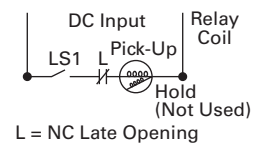

#### Product Selection

##### Complete DC Relays

When Ordering, Specify

- Catalog number and magnet coil suffix letter.
- Example: For a 4-pole relay having 4NO contacts, order Catalog Number **D26MRD40**, with a 120 Vdc coil, order **D26MRD40A1**.

3

##### 3-Pole



##### 3-Pole with Latch



#### Complete DC Relays—Open Type

| Number of Contacts | Type of Contact <sup>①</sup> |             | Relay Only Catalog Number | Relay with Mechanical Latch Catalog Number |
|--------------------|------------------------------|-------------|---------------------------|--|
|                    | NO (Form A)                  | NC (Form B) |                           |  |
| 2                  | 2                            | 0           | D26MRD20                  | D26MRD202                                  |
|                    | 1                            | 1           | D26MRD11                  | D26MRD112                                  |
|                    | 0                            | 2           | D26MRD02                  | D26MRD022                                  |
| 3                  | 3                            | 0           | D26MRD30                  | D26MRD302                                  |
|                    | 2                            | 1           | D26MRD21                  | D26MRD212                                  |
|                    | 1                            | 2           | D26MRD12                  | D26MRD122                                  |
| 4                  | 0                            | 3           | D26MRD03                  | D26MRD032                                  |
|                    | 4                            | 0           | D26MRD40                  | D26MRD402                                  |
|                    | 3                            | 1           | D26MRD31                  | D26MRD312                                  |
| 6 <sup>②</sup>     | 2                            | 2           | D26MRD22                  | D26MRD222                                  |
|                    | 1                            | 3           | D26MRD13                  | D26MRD132                                  |
|                    | 0                            | 4           | D26MRD04                  | D26MRD042                                  |
|                    | 6                            | 0           | D26MRD60                  | D26MRD602                                  |
| 7 <sup>②</sup>     | 5                            | 1           | D26MRD51                  | D26MRD512                                  |
|                    | 4                            | 2           | D26MRD42                  | D26MRD422                                  |
|                    | 3                            | 3           | D26MRD33                  | D26MRD332                                  |
|                    | 2                            | 4           | D26MRD24                  | D26MRD242                                  |
|                    | 1                            | 5           | D26MRD15                  | D26MRD152                                  |
|                    | 0                            | 6           | D26MRD06                  | D26MRD062                                  |
|                    | 7                            | 0           | D26MRD70                  | —  |
| 6                  | 1                            | D26MRD61    | —                         |  |
| 5                  | 2                            | D26MRD52    | —                         |  |
| 4                  | 3                            | D26MRD43    | —                         |  |
| 3                  | 4                            | D26MRD34    | —                         |  |
| 2                  | 5                            | D26MRD25    | —                         |  |
| 1                  | 6                            | D26MRD16    | —                         |  |
| 0                  | 7                            | D26MRD07    | —                         |  |

#### Magnet Coil Selection

| Volts/Hertz | Suffix Code | Volts/Hertz | Suffix Code |
|-------------|-------------|-------------|-------------|
| 12          | R1          | 120         | A1          |
| 24          | T1          | 240         | B1          |
| 48          | W1          |             |             |

#### Notes

- <sup>①</sup> Relay has additional factory wired normally closed coil clearing contact (see diagram).
- <sup>②</sup> **10- and 11-Poles:** The 6 and 7 contact relays (without mechanical latch only) listed above can be provided with four additional NO non-convertible contacts. Add suffix number **4** to above listed catalog number plus magnet coil suffix. Example: For an 11 contact relay, order D26MRD70**4A1**.



**3-Pole with Timer Attachment****Relay with Pneumatic Timer Attachment (without Relay Contacts)**

| Contact Positions <sup>①</sup> | Timer Operation | Catalog Number   |
|--------------------------------|-----------------|------------------|
| 3                              | ON delay        | <b>D26MRD005</b> |
| 3                              | OFF delay       | <b>D26MRD006</b> |

The relays listed above will accept up to three catalog number D26MPR contacts (convertible—NO or NC) for instantaneous operation.

Order contacts separately. For additional information on timer attachment, see **Page V7-T3-161**.

**Technical Data and Specifications****General****Contact Ratings (Amperes) <sup>②</sup>**

| DC Volts | Inductive Make/Break | Resistive Make/Break |
|----------|----------------------|----------------------|
| 28       | 7.0                  | 10.0                 |
| 48       | 2.5                  | 10.0                 |
| 120      | 1.1                  | 2.0                  |
| 240      | 0.2                  | 0.4                  |

| Relay           | Coil Power        |                   | Operating Time       |
|-----------------|-------------------|-------------------|----------------------|
|                 | Watts Inrush      | Sealed            | Average Milliseconds |
| Two- to 11-pole | 168               | 13.2              | Pickup: 10           |
| Latch coil      | 21.6 intermittent | 21.6 intermittent | Dropout: 16          |

**Notes**

- <sup>①</sup> Number of available instantaneous contact positions (order contacts separately—Catalog Number D26MPR).
- <sup>②</sup> Contact ratings do not apply to contacts D26MPL and D26MPS. For AC contact ratings, see **Page V7-T3-161**.

# 3.7

## Control Relays and Timers

### Machine Tool Relays

#### Dimensions

Approximate Dimensions in Inches (mm)

#### AC and DC D26 Relays

3

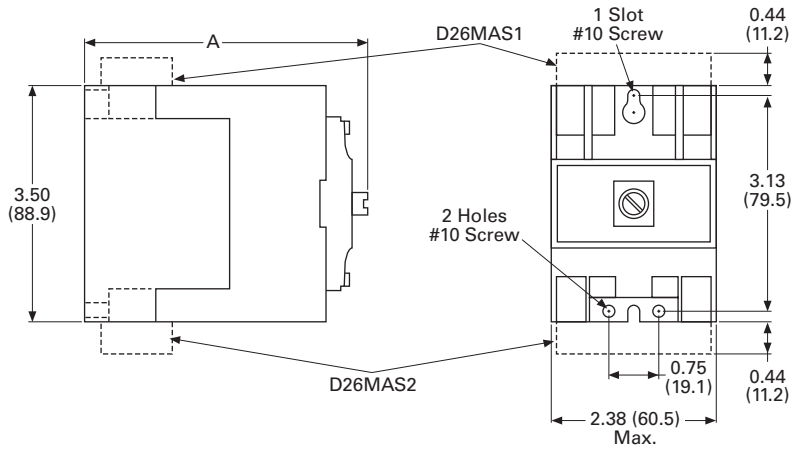

| AC Relay<br>D26                 | DC Relay<br>D26                 | Dimension A  | Ship. Wt.<br>Lbs (kg) |
|---------------------------------|---------------------------------|--------------|-----------------------|
| 1-4 poles                       | 1-3 poles                       | 4.00 (101.6) | 2.5 (1.1)             |
| 1-4 poles with timer D26 or D87 | 1-3 poles with timer D26 or D87 | 6.00 (152.4) | 3.3 (1.5)             |
| 1-4 poles with latch            | 1-2 poles with latch            | 6.13 (155.7) | 3.5 (1.6)             |
| 1-4 poles with D26MF            | 1-3 poles with D26MF            | 5.81 (147.6) | 2.8 (1.3)             |
| 5-8 poles                       | 4-7 poles                       | 5.25 (133.4) | 2.8 (1.3)             |
| 5-8 poles with timer D87        | 4-7 poles with timer D87        | 7.25 (184.2) | 3.5 (1.6)             |
| 5-8 poles with latch            | 3-6 poles with latch            | 7.31 (185.7) | 3.8 (1.7)             |
| 9-12 poles                      | 8-11 poles                      | 7.00 (177.8) | 3.0 (1.4)             |

#### Mounting Channel

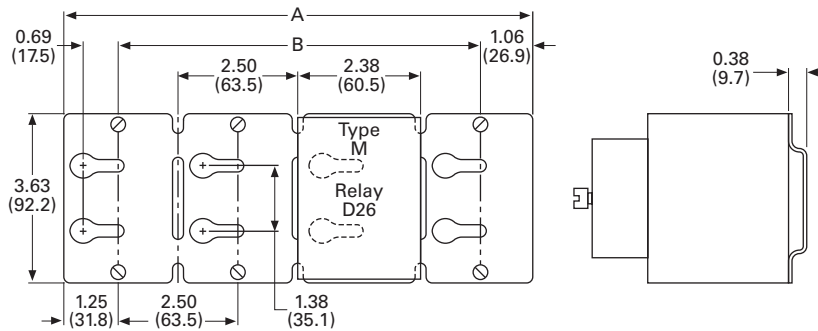

| Catalog<br>Number | Dimension A | Dimension B  |
|-------------------|-------------|--------------|
| <b>D26MC16</b>    | 40 (1016)   | 37.5 (952.5) |
| <b>D26MC12</b>    | 30 (762)    | 27.5 (698.5) |
| <b>D26MC8</b>     | 20 (508)    | 17.5 (444.5) |
| <b>D26MC4</b>     | 10 (254)    | 7.5 (190.5)  |

**Note:** Channel mounts through keyholes with #10 screws (two each end and one every fourth relay). Relays mount with screws captive in channel. All screws must be tightened firmly.

## Timing Relays



## Contents

| Description         | Page      |
|---------------------|-----------|
| Timing Relays       |           |
| Universal TR Series | V7-T3-172 |
| TR Series           | V7-T3-176 |
| TMR5 Series         | V7-T3-179 |
| TMR6 Series         | V7-T3-183 |
| TMRP Series         | V7-T3-185 |

## Product Selection Guide

## Function Code Cross-Reference Guide

| Function | Description  | Timer Series |                |      |      |      |                     |
|----------|--|--------------|----------------|------|------|------|---------------------|
|          |  | Universal TR | TR             | TMR5 | TMR6 | TMRP | E5-248 <sup>③</sup> |
| 1        | Asymmetrical flasher, pause first                                      | lp           | —              | R/P  | —    | —    | RC DLY              |
| 2        | Asymmetrical flasher, pulse first                                      | li           | —              | Y    | —    | —    | RC                  |
| 3        | ON delay and OFF delay with control contact                            | ER           | —              | —    | —    | —    | —                   |
| 4        | ON delay and single shot leading edge voltage controlled               | EWu          | —              | —    | —    | —    | —                   |
| 5        | ON delay and single shot leading edge control contact                  | EWs          | —              | —    | —    | —    | —                   |
| 6        | Single shot leading and single shot trailing edge with control contact | WsWa         | —              | —    | —    | —    | —                   |
| 7        | Pulse sequence monitoring  | Wt           | —              | —    | —    | —    | —                   |
| 8        | ON delay, power triggered  | E            | A <sup>①</sup> | N    | —    | A    | —                   |
| 9        | Single shot leading edge voltage controlled                            | Wu           | B <sup>①</sup> | T    | —    | C    | —                   |
| 10       | OFF delay/signal OFF delay   | R            | E <sup>②</sup> | F    | —    | D    | OFF DLY             |
| 11       | Single shot leading edge with control input                            | Ws           | F <sup>②</sup> | C/G  | —    | H    | SS                  |
| 12       | Single shot trailing edge with control input                           | Wa           | —              | —    | —    | —    | —                   |
| 13       | ON delay control signal start, trailing edge OFF                       | Es           | —              | —    | —    | —    | —                   |
| 14       | Flasher, pause first   | Bp           | C <sup>①</sup> | L    | —    | B    | —                   |
| 15       | Retriggerable single shot  | —            | —              | W/D  | —    | E    | SS                  |
| 16       | Flasher, ON first  | —            | D <sup>①</sup> | —    | —    | F    | —                   |
| 17       | ON delay control signal start, leading edge OFF                        | —            | A <sup>②</sup> | —    | —    | —    | ON DLY              |
| 18       | Flasher—control signal start, pause first                              | —            | B <sup>②</sup> | —    | —    | —    | RC DLY              |
| 19       | Flasher—control signal start, ON first                                 | —            | C <sup>②</sup> | —    | —    | —    | RC                  |
| 20       | Signal ON/OFF delay  | —            | D <sup>②</sup> | —    | —    | —    | —                   |
| 21       | ON/OFF delay   | —            | —              | —    | —    | I    | —                   |
| 22       | Single pulse generator   | —            | —              | —    | —    | G    | OS                  |
| 23       | Memory latch   | —            | —              | —    | —    | J    | —                   |
| 24       | True OFF delay   | —            | —              | —    | X    | —    | —                   |

## Notes

<sup>①</sup> Applies to TRN model only.

<sup>②</sup> Applies to TRF model only.

<sup>③</sup> The E5-248 is battery powered and has three programmable trigger functions. This product may perform somewhat differently from the standard timing relays. Refer to the operator instructions for details.

#### Product Overview

#### Timer Function Descriptions

##### Function #1—Universal TR, TMR5, E5-248

##### Asymmetrical Flasher, Pause First Repeat Cycle, OFF/ON Delay

When the supply voltage U is applied, the set interval t1 begins. After the interval t1 has expired, the output relay R switches into ON position and the set interval t2 begins.

After the interval t2 has expired, the output relay switches into OFF position. The output relay is triggered at the ratio of t1:t2 until the supply voltage is interrupted.

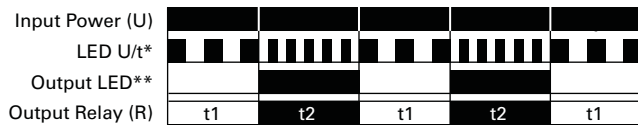

##### Function #2—Universal TR, TMR5, E5-248

##### Asymmetrical Flasher, Pulse First Repeat Cycle, ON/OFF Delay

When the supply voltage U is applied, the output relay R switches into the ON position and the set interval t1 begins. After the interval t1 has expired, the output relay R switches into OFF position

and the set interval t2 begins. After the interval t2 has expired, the output relay switches into ON position. The output relay is triggered at the ratio of t1:t2 until the supply voltage is interrupted.

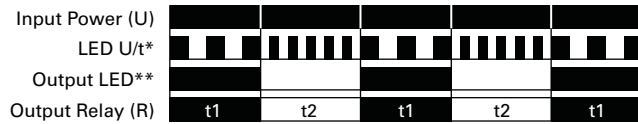

##### Function #3—Universal TR

##### ON Delay and OFF Delay with Control Contact

The supply voltage U must be constantly applied to the device. When the control contact S is closed, the set interval t1 begins. After the interval t1 has expired, the output relay R switches into ON position. If the control contact is opened, the set

interval t2 begins. After the interval t2 has expired, the output relay R switches into OFF position. If the control contact is opened before the interval t1 has expired, the interval already expired is erased and is restarted with the next cycle.

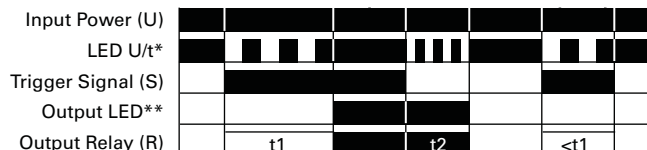

##### Function #4—Universal TR

##### ON Delay and Single Shot Leading Edge Voltage Controlled

When the supply voltage U is applied, the set interval t1 begins. After the interval t1 has expired, the output relay R switches into ON position. After the interval t2 has expired, the output relay

switches into OFF position. If the supply voltage is interrupted before the interval t1 + t2 has expired, the interval already expired is erased and is restarted when the supply voltage is next applied.



##### Function #5—Universal TR

##### ON Delay and Single Shot Leading Edge Control Contact

The supply voltage U must be constantly applied to the device. When the control contact S is closed, the set interval t1 begins. After the interval t1 has expired, the output relay R switches into ON position and the set

interval t2 begins. After the interval t2 has expired, the output relay R switches into OFF position. During the interval, the control contact is ignored. A new cycle can only be initiated when the control has been completed.

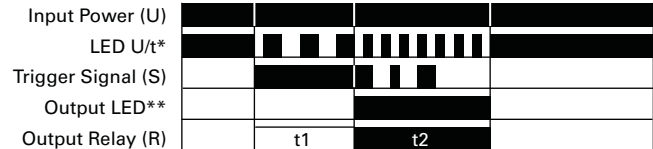

##### Function #6—Universal TR

##### Single Shot Leading and Single Shot Trailing Edge with Control Contact Asymmetrical Signal ON/OFF Delay

The supply voltage U must be constantly applied to the device. When the control contact S is closed, the output relay R switches to the ON position and the set interval t1 begins. After the interval t1 has expired, the output relay R switches into OFF position. If the control contact S is opened, the

output relay again switches to the ON position and the set interval t2 begins. After the interval t2 has expired, the output relay R switches into OFF position. During the interval, the control contact is ignored. During the interval, the control contact can be operated any number of times.

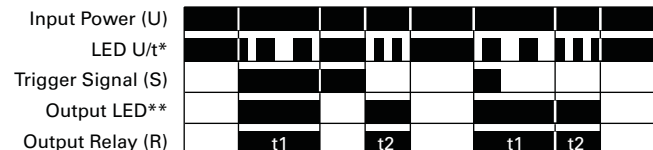

### Function #7—Universal TR Pulse Sequence Monitoring

When the supply voltage U is applied, the set interval t1 begins and the output relay R switches to the ON position. After the interval t1 has expired, the interval t2 begins. As long as the control switch S is closed and opened within the

interval t2, the relay will remain in the ON position. If the control switch is not closed and opened within the interval t2, the relay will change to the OFF position until supply voltage U is interrupted and reapplied.



### Function #10—Universal TR, TRF, TMR5, TMRP, E5-248 OFF Delay/Signal OFF Delay Delay ON Release

The supply voltage U must be constantly applied to the device. When the control contact S is closed, the output relay R switches to the ON position. When the control contact is opened, interval t begins. After the interval t has expired, the

output relay R switches to the OFF position. If the control contact S is closed before interval t expires, the output relay will remain in the ON position until the control switch opens, at which time the interval t will begin again.

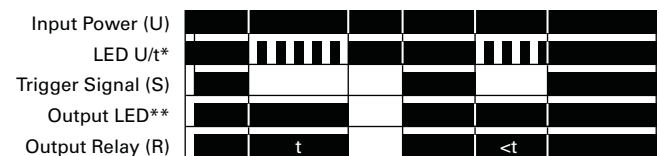

### Function #8—Universal TR, TRN, TMR5, TMRP ON Delay, Power Triggerged Delay ON Make

When the supply voltage U is applied, the set interval t begins. After the interval t has expired, the output relay

R switches to the ON position. The relay will remain in that position until supply voltage U is interrupted.

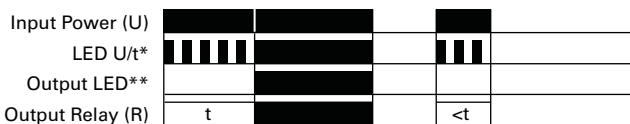

### Function #11—Universal TR, TRF, TMR5, TMRP, E5-248 Single Shot Leading Edge with Control Input Single Shot/One Shot (Signal Start)/Momentary Interval

The supply voltage U must be constantly applied to the device. When the control contact S is closed, the output relay R switches to the ON position and the set interval t begins. After the

interval t has expired, the output relay R switches to the OFF position. The control contact is ignored during the interval t, and a new cycle cannot be started until the set interval t has timed out.

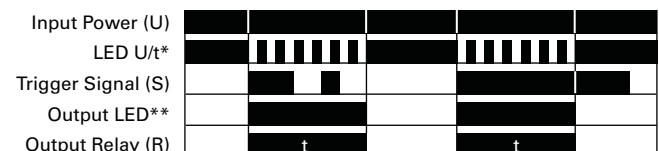

### Function #9—Universal TR, TRN, TMR5, TMRP Single Shot Leading Edge Voltage Controlled Interval ON/Interval (Power Start)

When the supply voltage U is applied, the output relay R switches to the ON position and set interval t begins. After the interval t has expired, the output relay R switches to the OFF position.

The relay will remain in that position until supply voltage U is interrupted. If the supply voltage is interrupted prior to interval t timing out, the relay will immediately switch to the OFF position.



### Function #12—Universal TR Single Shot Trailing Edge with Control Input

The supply voltage U must be constantly applied to the device. When the control contact S is closed and reopened, the output relay R switches to the ON position and the set interval t begins. After the interval t

has expired, the output relay R switches to the OFF position. The control contact is ignored during the interval t, and a new cycle must be started after the set interval t has timed out.

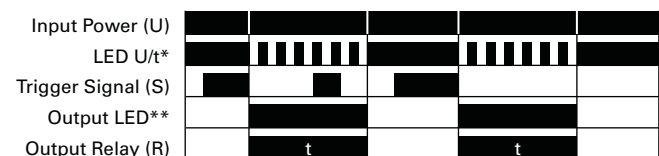

# 3.8

## Control Relays and Timers

### Timing Relays

3

#### Function #13—Universal TR ON Delay Control Signal Start, Trailing Edge OFF

The supply voltage U must be constantly applied to the device. When the control switch S is applied, the set interval t begins. After the interval t has expired, the output relay R switches to the ON position. The relay

will remain in that position until the control switch opens. If the control switch is opened prior to interval t timing out, the relay will remain in the OFF position and any elapsed time will be erased.

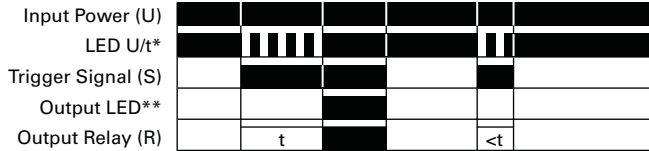

#### Function #14—Universal TR, TRN, TMR5, TMRP Flasher, Pause First Cycle 1 (Power Start, OFF First)

When the supply voltage U is applied, the set interval t begins. After the interval t has expired, the output relay R switches to the ON position and set interval t will begin again. After interval t

has expired, the relay will switch to the OFF position for the set interval t. This cycle will repeat at a 1:1 ratio until supply voltage U is interrupted.

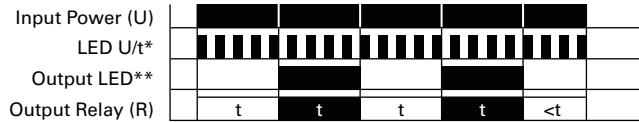

#### Function #15—TMR5, TMRP, E5-248 Watchdog Retriggerable Single Shot

The supply voltage U must be constantly applied to the device. When the control switch S is applied, the relay switches to the ON position and the set interval t begins. After the interval t has expired, the output relay R

switches to the OFF position. Closing the control switch during interval t will reset the time. Continuous cycling of the trigger signal at a rate faster than the preset time will cause the relay to remain in the ON position.



#### Function #16—TRN, TMRP Flasher, ON First Cycle 3 (Power Start, ON First)

When the supply voltage U is applied, the relay switches to the ON position and set interval t begins. After the interval t has expired, the output relay R switches to the OFF position and set interval t will begin again.

After interval t has expired, the relay will again switch to the ON position for the set interval t. This cycle will repeat at a 1:1 ratio until supply voltage U is interrupted.



#### Function #17—TRF, E5-248 ON Delay Control Signal Start, Leading Edge OFF

The supply voltage U must be constantly applied to the device. When the control switch S is applied, the set interval t begins. After the interval t has expired, the output relay R switches to the ON position. The relay will remain in that position

until the control switch has opened and closed. If the control switch is opened and closed prior to interval t timing out, the relay will remain in the OFF position and any elapsed time will be erased.

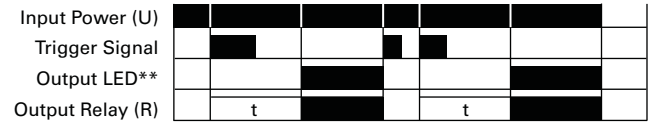

#### Function #18—TRF, E5-248 Flasher—Control Signal Start, Pause First

The supply voltage U must be constantly applied to the device. When the control switch S is closed, the set interval t begins. After the interval t has expired, the output relay R switches to the ON position and set interval t will begin again.

After interval t has expired, the relay will switch to the OFF position for the set interval t. This cycle will repeat at a 1:1 ratio until supply voltage U is interrupted. The control switch is ignored during the cycle.

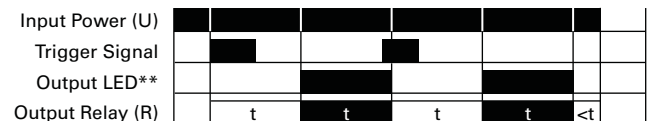

### Function #19—TRF, E5-248

#### Flasher—Control Signal Start, ON First

The supply voltage U must be constantly applied to the device. When the control switch S is closed, the relay switches to the ON position and set interval t begins. After the interval t has expired, the output relay R switches to the OFF position and set interval t will begin

again. After interval t has expired, the relay will again switch to the ON position for the set interval t. This cycle will repeat at a 1:1 ratio until supply voltage U is interrupted. The control switch is ignored during the cycle.

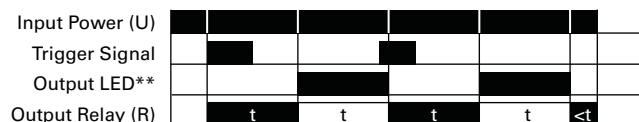

### Function #20—TRF Signal ON/OFF Delay

The supply voltage U must be constantly applied to the device. When the control switch S is closed, the relay switches to the ON position and set interval t begins. After the interval t has expired with the control switch still closed, the output relay R switches to the OFF

position. When the control switch is opened, the relay will switch to the ON position again and the interval t will begin. If the control switch is closed and opened within the interval t, the relay will remain in the ON position until interval t has timed out after the control switch is opened.

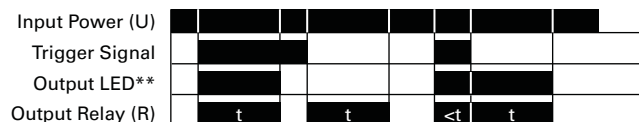

### Function #21—TMRP

#### ON/OFF Delay Make/Break with Control Switch Trigger

The supply voltage U must be constantly applied to the device. When the control switch S is closed, the set interval t begins. After the interval t has expired, the output relay R switches to the ON position. When the

control switch is opened, interval t will begin again. After interval t has timed out, the relay will switch to the OFF position. If supply voltage U is removed at any time, the relay will return to the OFF position.

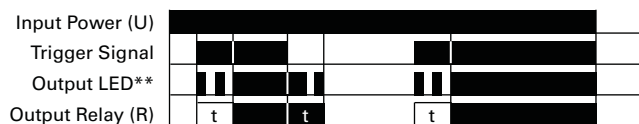

### Function #22—TMRP, E5-248

#### Single Pulse Generator, Voltage Controlled

When the supply voltage U is applied, the set interval t begins. After the interval t has expired, the relay will switch to the ON position for

0.5 seconds before returning to the OFF position. Supply voltage U must be removed and reapplied to repeat the pulse.

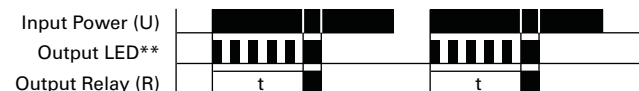

### Function #23—N/A

#### Memory Latch Control Switch Make

The supply voltage U must be constantly applied to the device. Output changes state

with every closure of the control switch S (leading edge).

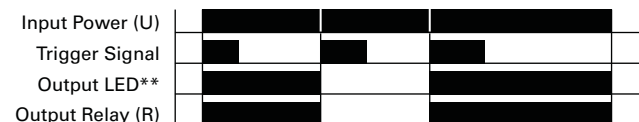

### Function #24—TMR6

#### True OFF Delay

When the supply voltage U is applied, the relay switches to the ON position. When supply power is removed, set time interval t begins. After

interval t has expired, the relay switches to the OFF position and will remain there until supply power U is applied again.



#### Universal TR Series



3

### Universal TR Series

#### Product Description

Eaton's Universal TR Series timers are our most flexible and cost-effective timing relays available. Products are available with up to seven user-selectable functions and seven user-selectable time ranges. Each unit is DIN rail mountable with a direct connection, eliminating the need for additional sockets. The Universal TR Series timers are available in SPDT and DPDT contact configurations, and have a compact IEC-style footprint and a universal input voltage range for AC and DC applications.

#### Application Description

A timing relay is a simple form of time-based control, allowing the user to open or close the contacts based on a specified timing function. The Universal TR Series timers are equipped with a set of selector switches, which can easily be set to a specific function and time, thereby reducing the number of product variations required. The universal input voltage (either 12–240 Vac/Vdc or 24–240 Vac/Vdc, depending on the model) further reduces the number of product variations.

The Universal TR Series timers are ideal for high-variability operations, such as systems integrators, distributors, and small equipment manufacturers. The compact design saves panel space, and the low cost and high flexibility of the units reduce inventory requirements.

### Contents

#### Description

|   | <i>Page</i>      |
|---|------------------|
| Universal TR Series                     |                  |
| Product Selection .....                 | <b>V7-T3-173</b> |
| Technical Data and Specifications ..... | <b>V7-T3-173</b> |
| Wiring Diagrams .....                   | <b>V7-T3-174</b> |
| Dimensions .....                        | <b>V7-T3-175</b> |
| TR Series .....                         | <b>V7-T3-176</b> |
| TMR5 Series .....                       | <b>V7-T3-179</b> |
| TMR6 Series .....                       | <b>V7-T3-183</b> |
| TMRP Series .....                       | <b>V7-T3-185</b> |

#### Features

- Multiple user-selectable timing functions and timing ranges in a single unit reduce product variations and stock keeping units (SKUs)
- Universal input voltages from 12 or 24 to 240 Vac or Vdc eliminate the need to order and stock separate coil voltages
- Compact, DIN rail mountable case reduces panel size
- Advanced LED indication makes troubleshooting easy
- Staggered terminal locations allow access to lower-level terminals after wiring
- SPDT or DPDT contacts with 8 A ratings

#### Standards and Certifications

- cULus listed
- CE marked
- RoHS compliant
- IEC/EN 61812





## Product Selection

## Single-Pole Model

## Universal TR Timing Relays



| Supply Voltage    | Description                        | Catalog Number |
|-------------------|------------------------------------|----------------|
| <b>4-Function</b> |                                    |                |
| 24–240 Vac/Vdc    | Compact DIN rail mount, SPDT       | <b>TRL04</b>   |
| <b>7-Function</b> |                                    |                |
| 24–240 Vac/Vdc    | Compact DIN rail mount, SPDT       | <b>TRL07</b>   |
| 12–240 Vac/Vdc    | Compact DIN rail mount, DPDT       | <b>TRL27</b>   |
|                   | Asymmetrical pulse generator, DPDT | <b>TRW27</b>   |

## Technical Data and Specifications

## Universal TR Timing Relays

| Description                  | TRL04  | TRL07  | TRL27  | TRW27  |
|------------------------------|--|--|--|--|
| Functions <sup>①</sup>       | E, R, Wu, Bp   | E, R, Wu, Bp, Ws, Wa, Es   | E, R, Wu, Bp, Ws, Wa, Es   | Ii, Ip, ER, Ewu, Ews, WsWa, Wt   |
| Time range                   | 0.05 sec to 100 hours  | 0.05 sec to 100 hours  | 0.05 sec to 100 hours  | 0.05 sec to 100 hours  |
| <b>Input</b>                 |  |  |  |  |
| Supply voltage               | 24–240 Vac/Vdc   | 24–240 Vac/Vdc   | 12–240 Vac/Vdc   | 12–240 Vac/Vdc   |
| Rated supply frequency       | +10% /–15%   | +10% /–15%   | ±10%   | ±10%   |
| Rated consumption            | 4 VA (1.5 W)   | 4 VA (1.5 W)   | 6 VA (2 W)   | 6 VA (2 W)   |
| Duty cycle                   | 100%   | 100%   | 100%   | 100%   |
| Reset time                   | 100 ms   | 100 ms   | 100 ms   | 100 ms   |
| Residual ripple for DC       | 10%  | 10%  | 10%  | 10%  |
| dropout voltage              | >30% of rated supply voltage   | >30% of rated supply voltage   | >30% of rated supply voltage   | >30% of rated supply voltage   |
| Overvoltage category         | III (in accordance with IEC 60664-1)                                     | III (in accordance with IEC 60664-1)                                     | III (in accordance with IEC 60664-1)                                     | III (in accordance with IEC 60664-1)                                     |
| Rated surge voltage          | 4 kV   | 4 kV   | 4 kV   | 4 kV   |
| <b>Output</b>                |  |  |  |  |
| Contact configuration        | SPDT (one changeover contact)  | SPDT (one changeover contact)  | DPDT (two changeover contacts)   | DPDT (two changeover contacts)   |
| Rated voltage                | 250 Vac  | 250 Vac  | 250 Vac  | 250 Vac  |
| Switching capacity           | 2000 VA (8 A/250 V)  | 2000 VA (8 A/250 V)  | 2000 VA (8 A/250 V)  | 2000 VA (8 A/250 V)  |
| Fusing                       | 8 A fast acting  | 8 A fast acting  | 8 A fast acting  | 8 A fast acting  |
| Mechanical life              | 20 x 10 <sup>6</sup> operations  | 20 x 10 <sup>6</sup> operations  | 20 x 10 <sup>6</sup> operations  | 20 x 10 <sup>6</sup> operations  |
| Electrical life              | 2 x 10 <sup>5</sup> operations at 1000 VA load, resistive                | 2 x 10 <sup>5</sup> operations at 1000 VA load, resistive                | 2 x 10 <sup>5</sup> operations at 1000 VA load, resistive                | 2 x 10 <sup>5</sup> operations at 1000 VA load, resistive                |
| Switching frequency          | Max. 6/min. at 1000 VA resistive load (in accordance with IEC 60947-5-1) | Max. 6/min. at 1000 VA resistive load (in accordance with IEC 60947-5-1) | Max. 6/min. at 1000 VA resistive load (in accordance with IEC 60947-5-1) | Max. 6/min. at 1000 VA resistive load (in accordance with IEC 60947-5-1) |
| Overvoltage category         | III (in accordance with IEC 60664-1)                                     | III (in accordance with IEC 60664-1)                                     | III (in accordance with IEC 60664-1)                                     | III (in accordance with IEC 60664-1)                                     |
| Rated surge voltage          | 4 kV   | 4 kV   | 4 kV   | 4 kV   |
| <b>Control Signal</b>        |  |  |  |  |
| Loadable                     | Yes  | Yes  | Yes  | Yes  |
| Maximum cable length         | 10m  | 10m  | 10m  | 10m  |
| Trigger level (sensitivity)  | Automatic adaption to supply voltage                                     | Automatic adaption to supply voltage                                     | Automatic adaption to supply voltage                                     | Automatic adaption to supply voltage                                     |
| Minimum control pulse length | DC 50 ms/AC 100 ms   | DC 50 ms/AC 100 ms   | DC 50 ms/AC 100 ms   | DC 50 ms/AC 100 ms   |

**Note**

<sup>①</sup> Refer to Function Code Cross-Reference Guide on **Page V7-T3-167** for function details.

#### Universal TR Timing Relays, continued

| Description           | TRL04   | TRL07   | TRL27   | TRW27   |
|-----------------------|---|---|---|---|
| <b>Accuracy</b>       |   |   |   |   |
| Base accuracy         | ±1% of maximum scale value  | ±1% of maximum scale value  | ±1% of maximum scale value  | ±1% of maximum scale value  |
| Adjustment accuracy   | <5% of maximum scale value  | <5% of maximum scale value  | <5% of maximum scale value  | <5% of maximum scale value  |
| Repetition accuracy   | <0.5% or ±5 ms  | <0.5% or ±5 ms  | <0.5% or ±5 ms  | <0.5% or ±5 ms  |
| Temperature influence | ≤0.01% / °C   | ≤0.01% / °C   | ≤0.01% / °C   | ≤0.01% / °C   |
| <b>Physical</b>       |   |   |   |   |
| Ambient temperature   | -25 to 55 °C  | -25 to 55 °C  | -25 to 55 °C  | -25 to 55 °C  |
| Storage temperature   | -25 to 70 °C  | -25 to 70 °C  | -25 to 70 °C  | -25 to 70 °C  |
| Relative humidity     | 15% to 85% (in accordance with IEC 60721-3-3 Class 3K3)                       | 15% to 85% (in accordance with IEC 60721-3-3 Class 3K3)                       | 15% to 85% (in accordance with IEC 60721-3-3 Class 3K3)                       | 15% to 85% (in accordance with IEC 60721-3-3 Class 3K3)                       |
| Pollution degree      | 2, if built in 3 (in accordance with IEC 60664-1)                             | 2, if built in 3 (in accordance with IEC 60664-1)                             | 2, if built in 3 (in accordance with IEC 60664-1)                             | 2, if built in 3 (in accordance with IEC 60664-1)                             |
| Housing material      | Self-extinguishing plastic housing, IP40 rating                               | Self-extinguishing plastic housing, IP40 rating                               | Self-extinguishing plastic housing, IP40 rating                               | Self-extinguishing plastic housing, IP40 rating                               |
| Mounting              | Mounted on DIN rail TS 35 according to EN 60715, any position                 | Mounted on DIN rail TS 35 according to EN 60715, any position                 | Mounted on DIN rail TS 35 according to EN 60715, any position                 | Mounted on DIN rail TS 35 according to EN 60715, any position                 |
| Terminal rating       | Shockproof terminal connection according to VBG 4 (PZ1 required), IP20 rating | Shockproof terminal connection according to VBG 4 (PZ1 required), IP20 rating | Shockproof terminal connection according to VBG 4 (PZ1 required), IP20 rating | Shockproof terminal connection according to VBG 4 (PZ1 required), IP20 rating |
| Tightening torque     | Max. 1 Nm   | Max. 1 Nm   | Max. 1 Nm   | Max. 1 Nm   |

#### Terminal Capacity

##### Description

- 1 x 0.5 to 2.5 mm<sup>2</sup> with/without multicore cable end
- 1 x 4 mm<sup>2</sup> without multicore cable end
- 2 x 0.5 to 1.5 mm<sup>2</sup> with/without multicore cable end
- 2 x 2.5 mm<sup>2</sup> flexible without multicore cable end

#### Wiring Diagrams

##### Single-Pole, Double-Throw Units (SPDT)—TRL04 and TRL07

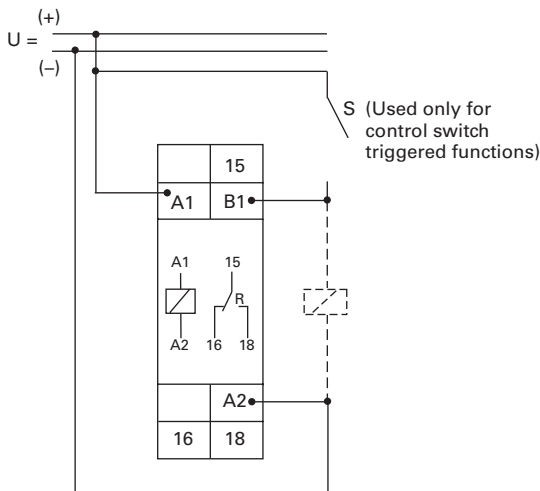

##### Double-Pole, Double-Throw Units (DPDT)—TRL27 and TRW27

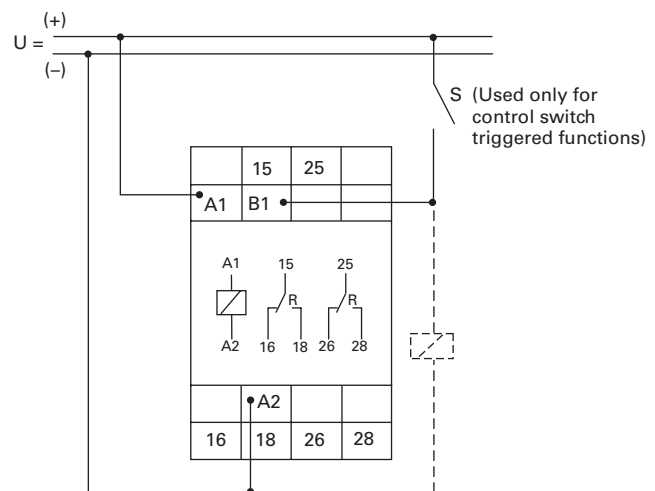

### Dimensions

Approximate Dimensions in Inches (mm)

#### 17.5 mm (TRL04 and TRL07)

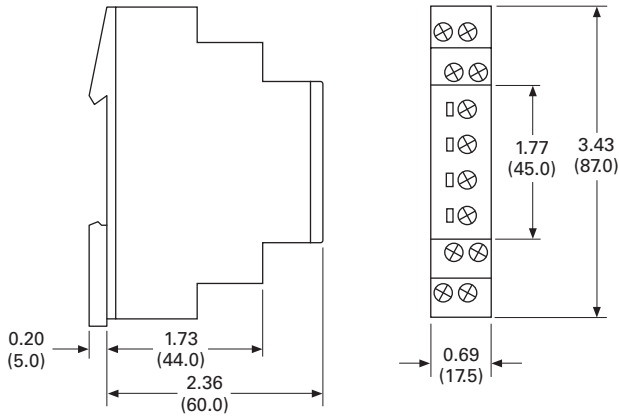

#### 35 mm (TRL27 and TRW27)

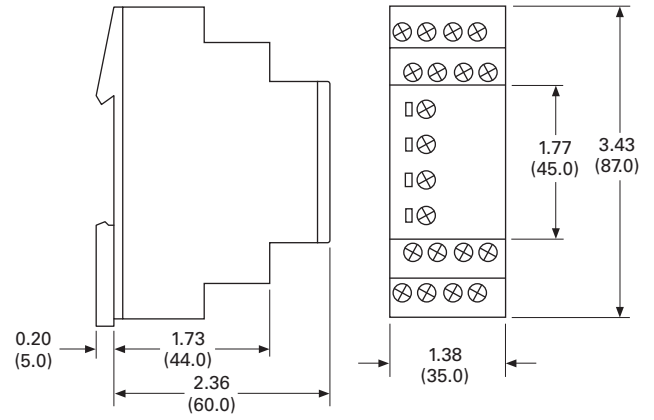

#### TR Series

3



### TR Series

#### Product Description

The upgraded TR Series Timing Relays are designed to meet most timing requirements by offering more flexibility in range of input voltage, timing range and functionality. Use a rotary switch to choose from 20 selectable time ranges from 0.1 second to 600 hours. We offer both a power triggered and signal triggered model—each with expanded operation modes. There is a green LED to indicate when power is ON and an orange LED when output is ON.

#### Features

- 20 time ranges and 10 timing functions
- Time delays from 0.1 sec to 600 hrs
- Space-saving, compact package
- High repeat accuracy of  $\pm 0.2\%$
- LED indication
- Standard 8- or 11-pin and 11-blade termination
- 2 Form C DPDT delayed output contacts
- 10 A contact rating

### Contents

#### Description

|                                   | <i>Page</i> |
|-----------------------------------|-------------|
| Universal TR Series               | V7-T3-172   |
| TR Series                         |             |
| Catalog Number Selection          | V7-T3-177   |
| Product Selection                 | V7-T3-177   |
| Accessories                       | V7-T3-177   |
| Technical Data and Specifications | V7-T3-178   |
| Dimensions                        | V7-T3-178   |
| TMR5 Series                       | V7-T3-179   |
| TMR6 Series                       | V7-T3-183   |
| TMRP Series                       | V7-T3-185   |

### Operation

#### TRNP and TRNB

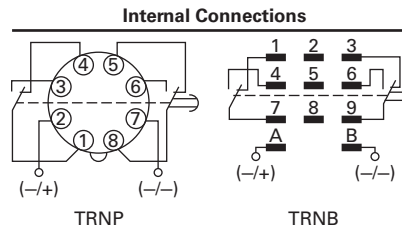

#### TRFP and TRFB

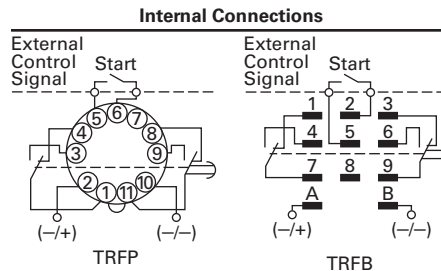

### Standards and Certifications

- cULus listed
- CSA
- CE marked
- TUV



### Catalog Number Selection

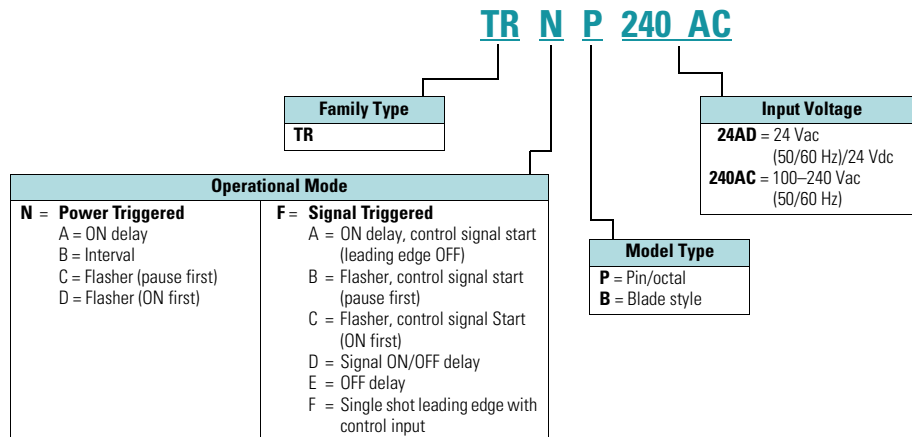

### Product Selection

#### TR Plug-In Timing Relays—Power Triggered

| Coil Voltage | Octal Catalog Number | Blade Catalog Number |
|--------------|----------------------|----------------------|
| 24 Vac/Vdc   | <b>TRNP24AD</b>      | <b>TRNB24AD</b>      |
| 100–240 Vac  | <b>TRNP240AC</b>     | <b>TRNB240AC</b>     |

#### TR Plug-In Timing Relays—Signal Triggered

| Coil Voltage | Octal Catalog Number | Blade Catalog Number |
|--------------|----------------------|----------------------|
| 24 Vac/Vdc   | <b>TRFP24AD</b>      | <b>TRFB24AD</b>      |
| 100–240 Vac  | <b>TRFP240AC</b>     | <b>TRFB240AC</b>     |

### Accessories

#### Sockets for Use with TR Timers—Standard Pack of 10

| Timing Relay | Terminal Style                             | Catalog Number |
|--------------|--|----------------|
| TRNP         | 8-pin octal                                | <b>D3PA2</b>   |
| TRFP         | 11-pin octal                               | <b>D3PA3</b>   |
| TRNB, TRFB   | 0.187 in solder/QC terminals (blade style) | <b>D5PA2</b>   |

## Technical Data and Specifications

### General

| Description                         | Specification   |
|-------------------------------------|---|
| Operation system                    | Solid-state CMOS circuit                              |
| Time range                          | 0.1 sec to 600 hours                                  |
| Pollution degree                    | 2 (IE60664-1)   |
| Overvoltage category                | III (IE60664-1)                                       |
| Rated operational voltage           |   |
| 240 AC                              | 100–240 Vac (50/60 Hz)                                |
| 24 AC                               | 24 Vac (50/60 Hz)/24 Vdc                              |
| 12 DC                               | 12 Vdc  |
| Voltage tolerance                   |   |
| 240 AC                              | 85–264 Vac (50/60 Hz)                                 |
| 24 AC                               | 20.4–26.4 Vac (50/60 Hz)/21.6–26.4 Vdc                |
| 12 DC                               | 10.8–13.2 Vdc   |
| Input OFF voltage                   | Rated voltage x 10% minimum                           |
| Ambient operating temperature       | –4 to 149 °F (–20 to 65 °C)                           |
| Reset time                          | 100 ms maximum  |
| Repeat error                        | ± 0.2%, ± 20 ms <sup>①</sup>                          |
| Voltage error                       | ± 0.2%, ± 20 ms <sup>①</sup>                          |
| Temperature error                   | ± 0.5%, ± 20 ms <sup>①</sup>                          |
| Setting error                       | ± 10% maximum   |
| Insulation resistance               | 100M ohm minimum (500 Vdc)                            |
| Dielectric strength                 |   |
| Between power and output terminals  | 2000 Vac, 1 minute                                    |
| Between contacts of different poles | 2000 Vac, 1 minute                                    |
| Between contacts of same pole       | 1000 Vac, 1 minute                                    |
| Vibration resistance                | 10–55 Hz amplitude 0.5 mm;<br>2 hrs in each of 3 axes |
| Shock resistance                    |   |
| Operating extremes                  | 10G   |
| Damage limits —                     |   |
| TRNP, TRFP                          | 40G (3x in each of 3 axes)                            |
| TRNB, TRFB                          | 10G (3x in each of 3 axes)                            |
| Power consumption (approx.)         |   |
| 240 AC                              | 6.5 VA TRNP, TRNB/6.6 VA TRFP, TRFB                   |
| 240 Vac/60 Hz                       | 11.6 VA TRNP, TRNB/12.1 VA TRFP, TRFB                 |
| 24 AC (AC/DC)                       | 3.4 VA–1.7 W TRNP, TRNB/3.5 VA–1.7 W TRFP, TRFB       |
| 12 DC                               | 1.6 W   |

### TR Series Contact Ratings

| Description                          | Specification                          |
|--------------------------------------|--|
| Contact configuration                | 2 Form C, DPDT (delayed output)        |
| Allowable voltage/current            | 240 Vac, 30 Vdc/10 A                   |
| Max. permissible operating frequency | 1800 cycles per hour                   |
| Rated load                           |  |
| Resistive                            | 10 A, 240 Vac/30 Vdc                   |
| Inductive                            | 7 A, 240 Vac/30 Vdc                    |
| Horsepower rating                    | 1/6 hp 120 Vac, 1/3 hp 240 Vac         |
| Life                                 |  |
| Electrical                           | 500,000 operations minimum (resistive) |
| Mechanical                           | 50,000,000 operations minimum          |

### Dimensions

Approximate Dimensions in Inches (mm)

#### TR Series Dimensions and Weights

| Description       | Specification                                    |
|-------------------|--|
| <b>Dimensions</b> |  |
| TRNP, TRFP        | 1.58H x 1.42W x 3.07D in. (40H x 36W x 77.9D mm) |
| TRNB, TRFB        | 1.58H x 1.42W x 2.95D in. (40H x 36W x 74.9D mm) |
| <b>Weights</b>    |  |
| TRNP              | 87g  |
| TRFP              | 89g  |
| TRNB, TRFB        | 85g  |

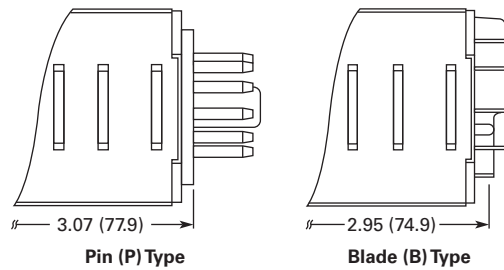

#### Note

<sup>①</sup> For the value of the error against a preset time, whichever value is larger should apply.

## TMR5 Series



## TMR5 Series

## Product Description

The TMR5 Series Time Delay Relays are designed for a broad range of OEM applications. The TMR5 Series offers non-programmable plug-in style timers with a variety of functions available. Each unit offers a single function and single input voltage, and operates over a defined time delay range. Units with fixed time delays are also available. Eaton also offers customization capabilities for these timers—remote adjustments, special pin configurations, and more. Contact us to discuss your specific application and design of a custom timer.

## Features

- Single timing range for each unit
- Ranges available from 0.02 sec to 24 hours
- Wide variety of functions available
- Plugs into standard 8- or 11-pin socket
- 10 A DPDT output contacts
- Can be easily customized to meet your needs

## Contents

## Description

| Description                       | Page      |
|-----------------------------------|-----------|
| Universal TR Series               | V7-T3-172 |
| TR Series                         | V7-T3-176 |
| TMR5 Series                       |           |
| Catalog Number Selection          | V7-T3-180 |
| Product Selection                 | V7-T3-180 |
| Accessories                       | V7-T3-180 |
| Technical Data and Specifications | V7-T3-181 |
| Wiring Diagrams                   | V7-T3-181 |
| Dimensions                        | V7-T3-182 |
| TMR6 Series                       | V7-T3-183 |
| TMRP Series                       | V7-T3-185 |

## Standards and Certifications

- cRUus
- UL listed (with Eaton socket)
- RoHS compliant
- CE marked

cRUUS

ROHS  
COMPLIANT

#### Catalog Number Selection

All configurations from Catalog Number Selection are available.

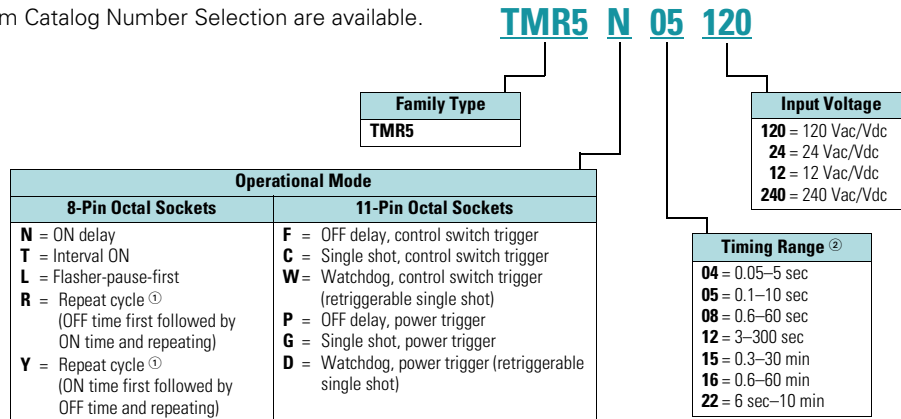

#### Product Selection

##### TMR5 Time Delay Relays

| Input Voltage  | Socket | Timing Range | Catalog Number |
|--|--------|--------------|----------------|
| <b>ON Delay</b>  |        |              |                |
| 120 Vac/Vdc  | 8-pin  | 0.1–10 sec   | TMR5N05120     |
|  |        | 0.6–60 sec   | TMR5N08120     |
| 24 Vac/Vdc   |        | 0.1–10 sec   | TMR5N0524      |
|  |        | 0.6–60 sec   | TMR5N0824      |
| <b>OFF Delay, Control Switch Trigger</b>                               |        |              |                |
| 120 Vac/Vdc  | 11-pin | 0.1–10 sec   | TMR5F05120     |
|  |        | 0.6–60 sec   | TMR5F08120     |
| 24 Vac/Vdc   |        | 0.1–10 sec   | TMR5F0524      |
|  |        | 0.6–60 sec   | TMR5F0824      |
| <b>Interval ON</b>   |        |              |                |
| 120 Vac/Vdc  | 8-pin  | 0.1–10 sec   | TMR5T05120     |
|  |        | 0.6–60 sec   | TMR5T08120     |
| 24 Vac/Vdc   |        | 0.1–10 sec   | TMR5T0524      |
|  |        | 0.6–60 sec   | TMR5T0824      |
| <b>Single Shot, Control Switch Trigger</b>                             |        |              |                |
| 120 Vac/Vdc  | 11-pin | 0.1–10 sec   | TMR5C05120     |
|  |        | 0.6–60 sec   | TMR5C08120     |
| 24 Vac/Vdc   |        | 0.1–10 sec   | TMR5C0524      |
|  |        | 0.6–60 sec   | TMR5C0824      |
| <b>Repeat Cycle (OFF Time First Followed by ON Time and Repeating)</b> |        |              |                |
| 120 Vac/Vdc  | 8-pin  | 0.1–10 sec   | TMR5R05120     |
|  |        | 0.6–60 sec   | TMR5R08120     |
| 24 Vac/Vdc   |        | 0.1–10 sec   | TMR5R0524      |
|  |        | 0.6–60 sec   | TMR5R0824      |
| <b>Repeat Cycle (ON Time First Followed by OFF Time and Repeating)</b> |        |              |                |
| 120 Vac/Vdc  | 8-pin  | 0.1–10 sec   | TMR5Y05120     |
|  |        | 0.6–60 sec   | TMR5Y08120     |
| 24 Vac/Vdc   |        | 0.1–10 sec   | TMR5Y0524      |
|  |        | 0.6–60 sec   | TMR5Y0824      |

#### Accessories

##### Accessories for Use with TMR5 Time Delay Relays

| Description      | Standard Pack | Catalog Number |
|------------------|---------------|----------------|
| 8-pin socket     | 10            | D3PA2          |
| 11-pin socket    | 10            | D3PA3-A2       |
| Hold-down spring | 10            | D65CHDS        |

#### Notes

- Indicates DUAL knob unit. All dual knob units can have independently selectable and adjustable ON and OFF times. If different ON and OFF times are desired, add two codes for time ranges in the part number. The first code listed indicates the first timing range of the unit (OFF time for R, ON time for Y) and the second code indicates the second timing range (ON time for R, OFF Time for Y).
- Fixed time delay settings are available for orders of 50 pieces or more. Contact EatonCare for additional information at 877-ETN-CARE (386-2273).



### Technical Data and Specifications

#### TMR5 Time Delay Relays

| Description   | Specification   |
|---|---|
| Voltage tolerance   |   |
| AC operation  | +10/−15% of nominal at 50/60 Hz   |
| DC operation  | +10/−15% of nominal   |
| Load burden   | 2 VA  |
| Setting accuracy  |   |
| Maximum setting (adjustable)  | +5%, −0%  |
| Minimum setting (adjustable)  | +0%, −50%   |
| Fixed time delay  |   |
| < 2 seconds   | +1%   |
| 0.1–2 seconds   | ±5%   |
| Repeat accuracy (constant voltage and temperature)                          |   |
| > 2 seconds delay   | ±0.1%   |
| 0.1–2 seconds delay   | ±2%   |
| Reset time  |   |
| ON Delay/interval/repeat cycle  | 0.1 second  |
| OFF Delay/single shot/watchdog  | 0.04 second   |
| Startup time (time from when power is applied until unit is timing)         |   |
| 120 and 240 V units   | 0.05 second   |
| 12, 24 and 48 V units   | 0.08 second   |
| Maintain function time (time unit continues to time after power is removed) | 0.01 second   |
| Temperature   |   |
| 12–120 V input voltage  | −18 to 150 °F (−28 to 65 °C)  |
| 240 V input voltage   | −18 to 122 °F (−28 to 50 °C)  |
| Insulation voltage  | 2000 V  |
| Output contacts   | DPDT 10 A @ 240 Vac/30 Vdc,<br>1/2 hp @ 120/240 Vac (NO contacts)<br>1/3 hp @ 120/240 Vac (NC contacts)<br>B300 and R300; AC-15 and DC-13 |
| Life  |   |
| Mechanical  | 10,000,000 operations   |
| Full load   | 100,000 operations  |

### Wiring Diagrams

#### Wiring for 8-Pin Units

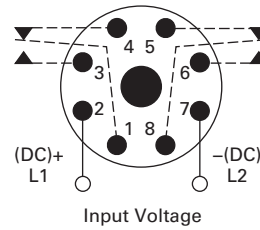

#### Wiring for 11-Pin Control Switch Trigger Units

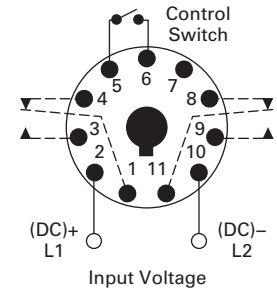

#### Wiring for 11-Pin Power Trigger Units

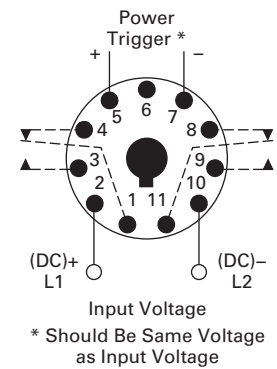

# 3.8

## Control Relays and Timers

### Timing Relays

#### Dimensions

Approximate Dimensions in Inches (mm)

#### TMR5

3

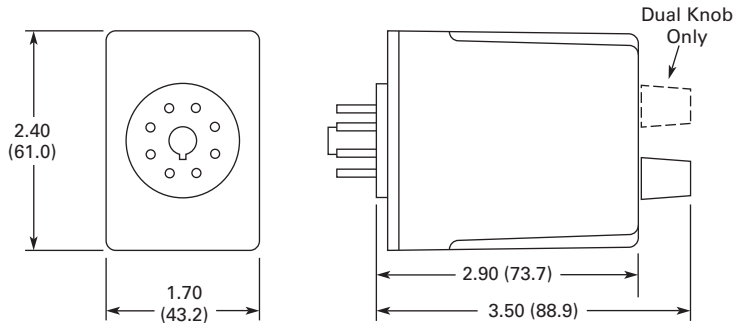

#### D3PA2 Socket

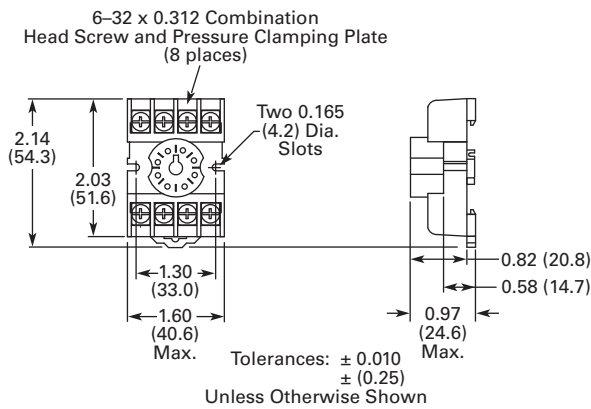

#### D3PA3 Socket

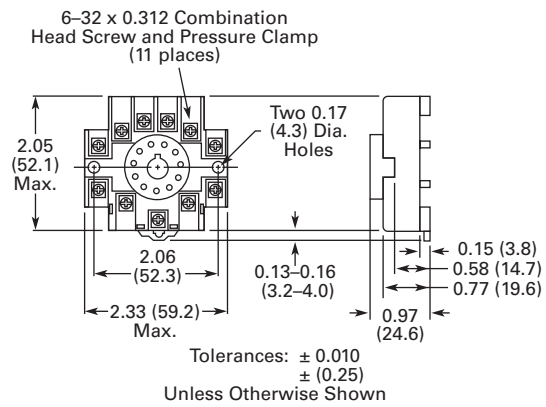

### TMR6 Series



## TMR6 Series

### Product Description

Most electronic time delay relays with an OFF delay function require input voltage to be applied continuously in order to operate correctly. However, there are many applications where this is not possible—keeping a relay energized for some amount of time after input voltage has been removed. Eaton’s TMR6 true OFF delay product provides this function even when input voltage is removed. It duplicates the operation of the older OFF delay pneumatic time delay relays.

### Features

- Provides OFF delay function without requiring input voltage during OFF time delay
- Duplicates operation of pneumatic OFF delay timers
- Each unit has eight timing ranges built in, covering 0.05 seconds to 30 minutes
- Selecting a range is easy using a rotary switch (no math is required or DIP switches to set)
- Uses industry-standard 8-pin octal socket
- 10 A DPDT output contacts

### Timing Ranges

Select one of the eight timing ranges using the selector knob, and then adjust the time within that range for an accurate delay setting.

### Timing Ranges

| Dial Setting | Timing Range |
|--------------|--------------|
| A            | 0.05–5 sec.  |
| B            | 0.1–10 sec.  |
| C            | 0.3–30 sec.  |
| D            | 0.6–60 sec.  |
| E            | 1.8–180 sec. |
| F            | 3–300 sec.   |
| G            | 0.1–10 min.  |
| H            | 0.3–30 min   |

## Contents

### Description

|                                   | Page      |
|-----------------------------------|-----------|
| Universal TR Series               | V7-T3-172 |
| TR Series                         | V7-T3-176 |
| TMR5 Series                       | V7-T3-179 |
| TMR6 Series                       |           |
| Catalog Number Selection          | V7-T3-184 |
| Product Selection                 | V7-T3-184 |
| Accessories                       | V7-T3-184 |
| Technical Data and Specifications | V7-T3-184 |
| Wiring Diagram                    | V7-T3-184 |
| Dimensions                        | V7-T3-184 |
| TMRP Series                       | V7-T3-185 |

### Operation

#### True OFF Delay

Upon application of input voltage, the relay is energized. When the input voltage is removed, the preset time begins. At the end of the preset time, the relay is de-energized.

**Voltage must be applied for a minimum of 0.1 second to assure proper operation.**

Any application of the input voltage during the preset time will keep the relay energized and reset the time delay. No external trigger switch is required.

#### True OFF Delay

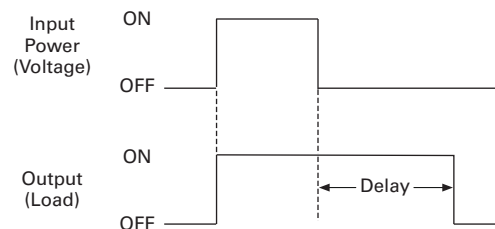

### Standards and Certifications

- cRUus
- UL listed (with Eaton socket)
- RoHS compliant
- CE marked



# 3.8

## Control Relays and Timers

### Timing Relays

3

#### Catalog Number Selection

All configurations from Catalog Number Selection are available.

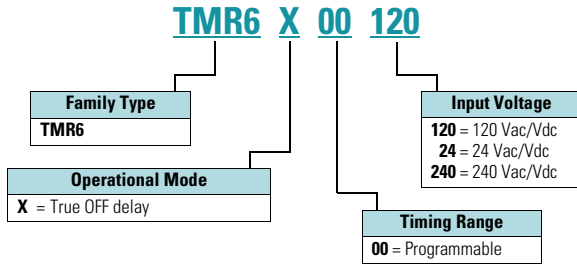

#### Wiring Diagram

##### Wiring for 8-Pin Units

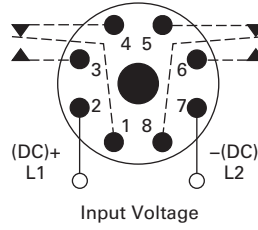

#### Product Selection

##### TMR6 True OFF Delay Relays

| Input Voltage         | Timing Range                                   | Catalog Number |
|-----------------------|--|----------------|
| <b>True OFF Delay</b> |  |                |
| 120 Vac/Vdc           | 0.05 sec–30 min<br>(user selectable, 8 ranges) | TMR6X00120     |
| 24 Vac/Vdc            |  | TMR6X0024      |
| 240 Vac/Vdc           |  | TMR6X00240     |

#### Accessories

##### Accessories for Use with TMR6 Time Delay Relays

| Description      | Standard Pack | Catalog Number |
|------------------|---------------|----------------|
| 8-pin socket     | 10            | D3PA2          |
| Hold-down spring | 10            | D65CHDS        |

#### Technical Data and Specifications

##### TMR6 Time Delay Relays

| Description  | Specification   |
|--|---|
| <b>Voltage tolerance</b>                           |   |
| AC operation                                       | +10/–15% of nominal at 50/60 Hz   |
| DC operation                                       | +10/–15% of nominal   |
| Load burden  | 2 VA  |
| <b>Setting accuracy</b>                            |   |
| Maximum setting (adjustable)                       | +5%, –0%  |
| Minimum setting (adjustable)                       | +0%, –50%   |
| Repeat accuracy (constant voltage and temperature) | ±0.1% or 50 ms, whichever is greater  |
| Temperature  | –18 to 150 °F (–28 to 65 °C)  |
| Insulation voltage                                 | 2,000 V   |
| Output contacts                                    | DPDT 10 A @ 240 Vac/30 Vdc,<br>1/2 hp @ 120/240 Vac (NO contacts)<br>1/3 hp @ 120/240 Vac (NC contacts)<br>B300 and R300; AC-15 and DC-13 |
| <b>Life</b>  |   |
| Mechanical   | 2,000,000 operations  |
| Full load  | 100,000 operations  |

#### Dimensions

Approximate Dimensions in Inches (mm)

##### TMR6

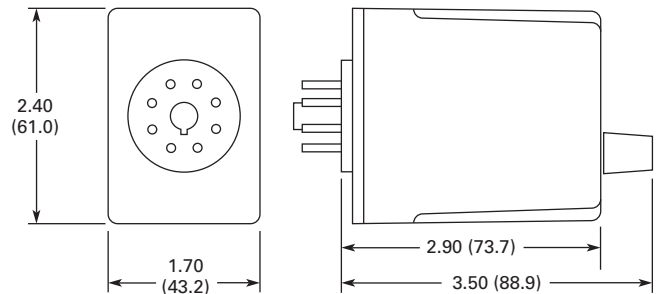

##### D3PA2 Socket

6–32 x 0.312 Combination Head Screw and Pressure Clamping Plate (8 places)

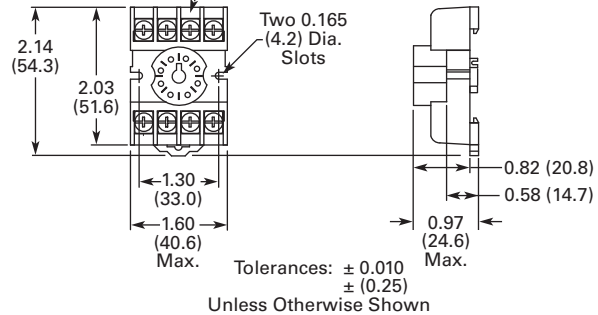

## TMRP Series



## TMRP Series

## Product Description

Eaton's TMRP Series timers combine flexibility with ease of use and installation to make the most versatile timer in our offering. The thumb-wheel setting design allows for quick selection and review of up to 10 timing functions and seven timing ranges. The TMRP units can be mounted in a 1/16 DIN cutout or on a DIN rail with our D3 series sockets. Input voltage is 12–240 Vac/Vdc to work with all popular control voltages.

## Application Description

A timing relay is a simple form of time-based control, allowing the user to open or close the contacts based on a specified timing function. The TMRP series is equipped with a set of thumb-wheel style selector switches, which can easily be set to a specific function and time, thereby reducing the number of product variations required. The universal input voltage of 12–240 Vac/Vdc further reduces the number of product variations.

The TMRP timers are ideal for high-variability operations, such as systems integrators, distributors, and small equipment manufacturers. The flexible enclosure design allows for back-panel mounting, through-panel mounting, or DIN rail mounting.

## Contents

| <b>Description</b>                      | <b>Page</b> |
|---|-------------|
| Universal TR Series .....               | V7-T3-172   |
| TR Series .....                         | V7-T3-176   |
| TMR5 Series .....                       | V7-T3-179   |
| TMR6 Series .....                       | V7-T3-183   |
| TMRP Series                             |             |
| Product Selection .....                 | V7-T3-186   |
| Technical Data and Specifications ..... | V7-T3-186   |
| Wiring Diagrams .....                   | V7-T3-187   |
| Dimensions .....                        | V7-T3-187   |

## Features

- Multiple user-selectable timing functions and timing ranges in a single unit reduce product variations and stock keeping units (SKUs)
- Universal input voltages from 12–240 Vac/Vdc eliminate the need to order and stock separate coil voltages
- Timing ranges up to 9990 hours
- Dual LED indication makes troubleshooting easy
- Flexible design for back-panel, through-panel (45 mm x 45 mm cutout), or DIN rail mounting
- SPDT or DPDT contacts with 12 A ratings
- Plastic dust cover keeps out contaminants and eliminates accidental set point changes
- Use with standard Eaton D3 sockets—see Technical Data and Specifications

## LED Indicator

| LED Description               | Function                                    |
|-------------------------------|---|
| Solid green "Input"           | Supply voltage present                      |
| Solid red "Output"            | Relay energized                             |
| Slowly flashing red "Output"  | Timing cycle activated, relay not energized |
| Rapidly flashing red "Output" | Timing cycle activated, relay energized     |

## Standards and Certifications

- UL recognized
- CE marked
- RoHS compliant



## Product Selection

## TMRP5100

## TMRP Timing Relays



| Supply Voltage     | Description                  | Catalog Number  |
|--------------------|------------------------------|-----------------|
| <b>10-Function</b> |                              |                 |
| 12–240 Vac/Vdc     | Control switch trigger, DPDT | <b>TMRP5100</b> |
|                    | Control switch trigger, SPDT | <b>TMRP5101</b> |
|                    | Power trigger, DPDT          | <b>TMRP5102</b> |

## Technical Data and Specifications

## TMRP Timing Relays

| Description                  | TMRP5100                                  | TMRP5101                                  | TMRP5102                                  |
|------------------------------|---|---|---|
| Functions <sup>①</sup>       | A, B, C, D, E, F, G, H, I, J              | A, B, C, D, E, F, G, H, I, J              | A, B, C                                   |
| Time range                   | 0.1 sec to 9,990 hours                    | 0.1 sec to 9,990 hours                    | 0.1 sec to 9,990 hours                    |
| <b>Input</b>                 |   |   |   |
| Supply voltage               | 12–240 Vac/Vdc                            | 12–240 Vac/Vdc                            | 12–240 Vac/Vdc                            |
| Supply voltage tolerance     | ±15%                                      | ±15%                                      | ±15%                                      |
| Rated consumption            | 2.5 VA (2 W) maximum                      | 2.5 VA (2 W) maximum                      | 2.5 VA (2 W) maximum                      |
| Reset time                   | 150 ms                                    | 150 ms                                    | 150 ms                                    |
| Reverse polarity protection  | Yes                                       | Yes                                       | Yes                                       |
| Operate time                 | 25 ms maximum                             | 25 ms maximum                             | 25 ms maximum                             |
| Release time                 | 25 ms maximum                             | 25 ms maximum                             | 25 ms maximum                             |
| Rated surge voltage          | 4 kV                                      | 4 kV                                      | 4 kV                                      |
| <b>Output</b>                |   |   |   |
| Contact configuration        | DPDT                                      | SPDT                                      | DPDT                                      |
| Contact rating (AC)          | 12 A resistive at 120, 240 UL 508         | 12 A resistive at 120, 240 UL 508         | 12 A resistive at 120, 240 UL 508         |
| Contact rating (DC)          | 12 A resistive at 30 UL 508               | 12 A resistive at 30 UL 508               | 12 A resistive at 30 UL 508               |
| Contact rating horsepower    | 1/2 at 120 Vac, 1 at 240 Vac              | 1/2 at 120 Vac, 1 at 240 Vac              | 1/2 at 120 Vac, 1 at 240 Vac              |
| Contact rating pilot duty    | A300, 720 VA at 240 Vac                   | A300, 720 VA at 240 Vac                   | A300, 720 VA at 240 Vac                   |
| Minimum load                 | 12 V/100 mA                               | 12 V/100 mA                               | 12 V/100 mA                               |
| Contact material             | Silver-nickel 90/10                       | Silver-nickel 90/10                       | Silver-nickel 90/10                       |
| Contact resistance           | 100 milliohms max. at 1 A 12 Vdc          | 100 milliohms max. at 1 A 12 Vdc          | 100 milliohms max. at 1 A 12 Vdc          |
| Mechanical life—full load    | 10 million operations                     | 10 million operations                     | 10 million operations                     |
| Electrical life—full load    | 100,000 operations                        | 100,000 operations                        | 100,000 operations                        |
| <b>Control Signal</b>        |   |   |   |
| Minimum control pulse length | 50 ms minimum                             | 50 ms minimum                             | 50 ms minimum                             |
| <b>Accuracy</b>              |   |   |   |
| Repetition accuracy          | 0.10% at constant voltage and temperature | 0.10% at constant voltage and temperature | 0.10% at constant voltage and temperature |
| <b>Physical</b>              |   |   |   |
| Ambient temperature          | –10 to 55 °C                              | –10 to 55 °C                              | –10 to 55 °C                              |
| Storage temperature          | –40 to 85 °C                              | –40 to 85 °C                              | –40 to 85 °C                              |
| Mounting                     | Use with D3PA3 socket                     | Use with D3PA2 socket                     | Use with D3PA2 socket                     |

**Note**

<sup>①</sup> Refer to Function Code Cross-Reference Guide on **Page V7-T3-167** for function details.

### Wiring Diagrams

**TMRP5100**

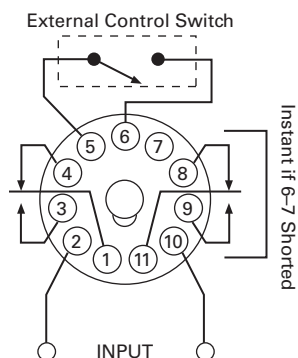

**TMRP5101**

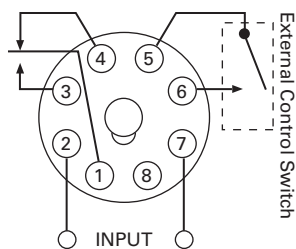

**TMRP5102**

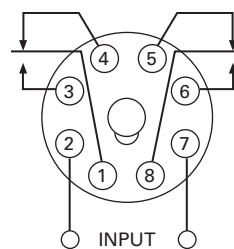

### Dimensions

Approximate Dimensions in Inches (mm)

**TMRP Series**

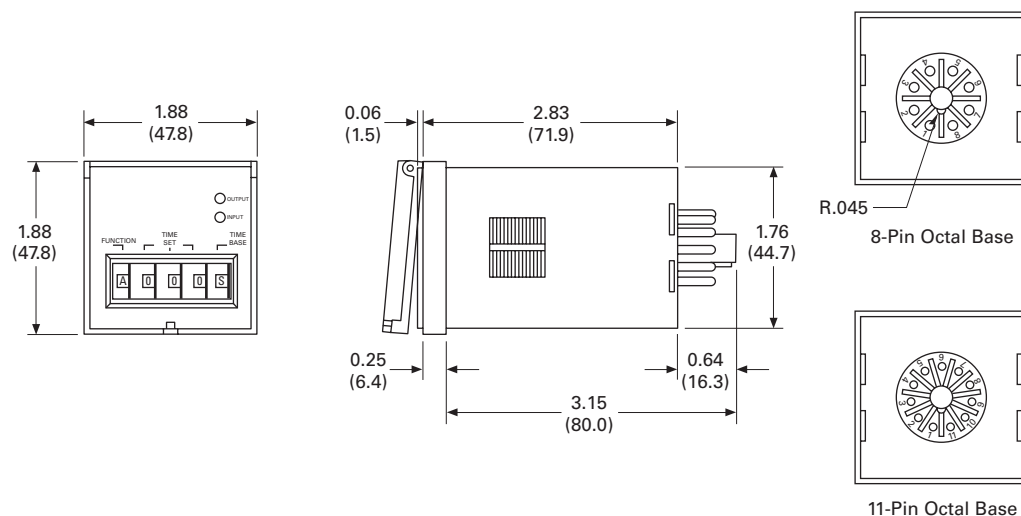

D85 Series—Alternating Relays



### Product Description

Alternating relays are used in applications where the optimization of load usage is required by equalizing the run time of two loads. They are also used where additional capacity is required in case of excess load requirements. This alternating action is initiated by a control switch—such as a float switch, manual switch, timing relay, pressure switch or other isolated contact. Each time the initiating switch is opened, the output relay contacts will change state, thus alternating the two loads. Two LED indicators show the status of the output relay.

The D851 and D852 Series Relays are used with one control switch and are available in either SPDT or DPDT output configurations with or without a selector switch to lock in one sequence. The D852X Series Relays are available in DPDT cross-wired output configurations for use with one or two control switches (LEAD and LAG).

The D853 Series is designed for use with three-switch applications (LEAD, LAG and STOP). The D853 Series combines a standard DPDT Cross-Wired alternating relay, contactor auxiliary contacts, and a control relay into one compact and economical product. This saves space and labor, while reducing the number of components needed. The D853 Series uses Sequence On—Simultaneous Off (S.O.S.O.) operation, where the two loads are energized sequentially, but remain on together until the STOP switch is opened. This device also protects against failure of the STOP and LEAD switches. If both switches fail, the two pump motors will be energized simultaneously when the LAG switch is closed.

### Contents

#### Description

|   | <i>Page</i>      |
|---|------------------|
| D85 Series—Alternating Relays               |                  |
| Product Selection . . . . .                 | <b>V7-T3-189</b> |
| Accessories . . . . .                       | <b>V7-T3-189</b> |
| Technical Data and Specifications . . . . . | <b>V7-T3-190</b> |
| Wiring Diagrams . . . . .                   | <b>V7-T3-190</b> |
| Dimensions . . . . .                        | <b>V7-T3-192</b> |

Each of the D85 Series alternating relays is available with an optional three-position selector switch, which allows the unit to alternate the two loads as normal, or lock the relay to one load or the other. By locking the alternating relay to one load, the other load can be removed for service without rewiring the first load for continuous operation. The selector switch has a low profile to prevent any accidental actuation.

### Features

- For duplex loads
- Works with one-, two-, or three-switch applications
- Compact plug-in design using industry standard sockets
- 10 A SPDT or DPDT output configurations
- Optional low profile selector switch to lock in one sequence
- Two LEDs indicate relay status
- D853 Series replaces separate components in duplex panel—saving space and reducing labor

### Standards and Certifications

- CE
- cRUus
- UL listed ①
- RoHS compliant



#### Note

① When used with appropriate Eaton socket.



## Product Selection

### D85 Series—Alternating Relays <sup>①</sup>

| Output Contacts                    | Control Voltage | Socket | Catalog Number |
|------------------------------------|-----------------|--------|----------------|
| SPDT                               | 12 Vac          | 8-pin  | <b>D851NR</b>  |
| SPDT                               | 24 Vac          | 8-pin  | <b>D851NT</b>  |
| SPDT                               | 120 Vac         | 8-pin  | <b>D851NA</b>  |
| SPDT                               | 240 Vac         | 8-pin  | <b>D851NB</b>  |
| SPDT w/selector switch             | 12 Vac          | 8-pin  | <b>D851LR</b>  |
| SPDT w/selector switch             | 24 Vac          | 8-pin  | <b>D851LT</b>  |
| SPDT w/selector switch             | 120 Vac         | 8-pin  | <b>D851LA</b>  |
| SPDT w/selector switch             | 240 Vac         | 8-pin  | <b>D851LB</b>  |
| DPDT                               | 12 Vac          | 11-pin | <b>D852NR</b>  |
| DPDT                               | 24 Vac          | 11-pin | <b>D852NT</b>  |
| DPDT                               | 120 Vac         | 11-pin | <b>D852NA</b>  |
| DPDT                               | 240 Vac         | 11-pin | <b>D852NB</b>  |
| DPDT w/selector switch             | 12 Vac          | 11-pin | <b>D852LR</b>  |
| DPDT w/selector switch             | 24 Vac          | 11-pin | <b>D852LT</b>  |
| DPDT w/selector switch             | 120 Vac         | 11-pin | <b>D852LA</b>  |
| DPDT w/selector switch             | 240 Vac         | 11-pin | <b>D852LB</b>  |
| DPDT cross-wired                   | 12 Vac          | 8-pin  | <b>D852XNR</b> |
| DPDT cross-wired                   | 24 Vac          | 8-pin  | <b>D852XNT</b> |
| DPDT cross-wired                   | 120 Vac         | 8-pin  | <b>D852XNA</b> |
| DPDT cross-wired                   | 240 Vac         | 8-pin  | <b>D852XNB</b> |
| DPDT cross-wired w/selector switch | 12 Vac          | 8-pin  | <b>D852XLR</b> |
| DPDT cross-wired w/selector switch | 24 Vac          | 8-pin  | <b>D852XLT</b> |
| DPDT cross-wired w/selector switch | 120 Vac         | 8-pin  | <b>D852XLA</b> |
| DPDT cross-wired w/selector switch | 240 Vac         | 8-pin  | <b>D852XLB</b> |

## Accessories

### D85 Series—Alternating Relays

| Description      | Standard Pack | Catalog Number  |
|------------------|---------------|-----------------|
| 8-pin socket     | 10            | <b>D3PA2</b>    |
| 11-pin socket    | 10            | <b>D3PA3-A2</b> |
| Hold-down spring | 10            | <b>D65CHDS</b>  |

#### Note

<sup>①</sup> Contact Eaton for relays for 3-switch applications (Lead-Lag-Stop).

#### Technical Data and Specifications

##### D85 Series—Alternating Relays

| Description                       | Specification  |
|-----------------------------------|--|
| Voltage tolerance                 | +10%/-15% of control voltage at 50/60 Hz   |
| Load (burden)                     | Less than 3 VA   |
| Output contacts                   | 10 A resistive at 240 Vac / 30 Vdc, 1/2 hp at 120/240 Vac (NO), 1/3 hp at 120/240 Vac (NC) |
| Mechanical life                   | 10,000,000 operations  |
| Electrical life                   | 100,000 operations   |
| Temperature                       | -20 °F to +150 °F (-28 ° to 65 °C)   |
| Transient protection              | 10,000 volts for 20 microseconds   |
| Indicator LEDs                    | 2 LEDs marked LOAD A and LOAD B  |
| Optional selector switch settings | ALTERNATE, LOCK LOAD A, LOCK LOAD B  |

#### Wiring Diagrams

##### D851 Series Relays, SPDT

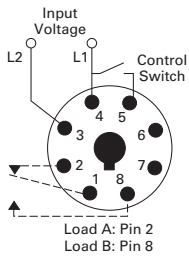

##### D852 Series Relays, DPDT

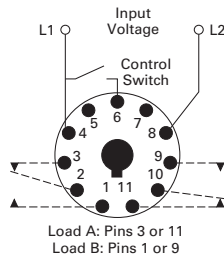

##### D852X Series Relays, DPDT Cross-Wired

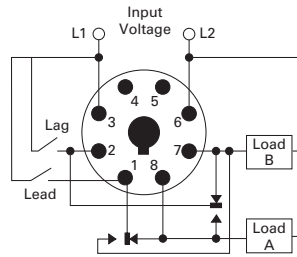

##### D853 Series Relays, Three-Switch Applications

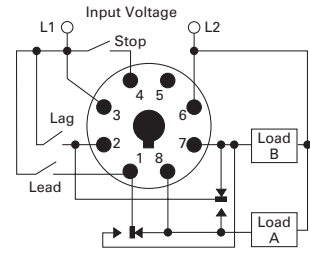

#### Typical Installations for SPDT and DPDT Alternating Relays, Standard Installation

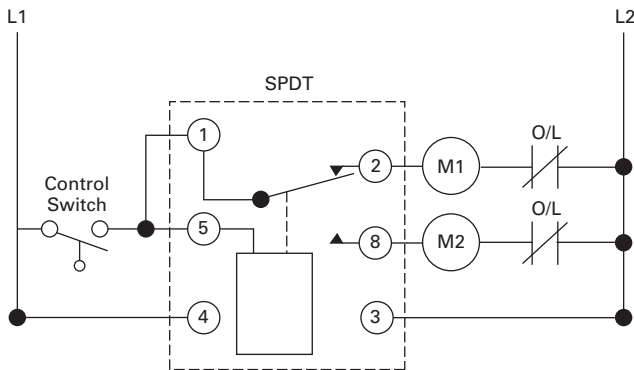

In the OFF state (standard installation), the control switch is open, the alternating relay is in the LOAD A position, and both loads (M1 and M2) are off. When the control switch closes, it energizes the first load (M1). The red LED marked "LOAD A" glows. As long as the control switch remains closed, M1 remains energized.

When the control switch opens, the first load (M1) is turned off and the alternating relay toggles to the LOAD B position. When the control switch closes again, it energizes the second load (M2). The red LED marked "LOAD B" glows.

#### Typical Installations for SPDT and DPDT Alternating Relays, Anti-Bounce Installation

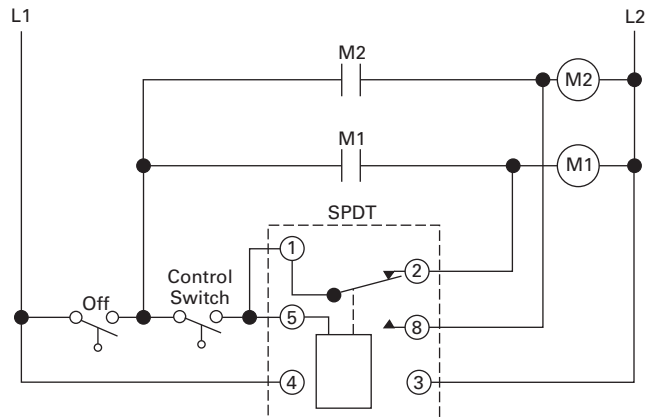

When the control switch opens, the second load (M2) is turned off, the alternating relay toggles back to the LOAD A position, and the process can be repeated again. On relays with DPDT contacts, two pilot lights can be used for remote indication of LOAD A or LOAD B status.

To eliminate any bounce condition of the control switch, the addition of a second switch (OFF) along with two auxiliary contacts is recommended as shown in the Anti-Bounce Installation.

### Typical Installations for DPDT Cross-Wired Alternating Relays, Standard Installation

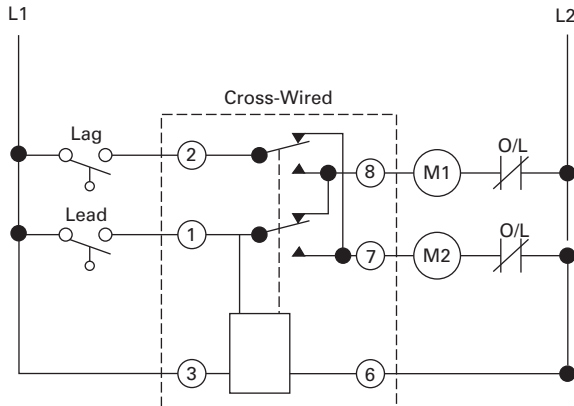

In the OFF state, both the LEAD control switch and the LAG control switch are open, the alternating relay is in the LOAD A position, and both loads are off. When the LEAD control switch closes, it energizes the first load (M1). The red LED marked "LOAD A" glows. As long as the LEAD control switch remains closed, M1 remains energized. If the LAG control switch closes, it energizes the second load (M2).

When the LAG control switch opens, the second load (M2) is turned off. When the LEAD control switch opens, the first load (M1) is turned off and the alternating relay toggles to the LOAD B position.

### Typical Installations for DPDT Cross-Wired Alternating Relays, Anti-Bounce Installation

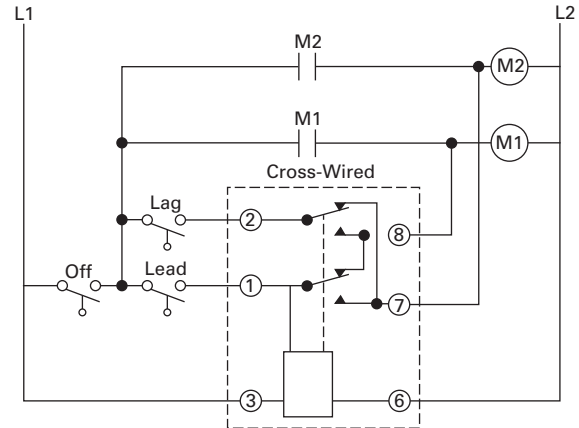

When the LEAD control switch closes, it turns on the second load (M2). The red LED marked "LOAD B" glows. If the LAG control switch closes, it will energize the first load (M1). When the LAG control switch opens, the first load (M1) is turned off. When the LEAD control switch opens, the second load (M2) is turned off, the alternating relay toggles back to the LOAD A position, and the process can be repeated again.

To eliminate any bounce condition of the control switch, the addition of a second switch (OFF) along with two auxiliary contacts is recommended as shown in the Anti-Bounce Installation.

### Typical Installations for DPDT Cross-Wired Relays for Three-Switch Applications

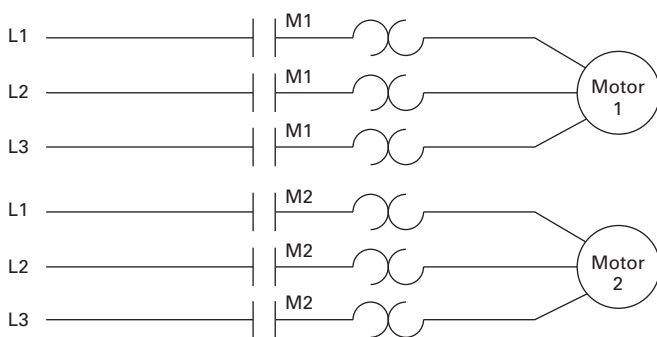

In the OFF state, all three switches are open, the alternating relay is in the LOAD A position, and both loads are off. No action happens with the alternating relay or either load when the STOP switch closes. When the LEAD switch closes, Load #1 (M1) turns on. When the LAG switch closes, Load #2 (M2) turns on. Both loads remain on as long as all three switches are closed.

When the LAG switch opens, Load #2 (M2) remains on because the STOP switch is still closed. When the LEAD switch opens, Load #1 (M1) remains on because the STOP switch is still closed. When the STOP switch opens, both Load #1 (M1) and Load #2 (M2) are turned off simultaneously.

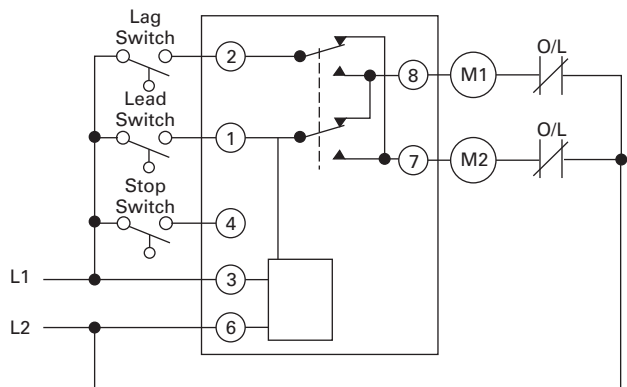

The alternating relay toggles to the LOAD B position. The entire cycle is then repeated, but with Load #2 (M2) energized first followed by Load #1 (M1). This type of operation is known as "Sequence On-Simultaneously Off (S.O.S.O.)"—the two loads are energized sequentially, but remain on together until the STOP switch is opened.

If both the STOP switch and LEAD switch fail to close and turn on the first load, both loads will be turned on simultaneously when the LAG switch is closed.

# 3.9

## Control Relays and Timers

### Alternating Relays

#### Dimensions

Approximate Dimensions in Inches (mm)

#### D85 Series—Alternating Relays

3

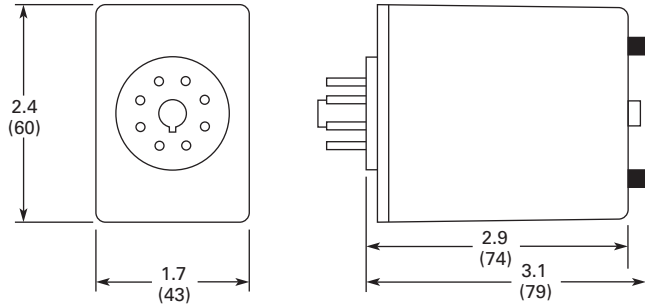

## Safety Relays



### Product Description

Safety relays are intended to reliably monitor the signals from safety devices at all times and switch off quickly and reliably in an emergency. Single-channel and dual channel versions are available for the construction of safety applications. The internal logic of the safety relays monitors the safety circuits (emergency stop, guard door, and so on) and activates the enable paths in a fault-free condition. Upon actuation of the safety device or in the event of a fault, the enable paths are switched off. Any faults that occur in the control circuit, such as ground fault, cross connection fault or wire breakage are also detected.

### Application Description

Eaton's ESR5 safety relays provide optimal safety and a high degree of reliability on plant machinery. Applications that meet the highest safety requirements in accordance with EN 954-1, EN ISO 13849-1 up to PL e and accordance with IEC 62061 up to SILCL 3 can be realized with the ESR5 safety relay.

Compatible with a wide variety of safety devices:

- Emergency stops
- Rope pulls
- Two-hand control stations
- Light curtain (OSSD)
- Gate enable device
- Safety switches

### Contents

#### Description

Safety Relays

|   | <i>Page</i> |
|---|-------------|
| Product Selection .....                 | V7-T3-194   |
| Technical Data and Specifications ..... | V7-T3-195   |
| Dimensions .....                        | V7-T3-198   |

### Features

- Use for the highest safety requirements in accordance with EN 954-1, EN ISO 13849-1, IEC 62061 and EC 61508
- Suitable for the world market with UL, cUL certifications and TÜV Rhineland functional safety certifications
- Applicable for EN 60204 stop categories 0 or 1
- Plug-in screw terminals for fast and fault-free replacement
- Multi-voltage versions (24–230 Vac/Vdc) for a flexible range of application
- Delayed and non-delayed contact expansions accommodate a wide variety of applications

### Standards and Certifications

- UL 508; CSA C22.2 No 14-95; CE Marked
- UL/cUL file number: E29184
- Degree of protection: IP20
- TÜV Rhineland certified
- UL/cULus listed



#### Product Selection

##### Safety Relays



3

#### Technical Overview

| Single Channel | Dual Channel | Safety Output (NO) | Safety Output (NO) (Delayed) | Output Delay | Signal Output (NC) | Feedback Output | Control Voltage | Removable Terminal Blocks | Type of Unit | Catalog Number      |
|----------------|--------------|--------------------|------------------------------|--------------|--------------------|-----------------|-----------------|---------------------------|--------------|---------------------|
| ■              | —            | 4                  | —                            | —            | 1                  | —               | 24 Vac/Vdc      | ■                         | Main         | ESR5-NO-41-24VAC-DC |
| ■              | ■            | 2                  | —                            | —            | 1                  | —               | 24 Vac/Vdc      | ■                         | Main         | ESR5-NO-21-24VAC-DC |
| ■              | ■            | 3                  | —                            | —            | 1                  | —               | 24 Vac/Vdc      | ■                         | Main         | ESR5-NO-31-24VAC-DC |
| ■              | ■            | 3                  | —                            | —            | 1                  | —               | 230 Vac         | ■                         | Main         | ESR5-NO-31-230VAC   |
| ■              | ■            | 3                  | —                            | —            | 1                  | —               | 24–230 Vac/Vdc  | ■                         | Main         | ESR5-NO-31-AC-DC    |
| ■              | ■            | 2                  | 2                            | 0.1–30s      | —                  | —               | 24 Vdc          | ■                         | Main         | ESR5-NV3-30         |
| —              | ■            | 2                  | —                            | —            | 1                  | —               | 24 Vac/Vdc      | ■                         | Main         | ESR5-NZ-21-24VAC-DC |
| ■              | —            | 5                  | —                            | —            | 1                  | 1               | 24 Vac/Vdc      | ■                         | Expansion    | ESR5-NE-51-24VAC-DC |
| ■              | —            | —                  | 4                            | 0.3–3s       | 1                  | 1               | 24 Vdc          | ■                         | Expansion    | ESR5-VE3-42         |

#### Application Overview

| Emergency Stop | Safety Switches | Light Curtain/OSSD ① | Two-Hand Control (EN 574 Type III C) | Contact Expansion | Off-Delayed | Cross Circuit Recognition | Monitored Manual Reset ② | Catalog Number      |
|----------------|-----------------|----------------------|--------------------------------------|-------------------|-------------|---------------------------|--------------------------|---------------------|
| ■              | ■               | —                    | —                                    | —                 | —           | —                         | —                        | ESR5-NO-41-24VAC-DC |
| ■              | ■               | —                    | —                                    | —                 | —           | ■                         | —                        | ESR5-NO-21-24VAC-DC |
| ■              | ■               | —                    | —                                    | —                 | —           | ■                         | —                        | ESR5-NO-31-24VAC-DC |
| ■              | ■               | —                    | —                                    | —                 | —           | ■                         | ■                        | ESR5-NO-31-230VAC   |
| ■              | ■               | —                    | —                                    | —                 | —           | ■                         | ■                        | ESR5-NO-31-AC-DC    |
| ■              | ■               | ■                    | —                                    | —                 | ■           | ■                         | ■                        | ESR5-NV3-30         |
| —              | ■               | —                    | ■                                    | —                 | —           | ■                         | —                        | ESR5-NZ-21-24VAC-DC |
| —              | —               | —                    | —                                    | ■                 | —           | —                         | —                        | ESR5-NE-51-24VAC-DC |
| —              | —               | —                    | —                                    | ■                 | ■           | —                         | —                        | ESR5-VE3-42         |

#### Application Overview, continued

| Single Channel | Dual Channel | Stop Category EN 60204 | Control Category to EN 954-1 | Achievable PL per ISO 13849-1 | Achievable SIL per EN IEC 62061 | Catalog Number      |
|----------------|--------------|------------------------|------------------------------|-------------------------------|---------------------------------|---------------------|
| ■              | —            | 0                      | 2                            | PL d                          | SIL 3                           | ESR5-NO-41-24VAC-DC |
| ■              | ■            | 0                      | 4                            | PL e                          | SIL 3                           | ESR5-NO-21-24VAC-DC |
| ■              | ■            | 0                      | 4                            | PL e                          | SIL 3                           | ESR5-NO-31-24VAC-DC |
| ■              | ■            | 0                      | 4                            | PL e                          | SIL 3                           | ESR5-NO-31-230VAC   |
| ■              | ■            | 0                      | 4                            | PL e                          | SIL 3                           | ESR5-NO-31-AC-DC    |
| ■              | ■            | 0/1                    | 4                            | PL e                          | SIL 3                           | ESR5-NV3-30         |
| —              | ■            | 0                      | 4                            | PL e                          | SIL 3                           | ESR5-NZ-21-24VAC-DC |
| ■              | —            | 0                      | 4                            | PL e                          | SIL 3                           | ESR5-NE-51-24VAC-DC |
| ■              | —            | 1                      | 3                            | PL d                          | SIL 2                           | ESR5-VE3-42         |

#### Notes

① Laser scanners or light curtains with OSSD outputs.

② All main units can also be reset automatically or manually.

## Technical Data and Specifications

### Safety Relay

| Description  | Unit              | ESR5-NO-21_  | ESR5-NO-41_  | ESR5-NO-31-24VAC-DC  | ESR5-NZ-21_  |
|--|-------------------|--|--|--|--|
| <b>General</b>   |                   |  |  |  |  |
| Standards  |                   | EN ISO 13849-1, IEC 62061, IEC 61508, DIN EN 50178, UL/CUL listed                                      | EN ISO 13849-1, IEC 62061, IEC 61508, DIN EN 50178, UL/CUL listed      | EN ISO 13849-1, IEC 62061, IEC 61508, DIN EN 50178, UL/CUL listed                                      | EN ISO 13849-1, IEC 62061, IEC 61508, DIN EN 50178, UL/CUL listed      |
| Type-dependent standards   |                   | —  | —  | —  | EN 574 Part no. IIIC   |
| Lifespan, mechanical—c (contacts)  | x 10 <sup>6</sup> | 10   | 10   | 10   | 10   |
| Maximum operating frequency  | Ops/h             | 3600   | 3600   | 3600   | 3600   |
| Climatic proofing  |                   | Cold according to EN 60068-2-1, dry heat according to EN60068-2-2, damp heat according to EN 60068-2-3 | Dry heat according to EN60068-2-2, damp heat according to EN 60068-2-3 | Cold according to EN 60068-2-1, dry heat according to EN60068-2-2, damp heat according to EN 60068-2-3 | Dry heat according to EN60068-2-2, damp heat according to EN 60068-2-3 |
| Ambient temperature  | °F (°C)           | −4 ° to 131 ° (−20 ° to 55 °)  | −4 ° to 131 ° (−20 ° to 55 °)  | −4 ° to 131 ° (−20 ° to 55 °)  | −4 ° to 131 ° (−20 ° to 55 °)  |
| Ambient temperature storage  | °F (°C)           | −13 ° to 167 ° (−25 ° to 75 °)   | −13 ° to 167 ° (−25 ° to 75 °)   | −13 ° to 167 ° (−25 ° to 75 °)   | −13 ° to 167 ° (−25 ° to 75 °)   |
| Mounting position  |                   | Any  | Any  | Any  | Any  |
| Vibration resistance (IEC/EN 60068-2-6)  |                   | 2g, frequency: 10–150 Hz, amplitude: 0.15 mm   | 2g, frequency: 10–150 Hz, amplitude: 0.15 mm                           | 2g, frequency: 10–150 Hz, amplitude: 0.15 mm   | 2g, frequency: 10–150 Hz, amplitude: 0.15 mm                           |
| Shock resistance (IEC 60068-2-27)  |                   | —  | —  | —  | —  |
| <b>Protection type</b>   |                   |  |  |  |  |
| Housing  |                   | IP20   | IP20   | IP20   | IP20   |
| Terminals  |                   | IP20   | IP20   | IP20   | IP20   |
| Protection against direct contact when actuated from front (IEC 0106 Part 100) |                   | Finger- and back-of-hand proof   | Finger- and back-of-hand proof   | Finger- and back-of-hand proof   | Finger- and back-of-hand proof   |
| Weight   | kg                | 0.17   | 0.22   | 0.17   | 0.22   |
| <b>Terminal capacity</b>   |                   |  |  |  |  |
| Solid or flexible  | mm <sup>2</sup>   | 1 x (0.2–2.5)<br>2 x (0.2–1)   | 1 x (0.2–2.5)<br>2 x (0.2–1)   | 1 x (0.2–2.5)<br>2 x (0.2–1)   | 1 x (0.2–2.5)<br>2 x (0.2–1)   |
| Flexible with ferrule  | mm <sup>2</sup>   | 1 x (0.25–2.5)<br>2 x (0.25–1)   | 1 x (0.25–2.5)<br>2 x (0.25–1)   | 1 x (0.25–2.5)<br>2 x (0.25–1)   | 1 x (0.25–2.5)<br>2 x (0.25–1)   |
| Solid or stranded  | AWG               | 24–12  | 24–12  | 24–12  | 24–12  |
| <b>Terminal screw</b>  |                   |  |  |  |  |
| Pozidriv screwdriver   | Size              | 2  | 2  | 2  | 2  |
| Flat-blade screwdriver   | mm                | 0.6 x 3.5  | 0.6 x 3.5  | 0.6 x 3.5  | 0.6 x 3.5  |
| Max. tightening torque   | Nm                | 0.6  | 0.6  | 0.6  | 0.6  |
| <b>Main Contacts</b>   |                   |  |  |  |  |
| Rated impulse withstand voltage—U <sub>imp</sub>                               | Vac               | 6000   | 4000   | 4000   | 6000   |
| <b>Overvoltage category/pollution degree</b>                                   |                   |  |  |  |  |
| Outside  |                   | III/2  | III/2  | III/2  | III/2  |
| Inside   |                   | —  | —  | —  | —  |
| Rated insulation voltage—U <sub>i</sub>  | Vac               | 250  | 250  | 250  | 250  |
| Rated operating voltage—U <sub>e</sub>   | Vac               | 230  | 230  | 230  | 230  |
| <b>Rated operation current</b>   |                   |  |  |  |  |
| <b>AC-15</b>   |                   |  |  |  |  |
| 230 V (360 ops./h)—I <sub>e</sub>  | A                 | 5  | 4  | 5  | 4  |
| 230 V (3600 ops./h)—I <sub>e</sub>   | A                 | 3  | 3  | 3  | 3  |
| <b>DC-13</b>   |                   |  |  |  |  |
| 24 V (360 ops./h)—I <sub>e</sub>   | A                 | 6  | 4  | 6  | 4  |
| 24 V (3600 ops./h)—I <sub>e</sub>  | A                 | 3  | 2.5  | 3  | 2.5  |
| <b>Max. summation current of all poles</b>                                     |                   |  |  |  |  |
| 24 Vac/Vdc devices   | A                 | 72   | 72   | 72   | 72   |
| 230 Vac devices  | A                 | —  | —  | —  | —  |
| Square of the total current (and total current) of all current paths           |                   | 72 A <sup>2</sup> (6 + 6)  | 72 A <sup>2</sup> (4.2 + 4.2 + 4.2 + 4.2)                              | 72 A <sup>2</sup> (4.9 + 4.9 + 4.9)  | 72 A <sup>2</sup> (6 + 6)  |
| <b>Short-circuit protection</b>  |                   |  |  |  |  |
| Max. fuse  | A gG/gL           | 10   | 6  | 10   | 6  |

## Safety Relay, continued

| Description                                      | Unit  | ESR5-N0-21_                            | ESR5-N0-41_               | ESR5-N0-31-24VAC-DC                    | ESR5-NZ-21_               |
|--|-------|--|---------------------------|--|---------------------------|
| <b>Power Supply Circuit</b>                      |       |  |                           |  |                           |
| Actuating voltage 50/60 Hz                       | Vac   | 24                                     | 24                        | 24                                     | 24                        |
| Actuating voltage— $U_s$                         | Vdc   | 24                                     | 24                        | 24                                     | 24                        |
| Voltage tolerance pick-up voltage                | $x_e$ | 0.85–1.1                               | 0.85–1.1                  | 0.85–1.1                               | 0.85–1.1                  |
| Power consumption                                |       |  |                           |  |                           |
| AC operated 50/60 Hz                             | VA    | —                                      | —                         | —                                      | —                         |
| AC operated 50/60 Hz                             | W     | 3.4                                    | 3.4                       | 3.4                                    | 3                         |
| DC operated                                      | W     | 1.6                                    | 1.6                       | 1.6                                    | 1.5                       |
| Fuse for control circuit supply                  |       |  |                           |  |                           |
| 24 V   |       | Short-circuit proof                    | Short-circuit proof       | Short-circuit proof                    | Short-circuit proof       |
| 115/230 V  |       | —                                      | —                         | —                                      | —                         |
| <b>Control Circuit</b>                           |       |  |                           |  |                           |
| Rated output voltage                             | Vdc   | 24                                     | 24                        | 24                                     | 24                        |
| Rated operational current                        | mA    | S12, S22: 30, S34: 45                  | S12: 65, S34: 40          | S12, S22: 30, S34: 45                  | S11, S21: 60, Y2: 45      |
| Resistance—R                                     |       | 50                                     | 22                        | 50                                     | 22                        |
| Short-circuit current                            | A     | 2.3                                    | 2.3                       | 2.3                                    | 2.3                       |
| Response time                                    | ms    | 100                                    | 65                        | 100                                    | 50                        |
| Recovery time                                    | ms    | —                                      | —                         | —                                      | —                         |
| Response time with reset monitoring— $t_{A1}$    | ms    | —                                      | —                         | —                                      | —                         |
| Response time without reset monitoring— $t_{A2}$ | ms    | 100                                    | 65                        | 100                                    | 50                        |
| Reset time— $t_R/t_{R1}$                         | ms    | Single-channel 45;<br>dual-channel 10  | 45                        | Single-channel 45;<br>dual-channel 10  | 20                        |
| Minimum on duration— $t_M$                       | ms    | —                                      | —                         | —                                      | —                         |
| Recovery time— $t_W$                             | ms    | Approx. 1000                           | Approx. 1000              | Approx. 1000                           | Approx. 1000              |
| Synchronous monitoring time— $t_S$               | ms    | —                                      | —                         | —                                      | 500                       |
| <b>Electromagnetic Compatibility (EMC)</b>       |       |  |                           |  |                           |
| Emitted interference                             |       | EN 61000-6-4                           | EN 61000-6-4              | EN 61000-6-4                           | EN 61000-6-4              |
| Interference immunity                            |       | According to EN 61000-6-2,<br>EN 62061 | According to EN 61000-6-2 | According to EN 61000-6-2,<br>EN 62061 | According to EN 61000-6-2 |



## Safety Relay, continued

| Description  | Unit              | ESR5-NO-31-230VAC  | ESR5-NO-31-24V-230VAC-DC   | ESR5-NV3_  | ESR5-VE3_  | ESR5-NE-51_  |
|--|-------------------|--|--|--|--|--|
| <b>General</b>   |                   |  |  |  |  |  |
| Standards  |                   | EN ISO 13849-1, IEC 62061, IEC 61508, DIN EN 50178, UL/CUL listed      | EN ISO 13849-1, IEC 62061, IEC 61508, DIN EN 50178, UL/CUL listed      | EN ISO 13849-1, IEC 62061, IEC 61508, DIN EN 50178, UL/CUL listed  | EN ISO 13849-1, IEC 62061, IEC 61508, DIN EN 50178, UL/CUL listed      | EN ISO 13849-1, IEC 62061, IEC 61508, DIN EN 50178, UL/CUL listed      |
| Type-dependent standards   |                   | EN 60204 (if applicable)   | EN 60204 (if applicable)   | EN 60204 (if applicable)   | —  | —  |
| Lifespan, mechanical—c (contacts)  | x 10 <sup>6</sup> | 10   | 10   | 10   | 10   | 10   |
| Maximum operating frequency  | Ops/h             | 3600   | 3600   | 3600   | 900  | 3600   |
| Climatic proofing  |                   | Dry heat according to EN60068-2-2, damp heat according to EN 60068-2-3 | Dry heat according to EN60068-2-2, damp heat according to EN 60068-2-3 | Cold in accordance with: EN 60068-2-1, dry heat in accordance with EN 60068-2-2, humidity storage test in accordance with 60068-2-78 | Dry heat according to EN60068-2-2, damp heat according to EN 60068-2-3 | Dry heat according to EN60068-2-2, damp heat according to EN 60068-2-3 |
| Ambient temperature  | °F (°C)           | −4 ° to 131 ° (−20 ° to 55 °)  | −4 ° to 131 ° (−20 ° to 55 °)  | −4 ° to 131 ° (−20 ° to 55 °)  | −4 ° to 131 ° (−20 ° to 55 °)  | −4 ° to 131 ° (−20 ° to 55 °)  |
| Ambient temperature storage  | °F (°C)           | −13 ° to 167 ° (−25 ° to 75 °)   | −13 ° to 167 ° (−25 ° to 75 °)   | −13 ° to 167 ° (−25 ° to 75 °)   | −13 ° to 167 ° (−25 ° to 75 °)   | −13 ° to 167 ° (−25 ° to 75 °)   |
| Mounting position  |                   | Any  | Any  | Any  | Any  | Any  |
| Vibration resistance (IEC/EN 60068-2-6)  |                   | 2g, frequency: 10–150 Hz, amplitude: 0.15 mm                           | 2g, frequency: 10–150 Hz, amplitude: 0.15 mm                           | 2g, frequency: 10–150 Hz, amplitude: 0.15 mm   | 2g, frequency: 10–150 Hz, amplitude: 0.15 mm                           | 2g, frequency: 10–150 Hz, amplitude: 0.15 mm                           |
| Shock resistance (IEC 60068-2-27)  |                   | —  | —  | —  | —  | —  |
| <b>Protection type</b>   |                   |  |  |  |  |  |
| Housing  |                   | IP40   | IP40   | IP20   | IP20   | IP20   |
| Terminals  |                   | IP20   | IP20   | IP20   | IP20   | IP20   |
| Protection against direct contact when actuated from front (IEC 0106 Part 100) |                   | Finger- and back-of-hand proof   | Finger- and back-of-hand proof   | Finger- and back-of-hand proof   | Finger- and back-of-hand proof   | Finger- and back-of-hand proof   |
| Weight   | kg                | 0.3  | 0.3  | 0.17   | 0.17   | 0.22   |
| <b>Terminal capacity</b>   |                   |  |  |  |  |  |
| Solid or flexible  | mm <sup>2</sup>   | 1 x (0.2–2.5)<br>2 x (0.2–1)   | 1 x (0.2–2.5)<br>2 x (0.2–1)   | 1 x (0.2–2.5)<br>2 x (0.2–1)   | 1 x (0.2–2.5)<br>2 x (0.2–1)   | 1 x (0.2–2.5)<br>2 x (0.2–1)   |
| Flexible with ferrule  | mm <sup>2</sup>   | 1 x (0.25–2.5)<br>2 x (0.25–1)   | 1 x (0.25–2.5)<br>2 x (0.25–1)   | 1 x (0.25–2.5)<br>2 x (0.25–1)   | 1 x (0.25–2.5)<br>2 x (0.25–1)   | 1 x (0.25–2.5)<br>2 x (0.25–1)   |
| Solid or stranded  | AWG               | 24–12  | 24–12  | 24–12  | 24–12  | 24–12  |
| <b>Terminal screw</b>  |                   |  |  |  |  |  |
| Pozidriv screwdriver   | Size              | 2  | 2  | 2  | 2  | 2  |
| Flat-blade screwdriver   | mm                | 0.6 x 3.5  | 0.6 x 3.5  | 0.6 x 3.5  | 0.6 x 3.5  | 0.6 x 3.5  |
| Max. tightening torque   | Nm                | 0.6  | 0.6  | 0.6  | 0.6  | 0.6  |
| <b>Main Contacts</b>   |                   |  |  |  |  |  |
| Rated impulse withstand voltage—U <sub>imp</sub>                               | Vac               | 6000   | 6000   | 4000   | 4000   | 4000   |
| <b>Overvoltage category/pollution degree</b>                                   |                   |  |  |  |  |  |
| Outside  |                   | III/2  | III/2  | III/2  | III/2  | III/2  |
| Inside   |                   | —  | —  | —  | —  | —  |
| Rated insulation voltage—U <sub>i</sub>  | Vac               | 250  | 250  | 250  | 250  | 250  |
| Rated operating voltage—U <sub>e</sub>   | Vac               | 230  | 230  | 230  | 230  | 230  |
| <b>Rated operation current</b>   |                   |  |  |  |  |  |
| <b>AC-15</b>   |                   |  |  |  |  |  |
| 230 V (360 ops./h)—I <sub>e</sub>  | A                 | 4  | 4  | —  | 5  | 4  |
| 230 V (3600 ops./h)—I <sub>e</sub>   | A                 | 3  | 3  | 3  | 3  | 3  |
| <b>DC-13</b>   |                   |  |  |  |  |  |
| 24 V (360 ops./h)—I <sub>e</sub>   | A                 | 4  | 4  | —  | 6  | 4  |
| 24 V (3600 ops./h)—I <sub>e</sub>  | A                 | 2.5  | 2.5  | 3  | 3  | 2.5  |
| <b>Max. summation current of all poles</b>                                     |                   |  |  |  |  |  |
| 24 Vac/Vdc devices   | A                 | 50   | 50   | 49   | 50   | 50   |
| 230 Vac devices  | A                 | 50   | 50   | —  | —  | —  |
| Square of the total current (and total current) of all current paths           |                   | 50 A <sup>2</sup> (4 + 4 + 4)  | 50 A <sup>2</sup> (4 + 4 + 4)  | 50 A <sup>2</sup> (4 + 4 + 4)  | 49 A <sup>2</sup> (3.5 + 3.5 + 3.5 + 3.5)                              | 50 A <sup>2</sup> (3.7 + 3.7 + 3.7 + 3.7)                              |
| <b>Short-circuit protection</b>  |                   |  |  |  |  |  |
| Max. fuse  | A gG/gL           | 6  | 6  | 10   | 10   | 6  |

# 3.10

## Control Relays and Timers

### Safety Relays

3

#### Safety Relay, continued

| Description                                      | Unit  | ESR5-NO-31-230VAC               | ESR5-NO-31-24V-230 VAC-DC       | ESR5-NV3_  | ESR5-VE3_                 | ESR5-NE-51_               |
|--|-------|---------------------------------|---------------------------------|--|---------------------------|---------------------------|
| <b>Power Supply Circuit</b>                      |       |                                 |                                 |  |                           |                           |
| Actuating voltage 50/60 Hz                       | Vac   | 230                             | 24–230                          | —  | —                         | 24                        |
| Actuating voltage— $U_s$                         | Vdc   | —                               | 230                             | 24   | 24                        | 24                        |
| Voltage tolerance pick-up voltage                | $x_e$ | 0.85–1.1                        | 0.85–1.1                        | 0.85–1.1   | 0.85–1.1                  | 0.8–1.1                   |
| Power consumption                                |       |                                 |                                 |  |                           |                           |
| AC operated 50/60 Hz                             | VA    | —                               | —                               | —  | —                         | —                         |
| AC operated 50/60 Hz                             | W     | 5.8                             | 5.8                             | —  | —                         | 2.2                       |
| DC operated                                      | W     | 2.9                             | 2.9                             | 1.8  | 2                         | 2.2                       |
| Fuse for control circuit supply                  |       |                                 |                                 |  |                           |                           |
| 24 V   |       | —                               | Short-circuit proof             | —  | —                         | —                         |
| 115/230 V  |       | Short-circuit proof             | Short-circuit proof             | —  | —                         | —                         |
| <b>Control Circuit</b>                           |       |                                 |                                 |  |                           |                           |
| Rated output voltage                             | Vdc   | 24                              | 24                              | 24   | 24                        | 24                        |
| Rated operational current                        | mA    | S10, S12, S22: 35, S34, S35: 45 | S10, S12, S22: 35, S34, S35: 45 | S12, S22: 3.5, S34, S35: 7                                     | A1, A2: 84, K1/K2: 5      | A1, A2: 92                |
| Resistance—R                                     |       | 11                              | 11                              | 500  | —                         | —                         |
| Short-circuit current                            | A     | 0.7                             | 0.7                             | 0.1  | —                         | —                         |
| Response time                                    | ms    | 250                             | 250                             | 150  | 20                        | 20                        |
| Recovery time                                    | ms    | —                               | —                               | —  | —                         | —                         |
| Response time with reset monitoring— $t_{A1}$    | ms    | 60                              | 60                              | 150  | 20                        | 20                        |
| Response time without reset monitoring— $t_{A2}$ | ms    | 250                             | 250                             | 150  | 20                        | 20                        |
| Reset time— $t_R/t_{R1}$                         | ms    | 20                              | 20                              | 20 (non-delayed enable paths); 100 (min. delayed enable paths) | 0.3–3 s (+50%) adjustable | 20                        |
| Minimum on duration— $t_M$                       | ms    | —                               | —                               | —  | —                         | —                         |
| Recovery time— $t_W$                             | ms    | Approx. 1000                    | Approx. 1000                    | Approx. 330  | Approx. 1000              | —                         |
| Synchronous monitoring time— $t_S$               | ms    | —                               | —                               | —  | —                         | —                         |
| <b>Electromagnetic Compatibility (EMC)</b>       |       |                                 |                                 |  |                           |                           |
| Emitted interference                             |       | EN 61000-6-4                    | EN 61000-6-4                    | EN 61000-6-4   | EN 61000-6-4              | EN 61000-6-4              |
| Interference immunity                            |       | According to EN 61000-6-2       | According to EN 61000-6-2       | According to EN 61000-6-2, EN 62061                            | According to EN 61000-6-2 | According to EN 61000-6-2 |

### Dimensions

Approximate Dimensions in Inches (mm)

#### Safety Relays, Contact Expansion Modules

##### ESR5\_ 24 Vac/Vdc

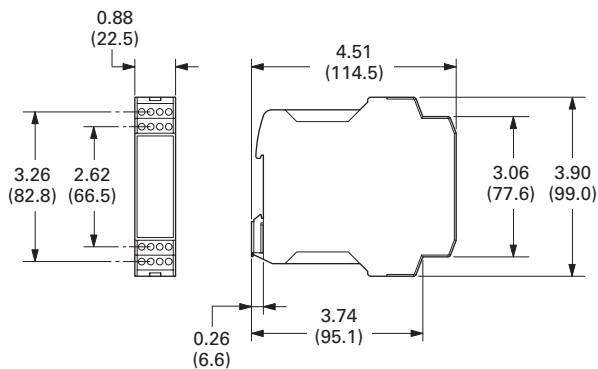

##### ESR5\_ 230 Vac

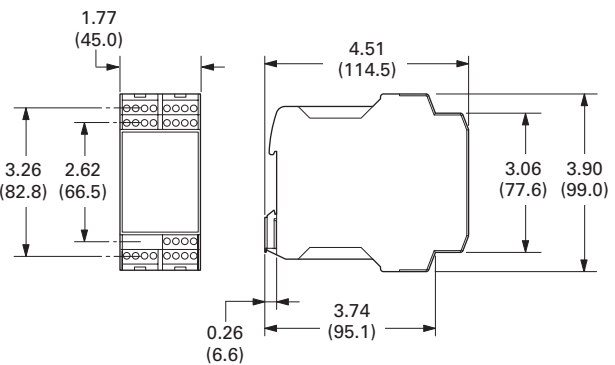

easySafety



## Product Description

The easySafety control relay for safety-related applications monitors all commonly used safety devices and also takes over the required control tasks for the machine. Packed with a host of conventional safety relays in the form of safety function blocks, easySafety not only features integrated safety functions but also standard functions in a single device—all in one.

In addition to the safety circuit diagram containing the safety configuration, the safety control relay also contains a standard circuit diagram. This circuit diagram can be used for standard tasks, such as the processing of diagnostics signals or general control tasks of a machine.

## Application Description

Because of the large number of safety function blocks, the user can tackle a large number of application options with only one device. The user can also respond directly to future and changing application requirements. This saves financial resources and offers future investment security. Last but not least, it reduces the stock-keeping required for special safety relays. The easySafety meets the requirements of Category 4 to EN 954-1, PL e to EN ISO 13849-1, SILCL 3 to EN IEC 62061 and SIL 3 to EN IEC 61508. With easySafety, it is possible to implement applications meeting the most stringent safety requirements.

## Contents

### Description

| Description                       | Page      |
|-----------------------------------|-----------|
| easySafety                        |           |
| Product Selection                 | V7-T3-200 |
| Accessories                       | V7-T3-200 |
| Technical Data and Specifications | V7-T3-201 |
| Dimensions                        | V7-T3-204 |

3

## Features

Safety function blocks:

- Emergency stop
- Guard door monitoring with and without interlock/guard locking
- Two-hand control (EN 574)
- Electro-sensitive protective devices (light curtains)
- Light curtain muting
- Enable switch
- Start device
- Operating mode selector
- Safety timing relay
- Overspeed monitoring
- Feedback loop monitoring (EDM)
- Zero speed monitoring

- All-in-one: Safety and control functions combined in one device
- Simple configuration through prefabricated and tested safety components
- Direct state display and increased machine availability due to fast error diagnosis through integrated display
- Multistep password concept prevents unwanted manipulation

## Standards and Certifications

- Product standards: CE marked; UL 508; CSA C22.20.4-04; CSA 22.2 No. 142-M11987
- UL CCN: NRAQ
- CSA File No. 012528
- CSA Class No. 2252-81 and 2252-01
- TÜV Rhineland certified
- Degree of Protection IEC: IP20



### Product Selection

easySafety

#### easySafety Relays ①



| Inputs (Safety)<br>Digital | Outputs (Safety)<br>6 A Relay | Outputs (Safety)<br>Transistor | Outputs (Safety)<br>Test Signal | Display +<br>Keypad | Catalog Number |
|----------------------------|-------------------------------|--------------------------------|---------------------------------|---------------------|----------------|
| 14                         | 1 (redundant)                 | 4                              | 4                               | —                   | ES4P-221-DMXX1 |
| 14                         | 1 (redundant)                 | 4                              | 4                               | Yes                 | ES4P-221-DMXD1 |
| 14                         | 4                             | —                              | 4                               | —                   | ES4P-221-DRXX1 |
| 14                         | 4                             | —                              | 4                               | Yes                 | ES4P-221-DRXD1 |

### Accessories

easySoft



#### Programming Software

| Description                                  | Catalog Number |
|--|----------------|
| easySoft-Safety<br>(including easySoftPro) ② | ESP-SOFT       |

Memory Card



#### Memory Card

| Description   | Catalog Number |
|---------------|----------------|
| 256 kB module | ES4A-MEM-CARD1 |

#### Programming Cables

| Description                  | Catalog Number |
|------------------------------|----------------|
| SUB-D, nine-pole, serial, 2m | EASY800-PC-CAB |

SUB-D Cable



| Description | Catalog Number  |
|-------------|-----------------|
| USB, 2m     | EASY800-USB-CAB |

USB Cable



Input/Output Simulator

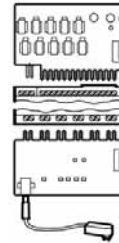

#### Input/Output Simulator

| Description  | Catalog Number   |
|--|------------------|
| With plug-in power supply unit<br>100–240 Vac/24 Vdc | ES4A-221-DMX-SIM |

#### Notes

- ① EN 954-1: 1996, Category 4.  
EN ISO 13849-1: 2006, PL e (Performance Level).  
IEC 61508: 1998, SIL 3 (Safety Integrity Level).  
IEC 62061: 2005, SILCL 3 (Safety Integrity Level Claim Limit).  
Expandable: standard inputs/outputs and standard bus systems.  
24 Vdc supply voltage.
- ② Operating systems:  
Windows® 2000 SP4, Windows XP SP1, Windows Vista (32 bit).

## Technical Data and Specifications

### easySafety Relay

| Description   | Unit            | ES4P_   |    |
|---|-----------------|---|----|
| <b>General</b>  |                 |   |    |
| Standards   |                 | EN 55011, EN 55022, IEC/EN 61000-4, IEC 60068-2-6, IEC 60068-2-27, EN 954-1: Category 4, EN ISO 13849-1: PL e, EN IEC 62061: SILCL 3, EN IEC 61508: SIL 3 |    |
| Dimensions (W x H x D)  | mm              | 107.5 (6 space units) x 90 x 72   |    |
| Mounting  |                 | Top-hat rail IEC/EN 60715, 35 mm or screw fixing using fixing brackets ZB4-101-GF1 (accessories)  |    |
| <b>Times</b>  |                 |   |    |
| Inputs  |                 |   |    |
| Maximum duration of external test pulse                                   | ms              | 1   |    |
| Semi-conductor output   |                 |   |    |
| Off test pulse  | ms              | <1  |    |
| Switch-off delay  | ms              | <0.15   |    |
| <b>Terminal Capacity</b>  |                 |   |    |
| Solid   | mm <sup>2</sup> | 0.2–4 (AWG 22–12)   |    |
| Flexible with ferrule   | mm <sup>2</sup> | 0.2–2.5 (AWG 22–12)   |    |
| Standard screwdriver  | mm              | 3.5 x 0.8   |    |
| Maximum tightening torque   | Nm              | 0.6   |    |
| <b>Ambient Climatic Conditions</b>  |                 |   |    |
| Operating ambient temperature   | °C              | –25 to +55, low temperatures to IEC 60068-2-1, high temperatures to IEC 60068-2-2   |    |
| Condensation  |                 | Prevent condensation by means of suitable measures  |    |
| LCD display (clearly legible)   | °C              | 0 to +55  |    |
| Storage   | °C              | –40 to +70  |    |
| Relative humidity, noncondensing (IEC/EN 60068-2-30)                      | %               | 5 to 95   |    |
| Air pressure (in operation)   | hPa             | 795 to 1080   |    |
| <b>Ambient Mechanical Conditions</b>                                      |                 |   |    |
| Protection type, IEC/EN 60529   |                 | IP20  |    |
| Vibrations (IEC/EN 60068-2-6)   |                 |   |    |
| Constant amplitude 0.15 mm  | Hz              | 10 to 57  |    |
| Constant acceleration, 2g   | Hz              | 57 to 150   |    |
| Mechanical shock resistance (IEC/EN 60068-2-27) semi-sinusoidal 15g/11 ms | Shocks          | 18  |    |
| Drop to IEC/EN 60068-2-31   | Drop            | mm  | 50 |
| Mounting position   |                 | Horizontal/vertical   |    |
| <b>Electromagnetic Compatibility (EMC) According to IEC/EN 61000-6-2</b>  |                 |   |    |
| Electrostatic discharge (IEC/EN 61000-4-2, Level 3, ESD)                  |                 |   |    |
| Air discharge   | kV              | 8   |    |
| Contact discharge   | kV              | 6   |    |
| Radio interference suppression (EN 55011)                                 |                 | EN 55011 Class B, EN 55022 Class B  |    |
| Power pulses (surge) (IEC/EN 61000-4-5, Level 2)                          | kV              | 1 (supply cables, symmetrical)  |    |
| <b>Insulation Resistance</b>  |                 |   |    |
| Overvoltage category/pollution degree                                     |                 | III/2   |    |
| Clearance in air and creepage distances                                   |                 | EN 50178, UL 508, CSA C22.2, No. 142, EN 60664-1:2003   |    |
| Insulation resistance   |                 | EN 50178  |    |
| <b>Backup/Accuracy of the Real-Time Clock</b>                             |                 |   |    |
| Accuracy of the real-time clock   | s/day           | Normally ±5 (±0.5 h/year)   |    |
| <b>Repetition Accuracy of Timing Relays in Standard Circuit</b>           |                 |   |    |
| Accuracy of timing relay (of value)                                       | %               | ±0.02   |    |
| Resolution  |                 |   |    |
| Range "S"   | ms              | 5   |    |
| Range "M:S"   | s               | 1   |    |
| <b>Retentive Memory</b>   |                 |   |    |
| Write cycles of the retentive memory (minimum)                            |                 | 10,000,000,000 (1010) (read/write cycles)   |    |

## easySafety Relay, continued

| Description   | Unit   | ES4P_ |   |
|---|--------|-------|---|
| <b>Power Supply</b>                                       |        |       |   |
| Rated operational voltage                                 | $U_e$  | V     | 24 Vdc (–15/+20%)   |
| Permissible range   |        | Vdc   | 20.4 to 28.8  |
| Ripple  |        | %     | ≤ 5   |
| <b>Interfaces</b>   |        |       |   |
| EASyNet (CAN-based)                                       |        |       |   |
| Bus termination (first and last station)                  |        |       | Yes   |
| Control operating mode EASyNet                            |        |       |   |
| Number of users   |        |       | Maximum 8   |
| <b>NET Network</b>  |        |       |   |
| Stations  | Number |       | Maximum 8   |
| Data transfer rate/distance                               |        |       | 1000 Kbit/s, 6m<br>500 Kbit/s, 25m<br>250 Kbit/s, 60m<br>125 Kbit/s, 125m<br>50 Kbit/s, 300m<br>20 Kbit/s, 700m<br>10 Kbit/s, 1000m<br>Bus lengths greater than 40m can only be achieved with enhanced cross-section conductors and terminal adapters |
| Potential isolation                                       |        |       |   |
| From power supply   |        |       | Yes   |
| From the inputs   |        |       | Yes   |
| From the outputs  |        |       | Yes   |
| From the PC interface, memory card, NET network, EASYLink |        |       | Yes   |
| Bus termination (first and last station)                  |        |       | Yes   |
| Terminal type   |        |       | RJ45  |
| <b>Digital Inputs 24 Vdc</b>                              |        |       |   |
| Number  |        |       | 14  |
| Inputs can be used as analog inputs                       |        |       | —   |
| Status display  |        |       | LCD display (if provided)   |
| Potential isolation                                       |        |       |   |
| From power supply   |        |       | No  |
| Between digital inputs                                    |        |       | No  |
| From the outputs  |        |       | Yes   |
| From PC interface, memory card, EASYLink                  |        |       | No  |
| From network EASyNet                                      |        |       | Yes   |
| Rated operational voltage                                 | $U_e$  | Vdc   | 24  |
| At signal "0"   | $U_e$  | Vdc   | <5  |
| At signal "1"   | $U_e$  | Vdc   | >15   |
| <b>Clock Outputs</b>                                      |        |       |   |
| Number  |        |       | 4   |
| Voltage   |        | Vdc   | 24  |
| Electrical isolation                                      |        |       | No  |

## easySafety Relay, continued

| Description   | Unit          | ES4P_  |
|---|---------------|--|
| <b>Relay Outputs</b>  |               |  |
| Number  |               | 4 for ES4P-...-DR_, 1 redundant for ES4P-...-DM_   |
| Outputs in groups of  |               | 1  |
| Parallel switching of outputs to increase power   |               | Not permissible  |
| Protection of an output relay   |               | Fuse: 6 A gG, circuit breaker with characteristic C: 24 Vdc 4 A, Short-circuit current <250 A  |
| Potential isolation   |               |  |
| From power supply   |               | Yes  |
| From the inputs   |               | Yes  |
| From PC interface, memory card, EASYNet, EASYLink   |               | Yes  |
| Safe isolation according to EN 50178  | Vac           | 300  |
| Basic insulation  | Vac           | 600  |
| Lifespan, mechanical  | Operations    | $\times 10^6$ 10   |
| <b>Contacts</b>   |               |  |
| Conventional thermal current  | A             | 6  |
| Rated impulse withstand voltage $U_{imp}$ contact coil  | kV            | 6  |
| Rated operational voltage   | $U_e$         | Vac 250  |
| Rated insulation voltage  | $U_i$         | Vac 250  |
| Safe isolation to EN 50178 between coil and contact   | Vac           | 300  |
| <b>Making capacity</b>  |               |  |
| AC-15, 230 Vac, 3 A   | Operations    | 80,000   |
| DC-13, 24 Vdc, 5 A, 0.1 Hz  | Operations    | 40,000   |
| <b>Switching frequency</b>  |               |  |
| Mechanical operations   | $\times 10^6$ | 10   |
| Switching frequency   | Hz            | 10   |
| <b>UL/CSA</b>   |               |  |
| UL 508  |               | B300/R300  |
| <b>Transistor Outputs</b>   |               |  |
| Number  |               | 4  |
| Rated operational voltage   | $U_e$         | Vdc 24   |
| Permissible range   | $U_e$         | Vdc 20.4–28.8  |
| Ripple  | %             | $\leq 5$   |
| Protection against polarity reversal  |               | Yes (Caution: A short-circuit will result if 0 V or GND is applied to the outputs in the event that the supply voltage is connected to the wrong poles.) |
| Potential isolation   |               |  |
| From power supply   |               | Yes  |
| From the inputs   |               | Yes  |
| From PC interface, memory card, network, EASYNet, EASYLink  |               | Yes  |
| Rated operational current at signal "1" DC  | $I_e$         | A Maximum 0.5  |
| At signal "1" with $I_e = 0.5$ A  |               | V $U = U_e - 1$ V  |
| Short-circuit protection  |               | Yes, thermal   |
| Short-circuit tripping current for $R_A \leq 10$ m ohms   | A             | $0.7 \leq I_e \leq 2$ per output   |
| Total short-circuit current   | A             | 8  |
| Peak short-circuit current  | A             | 16   |
| Thermal cutout  |               | Yes  |
| Maximum operating frequency at constant resistive load $R_L < 100$ k $\Omega$ (dependant on program and load) | Ops/h         | 40,000   |
| Parallel connection of outputs  |               | No   |
| Status indication of the outputs  |               | LCD display (if provided)  |
| <b>Inductive load</b>   |               |  |
| Without external suppressor circuit   |               |  |
| Duty factor   |               | $T_{0.95} = 3 \times T_{0.65} = 3 \times L/R$ $T_{0.95}$ = Time in ms, until 95% of the steady-state current has been reached                            |
| <b>With external suppressor circuit</b>   |               |  |
| Utilization factor  | g             | 1  |
| Duty factor   | % DF          | 100  |
| Maximum switching frequency, maximum duty factor  | Operations    | Depending on the suppressor circuit  |

# 3.11

## Control Relays and Timers

easySafety

### Dimensions

Approximate Dimensions in Inches (mm)

ESR5\_

3

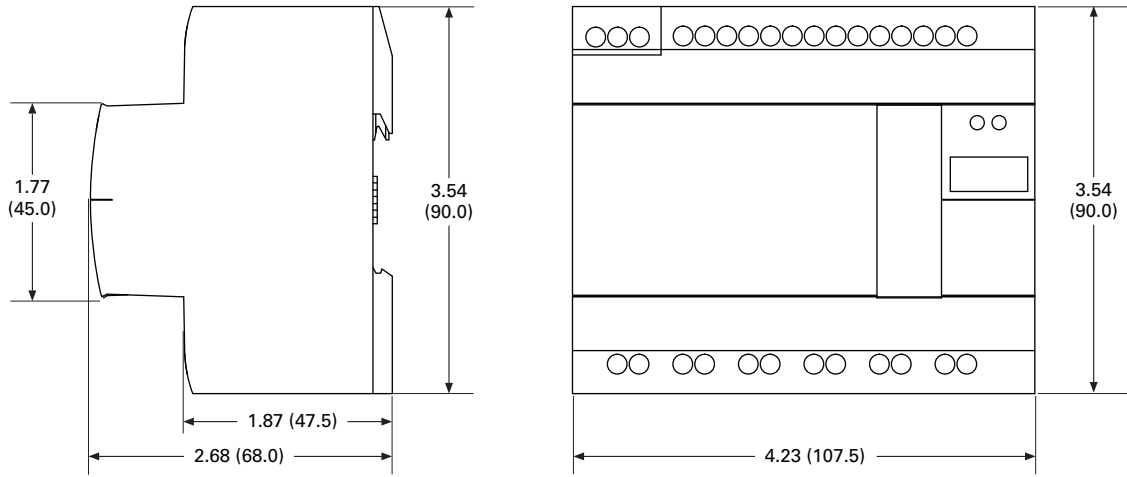



ELC Series PLCs



XC Series PLCs



XC152 Series PLCs



XV Series HMI-PLC



XI/ON Series Distributed I/O



|  |           |
|--|-----------|
| <b>4.1 ELC Series Programmable Logic Controllers</b>   |           |
| Product Overview .....                                 | V7-T4-2   |
| Product Selection Guide .....                          | V7-T4-3   |
| Product Selection .....                                | V7-T4-4   |
| Accessories .....                                      | V7-T4-17  |
| Technical Data and Specifications .....                | V7-T4-19  |
| Circuit Diagrams .....                                 | V7-T4-24  |
| Dimensions .....                                       | V7-T4-25  |
| <b>4.2 XC Series Programmable Logic Controllers</b>    |           |
| Product Overview .....                                 | V7-T4-29  |
| Product Selection Guide .....                          | V7-T4-30  |
| Catalog Number Selection .....                         | V7-T4-31  |
| System Overview .....                                  | V7-T4-31  |
| Product Selection .....                                | V7-T4-33  |
| Accessories .....                                      | V7-T4-36  |
| Technical Data and Specifications .....                | V7-T4-39  |
| Dimensions .....                                       | V7-T4-55  |
| <b>4.3 XC152 Series Programmable Logic Controllers</b> |           |
| Product Description .....                              | V7-T4-57  |
| Catalog Number Selection .....                         | V7-T4-58  |
| Product Selection .....                                | V7-T4-58  |
| Accessories .....                                      | V7-T4-58  |
| Technical Data and Specifications .....                | V7-T4-59  |
| Dimensions .....                                       | V7-T4-60  |
| <b>4.4 XV Series HMI-PLCs</b>                          |           |
| Product Description .....                              | V7-T4-61  |
| Catalog Number Selection .....                         | V7-T4-61  |
| Product Selection .....                                | V7-T4-62  |
| Accessories .....                                      | V7-T4-62  |
| <b>4.5 XI/ON Series Remote I/O</b>                     |           |
| Product Overview .....                                 | V7-T4-63  |
| Product Selection Guide .....                          | V7-T4-64  |
| Catalog Number Selection .....                         | V7-T4-65  |
| System Overview .....                                  | V7-T4-67  |
| Product Selection .....                                | V7-T4-71  |
| Accessories .....                                      | V7-T4-80  |
| Technical Data and Specifications .....                | V7-T4-81  |
| Connection Diagrams .....                              | V7-T4-94  |
| Dimensions .....                                       | V7-T4-106 |

**Note:** For EASY Programmable Relays, see Tab 3 in this volume.

#### ELC Series Programmable Logic Controllers



### Contents

| <i>Description</i>                          | <i>Page</i>     |
|---|-----------------|
| ELC Series Programmable Logic Controllers   |                 |
| Product Selection Guide . . . . .           | <b>V7-T4-3</b>  |
| Product Selection                           |                 |
| ELCM Modular Brick PLCs . . . . .           | <b>V7-T4-4</b>  |
| ELC/ELC2 Modular PLCs . . . . .             | <b>V7-T4-6</b>  |
| ELC System Overview . . . . .               | <b>V7-T4-8</b>  |
| ELC Communication Modules . . . . .         | <b>V7-T4-12</b> |
| ELC Remote I/O Adapters . . . . .           | <b>V7-T4-13</b> |
| ELC Expansion Modules . . . . .             | <b>V7-T4-14</b> |
| Programming Software . . . . .              | <b>V7-T4-16</b> |
| Accessories . . . . .                       | <b>V7-T4-17</b> |
| Technical Data and Specifications . . . . . | <b>V7-T4-19</b> |
| Circuit Diagrams . . . . .                  | <b>V7-T4-24</b> |
| Dimensions . . . . .                        | <b>V7-T4-25</b> |

### Product Overview

#### Controllers

##### **ELC2 Modular Controllers**

The ELC lineup is focused on compact size, powerful features, and affordability. Whether your needs involve discrete standalone control, necessitate distributed control networks, or even a control system using centralized control with distributed I/O, ELCs provide the solution your application demands.

While the ELCs are perfectly suited for small applications of <40 I/O with a diverse mix of I/O, they can also expand to hundreds of I/O points when needed. These controllers are modular, with a wide range of digital, analog, thermocouple, RTD, and even motion expansion modules. Despite a world-class small footprint—with controllers as small as 1.00-inch wide, these controllers perform like much larger PLCs.

With online editing, high-speed processing (basic instructions as fast as 0.24 microseconds), multiple high-speed inputs/outputs (up to 200 kHz), and multiple independent master communication channels, these controllers excel where only the largest PLCs could go only a few years ago.

##### **ELCM Modular Brick-Style Controllers**

The next member of the ELC portfolio of controllers is the ELCM. This midrange family comprises “brick-style” controllers, with expansion I/O modules. These all-in-one controllers combine inputs, outputs, logic processing, and an integrated AC power supply into a compact package—but also provide the means to expand as applications change or grow. The controller also provides 24 Vdc power for sensors, eliminating the space, wiring, and expense of an additional power supply. And with three communication ports, the ELCM is able to interface into a local operator interface, connect to other controllers or supervisory computers, and still maintain an open port for programming.

##### **Electrical/EMC**

- ESD Immunity
  - 8 kV air discharge
- EFT Immunity
  - Power Line: 2 kV
  - Digital I/O: 1 kV
  - Analog and Communication I/O: 250V
- Damped-Oscillatory Wave
  - Power Line: 1 kV
  - Digital I/O: 1 kV
- RS Immunity
  - 26 MHz–1 GHz, 10 V/m

##### **Standards and Certifications**

- cULus
- CE
- C-Tick
- RoHS



**Product Selection Guide**

**ELC Series Programmable Logic Controllers**



**Model ELCM Modular Brick PLCs**

**ELC/ELC2 Modular PLCs**

**Page V7-T4-4**

**Page V7-T4-6**

**Product Description**

- Expandable brick PLCs
- Digital and analog I/O
  - 16, 20, 24, 32 or 40 I/O base controllers
  - 8 and 16 digital I/O expansion modules
  - 24 Vdc inputs
  - Relay or transistor outputs
  - Built-in 110 Vac power supply
  - On board 400 mA 24 Vdc sensor power
  - RS-232 programming port
  - Two RS-485 Modbus serial ports
  - DIN rail or panel mount

- Modular and expandable PLCs with distributed I/O capability
- Digital, analog, thermocouple and RTD/I/O
  - 10, 12, 14 and 28 I/O base controllers
  - 6, 8 or 16 digital I/O expansion modules
  - 2, 4 and 6 analog I/O expansion modules
  - 24 Vdc and 110 Vac inputs
  - Relay or transistor outputs
  - High current relay output module
  - High speed pulse capture and high speed pulse output up to 200 kHz
  - Up to 2 RS-485 Modbus serial ports
  - DIN rail mounting only
  - Distributed I/O adapters for EtherNet/IP, Modbus TCP, DeviceNet, PROFIBUS-DP and RS-485

**Features**

|                                     | Model ELCM Modular Brick PLCs | ELC/ELC2 Modular PLCs     |
|-------------------------------------|-------------------------------|---------------------------|
| Input voltage                       | 120 Vac                       | 24 Vdc                    |
| Maximum local I/O points            | 40                            | 264                       |
| Built-in power supply               | Yes                           | No                        |
| Built-in 24 Vdc sensor power supply | Yes                           | No                        |
| DC inputs                           | Yes                           | Yes                       |
| AC inputs                           | No                            | Yes                       |
| Transistor outputs                  | Yes                           | Yes                       |
| Relay outputs                       | Yes                           | Yes                       |
| High current relay outputs          | No                            | Yes                       |
| Clock/calendar                      | No                            | Yes                       |
| Expandable                          | Yes                           | Yes                       |
| Removable terminal blocks           | Yes                           | Yes                       |
| RS-232 communication ports          | 1                             | 1                         |
| RS-485 communication ports          | 2                             | 1 or 2 depending on model |
| High-speed counters                 | Yes                           | Yes                       |
| Analog I/O                          | Yes                           | Yes                       |
| Thermocouple module                 | No                            | Yes                       |
| Platinum RTD module                 | No                            | Yes                       |
| Single axis motion control module   | No                            | Yes                       |
| DeviceNet master                    | No                            | Yes                       |
| Ethernet (Modbus TCP) master        | No                            | Yes                       |
| Distributed I/O adapters            | No                            | Yes                       |

### Product Selection

#### ELCM Modular Brick PLCs

##### Features

- Midrange brick style controller with digital, analog, thermocouple and RTD expansion capability
- Expansion modules can optionally be used to increase the total number of I/O, to provide a mix of different types of I/O, or both
- These controllers include an embedded AC power supply and provide up to 400 mA of DC sensor power
- Each controller supports two RS-485 Modbus serial (master/node) and one RS-232 programming port

#### Controllers

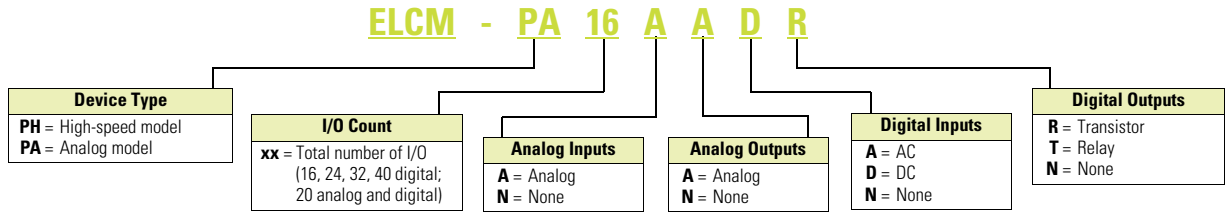

#### ELCM-PH16NNDR

#### Controllers



| Description     | Inputs |    |        | Outputs |                        |        | Catalog Number |
|-----------------|--------|----|--------|---------|------------------------|--------|----------------|
|                 | AC     | DC | Analog | Relay   | NPN Sinking Transistor | Analog |                |
| 16 I/O PH model | —      | 8  | —      | 8       | —                      | —      | ELCM-PH16NNDR  |
|                 | —      | 8  | —      | —       | 8                      | —      | ELCM-PH16NNDT  |
| 24 I/O PH model | —      | 16 | —      | 8       | —                      | —      | ELCM-PH24NNDR  |
|                 | —      | 16 | —      | —       | 8                      | —      | ELCM-PH24NNDT  |
| 32 I/O PH model | —      | 16 | —      | 16      | —                      | —      | ELCM-PH32NNDR  |
|                 | —      | 16 | —      | —       | 16                     | —      | ELCM-PH32NNDT  |
| 40 I/O PH model | —      | 24 | —      | 16      | —                      | —      | ELCM-PH40NNDR  |
|                 | —      | 24 | —      | —       | 16                     | —      | ELCM-PH40NNDT  |
| 20 I/O PH model | —      | 8  | 4      | 6       | —                      | 2      | ELCM-PA20AADR  |
|                 | —      | 8  | 4      | —       | 6                      | 2      | ELCM-PA20AADT  |

Expanded and Specialty Modules

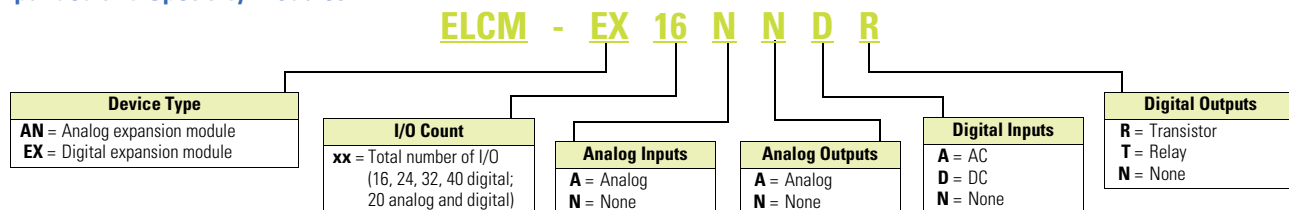

Right Side Digital Expansion Modules

| Description                     | Inputs |                | Outputs |                        | Catalog Number |
|---------------------------------|--------|----------------|---------|------------------------|----------------|
|                                 | AC     | DC Sink/Source | Relay   | NPN Sinking Transistor |                |
| 8 DC input module               | —      | 8              | —       | —                      | ELCM-EX08NNDN  |
| 16 DC input module              | —      | 16             | —       | —                      | ELCM-EX16NNDN  |
| 8 Relay output module           | —      | —              | 8       | —                      | ELCM-EX08NNNR  |
| 16 Relay output module          | —      | —              | 16      | —                      | ELCM-EX16NNNR  |
| 8 Transistor output module      | —      | —              | 8       | —                      | ELCM-EX08NNNT  |
| 16 Transistor output module     | —      | —              | 16      | —                      | ELCM-EX16NNNT  |
| 8 DC input/relay output module  | —      | 4              | 4       | —                      | ELCM-EX08NNDR  |
| 16 DC input/relay output module | —      | 8              | 8       | —                      | ELCM-EX16NNDR  |
| 8 DC input/output module        | —      | 4              | —       | 4                      | ELCM-EX08NNDT  |
| 16 DC input/output module       | —      | 8              | —       | 8                      | ELCM-EX16NNDT  |

**ELC2 Modular PLCs****Features**

- **PB Base Model**—
  - 14 I/O (8I+6O)
  - Over 130 instructions
  - RS-485 master port with the ability to communicate to 31 other devices
  - The master port can also be configured to communicate to devices such as ASCII, bar code readers, and so on
  - Retentive flash memory
- **PC Clock/Calendar Model**
  - 12 I/O (8I+4O)
  - Same features as the basic model plus clock/calendar
  - Distributed I/O capability with up to 14 devices
  - File area for data storage and retrieval
  - Two digital potentiometers that vary the data in internal registers
  - Compatible with left side Ethernet and DeviceNet master communication modules
- **PE Ethernet Model**
  - 12 I/O (8I+4O)
  - All the features of the PC model
  - Built-in Ethernet client/server
  - EtherNet/IP server
- **PA20 Analog Model**
  - 20 I/O (12I+8O)
  - Same features as PC model with analog I/O
  - Analog channels can be set up for either voltage or current
- **PV Advanced Model**
  - 28 I/O (16I+12O)
  - The PV model has the most extensive features
  - Programs written for the other controllers can be migrated to a PV model controller where greater speed or more I/O is required
  - Flash ROM and SRAM program storage and backed using a rechargeable lithium-ion battery that charges with normal use
  - Includes 2-axis motion control
  - Additional expansion bus to the left of the controller
  - Add high-speed and specialty modules to the left
  - Compatible with left side Ethernet and DeviceNet master communication modules

**ELC Modular PLCs****Features**

- **PA10 Analog Model**
  - 10 I/O (6I+4O)
  - Same features as PC model with a different I/O mix
  - Four digital inputs, two digital outputs, two analog inputs, and two analog outputs
  - Analog channels can be set up for either voltage or current
  - Two 7-segment LEDs that can be used to display unit ID, error codes, process steps, and so on

ELC Series Programmable Logic Controllers

ELC2

ELC



| Model                      | PB–Basic<br>Page V7-T4-11  | PC–Clock/calendar<br>Page V7-T4-11   | PA–Analog<br>Page V7-T4-10   | PE–Ethernet<br>Page V7-T4-10   | PV–Advanced function<br>Page V7-T4-10   | PA–Analog<br>Page V7-T4-10  |
|----------------------------|--|--|--|--|---|---|
| <b>Product Description</b> | <ul style="list-style-type: none"> <li>• Most popular, best value PLC</li> <li>• Smallest footprint</li> <li>• Relay, NPN or PNP outputs</li> <li>• No clock/calendar function</li> <li>• No battery required</li> </ul> | <ul style="list-style-type: none"> <li>• Clock/calendar functions</li> <li>• Built-in potentiometers</li> <li>• Relay or NPN outputs</li> <li>• No battery required</li> </ul> | <ul style="list-style-type: none"> <li>• Analog I/O for voltage or current</li> <li>• Clock/calendar functions</li> <li>• Built-in potentiometers</li> <li>• Relay, NPN or PNP outputs</li> <li>• No battery required</li> </ul> | <ul style="list-style-type: none"> <li>• Built-in Ethernet</li> <li>• EtherNet/IP server</li> <li>• Clock/calendar functions</li> <li>• Relay or NPN outputs</li> <li>• No battery required</li> </ul> | <ul style="list-style-type: none"> <li>• Fastest CPU</li> <li>• Clock/calendar functions</li> <li>• Built-in potentiometers</li> <li>• Relay, NPN or PNP outputs</li> <li>• Battery backup</li> </ul> | <ul style="list-style-type: none"> <li>• Built-in LED displays</li> <li>• Analog I/O for voltage or current</li> <li>• Clock/calendar functions</li> <li>• Relay or NPN outputs</li> <li>• Replaceable battery</li> </ul> |
| <b>Features</b>            |  |  |  |  |   |   |
| On-board I/O               | 12/14  | 12   | 20   | 12   | 28  | 10  |
| Analog I/O                 | —  | —  | 4I + 2O  | —  | —   | 2I + 2O   |
| CPU                        | 32-bit   | 32-bit   | 32-bit   | 32-bit   | 32-bit  | 16-bit  |
| Program capacity           | 8 k  | 16 k   | 16 k   | 16 k   | 30 k  | 8 k   |
| RS-232                     | 1  | 1  | 1  | 1  | 1   | 1   |
| RS-485                     | 1  | 2  | 1  | 1  | 1   | 1   |
| USB                        | —  | —  | 1  | 1  | —   | —   |
| Clock/calendar             | No   | Yes  | Yes  | Yes  | Yes   | Yes   |
| Battery                    | No   | No   | No   | No   | Yes   | Yes   |
| Right side bus             | Yes  | Yes  | Yes  | Yes  | Yes   | Yes   |
| Left side bus              | No   | Yes  | Yes  | Yes  | Yes   | No  |
| Potentiometers             | —  | 2  | 2  | —  | 2   | —   |
| LED displays               | —  | —  | —  | —  | —   | 2   |

#### ELC System Overview

#### Configuration and Layout

4

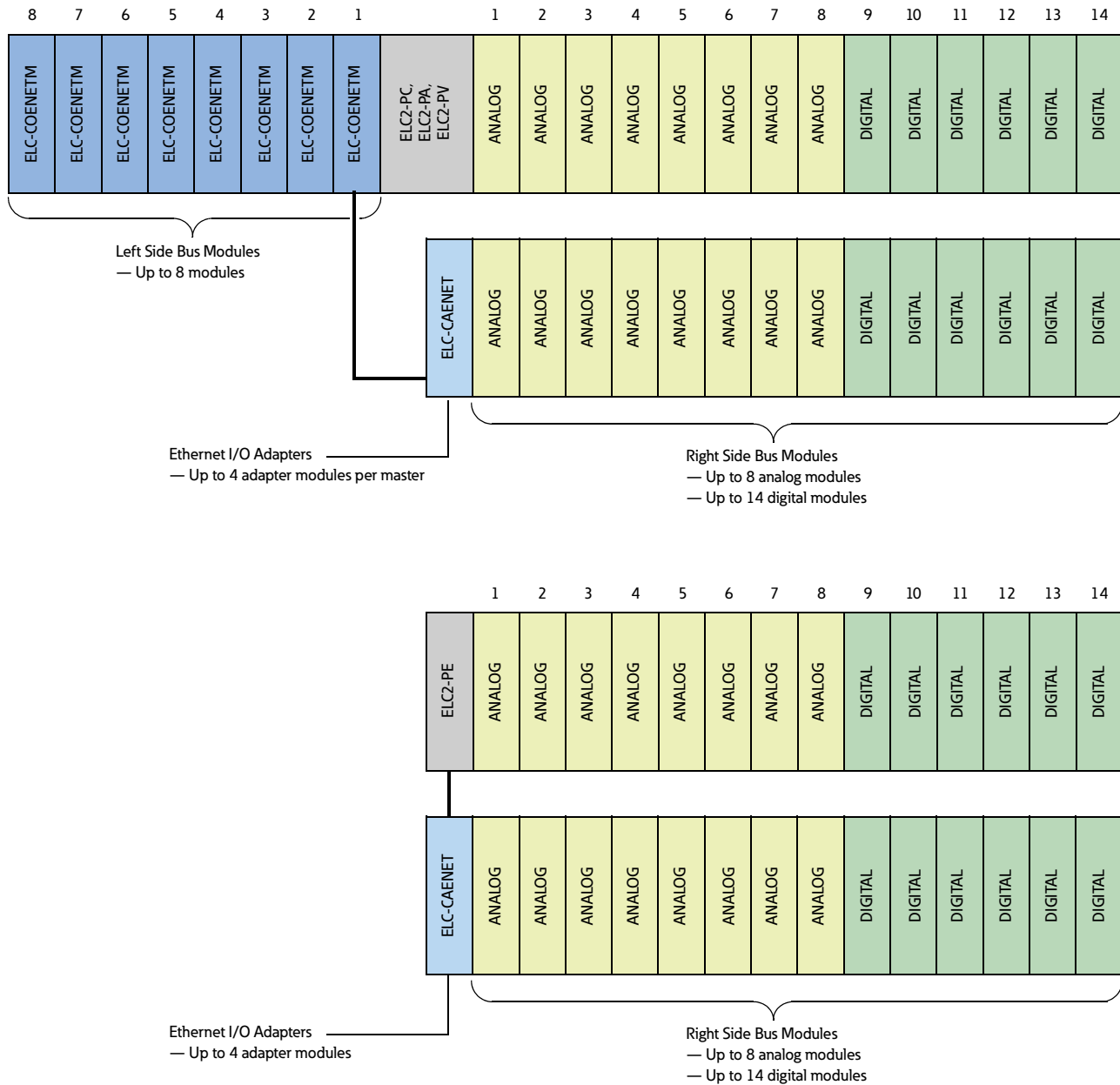



Controllers—Basic

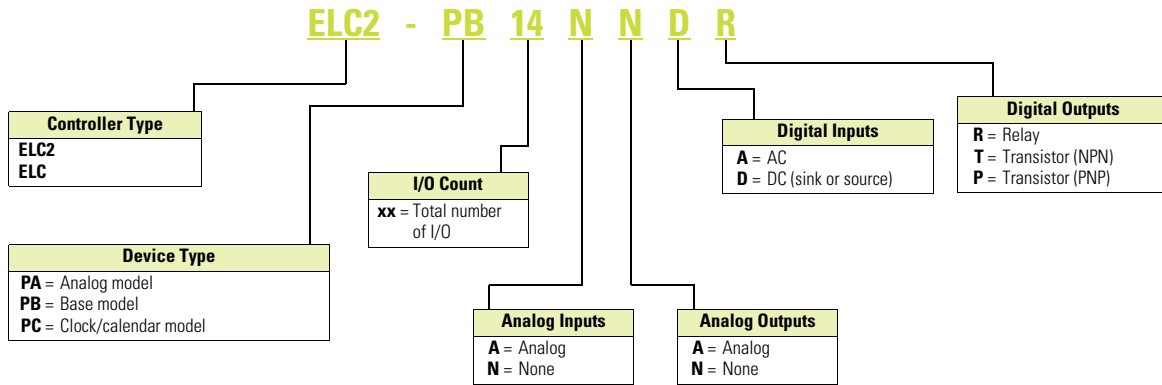

Controllers—Basic

All models include RS-232 and RS-485 programming/communication ports and can be expanded with up to 14 extension modules on the right-hand side bus.

| On-Board I/O  | Program Memory Steps | Inputs |       |     | Outputs |        |         | Analog |        | High Speed Inputs |         |        |         | High Speed Outputs |              |              | Catalog Number |
|---|----------------------|--------|-------|-----|---------|--------|---------|--------|--------|-------------------|---------|--------|---------|--------------------|--------------|--------------|----------------|
|   |                      | 24 Vdc | Relay | NPN | PNP     | Inputs | Outputs | 10 kHz | 20 kHz | 100 kHz           | 200 kHz | 10 kHz | 100 kHz | 200 kHz            |              |              |                |
| <b>ELC2-PB Basic Controllers</b>  |                      |        |       |     |         |        |         |        |        |                   |         |        |         |                    |              |              |                |
| <ul style="list-style-type: none"> <li>• Smallest size and footprint</li> <li>• Retentive flash memory</li> </ul>   |                      |        |       |     |         |        |         |        |        |                   |         |        |         |                    |              |              |                |
| 14  | 8 k                  | 8      | 6     | —   | —       | —      | —       | 4      | 4      | —                 | —       | —      | —       | —                  | —            | ELC2-PB14NDR |                |
| 14  | 8 k                  | 8      | —     | 6   | —       | —      | —       | 4      | 4      | —                 | —       | 4      | —       | —                  | ELC2-PB14NDR |              |                |
| 12  | 8 k                  | 8      | —     | —   | 4       | —      | —       | 4      | 4      | —                 | —       | 4      | —       | —                  | ELC2-PB12NDR |              |                |
| <b>ELC2-PC Basic Clock Controllers</b>  |                      |        |       |     |         |        |         |        |        |                   |         |        |         |                    |              |              |                |
| <ul style="list-style-type: none"> <li>• Suitable for larger capacity and RTC applications</li> <li>• Expandable with left side communication modules</li> <li>• 2 RS-485 ports</li> <li>• 2 built-in potentiometers</li> <li>• Retentive flash memory</li> </ul> |                      |        |       |     |         |        |         |        |        |                   |         |        |         |                    |              |              |                |
| 12  | 16 k                 | 8      | 4     | —   | —       | —      | —       | 4      | —      | 4                 | —       | —      | —       | —                  | ELC2-PC12NDR |              |                |
| 12  | 16 k                 | 8      | —     | 4   | —       | —      | —       | 4      | —      | 4                 | —       | 2      | 2       | —                  | ELC2-PC12NDR |              |                |
| <b>ELC-PA Basic Analog Controllers</b>  |                      |        |       |     |         |        |         |        |        |                   |         |        |         |                    |              |              |                |
| <ul style="list-style-type: none"> <li>• Built-in 2 analog inputs and 2 analog outputs</li> <li>• 2-digit, 7-segment display</li> <li>• SRAM and replaceable battery</li> <li>• Retentive flash memory (style -3 and above)</li> </ul>                            |                      |        |       |     |         |        |         |        |        |                   |         |        |         |                    |              |              |                |
| 10  | 8 k                  | 4      | 2     | —   | —       | 2      | 2       | 2      | 2      | —                 | —       | —      | —       | —                  | ELC-PA10ADR  |              |                |
| 10  | 8 k                  | 4      | —     | 2   | —       | 2      | 2       | 2      | 2      | —                 | —       | 2      | —       | —                  | ELC-PA10ADR  |              |                |



# 4.1

## PLC, I/O and Communications Products

### ELC Series Programmable Logic Controllers

#### Controllers—Advanced

4

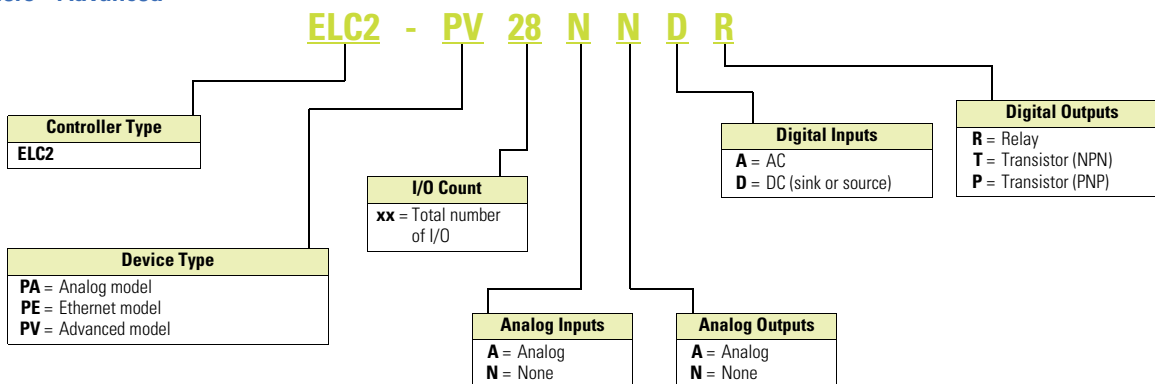

#### Controllers—Advanced

All models (except ELC2-PE) include RS-232 and RS-485 programming/communication ports and can be expanded with up to 14 extension modules on the right-hand side bus.

| On-Board I/O   | Program Memory Steps | Inputs |       |     | Outputs        |        |         | Analog |        | High Speed Inputs |         |        |         | High Speed Outputs |               |               | Catalog Number |
|--|----------------------|--------|-------|-----|----------------|--------|---------|--------|--------|-------------------|---------|--------|---------|--------------------|---------------|---------------|----------------|
|  |                      | 24 Vdc | Relay | NPN | PNP            | Inputs | Outputs | 10 kHz | 20 kHz | 100 kHz           | 200 kHz | 10 kHz | 100 kHz | 200 kHz            |               |               |                |
| <b>ELC2-PA Advanced Analog Controllers</b>   |                      |        |       |     |                |        |         |        |        |                   |         |        |         |                    |               |               |                |
| <ul style="list-style-type: none"> <li>• Built-in 4 analog inputs and 2 analog outputs</li> <li>• Expandable with left side communication modules</li> <li>• 2 built-in potentiometers</li> <li>• Retentive flash memory</li> </ul>  |                      |        |       |     |                |        |         |        |        |                   |         |        |         |                    |               |               |                |
| 20   | 16 k                 | 8      | 6     | —   | —              | 4      | 2       | 6      | —      | 2                 | —       | —      | —       | —                  | —             | ELC2-PA20AADR |                |
| 20   | 16 k                 | 8      | —     | 6   | —              | 4      | 2       | 6      | —      | 2                 | —       | 2      | 2       | —                  | ELC2-PA20AADT |               |                |
| 20   | 16 k                 | 8      | —     | —   | 6 <sup>①</sup> | 4      | 2       | 6      | —      | 2                 | —       | 2      | 2       | —                  | ELC2-PA20AADP |               |                |
| <b>ELC2-PE Ethernet Controllers</b>  |                      |        |       |     |                |        |         |        |        |                   |         |        |         |                    |               |               |                |
| <ul style="list-style-type: none"> <li>• Built-in Ethernet and USB port</li> <li>• Expandable with left side communication modules</li> <li>• Retentive flash memory</li> </ul>  |                      |        |       |     |                |        |         |        |        |                   |         |        |         |                    |               |               |                |
| 12   | 16 k                 | 8      | 4     | —   | —              | —      | —       | 6      | —      | 2                 | —       | —      | —       | —                  | ELC2-PE12NNDR |               |                |
| 12   | 16 k                 | 8      | —     | 4   | —              | —      | —       | 6      | —      | 2                 | —       | 2      | 2       | —                  | ELC2-PE12NNDT |               |                |
| <b>ELC2-PV Large Capacity Advanced Controllers</b>   |                      |        |       |     |                |        |         |        |        |                   |         |        |         |                    |               |               |                |
| <ul style="list-style-type: none"> <li>• 4, 200 kHz inputs and 4, 200 kHz outputs</li> <li>• Expandable with left side communication modules</li> <li>• 2 built-in potentiometers</li> <li>• Self-charging lithium-ion battery</li> <li>• Retentive flash memory and SRAM</li> </ul> |                      |        |       |     |                |        |         |        |        |                   |         |        |         |                    |               |               |                |
| 28   | 30 k                 | 16     | 12    | —   | —              | —      | —       | 12     | —      | —                 | 4       | —      | —       | —                  | ELC2-PV28NNDR |               |                |
| 28   | 30 k                 | 16     | —     | 12  | —              | —      | —       | 12     | —      | —                 | 4       | —      | —       | 4                  | ELC2-PV28NNDT |               |                |
| 28   | 30 k                 | 16     | —     | —   | 12             | —      | —       | 12     | —      | —                 | 4       | —      | —       | 4                  | ELC2-PV28NNDP |               |                |

**Note**

① PNP transistor outputs are only 0.3 A.

Controllers—Superseded

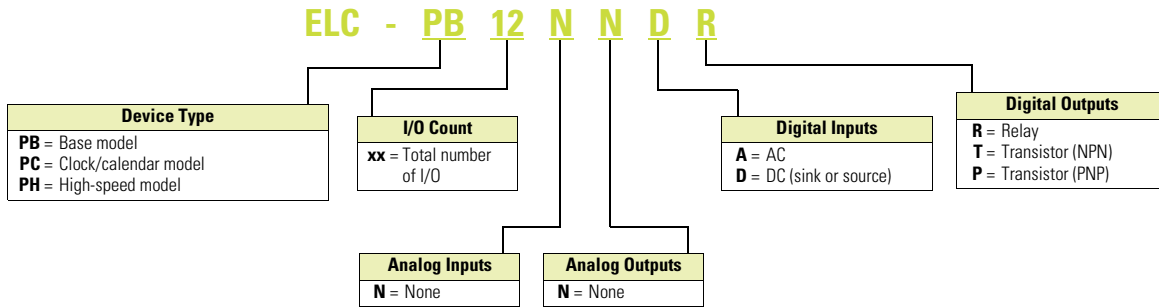

ELC2-PB\_

Controllers—Superseded

For Replacement Only



| Description                      | Inputs      | Outputs                | Analog | High Speed I/O     | Max. Current Consumption (at 24 Vdc) | Catalog Number      |
|----------------------------------|-------------|------------------------|--------|--------------------|--------------------------------------|---------------------|
| ELC-PB model and 14 I/O built-in | (8) 24 Vdc  | (6) Relay, 1.5 A       | —      | (2) 20 kHz inputs  | 150 mA                               | <b>ELC-PB14NNDR</b> |
|                                  | (8) 24 Vdc  | (6) Transistor, 100 mA | —      | (2) 20 kHz inputs  | 150 mA                               | <b>ELC-PB14NNDT</b> |
| ELC-PC model and 12 I/O built-in | (8) 24 Vdc  | (4) Relay, 1.5 A       | —      | (1) 30 kHz inputs  | 150 mA                               | <b>ELC-PC12NNDR</b> |
|                                  | (8) 24 Vdc  | (4) Transistor, 100 mA | —      | (1) 30 kHz inputs  | 150 mA                               | <b>ELC-PC12NNDT</b> |
|                                  | (8) 110 Vac | (4) Relay, 1.5 A       | —      | (1) 30 kHz inputs  | 150 mA                               | <b>ELC-PC12NNAR</b> |
| ELC-PH model and 12 I/O built-in | (8) 24 Vdc  | (4) Transistor, 100 mA | —      | (1) 100 kHz inputs | 170 mA                               | <b>ELC-PH12NNDT</b> |

#### ELC Communication Modules

##### ELC Communication Modules

### ELC - CO ENETM

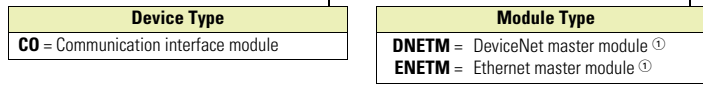

#### Ethernet Master Communication Module (Left Side Bus)

##### Features

- Ethernet communication module
- Enables the ELC2-PC, EL2C-PA and ELC2-PV controllers to connect to Modbus TCP networks auto detecting 10/100 MB connections
- Enables the uploading and downloading of programs in addition to program monitoring
- Use ELCSOft to search for all the Ethernet modules attached to the network and manage them remotely
- Share data in a peer-to-peer network to reduce long I/O wiring
- Send e-mails for alerts and notifications. For example, advise personnel of alarm condition or send daily production yield summaries
- Keep accurate time with the NTP (Network Time Protocol) feature, which synchronizes your controller with an NTP server
- The Ethernet module will automatically detect and use the type of patch or crossover cable attached
- IP addresses may be filtered to manage module traffic in order to maximize communication performance.

#### ELC-COENETM



#### Ethernet Master Communication Module (Left Side Bus)

| Description                         | Inputs Points | Type       | Outputs Points | Catalog Number |
|-------------------------------------|---------------|------------|----------------|----------------|
| Ethernet Modbus TCP (client/server) | N/A           | Modbus TCP | N/A            | ELC-COENETM    |

#### DeviceNet Master Communication Module (Left Side Bus)

##### Features

- DeviceNet master module maps up to 380 bytes of data directly into the PV model controller for quick and easy access
- Use polled, bit-strobe and change of state/cyclic DeviceNet commands, or send explicit messages
- Configuration of DeviceNet components in ELCSOft is easy with the drag-and-drop interface
- Use the pre-populated EDS files within ELCSOft and add others to simplify the configuration

#### ELC-CODNETM



#### DeviceNet Master Communication Module (Left Side Bus)

| Description                       | Inputs Points | Type      | Outputs Points | Catalog Number |
|-----------------------------------|---------------|-----------|----------------|----------------|
| DeviceNet Scanner (client/server) | 190 bytes     | DeviceNet | 190 bytes      | ELC-CODNETM    |

##### Note

① Left side bus communications module—for use with ELC-PV, ELC2-PC, ELC2-PA, ELC2-PE and ELC2-PV controllers only.

**ELC Remote I/O Adapters**

**Features**

- Combine with ELC expansion modules to create remote I/O racks for different PLC networks
- Use ELC-CAENET and ELC-COENETM to create remote I/O racks to the ELC-PV controllers
- Connect cost effective ELC expansion modules to third-party PLCs using standard networks
- EtherNet/IP, Modbus TCP, DeviceNet, PROFIBUS-DP and Modbus serial RS-485 remote I/O adapters
- Connect up to 8 analog expansion modules or 14 digital expansion modules

**ELC Remote I/O Adapters**

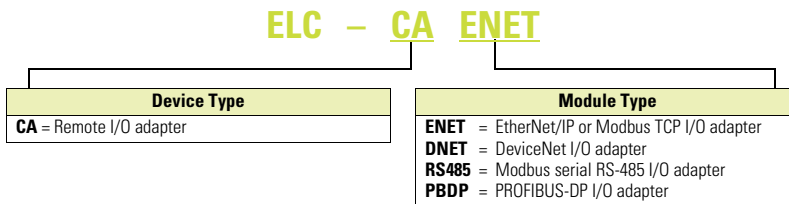

**ELC-CAENET**



**Remote I/O Adapter Modules**

| Description                           | Catalog Number     |
|---------------------------------------|--------------------|
| EtherNet/IP or Modbus TCP I/O adapter | <b>ELC-CAENET</b>  |
| Modbus serial RS-485 I/O adapter      | <b>ELC-CARS485</b> |
| DeviceNet I/O adapter                 | <b>ELC-CADNET</b>  |
| PROFIBUS-DP I/O adapter               | <b>ELC-CAPBDP</b>  |

#### ELC Expansion Modules

##### Right Side Bus

##### Expansion Modules

4

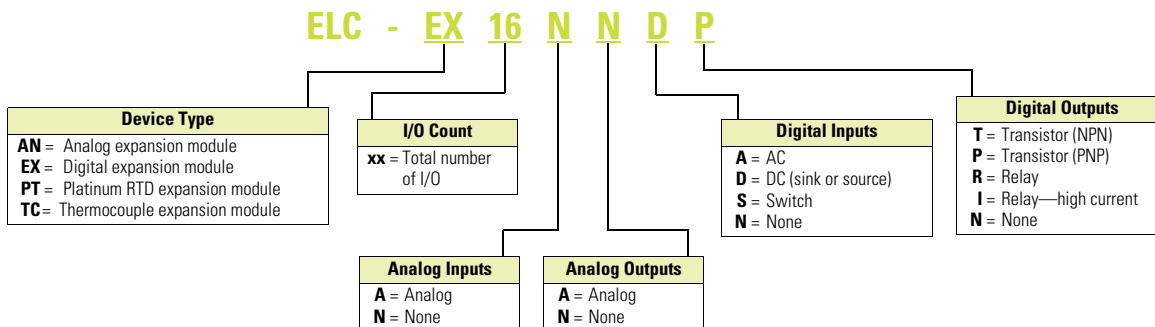

#### Features

- Digital right side expansion modules can be used with any ELC controller
- They simply snap together to allow the ELC backplane to pass through each connected module
- Add only the amount of I/O you need
- Choose I/O counts as small as 6 points and as large as 14 points per module
- I/O modules are available in a broad selection of AC/DC inputs, relay/transistor and high current outputs that may be used together in any combination
- Maximum of 14 modules per controller

#### ELC-EX08NNDN



#### Digital Expansion Modules (Right Side Bus) 8-Point

| Description                | Inputs      | Outputs                      | Max. Current Consumption (at 24 Vdc) | Catalog Number |
|----------------------------|-------------|------------------------------|--------------------------------------|----------------|
| 8 DC input module          | (8) 24 Vdc  | —                            | 50 mA                                | ELC-EX08NNDN   |
| 8 AC input module          | (8) 110 Vac | —                            | 50 mA                                | ELC-EX08NNAN   |
| 8 Transistor output module | —           | (8) Transistor (sink), 0.3 A | 70 mA                                | ELC-EX08NNNT   |
| 8 Relay output module      | —           | (8) Relay, 1.5 A             | 70 mA                                | ELC-EX08NNNR   |

#### ELC-EX08NNDT



#### Digital Expansion Modules (Right Side Bus) 16-Point

| Description                        | Inputs      | Outputs                        | Max. Current Consumption (at 24 Vdc) | Catalog Number |
|------------------------------------|-------------|--------------------------------|--------------------------------------|----------------|
| 8 DC input/output module           | (4) 24 Vdc  | (4) Transistor (sink), 0.3 A   | 70 mA                                | ELC-EX08NNDT   |
| 8 DC input/relay output module     | (4) 24 Vdc  | (4) Relay, 1.5 A               | 70 mA                                | ELC-EX08NNDR   |
| 6 High current relay output module | —           | (6) Relay, 6 A                 | 70 mA                                | ELC-EX06NNNI   |
| 16 DC input module                 | (16) 24 Vdc | —                              | 100 mA                               | ELC-EX16NNDN   |
| 16 DC input/output module          | (8) 24 Vdc  | (8) Transistor (sink), 0.3 A   | 90 mA                                | ELC-EX16NNDT   |
| 16 DC input/output module          | (8) 24 Vdc  | (8) Transistor (source), 0.3 A | 100 mA                               | ELC-EX16NNDP   |
| 16 DC input/relay output module    | (8) 24 Vdc  | (8) Relay, 1.5 A               | 90 mA                                | ELC-EX16NNDR   |

**ELC-AN04ANNN**



**Analog Input and Output Modules (Right Side Bus)**

Analog input/output modules uses voltage or current mode for any channel—see table for resolution based on type and mode.

| Description                  | Input Points | Resolution               | Mode            | Output Points | Resolution | Mode                               | Maximum Current Consumption (at 24 Vdc) | Catalog Number |
|------------------------------|--------------|--------------------------|-----------------|---------------|------------|------------------------------------|---|----------------|
| 4 Analog input module        | 4            | V = 14 bit<br>I = 13 bit | ±10 V<br>±20 mA | —             | —          | —                                  | 90 mA                                   | ELC-AN04ANNN   |
| 2 Analog output module       | —            | —                        | —               | 2             | 12 bit     | 0–20 mA; 4–20 mA<br>0–10 V; 2–10 V | 125 mA                                  | ELC-AN02NANN   |
| 4 Analog output module       | —            | —                        | —               | 4             | 12 bit     | 0–20 mA; 4–20 mA<br>0–10 V; 2–10 V | 170 mA                                  | ELC-AN04ANNN   |
| 6 Analog input/output module | 4            | V = 12 bit<br>I = 11 bit | ±10 V<br>±20 mA | 2             | 12 bit     | 0–20 mA<br>0–10 V                  | 170 mA                                  | ELC-AN06AANN   |

**ELC-PT04ANNN**



**Temperature Input Modules (Right Side Bus)**

Thermocouple and Platinum RTD temperature sensor input modules with 14 bit resolution.

| Description                 | Input Points | Resolution | Sensor Type   | Maximum Current Consumption (at 24 Vdc) | Catalog Number |
|-----------------------------|--------------|------------|---------------|---|----------------|
| 4 Thermocouple input module | 4            | —          | J, K, R, S, T | 90 mA                                   | ELC-TC04ANNN   |
| 4 Platinum RTD input module | 4            | 14 bit     | PT100         | 90 mA                                   | ELC-PT04ANNN   |

**ELC-MC01**



**Motion Control Module (Right Side Bus)**

Single axis motion control module.

If used with ELC2-PC controllers, it can provide a second axis because these controllers have a single axis built-in.

If used with the ELC2-PV controllers, it can provide a third axis because these controllers incorporate two axis of motion control and are capable of output pulses up to 200 kHz.

| Description                       | Input Type                       | Output Type             | Catalog Number |
|-----------------------------------|----------------------------------|-------------------------|----------------|
| Single axis motion control module | Phase in, start, stop, and so on | Phase, pulse, direction | ELC-MC01       |

**ELC-485APTR**



**RS-485 Adapter Module (Right Side Bus—End Module)**

Passive RS-485 connection device module.

RJ12 port for connecting to a drive.

2-pin screw terminal to connect to ELC controller.

Male and female DB9 connectors to connect to other RS-485 devices.

| Description                   | Connector Types                                    | Catalog Number |
|-------------------------------|--|----------------|
| RS-485 Connect adapter module | RJ12, DB9 (male and female), 2-pin screw terminals | ELC-485APTR    |

**ELC-EX08NNSN**



**Toggle Switch Input Module (Right Side Bus)**

8 input switch module for manual switch inputs to the ELC controllers—used for debugging applications or product training demonstrations

| Description                  | Maximum Current Consumption (at 24 Vdc) | Catalog Number |
|------------------------------|---|----------------|
| 8 Toggle switch input module | 20 mA                                   | ELC-EX08NNSN   |

# 4.1

## PLC, I/O and Communications Products

### ELC Series Programmable Logic Controllers

4

#### Programming Software

ELCSoft programming software configures all ELC controllers. With ELCSoft, applications can be created, edited and monitored. Move programs from one controller to another with ease. Program in ladder, sequential function chart or instruction language. ELCSoft is the single program to develop

ELC controller applications. ELCSoft is also used to configure the DeviceNet master and Modbus TCP Ethernet modules.

New program simulation capabilities are available in ELCSoft Version 2.

#### Requirements

Operating Systems

- Windows® 2000
- Windows XP
- Windows Vista
- Windows 7

Hard Drive

- At least 100 Mbytes

RAM

- At least 512 Mbytes

#### ELCSoft Editor



#### ELC Software

| Description                                      | Catalog Number |
|--|----------------|
| Programming Software for ELC Controllers         | <b>ELCSOFT</b> |
| Configuration Software for ELC Ethernet networks | <b>ECISOFT</b> |



**Accessories**

**Power Supplies**

All ELC controllers, analog and specialty expansion modules operate from 24 Vdc.

These power supplies provide a convenient way to provide robust DC voltage for ELC and other products.

**ELC-PS01**

**Power Supplies**



| Description                 | Input Power          | Output Volts | Output Current (A) | Watts | Catalog Number  |
|-----------------------------|----------------------|--------------|--------------------|-------|-----------------|
| 24 watt, 1 amp power supply | 100–240 Vac 50/60 Hz | 24 Vdc       | 1 A                | 24    | <b>ELC-PS01</b> |
| 48 watt, 2 amp power supply | 100–240 Vac 50/60 Hz | 24 Vdc       | 2 A                | 48    | <b>ELC-PS02</b> |

**Cables**

Use these cables to connect your PC's RS-232 serial port to your ELC controller to download, upload and monitor your ELC controllers,

or to connect any ELC-GP to an ELC controller. The ELC-CBPCELC1 cable is 1 meter long and has a right angle connector to

the ELC controller to help reduce depth when cable is attached. The ELC-CBPCELC3 is 3 meters long with a straight connector.

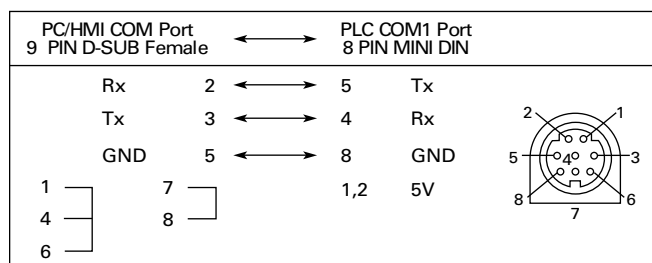

**Cables**

| Description   | Catalog Number      |
|---|---------------------|
| Cable to connect a PC or an ELC-GP unit to ELC, 1 meter with right angle connector (DB 9-pin female to 8-pin DIN) | <b>ELC-CBPCELC1</b> |
| Cable to connect a PC or an ELC-GP unit to ELC, 3 meters (DB 9-pin female to 8-pin DIN)                           | <b>ELC-CBPCELC3</b> |

**Storage/Transfer Module**

The ELC-ACPGMXFR module is a multifunction device that provides the ability to back up an application already loaded onto one of the ELC or ELC2 controllers. The transfer module can be used for copying the same application

to multiple controllers and to transfer an existing application to a new controller in the event of a failure. It will store system settings, passwords and the application, including the data registers for pre-loaded

recipes. Once stored in the module, the application, data registers and settings can be transferred to another ELC/ELC2 controller of the same model number.

**ELC-ACPGMXFR**

**Storage/Transfer Module**



| Description  | Catalog Number      |
|--|---------------------|
| Program transfer module for ELC and ELC2 controllers (Not compatible with ELC2-PE controllers) | <b>ELC-ACPGMXFR</b> |

# 4.1

## PLC, I/O and Communications Products

### ELC Series Programmable Logic Controllers

#### Plate Mount

Use the ELC-ACCOVER surface mount stand-alone modules instead of mounting to a DIN rail.

This may be used to mount analog, temperature or the RS-485 adapters remotely.

#### Plate Mount

| Description                                | Catalog Number     |
|--|--------------------|
| Plate mount for specialty modules, qty. 10 | <b>ELC-ACCOVER</b> |

#### Spare Parts

##### ELC Spare Parts

| Description  | Catalog Number     |
|--|--------------------|
| Kit consists of:   | <b>ELC-SPKIT</b>   |
| Module to module locking clips (white)   | 4                  |
| Module DIN rail clip (white)   | 2                  |
| 3-pin power plug and cable assembly (white)  | 4                  |
| 2-pin RS-485 communications connector (green—for latest version PA, PB, PC and PH)   | 4                  |
| 3-pin RS-485 communications connector (green—PV controllers only)                    | 2                  |
| Left side expansion port cover (PV controllers and left side communications modules) | 2                  |
| Right side I/O expansion port cover (all controllers and I/O modules)                | 2                  |
| Battery cover door (for PA, PC and PH controllers)                                   | 2                  |
| Metal mounting clips (only for PV controllers)                                       | 2                  |
| Kit consists of:   | <b>ELC-IOBLOCK</b> |
| 9-pin replacement I/O blocks (green)   | 4                  |
| Battery with pigtail and connector (for ELC-PA, PC and PH controllers only)          | <b>ELC-BAT</b>     |

**ELC-BAT**



## Technical Data and Specifications

### ELC2 Controllers

| Description                                | ELC2-PB14NNDR/T  | ELC2-PB12NNDP  | ELC2-PC12NNDR/T  |
|--|--|--|--|
| Dimensions W x H x D<br>in inches (mm)     | 0.99 x 3.54 x 2.36<br>(25.2 x 90.0 x 60.0)                         | 0.99 x 3.54 x 2.36<br>(25.2 x 90.0 x 60.0)                         | 1.47 x 3.54 x 2.36<br>(37.4 x 90.0 x 60.0)                         |
| I/O type—embedded                          | 14 (8DI/6DO)   | 12 (8DI/4DO)   | 12 (8DI/4DO)   |
| Maximum additional I/O points              | Up to 14 expansion modules (maximum of 8 analog/specialty modules) | Up to 14 expansion modules (maximum of 8 analog/specialty modules) | Up to 14 expansion modules (maximum of 8 analog/specialty modules) |
| DC in sink/source                          | Yes  | Yes  | Yes  |
| Execution speed (basic instructions)       | 0.54 μs  | 0.54 μs  | 0.54 μs  |
| Program language                           | Instructions + Ladder Logic + SFC                                  | Instructions + Ladder Logic + SFC                                  | Instructions + Ladder Logic + SFC                                  |
| Program capacity (steps)                   | 7,920  | 7,920  | 15,872   |
| Data memory capacity<br>(M device—bits)    | 4096   | 4096   | 4096   |
| Data memory capacity<br>(D register—words) | 5000   | 5000   | 10,000   |
| Index registers                            | 16   | 16   | 16   |
| File memory capacity (words)               | 0  | 0  | 5000   |
| Retentive storage                          | Flash ROM  | Flash ROM  | Flash ROM  |
| <b>Commands Basic/Advanced</b>             |  |  |  |
| Floating point                             | Support  | Support  | Support  |
| SFC commands (steps)                       | 1024   | 1024   | 1024   |
| Timers quantity                            | 256  | 256  | 256  |
| Timers resolution                          | 1 ms, 10 ms, 100 ms  | 1 ms, 10 ms, 100 ms  | 1 ms, 10 ms, 100 ms  |
| Counters quantity                          | 256  | 256  | 256  |
| High-speed counters <sup>①</sup>           | 22   | 22   | 22   |
| Max. high-speed counting <sup>①</sup>      | 20 kHz   | 20 kHz   | 100 kHz  |
| Pulse output                               | 4*10 kHz   | 4*10 kHz   | 2*10 kHz+2*100 kHz   |
| PID  | Support  | Support  | Support  |
| Master control                             | 8  | 8  | 8  |
| Subroutines                                | 256  | 256  | 256  |
| For/next loops                             | Max. 6 loops   | Max. 6 loops   | Max. 6 loops   |
| Max. interrupts quantity                   | 21   | 21   | 22   |
| Real-time clock/calendar                   | No   | No   | Built-in   |
| Password security                          | Yes  | Yes  | Yes  |
| Diagnostic relays                          | Yes  | Yes  | Yes  |
| Diagnostic word registers                  | Yes  | Yes  | Yes  |
| Specialty expansion modules                | Up to a maximum of 8 (Analog in/analog out/TC/RTD/PT) modules      | Up to a maximum of 8 (Analog in/analog out/TC/RTD/PT) modules      | Up to a maximum of 8 (Analog in/analog out/TC/RTD/PT) modules      |
| Serial ports                               | 2 Modbus* (ASCII/RTU) 1=server (RS-232)/1=client/server (RS-485)   | 2 Modbus* (ASCII/RTU) 1=server (RS-232)/1=client/server (RS-485)   | 2 Modbus* (ASCII/RTU) 1=server (RS-232)/1=client/server (RS-485)   |
| Max. digital I/O                           | 494  | 492  | 492  |
| On-line editing                            | Yes  | Yes  | Yes  |
| Run/stop switch                            | Yes  | Yes  | Yes  |
| Removable terminal strips                  | Yes  | Yes  | Yes  |
| Special features                           | —  | —  | 2 potentiometers, high-speed, left-side bus                        |

#### Note

<sup>①</sup> High-speed counter inputs can be used for different types of 32-bit counting, such as single-ended, single-phase two inputs, and quadrature. Therefore, all high-speed counters may not be used at the same time. Please refer to the ELC Programming Manual, MN05003003E, for details.

## ELC2 Controllers, continued

| Description                                | ELC2-PA20AADR/T/P  | ELC2-PE12NDR/T  | ELC2-PV28NDR/T   |
|--|--|---|--|
| Dimensions W x H x D<br>in inches (mm)     | 2.76 x 3.54 x 2.36<br>(70.0 x 90.0 x 60.0)                         | 1.47 x 3.54 x 2.36<br>(37.4 x 90.0 x 60.0)                                | 2.76 x 3.54 x 2.36<br>(70.0 x 90.0 x 60.0)                         |
| I/O type—embedded                          | 20 (8DI/6DO/4AI/2AO)   | 12 (8DI/4DO)  | 28 (16DI/12DO)   |
| Maximum additional I/O points              | Up to 14 expansion modules (maximum of 8 analog/specialty modules) | Up to 14 expansion modules (maximum of 8 analog/specialty modules)        | Up to 14 expansion modules (maximum of 8 analog/specialty modules) |
| DC in sink/source                          | Yes  | Yes   | Yes  |
| Execution speed (basic instructions)       | 0.54 $\mu$ s   | 0.54 $\mu$ s  | 0.24 $\mu$ s   |
| Program language                           | Instructions + Ladder Logic + SFC                                  | Instructions + Ladder Logic + SFC   | Instructions + Ladder Logic + SFC                                  |
| Program capacity (steps)                   | 15,872   | 15,872  | 30,000   |
| Data memory capacity<br>(M device—bits)    | 4096   | 4096  | 4096   |
| Data memory capacity<br>(D register—words) | 10,000   | 10,000  | 12,000   |
| Index registers                            | 16   | 16  | 16   |
| File memory capacity (words)               | 5000   | 5000  | 50,000   |
| Retentive storage                          | Flash ROM  | Flash ROM   | Flash ROM+SRAM with rechargeable battery                           |
| <b>Commands Basic/Advanced</b>             |  |   |  |
| Floating point                             | Support  | Support   | Support  |
| SFC commands (steps)                       | 1024   | 1024  | 1024   |
| Timers quantity                            | 256  | 256   | 256  |
| Timers resolution                          | 1 ms, 10 ms, 100 ms  | 1 ms, 10 ms, 100 ms   | 1 ms, 10 ms, 100 ms  |
| Counters quantity                          | 256  | 256   | 256  |
| High-speed counters <sup>①</sup>           | 22   | 22  | 18   |
| Max. high-speed counting <sup>①</sup>      | 100 kHz  | 100 kHz   | 200 kHz  |
| Pulse output                               | 2*10 kHz+2*100 kHz   | 2*10 kHz+2*100 kHz  | 4*200 kHz  |
| PID  | Support  | Support   | Support  |
| Master control                             | 8  | 8   | 8  |
| Subroutines                                | 256  | 256   | 256  |
| For/next loops                             | Max. 6 loops   | Max. 6 loops  | Max. 6 loops   |
| Max. interrupts quantity                   | 22   | 22  | 36   |
| Real-time clock/calendar                   | Built-in   | Built-in  | Built-in   |
| Password security                          | Yes  | Yes   | Yes  |
| Diagnostic relays                          | Yes  | Yes   | Yes  |
| Diagnostic word registers                  | Yes  | Yes   | Yes  |
| Specialty expansion modules                | Up to a maximum of 8 (Analog in/analog out/TC/RTD/PT) modules      | Up to a maximum of 8 (Analog in/analog out/TC/RTD/PT) modules             | Up to a maximum of 8 (Analog in/analog out/TC/RTD/PT) modules      |
| Serial ports                               | 2 Modbus* (ASCII/RTU) 1=server (RS-232)/1=client/server (RS-485)   | 2 Modbus* (ASCII/RTU) 1=server (RS-232)/1=client/server (RS-485)          | 2 Modbus* (ASCII/RTU) 1=server (RS-232)/1=client/server (RS-485)   |
| Max. digital I/O                           | 494  | 492   | 508  |
| On-line editing                            | Yes  | Yes   | Yes  |
| Run/stop switch                            | Yes  | Yes   | Yes  |
| Removable terminal strips                  | Yes  | Yes   | Yes  |
| Special features                           | 2 potentiometers, high-speed, left-side bus                        | 2 potentiometers, high-speed, left-side bus, Built-in Ethernet & USB port | 2 potentiometers, high-speed, left-side bus                        |

**Note**

<sup>①</sup> High-speed counter inputs can be used for different types of 32-bit counting, such as single-ended, single-phase two inputs, and quadrature. Therefore, all high-speed counters may not be used at the same time. Please refer to the ELC Programming Manual, MN05003003E, for details.

## ELC Controllers

| Description                            | ELC-PB14NNDR/DT   | ELC-PC12NNAR/DR/DT  | ELC-PH12NNDT  | ELC-PA10AADR/DT   | ELC-PV28NNDR/DT   |
|--|---|---|---|---|---|
| Dimensions W x H x D<br>in inches (mm) | 0.99 x 3.54 x 2.36<br>(25.2 x 90.0 x 60.0)                                | 1.47 x 3.54 x 2.36<br>(37.4 x 90.0 x 60.0)                                    | 1.47 x 3.54 x 2.36<br>(37.4 x 90.0 x 60.0)                                | 1.47 x 3.54 x 2.36<br>(37.4 x 90.0 x 60.0)                                | 2.76 x 3.54 x 2.36<br>(70.0 x 90.0 x 60.0)                                |
| I/O type—embedded                      | 14 (8DI/6DO)  | 12 (8DI/4DO)  | 12 (8DI/4DO)  | 10 (4DI/2DO/2AI/2AO)  | 28 (16DI/12DO)  |
| Maximum additional I/O points          | Up to 14 expansion modules<br>(maximum of 8 analog/<br>specialty modules) | Up to 14 expansion modules<br>(maximum of 8 analog/<br>specialty modules)     | Up to 14 expansion modules<br>(maximum of 8 analog/<br>specialty modules) | Up to 14 expansion modules<br>(maximum of 8 analog/<br>specialty modules) | Up to 14 expansion modules<br>(maximum of 8 analog/<br>specialty modules) |
| DC in sink/source                      | Yes   | Yes   | Yes   | Yes   | Yes   |
| Execution speed (basic instructions)   | 2 µs  | 2 µs  | 2 µs  | 2 µs  | 0.24 µs   |
| Program language                       | Instructions + Ladder Logic + Sequential Function Chart                   |   |   |   |   |
| Program capacity (steps)               | 3792  | 7920  | 7920  | 7920  | 15,872  |
| Data memory capacity (bits)            | 1280  | 4096  | 4096  | 4096  | 4096  |
| Data memory capacity (words)           | 744   | 5000  | 5000  | 5000  | 10,000  |
| Index registers                        | 2   | 8   | 8   | 8   | 16  |
| File memory capacity (words)           | None  | 1600 words  | 1600 words  | 1600 words  | 10,000 words  |
| Retentive storage                      | Yes   | Yes   | Yes   | Yes   | Yes   |
| Commands basic/advanced                | 32/107  | 32/168  | 32/168  | 32/168  | 32/193  |
| Floating point                         | Yes   | Yes   | Yes   | Yes   | Yes   |
| SFC commands (steps)                   | 128   | 1024  | 1024  | 1024  | 1024  |
| Timers qty.                            | 128   | 244 Standard with additional timers for subroutine and retentive applications |   |   |   |
| Timers resolution                      | 1–100 ms  | 1–100 ms  | 1–100 ms  | 1–100 ms  | 1–100 ms  |
| Counters qty.                          | 128   | 250   | 250   | 250   | 253   |
| High-speed counters <sup>①</sup>       | Up to 4   | Up to 6   | Up to 8   | Up to 6   | Up to 8   |
| Max. high-speed counting <sup>①</sup>  | 2 at 20 kHz   | 1 at 30 kHz   | 1 at 100 kHz  | 1 at 30 kHz   | 2 at 200 kHz  |
| Pulse output                           | 2 channels, 10 kHz max.   | 2 channels, 50 kHz max.   | 100 kHz   | 2 channels, 50 kHz max.   | 200 kHz   |
| PID                                    | Yes   | Yes   | Yes   | Yes   | Yes   |
| Master control loop                    | 8 loops   | 8 loops   | 8 loops   | 8 loops   | 8 loops   |
| Subroutines                            | 64 subroutines  | 256 subroutines   | 256 subroutines   | 256 subroutines   | 256 subroutines   |
| For/next loops                         | Yes   | Yes   | Yes   | Yes   | Yes   |
| Interrupts                             | 6   | 15  | 15  | 15  | 22  |
| Real-time clock/calendar               | No  | Built-in  | Built-in  | Built-in  | Built-in  |
| Password security                      | Yes   | Yes   | Yes   | Yes   | Yes   |
| Diagnostic relays                      | Yes   | Yes   | Yes   | Yes   | Yes   |
| Diagnostic word registers              | Yes   | Yes   | Yes   | Yes   | Yes   |
| Specialty expansion modules            | Up to a maximum of 8 (Analog In/Analog Out/TC/RTD/PT) Modules             |   |   |   |   |
| Serial ports                           | 2 Modbus (ASCII/RTU) 1 = Slave (RS-232)/11 = Master-Slave (RS-485)        |   |   |   |   |
| Remote I/O                             | No  | With 16 other devices   | With 16 other devices   | With 16 other devices   | With 32 other devices   |
| Runtime editing                        | No  | Yes   | Yes   | Yes   | Yes   |
| Run/stop switch                        | Yes   | Yes   | Yes   | Yes   | Yes   |
| Removable terminal strips              | Yes   | Yes   | Yes   | Yes   | Yes   |
| Special features                       | —   | 2 potentiometers  | 2 potentiometers  | 2, 7-segment displays   | 2 potentiometers high-speed, left side bus                                |

**Note**

<sup>①</sup> High-speed counter inputs can be used for different types of 32-bit counting, such as single-ended, single-phase two inputs, and quadrature. Therefore, all high-speed counters may not be used at the same time. Please refer to the ELC Programming Manual, MN05003003E, for details.

### Environmental Ratings

| Description                       | Specification   |
|-----------------------------------|---|
| <b>Transportation and Storage</b> |   |
| Temperature                       | -13 to +158 °F (-25 to +70 °C)  |
| Humidity                          | 5–95%   |
| <b>Operating</b>                  |   |
| Temperature                       | 32 to 131 °F (0 to 55 °C)   |
| Humidity                          | 50–95%  |
| Power supply voltage              | ELC: 24 Vdc (-15%–20%) (with DC input reverse polarity protection)  |
| Power consumption                 | 3–6 W   |
| Insulation resistance             | >5 M ohms at 500 Vdc (between all inputs/outputs and earth)   |
| Grounding                         | The diameter of grounding wire cannot be smaller than the wire diameter of terminals L and N (All ELC units should be grounded directly to the ground pole) |
| Vibration / shock resistance      | IEC1131-2, IEC 68-2-6 (TEST Fc)/IEC1131-2 and IEC 68-2-27 (TEST Ea)   |

### DC Input Point Electrical Specifications

| Description   | Specification  |
|---------------|--|
| Input type    | DC (SINK or SOURCE)  |
| Input current | 24 Vdc 5 mA  |
| Active level  | OFF → ON, above 16 Vdc<br>ON → OFF, below 14.4 Vdc   |
| Response time | About 10 ms (an adjustment range of 0–10,000 ms could be selected through D1020 and D1021) |

### Output Point Electrical Specifications

| Output Type           | Relay–R                                 | Transistor–T  |
|-----------------------|---|---|
| Current specification | 1.5 A / 1 point (5 A / COM)             | 0.5 A / 1 point @ 40 °C; When the output of Y0 and Y1 is high-speed pulse, Y0 and Y1 = 30 mA  |
| Voltage specification | Below 250 Vac, 30 Vdc                   | 30 Vdc  |
| Maximum loading       | 75 VA (inductive)<br>90 W (resistive)   | 9 W / 1 point; When the output of Y0 and Y1 is high-speed pulse, Y0 and Y1 = 0.9 W (Y0 = 32 kHz, Y1 = 10 kHz), Y0 can be 50 kHz using D registers |
| Response time         | Adjustable 0–15 ms,<br>default is 10 ms | OFF → ON 20 μs Y0 and Y1 are specified points for high-speed pulse<br>ON → OFF 30 μs Y0 and Y1 are specified points for high-speed pulse          |

**ELC vs. ELC2 Memory Maps**

The ELC2 memory map is different from the ELC memory map—except the ELC2-PV, which is the same as the ELC-PV; the differences are listed below.

| Device | Non-Latched Area |                                       | Latched Area |                           |
|--------|------------------|---------------------------------------|--------------|---------------------------|
|        | ELC-PB           | ELC2-PB                               | ELC-PB       | ELC2-PB                   |
| S      | None             | S128-S911                             | S0-S127      | S0-S127,<br>S912-S1023    |
| M      | M0-M511          | M0-M511,<br>M768-M999<br>M2000-M2047  | M512-M767    | M512-M767,<br>M2048-M4095 |
| D      | D0-D407          | D0-D407,<br>D600-D999,<br>D3920-D4999 | D408-D599    | D408-D599<br>D2000-D3919  |

| Device     |     | Non-Latched Area |                                   | Latched Area |           |
|------------|-----|------------------|-----------------------------------|--------------|-----------|
|            |     | ELC-PB           | ELC2-PB                           | ELC-PB       | ELC2-PB   |
| T<br>(ms)  | 100 | T0-T63           | T0-T126<br>T128-T199<br>T250-T255 | None         | None      |
|            | 10  | T64-T126         | T200-T245                         | None         | None      |
|            | 1   | T127             | T127, T246-T249                   | None         | None      |
| C<br>(Bit) | 16  | C0-C111          | C0-C111<br>C128-C199              | C112-C127    | C112-C127 |
|            | 32  | None             | C200-C223                         | C235-C255    | C224-C255 |

| Device     |     | Non-Latched Area      |                                       | Latched Area             |                           |
|------------|-----|-----------------------|---------------------------------------|--------------------------|---------------------------|
|            |     | ELC-PA/PC/PH          | ELC2-PA/PC                            | ELC-PA/PC/PH             | ELC2-PA/PC                |
| S          |     | S0-S511               | S128-S911                             | S512-S1023               | S0-S127,<br>S912-S1023    |
| M          |     | M0-M511               | M0-M511,<br>M768-M999<br>M2000-M2047  | M512-M999<br>M2000-M4095 | M512-M767,<br>M2048-M4095 |
| D          |     | D0-D199               | D0-D407,<br>D600-D999,<br>D3920-D9999 | D200-D999<br>D2000-D4999 | D408-D599<br>D2000-D3919  |
| T<br>(ms)  | 100 | T0-T199,<br>T250-T255 | T0-T126<br>T128-T199<br>T250-T255     | None                     | None                      |
|            | 10  | T200-T245             | T200-T245                             | None                     | None                      |
|            | 1   | T246-T249             | T127, T246-T249                       | None                     | None                      |
| C<br>(Bit) | 16  | C0-C95                | C0-C111<br>C128-C199                  | C96-C199                 | C112-C127                 |
|            | 32  | C200-C215             | C200-C223                             | C216-C255                | C224-C255                 |

#### Circuit Diagrams

##### DC Input Sink Mode

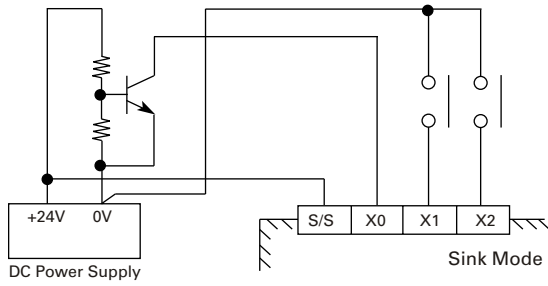

##### DC Input Source Mode

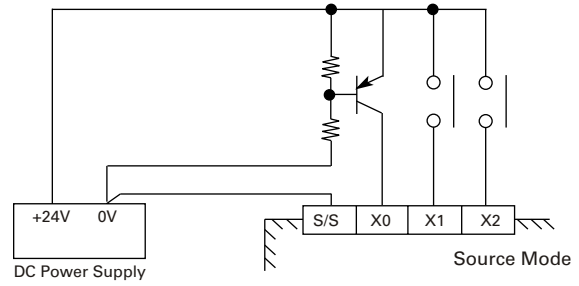

##### DC Transistor Sinking Output

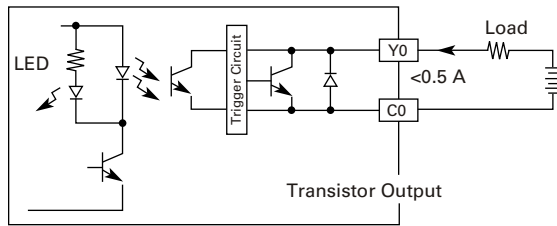

##### Relay Outputs

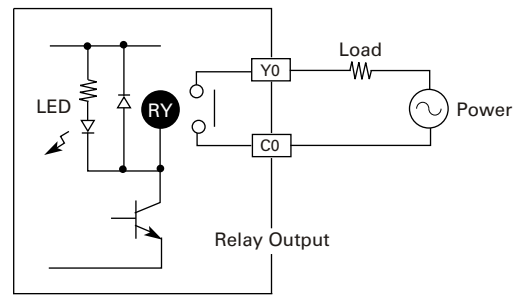



**Dimensions**

Approximate Dimensions in Inches (mm)

**ELC-PB and ELC2-PB Controllers**

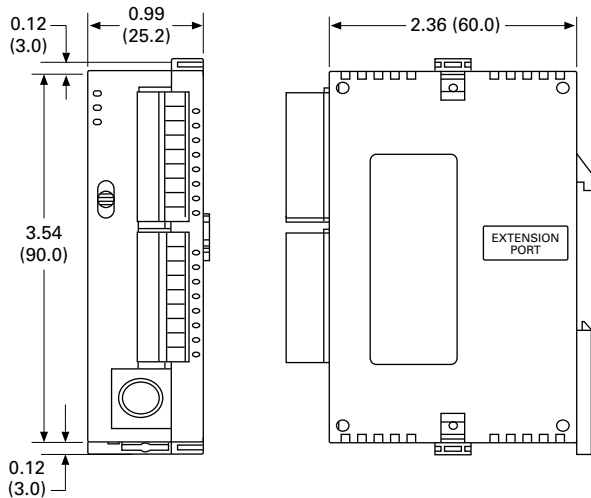

**ELC-PC, ELC-PH, ELC-PA10, ELC2-PC and ELC2-PE Controllers**

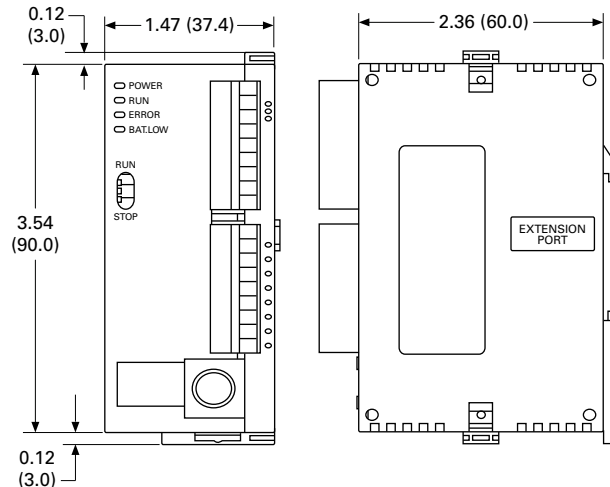

**ELC-PV, ELC2-PV and ELC2-PA20 Controllers**

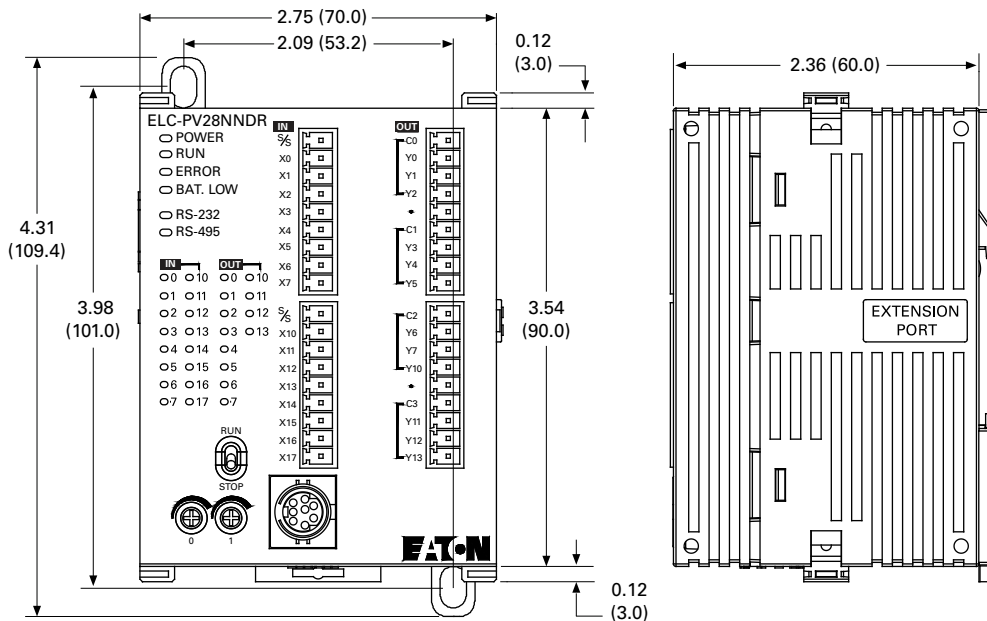

# 4.1

## PLC, I/O and Communications Products

### ELC Series Programmable Logic Controllers

Approximate Dimensions in Inches (mm)

#### ELC-COENETM Communication Module

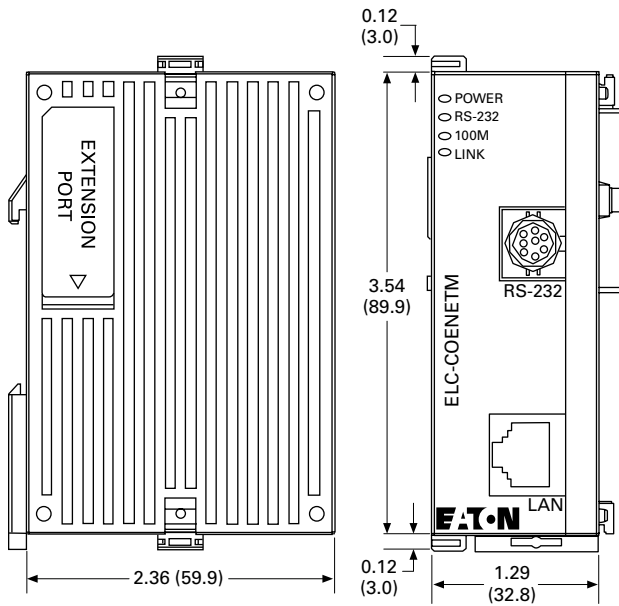

#### Right Side Expansion and Specialty Modules

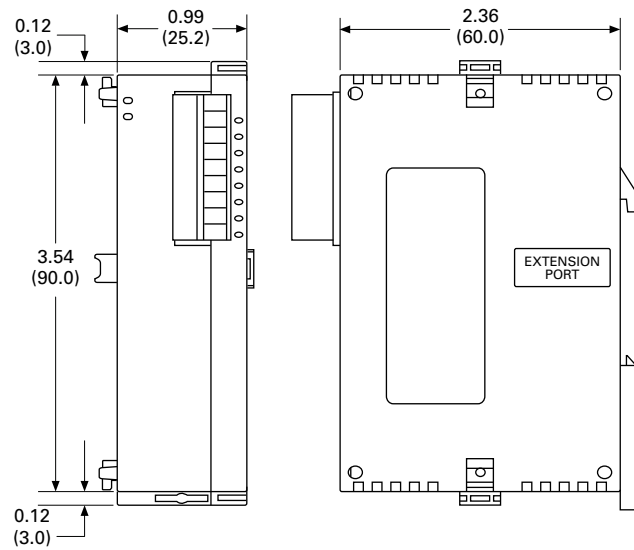

#### ELC-CODNETM Communication Module

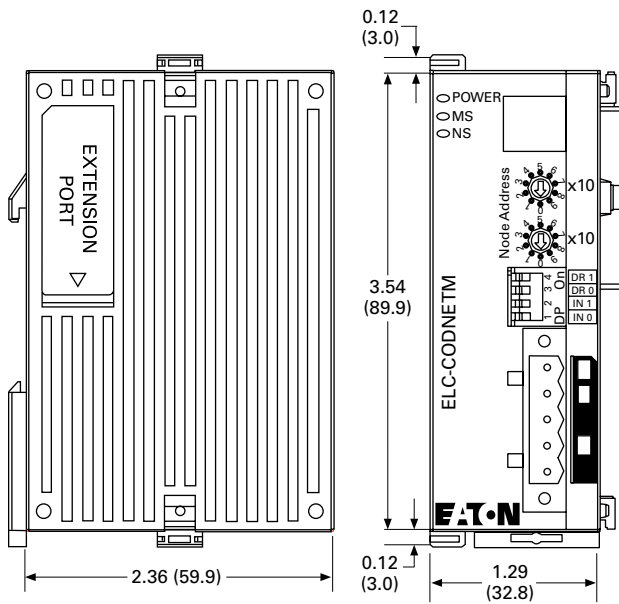

#### ELC-ACCOVER Plate Mount for Specialty Modules

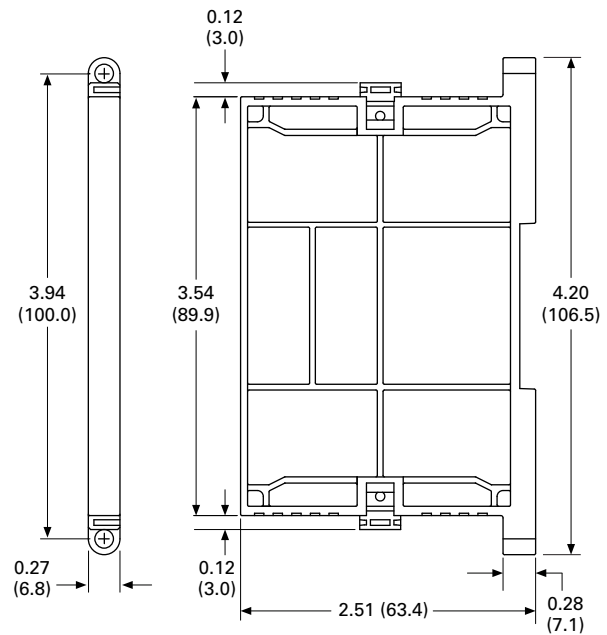

Approximate Dimensions in Inches (mm)

**ELC-PS01 Power Supply**

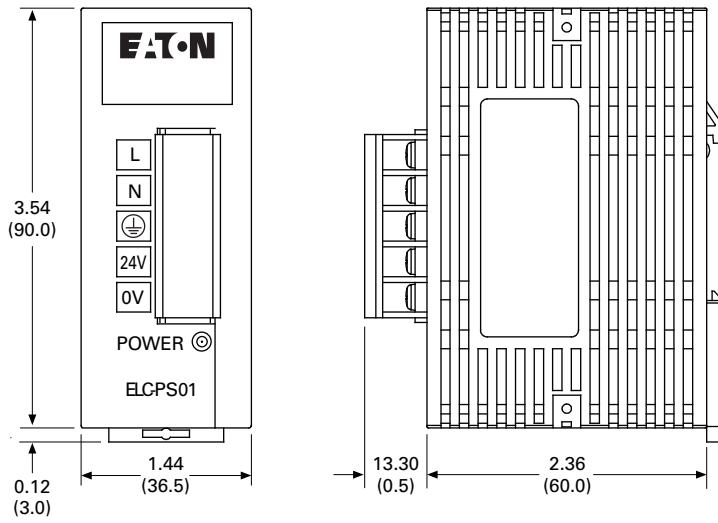

**ELC-PS02 Power Supply**

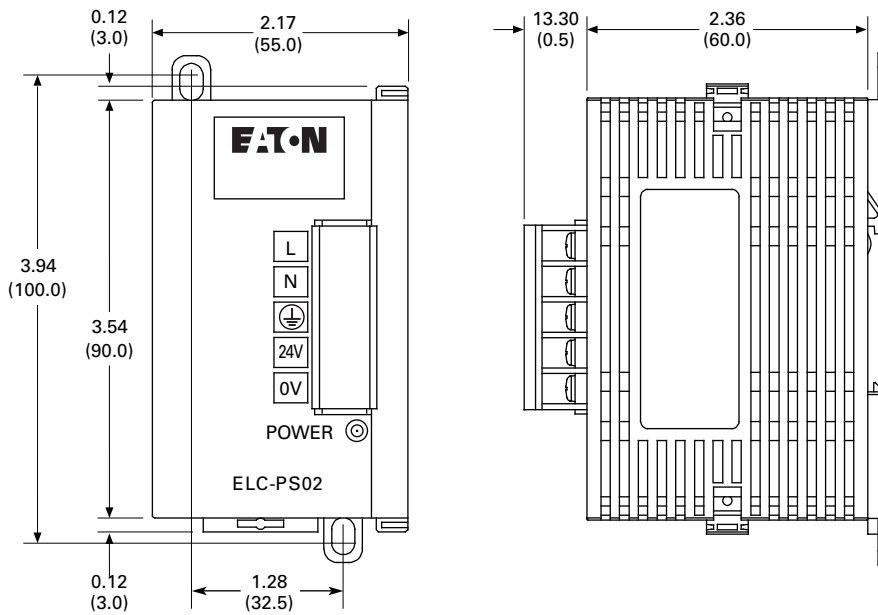

**ELC-CBPCELC1 Cable (Right Angle Connector not Shown) and ELC-CBPCELC3 Cable (Straight Connector as Shown)**

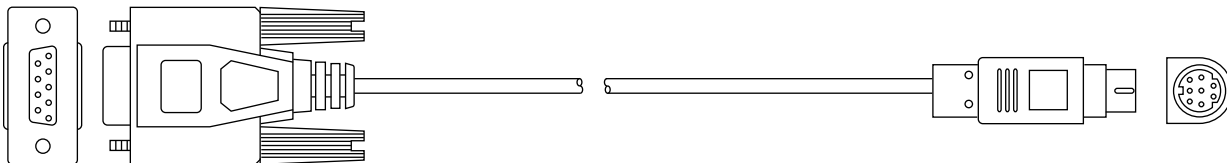

# 4.1

## PLC, I/O and Communications Products

### ELC Series Programmable Logic Controllers

Approximate Dimensions in Inches (mm)

#### ELC-ACPGMXFER Storage/Transfer Module

4

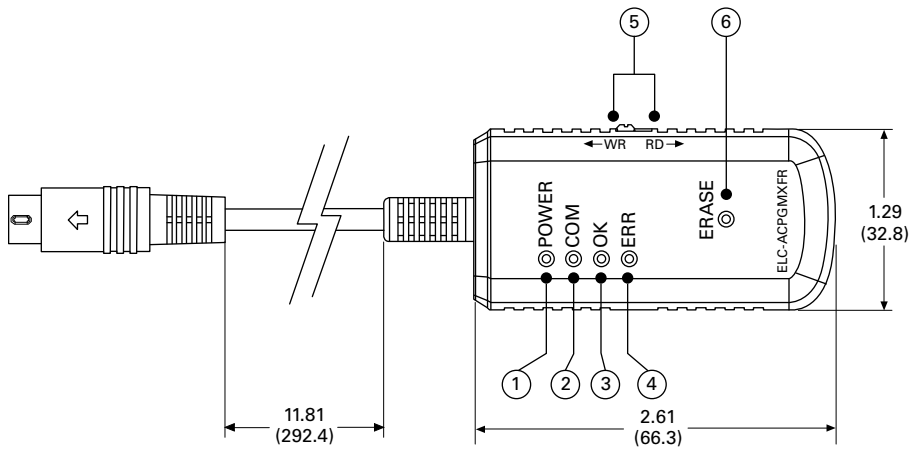

XC Series Programmable Logic Controllers



Contents

| <b>Description</b>                          | <b>Page</b>     |
|---|-----------------|
| XC Series Programmable Logic Controllers    |                 |
| Product Selection Guide . . . . .           | <b>V7-T4-30</b> |
| Catalog Number Selection . . . . .          | <b>V7-T4-31</b> |
| System Overview . . . . .                   | <b>V7-T4-31</b> |
| Product Selection . . . . .                 | <b>V7-T4-33</b> |
| Accessories . . . . .                       | <b>V7-T4-36</b> |
| Technical Data and Specifications . . . . . | <b>V7-T4-39</b> |
| Dimensions . . . . .                        | <b>V7-T4-55</b> |

**Product Overview**

The XC100 and XC200 series modular PLCs stand out on account of their highly scalable design. Different CPU performance classes and a wide range of expansion modules are available. An important feature is their ability to be integrated in modern communication systems. Innovative solutions can be created thanks to the possibility of exchanging data with OPC clients via the Ethernet interface and the integrated web server.

**Features and Benefits**

**Flexible Range**

- Compact and modular CPU versions to suit the needs of the application
- With or without on-board Ethernet and/or built-in web server
- Range of CPU performance
- Integrated CANopen interface for easy integration with XI/ON remote I/O

**High Performance**

- Parallel backplane bus for faster processing speed
- Fiber optic CANopen interface for environments with severe electromagnetic interference
- High performance XC202 CPU with
  - 10/100 Mbit Ethernet
  - XSoft-CoDeSys programming software

**Standards and Certifications**

- IEC—UL508; CSA C22.2 No. 0-M; CSA C22.2 No. 142-M; CE marking
- UL File No.—E135462
- UL CCN—NRAQ
- CSA File No. 012528
- CSA Class No. 2252-01
- NA Certification—
  - UL Listed
  - CSA certified/cUL
- RoHS



#### Product Selection Guide

##### XC Series Programmable Logic Controllers

4



**XC121 Compact PLC**

Page V7-T4-33

This PLC is particularly suitable for applications where space is at premium and with high communication requirements.

- Two serial and two CAN interfaces enable:
  - the coupling of two CAN networks
  - Modbus master/slave coupling (RS-232 or RS-485)—CAN
  - RS-232—CAN coupling
- I/O expansion with 18 digital and 8 analog inputs/outputs
- 6 interrupt inputs
- Expandable with standard XIOC modules



**XC101 Modular PLCs**

Page V7-T4-33

The modular PLCs of the XC101 series are universal automation devices for small and medium-sized applications.

- Locally expandable with up to 15 XIOC modules
- Data storage on SD card
- CAN interface



**XC201 Modular PLCs**

Page V7-T4-34

The modular PLCs of the XC201 series offer a high CPU performance, a high speed and a wide range of communication options.

- Locally expandable with up to 15 XIOC modules
- Ethernet interface for communication and programming
- CAN interface
- Data storage on SD card or USB stick
- Web server enables visualization via CoDeSys
- Operating system update SD card or USB



**XC202 Modular PLCs**

Page V7-T4-34

The modular PLCs of the XC202 series offer higher CPU performance and memory than the XC201 PLCs.

- Locally expandable with up to 15 XIOC modules
- Ethernet interface for communication and programming
- CAN interface
- Data storage on SD card or USB stick
- Operating system update via Ethernet, SD card or USB
- Up to three IP addresses can be configured
- 29-bit CAN identifier

| Features                       | XC121                                       | XC101                       | XC201                                | XC202                                |
|--------------------------------|---|-----------------------------|--------------------------------------|--------------------------------------|
| Input voltage                  | 24 Vdc                                      | 24 Vdc                      | 24 Vdc                               | 24 Vdc                               |
| Memory size                    | 256 kB                                      | 64, 128 or 256 kB           | 256 kB or 2 MB                       | 4 MB                                 |
| Microprocessor                 | Infineon CC161                              | Infineon C164               | MIPS RISC                            | ARM11                                |
| Processor speed                | 36 MHz                                      | 24 MHz                      | 131 MHz                              | 532 MHz                              |
| Cycle time per 1k instructions | <0.3 ms                                     | <0.5 ms                     | <0.15 ms                             | <0.025 ms                            |
| SD card slot                   | Yes   | Yes                         | Yes                                  | Yes                                  |
| USB interface                  | No  | No                          | Yes                                  | Yes                                  |
| Real time clock                | Yes   | Yes                         | Yes                                  | Yes                                  |
| On-board digital inputs        | —   | 8                           | 8                                    | 8                                    |
| On-board digital outputs       | —   | 6                           | 6                                    | 6                                    |
| Interrupt inputs               | 6   | 4                           | 2                                    | 2                                    |
| Expandability                  | XIO-EXT base module + Up to 15 XIOC modules | Up to 15 XIOC modules       | Up to 15 XIOC modules                | Up to 15 XIOC modules                |
| Removable terminal blocks      | Yes   | Yes                         | Yes                                  | Yes                                  |
| Screw terminal option          | No  | Yes                         | Yes                                  | Yes                                  |
| Spring-cage terminal option    | Yes   | Yes                         | Yes                                  | Yes                                  |
| Serial interface               | 1, RS-232<br>1, RS-232/RS-485               | 1, RS-232                   | 1, RS-232                            | 1, RS-232                            |
| Ethernet port                  | No  | No                          | Yes                                  | Yes                                  |
| CANopen interface              | 2   | 1                           | 1                                    | 1                                    |
| On-board high speed counters   | No  | No                          | Yes                                  | Yes                                  |
| On-board encoder inputs        | No  | No                          | Yes                                  | Yes                                  |
| OPC server                     | Yes   | Yes                         | Yes                                  | Yes                                  |
| Integrated web server          | No  | No                          | On suffix “-XV” models               | Yes                                  |
| FTP server                     | No  | No                          | On suffix “-XV” models               | Yes                                  |
| Networks master                | CANopen/easyNet                             | CANopen/PROFIBUS-DP/easyNet | Ethernet/CANopen/PROFIBUS-DP/easyNet | Ethernet/CANopen/PROFIBUS-DP/easyNet |
| Networks node/device           | CANopen/PROFIBUS-DP®/easyNet                | CANopen/PROFIBUS-DP/easyNet | Ethernet/CANopen/PROFIBUS-DP/easyNet | Ethernet/CANopen/PROFIBUS-DP/easyNet |
| Operating system               | Proprietary                                 | Proprietary                 | Windows CE                           | Windows CE                           |
| X-Soft-CoDeSys version         | V2.3  | V2.3                        | V2.3                                 | V2.3 and 3.0                         |

### Catalog Number Selection

#### Controllers

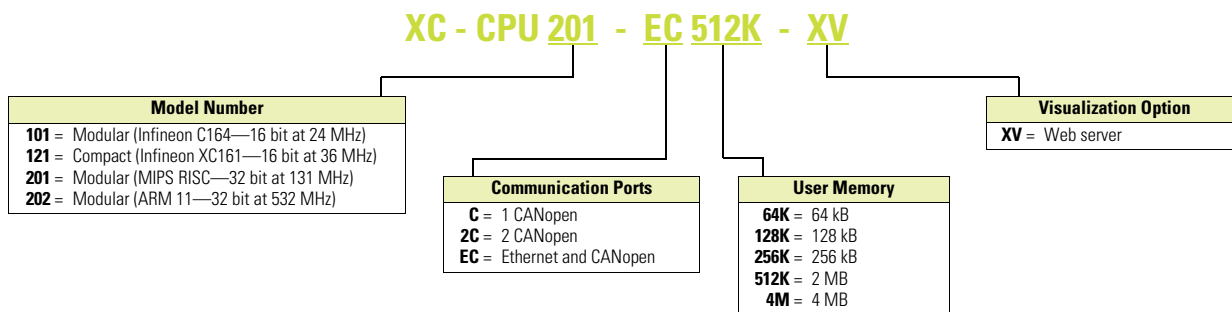

### System Overview

#### System Configuration

| CPU | 1           | 2         | 3         | 4         | 5         | 6 | 7         |
|-----|-------------|-----------|-----------|-----------|-----------|---|-----------|
| ①   | XIOC-BP-XC  | XIOC-BP-2 | XIOC-BP-2 | XIOC-BP-3 |           |   | XIOC-BP-3 |
|     | XIOC-BP-XC1 |           | XIOC-BP-3 |           | XIOC-BP-3 |   |           |

| CPU | 1           | 2         | 3         | 4           | 5           | 6         | 7         | 8         | 9         | 10 | 11 | 12 | 13 | 14 | 15 |
|-----|-------------|-----------|-----------|-------------|-------------|-----------|-----------|-----------|-----------|----|----|----|----|----|----|
| ②   | XIOC-BP-XC  | XIOC-BP-2 | XIOC-BP-3 | XIOC-BP-EXT |             | XIOC-BP-3 | XIOC-BP-2 | XIOC-BP-2 |           |    |    |    |    |    |    |
|     | XIOC-BP-XC1 |           | XIOC-BP-2 | XIOC-BP-2   | XIOC-BP-EXT |           | XIOC-BP-3 | XIOC-BP-2 | XIOC-BP-2 |    |    |    |    |    |    |

**Notes**

- ① Maximum basic version, ≤7 signal modules.
- ② Maximum total version, ≤15 signal modules.

#### Product Identification

4

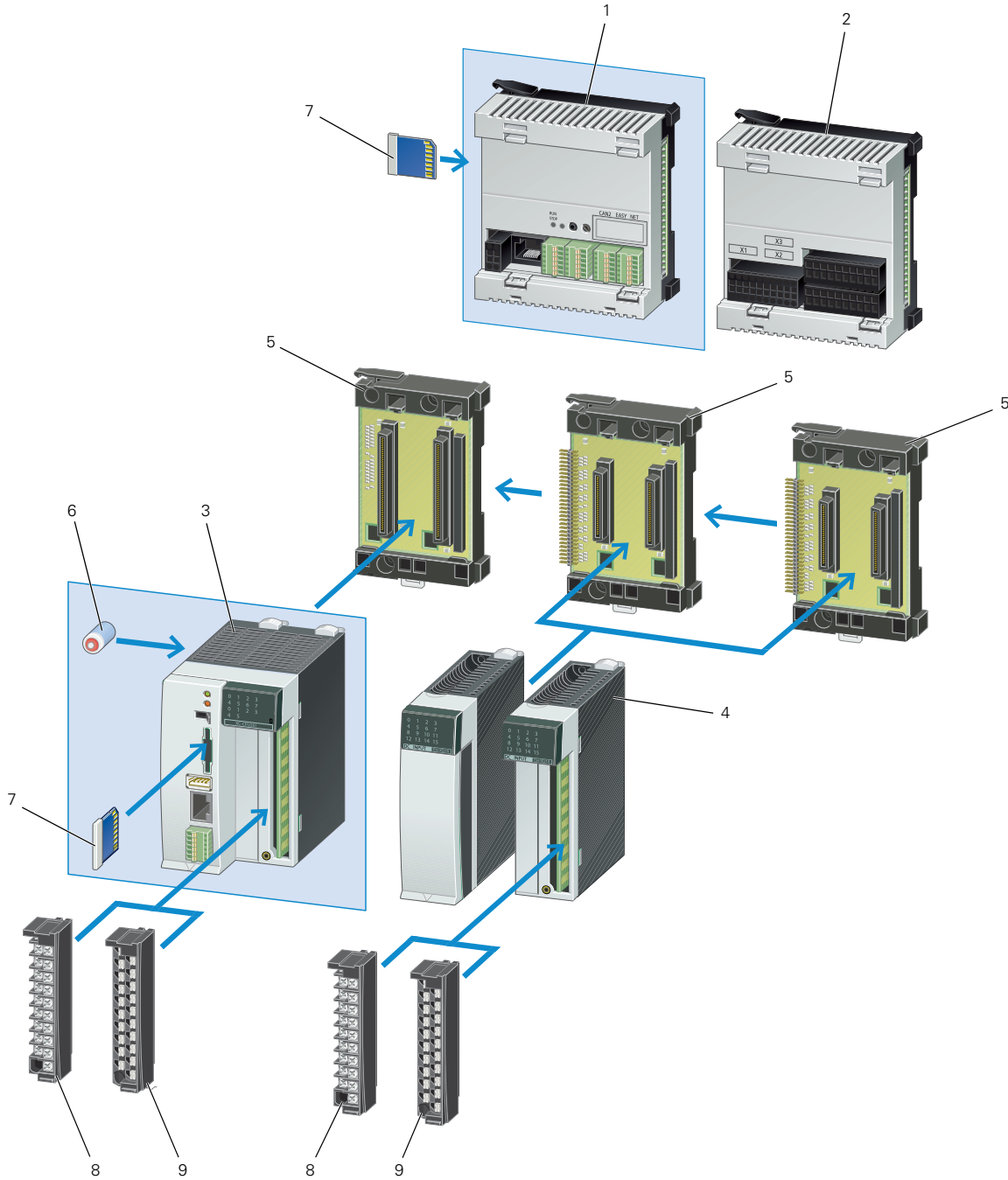

| Item Number | Description                |
|-------------|----------------------------|
| 1           | XC121 Compact PLC CPU      |
| 2           | XC121 I.O Expansion module |
| 3           | XC100/XC200 Modular PLC    |
| 4           | XIOC I/O modules           |
| 5           | XIOC Module backplane      |

| Item Number | Description                                |
|-------------|--|
| 6           | Battery                                    |
| 7           | SD Memory card                             |
| 8           | XIOC Terminal block, screw terminals       |
| 9           | XIOC Terminal block, spring-cage terminals |



**Product Selection**

**XC121 Compact PLC CPU**

Can be locally expanded with I/O module XIO-EXT-121-1.

- 24 Vdc input supply
- Real time clock
- 2 CANopen interfaces (500 kB)
- RS-232 interface for programming and communication
- Second RS-232/RS-485 interface
- Slot for SD memory card
- Spring-cage terminal blocks
- OPC server
- RUN/STOP switch

**XC121**

**XC121 Compact PLC**



| Program Memory Size | Cycle Time ① | Ethernet | CAN | Serial Interface              | Web Server | Pkg. Qty. | Style Number | Catalog Number          |
|---------------------|--------------|----------|-----|-------------------------------|------------|-----------|--------------|-------------------------|
| 256 kB              | <0.3 ms      | —        | 2   | 1, RS-232<br>1, RS-232/RS-485 | —          | 1         | 290446       | <b>XC-CPU121-2C256K</b> |

**XC121 I/O Expansion Module**

Base I/O module for the XC121.

- 10 digital inputs 24 Vdc
- 6 interrupt inputs
- 8 digital inputs/outputs 24 Vdc 0.5A
- 2 analog inputs 0–10V
- 2 analog inputs 0–20 mA
- 2 analog inputs PT100 RTD
- 2 analog outputs 0–10V
- Removable spring-cage terminals
- Expandable with 15 XIOC modules ②

**XC121 I/O Module**

**XC121 I/O Expansion Module**



| Digital Inputs | Digital Inputs/Outputs | Analog Inputs                          | Analog Outputs | Pkg. Qty. | Style Number | Catalog Number      |
|----------------|------------------------|--|----------------|-----------|--------------|---------------------|
| 10, 24 Vdc     | 8, 24 Vdc 0.5A         | 2, 0–10V<br>2, 0–20 mA<br>2, PT100 RTD | 2, 0–10V       | 1         | 290450       | <b>XIO-EXT121-1</b> |

**XC101 Modular PLCs**

Order backplane, terminals and battery separately.

- 24 Vdc input supply
- Real time clock
- Expandable with 15 XIOC modules
- 8 digital inputs
- 4 interrupt inputs
- 6 digital outputs
- RS-232 interface for programming and communication
- CANopen interface (500 kB)
- Slot for SD memory card
- RUN/STOP switch and LED indicators

**XC101**

**XC101 Modular PLCs**



| Program Memory Size | Cycle Time ① | Ethernet | CANOpen | Serial Interface | Web Server | Pkg. Qty. | Style Number | Catalog Number         |
|---------------------|--------------|----------|---------|------------------|------------|-----------|--------------|------------------------|
| 64 kB               | <0.5 ms      | —        | 1       | 1, RS-232 typ.   | —          | 1         | 262152       | <b>XC-CPU101-C64K</b>  |
| 128 kB              | <0.5 ms      | —        | 1       | 1, RS-232 typ.   | —          | 1         | 262146       | <b>XC-CPU101-C128K</b> |
| 256 kB              | <0.5 ms      | —        | 1       | 1, RS-232 typ.   | —          | 1         | 274399       | <b>XC-CPU101-C256K</b> |

**Notes**

- ① Cycle time per 1k of instructions.
- ② Except the XIOC-NET-DP-M module.

#### XC201 Modular PLCs

Order backplane, terminals and battery accessories separately.

- 24 Vdc input supply
- Real time clock
- Expandable with 15 XIOC modules
- 8 digital inputs
- 2 interrupt inputs
- Incremental encoder inputs
- High speed counter (50 kHz) inputs
- 6 digital outputs
- Ethernet and RS-232 interface for programming and communication
- CANopen interface (1 MB)
- Slot for SD memory card
- USB interface
- RUN/STOP switch and LED indicators
- Built-in Web server on XV models

#### XC201



#### XC201 Modular PLCs

| Program Memory Size             | Cycle Time ① | Ethernet | CANOpen | Serial Interface | Web Server | Pkg. Qty. | Style Number | Catalog Number             |
|---------------------------------|--------------|----------|---------|------------------|------------|-----------|--------------|----------------------------|
| 256 kB                          | <0.15 ms     | ✓        | 1       | 1, RS-232        | —          | 1         | 262155       | <b>XC-CPU201-EC256K</b>    |
| 2 MB                            | <0.15 ms     | ✓        | 1       | 1, RS-232        | —          | 1         | 262157       | <b>XC-CPU201-EC512K</b>    |
| 256 kB<br>Integrated web server | <0.15 ms     | ✓        | 1       | 1, RS-232        | ✓          | 1         | 262156       | <b>XC-CPU201-EC256K-XV</b> |
| 2 MB<br>Integrated web server   | <0.15 ms     | ✓        | 1       | 1, RS-232        | ✓          | 1         | 262158       | <b>XC-CPU201-EC512K-XV</b> |

#### XC202 Modular PLCs

Order backplane, terminals and battery accessories separately.

- 24 Vdc input supply
- Real time clock
- Expandable with 15 XIOC modules
- 8 digital inputs
- 2 interrupt inputs
- Incremental encoder inputs
- High speed counter (50 kHz) inputs
- 6 digital outputs
- Ethernet and RS-232 interface for programming and communication
- CANopen interface (1 MB)
- Slot for SD memory card
- USB interface
- RUN/STOP switch and LED indicators
- Built-in Web server

#### XC202



#### XC202 Modular PLCs

| Program Memory Size           | Cycle Time ① | Ethernet | CANOpen | Serial Interface | Web Server | Pkg. Qty. | Style Number | Catalog Number           |
|-------------------------------|--------------|----------|---------|------------------|------------|-----------|--------------|--------------------------|
| 4 MB<br>Integrated web server | <0.025 ms    | ✓        | 1       | 1, RS-232        | ✓          | 1         | 134238       | <b>XC-CPU202-EC4M-XV</b> |

#### XIOC Expansion Modules

Order screw, spring-cage terminals or 40-pin connector cable for 32 I/O modules separately.

- 8, 16 and 32 input modules
- 8, 16 and 32 output modules
- User configurable input/output module
- Isolated relay output module

#### XIOC—Digital

#### XIOC Digital Expansion Modules



| Description  | Pkg. Qty. | Style Number | Catalog Number     |
|--|-----------|--------------|--------------------|
| 8 inputs, 24 Vdc   | 1         | 257891       | <b>XIOC-8DI</b>    |
| 16 inputs, 24 Vdc  | 1         | 257892       | <b>XIOC-16DI</b>   |
| 32 inputs, 24 Vdc  | 1         | 267411       | <b>XIOC-32DI</b>   |
| 8 outputs, 24 Vdc, 0.3A  | 1         | 257894       | <b>XIOC-8DO</b>    |
| 16 outputs, 24 Vdc, 0.3A   | 1         | 257896       | <b>XIOC-16DO</b>   |
| 16 outputs, 24 Vdc, 0.8A, short-circuit protected                              | 1         | 257895       | <b>XIOC-16DO-S</b> |
| 16 terminals, 4 inputs, 12 configurable as inputs/outputs, 24 Vdc—outputs 0.5A | 1         | 262322       | <b>XIOC-16DX</b>   |
| 32 outputs, 24 Vdc, 0.2A   | 1         | 267413       | <b>XIOC-32DO</b>   |
| 12 relay outputs, isolated   | 1         | 257897       | <b>XIOC-12DO-R</b> |

#### Note

① Cycle time per 1k of instructions.

**XIOC—Analog**



**XIOC Analog Modules**

| Description  | Pkg. Qty. | Style Number | Catalog Number            |
|--|-----------|--------------|---------------------------|
| Inputs: 8 inputs 4–20 mA   | 1         | 262549       | <b>XIOC-8AI-I2</b>        |
| Inputs: 8 voltage inputs 0–10V   | 1         | 257899       | <b>XIOC-8AI-U1</b>        |
| Inputs: 8 voltage inputs, ±10V   | 1         | 257900       | <b>XIOC-8AI-U2</b>        |
| Inputs: 4 inputs for temperature monitoring, PT100/1000  | 1         | 257901       | <b>XIOC-4T-PT</b>         |
| Inputs: 4 inputs for thermocouples Type K, J, L, B, N, E, R, S, T                                      | 1         | 289933       | <b>XIOC-4AI-T</b>         |
| Outputs: 2 outputs, ±10V   | 1         | 257904       | <b>XIOC-2AO-U2</b>        |
| Outputs: 2 outputs 0–10V, 2 outputs 4–20 mA  | 1         | 257902       | <b>XIOC-2AO-U1-2AO-I2</b> |
| Outputs: 4 outputs 0–10 V  | 1         | 257903       | <b>XIOC-4AO-U1</b>        |
| Combination modules: 2 inputs and 1 output 0–10V/1 ms conversion time                                  | 1         | 262409       | <b>XIOC-2AI-1AO-U1</b>    |
| Combination modules: 2 inputs and 1 output 0–10V, 0–20 mA/1 ms conversion time, individual changeover  | 1         | 281545       | <b>XIOC-2AI-1AO-U1-I1</b> |
| Combination modules: 4 inputs and 2 outputs 0–10V/1 ms conversion time                                 | 1         | 262405       | <b>XIOC-4AI-2AO-U1</b>    |
| Combination modules: 4 inputs and 2 outputs 0–10V, 0–20 mA/1 ms conversion time, individual changeover | 1         | 281544       | <b>XIOC-4AI-2AO-U1-I1</b> |

**XIOC—Counter**



**Counter Modules**

| Description  | Pkg. Qty. | Style Number | Catalog Number           |
|--|-----------|--------------|--------------------------|
| 1 input up to 100 kHz, 24 Vdc, 5 Vdc, 2 digital transistor outputs, opto-isolated, 24 Vdc<br>30-pin connector required for counter module        | 1         | 257906       | <b>XIOC-1CNT-100KHZ</b>  |
| 2 inputs up to 100 kHz, (24 Vdc or 5V diff), 4 digital transistor outputs, opto-isolated, 24 Vdc<br>30-pin connector required for counter module | 1         | 257907       | <b>XIOC-2CNT-100KHZ</b>  |
| 2 incremental encoders up to 400 kHz, 5 Vdc, 2 analog outputs ±10V   | 1         | 262417       | <b>XIOC-2CNT-2AO-INC</b> |

**XIOC—Communication Card**



**Communication Modules**

| Description   | Pkg. Qty. | Style Number | Catalog Number       |
|---|-----------|--------------|----------------------|
| PROFIBUS-DP master module   | 1         | 257908       | <b>XIOC-NET-DP-M</b> |
| PROFIBUS-DP node module   | 1         | 286419       | <b>XIOC-NET-DP-S</b> |
| Serial interfaces: RS-232C, RS-485, RS-422 (for XC101, XC201 and XC202)<br>Modes of operation: Transparent mode, Modbus master/node | 1         | 267191       | <b>XIOC-SER</b>      |
| Serial interfaces: RS-232C, RS-485, RS-422 (for XC201 and XC202 only)<br>Modes of operation: Transparent mode, Modbus master/node   | 1         | 135265       | <b>XIOC-TC1</b>      |

#### Accessories

4

##### Terminals



##### Terminals

One 18 pole terminal plug is required for each digital and analog module.

| Description   | Pkg. Qty. | Style Number | Catalog Number          |
|---|-----------|--------------|-------------------------|
| 18-pin connector with screw terminals for digital or analog I/O                             | 10        | 258102       | <b>XIOC-TERM-18S</b>    |
| 18-pin connector with spring-cage terminal for digital or analog I/O                        | 10        | 258104       | <b>XIOC-TERM-18T</b>    |
| 40-pin connector for digital module, with 4 m cable<br>XIOC-32DI<br>XIOC-32DO               | 1         | 267414       | <b>XIOC-TERM32</b>      |
| 30-pin connector for counter module, with 4 m cable<br>XIOC-1CNT-100KHZ<br>XIOC-2CNT-100KHZ | 1         | 262248       | <b>XIOC-TERM30-CNT4</b> |

##### Module Backplane

##### Backplane



| Description   | Pkg. Qty. | Style Number | Catalog Number    |
|---|-----------|--------------|-------------------|
| Basic backplane for mounting XC100/200 on top-hat rail, can be expanded<br>Width: 2 slots for controller          | 1         | 260792       | <b>XIOC-BP-XC</b> |
| Expansion backplane for mounting XIOC modules on top-hat rail, can be expanded<br>Width: 2 slots for XIOC modules | 1         | 260794       | <b>XIOC-BP-2</b>  |

##### Backplane



|  |   |        |                    |
|--|---|--------|--------------------|
| Basic backplane for mounting XC100/200 on DIN rail, can be expanded<br>Width: 3 slots for controller and one XIOC module   | 1 | 260793 | <b>XIOC-BP-XC1</b> |
| Expansion backplane for mounting XIOC modules on DIN rail, can be expanded<br>Width: 3 slots for XIOC modules              | 1 | 260795 | <b>XIOC-BP-3</b>   |
| Expansion backplane for mounting XIOC modules on DIN rail, can be expanded<br>Width: 3 slots for XIOC modules <sup>①</sup> | 1 | 274291 | <b>XIOC-BP-EXT</b> |

##### Memory Card



##### Memory Card

For storage of programs, data, recipes for XC100, XC121, XC200.

| Description | Pkg. Qty. | Style Number | Catalog Number       |
|-------------|-----------|--------------|----------------------|
| 512 MB      | 1         | 138257       | <b>XT-MEM-MM512M</b> |
| 32 MB       | 1         | 262731       | <b>XT-MEM-MM32M</b>  |

##### Note

<sup>①</sup> Module backplane for expansion with up to 15 modules, must be plugged into the 6th slot.

**Battery**



**Battery**

| Description   | Pkg. Qty. | Style Number | Catalog Number     |
|---|-----------|--------------|--------------------|
| Lithium 1/2 AA 3.6V battery for backup of real-time clock | 1         | 256209       | <b>XT-CPU-BAT1</b> |

**Programming Cables**

| Description                                   | Pkg. Qty. | Style Number | Catalog Number       |
|---|-----------|--------------|----------------------|
| <b>D-Sub 9-Pin</b><br>2m, D-sub 9-pin, serial | 1         | 262186       | <b>XT-SUB-D/RJ45</b> |
| <b>Ethernet Cross</b><br>2m, Ethernet cross   | 1         | 256487       | <b>XT-CAT5-X-2</b>   |
| 5m, Ethernet cross                            | 1         | 256488       | <b>XT-CAT5-X-5</b>   |

**D-Sub 9-Pin**



**Ethernet Cross**



**Programming**

|  |   |        |                           |
|--|---|--------|---------------------------|
| Programming cable for XC through USB interface | 1 | 115735 | <b>EU4A-RJ45-USB-CAB1</b> |
|--|---|--------|---------------------------|



**Connection Cable**

**Connection Cables**

| Description  | Pkg. Qty. | Style Number | Catalog Number     |
|--|-----------|--------------|--------------------|
| 0.3m: Connection cable for XC200 to interface switch | 1         | 256283       | <b>EASY-NT-30</b>  |
| 0.8m: Connection cable for XC200 to interface switch | 1         | 256284       | <b>EASY-NT-80</b>  |
| 1.5m: Connection cable for XC200 to interface switch | 1         | 256285       | <b>EASY-NT-150</b> |



**Empty Module**

**Empty Module**

| Description                           | Pkg. Qty. | Style Number | Catalog Number  |
|---------------------------------------|-----------|--------------|-----------------|
| Empty module to cover open XIOC slots | 1         | 288894       | <b>XIOC-NOP</b> |



**Interface Switch**

**Interface Switch**

| Description   | Pkg. Qty. | Style Number | Catalog Number           |
|---|-----------|--------------|--------------------------|
| Interface adapter to split the combined RS-232/Ethernet interface of the XC200 into RJ45 sockets. Connection cable EASY-NT-30/80/150 usable for connection to XC200 | 1         | 289170       | <b>XT-RJ45-ETH-RS232</b> |



**Filter**

**Filter**

| Description  | Pkg. Qty. | Style Number | Catalog Number  |
|--|-----------|--------------|-----------------|
| Interference suppression of the external 24 Vdc supply of the XC100/200. Maximum current consumption: 2.2A | 1         | 285316       | <b>XT-FIL-1</b> |
| Power supply interference suppression of I/O modules of XC100/200. Maximum current consumption: 12A        | 1         | 118980       | <b>XT-FIL-2</b> |



#### XSoft-CoDeSys-2 Software

*Combined Logic and Visualization Development for XC Series PLCs and XV Series HMI-PLCs*

#### IEC 61131-3 Programming Languages

- Ladder Diagram
- Structured Text
- Sequential function chart
- Function block diagram
- Freely definable function block chart/continuous function chart
- Instruction List

#### Project Development

- Automatic variable declaration
- On-line editing
- Pop-up variable and function search/pick tools
- Automatic formatting and color coding of logic/declaration text
- Re-usable Visual-Logic Function Blocks

#### Debugging and commissioning

XSoft-CoDeSys-2 offers you a number of important functions for debugging, testing and commissioning your applications quickly and efficiently.

All these features are available as soon as you log on to the XV HMI-PLC or XC200 PLC (online mode) over an Ethernet connection.

#### Target Visualization

Integrated design of Operator Interface screens for the XV HMI-PLC series. Visualization and logic developed as part of the same project. Simplifies screen design and always keeps the Logic and visualization in synch.

#### Web Visualization

Optionally XSoft-CoDeSys-2 can automatically generate XML-based runtime screens to make the screens from the XV HMI-PLC accessible remotely using a web browser with a JavaScript plug-in such as Internet Explorer®, Firefox® and others.

#### Simulation

Users can also test the application when the XV HMI-PLC is not connected to the process. This is possible thanks to the integrated online simulation feature. Simulation supports both the screens and logic that have been designed using XSoft-CoDeSys.

#### Advanced Features

- Up to 16 time and/or event driven tasks per project
- Each task can include multiple logic programs or subroutines
- Programs and screen designs can be exported and imported to support reuse
- Powerful, built-in function block libraries
- Ability to create user-defined function blocks

- Fieldbus Configurator for CANopen, PROFIBUS-DP and SmartWire-DT device I/O
- Ethernet and serial communication function blocks (OPC server, UDP, TCP/IP, FTP client/ server, Modbus Master/Node, email, SMS, and more)
- 8 level password protection
- Web access selectable per screen
- System function libraries (OS Storage Card, and more)
- On-line and historical alarms
- On-line and historical trends

#### System Requirements

Windows XP and Windows 7 32-bit systems

#### XSoft-CoDeSys-2

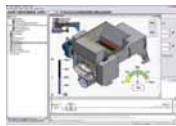

#### XSoft-CoDeSys-2 Software

| Description               | Catalog Number       |
|---------------------------|----------------------|
| Single Seat License       | SW-XSOFT-CODESYS-2-S |
| Multiple Seat License (3) | SW-XSOFT-CODESYS-2-M |

## Technical Data and Specifications

### XC121 Compact PLC

| Description  | Unit             | XC-CPU121-2C256K   |
|--|------------------|--|
| <b>General</b>   |                  |  |
| Standards  |                  | IEC/EN 61131-2; EN 50178   |
| Ambient temperature  | °F (°C)          | 32° to 131° (0° to 55°)  |
| Storage  | °F (°C)          | −13° to 158° (−25° to 70°)   |
| Mounting position  |                  | Horizontal   |
| Relative humidity, noncondensing (IEC/EN 60068-2-30)           | %                | 10–95  |
| Air pressure (in operation)                                    | hPa              | 795–1080   |
| Vibration resistance   |                  | Frequency 5–9 Hz; 3.5 mm amplitude<br>9–150 Hz; 1.0g constant acceleration |
| Mechanical shock resistance                                    |                  | 15g/11 ms  |
| Overvoltage category   |                  | II   |
| Pollution degree   |                  | 2  |
| Degree of protection   |                  | IP20   |
| Rated insulation voltage (U <sub>i</sub> )                     | V                | 500  |
| Emitted interference   |                  | EN 61000-6-4   |
| Interference immunity  |                  | EN 61000-6-2   |
| Backup time  |                  | At least 72 hours  |
| Weight   | kg               | 0.15   |
| <b>Electromagnetic Compatibility (EMC)</b>                     |                  | Refer to Page <b>V7-T4-54</b>  |
| <b>Connections</b>   |                  |  |
| Supply voltage   |                  |  |
| Connection type  |                  | —  |
| Terminal capacity  | mm <sup>2</sup>  | 0.14–1 (AWG28-18)  |
| COM1 interface   |                  |  |
| Connection type  |                  | RJ45   |
| COM2, CAN1, CAN2 interfaces                                    |                  |  |
| Connection type  |                  | Spring-loaded terminal block, 6-pole                                       |
| Terminal capacity  | mm <sup>2</sup>  | 0.14–0.5 (AWG28-20)  |
| <b>Power Supply</b>  |                  |  |
| Input voltage  | Vdc              | 24   |
| Permissible range  | Vdc              | 20.4–28.8  |
| Input power  | W                | Max. 1.44  |
| Input current  | mA               | 60   |
| Ripple   | %                | ≤5   |
| Maximum heat dissipation (without local I/O) (P <sub>v</sub> ) | W                | 6  |
| Overvoltage protection   |                  | Yes  |
| Protection against polarity reversal                           |                  | Yes  |
| Inrush current   | x I <sub>n</sub> | No limitation<br>(limited only by upstream 24 Vdc power supply unit)       |
| Supply failure bridging  |                  |  |
| Duration of power failure                                      | ms               | 10   |
| Repetition rate  | s                | 1  |
| External supply filter   |                  | Part No.: XT-FIL-1, Refer to <b>Page V7-T4-37</b>                          |
| <b>Memory</b>  |                  |  |
| Program code/program data                                      | kByte            | 256/244  |
| Marker/input/output/retain data                                | kByte            | 16/4/4/8   |
| Cycle time for 1k of instructions (bits, bytes)                | ms               | <0.3   |

**XC121 Compact PLC, continued**

| Description  | Unit   | XC-CPU121-2C256K   |
|--|--------|--|
| <b>Interfaces</b>  |        |  |
| Serial interface (RS-232) without handshake lines                              |        |  |
| Baud rate  | kbit/s | Programming (character format: 8 data bits, No parity, 1 stop bit) 19.2, 38.4 (default), 57.6        |
| Connector type   |        | RJ45   |
| Potential isolation  |        | No   |
| In transparent mode  |        |  |
| Baud rate  | kbit/s | 0.3, 0.6, 1.2, 2.4, 4.8, 9.6, 19.2, 38.4, 57.6, 115.2  |
| Character formats  |        | 8E1, 8O1, 8N1, 8N2, 7E2, 7O2, 7N2, 7E1   |
| Number of send bytes for block   |        | 190  |
| Number of receive bytes for block  |        | 190  |
| COM2 (RS-232/RS-485) without handshake lines                                   |        |  |
| Baud rate  | kbit/s | Transparent mode (setting through function blocks)<br>0.3, 0.6, 1.2, 2.4, 4.8, 9.6, 19.2, 38.4, 57.6 |
| Character formats  |        | 8E1, 8O1, 8N1, 8N2, 7E2, 7O2, 7N2, 7E1<br>(setting through function blocks)                          |
| Potential isolation  |        | No   |
| Bus termination  |        | External, for RS-485   |
| CAN1/CAN2 interface  |        |  |
| Baud rate  | kbit/s | 10 – 500   |
| Potential isolation  |        | No   |
| Stations   |        | 126  |
| Bus termination  |        | Adjustable for each interface (CAN1/CAN2)  |
| PDO type   |        | Asyn., cyc., acyc.   |
| <b>Power Supply of Local Inputs/Outputs (24 V<sub>Q</sub>/0 V<sub>Q</sub>)</b> |        |  |
| Input voltage  | Vdc    | 24   |
| Voltage range  | Vdc    | 19.2–30, observe polarity  |
| Potential isolation  |        |  |
| Between power supply and CPU voltage   |        | Yes  |
| Overvoltage protection   |        | Yes  |



**XC121 Expansion Module**

| Description  | Unit             | X10-EXT121-1   |
|--|------------------|--|
| <b>General</b>                                       |                  |  |
| Standards  |                  | IEC/EN 61131-2; EN 50178   |
| Ambient temperature                                  | °F (°C)          | 32° to 131° (0° to 55°)  |
| Storage  | °F (°C)          | −13° to 158° (−25° to 70°)   |
| Mounting position                                    |                  | Horizontal   |
| Relative humidity, noncondensing (IEC/EN 60068-2-30) | %                | 10–95  |
| Air pressure (in operation)                          | hPa              | 795–1080   |
| Vibration resistance                                 |                  | Frequency 5–9 Hz; 3.5 mm amplitude<br>9–150 Hz; 1.0g constant acceleration                         |
| Mechanical shock resistance                          |                  | 15g/11 ms  |
| Overvoltage category                                 |                  | II   |
| Pollution degree                                     |                  | 2  |
| Degree of protection                                 |                  | IP20   |
| Rated insulation voltage (U <sub>i</sub> )           | V                | 500  |
| Emitted interference                                 |                  | EN 61000-6-4   |
| Interference immunity                                |                  | EN 61000-6-2   |
| Backup time  |                  | At least 72 hours  |
| Weight   | kg               | 0.15   |
| <b>Electromagnetic Compatibility (EMC)</b>           |                  |  |
| Refer to Page <b>V7-T4-54</b>                        |                  |  |
| <b>Connections</b>                                   |                  |  |
| X1 connector   |                  |  |
| Connector type                                       |                  | Spring-loaded terminal block, 20 pole, B2L 3.5   |
| Terminal capacity (solid)                            | mm <sup>2</sup>  | 0.5–1  |
| X2/X3 connector                                      |                  |  |
| Connector type                                       |                  | Spring-loaded terminal block, 10-pole, BLZF 3.5/180 or<br>BLI/O 3.5/10F with LEDs                  |
| Terminal capacity (solid)                            | mm <sup>2</sup>  | 0.5–1  |
| <b>Power Supply</b>                                  |                  |  |
| Supply failure bridging                              |                  |  |
| Duration of power failure                            | ms               | 10   |
| Repetition rate                                      | s                | 1  |
| Input voltage  | Vdc              | 24   |
| Permissible range                                    | Vdc              | 20.4 – 28.8  |
| Input power  | W                | Max.1.68   |
| Input current  | mA               | 70   |
| Ripple   | %                | ≤5   |
| Overvoltage protection                               |                  | Yes  |
| Protection against polarity reversal                 |                  | Yes  |
| Inrush current                                       | x I <sub>n</sub> | Max. 1A  |
| Output voltage for signal modules                    |                  |  |
| Max. field current (I <sub>f</sub> )                 | A                | 2  |
| <b>Digital Inputs</b>                                |                  |  |
| Number   |                  | X2: 9 with plug BLI/O 3.5/10F or 10 with plug BLZF 3.5/<br>180 X3: 8 (can also be used as outputs) |
| Rated voltage (U <sub>0</sub> )                      | Vdc              | 24   |
| At state "0" (U <sub>0</sub> )                       | Vdc              | <5   |
| At state "1" (U <sub>0</sub> )                       | Vdc              | >15  |
| Rated operational current                            |                  |  |
| At state "1" (I <sub>0</sub> )                       | mA               | 3.3  |
| Delay time   |                  |  |
| X2: DI0–DI3  | μs               | 20   |
| X2: DI4–DI9  | μs               | 250  |
| X2: DX0–DX7  | ms               | 20   |
| Potential isolation                                  |                  | No   |

**XC121 Expansion Module, continued**

| Description   | Unit    | XIO-EXT121-1                          |
|---|---------|---------------------------------------|
| <b>Digital Outputs</b>                              |         |                                       |
| Number  |         | At X3: 8 (can also be used as inputs) |
| Rated voltage                                       |         |                                       |
| Rated voltage ( $U_o$ )                             | Vdc     | 24                                    |
| Permissible range                                   |         | 20.4–28.8 Vdc                         |
| Ripple  | %       | ≤5                                    |
| Rated operational current                           |         |                                       |
| At state "1" ( $I_o$ )                              | A       | 0.5 at 24 Vac                         |
| Utilization factor (%)                              | g       | 1                                     |
| Maximum duty factor                                 | ms      | 100%                                  |
| Lamp load without ( $R_v$ )                         | W       | 5                                     |
| Potential isolation                                 |         | No                                    |
| Residual current at state "0" per channel           | mA      | <0.1                                  |
| Max. output voltage                                 |         |                                       |
| At state "0" with external load <10M ohms           | V       | 2.5                                   |
| At state "1" at $I_o = 0.5A$                        | V       | $U = U_o - 1V$                        |
| Short-circuit tripping current                      |         |                                       |
| Short-circuit tripping current for $R_a < 10M$ ohms | A       | $0.7 \leq I_o \leq 2$ for output      |
| Total short-circuit current                         | A       | 16                                    |
| Peak short-circuit current                          | A       | 32                                    |
| Max. operating frequency                            | ops/h   | 40,000                                |
| Parallel connection capability                      |         | Yes                                   |
| <b>Analog Inputs 0–10V</b>                          |         |                                       |
| Number of channels                                  |         | 2                                     |
| Primary voltage range                               | V       | 0–10                                  |
| Resolution  | bit     | 10                                    |
| Conversion time                                     | ms      | ≤5                                    |
| Overall accuracy                                    |         | ≤ ± 1% (of full-scale value)          |
| Input resistance                                    | kohm    | 200                                   |
| <b>Analog Inputs 0–20 mA</b>                        |         |                                       |
| Number of channels                                  |         | 2                                     |
| Primary voltage range                               | mA      | 0–20                                  |
| Resolution  | bit     | 10                                    |
| Conversion time                                     | ms      | ≤5                                    |
| Overall accuracy                                    |         | ≤ ± 1% (of full-scale value)          |
| Input resistance                                    | ohm     | 50                                    |
| <b>PT100 RTD</b>                                    |         |                                       |
| Number of channels                                  |         | 2                                     |
| Temperature range                                   | °F (°C) | –348° to 392° (–200° to 200°)         |
| Resistance range                                    | ohm     | 18.5–175.8                            |
| Resolution  | bit     | 10                                    |
| Overall accuracy                                    |         | ≤ ± 2%                                |
| <b>Analog Outputs</b>                               |         |                                       |
| Number of channels                                  |         | 2                                     |
| Secondary voltage range                             | V       | 0–10                                  |
| Resolution  | bit     | 12                                    |
| Conversion time                                     | ms      | ≤5                                    |
| Overall accuracy                                    |         | ≤ ± 1% (of full-scale value)          |
| External load resistance (R)                        | kohm    | 10                                    |

## XC101 Modular PLCs

| Description  | Unit             | XC-CPU101-C64K-8DI-6DO                                   | XC-CPU101-C128K-8DI-6DO       | XC-CPU101-FC128K-8DI-6DO   | XC-CPU101-C256K-8DI-6DO    |
|--|------------------|--|-------------------------------|----------------------------|----------------------------|
| <b>General</b>   |                  |  |                               |                            |                            |
| Standards  |                  | IEC/EN 61131-2; EN 50178                                 | IEC/EN 61131-2; EN 50178      | IEC/EN 61131-2; EN 50178   | IEC/EN 61131-2; EN 50178   |
| Ambient temperature  | °F (°C)          | 32° to 131° (0° to 55°)                                  | 32° to 131° (0° to 55°)       | 32° to 131° (0° to 55°)    | 32° to 131° (0° to 55°)    |
| Storage  | °F (°C)          | –13° to 158° (–25° to 70°)                               | –13° to 158° (–25° to 70°)    | –13° to 158° (–25° to 70°) | –13° to 158° (–25° to 70°) |
| Mounting position  |                  | Horizontal   | Horizontal                    | Horizontal                 | Horizontal                 |
| Relative humidity, noncondensing (IEC/EN 60068-2-30)           | %                | 10–95  | 10–95                         | 10–95                      | 10–95                      |
| Air pressure (in operation)                                    | hPa              | 795–1080   | 795–1080                      | 795–1080                   | 795–1080                   |
| Vibration resistance   |                  | 10–57 Hz ±0.075 mm/57–150 Hz ±1.0g                       |                               |                            |                            |
| Mechanical shock resistance                                    |                  | 15g/11 ms  | 15g/11 ms                     | 15g/11 ms                  | 15g/11 ms                  |
| Overvoltage category   |                  | II   | II                            | II                         | II                         |
| Pollution degree   |                  | 2  | 2                             | 2                          | 2                          |
| Degree of protection   |                  | IP20   | IP20                          | IP20                       | IP20                       |
| Rated insulation voltage (U <sub>i</sub> )                     | V                | 500  | 500                           | 500                        | 500                        |
| Emitted interference   | U <sub>i</sub>   | EN 61000-6-4, Class A                                    | EN 61000-6-4, Class A         | EN 61000-6-4, Class A      | EN 61000-6-4, Class A      |
| Interference immunity  |                  | EN 61000-6-2   | EN 61000-6-2                  | EN 61000-6-2               | EN 61000-6-2               |
| Battery (lifespan)   |                  | Normally 5 years   | Normally 5 years              | Normally 5 years           | Normally 5 years           |
| Weight   | kg               | 0.23   | 0.23                          | 0.23                       | 0.23                       |
| Terminals  |                  | Plug-in terminal block                                   | Plug-in terminal block        | Plug-in terminal block     | Plug-in terminal block     |
| <b>Terminal capacity</b>                                       |                  |  |                               |                            |                            |
| <b>Screw terminals</b>   |                  |  |                               |                            |                            |
| Flexible with ferrule  | mm <sup>2</sup>  | 0.5–1.5  | 0.5–1.5                       | 0.5–1.5                    | 0.5–1.5                    |
| Solid  | mm <sup>2</sup>  | 0.5–2.5  | 0.5–2.5                       | 0.5–2.5                    | 0.5–2.5                    |
| <b>Spring-cage terminal</b>                                    |                  |  |                               |                            |                            |
| Flexible   | mm <sup>2</sup>  | 0.34–1.0   | 0.34–1.0                      | 0.34–1.0                   | 0.34–1.0                   |
| Solid  | mm <sup>2</sup>  | 0.14–1.0   | 0.14–1.0                      | 0.14–1.0                   | 0.14–1.0                   |
| <b>Electromagnetic Compatibility (EMC)</b>                     |                  |  | Refer to Page <b>V7-T4-54</b> |                            |                            |
| <b>Power Supply</b>  |                  |  |                               |                            |                            |
| Mains failure duration   | ms               | 10   | 10                            | 10                         | 10                         |
| Repetition rate  | s                | 1  | 1                             | 1                          | 1                          |
| Input voltage  | Vdc              | 24   | 24                            | 24                         | 24                         |
| Permissible range  | Vdc              | 20.4–28.8  | 20.4–28.8                     | 20.4–28.8                  | 20.4–28.8                  |
| Input power  | W                | Max. 26  | Max. 26                       | Max. 26                    | Max. 26                    |
| Ripple   | %                | ≤5   | ≤5                            | ≤5                         | ≤5                         |
| Maximum heat dissipation (without local I/O) (P <sub>v</sub> ) | W                | 6  | 6                             | 6                          | 6                          |
| Overvoltage protection   |                  | Yes  | Yes                           | Yes                        | Yes                        |
| Protection against polarity reversal                           |                  | Yes  | Yes                           | Yes                        | Yes                        |
| Mains filter (external)  |                  | Yes  | Yes                           | Yes                        | Yes                        |
| Inrush current   | x I <sub>n</sub> | Not limited, (limiting only by a supply-side 24 Vdc PSU) |                               |                            |                            |
| <b>Output voltage for signal modules</b>                       |                  |  |                               |                            |                            |
| Rated value  | Vdc              | 5  | 5                             | 5                          | 5                          |
| Output current   | A                | 3.2  | 3.2                           | 3.2                        | 3.2                        |
| Short-circuit rating   |                  | Yes  | Yes                           | Yes                        | Yes                        |
| Isolated from supply voltage                                   |                  | No   | No                            | No                         | No                         |
| <b>CPU</b>   |                  |  |                               |                            |                            |
| Microprocessor   |                  | Infineon C164  | Infineon C164                 | Infineon C164              | Infineon C164              |
| <b>Memory</b>  |                  |  |                               |                            |                            |
| Program code/program data                                      | kByte            | 64/64  | 128/128                       | 128/128                    | 256/256                    |
| Marker/retain data   | kByte            | 4/4  | 8/8                           | 8/8                        | 8/8                        |
| Cycle time for 1k of instructions (bits, bytes)                | ms               | <0.5   | <0.5                          | <0.5                       | <0.5                       |

## XC101 Modular PLCs, continued

| Description  | Unit            | XC-CPU101-C64K-8DI-6DO                           | XC-CPU101-C128K-8DI-6DO                          | XC-CPU101-FC128K-8DI-6DO  | XC-CPU101-C256K-8DI-6DO                          |
|--|-----------------|--|--|---|--|
| <b>Interfaces</b>  |                 |  |  |   |  |
| Serial interface (RS-232) without handshake lines                                |                 |  |  |   |  |
| Baud rate  | kbit/s          | Max. 57.6  | Max. 57.6  | Max. 57.6   | Max. 57.6  |
| Connections  |                 | RJ45   | RJ45   | RJ45  | RJ45   |
| Potential isolation  |                 | No   | No   | No  | No   |
| CANopen  |                 |  |  |   |  |
| Maximum data transfer rate   | bit/s           | 500,000  | 500,000  | 500,000   | 500,000  |
| Potential isolation  |                 | Yes  | Yes  | Yes   | Yes  |
| Device profile   |                 | To DS 301 V4                                     | To DS 301 V4                                     | To DS 301 V4  | To DS 301 V4                                     |
| PDO type   |                 | Asyn., cyc., acyc.                               | Asyn., cyc., acyc.                               | Asyn., cyc., acyc.  | Asyn., cyc., acyc.                               |
| Connection   |                 | Plug-in terminal block                           | Plug-in terminal block                           | Optical fiber interface, wavelength 660 nm, plug for example HFBR-4516 Agilent Technologies | Plug-in terminal block                           |
| Bus terminating resistors  |                 |  |  |   |  |
| Stations   | Number          | Max. 126   | Max. 126   | Max. 126  | Max. 126   |
| Watchdog   |                 | Yes  | Yes  | Yes   | Yes  |
| RTC (real-time clock)  |                 | Yes  | Yes  | Yes   | Yes  |
| <b>Power Supply of Local Inputs/Outputs (24 V<sub>DC</sub>/0 V<sub>DC</sub>)</b> |                 |  |  |   |  |
| Input voltage  | V <sub>DC</sub> | 24   | 24   | 24  | 24   |
| Voltage range  | V <sub>DC</sub> | 19.2–30, observe polarity                        | 19.2–30, observe polarity                        | 19.2–30, observe polarity   | 19.2–30, observe polarity                        |
| Potential isolation  |                 |  |  |   |  |
| Between power supply and CPU voltage   |                 | Yes  | Yes  | Yes   | Yes  |
| Overvoltage protection   |                 | Yes  | Yes  | Yes   | Yes  |
| Protection against polarity reversal   |                 | Yes  | Yes  | Yes   | Yes  |
| <b>Digital Inputs</b>  |                 |  |  |   |  |
| Input current for channel at rated voltage                                       | mA              | Normally 3.5                                     | Normally 3.5                                     | Normally 3.5  | Normally 3.5                                     |
| Heat dissipation for channel   | mW              | Normally 85                                      | Normally 85                                      | Normally 85   | Normally 85                                      |
| Voltage level to IEC/EN 61131-2  |                 |  |  |   |  |
| Limit value type 1   |                 | Low <5 V <sub>DC</sub> /High >15 V <sub>DC</sub> | Low <5 V <sub>DC</sub> /High >15 V <sub>DC</sub> | Low <5 V <sub>DC</sub> /High >15 V <sub>DC</sub>  | Low <5 V <sub>DC</sub> /High >15 V <sub>DC</sub> |
| Input delay  |                 |  |  |   |  |
| OFF → ON   | ms              | Normally 0.1                                     | Normally 0.1                                     | Normally 0.1  | Normally 0.1                                     |
| ON → OFF   | ms              | Normally 0.1                                     | Normally 0.1                                     | Normally 0.1  | Normally 0.1                                     |
| Inputs   | Number          | 8 (of which 4 interrupt inputs)                  | 8 (of which 4 interrupt inputs)                  | 8 (of which 4 interrupt inputs)   | 8 (of which 4 interrupt inputs)                  |
| Channels with the same reference potential                                       | Number          | 8  | 8  | 8   | 8  |
| Status indication  |                 | LED  | LED  | LED   | LED  |
| <b>Digital Outputs</b>   |                 |  |  |   |  |
| Channels   | Number          | 6  | 6  | 6   | 6  |
| Heat dissipation for channel   | W               | 0.08   | 0.08   | 0.08  | 0.08   |
| Load circuits  | A               | 0.5  | 0.5  | 0.5   | 0.5  |
| Output delay   |                 |  |  |   |  |
| OFF → ON   |                 | Normally 0.1 ms                                  | Normally 0.1 ms                                  | Normally 0.1 ms   | Normally 0.1 ms                                  |
| ON → OFF   |                 | Normally 0.1 ms                                  | Normally 0.1 ms                                  | Normally 0.1 ms   | Normally 0.1 ms                                  |
| Channels with the same reference potential                                       | Number          | 6  | 6  | 6   | 6  |
| Status indication  |                 | LED  | LED  | LED   | LED  |
| Switching capacity   |                 | IEC/EN 60947-5-1, utilization category DC-13     | IEC/EN 60947-5-1, utilization category DC-13     | IEC/EN 60947-5-1, utilization category DC-13  | IEC/EN 60947-5-1, utilization category DC-13     |
| Duty factor  | % DF            | 100  | 100  | 100   | 100  |
| Utilization factor   | g               | 1  | 1  | 1   | 1  |

## XC200 Series Modular PLCs

| Description  | Unit             | XC-CPU201-EC256K-8DI-6DO(-XV)                           | XC-CPU201-EC512K-8DI-6DO(-XV)         | XC-CPU202-EC4M-8DI-6DO-XV             |
|--|------------------|---|---------------------------------------|---------------------------------------|
| <b>General</b>                                       |                  |   |                                       |                                       |
| Standards  |                  | IEC/EN 61131-2; EN 50178                                | IEC/EN 61131-2; EN 50178              | IEC/EN 61131-2; EN 50178              |
| Ambient temperature                                  | °F (°C)          | 32° to 131° (0° to 55°)                                 | 32° to 131° (0° to 55°)               | 32° to 131° (0° to 55°)               |
| Storage  | °F (°C)          | -13° to 158° (-25° to 70°)                              | -13° to 158° (-25° to 70°)            | -13° to 158° (-25° to 70°)            |
| Mounting position                                    |                  | Horizontal  | Horizontal                            | Horizontal                            |
| Relative humidity, noncondensing (IEC/EN 60068-2-30) | %                | 10–95   | 10–95                                 | 10–95                                 |
| Air pressure (in operation)                          | hPa              | 795–1080  | 795–1080                              | 795–1080                              |
| Vibration resistance                                 |                  | 10–57 Hz ±0.075 mm<br>57–150 Hz ±1.0g                   | 10–57 Hz ±0.075 mm<br>57–150 Hz ±1.0g | 10–57 Hz ±0.075 mm<br>57–150 Hz ±1.0g |
| Mechanical shock resistance                          |                  | 15g/11 ms   | 15g/11 ms                             | 15g/11 ms                             |
| Overvoltage category                                 |                  | II  | II                                    | II                                    |
| Pollution degree                                     |                  | 2   | 2                                     | 2                                     |
| Degree of protection                                 |                  | IP20  | IP20                                  | IP20                                  |
| Rated impulse withstand voltage (U <sub>imp</sub> )  | V                | 850   | 850                                   | 850                                   |
| Emitted interference                                 |                  | EN 61000-6-4, Class A                                   | EN 61000-6-4, Class A                 | EN 61000-6-4, Class A                 |
| Interference immunity                                |                  | EN 61000-6-2  | EN 61000-6-2                          | EN 61000-6-2                          |
| Battery (lifespan)                                   |                  | Normally 5 years  | Normally 5 years                      | Normally 5 years                      |
| Weight   | kg               | 0.23  | 0.23                                  | 0.23                                  |
| Terminals  |                  | Plug-in terminal block                                  | Plug-in terminal block                | Plug-in terminal block                |
| Terminal capacity                                    |                  |   |                                       |                                       |
| Screw terminals                                      |                  |   |                                       |                                       |
| Flexible with ferrule                                | mm <sup>2</sup>  | 0.5–1.5   | 0.5–1.5                               | 0.5–1.5                               |
| Solid  | mm <sup>2</sup>  | 0.5–2.5   | 0.5–2.5                               | 0.5–2.5                               |
| Spring-cage terminal                                 |                  |   |                                       |                                       |
| Flexible   | mm <sup>2</sup>  | 0.34–1.0  | 0.34–1.0                              | 0.34–1.0                              |
| Solid  | mm <sup>2</sup>  | 0.14–1.0  | 0.14–1.0                              | 0.14–1.0                              |
| <b>Electromagnetic Compatibility (EMC)</b>           |                  | Refer to Page <b>V7-T4-54</b>                           |                                       |                                       |
| <b>Power Supply</b>                                  |                  |   |                                       |                                       |
| Duration of mains failure                            | ms               | 10  | 10                                    | 10                                    |
| Repetition rate                                      | s                | 1   | 1                                     | 1                                     |
| Input voltage  | Vdc              | 24  | 24                                    | 24                                    |
| Permissible range                                    | Vdc              | 20.4–28.8   | 20.4–28.8                             | 20.4–28.8                             |
| Input power  | W                | Max. 33   | Max. 33                               | Max. 33                               |
| Ripple   | %                | ≤5  | ≤5                                    | ≤5                                    |
| Maximum heat dissipation (P <sub>v</sub> )           | W                | 6   | 6                                     | 6                                     |
| Overvoltage protection                               |                  | Yes   | Yes                                   | Yes                                   |
| Protection against polarity reversal                 |                  | Yes   | Yes                                   | Yes                                   |
| Line filter  |                  | Yes   | Yes                                   | Yes                                   |
| Inrush current                                       | x I <sub>n</sub> | Not limited (limiting only by a supply-side 24 Vdc PSU) |                                       |                                       |
| Output voltage for signal modules                    |                  |   |                                       |                                       |
| Rated value  | Vdc              | 5   | 5                                     | 5                                     |
| Output current                                       | A                | 3.2   | 3.2                                   | 3.2                                   |
| Short-circuit rating                                 |                  | Yes   | Yes                                   | Yes                                   |
| Isolated from supply voltage                         |                  | No  | No                                    | No                                    |
| <b>CPU</b>   |                  |   |                                       |                                       |
| Microprocessor                                       |                  | NEC VR4181 A MIPS                                       | NEC VR4181 A MIPS                     | ARM 532 MHz                           |
| <b>Memory</b>  |                  |   |                                       |                                       |
| Program code/program data                            |                  | 256 kByte/256 kByte                                     | 2 Mbyte/512 kByte                     | 4 Mbyte/512 kByte                     |
| Marker/retain data                                   | kByte            | 16/32   | 16/32                                 | 16/64                                 |
| Cycle time for 1k of instructions (bits, bytes)      | ms               | <0.15   | <0.15                                 | <0.025                                |

## XC200 Series Modular PLCs, continued

| Description  | Unit   | XC-CPU201-EC256K-8DI-6DO(-XV)  | XC-CPU201-EC512K-8DI-6DO(-XV) | XC-CPU202-EC4M-8DI-6DO-XV |
|--|--------|--|-------------------------------|---------------------------|
| <b>Interfaces</b>  |        |  |                               |                           |
| Ethernet   |        |  |                               |                           |
| Baud rate  | Mbit/s | 10/100–Autodetect  | 10/100–Autodetect             | 10/100–Autodetect         |
| Connector type   |        | RJ45   | RJ45                          | RJ45                      |
| Potential isolation  |        | No   | No                            | No                        |
| Serial interface (RS-232) without handshake lines                              |        |  |                               |                           |
| Baud rate  | kbit/s | Max. 115.2   | Max. 115.2                    | Max. 115.2                |
| Connector type   |        | RJ45   | RJ45                          | RJ45                      |
| Potential isolation  |        | No   | No                            | No                        |
| USB interface  |        | 1.0  | 1.0                           | 2.0                       |
| CANopen  |        |  |                               |                           |
| Maximum data transfer rate   | Mbit/s | 1  | 1                             | 1                         |
| Potential isolation  |        | Yes  | Yes                           | Yes                       |
| Device profile   |        | To DS 301 V4   | To DS 301 V4                  | To DS 301 V4              |
| PDO type   |        | Asyn., cyc., acyc.   | Asyn., cyc., acyc.            | Asyn., cyc., acyc.        |
| Connection   |        | Plug-in terminal block   | Plug-in terminal block        | Plug-in terminal block    |
| Bus terminating resistors  |        | External   | External                      | Internal                  |
| Stations   | Number | Max. 126   | Max. 126                      | Max. 126                  |
| Watchdog   |        | Yes  | Yes                           | Yes                       |
| RTC (real-time clock)  |        | Yes  | Yes                           | Yes                       |
| <b>Power Supply of Local Inputs/Outputs (24 V<sub>Q</sub>/0 V<sub>Q</sub>)</b> |        |  |                               |                           |
| Input voltage  | Vdc    | 24   | 24                            | 24                        |
| Voltage range  | Vdc    | 19.2–30, observe polarity  | 19.2–30, observe polarity     | 19.2–30, observe polarity |
| Potential isolation  |        |  |                               |                           |
| Between power supply and CPU voltage   |        | Yes  | Yes                           | Yes                       |
| Between power supply and inputs/outputs  |        | No   | No                            | No                        |
| Status indication  |        | LED  | LED                           | LED                       |
| Terminals  |        | Plug-in terminal block   | Plug-in terminal block        | Plug-in terminal block    |
| Overvoltage protection   |        | Yes  | Yes                           | Yes                       |
| Protection against polarity reversal   |        | Yes  | Yes                           | Yes                       |
| <b>Digital Inputs</b>  |        |  |                               |                           |
| Input current per channel at rated voltage                                     | mA     | Normally 3.5   | Normally 3.5                  | Normally 3.5              |
| Heat dissipation per channel   |        | Normally 85m W   | Normally 85m W                | Normally 85m W            |
| Voltage level to IEC/EN 61131-2  |        |  |                               |                           |
| Limit value type 1   |        | Low <5 Vdc/High >15 Vdc  | Low <5 Vdc/High >15 Vdc       | Low <5 Vdc/High >15 Vdc   |
| Input delay  |        |  |                               |                           |
| OFF → ON   | ms     | Type 0.1   | Type 0.1                      | Type 0.1                  |
| ON → OFF   | ms     | Type 0.1   | Type 0.1                      | Type 0.1                  |
| Inputs   | Number | 8, of which parameterizable: 2 counters, 50 kHz, 2 interrupt inputs, 1 incremental input |                               |                           |
| Channels with the same reference potential                                     | Number | 8  | 8                             | 8                         |
| Status indication  |        | LED  | LED                           | LED                       |
| <b>Digital Outputs</b>   |        |  |                               |                           |
| Channels   | Number | 6  | 6                             | 6                         |
| Heat dissipation per channel   | W      | 0.08   | 0.08                          | 0.08                      |
| Load circuits  | A      | 0.5  | 0.5                           | 0.5                       |
| Output delay   |        |  |                               |                           |
| OFF → ON   |        | Normally 0.1 ms  | Normally 0.1 ms               | Normally 0.1 ms           |
| ON → OFF   |        | Normally 0.1 ms  | Normally 0.1 ms               | Normally 0.1 ms           |
| Channels with the same reference potential                                     | Number | 6  | 6                             | 6                         |
| Status indication  |        | LED  | LED                           | LED                       |
| Switching capacity   |        | IEC/EN 60947-5-1, utilization category DC-13   |                               |                           |
| Duty factor  | % DF   | 100  | 100                           | 100                       |
| Utilization factor   | g      | 1  | 1                             | 1                         |

**XIOC Digital Input Modules**

| Description                                      | Unit   | XIOC-8DI               | XIOC-16DI              | XIOC-32DI                                |
|--|--------|------------------------|------------------------|--|
| <b>Modules</b>                                   |        |                        |                        |  |
| Input type                                       |        | DC input               | DC input               | DC input                                 |
| Input voltage                                    | Vdc    | 24                     | 24                     | 24                                       |
| Permissible range                                | Vdc    | 20.4–28.8              | 20.4–28.8              | 20.4–28.8                                |
| Input voltage                                    | Vac    | —                      | —                      | —  |
| Permissible range                                | Vac    | —                      | —                      | —  |
| Input resistance                                 |        | Normally 3.5 kohm      | Normally 5.9 kohm      | Normally 5.6 kohm                        |
| Input current                                    | mA     | Normally 6.9           | Normally 4.0           | Normally 4.3                             |
| Voltage level to IEC 61131-2, limit value type 1 |        |                        |                        |  |
| ON   | Vdc    | ≥15                    | ≥15                    | ≥15                                      |
| OFF  | Vdc    | ≤5                     | ≤5                     | ≤5                                       |
| Input delay                                      |        |                        |                        |  |
| OFF → ON   | ms     | 5 (normally 4)         | 5 (normally 4)         | 5 (normally 4)                           |
| OFF → ON   | ms     | 5 (normally 4)         | 5 (normally 4)         | 5 (normally 4)                           |
| Input channels                                   | Number | 8                      | 16                     | 32                                       |
| Channels with the same reference potential       | Number | 8                      | 16                     | 32                                       |
| Potential isolation                              |        | With optocouplers      | With optocouplers      | With optocouplers                        |
| Indication                                       |        | LED (green)            | LED (green)            | 16 LEDs (green), switchable: 0–15, 16–31 |
| Terminals  |        | Plug-in terminal block | Plug-in terminal block | XIOC-TERM32 (connector and cable)        |
| Internal current consumption (5 Vdc)             | mA     | Normally 26            | Normally 51            | Normally 100                             |
| Weight   | kg     | 0.16                   | 0.16                   | 0.16                                     |

**XIOC Digital Output Modules**

| Description   | Unit   | XIOC-8DO                 | XIOC-16DO                | XIOC-16DO-S              | XIOC-32DO                               |
|---|--------|--------------------------|--------------------------|--------------------------|---|
| <b>Modules</b>  |        |                          |                          |                          |   |
| Output type   |        | Transistor (source type) | Transistor (source type) | Transistor (source type) | Transistor (source type)                |
| Output voltage  | Vdc    | 24 (–15 to +20%)         | 24 (–15 to +20%)         | 24 (–15 to +20%)         | 24 (–15 to +20%)                        |
| Switching current, minimum  | mA     | 1                        | 1                        | 1                        | 1                                       |
| Leakage current   | mA     | 0.1                      | 0.1                      | 0.1                      | 0.1                                     |
| Maximum load current  |        |                          |                          |                          |   |
| Per circuit   | A      | 0.3                      | 0.3                      | 0.8                      | 0.2                                     |
| Per common potential terminal   | A      | 2.4                      | 4                        | 5                        | 3.2                                     |
| Output delay  |        |                          |                          |                          |   |
| OFF → ON  | ms     | ≤0.3                     | ≤0.3                     | ≤0.3                     | ≤0.3                                    |
| OFF → ON  | ms     | ≤1                       | ≤1                       | ≤1                       | ≤1                                      |
| Output channels   | Number | 8                        | 16                       | 16                       | 32                                      |
| Channels with the same reference potential                                      | Number | 8                        | 16                       | 16                       | 32                                      |
| Overvoltage protection  |        | Diode                    | Diode                    | Integrated               | Diode                                   |
| Fuse rating   | A      | 4                        | 8                        | None                     | 8                                       |
| Potential isolation   |        | With optocouplers        | With optocouplers        | With optocouplers        | With optocouplers                       |
| Indication  |        | LED (green)              | LED (green)              | LED (green)              | 16 LEDs (green) switchable: 0–15, 16–31 |
| Terminals   |        | Plug-in terminal block   | Plug-in terminal block   | Plug-in terminal block   | XIOC-TERM32 (connector and cable)       |
| Internal current consumption (5 Vdc)  | mA     | Normally 30              | Normally 50              | Normally 50              | Normally 250                            |
| External voltage for outputs/module (30 mA for module supply) (U <sub>S</sub> ) | Vdc    | 24 (–15 to +20%)         | 24 (–15 to +20%)         | 24 (–15 to +20%)         | 24 (–15 to +20%)                        |
| Short-circuit protection  |        | —                        | —                        | Yes                      | —                                       |
| Weight  | kg     | 0.16                     | 0.16                     | 0.16                     | 0.16                                    |

**XIOC Relay Output Module**

| <b>Description</b>                         | <b>Unit</b> | <b>XIOC-12D0-R</b>               |
|--|-------------|----------------------------------|
| <b>Modules</b>                             |             |                                  |
| Output type                                |             | Relays                           |
| Output voltage                             | Vdc         | 24                               |
| Output voltage                             | Vac         | 100/240                          |
| Switching current, minimum                 | mA          | 1                                |
| Maximum load current                       |             |                                  |
| Per circuit                                | A           | 2                                |
| Per common potential terminal              | A           | 5                                |
| Output delay                               |             |                                  |
| OFF → ON                                   | ms          | ≤10                              |
| OFF → ON                                   | ms          | ≤10                              |
| Output channels                            | Number      | 12                               |
| Channels with the same reference potential | Number      | 12                               |
| Overvoltage protection                     |             | External                         |
| Fuse rating                                | A           | External                         |
| Potential isolation                        |             | With optocouplers                |
| Indication                                 |             | LED (green)                      |
| Terminals                                  |             | Plug-in terminal block           |
| Internal current consumption (5 Vdc)       | mA          | Normally 40                      |
| External voltage for operating the relay   |             | 24 Vdc (-15 to +20%, max. 70 mA) |
| Weight                                     | kg          | 0.2                              |



**XIOC Digital Input/Output Module**

| Description  | Unit   | XIOC-16DX  |
|--|--------|--|
| <b>Power Supply</b>                                |        |  |
| Supply voltage                                     |        | 24 Vdc (–15 to +20%)   |
| Ripple   | %      | ≤5   |
| Oversvoltage protection                            |        | Yes  |
| Protection against polarity reversal               |        | Yes  |
| Potential isolation                                |        |  |
| Between power supply and I/O bus                   |        | Yes  |
| Between power supply and I/O                       |        | No   |
| Internal current consumption (5 Vdc)               | mA     | Normally 80  |
| Channels   | Number | 16   |
| Terminals  |        | Plug-in terminal block   |
| Status indication                                  |        | LED  |
| <b>Inputs</b>                                      |        |  |
| Input type   |        | DC input   |
| Input voltage                                      | Vdc    | 24   |
| Inputs   | Number | 4, 12, configurable  |
| Input current                                      | mA     | Normally 4   |
| Voltage level to IEC 61131-2, limit value type 1   |        |  |
| ON   | Vdc    | ≥15  |
| OFF  | Vdc    | ≤5   |
| Input delay  |        |  |
| OFF → ON   | ms     | Normally 0.1   |
| OFF → ON   | ms     | Normally 0.1   |
| <b>Outputs</b>                                     |        |  |
| Output type  |        | Transistor (source type)   |
| Output voltage                                     | Vdc    | 12/24 –15 to +20%)   |
| Output current                                     | A      | Normally 0.5   |
| Outputs  | Number | Max. 12, configurable  |
| Short-circuit tripping current                     | A      | Max. 1.2 over 3 ms for output  |
| Lamp load  | W      | Max. 3   |
| Drop-out delay (High → Low)                        | μs     | Normally 100   |
| Switching capacity                                 |        | IEC/EN 60947-5-1, utilization category DC-13   |
| Short-circuit rating                               |        | Yes  |
| Parallel connection of outputs                     |        | In groups 0 – 3, 4 – 7, 8 – 11; Actuation of the outputs within a group only in the same program cycle |
| Number of outputs that can be switched in parallel |        | Max. 3   |
| Total maximum current                              | A      | 2 for group  |
| <b>Weight</b>                                      | kg     | 0.16   |

## XIOC Analog Modules

| Description                              | Unit   | XIOC-8AI-I2                             | XIOC-8AI-U1                             | XIOC-8AI-U2                             | XIOC-4T-PT  |
|--|--------|---|---|---|---|
| <b>Modules</b>                           |        |   |   |   |   |
| Input voltage                            | Vdc    | —                                       | 0 to 10                                 | -10 to +10                              | —   |
| Input current                            | mA     | 4-20                                    | —                                       | —                                       | —   |
| Resolution, digital                      | bit    | 12                                      | 12                                      | 12                                      | 15 bit with sign  |
| Conversion time                          |        | ≤5 ms                                   | ≤5 ms                                   | ≤5 ms                                   | —   |
| Total errors                             | %      | ≤ ± 1 (of full-scale value)             | ≤ ± 1 (of full-scale value)             | ≤ ± 1 (of full-scale value)             | ≤ ± 1 (of full-scale value)                             |
| Input resistance                         | kohm   | —                                       | 100                                     | 100                                     | —   |
| Potential isolation                      |        |   |   |   |   |
| Circuit within each channel              |        | With optocouplers                       | With optocouplers                       | With optocouplers                       | With optocouplers                                       |
| Between the input channels               |        | No                                      | No                                      | No                                      | No  |
| Input channels                           | Number | 8                                       | 8                                       | 8                                       | 4   |
| Terminals                                |        | Plug-in terminal block                  | Plug-in terminal block                  | Plug-in terminal block                  | Plug-in terminal block                                  |
| External power supply                    |        | 24 Vdc (-15 to +20%),<br>approx. 150 mA | 24 Vdc (-15 to +20%),<br>approx. 150 mA | 24 Vdc (-15 to +20%),<br>approx. 150 mA | 24 Vdc (-15 to +20%),<br>100 mA                         |
| External resistance (R)                  | kohm   | —                                       | —                                       | —                                       | Max. 0.4, 4 channels                                    |
| Connection type                          |        | 2-core shielded cable (≤20m)            | 2-core shielded cable (≤20m)            | 2-core shielded cable (≤20m)            | Shielded cable  |
| Platinum RTD                             |        | —                                       | —                                       | —                                       | PT100 (IEC 751), PT1000                                 |
| Accuracy                                 |        |   |   |   |   |
| -20° to 40°C (PT100)                     | °C     | —                                       | —                                       | —                                       | ±0.5  |
| -50° to 400°C (PT100)                    | °C     | —                                       | —                                       | —                                       | ±3  |
| -50° to 400°C (PT1000)                   | °C     | —                                       | —                                       | —                                       | ±6  |
| Temperature measuring range              |        | —                                       | —                                       | —                                       | -20 to 40°/-50 to 400°<br>(uninterrupted current: 2 mA) |
| Internal current consumption (5 Vdc)     | mA     | Normally 100                            | Normally 100                            | Normally 100                            | Max. 200  |
| Additional function                      |        | —                                       | —                                       | —                                       | Linearization   |
| Fault detection                          |        |   |   |   |   |
| -20° to 40°C                             |        | —                                       | —                                       | —                                       | ≤ -25°C or ≥ +45°C = resistance<br>value 7FFFhex        |
| -50° to 400°C                            |        | —                                       | —                                       | —                                       | ≤ -60°C or ≥ +410°C =<br>resistance value 7FFFhex       |
| Response to cable break or unused inputs |        | —                                       | —                                       | —                                       | In these cases, the resistance<br>value is 7FFFhex      |
| Weight                                   | kg     | 0.18                                    | 0.18                                    | 0.18                                    | 0.18  |

## XIOC Thermocouple Module

| Description                 | Unit | XIOC-4AI-T  |
|-----------------------------|------|---|
| <b>Channels</b>             |      |   |
| Number                      |      | 4   |
| Temperature measuring range | °C   | Type K: -270 to 1370<br>Type J: -210 to 1200<br>Type B: 100 to 1800<br>Type N: -270 to 1300<br>Type E: -270 to 1000<br>Type R: -50 to 1760<br>Type T: -200 to 400 |
| Voltage measurement         | mV   | -50 to 50<br>-100 to 100<br>-500 to 500<br>-1000 to 1000  |
| Cold-junction compensation  |      | Yes, built-in   |
| Interference suppression    |      | 50 Hz, 60 Hz  |
| Unit                        |      | 0.1°C, 0.1 F  |
| Resolution                  | bit  | 16  |
| Total errors                | %    | ±0.5 of measurement range   |
| Conversion time             |      | <1s   |
| Temperature coefficient     |      | <200 ppm/°C of measurement range  |

**XIOC Analog Modules**

| Description                          | Unit | XIOC-2AO-U1-2AO-I2                | XIOC-4AO-U1               | XIOC-2AO-U2               |
|--------------------------------------|------|-----------------------------------|---------------------------|---------------------------|
| <b>Modules</b>                       |      |                                   |                           |                           |
| Output voltage                       | Vdc  | 0–10                              | 0–10                      | –10 to 10                 |
| Output current                       | mA   | 4–20                              | —                         | —                         |
| Resolution                           | bit  | 12                                | 12                        | 12                        |
| Conversion time                      |      | ≤5 ms                             | ≤5 ms                     | ≤5 ms                     |
| Total errors                         | %    | ≤±1 (of full-scale value)         | ≤±1 (of full-scale value) | ≤±1 (of full-scale value) |
| External load resistance             |      |                                   |                           |                           |
| Voltage output                       |      | ≥10 kohm                          | ≥10 kohm                  | ≥10 kohm                  |
| Current output                       | ohm  | 0 to 500 ohm                      | —                         | —                         |
| Potential isolation                  |      |                                   |                           |                           |
| Circuit within each channel          |      | With optocouplers                 |                           |                           |
| Between channels                     |      | No                                | No                        | No                        |
| Number of outputs                    |      |                                   |                           |                           |
| Output voltage                       |      | 2 (channels 0 and 1)              | 4                         | 2                         |
| Output current                       |      | 2 (channels 2 and 3)              | —                         | —                         |
| Terminals                            |      | Plug-in terminal block            |                           |                           |
| Internal current consumption (5 Vdc) | mA   | Normally 100                      | Normally 100              | Normally 100              |
| External power supply                |      | 24 Vdc (–15/+20%), approx. 150 mA |                           |                           |
| Connection type                      |      | 2-core shielded cable (≤20m)      |                           |                           |

**XIOC Analog Modules**

| Description                          | Unit   | XIOC-2AI-1AO-U1        | XIOC-2AI-1AO-U1-I1 | XIOC-4AI-2AO-U1 | XIOC-4AI-2AO-U1-I1 |
|--------------------------------------|--------|------------------------|--------------------|-----------------|--------------------|
| <b>Inputs</b>                        |        |                        |                    |                 |                    |
| Input voltage                        | Vdc    | 0–10                   | 0–10               | 0–10            | 0–10               |
| Input current                        | mA     | —                      | 0–20               | —               | 0–20               |
| Resolution                           | bit    | 14                     | 14                 | 14              | 14                 |
| Conversion time                      |        | <1 ms                  | <1 ms              | <1 ms           | <1 ms              |
| Total errors                         | %      | Normally 0.4           | Normally 0.4       | Normally 0.4    | Normally 0.4       |
| Potential isolation                  |        |                        |                    |                 |                    |
| Circuit within each channel          |        | No                     | No                 | No              | No                 |
| Between the input channels           |        | No                     | No                 | No              | No                 |
| Between input/output channels        |        | No                     | No                 | No              | No                 |
| Channels                             | Number | 2                      | 2                  | 4               | 4                  |
| Input resistance                     | kohm   | 40                     | 40                 | 40              | 40                 |
| <b>Outputs</b>                       |        |                        |                    |                 |                    |
| Output voltage                       | Vdc    | 0–10                   | 0–10               | 0–10            | 0–10               |
| Output current                       | mA     | —                      | 0–20               | —               | 0–20               |
| Resolution                           | bit    | 12                     | 12                 | 12              | 12                 |
| Errors                               |        | Normally 0.4%          | Normally 0.4%      | Normally 0.4%   | Normally 0.4%      |
| Potential isolation                  |        |                        |                    |                 |                    |
| Circuit within each channel          |        | No                     | No                 | No              | No                 |
| Between the output channels          |        | No                     | No                 | No              | No                 |
| Number of channels                   |        | 1                      | 1                  | 2               | 2                  |
| External load resistance             |        | ≥2 kohm                | ≥2 kohm            | ≥2 kohm         | ≥2 kohm            |
| Short-circuit rating                 |        | Yes                    | Yes                | Yes             | Yes                |
| <b>Terminal Connection</b>           |        |                        |                    |                 |                    |
| Terminals                            |        | Plug-in terminal block |                    |                 |                    |
| Internal current consumption (5 Vdc) | mA     | Normally 200           | Normally 200       | Normally 200    | Normally 200       |
| Weight                               | kg     | 0.16                   | 0.16               | 0.16            | 0.16               |

## XIOC Communication Modules

| Description               | Unit   | XIOC-NET-DP-M                 | XIOC-NET-DP-S                 | XIOC-SER   | XIOC-TC1   |
|---------------------------|--------|-------------------------------|-------------------------------|--|--|
| <b>Interfaces</b>         |        |                               |                               |  |  |
| Interfaces                |        | PROFIBUS-DP, RS-485, EN 50170 | PROFIBUS-DP, RS-485, EN 50170 | RS-232(C), RS-422, RS-485                                  | RS-232(C), RS-422, RS-485                                  |
| Protocol                  |        | PROFIBUS-DP master (class 1)  | PROFIBUS-DP slave             | Transparent mode, Modbus master/slave                      | Transparent mode, Modbus master/slave, DNP3 protocol       |
| Character formats         |        | —                             | —                             | 8E1, 8O1, 8N1, 8N2, 7E2, 7O2, 7N2, 7E1                     | 8E1, 8O1, 8N1, 8N2, 7E2, 7O2, 7N2, 7E1                     |
| Control and signal cables |        | —                             | —                             | RTS, CTS, DTR, DSR, DCD                                    | RTS, CTS, DTR, DSR, DCD                                    |
| Transfer rate             | kbit/s | 9.6 to 12,000                 | 9.6 to 12,000                 | 0.3–57.6   | 0.3–57.6   |
| Potential isolation       |        | Yes                           | Yes                           | Yes (RS-485, RS-422)                                       | Yes (RS-485, RS-422)                                       |
| Number of slaves          |        | 124                           | —                             | —  | —  |
| Send/receive data         |        | 3500 Byte each                | Max. 244 Byte                 | 250 Byte per slave<br>120 Byte per slave                   | 250/500  |
| Bus terminating resistors |        | Switchable                    | Switchable                    | Switchable for RS-485, RS-422                              | Switchable for RS-485, RS-422                              |
| Connector type            |        | D-sub 9-pin socket            | D-sub 9-pin socket            | RS-232: D-sub 9-pin<br>RS-485, 422: plug-in terminal block | RS-232: D-sub 9-pin<br>RS-485, 422: plug-in terminal block |
| Current consumption       | mA     | <300                          | <300                          | <275   | <275   |
| Weight                    | kg     | Approx. 0.2                   | Approx. 0.2                   | Approx. 0.2  | Approx. 0.2  |
| Number of modules         |        | XC100: 1/XC200: 3             | XC100: 1/XC200: 3             | XC100: 2/XC200: 4  | XC200: 4   |
| Slots                     |        | 1, 2, 3                       | 1, 2, 3                       | Any  | Any  |

## XIOC Counter Modules

| Description                            | Unit   | XIOC-1CNT-100KHZ                    | XIOC-2CNT-100KHZ                    | XIOC-2CNT-2AO-INC                    |
|--|--------|-------------------------------------|-------------------------------------|--------------------------------------|
| <b>Inputs</b>                          |        |                                     |                                     |                                      |
| Counter limits                         |        | 0–4294967295 (32 bit)               | 0–4294967295 (32 bit)               | 0–4294967295 (32 bit)                |
| Internal current consumption           | mA     | 200                                 | 200                                 | 450                                  |
| Frequency                              | kHz    | 100 (25 with four times resolution) | 100 (25 with four times resolution) | 400 (100 with four times resolution) |
| Number of channels                     |        | 1                                   | 2                                   | 2                                    |
| Input voltage                          | Vdc    | 12–24                               | 12–24                               | —                                    |
| Voltage for ON                         | Vdc    | >10                                 | >10                                 | —                                    |
| Voltage for OFF                        | VA/W   | <4                                  | <4                                  | —                                    |
| Input current                          | mA     | ≥4                                  | ≥4                                  | —                                    |
| Differential input voltage             | Vdc    | ±5                                  | ±5                                  | ±5                                   |
| Voltage for ON                         | Vdc    | 2–5                                 | 2–5                                 | 0.2–5                                |
| Voltage for OFF                        | Vdc    | –5 to 8                             | –5 to 8                             | –5 to –0.2                           |
| Differential input current             | mA     | 35                                  | 35                                  | 5                                    |
| Minimum pulse width                    | μs     | ON ≥4/OFF ≥4                        | ON ≥4/OFF ≥4                        | —                                    |
| Potential isolation                    |        | With optocouplers                   | With optocouplers                   | —                                    |
| Connection for external cabling        |        | 30-pin plug: XIOC-TERM30-CNT4       | 30-pin plug: XIOC-TERM30-CNT4       | Plug-in terminal block               |
| External cabling                       |        | Shielded, twisted pair cable        | Shielded, twisted pair cable        | Shielded, twisted pair cable         |
| <b>Outputs</b>                         |        |                                     |                                     |                                      |
| Output type                            |        | Transistor (open collector)         | Transistor (open collector)         | Analog                               |
| External power supply                  |        | 12/24 Vdc (30 max.)                 | 12/24 Vdc (30 max.)                 | —                                    |
| Minimum load current                   | mA     | 1                                   | 1                                   | —                                    |
| Maximum load current (I <sub>o</sub> ) | mA     | 20                                  | 20                                  | —                                    |
| Max. leakage current                   | mA     | 0.5                                 | 0.5                                 | —                                    |
| Max. voltage drop at ON                | V      | 1.5                                 | 1.5                                 | —                                    |
| Debounce OFF                           |        |                                     |                                     |                                      |
| OFF → ON                               | ms     | ≤1                                  | ≤1                                  | —                                    |
| OFF → ON                               | ms     | ≤1                                  | ≤1                                  | —                                    |
| Output channels                        | Number | 2                                   | 4                                   | 2                                    |
| Potential isolation                    |        | With optocouplers                   | With optocouplers                   | —                                    |
| Output voltage                         | Vdc    | —                                   | —                                   | –10 to 10                            |
| Resolution                             | bit    | —                                   | —                                   | 12                                   |
| Conversion time                        |        | —                                   | —                                   | ≤1 ms                                |
| Total errors                           | %      | —                                   | —                                   | Normally 0.4                         |
| Load resistance                        |        | —                                   | —                                   | ≥1 kohm                              |
| Connection for external cabling        |        | 30-pin plug: XIOC-TERM30-CNT4       | 30-pin plug: XIOC-TERM30-CNT4       | Plug-in terminal block               |
| External cabling                       |        | Shielded, twisted pair cable        | Shielded, twisted pair cable        | Shielded 2-core cable                |
| Current per channel                    | mA     | —                                   | —                                   | ≤300                                 |
| Power supply of encoders               |        | —                                   | —                                   | 5 Vdc                                |
| Current consumption                    | mA     | 200                                 | 200                                 | Max. 450                             |
| Weight                                 | kg     | 0.16                                | 0.16                                | 0.18                                 |

### Power Supply Suppression Filters

| Description   | Unit            | XT-FIL-1                                | XT-FIL-2                                |
|---|-----------------|---|---|
| <b>General</b>                                      |                 |   |   |
| Standards   |                 | IEC/EN 61131-2; EN 50178                | IEC/EN 61131-2; EN 50178                |
| Ambient temperature                                 | °F (°C)         | 32° to 131° (0° to 55°)                 | 32° to 131° (0° to 55°)                 |
| Storage   | °F (°C)         | −13° to 158° (−25° to 70°)              | −13° to 158° (−25° to 70°)              |
| Mounting position                                   |                 | Vertical or horizontal                  | Vertical or horizontal                  |
| Vibration resistance                                |                 | 10–57 Hz ± 0.075 mm<br>57–150 Hz ± 1.0g | 10–57 Hz ± 0.075 mm<br>57–150 Hz ± 1.0g |
| Mechanical shock resistance                         |                 | 15g/11 ms                               | 15g/11 ms                               |
| Impact strength                                     |                 | 500g /50 mm ±25g                        | 500g/50 mm ±25g                         |
| Overvoltage category                                |                 | II                                      | II                                      |
| Pollution degree                                    |                 | 2                                       | 2                                       |
| Protection type                                     |                 | IP20                                    | IP20                                    |
| Rated impulse withstand voltage (U <sub>imp</sub> ) | V               | 850                                     | 850                                     |
| Interference immunity                               |                 | EN 61000-6-2                            | EN 61000-6-2                            |
| Weight  | kg              | 0.1                                     | 0.1                                     |
| Dimensions (W x H x D)                              | mm              | 35 x 90 x 30                            | 35 x 90 x 57                            |
| Terminals   |                 | Screw terminals                         | Screw terminals                         |
| Terminal capacity                                   |                 |   |   |
| Screw terminals                                     |                 |   |   |
| Flexible with ferrule                               | mm <sup>2</sup> | 0.2–2.5 (AWG22–12)                      | 0.2–2.5 (AWG22–12)                      |
| Solid   | mm <sup>2</sup> | 0.2–2.5 (AWG22–12)                      | 0.2–2.5 (AWG22–12)                      |
| <b>Power Supply</b>                                 |                 |   |   |
| Input voltage                                       | Vdc             | 24                                      | 24                                      |
| Permissible range                                   | Vdc             | 20.4–28.8                               | 20.4–28.8                               |
| Ripple  | %               | ≤5                                      | ≤5                                      |
| Mains overvoltage protection                        |                 | Yes                                     | Yes                                     |
| Potential isolation                                 |                 |   |   |
| Between input voltage and PE                        |                 | Yes                                     | Yes                                     |
| Between input voltage and output voltage            |                 | No                                      | No                                      |
| Between output voltage and PE                       |                 | Yes                                     | Yes                                     |
| Rated value   | Vdc             | 24                                      | 24                                      |
| Output current                                      | A               | 2.2                                     | 12                                      |

### General Information on Electromagnetic Compatibility (EMC) of Automation Systems

| Description  | Specification  |
|--|--|
| Emitted interference                                     | EN 55011/22 Class A (VDE 0875, Part 11)  |
| Interference immunity                                    |  |
| ESD  | IEC/EN 61000-4-2<br>Contact discharge: 4 kV<br>Air discharge 8 kV  |
| RFI  | IEC/EN 61000-4-3<br>AM (80%) 80–1000 MHz 10V/m   |
| Mobile phones/cellphones                                 | IEC/EN 61000-4-3<br>PM 800–960 MHz 10V/m   |
| Burst  | IEC/EN 61000-4-4<br>Mains/digital I/O (direct): 2 kV<br>Analog I/O, fieldbus (capacitive coupling): 1 kV   |
| Surge  | IEC/EN 61000-4-5<br>Digital I/O, asymmetric, analog I/O, asymmetric, connection to shielding: 0.5 kV<br>Mains DC, asymmetric: 1 kV<br>Mains DC, symmetric: 1 kV<br>Mains AC, asymmetric: 0.5 kV<br>Mains AC, symmetric: 2 kV |
| Conducted interference, induced by high-frequency fields | IEC/EN 61000-4-6; 2003<br>AM (80%) 150 kHz–80 MHz 3V   |

**Dimensions**

Approximate Dimensions in Inches (mm)

**XC-CPU101, XC-CPU201, XC-CPU202**

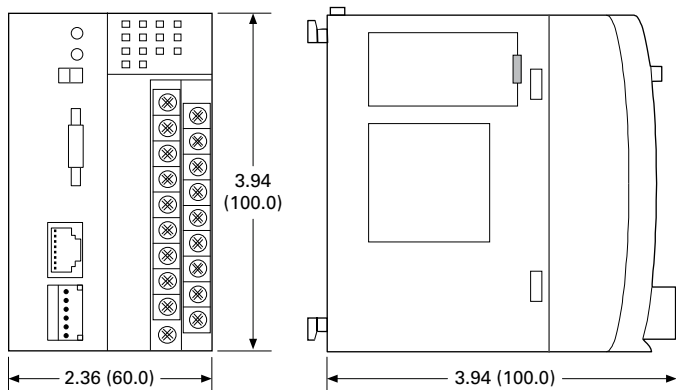

**XIOC\_**

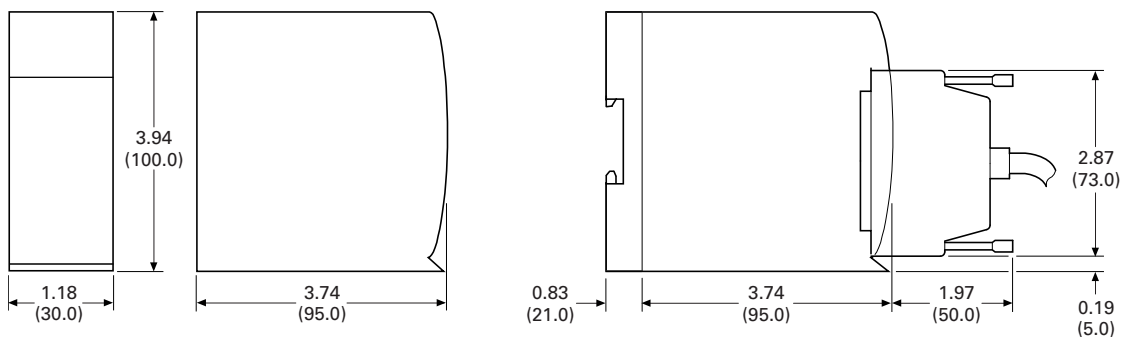

**Backplates**

**XIOC-BP-2  
XIOC-BP-XC**

**XIOC-BP-3  
XIOC-BP-EXT**

**XIOC-BP-XC1**

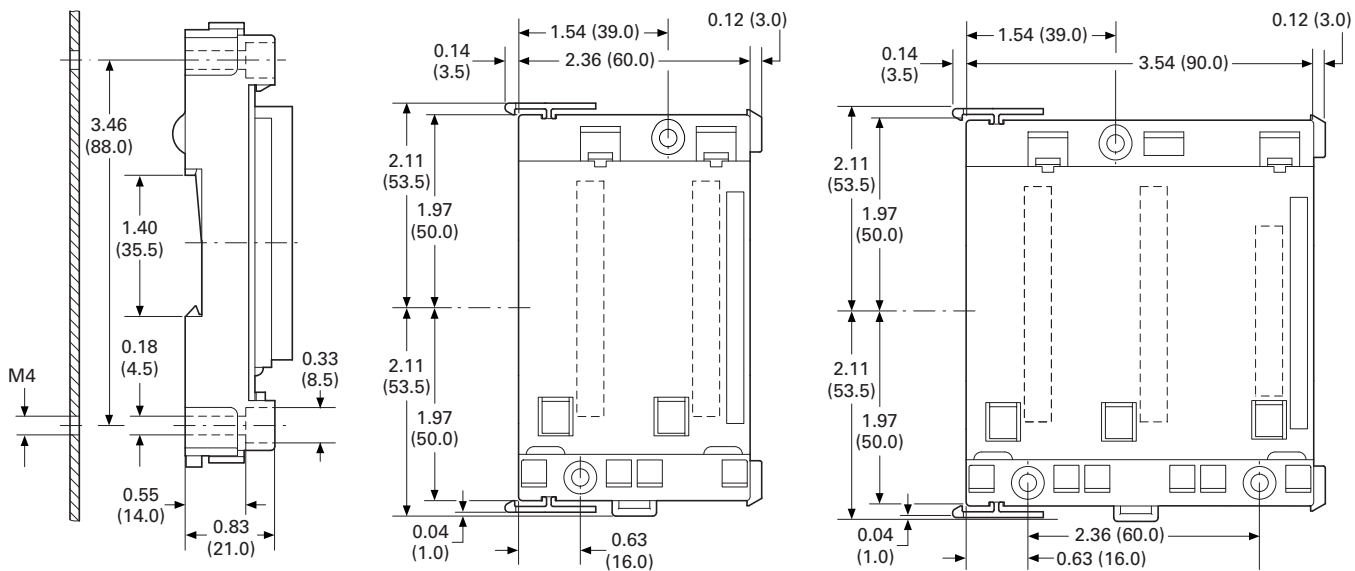

# 4.2

## PLC, I/O and Communications Products

### XC Series Programmable Logic Controllers

Approximate Dimensions in Inches (mm)

**XC-CPU-121\_, XIO-EXT121-1**

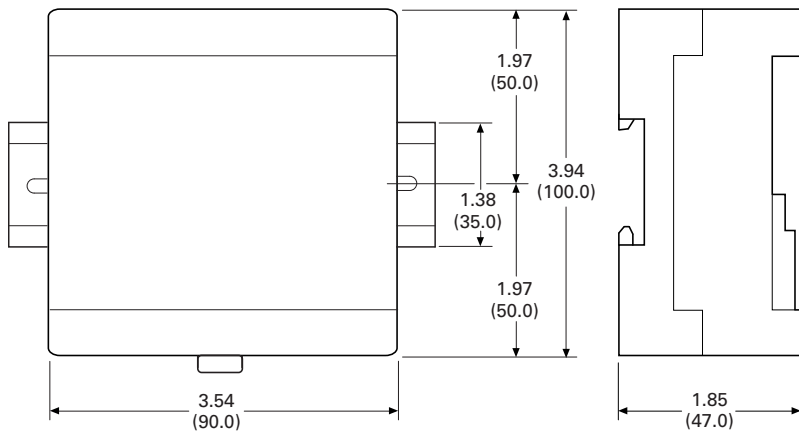

**XT-RJ45-ETH-RS232**

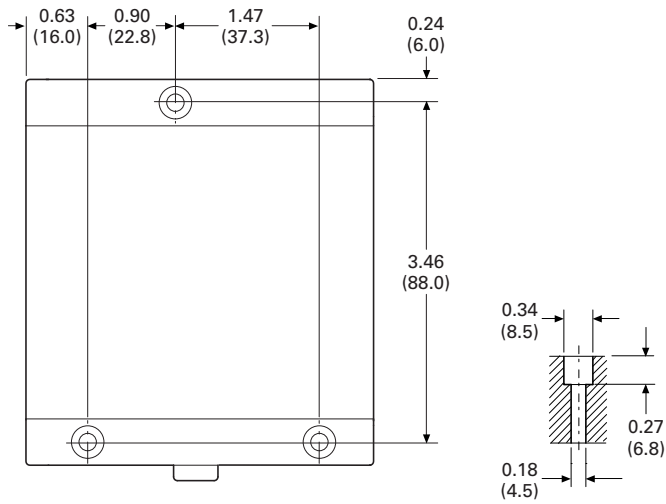
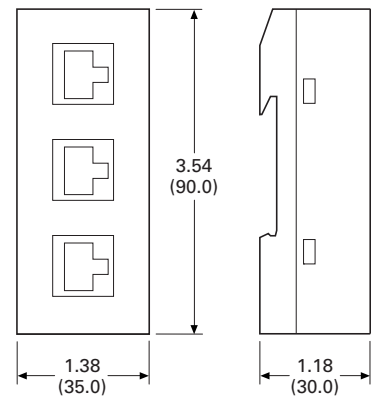

4



**XC152 Series Programmable Logic Controllers**



**Contents**

| <b>Description</b>                          | <b>Page</b>     |
|---|-----------------|
| XC152 Series Programmable Logic Controllers |                 |
| Catalog Number Selection . . . . .          | <b>V7-T4-58</b> |
| Product Selection . . . . .                 | <b>V7-T4-58</b> |
| Accessories . . . . .                       | <b>V7-T4-58</b> |
| Technical Data and Specifications . . . . . | <b>V7-T4-59</b> |
| Dimensions . . . . .                        | <b>V7-T4-60</b> |

**Product Description**

The XC152 compact PLC combines plenty of processing power with a large number of communication interfaces. This makes the device particularly well-suited to standardized automation solutions in modular machine building applications.

The XC152 not only provides machine segment control functions that can be programmed with CoDeSys, but it can store module-specific visualizations. These visualizations can be retrieved and displayed on a central HMI or a computer as needed.

In addition, the XC152 connects SmartWire-DT systems to standard fieldbus systems via its interfaces. This enables the XC152 PLC to support Eaton’s Lean Automation strategy while enabling users to design automation systems in a flexible manner and run them cost-effectively.

**Application Description**

**Flexible Solutions for Modular Machine Units**

In the field of automation, complex processes are subdivided into easily manageable functional units to make programming, production and installation easier. For example, a packaging machine can be subdivided into infeed, positioning (erector), filling and sealing (gluing) modules. Other systems and machines can also be effectively subdivided to create a wide variety of different models or to delimit various expansion stages.

With the XC152, a powerful PLC controls individual system modules while making it possible to directly connect SmartWire-DT system devices and standard fieldbus components. Data transfers via the Ethernet interface to OPC clients, together with the available remote visualization system, support a connection to a central control and visualization system.

**SmartWire-DT**

The XC152 relies on Eaton’s tried-and-true SmartWire-DT connection system, eliminating the need for control current wiring in every single machine module and simplifying the commissioning process by means of better diagnostic options. This results in significant design, commissioning and maintenance cost reductions.

**Standard CAN and PROFIBUS Fieldbus Systems**

Servo drives, frequency inverters and hydraulic components can all be easily connected using the large number of fieldbus interfaces available on the XC152.

**Visualization**

The integrated Web visualization function offers a key advantage, as machine module diagnostic and visualization information can be displayed on a central HMI or a terminal.

**Features and Benefits**

- CoDeSys PLC and Web visualization
- Galileo/CoDeSys remote visualization
- Ethernet port on all models
- Windows® CE 5 operating system
- 32-bit RISC CPU at 400 MHz
- 64 MB internal memory
- SD card slot for external memory
- Run/Stop switch
- Optional: Integrated SmartWire-DT master for 99 nodes
- Optional: RS-232, RS-485, PROFIBUS-DP/MPI, CANopen/easyNet

**Standards and Certifications**

- IEC/EN 61131-2, EN 50178
- EN 61000-6-2, EN 61000-6-4
- cULus
- CE



### Catalog Number Selection

XC152 PLCs with and without SmartWire-DT

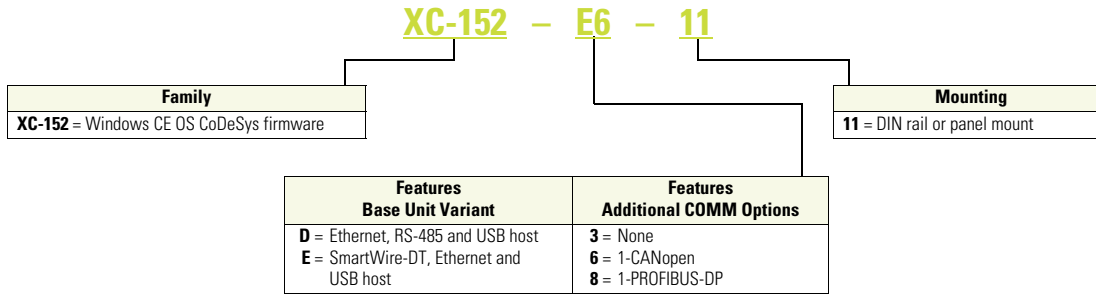

### Product Selection

#### XC152 PLC



#### XC152 PLC

| CoDeSys Firmware | Fieldbus Type | RS-232 | RS-485 | Ethernet | Catalog Number      |
|------------------|---------------|--------|--------|----------|---------------------|
| Yes              | CANopen       | Yes    | Yes    | Yes      | <b>XC-152-D6-11</b> |
| Yes              | PROFIBUS-DP   | Yes    | Yes    | Yes      | <b>XC-152-D8-11</b> |

#### XC152 PLC SmartWire-DT



#### XC152 PLC SmartWire-DT

| CoDeSys Firmware | Fieldbus Type | RS-232 | RS-485 | Ethernet | SmartWire-DT | Catalog Number      |
|------------------|---------------|--------|--------|----------|--------------|---------------------|
| Yes              | None          | Y      | None   | Yes      | Yes          | <b>XC-152-E3-11</b> |
| Yes              | CANopen       | None   | Yes    | Yes      | Yes          | <b>XC-152-E6-11</b> |
| Yes              | PROFIBUS-DP   | None   | Yes    | Yes      | Yes          | <b>XC-152-E8-11</b> |

### Accessories

#### XC PLC Accessories

| Description                                     | Catalog Number              |
|---|-----------------------------|
| PLC programming software, single seat license   | <b>SW-XSOFT-CODESYS-2-S</b> |
| PLC programming software, multiple seat license | <b>SW-XSOFT-CODESYS-2-M</b> |
| SD memory card                                  | <b>MEMORY-SD-A1-S</b>       |

**Technical Data and Specifications**

**XC152 Series Programmable Logic Controllers**

| Description                                | Unit  | XC-152-D6-11               | XC-152-D8-11               | XC-152-E3-11               | XC-152-E6-11               | XC-152-E8-11               |
|--|-------|----------------------------|----------------------------|----------------------------|----------------------------|----------------------------|
| <b>System</b>                              |       |                            |                            |                            |                            |                            |
| Processor                                  |       | RISC, 32 bit at 400 MHz    | RISC, 32 bit at 400 MHz    | RISC, 32 bit at 400 MHz    | RISC, 32 bit at 400 MHz    | RISC, 32 bit at 400 MHz    |
| Internal memory                            |       |                            |                            |                            |                            |                            |
| DRAM (OS-, program and data memory)        | Mbyte | 64                         | 64                         | 64                         | 64                         | 64                         |
| NAND FLASH (can be used for data security) | Mbyte | Approx. 128 available      | Approx. 128 available      | Approx. 128 available      | Approx. 128 available      | Approx. 128 available      |
| NVRAM (retain)                             | kByte | Approx. 32 available       | Approx. 32 available       | Approx. 32 available       | Approx. 32 available       | Approx. 32 available       |
| External memory                            |       |                            |                            |                            |                            |                            |
| SD memory card slot                        |       | SDA Specification 1.00     | SDA Specification 1.00     | SDA Specification 1.00     | SDA Specification 1.00     | SDA Specification 1.00     |
| Real-time clock (battery backup)           |       |                            |                            |                            |                            |                            |
| Battery (not rechargeable)                 |       | Zero maintenance           | Zero maintenance           | Zero maintenance           | Zero maintenance           | Zero maintenance           |
| Backup time at zero voltage                |       | Normally 10 years          | Normally 10 years          | Normally 10 years          | Normally 10 years          | Normally 10 years          |
| Operating system                           |       | Windows CE 5               | Windows CE 5               | Windows CE 5               | Windows CE 5               | Windows CE 5               |
| <b>Engineering</b>                         |       |                            |                            |                            |                            |                            |
| PLC-Programming software                   |       | CoDeSys 2/3                | CoDeSys 2/3                | CoDeSys 2/3                | CoDeSys 2/3                | CoDeSys 2/3                |
| Visualization                              |       |                            |                            |                            |                            |                            |
| WEB-VISU                                   |       | CoDeSys                    | CoDeSys                    | CoDeSys                    | CoDeSys                    | CoDeSys                    |
| Remote Client                              |       | Galileo/CoDeSys            | Galileo/CoDeSys            | Galileo/CoDeSys            | Galileo/CoDeSys            | Galileo/CoDeSys            |
| <b>Communication Interfaces</b>            |       |                            |                            |                            |                            |                            |
| Ethernet                                   |       | 100Base-TX/10Base-T        | 100Base-TX/10Base-T        | 100Base-TX/10Base-T        | 100Base-TX/10Base-T        | 100Base-TX/10Base-T        |
| USB host ①                                 |       | —                          | —                          | —                          | —                          | —                          |
| USB device ①                               |       | USB 2.0                    | USB 2.0                    | USB 2.0                    | USB 2.0                    | USB 2.0                    |
| System port (RS-232) ①                     |       | ■                          | ■                          | ■                          | —                          | —                          |
| SmartWire-DT ①                             |       | —                          | —                          | ■                          | ■                          | ■                          |
| CAN ①                                      |       | ■                          | —                          | —                          | ■                          | —                          |
| PROFIBUS/MP ①                              |       | —                          | ■                          | —                          | —                          | ■                          |
| RS-485 ①                                   |       | ■                          | ■                          | —                          | ■                          | ■                          |
| <b>General</b>                             |       |                            |                            |                            |                            |                            |
| Rated operating voltage                    |       | 24 Vdc SELV                | 24 Vdc SELV                | 24 Vdc SELV                | 24 Vdc SELV                | 24 Vdc SELV                |
| Power consumption                          | W     | Max. 5                     | Max. 5                     | Max. 5                     | Max. 5                     | Max. 5                     |
| Protect against polarity reversal          |       | Yes                        | Yes                        | Yes                        | Yes                        | Yes                        |
| Approvals                                  |       | CE, cULus                  | CE, cULus                  | CE, cULus                  | CE, cULus                  | CE, cULus                  |
| Ambient air temperature                    | °C    | 0 to 55                    | 0 to 55                    | 0 to 55                    | 0 to 55                    | 0 to 55                    |
| Storage temperature                        | °C    | -40 to +70                 | -40 to +70                 | -40 to +70                 | -40 to +70                 | -40 to +70                 |
| Protection type                            |       | IP20                       | IP20                       | IP20                       | IP20                       | IP20                       |
| Flush mounting                             |       | DIN rail EN 60715, 35 mm   | DIN rail EN 60715, 35 mm   | DIN rail EN 60715, 35 mm   | DIN rail EN 60715, 35 mm   | DIN rail EN 60715, 35 mm   |
| Dimensions (H x W x D)                     | mm    | 105 x 155 x 40             | 105 x 155 x 40             | 105 x 155 x 40             | 105 x 155 x 40             | 105 x 155 x 40             |
| Weight (approximate)                       | kg    | 0.3                        | 0.3                        | 0.3                        | 0.3                        | 0.3                        |
| Applied standards and directives           |       |                            |                            |                            |                            |                            |
| Product standard                           |       | IEC/EN 61131-2, EN50178    | IEC/EN 61131-2, EN50178    | IEC/EN 61131-2, EN50178    | IEC/EN 61131-2, EN50178    | IEC/EN 61131-2, EN50178    |
| EMC  |       | EN 61000-6-2, EN 61000-6-4 | EN 61000-6-2, EN 61000-6-4 | EN 61000-6-2, EN 61000-6-4 | EN 61000-6-2, EN 61000-6-4 | EN 61000-6-2, EN 61000-6-4 |

**Note**

① Interface not galvanically isolated.

# 4.3

## PLC, I/O and Communications Products

### XC152 Series Programmable Logic Controllers

#### Dimensions

Approximate Dimensions in Inches (mm)

#### XC152 Series Programmable Logic Controllers

4

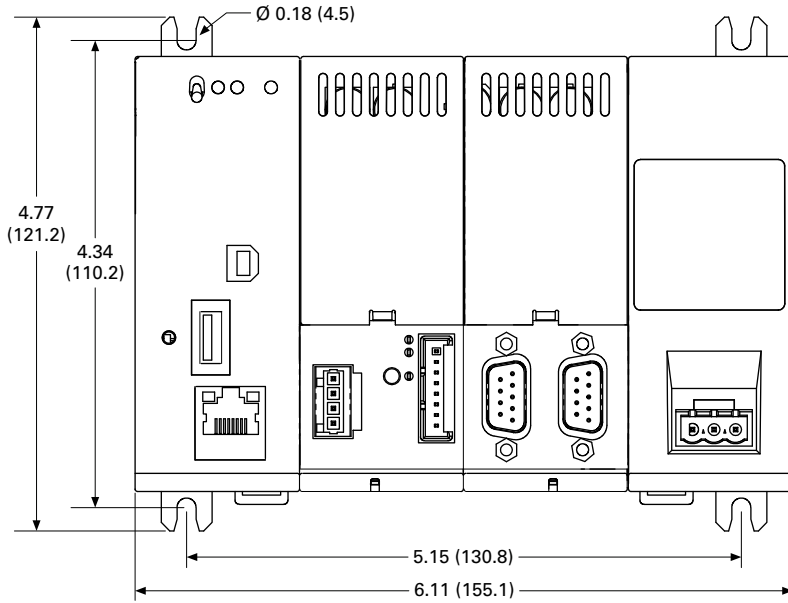

With Fixing Brackets

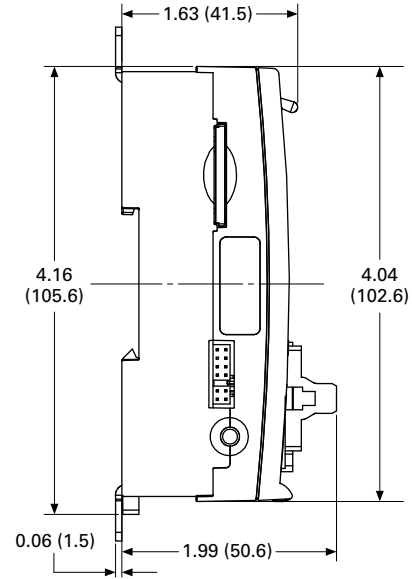

Without Fixing Brackets

XV Series HMI-PLC

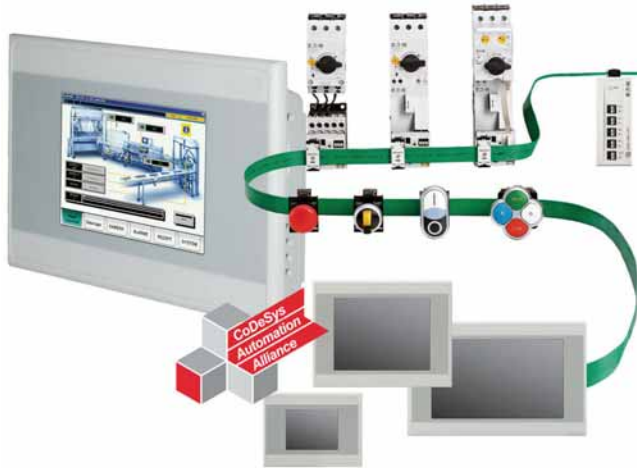

Contents

| Description             | Page     |
|-------------------------|----------|
| XV Series HMI-PLC       |          |
| Product Selection ..... | V7-T4-62 |
| Accessories .....       | V7-T4-62 |

Product Description

The XV HMI-PLC is a powerful combination of logic and visualization based on the open CoDeSys programming platform. It is ideal for small to mid-range PLC applications where integrated logic and visualization is advantageous and/or where remote administration is critical.

The XV HMI-PLC is also available with an integrated SmartWire-DT™ master. This combination of visualization, control and SmartWire-DT connectivity is the ultimate lean automation solution.

Features

- Built-in SmartWire-DT master for 99 nodes
- Brilliant image display with 65,536 colors
- High resolution resistive touch TFT displays
- 3.5 in, 5.7 in or 7 in widescreen displays in a robust plastic housings and bezels, or
- 5.7 in, 8.4 in or 10.4 in displays in high-end aluminum front bezels and metal housings
- Ethernet on all models
- RS-232 or RS-485 serial ports available
- PROFIBUS-DP or CANopen master on all models larger than 3.5 in
- Programmable with IEC 61131-3 compliant XSoft-CoDeSys software
- Easy connection direct to motor control components or I/O modules on the SmartWire-DT flat cable

Standards and Certifications

- CE
- UL
- cUL
- RoHS



Catalog Number Selection

XV HMI-PLC

XV - 102 - E6 - 35TQRG - 10

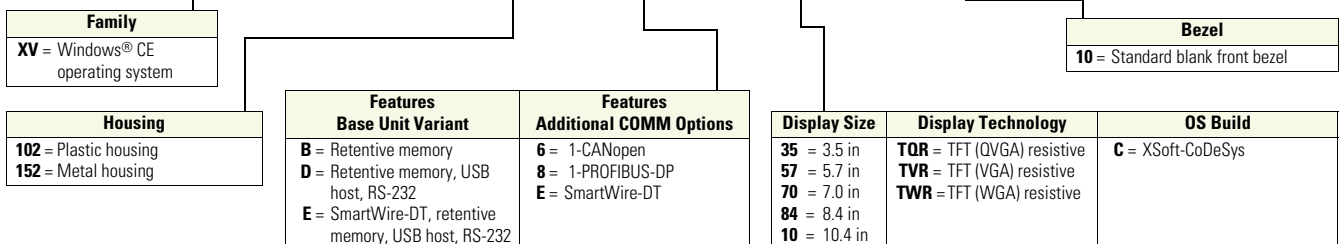

## Product Selection

## XV HMI-PLC

## XV HMI-PLC



4

| Display Size/Type      | Display Resolution | CoDeSys Firmware | Fieldbus Type | RS485 | Ethernet | Catalog Number             |
|------------------------|--------------------|------------------|---------------|-------|----------|----------------------------|
| <b>Plastic Housing</b> |                    |                  |               |       |          |                            |
| 3.5 in TFT Resistive   | QVGA<br>320x240    | Y                | CANopen       | Y     | Y        | <b>XV-102-B6-35TQRC-10</b> |
|                        |                    | Y                | PROFIBUS-DP   | Y     | Y        | <b>XV-102-B8-35TQRC-10</b> |
| 5.7 in TFT Resistive   | VGA<br>640x480     | Y                | CANopen       | Y     | Y        | <b>XV-102-D6-57TVRC-10</b> |
|                        |                    | Y                | PROFIBUS-DP   | Y     | Y        | <b>XV-102-D8-57TVRC-10</b> |
| 7.0 in TFT Resistive   | WGA<br>800x480     | Y                | CANopen       | Y     | Y        | <b>XV-102-D6-70TWRC-10</b> |
|                        |                    | Y                | PROFIBUS-DP   | Y     | Y        | <b>XV-102-D8-70TWRC-10</b> |
| <b>Metal Housing</b>   |                    |                  |               |       |          |                            |
| 5.7 in TFT Resistive   | VGA<br>640x480     | Y                | CANopen       | Y     | Y        | <b>XV-152-D6-57TVRC-10</b> |
|                        |                    | Y                | PROFIBUS-DP   | Y     | Y        | <b>XV-152-D8-57TVRC-10</b> |
| 8.4 in TFT Resistive   | VGA<br>640x480     | Y                | CANopen       | Y     | Y        | <b>XV-152-D6-84TVRC-10</b> |
|                        |                    | Y                | PROFIBUS-DP   | Y     | Y        | <b>XV-152-D8-84TVRC-10</b> |
| 10.4 in TFT Resistive  | VGA<br>640x480     | Y                | CANopen       | Y     | Y        | <b>XV-152-D6-10TVRC-10</b> |
|                        |                    | Y                | PROFIBUS-DP   | Y     | Y        | <b>XV-152-D8-10TVRC-10</b> |

## XV HMI-PLC SmartWire-DT

| Display Size/Type      | Display Resolution | CoDeSys Firmware | Fieldbus Type | RS485 | Ethernet | SmartWire-DT | Catalog Number             |
|------------------------|--------------------|------------------|---------------|-------|----------|--------------|----------------------------|
| <b>Plastic Housing</b> |                    |                  |               |       |          |              |                            |
| 3.5 in TFT             | QVGA<br>320x240    | Y                | None          | None  | Y        | Y            | <b>XV-102-BE-35TQRC-10</b> |
|                        |                    | Y                | CANopen       | Y     | Y        | Y            | <b>XV-102-E6-57TVRC-10</b> |
| 5.7 in TFT             | VGA<br>640x480     | Y                | PROFIBUS-DP   | Y     | Y        | Y            | <b>XV-102-E8-57TVRC-10</b> |
|                        |                    | Y                | CANopen       | Y     | Y        | Y            | <b>XV-102-E6-70TWRC-10</b> |
| 7.0 in TFT             | WGA<br>800x480     | Y                | PROFIBUS-DP   | Y     | Y        | Y            | <b>XV-102-E8-70TWRC-10</b> |
|                        |                    | Y                | CANopen       | Y     | Y        | Y            | <b>XV-152-E6-57TVRC-10</b> |
| 5.7 in TFT             | VGA<br>640x480     | Y                | PROFIBUS-DP   | Y     | Y        | Y            | <b>XV-152-E8-57TVRC-10</b> |
|                        |                    | Y                | CANopen       | Y     | Y        | Y            | <b>XV-152-E6-84TVRC-10</b> |
| 8.4 in TFT             | VGA<br>640x480     | Y                | PROFIBUS-DP   | Y     | Y        | Y            | <b>XV-152-E8-84TVRC-10</b> |
|                        |                    | Y                | CANopen       | Y     | Y        | Y            | <b>XV-152-E6-10TVRC-10</b> |
| 10.4 in TFT            | VGA<br>640x480     | Y                | PROFIBUS-DP   | Y     | Y        | Y            | <b>XV-152-E8-10TVRC-10</b> |
|                        |                    | Y                | CANopen       | Y     | Y        | Y            |                            |

## Accessories

## XV HMI-PLC Accessories

| Description   | Catalog Number                |
|---|-------------------------------|
| HMI-PLC programming software, single seat license                                       | <b>SW-XSOFT-CODESYS-2-S</b> ① |
| HMI-PLC programming software, multiple seat license                                     | <b>SW-XSOFT-CODESYS-2-M</b> ① |
| SD memory card  | <b>MEMORY-SD-A1-S</b>         |
| XV-102 parts kit (1 power conductor, 8 mounting brackets, 1 sealing strip, 1 touch pen) | <b>ACC-TP-57-KG-1</b>         |
| XV-152 parts kit (1 power conductor, 8 mounting brackets, 1 sealing strip, 1 touch pen) | <b>ACC-TP-10-12-RES-1</b>     |

**Note**

① For details on SW-XSoft-CoDeSys software, see [Page V7-T4-38](#).

XI/ON Series Remote I/O

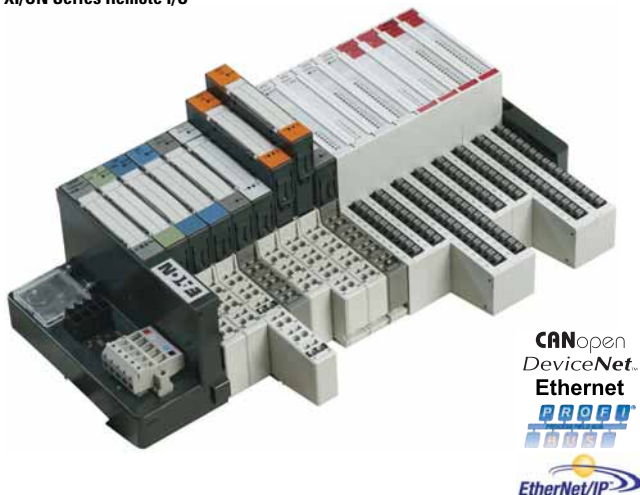

**Contents**

| <b>Description</b>                          | <b>Page</b>      |
|---|------------------|
| XI/ON Series Remote I/O                     |                  |
| Product Selection Guide . . . . .           | <b>V7-T4-64</b>  |
| Catalog Number Selection . . . . .          | <b>V7-T4-65</b>  |
| System Overview . . . . .                   | <b>V7-T4-67</b>  |
| Product Selection . . . . .                 | <b>V7-T4-71</b>  |
| Accessories . . . . .                       | <b>V7-T4-80</b>  |
| Technical Data and Specifications . . . . . | <b>V7-T4-81</b>  |
| Connection Diagrams . . . . .               | <b>V7-T4-94</b>  |
| Dimensions . . . . .                        | <b>V7-T4-106</b> |

**Product Overview**

Whether for controlling movements, measuring temperature or speed, or logging currents and voltages, the application ranges for remote I/Os are as extensive as the different applications involved. They are used wherever decentralized signal processing is the essential element of the automation concept.

Thanks to the high modularity of the XI/ON system and the wide range of functions, Eaton is able to offer the right I/O solution for every application. XI/ON: A modular concept with simple handling—adaptable to any application, intelligent and ready for future developments.

**Standards and Certifications**

- UL File No. E205091
- UL CCN—NRAQ, NRAQ7
- cULus
- CE
- RoHS



#### Product Selection Guide

#### XI/ON Series Remote I/O

4



#### XI/ON

As many as needed, as few as possible—this is the principle on which the XI/ON modular I/O system was built. An extensive range of digital and analog I/Os as well as technology modules are available.

- High level of modularity
- Fieldbuses: CANopen, PROFIBUS-DP, DeviceNet and Ethernet
- Bus-independent, pluggable modules
- Low wiring requirement
- Precise diagnostics
- Space and cost saving with XNE modules
- Programmable CANopen gateway
- Standard and XNE modules can be mixed



#### XNE Gateways and Integrated Modules

Page V7-T4-71

XI/ON XNE completes the XI/ON I/O system with price and space optimized I/O modules and gateways. The XNE gateways use the EtherNet/IP, Modbus TCP Ethernet, CANopen and PROFIBUS-DP bus systems.

- XNE gateways with integrated bus terminating resistors
- Full compatibility with the standard XI/ON system
- No base module required
- High channel density (up to 16 DI/DO on 12.5 mm width)
- "Push-In" spring-loaded terminals
- Multi-functional slices
- Diagnostics interface



#### XN Standard Gateways and Plug-in Modules

Page V7-T4-73

The standard gateways use the Modbus TCP, DeviceNet, Ethernet, CANopen and PROFIBUS-DP bus systems.

- The use of pluggable I/O modules is independent on the fieldbus used
- Wiring is implemented on the base module, fixed wiring
- Fast module exchange under power (hot swapping)
- Generation of diagnostics information to higher-level controller
- Up to 74 slice modules can be connected per gateway
- Mechanical coding of modules
- Diagnostics interface

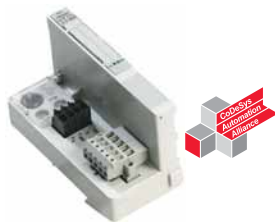

#### Programmable CANopen Gateway

Page V7-T4-73

The programmable CANopen gateway brings the power of the PLC directly to the fieldbus terminal. The device is ideal for handling decentralized automation tasks and thus for relieving the load of a higher-level PLC.

The serial onboard interface is used for local programming access and as an interface for the I/Oassistant configuration and diagnostics tool. Alternatively, this interface can also be used as a free user interface. The gateway is programmed with XSoft-CoDeSys-2.

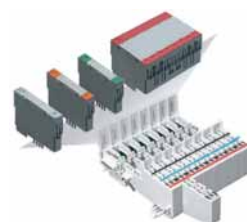

#### Base Modules for Every Requirement

Page V7-T4-77

The base modules are used to connect the field wiring for the standard XI/ON modules. They are available for 2-, 3- and 4-wire connections, as block or slice modules, with either spring-loaded terminals or screw terminals—the right format for every application.

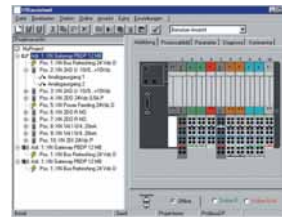

#### I/Oassistant—the Universal Configuration and Diagnostics Tool

The I/Oassistant provides you with a universal tool that offers interactive support with the entire planning and implementation of your XI/ON installation. The I/Oassistant is integrated in XSoft-CoDeSys-2.

A project is first of all created and structured on the screen. For this you choose gateways, electronic and base modules as well as the appropriate accessories. The individual stations are then configured offline or online. Once everything is set to your satisfaction, you simply put your installation into operation. The I/Oassistant also automatically generates a parts list for your order.

I/Oassistant checks the station, reads the process data, outputs values and visualizes the diagnostics data of the channel. This enables you to commission your station without a higher-level PLC and ensure that a section of the system is functioning correctly.



**Catalog Number Selection**

**Gateway Modules**

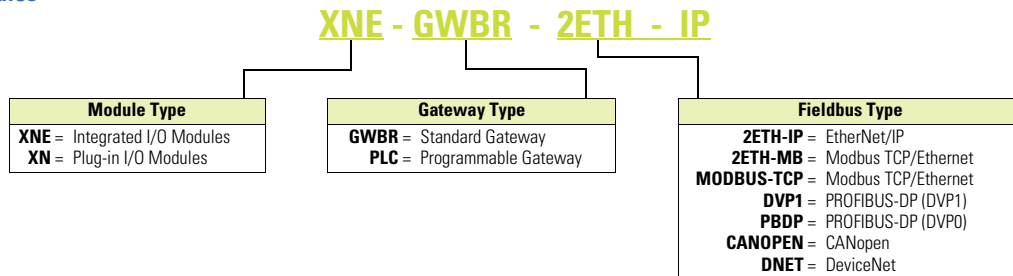

**Digital I/O Modules**

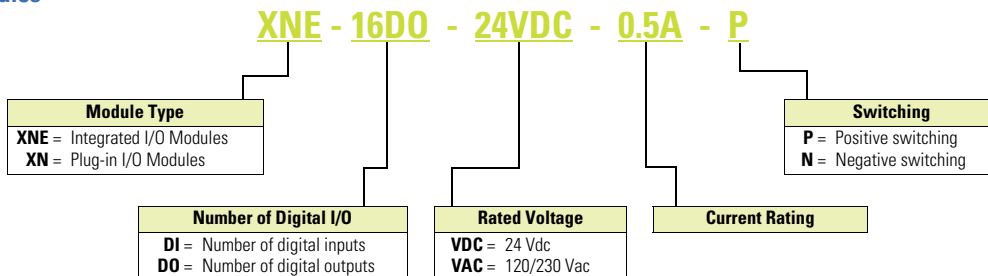

**Analog I/O Modules**

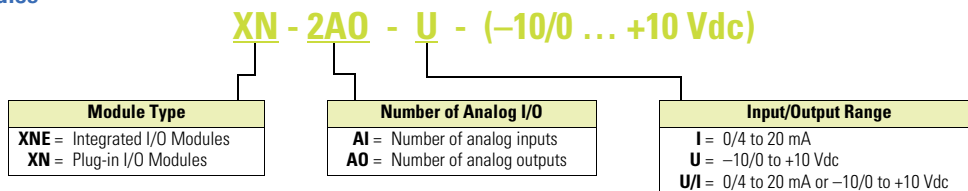

#### Base Modules

4

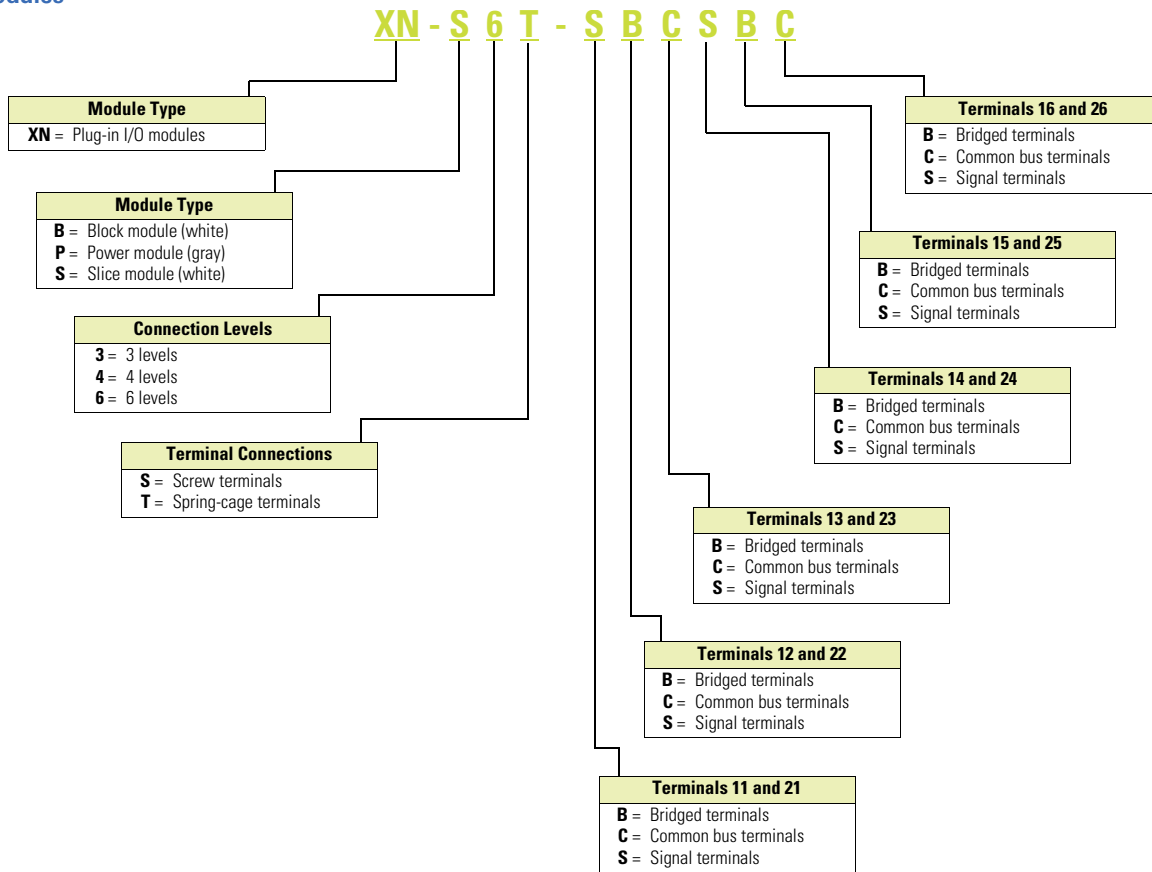

**System Overview**

**System Configuration**

**XN Module and Base Compatibility Chart**

|                               | Base Modules |            |            |            |             |             |             |             |             |             |                |                |               |               |               |                               |
|-------------------------------|--------------|------------|------------|------------|-------------|-------------|-------------|-------------|-------------|-------------|----------------|----------------|---------------|---------------|---------------|-------------------------------|
|                               | XN-S3S-SBB   | XN-S3T-SBB | XN-S3S-SBC | XN-S3T-SBC | XN-S4S-SBRC | XN-S4T-SBRC | XN-S4S-SBBS | XN-S4T-SBBS | XN-S4S-SBCS | XN-S4T-SBCS | XN-S4S-SBBS-CJ | XN-S4T-SBBS-CJ | XN-S6S-SBBSBB | XN-S6T-SBBSBB | XN-S6S-SBCSBC | XN-S6T-SBCSBC                 |
| <b>Electronics Modules</b>    |              |            |            |            |             |             |             |             |             |             |                |                |               |               |               |                               |
| <b>Digital Input Modules</b>  |              |            |            |            |             |             |             |             |             |             |                |                |               |               |               |                               |
| XN-2DI-24VDC-P                | ✓            | —          | —          | ✓          | —           | —           | —           | —           | —           | —           | —              | —              | —             | —             | —             | —                             |
| XN-2DI-24VDC-N                | ✓            | —          | —          | ✓          | —           | —           | —           | —           | —           | —           | —              | —              | —             | —             | —             | —                             |
| XN-2DI-120/230VAC             | ✓            | —          | —          | ✓          | —           | —           | —           | —           | —           | —           | —              | —              | —             | —             | —             | —                             |
| XN-4DI-24VDC-P                | —            | —          | —          | —          | ✓           | —           | —           | —           | —           | —           | —              | —              | ✓             | —             | —             | —                             |
| XN-4DI-24VDC-N                | —            | —          | —          | —          | ✓           | —           | —           | —           | —           | —           | —              | —              | ✓             | —             | —             | —                             |
| XN-16DI-24VDC-P               | —            | —          | —          | —          | —           | —           | —           | —           | —           | —           | —              | —              | ✓             | —             | —             | —                             |
| XN-32DI-24VDC-P               | —            | —          | —          | —          | —           | —           | —           | —           | —           | —           | —              | —              | —             | —             | ✓             | —                             |
| <b>Digital Output Modules</b> |              |            |            |            |             |             |             |             |             |             |                |                |               |               |               |                               |
| XN-2DO-24VDC-0.5A-P           | —            | ✓          | —          | —          | —           | ✓           | —           | —           | —           | —           | —              | —              | —             | —             | —             | —                             |
| XN-2DO-24VDC-0.5A-N           | —            | ✓          | —          | —          | —           | ✓           | —           | —           | —           | —           | —              | —              | —             | —             | —             | —                             |
| XN-2DO-24VDC-2A-P             | —            | ✓          | —          | —          | —           | ✓           | —           | —           | —           | —           | —              | —              | —             | —             | —             | —                             |
| XN-2DO-120/230VAC-0.5A        | —            | ✓          | —          | —          | —           | ✓           | —           | —           | —           | —           | —              | —              | —             | —             | —             | —                             |
| XN-4DO-24VDC-0.5A-P           | —            | —          | —          | —          | —           | ✓           | —           | —           | —           | —           | —              | —              | ✓             | —             | —             | —                             |
| XN-16DO-24VDC-0.5A-P          | —            | —          | —          | —          | —           | —           | —           | —           | —           | —           | —              | —              | —             | —             | ✓             | —                             |
| XN-32DO-24VDC-0.5A-P          | —            | —          | —          | —          | —           | —           | —           | —           | —           | —           | —              | —              | —             | —             | ✓             | —                             |
| <b>Relay Modules</b>          |              |            |            |            |             |             |             |             |             |             |                |                |               |               |               |                               |
| XN-2DO-R-NC                   | —            | —          | —          | —          | ✓           | ✓           | —           | —           | —           | —           | —              | —              | —             | —             | —             | —                             |
| XN-2DO-R-NO                   | —            | —          | —          | —          | ✓           | ✓           | —           | —           | —           | —           | —              | —              | —             | —             | —             | —                             |
| XN-2DO-R-CO                   | —            | —          | —          | —          | ✓           | —           | —           | —           | —           | —           | —              | —              | —             | —             | —             | —                             |
| <b>Analog Input Modules</b>   |              |            |            |            |             |             |             |             |             |             |                |                |               |               |               |                               |
| XN-1AI-I(0/4...20MA)          | ✓            | —          | —          | —          | ✓           | —           | —           | —           | —           | —           | —              | —              | —             | —             | —             | —                             |
| XN-2AI-I(0/4...20MA)          | ✓            | —          | —          | —          | ✓           | —           | —           | —           | —           | —           | —              | —              | —             | —             | —             | —                             |
| XN-1AI-U(-10/0...+10VDC)      | ✓            | —          | —          | —          | ✓           | —           | —           | —           | —           | —           | —              | —              | —             | —             | —             | —                             |
| XN-2AI-U(-10/0...+10VDC)      | ✓            | —          | —          | —          | ✓           | —           | —           | —           | —           | —           | —              | —              | —             | —             | —             | —                             |
| XN-2AI-PT/NI-2/3              | ✓            | —          | —          | —          | ✓           | —           | —           | —           | —           | —           | —              | —              | —             | —             | —             | —                             |
| XN-2AI-THERMO-PI              | —            | —          | —          | —          | —           | —           | —           | ✓           | —           | —           | —              | —              | —             | —             | —             | —                             |
| XN-4AI-U/I                    | —            | —          | —          | —          | —           | —           | —           | —           | —           | ✓           | —              | —              | —             | —             | —             | —                             |
| <b>Analog Output Modules</b>  |              |            |            |            |             |             |             |             |             |             |                |                |               |               |               |                               |
| XN-1AO-I(0/4...20MA)          | ✓            | —          | —          | —          | —           | —           | —           | —           | —           | —           | —              | —              | —             | —             | —             | —                             |
| XN-2AO-I(0/4...20MA)          | ✓            | —          | —          | —          | —           | —           | —           | —           | —           | —           | —              | —              | —             | —             | —             | —                             |
| XN-2AO-U(-10/0...+10VDC)      | ✓            | —          | —          | —          | —           | —           | —           | —           | —           | —           | —              | —              | —             | —             | —             | —                             |
| <b>Technology Modules</b>     |              |            |            |            |             |             |             |             |             |             |                |                |               |               |               |                               |
| XN-1CNT-24VDC                 | —            | —          | —          | —          | ✓           | —           | —           | —           | —           | —           | —              | —              | —             | —             | —             | —                             |
| XN-1RS232                     | —            | —          | —          | —          | ✓           | —           | —           | —           | —           | —           | —              | —              | —             | —             | —             | —                             |
| XN-1RS485/422                 | —            | —          | —          | —          | ✓           | —           | —           | —           | —           | —           | —              | —              | —             | —             | —             | —                             |
| XN-1SSI                       | —            | —          | —          | —          | ✓           | —           | —           | —           | —           | —           | —              | —              | —             | —             | —             | —                             |
| <b>Supply Modules</b>         |              |            |            |            |             |             |             |             |             |             |                |                |               |               |               |                               |
| XN-BR-24VDC-D                 | —            | —          | —          | —          | —           | —           | —           | —           | —           | —           | —              | —              | —             | —             | —             | ✓ <sup>①</sup> ✓ <sup>②</sup> |
| XN-PF-24VDC-D                 | —            | —          | —          | —          | —           | —           | —           | —           | —           | —           | —              | —              | —             | —             | —             | ✓ <sup>①</sup> —              |
| XN-PF-120/230VAC-D            | —            | —          | —          | —          | —           | —           | —           | —           | —           | —           | —              | —              | —             | —             | —             | ✓ <sup>①</sup> —              |

**Notes**

- ① Base module for gateway supply.
- ② Base module for bus refreshing within the station.

#### Maximum System Configuration

##### Maximum 74 XI/ON Modules in Slice Design

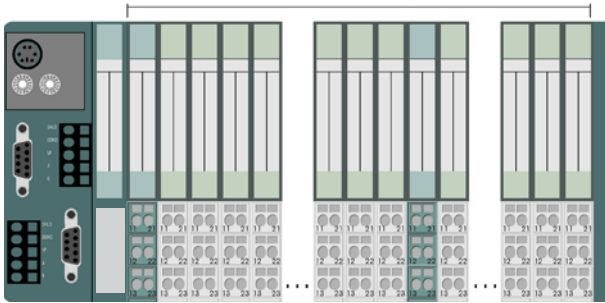

Plan your XI/ON station with the software “I/Oassistant”.

#### Advantage 1:

Automatically generates a full parts list for your order.

#### Advantage 2:

Generates an error message as soon as the system limits are exceeded.

#### IMPORTANT:

When extending your system, make sure that you have a sufficient number of bus refresh or power feed modules.

| Style Number:            | 140045          |               | 140044           |                  | 140047           |          | 152279  |          |         |
|--------------------------|-----------------|---------------|------------------|------------------|------------------|----------|---------|----------|---------|
|                          | Catalog Number: | XNE-GWBR-PBDP | XNE-GWBR-CANOPEN | XNE-GWBR-2ETH-IP | XNE-GWBR-2ETH-MB | Channels | Modules | Channels | Modules |
| <b>Modules</b>           |                 |               |                  |                  |                  |          |         |          |         |
| XN-4DI-24VDC-P           | 136             | 34            | 244              | 61               | 288              | 72       | 288     | 72       |         |
| XN-4DI-24VDC-N           | 136             | 34            | 244              | 61               | 288              | 72       | 288     | 72       |         |
| XN-16DI-24VDC-P          | 128             | 8             | 128              | 8                | 128              | 8        | 128     | 8        |         |
| XN-32DI-24VDC-P          | 256             | 8             | 256              | 8                | 256              | 8        | 256     | 8        |         |
| XNE-8DI-24VDC-P          | 384             | 48            | 512              | 64               | 512              | 64       | 512     | 64       |         |
| XNE-16DI-24VDC-P         | 768             | 48            | 512              | 32               | 512              | 32       | 512     | 32       |         |
| XN-4DO-24VDC-0.5A-P      | 132             | 33            | 244              | 61               | 288              | 72       | 288     | 72       |         |
| XN-16DO-24VDC-0.5A-P     | 128             | 8             | 128              | 8                | 128              | 8        | 128     | 8        |         |
| XN-32DO-24VDC-0.5A-P     | 256             | 8             | 256              | 8                | 256              | 8        | 256     | 8        |         |
| XNE-8DO-24VDC-0.5A-P     | 384             | 48            | 488              | 61               | 512              | 64       | 512     | 64       |         |
| XNE-16DO-24VDC-0.5A-P    | 640             | 40            | 512              | 32               | 512              | 32       | 512     | 32       |         |
| XN-2DO-R_                | 70              | 35            | 122              | 61               | 144              | 72       | 144     | 72       |         |
| XN-2AI-I(0/4...20MA)     | 56              | 28            | 100              | 50               | 126              | 63       | 126     | 63       |         |
| XN-2AI-U(-10/0...+10VDC) | 56              | 28            | 100              | 50               | 126              | 63       | 126     | 63       |         |
| XN-2AI-PT/NI2/3          | 44              | 22            | 98               | 49               | 126              | 63       | 126     | 63       |         |
| XN-2AI-THERMO-PI         | 44              | 22            | 98               | 49               | 126              | 63       | 126     | 63       |         |
| XN-4AI-U/I               | 64 (132)        | 16 (33)       | 108              | 27               | 124              | 31       | 124     | 31       |         |
| XNE-8AI-U/I-4PT/NI       | 72 (120)        | 9 (15)        | 144              | 18               | 128              | 16       | 128     | 16       |         |
| XN-2AO-I(0/4...20MA)     | 50              | 25            | 70               | 35               | 126              | 63       | 126     | 63       |         |
| XN-2AO-U(-10/0...+10VDC) | 46              | 23            | 70               | 35               | 126              | 63       | 126     | 63       |         |
| XNE-4AO-U/I              | 64 (76)         | 16 (19)       | 108              | 27               | 64               | 16       | 64      | 16       |         |
| XN-1CNT-24VDC            | 13              | 13            | 27               | 27               | 31               | 31       | 31      | 31       |         |
| XN-1RS232                | 7               | 7             | 27               | 27               | 31               | 31       | 31      | 31       |         |
| XN-1RS485/422            | 16              | 16            | 27               | 27               | 31               | 31       | 31      | 31       |         |
| XN-1SSI                  | 20              | 20            | 27               | 27               | 31               | 31       | 31      | 31       |         |

#### Note

Numeric values in parentheses. Maximum number when diagnostic alarm disabled.  
The supply module XN-BR-24VDC-D must be mounted immediately next to the gateway XN-GW\_ to provide power for the gateways.

Maximum System Configuration, continued

Maximum 74 XI/ON Modules in Slice Design

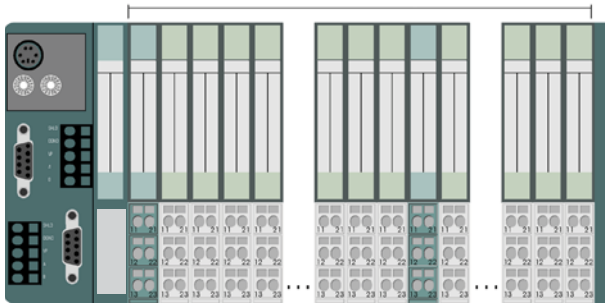

Plan your XI/ON station with the software “I/Oassistant”.

**Advantage 1:**

Automatically generates a full parts list for your order.

**Advantage 2:**

Generates an error message as soon as the system limits are exceeded.

**IMPORTANT:**

When extending your system, make sure that you have a sufficient number of bus refresh or power feed modules.

| Style Number:            | 140154          |                     | 140055                 |                     | 140156                    |          | 140162  |          |         |
|--------------------------|-----------------|---------------------|------------------------|---------------------|---------------------------|----------|---------|----------|---------|
|                          | Catalog Number: | <b>XN-GWBR-PBDP</b> | <b>XN-GWBR-CANOPEN</b> | <b>XN-GWBR-DNET</b> | <b>XN-GWBR-MODBUS-TCP</b> | Channels | Modules | Channels | Modules |
| <b>Modules</b>           |                 |                     |                        |                     |                           |          |         |          |         |
| XN-4DI-24VDC-P           | 288             | 72                  | 288                    | 72                  | 288                       | 72       | 288     | 72       |         |
| XN-4DI-24VDC-N           | 288             | 72                  | 288                    | 72                  | 288                       | 72       | 288     | 72       |         |
| XN-16DI-24VDC-P          | 128             | 8                   | 128                    | 8                   | 128                       | 8        | 128     | 8        |         |
| XN-32DI-24VDC-P          | 256             | 8                   | 256                    | 8                   | 256                       | 8        | 256     | 8        |         |
| XNE-8DI-24VDC-P          | 592             | 74                  | 512                    | 64                  | 576                       | 72       | 512     | 64       |         |
| XNE-16DI-24VDC-P         | 1184            | 74                  | 512                    | 32                  | 1152                      | 72       | 512     | 32       |         |
| XN-4DO-24VDC-0.5A-P      | 288             | 72                  | 288                    | 72                  | 128                       | 32       | 288     | 72       |         |
| XN-16DO-24VDC-0.5A-P     | 128             | 8                   | 128                    | 8                   | 128                       | 8        | 128     | 8        |         |
| XN-32DO-24VDC-0.5A-P     | 256             | 8                   | 256                    | 8                   | 256                       | 8        | 256     | 8        |         |
| XNE-8DO-24VDC-0.5A-P     | 592             | 74                  | 512                    | 64                  | 256                       | 32       | 512     | 64       |         |
| XNE-16DO-24VDC-0.5A-P    | 1168            | 73                  | 512                    | 32                  | 512                       | 32       | 512     | 32       |         |
| XN-2DO-R-__              | 144             | 72                  | 144                    | 72                  | 64                        | 32       | 144     | 72       |         |
| XN-2AI-I(0/4...20MA)     | 78              | 39                  | 144                    | 72                  | 32                        | 16       | 144     | 72       |         |
| XN-2AI-U(-10/0...+10VDC) | 78              | 39                  | 144                    | 72                  | 32                        | 16       | 144     | 72       |         |
| XN-2AI-PT/NI-2/3         | 46              | 23                  | 144                    | 72                  | 32                        | 16       | 144     | 72       |         |
| XN-2AI-THERMO-PI         | 58 (76)         | 29 (38)             | 144                    | 72                  | 32                        | 16       | 144     | 72       |         |
| XN-4AI-U/I               | 112             | 28                  | 144                    | 36                  | 64                        | 16       | 144     | 36       |         |
| XNE-8AI-U/I-4PT/NI       | 88              | 11                  | 144                    | 18                  | 128                       | 16       | 144     | 18       |         |
| XN-2AO-I(0/4...20MA)     | 38              | 19                  | 144                    | 72                  | 32                        | 16       | 144     | 72       |         |
| XN-2AO-U(-10/0...+10VDC) | 38              | 19                  | 144                    | 72                  | 32                        | 16       | 144     | 72       |         |
| XNE-4AO-U/I              | 36              | 9                   | 144                    | 36                  | 64                        | 16       | 124     | 31       |         |
| XN-1CNT-24VDC            | 7               | 7                   | 72                     | 72                  | 16                        | 16       | 72      | 72       |         |
| XN-1RS232                | 22              | 22                  | 68                     | 68                  | 8                         | 8        | 68      | 68       |         |
| XN-1RS485/422            | 22              | 22                  | 72                     | 72                  | 8                         | 8        | 72      | 72       |         |
| XN-1SSI                  | 22              | 22                  | 72                     | 72                  | 8                         | 8        | 72      | 72       |         |

**Note**

Numeric values in parentheses. Maximum number when diagnostic alarm disabled.

# 4.5

## PLC, I/O and Communications Products

### XI/ON Series Remote I/O

#### System Overview

4

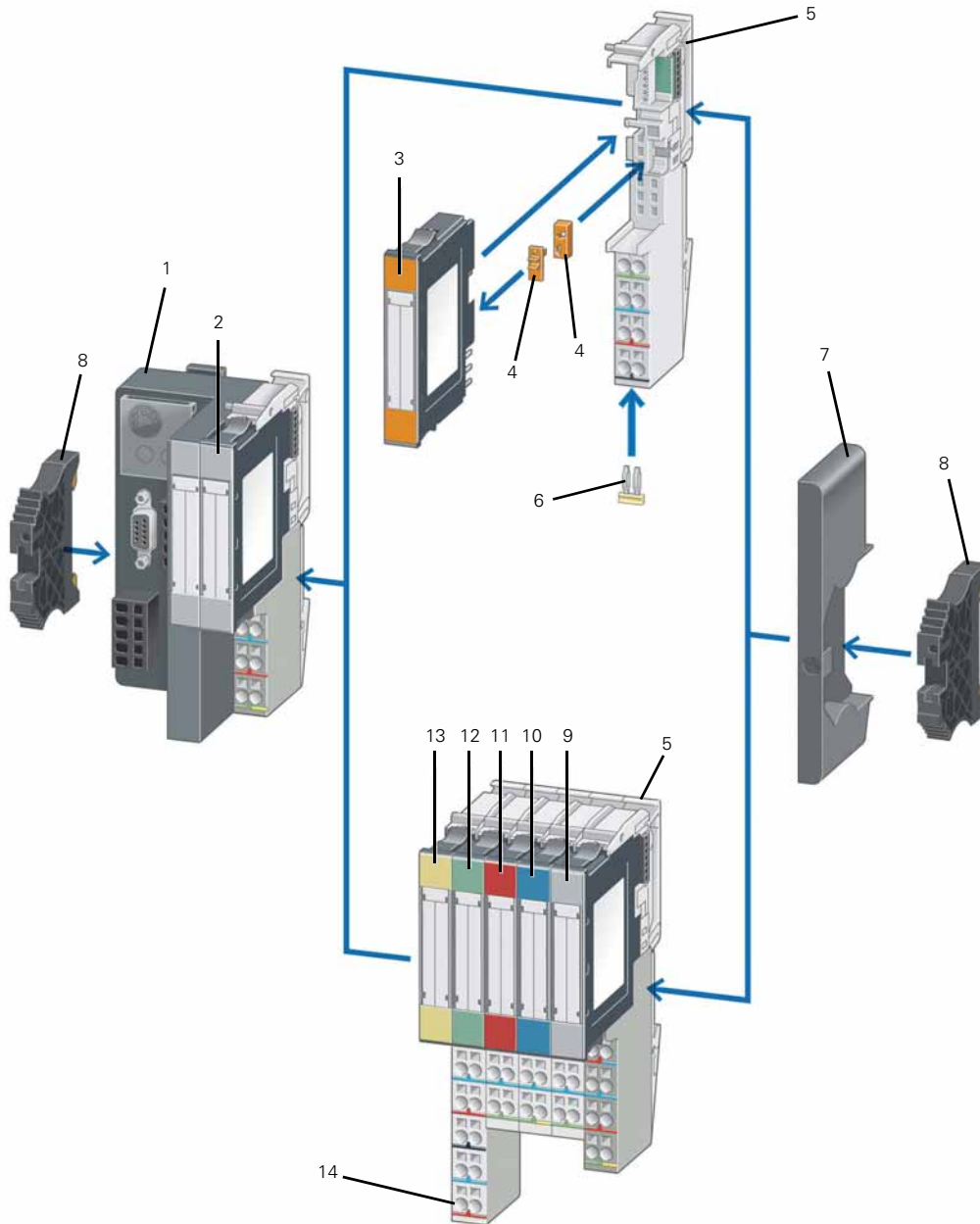

| Item Number | Description          |
|-------------|----------------------|
| 1           | Gateway              |
| 2           | Digital input module |
| 3           | Relay module         |
| 4           | Coding element       |
| 5           | Base module          |
| 6           | Relay jumper         |
| 7           | End plate            |



| Item Number | Description           |
|-------------|-----------------------|
| 8           | End bracket           |
| 9           | Power supply module   |
| 10          | Analog input module   |
| 11          | Digital output module |
| 12          | Analog output module  |
| 13          | Technology module     |
| 14          | Marker                |

**Product Selection**

**XNE Series**

The following are included as standard with all gateways:  
 2 x End bracket XN-WEW-32/2-SW,  
 1 x End plate XN-ABPL.

**XNE Gateway with Integrated Supply**

|   | Description   | Fieldbus Connection              | Terminal Capacity (Fieldbus/Supply Voltage) | Servicing Interface | Transfer Rate   | Style Number | Catalog Number          |
|---|---|----------------------------------|---|---------------------|---|--------------|-------------------------|
|    | <b>Ethernet</b>   |                                  |   |                     |   |              |                         |
|   | Supports up to 74 disc type modules (XN, XNE)<br>2xRJ45 socket<br>Address set with decimal rotary coding switches,<br>BootP, DHCP or I/Oassistant<br>Address range: 1–254 (dec.)        | Ethernet (EtherNet/IP protocol)  | Push-in spring-cage terminals               | Mini USB            | 10/100 MBit/s   | 140047       | <b>XNE-GWBR-2ETH-IP</b> |
|   | Supports up to 74 disc type modules (XN, XNE)<br>RJ45 Ethernet switch<br>Address set with decimal rotary coding switches,<br>BootP, DHCP or I/Oassistant<br>Address range: 1–254 (dec.) | Ethernet (Modbus TCP)            | Push-in spring-cage terminals               | Mini USB            | 10/100 MBit/s   | 152279       | <b>XNE-GWBR-2ETH-MB</b> |
|   | <b>PROFIBUS-DP</b>  |                                  |   |                     |   |              |                         |
|   | Supports up to 48 slice type modules (XN, XNE)<br>Address setting through DIP switch<br>Address range: 1–125 (dec.)   | PROFIBUS-DP (DPV0/DPV1 protocol) | Push-in spring-cage terminals               | PS/2 socket         | 9.6 kbit/s to 12 Mbit/s   | 140045       | <b>XNE-GWBR-PBDP</b>    |
|  | <b>CANopen</b>  |                                  |   |                     |   |              |                         |
|   | Supports up to 62 disc type modules (XN, XNE)<br>Address set with DIP switch<br>Address range: 1–63 (dec.)  | CANopen                          | Push-in spring-cage terminals               | PS/2 socket         | 1000 kbit/s<br>800 kbit/s<br>500 kbit/s<br>250 kbit/s<br>125 kbit/s<br>50 kbit/s<br>20 kbit/s | 140044       | <b>XNE-GWBR-CANOPEN</b> |

#### XNE Digital Input



#### XNE Digital Input Modules

Positive switching.

| Channels | Rated Voltage via Power Supply Terminal | Input Delay t <sub>Rise</sub> /t <sub>Fall</sub> | Input Voltage High Signal | Style Number | Catalog Number          |
|----------|---|--|---------------------------|--------------|-------------------------|
| 8        | 24 Vdc                                  | <100/<200 μs                                     | 11 V-U <sub>L</sub>       | 140035       | <b>XNE-8DI-24VDC-P</b>  |
| 16       | 24 Vdc                                  | <150/<300 μs                                     | 11 V-U <sub>L</sub>       | 140040       | <b>XNE-16DI-24VDC-P</b> |

#### XNE Digital Output



#### XNE Digital Output Modules

Resistive inductive and lamp load connectable.

| Channels | Rated Voltage via Power Supply Terminal | Switching Frequency with Resistive Load in Hz | Utilization Factor g in % | Style Number | Catalog Number               |
|----------|---|---|---------------------------|--------------|------------------------------|
| 8        | 24 Vdc                                  | <100  | 100                       | 140036       | <b>XNE-8DO-24VDC-0.5A-P</b>  |
| 16       | 24 Vdc                                  | <100  | 50%, maximum 4A           | 140039       | <b>XNE-16DO-24VDC-0.5A-P</b> |

#### XNE Analog Input



#### XNE Analog Input and RTD Module

Rated voltage via power supply terminal: 24 Vdc.

| Channels               | Measured Variables                                  | Measuring Ranges   | Value Representation  | Limit Frequency in Hz | Style Number | Catalog Number            |
|------------------------|---|--|---|-----------------------|--------------|---------------------------|
| 8 (U/I)<br>4 (PT/NI/R) | Voltage, current temperature (PT, NI), resistance R | -10 to 10 Vdc/0 to 10 Vdc<br>PT100, 200, 500, 1000, NI100, 1000 2-, 3-wire | Standard:<br>16-bit/12-bit (flush-left)<br><br>Extended range:<br>16-bit/12-bit (flush-left) PA (NE43),<br>16-bit/12-bit (flush-left) | 1.5                   | 140037       | <b>XNE-8AI-U/I-4PT/NI</b> |

#### XNE Analog Output



#### XNE Analog Output Module

Rated voltage via power supply terminal: 24 Vdc.

| Channels | Measured Variables | Output Variables                                      | Value Representation                    | Style Number | Catalog Number       |
|----------|--------------------|---|---|--------------|----------------------|
| 4        | Voltage, current   | -10 to 10 Vdc/0 to 10 Vdc<br>0 to 20 mA<br>4 to 20 mA | Standard:<br>16-bit/12-bit (flush-left) | 140034       | <b>XNE-4AO-U/I</b> ① |

#### XNE Counter



#### XNE Counter Module

Rated voltage via power supply terminal: 24 Vdc.

Signal evaluation A, B: Pulse and direction, rotary encoder single/double/quadruple.

| Channels | Operating Modes                             | Pulse Duration      | PWM Module | Resolution | Style Number | Catalog Number       |
|----------|---|---------------------|------------|------------|--------------|----------------------|
| 2        | Continuous, once only and periodic counting | 32-bit/maximum 120s | ✓          | 32-bit     | 140038       | <b>XNE-2CNT-2PWM</b> |

**Note**

① cUL pending.



**XN Series**

The following are included as standard with all gateways:  
 2 x End bracket XN-WEW-32/2-SW,  
 1 x End plate XN-ABPL.

**XN Gateway with Integrated Supply**

**XN-GWBR-MODBUS\_**

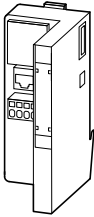

| Description   | Fieldbus Connection            | Terminal Capacity (Fieldbus/Supply Voltage) | Servicing Interface | Transfer Rate | Style Number | Catalog Number            |
|---|--------------------------------|---|---------------------|---------------|--------------|---------------------------|
| <b>Ethernet</b>   |                                |   |                     |               |              |                           |
| Supports up to 74 slice type modules (XN, XNE)<br>1 x RJ45 socket<br>Address set with decimal rotary coding switches,<br>BootP, DHCP or I/Oassistant<br>Address range: 1–254 (dec.) | Ethernet (Modbus TCP protocol) | Screw terminals                             | PS/2 socket         | 10/100 Mbit/s | 140162       | <b>XN-GWBR-MODBUS-TCP</b> |

**XN-GWBR-D\_**  
**XN-GWBR-C\_**



|  |           |                 |             |  |        |                     |
|--|-----------|-----------------|-------------|--|--------|---------------------|
| <b>DeviceNet</b>   |           |                 |             |  |        |                     |
| Supports up to 74 disc type modules (XN, XNE)<br>1 x open-style connector<br>Address set with two decimal rotary coding switches<br>Address range: 1–63 (dec.) | DeviceNet | Screw terminals | PS/2 socket | 500 kbit/s<br>250 kbit/s<br>125 kbit/s | 140156 | <b>XN-GWBR-DNET</b> |

|  |         |                 |             |  |        |                        |
|--|---------|-----------------|-------------|--|--------|------------------------|
| <b>CANopen</b>   |         |                 |             |  |        |                        |
| Supports up to 74 disc type modules (XN, XNE)<br>1 x open-style connector<br>Address set with two decimal rotary coding switches<br>Address range: 1–99 (dec.) | CANopen | Screw terminals | PS/2 socket | 1000 kbit/s<br>800 kbit/s<br>500 kbit/s<br>250 kbit/s<br>125 kbit/s<br>50 kbit/s<br>20 kbit/s<br>10 kbit/s | 140155 | <b>XN-GWBR-CANOPEN</b> |

**XN-GWBR-DVP1**



|  |                             |                 |             |                         |        |                     |
|--|-----------------------------|-----------------|-------------|-------------------------|--------|---------------------|
| <b>PROFIBUS-DP</b>   |                             |                 |             |                         |        |                     |
| Supports up to 74 disc type modules (XN, XNE)<br>1 x D-sub 9-pin socket<br>Address set with decimal rotary coding switches<br>Address range: 1–99 (dec.) | PROFIBUS-DP (DVP1 protocol) | Screw terminals | PS/2 socket | 9.6 kbit/s to 12 Mbit/s | 148561 | <b>XN-GWBR-DVP1</b> |
| Supports up to 74 disc type modules (XN, XNE)<br>1 x D-sub 9-pin socket<br>Address set with decimal rotary coding switches<br>Address range: 1–99 (dec.) | PROFIBUS-DP (DVPO protocol) | Screw terminals | PS/2 socket | 9.6 kbit/s to 12 Mbit/s | 140154 | <b>XN-GWBR-PBDP</b> |

**XN-PLC-CANOPEN**



**XN Programmable Gateway with Integrated Supply**

| Description   | Fieldbus Connection | Terminal Capacity (Fieldbus/Supply Voltage) | Servicing Interface | Transfer Rate             | Style Number | Catalog Number        |
|---|---------------------|---|---------------------|---------------------------|--------------|-----------------------|
| <b>CANopen</b>  |                     |   |                     |                           |              |                       |
| Supports up to 74 disc type modules (XN, XNE to limited extent)<br>1 x open-style connector<br>Operating mode and address setting with two hexadecimal rotary coding switches<br>Address range: 1–99 (dec.) | CANopen             | Screw terminals                             | PS/2 socket         | Adjustable up to 1 Mbit/s | 140157       | <b>XN-PLC-CANOPEN</b> |

**Slice Module**



**XN Power Supply Modules**

Number of diagnostic bits: 4.  
Ripple <5% (to EN 61131-2).

| Operating and Field Voltage | System Power Supply | Rated Current Consumption from Modbus | Maximum System Supply Current | For Use With ...   | Style Number | Catalog Number            |
|-----------------------------|---------------------|---------------------------------------|-------------------------------|--|--------------|---------------------------|
| 24 Vdc                      | 24 Vdc              | —                                     | 1.5A                          | XN-P3T-SBB<br>XN-P3S-SBB<br>XN-P4T-SBBC<br>XN-P4S-SBBC<br>XN-P3T-SBB-B<br>XN-P3S-SBB-B<br>XN-P4T-SBBC-B<br>XN-P4S-SBBC-B | 140071       | <b>XN-BR-24VDC-D</b>      |
| 24 Vdc                      | —                   | ≤28 mA                                | —                             | XN-P3T-SBB<br>XN-P3S-SBB<br>XN-P4T-SBBC<br>XN-P4S-SBBC   | 140070       | <b>XN-PF-24VDC-D</b>      |
| 120/230 Vac                 | —                   | ≤25 mA                                | —                             | XN-P3T-SBB<br>XN-P3S-SBB<br>XN-P4T-SBBC<br>XN-P4S-SBBC   | 140072       | <b>XN-PF-120/230VAC-D</b> |

**XN Digital Input Modules**

Base module required.

**Slice Module**



| Channels | Rated Voltage via Power Supply Terminal | Input Delay tRise/tFall | Input Voltage High Signal | For Use With ...                              | Style Number | Catalog Number           |
|----------|---|-------------------------|---------------------------|---|--------------|--------------------------|
| 2        | 24 Vdc                                  | <200/<200 μs            | 11–30 Vdc                 | XN-S3T-SBB                                    | 140056       | <b>XN-2DI-24VDC-P</b>    |
|          |   |                         | 0–5 Vdc                   | XN-S3S-SBB<br>XN-S4T-SBBC                     | 140057       | <b>XN-2DI-24VDC-N</b>    |
| 2        | 120/230 Vac                             | <20,000/<20,000 μs      | 79–265 Vac                | XN-S4S-SBBC                                   | 140058       | <b>XN-2DI-120/230VAC</b> |
| 4        | 24 Vdc                                  | <200/<200 μs            | 15–30 Vdc                 | XN-S4T-SBBS                                   | 140052       | <b>XN-4DI-24VDC-P</b>    |
|          |   |                         | 0–5 Vdc                   | XN-S4S-SBBS<br>XN-S6T-SBBSBB<br>XN-S6S-SBBSBB | 140059       | <b>XN-4DI-24VDC-N</b>    |
| 16       | 24 Vdc                                  | <200/<200 μs            | 15–30 Vdc                 | XN-B3T-SBB                                    | 140142       | <b>XN-16DI-24VDC-P</b>   |
|          |   |                         |                           | XN-B3S-SBB<br>XN-B4T-SBBC<br>XN-B4S-SBBC      |              |                          |
| 32       | 24 Vdc                                  | <200/<200 μs            | 15–30 Vdc                 | XN-B6T-SBBSBB<br>XN-B6S-SBBSBB                | 140147       | <b>XN-32DI-24VDC-P</b>   |

**Block Module**



**XN Digital Output Modules**

Base module required.

Resistive inductive and lamp load connectable.

**Slice Module**



| Channels | Rated Voltage via Power Supply Terminal | Switching Frequency with Resistive Load in Hz | Utilization Factor g in %           | For Use With ...               | Style Number | Catalog Number                |
|----------|---|---|-------------------------------------|--------------------------------|--------------|-------------------------------|
| 2        | 24 Vdc                                  | <5000 ( $R_{L0} < 1 \text{ kohm}$ )           | 100                                 | XN-S3T-SBC                     | 140053       | <b>XN-2DO-24VDC-0.5A-P</b>    |
|          |   | <100 ( $R_{L0} < 1 \text{ kohm}$ )            |                                     | XN-S3S-SBC                     | 140060       | <b>XN-2DO-24VDC-0.5A-N</b>    |
|          |   | <5000 ( $R_{L0} < 1 \text{ kohm}$ )           |                                     | XN-S4T-SBCS<br>XN-S4S-SBCS     | 140055       | <b>XN-2DO-24VDC-2A-P</b>      |
| 2        | 120–230 Vac (45–65 Hz)                  | —   | 100 (observe derating requirements) |                                | 140150       | <b>XN-2DO-120/230VAC-0.5A</b> |
| 4        | 24 Vdc                                  | <1000 ( $R_{L0} < 1 \text{ kohm}$ )           | 100                                 | XN-S4T-SBCS                    | 140148       | <b>XN-4DO-24VDC-0.5A-P</b>    |
|          |   |   |                                     | XN-S4S-SBCS                    |              |                               |
|          |   |   |                                     | XN-S6T-SBCSBC                  |              |                               |
|          |   |   |                                     | XN-S6S-SBCSBC                  |              |                               |
| 16       | 24 Vdc                                  | <100 ( $R_{L0} < 1 \text{ kohm}$ )            | 100                                 | XN-B3T-SBC                     | 140141       | <b>XN-16DO-24VDC-0.5A-P</b>   |
|          |   |   |                                     | XN-B3S-SBC                     |              |                               |
| 32       | 24 Vdc                                  | <100 ( $R_{L0} < 1 \text{ kohm}$ )            | See total module current            | XN-B6T-SBCSBC<br>XN-B6S-SBCSBC | 140161       | <b>XN-32DO-24VDC-0.5A-P</b>   |

**Block Module**



**Slice Module**



**XN Relay Modules**

Base module required.

Rated voltage via power supply terminal: 24 Vdc.

Resistive inductive and lamp load connectable.

| Channels | Contact Type        | Rated Load Voltage | Maximum Continuous Current per Channel/ 230 Vac Resistive Load | For Use With ...           | Style Number | Catalog Number     |
|----------|---------------------|--------------------|--|----------------------------|--------------|--------------------|
| 2        | Changeover Contacts | 230 Vac, 30 Vdc    | 5A   | XN-S4T-SBBS                | 140054       | <b>XN-2DO-R-CO</b> |
|          |                     |                    |  | XN-S4S-SBBS                |              |                    |
| 2        | NC                  | 230 Vac, 30 Vdc    | 5A   | XN-S4T-SBBS                | 140061       | <b>XN-2DO-R-NC</b> |
|          |                     |                    |  | XN-S4S-SBBS                | 140062       | <b>XN-2DO-R-NO</b> |
|          | NO                  |                    |  | XN-S4T-SBCS<br>XN-S4S-SBCS |              |                    |

**Slice Module**



**XN Analog Input Modules**

Base module required.

Rated voltage via power supply terminal: 24 Vdc.

| Channels | Measured Variables | Measuring Range             | Value Representation                      | Limit Frequency in Hz | For Use With ... | Style Number                | Catalog Number  |
|----------|--------------------|-----------------------------|---|-----------------------|------------------|-----------------------------|-----------------|
| 1        | Current            | 0–20 mA,<br>4–20 mA         | Standard<br>16-bit/12-bit<br>(flush left) | —                     | XN-S3T-SBB       | 140063                      | <b>XN-1AI-I</b> |
| 2        |                    |                             |   |                       | XN-S3S-SBB       | 140144                      | <b>XN-2AI-I</b> |
| 1        | Voltage            | –10...10 Vdc,<br>0...10 Vdc |   | 200                   | XN-S4S-SBBS      | 140064                      | <b>XN-1AI-U</b> |
| 2        |                    |                             |   |                       |                  | 140145                      | <b>XN-2AI-U</b> |
| 4        |                    |                             |   |                       | Voltage/Current  | –10...10 Vdc,<br>0...10 Vdc | 20              |

**Slice Module**



**XN Temperature Modules**

Base module required.

Rated voltage via power supply terminal: 24 Vdc.

| Channels | Connectable Sensors                       | Measuring Range (°C)   | Value Representation                      | For Use With ...                                       | Style Number | Catalog Number            |
|----------|---|--|---|--|--------------|---------------------------|
| 2        | PT100, 200, 500, 1000<br>Ni100, Ni1000    | Platinum sensors:<br>-200...850/-200...150<br>Nickel sensors:<br>-60...250/-60...150 | Standard<br>16-bit/12-bit<br>(flush left) | XN-S3T-SBB<br>XN-S3S-SBB<br>XN-S4T-SBBS<br>XN-S4S-SBBS | 140067       | <b>XN-2AI-PT/NI-2/3</b>   |
| 2        | Type B, E, J, K, N, R, S, T Thermocouples | See user manual  | Standard<br>16-bit/12-bit<br>(flush left) | XN-S4T-SBBS-CJ<br>XN-S4S-SBBS-CJ                       | 140068       | <b>XN-2AI-THERMO-PI</b> ① |

**Slice Module**



**XN Analog Output Modules**

Base module required.

Rated voltage via power supply terminal: 24 Vdc.

| Channels | Measured Variables | Output Variables        | Value Representation                      | For Use With ...         | Style Number | Catalog Number  |
|----------|--------------------|-------------------------|---|--------------------------|--------------|-----------------|
| 1        | Current            | 0-20 mA/4-20 mA         | Standard<br>16-bit/12-bit<br>(flush left) | XN-S3T-SBB<br>XN-S3S-SBB | 140065       | <b>XN-1AO-I</b> |
| 2        |                    |                         |   |                          | 140146       | <b>XN-2AO-I</b> |
| 2        | Voltage            | -10...10 Vdc/0...10 Vdc |   |                          | 140066       | <b>XN-2AO-U</b> |

**Slice Module**



**XN Counter Modules**

Base module required.

Rated voltage via power supply terminal: 24 Vdc.

Signal evaluation A, B: Pulse and direction, rotary encoder single/double/quadruple.

| Channels | Operating Modes                             | Pulse Duration      | Resolution | For Use With ...           | Style Number | Catalog Number       |
|----------|---|---------------------|------------|----------------------------|--------------|----------------------|
| 1        | Continuous, once only and periodic counting | 8-bit<br>max. 0.51s | 32-bit     | XN-S4T-SBBS<br>XN-S4S-SBBS | 140069       | <b>XN-1CNT-24VDC</b> |

**Slice Module**



**XN Serial Interfaces**

Base module required.

Rated voltage via power supply terminal: 24 Vdc.

| Type          | Transfer Channels  | Bit Transfer Rate                   | Cable Length | For Use With ...           | Style Number | Catalog Number       |
|---------------|--------------------|-------------------------------------|--------------|----------------------------|--------------|----------------------|
| RS-232        | RxD, TxD, RTS, CTS | Max. 115,200 bits/s<br>(adjustable) | Max. 15m     | XN-S4T-SBBS<br>XN-S4S-SBBS | 140151       | <b>XN-1RS232</b>     |
| RS-485/RS-422 | RxD, TxD           |                                     | Max. 30m     |                            | 140152       | <b>XN-1RS485/422</b> |
| SS1           | CL, D              | Max. 1 MHz (adjustable)             | Max. 30m     |                            | 140153       | <b>XN-1SSI</b>       |

**Note**

① cUL pending.

**Base Modules**

**Spring-Cage Terminals**

| Description | For Use With ... | Style Number | Catalog Number |
|-------------|------------------|--------------|----------------|
|-------------|------------------|--------------|----------------|

**Three Connection Levels**

**Slice Module**



|  |  |        |                     |
|--|--|--------|---------------------|
| Base module for field power supply<br>Base module for the gateway supply<br>(with XN-BR-24VDC-D) | XN-BR-24VDC-D<br>XN-PF-24VDC-D<br>XN-PF-120/230VAC-D   | 140074 | <b>XN-P3T-SBB</b>   |
| Base module for bus refresh within the station   | XN-BR-24VDC-D  | 140073 | <b>XN-P3T-SBB-B</b> |
| —  | XN-2DI-_<br>XN-1AI-_<br>XN-2AI-I(0/4...20MA)<br>XN-2AI-U(-10/0...+10VDC)<br>XN-2AI-PT/Ni-2/3<br>XN-1AO-I(0/4...20MA)<br>XN-2AO-_<br>Connection to C rail | 140077 | <b>XN-S3T-SBB</b>   |
| —  | XN-2DO-24VDC-_<br>XN-2DO-120/230VAC-0.5A   | 140079 | <b>XN-S3T-SBC</b>   |

**Block Module**

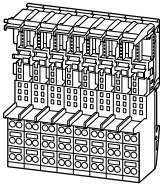

|                      |                     |        |                   |
|----------------------|---------------------|--------|-------------------|
| —                    | XN-16DI-24VDC-P     | 140133 | <b>XN-B3T-SBB</b> |
| Connection to C rail | XN-16DO-24VDC-0.5-P | 140134 | <b>XN-B3T-SBC</b> |

**Four Connection Levels**

**Slice Module**

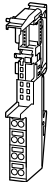

|  |   |        |                       |
|--|---|--------|-----------------------|
| Base module for field power supply<br>Base module for the gateway supply<br>(with XN-BR-24VDC-D)<br>Connection to C rail | XN-BR-24VDC-D<br>XN-PF-24VDC-D<br>XN-PF-120/230VAC-D  | 140076 | <b>XN-P4T-SBBC</b>    |
| Base module for bus refresh within the station<br>Connection to C rail   | XN-BR-24VDC-D   | 140075 | <b>XN-P4T-SBBC-B</b>  |
| Connection to C rail   | XN-2DI-24VDC-P<br>XN-2DI-24VDC-N<br>XN-2DI-120/230VAC   | 140078 | <b>XN-S4T-SBBC</b>    |
| Connection to C rail   | XN-2DO-24VDC-_<br>XN-2DO-120/230VAC-0.5A<br>XN-4DO-24VDC-0.5A-P<br>XN-2DO-R-NO<br>XN-2DO-R-NC   | 140080 | <b>XN-S4T-SBCS</b>    |
| —  | XN-4DI-_<br>XN-2DO-R-_<br>XN-1AI-_<br>XN-2AI-I(0/4...20MA)<br>XN-2AI-U(-10/0...+10VDC)<br>XN-2AI-PT/Ni-2/3<br>XN-1CNT-24VDC<br>XN-1RS-_<br>Base module with temperature sensors for<br>cold-junction compensation | 140081 | <b>XN-S4T-SBBS</b>    |
| —  | XN-2AI-THERMO-PI  | 140084 | <b>XN-S4T-SBBS-CJ</b> |

**Block Module**

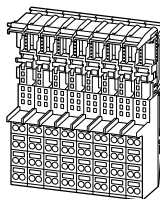

|                      |                 |        |                    |
|----------------------|-----------------|--------|--------------------|
| Connection to C rail | XN-16DI-24VDC-P | 140135 | <b>XN-B4T-SBBC</b> |
|----------------------|-----------------|--------|--------------------|

#### Spring-Cage Terminals, continued

4

##### Slice Module

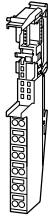

| Description                  | For Use With ...                  | Style Number | Catalog Number       |
|------------------------------|-----------------------------------|--------------|----------------------|
| <b>Six Connection Levels</b> |                                   |              |                      |
| —                            | XN-4DI-24VDC-P<br>XN-4DI-24VDC-N  | 140082       | <b>XN-S6T-SBBSBB</b> |
| Connection to C rail         | XN-4DO-24VDC-0.5A-P<br>XN-4AI-U/I | 140083       | <b>XN-S6T-SBCSBC</b> |
| <b>Block Module</b>          |                                   |              |                      |
| —                            | XN-32DI-24VDC-P                   | 140136       | <b>XN-B6T-SBBSBB</b> |
| Connection to C rail         | XN-32DO-24VDC-0.5A-P              | 140159       | <b>XN-B6T-SBCSBC</b> |

##### Block Module

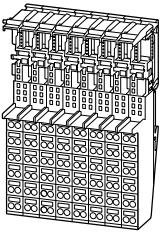

#### Screw Terminals

##### Slice Module

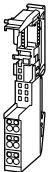

| Description  | For Use With ...  | Style Number | Catalog Number    |
|--|---|--------------|-------------------|
| <b>Three Connection Levels</b>   |   |              |                   |
| Base module for field power supply<br>Base module for the gateway supply<br>(with XN-BR-24VDC-D) | XN-BR-24VDC-D<br>XN-PF-24VDC-D<br>XN-PF-120/230VAC-D  | 140085       | <b>XN-P3S-SBB</b> |
| —  | XN-2DI-24VDC-P<br>XN-2DI-24VDC-N<br>XN-2DI-120/230VAC<br>XN-1AI-_<br>XN-2AI-I(0/4...20MA)<br>XN-2AI-U(-10/0...+10VDC)<br>XN-2AI-PT/NI-2/3<br>XN-1AO-I(0/4...20MA)<br>XN-2AO-_<br>XN-2AO-2 | 140088       | <b>XN-S3S-SBB</b> |
| Connection to C rail   | XN-2DO-24VDC-_<br>XN-2DO-120/230VAC-0.5A  | 140090       | <b>XN-S3S-SBC</b> |
| <b>Block Module</b>  |   |              |                   |
| —  | XN-16DI-24VDC-P   | 140137       | <b>XN-B3S-SBB</b> |
| Connection to C rail   | XN-16DO-24VDC-0.5A-P  | 140138       | <b>XN-B3S-SBC</b> |

##### Block Module

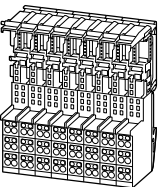

Screw Terminals, continued

Slice Module



| Description  | For Use With ...   | Style Number | Catalog Number       |
|--|--|--------------|----------------------|
| <b>Four Connection Levels</b>  |  |              |                      |
| Base module for field power supply<br>Base module for the gateway supply<br>(with XN-BR-24VDC-D)<br>Connection to C rail | XN-BR-24VDC-D<br>XN-PF-24VDC-D<br>XN-PF-120/230VAC-D   | 140087       | <b>XN-P4S-SBBC</b>   |
| Base module for bus refresh within the station<br>Connection to C rail   | XN-BR-24VDC-D  | 140086       | <b>XN-P4S-SBBC-B</b> |
| Connection to C rail   | XN-2DI-24VDC-P<br>XN-2DI-24VDC-N<br>XN-2DI-120/230VAC  | 140089       | <b>XN-S4S-SBBC</b>   |
| Connection to C rail   | XN-2DO-24VDC-_<br>XN-2DO-120/230VAC-0.5A<br>XN-4DO-24VDC-0.5A-P<br>XN-2DO-R-NO<br>XN-2DO-R-NC  | 140091       | <b>XN-S4S-SBCS</b>   |
| —  | XN-4DI-_<br>XN-2DO-R-_<br>XN-1AI-_<br>XN-2AI-I(0/4...20MA)<br>XN-2AI-U(-10/0...+10VDC)<br>XN-2AI-PT/NI-2/3<br>XN-1CNT-24VDC<br>XN-1RS-_<br>XN-1SSI | 140092       | <b>XN-S4S-SBBS</b>   |

Block Module

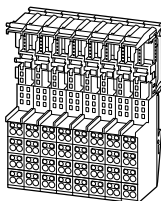

|   |                  |        |                       |
|---|------------------|--------|-----------------------|
| Base module with temperature sensors for cold-junction compensation | XN-2AI-THERMO-PI | 140095 | <b>XN-S4S-SBBS-CJ</b> |
| Connection to C rail  | XN-16DI-24VDC-P  | 140139 | <b>XN-B4S-SBBC</b>    |

Slice Module

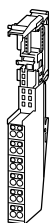

| <b>Six Connection Levels</b> |                                   |        |                      |
|------------------------------|-----------------------------------|--------|----------------------|
| —                            | XN-4DI-24VDC-P<br>XN-4DI-24VDC-N  | 140093 | <b>XN-S6S-SBBSBB</b> |
| Connection to C rail         | XN-4DO-24VDC-0.5A-P<br>XN-4AI-U/I | 140094 | <b>XN-S6S-SBCSBC</b> |

Block Module

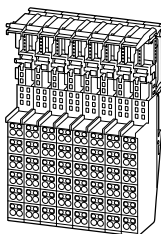

|                      |                      |        |                      |
|----------------------|----------------------|--------|----------------------|
| —                    | XN-32DI-24VDC-P      | 140140 | <b>XN-B6S-SBBSBB</b> |
| Connection to C rail | XN-32DO-24VDC-0.5A-P | 140160 | <b>XN-B6S-SBCSBC</b> |

## Accessories

### Coding Elements

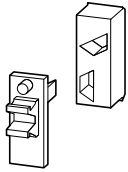

4

### Coding Elements

| Description  | For Use With ...   | Style Number | Catalog Number  |
|--|--|--------------|-----------------|
| Included as standard with every electronics module. Prevents incorrect connection of the electronics modules | XN-...DI-24VDC_  | 140114       | <b>XN-KO/2</b>  |
|  | XN-2DI-120/230VAC  | 140117       | <b>XN-KO/5</b>  |
|  | XN-xDO-24VDC_  | 140118       | <b>XN-KO/6</b>  |
|  | XN-2DO-R-NO  | 140119       | <b>XN-KO/8</b>  |
|  | XN-2DO-R-NC  | 140120       | <b>XN-KO/9</b>  |
|  | XN-2DO-R-CO  | 140121       | <b>XN-KO/10</b> |
|  | XN-1AI-I(0/4...20MA)<br>XN-2AI-I(0/4...20MA)   | 140122       | <b>XN-KO/11</b> |
|  | XN-1AI-U(-10/0...+10VDC)<br>XN-2AI-U(-10/0...+10VDC)<br>XN-2AI-PT/Ni-2/3<br>XN-2AI-THERMO-PI<br>XN-4AI-U/I | 140123       | <b>XN-KO/12</b> |
|  | XN-1AO-I(0/4...20MA)<br>XN-2AO-I(0/4...20MA)   | 140124       | <b>XN-KO/13</b> |
|  | XN-2AO-U(-10/0...+10VDC)   | 140125       | <b>XN-KO/14</b> |
|  | XN-1CNT-24VDC<br>XN-1RS232<br>XN-1RS485/422<br>XN-1SSI   | 140126       | <b>XN-KO/15</b> |
|  | XN-BR-24VDC-D<br>XN-PF-24VDC-D   | 140127       | <b>XN-KO/16</b> |
|  | XN-PF-120/230VAC-D   | 140128       | <b>XN-KO/17</b> |

### Relay Jumper



### Relay Jumpers

| Description | Style Number | Catalog Number |
|-------------|--------------|----------------|
| 1-grid      | 140097       | <b>XN-QV/1</b> |
| 2-grid      | 140098       | <b>XN-QV/2</b> |
| 3-grid      | 140099       | <b>XN-QV/3</b> |
| 4-grid      | 140100       | <b>XN-QV/4</b> |
| 5-grid      | 140101       | <b>XN-QV/5</b> |
| 6-grid      | 140102       | <b>XN-QV/6</b> |
| 7-grid      | 140103       | <b>XN-QV/7</b> |
| 8-grid      | 140104       | <b>XN-QV/8</b> |

### Servicing Cable

| Description   | Style Number | Catalog Number      |
|---|--------------|---------------------|
| Establishes the connection between I/O assistant and the service interface at the gateway | 140096       | <b>XN-PS2-CABLE</b> |

### End Bracket

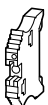

### End Bracket

| Description   | Style Number | Catalog Number        |
|---|--------------|-----------------------|
| For fixing the XI/ON station on the top-hat rail. Two end brackets are supplied as standard with the gateways | 140130       | <b>XN-WEW-35/2-SW</b> |

### End Cover

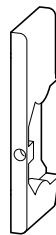

### End Cover

| Description  | Style Number | Catalog Number |
|--|--------------|----------------|
| For covering an XI/ON station. An end cover is supplied with the gateway as standard | 140129       | <b>XN-ABPL</b> |

### Connection Level Labels

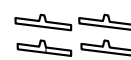

### Connection Level Labels

| Description  | Style Number | Catalog Number           |
|--------------|--------------|--------------------------|
| Blue         | 140105       | <b>XN-ANBZ-BL</b>        |
| Red          | 140106       | <b>XN-ANBZ-RT</b>        |
| Green        | 140107       | <b>XN-ANBZ-GN</b>        |
| Black        | 140108       | <b>XN-ANBZ-SW</b>        |
| Brown        | 140109       | <b>XN-ANBZ-BR</b>        |
| Red/blue     | 140110       | <b>XN-ANBZ-RT/BL-BED</b> |
| Yellow/green | 140111       | <b>XN-ANBZ-GN/GE-BED</b> |
| White        | 140112       | <b>XN-ANBZ-WS</b>        |

### Labels

| Description                         | Style Number | Catalog Number          |
|-------------------------------------|--------------|-------------------------|
| A5 sheet, perforated, 1 x 57 labels | 140131       | <b>XN-LABEL/SCHIEBE</b> |
| A5 sheet, perforated, 1 x 6 labels  | 140132       | <b>XN-LABEL/BLOCK</b>   |



## Technical Data and Specifications

### XI/ON General

| Description                                | Unit    | Specification   |
|--|---------|---|
| Standards                                  |         | EN 61000-6-2, EN 61000-6-4, EN 61131-2  |
| Supported fieldbus systems                 |         | PROFIBUS-DP, CANopen, DeviceNet, Modbus TCP, EtherNet/IP (depending on gateway) |
| Potential isolation                        |         | Yes, through optocoupler  |
| Ambient temperature                        | °F (°C) | 32° to 131° (0° to 55°)   |
| Ambient temperature, storage               | °F (°C) | −13° to 185° (−25° to 85°)  |
| Relative humidity                          | %       | 5–95 (indoor), Level RH-2, noncondensing (for storage at 45°C)                  |
| Harmful gases                              |         |   |
| SO <sub>2</sub>                            | ppm     | 10 (relative humidity <75%, noncondensing)                                      |
| H <sub>2</sub> S                           | ppm     | 1.0 (relative humidity <75%, noncondensing)                                     |
| Vibration resistance, operating conditions |         | According to IEC 60068-2-6  |
| Mechanical shock resistance                |         | According to IEC 60068-2-27   |
| Repetitive shock resistance                |         | According to IEC 60068-2-29   |
| Drop and free fall                         |         | According to IEC 60068-2-31, free fall to IEC 60068-2-32                        |
| Protection type                            |         | IP20  |
| Electromagnetic compatibility (EMC)        |         |   |
| ESD  |         | EN 61000-4-2  |
| Electromagnetic fields                     |         | EN 61000-4-3  |
| Burst                                      |         | EN 61000-4-4  |
| Surge                                      |         | EN 61000-4-5  |
| HF, asymmetric                             |         | EN 61000-4-6  |
| Radiated interference (RFI)                |         | EN 55016-2-3  |
| Voltage fluctuations                       |         | EN 61131-2  |
| Type test                                  |         | To EN 61131-2   |
| Approvals                                  |         | CE, cUL   |

### Terminals

| Description   | Unit            | XN Gateways and XN Basic Modules             | XNE Gateways and Integrated XNE Modules      |
|---|-----------------|--|--|
| Dimensional data  |                 | To VDE 0611 Part 1/8.92/<br>IEC/EN 60947-7-1 | To VDE 0611 Part 1/8.92/<br>IEC/EN 60947-7-1 |
| Connection from above   |                 | Spring-loaded/screw terminals                | Push-in spring-cage terminals                |
| Cable stripped length   | mm              | 8  | 8  |
| Max. terminal capacity  | mm <sup>2</sup> | 0.5–2.5                                      | 0.14–1.5                                     |
| Connectable conductors  |                 |  |  |
| “e” solid H07V-U  | mm <sup>2</sup> | 0.5–2.5                                      | 0.25–1.5                                     |
| “f” flexible H 07V-K  | mm <sup>2</sup> | 0.5–1.5                                      | 0.25–1.5                                     |
| “f” with ferrule without plastic collar to DIN 46228-1 (ferrules gas-tight) | mm <sup>2</sup> | 0.5–1.5                                      | 0.25–1.5                                     |
| “f” with ferrule with plastic collar to DIN 46228-1 (ferrules gas-tight)    | mm <sup>2</sup> | 0.5–1.5                                      | 0.25–0.75                                    |
| Gauge pin IEC/EN 60947-1  |                 | A1   | A1   |

## XNE Gateways

| Description                                   | Unit   | XNE-GWBR-PBDP  | XNE-GWBR-CANOPEN   | XNE-GWBR-2ETH-IP   |
|---|--------|--|--|--|
| Fieldbus                                      |        | PROFIBUS-DP  | CANopen  | Ethernet   |
| Protocol                                      |        | PROFIBUS-DPv0 and PROFIBUS-DPv1                                    | CANopen  | EtherNet/IP  |
| Maximum number of stations                    |        | 48 modules (XN, XNE) of slice design or max. length of station: 1m | 62 modules (XN, XNE) of slice design or max. length of station: 1m | 74 modules (XN, XNE) of slice design or max. length of station: 1m |
| System supply (U <sub>SYS</sub> )             | Vdc    | 24/5   | 24/5   | 24/5   |
| Permissible range, 5 Vdc (U <sub>SYS</sub> )  | Vdc    | 4.7–5.3  | 4.7–5.3  | 4.7–5.3  |
| Permissible range, 24 Vdc (U <sub>SYS</sub> ) | Vdc    | 18–30  | 18–30  | 18–30  |
| Field voltage (U <sub>I</sub> )               | Vdc    | 24   | 24   | 24   |
| Permissible range (U <sub>I</sub> )           | Vdc    | 18–30  | 18–30  | 18–30  |
| Ripple  | %      | <5 (to EN 61131-2)   | <5 (to EN 61131-2)   | <5 (to EN 61131-2)   |
| Servicing interface                           |        | PS/2 socket  | PS/2 socket  | Mini USB   |
| Fieldbus terminals                            |        | Push-in spring-cage terminals                                      | Push-in spring-cage terminals                                      | 2x RJ45 socket   |
| Transfer rate                                 | kBit/s | 9.6–12,000   | 20, 50, 125, 250, 500, 800, 1000                                   | 10,000, 100,000  |
| Data transfer rate setting                    |        | Automatic  | Through DIP switch or automatically                                | Automatic  |
| Address assignment                            |        | Through DIP switch   | Through DIP switch   | Through DIP switch, BootP, DHCP or PGM                             |
| Fieldbus termination                          |        | Through DIP switch   | Through DIP switch   | —  |
| Number of parameter bytes                     |        | 2  | —  | —  |
| Number of diagnosis bytes                     |        | 2  | —  | —  |
| Address range                                 |        | 1–125 decimal  | 1–63 decimal   | 1–254 decimal  |

## XN Gateways with Built-In Supply Module

| Description                                     | Unit   | XN-GWBR-PBDP   | XN-GWBR-CANOPEN  | XN-GWBR-DNET  | XN-GWBR-MODBUS-TCP   | XN-PLC-CANOPEN  |
|---|--------|--|--|---|--|---|
| Fieldbus  |        | PROFIBUS-DP  | CANopen  | DeviceNet   | Ethernet   | CANopen   |
| Protocol  |        | PROFIBUS-DPv0  | CANopen  | DeviceNet   | Modbus-TCP   | CANopen   |
| Maximum number of stations                      |        | 74 modules (XN, XNE) of slice design or max. length of station: 1m | 74 modules (XN, XNE) of slice design or max. length of station: 1m | 74 modules (XN) of slice design or max. length of station: 1m | 74 modules (XN, XNE) of slice design or max. length of station: 1m | 74 modules (XN, XNE with limitations) of slice design or max. length of station: 1m |
| System supply (U <sub>SYS</sub> )               | Vdc    | 24/5   | 24/5   | 24/5  | 24/5   | 24/5  |
| Permissible range, 5 Vdc (U <sub>SYS</sub> )    | Vdc    | 4.7–5.3  | 4.7–5.3  | 4.7–5.3   | 4.7–5.3  | 4.7–5.3   |
| Permissible range, 24 Vdc (U <sub>SYS</sub> )   | Vdc    | 18–30  | 18–30  | 18–30   | 18–30  | 18–30   |
| Field voltage (U <sub>I</sub> )                 |        | 24   | 24   | 24  | 24   | 24  |
| Permissible range (U <sub>I</sub> )             | Vdc    | 18–30  | 18–30  | 18–30   | 18–30  | 18–30   |
| Ripple  | %      | <5 (to EN 61131-2)   | <5 (to EN 61131-2)   | <5 (to EN 61131-2)  | <5 (to EN 61131-2)   | <5 (to EN 61131-2)  |
| Servicing interface                             |        | PS/2 socket  | PS/2 socket  | PS/2 socket   | PS/2 socket  | PS/2 socket   |
| Fieldbus terminals                              |        | 1 x D-sub 9-pin socket   | Open style connector   | Open style connector  | RJ45 bus   | Open style connector  |
| Transfer rate                                   | kBit/s | 9.6–12,000   | 10, 20, 50, 125, 250, 500, 800, 1000                               | 125, 250, 500   | 10,000, 100,000  | 10, 20, 50, 125, 250, 500, 800, 1000  |
| Data transfer rate setting                      |        | —  | Through DIP switch   | Through DIP switch  | Automatic  | Software  |
| Address assignment                              |        | 2 decimal rotary coding switches                                   | 2 decimal rotary coding switches                                   | 2 decimal rotary coding switches                              | Decimal rotary coding switch, BootP, DHCP or I/Oassistant          | Software  |
| Fieldbus termination                            |        | External   | External   | External  | —  | External  |
| Number of parameter bytes                       |        | 5  | —  | —   | —  | —   |
| Number of diagnosis bytes                       |        | 3  | —  | —   | —  | —   |
| Address range                                   |        | 1–99 decimal   | 1–99 decimal   | 1–63 decimal  | 1–254 decimal  | 1–127 decimal   |
| Program data                                    | kByte  | —  | —  | —   | —  | 128   |
| Program code                                    | kByte  | —  | —  | —   | —  | 128   |
| Cycle time for 1k of instructions (bits, bytes) | ms     | —  | —  | —   | —  | 0.5   |
| Real-time clock                                 |        | —  | —  | —   | —  | Yes   |

Supply Modules

| Description  | Unit | XN-BR-24VDC-D                 | XN-PF-24VDC-D      | XN-PF-120/230VAC-D                                 |
|--|------|-------------------------------|--------------------|--|
| Operating voltage  |      | 24 Vdc                        | 24 Vdc             | 120/230 Vac  |
| System supply ( $U_{SYS}$ )                              | Vdc  | 24                            | —                  | —  |
| Permissible range, 24 Vdc ( $U_{SYS}$ )                  | Vdc  | 18–30 ①                       | —                  | —  |
| Permissible range, 5 Vdc ( $U_{MB}$ [built into system]) | Vdc  | 4.7–5.3                       | —                  | —  |
| Field voltage ( $U_L$ )                                  |      | 24 Vdc                        | 24 Vdc             | 120/230 Vac  |
| Permissible range ( $U_L$ )                              |      | 18–30 Vdc                     | 18–30 Vdc ②        | 102–132 Vac (120 Vac)<br>195.5–253 Vac (230 Vac) ③ |
| Rated current drawn from module bus ( $I_{MB}$ )         | mA   | —                             | ≤28                | ≤25  |
| Insulation test ( $U_i$ )                                | Vac  | 500                           | 500                | 1500   |
| Ripple   | %    | <5 (to EN 61131-2)            | <5 (to EN 61131-2) | <5 (to EN 61131-2)                                 |
| Maximum operating current ( $I_L$ )                      | A    | 10                            | 10                 | 10   |
| Maximum system supply current ( $I_{MB}$ )               | A    | 1.5                           | —                  | —  |
| Number of diagnostic bits                                |      | 4                             | 4                  | 4  |
| Base module without gateway power supply                 |      |                               |                    |  |
| Without C connection                                     |      | XN-P3...-SBB/XN-P3...-SBB-B   | XN-P3...-SBB       | XN-P3...-SBB                                       |
| With C connection  |      | XN-P4...-SBBC/XN-P4...-SBBC-B | XN-P4...-SBBC      | XN-P4...-SBBC                                      |

Digital Input Modules

| Description   | Unit   | XN-2DI-24VDC-P   | XN-2DI-24VDC-N    | XN-2DI-120/230VAC | XN-4DI-24VDC-P                   | XN-4DI-24VDC-N                   |
|---|--------|--|-------------------|-------------------|----------------------------------|----------------------------------|
| Channels  | Number | 2  | 2                 | 2                 | 4                                | 4                                |
| Rated voltage at supply terminal ( $U_L$ )            |        | 24 Vdc   | 24 Vdc            | 120/230 Vac       | 24 Vdc                           | 24 Vdc                           |
| Rated current drawn from supply terminal ( $I_L$ ) ④⑤ | mA     | ≤20  | ≤20               | ≤20               | ≤40                              | ≤40                              |
| Rated current drawn from module bus ( $I_{MB}$ ) ⑤    | mA     | ≤28  | ≤28               | ≤28               | ≤29                              | ≤28                              |
| Insulation test ( $U_i$ )                             | Vac    | 500  | 500               | 1500              | 500                              | 500                              |
| Heat dissipation                                      | W      | 0.7  | 0.7               | 1                 | 1                                | 1                                |
| Input voltage   |        |  |                   |                   |                                  |                                  |
| Input voltage, rated value                            |        | 24 Vdc   | 24 Vdc            | 120/230 Vac       | 24 Vdc                           | 24 Vdc                           |
| Low level   |        | –30V to 5V   | 30V ( $U_L$ –11V) | 0–20 Vac          | –30V to 5V                       | 30V ( $U_L$ –11V)                |
| High level  |        | 11–30V   | 0–5V              | 79 Vac–265 Vac ⑥  | 15 V–30V                         | 0–5V                             |
| Frequency range                                       | Hz     | —  | —                 | 48–63             | —                                | —                                |
| Input current   |        |  |                   |                   |                                  |                                  |
| Low level/active level                                |        | 0 mA–1.5 mA  | 0 mA–1.7 mA       | 0 mA–1 mA         | 0 mA–1.5 mA                      | 0 mA–1.2 mA                      |
| High level/active level                               |        | 2 mA–10 mA   | 1.8 mA–10 mA      | 3 mA–10 mA        | 2 mA–10 mA                       | 1.3 mA–6 mA                      |
| Input delay   |        |  |                   |                   |                                  |                                  |
| $t_{rising\ edge}$                                    | μs     | <200   | <200              | <20,000           | <200                             | <200                             |
| $t_{falling\ edge}$                                   | μs     | <200   | <200              | <20,000           | <200                             | <200                             |
| Basic modules   |        |  |                   |                   |                                  |                                  |
| Without C connection                                  |        | XN-S3...-SBB 2-conductor proximity switches (Bero®) can be connected, with a permissible quiescent current of up to 1.5 mA |                   | XN-S3...-SBB      | XN-S4...-SBBS<br>XN-S6...-SBBSBB | XN-S4...-SBBS<br>XN-S6...-SBBSBB |
| With C connection                                     |        | XN-S4...-SBBC  | XN-S4...-SBBC     | XN-S4...-SBBC     | —                                | —                                |

Notes

- ① Permissible range for system supply: for  $U_{SYS} = 24$  Vdc: 18 to 30 Vdc (to EN 61131-2).
- ② Permissible range for field voltage  $U_L$ : to EN 61131-2 (18 to 30 Vdc).
- ③ Permissible range for rated voltage and field voltage  $U_L$ : to EN 61131-2.
- ④ The supply terminal ( $U_L$ ) provides power for the module electronics and for the sensors at the inputs. The total current required for each module consists of the sum of all partial currents.
- ⑤ Part of the XI/ON module's electronics is supplied with module bus voltage (5 Vdc), the other part through the supply terminal ( $U_L$ ).
- ⑥ Maximum permissible capacity: 141 nF at 79 Vac/50 Hz; 23 nF at 265 Vac/50 Hz.

## Digital Input Modules, continued

| Description  | Unit   | XN-16DI-24VDC-P | XN-32DI-24VDC-P | XNE-8DI-24VDC-P  | XNE-16DI-24VDC-P |
|--|--------|-----------------|-----------------|------------------|------------------|
| Channels   | Number | 16              | 32              | 8                | 16               |
| Rated voltage at supply terminal ( $U_L$ )                       | Vdc    | 24              | 24              | 24               | 24               |
| Rated current drawn from supply terminal ( $I_L$ ) <sup>①②</sup> | mA     | ≤40             | ≤30             | ≤1.5             | ≤3               |
| Rated current drawn from module bus ( $I_{MB}$ ) <sup>②</sup>    | mA     | ≤45             | ≤30             | ≤15              | ≤15              |
| Insulation test ( $U_i$ )  | Vac    | 500             | 500             | 500              | 500              |
| Heat dissipation   | W      | 2.5             | 4.2             | <1.5             | <2.5             |
| Input voltage  |        |                 |                 |                  |                  |
| Input voltage, rated value                                       | Vdc    | 24              | 24              | 24               | 24               |
| Low level  |        | -30V to 5V      | -30V to 5V      | - $U_L$ to 5V    | - $U_L$ to 5V    |
| High level   |        | 15V-30V         | 15V-30V         | 11V- $U_L$       | 11V- $U_L$       |
| Frequency range  | Hz     | —               | —               | —                | —                |
| Input current  |        |                 |                 |                  |                  |
| Low level/active level   |        | 0 mA-1.5 mA     | 0 mA-1.5 mA     | -1 mA-1.5 mA     | -1 mA-1.5 mA     |
| High level/active level  |        | 2 mA-10 mA      | 2 mA-10 mA      | 2 mA-5 mA        | 2 mA-5 mA        |
| Input delay  |        |                 |                 |                  |                  |
| $t_{\text{rising edge}}$   | μs     | <200            | <200            | <100             | <150             |
| $t_{\text{falling edge}}$  | μs     | <200            | <200            | <200             | <300             |
| Basic modules  |        |                 |                 |                  |                  |
| Without C connection   |        | XN-B3...-SBB    | XN-B6...-SBBSBB | Already built in | Already built in |
| With C connection  |        | XN-B4...-SBBC   | —               | —                | —                |

**Notes**

- ① The supply terminal ( $U_L$ ) provides power for the module electronics and for the sensors at the inputs. The total current required for each module consists of the sum of all partial currents.
- ② Part of the XI/ON module's electronics is supplied with module bus voltage (5 Vdc), the other part through the supply terminal ( $U_L$ ).

## Digital Output Modules

| Description   | Unit   | XN-2DO-24VDC-0.5A-P           | XN-2DO-24VDC-0.5A-N           | XN-2DO-120/230VAC-0.5A  | XN-2DO-24VDC-2A-P             | XN-4DO-24VDC-0.5A-P              |
|---|--------|-------------------------------|-------------------------------|---|-------------------------------|----------------------------------|
| Channels  | Number | 2                             | 2                             | 2   | 2                             | 4                                |
| Rated voltage at supply terminal ( $U_L$ )  |        | 24 Vdc                        | 24 Vdc                        | 120/230 Vac (45–65 Hz)  | 24 Vdc                        | 24 Vdc                           |
| Rated current drawn from supply terminal (for 0 mA load current) ( $I_L$ ) <sup>①</sup> | mA     | ≤20                           | ≤20                           | ≤20   | ≤50                           | ≤25                              |
| Rated current drawn from module bus ( $I_{MB}$ ) <sup>②</sup>                           | mA     | ≤32                           | ≤32                           | ≤35   | ≤33                           | ≤30                              |
| Insulation test ( $U_i$ )   | Vac    | 500                           | 500                           | 1500  | 500                           | 500                              |
| Heat dissipation  | W      | Normally 1                    | Normally 1                    | Normally 1  | Normally 1                    | Normally 1                       |
| Output voltage  |        |                               |                               |   |                               |                                  |
| High level  |        | > $U_L$ -1 Vdc                | <GND <sub>L</sub> +1 Vdc      | > $U_L$ -2 Vac,<br>(zero-point switching triac)                         | > $U_L$ -1 Vdc                | > $U_L$ -1 Vdc                   |
| Output current  |        |                               |                               |   |                               |                                  |
| High level (rated)  | A      | 0.5                           | 0.5                           | 0.5 <sup>③</sup>  | 2                             | 0.5                              |
| High level (permissible range)  | A      | <0.6                          | <0.6                          | 0.02–0.5  | <2.4                          | <0.6                             |
| Low level   | mA     | —                             | —                             | <1.5  | —                             | —                                |
| Back-up fuse  |        | —                             | —                             | 500 mA FF   | —                             | —                                |
| Surge current ( $I_S$ )   | A      | —                             | —                             | 8 (1 period at 60 Hz)   | —                             | —                                |
| Number of parallel-switchable outputs (maximum)   |        | —                             | —                             | —   | —                             | 4                                |
| Total module current  | A      | 1                             | 1                             | 1   | 4                             | 2                                |
| Delay for signal changeover, resistive load   |        |                               |                               |   |                               |                                  |
| From Low to High level  | μs     | <100                          | <100                          | <T/2 +1 ms  | <100                          | <250                             |
| From High to Low level  | μs     | <100                          | <100                          | <T/2 +1 ms  | <100                          | <250                             |
| Load resistance range   |        | >48 ohm                       | >48 ohm                       | At 120 Vac:<br>240 ohm to 6 kohm<br>At 230 Vac:<br>460 ohm to 11.5 kohm | <12 ohm                       | >48 ohm                          |
| Utilization factor (%)  | g      | 100                           | 100                           | 100 (observe derating)  | 100                           | 100                              |
| The following can be connected:   |        |                               |                               | Resistive loads/Inductive loads/Lamp loads                              |                               |                                  |
| Resistive load  | ohm    | >48                           | >48                           | —   | >12                           | >48                              |
| Inductive load  | H      | <1.2                          | <1.2                          | —   | <1.2                          | <1.2                             |
| Lamp load ( $R_{LL}$ )  | W      | <3                            | <12                           | —   | <6                            | <6                               |
| Switching frequency   |        |                               |                               |   |                               |                                  |
| For resistive load (f)  | Hz     | <5000 ( $R_{L0}$ <1 kohm)     | <100 ( $R_{L0}$ <1 kohm)      | —   | <5000 ( $R_{L0}$ <1 kohm)     | <1000 ( $R_{L0}$ <1 kohm)        |
| For inductive load  | Hz     | <2                            | <2                            | —   | <2                            | <2                               |
| For lamps   | Hz     | <10                           | <10                           | —   | <10                           | <10                              |
| Number of diagnostic bits   |        | 2                             | 2                             | —   | 2                             | 1                                |
| Diagnostics   |        | Yes                           | Yes                           | No  | Yes                           | Yes                              |
| Outputs to EN 61131-1   |        | Protected                     | Protected                     | —   | Protected                     | Short-circuit proof              |
| Retriggering after elimination of short circuit ( $I_f$ )                               |        | Self-acting                   | Self-acting                   | —   | Self-acting                   | Self-acting                      |
| Basic modules   |        |                               |                               |   |                               |                                  |
| With C connection   |        | XN-S3...-SBC<br>XN-S4...-SBCS | XN-S3...-SBC<br>XN-S4...-SBCS | XN-S3...-SBC<br>XN-S4...-SBCS   | XN-S3...-SBC<br>XN-S4...-SBCS | XN-S4...-SBCS<br>XN-S4...-SBCSBC |

## Notes

- ① The supply terminal ( $U_L$ ) provides power for the module electronics and for the consumers at the outputs. The total current required for each module consists of the sum of all partial currents.
- ② Part of the XI/ON module's electronics is supplied with module bus voltage (5 Vdc), the other part through the supply terminal ( $U_L$ ).
- ③ To increase the maximum output current to up to 1A, two outputs can be connected in parallel.

## Digital Output Modules, continued

| Description   | Unit   | XN-16DO-24VDC-0.5A-P     | XN-32DO-24VDC-0.5A-P     | XNE-8DO-24VDC-0.5A-P                       | XNE-16DO-24VDC-0.5A-P        |
|---|--------|--------------------------|--------------------------|--|------------------------------|
| Channels  | Number | 16                       | 32                       | 8  | 16                           |
| Rated voltage at supply terminal ( $U_L$ )  | Vdc    | 24                       | 24                       | 24   | 24                           |
| Rated current drawn from supply terminal (for 0 mA load current) ( $I_L$ ) <sup>①</sup> | mA     | ≤30                      | ≤50                      | ≤3 (all outputs OFF)                       | ≤3 (all outputs OFF)         |
| Rated current drawn from module bus ( $I_{MB}$ ) <sup>②</sup>                           | mA     | ≤120                     | ≤30                      | ≤15  | ≤25                          |
| Insulation test ( $U_i$ )   | Vac    | 500                      | 500                      | 500  | 500                          |
| Heat dissipation  | W      | Normally 4               | Normally 5               | Normally 1.5                               | Normally 2.5                 |
| Output voltage  |        |                          |                          |  |                              |
| High level  | Vdc    | > $U_L$ -1               | > $U_L$ -1               | > $U_L$ -1                                 | > $U_L$ -1                   |
| Output current  |        |                          |                          |  |                              |
| High level (rated)  | A      | 0.5                      | 0.5                      | 0.5 <sup>③</sup>                           | 0.5 <sup>③</sup>             |
| High level (permissible range)  | A      | <0.6                     | <1.0                     | <1.0                                       | <1.0                         |
| Low level   | mA     | —                        | —                        | —  | —                            |
| Back-up fuse  |        | —                        | —                        | —  | —                            |
| Surge current ( $I_S$ )   | A      | —                        | —                        | —  | —                            |
| Number of parallel-switchable outputs (maximum)   |        | —                        | 2                        | —  | —                            |
| Total module current  | A      | 8                        | 10                       | 4  | 4                            |
| Delay for signal changeover, resistive load   |        |                          |                          |  |                              |
| From Low to High level  | μs     | <100                     | <300                     | <300                                       | <300                         |
| From High to Low level  | μs     | <100                     | <300                     | <300                                       | <300                         |
| Load resistance range   |        | >48 ohm                  | >48 ohm                  | >48 ohm                                    | >48 ohm                      |
| Utilization factor (%)  | g      | 100                      | See total module current | 100  | 50%, max. 4A                 |
| The following can be connected:   |        |                          |                          | Resistive loads/Inductive loads/Lamp loads |                              |
| Resistive load  | ohm    | >48                      | >48                      | >48  | >48                          |
| Inductive load  | H      | <1.2                     | <1.2                     | As for DC13 to IEC 60947-5-1               | As for DC13 to IEC 60947-5-1 |
| Lamp load ( $R_{LL}$ )  | W      | <3                       | <6                       | <6   | <6                           |
| Switching frequency   |        |                          |                          |  |                              |
| For resistive load (f)  | Hz     | <100 ( $R_{LO}$ <1 kohm) | <100 ( $R_{LO}$ <1 kohm) | <100                                       | <100                         |
| For inductive load  | Hz     | —                        | —                        | As for DC13 to IEC 60947-5-1               | As for DC13 to IEC 60947-5-1 |
| For lamps   | Hz     | —                        | —                        | <10  | <10                          |
| Number of diagnostic bits   |        | 4                        | 8                        | —  | —                            |
| Diagnostics   |        | Yes                      | Yes                      | —  | —                            |
| Outputs to EN 61131-1   |        | Short-circuit proof      | Short-circuit proof      | Short-circuit proof                        | Short-circuit proof          |
| Retriggering after elimination of short circuit ( $I_L$ )                               |        | Self-acting              | Self-acting              | Self-acting                                | Self-acting                  |
| Basic modules   |        |                          |                          |  |                              |
| With C connection   |        | XN-B3...-SBC             | XN-B6...-SBCSBC          | Already built in                           | Already built in             |

**Notes**

① The supply terminal ( $U_L$ ) provides power for the module electronics and for the consumers at the outputs. The total current required for each module consists of the sum of all partial currents.

② Part of the XI/ON module's electronics is supplied with module bus voltage (5 Vdc), the other part through the supply terminal ( $U_L$ ).

③ To increase the maximum output current to up to 1A, two outputs can be connected in parallel.

Analog Input Modules

| Description  | Unit   | XN-1AI-I(0/4...20mA)   | XN-2AI-I(0/4...20mA)  | XN-1AI-U(-10/0...+10VDC)   | XN-2AI-U(-10/0...+10VDC)  |
|--|--------|--|---|--|---|
| Measured variables   |        | Current  | Current   | Voltage  | Voltage   |
| Channels   | Number | 1  | 2   | 1  | 2   |
| Rated voltage at supply terminal (U <sub>L</sub> )                       | Vdc    | 24   | 24  | 24   | 24  |
| Rated current drawn from supply terminal (I <sub>L</sub> ) <sup>①②</sup> | mA     | ≤50  | ≤12   | ≤50  | ≤12   |
| Rated current drawn from module bus (I <sub>MB</sub> ) <sup>②</sup>      | mA     | ≤41  | ≤35   | ≤41  | ≤35   |
| Heat dissipation   | W      | <1   | <1  | <1   | <1  |
| Sensor/transmitter supply  |        | Bridged with U <sub>L</sub> and GND <sub>L</sub> of incoming unit; not protected | ≤250 mA; bridged with U <sub>L</sub> and GND <sub>L</sub> of incoming unit; not protected | Bridged with U <sub>L</sub> and GND <sub>L</sub> of incoming unit; not protected | ≤250 mA; bridged with U <sub>L</sub> and GND <sub>L</sub> of incoming unit; not protected |
| Voltage measurement  |        |  |   |  |   |
| Measurement ranges   |        | —  | —   | -10 to 10 Vdc/0 to 10 Vdc  | -10 to 10 Vdc/0 to 10 Vdc   |
| Value representation   |        | —  | —   | Standard, 16-bit/12-bit left-aligned   | Standard, 16-bit/12-bit left-aligned  |
| The following can be connected:  |        | —  | —   | 2-/3-/4-conductor + shield   | 2-/3-conductor + shield   |
| Maximum input voltage (U <sub>max</sub> )                                | Vdc    | —  | —   | 35   | 35  |
| Input resistance (R <sub>I</sub> )                                       | kohm   | —  | —   | ≥98.5  | ≥98.5   |
| Limiting frequency (f <sub>G</sub> )                                     | Hz     | —  | —   | 200  | 50  |
| Basic error limit at 23°C  | %      | —  | —   | <0.2   | <0.2  |
| Temperature coefficient  |        | —  | —   | ≤300 ppm/°C of full-scale value  | ≤150 ppm/°C of full-scale value   |
| Current measurement  |        |  |   |  |   |
| Measurement ranges   | mA     | 0–20/4–20  | 0–20/4–20   | —  | —   |
| Value representation   |        | Standard, 16-bit/12-bit (left-aligned)   | Standard, 16-bit/12-bit (left-aligned)  | —  | —   |
| The following can be connected:  |        | 2-/3-/4-conductor + shield   | 2-/3-conductor + shield   | —  | —   |
| Maximum input current (I <sub>max</sub> )                                | mA     | 50   | 50  | —  | —   |
| Input resistance (R <sub>I</sub> )                                       | ohm    | <125 ohm   | <125 ohm  | —  | —   |
| Limiting frequency (f <sub>G</sub> )                                     | Hz     | 200  | 50  | —  | —   |
| Basic error limit at 23°C  | %      | <0.2   | <0.2  | —  | —   |
| Temperature coefficient  |        | ≤300 ppm/°C of full-scale value  | ≤300 ppm/°C of full-scale value   | —  | —   |
| Temperature measurement  |        |  |   |  |   |
| Connectable sensors  |        | —  | —   | —  | —   |
| Measurement ranges   |        | —  | —   | —  | —   |
| Value representation   |        | —  | —   | —  | —   |
| The following can be connected:  |        | —  | —   | —  | —   |
| Measuring current (I <sub>mess</sub> )                                   |        | —  | —   | —  | —   |
| Destruction limit (U <sub>max</sub> )                                    | Vdc    | —  | —   | —  | —   |
| Basic error limit at 23°C  | %      | —  | —   | —  | —   |
| Temperature coefficient  |        | —  | —   | —  | —   |
| R (resistance measurement)   |        |  |   |  |   |
| Measurement ranges   |        | —  | —   | —  | —   |
| Value representation   |        | —  | —   | —  | —   |
| The following can be connected:  |        | —  | —   | —  | —   |
| Destruction limit (U <sub>max</sub> )                                    | Vdc    | —  | —   | —  | —   |
| Limiting frequency (f <sub>G</sub> )                                     | Hz     | —  | —   | —  | —   |
| Basic error limit at 23°C  | %      | —  | —   | —  | —   |
| Temperature coefficient  |        | —  | —   | —  | —   |
| Basic modules  |        |  |   |  |   |
| Without C connection   |        | XN-S3...-SBB   | XN-S3...-SBB  | XN-S3...-SBB   | XN-S3...-SBB  |
| Without C connection, for sensor supply                                  |        | XN-S4...-SBBS  | XN-S4...-SBBS   | XN-S4...-SBBS  | XN-S4...-SBBS   |

Notes

- ① The supply terminal (U<sub>L</sub>) provides power for the module electronics and for the analog transmitters at the inputs. The total current required for each module consists of the sum of all partial currents.
- ② Part of the XI/ON module's electronics is supplied with module bus voltage (5 Vdc), the other part through the supply terminal (U<sub>L</sub>).

## Analog Input Modules, continued

| Description  | Unit   | XN-4AI-U/I                                | XN-2AI-THERMO-PI   | XN-2AI-PT/NI-2/3   | XNE-8AI-U/I-4PT/NI   |
|--|--------|---|--|--|--|
| Measured variables   |        | Voltage, current                          | Temperature (thermocouples)  | Temperature PT, NI resistance R  | Voltage, current, temperature PT, NI resistance R  |
| Channels   | Number | 4   | 2  | 2  | 8 (U/I)/4 (PT/NI/R)  |
| Rated voltage at supply terminal ( $U_L$ )                       | Vdc    | 24  | 24   | 24   | 24   |
| Rated current drawn from supply terminal ( $I_L$ ) <sup>①②</sup> | mA     | ≤20                                       | ≤30  | ≤30  | Normally 35  |
| Rated current drawn from module bus ( $I_{MB}$ ) <sup>②</sup>    | mA     | ≤50                                       | ≤45  | ≤45  | ≤30  |
| Heat dissipation   | W      | <1  | <1   | <1   | <1.5   |
| Sensor/transmitter supply  |        | —   | —  | —  | —  |
| Voltage measurement  |        |   |  |  |  |
| Measurement ranges   |        | –10 to 10 Vdc/0 to 10 Vdc                 | –50 to 50 mV, –100 to 100 mV<br>–500 to 500 mV,<br>–1,000 to 1,000 mV  | —  | –10 to 10 Vdc/0 to 10 Vdc  |
| Value representation   |        | Standard, 16-bit/12-bit<br>(left-aligned) | Standard, 16-bit/12-bit<br>(left-aligned)  | —  | Standard, 16-bit/12-bit<br>(left-aligned)<br>Extended range, 16-bit/12-bit<br>(left-aligned)<br>PA (NE43), 16-bit/12-bit<br>(left-aligned) |
| The following can be connected:                                  |        | 2-conductor + shield                      | 2-conductor  | —  | 2-conductor  |
| Maximum input voltage ( $U_{max}$ )                              | Vdc    | 30  | 10   | —  | ±20  |
| Input resistance ( $R_I$ )                                       | kohm   | ≥98.5                                     | —  | —  | ≥200   |
| Limiting frequency ( $f_G$ )                                     | Hz     | 20  | —  | —  | 1.5  |
| Basic error limit at 23°C  | %      | <0.3                                      | <0.2 (normally)  | —  | <0.2   |
| Temperature coefficient  |        | ≤300 ppm/°C of full-scale value           | ≤300 ppm/°C of full-scale value  | —  | ≤200 ppm/°C of full-scale value  |
| Current measurement  |        |   |  |  |  |
| Measurement ranges   | mA     | 0–20/4–20                                 | —  | —  | 0–20/4–20  |
| Value representation   |        | Standard, 16-bit/12-bit<br>(left-aligned) | —  | —  | Standard, 16-bit/12-bit<br>(left-aligned)<br>Extended range, 16-bit/12-bit<br>(left-aligned)<br>PA (NE43), 16-bit/12-bit<br>(left-aligned) |
| The following can be connected:                                  |        | 2-conductor + shield                      | —  | —  | 2-conductor  |
| Maximum input current ( $I_{max}$ )                              | mA     | 50  | —  | —  | 40 (Max. input voltage: <17V)  |
| Input resistance ( $R_I$ )                                       | ohm    | <62                                       | —  | —  | <52  |
| Limiting frequency ( $f_G$ )                                     | Hz     | 20  | —  | —  | 1.5  |
| Basic error limit at 23°C  | %      | <0.3                                      | —  | —  | <0.2   |
| Temperature coefficient  |        | ≤300 ppm/°C of full-scale value           | —  | —  | ≤200 ppm/°C of full-scale value  |
| Temperature measurement  |        |   |  |  |  |
| Connectable sensors  |        | —   | Thermocouple type B, E, J, K, N,<br>R, S, T to IEC 584, Class 1, 2, 3  | PT100 RTD, PT200, PT500, PT100<br>RTDO (EN 60751)<br>NI100, NI1000 (DIN 43760)             | PT100 RTD, PT200, PT500, PT100<br>RTDO (all: EN 60751)<br>NI100, NI1000 (DIN 43760),<br>NI1000TK5000                                       |
| Measurement ranges   |        | —   | Type B: 100 to 1820 °C<br>Type E: –270 to 1000 °C<br>Type J: –210 to 1200 °C<br>Type K: –270 to 1370 °C<br>Type N: –270 to 1300 °C<br>Type R: –50 to 1760 °C<br>Type S: –50 to 1540 °C<br>Type T: –270 to 400 °C | Platinum RTDs:<br>–200 to 850°C/–200 to 150°C<br>Nickel RTDs:<br>–60 to 250°C/–60 to 150°C | Platinum RTDs:<br>–200 to 850°C/–200 to 150°C<br>Nickel RTDs:<br>–60 to 250°C/–60 to 150°C   |

## Notes

- ① The supply terminal ( $U_L$ ) provides power for the module electronics and for the analog transmitters at the inputs. The total current required for each module consists of the sum of all partial currents.
- ② Part of the XI/ON module's electronics is supplied with module bus voltage (5 Vdc), the other part through the supply terminal ( $U_L$ ).



Analog Input Modules, continued

| Description                             | Unit | XN-4AI-U/I      | XN-2AI-THERMO-PI  | XN-2AI-PT/NI-2/3                            | XNE-8AI-U/I-4PT/NI  |
|---|------|-----------------|---|---|---|
| Temperature measurement, continued      |      |                 |   |   |   |
| Value representation                    |      | —               |   | Standard, 16-bit/12-bit left-aligned        |   |
| The following can be connected:         |      | —               | 2-conductor (cold-junction compensation in base module)     | 2-conductor/3-conductor                     | 2-conductor/3-conductor   |
| Measuring current ( $I_{mess}$ )        |      | —               | —   | <1 mA                                       | <0.5 mA   |
| Destruction limit ( $U_{max.}$ )        | Vdc  | —               | —   | >30   | >30   |
| Basic error limit at 23°C               | %    | —               | <0.2 (type T, -200 to 0°C: 0.6%)                            | <0.2  | PT100 RTD, NI100: 0.35%, PT200, PT500, PT100 RTDO, NI1000, NI1000TK5000: 0.2% |
| Temperature coefficient                 |      | —               | ≤300 ppm/°C of full-scale value                             | ≤300 ppm/°C of full-scale value             | ≤200 ppm/°C of full-scale value   |
| R (resistance measurement)              |      |                 |   |   |   |
| Measurement ranges                      |      | —               | —   | 0–100 ohm, 0–200 ohm, 0–400 ohm, 0–1000 ohm | 0–250 ohm, 0–400 ohm, 0–800 ohm, 0–2000 ohm, 0–4000 ohm                       |
| Value representation                    |      | —               | —   | Standard, 16-bit/12-bit left-aligned        | Standard, 16-bit/12-bit left-aligned  |
| The following can be connected:         |      | —               | —   | 2-conductor/3-conductor                     | 2-conductor/3-conductor   |
| Destruction limit ( $U_{max.}$ )        | Vdc  | —               | —   | >30   | >30   |
| Limiting frequency ( $f_G$ )            | Hz   | —               | —   | —   | 1.5   |
| Basic error limit at 23°C               | %    | —               | —   | <0.2  | <0.2  |
| Temperature coefficient                 |      | —               | —   | ≤300 ppm/°C of full-scale value             | ≤200 ppm/°C of full-scale value   |
| Basic modules                           |      |                 |   |   |   |
| Without C connection                    |      | XN-S6...-SBCSBC | —   | XN-S3...-SBB                                | Already built in  |
| Without C connection, for sensor supply |      | —               | With integrated cold-junction compensation XN-S4...-SBBS-CJ | XN-S4...-SBBS                               | —   |

## Analog Output Modules

| Description   | Unit   | XN-1AO-I(0/4...20MA)                   | XN-2AO-I(0/4...20MA)                   | XN-2AO-U(-10/0...+10VDC)               | XNE-4AO-U/I   |
|---|--------|--|--|--|---|
| Measured variables  |        | Current                                | Current                                | Voltage                                | Voltage, current  |
| Channels  | Number | 1                                      | 2                                      | 2                                      | 4   |
| Rated voltage at supply terminal ( $U_L$ )                      | Vdc    | 24                                     | 24                                     | 24                                     | 24  |
| Rated current drawn from supply terminal ( $I_L$ ) <sup>①</sup> | mA     | ≤50                                    | ≤50                                    | ≤50                                    | ≤150  |
| Rated current drawn from module bus ( $I_{MB}$ ) <sup>①</sup>   | mA     | ≤39                                    | ≤40                                    | ≤43                                    | ≤40   |
| Heat dissipation  | W      | Normally 1                             | Normally 1                             | Normally 1                             | <3  |
| <b>Output Value, Voltage</b>                                    |        |  |  |  |   |
| Output voltage  | Vdc    | —                                      | —                                      | -10 to 10 Vdc/0 to 10 Vdc              | -10 to 10 Vdc/0 to 10 Vdc   |
| Value representation  |        | —                                      | —                                      | Standard, 16-bit/12-bit (left-aligned) | Standard, 16-bit/12-bit (left-aligned)<br>Extended range, 16-bit/12-bit (left-aligned)<br>PA (NE43), 16-bit/12-bit (left-aligned) |
| The following can be connected:                                 |        | —                                      | —                                      | 2-conductor + shield                   | 2-conductor   |
| Load resistor   |        |  |  |  |   |
| Resistive load  | ohm    | —                                      | —                                      | >1000                                  | >1000   |
| Capacitive load   | μF     | —                                      | —                                      | <1                                     | <1  |
| Transfer frequency  | Hz     | —                                      | —                                      | <100                                   | <20   |
| Recovery time   |        |  |  |  |   |
| Resistive load  | ms     | —                                      | —                                      | <0.1                                   | <1  |
| Inductive load  | ms     | —                                      | —                                      | <0.5                                   | <2  |
| Capacitive load   | ms     | —                                      | —                                      | <0.5                                   | <2  |
| Short-circuit current   | mA     | —                                      | —                                      | ≤40                                    | ≤40   |
| Basic error limit at 23°C                                       | %      | —                                      | —                                      | <0.2                                   | <0.2  |
| Temperature coefficient   |        | —                                      | —                                      | ≤300 ppm/°C of full-scale value        | ≤200 ppm/°C of full-scale value   |
| <b>Output Value, Current</b>                                    |        |  |  |  |   |
| Output current  | mA     | 0-20/4-20                              | 0-20/4-20                              | —                                      | 0-20/4-20   |
| Value representation  |        | Standard, 16-bit/12-bit (left-aligned) | Standard, 16-bit/12-bit (left-aligned) | —                                      | Standard, 16-bit/12-bit (left-aligned)<br>Extended range, 16-bit/12-bit (left-aligned)<br>PA (NE43), 16-bit/12-bit (left-aligned) |
| The following can be connected:                                 |        | 2-conductor + shield                   | 2-conductor + shield                   | —                                      | 2-conductor   |
| Load resistor   |        |  |  |  |   |
| Resistive load  | ohm    | <550                                   | <450                                   | —                                      | <450  |
| Inductive load  | μH     | <1                                     | <1                                     | —                                      | <1  |
| Transfer frequency  | Hz     | <200                                   | <200                                   | —                                      | <20   |
| Recovery time   |        |  |  |  |   |
| Resistive load  | ms     | <0.1                                   | <2                                     | —                                      | <1  |
| Inductive load  | ms     | <0.5                                   | <2                                     | —                                      | <2  |
| Capacitive load   | ms     | <0.5                                   | —                                      | —                                      | <2  |
| Short-circuit current   | mA     | —                                      | —                                      | —                                      | ≤40   |
| Basic error limit at 23°C                                       | %      | <0.2                                   | <0.2                                   | —                                      | <0.2  |
| Temperature coefficient   |        | ≤300 ppm/°C of full-scale value        | ≤300 ppm/°C of full-scale value        | —                                      | ≤200 ppm/°C of full-scale value   |
| Basic modules   |        |  |  |  |   |
| Without C connection  |        | XN-S3...-SBB                           | XN-S3...-SBB                           | XN-S3...-SBB                           | Already built in  |

**Note**

<sup>①</sup> Part of the XI/ON module's electronics is supplied with module bus voltage (5 Vdc), the other part through the supply terminal ( $U_L$ ).

**Relay Modules**

| Description  | Unit              | XN-2DO-R-NC        | XN-2DO-R-NO                                 | XN-2DO-R-CO            |
|--|-------------------|--------------------|---|------------------------|
| Contact type                                       |                   | 2 NC               | 2 N/O                                       | 2 change-over contacts |
| Rated voltage at supply terminal ( $U_i$ )         | Vdc               | 24                 | 24  | 24                     |
| Rated current drawn from supply terminal ( $I_i$ ) | mA                | ≤20                | ≤20   | ≤20                    |
| Rated current drawn from module bus ( $I_{MB}$ )   | mA                | ≤28                | ≤28   | ≤28                    |
| Insulation test ( $U_i$ )                          | Vac               | 1500, 500          | 1500, 500                                   | 1500, 500              |
| Heat dissipation                                   | W                 | Normally 1         | Normally 1                                  | Normally 1             |
| The following can be connected:                    |                   |                    | Resistive loads/Inductive loads/Lamp loads  |                        |
| Nominal load voltage                               |                   | 230 Vac, 30 Vdc    | 230 Vac, 30 Vdc                             | 230 Vac, 30 Vdc        |
| Output current for channel/230 Vac                 |                   |                    |   |                        |
| Maximum continuous current                         | A                 | 2                  | 2   | 2                      |
| Maximum continuous current, resistive load         |                   | 5A, load-dependent | 5A, load-dependent                          | 5A, load-dependent     |
| Minimum load current                               | mA                | 100 at 12 Vdc      | 100 at 12 Vdc                               | 100 at 12 Vdc          |
| Output current for DC voltage (resistive)          |                   |                    | Load limit curve, see <b>Page V7-T4-104</b> |                        |
| Utilization factor (g)                             | %                 | 100                | 100   | 100                    |
| Lifespan at 230 Vac                                |                   |                    |   |                        |
| At 5A (Operations)                                 | x 10 <sup>6</sup> | >0.1               | >0.1  | >0.1                   |
| At 0.5A (Operations)                               | x 10 <sup>6</sup> | >1                 | >1  | >1                     |
| Basic modules                                      |                   |                    |   |                        |
| Without C connection                               |                   | XN-S4...-SBBS      | XN-S4...-SBBS                               | XN-S4...-SBBS          |
| With C connection                                  |                   | XN-S4...-SBCS      | XN-S4...-SBCS                               | —                      |

## Technology Modules

| Description  | Unit    | XN-1CNT-24VDC  | XNE-2CNT-2PWM  |
|--|---------|--|--|
| Rated voltage at supply terminal ( $U_L$ )         | Vdc     | 24   | 24   |
| Rated current drawn from supply terminal ( $I_L$ ) | mA      | $\leq 50$ ①  | $\leq 20$  |
| Rated current drawn from module bus ( $I_{MB}$ )   | mA      | $\leq 40$  | $\leq 50$  |
| Heat dissipation                                   | W       | <1.3   | <3   |
| Power supply of encoders                           |         | Output voltage $U_L$ (-0.8V)<br>Output current $\leq 0.5A$ , short-circuit proof | Output voltage $U_L$ , $GND_L$<br>Output current 0.5A, not protected     |
| <b>Digital Inputs</b>                              |         |  |  |
| Input voltage                                      |         |  |  |
| Input voltage, rated value                         | Vdc     | 24   | 24   |
| Low level  | Vdc     | -30 to 5   | -30 to 5   |
| High level   | Vdc     | 11 to 30   | 11 to 30   |
| Input current                                      |         |  |  |
| Low level  | mA      | -8 to 1.5  | -1 to 1.5  |
| High level   | mA      | 2 to 10  | 2 to 10  |
| Minimum pulse width                                | $\mu s$ | Filter on: >25 (20 kHz)<br>Filter off: <2.5 (200 kHz)                            | Filter on: >25 (20 kHz)<br>Filter off: <2.5 (200 kHz)                    |
| <b>Counter Modules</b>                             |         |  |  |
| Channels   | Number  | 1  | 2  |
| Resolution   | bit     | 32   | 32   |
| <b>Measurement Ranges</b>                          |         |  |  |
| Frequency  |         | 0.1 Hz–200 kHz   | 0.01 Hz–200 kHz (scaleable)  |
| Rotational speed                                   |         | 1–25,000 rpm   | Scaleable  |
| Period duration                                    |         | 5 ms to 120s   | 5 ms to 120s (scaleable)   |
| <b>Counter Modes</b>                               |         |  |  |
| Signal evaluation A, B                             |         | Pulse and direction, rotary encoder: single/double/quadruple                     | Pulse and direction, rotary encoder: single/double/quadruple             |
| Operating mode                                     |         | Endless count, count once, count periodically                                    | Endless count, count once, count periodically                            |
| Hysteresis   | bit     | 8  | 32   |
| Pulse duration                                     |         | 8-bit/max. 0.51s   | 32-bit/max. 120s   |
| Synchronization                                    |         | Once/periodic  | Once/periodic  |
| Counter limits                                     |         | Upper count limit: 0–7FFF FFFF<br>Lower count limit: 8000 0000–FFFF FFFF         | Upper count limit: 0–7FFF FFFF<br>Lower count limit: 8000 0000–FFFF FFFF |
| <b>Measurement Modes</b>                           |         |  |  |
| Signal evaluation A, B                             |         | Pulse and direction, single rotary encoder                                       | Pulse and direction, single rotary encoder                               |
| <b>Digital Outputs</b>                             |         |  |  |
| Output voltage                                     |         |  |  |
| Output voltage, nominal value                      | Vdc     | 24   | 24   |
| Low level  | Vdc     | $\leq 3$   | $\leq 3$   |
| High level   |         | $\geq U_L$ (-1V)   | $\geq U_L$ (-1V)   |
| Output current                                     |         |  |  |
| High level (permissible range)                     |         | 5 mA to 2A   | 5 mA to 0.6A   |
| High level (nominal)                               |         | $\leq 0.5A$ (55°C)   | 0.5A (55°C)  |
| Switching frequency                                |         |  |  |
| For resistive load                                 | Hz      | 100  | 20,000/100   |
| For inductive load                                 | Hz      | 2  | —  |
| For lamps  | Hz      | $\leq 10$  | —  |
| Lamp load ( $R_{LL}$ )                             | W       | $\leq 10$  | —  |
| Output delay                                       | $\mu s$ | 100 (resistive load)   | 25 (resistive load)  |
| Short-circuit rating                               |         | Yes  | Yes  |

**Note**

① The figures for rated operational current from the supply terminal apply for load current = 0 mA.

Technology Modules, continued

| Description                                   | Unit   | XN-1CNT-24VDC | XNE-2CNT-2PWM         |
|---|--------|---------------|-----------------------|
| <b>PWM Module</b>                             |        |               |                       |
| Channels                                      | Number | —             | 2                     |
| PWM   |        | —             | 0.01Hz–20 kHz         |
| Period duration/duty cycle                    |        | —             | 32-bit at 41.6 ns/bit |
| Pulse duration                                |        | —             | 32-bit at 41.6 ns/bit |
| Pause time                                    |        | —             | 32-bit at 41.6 ns/bit |
| Output, number of pulses                      |        | —             | 32-bit counter        |
| Pulse output modes                            |        | —             | Once, endless         |
| <b>General Data</b>                           |        |               |                       |
| Diagnostics                                   |        | 1 bit         | 4 Byte                |
| Parameters                                    |        | 15 bit        | 16 Byte               |
| <b>Basic Modules</b>                          |        |               |                       |
| No C-connection for sensor/transmitter supply |        | XN-S4...-SBBS | Already built in      |

Interfaces

| Description  | Unit      | XN-1RS232  | XN-1RS485/422  | XN-1SSI  |
|--|-----------|--|--|--|
| Type   |           | RS-232   | RS-485/RS-422  | SSI  |
| Rated voltage at supply terminal ( $U_L$ )         | Vdc       | 24   | 24   | 24   |
| Rated current drawn from supply terminal ( $I_L$ ) | mA        | 0  | ≤25  | ≤25 ①  |
| Rated current drawn from module bus ( $I_{MB}$ )   | mA        | ≤140   | ≤60  | ≤50  |
| Heat dissipation                                   | W         | Normally 1   | Normally 1   | Normally 1   |
| Transfer channels                                  |           | RxD, TxD, RTS, CTS   | RxD, TxD   | CL, D  |
| Data buffer  |           |  |  |  |
| Receive  | Byte      | 128  | 128  | —  |
| Send   | Byte      | 64   | 64   | —  |
| Connection type                                    |           |  |  |  |
| RS-232   |           | Full-duplex  | —  | —  |
| RS-485   |           | —  | 2-wire, half-duplex  | —  |
| RS-422   |           | —  | 2-conductor, half-duplex or 4-conductor, full-duplex   | 4-conductor, full-duplex (clock output/signal input)       |
| Bit transfer rate                                  |           | Max. 115200 bits/s (parameterizable), Standard: 9600 bits/s, 7 data bits, odd parity and 2 stop bits | Max. 115200 bits/s (parameterizable), Standard: 9600 bits/s, 7 data bits, odd parity and 2 stop bits | Max. 1 MHz (parameterizable), default settings: 500 kBit/s |
| Insulation test ( $U_i$ )                          |           |  |  |  |
| Between interface and module bus/system voltage    | $V_{eff}$ | 500  | 500  | 500  |
| Between interface and field voltage                | $V_{eff}$ | 500  | 500  | 500  |
| Common-mode range                                  | Vdc       | –7 to 12   | —  | —  |
| Cable impedance                                    | ohm       | —  | 120  | 120  |
| Bus termination                                    | ohm       | —  | 120 (external)   | Internal   |
| Cable length                                       | m         | Max. 15  | Max. 30  | Max. 30  |
| Number of diagnosis bytes                          |           | 1  | 1  | 1  |
| Number of parameter bytes                          |           | 4  | 4  | 4  |
| Basic modules                                      |           |  |  |  |
| No C-connection for sensor/transmitter supply      |           | XN-S4...-SBBS  | XN-S4...-SBBS  | XN-S4...-SBBS  |

Note

① The figures for rated operational current from the supply terminal apply when there is no sensor/transmitter current.

#### Connection Diagrams

##### Gateway XN...GWBR\_

24V Supply from Gateway ( $U_L$ ) and System Bus ( $U_{sys}$ )

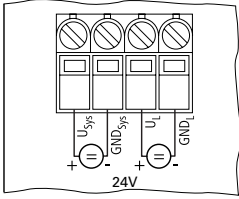

4

#### Bus Refreshing Modules

XN-P3x-SBB with Gateway Power Supply  
XN-P3...-SBB-B without Gateway Power Supply

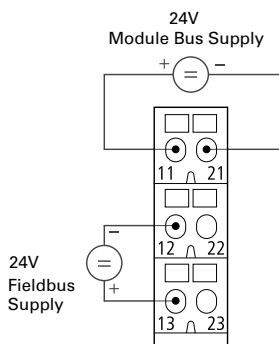

XN-P4...-SBBC with Gateway Power Supply  
XN-P4...-SBBC-B without Gateway Power Supply

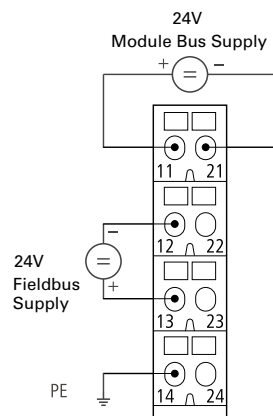

#### Power Feeding Modules

XN-P3...-SBB for XN-PF-24VDC-D

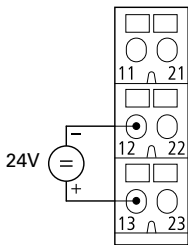

XN-P4...-SBBC for XN-PF-24VDC-D

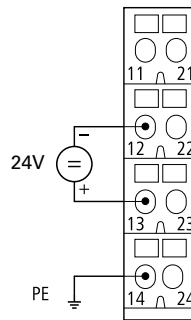

XN-P3...-SBB for XN-PF-120/230VAC-D

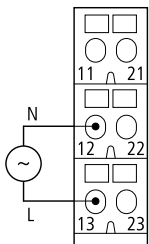

XN-P4...-SBB for XN-PF-120/230VAC-D

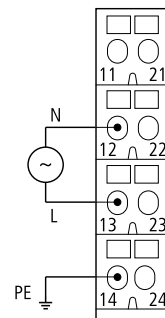

**Digital Input Modules**

**XN-S3...-SBB for XN-2DI-24VDC-P**

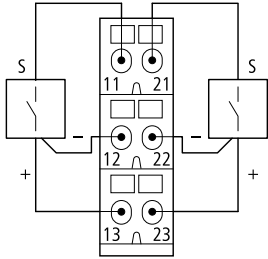

**XN-S4...-SBBC for XN-2DI-24VDC-P**

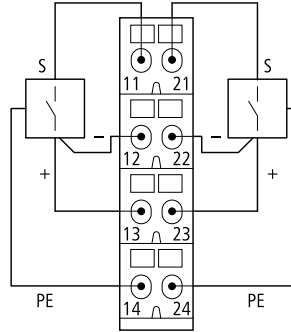

**XN-S3...-SBB for XN-2DI-24VDC-N**

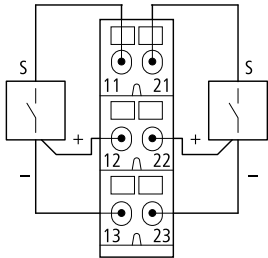

**XN-S4...-SBBC for XN-2DI-24VDC-N**

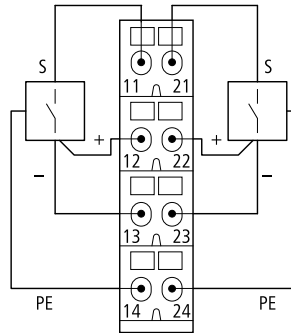

**XN-S3...-SBB for XN-2DI-120/230VAC**

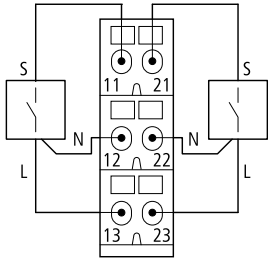

**XN-S4...-SBBC for XN-2DI-120/230VAC**

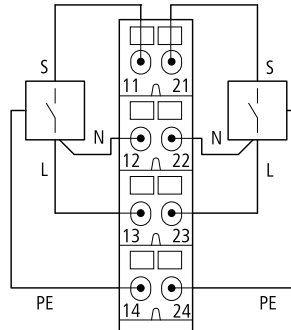

**XN-S4...-SBBS for XN-4DI-24VDC-P**

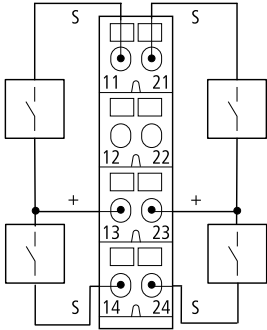

**XN-S6...-SBBSBB for XN-4DI-24VDC-P**

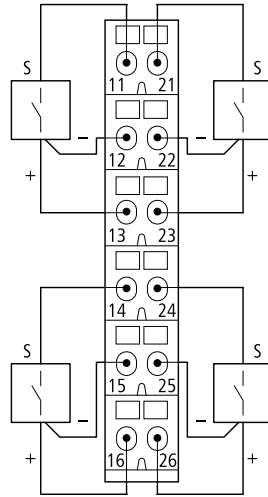

**XN-S4...-SBBS for XN-4DI-24VDC-N**

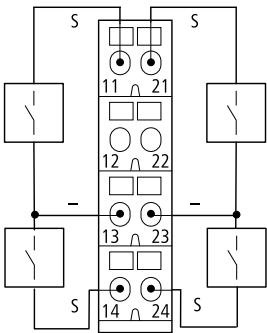

**XN-S6...-SBBSBB for XN-4DI-24VDC-N**

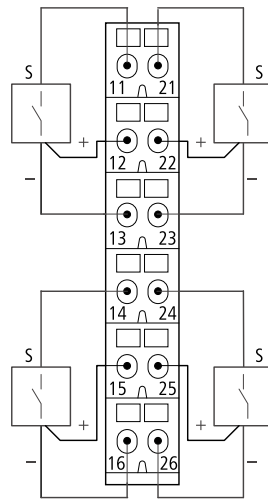

**XN-B3...-SBB for XN-16DI-24VDC-P**

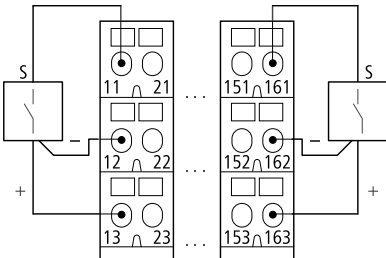

**XN-B4...-SBBC for XN-16DI-24VDC-P**

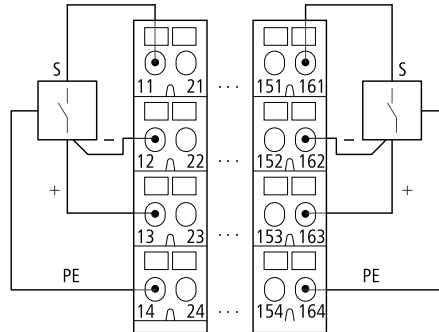



**XN-B6...-SBBSBB for XN-32DI-24VDC-P**

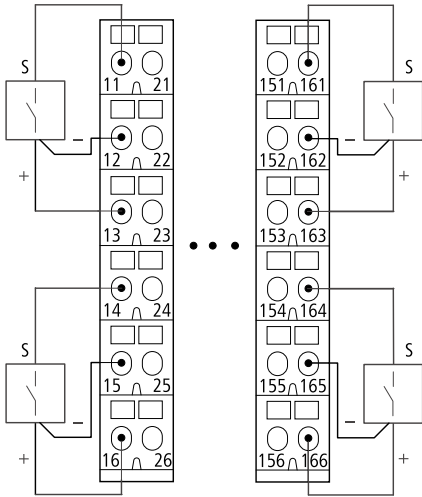

**XNE-8DI-24VDC-P**

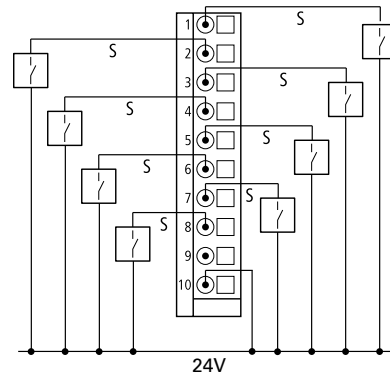

**XNE-16DI-24VDC-P**

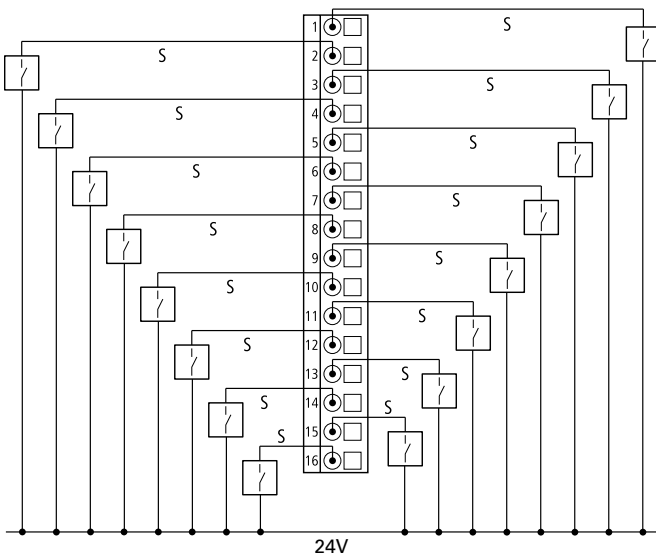

#### Digital Output Modules

**XN-S3...-SBC for XN-2DO-24VDC-0.5A-P and XN-2DO-24VDC-2A-P**

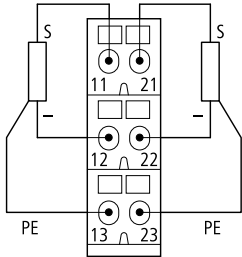

**XN-S4...-SBCS for XN-2DO-24VDC-0.5A-P and XN-2DO-24VDC-2A-P**

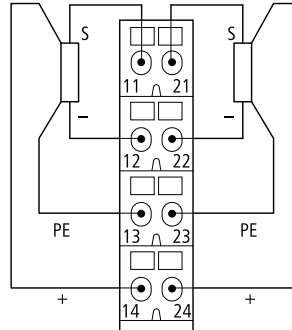

**XN-S3...-SBC for XN-2DO-24VDC-0.5A-N**

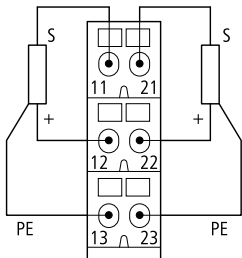

**XN-S4...-SBCS for XN-2DO-24VDC-0.5A-N**

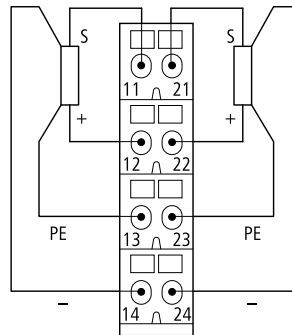

**XN-S3...-SBC for XN-2DO-120/230VAC-0.5A**

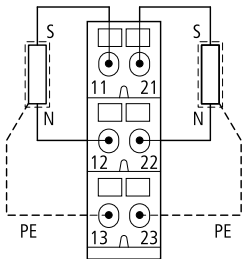

**XN-S4...-SBCS for XN-2DO-120/230VAC-0.5A**

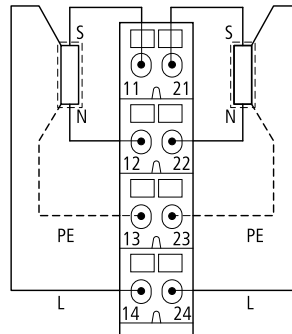

**XN-S4...-SBCS for XN-4DO-24VDC-0.5A-P**

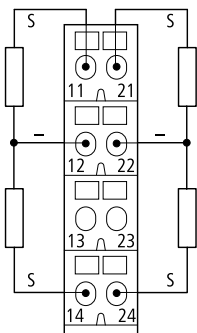

**XN-B3...-SBC for XN-16DO-24VDC-0.5A-P**

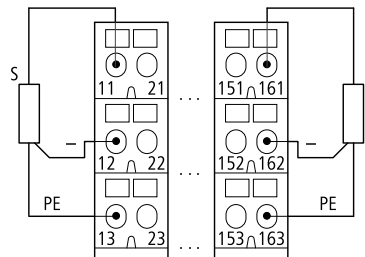

XN-S6...-SBCSBC for XN-4DO-24VDC-0.5A-P

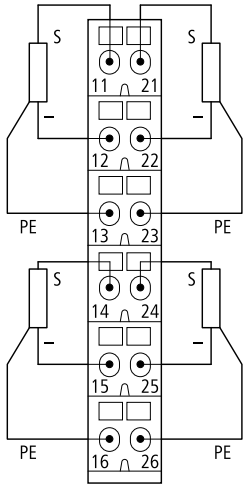

XNE-8DO-24VDC-0.5A-P

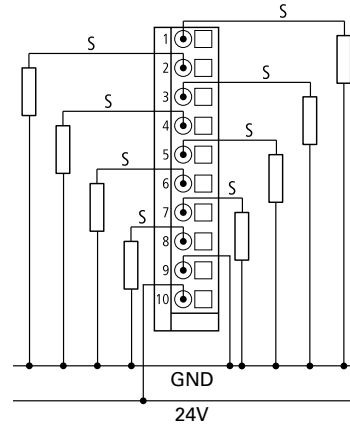

XN-B6...-SBCSBC for XN-32DO-24VDC-0.5A-P

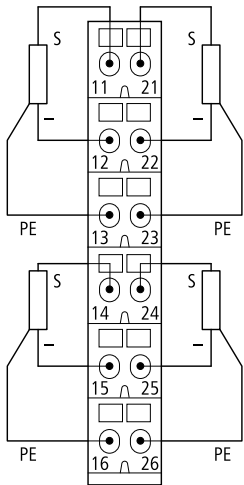

XNE-16DO-24VDC-0.5A-P

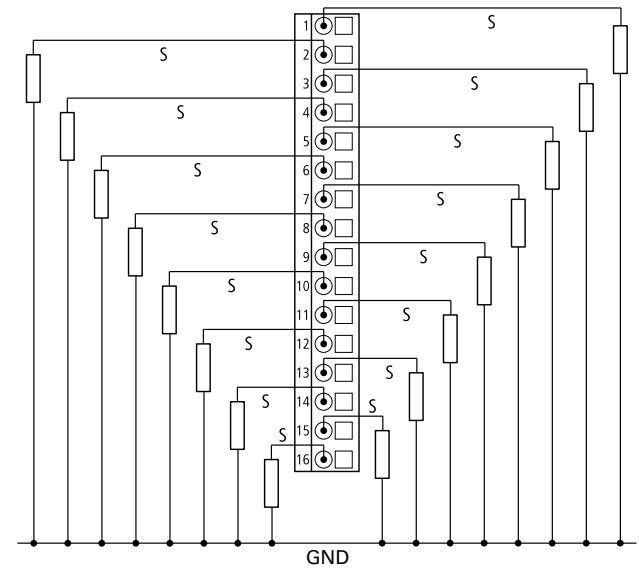

#### Analog Input Modules

**XN-S3...-SBB for XN-1AI-I(0/4...20MA)**  
**XN-S3...-SBB for XN-1AI-U(-10/0...+10VDC)**  
**Analog Sensor/Transmitter, without Transmitter Supply**

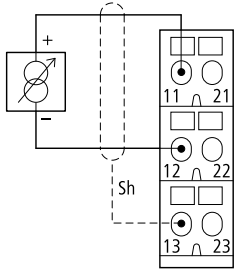

**XN-S4...-SBBS for XN-1AI-I(0/4...20MA)**  
**XN-S4...-SBBS for XN-1AI-U(-10/0...+10VDC)**  
**Analog Transmitter with Non-Isolated Transmitter Supply**

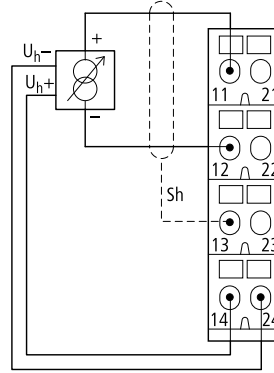

**XN-S3...-SBB for XN-2AI-I(0/4...20MA),**  
**XN-2AI-U(-10/0...+10VDC)**  
**Analog Sensor/Transmitter, without Transmitter Supply**

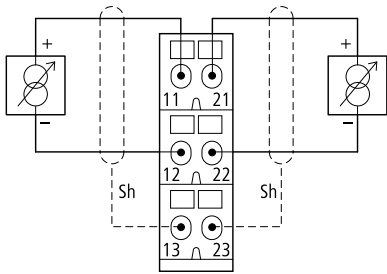

**XN-S4...-SBBS for XN-2AI-I(0/4...20MA),**  
**XN-2AI-U(-10/0...+10VDC)**  
**Analog Transmitter with Non-Isolated Transmitter Supply**

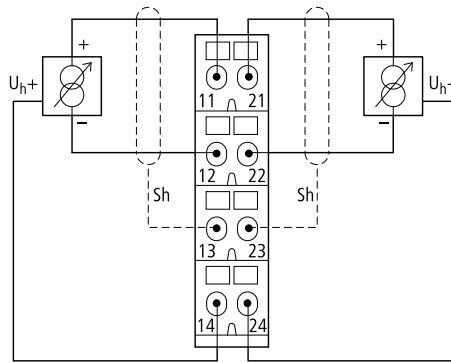

**XN-S4...-SBBS for XN-2AI-I(0/4...20MA)**  
**Two-Conductor Connection without**  
**External Transmitter Supply**

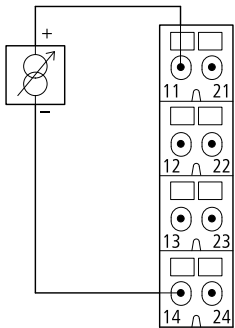

**XN-S6...-SBCSBC for XN-4AI-U/I**  
Analog Sensor/Transmitter,  
without Transmitter Supply

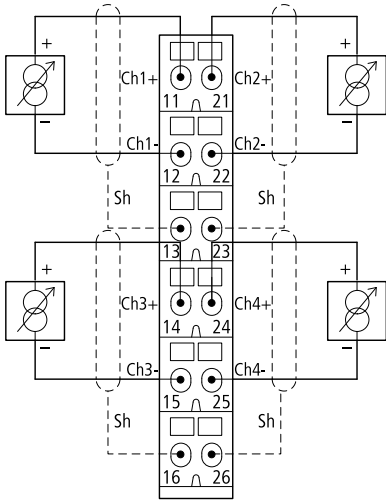

**XN-S3...-SSB for XN-AI-U/I**  
Two-Conductor Connection without  
External Transmitter Supply

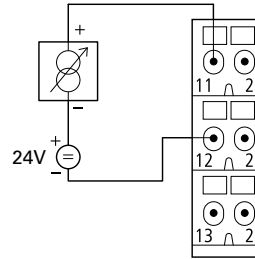

**XN-S3...-SBB for XN-2AI-PT/NI-2/3**  
Two-Conductor Connection

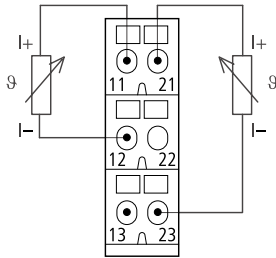

**XN-S4...-SBBS for XN-2AI-PT/NI-2/3**  
Three-Conductor Connection

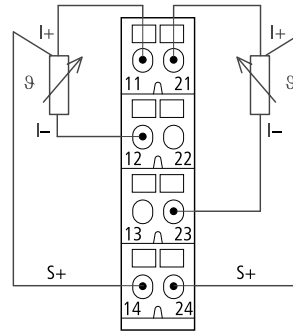

**XN-S4...-SBBS-CJ for XN-2AI-THERMO-PI**

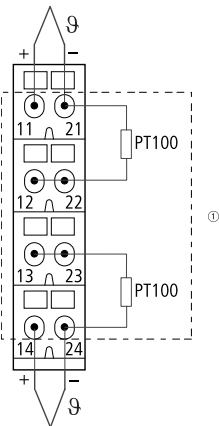

**XNE-8AI-U/I-4PT/NI**

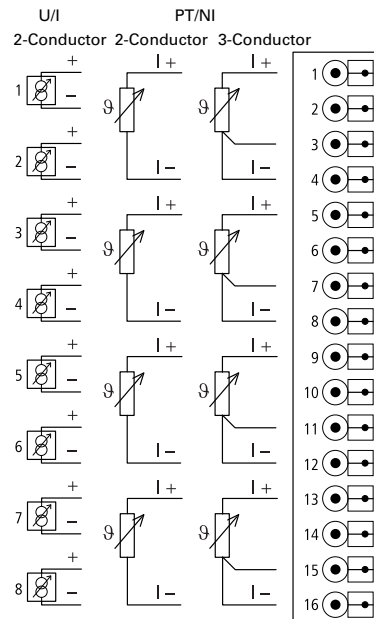

**Note**

① Cold-junction compensation in base module.

#### Analog Output Modules

**XN-S3...-SSB for XN-1AO-I(0/4...20MA)**

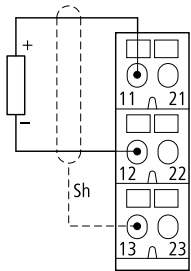

**XN-S3...-SBB for XN-2AO-I(0/4...20MA)**

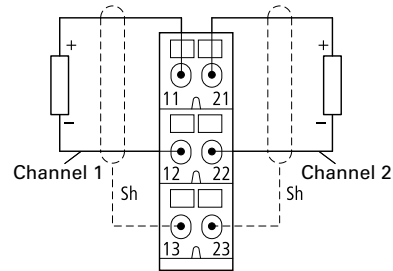

**XN-S3...-SBB for XN-2AO-U(-10/0...+10VDC)**

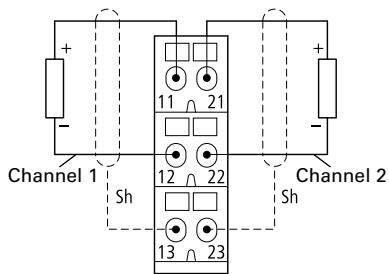

**XNE-4AO-U/I**

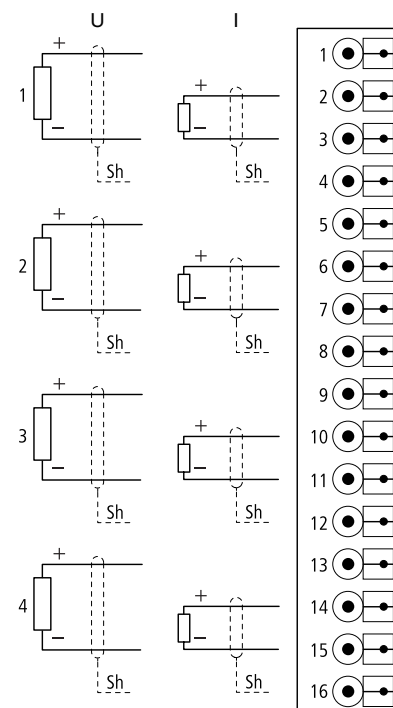

**Relay Modules**

**XN-S4x...-SBBS with Externally Applied Supply and Common Potential Link for XN-2DO-R-NC**

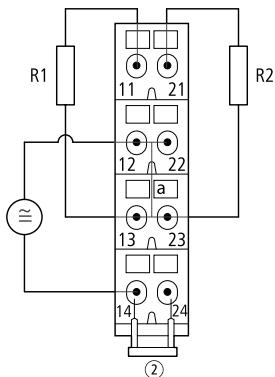

**Module Circuit XN-S4x...SBBS for XN-2DO-R-NC**

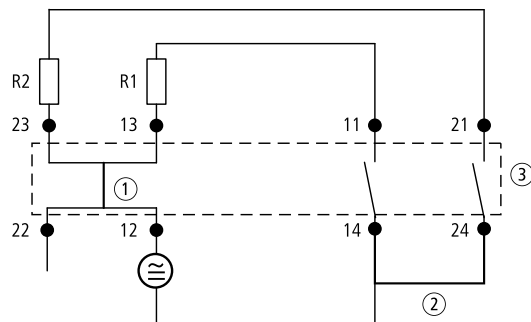

**XN-S4x...-SBCS Supply via C-Rail and Common Potential Link for XN-2DO-R-NC**

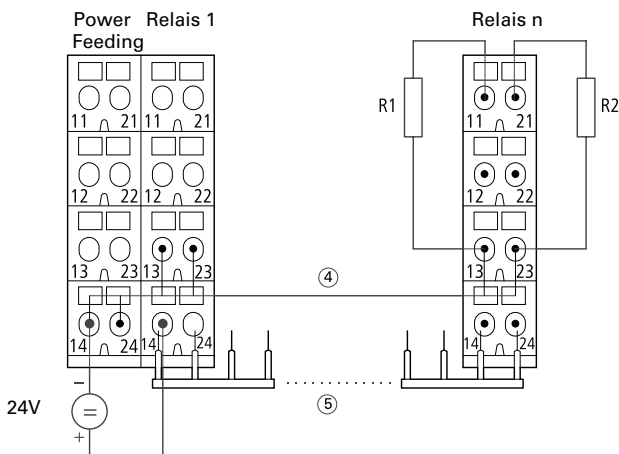

**Module Circuit XN-S4x...-SBCS for XN-2DO-R-NC**

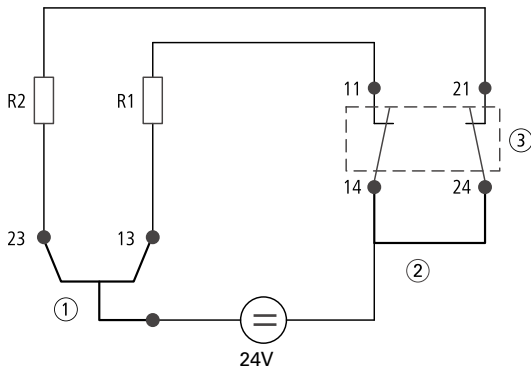

**XN-S4x...-SBBS with Externally Applied Supply and Common Potential Link for XN-2DO-R-NO**

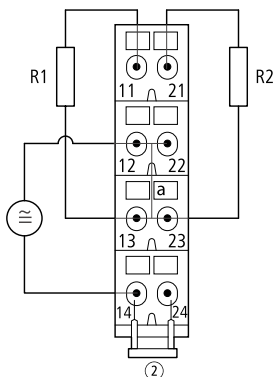

**Module Circuit XN-S4x...-SBBS for XN-2DO-R-NO**

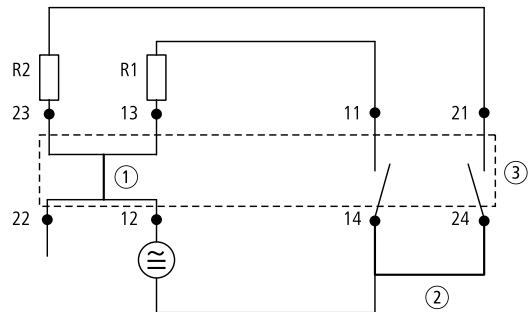

**Notes**

- ① Linked in the electronics.
- ② Cross-link via QVR in the base module.
- ③ Electronics module.
- ④ Supply via C-rail.
- ⑤ Maximum eight relay modules.

#### XN-S4x...-SBCS Supply via C-rail and Common Potential Link for XN-2DO-R-NO

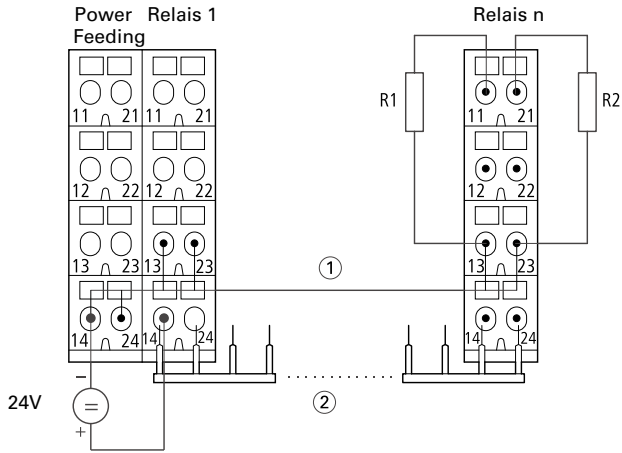

#### Module Circuit XN-S4x...-SBCS for XN-2DO-R-NO

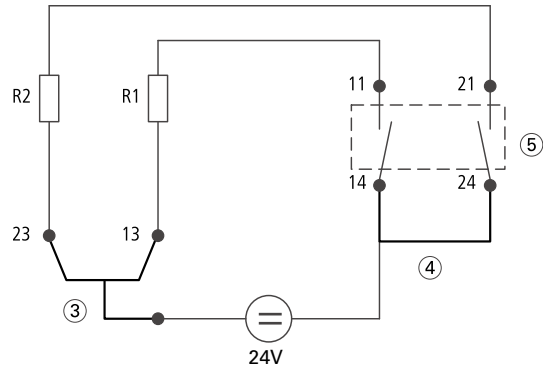

#### XN-S4x...-SBBS for XN-2DO-R-CO

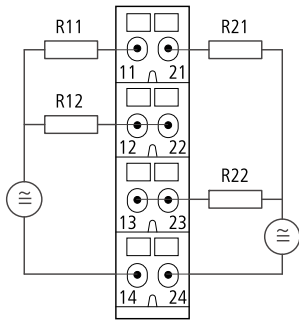

#### Module Circuit XN-S4x...-SBBS for XN-2DO-R-CO

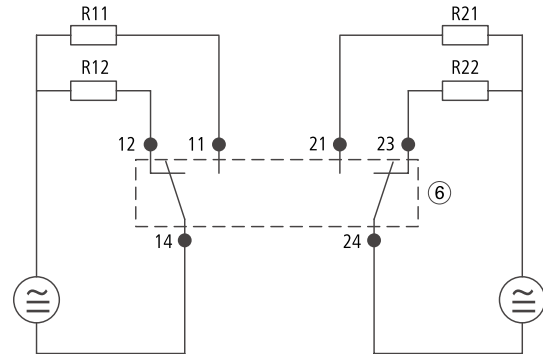

#### Load Limit Curve

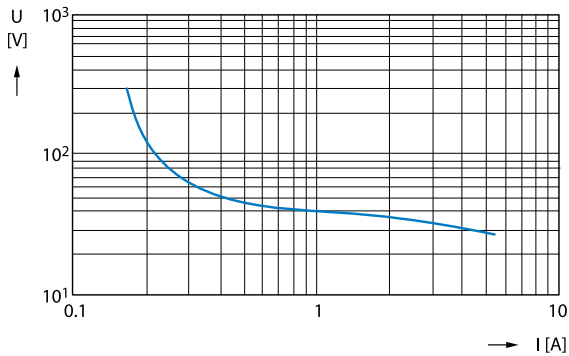

#### Notes

- ① Supply via C-rail.
- ② Maximum eight relay modules.
- ③ Top-hat rail.
- ④ Cross-link via QVR in the base module.
- ⑤ Electronics module.
- ⑥ Electronics module—  
Definition: At 1000 operations, no arc with a duration >10 ms must occur.



**Serial Interfaces**

**XN-S4x...-SBBS for XN-1RS232 and D-Sub Plug**

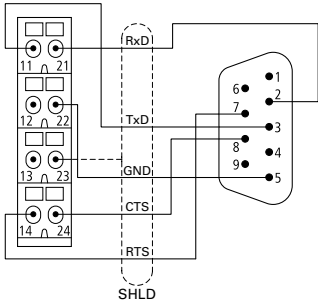

**XN-S4x...-SBBS for XN-1RS485/422 in RS422 Mode**

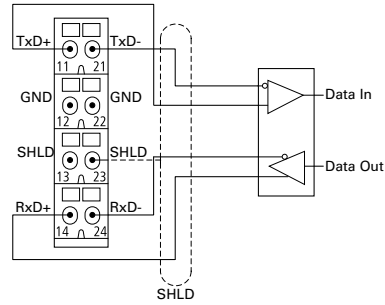

**XN-S4x...-SBBS for XN-1SSI on an SSI Rotary Encoder**

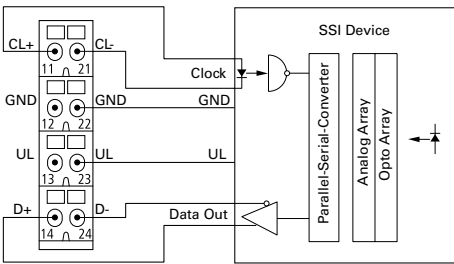

**XN-S4...-SBBS for XN-1RS485/422 in RS485 Mode**

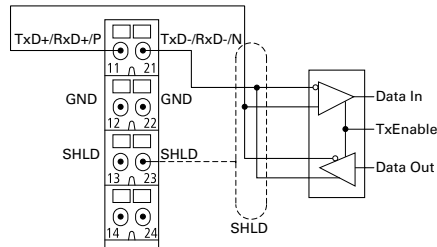

**Technology Modules/Counter**

**XN-S4...-SBBS for XN-1CNT-24VDC**

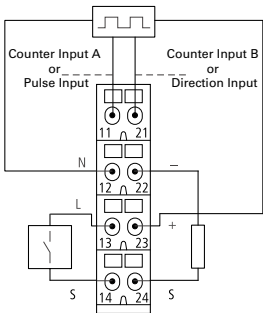

**XNE-2CNT-2PWM**

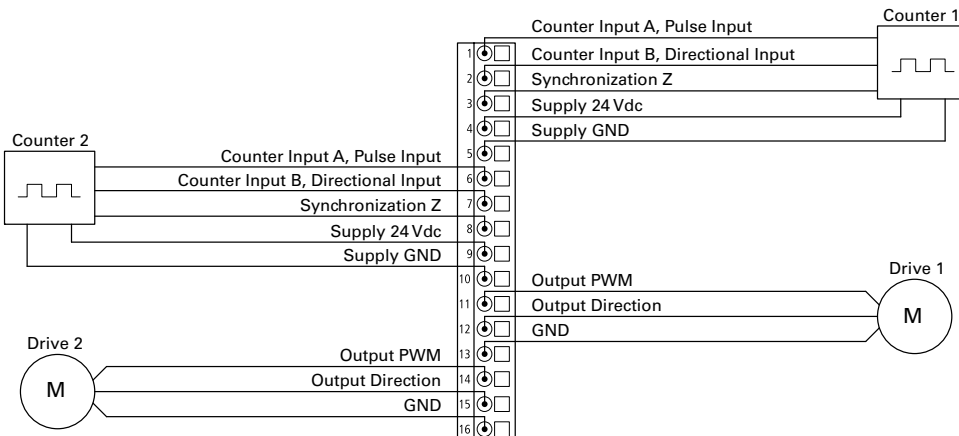

### Dimensions

Approximate Dimensions in Inches (mm)

#### XN Gateways

**XN-GWBR-PBDP**

**XN-GWBR-CANOPEN**

**XN-GWBR-DNET**

**XN-GWBR-MODBUS-TCP**

**XN-PLC-CANOPEN**

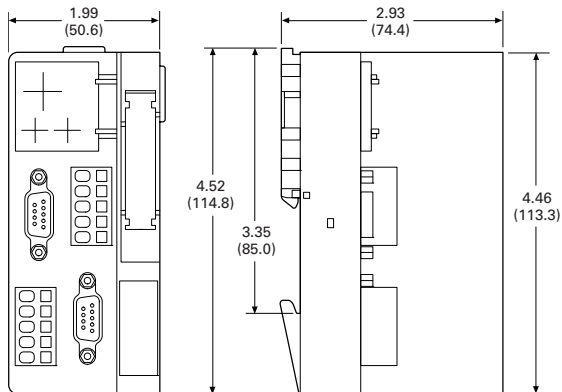

**Note:** The plugs/connectors used depends on the version.

#### XNE Gateways

**XNE-GWBR-PBDP**

**XNE-GWBR-CANOPEN**

**XNE-GWBR-2ETH-IP**

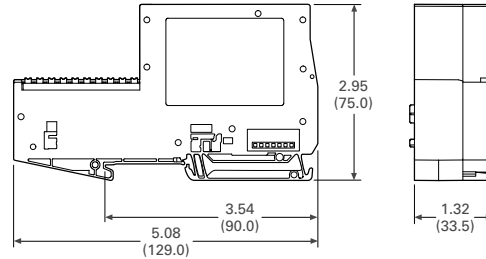

#### XNE Electronics Modules

**XNE-8DO-24VDC-0.5A-P**

**XNE-8DI-24VDC-P**

**XNE-16DI-24VDC-P**

**XNE-16DO-24VDC-0.5A-P**

**XNE-8AI-U/I/4PT/NI**

**XNE-4AO-U/I**

**XNE-2CNT-2PWM**

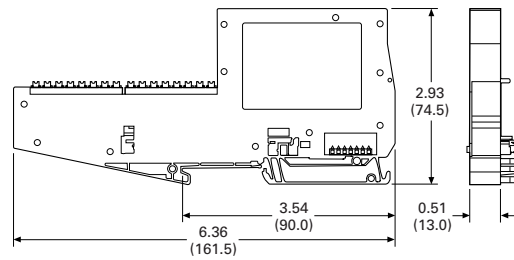
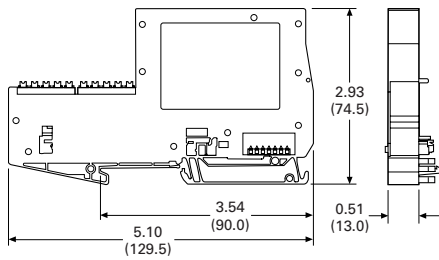

#### End Cover

**XN-ABPL**

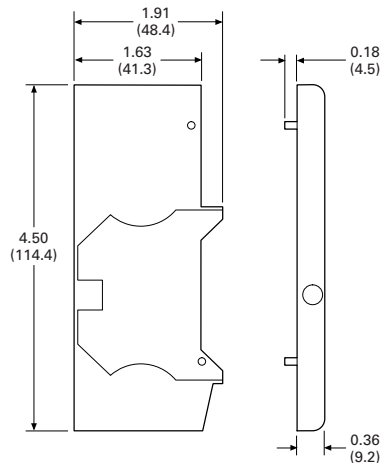

#### End Bracket

**XN-WEW-35/2-SW**

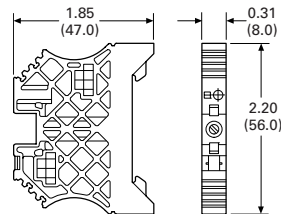

Approximate Dimensions in Inches (mm)

**XN Electronics Modules in Slice Design**

- |                           |                               |                                 |                      |
|---------------------------|-------------------------------|---------------------------------|----------------------|
| <b>XN-BR-24VDC-D</b>      | <b>XN-2DI-24VDC-P</b>         | <b>XN-1AI-I(0/4...20MA)</b>     | <b>XN-1CNT-24VDC</b> |
| <b>XN-PF-24VDC-D</b>      | <b>XN-2DI-24VDC-N</b>         | <b>XN-2AI-I(0/4...20MA)</b>     | <b>XN-1RS232</b>     |
| <b>XN-PF-120/230VAC-D</b> | <b>XN-12DI-120/230VAC</b>     | <b>XN-1AI-U(-10/0...+10VDC)</b> | <b>XN-1RS485/422</b> |
|                           | <b>XN-4DI-24VDC-P</b>         | <b>XN-2AI-U(-10/0...+10VDC)</b> | <b>XN-1SSI</b>       |
|                           | <b>XN-4DI-24VDC-N</b>         | <b>XN-2AI-PT/NI-2/3</b>         |                      |
|                           | <b>XN-2DO-24VDC-2A-P</b>      | <b>XN-2AI-THERMO-PI</b>         |                      |
|                           | <b>XN-2DO-24VDC-0.5A-P</b>    | <b>XN-4AI-U/I</b>               |                      |
|                           | <b>XN-2DO-24VDC-0.5A-N</b>    | <b>XN-1AO-I(0/4...20MA)</b>     |                      |
|                           | <b>XN-2DO-120/230VAC-0.5A</b> | <b>XN-2AO-I(0/4...20MA)</b>     |                      |
|                           | <b>XN-4DO-24VDC-0.5A-P</b>    | <b>XN-2AO-U(-10/0...+10VDC)</b> |                      |
|                           | <b>XN-2DO-R-CO</b>            |                                 |                      |
|                           | <b>XN-2DO-R-NC</b>            |                                 |                      |
|                           | <b>XN-2DO-R-NO</b>            |                                 |                      |

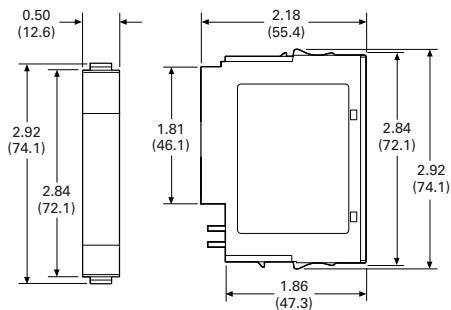

**XN Electronics Modules in Block Design**

- |                        |                             |
|------------------------|-----------------------------|
| <b>XN-16DI-24VDC-P</b> | <b>XN-16DO-24VDC-0.5A-P</b> |
| <b>XN-32DI-24VDC-P</b> | <b>XN-32DO-24VDC-0.5A-P</b> |

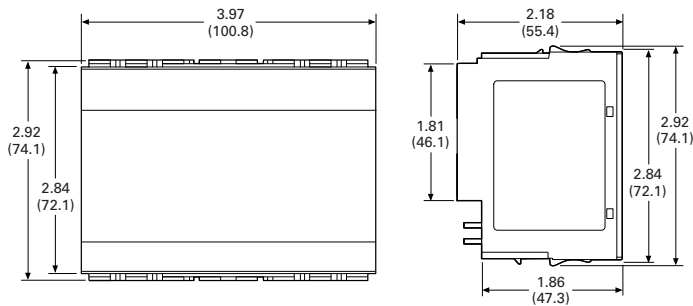

**XN Electronics Modules Completed with Base Module**

All Types

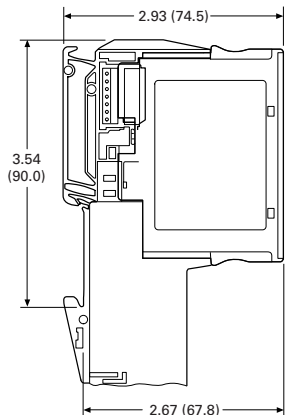

Approximate Dimensions in Inches (mm)

#### Base Modules in Slice Design

##### Spring-Cage Terminals

##### 3 Connection Levels

XN-S3T-SBB  
XN-S3T-SBC  
XN-P3T-SBB  
XN-P3T-SBB-B

##### 4 Connection Levels

XN-S4T-SBBC  
XN-S4T-SBBS  
XN-S4T-SBBS-CJ  
XN-S4T-SBCS  
XN-P4T-SBBC  
XN-P4T-SBBC-B

##### 6 Connection Levels

XN-S6T-SBBSBB  
XN-S6T-SBCSBC

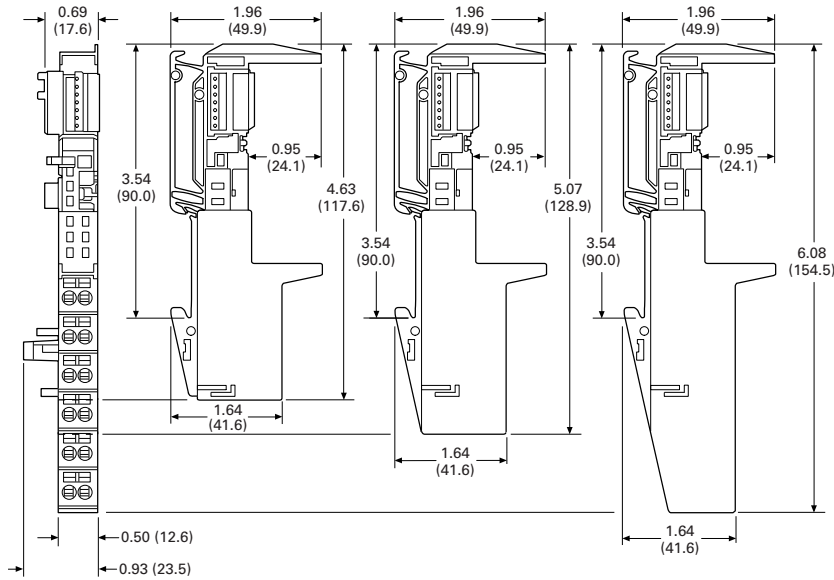

##### Screw Terminals

##### 3 Connection Levels

XN-S3S-SBB  
XN-S3S-SBC  
XN-P3S-SBB  
XN-P3S-SBB-B

##### 4 Connection Levels

XN-S4S-SBBC  
XN-S4S-SBBS  
XN-S4S-SBBS-CJ  
XN-S4S-SBCS  
XN-P4S-SBBC  
XN-P4S-SBBC-B

##### 6 Connection Levels

XN-S6S-SBBSBB  
XN-S6S-SBCSBC

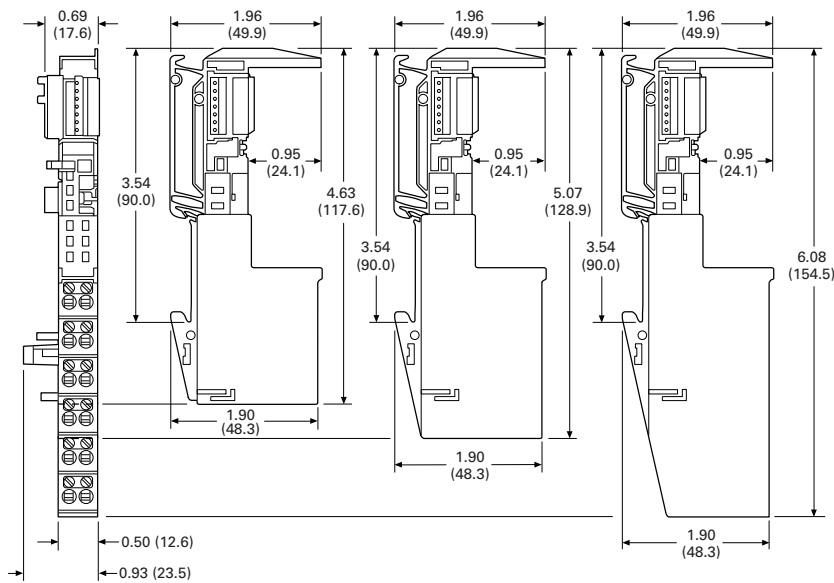

Approximate Dimensions in Inches (mm)

**Base Modules in Block Design**

**Spring-Cage Terminals**

**3 Connection Levels**

**XN-B3T-SBB**

**XN-B3T-SBC**

**4 Connection Levels**

**XN-B4T-SBBC**

**6 Connection Levels**

**XN-B6T-SBBSBB**

**XN-B6T-SBCSBC**

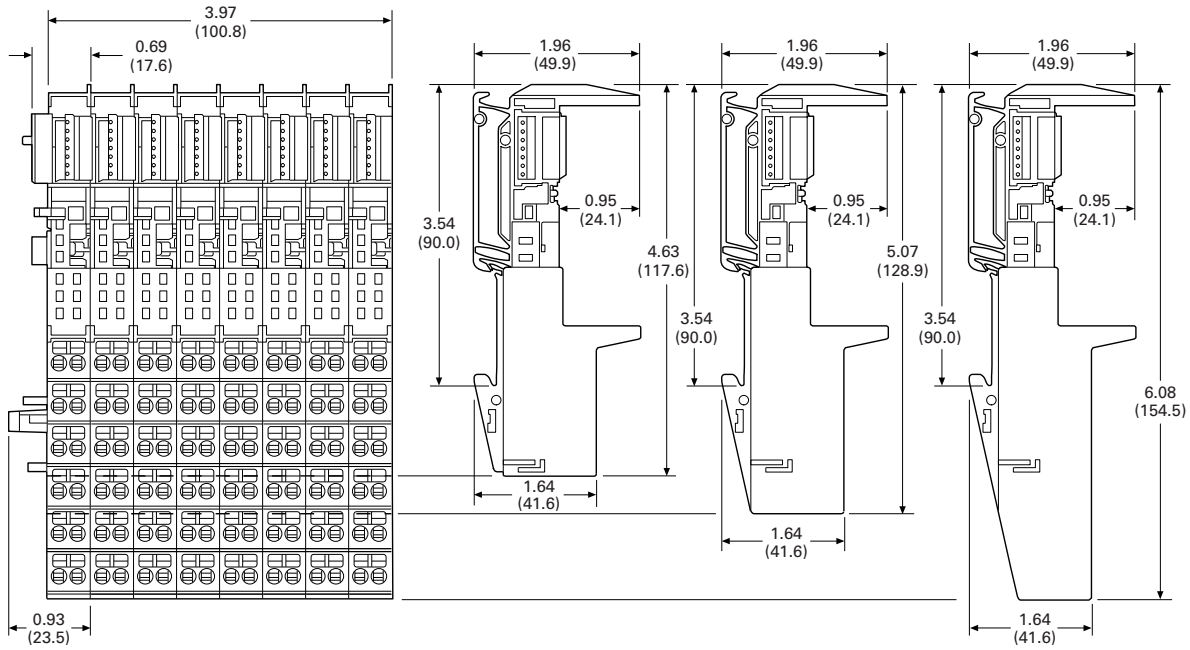

**Screw Terminals**

**3 Connection Levels**

**XN-B3S-SBB**

**XN-B3S-SBC**

**4 Connection Levels**

**XN-B4S-SBBC**

**6 Connection Levels**

**XN-B6S-SBBSBB**

**XN-B6S-SBCSBC**

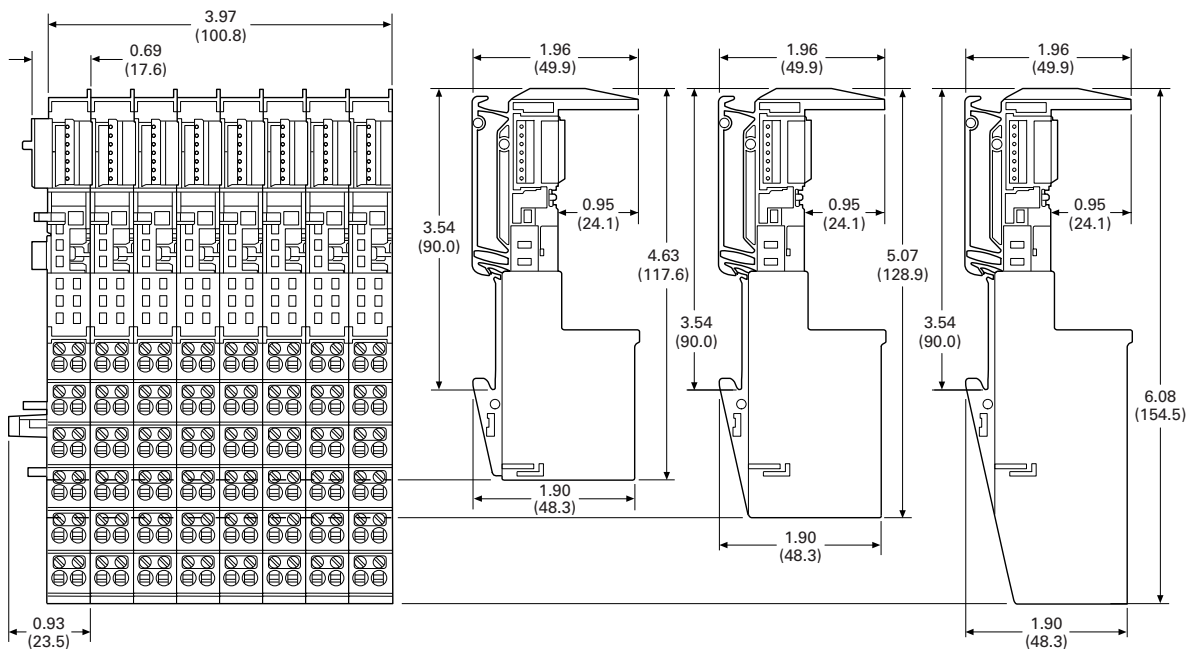

**ELC Graphics Panel**



**HMi Operator Interface**



**XV Operator Interface**



**XP Operator Interface**



**5.1 Product Overview**

Product and Software Selection Guides ..... **V7-T5-2**

**5.2 ELC Graphics Panels**

Product Description ..... **V7-T5-5**

Features ..... **V7-T5-5**

Standards and Certifications ..... **V7-T5-6**

Catalog Number Selection ..... **V7-T5-7**

Product Selection ..... **V7-T5-7**

Software and Accessories ..... **V7-T5-8**

Technical Data and Specifications ..... **V7-T5-10**

Dimensions ..... **V7-T5-11**

**5.3 HMi Operator Interface**

Product Description ..... **V7-T5-13**

Features ..... **V7-T5-13**

Standards and Certifications ..... **V7-T5-14**

Catalog Number Selection ..... **V7-T5-15**

Product Selection ..... **V7-T5-15**

Software and Accessories ..... **V7-T5-16**

Technical Data and Specifications ..... **V7-T5-18**

Dimensions ..... **V7-T5-19**

**5.4 XP and XV Operator Interface**

XP-503 with Visual Designer ..... **V7-T5-21**

XV with Visual Designer, Galileo or XSoft-CoDeSys-3 ..... **V7-T5-24**

Product Selection Guide ..... **V7-T5-26**

Visual Designer Software ..... **V7-T5-33**

Galileo Software ..... **V7-T5-36**

XSoft-CoDeSys-3 Software ..... **V7-T5-37**



### Product and Software Selection Guides

#### Operator Interfaces and Programming Software Selection Guide



| Description                  | ELC-GP Graphics Panel<br>Page V7-T5-5 | HMI Operator Interface<br>Page V7-T5-13   |
|------------------------------|---------------------------------------|---|
| Screen size                  | Two-line and four-line                | 4.3-inch, 5.7-inch, 7.0-inch, 8.0-inch and 10.4-inch                                |
| Screen options               | Monochrome                            | 65 k color TFT  |
| Interface                    | Keypad only                           | Resistive touchscreen only or touchscreen and keypad                                |
| Communication ports          | 2 serial                              | 3 serial; USB; Expansion port for Ethernet or Local I/O, onboard Ethernet VU models |
| Simultaneous protocols       | 1                                     | 3 or 4  |
| Ethernet drivers             | —                                     | Yes   |
| Upload/download              | Serial cable                          | Serial, Ethernet, and/or USB  |
| Operating system             | Proprietary                           | Proprietary   |
| Third-party software support | —                                     | —   |
| Screen saver                 | —                                     | Yes   |

#### Operator Interfaces and Programming Software Selection Guide, continued



| Description                  | XP-500 Series Operator Interface<br>Page V7-T5-21  | XV Operator Interface<br>Page V7-T5-24  |
|------------------------------|--|---|
| Screen size                  | 10.1-inch, 15.6-inch, 21.5-inch  | 3.5-inch, 5.7-inch, 7.0-inch, 8.4-inch and 10.4-inch  |
| Screen options               | LED backlit Projected Capacitive Touchscreen (PCT), resolutions from (1024 x 600) to (1920 x 1080) | Color TFT, 64 k colors; resolutions from QVGA (320 x 240) to WVGA (800 x 480)                                 |
| Interface                    | Non-reflective tempered scratch-resistant glass  | Resistive touchscreen   |
| Communication ports          | 2 Ethernet, 1 RS-232, 1 RS-485, 2 USB 3.0, 1 DVI-I   | Ethernet, RS-232 and/or RS-485, USB; CANopen or PROFIBUS®-DP, SmartWire-DT®, USB and RS-485 on CoDeSys models |
| Simultaneous protocols       | 5 (8 optional)   | 3 on Visual Designer, varies for Galileo and XSoft-CoDeSys-3  |
| Ethernet drivers             | Yes  | Yes   |
| Upload/download              | Serial, Ethernet, USB  | Serial, Ethernet, USB   |
| Operating system             | Windows® Embedded Standard 7 (protected)   | Windows CE 5.0 Professional   |
| Third-party software support | Yes  | —   |
| Screen saver                 | Yes  | Yes   |

### Software Product Selection Guide



| Description  | Visual Designer  | XSoft-CoDeSys-3 <sup>①</sup>   | Galileo   | HM/Soft  | ELCSoftGP  |
|--|--|--|---|--|--|
| Overview   | Feature-rich software package with SCADA functionality and Web serving capabilities that can be run on XV, XP, ePro PS operator interfaces or personal computers | Feature-rich software package with integrated logic and visualization that can be run on specific XV operator interface models | Intuitive visualization tool. Use Galileo on XV-102-H_ units or on XV units running CoDeSys when a stronger visualization package is needed | Use <b>HM/Soft</b> to create, edit, upload and download applications to the <b>HM/Soft</b> family of operator interfaces | Use ELCSoftGP to create, edit, upload and download applications to ELC Graphics Panels |
| <b>Catalog ID</b>  |  |  |   |  |  |
| Development software seat license                          | VISUALDCE (CE hardware)<br>VISUALDXP5 (5-pack of VISUALDXP)<br>VISUALDCE5 (5-pack of VISUALDCE)<br>VISUALDXP (PCs, XPe, and CE hardware)                         | SW-XSOFT-CODESYS-3-S <sup>②</sup><br>SW-XSOFT-CODESYS-3-M <sup>③</sup>   | SW-GALILEO-S<br>SW-GALILEO-M  | HMISOFT  | ELCSOFTGP  |
| Runtime software for a PC                                  | VISUALRTPC   | N/A  | ■   | N/A  | N/A  |
| <b>Time-Saving Editor Features</b>                         |  |  |   |  |  |
| Online and offline simulation                              | ■  | ■  | ■   | ■  | —  |
| Macro capability   | ■  | ■  | ■   | ■  | —  |
| VB scripting   | ■  | —  | —   | —  | —  |
| Multi-language   | ■  | ■  | ■   | ■  | —  |
| System/internal variables                                  | ■  | ■  | ■   | ■  | —  |
| Auto-scale application to different resolution/screen size | ■  | ■  | ■   | ■  | —  |
| Scripting (IF, THEN, ELSE, GOTO)                           | ■  | ■  | ■   | ■  | —  |
| Graphics library   | ■  | —  | ■   | ■  | —  |
| Master pages   | ■ Screen groups  | ■ One  | ■ Screen groups   | ■ Base screen  | —  |
| User-created controls                                      | ■  | ■  | ■   | ■  | —  |
| Customizable application symbols                           | ■  | ■  | ■   | —  | —  |
| Full math evaluation                                       | ■  | ■  | ■ With macros   | ■ With macros  | —  |
| Reusable controls, images and pages                        | ■ Via indirect tag and/or PLC assignments  | ■  | ■   | —  | —  |
| Advanced search and replace                                | ■  | ■  | ■   | —  | —  |
| Advanced context sensitive help                            | ■  | ■  | ■   | —  | —  |
| Conversion of legacy PanelMate <sup>®</sup> configurations | ■  | —  | —   | —  | —  |
| Optional PanelBuilder <sup>™</sup> conversion utility      | ■  | —  | —   | —  | —  |
| Online configuration/editing                               | ■  | ■  | —   | —  | —  |

**Notes**

- ① See the logic section of the catalog for details on the logic features in the XSoft-CoDeSys-3 software package.
- ② Includes XSoft-CoDeSys-3 software for developing applications, runtime software for the XV Series. Single User License.
- ③ Includes XSoft-CoDeSys-3 software for developing applications, runtime software for the XV Series. Multi User License.



#### Software Product Selection Guide, continued



5

| Description  | Visual Designer        | XSoft-CoDeSys-3 <sup>①</sup>           | Galileo                | HM/Soft                      | ELCSoftGP |
|--|------------------------|--|------------------------|------------------------------|-----------|
| <b>Runtime Features</b>                                  |                        |  |                        |                              |           |
| Clock synchronization with controller                    | ■                      | ■ Configured via visualization screens | ■                      | ■                            | ■         |
| Sound actions or control                                 | ■                      | —                                      | ■                      | ■                            | ■         |
| Security   | ■ Advanced multi-level | ■                                      | ■                      | ■ Multi-level                | ■         |
| Pop-up screens   | ■ And group screens    | —                                      | ■                      | ■                            | —         |
| Animated graphics  | ■                      | ■                                      | ■                      | ■                            | —         |
| Multi-touch and gesture support                          | ■                      | —                                      | ■                      | —                            | —         |
| Real-time trending                                       | ■                      | ■                                      | ■                      | ■                            | —         |
| Recipes  | ■                      | ■                                      | ■                      | ■                            | —         |
| Report generation  | ■                      | —                                      | ■                      | ■ Using Excel® and VU Server | —         |
| Timer scheduling   | ■                      | ■                                      | ■                      | ■                            | —         |
| Calendar scheduling                                      | ■                      | ■                                      | —                      | —                            | —         |
| Notification of data and events via email/text messaging | ■                      | ■                                      | —                      | —                            | —         |
| Data archiving   | ■                      | ■                                      | ■                      | ■                            | —         |
| Archive to shared network drive                          | ■                      | ■                                      | ■                      | —                            | —         |
| Alarm and event archiving                                | ■                      | ■                                      | ■                      | ■                            | —         |
| Historical trending                                      | ■                      | ■                                      | ■                      | ■                            | —         |
| Import/export from XML or CSV                            | ■                      | ■                                      | ■                      | —                            | —         |
| Database interface                                       | ■ ADO.net compliant    | ■ DDE                                  | —                      | ■                            | —         |
| Vision system interfaces                                 | ■                      | —                                      | ■                      | —                            | —         |
| Secure document and Web network browser                  | ■                      | ■ With user created passwords          | —                      | —                            | —         |
| Web server—viewing and control                           | ■                      | ■                                      | —                      | —                            | —         |
| Automatic scaling of Web clients                         | ■                      | —                                      | —                      | —                            | —         |
| Remote desktop   | ■ VNC and RemoteClient | ■ VNC and RemoteClient                 | ■ VNC and RemoteClient | ■ VU Remote                  | —         |
| Launch/control third-party applications                  | ■                      | —                                      | —                      | —                            | —         |
| Embedded PLC logic                                       | —                      | ■                                      | —                      | —                            | —         |

**Note**

① See the logic section of the catalog for details on the logic features in the XSoft-CoDeSys-3 software package.

### ELC Graphics Panels



### Contents

#### Description

| <i>Description</i>                | <i>Page</i> |
|-----------------------------------|-------------|
| ELC Graphics Panels               |             |
| Standards and Certifications      | V7-T5-6     |
| Catalog Number Selection          | V7-T5-7     |
| Product Selection                 | V7-T5-7     |
| Technical Data and Specifications | V7-T5-10    |
| Dimensions                        | V7-T5-11    |



Drawings  
Online



An Eaton  
Green Solution

### Product Description

ELC Graphics Panels are simple to program and easily connect to ELC products. ELC graphics panels make modifying an application quick and easy. With more than 30 objects that can be placed anywhere on the display, these tough panels also communicate to other major controllers. These graphics panels have two serial ports that can be used simultaneously to communicate. Transfer applications to or from these graphics panels using the handy transfer module. Ten programmable functions keys on the outdoor rated display provide easy-to-change pages, input numeric values, enter alpha-numeric passwords, set, reset and more. Create alarms, password protect, import bitmaps and use many different fonts.

### Features

#### Protocols

#### Supported Protocols

##### Protocol

- \_\_\_\_ Eaton ELC
- \_\_\_\_ Eaton D50/D32LT, D320
- \_\_\_\_ Eaton MVX ASCII
- \_\_\_\_ Eaton MVX RTU
- \_\_\_\_ Modbus® ASCII
- \_\_\_\_ Modbus RTU
- \_\_\_\_ Allen-Bradley DF1
- \_\_\_\_ Mitsubishi FX Series
- \_\_\_\_ Mitsubishi FX2N Series
- \_\_\_\_ Koyo K-Sequence
- \_\_\_\_ LG 200S
- \_\_\_\_ OMRON C-Series
- \_\_\_\_ Siemens S7-200 Series
- \_\_\_\_ ASCII Slave Mode
- \_\_\_\_ And more...

#### ELC Graphics Panel Features

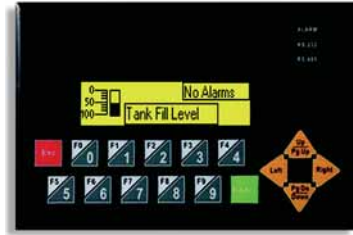

| Item  | ELC-GP02   | ELC-GP04   |
|---|--|--|
| Display screen  |  |  |
| Screen  | STN-LCD  | STN-LCD  |
| Color   | Monochromatic  | Monochromatic  |
| Backlight   | The backlight automatic turn off time is 1–99 minutes (0 = do not to turn off) (backlight life is 50 thousand hours at 25 °C)  | The backlight automatic turn off time is 1–99 minutes (0 = do not to turn off) (backlight life is 50 thousand hours at 25 °C)  |
| Resolution  | 160 x 32 pixels  | 128 x 64 pixels  |
| Display range   | 72 mm (W) x 22 mm (H)  | 67 mm (W) x 32 mm (H)  |
| Contrast adjustment   | 15-step contrast adjustment  | 10-step contrast adjustment  |
| Language font   | ASCII: characters (including European fonts)<br>Taiwan: (BIG 5 code) traditional Chinese character font<br>China: (GB2324-80 code) simplified Chinese character font | ASCII: characters (including European fonts)<br>Taiwan: (BIG 5 code) traditional Chinese character font<br>China: (GB2324-80 code) simplified Chinese character font |
| Font size (ASCII)   | 5 x 8, 8 x 8, 8 x 12, 8 x 16   | 5 x 8, 8 x 8, 8 x 12, 8 x 16   |
| ALARM indication LED  | 1. Power-on indication (flash three times)<br>2. Flash for communication error or other alarm<br>3. Special indication by user programming                           | 1. Power-on indication (flash three times)<br>2. Flash for communication error or other alarm<br>3. Special indication by user programming                           |
| RS-232 LED (yellow)   | Flashes when communicating   | Flashes when communicating   |
| RS-485 LED (green)  | Flashes when communicating   | Flashes when communicating   |
| Program memory  | 256 KB flash memory  | 256 KB flash memory  |
| External interface  |  |  |
| Serial communication port<br>RS-232 (COM1)<br>9 PIN D-SUB male                                | Data length: 7 or 8 bits<br>Stop bits: 1 or 2 bits<br>Parity: None/Odd/Even<br>Baud rate: 4800 bps–115,200 bps   | Data length: 7 or 8 bits<br>Stop bits: 1 or 2 bits<br>Parity: None/Odd/Even<br>Baud rate: 4800 bps–115,200 bps   |
| Extension communication port<br>RS-485 (COM2)<br>5-pin removal terminal<br>(RS-485 or RS-422) | Data length: 7 or 8 bits<br>Stop bits: 1 or 2 bits<br>Parity: None/Odd/Even<br>Baud rate: 4800 bps–115,200 bps   | Data length: 7 or 8 bits<br>Stop bits: 1 or 2 bits<br>Parity: None/Odd/Even<br>Baud rate: 4800 bps–115,200 bps   |
| Extension slot  | The slot for program copy card   | The slot for program copy card   |
| Power   | 24 Vdc input   | 24 Vdc input   |

#### Standards and Certifications

- UL® 508
- cUL® (CSA C22.2 No. 14)
- CE (Low Voltage Directive); Class 1 Div 2 Groups A, B, C, D
- RoHS



**Catalog Number Selection**

**ELC-GP Graphics Panel**

**ELC-GP**

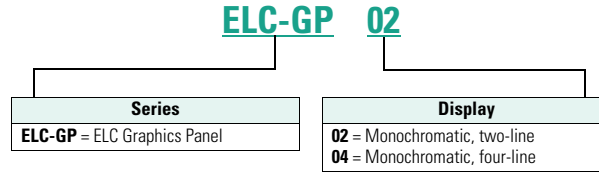

**Product Selection**

**ELC-GP04**

**Graphics Panels**



| Description   | Catalog Number     |
|---|--------------------|
| <b>Panels</b>   |                    |
| 160 x 32 pixels, 10 function keys, monochrome                                   | <b>ELC-GP02</b>    |
| 128 x 64 pixels, 10 function keys, monochrome                                   | <b>ELC-GP04</b>    |
| <b>Spare Parts Kit</b>  |                    |
| Includes several power connectors, battery doors, gaskets, mounting clips, etc. | <b>ELC-GPSPKIT</b> |

#### Software and Accessories

##### ELCSoftGP Programming Software

###### System Requirements

- Operating Systems—Windows 2000, Windows XP

ELCSoftGP Programming Software configures all ELC graphic panels. With ELCSoftGP, applications can be created, edited, downloaded and uploaded. Move programs from one controller to a different one with ease.

##### ELCSoftGP

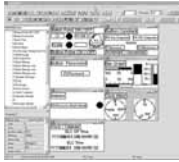

##### ELCSoftGP Editing Environment

| Description                       | Catalog Number |
|-----------------------------------|----------------|
| Programming software for GP units | ELCSOFTGP      |

#### Program Transfer Cables

##### ELC-CBPCELC\_

| Description  | Catalog Number |
|--|----------------|
| 1 meter cable to connect between the <b>HMI</b> and Eaton Logic Controller (ELC) | ELC-CBPCELC1   |
| 3 meter cable to connect between the <b>HMI</b> and Eaton Logic Controller (ELC) | ELC-CBPCELC3   |

##### ELC-CBPCGP3 Cable

Use this cable to download or upload applications between a PC and the ELC-GP graphics panels. This cable can also be used to transfer a program from an ELC-GP to another ELC-GP.

Pin definition of 9 PIN D-SUB RS-232:

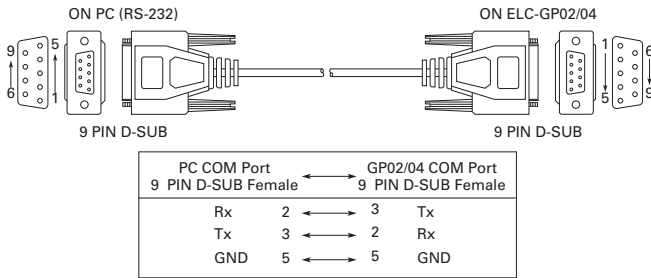

##### PC to ELC-GPxx Cable

| Description                       | Catalog Number |
|-----------------------------------|----------------|
| Cable, PC to ELC-GP, 9.8 ft (3 m) | ELC-CBPCGP3    |

### Power Supplies

All ELC modules operate from 24 Vdc. These power supplies provide a convenient way to provide robust DC voltage.

#### ELC Power Supplies

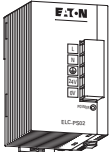
|  | Description                         | Catalog Number         |
|--|-------------------------------------|------------------------|
| <p><b>ELC-PS01</b></p>  | <p>Power supply, 24 watt, 1 amp</p> | <p><b>ELC-PS01</b></p> |
| <p><b>ELC-PS02</b></p>  | <p>Power supply, 48 watt, 2 amp</p> | <p><b>ELC-PS02</b></p> |

## Technical Data and Specifications

### ELC Graphics Panels

| Description                      | Specification  |
|----------------------------------|--|
| <b>Environmental</b>             |  |
| Transportation and storage       |  |
| Temperature                      | –4 to 140 °F (–20 to 60 °C)  |
| Operating                        |  |
| Temperature                      | 32 to 122 °F (0 to 50 °C)  |
| Humidity                         | 20–90% RH (noncondensing)  |
| Communication interface          | COM1: RS-232; COM2: RS-485/RS-422  |
| Vibration                        | 0.5 mm displacement, 10–55 Hz, X, Y, Z three directions and two hours for each direction |
| Impact                           | 10 G, 11 ms, from X, Y, Z three directions and three times for each direction            |
| Weight                           | 0.53 lbs (0.24 kg)   |
| Cooling method                   | Natural air cooling  |
| <b>Electrical/EMC Approvals</b>  |  |
| Electrostatic discharge immunity | EN61000-4-2/1995   |
| Radiated immunity                | EN61000-4-3/1995   |
| Electrical fast transient        | EN61000-4-4/1995   |
| Radiated emission                | CISPR22, Class A   |
| <b>Other Approvals</b>           |  |
| Waterproof class of front panel  | UL Type 4X outdoor rated   |
| UV resistant                     | UL 746C  |

### ELC Power Supply

| Item                                   | ELC-PS01                               | ELC-PS02                             |
|--|--|--------------------------------------|
| Dimensions W x H x D<br>in inches (mm) | 1.44 x 3.54 x 2.36<br>(36.5 x 90 x 60) | 2.17 x 3.54 x 2.36<br>(55 x 90 x 60) |
| Input power                            | 100–240 Vac 50/60 Hz                   | 100–240 Vac 50/60 Hz                 |
| Output volts                           | 24 Vdc                                 | 24 Vdc                               |
| Output current (A)                     | 1A                                     | 2A                                   |
| Watts                                  | 24                                     | 48                                   |

**Dimensions**

Approximate Dimensions in Inches (mm)

**ELC-GP04**

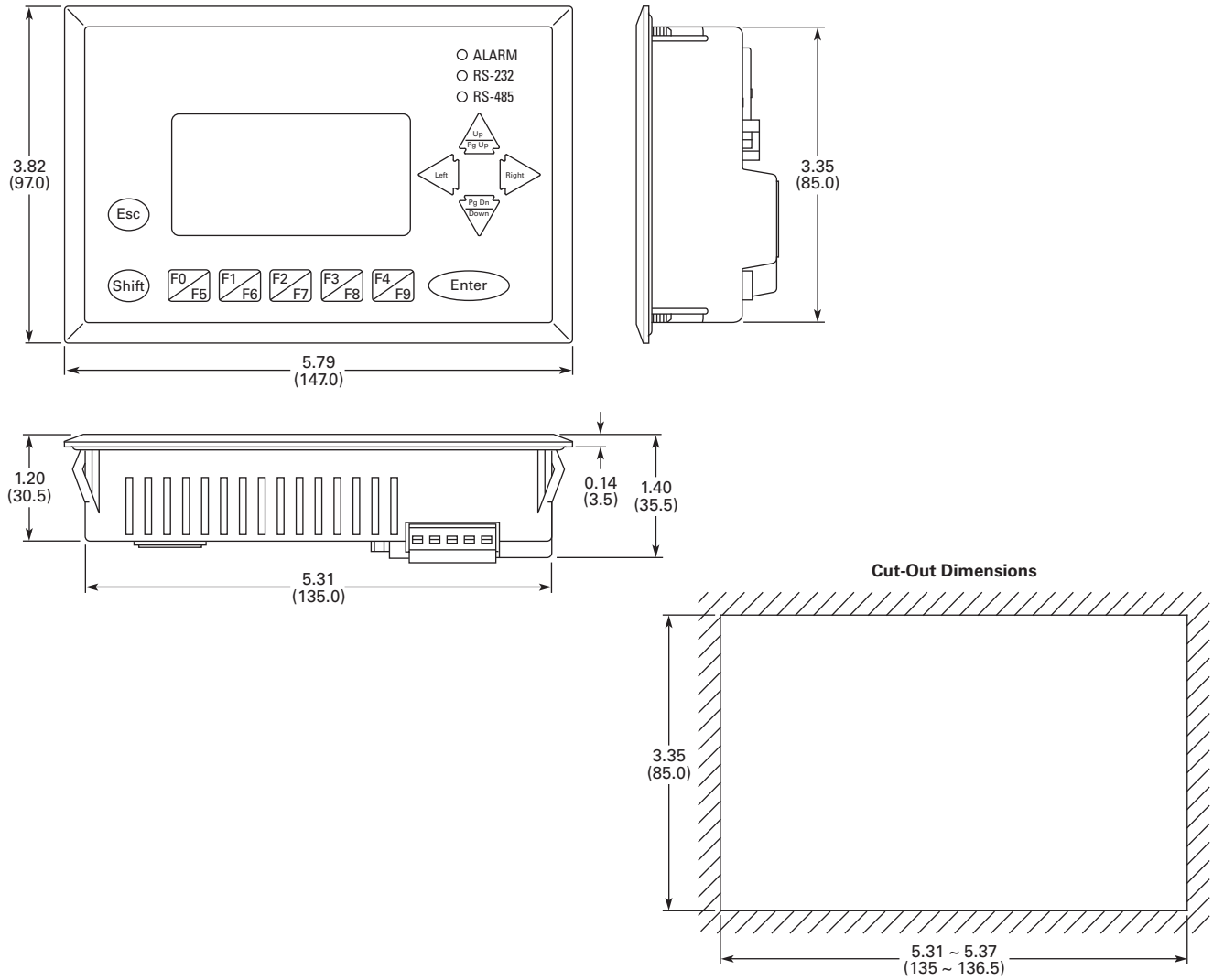



# 5.2

## Operator Interface Products

### ELC Graphics Panels

Approximate Dimensions in Inches (mm)

#### ELC-GP02

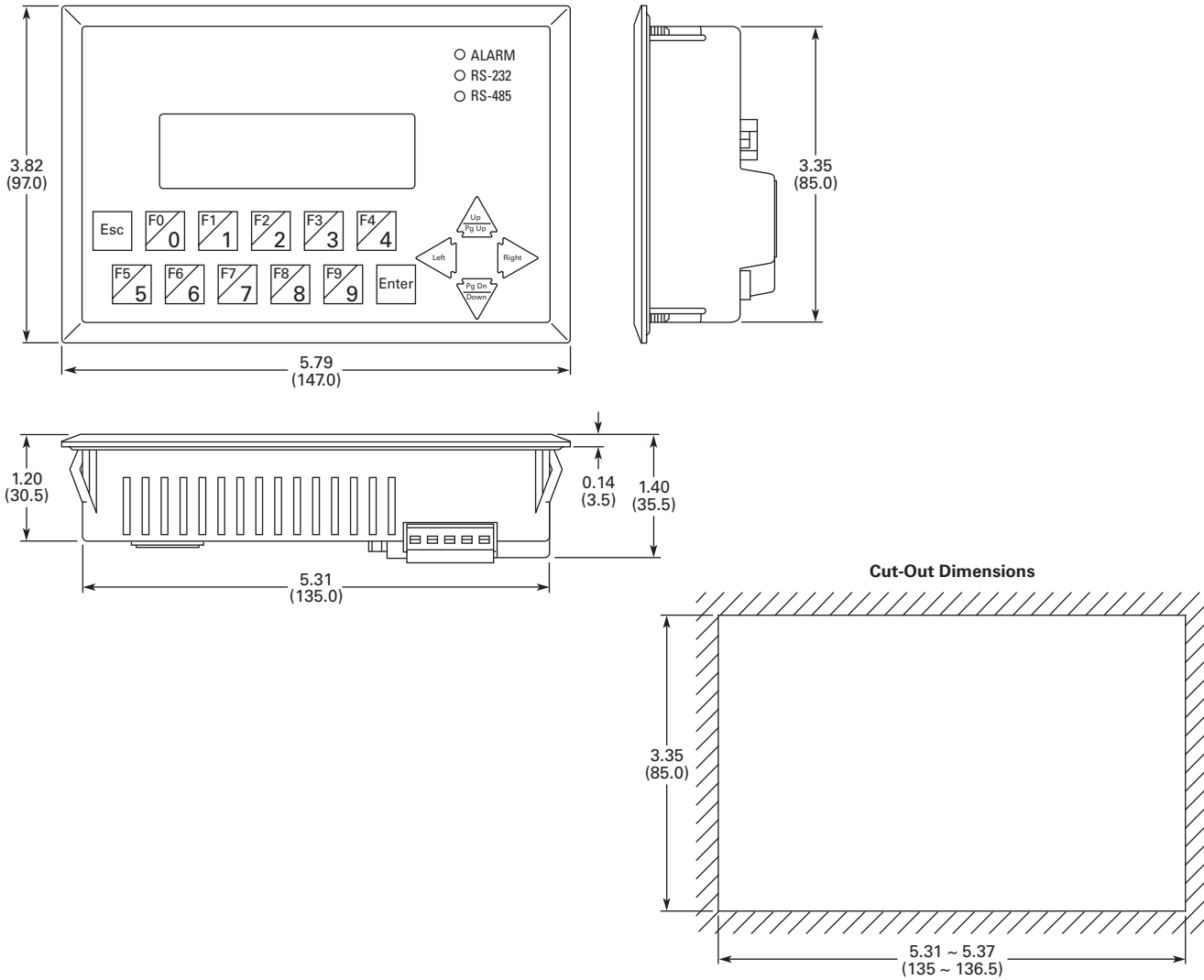

#### ELC-GPXFERMOD

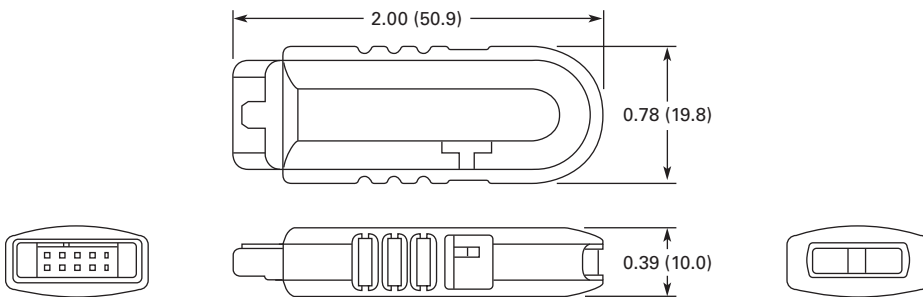

HMi Operator Interface



Contents

| <i>Description</i>                          | <i>Page</i>     |
|---|-----------------|
| <b>HMi Operator Interface</b>               |                 |
| Features                                    |                 |
| Protocols . . . . .                         | <b>V7-T5-14</b> |
| Standards and Certifications . . . . .      | <b>V7-T5-14</b> |
| Catalog Number Selection . . . . .          | <b>V7-T5-15</b> |
| Product Selection . . . . .                 | <b>V7-T5-15</b> |
| Technical Data and Specifications . . . . . | <b>V7-T5-18</b> |
| Dimensions . . . . .                        | <b>V7-T5-19</b> |



**Product Description**

Positioned between the ELC graphics panels and the XV series of operator interfaces, **HMi** is the workhorse of the industry. Ideal for machinery OEMs, the **HMi** series provides the most value with the latest technology and advanced feature set in an economical hardware and software package. All units offer RS-232, RS-485 and RS-422 communications. The 4-, 7-, 8- and 10-inch units also offer Ethernet communication options.

**Features**

- Auto-scale application from 10 to 4 inches
- Screen and backlight saver
- Pop-up screens
- Animated graphics
- Conditional visibility
- Application lock for IP protection
- Data archiving
- Multi-language
- Eight levels of security
- Ethernet communication drivers
- Ethernet, COMM port and USB upload/download
- USB ports for data storage
- Three serial ports
- Up to four simultaneous protocols
- Math and logic functions
- CSV import/export tags and recipes
- Macro capability
- Alarm/event recording and viewing
- Real-time and historical trending
- Online and offline simulation

**HMi VU Exclusive Features**

- VU server
- VU remote
- Multi-link
- Onboard Ethernet on some models
- Audio and SD on some models
- Supports USB mouse and other industrial pointing devices

## Protocols

### Supported Protocols

| Manufacturer and Protocol                            |
|--|
| <b>Allen-Bradley</b>                                 |
| MicroLogix   |
| SLC 5  |
| DH485  |
| EtherNet/IP (Micro, Compact and ControlLogix, SCL 5) |
| <b>Cimon</b>   |
| BP Series Loader Protocol                            |
| CP Series Loader Protocol                            |
| XP Series Loader Protocol                            |
| <b>Copley</b>  |
| Stepnet  |
| <b>Danfoss</b>                                       |
| VLT 2800 (FC Protocol)                               |
| <b>Delta</b>   |
| Delta DVP PLC  |
| Delta DVP EH/SA ES/EX/SS (V5.1)                      |
| Delta Controller ASCII                               |
| Delta Controller RTU                                 |
| Delta DVP TCP/IP                                     |
| <b>Eaton</b>   |
| ELC Series Serial                                    |
| ELC Series TCP/IP                                    |
| GVX—RTU  |
| GVX—ASCII  |
| MXV—RTU  |
| MXV—ASCII  |
| NFX—RTU  |
| NFX—ASCII  |
| Eaton Controller ASCII                               |
| Eaton Controller RTU                                 |
| EasyPLC 800/MFD (EasyCom)                            |
| <b>Emerson</b>                                       |
| EC20 Series  |
| <b>Facon</b>   |
| FB Series  |

| Manufacturer and Protocol |
|---------------------------|
| <b>Festo</b>              |
| Festo PLC                 |
| <b>FuFeng</b>             |
| APC                       |
| <b>Fuji Electric</b>      |
| Frenic Inverter           |
| <b>GE Fanuc</b>           |
| Series 90 SNP             |
| <b>Hitachi</b>            |
| EH Series Procedure 1     |
| EH Series Procedure 2     |
| <b>Hust</b>               |
| Hust CNC Controller       |
| Hust CNC Controller v2    |
| <b>IDEC</b>               |
| Micro Smart               |
| <b>Jetter</b>             |
| JC Series                 |
| Nano Series               |
| <b>Keyence</b>            |
| KV/KZ Series              |
| <b>Koyo</b>               |
| DL/SU Series              |
| K-Sequence                |
| <b>Lenze</b>              |
| LECOM-A/B Protocol        |
| <b>LG</b>                 |
| Master-K 120S/200S        |
| Glofa GM6 CNET            |
| Master-K CNET             |
| XGT CNET                  |
| <b>LiYan</b>              |
| LYPLC EX                  |

| Manufacturer and Protocol  |
|----------------------------|
| <b>M2i</b>                 |
| M2i Master                 |
| M2i Slave                  |
| <b>Matsushita</b>          |
| FP Series                  |
| <b>Mirle</b>               |
| FAMA SC                    |
| <b>Mitsubishi</b>          |
| FX Series                  |
| FX2N                       |
| FX3U                       |
| FX Series Computer Link    |
| A Series/J71UC24           |
| A2A/A2AS/A2USH             |
| A1SH/A3N/A2ASH CPU Port    |
| Q Series CPU Port          |
| Q Series Ethernet          |
| Q Series Computer Link     |
| J2s Series                 |
| <b>MKS</b>                 |
| BY125                      |
| CT150                      |
| MC700/720                  |
| <b>Modbus</b>              |
| ASCII (Master)             |
| 984 RTU (Master)           |
| RTU 2W (Master)            |
| ASCII Hex Address (Master) |
| RTU Hex Address (Master)   |
| ASCII nW (Master)          |
| RTU nW (Master)            |
| ASCII (Slave)              |
| RTU (Slave)                |
| TCP/IP                     |

| Manufacturer and Protocol    |
|------------------------------|
| <b>Modicon</b>               |
| TSX Micro (Uni-Telway)       |
| TSX Premium (Uni-Telway 1-1) |
| NEZA (Uni-Telway)            |
| TWIDO                        |
| <b>Moeller</b>               |
| PS3 Series                   |
| PS4 Series                   |
| <b>Nikki Denso</b>           |
| NCS-FI/FS Series             |
| <b>Omron</b>                 |
| C Series                     |
| CJ1 Series                   |
| TPM1A                        |
| <b>Parker</b>                |
| Compax 3                     |
| <b>Siemens</b>               |
| S7 200                       |
| S7 300 (with PC Adapter)     |
| S7 300 (without PC Adapter)  |
| S7 300 (Direct MPI)          |
| S7 300 (ISO TCP)             |
| S7 1200 (ISO TCP)            |
| <b>Taian</b>                 |
| TP02                         |
| <b>Ti</b>                    |
| Ti435                        |
| <b>Vigor</b>                 |
| M Series                     |
| <b>VIPA</b>                  |
| S7 300 (with PC Adapter)     |
| <b>Yokogawa</b>              |
| ACE                          |

## Standards and Certifications

- CE
- UL
- cUL
- C-Tick
- RoHS



**Catalog Number Selection**

**HMi Operator Interface**

HMi

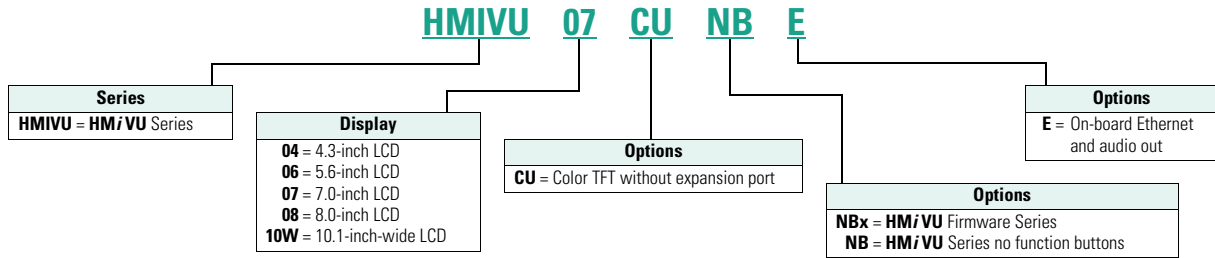

**Product Selection**

HMI\_

**HMi VU Products**



| Description   | Catalog Number |
|---|----------------|
| 4-inch color TFT, no function buttons, on-board Ethernet  | HMIVU04CUNBE   |
| 6-inch color TFT, no function buttons, no Ethernet        | HMIVU06CUNB1   |
| 7-inch color TFT, no function buttons, on-board Ethernet  | HMIVU07CUNBE   |
| 8-inch color TFT, no function buttons, on-board Ethernet  | HMIVU08CUNBE   |
| 10-inch color TFT, no function buttons, on-board Ethernet | HMIVU10WCUNBE  |

### Software and Accessories

#### HM*i*Soft Programming Software

For use with the of **HM*i*** and **HM*i*VU** series touchscreens. This easy to use Windows based software can run on Windows XP and Windows 7 32-bit and 64-bit systems.

- Ethernet and serial communication drivers
- Up to four simultaneous protocols
- Screen manager
- Over 70 on-screen objects

- Pop-up screens
- Animated graphics
- Conditional visibility
- Built-in picture library
- Create your own picture library
- Multi-language
- Eight levels of security
- Macro editing with math and logic functions
- CSV import/export tags and recipes

- Alarm/event recording and viewing
- Store archived data, alarms and events to USB
- Real-time and historical trending
- Auto-scale application from 10 to 4 inches
- On and offline simulation
- Upload/download applications over USB, serial or Ethernet

- Application lock for IP protection
- Screen and backlight saver
- Multi-link allows sharing of PLC data over Ethernet ①
- VU Server optional download ①
- VU Remote optional download ①

#### HM*i* Editor



#### HM*i* Editor

##### Description

Programming software for **HM*i*** and **HM*i*VU** models

##### Catalog Number

**HMISOFT**

### HM*i* Screen Management



### HM*i*Soft Editor

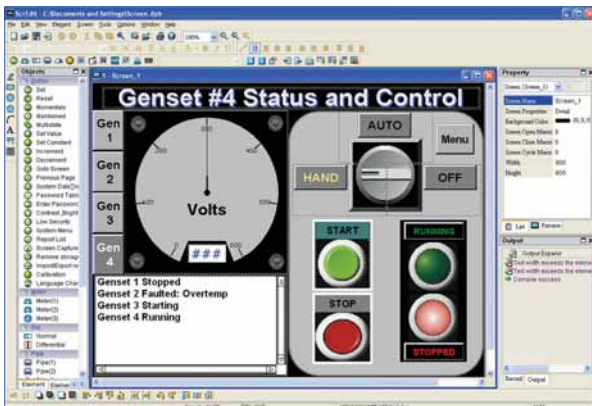

#### Note

① Exclusive **HM*i*VU** features.

**Adapter Plate**

| Description                                | Catalog Number |
|--|----------------|
| 6-inch <b>HMI</b> adapter plate for PM1000 | APPM1HMI6      |

**Kits**

| Description   | Catalog Number |
|---|----------------|
| <b>HMI</b> spare parts kits (includes several power connectors, battery doors, gaskets, mounting clips, etc.) | HMI-SPKIT      |

**Replacement Gaskets**

| Description   | Catalog Number |
|---|----------------|
| 4-inch <b>HMI</b> replacement gasket (2/kit)                          | HMI04-GASKET   |
| 6-inch <b>HMI</b> and 7-inch <b>HMI VU</b> replacement gasket (2/kit) | HMI06-GASKET   |
| 8-inch <b>HMI</b> replacement gasket (2/kit)                          | HMI08-GASKET   |
| 10-inch <b>HMI</b> replacement gasket (2/kit)                         | HMI10-GASKET   |

**Cable**

| Description  | Catalog Number |
|--|----------------|
| 1 meter cable to connect between the <b>HMI</b> and Eaton Logic Controller (ELC) | ELC-CBPCELC1   |
| 3 meter cable to connect between the <b>HMI</b> and Eaton Logic Controller (ELC) | ELC-CBPCELC3   |

**Power Supply**

| Description               | Catalog Number |
|---------------------------|----------------|
| 1 amp 24 Vdc power supply | ELC-PS01       |
| 2 amp 24 Vdc power supply | ELC-PS02       |

## Technical Data and Specifications

### HM*i* VU Operator Interface

| Description                    | Specification<br>HMIVU04CUNBE  | HMIVU06CUNB1   | HMIVU07CUNBE  | HMIVU08CUNBE   | HMIVU10WCUNBE  |
|--------------------------------|--|--|---|--|--|
| LCD module                     |  |  |   |  |  |
| Display type                   | 4.3-inch TFT LCD   | 5.6-inch TFT LCD   | 7-inch TFT LCD  | 8-inch TFT LCD   | 10.1-inch widescreen TFT LCD   |
| Display color                  | 65536 colors   | 65536 colors   | 65536 colors  | 65536 colors   | 65536 colors   |
| Resolution                     | 480 x 234 pixels   | 320 x 234 pixels   | 800 x 600 pixels  | 800 x 600 pixels   | 1024 x 600 pixels  |
| Backlight                      | LED backlight (20,000 hours half-life at 25 °C) <sup>①</sup>   | LED backlight (20,000 hours half-life at 25 °C) <sup>①</sup>                     | LED backlight (10,000 hours half-life at 25 °C) <sup>①</sup>  | LED backlight (10,000 hours half-life at 25 °C) <sup>①</sup>   | LED backlight (10,000 hours half-life at 25 °C) <sup>①</sup>   |
| Brightness NIT rating          | 400 DC/m <sup>2</sup>  | 200 DC/m <sup>2</sup>  | 200 DC/m <sup>2</sup>   | 250 DC/m <sup>2</sup>  | 200 DC/m <sup>2</sup>  |
| Display size                   | 95.04 x 53.856 mm  | 113.28 x 84.70 mm  | 141 x 105.75 mm   | 162 x 121.5 mm   | 226 x 128.7 mm   |
| Operation system               | Real Time OS   | Real Time OS   | Real Time OS  | Real Time OS   | Real Time OS   |
| MCU                            | 32-bit RISC micro-controller   | 32-bit RISC micro-controller   | 32-bit RISC micro-controller  | 32-bit RISC micro-controller   | 32-bit RISC micro-controller   |
| NOR Flash ROM                  | Flash ROM 128 MB<br>OS System: 30 MB<br>Backup: 16 MB<br>User Application: 82 MB                     | Flash ROM 128 MB<br>OS System: 30 MB<br>Backup: 16 MB<br>User Application: 82 MB | Flash ROM 128 MB<br>OS System: 30 MB<br>Backup: 16 MB<br>User Application: 82 MB  | Flash ROM 128 MB<br>OS System: 30 MB<br>Backup: 16 MB<br>User Application: 82 MB                     | Flash ROM 128 MB<br>OS System: 30 MB<br>Backup: 16 MB<br>User Application: 82 MB                     |
| SDRAM                          | 64 M bytes   | 64 M bytes   | 64 M bytes  | 64 M bytes   | 64 M bytes   |
| Backup memory                  | 16 M bytes   | 16 M bytes   | 16 M bytes  | 16 M bytes   | 16 M bytes   |
| Sound effect output            |  |  |   |  |  |
| Buzzer                         |  |  | Multi-tone frequency (2–4 kHz)/85 dB  |  |  |
| AUX                            | N/A  | N/A  | Stereo output   | Stereo output  | Stereo output  |
| Ethernet interface             | IEEE 802.3, IEEE 802.3u<br>10/100 Mbps auto-sensing has built-in isolated power circuit <sup>③</sup> | N/A  | IEEE 802.3, IEEE 802.3u<br>10/100 Mbps auto-sensing has built-in isolated power circuit <sup>③</sup>  | IEEE 802.3, IEEE 802.3u<br>10/100 Mbps auto-sensing has built-in isolated power circuit <sup>③</sup> | IEEE 802.3, IEEE 802.3u<br>10/100 Mbps auto-sensing has built-in isolated power circuit <sup>③</sup> |
| Memory card                    | N/A  | N/A  | SD card (supports SDHC)   | SD card (supports SDHC)  | SD card (supports SDHC)  |
| USB                            |  |  | 1 USB Host <sup>②</sup> Ver 2.0 1 USB Client Ver 1.1  |  |  |
| Serial COM port                |  |  |   |  |  |
| COM1                           | RS-232 (supports hardware flow control) / RS-485   | RS-232 (supports hardware flow control)  | RS-232 (supports hardware flow control)   | RS-232 (supports hardware flow control)  | RS-232 (supports hardware flow control)  |
| COM2                           | RS-422/RS-485  | RS-232/RS-485  | RS-232/RS-422/RS-485 (has built-in isolated power circuit) <sup>③</sup>   |  |  |
| COM3                           | N/A  | RS-422/RS-485  | RS-232/RS-422/RS-485 (has built-in isolated power circuit) <sup>③</sup>   |  |  |
| Perpetual calendar (RTC)       | Built-in   | Built-in   | Built-in  | Built-in   | Built-in   |
| Cooling method                 | Natural air circulation  | Natural air circulation  | Natural air circulation   | Natural air circulation  | Natural air circulation  |
| Safety approval                | CE/UL  | CE/UL  | CE/UL   | CE/UL  | CE/UL  |
| Waterproof degree              |  |  | IP65/NEMA <sup>®</sup> 4X (indoor use only)   |  |  |
| Operation voltage <sup>④</sup> |  |  | DC +24 V (–10 to +15%) Please use isolated power supply   |  |  |
| Voltage endurance              |  |  | AC500V for 1 minute (between charging [DC24 terminal] and FG terminals)   |  |  |
| Power consumption <sup>④</sup> | 4.8 W  | 3.0 W  | 7.68 W  | 7.8 W  | 12 W   |
| Backup battery                 | 3 V lithium battery CR2032 x 1   | 3 V lithium battery CR2032 x 1   | 3 V lithium battery CR2032 x 1  | 3 V lithium battery CR2032 x 1   | 3 V lithium battery CR2032 x 1   |
| Backup battery life            | It depends on the temperature used and the conditions of usage, about 3 years or more at 25 °C       |  |   |  |  |
| Operation temp.                | 0 to 50 °C   | 0 to 50 °C   | 0 to 50 °C  | 0 to 50 °C   | 0 to 50 °C   |
| Storage temp.                  | –20 to 60 °C   | –20 to 60 °C   | –20 to 60 °C  | –20 to 60 °C   | –20 to 60 °C   |
| Ambient humidity               | 10%–90% RH [0 to 40 °C], 10%–55% RH [41 to 50 °C] / Pollution Degree 2                               |  |   |  |  |
| Vibration resistance           |  |  | 5 Hz < f < 8.3 Hz = continuous: 3.5 mm<br>8.3 Hz < f < 150 Hz = continuous: 1.0 g   |  |  |
| Shock                          |  |  | IEC 61131-2 Compliant<br>5 Hz < f < 9 Hz = continuous: 1.75 mm/occasional: 3.5 mm<br>9 Hz < f < 150 Hz = continuous: 0.5 g/occasional: 1.0 g<br>X, Y, Z directions for 10 times |  |  |
| Dimensions                     |  |  |   |  |  |
| (W) x (H) x (D) mm             | 129 x 103 x 39   | 184 x 144 x 50   | 184 x 144 x 50  | 227.1 x 174.1 x 61   | 272 x 200 x 61   |
| Panel cutout                   |  |  |   |  |  |
| (W) x (H) mm                   | 118.8 x 92.8   | 172.4 x 132.4  | 172.4 x 132.4   | 219.4 x 166.5  | 261.3 x 189.3  |
| Weight                         | Approx. 264 g  | Approx. 670 g  | Approx. 800 g   | Approx. 1228 g   | Approx. 1520 g   |

#### Notes

<sup>①</sup> The half-life of backlight is defined as original luminance being reduced by 50% when the maximum driving current is supplied to **HM*i***. The life of LED backlight shown is an estimated value under 25 °C normal temperature and humidity conditions

<sup>②</sup> USB Host port can provide up to 5 V/500 mA of power.

<sup>③</sup> The withstand voltage of the isolated power circuit is 1500 V peak for 1 minute.

<sup>④</sup> The value of the power consumption indicates the electrical power consumed by **HM*i*** only without connecting to any peripheral devices. In order to ensure the normal operation, it is recommended to use a power supply where the capacity is 1.5–2 times the value of the power consumption.

**Dimensions**

Approximate Dimensions in Inches (mm)

**HMIVU04**

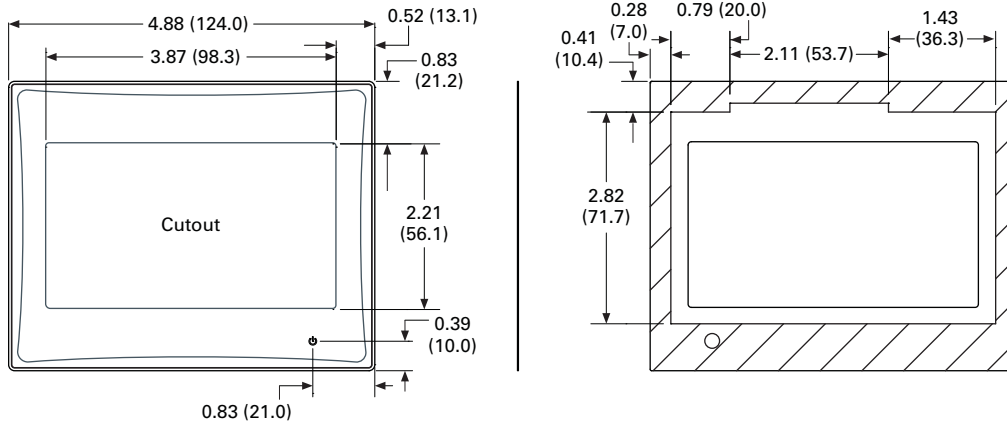

**HMIVU06**

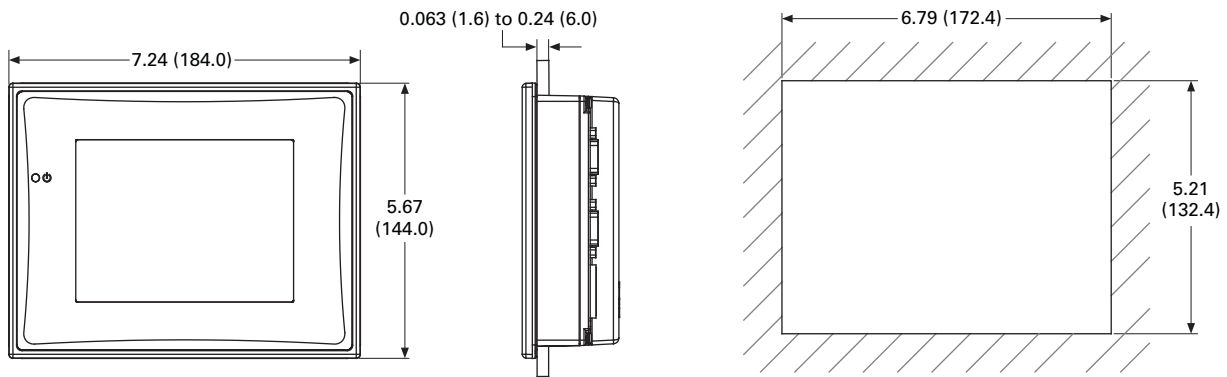

**HMIVU07**

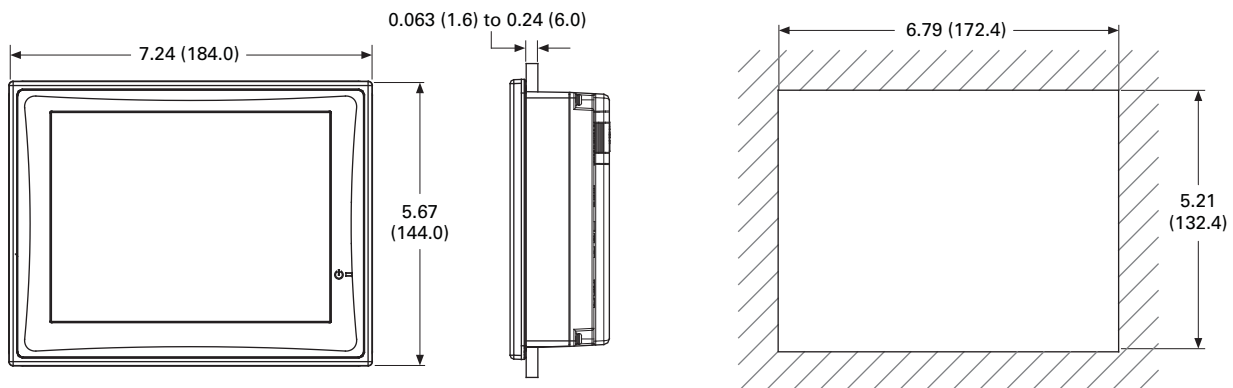



# 5.3

## Operator Interface Products

### HM/Operator Interface

Approximate Dimensions in Inches (mm)

#### HMIVU08

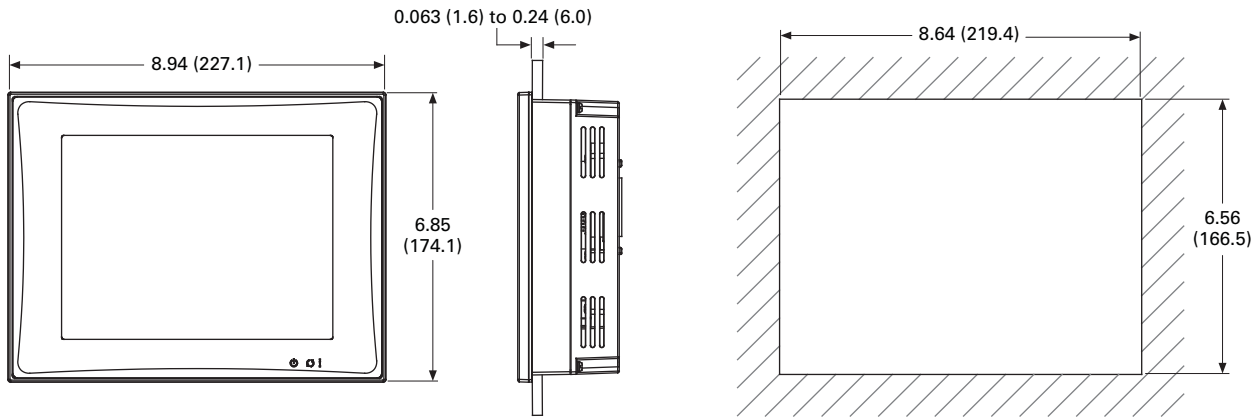

#### HMIVU10

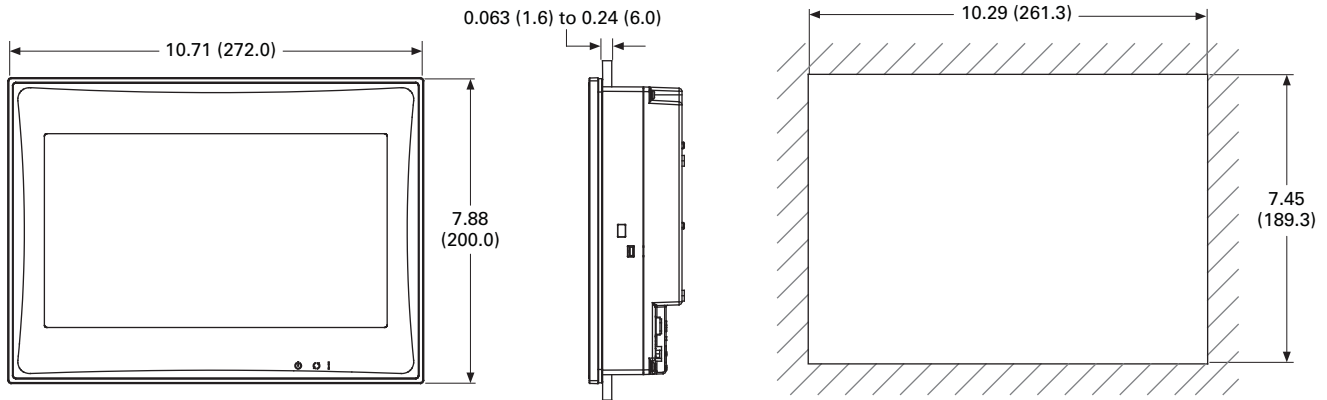

XP Operator Interface



Contents

| <b>Description</b>  | <b>Page</b>     |
|---|-----------------|
| XP-503 with Visual Designer                                   |                 |
| Catalog Number Selection .....                                | <b>V7-T5-22</b> |
| Product Selection .....                                       | <b>V7-T5-22</b> |
| Accessories .....   | <b>V7-T5-22</b> |
| Technical Data and Specifications .....                       | <b>V7-T5-23</b> |
| XV with Visual Designer, Galileo,<br>or XSoft-CoDeSys-3 ..... | <b>V7-T5-24</b> |
| Visual Designer Software .....                                | <b>V7-T5-34</b> |
| Galileo Software .....  | <b>V7-T5-37</b> |
| XSoft-CoDeSys-3 Software .....                                | <b>V7-T5-38</b> |

**XP-503 with Visual Designer**

**Product Description**

The XP-500 series sets a new standard for HMI and SCADA controls. Capacitive multi-touch displays allow familiar intuitive gestures for zoom, scroll and swipe, and offer increased safety to your system with two hand or multiple button activation control for critical functions.

XP-500 Panel PCs run on an open Windows Embedded Standard 7 Operating System to support all Windows standard PC applications and feature Protect Mode™ for preventing unauthorized changes to the operating system.

XP-500 units come with advanced yet easy-to-use Visual Designer software pre-installed and licensed.

All these features come standard in a package that is slim and modern in design yet also rugged. With no fan or moving parts, a scratch-resistant glass screen, and powder-coated aluminum body, XP-500 is fit for any industrial application.

**Features**

XP-500 series operator interface with Windows Embedded Standard 7 operating system

- 10.1, 15.6 and 21.5 inch high resolution widescreen displays
- Projected capacitive touchscreen supports gestures and recognizes up to 4 simultaneous touch inputs
- Remote access to mobile devices or tablets using HTML5 interface
- 1.65 GHz Dual Core CPU with fast Radeon™ HD graphics for best-in-class speed and graphics performance

- 4 GB DDR3-RAM large memory for parallel processing and increased system performance
- 32 GB internal solid-state drive high volume internal memory
- 2 independent Ethernet ports standard for separation of IT and process level communications
- All solid-state media and no moving parts or fan increases reliability
- Non-corruptible OS with Protect Mode increases security and reliability

**Standards and Certifications**

- UL/cUL (UL 508)
- CE Mark
- UL Class 1 Div 2 (Groups A, B, C, D)
- ATEX Zone 22, Category 3D
- Front
  - IP65, NEMA 4X (indoor), NEMA 12
- Rear
  - IP20



# 5.4

## Operator Interface Products

### XP and XV Operator Interface

#### Catalog Number Selection

##### XP Operator Interface

XP

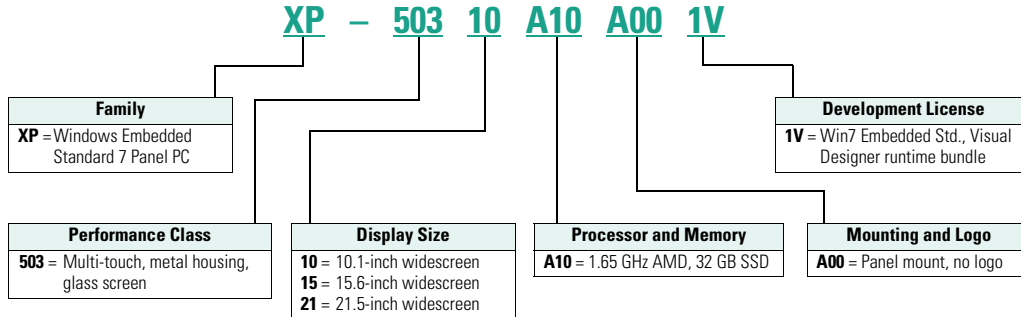

#### Product Selection

##### Series Information

All XP-500 models have a Microsoft® Windows Embedded Standard 7 operating system and are pre-licensed with Visual Designer runtime. The standard license is for 4000 tags, 5 simultaneous communication drivers and 1 Web session each of 3 types—Thin Client, Secure Viewer and Mobile Access. Field upgrades are available for 64,000 tags, 8 drivers and 2, 4, 8, 16, 32, 64 or 128 simultaneous Web sessions of each type.

##### XP Operator Interface

#### XP Operator Interface



##### Description

| Description   | Catalog Number              |
|---|-----------------------------|
| XP 10.1-inch widescreen with multi-touch, 1.65 GHz dual core CPU, 4 GB DDR3-RAM, 4 GB CFast memory, 4000 tags, 5 drivers, 1 Web session | <b>XP-503-10-A10-A00-1V</b> |
| XP 15.6-inch widescreen with multi-touch, 1.65 GHz dual core CPU, 4 GB DDR3-RAM, 4 GB CFast memory, 4000 tags, 5 drivers, 1 Web session | <b>XP-503-15-A10-A00-1V</b> |
| XP 21.5-inch widescreen with multi-touch, 1.65 GHz dual core CPU, 4 GB DDR3-RAM, 4 GB CFast memory, 4000 tags, 5 drivers, 1 Web session | <b>XP-503-21-A10-A00-1V</b> |

##### Notes

- ① All 5XX units have 2 x 10/100/1000 Ethernet, 2 x USB 3.0, 1 x RS-232, 1 x RS-485, 1 x DVI-I.
- ② Standard software on embedded hardware.

#### Accessories

##### XP Operator Interface

##### Description

XP-702 spare part kit for all XP models—1 power connector, 8 mounting brackets, 1 sealing strip

##### Catalog Number

**ACC-TP-57-RES-1**

## Technical Data and Specifications

### XP Operator Interface



**10.1-inch XP-503-10-A10-A00-1V**



**15.6-inch XP-503-15-A10-A00-1V**



**21.5-inch XP-503-21-A10-A00-1V**

| Model   | 10.1-inch XP-503-10-A10-A00-1V   | 15.6-inch XP-503-15-A10-A00-1V   | 21.5-inch XP-503-21-A10-A00-1V   |
|---|--|--|--|
| <b>Display</b>                                    |  |  |  |
| Screen diagonal                                   | 10.1-inch widescreen   | 15.6-inch widescreen   | 21.5-inch widescreen   |
| Resolution  | 1024 x 600 pixels  | 1366 x 768 pixels  | 1920 x 1080 pixels   |
| Backlight   | LED, dimmable via software   | LED, dimmable via software   | LED, dimmable via software   |
| Display brightness (typical)                      | 500 cd/m <sup>2</sup>  | 300 cd/m <sup>2</sup>  | 250 cd/m <sup>2</sup>  |
| Contrast ratio (typical)                          | 500:1  | 500:1  | 1000:1   |
| <b>Operation</b>                                  |  |  |  |
| Touch sensor                                      | Multi-touch touchscreen (4 simultaneous touches)   | Multi-touch touchscreen (4 simultaneous touches)   | Multi-touch touchscreen (4 simultaneous touches)   |
| Technology  | Projected Capacitive Touch (PCT)   | Projected Capacitive Touch (PCT)   | Projected Capacitive Touch (PCT)   |
| <b>Enclosures</b>                                 |  |  |  |
| Front glass                                       | Non-reflective tempered glass  | Non-reflective tempered glass  | Non-reflective tempered glass  |
| Bezel   | Powder-coated aluminum   | Powder-coated aluminum   | Powder-coated aluminum   |
| Device dimensions (w x h x d)                     | 275 x 179 x 80 mm  | 404 x 255 x 80 mm  | 536 x 328 x 83 mm  |
| Installation cutout (w x h)                       | 261 x 164 mm   | 387 x 238 mm   | 519 x 313 mm   |
| Weight  | 2.6 kg   | 4.8 kg   | 7.8 kg   |
| <b>System</b>                                     |  |  |  |
| Processor   | AMD GX217GA 1.65 GHz DualCore  | AMD GX217GA 1.65 GHz DualCore  | AMD GX217GA 1.65 GHz DualCore  |
| Graphic   | AMD Radeon HD8280E 450 MHz   | AMD Radeon HD8280E 450 MHz   | AMD Radeon HD8280E 450 MHz   |
| Memory  | 4 GB DDR3-RAM  | 4 GB DDR3-RAM  | 4 GB DDR3-RAM  |
| Internal mass memory                              | 32 GB SSD mSATA  | 32 GB SSD mSATA  | 32 GB SSD mSATA  |
| Removable memory                                  | 1 x CFast slot, pre-populated with 4 GB CFast memory card  | 1 x CFast slot, pre-populated with 4 GB CFast memory card  | 1 x CFast slot, pre-populated with 4 GB CFast memory card  |
| Interfaces  | 2 x Ethernet 10/100/1000 Mbps; 2 x USB 3.0; 1 x RS-232; 1 x RS-485; 1 x DVI-I                                | 2 x Ethernet 10/100/1000 Mbps; 2 x USB 3.0; 1 x RS-232; 1 x RS-485; 1 x DVI-I                                | 2 x Ethernet 10/100/1000 Mbps; 2 x USB 3.0; 1 x RS-232; 1 x RS-485; 1 x DVI-I                                |
| Power supply                                      | 24 Vdc   | 24 Vdc   | 24 Vdc   |
| Maximum current                                   | 1.2 A  | 1.5 A  | 1.7 A  |
| Operating system                                  | Windows Embedded Standard 7  | Windows Embedded Standard 7  | Windows Embedded Standard 7  |
| <b>Environment</b>                                |  |  |  |
| Agency certifications                             | UL/cUL Class I Div 2, Groups A, B, C, D, ATEX Zone 22  | UL/cUL Class I Div 2, Groups A, B, C, D, ATEX Zone 22  | UL/cUL Class I Div 2, Groups A, B, C, D, ATEX Zone 22  |
| Degree of protection                              | Front: IP65, NEMA 4X (indoor), NEMA 12; Rear: IP20   | Front: IP65, NEMA 4X (indoor), NEMA 12; Rear: IP20   | Front: IP65, NEMA 4X (indoor), NEMA 12; Rear: IP20   |
| Operating temperature                             | 0 to +50 °C  | 0 to +50 °C  | 0 to +50 °C  |
| Storage temperature                               | -20 to +60 °C  | -20 to +60 °C  | -20 to +60 °C  |
| Relative air humidity                             | 10 to 20% noncondensing  | 10 to 20% noncondensing  | 10 to 20% noncondensing  |
| Shock   | IEC 60068-2-27 15 g for 11 ms duration   | IEC 60068-2-27 15 g for 11 ms duration   | IEC 60068-2-27 15 g for 11 ms duration   |
| Vibration   | IEC 60068-2-6<br>5-9 Hz: 3.5 mm displacement<br>9-60 Hz: 0.15 mm displacement<br>60-150 Hz: 2 g acceleration | IEC 60068-2-6<br>5-9 Hz: 3.5 mm displacement<br>9-60 Hz: 0.15 mm displacement<br>60-150 Hz: 2 g acceleration | IEC 60068-2-6<br>5-9 Hz: 3.5 mm displacement<br>9-60 Hz: 0.15 mm displacement<br>60-150 Hz: 2 g acceleration |
| <b>Software</b>                                   |  |  |  |
| Development software                              | Visual Designer  | Visual Designer  | Visual Designer  |
| Ability to run third-party software               | Yes  | Yes  | Yes  |
| Pre-licensed tags, drivers, Web sessions          |  |  |  |
| Standard models                                   | 4000 tags, 5 drivers, 1 Web session  | 4000 tags, 5 drivers, 1 Web session  | 4000 tags, 5 drivers, 1 Web session  |
| Field upgradable max. tags, drivers, Web sessions | 64,000 tags, 8 drivers, 1, 2, 4, 8, 16, 32, 64 or 128 Web sessions simultaneously                            | 64,000 tags, 8 drivers, 1, 2, 4, 8, 16, 32, 64 or 128 Web sessions simultaneously                            | 64,000 tags, 8 drivers, 1, 2, 4, 8, 16, 32, 64 or 128 Web sessions simultaneously                            |

**XV-100 and XV-300 Series Operator Interface****Contents**

| <b>Description</b>  | <b>Page</b>     |
|---|-----------------|
| XP-503 with Visual Designer .....   | <b>V7-T5-21</b> |
| XV with Visual Designer, Galileo or XSoft-CoDeSys-3<br>Catalog Number Selection ..... | <b>V7-T5-28</b> |
| Product Selection .....   | <b>V7-T5-28</b> |
| Accessories .....   | <b>V7-T5-31</b> |
| Technical Data and Specifications .....   | <b>V7-T5-32</b> |
| Visual Designer Software .....  | <b>V7-T5-34</b> |
| Galileo Software .....  | <b>V7-T5-37</b> |
| XSoft-CoDeSys-3 Software .....  | <b>V7-T5-38</b> |

**XV with Visual Designer, Galileo or XSoft-CoDeSys-3****Product Description****XV with Visual Designer**

Positioned between the **HMI** and the XP series of operator interface, the XV series is ideal for applications requiring extensive connectivity and the advanced features available in Visual Designer without the expense associated with more powerful open platforms.

The XV models were designed with OEMs in mind featuring an attractive bezel and slim and light weight housing. The clip mount design simplifies installation.

**XV with Galileo**

The XV Series with Galileo offers a global visualization software package for all applications in system and machine building. It is designed to optimize performance on the XV platform. Galileo can also run as the visualization package on XV CoDeSys units when a stronger visualization tool is required.

**XV with XSoft-CoDeSys**

The XV series with XSoft-CoDeSys combines powerful logic and visualization capabilities into a single device. It is ideal for OEM applications where low component count and ease of program development and remote administration is critical.

The XV Models with XSoft-CoDeSys offer multiple field bus options built directly on-board the unit to provide an overall solution optimized both for size and cost.

**XV-300 Software Bundles**

The XV-300 series is the latest and most powerful in the XV product line. It's powerful CPU and graphics co-processor provide the high-performance engine required by demanding HMI and HMI-PLC applications. Coupled with an attractive, sleek design and multi-touch touchscreen, it supports the modern gesture based user interface that redefines ease of use.

The XV-300 series can run Visual Designer, XSoft-CoDeSys and Galileo and unlike the XV-100 series, there are bundles that include Visual Designer and XSoft-CoDeSys runtime licenses on a single unit. Because of the higher capacity and performance of the XV-300 over the XV-100, these appeal to OEMs who have demanding HMI-PLC applications in which case they will choose a model bundled with XSoft-CoDeSys software.

All XSoft-CoDeSys models include XSoft-CoDeSys logic and visualization tools, but also include a Galileo runtime license at no additional charge so the user can choose which visualization tool is appropriate for their needs. Users who have large or demanding HMI applications that also require some SCADA software features such as web serving, document (PDF) viewing, SQL database interfaces, FDA 21 CFR Part 11 compliance or other advanced functionality could choose the XV-300 models bundled with Visual Designer software. For users who need PLC applications and advanced Visualization and SCADA features, they can choose XV-300 models with both XSoft-CoDeSys and Visual Designer runtime licenses bundled in a single package.

### Features

#### **XV-100 with Visual Designer**

XV Series operator interface with Windows CE operating system

- 3.5-, 5.7-, 7.0- (widescreen), 8.4- and 10.4-inch screen sizes
- Cost-effective plastic or metal housing
- Resistive touch with flush bezel
- Ethernet and serial ports on all models
- Visual Designer XP or CE development software
- Pre-installed Visual Designer runtime and Web serving licenses

#### **XV-102 with Galileo only units**

- 3.5-, 5.7- and 7.0-inch (widescreen)
- Plastic housing
- Resistive touch with flush bezel
- Ethernet on all models
- RS-232 or RS-485 serial ports available
- Prelicensed for Galileo Runtime (GRS)

#### **XV-100 with XSoft-CoDeSys**

XV Series operator interface with Windows CE operating system

- 3.5-, 5.7-, 7.0- (widescreen), 8.4- and 10.4-inch screen sizes
- Cost-effective plastic or metal housing
- Resistive touch with flush bezel
- Ethernet and serial ports on all models
- PROFIBUS, CANopen and SmartWire-DT optional
- XSoft-CoDeSys-3 programming software
- Pre-licensed for CoDeSys runtime

### Standards and Certifications

- CE
- UL
- cUL
- RoHS



### Selecting the right model for your application

The XV product offered with Visual Designer, Galileo or XSoft-CoDeSys offers the highest level of flexibility for one operator interface product.

Visual Designer provides a fully integrated SCADA and HMI platform. Use Visual Designer when Web enabling, remote access, database and connectivity, and when one operator software package is required across XV and XP platforms.

Galileo provides a visualization environment designed around the needs of machine building OEMs. Use Galileo when designing high-performance machines in the OEM space.

XSoft-CoDeSys turns the XV into a fully integrated Logic and OI platform (HMI-PLC). Use XSoft-CoDeSys to unleash the PLC functionality on an XV. With optional communication interfaces like SmartWire-DT, CANopen and PROFIBUS, Eaton welcomes you into the Lean Automation space.

On XV-300 models, you can take advantage of the best of both worlds with Visual Designer and XSoft-CoDeSys together. Combining the power of these two software platforms provides limitless possibilities on an HMI-PLC and SCADA platform.

### Software Suite

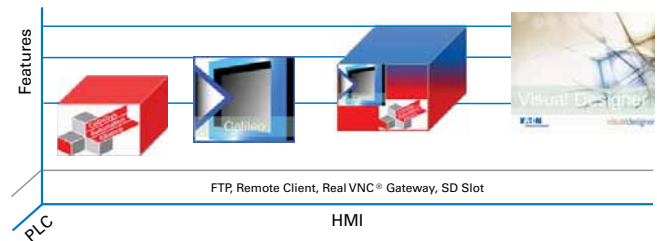

## Product Selection Guide

### XP and XV Operator Interface with Visual Designer

| Series  | XP   |  |  |
|---|--|--|--|
|   | XP-503   |  |  |
| Model   | 10.1, 15.6, 21.5   |  |  |
| Screen Size   | 10.1, 15.6, 21.5   |  |  |
| Housing material  | Powder-coated aluminum   |  |  |
| Operating system  | Windows Embedded Standard 7  |  |  |
| Touchscreen technology  | Projected Capacitive Touchscreen (PCT), non-reflective tempered glass  |  |  |
| Communication ports   | 2 Ethernet, 2 serial, 4 USB<br>2 Ethernet; 1 RS-232; 1 RS-485; 2 USB 3.0   |  |  |
| Optional field buses  | N/A  |  |  |
| Development software  | Visual Designer (VISUALDXP)<br>(Runtime pre-installed)   |  |  |
| Pre-licensed tags, driver and Web session and field upgrade options | Standard 4000 tags, 5 drivers, 1 Web session<br>Optional upgrades to 64,000 tags, 8 drivers, 1, 2, 4, 8, 16, 32, 64 or 128 simultaneous Web sessions |  |  |
| Alarm online/history  | Yes  |  |  |
| Trend online/history  | Yes  |  |  |
| Scripting   | Yes (VB Script)  |  |  |
| Scheduler   | Yes  |  |  |
| Recipe  | Yes  |  |  |
| Reports   | Yes  |  |  |
| OPC, TCP/IP, and communication drivers                              | Yes  |  |  |
| Web Server and Web Thin Client support                              | Yes  |  |  |
| Full remote access  | Yes  |  |  |
| Local/remote database interface                                     | Yes  |  |  |
| Ability to run third-party software                                 | Yes  |  |  |
| ActiveX and .NET controls   | Yes  |  |  |
| Full document viewing   | Yes  |  |  |
| Windows media player  | Yes  |  |  |
| Vision system interfaces  | Yes  |  |  |
| Network camera monitoring   | Yes  |  |  |

|   | XV  |                |   |
|---|---|----------------|---|
|   | XV-102  | XV-152         | XV-300  |
| Model   | 3.5, 5.7, 7.0   | 5.7, 8.4, 10.4 | 7.0, 10.1   |
| Housing material  | Plastic   | Metal          | Plastic   |
| Operating system  | WinCE 5.0 Professional  |                | WinCE 7.0 Professional  |
| Touchscreen technology  | Resistive   |                | PCT, ruggedized glass   |
| Communication ports   | 1 Ethernet, 1 or 2 serial, 0 or 1 USB   |                | 1 Ethernet, 2 serial, 1 USB, CAN  |
| Optional field buses  | PROFIBUS, CANopen, SmartWire-DT   |                | Optional Communication Ports—2nd Ethernet, SmartWire-DT, PROFIBUS-DP  |
| Development software  | Visual Designer (VISUALDCE or VISUALDXP)  |                | Visual Designer   |
| Pre-licensed tags, driver and Web session and field upgrade options | 1500 tags, 3 drivers, 1 Web session<br>4000 tags, 3 drivers, 1, 2, 4 or 8 simultaneous Web sessions |                | 1500 tags, 3 drivers, 1 Web session<br>Optional upgrade to 4000 tags, 3 drivers, 1, 2, 4 or 8 simultaneous Web sessions |
| Alarm online/history  | Yes   |                | Yes   |
| Trend online/history  | Yes   |                | Yes   |
| Scripting   | Yes (VB Script)   |                | Yes (VB Script)   |
| Scheduler   | Yes   |                | Yes   |
| Recipe  | Yes   |                | Yes   |
| Reports   | Yes   |                | Yes   |
| OPC, TCP/IP, and communication drivers                              | Yes   |                | Yes   |
| Web Server and Web Thin Client support                              | Yes   |                | Yes   |
| Full remote access  | Yes   |                | Yes   |
| Local/remote database interface                                     | Yes   |                | Yes   |
| Ability to run third-party software                                 | No  |                | No  |
| ActiveX and .NET controls   | No  |                | No  |
| Full document viewing   | No  |                | Yes (PDF and HTML)  |
| Windows media player  | No  |                | No  |
| Vision system interfaces  | No  |                | No  |
| Network camera monitoring   | No  |                | No  |

**XV Series with Galileo Only Runtime Option** (Not Available on XP Series)

| <b>Series</b>                       | <b>XV</b>                                |
|-------------------------------------|--|
| <b>Model</b>                        | <b>Model XV-102-H</b>                    |
| <b>Screen Size</b>                  | <b>3.5, 5.7, 7.0</b>                     |
| Housing material                    | Plastic                                  |
| Operating system                    | WinCE 5.0 standard                       |
| Touchscreen                         | Resistive                                |
| Communications ports                | 1 Ethernet, 1 RS-232, or 1 RS-485, 1 USB |
| Optional field buses                | N/A                                      |
| Development software                | Galileo                                  |
| Alarm online/historical             | Yes                                      |
| Trend online/historical             | Yes                                      |
| Scripting                           | Structured text                          |
| Scheduler                           | No                                       |
| Recipe                              | Yes                                      |
| Reports                             | No                                       |
| Full remote access                  | Yes                                      |
| Ability to run third-party software | No                                       |
| Vision system interfaces            | Yes                                      |
| Multi-language support              | Yes                                      |
| PLC variable import                 | Yes                                      |

**XV Series with CoDeSys Runtime** (Not Available on XP Series)

| <b>Series</b>                          | <b>XV</b>                             |                                       |   |
|--|---------------------------------------|---------------------------------------|---|
| <b>Model</b>                           | <b>XV-102</b>                         | <b>XV-152</b>                         | <b>XV-303</b>   |
| <b>Screen Size</b>                     | <b>3.5, 5.7, 7.0</b>                  | <b>5.7, 8.4, 10.4</b>                 | <b>7.0, 10.1</b>  |
| Housing material                       | Plastic                               | Metal                                 | Plastic   |
| Operating system                       | WinCE 5.0 Standard                    | WinCE 5.0 Standard                    | WinCE 7.0 Professional                                    |
| Touchscreen                            | Resistive                             | Resistive                             | PCT, ruggedized glass                                     |
| Communications ports                   | 1 Ethernet, 1 or 2 serial, 0 or 1 USB | 1 Ethernet, 1 or 2 serial, 0 or 1 USB | 1 Ethernet, 2 serial, 1 USB, CAN                          |
| Optional field buses                   | PROFIBUS, CANopen, SmartWire-DT       | PROFIBUS, CANopen, SmartWire-DT       | Optional Field Buses—2nd Ethernet, SmartWire-DT, PROFIBUS |
| Development software                   | XSoft-CoDeSys-3                       | XSoft-CoDeSys-3                       | XSoft-CoDeSys-3   |
| IEC-61131-3 logic programming          | (LD, ST, SFC, IL, FBD, CFC) Yes       | (LD, ST, SFC, IL, FBD, CFC) Yes       | (LD, ST, SFC, IL, FBD, CFC) Yes                           |
| Integrated screen design               | Yes                                   | Yes                                   | Yes   |
| Integrated field bus configuration     | Yes                                   | Yes                                   | Yes   |
| Alarm online/historical                | Yes                                   | Yes                                   | Yes   |
| Trend online/historical                | Yes                                   | Yes                                   | Yes   |
| Scripting                              | Structured Text                       | Structured Text                       | Structured Text (ST)                                      |
| Scheduler                              | Yes                                   | Yes                                   | Yes   |
| Recipe                                 | Yes                                   | Yes                                   | No  |
| Reports                                | No                                    | No                                    | Yes   |
| OPC, TCP/IP and communication driver   | Yes (OPC Server for PC)               | Yes (OPC Server for PC)               | Yes (OPC Server for PC)                                   |
| Web Server and Web Thin Client support | Yes                                   | Yes                                   | Yes   |
| Full remote access                     | Yes                                   | Yes                                   | Yes   |
| Local/remote data base access          | Limited (DDE)                         | Limited (DDE)                         | Yes (with Visual Designer software bundle)                |
| Ability to run third-party software    | No                                    | No                                    | No  |
| ActiveX and .NET controls              | No                                    | No                                    | No  |
| Full document viewing                  | No                                    | No                                    | Yes (PDF and HTML)  |
| Windows media player                   | No                                    | No                                    | No  |
| Vision system interfaces               | No                                    | No                                    | No  |
| Network camera monitoring              | No                                    | No                                    | No  |



# 5.4

## Operator Interface Products

### XP and XV Operator Interface

#### Catalog Number Selection

##### XV Operator Interface—XV-102, XV-152

##### XV-102, XV-152

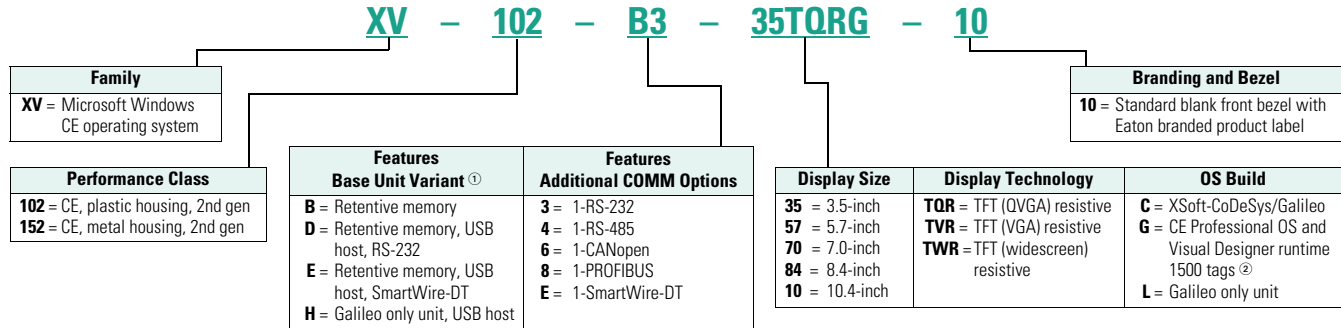

#### Product Selection

##### XV Operator Interface

##### XV Operator Interface with Visual Designer



| Description   | Catalog Number             |
|---|----------------------------|
| XV 3.5-inch TFT, plastic housing, resistive touch, Ethernet and RS-232                  | <b>XV-102-B3-35TORG-10</b> |
| XV 3.5-inch TFT, plastic housing, resistive touch, Ethernet and RS-485                  | <b>XV-102-B4-35TORG-10</b> |
| XV 5.7-inch TFT, plastic housing, resistive touch, Ethernet, RS-232, RS-485             | <b>XV-102-D4-57TVRG-10</b> |
| XV 7.0-inch TFT wide screen, plastic housing, resistive touch, Ethernet, RS-232, RS-485 | <b>XV-102-D4-70TWRG-10</b> |
| XV 5.7-inch TFT, metal housing, resistive touch, Ethernet, RS-232, RS-485               | <b>XV-152-D4-57TVRG-10</b> |
| XV 8.4-inch TFT, metal housing, resistive touch, Ethernet, RS-232, RS-485               | <b>XV-152-D4-84TVRG-10</b> |
| XV 10.4-inch TFT, metal housing, resistive touch, Ethernet, RS-232, RS-485              | <b>XV-152-D4-10TVRG-10</b> |

#### Notes

- ① All 1xx performance class units have 400 MHz processor, 64 MB DRAM, 1 x 10/100 Ethernet, and 1 x USB device.
- ② Standard software on embedded hardware. These XV models have a Microsoft Windows CE 5.0 Professional operating system and are pre-licensed with Visual Designer runtime for up to 1500 tags, 3 simultaneous communication drivers, and 1 Web session. Field upgrades are available for up to 4000 tags, 3 drivers, and 2, 4 or 8 simultaneous Web sessions.



### XV Operator Interface with XSoft-CoDeSys, HMI-PLC

| Description  | Catalog Number             |
|--|----------------------------|
| XV 3.5-inch TFT plastic housing, resistive touch, CANopen, RS-485                | <b>XV-102-B6-35TQRC-10</b> |
| XV 3.5-inch TFT plastic housing, resistive touch, PROFIBUS, RS-485               | <b>XV-102-B8-35TQRC-10</b> |
| XV 3.5-inch TFT plastic housing, resistive touch, SmartWire-DT                   | <b>XV-102-BE-35TQRC-10</b> |
| XV 5.7-inch TFT plastic housing, resistive touch, CANopen, RS-232, RS-485        | <b>XV-102-D6-57TVRC-10</b> |
| XV 5.7-inch TFT plastic housing, resistive touch, PROFIBUS, RS-232, RS-485       | <b>XV-102-D8-57TVRC-10</b> |
| XV 5.7-inch TFT plastic housing, resistive touch, CANopen, SmartWire-DT, RS-485  | <b>XV-102-E6-57TVRC-10</b> |
| XV 5.7-inch TFT plastic housing, resistive touch, PROFIBUS, SmartWire-DT, RS-485 | <b>XV-102-E8-57TVRC-10</b> |
| XV 7.0-inch TFT plastic housing, resistive touch, CANopen, RS-232, RS-485        | <b>XV-102-D6-70TWRC-10</b> |
| XV 7.0-inch TFT plastic housing, resistive touch, PROFIBUS, RS-232, RS-485       | <b>XV-102-D8-70TWRC-10</b> |
| XV 7.0-inch TFT plastic housing, resistive touch, CANopen, SmartWire-DT, RS-485  | <b>XV-102-E6-70TWRC-10</b> |
| XV 7.0-inch TFT plastic housing, resistive touch, PROFIBUS, SmartWire-DT, RS-485 | <b>XV-102-E8-70TWRC-10</b> |
| XV 5.7-inch TFT metal housing, resistive touch, CANopen, RS-232, RS-485          | <b>XV-152-D6-57TVRC-10</b> |
| XV 5.7-inch TFT metal housing, resistive touch, PROFIBUS, RS-232, RS-485         | <b>XV-152-D8-57TVRC-10</b> |
| XV 5.7-inch TFT metal housing, resistive touch, CANopen, SmartWire-DT, RS-485    | <b>XV-152-E6-57TVRC-10</b> |
| XV 5.7-inch TFT metal housing, resistive touch, PROFIBUS, SmartWire-DT, RS-485   | <b>XV-152-E8-57TVRC-10</b> |
| XV 8.4-inch TFT metal housing, resistive touch, CANopen, RS-232, RS-485          | <b>XV-152-D6-84TVRC-10</b> |
| XV 8.4-inch TFT metal housing, resistive touch, PROFIBUS, RS-232, RS-485         | <b>XV-152-D8-84TVRC-10</b> |
| XV 8.4-inch TFT metal housing, resistive touch, CANopen, SmartWire-DT, RS-485    | <b>XV-152-E6-84TVRC-10</b> |
| XV 8.4-inch TFT metal housing, resistive touch, PROFIBUS, SmartWire-DT, RS-485   | <b>XV-152-E8-84TVRC-10</b> |
| XV 10.4-inch TFT metal housing, resistive touch, CANopen, RS-232, RS-485         | <b>XV-152-D6-10TVRC-10</b> |
| XV 10.4-inch TFT metal housing, resistive touch, PROFIBUS, RS-232, RS-485        | <b>XV-152-D8-10TVRC-10</b> |
| XV 10.4-inch TFT metal housing, resistive touch, CANopen, SmartWire-DT, RS-485   | <b>XV-152-E6-10TVRC-10</b> |
| XV 10.4-inch TFT metal housing, resistive touch, PROFIBUS, SmartWire-DT, RS-485  | <b>XV-152-E8-10TVRC-10</b> |

### XV Operator Interface with Galileo Only



| Description   | Catalog Number             |
|---|----------------------------|
| XV 3.5-inch TFT plastic housing, resistive touch, Ethernet RS-232 | <b>XV-102-H3-35TQRL-10</b> |
| XV 3.5-inch TFT plastic housing, resistive touch, Ethernet RS-485 | <b>XV-102-H4-35TQRL-10</b> |
| XV 5.7-inch TFT plastic housing, resistive touch, Ethernet RS-232 | <b>XV-102-H3-57TVRL-10</b> |
| XV 5.7-inch TFT plastic housing, resistive touch, Ethernet RS-485 | <b>XV-102-H4-57TVRL-10</b> |
| XV 7.0-inch TFT plastic housing, resistive touch, Ethernet RS-232 | <b>XV-102-H3-70TVRL-10</b> |
| XV 7.0-inch TFT plastic housing, resistive touch, Ethernet RS-485 | <b>XV-102-H4-70TVRL-10</b> |

# 5.4

## Operator Interface Products

### XP and XV Operator Interface

5

#### Catalog Number Selection

##### XV Operator Interface—XV-303, XV-313

##### XV-303, XV-313

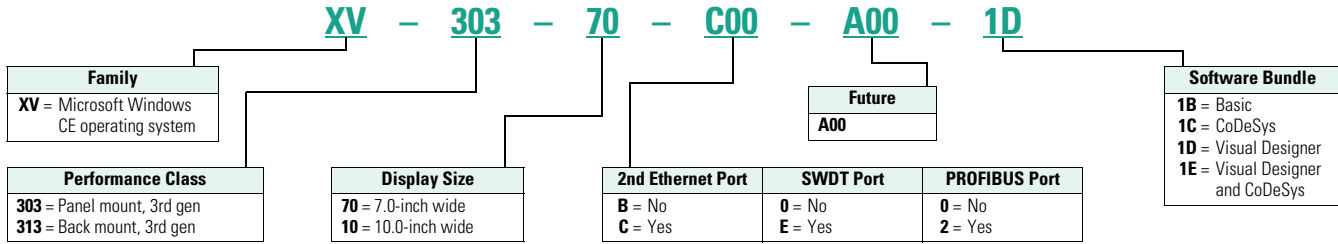

#### Product Selection

##### XV Operator Interface



##### XV Operator Interface with Visual Designer

| Description   | Catalog Number              |
|---|-----------------------------|
| XV with 7.0-inch TFT, plastic housing, PCT multi-touch, dual Ethernet, CAN, RS-232, RS-485, USB host  | <b>XV-303-70-C00-A00-1D</b> |
| XV with 10.0-inch TFT, plastic housing, PCT multi-touch, dual Ethernet, CAN, RS-232, RS-485, USB host | <b>XV-303-10-C00-A00-1D</b> |

##### XV Operator Interface with XSoft-CoDeSys, HMI-PLC



| Description   | Catalog Number              |
|---|-----------------------------|
| XV with 7.0-inch TFT, plastic housing, PCT multi-touch, single Ethernet, CAN, RS-232, RS-485, USB host                | <b>XV-303-70-B00-A00-1C</b> |
| XV with 7.0-inch TFT, plastic housing, PCT multi-touch, dual Ethernet, CAN, RS-232, RS-485, USB host                  | <b>XV-303-70-C00-A00-1C</b> |
| XV with 7.0-inch TFT, plastic housing, PCT multi-touch, single Ethernet, CAN, PROFIBUS, RS-232, RS-485, USB host      | <b>XV-303-70-B02-A00-1C</b> |
| XV with 7.0-inch TFT, plastic housing, PCT multi-touch, dual Ethernet, CAN, PROFIBUS, RS-232, RS-485, USB host        | <b>XV-303-70-C02-A00-1C</b> |
| XV with 7.0-inch TFT, plastic housing, PCT multi-touch, single Ethernet, CAN, SmartWire-DT, RS-232, RS-485, USB host  | <b>XV-303-70-BE0-A00-1C</b> |
| XV with 7.0-inch TFT, plastic housing, PCT multi-touch, dual Ethernet, CAN, SmartWire-DT, RS-232, RS-485, USB host    | <b>XV-303-70-CE0-A00-1C</b> |
| XV with 10.0-inch TFT, plastic housing, PCT multi-touch, single Ethernet, CAN, RS-232, RS-485, USB host               | <b>XV-303-10-B00-A00-1C</b> |
| XV with 10.0-inch TFT, plastic housing, PCT multi-touch, dual Ethernet, CAN, RS-232, RS-485, USB host                 | <b>XV-303-10-C00-A00-1C</b> |
| XV with 10.0-inch TFT, plastic housing, PCT multi-touch, single Ethernet, CAN, PROFIBUS, RS-232, RS-485, USB host     | <b>XV-303-10-B02-A00-1C</b> |
| XV with 10.0-inch TFT, plastic housing, PCT multi-touch, dual Ethernet, CAN, PROFIBUS, RS-232, RS-485, USB host       | <b>XV-303-10-C02-A00-1C</b> |
| XV with 10.0-inch TFT, plastic housing, PCT multi-touch, single Ethernet, CAN, SmartWire-DT, RS-232, RS-485, USB host | <b>XV-303-10-BE0-A00-1C</b> |
| XV with 10.0-inch TFT, plastic housing, PCT multi-touch, dual Ethernet, CAN, SmartWire-DT, RS-232, RS-485, USB host   | <b>XV-303-10-CE0-A00-1C</b> |

##### XV Operator Interface with Visual Designer and XSoft-CoDeSys, HMI-PLC-SCADA

| Description   | Catalog Number              |
|---|-----------------------------|
| XV with 7.0-inch TFT, plastic housing, PCT multi-touch, dual Ethernet, CAN, RS-232, RS-485, USB host                | <b>XV-303-70-C00-A00-1E</b> |
| XV with 7.0-inch TFT, plastic housing, PCT multi-touch, dual Ethernet, CAN, SmartWire-DT, RS-232, RS-485, USB host  | <b>XV-303-70-CE0-A00-1E</b> |
| XV with 10.0-inch TFT, plastic housing, PCT multi-touch, dual Ethernet, CAN, RS-232, RS-485, USB host               | <b>XV-303-10-C00-A00-1E</b> |
| XV with 10.0-inch TFT, plastic housing, PCT multi-touch, dual Ethernet, CAN, SmartWire-DT, RS-232, RS-485, USB host | <b>XV-303-10-CE0-A00-1E</b> |

**Accessories****XV Family Accessories**

| <b>Description</b>  | <b>Catalog Number</b>       |
|---|-----------------------------|
| SD memory card for all XV-102 and XV-152 models   | <b>MEMORY-SD-A1-S</b>       |
| Spare part kit for XV-102 models—1 power connector, 8 mounting brackets, 1 sealing strip, 1 touch pen | <b>ACC-TP-57-KG-1</b>       |
| Spare part kit for XV-152 models—1 power connector, 8 mounting brackets, 1 sealing strip, 1 touch pen | <b>ACC-TP-10-12-RES-1</b>   |
| SD memory card with 1 GB storage for all XV-100 and XV-300 models                                     | <b>MEMORY-SD-A2-S</b>       |
| Accessory set for XV-303 (10 mounting brackets and 1 power plug)                                      | <b>ACCESSORIES-TP-10-KG</b> |

**XV Family Software Options**

| <b>Description</b>   | <b>Catalog Number</b>    |
|--|--------------------------|
| Product license for 40 points for use with Galileo or XSoft-CoDeSys units        | <b>LIC-OPT-1ST-LEVEL</b> |
| Product license for 80 points for use with Galileo or XSoft-CoDeSys units        | <b>LIC-OPT-2ND-LEVEL</b> |
| License product Paper PLC with license sticker for XSoft-CoDeSys-2/-3 for XV-300 | <b>LIC-PLC-A</b>         |
| License product Paper Visual Designer with license sticker for XV-300            | <b>LIC-VISD-A</b>        |

## Technical Data and Specifications

### XV Operator Interface

| Series<br>Model  | XV Midrange Operator Interface   |   |                         | XV-152   |                         |                         |
|--|--|---|-------------------------|--|-------------------------|-------------------------|
|  | 3.5-Inch   | 5.7-Inch  | 7.0-Inch                | 5.7-Inch   | 8.4-Inch                | 10.4-Inch               |
| Operating system   | WinCE 5.0 Professional/Standard  |   |                         | WinCE 5.0 Professional/Standard  |                         |                         |
| Touchscreen technology   | Resistive  | Resistive   | Resistive               | Resistive  | Resistive               | Resistive               |
| Display, colors  | Color TFT, 64 k colors   | Color TFT, 64 k colors                                  | Color TFT, 64 k colors  | Color TFT, 64 k colors   | Color TFT, 64 k colors  | Color TFT, 64 k colors  |
| Pixel resolution (landscape)<br>portrait mode also available                     | QVGA 320 x 240   | VGA 640 x 480   | WVGA 800 x 480          | VGA 640 x 480  | VGA 640 x 480           | VGA 640 x 480           |
| Brightness (cd/m <sup>2</sup> )  | 250  | 250   | 250                     | 350  | 350                     | 350                     |
| Backlight  | LED, selectable dimming  | LED, selectable dimming                                 | LED, selectable dimming | LED, selectable dimming  | LED, selectable dimming | LED, selectable dimming |
| Lifespan of backlight (half-life)  | 40,000 hrs   | 40,000 hrs  | 40,000 hrs              | 40,000 hrs   | 40,000 hrs              | 40,000 hrs              |
| Processor  | 32 bit RISC, 400 MHz   | 32 bit RISC, 400 MHz                                    | 32 bit RISC, 400 MHz    | 32 bit RISC, 400 MHz   | 32 bit RISC, 400 MHz    | 32 bit RISC, 400 MHz    |
| Volatile memory  | 64 MB DRAM   | 64 MB DRAM  | 64 MB DRAM              | 64 MB DRAM   | 64 MB DRAM              | 64 MB DRAM              |
| Non-volatile memory  | 125 KB NVRAM/64 MB NAND,<br>1 SD card slot   | 125 KB NVRAM/64 MB NAND/<br>2 MB NOR, 1 SD card slot    |                         | 125 KB NVRAM/64 MB NAND/<br>2 MB NOR, 1 SD card slot   |                         |                         |
| Real time clock  | Yes  | Yes   | Yes                     | Yes  | Yes                     | Yes                     |
| Communication ports  | Ethernet 10/100, RS-485<br>or RS-232 USB Device  | Ethernet 10/100, RS-485, RS-232<br>USB Host, USB Device |                         | Ethernet 10/100, RS-485, RS-232 USB Host, USB Device   |                         |                         |
| Slots for COMM modules   | None   | None  | None                    | None   | None                    | None                    |
| Power supply rated voltage   | 24 Vdc nominal (–20%/+25%) with polarity protection  |   |                         | 24 Vdc nominal (–20%/+25%) with polarity protection  |                         |                         |
| Continuous current consumption<br>(max. amps)                                    | 0.2  | 0.4   | 0.4                     | 0.4  | 0.6                     | 0.6                     |
| Starting current inrush (A <sup>2</sup> s)                                       | 1.5  | 1.5   | 1.5                     | 1.5  | 1.5                     | 1.5                     |
| Ambient conditions   |  |   |                         |  |                         |                         |
| Operation—relative humidity,<br>noncondensing                                    | 0 to 50 °C, 10 to 95%  | 0 to 50 °C, 10 to 95%                                   | 0 to 50 °C, 10 to 95%   | 0 to 50 °C, 10 to 95%  | 0 to 50 °C, 10 to 95%   | 0 to 50 °C, 10 to 95%   |
| Storage/transport—relative<br>humidity, noncondensing                            | –20 to 60 °C, 10 to 95%  | –20 to 60 °C, 10 to 95%                                 | –20 to 60 °C, 10 to 95% | –20 to 60 °C, 10 to 95%  | –20 to 60 °C, 10 to 95% | –20 to 60 °C, 10 to 95% |
| Shock  | IEC 60068-2-27 15 g for 11 ms duration   |   |                         | IEC 60068-2-27 15 g for 11 ms duration   |                         |                         |
| Vibration  | IEC 60068-2-6<br>5–9 Hz: 3.5 mm displacement<br>9–60 Hz: 0.15 mm displacement<br>60–150 Hz: 2 g acceleration |   |                         | IEC 60068-2-6<br>5–9 Hz: 3.5 mm displacement<br>9–60 Hz: 0.15 mm displacement<br>60–150 Hz: 2 g acceleration |                         |                         |
| Agency certifications and<br>standards   | CE, UL/cUL, CSA (pending), RoHS  |   |                         | CE, UL/cUL, CSA (pending), RoHS  |                         |                         |
| Protection type  |  |   |                         |  |                         |                         |
| Front  | IP65, NEMA 4X (indoor)   | IP65, NEMA 4X (indoor)                                  | IP65, NEMA 4X (indoor)  | IP65, NEMA 4X (indoor)   | IP65, NEMA 4X (indoor)  | IP65, NEMA 4X (indoor)  |
| Rear   | IP20, NEMA 1   | IP20, NEMA 1  | IP20, NEMA 1            | IP20, NEMA 1   | IP20, NEMA 1            | IP20, NEMA 1            |
| Housing material   | Plastic  | Plastic   | Plastic                 | Metal  | Metal                   | Metal                   |
| Dimensions W x H x D (mm)  | 136 x 100 x 30   | 170 x 130 x 39  | 210 x 135 x 38          | 212 x 156 x 53   | 275 x 208 x 53          | 345 x 260 x 54          |
| Mounting cutout W x H (mm)   | 123 x 87   | 157 x 117   | 197 x 122               | 198 x 142  | 261 x 194               | 329 x 238               |
| Approximate weight lbs (kg)  | 0.7 (0.3)  | 1.3 (0.6)   | 1.3 (0.6)               | 2.9 (1.3)  | 4.3 (2.1)               | 6.1 (3.0)               |
| Ability to run third-party<br>software   | No   | No  | No                      | No   | No                      | No                      |
| Visual Designer<br>development software  | VISUALDCE or VISUALDXP   |   |                         | VISUALDCE or VISUALDXP   |                         |                         |
| Pre-licensed tags, drivers, Web<br>sessions (Visual Designer<br>models)          | 1500 tags, 3 drivers, 1 Web session  |   |                         | 1500 tags, 3 drivers, 1 Web session  |                         |                         |
| Field upgradeable max tags,<br>drivers, Web sessions (Visual<br>Designer Models) | 4000 tags, 3 drivers, 1, 2, 4, or 8 Web sessions simultaneously  |   |                         | 4000 tags, 3 drivers, 1, 2, 4, or 8 Web sessions simultaneously  |                         |                         |
| XSoft-CoDeSys-3 development<br>software  | SW-XSOFT-CODESYS-3-S (seat)<br>SW-XSOFT-CODESYS-3-M (multi-seat)   |   |                         | SW-XSOFT-CODESYS-3-S (seat)<br>SW-XSOFT-CODESYS-3-M (multi-seat)   |                         |                         |
| Galileo development software   | SW-GALILEO-S (seat)<br>SW-GALILEO-M (multi-seat)   |   |                         | SW-GALILEO-S (seat)<br>SW-GALILEO-M (multi-seat)   |                         |                         |

**XV Operator Interface****Series****Model****XV-303****Screen Size****7.0-Inch****10.0-Inch**

| Operating system  | WinCE7.0 Professional  |                                      |
|---|--|--------------------------------------|
| Touchscreen technology                                    | Projected Capacitive Multi-touch   |                                      |
| Display colors  | 16 million   |                                      |
| Pixel resolution (landscape) portrait mode also available | WSVGA 1024 x 600   |                                      |
| Brightness (cd/m <sup>2</sup> )                           | 400  |                                      |
| Backlight   | LED, selectable dimming  |                                      |
| Lifespan of backlight (half-life)                         | 50,000 hrs   |                                      |
| Processor   | 800 MHz Cortex A8 CPU with graphics co-processor   |                                      |
| Volatile memory   | 512 MB DRAM  |                                      |
| Non-volatile memory                                       | 128 KB NVRAM (PLC), 1 GB SLC, 1 SD card slot   |                                      |
| Real time clock   | Yes  |                                      |
| Communication ports                                       | Ethernet 10/100, RS-232, RS-485, CAN, USB Host, USB Device   |                                      |
| Optional communication ports                              | Second Ethernet 10/100, PROFIBUS DP, SmartWire-DT  |                                      |
| Power supply rated voltage                                | 24 Vdc nominal (–20%/+25%) with polarity protection  |                                      |
| Continuous current consumption (max. amps)                | 0.6 (7.0-inch)   | 0.75 (10.1-inch)                     |
| Starting current inrush (A2s)                             | 1.0 (7.0-inch)   | 1.0 (10.1-inch)                      |
| Ambient conditions  |  |                                      |
| Operation-relative humidity, noncondensing                | 0 to 50 °C, 10 to 95%  |                                      |
| Storage/transport-relative humidity, noncondensing        | –20 to +60 °C, 10 to 95%   |                                      |
| Shock   | IEC 60068-2-27 15 g for 11 ms duration   |                                      |
| Vibration   | IEC 60068-2-6<br>5–9 Hz: 3.5 mm displacement<br>9–60 Hz: 0.15 mm displacement<br>60–150 Hz: 2 g acceleration |                                      |
| Agency certifications and standards                       | CE, UL/cUL, RoHS2, UL/cUL Class I Div 2 groups A, B, C, D (pending)<br>ATEX Zone 22 (pending)                |                                      |
| Protection type   |  |                                      |
| Front   | IP65, NEMA 4X (indoor)   |                                      |
| Rear  | IP20, NEMA 1   |                                      |
| Housing material  | Plastic  |                                      |
| Dimensions W x H x D (mm)                                 | 196 x 135 x 51   | 269 x 174 x 58                       |
| Mounting cutout W x H (mm)                                | 182 x 121  | 254 x 160                            |
| Approximate weight lbs (kg)                               | 1.6 (0.74)   | 2.5 (1.13)                           |
| Ability to run third-party software                       | No   |                                      |
| Visual Designer development software                      | VISUALDCE or VISUALDXP   |                                      |
| Pre-licensed tags, drivers, Web                           | 1500 tags, 3 drivers, 1 Web session  |                                      |
| Field upgradeable max. tags, drivers, Web sessions (VisD) | 4000 tags, 5 drivers, 1, 2, 4 or 8 simultaneous Web sessions   |                                      |
| XSoft-CoDeSys-3 development software                      | SW-XSOFT-CODESYS-3-S<br>(seat)   | SW-XSOFT-CODESYS-3-M<br>(multi-seat) |

### Visual Designer Software

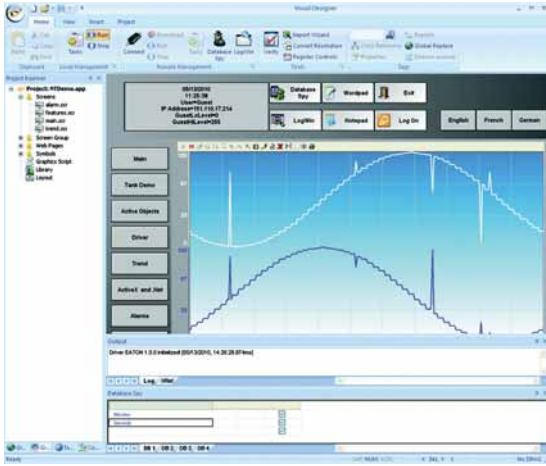

### Contents

| <i>Description</i>  | <i>Page</i>     |
|---|-----------------|
| XP-503 with Visual Designer .....                             | <b>V7-T5-21</b> |
| XV with Visual Designer, Galileo,<br>or XSoft-CoDeSys-3 ..... | <b>V7-T5-24</b> |
| Visual Designer Software<br>Product Selection .....           | <b>V7-T5-35</b> |
| Galileo Software .....  | <b>V7-T5-37</b> |
| XSoft-CoDeSys-3 Software .....                                | <b>V7-T5-38</b> |

### Visual Designer Software

#### Product Description

##### **Advanced GUI Development, Made Easy**

Time-saving solutions, lower costs.

With application development expense often outweighing the hardware expense, the demand to quickly design and implement advanced GUI solutions is greater than ever. Even advanced features such as data archiving, recipe management, multi-language, SQL database access, and Web serving are made easy through an elegant and modern user interface. Visual Designer's ease-of-use and time-saving features lower your total installed cost.

#### Features

Visual Designer is a software development package optimized for OEMs. New tools streamline the application development process, and the creation of Web-based applications has never been easier. In addition to basic monitor and control functionality, Visual Designer is packed with advanced features streamlining the design of sophisticated applications.

#### Advanced Features

- Pop-ups and group screens
- Full mathematical and logical evaluation
- Web browsing and document viewing
- Remote access and control without having to install software to the remote PC
- Database interfacing
- Historical alarms and events
- Historical data archiving and trending
- Recipe management
- Multi-language
- VB scripting
- Report generation
- Scheduling
- Resolution conversion
- Emailing and text messaging
- Launch and control of third-party applications

#### Advanced Development Features

- Conversion of legacy PanelMate configurations
- Optional PanelBuilder conversion utility
- Online configuration/editing
- Advanced search and replace
- Automatic scaling of Web clients
- Customizable application symbols
- Reusable controls, images, and screens via indirect tag and/or PLC assignments

#### System Requirements

Windows XP and Windows 7 32-bit and 64-bit systems

### Fully connected, Web-enabled

Today's operator interface applications range from basic monitor and control to high-end, feature-rich HMI software with Supervisory Control and Data Acquisition (SCADA). Customers demand communications capability with any network, PLC, Web client, and database. The answer: Eaton's Web-enabled Visual Designer operator interface software.

#### Web-based thin client

- Zero admin client—no need to install software on the remote PC
- Supports multiple simultaneous and independent Web clients
- Simplified security—the same local user accounts and passwords for viewing and control also apply remotely

#### Connectivity

- Extensive list of over 240 native communication drivers for PLCs, drives, and many other industrial and commercial devices
- Visual Designer software can interface to any relational database—access both local and enterprise functions such as MRP/ERP through databases such as Microsoft® Access, FoxPro, SQL Server, Oracle®, PI System® and many others
- Other connectivity tools provide redundancy capabilities, Real-Time Data Exchange, Centralized Alarm Management, and more

#### Open platform

- Visual Designer Software can host third-party ActiveX® and .NET controls and Visual Basic® programs
- In addition to Eaton's Operator Interface families, Visual Designer's runtime may be licensed on any 32 or 64-bit Windows PC

#### Peace of mind

All of these capabilities—combined with Eaton's commitment to provide free technical support for both OI hardware and software—make it quick and easy to purchase, develop and deploy XP and XV operator interface solutions.

#### Interoperability

- Software is designed to open standards such as XML, OPC, ActiveX, .NET, ODBC, ADO, SOAP, DDE and more

### Product Selection

#### Visual Designer Software

##### Visual Designer

#### Visual Designer Development Software License Key

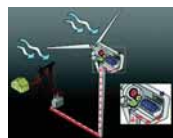

| Description  | Development Software Catalog Number | Runtime Software Catalog Number      |
|--|-------------------------------------|--------------------------------------|
| Development license for CE hardware  | <b>VISUALDCE</b>                    | —                                    |
| Development license for PCs, XP-503 and CE hardware  | <b>VISUALDXP</b>                    | —                                    |
| Multiple development licenses for CE hardware (5-pack of VISUALDCE)  | <b>VISUALDCE5</b>                   | —                                    |
| Multiple development licenses for PCs, XP-503 and CE hardware (5-pack of VISUALDXP)  | <b>VISUALDXP5</b>                   | —                                    |
| Development license for all hardware platforms (for use with VISUALD-LIC-SERVER)   | <b>VISUALDXPLS</b>                  | —                                    |
| Multiple development licenses for use with VISUALD-LIC-SERVER (5-pack for use with VISUALDXPLS)                                    | <b>VISUALDXP5LS</b>                 | —                                    |
| License server key to serve development licenses over a LAN  | <b>VISUALD-LIC-SERVER</b>           | —                                    |
| Visual Designer development software license and PC Runtime software licenses for a maximum of 64 k tags, 8 drivers, 1 Web session | <b>VISUALRTDEVPC</b>                | <b>VISUALRTDEVPC</b>                 |
| For a PC Runtime license with a maximum of 64 k tags, 8 drivers, 1 Web session   | —                                   | <b>VISUALRTPC64K</b>                 |
| For a PC Runtime license with a maximum of 4 k tags, 5 drivers, 1 Web session  | —                                   | <b>VISUALRTPC4k</b>                  |
| For a PC Runtime license with a maximum of 1500 tags, 3 drivers, 1 Web session   | —                                   | <b>VISUALRTPC1500</b>                |
| For a PC Runtime license with a maximum of 300 tags, 3 drivers, 1 Web session  | —                                   | <b>VISUALRTPC300</b>                 |
| For an XP-503 PC Runtime license with a maximum of 4 k tags, 5 drivers, 1 Web session  | —                                   | <b>N/A: Unit pre-licensed</b>        |
| For an XP-503 PC Runtime license with up to 64 k tags, 8 drivers, and 128 Web sessions   | —                                   | <b>See upgrade list on next page</b> |



#### Visual Designer

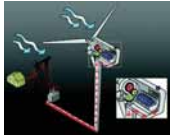

#### Software Updates and Upgrades

| Description  | Catalog Number         |
|--|------------------------|
| Update to current version Visual Designer development software for CE hardware                       | <b>VISUALDUPCE</b>     |
| Update to current version Visual Designer development software PCs/XPe/CE                            | <b>VISUALDUPXP</b>     |
| Update to current version of Visual Designer runtime license for PCs                                 | <b>VISUALRTUPPC</b>    |
| Upgrade from Visual Designer CE 1500 tag to 4000 tag runtime   | <b>VISUALRT4KCE</b>    |
| Upgrade from Visual Designer XP-500 4000 tag, 5 driver to 64 k tag, 8 driver runtime license         | <b>VISUALRT64KXP</b>   |
| Upgrade from Visual Designer development software CE to CE plus PC and XPe (64 k tag, 8 drivers)     | <b>VISUALDCE2XP</b>    |
| Visual Designer PanelBuilder conversion utility optional plug-in (requires Visual Designer software) | <b>VISUALDPBCU</b>     |
| Visual Designer 1 additional Web thin client license for Internet Explorer: Total of 2               | <b>VISUALWEB1</b>      |
| Visual Designer 3 additional Web thin client licenses for Internet Explorer: Total of 4              | <b>VISUALWEB3</b>      |
| Visual Designer 7 additional Web thin client licenses for Internet Explorer: Total of 8              | <b>VISUALWEB7</b>      |
| Visual Designer 15 additional Web thin client licenses for Internet Explorer: Total of 16            | <b>VISUALWEB16</b>     |
| Visual Designer 31 additional Web thin client licenses for Internet Explorer: Total of 32            | <b>VISUALWEB32</b>     |
| Visual Designer 63 additional Web thin client licenses for Internet Explorer: Total of 64            | <b>VISUALWEB64</b>     |
| Visual Designer 127 additional Web thin client licenses for Internet Explorer: Total of 128          | <b>VISUALWEB128</b>    |
| Visual Designer 1 additional Secure Viewer Thin Client license: Total of 2                           | <b>VISUALSVT2</b>      |
| Visual Designer 3 additional Secure Viewer Thin Client license: Total of 4                           | <b>VISUALSVT4</b>      |
| Visual Designer 7 additional Secure Viewer Thin Client license: Total of 8                           | <b>VISUALSVT8</b>      |
| Visual Designer 15 additional Secure Viewer Thin Client license: Total of 16                         | <b>VISUALSVT16</b>     |
| Visual Designer 31 additional Secure Viewer Thin Client license: Total of 32                         | <b>VISUALSVT32</b>     |
| Visual Designer 63 additional Secure Viewer Thin Client license: Total of 64                         | <b>VISUALSVT64</b>     |
| Visual Designer 127 additional Secure Viewer Thin Client license: Total of 128                       | <b>VISUALSVT128</b>    |
| Visual Designer 1 additional SMA Thin Client license: Total of 2                                     | <b>VISUALSMA2</b>      |
| Visual Designer 3 additional SMA Thin Client license: Total of 4                                     | <b>VISUALSMA4</b>      |
| Visual Designer 7 additional SMA Thin Client license: Total of 8                                     | <b>VISUALSMA8</b>      |
| Visual Designer 15 additional SMA Thin Client license: Total of 16                                   | <b>VISUALSMA16</b>     |
| Visual Designer 31 additional SMA Thin Client license: Total of 32                                   | <b>VISUALSMA32</b>     |
| Visual Designer 63 additional SMA Thin Client license: Total of 64                                   | <b>VISUALSMA64</b>     |
| Visual Designer 127 additional SMA Thin Client license: Total of 128                                 | <b>VISUALSMA128</b>    |
| Visual Designer collaborative server   | <b>VISUALCBSERVER</b>  |
| Visual Designer business dashboard tool  | <b>VISUALDASHBOARD</b> |
| Visual Designer communication package for electrical products  | <b>VISUALDELECDRVS</b> |

### Galileo Software

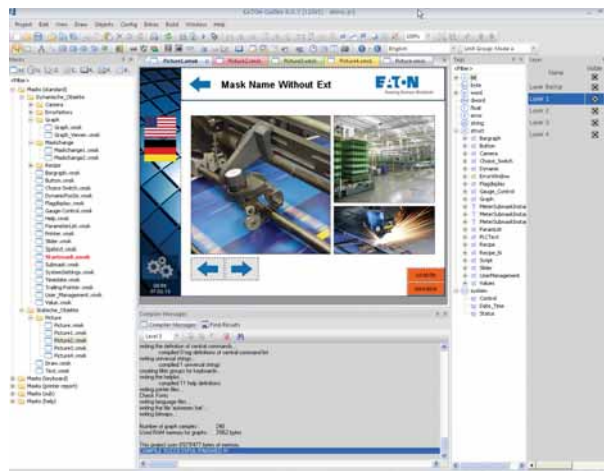

### Contents

| <b>Description</b>  | <b>Page</b>     |
|---|-----------------|
| XP-503 with Visual Designer .....                             | <b>V7-T5-21</b> |
| XV with Visual Designer, Galileo,<br>or XSoft-CoDeSys-3 ..... | <b>V7-T5-24</b> |
| Visual Designer Software .....                                | <b>V7-T5-34</b> |
| Galileo Software .....  | <b>V7-T5-38</b> |
| XSoft-CoDeSys-3 Software .....                                | <b>V7-T5-38</b> |

## Galileo Software

### Product Description

#### *The Intuitive Visualization Tool*

Galileo is an easy to learn yet powerful and extensive project design environment that can be used ideally in all system and machine building applications close to the machine and process.

Galileo is designed for use in all sectors and offers comprehensive project design tools. Galileo provides a full range of functions without any graduated restrictions on tags or screens, and is optimized for our XV operator interface panels.

### Features

- Easy to learn and intuitive graphical user interface with a project overview window
- User-friendly project design with project simulation on development PC
- Different user interface styles
- Drag and drop positioning of objects, WYSIWYG (what you see is what you get)
- Simple, clear user guidance
- Tabular object properties, easy and fast assignment of attributes—copy and paste
- Convenient series assignment of texts and images to tags
- Many graphical objects such as bar graph, slide adjuster, graph plotter, curve chart, camera
- Anti-aliased gauge display
- Enhanced password handling with complex password and aging
- Extensive recipe handling
- Alarm handling with time stamp, history and diagnostics support with image display
- Multi-line display of alarm entries
- Online language selection
- Unicode support (also Asian character sets)
- Text import/export in XML format (example, Excel®)
- Brilliant image display, up to 65536 colors
- Import of 15 different image formats
- Dynamic objects
- Object parameter list, any number of data objects in a screen
- Dynamic unit of measure selection (example, °C–°F, inch–mm)
- Direct printing on panel (reports, forms)
- Many specific objects and system functions
- Simple import of PLC variables
- Full functionality always available, no graduated performance level

### System Requirements

Windows XP and Windows 7

### Product Selection

#### Galileo Development Software

| Description           | Catalog Number      |
|-----------------------|---------------------|
| Single-seat license   | <b>SW-GALILEO-S</b> |
| Multiple-seat license | <b>SW-GALILEO-M</b> |

**XSoft-CoDeSys-3 Software**

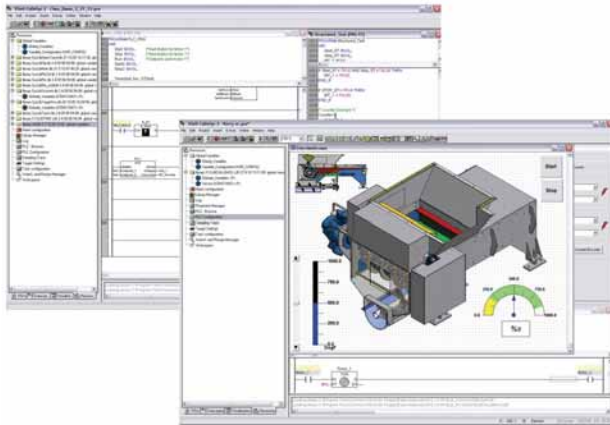

**Contents**

| <i><b>Description</b></i>                                     | <i><b>Page</b></i> |
|---|--------------------|
| XP-503 with Visual Designer .....                             | <b>V7-T5-21</b>    |
| XV with Visual Designer, Galileo,<br>or XSoft-CoDeSys-3 ..... | <b>V7-T5-24</b>    |
| Visual Designer Software .....                                | <b>V7-T5-34</b>    |
| Galileo Software .....  | <b>V7-T5-37</b>    |
| XSoft-CoDeSys-3 Software .....                                |                    |

**XSoft-CoDeSys-3 Software**

**Product Description**

**Combined Logic and Visualization Development**

**IEC 61131-3 Logic Programming**

- Ladder Diagram (LD)
- Structured Text (ST)
- Sequential function chart (SFC)
- Function block diagram (FBD)
- Freely definable function block chart/continuous function chart (CFC)
- Instruction List (IL)

**Target Visualization**

Integrated design of Operator Interface screens for the XV series. Visualization and logic developed as part of the same project. Simplifies screen design and always keeps the Logic and visualization in synch.

**Web Visualization**

Optionally XSoft-CoDeSys-3 can automatically generate XML-based runtime screens to make the screens from the XV accessible remotely using a Web browser with a JavaScript plug-in such as Internet Explorer®, Firefox® and others.

**Features**

**Project Development**

- Automatic variable declaration
- On line editing
- Pop-up variable and function search/pick tools
- Automatic formatting and color coding of logic/declaration text
- Re-usable Visual-Logic Function Blocks

**Debugging and commissioning**

XSoft-CoDeSys-3 offers you a number of important functions for debugging, testing and commissioning your XV applications quickly and efficiently.

All these features are available as soon as you log on to the XV (online mode) over an Ethernet connection.

**Simulation**

Users can also test the application when the XV is not connected to the process. This is possible thanks to the integrated online simulation feature. Simulation supports both the screens and logic that have been designed using XSoft-CoDeSys.

**Advanced Features**

- Up to 16 time and/or event driven tasks per project
- Each task can include multiple logic programs or subroutines
- Programs and screen designs can be exported and imported to support reuse
- Powerful, built-in function block libraries
- Ability to create user-defined function blocks
- Fieldbus Configurator for CANopen, PROFIBUS-DP and SmartWire-DT device I/O
- Ethernet and serial communication function blocks (OPC server, UDP, TCP/IP, FTP client/ server, Modbus Master/Slave, email, SMS, and more)
- 8-level password protection
- Web access selectable per screen
- System function libraries (OS Storage Card, and more)
- Online and historical alarms
- Online and historical trends

**System Requirements**

Windows XP and Windows 7 32-bit systems

**Product Selection**

| <b>XSoft-CoDeSys-3</b> | <b>XSoft-CoDeSys-3 Software</b> |                             |
|------------------------|---------------------------------|-----------------------------|
|                        | <b>Description</b>              | <b>Catalog Number</b>       |
|                        | Single Seat License             | <b>SW-XSOFT-CODESYS-3-S</b> |
|                        | Multiple Seat License (3)       | <b>SW-XSOFT-CODESYS-3-M</b> |

## Power Supply



## 6.1 General Purpose and Sensor Power Supplies

|                               |                 |
|-------------------------------|-----------------|
| Product Selection Guide ..... | <b>V7-T6-2</b>  |
| PSG Series .....              | <b>V7-T6-3</b>  |
| ELC Series .....              | <b>V7-T6-22</b> |
| easyRelay Power Supply .....  | <b>V7-T6-25</b> |
| Sensor Power Supply .....     | <b>V7-T6-29</b> |

# 6.1

## Power Supplies

### General-Purpose and Sensor Power Supplies

6

#### Power Supplies



#### Contents

##### Description

##### Page

|   |          |
|---|----------|
| General-Purpose and Sensor Power Supplies |          |
| PSG Series                                | V7-T6-3  |
| ELC Series                                | V7-T6-22 |
| easyRelay Power Supply                    | V7-T6-25 |
| Sensor Power Supply                       | V7-T6-29 |

### Product Selection Guide

#### Power Supply Series and Features



**PSG Series**



**ELC Series**



**easyRelay Power Series**



**Sensor Power Supplies**

|  | PSG Series  | ELC Series  | easyRelay Power Series  | Sensor Power Supplies   |
|--|---|---|---|---|
| <b>Features</b>                          | <ul style="list-style-type: none"> <li>General-purpose 12 Vdc and 24 Vdc output for 1.25A to 40A loads</li> <li>Single-phase and three-phase inputs up to 500 Vac</li> <li>150% power surge output</li> <li>Redundancy modules</li> <li>Buffer module</li> <li>DIN rail mount</li> <li>Rugged metal and plastic housing options</li> <li>Heavy-duty screw and finger-safe terminals</li> <li>Hazardous Location Class I, Division 2 rated models</li> <li>NEC® Class II rated model</li> <li>Protection from overvoltage, overcurrent and overtemperature conditions</li> </ul> | <ul style="list-style-type: none"> <li>Compact, low cost 24 Vdc control for loads up to 2A</li> <li>Plastic enclosure can be DIN rail or panel mounted</li> <li>Single-phase (100–240 Vac) input</li> </ul> | <ul style="list-style-type: none"> <li>Low profile power supplies for 12 Vdc or 24 Vdc applications</li> <li>8W, 30W, 60W or 100W output power</li> <li>easyRelay styling provides optimal panel aesthetics</li> <li>Plastic enclosure can be DIN rail or panel mounted (with optional kit)</li> <li>CSA Class 1, Division 2 qualified</li> <li>Single-phase (100–240 Vac) input</li> </ul> | <ul style="list-style-type: none"> <li>27 Vdc supplies for tough sensor applications</li> <li>Rugged housings with integrated junction box for mounting outside of electrical enclosures</li> <li>Advanced diagnostic features</li> </ul> |
| <b>Product Selection</b>                 | Page V7-T6-4  | Page V7-T6-23   | Page V7-T6-26   | Page V7-T6-30   |
| <b>Technical Data and Specifications</b> | Page V7-T6-5  | Page V7-T6-23   | Page V7-T6-27   | Page V7-T6-30   |
| <b>Dimensions</b>                        | Page V7-T6-16   | Page V7-T6-24   | Page V7-T6-28   | Page V7-T6-31   |

PSG Series



PSG Series

Product Description

Eaton’s PSG Series of power supplies is designed to be a high-performance, high-quality line of products covering a majority of 12 Vdc and 24 Vdc control applications. With global certifications, a compact size and an impressive operating temperature range, the PSG Series fits a wide variety of applications at a competitive price.

Our expansive 22 model offering is able to provide solutions for most applications with PSG outputs ranging from 12 Vdc at 1.25A up to 24 Vdc at 40A, plus redundancy and buffer modules to ensure uptime.

Application Description

The PSG Series is a line of general-purpose power supplies for use in a wide variety of industrial control applications. Applications include communication networks, sensors, PLCs and many other electrical systems. Each model is equipped with the options of a rugged metal or plastic housing, heavy-duty screw or finger-safe terminals and a variety of protection features, making the PSG one of the most versatile industrial power supply lines on the market.

Contents

| <b>Description</b>                          | <b>Page</b>     |
|---|-----------------|
| PSG Series                                  |                 |
| Catalog Number Selection . . . . .          | <b>V7-T6-4</b>  |
| Technical Data and Specifications . . . . . | <b>V7-T6-5</b>  |
| Power Derating Curves . . . . .             | <b>V7-T6-13</b> |
| Dimensions . . . . .                        | <b>V7-T6-16</b> |
| ELC Series . . . . .                        | <b>V7-T6-22</b> |
| easyRelay Power Supply . . . . .            | <b>V7-T6-25</b> |
| Sensor Power Supply . . . . .               | <b>V7-T6-29</b> |

Features, Benefits and Functions

- Universal input voltages: 100–240 Vac for single-phase units, 400–500 Vac for three-phase units
- General-purpose 12 Vdc and 24 Vdc adjustable output
- 150% power surge output
- Wide operating temperature range: –25°C to +80°C
- MTBF up to 1,000,000 hours ensures uptime and reliability
- Protection from overvoltage, overcurrent and over-temperature conditions
- Rugged aluminum and plastic housings provide the durability required to stand up to harsh environments
- All-metal DIN rail mounting hardware
- Heavy-duty screw and finger-safe terminals
- LED indicating light for DC OK simplifies troubleshooting
- Conformal coated electronics
- Hazardous Location Class I, Division 2 rated models
- NEC® Class II rated model
- Redundancy modules keep loads up and running in the event of a device failure
- Buffer module has the stored power needed to keep loads running through a short duration power failure
- Three-year standard warranty

Standards and Certifications

- cULus listed—UL 508
- CSA listed—CSA 22.2 No. 107.1-01
- Hazardous Location, Class I, Div. 2, Groups A, B, C, D
- IEC
- EN
- NEC Class 2

- CE marked
- RoHS compliant



**Note:** Some models may not carry all certifications listed.

# 6.1

## Power Supplies

### General-Purpose and Sensor Power Supplies

#### Catalog Number Selection

##### PSG Series

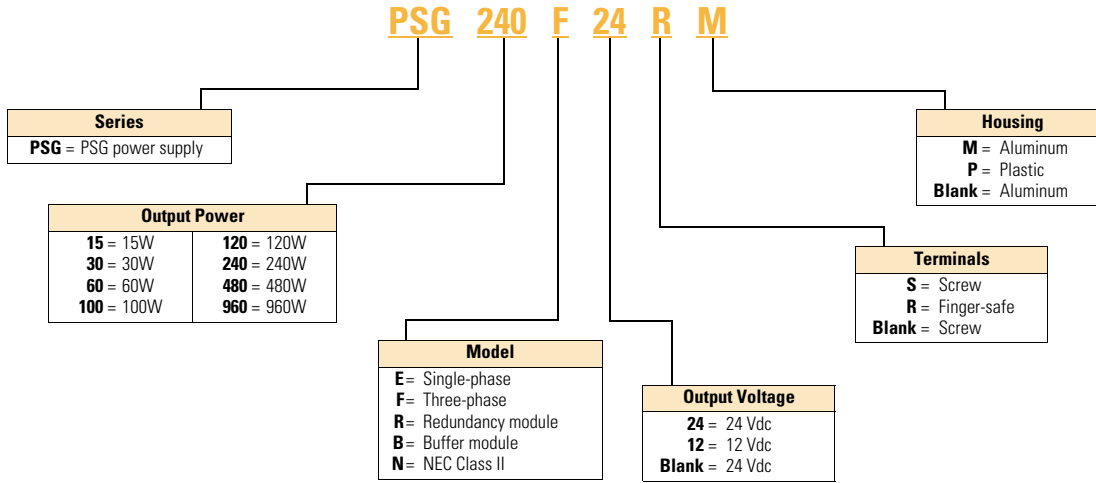

**Note:** Not all combinations are available. See Pages **V7-T6-5–V7-T6-12** for all available combinations.

## Technical Data and Specifications

### PSG Series

|  | Single-Phase<br>PSG15E12SP          | PSG30E12SP                     | PSG60E12SM                     | PSG100E12SM                             | PSG60E  | PSG60E24SP  | PSG60E24RM  |
|--|-------------------------------------|--------------------------------|--------------------------------|---|---|---|---|
| <b>Input</b>   |                                     |                                |                                |   |   |   |   |
| Nominal voltage  | 100–240 Vac                         | 100–240 Vac                    | 100–240 Vac                    | 100–240 Vac                             | 100–240 Vac   | 100–240 Vac   | 100–240 Vac   |
| AC input range   | 85–264 Vac                          | 85–264 Vac                     | 85–264 Vac                     | 85–264 Vac                              | 85–264 Vac  | 85–264 Vac  | 85–264 Vac  |
| DC input range   | 120–375 Vdc                         | 120–375 Vdc                    | 120–375 Vdc                    | 120–375 Vdc                             | 120–375 Vdc   | 120–375 Vdc   | 120–375 Vdc   |
| Frequency  | 47–63 Hz                            | 47–63 Hz                       | 47–63 Hz                       | 47–63 Hz                                | 47–63 Hz  | 47–63 Hz  | 47–63 Hz  |
| Nominal current <sup>①</sup>                           | <0.37A                              | <0.7A                          | <1.35A                         | <2.5A                                   | 1.1A  | <1.10A  | <1.4A   |
| Inrush current limitation <sup>①</sup>                 | <30A                                | <30A                           | <50A                           | <100A                                   | 30A   | <40A  | <20A  |
| Internal fuse  | T3.15AH / 250V                      | T3.15AH / 250V                 | T3.15AH / 250V                 | T3.15AH / 250V                          | T3.15AH / 250V                                      | T3.15AH / 250V                                      | T3.15AH / 250V                                      |
| External fusing  | 4A or 6A                            | 4A or 6A                       | 6A, 10A or 16A                 | 6A, 10A or 16A                          | 6A, 10A or 16A                                      | 6A, 10A or 16A                                      | 6A, 10A or 16A                                      |
| Leakage current  | <1 mA                               | <1 mA                          | <1 mA                          | <1 mA                                   | <1 mA   | <1 mA   | <1 mA   |
| <b>Output</b>  |                                     |                                |                                |   |   |   |   |
| Power  | 15W                                 | 30W                            | 60W                            | 100W                                    | 60W   | 60W   | 60W   |
| Nominal output voltage                                 | 12 Vdc ±2%                          | 12 Vdc ±2%                     | 12 Vdc ±2%                     | 12 Vdc ±2%                              | 24 Vdc ±2%  | 24 Vdc ±2%  | 24 Vdc ±2%  |
| Adjustment range                                       | 11–14 Vdc                           | 11–14 Vdc                      | 11–14 Vdc                      | 11–14 Vdc                               | 22–28 Vdc   | 22–28 Vdc   | 24–28 Vdc   |
| Nominal current  | 1.25A                               | 2.5A                           | 5A                             | 8.33A                                   | 2.5A  | 2.5A  | 2.5A  |
| Startup with capacitive loads                          | Max. 5000 µF                        | Max. 6600 µF                   | Max. 8000 µF                   | Max. 10,000 µF                          | Max. 8000 µF  | Max. 8000 µF  | Max. 8000 µF  |
| Efficiency   | >84% at 115 Vac,<br>>83% at 230 Vac | >85% at 115 Vac<br>and 230 Vac | >85% at 115 Vac<br>and 230 Vac | >85.5% at 115 Vac,<br>>87.5% at 230 Vac | >85% typ  | >86% at 115 Vac,<br>>87% at 230 Vac                 | >90% at 115 Vac<br>and 230 Vac                      |
| Current surge  | 1.875A                              | 3.75A                          | 7.5A                           | 12.495A                                 | 3.75A   | 3.75A   | 3.75A   |
| Current surge time                                     | 3s                                  | 3s                             | 3s                             | 3s                                      | 1s (at 10s intervals)                               | 3s  | 5s  |
| Residual ripple/peak switching<br>(20 MHz)             | <100m Vpp                           | <100m Vpp                      | <100m Vpp                      | <100m Vpp                               | <50m V /<br><240m Vpp                               | <50m V /<br><240m Vpp                               | <50m Vpp /<br><150m Vpp                             |
| Turn-on time   | <2.5s                               | <2.5s                          | <2.5s                          | <0.6s                                   | <2.5s   | <3s   | <2s   |
| Mains buffering at nominal<br>load (typ.) <sup>①</sup> | >22 ms                              | >22 ms                         | >22 ms                         | >22 ms                                  | >20 ms  | >20 ms  | >20 ms  |
| Parallel operation                                     | With o-ring diode                   | With o-ring diode              | With o-ring diode              | With o-ring diode                       | PSG480R24RM /<br>PSG960R24RM /<br>With o-ring diode | PSG480R24RM /<br>PSG960R24RM /<br>With o-ring diode | PSG480R24RM /<br>PSG960R24RM /<br>With o-ring diode |
| <b>Galvanic Isolation</b>                              |                                     |                                |                                |   |   |   |   |
| Input/output   | 4k Vac                              | 4k Vac                         | 4k Vac                         | 4k Vac                                  | 4k Vac (type test) /<br>3k Vac (routine test)       | 4k Vac  | 4k Vac  |
| Input/ground   | 1.5k Vac                            | 1.5k Vac                       | 1.5k Vac                       | 1.5k Vac                                | 1.5k Vac (type test) /<br>1.5k Vac (routine test)   | 1.5k Vac  | 1.5k Vac  |
| Output/ground  | 1.5k Vac                            | 1.5k Vac                       | 1.5k Vac                       | 1.5k Vac                                | 1.5k Vac (type test) /<br>500 Vac (routine test)    | 1.5k Vac  | 1.5k Vac  |
| <b>General/Physical Data</b>                           |                                     |                                |                                |   |   |   |   |
| Housing material                                       | Plastic                             | Plastic                        | Aluminum                       | Aluminum                                | Aluminum  | Plastic   | Aluminum  |
| Signals  | Green LED for DC OK                 | Green LED for DC OK            | Green LED for DC OK            | Green LED for DC OK                     | Green LED for DC OK                                 | Green LED for DC OK                                 | Green LED for DC OK                                 |
| MTBF   | >1,000,000 hr                       | >1,000,000 hr                  | >800,000 hr                    | >800,000 hr                             | >800,000 hr   | >800,000 hr   | >1,000,000 hr                                       |
| Dimensions (L)   | 100 mm                              | 100 mm                         | 121 mm                         | 121 mm                                  | 121 mm  | 120.6 mm  | 121 mm  |
| Dimensions (W)   | 32 mm                               | 32 mm                          | 32 mm                          | 50 mm                                   | 32 mm   | 32 mm   | 32 mm   |
| Dimensions (H)   | 100.6 mm                            | 100.6 mm                       | 120 mm                         | 118.7 mm                                | 120 mm  | 113 mm  | 125 mm  |
| Weight (kg)  | 0.18                                | 0.2                            | 0.33                           | 0.64                                    | 0.37  | 0.33  | 0.37  |
| Terminals  | Screw                               | Screw                          | Screw                          | Screw                                   | Screw   | Screw   | Finger-safe,<br>removable                           |
| Wire size  | AWG 22–14                           | AWG 22–14                      | AWG 22–14                      | AWG 18–24                               | AWG 22–14   | AWG 22–14   | AWG 22–12   |
| Operating temperature                                  | –20°C to +75°C                      | –20°C to +75°C                 | –20°C to +75°C                 | –20°C to +75°C                          | –20°C to +75°C                                      | –20°C to +75°C                                      | –20°C to +80°C                                      |
| Storage temperature                                    | –25°C to +85°C                      | –25°C to +85°C                 | –25°C to +85°C                 | –25°C to +85°C                          | –25°C to +85°C                                      | –25°C to +85°C                                      | –25°C to +85°C                                      |

#### Note

<sup>①</sup> Ratings for single-phase models are at 115 Vac; three-phase models are at 400 Vac.



# 6.1

## Power Supplies

### General-Purpose and Sensor Power Supplies

#### PSG Series, continued

|  | Single-Phase<br>PSG15E12SP  | PSG30E12SP   | PSG60E12SM   | PSG100E12SM  | PSG60E   | PSG60E24SP   | PSG60E24RM   |
|--|---|--|--|--|--|--|--|
| <b>General/Physical Data, continued</b>            |   |  |  |  |  |  |  |
| Power derating—<br>vertical mounting               | >50°C derate<br>power by 2.5% / °C,<br>>70°C derate<br>power by 4% / °C   | >50°C derate<br>power by 2.5% / °C,<br>>70°C derate<br>power by 4% / °C        | >50°C derate<br>power by 2.5% / °C,<br>>70°C derate<br>power by 4% / °C        | >50°C derate<br>power by 2.5% / °C   | >50°C derate<br>power by 2.5% / °C   | <0°C to –20°C derate<br>power by 1% / °C,<br>>50°C derate<br>power by 2.5% / °C,<br>>70°C derate<br>power by 4% / °C | >50°C derate<br>power by 2.5% / °C   |
| Power derating—<br>horizontal mounting             | N/A   | N/A  | N/A  | >50°C derate<br>power by 2.5% / °C,<br>>70°C derate power<br>by 4% / °C        | N/A  | N/A  | >50°C derate<br>power by 2.5% / °C   |
| Operating humidity                                 | <95% RH,<br>noncondensing   | <95% RH,<br>noncondensing  | <95% RH,<br>noncondensing  | <95% RH,<br>noncondensing  | <95% RH,<br>noncondensing  | <95% RH,<br>noncondensing  | <95% RH,<br>noncondensing  |
| Vibration  | 10 to 150 Hz, 0.35 mm acc. 50 m/s <sup>2</sup> , single amplitude (5G max.) for 90 min. in each X, Y and Z directions, in accordance with IEC 60068-2-6 |  |  |  |  |  |  |
| Pollution degree                                   | 2   | 2  | 2  | 2  | 2  | 2  | 2  |
| Climatic class                                     | 3K3 according to<br>EN 60721  | 3K3 according to<br>EN 60721   | 3K3 according to<br>EN 60721   | 3K3 according to<br>EN 60721   | 3K3 according to<br>EN 60721   | 3K3 according to<br>EN 60721   | 3K3 according to<br>EN 60721   |
| <b>Safety and Protection</b>                       |   |  |  |  |  |  |  |
| Transient surge voltage                            | Varistor  | Varistor   | Varistor   | Varistor   | Varistor   | Varistor   | Varistor   |
| Surge voltage protection against<br>internal surge | Yes   | Yes  | Yes  | Yes  | Yes  | Yes  | Yes  |
| Safety class                                       | Class I with ground<br>connection   | Class I with ground<br>connection  | Class I with ground<br>connection  | Class I with ground<br>connection  | Class I with ground<br>connection  | Class I with ground<br>connection  | Class I with ground<br>connection  |
| Shock  | 30G (300 m/s <sup>2</sup> ) in all<br>directions according<br>to IEC60068-2-27  | 30G (300 m/s <sup>2</sup> ) in all<br>directions according<br>to IEC60068-2-27 | 30G (300 m/s <sup>2</sup> ) in all<br>directions according<br>to IEC60068-2-27 | 30G (300 m/s <sup>2</sup> ) in all<br>directions according<br>to IEC60068-2-27 | 30G (300 m/s <sup>2</sup> ) in all<br>directions according<br>to IEC60068-2-27 | 30G (300 m/s <sup>2</sup> ) in all<br>directions according<br>to IEC60068-2-27                                       | 30G (300 m/s <sup>2</sup> ) in all<br>directions according<br>to IEC60068-2-27 |

## General-Purpose and Sensor Power Supplies

## PSG Series, continued

|  | Single-Phase, continued                             |   |   |   |   |   |   |
|--|---|---|---|---|---|---|---|
|  | PSG60N24RP  | PSG120E   | PSG120E24RM   | PSG240E   | PSG240E24RM   | PSG480E   | PSG480E24RM   |
| <b>Input</b>   |   |   |   |   |   |   |   |
| Nominal voltage  | 100–240 Vac   | 100–240 Vac   | 100–240 Vac   | 100–240 Vac   | 100–240 Vac   | 100–240 Vac   | 100–240 Vac   |
| AC input range   | 85–264 Vac  | 85–264 Vac  | 85–264 Vac  | 85–264 Vac  | 85–264 Vac  | 85–264 Vac  | 85–264 Vac  |
| DC input range   | N/A   | 120–375 Vdc   | 120–375 Vdc   | 120–375 Vdc   | 120–375 Vdc   | 120–375 Vdc   | 120–375 Vdc   |
| Frequency  | 47–63 Hz  | 47–63 Hz  | 47–63 Hz  | 47–63 Hz  | 47–63 Hz  | 47–63 Hz  | 47–63 Hz  |
| Nominal current <sup>①</sup>                           | <1.5A at 100 Vac                                    | 1.4A  | <2.2A   | 2.9A  | <2.5A   | 5.7A  | <5A   |
| Inrush current limitation <sup>①</sup>                 | <40A  | <80A  | <35A  | N/A   | <35A  | N/A   | <35A  |
| Internal fuse  | T3.15AH / 250V                                      | T3.15AH / 250V                                      | T4AH / 250V   | T6.3AH / 250V                                       | T6.3AH / 250V                                       | F10H / 250A   | T8AH / 250V   |
| External fusing  | 6A, 10A or 16A                                      | 6A, 10A or 16A                                      | 6A, 10A or 16A                                      | 10A or 16A  | 10A or 16A  | 10A or 16A  | 10A or 16A  |
| Leakage current  | <1 mA   | <1 mA   | <1 mA   | <3.5 mA   | <1 mA   | <1 mA   | <3 mA   |
| <b>Output</b>  |   |   |   |   |   |   |   |
| Power  | 60W   | 120W  | 120W  | 240W  | 240W  | 480W  | 480W  |
| Nominal output voltage                                 | 24 Vdc ±2%  | 24 Vdc ±2%  | 24 Vdc ±2%  | 24 Vdc ±2%  | 24 Vdc ±2%  | 24 Vdc ±2%  | 24 Vdc ±2%  |
| Adjustment range                                       | 22–28 Vdc   | 22–28 Vdc   | 24–28 Vdc   | 22–28 Vdc   | 24–28 Vdc   | 22–28 Vdc   | 22–28 Vdc   |
| Nominal current  | 2.5A  | 5A  | 5A  | 10A   | 10A   | 20A   | 20A   |
| Startup with capacitive loads                          | Max. 8000 µF  | Max. 10,000 µF                                      | Max. 10,000 µF                                      | Max. 10,000 µF                                      | Max. 10,000 µF                                      | Max. 10,000 µF                                      | Max. 10,000 µF                                      |
| Efficiency   | >86% at 115 Vac,<br>>87% at 230 Vac                 | >84% typ  | >89% at 115 Vac,<br>>90% at 230 Vac                 | >84% typ  | >90% at 115 Vac<br>and 230 Vac                      | >86% typ  | >90% at 115 Vac<br>and 230 Vac                      |
| Current surge  | N/A   | 7.5A  | 7.5A  | 15A   | 15A   | 30A   | 30A   |
| Current surge time                                     | N/A   | 1s (at 10s intervals)                               | 5s  | 1s (at 10s intervals)                               | 5s  | 1s (at 10s intervals)                               | 5s  |
| Residual ripple/peak switching<br>(20 MHz)             | <50m Vpp /<br><240m Vpp                             | <50m V /<br><240m Vpp                               | <50m Vpp /<br><150m Vpp                             | <50m V /<br><240m Vpp                               | <50m Vpp /<br><150m Vpp                             | <50m V /<br><240m Vpp                               | <50m Vpp  |
| Turn-on time   | <3s   | <1s   | <1s   | <1s   | <1s   | <1s   | <1s   |
| Mains buffering at nominal<br>load (typ.) <sup>①</sup> | >20 ms  | >35ms   | >20 ms  | >20 ms  | >20 ms  | >20 ms  | >20 ms  |
| Parallel operation                                     | PSG480R24RM /<br>PSG960R24RM /<br>With o-ring diode | PSG480R24RM /<br>PSG960R24RM /<br>With o-ring diode | PSG480R24RM /<br>PSG960R24RM /<br>With o-ring diode | PSG480R24RM /<br>PSG960R24RM /<br>With o-ring diode | PSG480R24RM /<br>PSG960R24RM /<br>With o-ring diode | PSG480R24RM /<br>PSG960R24RM /<br>With o-ring diode | PSG480R24RM /<br>PSG960R24RM /<br>With o-ring diode |
| <b>Galvanic Isolation</b>                              |   |   |   |   |   |   |   |
| Input/output   | 4k Vac  | 4k Vac (type test) /<br>3k Vac (routine test)       | 4k Vac  | 4k Vac (type test) /<br>3k Vac (routine test)       | 4k Vac  | 4k Vac (type test) /<br>3k Vac (routine test)       | 4k Vac  |
| Input/ground   | 1.5k Vac  | 1.5k Vac (type test) /<br>1.5k Vac (routine test)   | 1.5k Vac  | 1.5k Vac (type test) /<br>1.5k Vac (routine test)   | 1.5k Vac  | 1.5k Vac (type test) /<br>1.5k Vac (routine test)   | 1.5k Vac  |
| Output/ground  | 1.5k Vac  | 1.5k Vac (type test) /<br>500 Vac (routine test)    | 1.5k Vac  | 1.5k Vac (type test) /<br>500 Vac (routine test)    | 1.5k Vac  | 1.5k Vac (type test) /<br>500 Vac (routine test)    | 1.5k Vac  |
| <b>General/Physical Data</b>                           |   |   |   |   |   |   |   |
| Housing material                                       | Aluminum  | Aluminum  | Aluminum  | Aluminum  | Aluminum  | Aluminum  | Aluminum  |
| Signals  | Green LED for DC OK                                 | Green LED for DC OK                                 | Green LED for DC OK                                 | Green LED for DC OK                                 | Green LED for DC OK                                 | Green LED for DC OK                                 | Green LED for DC OK                                 |
| MTBF   | >800,000 hr   | >800,000 hr   | >800,000 hr   | >300,000 hr   | >500,000 hr   | >300,000 hr   | >500,000 hr   |
| Dimensions (L)   | 120.6 mm  | 121 mm  | 121 mm  | 121 mm  | 121 mm  | 121 mm  | 121 mm  |
| Dimensions (W)   | 32 mm   | 32 mm   | 50 mm   | 85 mm   | 85 mm   | 160 mm  | 144 mm  |
| Dimensions (H)   | 119.3 mm  | 120 mm  | 123.1 mm  | 118.5 mm  | 124.1 mm  | 115 mm  | 118.6 mm  |
| Weight (kg)  | 0.33  | 0.54  | 0.72  | 1.04  | 1.1   | 1.8   | 1.37  |
| Terminals  | Finger-safe, fixed                                  | Screw   | Finger-safe,<br>removable                           | Screw   | Finger-safe,<br>removable                           | Screw   | Finger-safe, fixed                                  |
| Wire size  | AWG 22–10   | AWG 22–14   | AWG 20–12   | AWG 22–14   | AWG 16–12   | AWG 16–14 (input)<br>AWG 12–10 (output)             | AWG 18–10   |
| Operating temperature                                  | –20°C to +80°C                                      | –20°C to +75°C                                      | –20°C to +80°C                                      | –20°C to +75°C                                      | –20°C to +80°C                                      | –20°C to +75°C                                      | –25°C to +75°C                                      |
| Storage temperature                                    | –25°C to +85°C                                      | –25°C to +85°C                                      | –25°C to +85°C                                      | –25°C to +85°C                                      | –25°C to +85°C                                      | –25°C to +85°C                                      | –25°C to +85°C                                      |

**Note**

<sup>①</sup> Ratings for single-phase models are at 115 Vac; three-phase models are at 400 Vac.

# 6.1

## Power Supplies

### General-Purpose and Sensor Power Supplies

#### PSG Series, continued

##### Single-Phase, continued

PSG60N24RP    PSG120E    PSG120E24RM    PSG240E    PSG240E24RM    PSG480E    PSG480E24RM

#### General/Physical Data, continued

|  |   |   |   |   |   |   |   |
|--|---|---|---|---|---|---|---|
| Power derating—<br>vertical mounting   | >50°C derate power<br>by 2.5% / °C,<br>>70°C derate power<br>by 4% / °C   | >50°C derate power<br>by 2.5% / °C  | >50°C derate power<br>by 2.5% / °C  | >50°C derate power<br>by 2.5% / °C,<br>>70°C derate power<br>by 4% / °C   | >50°C derate power<br>by 2.5% / °C  | >50°C derate power<br>by 2.5% / °C  | >50°C derate power<br>by 2.5% / °C,<br>>70°C to 75°C derate<br>power by 5% / °C   |
| Power derating—<br>horizontal mounting | >50°C derate power<br>by 2.5% / °C,<br>>70°C derate power<br>by 4% / °C   | N/A   | >50°C derate power<br>by 2.5% / °C  | N/A   | N/A   | N/A   | N/A   |
| Operating humidity                     | <95% RH,<br>noncondensing   | <95% RH,<br>noncondensing   | <95% RH,<br>noncondensing   | <95% RH,<br>noncondensing   | <95% RH,<br>noncondensing   | <95% RH,<br>noncondensing   | <95% RH,<br>noncondensing   |
| Vibration                              | 10 to 500 Hz, 0.35 mm<br>acc. 30 m/s <sup>2</sup> , single<br>amplitude (3G max.)<br>for 60 min. in each<br>X, Y and Z directions,<br>in accordance with<br>IEC 60068-2-6 | 10 to 150 Hz, 0.35 mm<br>acc. 50 m/s <sup>2</sup> , single<br>amplitude (5G max.)<br>for 90 min. in each<br>X, Y and Z directions,<br>in accordance with<br>IEC 60068-2-6 | 10 to 150 Hz, 0.35 mm<br>acc. 50 m/s <sup>2</sup> , single<br>amplitude (5G max.)<br>for 90 min. in each<br>X, Y and Z directions,<br>in accordance with<br>IEC 60068-2-6 | 10 to 150 Hz, 0.35 mm<br>acc. 50 m/s <sup>2</sup> , single<br>amplitude (5G max.)<br>for 90 min. in each<br>X, Y and Z directions,<br>in accordance with<br>IEC 60068-2-6 | 10 to 150 Hz, 0.35 mm<br>acc. 50 m/s <sup>2</sup> , single<br>amplitude (5G max.)<br>for 90 min. in each<br>X, Y and Z directions,<br>in accordance with<br>IEC 60068-2-6 | 10 to 150 Hz, 0.35 mm<br>acc. 50 m/s <sup>2</sup> , single<br>amplitude (5G max.)<br>for 90 min. in each<br>X, Y and Z directions,<br>in accordance with<br>IEC 60068-2-6 | 10 to 150 Hz, 0.35 mm<br>acc. 50 m/s <sup>2</sup> , single<br>amplitude (5G max.)<br>for 90 min. in each<br>X, Y and Z directions,<br>in accordance with<br>IEC 60068-2-6 |
| Pollution degree                       | 2   | 2   | 2   | 2   | 2   | 2   | 2   |
| Climatic class                         | 3K3 according to<br>EN 60721  | 3K3 according to<br>EN 60721  | 3K3 according to<br>EN 60721  | 3K3 according to<br>EN 60721  | 3K3 according to<br>EN 60721  | 3K3 according to<br>EN 60721  | 3K3 according to<br>EN 60721  |

#### Safety and Protection

|  |  |  |  |  |  |  |  |
|--|--|--|--|--|--|--|--|
| Transient surge voltage                            | Varistor   | Varistor   | Varistor   | Varistor   | Varistor   | Varistor   | Varistor   |
| Surge voltage protection against<br>internal surge | Yes  | Yes  | Yes  | Yes  | Yes  | Yes  | Yes  |
| Safety class                                       | Class I with ground<br>connection  | Class I with ground<br>connection  | Class I with ground<br>connection  | Class I with ground<br>connection  | Class I with ground<br>connection  | Class I with ground<br>connection  | Class I with ground<br>connection  |
| Shock  | 30G (300 m/s <sup>2</sup> ) in all<br>directions according<br>to IEC60068-2-27 | 30G (300 m/s <sup>2</sup> ) in all<br>directions according<br>to IEC60068-2-27 | 30G (300 m/s <sup>2</sup> ) in all<br>directions according<br>to IEC60068-2-27 | 30G (300 m/s <sup>2</sup> ) in all<br>directions according<br>to IEC60068-2-27 | 30G (300 m/s <sup>2</sup> ) in all<br>directions according<br>to IEC60068-2-27 | 30G (300 m/s <sup>2</sup> ) in all<br>directions according<br>to IEC60068-2-27 | 30G (300 m/s <sup>2</sup> ) in all<br>directions according<br>to IEC60068-2-27 |

## PSG Series, continued

|  | Three-Phase<br>PSG60F24RM                           | PSG120F24RM   | PSG240F24RM   | PSG480F24RM   | PSG960F24RM                            |
|--|---|---|---|---|--|
| <b>Input</b>   |   |   |   |   |  |
| Nominal voltage  | 3 x 400–500 Vac                                     | 3 x 400–500 Vac                                     | 3 x 400–500 Vac                                     | 3 x 400–500 Vac                                     | 3 x 400–500 Vac                        |
| AC input range   | 3 x 320–600 Vac                                     | 3 x 320–600 Vac                                     | 3 x 320–600 Vac                                     | 3 x 320–600 Vac                                     | 3 x 320–600 Vac                        |
| DC input range   | 450–800 Vdc   | 450–800 Vdc   | 450–800 Vdc   | 450–800 Vdc   | 450–800 Vdc                            |
| Frequency  | 47–63 Hz  | 47–63 Hz  | 47–63 Hz  | 47–63 Hz  | 47–63 Hz                               |
| Nominal current <sup>①</sup>                           | <0.3A   | <0.5A   | <0.75A  | <1A   | <1.7A                                  |
| Inrush current limitation <sup>①</sup>                 | <30A  | <30A  | <40A  | <50A  | <40A                                   |
| Internal fuse  | T 3.15AH / 500V, 600V                               | T 3.15AH / 500V, 600V                               | T 3.15AH / 500V, 600V                               | T 3.15AH / 500V                                     | T 4 AH / 500V                          |
| External fusing  | 3 x circuit breakers<br>6A, 10A or 16A              | 3 x circuit breakers<br>6A, 10A or 16A              | 3 x circuit breakers<br>6A, 10A or 16A              | 3 x circuit breakers<br>6A, 10A or 16A              | 3 x circuit breakers<br>10A or 16A     |
| Leakage current  | <3.5 mA   | <3.5 mA   | <3.5 mA   | <3.5 mA   | <3.5 mA                                |
| <b>Output</b>  |   |   |   |   |  |
| Power  | 60W   | 120W  | 240W  | 480W  | 960W                                   |
| Nominal output voltage                                 | 24 Vdc ±2%  | 24 Vdc ±2%  | 24 Vdc ±2%  | 24 Vdc ±2%  | 24 Vdc ±2%                             |
| Adjustment range                                       | 24–28 Vdc   | 24–28 Vdc   | 24–28 Vdc   | 24–28 Vdc   | 24–28 Vdc                              |
| Nominal current  | 2.5A  | 5A  | 10A   | 20A   | 40A                                    |
| Startup with capacitive loads                          | Max. 10,000 µF                                      | Max. 10,000 µF                                      | Max. 10,000 µF                                      | Max. 10,000 µF                                      | Max. 10,000 µF                         |
| Efficiency   | >86% at 3 x 400 Vac<br>and 3 x 500 Vac              | >88% at 3 x 400 Vac<br>and 3 x 500 Vac              | >92% at 3 x 400 Vac<br>and 3 x 500 Vac              | >91% at 3 x 400 Vac<br>and 3 x 500 Vac              | >92% at 3 x 400 Vac<br>and 3 x 500 Vac |
| Current surge  | 3.75A   | 7.5A  | 15A   | 30A   | 60A                                    |
| Current surge time                                     | 5s  | 5s  | 5s  | 5s  | 5s                                     |
| Residual ripple/peak switching<br>(20 MHz)             | <50m Vpp  | <50m Vpp  | <150m Vpp   | <150m Vpp   | <240m Vpp                              |
| Turn-on time   | <1s   | <1s   | <1s   | <1s   | <1.5s                                  |
| Mains buffering at nominal<br>load (typ.) <sup>①</sup> | >20 ms  | >20 ms  | >20 ms  | >20 ms  | >20 ms                                 |
| Parallel operation                                     | PSG480R24RM /<br>PSG960R24RM /<br>With o-ring diode | PSG480R24RM /<br>PSG960R24RM /<br>With o-ring diode | PSG480R24RM /<br>PSG960R24RM /<br>With o-ring diode | PSG480R24RM /<br>PSG960R24RM /<br>With o-ring diode | PSG960R24RM /<br>With o-ring diode     |
| <b>Galvanic Isolation</b>                              |   |   |   |   |  |
| Input/output   | 4k Vac  | 4k Vac  | 4k Vac  | 4k Vac  | 4k Vac                                 |
| Input/ground   | 2k Vac  | 2k Vac  | 2k Vac  | 2k Vac  | 2k Vac                                 |
| Output/ground  | 1.5k Vac  | 1.5k Vac  | 1.5k Vac  | 1.5k Vac  | 1.5k Vac                               |
| <b>General/Physical Data</b>                           |   |   |   |   |  |
| Housing material                                       | Aluminum  | Aluminum  | Aluminum  | Aluminum  | Aluminum                               |
| Signals  | Green LED for DC OK                                 | Green LED for DC OK                                 | Green LED for DC OK                                 | Green LED for DC OK                                 | Green LED for DC OK                    |
| MTBF   | >500,000 hr   | >500,000 hr   | >300,000 hr   | >500,000 hr   | >300,000 hr                            |
| Dimensions (L)   | 121 mm  | 121 mm  | 121 mm  | 121 mm  | 121 mm                                 |
| Dimensions (W)   | 50 mm   | 50 mm   | 70 mm   | 140 mm  | 255 mm                                 |
| Dimensions (H)   | 117.3 mm  | 117.3 mm  | 117.3 mm  | 117.3 mm  | 117.3 mm                               |
| Weight (kg)  | 0.66  | 0.66  | 0.89  | 1.35  | 2.6                                    |
| Terminals  | Finger-safe, fixed                                  | Finger-safe, fixed                                  | Finger-safe, fixed                                  | Finger-safe, fixed                                  | Finger-safe, fixed                     |
| Wire size  | AWG 18–12   | AWG 18–12   | AWG 18–12 (input)<br>AWG 16–12 (output)             | AWG 18–8 (input)<br>AWG 12–10 (output)              | AWG 18–8 (input)<br>AWG 12–10 (output) |
| Operating temperature                                  | –25°C to +75°C                                      | –25°C to +75°C                                      | –25°C to +75°C                                      | –25°C to +80°C                                      | –25°C to +65°C                         |
| Storage temperature                                    | –25°C to +85°C                                      | –25°C to +85°C                                      | –25°C to +85°C                                      | –25°C to +85°C                                      | –25°C to +85°C                         |

**Note**

<sup>①</sup> Ratings for single-phase models are at 115 Vac; three-phase models are at 400 Vac.

# 6.1

## Power Supplies

### General-Purpose and Sensor Power Supplies

#### PSG Series, continued

| <b>Three-Phase, continued</b>                      |   |   |   |   |   |
|--|---|---|---|---|---|
|  | <b>PSG60F24RM</b>   | <b>PSG120F24RM</b>  | <b>PSG240F24RM</b>  | <b>PSG480F24RM</b>  | <b>PSG960F24RM</b>  |
| <b>General/Physical Data, continued</b>            |   |   |   |   |   |
| Power derating—<br>vertical mounting               | >50°C derate power<br>by 2.5% / °C,<br>>70°C derate power<br>by 5% / °C   | >50°C derate power<br>by 2.5% / °C,<br>>70°C derate power<br>by 5% / °C     | >50°C derate power<br>by 2.5% / °C,<br>>70°C derate power<br>by 5% / °C     | >50°C derate power<br>by 2.5% / °C,<br>>70°C derate power<br>by 5% / °C     | >50°C derate power<br>by 2.5% / °C  |
| Power derating—<br>horizontal mounting             | >45°C derate power<br>by 2.5% / °C,<br>>55°C derate power<br>by 1.66% / °C,<br>>70°C derate power<br>by 5% / °C   | >40°C derate power<br>by 2.5% / °C,<br>>60°C derate power<br>by 5% / °C     | >40°C derate power<br>by 2.5% / °C,<br>>60°C derate power<br>by 5% / °C     | N/A   | N/A   |
| Operating humidity                                 | <95% RH, noncondensing  | <95% RH, noncondensing  | <95% RH, noncondensing  | 5 to 95% RH, noncondensing  | 5 to 95% RH, noncondensing  |
| Vibration  | 10 to 500 Hz, 0.35 mm acc. 30 m/s <sup>2</sup> , single amplitude (3G max.) for 60 min. in each X, Y and Z directions, in accordance with IEC 60068-2-6 |   |   |   |   |
| Pollution degree                                   | 2   | 2   | 2   | 2   | 2   |
| Climatic class                                     | 3K3 according to EN 60721   | 3K3 according to EN 60721   | 3K3 according to EN 60721   | 3K3 according to EN 60721   | 3K3 according to EN 60721   |
| <b>Safety and Protection</b>                       |   |   |   |   |   |
| Transient surge voltage                            | Varistor  | Varistor  | Varistor  | Varistor  | Varistor  |
| Surge voltage protection against<br>internal surge | Yes   | Yes   | Yes   | Yes   | Yes   |
| Safety class                                       | Class I with ground connection  |   |   |   |   |
| Shock  | 30G (300 m/s <sup>2</sup> ) in all directions<br>according to IEC60068-2-27   | 30G (300 m/s <sup>2</sup> ) in all directions<br>according to IEC60068-2-27 | 30G (300 m/s <sup>2</sup> ) in all directions<br>according to IEC60068-2-27 | 30G (300 m/s <sup>2</sup> ) in all directions<br>according to IEC60068-2-27 | 30G (300 m/s <sup>2</sup> ) in all directions<br>according to IEC60068-2-27 |

## PSG Series, continued

|                                     | Redundancy Modules   |  |
|-------------------------------------|--|--|
|                                     | PSG480R24RM  | PSG960R24RM  |
| <b>Input</b>                        |  |  |
| Nominal voltage                     | 24–48 Vdc  | 24–48 Vdc  |
| DC input range                      | 22–60 Vdc  | 22–60 Vdc  |
| Nominal current                     | <20A   | <40A   |
| Inrush current limitation           | <25A   | <50A   |
| <b>Output</b>                       |  |  |
| Nominal output voltage              | Vin–0.65V (typ.)   | Vin–0.65V (typ.)   |
| Nominal current                     | <20A   | <40A   |
| Efficiency                          | >97% typ.  | >97% typ.  |
| <b>Galvanic Isolation</b>           |  |  |
| Input/ground                        | 1.5k Vac   | 1.5k Vac   |
| Output/ground                       | 1.5k Vac   | 1.5k Vac   |
| <b>General/Physical Data</b>        |  |  |
| Housing material                    | Aluminum   | Aluminum   |
| Signals <sup>①</sup>                | Green LED for DC Vin1 OK and DC Vin2 OK  | Green LED for DC Vin1 OK and DC Vin2 OK  |
| MTBF                                | >800,000 hr  | >800,000 hr  |
| Dimensions (L)                      | 121 mm   | 121 mm   |
| Dimensions (W)                      | 50 mm  | 50 mm  |
| Dimensions (H)                      | 122.1 mm   | 122.1 mm   |
| Weight (kg)                         | 0.375  | 0.515  |
| Terminals                           | Finger safe—fixed  | Finger safe—fixed  |
| Wire size                           | AWG 12–10  | AWG 12–10  |
| Operating temperature               | –40°C to +80°C   | –40°C to +80°C   |
| Storage temperature                 | –40°C to +85°C   | –40°C to +85°C   |
| Power de-rating—vertical mounting   | > 50°C de-rate power by 2.5% / °C  | > 50°C de-rate power by 2.5% / °C  |
| Power de-rating—horizontal mounting | N/A  | N/A  |
| Operating humidity                  | < 95% RH, noncondensing  | < 95% RH, noncondensing  |
| Vibration                           | 10 to 500 Hz, 0.35 mm acc. 30m/s <sup>2</sup> , single amplitude (3G max.) for 60 min. in each X, Y and Z directions, in accordance with IEC 60068-2-6 | 10 to 500 Hz, 0.35 mm acc. 30m/s <sup>2</sup> , single amplitude (3G max.) for 60 min. in each X, Y and Z directions, in accordance with IEC 60068-2-6 |
| Pollution degree                    | 2  | 2  |
| Climatic class                      | 3K3 according to EN 60721  | 3K3 according to EN 60721  |
| <b>Safety and Protection</b>        |  |  |
| Safety class                        | Class III with ground connection   | Class III with ground connection   |
| Shock                               | 30G (300m/S <sup>2</sup> ) in all directions according to IEC 60068-2-27   | 30G (300m/S <sup>2</sup> ) in all directions according to IEC 60068-2-27   |

**Note**

<sup>①</sup> The LED will turn on when the Vin1 and Vin2 > 18V ±5% (for 24V system) or > 36V ±5% (for 48V system) and not more than 30V (for 24V system) or not more than 60V (for 48V system), the relay contacts will be closed. If Vin1 and Vin2 is under or over this range, the LED will be turned off.

## PSG Series, continued

**Buffer Module  
PSG480B24RM****Input**

|                          |  |
|--------------------------|--|
| Nominal voltage          | 24 Vdc   |
| DC input range           | 22.8–28.8 Vdc                                      |
| Maximum voltage          | 35 Vdc   |
| Current                  | Charging mode: <0.6A<br>Discharging mode: 20A max. |
| Power (standby mode)     | 2.5W average                                       |
| Maximum signal (inhibit) | 35V / 10 mA  |
| Max inrush current       | < 20A  |
| Charging time            | < 30s  |

**Output**

|                     |   |
|---------------------|---|
| Nominal voltage     | 24 Vdc typ.   |
| DC adjustment range | Switch = "Fix 22V": Buffering starts if terminal voltage falls below 22V<br>Switch = "Vin-1V" (Factory Setting): Buffering starts if terminal voltage is decreased by >1V |
| Maximum voltage     | 35 Vdc  |
| Current             | 20A max.  |
| buffering time      | 250 ms min. at 24V/20A load, 5s min. at 24V/1A load   |
| Maximum signal      | 35V / 10 mA   |
| PARD (20MHz)        | <200 mVpp   |
| Galvanic isolation  |   |
| Input/ground        | 1.5 kVac  |
| Output/ground       | 1.5 kVac  |
| Signal/ground       | 1.5 kVac  |

**General/Physical Data**

|                                   |  |
|-----------------------------------|--|
| Housing material                  | Aluminum   |
| Signals                           | Green LED off: unit is discharged or Vin < 22 Vdc<br>Green LED on: unit is fully charged<br>Green LED blinking slowly: unit is charging<br>Green LED blinking quickly: unit is discharging |
| MTBF                              | >800,000 hr  |
| Parallel connection               | Yes  |
| Series connection                 | No   |
| Dimensions (L)                    | 121 mm   |
| Dimensions (W)                    | 70 mm  |
| Dimensions (H)                    | 120.1 mm   |
| Weight (kg)                       | 0.76   |
| Terminals                         | Finger safe–fixed  |
| Wire Size                         | Input / Output: AWG 12–10<br>Signal: AWG 24–10   |
| Operating temperature             | –25°C to +75°C   |
| Storage temperature               | –25°C to +85°C   |
| Power de-rating—vertical mounting | >70°C de-rate power by 5% / °C   |
| Operating humidity                | < 95% RH, noncondensing  |
| Vibration                         | 10 to 500 Hz, 0.35 mm acc. 30m/s <sup>2</sup> , single amplitude (3G max.) for 60 min. in each X, Y and Z directions, in accordance with IEC 60068-2-6                                     |
| Pollution degree                  | 2  |

**Safety and Protection**

|              |   |
|--------------|---|
| Shock        | 30G (300m/S <sup>2</sup> ) in all directions according to IEC60068-2-27 |
| Safety class | Class I with ground connection  |

**Power Derating Curves**

**Vertical Mounting Position PSG15E12SP**

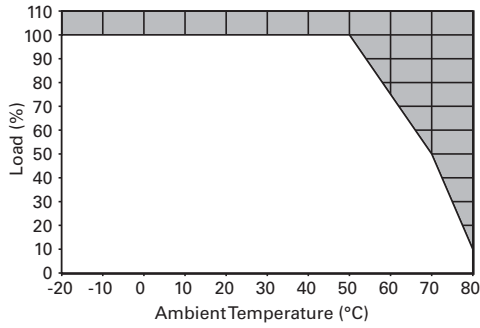

**Vertical Mounting Position PSG60E**

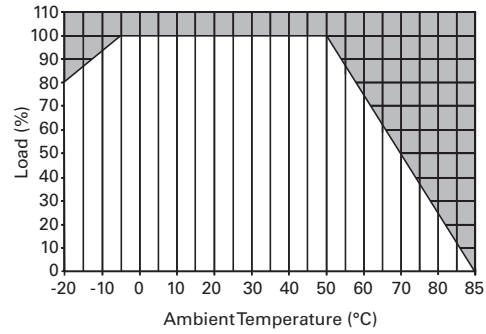

**Vertical Mounting Position PSG30E12SP**

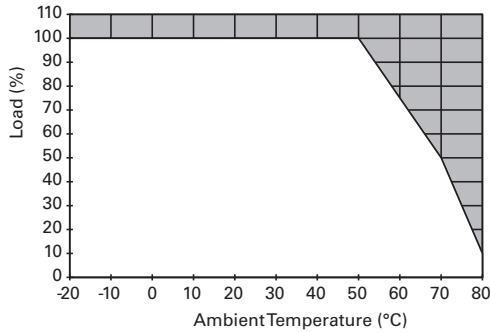

**Vertical Mounting Position PSG60E24SP**

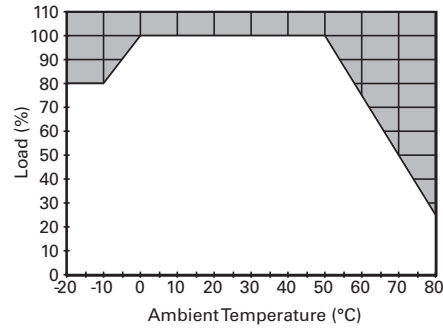

**Vertical Mounting Position PSG60E12SM**

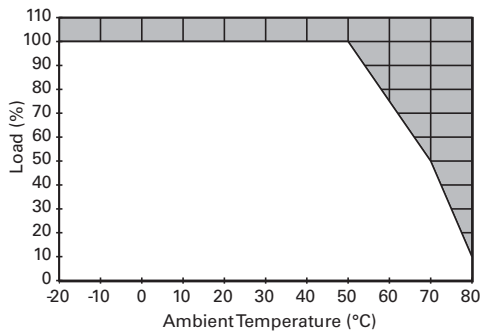

**Vertical and Horizontal Mounting Position PSG60E24RM**

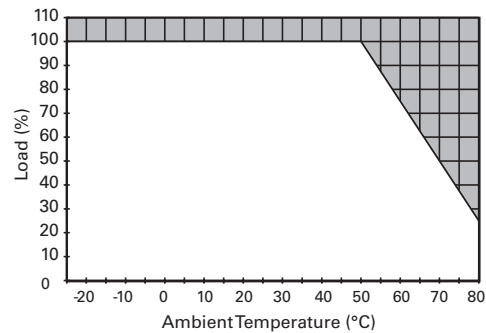

**Vertical and Horizontal Mounting Position PSG100E12SM**

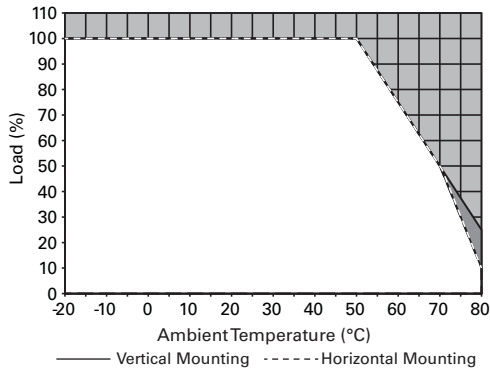

**Vertical and Horizontal Mounting Position PSG60N24RP**

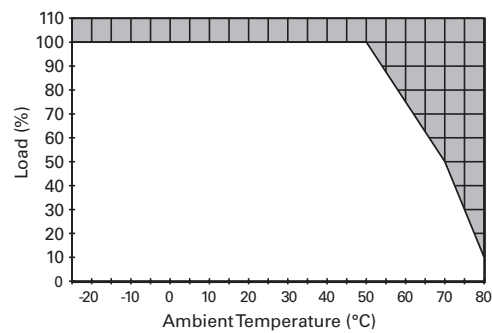



# 6.1

## Power Supplies

### General-Purpose and Sensor Power Supplies

6

**Vertical Mounting Position PSG120E**

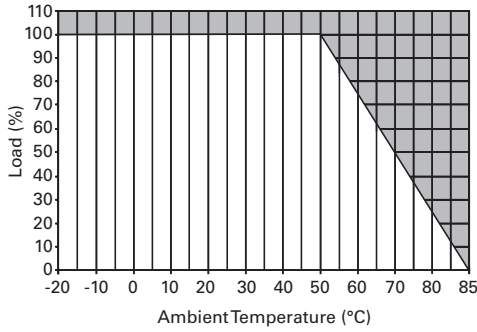

**Vertical Mounting Position PSG480E**

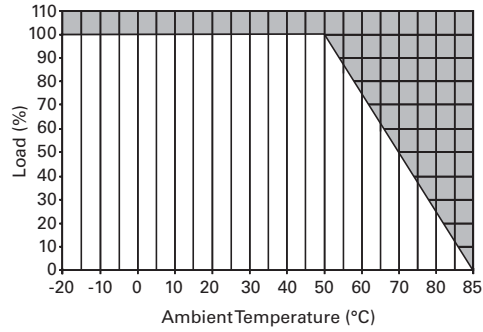

**Vertical and Horizontal Mounting Position PSG120E24RM**

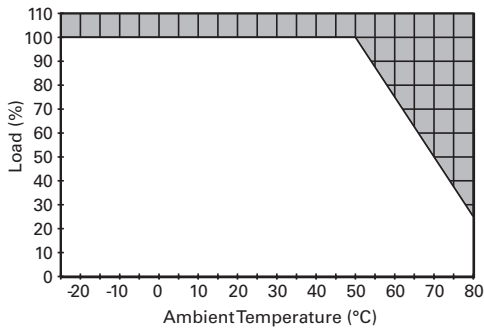

**Vertical Mounting Position PSG480E24RM**

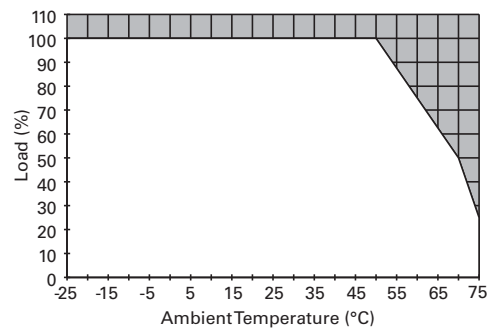

**Vertical Mounting Position PSG240E**

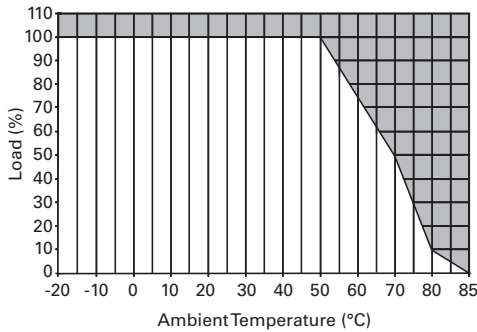

**Vertical and Horizontal Mounting Position PSG60F24RM**

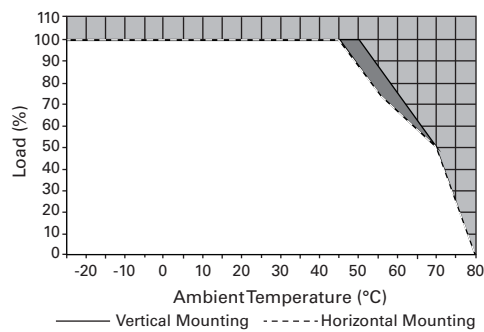

**Vertical and Horizontal Mounting Position PSG240E24RM**

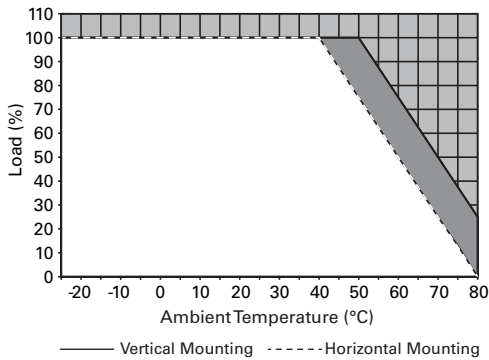

**Vertical and Horizontal Mounting Position PSG120F24RM**

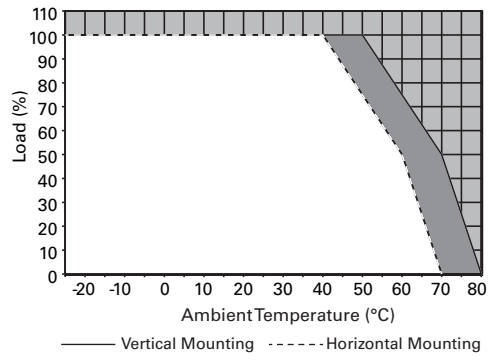

Vertical and Horizontal Mounting Position PSG240F24RM

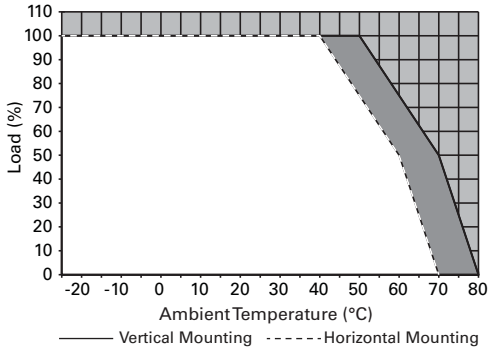

Vertical Mounting Position PSG480R24RM

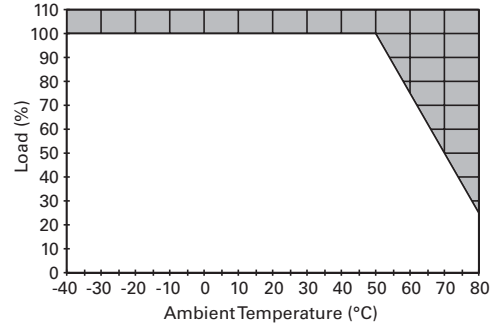

Vertical Mounting Position PSG480F24RM

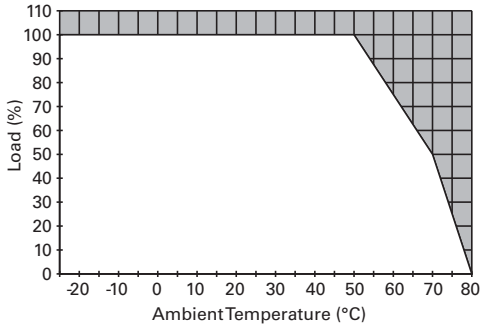

Vertical Mounting Position PSG960R24RM

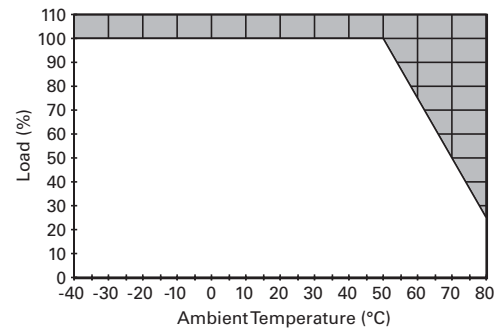

Vertical Mounting Position PSG960F24RM

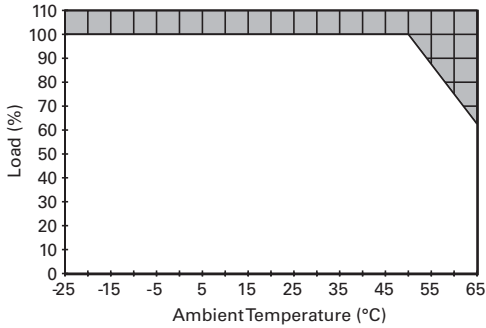

Vertical Mounting Position PSG480B24RM

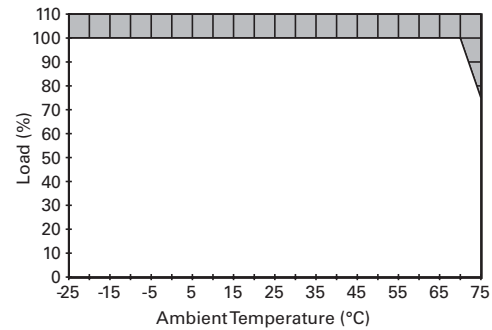

# 6.1

## Power Supplies

### General-Purpose and Sensor Power Supplies

#### Dimensions

Approximate Dimensions in mm

**Note:** Dimensions are for reference only.

#### PSG15E12SP

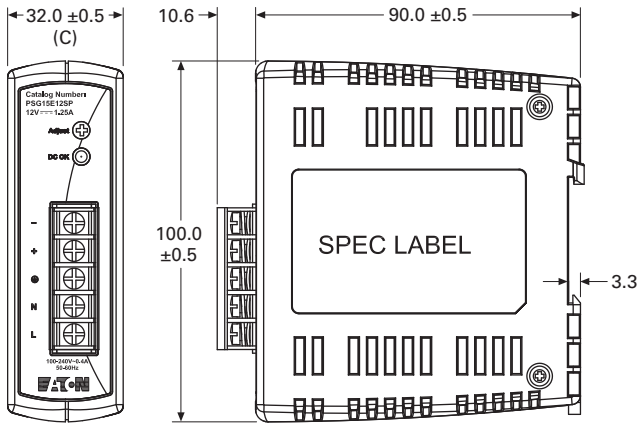

#### PSG60E12SM

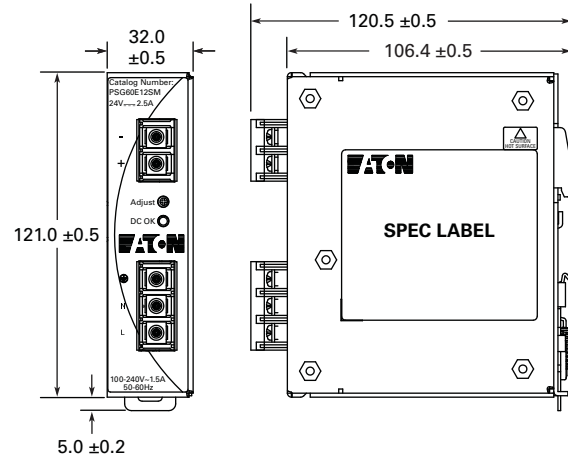

#### PSG30E12SP

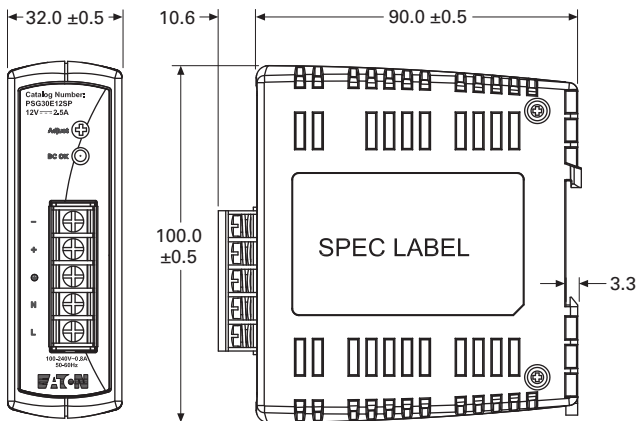

#### PSG100E12SM

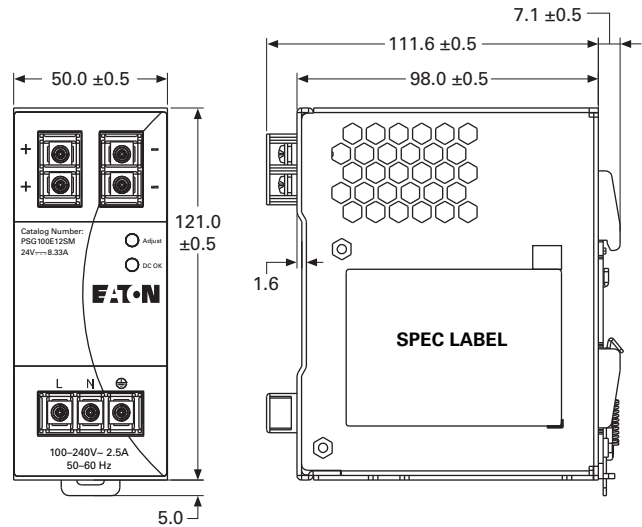

Approximate Dimensions in mm

**Note:** Dimensions are for reference only.

**PSG60E**

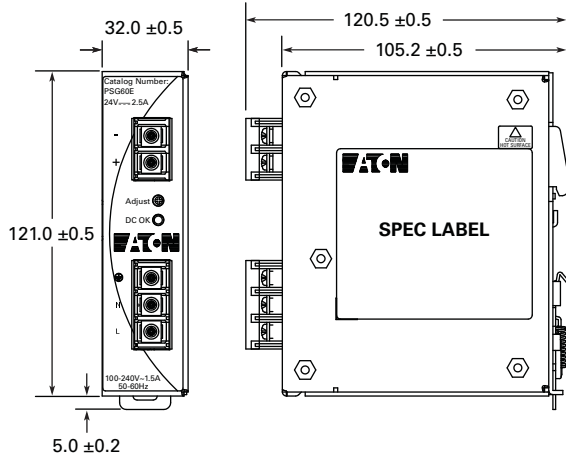

**PSG60E24RM**

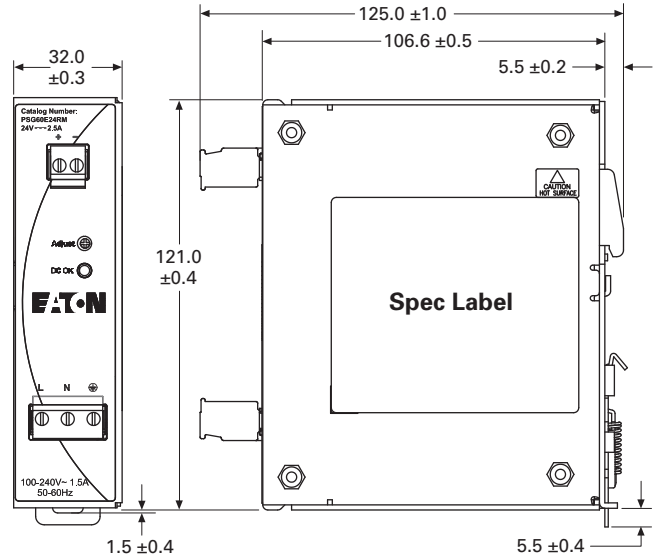

**PSG60E24SP**

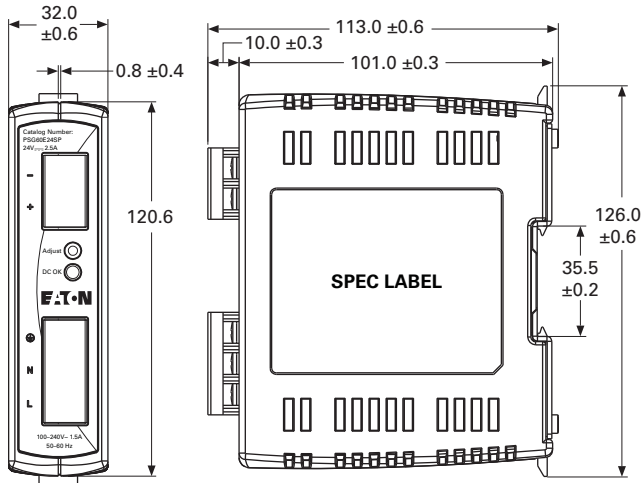

**PSG60N24RP**

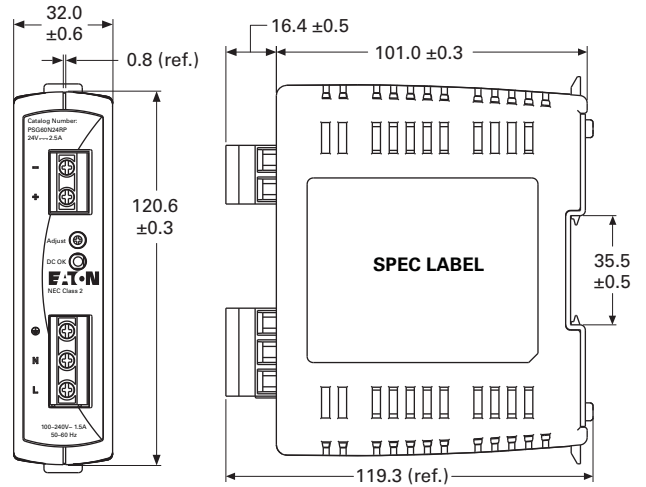

# 6.1

## Power Supplies

### General-Purpose and Sensor Power Supplies

Approximate Dimensions in mm

**Note:** Dimensions are for reference only.

#### PSG120E

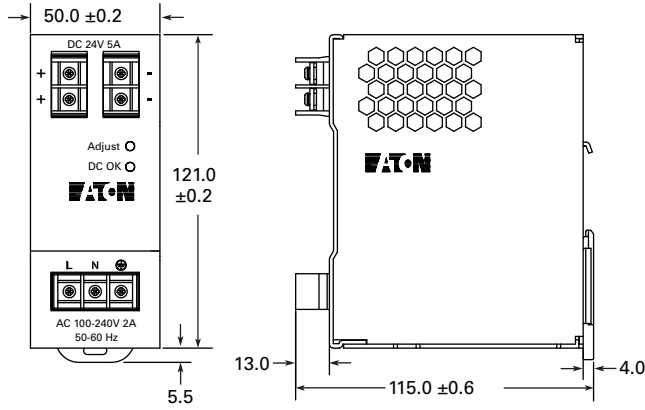

#### PSG240E

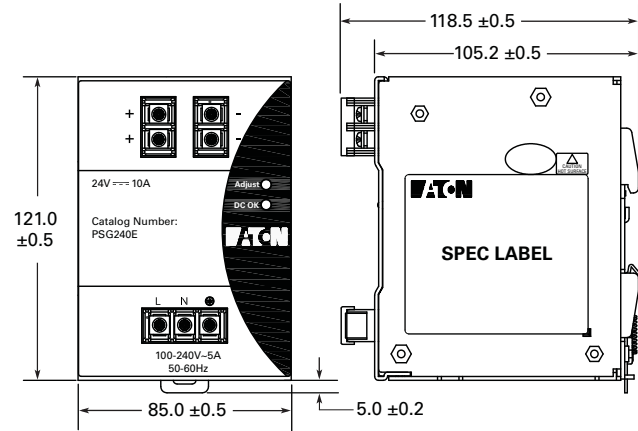

#### PSG120E24RM

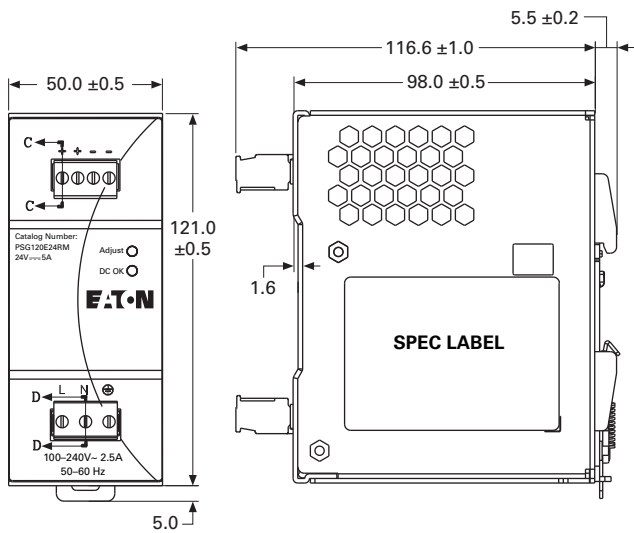

#### PSG240E24RM

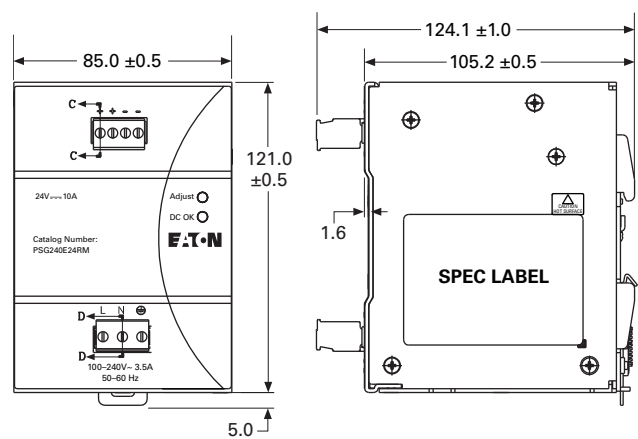

Approximate Dimensions in mm

**Note:** Dimensions are for reference only.

**PSG480E**

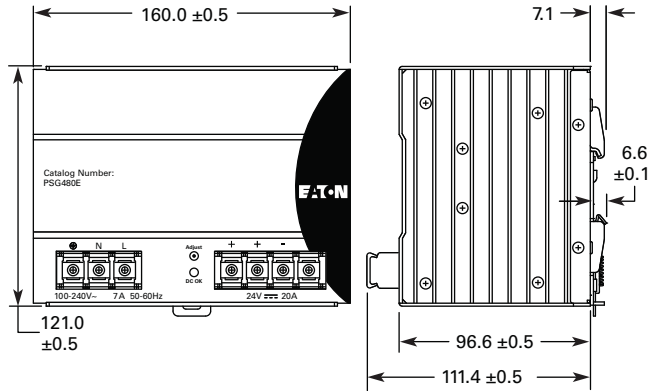

**PSG60F24RM**

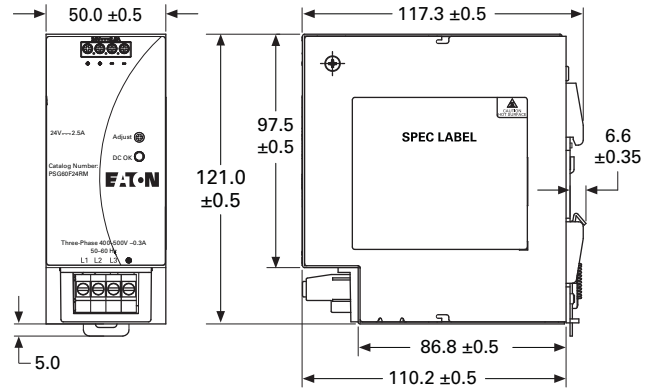

**PSG480E24RM**

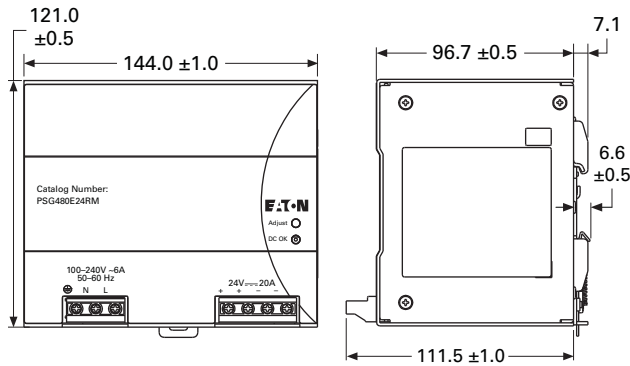

**PSG120F24RM**

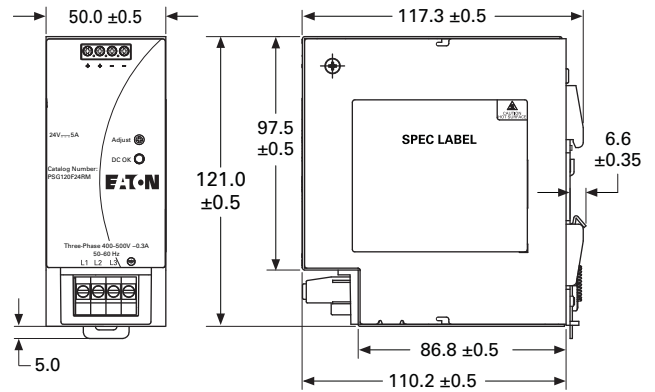

# 6.1

## Power Supplies

### General-Purpose and Sensor Power Supplies

Approximate Dimensions in mm

**Note:** Dimensions are for reference only.

**PSG240F24RM**

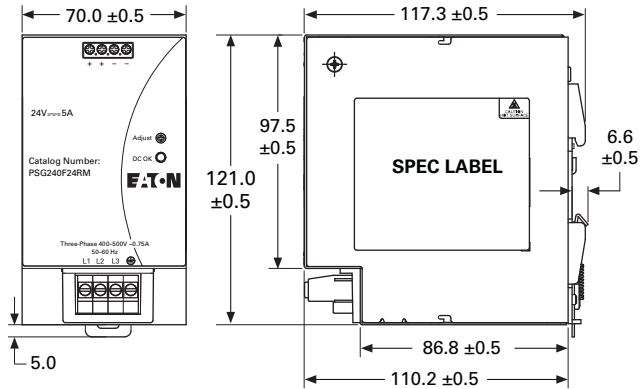

**PSG960F24RM**

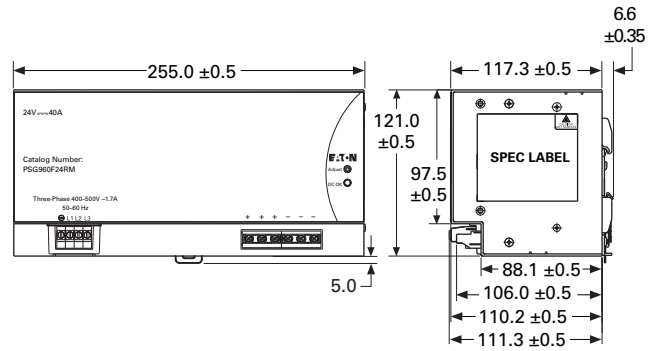

**PSG480F24RM**

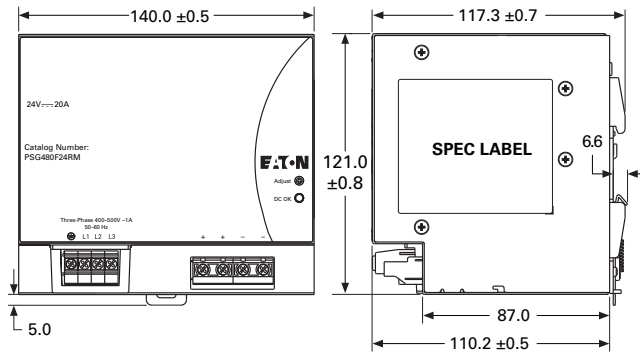

**PSG480R24RM**

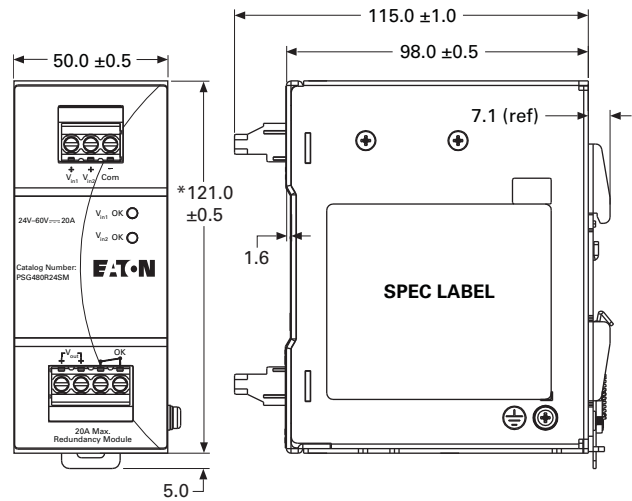

Approximate Dimensions in mm

**Note:** Dimensions are for reference only.

**PSG960R24RM**

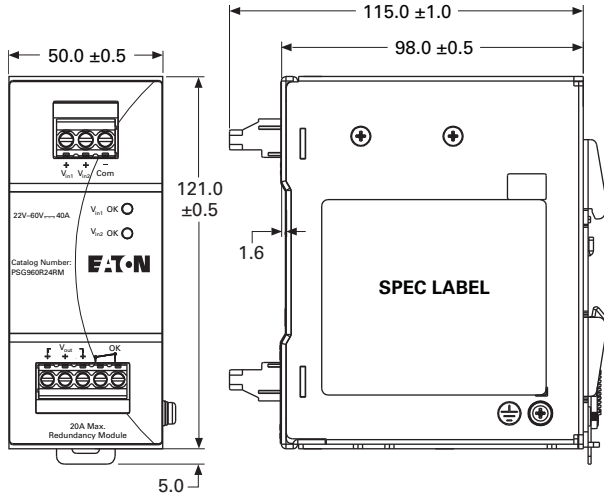

**PSG480B24RM**

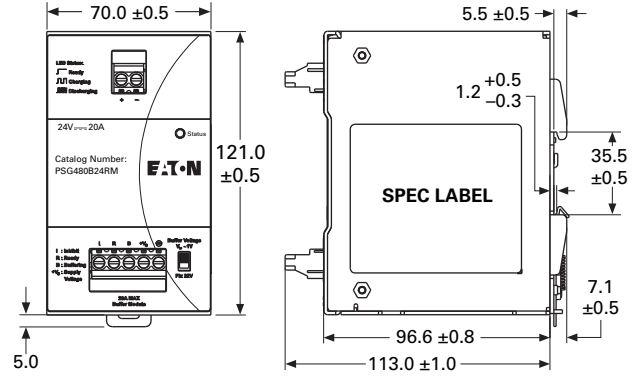



#### ELC Series



### ELC Series

#### Product Description

Eaton's ELC power supplies are the perfect products for those applications requiring a very compact and low-cost source for 24 Vdc power. While these products were developed to be a perfect match for our Eaton Logic Controllers, they can be used in a variety of applications.

The lightweight, DIN rail mounted enclosures, wide input voltage range and robust screw terminals make these power supplies easy to install and use. They are available in 1A and 2A models.

#### Features, Benefits and Functions

- Universal input voltage: 85–264 Vac
- Compact size, with common depth and height across models allows for common panel depths and family consistency
- ELC styling provides maximum aesthetic appeal when used with Eaton Logic Controllers
- Front-mounted pressure plate screw terminals for a robust connection
- Removable finger-safe protective cover for terminals
- Power ON indication LED
- Integrated mounting hardware for panel mounting or DIN rail mounting

### Contents

#### Description

|   | <i>Page</i>     |
|---|-----------------|
| PSG Series .....                        | <b>V7-T6-3</b>  |
| ELC Series                              |                 |
| Product Selection .....                 | <b>V7-T6-23</b> |
| Technical Data and Specifications ..... | <b>V7-T6-23</b> |
| Dimensions .....                        | <b>V7-T6-24</b> |
| easyRelay Power Supply .....            | <b>V7-T6-25</b> |
| Sensor Power Supply .....               | <b>V7-T6-29</b> |

#### Standards and Certifications

- cULus listed
- CE marked
- RoHS compliant



## Product Selection

ELC-PS01

## ELC Series



| Description                 | Catalog Number |
|-----------------------------|----------------|
| 24 watt, 1 amp power supply | ELC-PS01       |
| 48 watt, 2 amp power supply | ELC-PS02       |

## Technical Data and Specifications

## ELC Series

| Capacity                                | ELC-PS01<br>24W   | ELC-PS02<br>48W   |
|---|---|---|
| <b>Input</b>                            |   |   |
| Nominal voltage                         | 100–240 Vac   | 100–240 Vac   |
| Voltage range                           | 85–264 Vac  | 85–264 Vac  |
| Frequency                               | 47–63 Hz  | 47–63 Hz  |
| <b>Output</b>                           |   |   |
| Nominal output voltage                  | 24 Vdc ± 3%   | 24 Vdc ± 3%   |
| Nominal current                         | 1A  | 2A  |
| Efficiency                              | 78% to 87% typical at full load   | 78% to 87% typical at full load   |
| Residual ripple/peak switching (20 MHz) | < 100 mV typical at full load   | < 240 mV typical at full load   |
| <b>General/Physical Data</b>            |   |   |
| Housing material                        | Plastic   | Plastic   |
| Dimensions (D)                          | 60 mm   | 60 mm   |
| Dimensions (W)                          | 36.5 mm   | 55 mm   |
| Dimensions (H)                          | 90 mm   | 90 mm   |
| Weight (g)                              | 158   | 250   |
| Operating temperature                   | 0°C to +55°C  | 0°C to +55°C  |
| Storage temperature                     | –25°C to +70°C  | –25°C to +70°C  |
| Operating humidity                      | 50% to 95% RH, noncondensing  | 50% to 95% RH, noncondensing  |
| Pollution degree                        | 2   | 2   |
| <b>Approvals/Certifications</b>         |   |   |
|   | UL 508, CE, RoHS, EMC directive 89/336/EEC, low voltage directive 73/23/EEC | UL 508, CE, RoHS, EMC directive 89/336/EEC, low voltage directive 73/23/EEC |
| <b>Safety and Protection</b>            |   |   |
| Overload/short circuit protection       | Auto recovery   | Auto recovery   |

# 6.1

## Power Supplies

### General Purpose and Sensor Power Supplies

#### Dimensions

Approximate Dimensions in Inches (mm)

#### ELC-PS01 Power Supply

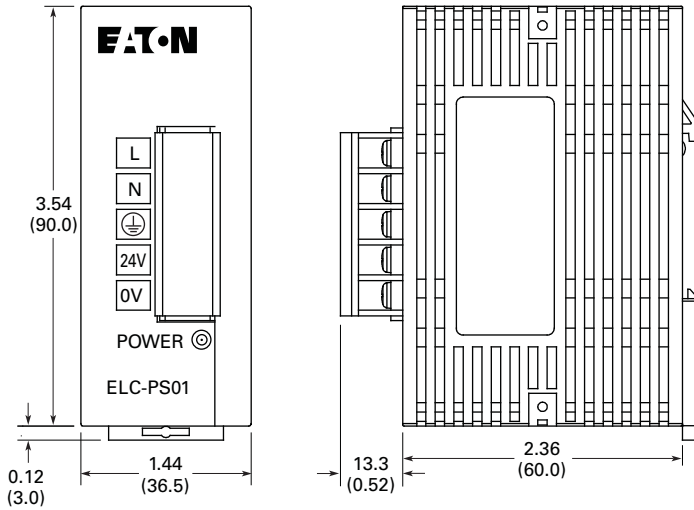

#### ELC-PS02 Power Supply

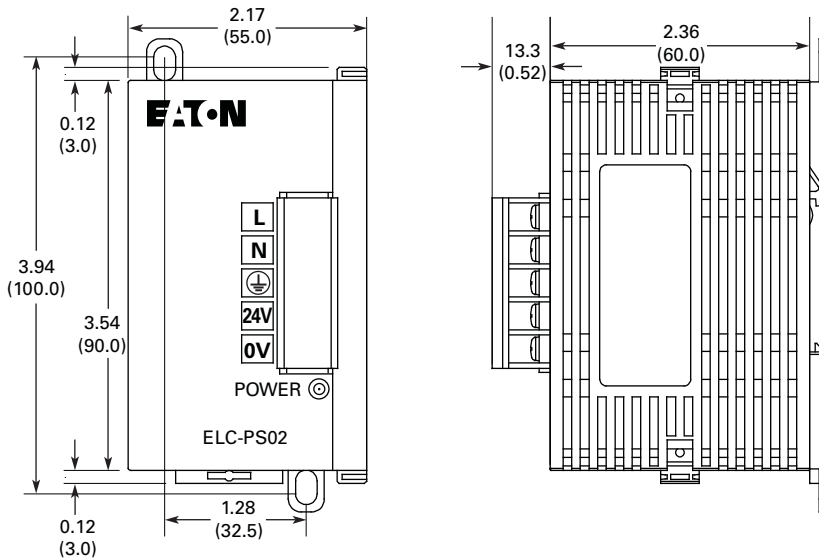

easyRelay Power Supply



Contents

| <b>Description</b>                      | <b>Page</b>     |
|---|-----------------|
| PSG Series .....                        | <b>V7-T6-3</b>  |
| ELC Series .....                        | <b>V7-T6-22</b> |
| easyRelay Power Supply                  |                 |
| Product Selection .....                 | <b>V7-T6-26</b> |
| Technical Data and Specifications ..... | <b>V7-T6-27</b> |
| Dimensions .....                        | <b>V7-T6-28</b> |
| Sensor Power Supply .....               | <b>V7-T6-29</b> |

easyRelay Power Supply

Product Description

Eaton’s easyRelay power supplies are the perfect products for those applications requiring a low amperage 24 Vdc power source. While these products were developed to be a perfect match for our easyRelay products, they can be used in a variety of applications.

Features, Benefits and Functions

- Universal input voltage: 85–264 Vac, 50/60 Hz
- Wide operating temperature range (–25°C to +55°C)
- Power ON / diagnostics LED: continuous light on—fault-free operation; flashing LED—short circuit overload on voltage output
- Optional mounting hardware for panel mounting (EZB4-101-GF1) or standard DIN rail mounting
- Finger-safe, side-entry screw clamp terminals for clean wiring
- Primary switched-mode power supplies
- Output voltages can be connected in parallel to increase power output or for redundant operation to achieve greater system availability
- Safety extra low voltage (SELV to EN 55 022)
- Radio interference Class B to EN 55 011 and EN 55 022 for use in industrial and public networks

Standards and Certifications

- UL listed
- CSA certified
- CE marked
- RoHS compliant
- CSA Class I, Division 2 rated for groups A, B, C, D



# 6.1





## Power Supplies

### General Purpose and Sensor Power Supplies

#### Product Selection

##### easyRelay Power Supply Units

Rated input voltage 100–240 Vac, single-phase.

|   | Input Voltage Range | Rated Output Voltage | Output Voltage Setting Range | Rated Output Power | Rated Output Current | Catalog Number     |
|---|---------------------|----------------------|------------------------------|--------------------|----------------------|--------------------|
| <b>EASY200-POW</b>  | 100–240 Vac         | 24 Vdc/12 Vdc        | —                            | 8W                 | 0.35A / 20 mA        | <b>EASY200-POW</b> |
|    |                     |                      |                              |                    |                      |                    |
| <b>EASY400-POW</b>  | 100–240 Vac         | 24 Vdc               | —                            | 30W                | 1.25A                | <b>EASY400-POW</b> |
|    |                     |                      |                              |                    |                      |                    |
| <b>EASY500-POW</b>  | 100–240 Vac         | 24 Vdc               | —                            | 60W                | 2.5A                 | <b>EASY500-POW</b> |
|   |                     |                      |                              |                    |                      |                    |
| <b>EASY600-POW</b>  | 100–240 Vac         | 24 Vdc               | —                            | 100W               | 4.2A                 | <b>EASY600-POW</b> |
|  |                     |                      |                              |                    |                      |                    |

## Technical Data and Specifications

### easyRelay Series

| Capacity                          | EASY200-POW<br>8W                                     | EASY400-POW<br>30W                                    | EASY500-POW<br>60W                                    | EASY600-POW<br>100W                                   |
|-----------------------------------|---|---|---|---|
| <b>Input</b>                      |   |   |   |   |
| Nominal voltage                   | 100–240 Vac   | 100–240 Vac   | 100–240 Vac   | 100–240 Vac   |
| Voltage range                     | 85–264 Vac  | 85–264 Vac  | 85–264 Vac  | 85–264 Vac  |
| Frequency                         | 47–63 Hz  | 47–63 Hz  | 47–63 Hz  | 47–63 Hz  |
| <b>Output</b>                     |   |   |   |   |
| 24 Vdc                            |   |   |   |   |
| Nominal output voltage            | 24 Vdc ± 3%   | 24 Vdc ± 3%   | 24 Vdc ± 3%   | 24 Vdc ± 3%   |
| Nominal current                   | 0.35A   | 1.25A   | 2.5A  | 4.2A  |
| 12 Vdc                            |   |   |   |   |
| Nominal output voltage            | 12 Vdc  | —   | —   | —   |
| Nominal current                   | 20 mA   | —   | —   | —   |
| <b>General/Physical Data</b>      |   |   |   |   |
| Housing material                  | Plastic   | Plastic   | Plastic   | Plastic   |
| Dimensions (D)                    | 2.22 in (56.5 mm)                                     | 2.22 in (56.5 mm)                                     | 2.22 in (56.5 mm)                                     | 2.22 in (56.5 mm)                                     |
| Dimensions (W)                    | 1.40 in (35.5 mm)                                     | 2.81 in (71.5 mm)                                     | 2.81 in (71.5 mm)                                     | 4.23 in (107.5 mm)                                    |
| Dimensions (H)                    | 3.54 in (90 mm)                                       | 3.54 in (90 mm)                                       | 3.54 in (90 mm)                                       | 3.54 in (90 mm)                                       |
| Operating temperature             | –25°C to +55°C  | –25°C to +55°C  | –25°C to +55°C  | –25°C to +55°C  |
| Storage temperature               | –40°C to +70°C  | –40°C to +70°C  | –40°C to +70°C  | –40°C to +70°C  |
| Pollution degree                  | 2   | 2   | 2   | 2   |
| Connection cables                 |   |   |   |   |
| Solid                             | 0.2–4.0 mm <sup>2</sup> (AWG 22-12)                   | 0.2–4.0 mm <sup>2</sup> (AWG 22-12)                   | 0.2–4.0 mm <sup>2</sup> (AWG 22-12)                   | 0.2–4.0 mm <sup>2</sup> (AWG 22-12)                   |
| Flexible                          | 0.2–2.5 mm <sup>2</sup> (AWG 221-12)                  | 0.2–2.5 mm <sup>2</sup> (AWG 221-12)                  | 0.2–2.5 mm <sup>2</sup> (AWG 221-12)                  | 0.2–2.5 mm <sup>2</sup> (AWG 221-12)                  |
| <b>Approvals/Certifications</b>   |   |   |   |   |
|                                   | UL, CE, RoHS, CSA,<br>EN 50178m IEC/EN 60947          | UL, CE, RoHS, CSA,<br>EN 50178m IEC/EN 60947          | UL, CE, RoHS, CSA,<br>EN 50178m IEC/EN 60947          | UL, CE, RoHS, CSA,<br>EN 50178m IEC/EN 60947          |
| <b>Safety and Protection</b>      |   |   |   |   |
| Overload/short circuit protection | Yes   | Yes   | Yes   | Yes   |
| Overcurrent limitation form       | 0.3A  | 1.4A  | 2.8A  | 4.6A  |
| Degree of protection              | IP20  | IP20  | IP20  | IP20  |
| RFI suppression                   | EN 55011, EN 55022 Class B,<br>IEC 61000-6-1, 2, 3, 4 | EN 55011, EN 55022 Class B,<br>IEC 61000-6-1, 2, 3, 4 | EN 55011, EN 55022 Class B,<br>IEC 61000-6-1, 2, 3, 4 | EN 55011, EN 55022 Class B,<br>IEC 61000-6-1, 2, 3, 4 |
| Potential isolation (prim./sec.)  | Yes, SELV, (to EN 600950, VDE 805)                    | Yes, SELV, (to EN 600950, VDE 805)                    | Yes, SELV, (to EN 600950, VDE 805)                    | Yes, SELV, (to EN 600950, VDE 805)                    |

# 6.1

## Power Supplies

### General Purpose and Sensor Power Supplies

#### Dimensions

Approximate Dimensions in Inches (mm)

#### EASY200-POW, EASY400-POW and EASY500-POW Series

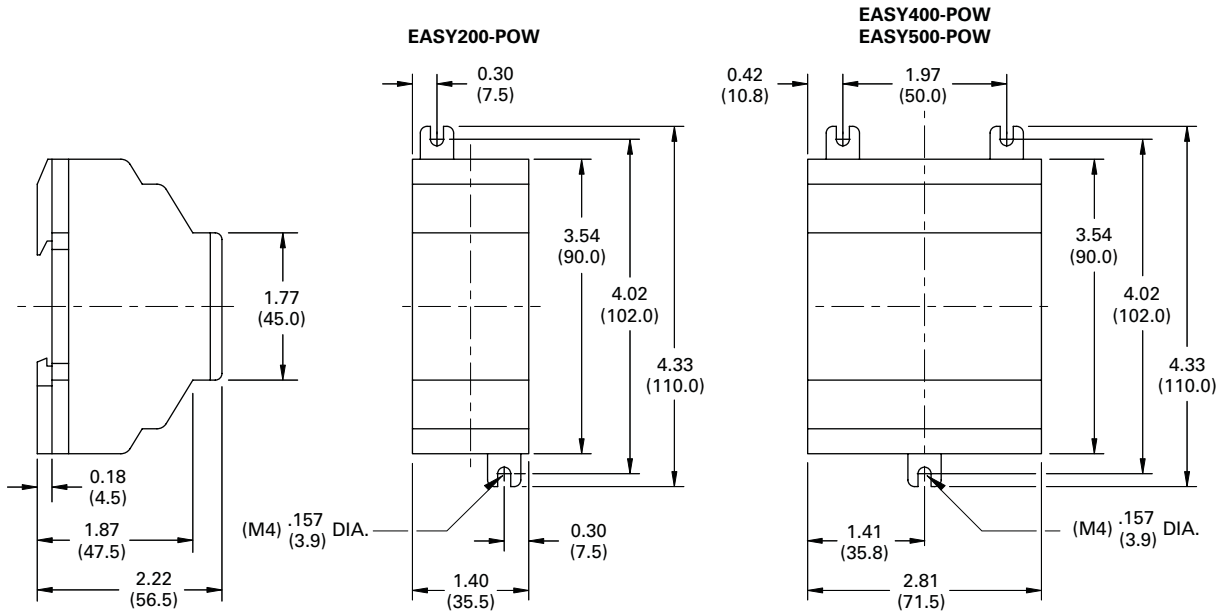

#### EASY600-POW Series

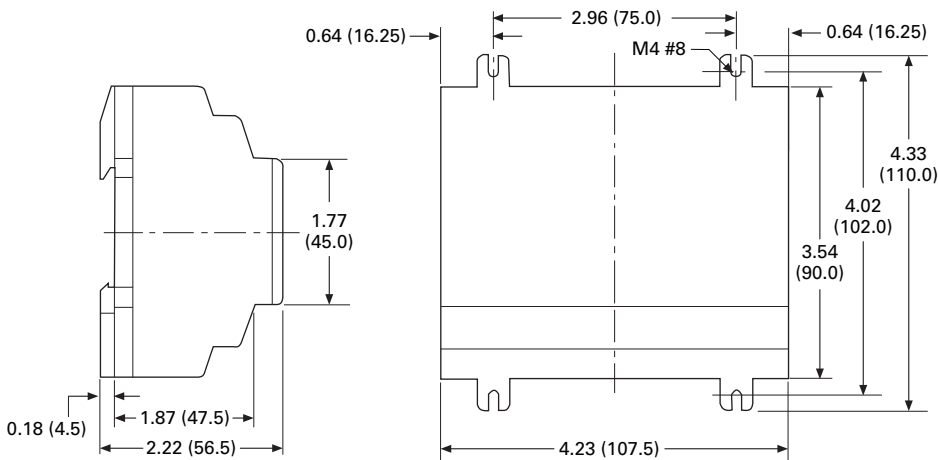

Sensor Power Supply



Contents

| <b>Description</b>                      | <b>Page</b>     |
|---|-----------------|
| PSG Series .....                        | <b>V7-T6-3</b>  |
| ELC Series .....                        | <b>V7-T6-22</b> |
| easyRelay Power Supply .....            | <b>V7-T6-25</b> |
| Sensor Power Supply                     |                 |
| Product Selection .....                 | <b>V7-T6-30</b> |
| Technical Data and Specifications ..... | <b>V7-T6-30</b> |
| Wiring Diagram .....                    | <b>V7-T6-31</b> |
| Dimensions .....                        | <b>V7-T6-31</b> |

Sensor Power Supply

Product Description

Eaton’s sensor power supply was specially designed to be used with the 200 Series and E68 Series zero pressure accumulation systems, but is also suitable for use in a wide variety of applications. The unit delivers 100W output at 27 Vdc and supports easy, Class II wiring. The power supply is a tamper-proof, rugged component easily mounted to a conveyor side-channel or support. Internal components are fully encapsulated in a strong die-cast housing to stand up to rugged handling, ensuring flawless performance in any material handling environment.

Features, Benefits and Functions

- Integrated AC junction box for one-step mounting and wiring without the need for additional accessories
- Built-in DC power health contact allows easy monitoring of power supply status
- Unitized design features a tamper-proof encapsulated construction to reduce the risk of damage associated with conventional open control-panel type construction
- Built-in slug-release input converts an AC or DC input to the appropriate DC signal for integration with the 200 Series and E68 Series zero pressure accumulation systems
- Dual output connection terminals to make it easy and convenient to locate the power supply at the center of the cable run
- Power switch protected against accidental operation
- Power in and out indicators show status at a glance
- Conduit entry box for NEC compliance
- Simple mounting with two 1/4-inch bolts
- Rugged die-cast housing
- Fully encapsulated electronics

Standards and Certifications

- UL listed
- CSA approved





## Product Selection

PS256A\_

## Sensor Power Supply



| Output   | Slug Input                     | Type  | Slug Output  | Catalog Number       |
|--|--------------------------------|---|--|----------------------|
| <b>Operating Voltage 105–132 Vac</b>   |                                |   |  |                      |
| 27 Vdc, 100W;<br>short circuit, overload and<br>overvoltage protection<br>(cycle power to reset) | 15–132 Vac/Vdc<br>3 mA minimum | Standard<br>For use with 200 Series and<br>E68 systems  | Sinking or sourcing, switch selectable;<br>80 mA maximum; short circuit protection for<br>loads less than 32 Vac or Vdc (auto reset) | <b>PS256A-01B1</b> ② |
|  | 15–132 Vac/Vdc<br>3 mA minimum | High current slug<br>For use with solenoid valve systems<br>requiring full current slug signals | Sinking only; 100W output; short circuit,<br>overload and overvoltage protection<br>(cycle power to reset) ①                         | <b>PS256A-04B1</b> ② |

6

## Technical Data and Specifications

## Sensor Power Supply

| Description               | PS256A-01B1  | PS256A-04B1  |
|---------------------------|--|--|
| Input power               | 144W, maximum inrush 30A from cold start   | 144W, maximum inrush 30A from cold start   |
| Input voltage             | 105–132 Vac  | 105–132 Vac  |
| Input current (full load) | 105 Vac–1.92A, 115 Vac–1.65A, 132 Vac–1.5A   | 105 Vac–1.92A, 115 Vac–1.65A, 132 Vac–1.5A   |
| Output power              | 100W   | 100W   |
| Output voltage            | 27 Vdc   | 27 Vdc   |
| Output protection         | Short circuit, overload and overvoltage protection<br>(cycle power to reset), diode protected  | Short circuit, overload and overvoltage protection<br>(cycle power to reset), diode protected  |
| Regulation                | ± 3%   | ± 3%   |
| Slug input                | 15–132 Vac/Vdc   | 15–132 Vac/Vdc   |
| Slug output               | Sinking or sourcing, switch selectable; 80 mA maximum;<br>short circuit protection for loads less than 32 Vac or Vdc<br>(auto reset)   | Sinking only; 100W output; short circuit, overload and<br>overvoltage protection (cycle power to reset) ①  |
| Indicators                | Red LED: AC In; Green LED: DC Out  | Red LED: AC In; Green LED: DC Out  |
| DC fail indication output | NO contact, solid-state relay, 80 mA maximum   | NO contact, solid-state relay, 80 mA maximum   |
| Temperature range         | –13° to 131°F (–25° to 55°C)   | –13° to 131°F (–25° to 55°C)   |
| Vibration                 | 20g  | 20g  |
| Enclosure material        | Die-cast aluminum  | Die-cast aluminum  |
| Enclosure rating          | NEMA 1   | NEMA 1   |
| Connections               | Main output/slug output:<br>Two three-position finger protected barrier strips;<br>AC line input, DC fail indication and slug input:<br>8-position screw terminal strip inside conduit entry box | Main output/slug output:<br>Two three-position finger protected barrier strips;<br>AC line input, DC fail indication and slug input:<br>8-position screw terminal strip inside conduit entry box |

## Notes

- ① Total output power of supply is 100W. Total supply output power (100W) = main output power + slug output power.  
 ② Stocked product, typical order quantities guaranteed in stock.

**Wiring Diagram**

**Sensor Power Supply**

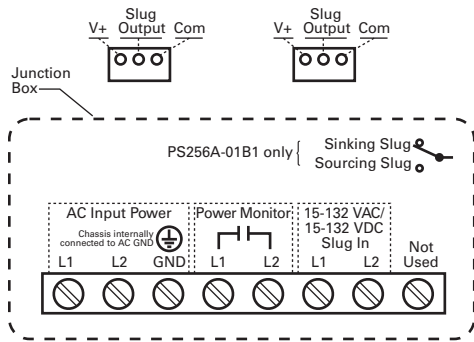

**Dimensions**

Approximate Dimensions in Inches (mm)

**Sensor Power Supply**

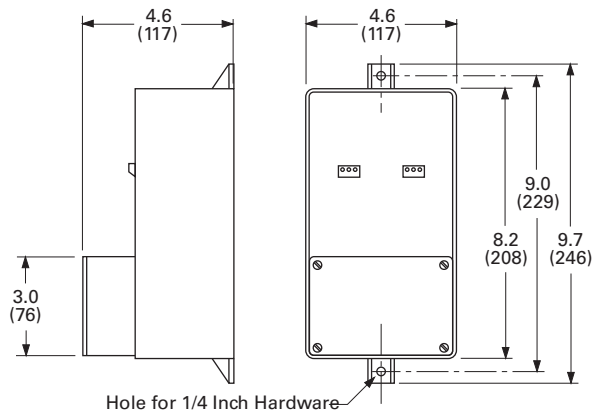

# Industrial Control Transformers

Types MTE and MTK



## 7.1 Transformers

|  |          |
|--|----------|
| Standards and Certifications . . . . . | V7-T7-2  |
| Catalog Number Selection . . . . .     | V7-T7-3  |
| Type MTE . . . . .                     | V7-T7-4  |
| Type MTK . . . . .                     | V7-T7-13 |
| CE Marked . . . . .                    | V7-T7-18 |
| Type AP. . . . .                       | V7-T7-25 |



CE Marked



Type AP



### Industrial Control Transformers



### Contents

| Description     | Page     |
|-----------------|----------|
| Transformers    |          |
| Type MTE .....  | V7-T7-4  |
| Type MTK .....  | V7-T7-13 |
| CE Marked ..... | V7-T7-18 |
| Type AP .....   | V7-T7-25 |

### Standards and Certifications

Eaton dry-type distribution transformers are approved, listed, recognized or may comply with the following standards.

#### Engineering Standards

| Catalog Product Name                  | UL Standard ① | UL/cUL File Number | UL Listed Control Number | cUL Energy Efficiency File Number | CSA File Number | Insulation System Temp/°C | kVA Single-Phase | kVA Three-Phase | Applicable IEC Standard |
|---------------------------------------|---------------|--------------------|--------------------------|-----------------------------------|-----------------|---------------------------|------------------|-----------------|-------------------------|
| <b>Industrial Control Transformer</b> |               |                    |                          |                                   |                 |                           |                  |                 |                         |
| MTE                                   | 5085          | E46323             | 702X                     | —                                 | —               | 105                       | 0.025–1.5        | N/A             | 61558                   |
| MTK                                   | 5085          | E46323             | 702X                     | —                                 | —               | 180                       | 0.05–5           | N/A             | 61558                   |
| <b>Encapsulated Transformer</b>       |               |                    |                          |                                   |                 |                           |                  |                 |                         |
| AP                                    | 5085          | E10156             | 591H                     | —                                 | —               | 180                       | 3–10             | N/A             | 61558                   |
| AP                                    | 1561          | E78389             | 591H                     | —                                 | —               | 180                       | 15               | N/A             | 61558                   |
| EP                                    | 5085          | E10156             | 591H                     | —                                 | LR60545         | 180                       | 0.05–10          | N/A             | 61558                   |
| EP                                    | 1561          | E78389             | 591H                     | EV157 ②                           | LR60545 ③       | 180                       | 15–50            | N/A             | 61558 ④ / 726 ⑤         |
| EPT                                   | 5085          | E10156             | 591H                     | —                                 | LR60545         | 180                       | N/A              | 3–9             | 61558 ⑥ / 726 ⑦         |
| EPT                                   | 1561          | E78389             | 591H                     | EV157 ⑧                           | LR60545 ⑨       | 180                       | N/A              | 15–75           | 726                     |
| MPC                                   | 1062          | E53449             | 591H                     | —                                 | LR60546         | 180                       | 3–25             | 15–30           | —                       |
| <b>Ventilated Transformer</b>         |               |                    |                          |                                   |                 |                           |                  |                 |                         |
| DS-3                                  | 1561          | E78389             | 591H                     | —                                 | —               | 220                       | 15–167           | N/A             | 60726                   |
| DT-3                                  | 1561          | E78389             | 591H                     | —                                 | —               | 220                       | N/A              | 15–750          | 60726                   |
| KT                                    | 1561          | E78389             | 591H                     | —                                 | —               | 220                       | N/A              | 9–500           | N/A                     |

#### Notes

- ① UL 5085 replaces UL 506.
- ② Applies to 25–50 kVA.
- ③ Applies to 25 kVA.
- ④ Applies to 15–25 kVA.
- ⑤ Applies to 37.5 kVA.
- ⑥ Applies to 3 kVA.
- ⑦ Applies to 5–9 kVA.
- ⑧ Applies to 30–75 kVA.
- ⑨ Applies to 30 kVA.

In addition to the above standards, Eaton dry-type distribution transformers are also manufactured in compliance with the applicable standards listed below.

Not all of the following standards apply to every transformer.

**NEC:** National Electrical Code®

**NEMA ST-1:** Specialty Transformers (C89.1) (control transformers).

**NEMA ST-20:** General-Purpose Transformers.

**NEMA TP-1:** Guide for Determining Energy Efficiency for Distribution Transformers.

**NEMA 250:** Enclosures for Electrical Equipment (1000 volts maximum).

**IEEE C57.12.01:** General Requirements for Dry-Type Distribution and Power Transformers (including those with solid-cast and/or resin-encapsulated windings).

**ANSI C57.12.70:** Terminal Markings and Connections for Distribution and Power Transformers.

**ANSI C57.12.91:** Standard Test Code for Dry-Type Distribution and Power Transformers.

**CSA C22 No. 47-M90:** Air-Cooled Transformers (Dry-Type).

**CSA C9-M1981:** Dry-Type Transformers.

**CSA C22.2 No. 66:** Specialty Transformers.

**CSA 802-94:** Maximum Losses for Distribution, Power and Dry-Type Transformers.

**NEMA TP-2:** Standard Test Method for Measuring the Energy Consumption of Distribution Transformers.

**NEMA TP-3**



## Catalog Number Selection

Industrial Control Transformers, CE Marked Control Transformers—Example: CE0250E2FCE ①

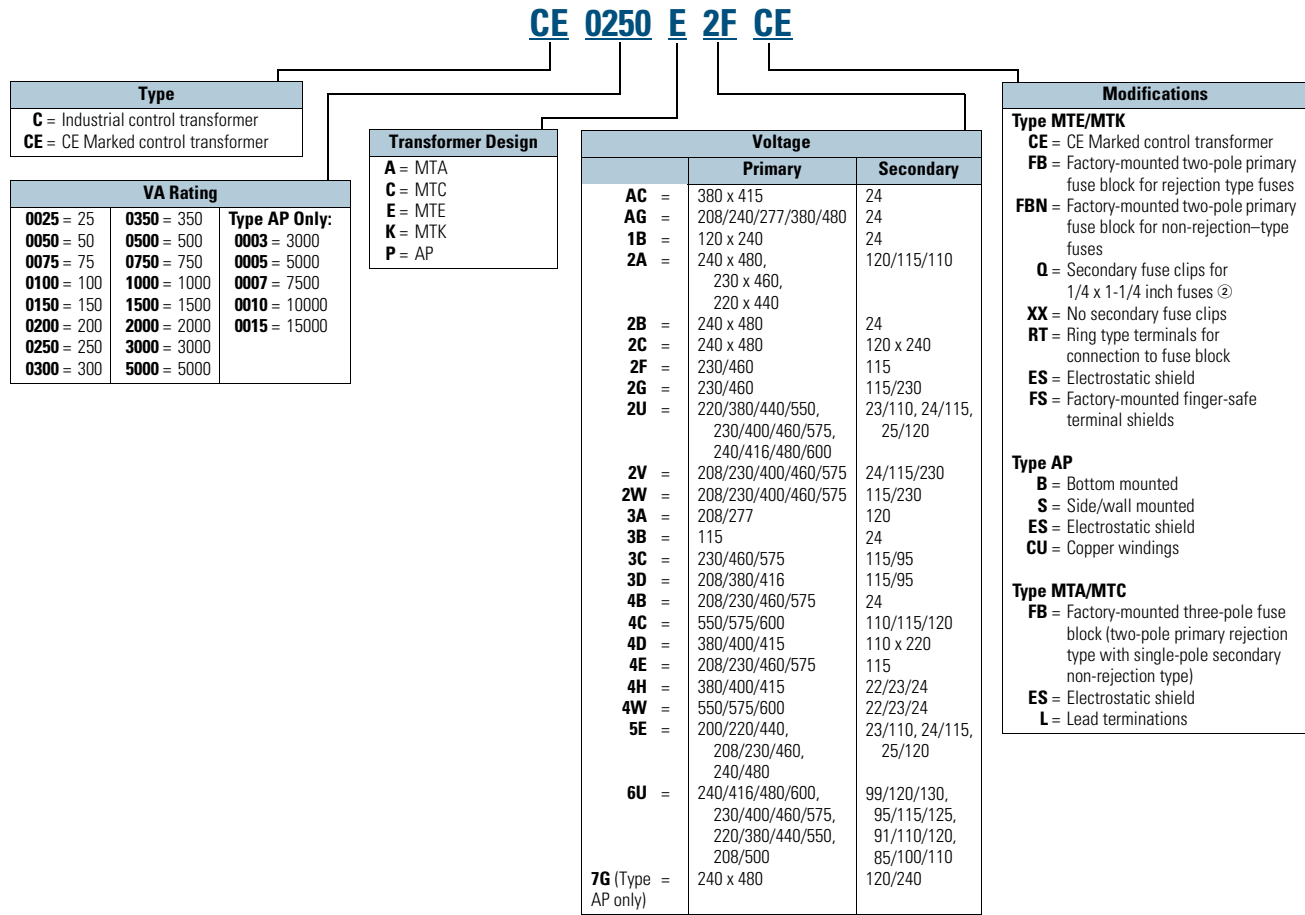

**Notes**

① For Eaton's dry-type transformers catalog number selection, see Volume 2, CA08100003E.

② Fuse clip covers not available with this option.

Contact your local Eaton sales office for voltage combinations not shown. Use table for catalog number breakdown only. Do not use to create catalog numbers because all combinations may not be valid.

#### Type MTE Transformer



### Contents

| <b>Description</b>                          | <b>Page</b> |
|---|-------------|
| Type MTE                                    |             |
| Product Selection . . . . .                 | V7-T7-5     |
| Accessories . . . . .                       | V7-T7-10    |
| Technical Data and Specifications . . . . . | V7-T7-10    |
| Wiring Diagrams . . . . .                   | V7-T7-11    |
| Type MTK . . . . .                          | V7-T7-13    |
| CE Marked . . . . .                         | V7-T7-18    |
| Type AP . . . . .                           | V7-T7-25    |

### Type MTE

#### Product Description

**Note:** The following pages provide listings for most standard transformer ratings and styles. For other ratings or styles not shown, or for special enclosure types (including stainless steel), refer to Eaton.

- Epoxy-encapsulated coils

#### Application Description

Transformers provide stepped-down voltages to machine tool control devices, enabling control circuits to be isolated from all power and lighting circuits. This allows the use of grounded or ungrounded circuits that are independent of the power or lighting grounds; thus, greater safety is afforded the operator. The control transformer line is particularly adaptable on applications where compact construction is demanded.

**Note:** The MTG “open core-coil design” has been superseded by the epoxy-encapsulated core-coil design MTE with no change to dimensions or functionality.

#### Features, Benefits and Functions

- Epoxy encapsulated
- Laminations of high-quality silicon steel to minimize core losses and optimize performance
- Copper magnet wire for high-quality, efficient operation
- Secondary fuse clips where applicable
- Optional primary fusing
- Molded in terminals
- 50/60 Hz operation
- 130°C insulation system standard
- Performance meets/exceeds requirements of ANSI/NEMA ST-1
- Regulation exceeds ANSI/NEMA requirements for all ratings
- 25–1500 VA ratings
- Molded-in terminals for maximum durability

#### Standards and Certifications

- UL listed
- cUL listed
- RoHS compliant



#### Industry Standards

All Eaton dry-type distribution and control transformers are built and tested in accordance with applicable NEMA, ANSI and IEEE Standards. All 600 volt class transformers are UL listed unless otherwise noted.

#### Catalog Number Selection

Please refer to **Page V7-T7-3**.

**Product Selection**

Additional Product Selection information is available in Volume 2, **CA08100003E**.

**Type MTE**

**Primary: 240 x 480, 230 x 460, 220 x 440 with Jumpers**  
**Secondary: 120/115/110 with Fuse Clips for 13/32 x 1-1/2 Fuses**

| VA   | Wiring Diagram ① | Weight Lbs (kg) | Style Number |
|------|------------------|-----------------|--------------|
| 25   | 1                | 1.7 (0.8)       | C0025E2A ②   |
| 50   | 1                | 2.6 (1.2)       | C0050E2A ②   |
| 75   | 1                | 3.5 (1.6)       | C0075E2A ②   |
| 100  | 1                | 4.2 (1.9)       | C0100E2A ②   |
| 150  | 1                | 6.7 (3.0)       | C0150E2A     |
| 200  | 1                | 8.5 (3.9)       | C0200E2A     |
| 250  | 1                | 10.0 (4.5)      | C0250E2A     |
| 300  | 1                | 11.3 (5.1)      | C0300E2A     |
| 350  | 1                | 13.6 (6.2)      | C0350E2A     |
| 500  | 1                | 19.2 (8.7)      | C0500E2A     |
| 750  | 1                | 28.1 (12.8)     | C0750E2A     |
| 1000 | 1                | 29.5 (13.4)     | C1000E2A     |
| 1500 | 1                | 40.0 (18.1)     | C1500E2A     |

**Primary: 240 x 480 with Jumpers**  
**Secondary: 24 with Fuse Clips for 13/32 x 1-1/2 Fuses (through 500 VA)**

| VA  | Wiring Diagram ① | Weight Lbs (kg) | Style Number |
|-----|------------------|-----------------|--------------|
| 50  | 2                | 2.7 (1.2)       | C0050E2B ②   |
| 75  | 2                | 3.5 (1.6)       | C0075E2B ②   |
| 100 | 2                | 4.2 (1.9)       | C0100E2B ②   |
| 150 | 2                | 6.7 (3.0)       | C0150E2B     |
| 200 | 2                | 8.5 (3.9)       | C0200E2B     |
| 250 | 2                | 10.1 (4.6)      | C0250E2B     |
| 300 | 2                | 11.4 (5.2)      | C0300E2B     |
| 350 | 2                | 13.4 (6.1)      | C0350E2B     |
| 500 | 2                | 17.5 (7.9)      | C0500E2B     |
| 750 | 2                | 28.1 (12.8)     | C0750E2B     |

**Primary: 120 X 240 with Jumpers**  
**Secondary: 24 with Fuse Clips for 13/32 x 1-1/2 Fuses**

| VA  | Wiring Diagram ① | Weight Lbs (kg) | Style Number |
|-----|------------------|-----------------|--------------|
| 50  | 3                | 2.6 (1.2)       | C0050E1B ②   |
| 75  | 3                | 3.6 (1.6)       | C0075E1B ②   |
| 100 | 3                | 4.4 (2.0)       | C0100E1B ②   |
| 150 | 3                | 6.7 (3.0)       | C0150E1B     |
| 200 | 3                | 8.3 (3.8)       | C0200E1B     |
| 250 | 3                | 10.1 (4.6)      | C0250E1B     |
| 300 | 3                | 11.2 (5.1)      | C0300E1B     |
| 350 | 3                | 13.2 (6.0)      | C0350E1B     |
| 500 | 3                | 17.5 (7.9)      | C0500E1B     |

**Primary: 208/277**  
**Secondary: 120 with Fuse Clips for 13/32 x 1-1/2 Fuses**

| VA  | Wiring Diagram ① | Weight Lbs (kg) | Style Number |
|-----|------------------|-----------------|--------------|
| 50  | 4                | 2.9 (1.3)       | C0050E3A ②   |
| 75  | 4                | 3.8 (1.7)       | C0075E3A ②   |
| 100 | 4                | 4.5 (2.0)       | C0100E3A ②   |
| 150 | 4                | 6.9 (3.1)       | C0150E3A     |
| 200 | 4                | 8.7 (3.9)       | C0200E3A     |
| 250 | 4                | 10.2 (4.6)      | C0250E3A     |
| 300 | 4                | 11.4 (5.2)      | C0300E3A     |
| 350 | 4                | 13.7 (6.2)      | C0350E3A     |
| 500 | 4                | 17.2 (7.8)      | C0500E3A     |
| 750 | 4                | 25.7 (11.7)     | C0750E3A     |

**Notes**

- ① See Page V7-T7-11 for wiring diagrams.  
 ② 105°C insulation system.

# 7.1

## Industrial Control Transformers

### Transformers

7

**Primary: 240 x 480 with Jumpers**  
**Secondary: 120 x 240 with Jumpers,**  
**Secondary Fuse Clips Not Applicable**

| VA  | Wiring Diagram ① | Weight Lbs (kg) | Style Number |
|-----|------------------|-----------------|--------------|
| 50  | 11               | 2.6 (1.2)       | C0050E2CXX ② |
| 75  | 11               | 3.5 (1.6)       | C0075E2CXX ② |
| 100 | 11               | 4.2 (1.9)       | C0100E2CXX ② |
| 150 | 11               | 6.7 (3.1)       | C0150E2CXX   |
| 200 | 11               | 8.5 (3.9)       | C0200E2CXX   |
| 250 | 11               | 10.0 (4.6)      | C0250E2CXX   |
| 300 | 11               | 11.8 (5.4)      | C0300E2CXX   |
| 350 | 11               | 13.6 (6.2)      | C0350E2CXX   |
| 500 | 11               | 17.5 (8.0)      | C0500E2CXX   |
| 750 | 11               | 26.4 (12.0)     | C0750E2CXX   |

**Primary: 550/575/600**  
**Secondary: 110/115/120 with for 13/32 x 1-1/2 Fuses**

| VA  | Wiring Diagram ① | Weight Lbs (kg) | Style Number |
|-----|------------------|-----------------|--------------|
| 50  | 10               | 2.7 (1.2)       | C0050E4C ②   |
| 75  | 10               | 3.6 (1.6)       | C0075E4C ②   |
| 100 | 10               | 4.2 (1.9)       | C0100E4C ②   |
| 150 | 10               | 6.8 (3.1)       | C0150E4C     |
| 200 | 10               | 8.4 (3.8)       | C0200E4C     |
| 250 | 10               | 10.0 (4.6)      | C0250E4C     |
| 300 | 10               | 11.3 (5.1)      | C0300E4C     |
| 350 | 10               | 13.6 (6.2)      | C0350E4C     |
| 500 | 10               | 16.8 (7.6)      | C0500E4C     |
| 750 | 10               | 25.7 (11.7)     | C0750E4C     |

**Primary: 380/400/415**  
**Secondary: 22/23/24 with Fuse Clips for 13/32 x 1-1/2 Fuses**

| VA  | Wiring Diagram ① | Weight Lbs (kg) | Style Number |
|-----|------------------|-----------------|--------------|
| 50  | 13               | 2.5 (1.1)       | C0050E4H ②   |
| 75  | 13               | 3.5 (1.6)       | C0075E4H ②   |
| 100 | 13               | 4.0 (1.8)       | C0100E4H ②   |
| 150 | 13               | 6.5 (3.0)       | C0150E4H     |
| 200 | 13               | 8.2 (3.7)       | C0200E4H     |
| 250 | 13               | 10.0 (4.5)      | C0250E4H     |
| 300 | 13               | 11.0 (5.0)      | C0300E4H     |
| 350 | 13               | 13.6 (6.2)      | C0350E4H     |
| 500 | 13               | 17.7 (8.0)      | C0500E4H     |

**Primary: 550/575/600**  
**Secondary: 22/23/24 with Fuse Clips for 13/32 x 1-1/2 Fuses**

| VA  | Wiring Diagram ① | Weight Lbs (kg) | Style Number |
|-----|------------------|-----------------|--------------|
| 50  | 12               | 2.5 (1.1)       | C0050E4W ②   |
| 75  | 12               | 3.5 (1.6)       | C0075E4W ②   |
| 100 | 12               | 4.0 (1.8)       | C0100E4W ②   |
| 150 | 12               | 6.5 (3.0)       | C0150E4W     |
| 200 | 12               | 8.2 (3.7)       | C0200E4W     |
| 250 | 12               | 10.0 (4.5)      | C0250E4W     |
| 300 | 12               | 11.0 (5.0)      | C0300E4W     |
| 350 | 12               | 13.6 (6.2)      | C0350E4W     |
| 500 | 12               | 17.7 (8.0)      | C0500E4W     |
| 750 | 12               | 28.0 (12.7)     | C0750E4WXX ③ |

**Primary: 230/460/575**  
**Secondary: 115/95 with Fuse Clips for 13/32 x 1-1/2 Fuses**

| VA  | Wiring Diagram ① | Weight Lbs (kg) | Style Number |
|-----|------------------|-----------------|--------------|
| 50  | 5                | 3.5 (1.6)       | C0050E3C ②   |
| 75  | 5                | 4.5 (2.0)       | C0075E3C ②   |
| 100 | 5                | 6.0 (2.7)       | C0100E3C ②   |
| 150 | 5                | 7.7 (3.5)       | C0150E3C     |
| 200 | 5                | 9.0 (4.1)       | C0200E3C     |
| 250 | 5                | 9.7 (4.4)       | C0250E3C     |
| 300 | 5                | 11.7 (5.3)      | C0300E3C     |
| 350 | 5                | 16.5 (7.5)      | C0350E3C     |
| 500 | 5                | 21.5 (9.8)      | C0500E3C     |
| 750 | 5                | 28.0 (12.7)     | C0750E3C     |

**Primary: 380/400/415**  
**Secondary: 110 x 220 with Jumpers;**  
**Fuse Clips Not Applicable**

| VA  | Wiring Diagram ① | Weight Lbs (kg) | Style Number |
|-----|------------------|-----------------|--------------|
| 50  | 6                | 3.0 (1.4)       | C0050E4D ②   |
| 75  | 6                | 4.0 (1.8)       | C0075E4D ②   |
| 100 | 6                | 5.2 (2.4)       | C0100E4D ②   |
| 150 | 6                | 7.0 (3.2)       | C0150E4D     |
| 200 | 6                | 8.7 (3.9)       | C0200E4D     |
| 250 | 6                | 10.2 (4.6)      | C0250E4D     |
| 300 | 6                | 11.0 (5.0)      | C0300E4D     |
| 350 | 6                | 13.0 (5.9)      | C0350E4D     |
| 500 | 6                | 20.0 (9.1)      | C0500E4D     |
| 750 | 6                | 28.0 (12.7)     | C0750E4D     |

**Notes**

- ① See Page V7-T7-11 for wiring diagrams.
- ② 105°C insulation system.
- ③ Secondary fuse clips are not available on this catalog number.



**Primary: 200/220/440, 208/230/460, 240/480**  
**Secondary: 23/110, 24/115, 25/120 with Fuse Clips for 13/32 x 1-1/2 Fuses**

| VA  | Wiring Diagram ① | Weight Lbs (kg) | Style Number |
|-----|------------------|-----------------|--------------|
| 50  | 7                | 3.4 (1.5)       | C0050E5E ②   |
| 75  | 7                | 4.8 (2.2)       | C0075E5E ②   |
| 100 | 7                | 5.9 (2.7)       | C0100E5E ②   |
| 150 | 7                | 7.9 (3.6)       | C0150E5E     |
| 200 | 7                | 10.6 (4.8)      | C0200E5E     |
| 250 | 7                | 13.9 (6.3)      | C0250E5E     |
| 300 | 7                | 15.5 (7.0)      | C0300E5E     |
| 350 | 7                | 16.8 (7.6)      | C0350E5E     |
| 500 | 7                | 23.4 (10.6)     | C0500E5E     |

**Universal Design (MTE Epoxy Encapsulated)**

**Primary: 240/416/480/600, 230/400/460/575, 220/380/440/550, 208/500**  
**Secondary: 99/120/130, 95/115/125, 91/110/120, 85/100/110 with Fuse Clips for 13/32 x 1-1/2 Fuses**

| VA  | Wiring Diagram ① | Weight Lbs (kg) | Style Number |
|-----|------------------|-----------------|--------------|
| 50  | 8                | 4.0 (1.8)       | C0050E6U ②③  |
| 100 | 8                | 6.6 (3.0)       | C0100E6U ②③  |
| 150 | 8                | 8.8 (4.0)       | C0150E6U ②④  |
| 250 | 8                | 14.7 (6.7)      | C0250E6U ②④  |
| 350 | 8                | 18.6 (8.4)      | C0350E6U ②④  |
| 500 | 8                | 25.6 (11.6)     | C0500E6U ②④  |
| 750 | 8                | 30.5 (13.8)     | C0750E6U ②④  |

**Transformers with Primary Fuse Blocks**

**Primary: 240 x 480, 230 x 460, 220 x 440 with Jumpers and Two-Pole Primary Fuse Block for Rejection-Type Fuses**  
**Secondary: 120/115/110 with Fuse Clips for 13/32 x 1-1/2 Fuses**

| VA   | Wiring Diagram ① | Weight Lbs (kg) | Style Number |
|------|------------------|-----------------|--------------|
| 50   | 1                | 2.8 (1.3)       | C0050E2AFB ② |
| 75   | 1                | 3.7 (1.7)       | C0075E2AFB ② |
| 100  | 1                | 4.4 (2.0)       | C0100E2AFB ② |
| 150  | 1                | 6.9 (3.1)       | C0150E2AFB   |
| 200  | 1                | 8.7 (3.9)       | C0200E2AFB   |
| 250  | 1                | 10.2 (4.6)      | C0250E2AFB   |
| 300  | 1                | 11.5 (5.2)      | C0300E2AFB   |
| 350  | 1                | 13.8 (6.3)      | C0350E2AFB   |
| 500  | 1                | 19.4 (8.8)      | C0500E2AFB   |
| 750  | 1                | 28.3 (12.8)     | C0750E2AFB   |
| 1000 | 1                | 29.7 (13.4)     | C1000E2AFB   |
| 1500 | 1                | 40.2 (18.1)     | C1500E2AFB   |

**Primary: 240 x 480 with Jumpers and Two-Pole Primary Fuse Block for Rejection-Type Fuses**  
**Secondary: 24 with Fuse Clips for 13/32 x 1-1/2 Fuses**

| VA  | Wiring Diagram ① | Weight Lbs (kg) | Style Number |
|-----|------------------|-----------------|--------------|
| 50  | 2                | 2.8 (1.3)       | C0050E2BFB ② |
| 75  | 2                | 3.8 (1.7)       | C0075E2BFB ② |
| 100 | 2                | 4.4 (2.1)       | C0100E2BFB ② |
| 150 | 2                | 6.9 (3.1)       | C0150E2BFB   |
| 200 | 2                | 8.7 (3.9)       | C0200E2BFB   |
| 250 | 2                | 10.3 (4.7)      | C0250E2BFB   |
| 300 | 2                | 11.6 (5.3)      | C0300E2BFB   |
| 350 | 2                | 13.6 (6.2)      | C0350E2BFB   |
| 500 | 2                | 17.7 (8.0)      | C0500E2BFB   |

**Notes**

- ① See Page V7-T7-11 for wiring diagrams.
- ② 105°C insulation system.
- ③ Type MTG open core-coil universal design has been superseded by Type MTE epoxy encapsulated universal design with no changes to form, fit or function.
- ④ Type MTE epoxy encapsulated universal design.

# 7.1

## Industrial Control Transformers

### Transformers

7

**Primary: 120 x 240 with Jumpers and Two-Pole Primary Fuse Block for Rejection-Type Fuses**  
**Secondary: 24 with Fuse Clips for 13/32 x 1-1/2 Fuses**

| VA  | Wiring Diagram ① | Weight Lbs (kg) | Style Number |
|-----|------------------|-----------------|--------------|
| 50  | 3                | 2.8 (1.3)       | C0050E1BFB ② |
| 75  | 3                | 3.8 (1.7)       | C0075E1BFB ② |
| 100 | 3                | 4.6 (2.1)       | C0100E1BFB ② |
| 150 | 3                | 6.9 (3.1)       | C0150E1BFB   |
| 200 | 3                | 8.5 (3.9)       | C0200E1BFB   |
| 250 | 3                | 10.3 (4.7)      | C0250E1BFB   |
| 300 | 3                | 11.4 (5.2)      | C0300E1BFB   |
| 350 | 3                | 13.4 (6.1)      | C0350E1BFB   |
| 500 | 3                | 17.7 (8.0)      | C0500E1BFB   |

**Primary: 208/277 with Two-Pole Primary Fuse Block for Rejection-Type Fuses**  
**Secondary: 120 with Fuse Clips for 13/32 x 1-1/2 Fuses**

| VA  | Wiring Diagram ① | Weight Lbs (kg) | Style Number |
|-----|------------------|-----------------|--------------|
| 50  | 4                | 3.1 (1.4)       | C0050E3AFB ② |
| 75  | 4                | 4.0 (1.8)       | C0075E3AFB ② |
| 100 | 4                | 4.7 (2.1)       | C0100E3AFB ② |
| 150 | 4                | 7.1 (3.2)       | C0150E3AFB   |
| 200 | 4                | 8.9 (4.0)       | C0200E3AFB   |
| 250 | 4                | 10.4 (4.7)      | C0250E3AFB   |
| 300 | 4                | 11.6 (5.3)      | C0300E3AFB   |
| 350 | 4                | 13.9 (6.3)      | C0350E3AFB   |
| 500 | 4                | 17.4 (7.9)      | C0500E3AFB   |

**Primary: 550/575/600 with Two-Pole Primary Fuse Block for Rejection-Type Fuses**  
**Secondary: 110/115/120 with Fuse Clips for 13/32 x 1-1/2 Fuses**

| VA  | Wiring Diagram ① | Weight Lbs (kg) | Style Number |
|-----|------------------|-----------------|--------------|
| 50  | 10               | 2.9 (1.3)       | C0050E4CFB ② |
| 75  | 10               | 3.8 (1.7)       | C0075E4CFB ② |
| 100 | 10               | 4.4 (2.0)       | C0100E4CFB ② |
| 150 | 10               | 7.0 (3.2)       | C0150E4CFB   |
| 200 | 10               | 8.6 (3.9)       | C0200E4CFB   |
| 250 | 10               | 10.2 (4.6)      | C0250E4CFB   |
| 300 | 10               | 11.5 (5.2)      | C0300E4CFB   |
| 350 | 10               | 13.8 (6.3)      | C0350E4CFB   |
| 500 | 10               | 17.0 (7.7)      | C0500E4CFB   |
| 750 | 10               | 25.9 (11.8)     | C0750E4CFB   |

**Primary: 380/400/415 with Two-Pole Primary Fuse Block for Rejection-Type Fuses**  
**Secondary: 22/23/24 with Fuse Clips for 13/32 x 1-1/2 Fuses**

| VA  | Wiring Diagram ① | Weight Lbs (kg) | Style Number |
|-----|------------------|-----------------|--------------|
| 50  | 13               | 2.6 (1.2)       | C0050E4HFB ② |
| 75  | 13               | 3.7 (1.7)       | C0075E4HFB ② |
| 100 | 13               | 4.2 (1.9)       | C0100E4HFB ② |
| 150 | 13               | 6.7 (3.0)       | C0150E4HFB   |
| 200 | 13               | 8.4 (3.8)       | C0200E4HFB   |
| 250 | 13               | 10.2 (4.6)      | C0250E4HFB   |

**Primary: 550/575/600 with Two-Pole Primary Fuse Block for Rejection-Type Fuses**  
**Secondary: 22/23/24 with Fuse Clips for 13/32 x 11/2 Fuses**

| VA  | Wiring Diagram ① | Weight Lbs (kg) | Style Number |
|-----|------------------|-----------------|--------------|
| 50  | 12               | 2.7 (1.2)       | C0050E4WFB ② |
| 75  | 12               | 3.7 (1.7)       | C0075E4WFB ② |
| 100 | 12               | 4.2 (1.9)       | C0100E4WFB ② |
| 150 | 12               | 6.7 (3.0)       | C0150E4WFB   |
| 200 | 12               | 8.4 (3.8)       | C0200E4WFB   |
| 250 | 12               | 10.2 (4.6)      | C0250E4WFB   |

**Primary: 230/460/575 with Two-Pole Primary Fuse Block for Rejection-Type Fuses**  
**Secondary: 115/95 with Fuse Clips for 13/32 x 1-1/2 Fuses**

| VA  | Wiring Diagram ① | Weight Lbs (kg) | Style Number |
|-----|------------------|-----------------|--------------|
| 50  | 5                | 3.7 (1.7)       | C0050E3CFB ② |
| 75  | 5                | 4.7 (2.1)       | C0075E3CFB ② |
| 100 | 5                | 6.2 (2.8)       | C0100E3CFB ② |
| 150 | 5                | 7.9 (3.6)       | C0150E3CFB   |
| 200 | 5                | 9.2 (4.2)       | C0200E3CFB   |
| 250 | 5                | 9.9 (4.5)       | C0250E3CFB   |
| 300 | 5                | 11.9 (5.4)      | C0300E3CFB   |
| 350 | 5                | 16.7 (7.6)      | C0350E3CFB   |
| 500 | 5                | 21.7 (9.9)      | C0500E3CFB   |

**Notes**

- ① See Page V7-T7-11 for wiring diagrams.
- ② 105°C insulation system.

**Primary: 380/400/415 with Two-Pole  
Primary Fuse Block for Rejection-Type Fuses  
Secondary: 110 x 220 with Jumpers;  
Fuse Clips Not Available**

| VA  | Wiring Diagram <sup>①</sup> | Weight Lbs (kg) | Style Number            |
|-----|-----------------------------|-----------------|-------------------------|
| 50  | 6                           | 3.2 (1.5)       | C0050E4DFB <sup>②</sup> |
| 75  | 6                           | 4.2 (1.9)       | C0075E4DFB <sup>②</sup> |
| 100 | 6                           | 5.4 (2.5)       | C0100E4DFB <sup>②</sup> |
| 150 | 6                           | 7.2 (3.3)       | C0150E4DFB              |
| 200 | 6                           | 8.9 (4.0)       | C0200E4DFB              |
| 250 | 6                           | 10.4 (4.7)      | C0250E4DFB              |
| 300 | 6                           | 11.2 (5.1)      | C0300E4DFB              |
| 350 | 6                           | 13.2 (6.0)      | C0350E4DFB              |
| 500 | 6                           | 20.2 (9.2)      | C0500E4DFB              |

**Primary: 200/220/440, 208/230/460, 240/480 with  
Two-Pole Primary Fuse Block for Rejection-Type Fuses  
Secondary: 23/110, 24/115, 25/120 with Fuse Clips  
for 13/32 x 1-1/2 Fuses**

| VA  | Wiring Diagram <sup>①</sup> | Weight Lbs (kg) | Style Number            |
|-----|-----------------------------|-----------------|-------------------------|
| 50  | 7                           | 3.6 (1.6)       | C0050E5EFB <sup>②</sup> |
| 75  | 7                           | 5.0 (2.3)       | C0075E5EFB <sup>②</sup> |
| 100 | 7                           | 6.1 (2.8)       | C0100E5EFB <sup>②</sup> |
| 150 | 7                           | 8.1 (3.7)       | C0150E5EFB              |
| 200 | 7                           | 10.8 (4.9)      | C0200E5EFB              |
| 250 | 7                           | 14.1 (6.4)      | C0250E5EFB              |
| 300 | 7                           | 15.7 (7.1)      | C0300E5EFB              |
| 350 | 7                           | 17.0 (7.7)      | C0350E5EFB              |
| 500 | 7                           | 23.6 (10.7)     | C0500E5EFB              |

**Universal Design (MTE Epoxy Encapsulated)  
Primary: 240/416/480/600, 230/400/460/575,  
220/380/440/550, 208/500 with Two-Pole  
Primary Fuse Block for Rejection-Type Fuses  
Secondary: 99/120/130, 95/115/125, 91/110/120,  
85/100/110 with Fuse Clips for 13/32 x 1-1/2 Fuses**

| VA  | Wiring Diagram <sup>①</sup> | Weight Lbs (kg) | Style Number             |
|-----|-----------------------------|-----------------|--------------------------|
| 50  | 8                           | 4.2 (1.9)       | C0050E6UFB <sup>②③</sup> |
| 100 | 8                           | 6.8 (3.1)       | C0100E6UFB <sup>②③</sup> |
| 150 | 8                           | 9.0 (4.1)       | C0150E6UFB <sup>②④</sup> |
| 250 | 8                           | 14.9 (6.8)      | C0250E6UFB <sup>②④</sup> |
| 350 | 8                           | 18.8 (8.5)      | C0350E6UFB <sup>②④</sup> |
| 500 | 8                           | 25.8 (11.7)     | C0500E6UFB <sup>②④</sup> |

#### Notes

- ① See Page V7-T7-11 for wiring diagrams.
- ② 105°C insulation system.
- ③ Type MTG open core-coil universal design has been superseded by Type MTE epoxy encapsulated universal design with no changes to form, fit or function.
- ④ Type MTE epoxy encapsulated universal design.

### Accessories

#### Primary Fuse Kit

The primary fuse kit includes a two-pole class CC fuse block, instructions, and all associated mounting and wiring hardware. Fuses are not included. When installed, the primary fuse kit will add a maximum of 11/16 inch to the transformer depth and 1-15/16 inches to the transformer height.



#### Primary Fuse Kit

| Description      | Catalog Number |
|------------------|----------------|
| Primary fuse kit | PFK1           |

#### Finger-Safe Terminal Covers (Optional)

- Fits CE Marked designs 50–750 VA
- Fits MTE designs 0.25–750 VA

#### Finger-Safe Terminal Covers

| Description   | Catalog Number |
|---|----------------|
|  <p>Four terminal transformers</p>               | <b>FSK4</b>    |
|  <p>Four terminal Series 2 transformers only</p> | <b>FSK4S2</b>  |
|  <p>Six terminal transformers</p>              | <b>FSK6</b>    |

#### Finger-Safe Primary Fuse Block Covers

- Fits two-pole primary fuse blocks on MTE designs
- No fuse block covers are available for transformers with suffix "FBQ"

#### Finger-Safe Primary Fuse Block Covers

| Description  | Catalog Number |
|--|----------------|
|  <p>Primary fuse block covers</p> | <b>FSKFB</b>   |

#### Secondary Fuse Clip Cover

#### Secondary Fuse Clip Cover

| Description                     | Catalog Number |
|---------------------------------|----------------|
| Fits 500 VA and smaller models  | <b>SFCS</b>    |
| Fits models greater than 500 VA | <b>SFCL</b>    |

### Technical Data and Specifications

#### Insulation System and Temperature Rise

Industry standards classify insulation systems and rise as shown below:

#### Insulation System Classification

| Ambient | + Winding Rise | + Hot Spot | = Temp. Class |
|---------|----------------|------------|---------------|
| 40°C    | 55°C           | 10°C       | 105°C         |
| 40°C    | 80°C           | 30°C       | 150°C         |
| 25°C    | 135°C          | 20°C       | 180°C         |
| 40°C    | 115°C          | 30°C       | 185°C         |
| 40°C    | 150°C          | 30°C       | 220°C         |

The design life of transformers having different insulation systems is the same—the lower-temperature systems are designed for the same life as the higher-temperature systems.

#### Series-Multiple Windings

Series-multiple windings consist of two similar coils in each winding that can be connected in series or parallel (multiple). Transformers with series-multiple windings are designated with an "x" or "/" between the voltage ratings, such as voltages of "120/240" or "240 x 480." If the series-multiple winding is designated by an "x," the winding can be connected only for a series or parallel. With the "/" designation, a mid-point also becomes available in addition to the series or parallel connection. As an example, a 120 x 240 winding can be connected for either 120 (parallel) or 240 (series), but a 120/240 winding can be connected for 120 (parallel), 240 (series) or 240 with a 120 mid-point.

For additional information, please refer to Volume 2, **CA08100003E**.

## Wiring Diagrams

Diagram 1

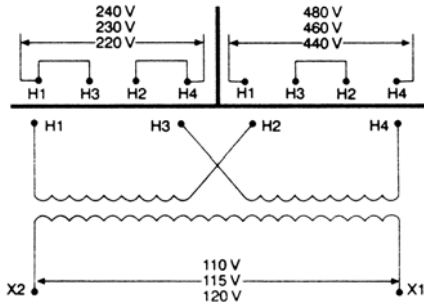

Diagram 5

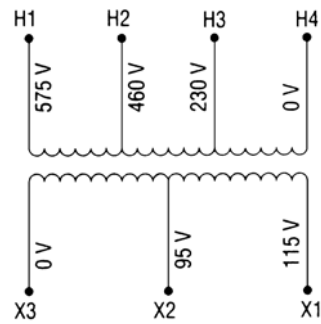

Diagram 2

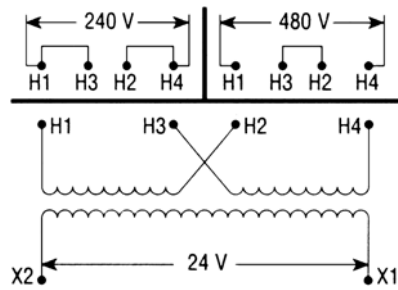

Diagram 6

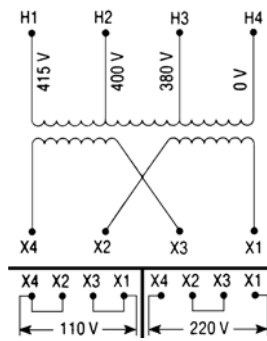

Diagram 3

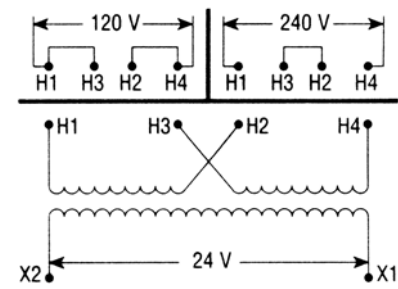

Diagram 7

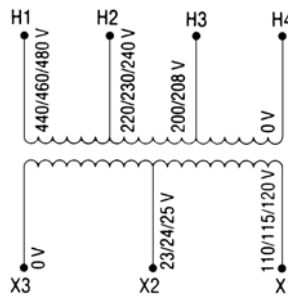

Diagram 4

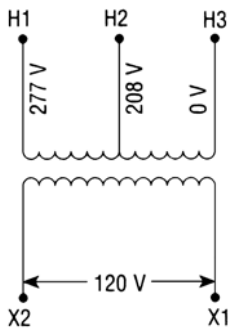
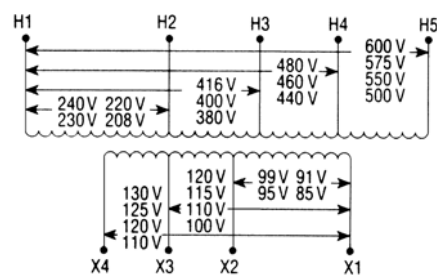

Diagram 8



# 7.1

## Industrial Control Transformers

### Transformers

7

Diagram 9

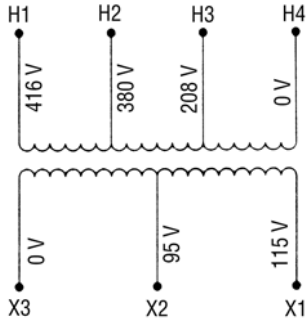

Diagram 13

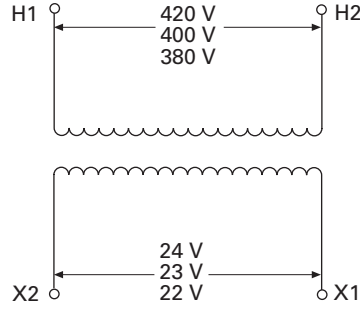

Diagram 10

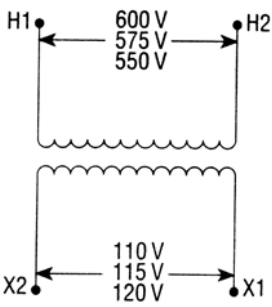

Diagram 14

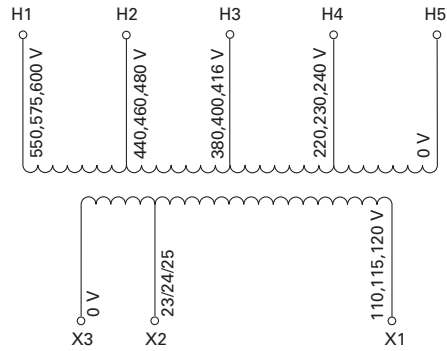

Diagram 11

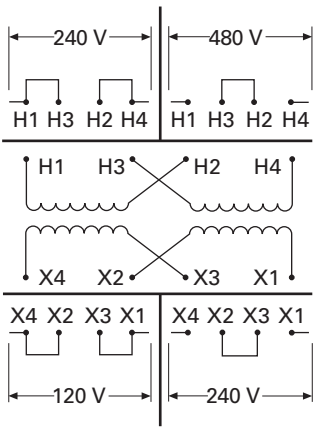

Diagram 15

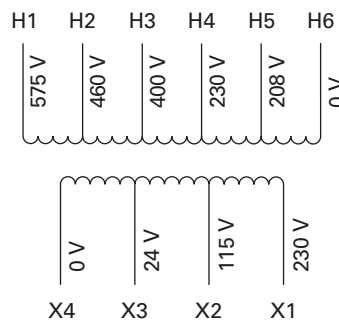

Diagram 12

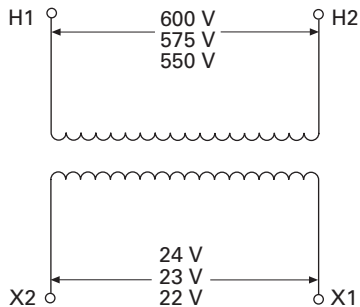
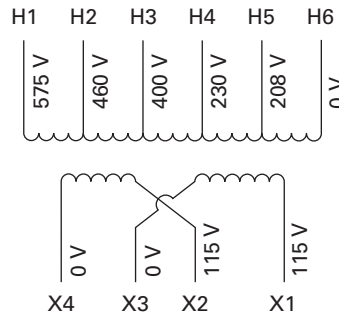

Diagram 16



**Type MTK Transformer**



**Contents**

| <b>Description</b>                      | <b>Page</b>     |
|---|-----------------|
| Type MTE .....                          | <b>V7-T7-4</b>  |
| Type MTK                                |                 |
| Product Selection .....                 | <b>V7-T7-14</b> |
| Technical Data and Specifications ..... | <b>V7-T7-15</b> |
| Wiring Diagrams .....                   | <b>V7-T7-15</b> |
| CE Marked .....                         | <b>V7-T7-18</b> |
| Type AP .....                           | <b>V7-T7-25</b> |

**Type MTK**

**Product Description**

**Note:** The following pages provide listings for most standard transformer ratings and styles. For other ratings or styles not shown, or for special enclosure types (including stainless steel), refer to Eaton.

- Epoxy resin-impregnated coil
- Economical solution for high inrush applications

**Application Description**

Transformers provide stepped-down voltages to machine tool control devices, enabling control circuits to be isolated from all power and lighting circuits. This allows the use of grounded or ungrounded circuits that are independent of the power or lighting grounds; thus, greater safety is afforded the operator. The control transformer line is particularly adaptable on applications where compact construction is demanded.

**Features, Benefits and Functions**

- Epoxy resin impregnated coil design
- Copper magnet wire for high-quality, efficient operation
- 50/60 Hz operation
- 180°C insulation system
- Performance meets/exceeds requirements of ANSI/NEMA ST-1
- Regulation exceeds ANSI/NEMA requirements for all ratings
- 500–5000 VA ratings

**Standards and Certifications**

- UL listed
- cUL listed
- RoHS compliant



**Industry Standards**

All Eaton dry-type distribution and control transformers are built and tested in accordance with applicable NEMA, ANSI and IEEE Standards. All 600 volt class transformers are UL listed unless otherwise noted.

**Catalog Number Selection**

Please refer to **Page V7-T7-3**.

**Product Selection**

Additional Product Selection information is available in Volume 2, **CA08100003E**.

**Type MTK****Primary: 240 x 480, 230 x 460, 220 x 440  
Secondary: 120/115/110**

| VA   | Wiring Diagram ① | Weight Lbs (kg) | Style Number |
|------|------------------|-----------------|--------------|
| 500  | 1                | 13.0 (5.9)      | C0500K2A     |
| 750  | 1                | 19.5 (8.9)      | C0750K2A     |
| 1000 | 1                | 29.8 (13.6)     | C1000K2A     |
| 1500 | 1                | 30.0 (13.6)     | C1500K2A     |
| 2000 | 1                | 38.0 (17.3)     | C2000K2A     |
| 3000 | 1                | 53.0 (24.1)     | C3000K2A     |
| 5000 | 1                | 89.0 (40.5)     | C5000K2A     |

**Primary: 208/277 Secondary: 120**

| VA   | Wiring Diagram ① | Weight Lbs (kg) | Style Number |
|------|------------------|-----------------|--------------|
| 1000 | 4                | 29.0 (13.1)     | C1000K3A     |
| 1500 | 4                | 33.0 (15.0)     | C1500K3A     |
| 2000 | 4                | 43.0 (19.5)     | C2000K3A     |
| 3000 | 4                | 64.0 (29.0)     | C3000K3A     |
| 5000 | 4                | 102.0 (46.3)    | C5000K3A     |

**Primary: 230/460/575 Secondary: 115/95**

| VA   | Wiring Diagram ① | Weight Lbs (kg) | Style Number |
|------|------------------|-----------------|--------------|
| 1000 | 5                | 29.2 (13.3)     | C1000K3C     |
| 1500 | 5                | 33.5 (15.2)     | C1500K3C     |
| 2000 | 5                | 42.5 (19.3)     | C2000K3C     |
| 3000 | 5                | 63.7 (29.0)     | C3000K3C     |
| 5000 | 5                | 102.0 (46.4)    | C5000K3C     |

**Primary: 208/380/416 Secondary: 115/95**

| VA   | Wiring Diagram ① | Weight Lbs (kg) | Style Number |
|------|------------------|-----------------|--------------|
| 1000 | 9                | 29.0 (13.1)     | C1000K3D     |
| 1500 | 9                | 43.0 (19.5)     | C1500K3D     |
| 2000 | 9                | 55.0 (25.0)     | C2000K3D     |
| 3000 | 9                | 74.0 (33.5)     | C3000K3D     |
| 5000 | 9                | 108.0 (49.0)    | C5000K3D     |

**Primary: 550/575/600 Secondary: 110/115/120**

| VA   | Wiring Diagram ① | Weight Lbs (kg) | Style Number |
|------|------------------|-----------------|--------------|
| 1000 | 10               | 29.0 (13.1)     | C1000K4C     |
| 1500 | 10               | 33.0 (15.0)     | C1500K4C     |
| 2000 | 10               | 43.0 (19.5)     | C2000K4C     |
| 3000 | 10               | 64.0 (29.0)     | C3000K4C     |
| 5000 | 10               | 102.0 (46.3)    | C5000K4C     |

**Primary: 380/400/415 Secondary: 110 x 220**

| VA   | Wiring Diagram ① | Weight Lbs (kg) | Style Number |
|------|------------------|-----------------|--------------|
| 1000 | 6                | 28.0 (12.7)     | C1000K4D     |
| 1500 | 6                | 33.0 (15.0)     | C1500K4D     |
| 2000 | 6                | 43.0 (19.5)     | C2000K4D     |
| 3000 | 6                | 64.0 (29.0)     | C3000K4D     |
| 5000 | 6                | 102.0 (46.3)    | C5000K4D     |

**Primary: 240 x 480 with Jumpers  
Secondary: 120 x 240 with Jumpers,  
Secondary Fuse Clips Not Applicable**

| VA   | Wiring Diagram ① | Weight Lbs (kg) | Style Number |
|------|------------------|-----------------|--------------|
| 1000 | 11               | 26.4 (12.0)     | C1000K2CXX   |
| 1500 | 11               | 31.0 (14.1)     | C1500K2CXX   |
| 2000 | 11               | 40.0 (18.2)     | C2000K2CXX   |
| 3000 | 11               | 56.0 (25.5)     | C3000K2CXX   |
| 5000 | 11               | 85.5 (28.9)     | C5000K2CXX   |

**Primary: 120 x 240 with Jumpers Secondary: 24**

| VA   | Wiring Diagram ① | Weight Lbs (kg) | Style Number |
|------|------------------|-----------------|--------------|
| 750  | 3                | 19.0 (8.6)      | C0750K1B     |
| 1000 | 3                | 26.4 (12.0)     | C1000K1B     |

**Primary: 240/416/480/600, 230/400/460/575,  
220/380/440/550, 208/500  
Secondary: 99/120/130, 95/115/125, 91/110/120, 85/100/110**

| VA   | Wiring Diagram ① | Weight Lbs (kg) | Style Number |
|------|------------------|-----------------|--------------|
| 1000 | 8                | 26.5 (12.0)     | C1000K6U     |
| 1500 | 8                | 38.5 (17.5)     | C1500K6U     |
| 2000 | 8                | 52.0 (23.6)     | C2000K6U     |
| 3000 | 8                | 68.0 (30.9)     | C3000K6U     |
| 5000 | 8                | 105.0 (47.7)    | C5000K6U     |

**Note**

① See Page V7-T7-15 for wiring diagrams.



## Technical Data and Specifications

### Insulation System and Temperature Rise

Industry standards classify insulation systems and rise as shown below:

### Insulation System Classification

| Ambient | + Winding Rise | + Hot Spot | = Temp. Class |
|---------|----------------|------------|---------------|
| 40°C    | 55°C           | 10°C       | 105°C         |
| 40°C    | 80°C           | 30°C       | 150°C         |
| 25°C    | 135°C          | 20°C       | 180°C         |
| 40°C    | 115°C          | 30°C       | 185°C         |
| 40°C    | 150°C          | 30°C       | 220°C         |

The design life of transformers having different insulation systems is the same—the lower-temperature systems are designed for the same life as the higher-temperature systems.

### Series-Multiple Windings

Series-multiple windings consist of two similar coils in each winding that can be connected in series or parallel (multiple). Transformers with series-multiple windings are designated with an "x" or "/" between the voltage ratings, such as voltages of "120/240" or "240 x 480." If the series-multiple winding is designated by an "x," the winding can be connected only for a series or parallel. With the "/" designation, a mid-point also becomes available in addition to the series or parallel connection. As an example, a 120 x 240 winding can be connected for either 120 (parallel) or 240 (series), but a 120/240 winding can be connected for 120 (parallel), 240 (series) or 240 with a 120 mid-point.

For additional information, please refer to Volume 2, CA08100003E.

## Wiring Diagrams

Diagram 1

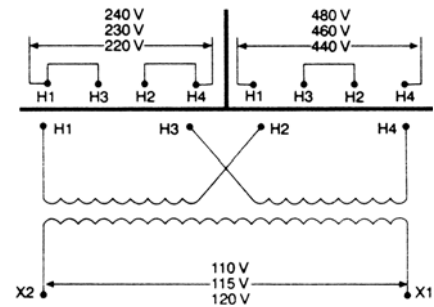

Diagram 2

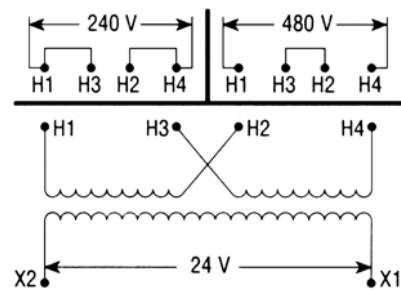

Diagram 3

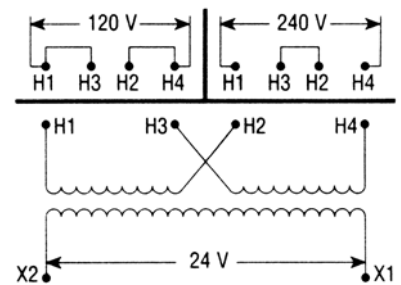
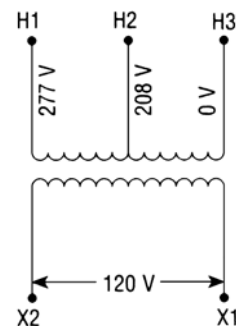

Diagram 4



# 7.1

## Industrial Control Transformers

### Transformers

7

Diagram 5

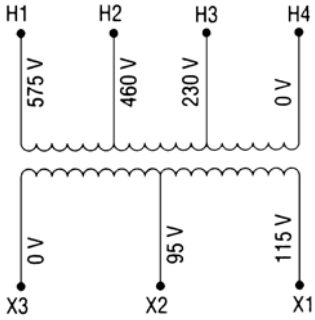

Diagram 9

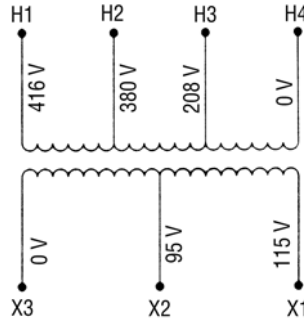

Diagram 6

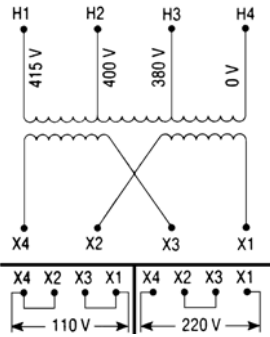

Diagram 10

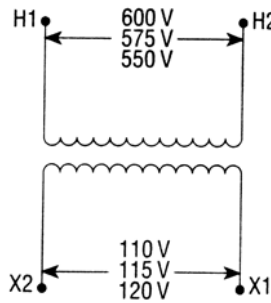

Diagram 7

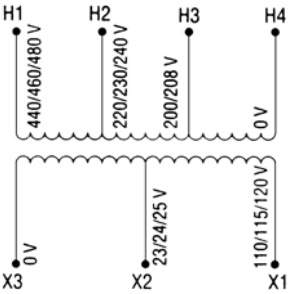

Diagram 11

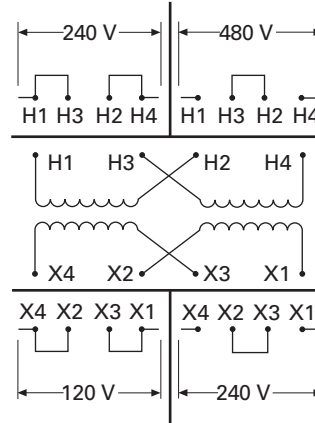

Diagram 8

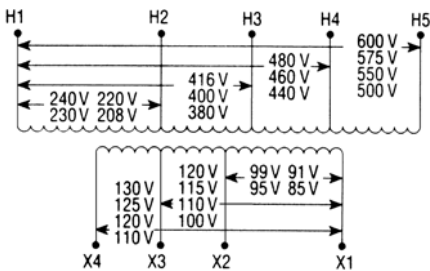
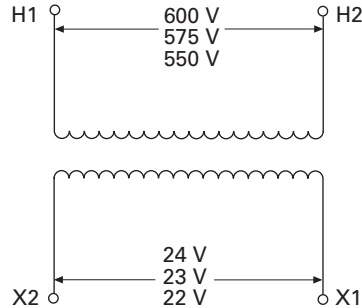
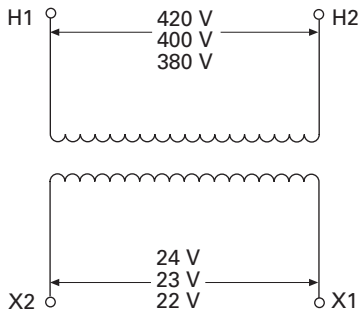

Diagram 12



**Diagram 13**



**Diagram 14**

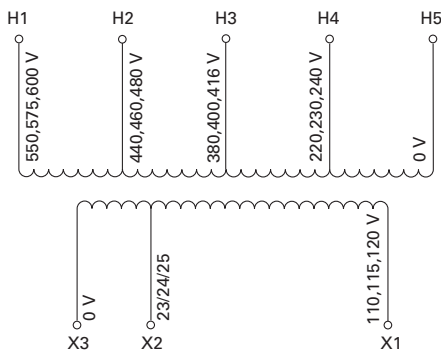

**Diagram 15**

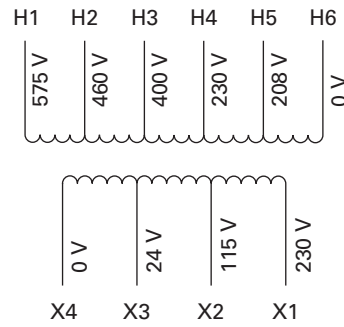

**Diagram 16**

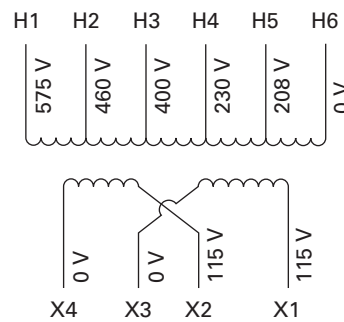

Type MTE CE-Marked CPT



### Contents

| <i>Description</i>                      | <i>Page</i> |
|---|-------------|
| Type MTE .....                          | V7-T7-4     |
| Type MTK .....                          | V7-T7-13    |
| CE Marked                               |             |
| Product Selection .....                 | V7-T7-19    |
| Accessories .....                       | V7-T7-21    |
| Technical Data and Specifications ..... | V7-T7-21    |
| Wiring Diagrams .....                   | V7-T7-22    |
| Type AP .....                           | V7-T7-25    |

### CE Marked

#### Product Description

**Note:** The following pages provide listings for most standard transformer ratings and styles. For other ratings or styles not shown, or for special enclosure types (including stainless steel), refer to Eaton.

#### Application Description

Transformers provide stepped-down voltages to machine tool control devices, enabling control circuits to be isolated from all power and lighting circuits. This allows the use of grounded or ungrounded circuits that are independent of the power or lighting grounds; thus, greater safety is afforded the operator. The control transformer line is particularly adaptable on applications where compact construction is demanded.

#### Features, Benefits and Functions

##### Type MTE

- Epoxy encapsulated coil design
- Copper magnet wire for high-quality, efficient operation
- Laminations of high-quality silicon steel to minimize core losses and optimize performance
- Molded-in terminals
- 50/60 Hz operation
- 130°C insulation system standard
- Performance meets/exceeds requirements of ANSI/NEMA ST-1
- Regulation exceeds ANSI/NEMA requirements for all ratings
- Non-short circuit-proof transformer, isolation type

##### Type MTK

- Epoxy resin-impregnated coil design
- Copper magnet wire for high-quality, efficient operation
- 50/60 Hz operation
- 180°C insulation system
- Performance meets/exceeds requirements of ANSI/NEMA ST-1
- Regulation exceeds ANSI/NEMA requirements for all ratings
- 500–5000 VA ratings

#### Standards and Certifications

- UL listed
- cUL listed
- CE Marked units comply with IEC EN-61558-2
- RoHS compliant



#### Industry Standards

All Eaton dry-type distribution and control transformers are built and tested in accordance with applicable NEMA, ANSI and IEEE Standards. All 600 volt class transformers are UL listed unless otherwise noted.

#### Catalog Number Selection

Please refer to **Page V7-T7-3**.

### Product Selection

Additional Product Selection information is available in Volume 2, **CA08100003E**.

#### Type MTE CE Marked IP00

**Primary: 240 x 480, 230 x 460, 220 x 440 with Jumpers**  
**Secondary: 120/115/110**

| VA  | Wiring Diagram ① | Weight Lbs (kg) | Style Number  |
|-----|------------------|-----------------|---------------|
| 50  | 1                | 3.5 (1.6)       | CE0050E2ACE ② |
| 75  | 1                | 4.8 (2.2)       | CE0075E2ACE ② |
| 100 | 1                | 5.9 (2.7)       | CE0100E2ACE ② |
| 150 | 1                | 8.5 (3.9)       | CE0150E2ACE   |
| 200 | 1                | 10.6 (4.8)      | CE0200E2ACE   |
| 250 | 1                | 11.3 (5.1)      | CE0250E2ACE   |
| 300 | 1                | 13.2 (6.0)      | CE0300E2ACE   |
| 350 | 1                | 14.9 (6.8)      | CE0350E2ACE   |
| 500 | 1                | 21.0 (9.5)      | CE0500E2ACE   |
| 750 | 1                | 29.8 (13.5)     | CE0750E2ACE   |

**Primary: 550/575/600**  
**Secondary: 110/115/1204**

| VA  | Wiring Diagram ① | Weight Lbs (kg) | Style Number  |
|-----|------------------|-----------------|---------------|
| 50  | 10               | 3.5 (1.6)       | CE0050E4CCE ② |
| 75  | 10               | 4.8 (2.2)       | CE0075E4CCE ② |
| 100 | 10               | 5.9 (2.7)       | CE0100E4CCE ② |
| 150 | 10               | 8.5 (3.9)       | CE0150E4CCE   |
| 200 | 10               | 10.6 (4.8)      | CE0200E4CCE   |
| 250 | 10               | 11.3 (5.1)      | CE0250E4CCE   |
| 300 | 10               | 13.2 (6.0)      | CE0300E4CCE   |
| 350 | 10               | 14.9 (6.8)      | CE0350E4CCE   |
| 500 | 10               | 21.0 (9.5)      | CE0500E4CCE   |
| 750 | 10               | 29.8 (13.5)     | CE0750E4CCE   |

**Primary: 240 x 480 with Jumpers**  
**Secondary: 24**

| VA  | Wiring Diagram ① | Weight Lbs (kg) | Style Number  |
|-----|------------------|-----------------|---------------|
| 50  | 2                | 3.4 (1.5)       | CE0050E2BCE ② |
| 75  | 2                | 4.2 (1.9)       | CE0075E2BCE ② |
| 100 | 2                | 5.9 (2.7)       | CE0100E2BCE ② |
| 150 | 2                | 8.5 (3.9)       | CE0150E2BCE   |
| 200 | 2                | 10.6 (4.5)      | CE0200E2BCE   |
| 250 | 2                | 11.3 (5.1)      | CE0250E2BCE   |
| 300 | 2                | 13.2 (6.0)      | CE0300E2BCE   |
| 350 | 2                | 14.9 (6.8)      | CE0350E2BCE   |
| 500 | 2                | 19.2 (8.7)      | CE0500E2BCE   |
| 750 | 2                | 28.1 (12.8)     | CE0750E2BCE   |

**Primary: 380/400/415**  
**Secondary: 110 x 220 with Jumpers**

| VA  | Wiring Diagram ① | Weight Lbs (kg) | Style Number  |
|-----|------------------|-----------------|---------------|
| 50  | 6                | 3.5 (1.6)       | CE0050E4DCE ② |
| 75  | 6                | 4.8 (2.2)       | CE0075E4DCE ② |
| 100 | 6                | 5.9 (2.7)       | CE0100E4DCE ② |
| 150 | 6                | 8.5 (3.9)       | CE0150E4DCE   |
| 200 | 6                | 10.6 (4.8)      | CE0200E4DCE   |
| 250 | 6                | 11.3 (5.1)      | CE0250E4DCE   |
| 300 | 6                | 13.2 (6.0)      | CE0300E4DCE   |
| 350 | 6                | 15.2 (6.9)      | CE0350E4DCE   |
| 500 | 6                | 21.0 (9.5)      | CE0500E4DCE   |
| 750 | 6                | 29.8 (13.5)     | CE0750E4DCE   |

**Primary: 120 x 240 with Jumpers**  
**Secondary: 24**

| VA  | Wiring Diagram ① | Weight Lbs (kg) | Style Number  |
|-----|------------------|-----------------|---------------|
| 50  | 3                | 3.4 (1.5)       | CE0050E1BCE ② |
| 75  | 3                | 4.2 (1.9)       | CE0075E1BCE ② |
| 100 | 3                | 5.9 (2.7)       | CE0100E1BCE ② |
| 150 | 3                | 8.5 (3.9)       | CE0150E1BCE   |
| 200 | 3                | 10.6 (4.5)      | CE0200E1BCE   |
| 250 | 3                | 11.3 (5.1)      | CE0250E1BCE   |
| 300 | 3                | 13.2 (6.0)      | CE0300E1BCE   |
| 350 | 3                | 14.9 (6.8)      | CE0350E1BCE   |
| 500 | 3                | 19.2 (8.7)      | CE0500E1BCE   |
| 750 | 3                | 29.8 (13.5)     | CE0750E1BCE   |

**Primary: 200/220/440, 208/230/460, 240/480**  
**Secondary: 23/110, 24/115, 25/120**

| VA  | Wiring Diagram ① | Weight Lbs (kg) | Style Number  |
|-----|------------------|-----------------|---------------|
| 50  | 7                | 4.2 (1.9)       | CE0050E5ECE ② |
| 75  | 7                | 5.9 (2.7)       | CE0075E5ECE ② |
| 100 | 7                | 7.9 (3.6)       | CE0100E5ECE ② |
| 150 | 7                | 10.0 (4.5)      | CE0150E5ECE   |
| 200 | 7                | 12.8 (5.8)      | CE0200E5ECE   |
| 250 | 7                | 15.2 (6.9)      | CE0250E5ECE   |
| 300 | 7                | 16.8 (7.6)      | CE0300E5ECE   |
| 350 | 7                | 19.2 (8.7)      | CE0350E5ECE   |
| 500 | 7                | 27.0 (12.3)     | CE0500E5ECE   |

#### Notes

① See Page V7-T7-22 for wiring diagrams.

② 105°C insulation system.

Transformers are designed to operate in a maximum ambient of 40°C. Contact your local Eaton sales office for availability on additional CE Marked control transformers. For other ratings or styles not shown, refer to Eaton.

# 7.1

## Industrial Control Transformers

### Transformers

#### Type MTK CE Marked with Factory Mounted Finger-Safe Terminal Covers IP20

Primary: 240 x 480, 230 x 460, 220 x 440 with Jumpers  
Secondary: 120/115/110

| VA   | Terminal Type | Wiring Diagram ① | Weight Lbs (kg) | Style Number  |
|------|---------------|------------------|-----------------|---------------|
| 250  | A             | 1                | 8.8 (4.0)       | CE0250K2ACEFS |
| 300  | A             | 1                | 11.0 (5.0)      | CE0300K2ACEFS |
| 350  | A             | 1                | 11.2 (5.1)      | CE0350K2ACEFS |
| 500  | A             | 1                | 14.8 (6.7)      | CE0500K2ACEFS |
| 750  | A             | 1                | 18.0 (8.2)      | CE0750K2ACEFS |
| 1000 | A             | 1                | 26.3 (11.9)     | CE1000K2ACEFS |
| 1500 | C             | 1                | 40.0 (18.1)     | CE1500K2ACEFS |
| 2000 | C             | 1                | 45.1 (20.5)     | CE2000K2ACEFS |
| 3000 | C             | 1                | 65.2 (29.6)     | CE3000K2ACEFS |
| 5000 | C             | 1                | 104.8 (47.5)    | CE5000K2ACEFS |

Primary: 240 x 480 with Jumpers  
Secondary: 24

| VA   | Terminal Type | Wiring Diagram ① | Weight Lbs (kg) | Style Number  |
|------|---------------|------------------|-----------------|---------------|
| 250  | C             | 2                | 8.2 (3.7)       | CE0250K2BCEFS |
| 300  | C             | 2                | 9.5 (4.3)       | CE0300K2BCEFS |
| 350  | C             | 2                | 12.2 (5.5)      | CE0350K2BCEFS |
| 500  | C             | 2                | 14.4 (6.5)      | CE0500K2BCEFS |
| 750  | C             | 2                | 19.5 (8.9)      | CE0750K2BCEFS |
| 1000 | C             | 2                | 26.2 (11.9)     | CE1000K2BCEFS |

Primary: 120 x 240 with Jumpers  
Secondary: 24

| VA   | Terminal Type | Wiring Diagram ① | Weight Lbs (kg) | Style Number  |
|------|---------------|------------------|-----------------|---------------|
| 250  | C             | 3                | 8.3 (3.8)       | CE0250K1BCEFS |
| 300  | C             | 3                | 9.3 (4.2)       | CE0300K1BCEFS |
| 350  | C             | 3                | 12.0 (5.4)      | CE0350K1BCEFS |
| 500  | C             | 3                | 14.4 (6.5)      | CE0500K1BCEFS |
| 750  | C             | 3                | 19.5 (8.9)      | CE0750K1BCEFS |
| 1000 | C             | 3                | 25.2 (11.4)     | CE1000K1BCEFS |

Primary: 200/220/440, 208/230/460, 240/480  
Secondary: 23/110, 24/115, 25/120

| VA   | Terminal Type | Wiring Diagram ① | Weight Lbs (kg) | Style Number  |
|------|---------------|------------------|-----------------|---------------|
| 250  | B             | 7                | 12.5 (5.7)      | CE0250K5ECEFS |
| 300  | B             | 7                | 14.0 (6.3)      | CE0300K5ECEFS |
| 350  | B             | 7                | 15.3 (6.9)      | CE0350K5ECEFS |
| 500  | B             | 7                | 20.8 (9.4)      | CE0500K5ECEFS |
| 750  | C             | 7                | 29.8 (13.5)     | CE0750K5ECEFS |
| 1000 | C             | 7                | 30.2 (13.7)     | CE1000K5ECEFS |

Primary: 220/380/440/550, 230/400/460/575,  
240/416/480/600  
Secondary: 23/110, 24/115, 25/120

| VA   | Terminal Type | Wiring Diagram ① | Weight Lbs (kg) | Style Number  |
|------|---------------|------------------|-----------------|---------------|
| 250  | B             | 14               | 14.3 (6.5)      | CE0250K2UCEFS |
| 300  | B             | 14               | 15.8 (7.2)      | CE0300K2UCEFS |
| 350  | B             | 14               | 16.5 (7.5)      | CE0350K2UCEFS |
| 500  | B             | 14               | 20.5 (9.3)      | CE0500K2UCEFS |
| 750  | C             | 14               | 28.8 (13.1)     | CE0750K2UCEFS |
| 1000 | C             | 14               | 39.4 (17.9)     | CE1000K2UCEFS |

Primary: 208/230/400/460/575  
Secondary: 24 ②/115/230

| VA   | Terminal Type | Wiring Diagram ① | Weight Lbs (kg) | Style Number  |
|------|---------------|------------------|-----------------|---------------|
| 250  | B             | 15               | 14.9 (6.8)      | CE0250K2VCEFS |
| 300  | B             | 15               | 17.4 (7.9)      | CE0300K2VCEFS |
| 350  | B             | 15               | 17.8 (8.1)      | CE0350K2VCEFS |
| 500  | B             | 15               | 26.6 (12.1)     | CE0500K2VCEFS |
| 750  | B             | 15               | 32.5 (14.7)     | CE0750K2VCEFS |
| 1000 | C             | 15               | 44.0 (20.0)     | CE1000K2VCEFS |
| 1500 | C             | 15               | 45.4 (20.6)     | CE1500K2WCEFS |
| 2000 | C             | 16               | 58.6 (26.6)     | CE2000K2WCEFS |
| 3000 | C             | 16               | 92.9 (42.1)     | CE3000K2WCEFS |
| 5000 | C             | 16               | 127.4 (57.8)    | CE5000K2WCEFS |

Primary: 240/416/480/600, 230/400/460/575,  
220/380/440/550, 208/500  
Secondary: 99/120/130, 95/115/125, 91/110/120, 85/100/110

| VA   | Terminal Type | Wiring Diagram ① | Weight Lbs (kg) | Style Number  |
|------|---------------|------------------|-----------------|---------------|
| 250  | A             | 8                | 11.4 (5.2)      | CE0250K6UCEFS |
| 300  | A             | 8                | 13.6 (6.2)      | CE0300K6UCEFS |
| 350  | A             | 8                | 14.2 (6.4)      | CE0350K6UCEFS |
| 500  | A             | 8                | 17.4 (7.9)      | CE0500K6UCEFS |
| 750  | A             | 8                | 27.5 (12.5)     | CE0750K6UCEFS |
| 1000 | A             | 8                | 27.9 (12.6)     | CE1000K6UCEFS |
| 1500 | A             | 8                | 43.1 (19.5)     | CE1500K6UCEFS |
| 2000 | B             | 8                | 56.0 (25.4)     | CE2000K6UCEFS |
| 3000 | B             | 8                | 76.2 (34.6)     | CE3000K6UCEFS |

#### Notes

① See Page V7-T7-22 for wiring diagrams.

② 24 volt secondary only available through 1000 VA.

### Accessories



#### Protection Index IP00

When terminal covers are installed on primary and secondary, and fuse block covers are used, the protection index is IP20.

#### Finger-Safe Terminal Covers (Optional)

- Fits CE Marked designs 50–750 VA
- Fits MTE designs 0.25–750 VA

#### Finger-Safe Terminal Covers

|   | Description                              | Catalog Number |
|---|--|----------------|
|  | Four terminal transformers               | <b>FSK4</b>    |
|   | Four terminal Series 2 transformers only | <b>FSK4S2</b>  |
|  | Six terminal transformers                | <b>FSK6</b>    |

#### Finger-Safe Primary Fuse Block Covers

- Fits two-pole primary fuse blocks on MTE designs

#### Finger-Safe Primary Fuse Block Covers

|   | Description               | Catalog Number |
|---|---------------------------|----------------|
|  | Primary fuse block covers | <b>FSKFB</b>   |

#### Secondary Fuse Clip Cover

#### Secondary Fuse Clip Cover

| Description                     | Catalog Number |
|---------------------------------|----------------|
| Fits 500 VA and smaller models  | <b>SFCS</b>    |
| Fits models greater than 500 VA | <b>SFCL</b>    |

### Technical Data and Specifications

#### Overload Capability

Short-term overload is designed into transformers as required by ANSI. Basically, dry-type distribution transformers will deliver 200% nameplate load for one-half hour, 150% load for one hour and 125% load for four hours without being damaged, provided that a constant 50% load precedes and follows the overload. See ANSI C57.96-01.250 for additional limitations.

Continuous overload capacity is not deliberately designed into a transformer because the design objective is to be within the allowed winding temperature rise with nameplate loading.

#### Insulation System and Temperature Rise

Industry standards classify insulation systems and rise as shown below:

#### Insulation System Classification

| Ambient | + Winding Rise | + Hot Spot | = Temp. Class |
|---------|----------------|------------|---------------|
| 40°C    | 55°C           | 10°C       | 105°C         |
| 40°C    | 80°C           | 30°C       | 150°C         |
| 25°C    | 135°C          | 20°C       | 180°C         |
| 40°C    | 115°C          | 30°C       | 185°C         |
| 40°C    | 150°C          | 30°C       | 220°C         |

The design life of transformers having different insulation systems is the same—the lower-temperature systems are designed for the same life as the higher-temperature systems.

#### Series-Multiple Windings

Series-multiple windings consist of two similar coils in each winding that can be connected in series or parallel (multiple). Transformers with series-multiple windings are designated with an “x” or “/” between the voltage ratings, such as voltages of “120/240” or “240 x 480.” If the series-multiple winding is designated by an “x,” the winding can be connected only for a series or parallel. With the “/” designation, a mid-point also becomes available in addition to the series or parallel connection. As an example, a 120 x 240 winding can be connected for either 120 (parallel) or 240 (series), but a 120/240 winding can be connected for 120 (parallel), 240 (series) or 240 with a 120 mid-point.

For additional information, please refer to Volume 2, **CA08100003E**.

# 7.1

## Industrial Control Transformers

### Transformers

#### Wiring Diagrams

Diagram 1

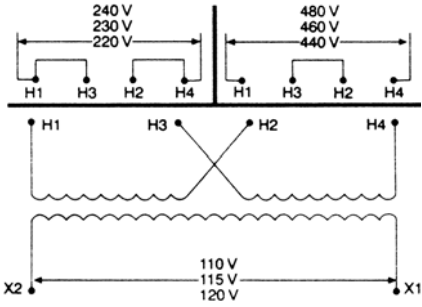

Diagram 5

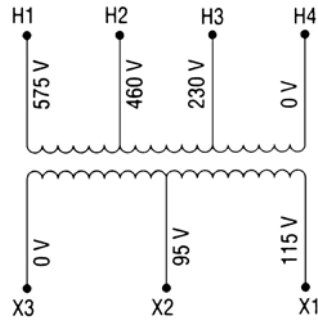

Diagram 2

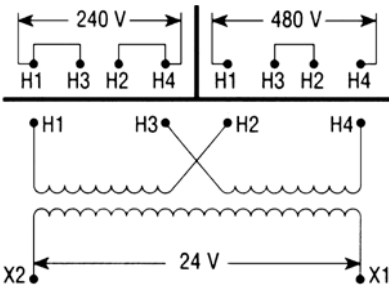

Diagram 6

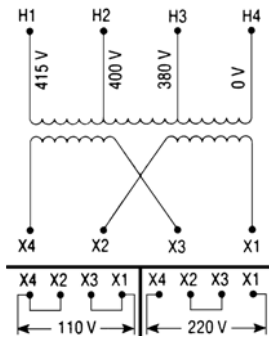

Diagram 3

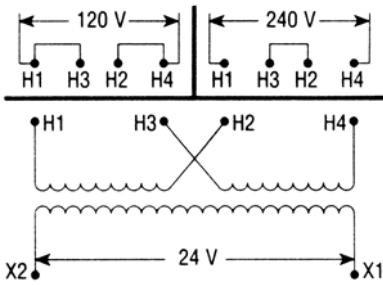

Diagram 7

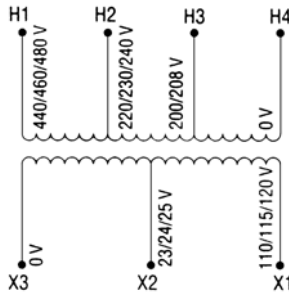

Diagram 4

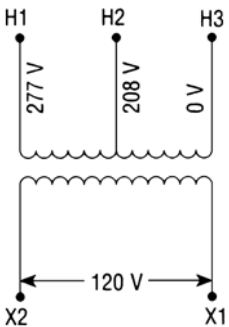
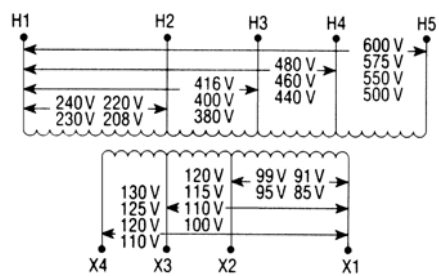
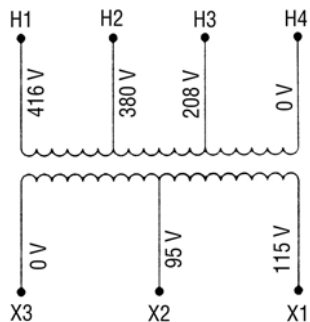

Diagram 8

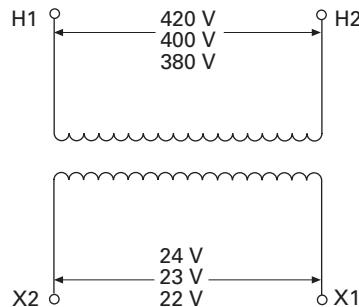



**Diagram 9**



**Diagram 13**



**Diagram 10**

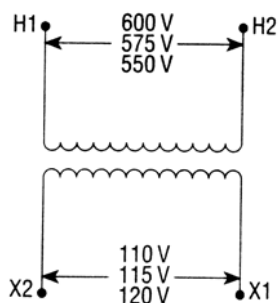

**Diagram 14**

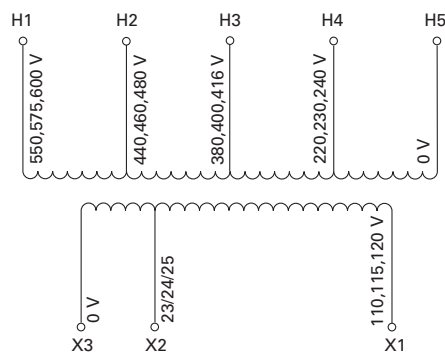

**Diagram 11**

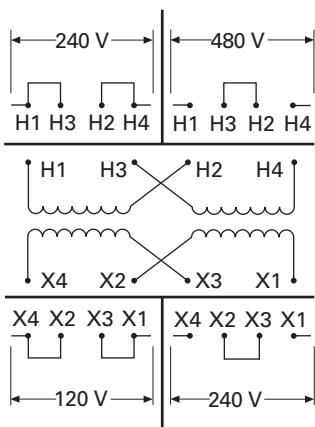

**Diagram 15**

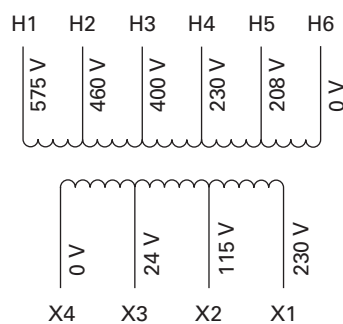

**Diagram 12**

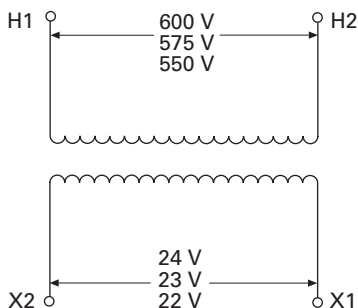

**Diagram 16**

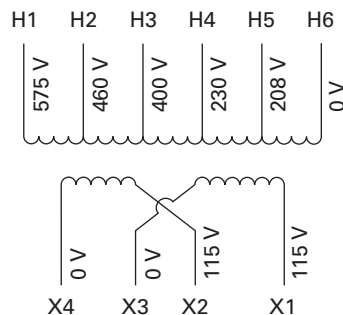

### Acceptable Rating of Primary Overcurrent Protection for CE Marked Control Transformers <sup>①</sup>

Fuses 13/32 x 1-1/2 Inches (10 x 38 mm) Timelag (IEC 269)

| Sec. Voltage | 50  | 75  | 100 | 150 | 200 | 250 | 300 | 350  | 500  | 750  |
|--------------|-----|-----|-----|-----|-----|-----|-----|------|------|------|
| 115          | 2.0 | 2.0 | 4.0 | 4.0 | 6.0 | 6.0 | 8.0 | 10.0 | 12.0 | 20.0 |
| 120          | 2.0 | 2.0 | 4.0 | 4.0 | 6.0 | 6.0 | 8.0 | 10.0 | 12.0 | 20.0 |
| 200          | 1.0 | 2.0 | 2.0 | 4.0 | 4.0 | 4.0 | 4.0 | 6.0  | 8.0  | 12.0 |
| 208          | 1.0 | 2.0 | 2.0 | 4.0 | 4.0 | 4.0 | 4.0 | 6.0  | 8.0  | 12.0 |
| 220          | 1.0 | 1.0 | 2.0 | 4.0 | 4.0 | 4.0 | 4.0 | 6.0  | 6.0  | 10.0 |
| 230          | 1.0 | 1.0 | 2.0 | 4.0 | 4.0 | 4.0 | 4.0 | 6.0  | 6.0  | 10.0 |
| 240          | 1.0 | 1.0 | 2.0 | 4.0 | 4.0 | 4.0 | 4.0 | 4.0  | 6.0  | 10.0 |
| 277          | 0.5 | 1.0 | 1.0 | 2.0 | 4.0 | 4.0 | 4.0 | 4.0  | 6.0  | 8.0  |
| 380          | 0.5 | 1.0 | 1.0 | 2.0 | 2.0 | 4.0 | 4.0 | 4.0  | 6.0  | 6.0  |
| 400          | 0.5 | 0.5 | 1.0 | 2.0 | 2.0 | 4.0 | 4.0 | 4.0  | 4.0  | 6.0  |
| 415          | 0.5 | 0.5 | 1.0 | 1.0 | 2.0 | 4.0 | 4.0 | 4.0  | 4.0  | 6.0  |
| 440          | 0.5 | 0.5 | 1.0 | 1.0 | 2.0 | 2.0 | 4.0 | 4.0  | 4.0  | 6.0  |
| 460          | 0.5 | 0.5 | 1.0 | 1.0 | 2.0 | 2.0 | 4.0 | 4.0  | 4.0  | 6.0  |
| 480          | 0.5 | 0.5 | 0.5 | 1.0 | 2.0 | 2.0 | 4.0 | 4.0  | 4.0  | 6.0  |
| 550          | 0.5 | 0.5 | 0.5 | 1.0 | 1.0 | 2.0 | 2.0 | 4.0  | 4.0  | 4.0  |
| 575          | 0.5 | 0.5 | 0.5 | 1.0 | 1.0 | 2.0 | 2.0 | 4.0  | 4.0  | 4.0  |
| 600          | 0.5 | 0.5 | 0.5 | 1.0 | 2.0 | 2.0 | 2.0 | 4.0  | 4.0  | 4.0  |

### Acceptable Maximum Rating of Secondary Overcurrent Protection <sup>①</sup>

Miniature Fuses 5 x 20 mm Timelag (IEC 127-2/III)

| Sec. Voltage | 50   | 75   | 100  | 150  | 200  | 250   | 300   | 350   | 500   | 750   |
|--------------|------|------|------|------|------|-------|-------|-------|-------|-------|
| 23           | 2.50 | 4.00 | 5.00 | 8.00 | 10.0 | 12.00 | 16.00 | 16.00 | 25.00 | —     |
| 24           | 2.50 | 4.00 | 5.00 | 8.00 | 10.0 | 12.00 | 16.00 | 16.00 | 25.00 | 32.00 |
| 25           | 2.50 | 4.00 | 5.00 | 8.00 | 10.0 | 12.00 | 16.00 | 16.00 | 25.00 | 32.00 |
| 90           | 0.63 | 1.00 | 1.25 | 2.00 | 2.50 | 3.15  | 4.00  | 4.00  | 6.30  | 10.00 |
| 95           | 0.63 | 0.80 | 1.25 | 1.60 | 2.50 | 3.15  | 4.00  | 4.00  | 6.30  | 8.00  |
| 100          | 0.50 | 0.80 | 1.00 | 1.60 | 2.00 | 2.50  | 3.15  | 4.00  | 5.00  | 8.00  |
| 110          | 0.50 | 0.80 | 1.00 | 1.60 | 2.00 | 2.50  | 3.15  | 4.00  | 5.00  | 8.00  |
| 115          | 0.50 | 0.80 | 1.00 | 1.60 | 2.00 | 2.50  | 3.15  | 3.15  | 5.00  | 8.00  |
| 120          | 0.50 | 0.63 | 1.00 | 1.25 | 2.00 | 2.50  | 2.50  | 3.15  | 5.00  | 6.30  |
| 220          | 0.25 | 0.40 | 0.50 | 0.80 | 1.00 | 1.25  | 1.60  | 1.60  | 2.50  | 4.00  |
| 230          | 0.25 | 0.40 | 0.50 | 0.80 | 1.00 | 1.25  | 1.60  | 1.60  | 2.50  | 4.00  |
| 240          | 0.25 | 0.32 | 0.50 | 0.63 | 1.00 | 1.25  | 1.25  | 1.60  | 2.50  | 3.15  |

### Regulation Data Chart

| Transformer VA Rating | Inrush VA at 20% Power Factor |                           |                           |
|-----------------------|-------------------------------|---------------------------|---------------------------|
|                       | NEMA/IEC 95% Sec. Voltage     | NEMA/IEC 90% Sec. Voltage | NEMA/IEC 85% Sec. Voltage |
| 25 <sup>②</sup>       | 100/—                         | 130/—                     | 150/—                     |
| 50 <sup>②</sup>       | 170/190                       | 200/220                   | 240/270                   |
| 75 <sup>②</sup>       | 310/350                       | 410/460                   | 450/600                   |
| 100 <sup>②</sup>      | 370/410                       | 540/600                   | 730/810                   |
| 150 <sup>③</sup>      | 780/850                       | 930/1030                  | 1150/1270                 |
| 200 <sup>③</sup>      | 810/900                       | 1150/1270                 | 1450/1600                 |
| 250 <sup>③</sup>      | 1400/1540                     | 1900/2090                 | 2300/2530                 |
| 300 <sup>③</sup>      | 1900/2090                     | 2700/2970                 | 3850/4240                 |
| 350 <sup>③</sup>      | 3100/3410                     | 3650/4020                 | 4800/5280                 |
| 500 <sup>③</sup>      | 4000/4400                     | 5300/5830                 | 7000/7700                 |
| 750 <sup>③</sup>      | 8300/9130                     | 11,000/12,100             | 14,000/15,400             |
| 1000 <sup>③</sup>     | 15,000/16,500                 | 21,000/23,000             | 27,000/29,500             |
| 1000 <sup>④</sup>     | 9000/9900                     | 13,000/14,300             | 18,500/20,300             |
| 1500 <sup>④</sup>     | 10,500/11,500                 | 15,000/16,500             | 20,500/22,500             |
| 2000 <sup>④</sup>     | 17,000/18,900                 | 25,500/27,300             | 34,000/36,400             |
| 3000 <sup>④</sup>     | 24,000/25,700                 | 36,000/38,500             | 47,500/50,200             |
| 5000 <sup>④</sup>     | 55,000/58,800                 | 92,500/98,900             | 115,000/122,000           |

#### Notes

- ① For values over 6.3A, use 10 x 38 mm timelag (IEC - 269-3-1). T<sub>a</sub> = 40°C control type.
- ② For units with Class 105°C insulation system.
- ③ For units with Class 130°C insulation system.
- ④ For units with Class 180°C insulation system.

To comply with NEMA standards that require all magnetic devices to operate successfully at 85% of rated voltage, the 90% secondary column is most often used in selecting a transformer. No comparable requirement is available for IEC.

Type AP Transformer



## Contents

| <b>Description</b>                      | <b>Page</b>     |
|---|-----------------|
| Type MTE .....                          | <b>V7-T7-4</b>  |
| Type MTK .....                          | <b>V7-T7-13</b> |
| CE Marked .....                         | <b>V7-T7-18</b> |
| Type AP                                 |                 |
| Catalog Number Selection .....          | <b>V7-T7-26</b> |
| Product Selection .....                 | <b>V7-T7-26</b> |
| Technical Data and Specifications ..... | <b>V7-T7-26</b> |

## Type AP

### Product Description

- Encapsulated designs

### Application Description

Transformers provide stepped-down voltages to machine tool control devices, enabling control circuits to be isolated from all power and lighting circuits. This allows the use of grounded or ungrounded circuits that are independent of the power or lighting grounds; thus, greater safety is afforded the operator. The control transformer line is particularly adaptable on applications where compact construction is demanded.

### Features, Benefits and Functions

- Resin encapsulated
- 60 Hz operation
- 180°C insulation system
- 115°C rise standard; 80°C rise optional
- Convenient screw-type terminal board
- Bottom or side/wall-mounting designs
- Performance meets/exceeds requirements of ANSI/NEMA ST-1
- Regulation exceeds ANSI/NEMA requirements for all ratings

### Standards and Certifications

- UL recognized



### Industry Standards

All Eaton dry-type distribution and control transformers are built and tested in accordance with applicable NEMA, ANSI and IEEE Standards.

**Catalog Number Selection**

Please refer to **Page V7-T7-3**.

**Product Selection**

Additional Product Selection information is available in Volume 2, **CA08100003E**.

**240/480 Volts to 120/240 Volts, 60 Hz**

| kVA | Mounting  | Frame | Wiring Diagram ① | Weight Lbs (kg) | Style Number     |
|-----|-----------|-------|------------------|-----------------|------------------|
| 3   | Bottom    | FR133 | 5                | 65 (29.5)       | <b>C0003P7GB</b> |
| 5   | Bottom    | FR99  | 5                | 104 (47.2)      | <b>C0005P7GB</b> |
| 7.5 | Bottom    | FR100 | 5                | 129 (58.6)      | <b>C0007P7GB</b> |
| 10  | Bottom    | FR101 | 5                | 148 (67.2)      | <b>C0010P7GB</b> |
| 15  | Bottom    | FR134 | 5                | 197 (89.4)      | <b>C0015P7GB</b> |
| 3   | Side/Wall | FR292 | 5                | 65 (29.5)       | <b>C0003P7GS</b> |
| 5   | Side/Wall | FR256 | 5                | 104 (47.2)      | <b>C0005P7GS</b> |
| 7.5 | Side/Wall | FR257 | 5                | 129 (58.6)      | <b>C0007P7GS</b> |
| 10  | Side/Wall | FR258 | 5                | 148 (67.2)      | <b>C0010P7GS</b> |
| 15  | Side/Wall | FR259 | 5                | 197 (89.4)      | <b>C0015P7GS</b> |

**Technical Data and Specifications****Overload Capability**

Short-term overload is designed into transformers as required by ANSI. Dry-type distribution transformers will deliver 200% nameplate load for one-half hour, 150% load for one hour and 125% load for four hours without being damaged, provided that a constant 50% load precedes and follows the overload. See ANSI C57.96-01.250 for additional limitations.

Continuous overload capacity is not deliberately designed into a transformer because the design objective is to be within the allowed winding temperature rise with nameplate loading.

**Insulation System and Temperature Rise**

Industry standards classify insulation systems and rise as shown below:

**Insulation System Classification**

| Ambient | + Winding Rise | + Hot Spot | = Temp. Class |
|---------|----------------|------------|---------------|
| 40°C    | 55°C           | 10°C       | 105°C         |
| 40°C    | 80°C           | 30°C       | 150°C         |
| 25°C    | 135°C          | 20°C       | 180°C         |
| 40°C    | 115°C          | 30°C       | 185°C         |
| 40°C    | 150°C          | 30°C       | 220°C         |

The design life of transformers having different insulation systems is the same—the lower-temperature systems are designed for the same life as the higher-temperature systems.

**Sound Levels**

All Eaton 600 volt class general-purpose dry-type distribution transformers are designed to meet NEMA ST-20 levels.

**Winding Terminations**

Eaton recommends external cables be rated 90°C (sized at 75°C ampacity) for encapsulated designs.

**Series-Multiple Windings**

Series-multiple windings consist of two similar coils in each winding that can be connected in series or parallel (multiple). Transformers with series-multiple windings are designated with an “x” or “/” between the voltage ratings, such as voltages of “120/240” or “240 x 480.” If the series-multiple winding is designated by an “x,” the winding can be connected only for a series or parallel.

With the “/” designation, a mid-point also becomes available in addition to the series or parallel connection. As an example, a 120 x 240 winding can be connected for either 120 (parallel) or 240 (series), but a 120/240 winding can be connected for 120 (parallel), 240 (series) or 240 with a 120 mid-point.

For additional information, please refer to Volume 2, **CA08100003E**.

**Note:** For additional information, refer to Eaton’s Industrial Control Transformer Binder B1228A. For other ratings or styles not shown, or for special enclosure types (including stainless steel), refer to Eaton.

**Note**

① See **Page V7-T7-22** for wiring diagrams.

# Terminal Blocks, Fuse Blocks and Fuse Holders

Screw Connection



Spring Cage



Insulation Displacement Connection



## 8.1 IEC—XB Series

|  |          |
|--|----------|
| IEC—XB Series Overview . . . . .                           | V7-T8-2  |
| Screw Connection Terminal Blocks . . . . .                 | V7-T8-4  |
| Spring Cage Terminal Blocks . . . . .                      | V7-T8-31 |
| Pluggable Spring Cage Connection Terminal Blocks . . . . . | V7-T8-58 |
| IDC Terminal Blocks . . . . .                              | V7-T8-67 |
| Miniature Circuit Breakers . . . . .                       | V7-T8-82 |
| XB Series Accessories . . . . .                            | V7-T8-90 |

## 8.2 NEMA

|   |           |
|---|-----------|
| NEMA Overview . . . . .                             | V7-T8-106 |
| C381 Series Terminal Blocks, Rail Mounted . . . . . | V7-T8-107 |
| TB Series Terminal Blocks, Modular . . . . .        | V7-T8-111 |

## 8.3 Power Distribution

|   |           |
|---|-----------|
| Power Distribution Overview . . . . .           | V7-T8-116 |
| CHDB Series—Power Distribution Blocks . . . . . | V7-T8-117 |
| CH160 Series—Power Terminal Blocks . . . . .    | V7-T8-123 |
| Power Terminal Block Accessories . . . . .      | V7-T8-126 |

## 8.4 Fuse Blocks and Fuse Holders

|   |           |
|---|-----------|
| Fuse Blocks and Fuse Holders Overview . . . . .             | V7-T8-128 |
| C383 Series Disconnect Fuse Holders . . . . .               | V7-T8-129 |
| C350 Series Fuse Blocks and W Series Fuse Holders . . . . . | V7-T8-131 |



# 8.1

## Terminal Blocks, Fuse Blocks and Fuse Holders

IEC—XB Series

IEC—XB Series



8

### IEC—XB Series Overview

#### Product Description

The **XB** Series from Eaton offers a complete terminal block system with a universal range of accessories. Marking, bridging and testing accessories are standardized across the different termination technologies—reducing inventory and logistics costs. The modular terminal block design allows for use of the different terminal block types together or individually, providing the highest degree of flexibility.

#### Application Description

The metal portion of the **XB** Series terminal blocks are made from high-grade, strain-crack and corrosion-proof copper alloys. They won't experience any electrolytic corrosion or rusting, even when moisture is present. The metal surfaces are protected with a lead-free, galvanic nickel or tin plating. The good electrical conductivity permits only a low temperature rise. The Polyamide 6.6 housings allow for operating temperatures up to 257°F (125°C) and are certified for inflammability Class V0 in accordance with UL 94.

#### Features

**Global acceptance**—The **XB** Series terminal blocks are designed to worldwide standards and meet the latest international requirements.

**Flexible Plug-in bridge system**—All three technologies (screw, spring and IDC) use the same bridge system, allowing for individual potential distribution and quickly bridged connections among the same terminal block type or across different types. The **XB** Series terminal blocks have two bridge shafts arranged in one line, making flexible chain bridging and skip bridging between non-adjacent terminal blocks possible. Plug-in bridges are available from 2 to 50 positions. Reducing bridges are also available to connect a larger terminal block to a smaller one.

### Contents

#### Description

|   | <i>Page</i>     |
|---|-----------------|
| IEC— <b>XB</b> Series                                     |                 |
| Screw Connection Terminal Blocks . . . . .                | <b>V7-T8-4</b>  |
| Spring Cage Terminal Blocks . . . . .                     | <b>V7-T8-31</b> |
| Pluggable Spring Cage Connection Terminal Blocks. . . . . | <b>V7-T8-58</b> |
| IDC Terminal Blocks . . . . .                             | <b>V7-T8-67</b> |
| Miniature Circuit Breakers. . . . .                       | <b>V7-T8-82</b> |
| <b>XB</b> Series Accessories . . . . .                    | <b>V7-T8-90</b> |

**Large surface area for marking**—All **XB** Series terminal blocks have generously sized surface areas for labeling. This allows for clearly labeled wiring that results in reduced startup time and simplifies activities such as testing and maintenance. There are provisions for marking individual terminal blocks and end stops, strips of terminal blocks, and large groups of terminal blocks.

**Standardized testing system**—All test plugs make contact in one of the easily accessible bridge shafts. A 2.3 mm diameter test plug is available for individual measuring wires. Modular test plugs are also available for more advanced testing.

#### Standards and Certifications

- UL® and cUL® recognized—File No. E67464
- CE approved
- LVD ①
  - EN 60947-7-1
  - EN 60947-7-2
  - EN 60998-2-3
  - EN 60352-4/A1
- ATEX approval (Eex e applications)



#### Note

① Not all standards apply to all terminal blocks. Contact Eaton for details.

## Technical Data and Specifications

### IEC—XB Series

| Description                      | Specification               |
|----------------------------------|-----------------------------|
| Insulation material              | Polyamide 6.6               |
| Dielectric strength              | 600 kV/cm                   |
| Creep resistance                 | 600 CTI                     |
| Internal insulation resistance   | 10 <sup>12</sup> ohms cm    |
| Surface resistance               | 10 <sup>10</sup> ohms       |
| Flammability rating              | UL 94 V0                    |
| Continuous operating temperature | –40 to 257°F (–40 to 125°C) |

### Modular Terminal Blocks for Potentially Explosive Environments

The standard modular terminal blocks from Eaton are approved for potentially explosive environments. In addition to the usual approvals, they also have been approved by a testing center authorized by the EU. No extra approval is required in Intrinsic Safety type applications.

Modular terminal blocks on [www.eaton.com](http://www.eaton.com) fulfill the requirements for “Increased Safety” protection type when installation instructions are followed, and have a type examination certificate in accordance with the Ex directive Ex-RL 94/9/EU.

These test certificates are recognized in all the EU member states and beyond.

The modular terminal blocks are approved for fitting in Zone 1, the Ex environment, as well as Zone 2. Zone 1 fitting is conditional upon terminal blocks being used in connection boxes approved for EEx e type protection and having the equivalent of at least IP54 protection.

The EEx approved modular terminal blocks can be divided into the following groups:

- Screw connection terminal blocks
- Spring-cage connection terminal blocks
- Insulation Displacement Connection terminal blocks
- Mini terminal blocks
- Terminal blocks for specialized applications

**More detailed information on modular terminal blocks in the EEx e area is available on the Internet at [www.eaton.com](http://www.eaton.com) for downloading.**

Here you will find the following:

- Technical data in accordance with EN 50 019
- Approved accessories
- Important installation instructions and mounting diagrams
- EU type examination certificates
- General information on Ex protection

### Identifications

Explosion protected electrical equipment must be marked so that the safety characteristics are identifiable. The identification of electrical equipment is described in the harmonized standard EN 50014, as shown in the following example:

#### EN 50014 Standard Example

| Description                          | Identification |
|--------------------------------------|----------------|
| Manufacturer or trademark            | Eaton          |
| Type designation                     | XBUT25         |
| Abbreviation of explosion protection | EEx e II       |
| Protection type increased safety “e” | e              |
| Equipment group                      | II             |
| Mark of the testing body             | KEMA           |
| Approval number                      | 05ATEX2158 U   |

#### Identification in Accordance with ATEX-RL

Electrical equipment that is certified in accordance with the ATEX 100a guideline also receives identification describing the site for use.

#### ATEX Guideline Example

| Description                        | Identification |
|------------------------------------|----------------|
| Manufacturing data                 | 02.01.2004     |
| Address of the manufacturer        | Duncan, SC     |
| Number of the appointed dept.      | 344            |
| Common marking                     | Ex symbol      |
| Equipment group                    | II             |
| Category                           | 2              |
| Use in gas and/or dust atmospheres | G D            |

# 8.1

## Terminal Blocks, Fuse Blocks and Fuse Holders

IEC—XB Series

Screw Connection



8

### Contents

#### Description

#### Page

|   |                 |
|---|-----------------|
| Screw Connection Terminal Blocks                      |                 |
| Single Level—Through-Feed . . . . .                   | <b>V7-T8-5</b>  |
| Single Level—Ground Blocks . . . . .                  | <b>V7-T8-10</b> |
| Multi-Conductor Terminal Blocks . . . . .             | <b>V7-T8-12</b> |
| Multi-Conductor Ground Blocks . . . . .               | <b>V7-T8-14</b> |
| Double Level . . . . .                                | <b>V7-T8-16</b> |
| Triple Level Sensor/Actuator . . . . .                | <b>V7-T8-18</b> |
| Fuse Terminal Blocks . . . . .                        | <b>V7-T8-21</b> |
| Disconnect and Component Terminal<br>Blocks . . . . . | <b>V7-T8-24</b> |
| High Current Blocks . . . . .                         | <b>V7-T8-27</b> |
| Mini Screw Connection . . . . .                       | <b>V7-T8-29</b> |



Drawings  
Online

### Screw Connection Terminal Blocks Overview

#### Product Description

The XBUT Series uses a screw connection system that is accepted worldwide and is suitable in most applications. The maintenance-free connection provides the reliability you expect from Eaton.

#### Application Description

Designed for applications with high demands, the XBUT Series screw terminal block has a maintenance-free wire connection. re-tightening of the terminal screws is not necessary to ensure proper operation. The screw locking technique prevents the screws from backing out. Copper wires can be clamped without pre-treatment or ferrules can be used for splicing protection. Multiple conductors can be connected in the same clamping mechanism, saving space.

#### Features

- Maintenance-free connections
- Global acceptance
- Multi-conductor connections
- Flexible Plug-in bridge system
- Large surface area for marking
- Standardized testing system
- Metal parts made of tin-plated copper alloy

#### Standards and Certifications

- UL and cUL recognized—File No. E67464
- CE approved
- LVD ①:
  - EN 60947-7-1
  - EN 60947-7-2
  - EN 60998-2-3
  - EN 60352-4/A1
- ATEX approval (Eex e applications)



#### Note

① Not all standards apply to all terminal blocks. Contact Eaton for details.



Single Level—Through-Feed

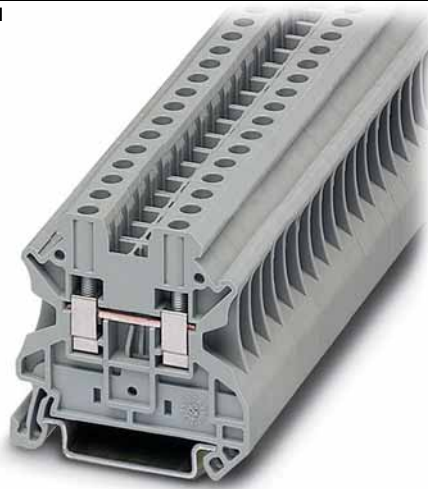

## Single Level—Through-Feed

### Product Description

The XBUT terminal blocks feature a compact design and maintenance-free screw connection. There is a double bridge shaft providing maximum flexibility.

The double bridge shaft can accommodate individual chain bridging and step-down bridging from other terminal blocks. There are numerous options for accessories,

## Contents

### Description

|  | <i>Page</i>     |
|--|-----------------|
| Single Level—Through-Feed                          |                 |
| Product Selection . . . . .                        | <b>V7-T8-6</b>  |
| Accessories . . . . .                              | <b>V7-T8-7</b>  |
| Technical Data and Specifications . . . . .        | <b>V7-T8-9</b>  |
| Dimensions . . . . .                               | <b>V7-T8-9</b>  |
| Single Level—Ground Blocks . . . . .               | <b>V7-T8-10</b> |
| Multi-Conductor Terminal Blocks . . . . .          | <b>V7-T8-12</b> |
| Multi-Conductor Ground Blocks . . . . .            | <b>V7-T8-14</b> |
| Double Level . . . . .                             | <b>V7-T8-16</b> |
| Triple Level Sensor/Actuator . . . . .             | <b>V7-T8-18</b> |
| Fuse Terminal Blocks . . . . .                     | <b>V7-T8-21</b> |
| Disconnect and Component Terminal Blocks . . . . . | <b>V7-T8-24</b> |
| High Current Blocks . . . . .                      | <b>V7-T8-27</b> |
| Mini Screw Connection . . . . .                    | <b>V7-T8-29</b> |

including those for testing and marking. Terminal blocks are available for wire cross-sections ranging from 12 AWG (2.5 mm<sup>2</sup>) to 2/0 AWG (150 mm<sup>2</sup>).

# 8.1

## Terminal Blocks, Fuse Blocks and Fuse Holders

IEC—XB Series

### Product Selection

**XBUT4**



#### Screw Connection Single Level—Through-Feed

| Terminal Width | Maximum Wire Size          | IEC 60 947-7-1 in V/A/AWG | EN 50 019 <sup>①</sup> in V/A/AWG | UL-cUL Ratings in V/A/AWG | Color  | Standard Pack | Catalog Number  |
|----------------|----------------------------|---------------------------|-----------------------------------|---------------------------|--------|---------------|-----------------|
| 5.2 mm         | 12 AWG/2.5 mm <sup>2</sup> | 800/32/26–12              | 750/22/28/26–12                   | 600/20/26–12              | Gray   | 50            | <b>XBUT25</b>   |
|                |                            |                           |                                   |                           | Blue   | 50            | <b>XBUT25BU</b> |
| 6.2 mm         | 10 AWG/4 mm <sup>2</sup>   | 800/41/26–10              | 750/30/38/26–10                   | 600/30/26–10              | Gray   | 50            | <b>XBUT4</b>    |
|                |                            |                           |                                   |                           | Blue   | 50            | <b>XBUT4BU</b>  |
|                |                            |                           |                                   |                           | Orange | 50            | <b>XBUT4OR</b>  |
|                |                            |                           |                                   |                           | Yellow | 50            | <b>XBUT4YE</b>  |
|                |                            |                           |                                   |                           | Red    | 50            | <b>XBUT4RD</b>  |
|                |                            |                           |                                   |                           | White  | 50            | <b>XBUT4WH</b>  |
|                |                            |                           |                                   |                           | Black  | 50            | <b>XBUT4BK</b>  |
| 8.2 mm         | 8 AWG/6 mm <sup>2</sup>    | 800/57/24–8               | 750/40/50/24–8                    | 600/50/24–8               | Gray   | 50            | <b>XBUT6</b>    |
|                |                            |                           |                                   |                           | Blue   | 50            | <b>XBUT6BU</b>  |
| 10.2 mm        | 6 AWG/10 mm <sup>2</sup>   | 1000/76/20–6              | 750/54/69/20–6                    | 600/65/20–6               | Gray   | 50            | <b>XBUT10</b>   |
|                |                            |                           |                                   |                           | Blue   | 50            | <b>XBUT10BU</b> |
|                |                            |                           |                                   |                           | Orange | 50            | <b>XBUT10OR</b> |
|                |                            |                           |                                   |                           | Yellow | 50            | <b>XBUT10YE</b> |
|                |                            |                           |                                   |                           | Red    | 50            | <b>XBUT10RD</b> |
| 12 mm          | 4 AWG/16 mm <sup>2</sup>   | 1000/101/17–4             | —                                 | 600/85/16–4               | Gray   | 50            | <b>XBUT16</b>   |
|                |                            |                           |                                   |                           | Blue   | 50            | <b>XBUT16BU</b> |
| 16 mm          | 0 AWG/35 mm <sup>2</sup>   | 1000/150/15–0             | —                                 | 600/150/14–1/0            | Gray   | 50            | <b>XBUT35</b>   |
|                |                            |                           |                                   |                           | Blue   | 50            | <b>XBUT35BU</b> |

**Note**

<sup>①</sup> EU type—examination certificate number: KEMA 05ATEX2158 U.

## Accessories

## Screw Connection Single Level—Through-Feed

| Description   | Color | Number of Positions | Standard Pack | XBUT25<br>Catalog<br>Number | XBUT4<br>Catalog<br>Number | XBUT6<br>Catalog<br>Number | XBUT10<br>Catalog<br>Number | XBUT16<br>Catalog<br>Number | XBUT35<br>Catalog<br>Number |
|---|-------|---------------------|---------------|-----------------------------|----------------------------|----------------------------|-----------------------------|-----------------------------|-----------------------------|
| End cover   | Gray  | —                   | 10            | <b>XBACUT10</b>             | <b>XBACUT10</b>            | <b>XBACUT10</b>            | <b>XBACUT10</b>             | <b>XBACUT16</b>             | ①                           |
| Partition plate   | Gray  | —                   | 10            | <b>XBATUT10</b>             | <b>XBATUT10</b>            | <b>XBATUT10</b>            | <b>XBATUT10</b>             | —                           | —                           |
| Plug-in bridge—<br>for cross connections<br>in the bridge shaft | Red   | 2                   | 10            | <b>XBAFBS25</b>             | <b>XBAFBS26</b>            | <b>XBAFBS28</b>            | <b>XBAFBS210</b>            | <b>XBAFBS212</b>            | <b>XBAFBS216</b>            |
|   |       | 3                   | 10            | <b>XBAFBS35</b>             | <b>XBAFBS36</b>            | —                          | —                           | —                           | —                           |
|   |       | 5                   | 10            | <b>XBAFBS55</b>             | <b>XBAFBS56</b>            | —                          | —                           | —                           | —                           |
|   |       | 10                  | 10            | <b>XBAFBS105</b>            | <b>XBAFBS106</b>           | —                          | —                           | —                           | —                           |
|   |       | 50                  | 10            | <b>XBAFBS505</b>            | <b>XBAFBS506</b>           | —                          | —                           | —                           | —                           |
| Test adapter  | —     | —                   | 10            | <b>XBATSPA14</b>            | <b>XBATSPA14</b>           | <b>XBATSPA14</b>           | —                           | —                           | —                           |
| 2.3 mm diameter test plug                                       | —     | —                   | —             | <b>XBATSMPS-</b> ①          | <b>XBATSMPS-</b> ①         | —                          | —                           | —                           | —                           |
| Modular test plug   | —     | —                   | 10            | <b>XBATSPS5</b>             | <b>XBATSPS6</b>            | <b>XBATSPS8</b>            | —                           | —                           | —                           |
| Blank marker strip (strip of 10)                                | White | —                   | 10            | <b>XBMZB5</b> ②             | <b>XBMZB6</b> ②            | <b>XBMZB8</b> ②            | <b>XBMZB10</b> ②            | <b>XBMZB12</b> ②            | <b>XBMZB15</b> ②            |

**Notes**

① Enclosed block, no end cover needed.

② For information on Printed Marking Tag Options, see **Page V7-T8-98**.For additional accessories, see **Page V7-T8-90**.

# 8.1

## Terminal Blocks, Fuse Blocks and Fuse Holders

IEC—XB Series

### XBUT with Reducing Bridge

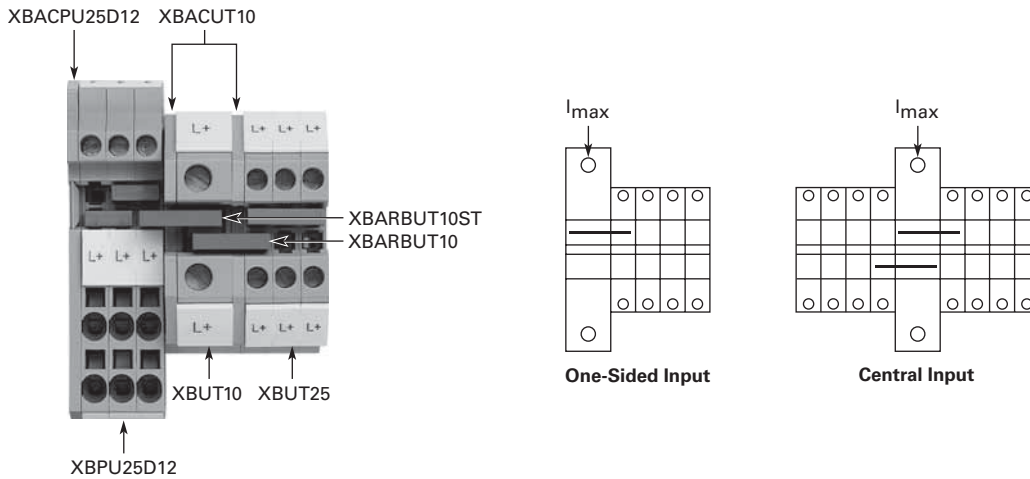

8

### Step-Down Bridge with Standard Feed-Through Terminal Blocks

| Input Terminal Blocks | Cross-Section               | Pick-Off Terminal Blocks | Cross-Section AWG (mm <sup>2</sup> ) | One-Sided Input I <sub>max</sub> | Central Input I <sub>max</sub> | Bridge Catalog Number |
|-----------------------|-----------------------------|--------------------------|--------------------------------------|----------------------------------|--------------------------------|-----------------------|
| XBUT10                | 6 AWG (10 mm <sup>2</sup> ) | XBUT25                   | 12 (2.5)                             | 40                               | 65                             | <b>XBARBUT10</b>      |
|                       |                             | XBUT4                    | 10 (4)                               | 45                               | 65                             | <b>XBARBUT10</b>      |
|                       |                             | XBPT25                   | 12 (2.5)                             | 40                               | 65                             | <b>XBARBUT10ST</b>    |
|                       |                             | XBPT4                    | 10 (4)                               | 45                               | 65                             | <b>XBARBUT10ST</b>    |
|                       |                             | XBQT15                   | 14 (1.5)                             | 35                               | 65                             | <b>XBARBUT10ST</b>    |
|                       |                             | XBQT25                   | 12 (2.5)                             | 40                               | 65                             | <b>XBARBUT10ST</b>    |
| XBUT16                | 4 AWG (16 mm <sup>2</sup> ) | XBUT25                   | 12 (2.5)                             | 40                               | 80                             | <b>XBARBUT16</b>      |
|                       |                             | XBUT4                    | 10 (4)                               | 45                               | 90                             | <b>XBARBUT16</b>      |
|                       |                             | XBPT25                   | 12 (2.5)                             | 40                               | 80                             | <b>XBARBUT16ST</b>    |
|                       |                             | XBPT4                    | 10 (4)                               | 45                               | 90                             | <b>XBARBUT16ST</b>    |
|                       |                             | XBQT15                   | 14 (1.5)                             | 35                               | 70                             | <b>XBARBUT16ST</b>    |
|                       |                             | XBQT25                   | 12 (2.5)                             | 40                               | 80                             | <b>XBARBUT16ST</b>    |

## Technical Data and Specifications

### Screw Connection Single Level—Through-Feed

| Description  | XBUT25            | XBUT4             | XBUT6               | XBUT10              | XBUT16            | XBUT35              |
|--|-------------------|-------------------|---------------------|---------------------|-------------------|---------------------|
| <b>Technical Data in Accordance with IEC</b>                             |                   |                   |                     |                     |                   |                     |
| Maximum load current in A/cross-section in mm <sup>2</sup>               | 32/4              | 41/6              | 57/10               | 76/16               | 101/25            | 150/50              |
| Rated surge voltage in kV/contamination class                            | 8/3               | 8/3               | 8/3                 | 8/3                 | 8/3               | 8/3                 |
| Surge voltage category/insulating material group                         | III/II            | III/I             | III/I               | III/I               | III/I             | III/I               |
| <b>Connection Capacity</b>   |                   |                   |                     |                     |                   |                     |
| Stranded with ferrule/with ferrule and plastic sleeve in mm <sup>2</sup> | 0.25–2.5/0.25–2.5 | 0.25–4/0.25–4     | 0.25–6/0.25–6       | 0.5–10/0.5–10       | 1.0–16/1.0–16     | 1.5–35/1.5–35       |
| <b>Multi-Conductor Connection</b><br>(same cross-section)                |                   |                   |                     |                     |                   |                     |
| Solid/stranded in mm <sup>2</sup>  | 0.14–1.5/0.14–1.5 | 0.14–1.5/0.14–1.5 | 0.2–2.5/0.2–2.5     | 0.5–4/0.5–4         | 1.0–6/1.0–4       | 1.5–16/1.5–10       |
| Stranded with ferrules without plastic sleeve in mm <sup>2</sup>         | 0.25–1.5          | 0.25–1.5          | 0.25–1.5            | 0.5–2.5             | 1.0–4             | 1.5–10              |
| Stranded with twin ferrule with plastic sleeve in mm <sup>2</sup>        | 0.5–1.5           | 0.5–2.5           | 0.5–4               | 0.5–6               | 0.75–10           | 1.5–10              |
| Stripping length in inches (mm)  | 0.35 (9)          | 0.35 (9)          | 0.39 (10)           | 0.39 (10)           | 0.39 (10)         | 0.63 (16)           |
| Thread   | M3                | M3                | M4                  | M4                  | M5                | M6                  |
| Torque in in-lb (Nm)   | 5.3–7.1 (0.6–0.8) | 5.3–7.1 (0.6–0.8) | 13.3–15.9 (1.5–1.8) | 13.3–15.9 (1.5–1.8) | 22.1–26.6 (2.5–3) | 28.3–32.7 (3.2–3.7) |

## Dimensions

Approximate Dimensions in Inches (mm)

### Screw Connection Single Level—Through-Feed

| Catalog Number | Width       | Length      | Cover Width | Height for— |             |
|----------------|-------------|-------------|-------------|-------------|-------------|
|                |             |             |             | 35 x 7.5 in | 35 x 15 in  |
| XBUT25         | 0.20 (5.2)  | 1.85 (46.9) | 0.09 (2.2)  | 1.87 (47.5) | 2.17 (55.0) |
| XBUT4          | 0.24 (6.2)  | 1.85 (46.9) | 0.09 (2.2)  | 1.87 (47.5) | 2.17 (55.0) |
| XBUT6          | 0.32 (8.2)  | 1.85 (46.9) | 0.09 (2.2)  | 1.87 (47.5) | 2.17 (55.0) |
| XBUT10         | 0.40 (10.2) | 1.85 (46.9) | 0.09 (2.2)  | 1.87 (47.5) | 2.17 (55.0) |
| XBUT16         | 0.47 (12.0) | 2.08 (52.8) | 0.09 (2.2)  | 2.16 (54.8) | 2.45 (62.3) |
| XBUT35         | 0.63 (16.0) | 2.37 (60.2) | —           | 2.59 (65.7) | 2.88 (73.2) |

#### Notes

- ① XBUT35 has an enclosed design. The use of an end cover is not required.
- ② For information on Printed Marking Tag Options, see **Page V7-T8-98**.

# 8.1

## Terminal Blocks, Fuse Blocks and Fuse Holders

IEC—XB Series

### Single Level—Ground Blocks



### Contents

#### Description

| <i>Description</i>                             | <i>Page</i>     |
|--|-----------------|
| Single Level—Through-Feed .....                | <b>V7-T8-5</b>  |
| Single Level—Ground Blocks                     |                 |
| Accessories .....                              | <b>V7-T8-11</b> |
| Technical Data and Specifications .....        | <b>V7-T8-11</b> |
| Dimensions .....                               | <b>V7-T8-11</b> |
| Multi-Conductor Terminal Blocks .....          | <b>V7-T8-12</b> |
| Multi-Conductor Ground Blocks .....            | <b>V7-T8-14</b> |
| Double Level .....                             | <b>V7-T8-16</b> |
| Triple Level Sensor/Actuator .....             | <b>V7-T8-18</b> |
| Fuse Terminal Blocks .....                     | <b>V7-T8-21</b> |
| Disconnect and Component Terminal Blocks ..... | <b>V7-T8-24</b> |
| High Current Blocks .....                      | <b>V7-T8-27</b> |
| Mini Screw Connection .....                    | <b>V7-T8-29</b> |

8

### Single Level—Ground Blocks

#### Product Description

The ground terminal blocks have the same shape and pitch as the standard terminal block, in a green-yellow housing. They easily snap

onto the DIN rail to make a reliable mechanical and electrical contact that meets all requirements of IEC 60-947-7-2.

#### Product Selection

**XBUT6PE**



#### Screw Connection Single Level—Ground Blocks

| Terminal Width | Maximum Wire Size          | IEC 60 947-7-1 in V/A/AWG | EN 50 019 ① in V/A/AWG | UL-cUL Ratings in V/A/AWG | Color        | Standard Pack | Catalog Number  |
|----------------|----------------------------|---------------------------|------------------------|---------------------------|--------------|---------------|-----------------|
| 5.2 mm         | 12 AWG/2.5 mm <sup>2</sup> | —/—/26-12                 | —/—/26-12              | —/—/26-12                 | Green/Yellow | 50            | <b>XBUT25PE</b> |
| 6.2 mm         | 10 AWG/4 mm <sup>2</sup>   | —/—/26-10                 | —/—/26-10              | —/—/26-10                 | Green/Yellow | 50            | <b>XBUT4PE</b>  |
| 8.2 mm         | 8 AWG/6 mm <sup>2</sup>    | —/—/24-8                  | —/—/24-8               | —/—/24-8                  | Green/Yellow | 50            | <b>XBUT6PE</b>  |
| 10.2 mm        | 6 AWG/10 mm <sup>2</sup>   | —/76/20-6                 | —/54/69/20-6           | —/—/20-6                  | Green/Yellow | 50            | <b>XBUT10PE</b> |
| 12 mm          | 4 AWG/16 mm <sup>2</sup>   | —/101/15-4                | —                      | —/—/16-4                  | Green/Yellow | 50            | <b>XBUT16PE</b> |
| 16 mm          | 2 AWG/35 mm <sup>2</sup>   | —/125/15-2                | —                      | —/—/14-1/0                | Green/Yellow | 50            | <b>XBUT35PE</b> |

#### Note

① EU type—examination certificate number: KEMA 05ATEX2158 U.

## Accessories

## Screw Connection Single Level—Ground Blocks

| Description   | Color | Number of Positions | Standard Pack | XBUT25PE<br>Catalog Number | XBUT4PE<br>Catalog Number | XBUT6PE<br>Catalog Number | XBUT10PE<br>Catalog Number | XBUT16PE<br>Catalog Number | XBUT35PE<br>Catalog Number |
|---|-------|---------------------|---------------|----------------------------|---------------------------|---------------------------|----------------------------|----------------------------|----------------------------|
| End cover   | Gray  | —                   | 10            | XBACUT10                   | XBACUT10                  | XBACUT10                  | XBACUT10                   | XBACUT16                   | ③                          |
| Partition plate   | —     | —                   | 10            | XBATUT10                   | XBATUT10                  | XBATUT10                  | XBATUT10                   | —                          | —                          |
| Plug-in bridge—<br>for cross connections<br>in the bridge shaft | Red   | 2                   | 10            | XBAFBS25                   | XBAFBS26                  | XBAFBS28                  | XBAFBS210                  | XBAFBS212                  | XBAFBS212                  |
|   |       | 3                   | 10            | XBAFBS35                   | XBAFBS36                  | —                         | —                          | —                          | —                          |
|   |       | 5                   | 10            | XBAFBS55                   | XBAFBS56                  | —                         | —                          | —                          | —                          |
|   |       | 10                  | 10            | XBAFBS105                  | XBAFBS106                 | —                         | —                          | —                          | —                          |
|   |       | 50                  | 10            | XBAFBS505                  | XBAFBS506                 | —                         | —                          | —                          | —                          |
| Test adapter  | —     | —                   | 10            | XBATSPA14                  | XBATSPA14                 | XBATSPA14                 | —                          | —                          | —                          |
| 2.3 mm diameter test plug                                       | —     | —                   | —             | XBATSMPS_①                 | XBATSMPS_①                | —                         | —                          | —                          | —                          |
| Modular test plug   | —     | —                   | 10            | XBATSPS5                   | XBATSPS6                  | XBATSPS8                  | —                          | —                          | —                          |
| Blank marker strip (strip of 10)                                | White | —                   | 10            | XBMZB5 ②                   | XBMZB6 ②                  | XBMZB8 ②                  | XBMZB10 ②                  | XBMZB12 ②                  | XBMZB15 ②                  |

## Technical Data and Specifications

## Screw Connection Single Level—Ground Blocks

| Description  | XBUT25PE          | XBUT4PE           | XBUT6PE             | XBUT10PE            | XBUT16PE          | XBUT35PE            |
|--|-------------------|-------------------|---------------------|---------------------|-------------------|---------------------|
| <b>Technical Data in Accordance with IEC</b>                             |                   |                   |                     |                     |                   |                     |
| Maximum load current in A/cross-section in mm <sup>2</sup>               | —                 | —                 | —                   | 76/16               | 101/25            | 125/50              |
| Rated surge voltage in kV/contamination class                            | 8/3               | 8/3               | 8/3                 | 8/3                 | 8/3               | 8/3                 |
| Surge voltage category/insulating material group                         | III/II            | III/I             | III/I               | III/I               | III/I             | III/I               |
| <b>Connection Capacity</b>   |                   |                   |                     |                     |                   |                     |
| Stranded with ferrule/with ferrule and plastic sleeve in mm <sup>2</sup> | 0.25–2.5/0.25–2.5 | 0.25–4/0.25–4     | 0.25–6/0.25–6       | 0.5–10/0.5–10       | 1.0–16/1.0–16     | 1.5–35/1.5–35       |
| <b>Multi-Conductor Connection</b><br>(same cross-section)                |                   |                   |                     |                     |                   |                     |
| Solid/stranded in mm <sup>2</sup>  | 0.14–1.5/0.14–1.5 | 0.14–1.5/0.14–1.5 | 0.2–2.5/0.2–2.5     | 0.5–4/0.5–4         | 1.0–6/1.0–4       | 1.5–16/1.5–10       |
| Stranded with ferrules without plastic sleeve in mm <sup>2</sup>         | 0.25–1.5          | 0.25–1.5          | 0.25–1.5            | 0.5–2.5             | 1.0–4             | 1.5–10              |
| Stranded with twin ferrule with plastic sleeve in mm <sup>2</sup>        | 0.5–1.5           | 0.5–2.5           | 0.5–4               | 0.5–6               | 0.75–10           | 1.5–10              |
| Stripping length in inches (mm)  | 0.35 (9)          | 0.35 (9)          | 0.39 (10)           | 0.39 (10)           | 0.39 (10)         | 0.63 (16)           |
| Thread   | M3                | M3                | M4                  | M4                  | M5                | M6                  |
| Torque in in-lb (Nm)   | 5.3–7.1 (0.6–0.8) | 5.3–7.1 (0.6–0.8) | 13.3–15.9 (1.5–1.8) | 13.3–15.9 (1.5–1.8) | 22.1–26.6 (2.5–3) | 28.3–32.7 (3.2–3.7) |

## Dimensions

Approximate Dimensions in Inches (mm)

## Screw Connection Single Level—Ground Blocks

| Catalog Number | Width       | Length      | Cover Width | Height for— |             |
|----------------|-------------|-------------|-------------|-------------|-------------|
|                |             |             |             | 35 x 7.5 in | 35 x 15 in  |
| XBUT25PE       | 0.20 (5.2)  | 1.85 (46.9) | 0.09 (2.2)  | 1.87 (47.5) | 2.17 (55.0) |
| XBUT4PE        | 0.24 (6.2)  | 1.85 (46.9) | 0.09 (2.2)  | 1.87 (47.5) | 2.17 (55.0) |
| XBUT6PE        | 0.32 (8.2)  | 1.85 (46.9) | 0.09 (2.2)  | 1.87 (47.5) | 2.17 (55.0) |
| XBUT10PE       | 0.40 (10.2) | 1.85 (46.9) | 0.09 (2.2)  | 1.87 (47.5) | 2.17 (55.0) |
| XBUT16PE       | 0.47 (12.0) | 2.08 (52.8) | 0.09 (2.2)  | 2.16 (54.8) | 2.45 (62.3) |
| XBUT35PE       | 0.63 (16.0) | 2.37 (60.2) | —           | 2.59 (65.7) | 2.88 (73.2) |

## Notes

- ① For ordering information, see [Page V7-T8-105](#).  
 ② For information on Printed Marking Tag Options, see [Page V7-T8-98](#).  
 ③ XBUT35PE has an enclosed design. The use of an end cover is not required.

For additional accessories, see [Page V7-T8-90](#).

# 8.1

## Terminal Blocks, Fuse Blocks and Fuse Holders

IEC—XB Series

### Multi-Conductor Terminal Blocks

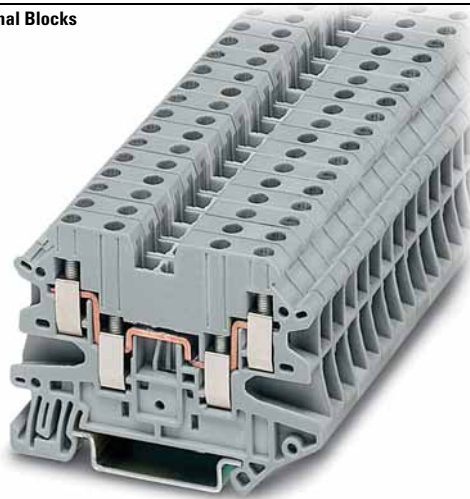

### Contents

| <b>Description</b>                                 | <b>Page</b>     |
|--|-----------------|
| Single Level—Through-Feed . . . . .                | <b>V7-T8-5</b>  |
| Single Level—Ground Blocks . . . . .               | <b>V7-T8-10</b> |
| Multi-Conductor Terminal Blocks                    |                 |
| Accessories . . . . .                              | <b>V7-T8-13</b> |
| Technical Data and Specifications . . . . .        | <b>V7-T8-13</b> |
| Dimensions . . . . .                               | <b>V7-T8-13</b> |
| Multi-Conductor Ground Blocks . . . . .            | <b>V7-T8-14</b> |
| Double Level . . . . .                             | <b>V7-T8-16</b> |
| Triple Level Sensor/Actuator . . . . .             | <b>V7-T8-18</b> |
| Fuse Terminal Blocks . . . . .                     | <b>V7-T8-21</b> |
| Disconnect and Component Terminal Blocks . . . . . | <b>V7-T8-24</b> |
| High Current Blocks . . . . .                      | <b>V7-T8-27</b> |
| Mini Screw Connection . . . . .                    | <b>V7-T8-29</b> |

8

### Multi-Conductor Terminal Blocks

#### Product Description

The multi-conductor terminal blocks offer a space-saving alternative to standard feed-through terminal blocks allowing for high density wiring. Often, three

connections have to be led to one terminal block. The XBUT...D12 terminal block accomplishes this without any additional terminal blocks or bridging required.

The XBUT...D22 terminal blocks allow four wires to be connected to one potential—and can therefore be used as compact power distributors.

#### Product Selection

##### XBUT25D12

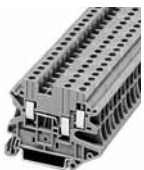

#### Screw Connection Multi-Conductor Terminal Blocks, Three-Wire

| Terminal Width | Maximum Wire Size          | IEC 60 947-7-1 in V/A/AWG | UL-cUL Ratings in V/A/AWG | Color | Standard Pack | Catalog Number     |
|----------------|----------------------------|---------------------------|---------------------------|-------|---------------|--------------------|
| 5.2 mm         | 12 AWG/2.5 mm <sup>2</sup> | 500/28/26–12              | 150/20/26–12              | Gray  | 50            | <b>XBUT25D12</b>   |
|                |                            |                           |                           | Blue  | 50            | <b>XBUT25D12BU</b> |
| 6.2 mm         | 10 AWG/4 mm <sup>2</sup>   | 500/39/26–10              | 150/30/26–10              | Gray  | 50            | <b>XBUT4D12</b>    |
|                |                            |                           |                           | Blue  | 50            | <b>XBUT4D12BU</b>  |

##### XBUT4D22



#### Screw Connection Multi-Conductor Terminal Blocks, Four-Wire

| Terminal Width | Maximum Wire Size          | IEC 60 947-7-1 in V/A/AWG | UL-cUL Ratings in V/A/AWG | Color | Standard Pack | Catalog Number     |
|----------------|----------------------------|---------------------------|---------------------------|-------|---------------|--------------------|
| 5.2 mm         | 12 AWG/2.5 mm <sup>2</sup> | 500/28/26–12              | 150/20/26–12              | Gray  | 50            | <b>XBUT25D22</b>   |
|                |                            |                           |                           | Blue  | 50            | <b>XBUT25D22BU</b> |
| 6.2 mm         | 10 AWG/4 mm <sup>2</sup>   | 500/39/26–10              | 150/30/26–10              | Gray  | 50            | <b>XBUT4D22</b>    |
|                |                            |                           |                           | Blue  | 50            | <b>XBUT4D22BU</b>  |



## Accessories

### Screw Connection Multi-Conductor Terminal Blocks

| Description  | Color | Number of Positions | Standard Pack | XBUT25D12                    | XBUT4D12                     | XBUT25D22                    | XBUT4D22                     |
|--|-------|---------------------|---------------|------------------------------|------------------------------|------------------------------|------------------------------|
|  |       |                     |               | Catalog Number               | Catalog Number               | Catalog Number               | Catalog Number               |
| End cover  | Gray  | —                   | 10            | <b>XBACUT4D12</b>            | <b>XBACUT4D12</b>            | <b>XBACUT4D22</b>            | <b>XBACUT4D22</b>            |
| End cover segment  | Gray  | —                   | 10            | <b>XBASUT4</b>               | <b>XBASUT4</b>               | <b>XBASUT4</b>               | <b>XBASUT4</b>               |
| Partition plate  | —     | —                   | 10            | <b>XBATUTD12</b>             | <b>XBATUTD12</b>             | <b>XBATUTD22</b>             | <b>XBATUTD22</b>             |
| Plug-in bridge—for cross connections in the bridge shaft | Red   | 2                   | 10            | <b>XBAFBS25</b>              | <b>XBAFBS26</b>              | <b>XBAFBS25</b>              | <b>XBAFBS26</b>              |
|  |       | 3                   | 10            | <b>XBAFBS35</b>              | <b>XBAFBS36</b>              | <b>XBAFBS35</b>              | <b>XBAFBS36</b>              |
|  |       | 5                   | 10            | <b>XBAFBS55</b>              | <b>XBAFBS56</b>              | <b>XBAFBS55</b>              | <b>XBAFBS56</b>              |
|  |       | 10                  | 10            | <b>XBAFBS105</b>             | <b>XBAFBS106</b>             | <b>XBAFBS105</b>             | <b>XBAFBS106</b>             |
|  |       | 50                  | 10            | <b>XBAFBS505</b>             | <b>XBAFBS506</b>             | <b>XBAFBS505</b>             | <b>XBAFBS506</b>             |
| Test adapter   | —     | —                   | 10            | <b>XBATSPAI4</b>             | <b>XBATSPAI4</b>             | <b>XBATSPAI4</b>             | <b>XBATSPAI4</b>             |
| 2.3 mm diameter test plug                                | —     | —                   | —             | <b>XBATSMPS-<sup>①</sup></b> | <b>XBATSMPS-<sup>①</sup></b> | <b>XBATSMPS-<sup>①</sup></b> | <b>XBATSMPS-<sup>①</sup></b> |
| Modular test plug  | —     | —                   | 10            | <b>XBATSPS5</b>              | <b>XBATSPS6</b>              | <b>XBATSPS5</b>              | <b>XBATSPS6</b>              |
| Blank marker strip (strip of 10)                         | White | —                   | 10            | <b>XBMZB5<sup>②</sup></b>    | <b>XBMZB6<sup>②</sup></b>    | <b>XBMZB5<sup>②</sup></b>    | <b>XBMZB6<sup>②</sup></b>    |

## Technical Data and Specifications

### Screw Connection Multi-Conductor Terminal Blocks

| Description  | XBUT25D12         | XBUT4D12          | XBUT25D22         | XBUT4D22          |
|--|-------------------|-------------------|-------------------|-------------------|
| <b>Technical Data in Accordance with IEC</b>                             |                   |                   |                   |                   |
| Maximum load current in A/cross-section in mm <sup>2</sup>               | 28/4              | 39/6              | 28/4              | 39/6              |
| Rated surge voltage in kV/contamination class                            | 6/3               | 6/3               | 6/3               | 6/3               |
| Surge voltage category/insulating material group                         | III/I             | III/I             | III/I             | III/I             |
| <b>Connection Capacity</b>   |                   |                   |                   |                   |
| Stranded with ferrule/with ferrule and plastic sleeve in mm <sup>2</sup> | 0.25–2.5/0.25–2.5 | 0.25–4/0.25–4     | 0.25–2.5/0.25–2.5 | 0.25–4/0.25–4     |
| <b>Multi-Conductor Connection</b><br>(same cross-section)                |                   |                   |                   |                   |
| Solid/stranded in mm <sup>2</sup>  | 0.14–1.0/0.14–1.0 | 0.14–1.0/0.14–1.5 | 0.14–1.0/0.14–1.0 | 0.14–1.0/0.14–1.5 |
| Stranded with ferrules without plastic sleeve in mm <sup>2</sup>         | 0.25–1.0          | 0.25–1.5          | 0.25–1.0          | 0.25–1.5          |
| Stranded with twin ferrule with plastic sleeve in mm <sup>2</sup>        | 0.5–1.0           | 0.5–1.0           | 0.5–1.0           | 0.5–1.0           |
| Stripping length in inches (mm)  | 0.31 (8)          | 0.31 (8)          | 0.31 (8)          | 0.31 (8)          |
| Thread   | M3                | M3                | M3                | M3                |
| Torque in in-lb (Nm)   | 5.3–7.1 (0.6–0.8) | 5.3–7.1 (0.6–0.8) | 5.3–7.1 (0.6–0.8) | 5.3–7.1 (0.6–0.8) |

## Dimensions

Approximate Dimensions in Inches (mm)

### Screw Connection Multi-Conductor Terminal Blocks

| Catalog Number   | Width      | Length      | Cover Width | Height for— |             |
|------------------|------------|-------------|-------------|-------------|-------------|
|                  |            |             |             | 35 x 7.5 in | 35 x 15 in  |
| <b>XBUT25D12</b> | 0.20 (5.2) | 2.24 (56.8) | 0.09 (2.2)  | 1.87 (47.5) | 2.17 (55.0) |
| <b>XBUT4D12</b>  | 0.24 (6.2) | 2.24 (56.8) | 0.09 (2.2)  | 1.87 (47.5) | 2.17 (55.0) |
| <b>XBUT25D22</b> | 0.20 (5.2) | 2.52 (64.1) | 0.09 (2.2)  | 1.87 (47.5) | 2.17 (55.0) |
| <b>XBUT4D22</b>  | 0.24 (6.2) | 2.52 (64.1) | 0.09 (2.2)  | 1.87 (47.5) | 2.17 (55.0) |

#### Notes

<sup>①</sup> For ordering information, see **Page V7-T8-105**.

<sup>②</sup> For information on Printed Marking Tag Options, see **Page V7-T8-98**.

For additional accessories, see **Page V7-T8-90**.

# 8.1

## Terminal Blocks, Fuse Blocks and Fuse Holders

IEC—XB Series

### Multi-Conductor Ground Blocks

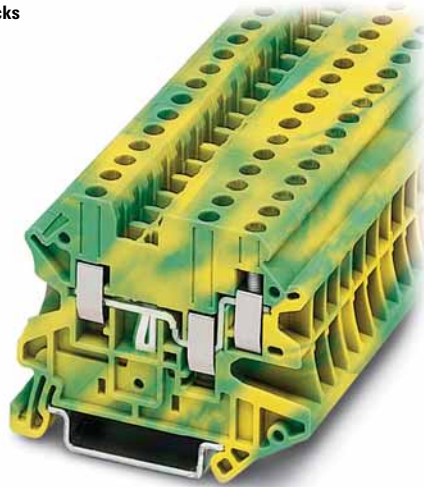

### Contents

| <b>Description</b>                             | <b>Page</b>     |
|--|-----------------|
| Single Level—Through-Feed .....                | <b>V7-T8-5</b>  |
| Single Level—Ground Blocks .....               | <b>V7-T8-10</b> |
| Multi-Conductor Terminal Blocks .....          | <b>V7-T8-12</b> |
| Multi-Conductor Ground Blocks                  |                 |
| Accessories .....                              | <b>V7-T8-15</b> |
| Technical Data and Specifications .....        | <b>V7-T8-15</b> |
| Dimensions .....                               | <b>V7-T8-15</b> |
| Double Level .....                             | <b>V7-T8-16</b> |
| Triple Level Sensor/Actuator .....             | <b>V7-T8-18</b> |
| Fuse Terminal Blocks .....                     | <b>V7-T8-21</b> |
| Disconnect and Component Terminal Blocks ..... | <b>V7-T8-24</b> |
| High Current Blocks .....                      | <b>V7-T8-27</b> |
| Mini Screw Connection .....                    | <b>V7-T8-29</b> |

8

### Multi-Conductor Ground Blocks

#### Product Description

The ground terminal blocks have the same shape and pitch as the standard terminal block, in a green-yellow housing. They easily snap

onto the DIN rail to make a reliable mechanical and electrical contact that meets all requirements of IEC 60-947-7-2.

#### Product Selection

##### XBUT4D12PE



#### Screw Connection Multi-Conductor Ground Blocks—Three-Wire

| Terminal Width | Maximum Wire Size          | IEC 60 947-7-1 in V/A/AWG | UL-cUL Ratings in V/A/AWG | Color        | Standard Pack | Catalog Number     |
|----------------|----------------------------|---------------------------|---------------------------|--------------|---------------|--------------------|
| 5.2 mm         | 12 AWG/2.5 mm <sup>2</sup> | —/—/26-12                 | —/—/26-12                 | Green/Yellow | 50            | <b>XBUT25D12PE</b> |
| 6.2 mm         | 10 AWG/4 mm <sup>2</sup>   | —/—/26-10                 | —/—/26-10                 | Green/Yellow | 50            | <b>XBUT4D12PE</b>  |

##### XBUT25D22PE



#### Screw Connection Multi-Conductor Ground Blocks—Four-Wire

| Terminal Width | Maximum Wire Size          | IEC 60 947-7-1 in V/A/AWG | UL-cUL Ratings in V/A/AWG | Color        | Standard Pack | Catalog Number     |
|----------------|----------------------------|---------------------------|---------------------------|--------------|---------------|--------------------|
| 5.2 mm         | 12 AWG/2.5 mm <sup>2</sup> | —/—/26-12                 | —/—/26-12                 | Green/Yellow | 50            | <b>XBUT25D22PE</b> |
| 6.2 mm         | 10 AWG/4 mm <sup>2</sup>   | —/—/26-10                 | —/—/26-10                 | Green/Yellow | 50            | <b>XBUT4D22PE</b>  |

## Accessories

## Screw Connection Multi-Conductor Ground Blocks

| Description  | Color | Number of Positions | Standard Pack | XBUT25D12PE                  | XBUT4D12PE                   | XBUT25D22PE                  | XBUT4D22PE                   |
|--|-------|---------------------|---------------|------------------------------|------------------------------|------------------------------|------------------------------|
|  |       |                     |               | Catalog Number               | Catalog Number               | Catalog Number               | Catalog Number               |
| End cover  | Gray  | —                   | 10            | <b>XBACUT4D12</b>            | <b>XBACUT4D12</b>            | <b>XBACUT4D22</b>            | <b>XBACUT4D22</b>            |
| End cover segment  | Gray  | —                   | 10            | <b>XBASUT4</b>               | <b>XBASUT4</b>               | <b>XBASUT4</b>               | <b>XBASUT4</b>               |
| Partition plate  | —     | —                   | 10            | <b>XBATUTD12</b>             | <b>XBATUTD12</b>             | <b>XBATUTD22</b>             | <b>XBATUTD22</b>             |
| Plug-in bridge—for cross connections in the bridge shaft | Red   | 2                   | 10            | <b>XBAFBS25</b>              | <b>XBAFBS26</b>              | <b>XBAFBS25</b>              | <b>XBAFBS26</b>              |
|  |       | 3                   | 10            | <b>XBAFBS35</b>              | <b>XBAFBS36</b>              | <b>XBAFBS35</b>              | <b>XBAFBS36</b>              |
|  |       | 5                   | 10            | <b>XBAFBS55</b>              | <b>XBAFBS56</b>              | <b>XBAFBS55</b>              | <b>XBAFBS56</b>              |
|  |       | 10                  | 10            | <b>XBAFBS105</b>             | <b>XBAFBS106</b>             | <b>XBAFBS105</b>             | <b>XBAFBS106</b>             |
|  |       | 50                  | 10            | <b>XBAFBS505</b>             | <b>XBAFBS506</b>             | <b>XBAFBS505</b>             | <b>XBAFBS506</b>             |
| Test adapter   | —     | —                   | 10            | <b>XBATSPA14</b>             | <b>XBATSPA14</b>             | <b>XBATSPA14</b>             | <b>XBATSPA14</b>             |
| 2.3 mm diameter test plug                                | —     | —                   | —             | <b>XBATSMPS-<sup>①</sup></b> | <b>XBATSMPS-<sup>①</sup></b> | <b>XBATSMPS-<sup>①</sup></b> | <b>XBATSMPS-<sup>①</sup></b> |
| Modular test plug  | —     | —                   | 10            | <b>XBATSPS5</b>              | <b>XBATSPS6</b>              | <b>XBATSPS5</b>              | <b>XBATSPS6</b>              |
| Blank marker strip (strip of 10)                         | White | —                   | 10            | <b>XBMZB5<sup>②</sup></b>    | <b>XBMZB6<sup>②</sup></b>    | <b>XBMZB5<sup>②</sup></b>    | <b>XBMZB6<sup>②</sup></b>    |

## Technical Data and Specifications

## Screw Connection Multi-Conductor Ground Blocks

| Description  | XBUT25D12PE       | XBUT4D12PE        | XBUT25D22PE       | XBUT4D22PE        |
|--|-------------------|-------------------|-------------------|-------------------|
| <b>Technical Data in Accordance with IEC</b>                             |                   |                   |                   |                   |
| Maximum load current in A/cross-section in mm <sup>2</sup>               | —                 | —                 | —                 | —                 |
| Rated surge voltage in kV/contamination class                            | 6/3               | 6/3               | 6/3               | 6/3               |
| Surge voltage category/insulating material group                         | III/I             | III/I             | III/I             | III/I             |
| <b>Connection Capacity</b>   |                   |                   |                   |                   |
| Stranded with ferrule/with ferrule and plastic sleeve in mm <sup>2</sup> | 0.25–2.5/0.25–2.5 | 0.25–4/0.25–4     | 0.25–2.5/0.25–2.5 | 0.25–4/0.25–4     |
| <b>Multi-Conductor Connection</b><br>(same cross-section)                |                   |                   |                   |                   |
| Solid/stranded in mm <sup>2</sup>  | 0.14–1.0/0.14–1.0 | 0.14–1.0/0.14–1.5 | 0.14–1.0/0.14–1.0 | 0.14–1.0/0.14–1.5 |
| Stranded with ferrules without plastic sleeve in mm <sup>2</sup>         | 0.25–1.0          | 0.25–1.5          | 0.25–1.0          | 0.25–1.5          |
| Stranded with twin ferrule with plastic sleeve in mm <sup>2</sup>        | 0.5–1.0           | 0.5–1.0           | 0.5–1             | 0.5–1             |
| Stripping length in inches (mm)  | 0.31 (8)          | 0.31 (8)          | 0.31 (8)          | 0.31 (8)          |
| Thread   | M3                | M3                | M3                | M3                |
| Torque in in-lb (Nm)   | 5.3–7.1 (0.6–0.8) | 5.3–7.1 (0.6–0.8) | 5.3–7.1 (0.6–0.8) | 5.3–7.1 (0.6–0.8) |

## Dimensions

Approximate Dimensions in Inches (mm)

## Screw Connection Multi-Connector Ground Blocks

| Catalog Number     | Width      | Length      | Cover Width | Height for— |             |
|--------------------|------------|-------------|-------------|-------------|-------------|
|                    |            |             |             | 35 x 7.5 in | 35 x 15 in  |
| <b>XBUT25D12PE</b> | 0.20 (5.2) | 2.24 (56.8) | 0.09 (2.2)  | 1.87 (47.5) | 2.17 (55.0) |
| <b>XBUT4D12PE</b>  | 0.24 (6.2) | 2.24 (56.8) | 0.09 (2.2)  | 1.87 (47.5) | 2.17 (55.0) |
| <b>XBUT25D22PE</b> | 0.20 (5.2) | 2.52 (64.1) | 0.09 (2.2)  | 1.87 (47.5) | 2.17 (55.0) |
| <b>XBUT4D22PE</b>  | 0.24 (6.2) | 2.52 (64.1) | 0.09 (2.2)  | 1.87 (47.5) | 2.17 (55.0) |

## Notes

① For ordering information, see **Page V7-T8-105**.② For information on Printed Marking Tag Options, see **Page V7-T8-98**.For additional accessories, see **Page V7-T8-90**.

# 8.1

## Terminal Blocks, Fuse Blocks and Fuse Holders

IEC—XB Series

Double Level

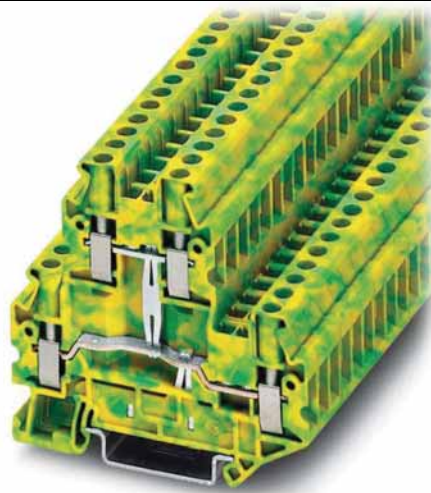

### Contents

| <i>Description</i>                                 | <i>Page</i>     |
|--|-----------------|
| Single Level—Through-Feed . . . . .                | <b>V7-T8-5</b>  |
| Single Level—Ground Blocks . . . . .               | <b>V7-T8-10</b> |
| Multi-Conductor Terminal Blocks . . . . .          | <b>V7-T8-12</b> |
| Multi-Conductor Ground Blocks . . . . .            | <b>V7-T8-14</b> |
| Double Level                                       |                 |
| Accessories . . . . .                              | <b>V7-T8-17</b> |
| Technical Data and Specifications . . . . .        | <b>V7-T8-17</b> |
| Dimensions . . . . .                               | <b>V7-T8-17</b> |
| Triple Level Sensor/Actuator . . . . .             | <b>V7-T8-18</b> |
| Fuse Terminal Blocks . . . . .                     | <b>V7-T8-21</b> |
| Disconnect and Component Terminal Blocks . . . . . | <b>V7-T8-24</b> |
| High Current Blocks . . . . .                      | <b>V7-T8-27</b> |
| Mini Screw Connection . . . . .                    | <b>V7-T8-29</b> |

8

### Double Level

#### Product Description

The potentials of the XBUTT double-level terminal blocks are on two levels to reduce space requirements by 50% over single-level terminal

blocks. The XBUTT Series can be bridged on both levels for maximum flexibility. Marking can be provided at each termination point.

### Product Selection

**XBUTT4**



#### Screw Connection Double Level Blocks, XBUTT4

| Terminal Width   | Maximum Wire Size        | IEC 60 947-7-1 in V/A/AWG | UL-cUL Ratings in V/A/AWG | Color | Standard Pack | Catalog Number  |
|--|--------------------------|---------------------------|---------------------------|-------|---------------|-----------------|
| <b>Screw Connection Double Level Blocks</b>  |                          |                           |                           |       |               |                 |
| 6.2 mm   | 10 AWG/4 mm <sup>2</sup> | 800/36/26–10              | 300/30/26–10              | Gray  | 50            | <b>XBUTT4</b>   |
|  |                          |                           |                           | Blue  | 50            | <b>XBUTT4BU</b> |
|  |                          |                           |                           | Red   | 50            | <b>XBUTT4RD</b> |
| <b>Screw Connection Double Level Block</b> (terminal block with potential distribution between the levels) |                          |                           |                           |       |               |                 |
| 6.2 mm   | 10 AWG/4 mm <sup>2</sup> | 800/36/26–10              | 300/30/26–10              | Gray  | 50            | <b>XBUTT4PV</b> |

**XBUTT4PE**



#### Screw Connection Double Level Ground Block, XBUTT4PE

| Terminal Width                                     | Maximum Wire Size        | IEC 60 947-7-1 in V/A/AWG | UL-cUL Ratings in V/A/AWG | Color        | Standard Pack | Catalog Number  |
|--|--------------------------|---------------------------|---------------------------|--------------|---------------|-----------------|
| <b>Screw Connection Double Level—Ground Blocks</b> |                          |                           |                           |              |               |                 |
| 6.2 mm   | 10 AWG/4 mm <sup>2</sup> | —/—/26–10                 | —/—/26–10                 | Green/Yellow | 50            | <b>XBUTT4PE</b> |

## Accessories

### Screw Connection Terminal/Ground Blocks, Double Level

| Description  | Color | Number of Positions | Standard Pack | XBUTT4                        | XBUTT4PE                      |
|--|-------|---------------------|---------------|-------------------------------|-------------------------------|
|  |       |                     |               | Catalog Number                | Catalog Number                |
| End cover  | Gray  | —                   | 10            | <b>XBACUTT4</b>               | <b>XBACUTT4</b>               |
| End cover segment  | Gray  | —                   | 10            | <b>XBDPUTT4</b>               | <b>XBDPUTT4</b>               |
| Partition plate  | —     | —                   | 10            | <b>XBATUTT4</b>               | <b>XBATUTT4</b>               |
| Plug-in bridge—for cross connections in the bridge shaft | Red   | 2                   | 10            | <b>XBAFBS26</b>               | <b>XBAFBS26</b>               |
|  |       | 3                   | 10            | <b>XBAFBS36</b>               | <b>XBAFBS36</b>               |
|  |       | 5                   | 10            | <b>XBAFBS56</b>               | <b>XBAFBS56</b>               |
|  |       | 10                  | 10            | <b>XBAFBS106</b>              | <b>XBAFBS106</b>              |
|  |       | 50                  | 10            | <b>XBAFBS506</b>              | <b>XBAFBS506</b>              |
| Test adapter   | —     | —                   | 10            | <b>XBATSPA14</b>              | <b>XBATSPA14</b>              |
| 2.3 mm diameter test plug                                | —     | —                   | —             | <b>XBATSMPS-</b> <sup>①</sup> | <b>XBATSMPS-</b> <sup>①</sup> |
| Modular test plug  | —     | —                   | 10            | <b>XBATSPS6</b>               | <b>XBATSPS6</b>               |
| Blank marker strip (strip of 10)                         | White | —                   | 10            | <b>XBMZB6</b> <sup>②</sup>    | <b>XBMZB6</b> <sup>②</sup>    |

## Technical Data and Specifications

### Screw Connection Double Level

| Description  | XBUTT4            | XBUTT4PE          |
|--|-------------------|-------------------|
| <b>Technical Data in Accordance with IEC</b>                             |                   |                   |
| Maximum load current in A/cross-section in mm <sup>2</sup>               | 30/6              | —/6               |
| Rated surge voltage in kV/contamination class                            | 8/3               | 6/3               |
| Surge voltage category/insulating material group                         | III/I             | III/I             |
| <b>Connection Capacity</b>   |                   |                   |
| Stranded with ferrule/with ferrule and plastic sleeve in mm <sup>2</sup> | 0.25–4/0.25–4     | 0.25–4/0.25–4     |
| <b>Multi-Conductor Connection</b><br>(same cross-section)                |                   |                   |
| Solid/stranded in mm <sup>2</sup>  | 0.14–1.5/0.14–1.5 | 0.14–1.5/0.14–1.5 |
| Stranded with ferrules without plastic sleeve in mm <sup>2</sup>         | 0.25–1.5          | 0.25–1.5          |
| Stranded with twin ferrule with plastic sleeve in mm <sup>2</sup>        | 0.5–2.5           | 0.5–2.5           |
| Stripping length in inches (mm)  | 0.35 (9)          | 0.35 (9)          |
| Thread   | M3                | M3                |
| Torque in in-lb (Nm)   | 5.3–7.1 (0.6–0.8) | 5.3–7.1 (0.6–0.8) |

## Dimensions

Approximate Dimensions in Inches (mm)

### Screw Connection Double Level

| Catalog Number  | Width      | Length      | Cover Width | Height for— |             |
|-----------------|------------|-------------|-------------|-------------|-------------|
|                 |            |             |             | 35 x 7.5 in | 35 x 15 in  |
| <b>XBUTT4</b>   | 0.24 (6.2) | 2.75 (69.9) | 0.09 (2.2)  | 2.56 (65.0) | 2.85 (72.5) |
| <b>XBUTT4PE</b> | 0.24 (6.2) | 2.75 (69.9) | 0.09 (2.2)  | 2.56 (65.0) | 2.85 (72.5) |

#### Notes

<sup>①</sup> For ordering information, see **Page V7-T8-105**.

<sup>②</sup> For information on Printed Marking Tag Options, see **Page V7-T8-98**.

For additional accessories, see **Page V7-T8-90**.

# 8.1

## Terminal Blocks, Fuse Blocks and Fuse Holders

IEC—XB Series

Triple Level Sensor/Actuator

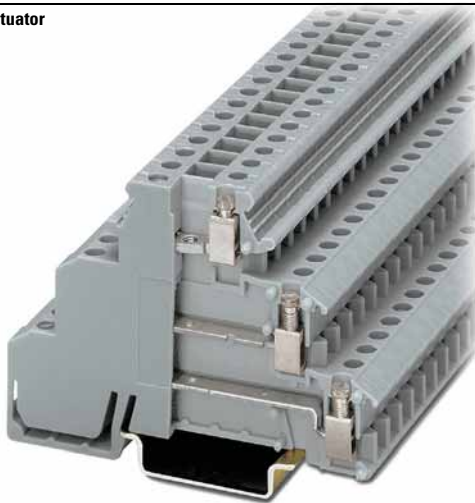

8

### Contents

| <b>Description</b>                             | <b>Page</b>     |
|--|-----------------|
| Single Level—Through-Feed .....                | <b>V7-T8-5</b>  |
| Single Level—Ground Blocks .....               | <b>V7-T8-10</b> |
| Multi-Conductor Terminal Blocks .....          | <b>V7-T8-12</b> |
| Multi-Conductor Ground Blocks .....            | <b>V7-T8-14</b> |
| Double Level .....                             | <b>V7-T8-16</b> |
| Triple Level Sensor/Actuator                   |                 |
| Accessories .....                              | <b>V7-T8-19</b> |
| Technical Data and Specifications .....        | <b>V7-T8-20</b> |
| Dimensions .....                               | <b>V7-T8-20</b> |
| Fuse Terminal Blocks .....                     | <b>V7-T8-21</b> |
| Disconnect and Component Terminal Blocks ..... | <b>V7-T8-24</b> |
| High Current Blocks .....                      | <b>V7-T8-27</b> |
| Mini Screw Connection .....                    | <b>V7-T8-29</b> |

### Triple Level Sensor/Actuator

#### Product Description

The XB3UK sensor terminal blocks reduce installation time by terminating three-wire devices such as photoelectric and proximity sensors in a single terminal block. The XB3UK Series accommodates a design where the positive and negative connections are

grouped so that only the signal lines and one pair of wires for the power supply need to be wired between the terminal box and the control. The upper level accommodates the markable feed-through terminals for the signal line. The two lower terminal points can be

bridged. These are used for the sensor power supply. The positive and negative potential can be fed into the bridges with XB3UKF25. The first sensor can also be connected to this three-wire feed-through block.

#### Product Selection

XB3UKA25

#### Screw Connection Triple Level Sensor/Actuator



| Terminal Width   | Maximum Wire Size          | Connection Data in V/A/AWG | IEC 60 947-7-1 in V/A/AWG | UL-cUL Ratings in V/A/AWG | Color | Standard Pack | Catalog Number     |
|--|----------------------------|----------------------------|---------------------------|---------------------------|-------|---------------|--------------------|
| <b>Screw Connection Triple Level</b>                                   |                            |                            |                           |                           |       |               |                    |
| 6.2 mm   | 14 AWG/2.5 mm <sup>2</sup> | 250/26/24-12               | —                         | 300/15/30-14              | Gray  | 50            | <b>XB3UKA25</b>    |
| <b>Screw Connection Triple Level with Red LED, 15-30 Vdc, 2.5-7.5A</b> |                            |                            |                           |                           |       |               |                    |
| 6.2 mm   | 14 AWG/2.5 mm <sup>2</sup> | 250/26/24-12               | —                         | 300/15/30-14              | Gray  | 50            | <b>XB3UKA25L24</b> |

XB3UKF25

#### Screw Connection Triple Level Sensor/Actuator



| Terminal Width                       | Maximum Wire Size          | Connection Data in V/A/AWG | IEC 60 947-7-1 in V/A/AWG | UL-cUL Ratings in V/A/AWG | Color | Standard Pack | Catalog Number  |
|--------------------------------------|----------------------------|----------------------------|---------------------------|---------------------------|-------|---------------|-----------------|
| <b>Screw Connection Triple Level</b> |                            |                            |                           |                           |       |               |                 |
| 6.2 mm                               | 14 AWG/2.5 mm <sup>2</sup> | —                          | 250/30/24-12              | 300/15/30-14              | Gray  | 50            | <b>XB3UKF25</b> |

## XB3UKA25PE



## Screw Connection Triple Level Sensor/Actuator

| Terminal Width   | Maximum Wire Size          | Connection Data in V/A/AWG | UL-cUL Ratings in V/A/AWG | Color | Standard Pack | Catalog Number       |
|--|----------------------------|----------------------------|---------------------------|-------|---------------|----------------------|
| <b>Screw Connection Triple Level</b>                                   |                            |                            |                           |       |               |                      |
| 6.2 mm   | 14 AWG/2.5 mm <sup>2</sup> | 250/26/24–12               | 300/15/30–14              | Gray  | 50            | <b>XB3UKA25PE</b>    |
| <b>Screw Connection Triple Level with Red LED, 15–30 Vdc, 2.5–7.5A</b> |                            |                            |                           |       |               |                      |
| 6.2 mm   | 14 AWG/2.5 mm <sup>2</sup> | 250/26/24–12               | 300/15/30–14              | Gray  | 50            | <b>XB3UKA25PEL24</b> |

## XB3UKF25PE



## Screw Connection Triple Level Sensor/Actuator

| Terminal Width                       | Maximum Wire Size          | Connection Data in V/A/AWG | UL-cUL Ratings in V/A/AWG | Color | Standard Pack | Catalog Number    |
|--------------------------------------|----------------------------|----------------------------|---------------------------|-------|---------------|-------------------|
| <b>Screw Connection Triple Level</b> |                            |                            |                           |       |               |                   |
| 6.2 mm                               | 14 AWG/2.5 mm <sup>2</sup> | —                          | 300/15/30–14              | Gray  | 50            | <b>XB3UKF25PE</b> |

## Accessories

## Screw Connection Triple Level Sensor/Actuator

| Description                      | Color | Number of Positions | Standard Pack | XB3UKA25           | XB3UKF25           | XB3UKA25PE         | XB3UKF25PE         |
|----------------------------------|-------|---------------------|---------------|--------------------|--------------------|--------------------|--------------------|
|                                  |       |                     |               | Catalog Number     | Catalog Number     | Catalog Number     | Catalog Number     |
| Insertion bridge                 | Blue  | 80                  | 1             | <b>XBAEB80DIKB</b> | <b>XBAEB80DIKB</b> | <b>XBAEB80DIKB</b> | <b>XBAEB80DIKB</b> |
|                                  | Red   | 80                  | 1             | <b>XBAEB80DIKR</b> | <b>XBAEB80DIKR</b> | <b>XBAEB80DIKR</b> | <b>XBAEB80DIKR</b> |
| Insertion bridge                 | Blue  | 10                  | 10            | <b>XBAEB10DIKB</b> | <b>XBAEB10DIKB</b> | <b>XBAEB10DIKB</b> | <b>XBAEB10DIKB</b> |
|                                  | Red   | 10                  | 10            | <b>XBAEB10DIKR</b> | <b>XBAEB10DIKR</b> | <b>XBAEB10DIKR</b> | <b>XBAEB10DIKR</b> |
| Blank marker strip (strip of 10) | White | —                   | 10            | <b>XBMZB6</b> ①    | <b>XBMZB6</b> ②    | <b>XBMZB6</b> ②    | <b>XBMZB6</b> ②    |

## Notes

① For information on Printed Marking Tag Options, see **Page V7-T8-98**.

For additional accessories, see **Page V7-T8-90**.

# 8.1

## Terminal Blocks, Fuse Blocks and Fuse Holders

IEC—XB Series

### Technical Data and Specifications

#### Screw Connection Triple Level Sensor/Actuator

| Description   | XB3UKA25          | XB3UKF25          | XB3UKA25PE        | XB3UKF25PE        |
|---|-------------------|-------------------|-------------------|-------------------|
| <b>Technical Data in Accordance with IEC</b>                                  |                   |                   |                   |                   |
| Maximum load current in A/cross-section in mm <sup>2</sup>                    | 26/2.5            | 30/4              | 26/2.5            | 26/2.5            |
| Maximum cross section with insertion bridge solid/stranded in mm <sup>2</sup> | 4/2.5             | 4/2.5             | 4/2.5             | 4/2.5             |
| Rated surge voltage in kV/contamination class                                 | 4/3               | 4/3               | 4/3               | 6/3               |
| Surge voltage category/insulating material group                              | III/1             | III/1             | III/1             | III/1             |
| <b>Connection Capacity</b>  |                   |                   |                   |                   |
| Stranded with ferrule/with ferrule and plastic sleeve in mm <sup>2</sup>      | 0.25–2.5/0.25–2.5 | 0.25–2.5/0.25–2.5 | 0.25–2.5/0.25–2.5 | 0.25–2.5/0.25–2.5 |
| <b>Multi-Conductor Connection</b><br>(same cross-section)                     |                   |                   |                   |                   |
| Solid/stranded in mm <sup>2</sup>   | 0.2–1.0/0.2–1.0   | 0.2–1.0/0.2–1.0   | 0.2–1.0/0.2–1.0   | 0.2–1.0/0.2–1.0   |
| Stranded with ferrules without plastic sleeve in mm <sup>2</sup>              | 0.25–1.0          | 0.25–1.0          | 0.25–1.0          | 0.25–1.0          |
| Stranded with twin ferrule with plastic sleeve in mm <sup>2</sup>             | 0.5–1.0           | 0.5–1.0           | 0.5–1.0           | 0.5–1.0           |
| Stripping length in inches (mm)   | 0.31 (8)          | 0.31 (8)          | 0.31 (8)          | 0.31 (8)          |
| Thread  | M3                | M3                | M3                | M3                |
| Torque in in-lb (Nm)  | 4.4–5.3 (0.5–0.6) | 4.4–5.3 (0.5–0.6) | 4.4–5.3 (0.5–0.6) | 4.4–5.3 (0.5–0.6) |

#### Wiring for Three-Level Sensor Terminal Blocks

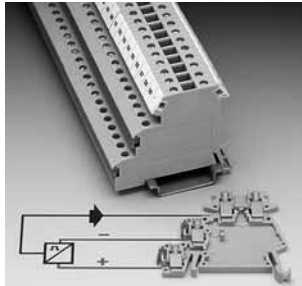

#### Wiring for Four-Level Sensor Terminal Blocks

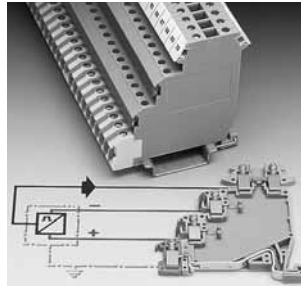

### Dimensions

Approximate Dimensions in Inches (mm)

#### Screw Connection Triple Level Sensor/Actuator

| Catalog Number | Width      | Length      | Height for— |             |
|----------------|------------|-------------|-------------|-------------|
|                |            |             | 35 x 7.5 in | 35 x 15 in  |
| XB3UKA25       | 0.24 (6.2) | 2.17 (55.0) | 2.15 (54.5) | 2.44 (62.0) |
| XB3UKF25       | 0.24 (6.2) | 2.85 (72.5) | 2.15 (54.5) | 2.44 (62.0) |
| XB3UKA25PE     | 0.24 (6.2) | 2.46 (62.5) | 2.76 (70.0) | 3.05 (77.5) |
| XB3UKF25PE     | 0.24 (6.2) | 3.25 (82.5) | 2.76 (70.0) | 3.05 (77.5) |



## Fuse Terminal Blocks



## Contents

| <i>Description</i>                             | <i>Page</i>     |
|--|-----------------|
| Single Level—Through-Feed .....                | <b>V7-T8-5</b>  |
| Single Level—Ground Blocks .....               | <b>V7-T8-10</b> |
| Multi-Conductor Terminal Blocks .....          | <b>V7-T8-12</b> |
| Multi-Conductor Ground Blocks .....            | <b>V7-T8-14</b> |
| Double Level .....                             | <b>V7-T8-16</b> |
| Triple Level Sensor/Actuator .....             | <b>V7-T8-18</b> |
| Fuse Terminal Blocks                           |                 |
| Accessories .....                              | <b>V7-T8-23</b> |
| Technical Data and Specifications .....        | <b>V7-T8-23</b> |
| Dimensions .....                               | <b>V7-T8-23</b> |
| Disconnect and Component Terminal Blocks ..... | <b>V7-T8-24</b> |
| High Current Blocks .....                      | <b>V7-T8-27</b> |
| Mini Screw Connection .....                    | <b>V7-T8-29</b> |

## Fuse Terminal Blocks

### Product Description

The UT Series fuse terminal blocks come in two varieties—lever type and cap. Each performs two functions. They act as a fuse carrier for most common North American and European fuses and they

allow for potential distribution with the double bridge shaft. The terminal blocks therefore allow bypass routing of two separate potentials next to each other. This has the advantage of a time-saving

potential infeed and a correct, functional configuration of the terminal strip. For signaling a triggered fuse, fuse terminal blocks with light indicators are available (for both AC and DC voltage).

### Product Selection

#### XBUT4FBE



#### Screw Connection Fuse Terminal Blocks, for 5 x 20 mm Fuse

| Terminal Width  | Maximum Wire Size        | IEC 60 947-7-3 in V/A/AWG | UL-cUL Ratings in V/A/AWG | Color | Standard Pack | Catalog Number      |
|---|--------------------------|---------------------------|---------------------------|-------|---------------|---------------------|
| <b>Fuse Terminal Blocks</b>                               |                          |                           |                           |       |               |                     |
| 6.2 mm  | 10 AWG/4 mm <sup>2</sup> | ①/6.3/26–10               | 600/6.3/26–10             | Black | 50            | <b>XBUT4FBE</b>     |
| <b>Fuse Terminal Blocks with LED 12–30V, 1–2.5 mA</b>     |                          |                           |                           |       |               |                     |
| 6.2 mm  | 10 AWG/4 mm <sup>2</sup> | ①/6.3/26–10               | 600/6.3/26–10             | Black | 50            | <b>XBUT4FBEL24</b>  |
| <b>Fuse Terminal Blocks with LED 30–60V, 0.8–2.0 mA</b>   |                          |                           |                           |       |               |                     |
| 6.2 mm  | 10 AWG/4 mm <sup>2</sup> | ①/6.3/26–10               | 600/6.3/26–10             | Black | 50            | <b>XBUT4FBEL60</b>  |
| <b>Fuse Terminal Blocks with LED 110–250V, 0.5–2.5 mA</b> |                          |                           |                           |       |               |                     |
| 6.2 mm  | 10 AWG/4 mm <sup>2</sup> | ①/6.3/26–10               | 600/6.3/26–10             | Black | 50            | <b>XBUT4FBEL250</b> |

#### Note

① As disconnect terminal block 400V, as fuse terminal block 250V.

# 8.1

## Terminal Blocks, Fuse Blocks and Fuse Holders

IEC—XB Series

**XBUT6FBN**



### Screw Connection Fuse Terminal Blocks for 6.3 x 32 mm (1/4 in x 1-1/4 in) Fuse

| Terminal Width  | Maximum Wire Size       | IEC 60 947-7-3 in V/A/AWG | UL-cUL Ratings in V/A/AWG | Color | Standard Pack | Catalog Number      |
|---|-------------------------|---------------------------|---------------------------|-------|---------------|---------------------|
| <b>Fuse Terminal Blocks</b>                               |                         |                           |                           |       |               |                     |
| 8.2 mm  | 8 AWG/6 mm <sup>2</sup> | ①/10/24-8                 | 400/10/24-8               | Black | 50            | <b>XBUT6FBN</b>     |
| <b>Fuse Terminal Blocks with LED 12-30V, 1-2.5 mA</b>     |                         |                           |                           |       |               |                     |
| 8.2 mm  | 8 AWG/6 mm <sup>2</sup> | ①/10/24-8                 | 400/10/24-8               | Black | 50            | <b>XBUT6FBNL24</b>  |
| <b>Fuse Terminal Blocks with LED 30-60V, 0.8-2.0 mA</b>   |                         |                           |                           |       |               |                     |
| 8.2 mm  | 8 AWG/6 mm <sup>2</sup> | ①/10/24-8                 | 400/10/24-8               | Black | 50            | <b>XBUT6FBNL60</b>  |
| <b>Fuse Terminal Blocks with LED 110-250V, 0.5-2.5 mA</b> |                         |                           |                           |       |               |                     |
| 8.2 mm  | 8 AWG/6 mm <sup>2</sup> | ①/10/24-8                 | 400/10/24-8               | Black | 50            | <b>XBUT6FBNL250</b> |

**8**

**XBUK10FBC**



### Screw Connection Fuse Terminal Blocks, XBUK10FBC

| Terminal Width   | Maximum Wire Size        | IEC 60 947-7-3 with Fuse in V/A/AWG | IEC 60 947-7-3 as Disconnected t.b. in V/A/AWG | UL-cUL Ratings in V/A/AWG | Color | Standard Pack | Catalog Number        |
|--|--------------------------|-------------------------------------|--|---------------------------|-------|---------------|-----------------------|
| <b>Fuse Terminal Blocks for 5 x 20 mm fuse</b>                                   |                          |                                     |  |                           |       |               |                       |
| 12 mm  | 6 AWG/16 mm <sup>2</sup> | ①/①/20-4                            | 800/10/20-6                                    | 300/20/22-6               | Black | 50            | <b>XBUK10FBCE</b>     |
| <b>Fuse Terminal Blocks for 6.3 x 32 mm (1/4 in x 1-1/4 in) fuse</b>             |                          |                                     |  |                           |       |               |                       |
| 12 mm  | 6 AWG/16 mm <sup>2</sup> | ①/①/20-4                            | 800/10/20-6                                    | 300/20/22-6               | Black | 50            | <b>XBUK10FBCN</b>     |
| <b>Fuse Terminal Blocks with Light Indicator 15-30V, 1-2.5 mA, 5 x 20 mm</b>     |                          |                                     |  |                           |       |               |                       |
| 12 mm  | 6 AWG/16 mm <sup>2</sup> | ①/①/20-4                            | 800/10/20-6                                    | 300/20/22-6               | Black | 50            | <b>XBUK10FBCEL24</b>  |
| <b>Fuse Terminal Blocks with Light Indicator 15-30V, 1-2.5 mA, 6.3 x 32 mm</b>   |                          |                                     |  |                           |       |               |                       |
| 12 mm  | 6 AWG/16 mm <sup>2</sup> | ①/①/20-4                            | 800/10/20-6                                    | 300/20/22-6               | Black | 50            | <b>XBUK10FBCNL24</b>  |
| <b>Fuse Terminal Blocks with Light Indicator 110-250V, 0.5-1.1A, 5 x 20 mm</b>   |                          |                                     |  |                           |       |               |                       |
| 12 mm  | 6 AWG/16 mm <sup>2</sup> | ①/①/20-4                            | 800/10/20-6                                    | 300/20/22-6               | Black | 50            | <b>XBUK10FBCEL250</b> |
| <b>Fuse Terminal Blocks with Light Indicator 110-250V, 0.5-1.1A, 6.3 x 32 mm</b> |                          |                                     |  |                           |       |               |                       |
| 12 mm  | 6 AWG/16 mm <sup>2</sup> | ①/①/20-4                            | 800/10/20-6                                    | 300/20/22-6               | Black | 50            | <b>XBUK10FBCNL250</b> |

### Cartridge Fuse Inserts 5 x 20 mm Based on DIN EN 60 947-7-3: 2003-7

| Terminal Blocks | U (V) | Overload Protection |                | Short-Circuit Protection Only |                | I <sub>max.</sub> (A) |
|-----------------|-------|---------------------|----------------|-------------------------------|----------------|-----------------------|
|                 |       | Individual          | Interconnected | Individual                    | Interconnected |                       |
| <b>XBUT4FBE</b> | 250   | 1.6W                | 1.6W           | 4W                            | 2.5W           | 6.3                   |

#### Notes

Max. power dissipation at 73.4°F (23°C) based on DIN EN 60 947-7-3: 2003-7.

When selecting cartridge fuse inserts, please ensure that the maximum power dissipation specified above is not exceeded. Details can be obtained from the fuse suppliers.

If the fuse is defective, the downstream circuit is not off load.

① As disconnect terminal block 500V, as fuse terminal block 400V.

## Accessories

### Screw Connection Fuse Terminal Blocks

| Description  | Color | Number of Positions | Standard Pack | XBUT4FBE<br>Catalog Number | XBUT6FBN<br>Catalog Number | XBUK10FBCE<br>Catalog Number |
|--|-------|---------------------|---------------|----------------------------|----------------------------|------------------------------|
| End cover  | —     | —                   | —             | ①                          | ①                          | —                            |
| Plug-in bridge—for cross connections in the bridge shaft | Red   | 2                   | 10            | XBAFBS26                   | XBAFBS28                   | —                            |
|  |       | 3                   | 10            | XBAFBS36                   | XBAFBS38                   | —                            |
|  |       | 5                   | 10            | XBAFBS56                   | XBAFBS58                   | —                            |
|  |       | 10                  | 10            | XBAFBS106                  | XBAFBS108                  | —                            |
|  |       | 50                  | 10            | XBAFBS506                  | —                          | —                            |
| Blank marker strip center labeling (strip of 10)         | White | —                   | —             | XBMZB5 ②                   | XBMZB6 ②                   | —                            |
| Blank marker strip external labeling (strip of 10)       | White | —                   | —             | XBMZB6 ②                   | XBMZB8 ②                   | —                            |
| Fixed bridge   | —     | 2                   | 10            | —                          | —                          | XBAFB1212                    |
| Screw heads with insulating collar                       | —     | 10                  | 10            | —                          | —                          | XBAFB1012                    |
| Blank marker strip (strip of 10)                         | White | —                   | 10            | —                          | —                          | XBMZB6 ②                     |

## Technical Data and Specifications

### Screw Connection Fuse Terminal Blocks

| Description   | XBUT4FBE          | XBUT4FBN            | XBUK10FBCE               |
|---|-------------------|---------------------|--------------------------|
| <b>Technical Data in Accordance with IEC</b>                                  |                   |                     |                          |
| Fuse type/dimensions in (mm)  | —                 | —                   | G/5 x 20/5 x 25/6.3 x 32 |
| Maximum cross section with insertion bridge solid/stranded in mm <sup>2</sup> | 6.3/6             | 10/10               | 10/10                    |
| Rated surge voltage in kV/contamination class                                 | 4/3               | 4/3                 | 4/3                      |
| Surge voltage category/insulating material group                              | III/II            | III/II              | III/I                    |
| <b>Connection Capacity</b>  |                   |                     |                          |
| Stranded with ferrule/with ferrule and plastic sleeve in mm <sup>2</sup>      | 0.25–4/0.25–4     | 0.25–6/0.25–6       | 0.5–10/0.5–10            |
| <b>Multi-Conductor Connection</b> (same cross-section)                        |                   |                     |                          |
| Solid/stranded in mm <sup>2</sup>   | 0.14–1.5/0.14–1.5 | —                   | 0.5–4/0.5–4              |
| Stranded with ferrules without plastic sleeve in mm <sup>2</sup>              | 0.25–1.5          | —                   | 0.5–4                    |
| Stranded with twin ferrule with plastic sleeve in mm <sup>2</sup>             | 0.5–2.5           | 0.5–4               | 0.5–10                   |
| Stripping length in inches (mm)   | 0.35 (9)          | 0.39 (10)           | 0.43 (11)                |
| Thread  | M3                | M4                  | M4                       |
| Torque in in-lb (Nm)  | 5.3–7.1 (0.6–0.8) | 13.3–15.9 (1.5–1.8) | 13.3–15.9 (1.5–1.8)      |

## Dimensions

Approximate Dimensions in Inches (mm)

### Screw Connection Fuse Terminal Blocks

| Catalog Number | Width       | Length      | Height for— |             |             |
|----------------|-------------|-------------|-------------|-------------|-------------|
|                |             |             | 35 x 7.5 in | 35 x 15 in  | 32 in       |
| XBUT4FBE       | 0.24 (6.2)  | 2.24 (56.8) | 2.87 (73.0) | 3.17 (80.5) | —           |
| XBUT4FBN       | 0.32 (8.2)  | 2.24 (56.8) | 2.87 (73.0) | 3.17 (80.5) | —           |
| XBUK10FBCE     | 0.47 (12.0) | 2.44 (62.0) | 2.32 (59.0) | 2.62 (66.5) | 2.52 (64.0) |

#### Notes

① XBUT4FBE and XBUT6FBN have an enclosed design. The use of an end cover is not required.

② For information on Printed Marking Tag Options, see **Page V7-T8-98**.

For additional accessories, see **Page V7-T8-90**.

# 8.1

## Terminal Blocks, Fuse Blocks and Fuse Holders

IEC—XB Series

### Disconnect and Component Terminal Blocks



8

### Contents

| <i>Description</i>                          | <i>Page</i>     |
|---|-----------------|
| Single Level—Through-Feed . . . . .         | <b>V7-T8-5</b>  |
| Single Level—Ground Blocks . . . . .        | <b>V7-T8-10</b> |
| Multi-Conductor Terminal Blocks . . . . .   | <b>V7-T8-12</b> |
| Multi-Conductor Ground Blocks . . . . .     | <b>V7-T8-14</b> |
| Double Level . . . . .                      | <b>V7-T8-16</b> |
| Triple Level Sensor/Actuator . . . . .      | <b>V7-T8-18</b> |
| Fuse Terminal Blocks . . . . .              | <b>V7-T8-21</b> |
| Disconnect and Component Terminal Blocks    |                 |
| Product Selection . . . . .                 | <b>V7-T8-25</b> |
| Accessories . . . . .                       | <b>V7-T8-26</b> |
| Technical Data and Specifications . . . . . | <b>V7-T8-26</b> |
| Dimensions . . . . .                        | <b>V7-T8-26</b> |
| High Current Blocks . . . . .               | <b>V7-T8-27</b> |
| Mini Screw Connection . . . . .             | <b>V7-T8-29</b> |

### Disconnect and Component Terminal Blocks

#### Product Description

The **XB** Series includes application specific terminal blocks like the XBUT4TG disconnect block that accommodates disconnect component and fuse terminal blocks. It can also be bridged with standard terminal blocks via the double bridge shaft. The component plug XBPCO serves to accommodate different components such as resistors or capacitors.

5 x 20 mm fuses can be inserted into the fuse plug XBPFU, also available with light indication. The XBUT4MT knife disconnect terminal block features a compact design and a high current carrying capacity of 16A. Versions with test socket screws provide a test option for 2.3 mm diameter test plugs on both sides of the disconnect point.

## Product Selection

XBUT4TG  
Disconnect

## Screw Connection Disconnect and Component Terminal Blocks

| Terminal Width  | Maximum Wire Size        | Connection Data in V/A/AWG | UL-cUL Ratings for Disconnect in V/A/AWG | UL-cUL Ratings for Disconnect with Test Sockets in V/A/AWG | Color | Standard Pack | Catalog Number   |
|---|--------------------------|----------------------------|--|--|-------|---------------|------------------|
| <b>Screw Connection Disconnect</b>                                    |                          |                            |  |  |       |               |                  |
| 6.2 mm  | 10 AWG/4 mm <sup>2</sup> | 500/16/26–10               | 600/16/26–10                             | 300/16/26–10   | Gray  | 50            | <b>XBUT4TG</b>   |
| <b>Screw Connection Disconnect with Test Sockets</b>                  |                          |                            |  |  |       |               |                  |
| 6.2 mm  | 10 AWG/4 mm <sup>2</sup> | 500/16/26–10               | 600/16/26–10                             | 300/16/26–10   | Gray  | 50            | <b>XBUT4TGP</b>  |
| <b>Component Plug</b>   |                          |                            |  |  |       |               |                  |
| 6.2 mm  | 10 AWG/4 mm <sup>2</sup> | 500/16/26–10               | 600/16/26–10                             | 300/16/26–10   | Gray  | 10            | <b>XBPCO</b>     |
| <b>Fuse Plug</b>  |                          |                            |  |  |       |               |                  |
| 6.2 mm  | 10 AWG/4 mm <sup>2</sup> | 500/16/26–10               | 600/16/26–10                             | 300/16/26–10   | Black | 10            | <b>XBPFU</b>     |
| <b>Fuse Plug with Light Indicator for 12–30V, 1–2.5 mA</b>            |                          |                            |  |  |       |               |                  |
| 6.2 mm  | 10 AWG/4 mm <sup>2</sup> | 500/16/26–10               | 600/16/26–10                             | 300/16/26–10   | Black | 10            | <b>XBPFUL24</b>  |
| <b>Fuse Plug with Light Indicator for 110–250V, 0.5–2.5 mA</b>        |                          |                            |  |  |       |               |                  |
| 6.2 mm  | 10 AWG/4 mm <sup>2</sup> | 500/16/26–10               | 600/16/26–10                             | 300/16/26–10   | Black | 10            | <b>XBPFUL250</b> |
| <b>Screw Connection Disconnect Knife Disconnect</b>                   |                          |                            |  |  |       |               |                  |
| 6.2 mm  | 10 AWG/4 mm <sup>2</sup> | 500/16/26–10               | 600/16/26–10                             | 300/16/26–10   | Gray  | 50            | <b>XBUT4MT</b>   |
| <b>Screw Connection Disconnect Knife Disconnect with Test Sockets</b> |                          |                            |  |  |       |               |                  |
| 6.2 mm  | 10 AWG/4 mm <sup>2</sup> | 500/16/26–10               | 600/16/26–10                             | 300/16/26–10   | Gray  | 50            | <b>XBUT4MTP</b>  |
| <b>Screw Connection Terminal Blocks with Integrated Diodes</b>        |                          |                            |  |  |       |               |                  |
| 6.2 mm  | 12 AWG/4 mm <sup>2</sup> | 500/32/24–10               | 600/30/26–10                             | —  | Gray  | 50            | <b>XBUK4DIO</b>  |

XBTKT25 Thermal  
Electric Voltage

## Screw Connection Thermoelectric Voltage Terminal Blocks

| Terminal Width                                | Maximum Wire Size          | Connection Data in V/A/AWG | UL-cUL Ratings in V/A/AWG | Color | Standard Pack | Catalog Number          |
|---|----------------------------|----------------------------|---------------------------|-------|---------------|-------------------------|
| <b>Copper/Constantan (CU/CUNI44)</b>          |                            |                            |                           |       |               |                         |
| 10.4 mm                                       | 12 AWG/2.5 mm <sup>2</sup> | 400/—/24–12                | 300/10/28–12              | Gray  | 50            | <b>XBTKT25 (Type T)</b> |
| <b>Iron/Constantan (FE/CUNI44)</b>            |                            |                            |                           |       |               |                         |
| 10.4 mm                                       | 12 AWG/2.5 mm <sup>2</sup> | 400/—/24–12                | 300/10/28–12              | Gray  | 50            | <b>XBTKJ25 (Type J)</b> |
| <b>Nickel-Chrome/Constantan (NICR/CUNI44)</b> |                            |                            |                           |       |               |                         |
| 10.4 mm                                       | 12 AWG/2.5 mm <sup>2</sup> | 400/—/24–12                | 300/10/28–12              | Gray  | 50            | <b>XBTKE25 (Type E)</b> |
| <b>Nickel-Chrome/Nickel (NICRNI)</b>          |                            |                            |                           |       |               |                         |
| 10.4 mm                                       | 12 AWG/2.5 mm <sup>2</sup> | 400/—/24–12                | 300/10/28–12              | Gray  | 50            | <b>XBTKK25 (Type K)</b> |
| <b>Copper/Copper Nickel (E-CU/A-CU)</b>       |                            |                            |                           |       |               |                         |
| 10.4 mm                                       | 12 AWG/2.5 mm <sup>2</sup> | 400/—/24–12                | 300/10/28–12              | Gray  | 50            | <b>XBTKR25 (Type R)</b> |

# 8.1

## Terminal Blocks, Fuse Blocks and Fuse Holders

IEC—XB Series

### Accessories

#### Screw Connection Disconnect and Component Terminal Blocks

| Description  | Color | Number of Positions | Standard Pack | XBUT4TG<br>Catalog Number    | XBUT4MT<br>Catalog Number    | XBUKK4D10<br>Catalog Number | XBTK25<br>Catalog Number   |
|--|-------|---------------------|---------------|------------------------------|------------------------------|-----------------------------|----------------------------|
| Plug-in bridge—for cross connections in the bridge shaft | Red   | 2                   | 10            | <b>XBAFBS26</b>              | <b>XBAFBS26</b>              | —                           | —                          |
|  |       | 3                   | 10            | <b>XBAFBS36</b>              | <b>XBAFBS36</b>              | —                           | —                          |
|  |       | 5                   | 10            | <b>XBAFBS56</b>              | <b>XBAFBS56</b>              | —                           | —                          |
|  |       | 10                  | 10            | <b>XBAFBS106</b>             | <b>XBAFBS106</b>             | —                           | —                          |
|  |       | 50                  | 10            | <b>XBAFBS506</b>             | <b>XBAFBS506</b>             | —                           | —                          |
| Test adapter   | —     | —                   | 10            | <b>XBATSPA14</b>             | <b>XBATSPA14</b>             | —                           | —                          |
| 2.3 mm diameter test plug                                | —     | —                   | —             | <b>XBATSMPS-<sup>①</sup></b> | <b>XBATSMPS-<sup>①</sup></b> | —                           | —                          |
| Modular test plug  | —     | —                   | 10            | <b>XBATSDPPS6</b>            | <b>XBATSDPPS6</b>            | —                           | —                          |
| Blank marker strip (strip of 10)                         | White | —                   | 10            | <b>XBMZB6<sup>②</sup></b>    | <b>XBMZB6<sup>②</sup></b>    | <b>XBMZB6<sup>②</sup></b>   | <b>XBMZB10<sup>②</sup></b> |
| End cover  | Gray  | —                   | 10            | —                            | —                            | <b>XBACUKK35</b>            | <b>XBACTK4</b>             |
| Spacer cover   | Gray  | —                   | 10            | —                            | —                            | <b>XBADGUKK35</b>           | —                          |
| Spacer plate   | —     | —                   | 10            | —                            | —                            | <b>XBADPUKK35</b>           | —                          |
| Partition plate  | —     | —                   | —             | —                            | —                            | —                           | <b>XBATTK4</b>             |
| Fixed bridge   | —     | 10                  | 10            | —                            | —                            | <b>XBAFB1106</b>            | —                          |

### Technical Data and Specifications

#### Screw Connection Disconnect and Component Terminal Blocks

| Description  | XBUT4TG           | XBUT4MT           | XBUKK4D10         | XBTK              |
|--|-------------------|-------------------|-------------------|-------------------|
| <b>Technical Data in Accordance with IEC</b>                             |                   |                   |                   |                   |
| Maximum load current in A/cross-section in mm <sup>2</sup>               | 16/6              | 16/6              | 32/4              | —                 |
| Rated surge voltage in kV/contamination class                            | 6/3               | 6/3               | 6/3               | —                 |
| Surge voltage category/insulating material group                         | III/I             | III/I             | III/I             | —                 |
| <b>Connection Capacity</b>   |                   |                   |                   |                   |
| Stranded with ferrule/with ferrule and plastic sleeve in mm <sup>2</sup> | 0.25–4/0.25–4     | 0.25–4/0.25–4     | 0.25–4/0.25–2.5   | —                 |
| <b>Multi-Conductor Connection</b><br>(same cross-section)                |                   |                   |                   |                   |
| Solid/stranded in mm <sup>2</sup>  | 0.14–1.5/0.14–1.5 | 0.14–1.5/0.14–1.5 | 0.2–1.5/0.2–1.5   | —                 |
| Stranded with ferrules without plastic sleeve in mm <sup>2</sup>         | 0.25–1.5          | 0.25–1.5          | 0.25–1.5          | —                 |
| Stranded with twin ferrule with plastic sleeve in mm <sup>2</sup>        | 0.5–2.5           | 0.5–2.5           | 0.5–1.5           | —                 |
| Stripping length in inches (mm)  | 0.35 (9)          | 0.35 (9)          | 0.31 (8)          | 0.28 (7)          |
| Thread   | M3                | M3                | M3                | M3                |
| Torque in in-lb (Nm)   | 5.3–7.1 (0.6–0.8) | 5.3–7.1 (0.6–0.8) | 5.3–7.1 (0.6–0.8) | 5.3–7.1 (0.6–0.8) |

### Dimensions

Approximate Dimensions in Inches (mm)

#### Screw Connection Disconnect and Component Terminal Blocks

| Catalog Number   | Width      | Length      | Cover Width | Height for— |             |             |
|------------------|------------|-------------|-------------|-------------|-------------|-------------|
|                  |            |             |             | 35 x 7.5 in | 35 x 15 in  | 32 in       |
| <b>XBUT4TG</b>   | 0.24 (6.2) | 2.24 (56.8) | —           | 1.87 (47.5) | 2.17 (55.0) | —           |
| <b>XBUT4MT</b>   | 0.24 (6.2) | 2.24 (56.8) | —           | 1.87 (47.5) | 2.17 (55.0) | —           |
| <b>XBUKK4D10</b> | 0.24 (6.2) | 2.20 (56.0) | 0.10 (2.5)  | 2.44 (62.0) | 2.74 (69.5) | 2.64 (67.0) |
| <b>XBTK</b>      | 0.20 (5.2) | 1.81 (46.0) | 0.04 (1.0)  | 1.57 (40.0) | 1.87 (47.5) | 1.77 (45.0) |

#### Notes

① For ordering information, see [Page V7-T8-105](#).

② For information on Printed Marking Tag Options, see [Page V7-T8-98](#).

For additional accessories, see [Page V7-T8-90](#).

## High Current Blocks

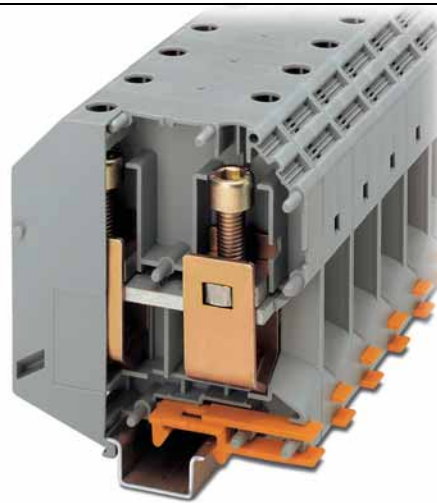

## Contents

| <b>Description</b>                       | <b>Page</b> |
|--|-------------|
| Single Level—Through-Feed                | V7-T8-5     |
| Single Level—Ground Blocks               | V7-T8-10    |
| Multi-Conductor Terminal Blocks          | V7-T8-12    |
| Multi-Conductor Ground Blocks            | V7-T8-14    |
| Double Level                             | V7-T8-16    |
| Triple Level Sensor/Actuator             | V7-T8-18    |
| Fuse Terminal Blocks                     | V7-T8-21    |
| Disconnect and Component Terminal Blocks | V7-T8-24    |
| High Current Blocks                      |             |
| Accessories                              | V7-T8-28    |
| Technical Data and Specifications        | V7-T8-28    |
| Dimensions                               | V7-T8-28    |
| Mini Screw Connection                    | V7-T8-29    |

## High Current Blocks

### Product Description

Eaton's XBUK high current terminal blocks offer a reliable connection via the superior construction that includes three-point centering of the wire in the

prism-shaped sleeve base, a fluted contact surface for low contact resistance, and screws secured with spring-loaded elements. The terminal blocks have

an enclosed housing made from polyamide 6.6. Green-yellow ground terminal blocks are also available.

### Product Selection

#### XBUK150



#### Screw Connection High Current Blocks

| Terminal Width | Maximum Wire Size             | IEC 60 947-7-1 in V/A/AWG | EN 50 019 ① in V/A/AWG | UL-cUL Ratings in V/A/AWG | Color | Standard Pack | Catalog Number |
|----------------|-------------------------------|---------------------------|------------------------|---------------------------|-------|---------------|----------------|
| 20.0 mm        | 1/0/50 mm <sup>2</sup>        | 1000/150/1/0              | 750/135/1/0            | 600/150/1/0               | Gray  | 10            | XBUK50         |
|                |                               |                           |                        |                           | Blue  | 10            | XBUK50BU       |
| 31.0 mm        | 300 kcmil/150 mm <sup>2</sup> | 1000/309/2–300            | 726/265/2–300          | 600/285/2 AWG–300 kcmil   | Gray  | 10            | XBUK150        |

#### XBUK95PE



#### Screw Connection High Current Ground Blocks

| Terminal Width | Maximum Wire Size          | IEC 60 947-7-1 in V/A/AWG | EN 50 019 ① in V/A/AWG | UL-cUL Ratings in V/A/AWG | Color        | Standard Pack | Catalog Number |
|----------------|----------------------------|---------------------------|------------------------|---------------------------|--------------|---------------|----------------|
| 25.0 mm        | 000 AWG/95 mm <sup>2</sup> | —/232/4–000               | —/—/4–000              | —/—/2–4/0                 | Green/Yellow | 10            | XBUK95PE       |

#### Note

① U type—examination certificate number: KEMA 05ATEX2170 U (XBUK50), KEMA 05ATEX2171 U (XBUK150).

# 8.1

## Terminal Blocks, Fuse Blocks and Fuse Holders

IEC—XB Series

### Accessories

#### Screw Connection High Current Blocks

| Description  | Color | Number of Positions | Standard Pack | XBUK50 Catalog Number | XBUK150 Catalog Number | XBUK95PE Catalog Number |
|--|-------|---------------------|---------------|-----------------------|------------------------|-------------------------|
| Fixed bridge, screw heads with insulating color    | —     | 2                   | 10            | XBAFBI220             | —                      | —                       |
| Insertion bridge                                   | —     | 2                   | 10            | —                     | XBAEB231               | —                       |
| Blank marker strip external labeling (strip of 10) | White | —                   | 10            | XBMZB10 ①             | XBMZB10 ①              | XBMZB10 ①               |

### Technical Data and Specifications

#### Screw Connection High Current Blocks

| Description   | XBUK50      | XBUK150         | XBUK95PE        |
|---|-------------|-----------------|-----------------|
| <b>Technical Data in Accordance with IEC</b>                                  |             |                 |                 |
| Maximum load current in A/cross-section in mm <sup>2</sup>                    | 150/50      | 309/150         | 232/95          |
| Maximum cross-section with insertion bridge solid/stranded in mm <sup>2</sup> | —/—         | 150/120         | —/—             |
| Rated surge voltage in kV/contamination class                                 | 8/3         | 8/3             | 8/3             |
| Surge voltage category/insulating material group                              | III/I       | III/I           | III/I           |
| <b>Connection Capacity</b>  |             |                 |                 |
| Stranded with ferrule/with ferrule and plastic sleeve in mm <sup>2</sup>      | 25–50/25–50 | 50–150/50–150   | 35–95/35–95     |
| <b>Multi-Conductor Connection</b><br>(same cross-section)                     |             |                 |                 |
| Solid/stranded in mm <sup>2</sup>   | 10–16/10–16 | 25–50/35–50     | 25–35/25–35     |
| Stranded with ferrules without plastic sleeve in mm <sup>2</sup>              | 10–16       | 25–50           | 16–35           |
| Stripping length in inches (mm)   | 0.94 (24)   | 1.57 (40)       | 1.18 (30)       |
| Thread  | M6          | M10             | M8              |
| Terminal point—thread/torque in in-lb (Nm)                                    | 53–71 (6–8) | 221–267 (25–30) | 133–177 (15–20) |
| Fastening—thread/torque in in-lb (Nm)   | 53–71 (6–8) | 221–267 (25–30) | 133–177 (15–20) |

### Dimensions

Approximate Dimensions in Inches (mm)

#### Screw Connection High Current Blocks

| Catalog Number | Width       | Length       | Height for—  |              |             |
|----------------|-------------|--------------|--------------|--------------|-------------|
|                |             |              | 35 x 7.5 in  | 35 x 15 in   | 32 in       |
| XBUK50         | 0.79 (20.0) | 2.78 (70.5)  | 3.29 (83.5)  | 3.21 (81.5)  | —           |
| XBUK150        | 1.22 (31.0) | 3.94 (100.0) | 4.67 (118.5) | 4.57 (116.0) | —           |
| XBUK95PE       | 0.98 (25.0) | 3.27 (83.0)  | —            | 3.90 (99.0)  | 3.80 (96.5) |

#### Notes

① For information on Printed Marking Tag Options, see **Page V7-T8-98**.

For additional accessories, see **Page V7-T8-90**.



## Mini Screw Connection Terminal Blocks



## Contents

| <b>Description</b>                                 | <b>Page</b>     |
|--|-----------------|
| Single Level—Through-Feed . . . . .                | <b>V7-T8-5</b>  |
| Single Level—Ground Blocks . . . . .               | <b>V7-T8-10</b> |
| Multi-Conductor Terminal Blocks . . . . .          | <b>V7-T8-12</b> |
| Multi-Conductor Ground Blocks . . . . .            | <b>V7-T8-14</b> |
| Double Level. . . . .                              | <b>V7-T8-16</b> |
| Triple Level Sensor/Actuator . . . . .             | <b>V7-T8-18</b> |
| Fuse Terminal Blocks . . . . .                     | <b>V7-T8-21</b> |
| Disconnect and Component Terminal Blocks . . . . . | <b>V7-T8-24</b> |
| High Current Blocks . . . . .                      | <b>V7-T8-27</b> |
| Mini Screw Connection                              |                 |
| Accessories . . . . .                              | <b>V7-T8-30</b> |
| Technical Data and Specifications . . . . .        | <b>V7-T8-30</b> |
| Dimensions . . . . .                               | <b>V7-T8-30</b> |

## Mini Screw Connection

### Product Description

The **XB** miniature terminal blocks have a connection cross-section from 2 mm<sup>2</sup> through 4 mm<sup>2</sup> and mount on 15 mm DIN rail. There is an

opening for bridging with a fixed bridge in the center of the terminal blocks. These miniature terminal blocks also offer the same accessories

that you would find with the larger blocks—including marking tags, end covers, end stop and ground blocks.

## Product Selection

### XB Muk4



### Mini Screw Connection Terminal Blocks

| Terminal Width | Maximum Wire Size          | IEC 60 947-7-1 in V/A/AWG | EN 50 019 ① in V/A/AWG | UL-cUL Ratings in V/A/AWG | Color | Standard Pack | Catalog Number    |
|----------------|----------------------------|---------------------------|------------------------|---------------------------|-------|---------------|-------------------|
| 5.2 mm         | 12 AWG/2.5 mm <sup>2</sup> | 400/32/24–12              | 275/28/21/24–12        | 600/20/28–12              | Gray  | 50            | <b>XB Muk25</b>   |
|                |                            |                           |                        |                           | Blue  | 50            | <b>XB Muk25BU</b> |
| 6.2 mm         | 10 AWG/4 mm <sup>2</sup>   | 500/41/24–10              | —/—/—                  | 600/10/26–10              | Gray  | 50            | <b>XB Muk4</b>    |
|                |                            |                           |                        |                           | Blue  | 50            | <b>XB Muk4BU</b>  |

### XB Muk25PE



### Mini Screw Connection Ground Blocks

| Terminal Width | Maximum Wire Size          | IEC 60 947-7-2 in V/A/AWG | UL-cUL Ratings in V/A/AWG | Color         | Standard Pack | Catalog Number    |
|----------------|----------------------------|---------------------------|---------------------------|---------------|---------------|-------------------|
| 5.2 mm         | 12 AWG/2.5 mm <sup>2</sup> | —/—/24–12                 | —/—/30–12                 | Green/ Yellow | 50            | <b>XB Muk25PE</b> |
| 6.2 mm         | 10 AWG/2.4 mm <sup>2</sup> | —/—/24–10                 | —/—/26–14                 | Green/ Yellow | 50            | <b>XB Muk4PE</b>  |

### Note

① EU type—examination certificate number: KEMA 05ATEX2169 U (XB Muk25).

# 8.1

## Terminal Blocks, Fuse Blocks and Fuse Holders

IEC—XB Series

### Accessories

#### Mini Screw Connection Terminal/Ground Blocks

| Description                      | Color | Number of Positions | Standard Pack | XBMUK25 Catalog Number | XBMUK4 Catalog Number | XBMUK25PE Catalog Number | XBMUK4PE Catalog Number |
|----------------------------------|-------|---------------------|---------------|------------------------|-----------------------|--------------------------|-------------------------|
| End cover                        | Gray  | —                   | 10            | <b>XBACMU254</b>       | <b>XBACMU254</b>      | —                        | —                       |
|                                  | Blue  | —                   | 10            | <b>XBACMU254B</b>      | <b>XBACMU254B</b>     | —                        | —                       |
| Partition plate                  | —     | —                   | 10            | <b>XBATMU254</b>       | <b>XBATMU254</b>      | —                        | —                       |
| Fixed bridge                     | —     | 10                  | 10            | <b>XBAFBR105N</b>      | —                     | —                        | —                       |
| Separating plate                 | —     | —                   | 10            | <b>XBATMPKK15</b>      | <b>XBATMPKK15</b>     | —                        | —                       |
| Blank marker strip (strip of 10) | White | —                   | 10            | <b>XBMZB5</b> ①        | <b>XBMZB6</b> ①       | <b>XBMZB5</b> ①          | <b>XBMZB6</b> ①         |

## 8

### Technical Data and Specifications

#### Mini Spring Cage Terminal/Ground Blocks

| Description   | XBMUK25           | XBMUK4            | XBMUK25PE         | XBMUK4PE          |
|---|-------------------|-------------------|-------------------|-------------------|
| <b>Technical Data in Accordance with IEC</b>                    |                   |                   |                   |                   |
| Maximum load current in A/cross-section in mm <sup>2</sup>      | 32/4              | 41/6              | —                 | —                 |
| Maximum cross-section with insertion bridge (solid/stranded)    | 2.5/2.5           | 4/4               | —                 | —                 |
| Rated surge voltage in kV/contamination class                   | 6/3               | 6/3               | 6/3               | 6/3               |
| Surge voltage category/insulating material group                | III/1             | III/1             | III/1             | III/1             |
| <b>Connection Cross-Section</b>                                 |                   |                   |                   |                   |
| Stranded with ferrule with plastic sleeve in mm <sup>2</sup>    | 0.25–1.5          | 0.25–2.5          | 0.25–1.5          | 0.25–2.5          |
| Stranded with ferrule without plastic sleeve in mm <sup>2</sup> | 0.25–2.5          | 0.25–4            | 0.25–2.5          | 0.25–4            |
| <b>Multi-Conductor Connection</b> (same cross-section)          |                   |                   |                   |                   |
| Solid/stranded in mm <sup>2</sup>                               | 0.2–1.0/0.2–1.5   | 0.2–1.5/0.2–1.5   | 0.2–1.0/0.2–1.5   | 0.2–1.5/0.2–1.5   |
| Stranded with ferrule without plastic sleeve in mm <sup>2</sup> | 0.25–1.5          | 0.25–1.5          | 0.25–1.5          | 0.25–1.5          |
| Stranded with ferrule with plastic sleeve in mm <sup>2</sup>    | 0.5–1.0           | 0.5–2.5           | 0.5–1.5           | 0.5–2.5           |
| Stripping length in Inches (mm)                                 | 0.31 (8)          | 0.31 (8)          | 0.31 (8)          | 0.31 (8)          |
| Thread  | M3                | M3                | M3                | M3                |
| Torque in in-lb (Nm)  | 5.3–7.1 (0.6–0.8) | 4.4–5.3 (0.5–0.6) | 5.3–7.1 (0.6–0.8) | 5.3–7.1 (0.6–0.8) |

### Dimensions

Approximate Dimensions in Inches (mm)

#### Mini Spring Cage Terminal/Ground Blocks

| Catalog Number   | Width      | Length      | Cover Length | Height for—<br>15 in |
|------------------|------------|-------------|--------------|----------------------|
| <b>XBMUK25</b>   | 0.20 (5.2) | 1.10 (28.0) | 0.04 (1.0)   | 1.26 (32.0)          |
| <b>XBMUK4</b>    | 0.24 (6.2) | 1.10 (28.0) | 0.04 (1.0)   | 1.26 (32.0)          |
| <b>XBMUK25PE</b> | 0.20 (5.2) | 1.10 (28.0) | —            | 1.24 (31.5)          |
| <b>XBMUK4PE</b>  | 0.24 (6.2) | 1.10 (28.0) | —            | 1.26 (32.0)          |

#### Notes

① For information on Printed Marking Tag Options, see **Page V7-T8-98**.

For additional accessories, see **Page V7-T8-90**.

Spring Cage Connection



## Contents

### Description

|  | <i>Page</i>     |
|--|-----------------|
| Spring Cage Terminal Blocks                  |                 |
| Single Level—Through-Feed . . . . .          | <b>V7-T8-32</b> |
| Single Level—Ground Blocks . . . . .         | <b>V7-T8-37</b> |
| Multi-Conductor Terminal Blocks . . . . .    | <b>V7-T8-39</b> |
| Multi-Conductor Ground Blocks . . . . .      | <b>V7-T8-42</b> |
| Double Level Blocks . . . . .                | <b>V7-T8-44</b> |
| Triple Level Blocks . . . . .                | <b>V7-T8-46</b> |
| Fuse Terminal Blocks . . . . .               | <b>V7-T8-48</b> |
| Disconnect and Component Terminal Blocks . . | <b>V7-T8-51</b> |
| Hybrid Terminal Blocks . . . . .             | <b>V7-T8-54</b> |
| Mini Spring Cage . . . . .                   | <b>V7-T8-56</b> |



Drawings  
Online

## Spring Cage Terminal Blocks Overview

### Product Description

The XBPT Series incorporates a spring cage connection system proven in applications that are sensitive to vibration. The spring mechanism always exerts the same constant force on the wire, resulting in a vibration-proof, gas-tight connection, independent of the user. The space-saving front connection, with the wire and screwdriver coming in parallel from the same direction, allows for simple wiring in places where there is little space available.

### Application Description

The connection point is opened with a standard screwdriver. After the wire has been inserted into the wire guide of the terminal block, the screwdriver is removed and the wire automatically makes contact.

### Features

- Vibration-resistance
- Global acceptance
- Multi-conductor connections
- Flexible Plug-in bridge system
- Large surface area for marking
- Standardized testing system

### Standards and Certifications

- UL recognized—File No. E67464
- CE approved
- LVD ①:
  - EN 60947-7-1
  - EN 60947-7-2
  - EN 60998-2-3
  - EN 60352-4/A1
- ATEX approval (Eex e applications)



#### Note

- ① Not all standards apply to all terminal blocks. Contact Eaton for details.

# 8.1

## Terminal Blocks, Fuse Blocks and Fuse Holders

IEC—XB Series

Single Level—Through-Feed



8

### Contents

#### Description

|  | <i>Page</i>     |
|--|-----------------|
| Single Level—Through-Feed                      |                 |
| Accessories .....                              | <b>V7-T8-34</b> |
| Technical Data and Specifications .....        | <b>V7-T8-36</b> |
| Dimensions .....                               | <b>V7-T8-36</b> |
| Single Level—Ground Blocks .....               | <b>V7-T8-37</b> |
| Multi-Conductor Terminal Blocks .....          | <b>V7-T8-39</b> |
| Multi-Conductor Ground Blocks .....            | <b>V7-T8-42</b> |
| Double Level Blocks .....                      | <b>V7-T8-44</b> |
| Triple Level Blocks .....                      | <b>V7-T8-46</b> |
| Fuse Terminal Blocks .....                     | <b>V7-T8-48</b> |
| Disconnect and Component Terminal Blocks ..... | <b>V7-T8-51</b> |
| Hybrid Terminal Blocks .....                   | <b>V7-T8-54</b> |
| Mini Spring Cage .....                         | <b>V7-T8-56</b> |

### Single Level—Through-Feed

#### Product Description

The space-saving design and front entry design make the XBPT Series ideal for control systems where there is little space. Even so, they offer maximum connection space, resulting in fast wiring of stranded and solid conductors with or without ferrules.

XBPT terminal blocks are available with cross-sections from 2.5 mm<sup>2</sup> up to 35 mm<sup>2</sup>. The double bridge shaft can accommodate individual chain bridging and step-down bridging from other terminal blocks.

## Product Selection

XBPT6



## Spring Cage Connection Single Level—Through-Feed

| Terminal Width | Maximum Wire Size          | IEC 60 947-7-1 in V/A/AWG | EN 50 019 <sup>①</sup> in V/A/AWG | UL-cUL Ratings in V/A/AWG | Color | Standard Pack | Catalog Number  |
|----------------|----------------------------|---------------------------|-----------------------------------|---------------------------|-------|---------------|-----------------|
| 5.2 mm         | 12 AWG/2.5 mm <sup>2</sup> | 800/31/28–12              | 550/25/21/24–12                   | 600/20/26–12              | Gray  | 50            | <b>XBPT25</b>   |
|                |                            |                           |                                   |                           | Blue  | 50            | <b>XBPT25BU</b> |
|                |                            |                           |                                   |                           | White | 50            | <b>XBPT25WH</b> |
|                |                            |                           |                                   |                           | Red   | 50            | <b>XBPT25RD</b> |
|                |                            |                           |                                   |                           | Black | 50            | <b>XBPT25BK</b> |
| 6.2 mm         | 10 AWG/4 mm <sup>2</sup>   | 800/40/28–10              | 550/34/30/24–10                   | 600/30/20–10              | Gray  | 50            | <b>XBPT4</b>    |
|                |                            |                           |                                   |                           | Blue  | 50            | <b>XBPT4BU</b>  |
| 8.2 mm         | 8 AWG/6 mm <sup>2</sup>    | 800/52/24–8               | 550/45/36/20–8                    | 600/50/20–8               | Gray  | 50            | <b>XBPT6</b>    |
|                |                            |                           |                                   |                           | Blue  | 50            | <b>XBPT6BU</b>  |
| 10.2 mm        | 6 AWG/10 mm <sup>2</sup>   | 800/65/24–6               | 550/50/63/16–6                    | 600/65/16–6               | Gray  | 50            | <b>XBPT10</b>   |
|                |                            |                           |                                   |                           | Blue  | 50            | <b>XBPT10BU</b> |
| 12 mm          | 4 AWG/16 mm <sup>2</sup>   | 800/90/24–4               | 550/65/82/16–4                    | 600/50/16–4               | Gray  | 50            | <b>XBPT16</b>   |
|                |                            |                           |                                   |                           | Blue  | 50            | <b>XBPT16BU</b> |
| 16 mm          | 2 AWG/35 mm <sup>2</sup>   | 800/125/14–2              | 750/108/14–2                      | 600/115/14–2              | Gray  | 50            | <b>XBPT35</b>   |
|                |                            |                           |                                   |                           | Blue  | 50            | <b>XBPT35BU</b> |

**Note**

<sup>①</sup> EU type—examination certificate number: KEMA 05ATEX2158 U.

# 8.1

## Terminal Blocks, Fuse Blocks and Fuse Holders

IEC—XB Series

### Accessories

#### Spring Cage Connection Single Level—Through-Feed, XBPT25, XBPT4 and XBPT6

| Description  | Color | Number of Positions | Standard Pack | XBPT25 Catalog Number        | XBPT4 Catalog Number         | XBPT6 Catalog Number         |
|--|-------|---------------------|---------------|------------------------------|------------------------------|------------------------------|
| End cover  | Gray  | —                   | 10            | <b>XBACPT25</b>              | <b>XBACPT4</b>               | <b>XBACPT6</b>               |
| Partition plate  | Gray  | —                   | 10            | <b>XBATPT4</b>               | <b>XBATPT4</b>               | <b>XBATPT6</b>               |
| Plug-in bridge—for cross connections in the bridge shaft | Red   | 2                   | 10            | <b>XBAFBS25</b>              | <b>XBAFBS26</b>              | <b>XBAFBS28</b>              |
|  |       | 3                   | 10            | <b>XBAFBS35</b>              | <b>XBAFBS36</b>              | —                            |
|  |       | 5                   | 10            | <b>XBAFBS55</b>              | <b>XBAFBS56</b>              | —                            |
|  |       | 10                  | 10            | <b>XBAFBS105</b>             | <b>XBAFBS106</b>             | —                            |
|  |       | 50                  | 10            | <b>XBAFBS505</b>             | <b>XBAFBS506</b>             | —                            |
| Test adapter   | —     | —                   | 10            | <b>XBATSPAI4</b>             | <b>XBATSPAI4</b>             | <b>XBATSPAI4</b>             |
| 2.3 mm diameter test plug                                | —     | —                   | —             | <b>XBATSMPS-<sup>①</sup></b> | <b>XBATSMPS-<sup>①</sup></b> | <b>XBATSMPS-<sup>①</sup></b> |
| Modular test plug  | —     | —                   | 10            | <b>XBATSPS5</b>              | <b>XBATSPS6</b>              | <b>XBATSPS8</b>              |
| Blank marker strip external labeling                     | White | —                   | 10            | <b>XBMZBF5<sup>②</sup></b>   | <b>XBMZBF6<sup>②</sup></b>   | <b>XBMZBF8<sup>②</sup></b>   |
| Blank marker strip center labeling (strip of 10)         | White | —                   | 10            | <b>XBMZB5<sup>②</sup></b>    | <b>XBMZB6<sup>②</sup></b>    | <b>XBMZB8<sup>②</sup></b>    |

#### Spring Cage Connection Single Level—Through-Feed, XBPT10, XBPT16 and XBPT35

| Description  | Color | Number of Positions | Standard Pack | XBPT10 Catalog Number        | XBPT16 Catalog Number        | XBPT35 Catalog Number        |
|--|-------|---------------------|---------------|------------------------------|------------------------------|------------------------------|
| End cover  | Gray  | —                   | 10            | <b>XBACPT10</b>              | <b>XBACPT16</b>              | <sup>③</sup>                 |
| Plug-in bridge—for cross connections in the bridge shaft | Red   | 2                   | 10            | <b>XBAFBS210</b>             | <b>XBAFBS212<sup>①</sup></b> | <b>XBAFBS216<sup>②</sup></b> |
| 2.3 mm diameter test plug                                | —     | —                   | 10            | <b>XBATSMPS-<sup>①</sup></b> | <b>XBATSMPS-<sup>①</sup></b> | <b>XBATSMPS-<sup>①</sup></b> |
| Blank marker strip external labeling                     | White | —                   | 10            | <b>XBMZF10<sup>②</sup></b>   | <b>XBMZBF12<sup>②</sup></b>  | <b>XBMZBF15<sup>②</sup></b>  |
| Blank marker strip center labeling (strip of 10)         | White | —                   | 10            | <b>XBMZB10<sup>②</sup></b>   | <b>XBMZB12<sup>②</sup></b>   | <b>XBMZB15<sup>②</sup></b>   |

#### Notes

- ① For ordering information, see **Page V7-T8-105**.
- ② For information on Printed Marking Tag Options, see **Page V7-T8-98**.
- ③ XBPT35 has an enclosed design. The use of an end cover is not required.

For additional accessories, see **Page V7-T8-90**.

## XBPT with Reducing Bridge

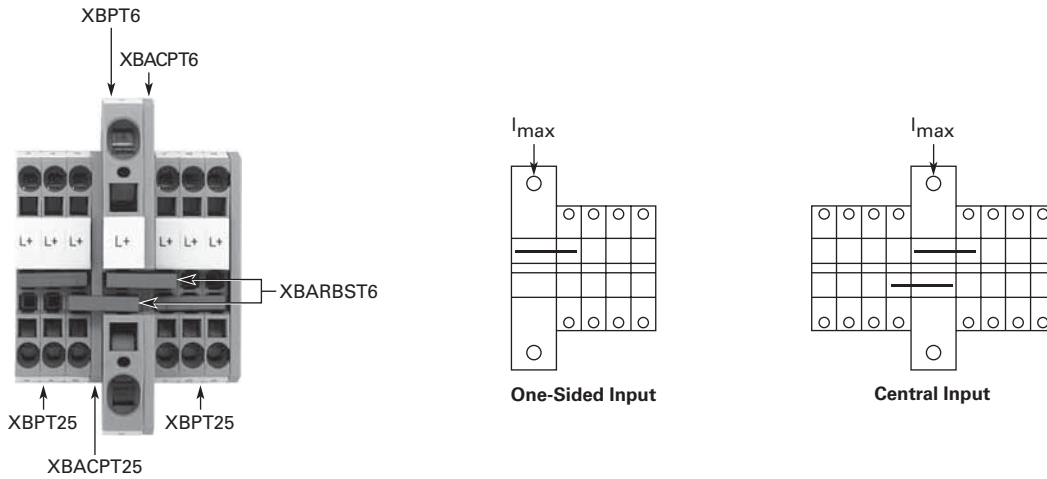

## Step-Down Bridge with Standard Feed-Through Terminal Blocks

| Input Terminal Blocks | Cross-Section               | Pick-Off Terminal Blocks | Cross-Section AWG (mm <sup>2</sup> ) | One-Sided Input I <sub>max</sub> | Central Input I <sub>max</sub> | Bridge Catalog Number |
|-----------------------|-----------------------------|--------------------------|--------------------------------------|----------------------------------|--------------------------------|-----------------------|
| XBPT6                 | 8 AWG (6 mm <sup>2</sup> )  | XBPT25                   | 12 (2.5)                             | 40                               | 56                             | <b>XBARBST6</b>       |
|                       |                             | XBPT4                    | 10 (4)                               | 45                               | 56                             | <b>XBARBST6</b>       |
|                       |                             | XBQT15                   | 14 (1.5)                             | 35                               | 56                             | <b>XBARBST6</b>       |
|                       |                             | XBQT25                   | 12 (2.5)                             | 40                               | 56                             | <b>XBARBST6</b>       |
| XBPT10                | 6 AWG (10 mm <sup>2</sup> ) | XBPT25                   | 12 (2.5)                             | 40                               | 65                             | <b>XBARBST10</b>      |
|                       |                             | XBPT4                    | 10 (4)                               | 45                               | 65                             | <b>XBARBST10</b>      |
|                       |                             | XBQT15                   | 14 (1.5)                             | 35                               | 65                             | <b>XBARBST10</b>      |
|                       |                             | XBQT25                   | 12 (2.5)                             | 40                               | 65                             | <b>XBARBST10</b>      |
| XBPT16                | 4 AWG (16 mm <sup>2</sup> ) | XBPT25                   | 12 (2.5)                             | 40                               | 80                             | <b>XBARBST16</b>      |
|                       |                             | XBPT4                    | 10 (4)                               | 45                               | 90                             | <b>XBARBST16</b>      |
|                       |                             | XBQT15                   | 14 (1.5)                             | 35                               | 70                             | <b>XBARBST16</b>      |
|                       |                             | XBQT25                   | 12 (2.5)                             | 40                               | 80                             | <b>XBARBST16</b>      |

# 8.1

## Terminal Blocks, Fuse Blocks and Fuse Holders

IEC—XB Series

### Technical Data and Specifications

#### Spring Cage Connection Single Level—Through-Feed

| Description  | XBPT25    | XBPT4     | XBPT6     | XBPT10    | XBPT16    | XBPT35    |
|--|-----------|-----------|-----------|-----------|-----------|-----------|
| <b>Technical Data in Accordance with IEC</b>                             |           |           |           |           |           |           |
| Maximum load current in A/cross-section in mm <sup>2</sup>               | 31/4      | 40/6      | 52/10     | 65/16     | 90/25     | 125/35    |
| Rated surge voltage in kV/contamination class                            | 8/3       | 8/3       | 8/3       | 8/3       | 8/3       | 8/3       |
| Surge voltage category/insulating material group                         | III/I     | III/I     | III/I     | III/I     | III/I     | III/I     |
| <b>Connection Capacity</b>   |           |           |           |           |           |           |
| Stranded with ferrule/with ferrule and plastic sleeve in mm <sup>2</sup> | 0.25–2.5  | 0.25–4    | 0.25–6    | 0.25–10   | 0.25–16   | 2.5–35    |
| Stranded with ferrules without plastic sleeve in mm <sup>2</sup>         | 0.25–2.5  | 0.25–4    | 0.25–6    | 0.25–10   | 0.25–16   | 2.5–35    |
| Stranded with twin ferrule with plastic sleeve in mm <sup>2</sup>        | 0.5       | 0.5–1     | 0.5–1.5   | 1.5–2.5   | 1.5–4     | 2.5–10    |
| Stripping length in inches (mm)  | 0.39 (10) | 0.39 (10) | 0.47 (12) | 0.71 (18) | 0.71 (18) | 0.98 (25) |

### Dimensions

Approximate Dimensions in Inches (mm)

#### Spring Cage Connection Single Level—Through-Feed

| Catalog Number | Width       | Length       | Cover Width | Height for— |             |
|----------------|-------------|--------------|-------------|-------------|-------------|
|                |             |              |             | 35 x 7.5 in | 35 x 15 in  |
| XBPT25         | 0.20 (5.2)  | 1.91 (48.5)  | 0.09 (2.2)  | 1.45 (36.8) | 1.73 (44.0) |
| XBPT4          | 0.24 (6.2)  | 2.20 (56.0)  | 0.09 (2.2)  | 1.45 (36.8) | 1.73 (44.0) |
| XBPT6          | 0.32 (8.2)  | 2.74 (69.5)  | 0.09 (2.2)  | 1.71 (43.5) | 2.01 (51.0) |
| XBPT10         | 0.39 (10.0) | 2.81 (71.5)  | 0.09 (2.2)  | 1.99 (50.5) | 2.30 (58.5) |
| XBPT16         | 0.47 (12.0) | 3.15 (80.0)  | 0.09 (2.2)  | 2.01 (51.0) | 2.30 (58.5) |
| XBPT35         | 0.63 (16.0) | 3.94 (100.0) | ①           | 2.32 (59.0) | 2.62 (66.5) |

#### Note

① XBPT35 has an enclosed design. The use of an end cover is not required.



## Single Level—Ground Blocks



## Contents

## Description

| Description                              | Page     |
|--|----------|
| Single Level—Through-Feed                | V7-T8-32 |
| Single Level—Ground Blocks               |          |
| Accessories                              | V7-T8-38 |
| Technical Data and Specifications        | V7-T8-38 |
| Dimensions                               | V7-T8-38 |
| Multi-Conductor Terminal Blocks          | V7-T8-39 |
| Multi-Conductor Ground Blocks            | V7-T8-42 |
| Double Level Blocks                      | V7-T8-44 |
| Triple Level Blocks                      | V7-T8-46 |
| Fuse Terminal Blocks                     | V7-T8-48 |
| Disconnect and Component Terminal Blocks | V7-T8-51 |
| Hybrid Terminal Blocks                   | V7-T8-54 |
| Mini Spring Cage                         | V7-T8-56 |

## Single Level—Ground Blocks

## Product Description

The XBPT ground blocks are the same shape as the feed-through terminal blocks with the same wide range of cross-sections available. They easily snap onto the

DIN rail to make a reliable mechanical and electrical contact that meets all requirements of IEC 60-947-7-2.

## Product Selection

## XBPT4PE



## Spring Cage Connection Single Level—Ground Blocks

| Terminal Width | Maximum Wire Size          | IEC 60 947-7-2 in V/A/AWG | EN 50 019 ① in V/A/AWG | UL-cUL Ratings in V/A/AWG | Color        | Standard Pack | Catalog Number |
|----------------|----------------------------|---------------------------|------------------------|---------------------------|--------------|---------------|----------------|
| 5.2 mm         | 12 AWG/2.5 mm <sup>2</sup> | —/—/28-12                 | —/—/24-12              | —/—/26-12                 | Green/Yellow | 50            | XBPT25PE       |
| 6.2 mm         | 10 AWG/4 mm <sup>2</sup>   | —/—/28-10                 | —/—/24-10              | —/—/20-10                 | Green/Yellow | 50            | XBPT4PE        |
| 8.2 mm         | 8 AWG/6 mm <sup>2</sup>    | —/—/24-8                  | —/—/20-8               | —/—/20-8                  | Green/Yellow | 50            | XBPT6PE        |
| 10.2 mm        | 6 AWG/10 mm <sup>2</sup>   | —/65/24-6                 | —/—/16-6               | —/—/16-6                  | Green/Yellow | 50            | XBPT10PE       |
| 12 mm          | 4 AWG/16 mm <sup>2</sup>   | —/90/24-4                 | —/—/16-4 ②             | —/—/16-4                  | Green/Yellow | 25            | XBPT16PE       |
| 16 mm          | 2 AWG/35 mm <sup>2</sup>   | —/125/14-2                | —/—/14-2 ②             | —/—/14-2                  | Green/Yellow | 10            | XBPT35PE       |

## Notes

① EU type—examination certificate number: KEMA 05ATEX2154 U (XBPT25PE), KEMA 05ATEX2155 U (XBPT4PE).

② EU type—examination certificate number: KEMA 05ATEX2156 U.

# 8.1

## Terminal Blocks, Fuse Blocks and Fuse Holders

IEC—XB Series

### Accessories

#### Spring Cage Connection Single Level Ground Blocks, XBPT25PE, XBPT4PE and XBPT6PE

| Description                                      | Color | Number of Positions | Standard Pack | XBPT25PE Catalog Number | XBPT4PE Catalog Number | XBPT6PE Catalog Number |
|--|-------|---------------------|---------------|-------------------------|------------------------|------------------------|
| End cover  | Gray  | —                   | 10            | <b>XBACPT25</b>         | <b>XBACPT4</b>         | <b>XBACPT6</b>         |
| Blank marker strip external labeling             | White | —                   | 10            | <b>XBMZBF5</b> ①        | <b>XBMZBF6</b> ①       | <b>XBMZBF8</b> ①       |
| Blank marker strip center labeling (strip of 10) | White | —                   | 10            | <b>XBMZB5</b> ①         | <b>XBMZB6</b> ①        | <b>XBMZB8</b> ①        |

#### Spring Cage Connection Single Level Ground Blocks, XBPT10PE, XBPT16PE and XBPT35PE

| Description  | Color | Number of Positions | Standard Pack | XBPT10PE Catalog Number | XBPT16PE Catalog Number | XBPT35PE Catalog Number |
|--|-------|---------------------|---------------|-------------------------|-------------------------|-------------------------|
| End cover  | Gray  | —                   | 10            | <b>XBACPT10</b>         | <b>XBACPT16</b>         | ②                       |
| Plug-in bridge—for cross connections in the bridge shaft | —     | 2                   | 10            | <b>XBAFBS210</b>        | <b>XBAFBS212</b>        | <b>XBAFBS216</b>        |
| Blank marker strip external labeling                     | White | —                   | 10            | <b>XBMZBF10</b> ①       | <b>XBMZBF12</b> ①       | <b>XBMZBF15</b> ①       |
| Blank marker strip center labeling (strip of 10)         | White | —                   | 10            | <b>XBMZB10</b> ①        | <b>XBMZB12</b> ①        | <b>XBMZB15</b> ①        |

8

### Technical Data and Specifications

#### Spring Cage Connection Single Level Ground Blocks

| Description   | XBPT25PE  | XBPT4PE   | XBPT6PE   | XBPT10PE  | XBPT16PE  | XBPT35PE  |
|---|-----------|-----------|-----------|-----------|-----------|-----------|
| <b>Technical Data in Accordance with IEC</b>                      |           |           |           |           |           |           |
| Maximum load current in A/cross-section in mm <sup>2</sup>        | —         | —         | —         | 65/16     | 90/25     | 125/35    |
| Rated surge voltage in kV/contamination class                     | 8/3       | 8/3       | 8/3       | 8/3       | 8/3       | 8/3       |
| Surge voltage category/insulating material group                  | III/I     | III/I     | III/I     | III/I     | III/I     | III/I     |
| <b>Connection Capacity</b>  |           |           |           |           |           |           |
| Stranded with ferrule with plastic sleeve in mm <sup>2</sup>      | 0.25–2.5  | 0.25–4    | 0.25–6    | 0.25–10   | 0.25–16   | 2.5–35    |
| Stranded with ferrules without plastic sleeve in mm <sup>2</sup>  | 0.25–2.5  | 0.25–4    | 0.25–6    | 0.25–10   | 0.25–16   | 2.5–35    |
| Stranded with twin ferrule with plastic sleeve in mm <sup>2</sup> | 0.5       | 0.5–1     | 0.5–1.5   | 1.5–2.5   | 1.5–4     | 2.5–10    |
| Stripping length in inches (mm)                                   | 0.39 (10) | 0.39 (10) | 0.47 (12) | 0.71 (18) | 0.71 (18) | 0.98 (25) |

### Dimensions

Approximate Dimensions in Inches (mm)

#### Spring Cage Connection Single Level Ground Blocks

| Catalog Number  | Width       | Length       | Cover Width | Height for— |             |
|-----------------|-------------|--------------|-------------|-------------|-------------|
|                 |             |              |             | 35 x 7.5 in | 35 x 15 in  |
| <b>XBPT25PE</b> | 0.20 (5.2)  | 1.91 (48.5)  | 0.09 (2.2)  | 1.45 (36.8) | 1.73 (44.0) |
| <b>XBPT4PE</b>  | 0.24 (6.2)  | 2.20 (56.0)  | 0.09 (2.2)  | 1.45 (36.8) | 1.73 (44.0) |
| <b>XBPT6PE</b>  | 0.32 (8.2)  | 2.74 (69.5)  | 0.09 (2.2)  | 1.71 (43.5) | 2.01 (51.0) |
| <b>XBPT10PE</b> | 0.39 (10.0) | 2.81 (71.5)  | 0.09 (2.2)  | 1.99 (50.5) | 2.28 (58.0) |
| <b>XBPT16PE</b> | 0.47 (12.0) | 3.15 (80.0)  | 0.09 (2.2)  | 2.01 (51.0) | 2.30 (58.5) |
| <b>XBPT35PE</b> | 0.63 (16.0) | 3.94 (100.0) | —           | 2.32 (59.0) | 2.62 (66.5) |

#### Notes

① For information on Printed Marking Tag Options, see **Page V7-T8-98**.

② XBPT35PE has an enclosed design. The use of an end cover is not required.

For additional accessories, see **Page V7-T8-90**.

## Multi-Conductor Terminal Blocks

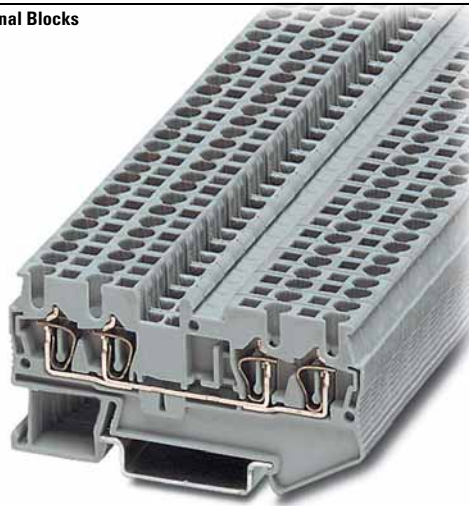

## Contents

| <b>Description</b>                       | <b>Page</b> |
|--|-------------|
| Single Level—Through-Feed                | V7-T8-32    |
| Single Level—Ground Blocks               | V7-T8-37    |
| Multi-Conductor Terminal Blocks          |             |
| Accessories                              | V7-T8-40    |
| Technical Data and Specifications        | V7-T8-41    |
| Dimensions                               | V7-T8-41    |
| Multi-Conductor Ground Blocks            | V7-T8-42    |
| Double Level Blocks                      | V7-T8-44    |
| Triple Level Blocks                      | V7-T8-46    |
| Fuse Terminal Blocks                     | V7-T8-48    |
| Disconnect and Component Terminal Blocks | V7-T8-51    |
| Hybrid Terminal Blocks                   | V7-T8-54    |
| Mini Spring Cage                         | V7-T8-56    |

## Multi-Conductor Terminal Blocks

### Product Description

The multi-conductor terminal blocks offer a space-saving alternative to standard feed-through terminal blocks, allowing for high-density wiring. Often, three connections have to be led to one terminal block. The XBPT...D12 terminal block accomplishes this without

any additional terminal blocks or bridging required. The XBPT...D22 terminal blocks allow four wires to be connected to one potential—and can therefore be used as compact power distributors. There is also a version, XBPT25D22U or XBPT4D22U, with an interrupted bus bar in

the terminal center. This makes two feed-through terminal blocks available in one level. One side of this block can be bridged using the standard Plug-in bridges. Double marker carriers are available for clear marking of the feed-through levels.

### Product Selection

#### XBPT4D12



#### Spring Cage Connection Multi-Conductor Terminal Blocks, Three-Wire

| Terminal Width | Maximum Wire Size          | IEC 60 947-7-1 in V/A/AWG | EN 50 019 ① in V/A/AWG | UL-cUL Ratings in V/A/AWG | Color | Standard Pack | Catalog Number     |
|----------------|----------------------------|---------------------------|------------------------|---------------------------|-------|---------------|--------------------|
| 5.2 mm         | 12 AWG/2.5 mm <sup>2</sup> | 800/28/28–12              | 550/25/21/24–12        | 600/20/26–12              | Gray  | 50            | <b>XBPT25D12</b>   |
|                |                            |                           |                        |                           | Blue  | 50            | <b>XBPT25D12BU</b> |
| 6.2 mm         | 10 AWG/4 mm <sup>2</sup>   | 800/40/28–10              | 550/34/29/24–10        | 600/30/20–10              | Gray  | 50            | <b>XBPT4D12</b>    |
|                |                            |                           |                        |                           | Blue  | 50            | <b>XBPT4D12BU</b>  |

#### Note

① EU type—examination certificate number: KEMA 05ATEX2154 U (XBPT25D12), KEMA 05ATEX2155 U (XBPT4D12).

# 8.1

## Terminal Blocks, Fuse Blocks and Fuse Holders

IEC—XB Series

XBPT25D22



### Spring Cage Connection Multi-Conductor Terminal Blocks, Four-Wire

| Terminal Width  | Maximum Wire Size          | IEC 60 947-7-1 in V/A/AWG | EN 50 019 ① in V/A/AWG | UL-cUL Ratings in V/A/AWG | Color | Standard Pack | Catalog Number     |
|---|----------------------------|---------------------------|------------------------|---------------------------|-------|---------------|--------------------|
| <b>Spring Cage Multi-Conductor</b>                          |                            |                           |                        |                           |       |               |                    |
| 5.2 mm  | 12 AWG/2.5 mm <sup>2</sup> | 800/28/28-12              | 550/24/21/24-12        | 600/20/26-12              | Gray  | 50            | <b>XBPT25D22</b>   |
|   |                            |                           |                        |                           | Blue  | 50            | <b>XBPT25D22BU</b> |
| 6.2 mm  | 10 AWG/4 mm <sup>2</sup>   | 800/40/28-10              | 550/34/25/24-10        | 600/30/20-10              | Gray  | 50            | <b>XBPT4D22</b>    |
|   |                            |                           |                        |                           | Blue  | 50            | <b>XBPT4D22BU</b>  |
| <b>Spring Cage Multi-Conductor with Interrupted Bus Bar</b> |                            |                           |                        |                           |       |               |                    |
| 5.2 mm  | 12 AWG/2.5 mm <sup>2</sup> | 800/28/28-12              | 550/24/21/24-12        | 600/20/26-12              | Blue  | 50            | <b>XBPT25D22U</b>  |
| 6.2 mm  | 10 AWG/4 mm <sup>2</sup>   | 800/40/28-10              | 550/34/25/24-10        | 600/30/20-10              | Blue  | 50            | <b>XBPT4D22U</b>   |

## 8

### Accessories

#### Spring Cage Connection Multi-Conductor Terminal Blocks

| Description  | Color | Number of Positions | Standard Pack | XBPT25D12 Catalog Number     | XBPT4D12 Catalog Number      | XBPT25D22 Catalog Number     | XBPT4D22 Catalog Number      |
|--|-------|---------------------|---------------|------------------------------|------------------------------|------------------------------|------------------------------|
| End cover  | Gray  | —                   | 10            | <b>XBACPT25D12</b>           | <b>XBACPT4D12</b>            | <b>XBACPT25D22</b>           | <b>XBACPT4D22</b>            |
| End cover segment  | Gray  | —                   | 10            | <b>XBASPT25</b>              | <b>XBASPT4</b>               | <b>XBASPT25</b>              | <b>XBASPT4</b>               |
| Partition plate  | —     | —                   | 10            | <b>XBATPTD12</b>             | <b>XBATPTD12</b>             | <b>XBATPTD22</b>             | <b>XBATPTD22</b>             |
| Plug-in bridge—for cross connections in the bridge shaft | Red   | 2                   | 10            | <b>XBAFBS25</b>              | <b>XBAFBS26</b>              | <b>XBAFBS25</b>              | <b>XBAFBS26</b>              |
|  |       | 3                   | 10            | <b>XBAFBS35</b>              | <b>XBAFBS36</b>              | <b>XBAFBS35</b>              | <b>XBAFBS36</b>              |
|  |       | 5                   | 10            | <b>XBAFBS55</b>              | <b>XBAFBS56</b>              | <b>XBAFBS55</b>              | <b>XBAFBS56</b>              |
|  |       | 10                  | 10            | <b>XBAFBS105</b>             | <b>XBAFBS106</b>             | <b>XBAFBS105</b>             | <b>XBAFBS106</b>             |
|  |       | 50                  | 10            | <b>XBAFBS505</b>             | <b>XBAFBS506</b>             | <b>XBAFBS505</b>             | <b>XBAFBS506</b>             |
| Test adapter   | —     | —                   | 10            | <b>XBATSPA14</b>             | <b>XBATSPA14</b>             | <b>XBATSPA14</b>             | <b>XBATSPA14</b>             |
| 2.3 mm diameter test plug                                | —     | —                   | —             | <b>XBATSMPS-<sup>②</sup></b> | <b>XBATSMPS-<sup>②</sup></b> | <b>XBATSMPS-<sup>②</sup></b> | <b>XBATSMPS-<sup>②</sup></b> |
| Modular test plug  | —     | —                   | 10            | <b>XBATSPS5</b>              | <b>XBATSPS6</b>              | <b>XBATSPS5</b>              | <b>XBATSPS6</b>              |
| Blank marker strip external labeling                     | White | —                   | 10            | <b>XBMZBF5<sup>③</sup></b>   | <b>XBMZBF6<sup>③</sup></b>   | <b>XBMZBF5<sup>③</sup></b>   | <b>XBMZBF6<sup>③</sup></b>   |
| Blank marker strip center labeling (strip of 10)         | White | —                   | 10            | <b>XBMZB5<sup>③</sup></b>    | <b>XBMZB6<sup>③</sup></b>    | <b>XBMZB5<sup>③</sup></b>    | <b>XBMZB6<sup>③</sup></b>    |

#### Notes

① EU type—examination certificate number: KEMA 05ATEX2154 U (XBPT25D22), KEMA 05ATEX2155 (XBPT4D22).

② For ordering information, see **Page V7-T8-105**.

③ For information on Printed Marking Tag Options, see **Page V7-T8-98**.

For additional accessories, see **Page V7-T8-90**.

**Technical Data and Specifications****Spring Cage Connection Multi-Conductor Terminal Blocks**

| Description   | XBPT25D12 | XBPT4D12  | XBPT25D22 | XBPT4D22  |
|---|-----------|-----------|-----------|-----------|
| <b>Technical Data in Accordance with IEC</b>                      |           |           |           |           |
| Maximum load current in A/cross-section in mm <sup>2</sup>        | 28/4      | 40/6      | 28/4      | 40/6      |
| Rated surge voltage in kV/contamination class                     | 8/3       | 8/3       | 8/3       | 8/3       |
| Surge voltage category/insulating material group                  | III/I     | III/I     | III/I     | III/I     |
| <b>Connection Capacity</b>  |           |           |           |           |
| Stranded with ferrule with plastic sleeve in mm <sup>2</sup>      | 0.25–2.5  | 0.25–4    | 0.25–2.5  | 0.25–4    |
| Stranded with ferrules without plastic sleeve in mm <sup>2</sup>  | 0.25–2.5  | 0.25–4    | 0.25–2.5  | 0.25–4    |
| Stranded with twin ferrule with plastic sleeve in mm <sup>2</sup> | 0.5       | 0.5–1     | 0.5       | 0.5–1     |
| Stripping length in inches (mm)                                   | 0.39 (10) | 0.39 (10) | 0.39 (10) | 0.39 (10) |

**Dimensions**

Approximate Dimensions in Inches (mm)

**Spring Cage Connection Multi-Conductor Terminal Blocks**

| Catalog Number   | Width      | Length      | Cover Width | Height for— |             |
|------------------|------------|-------------|-------------|-------------|-------------|
|                  |            |             |             | 35 x 7.5 in | 35 x 15 in  |
| <b>XBPT25D12</b> | 0.20 (5.2) | 2.38 (60.5) | 0.09 (2.2)  | 1.44 (36.5) | 1.73 (44.0) |
| <b>XBPT4D12</b>  | 0.24 (6.2) | 2.81 (71.5) | 0.09 (2.2)  | 1.44 (36.5) | 1.73 (44.0) |
| <b>XBPT25D22</b> | 0.20 (5.2) | 2.83 (72.0) | 0.09 (2.2)  | 1.44 (36.5) | 1.73 (44.0) |
| <b>XBPT4D22</b>  | 0.24 (6.2) | 3.43 (87.0) | 0.09 (2.2)  | 1.44 (36.5) | 1.73 (44.0) |

# 8.1

## Terminal Blocks, Fuse Blocks and Fuse Holders

IEC—XB Series

### Multi-Conductor Terminal Blocks



### Contents

| Description                              | Page     |
|--|----------|
| Single Level—Through-Feed                | V7-T8-32 |
| Single Level—Ground Blocks               | V7-T8-37 |
| Multi-Conductor Terminal Blocks          | V7-T8-39 |
| Multi-Conductor Ground Blocks            |          |
| Accessories                              | V7-T8-43 |
| Technical Data and Specifications        | V7-T8-43 |
| Dimensions                               | V7-T8-43 |
| Double Level Blocks                      | V7-T8-44 |
| Triple Level Blocks                      | V7-T8-46 |
| Fuse Terminal Blocks                     | V7-T8-48 |
| Disconnect and Component Terminal Blocks | V7-T8-51 |
| Hybrid Terminal Blocks                   | V7-T8-54 |
| Mini Spring Cage                         | V7-T8-56 |

8

### Multi-Conductor Ground Blocks

#### Product Description

The ground terminal blocks have the same shape and pitch as the standard terminal block, in a green-yellow housing. They easily snap

onto the DIN rail to make a reliable mechanical and electrical contact that meets all requirements of IEC 60-947-7-2.

#### Product Selection

##### XBPT25D12PE



#### Spring Cage Connection Multi-Conductor Ground Blocks, Three-Wire

| Terminal Width | Maximum Wire Size          | IEC 60 947-7-2 in V/A/AWG | EN 50 019 ① in V/A/AWG | UL-cUL Ratings in V/A/AWG | Color        | Standard Pack | Catalog Number |
|----------------|----------------------------|---------------------------|------------------------|---------------------------|--------------|---------------|----------------|
| 5.2 mm         | 12 AWG/2.5 mm <sup>2</sup> | —/—/28-12                 | —/—/24-12              | —/—/26-12                 | Green/Yellow | 50            | XBPT25D12PE    |
| 6.2 mm         | 10 AWG/4 mm <sup>2</sup>   | —/—/28-10                 | —/—/24-10              | —/—/20-10                 | Green/Yellow | 50            | XBPT4D12PE     |

##### XBPT4D22PE



#### Spring Cage Connection Multi-Conductor Ground Blocks, Four-Wire

| Terminal Width | Maximum Wire Size          | IEC 60 947-7-2 in V/A/AWG | EN 50 019 ① in V/A/AWG | UL-cUL Ratings in V/A/AWG | Color        | Standard Pack | Catalog Number |
|----------------|----------------------------|---------------------------|------------------------|---------------------------|--------------|---------------|----------------|
| 5.2 mm         | 12 AWG/2.5 mm <sup>2</sup> | —/—/28-12                 | —/—/24-12              | —/—/26-12                 | Green/Yellow | 50            | XBPT25D22PE    |
| 6.2 mm         | 10 AWG/4 mm <sup>2</sup>   | —/—/28-10                 | —/—/24-10              | —/—/20-10                 | Green/Yellow | 50            | XBPT4D22PE     |

#### Note

① EU type—examination certificate number: KEMA 05ATEX2154 U (XBPT25D12PE), KEMA 05ATEX2155 U (XBPT4D12PE).

## Accessories

### Spring Cage Connection Multi-Conductor Ground Blocks

| Description                                      | Color | Number of Positions | Standard Pack | XBPT25D12PE    | XBPT4D12PE     | XBPT25D22PE    | XBPT4D22PE     |
|--|-------|---------------------|---------------|----------------|----------------|----------------|----------------|
|  |       |                     |               | Catalog Number | Catalog Number | Catalog Number | Catalog Number |
| End cover  | Gray  | —                   | 10            | XBACPT25D12    | XBACPT4D12     | XBACPT25D22    | XBACPT4D22     |
| End cover segment                                | Gray  | —                   | 10            | XBASPT25       | XBASPT4        | XBASPT25       | XBASPT4        |
| Blank marker strip external labeling             | White | —                   | 10            | XBMZBF5 ①      | XBMZBF6 ①      | XBMZBF5 ①      | XBMZBF6 ①      |
| Blank marker strip center labeling (strip of 10) | White | —                   | 10            | XBMZB5 ①       | XBMZB6 ①       | XBMZB5 ①       | XBMZB6 ①       |

## Technical Data and Specifications

### Spring Cage Connection Multi-Conductor Ground Blocks

| Description   | XBPT25D12PE | XBPT4D12PE | XBPT25D22PE | XBPT4D22PE |
|---|-------------|------------|-------------|------------|
| <b>Technical Data in Accordance with IEC</b>                      |             |            |             |            |
| Maximum load current in A/cross-section in mm <sup>2</sup>        | —           | —          | —           | —          |
| Rated surge voltage in kV/contamination class                     | 8/3         | 8/3        | 8/3         | 8/3        |
| Surge voltage category/insulating material group                  | III/1       | III/1      | III/1       | III/1      |
| <b>Connection Capacity</b>  |             |            |             |            |
| Stranded with ferrule with plastic sleeve in mm <sup>2</sup>      | 0.25–2.5    | 0.25–4     | 0.25–2.5    | 0.25–4     |
| Stranded with ferrules without plastic sleeve in mm <sup>2</sup>  | 0.25–2.5    | 0.25–4     | 0.25–2.5    | 0.25–4     |
| Stranded with twin ferrule with plastic sleeve in mm <sup>2</sup> | 0.5         | 0.5–1      | 0.5         | 0.5–1      |
| Stripping length in inches (mm)                                   | 0.39 (10)   | 0.39 (10)  | 0.39 (10)   | 0.39 (10)  |

## Dimensions

Approximate Dimensions in Inches (mm)

### Spring Cage Connection Multi-Conductor Ground Blocks

| Catalog Number | Width      | Length      | Cover Width | Height for— |             |
|----------------|------------|-------------|-------------|-------------|-------------|
|                |            |             |             | 35 x 7.5 in | 35 x 15 in  |
| XBPT25D12PE    | 0.20 (5.2) | 2.38 (60.5) | 0.09 (2.2)  | 1.44 (36.5) | 1.73 (44.0) |
| XBPT4D12PE     | 0.24 (6.2) | 2.81 (71.5) | 0.09 (2.2)  | 1.44 (36.5) | 1.73 (44.0) |
| XBPT25D22PE    | 0.20 (5.2) | 2.83 (72.0) | 0.09 (2.2)  | 1.44 (36.5) | 1.73 (44.0) |
| XBPT4D22PE     | 0.24 (6.2) | 3.43 (87.0) | 0.09 (2.2)  | 1.44 (36.5) | 1.73 (44.0) |

#### Notes

① For information on Printed Marking Tag Options, see **Page V7-T8-98**.

For additional accessories, see **Page V7-T8-90**.

# 8.1

## Terminal Blocks, Fuse Blocks and Fuse Holders

IEC—XB Series

### Double Level Blocks



### Contents

| <i>Description</i>                                 | <i>Page</i>     |
|--|-----------------|
| Single Level—Through-Feed . . . . .                | <b>V7-T8-32</b> |
| Single Level—Ground Blocks . . . . .               | <b>V7-T8-37</b> |
| Multi-Conductor Terminal Blocks . . . . .          | <b>V7-T8-39</b> |
| Multi-Conductor Ground Blocks . . . . .            | <b>V7-T8-42</b> |
| Double Level Blocks                                |                 |
| Accessories . . . . .                              | <b>V7-T8-45</b> |
| Technical Data and Specifications . . . . .        | <b>V7-T8-45</b> |
| Dimensions . . . . .                               | <b>V7-T8-45</b> |
| Triple Level Blocks . . . . .                      | <b>V7-T8-46</b> |
| Fuse Terminal Blocks . . . . .                     | <b>V7-T8-48</b> |
| Disconnect and Component Terminal Blocks . . . . . | <b>V7-T8-51</b> |
| Hybrid Terminal Blocks . . . . .                   | <b>V7-T8-54</b> |
| Mini Spring Cage . . . . .                         | <b>V7-T8-56</b> |

8

### Double Level Blocks

#### Product Description

The potentials of the **XB** double level terminal blocks routed on two levels reduce space requirements by 50% compared with single level terminal blocks.

The XBPTT blocks can be bridged on both levels with the Plug-in bridge system and labeling options are available for each terminal point, resulting in maximum

customization for each application. The XBPTT25PV and XBPTT4PV terminal blocks have two interconnected levels.

Equipotential bonding is marked by an imprint on the housing. These terminal blocks can also be bridged and used to construct compact potential distributor blocks.

### Product Selection

#### XBPTT4



#### Spring Cage Connection Double Level Blocks

| Terminal Width  | Maximum Wire Size          | IEC 60 947-7-1 in V/A/AWG | EN 50 019 ① in V/A/AWG | UL-cUL Ratings in V/A/AWG | Color | Standard Pack | Catalog Number   |
|---|----------------------------|---------------------------|------------------------|---------------------------|-------|---------------|------------------|
| <b>Spring Cage Connection Double Level Blocks</b>   |                            |                           |                        |                           |       |               |                  |
| 5.2 mm  | 12 AWG/2.5 mm <sup>2</sup> | 500/26/28-12              | 420/23/19/24-12        | 600/20/26-12              | Gray  | 50            | <b>XBPTT25</b>   |
|   |                            |                           |                        |                           | Blue  | 50            | <b>XBPTT25BU</b> |
| 6.2 mm  | 10 AWG/4 mm <sup>2</sup>   | 500/32/28-10              | 420/32/27/24-10        | 300/30/20-10              | Gray  | 50            | <b>XBPTT4</b>    |
|   |                            |                           |                        |                           | Blue  | 50            | <b>XBPTT4BU</b>  |
| <b>Spring Cage Connection Double Level Blocks</b> (terminal block with potential distribution between the levels) |                            |                           |                        |                           |       |               |                  |
| 5.2 mm  | 12 AWG/2.5 mm <sup>2</sup> | 500/26/28-12              | 420/23/19/24-12        | 600/20/26-12              | Gray  | 50            | <b>XBPTT25PV</b> |
| 6.2 mm  | 10 AWG/4 mm <sup>2</sup>   | 500/32/28-10              | 420/32/27/24-10        | 300/30/20-10              | Gray  | 50            | <b>XBPTT4PV</b>  |

#### XBPTT25PE



#### Spring Cage Connection Double Level Ground Blocks

| Terminal Width | Maximum Wire Size          | IEC 60 947-7-2 in V/A/AWG | EN 50 019 ① in V/A/AWG | UL-cUL Ratings in V/A/AWG | Color        | Standard Pack | Catalog Number   |
|----------------|----------------------------|---------------------------|------------------------|---------------------------|--------------|---------------|------------------|
| 5.2 mm         | 12 AWG/2.5 mm <sup>2</sup> | —/—/28-12                 | —/—/24-12              | —/—/26-12                 | Green/Yellow | 50            | <b>XBPTT25PE</b> |
| 6.2 mm         | 10 AWG/4 mm <sup>2</sup>   | —/—/28-10                 | —/—/24-10              | —/—/20-10                 | Green/Yellow | 50            | <b>XBPTT4PE</b>  |

#### Note

① EU type—examination certificate number: KEMA 05ATEX2154 U (XBPTT25), KEMA 05ATEX2155 U (XBPTT4).



## Accessories

### Spring Cage Connection Double Level Blocks

| Description  | Color | Number of Positions | Standard Pack | XBPTT25<br>Catalog<br>Number | XBPTT4<br>Catalog<br>Number | XBPTT25PE<br>Catalog<br>Number | XBPTT4PE<br>Catalog<br>Number |
|--|-------|---------------------|---------------|------------------------------|-----------------------------|--------------------------------|-------------------------------|
| End cover  | Gray  | —                   | 10            | <b>XBACPTT25</b>             | <b>XBACPTT4</b>             | <b>XBACPTT25</b>               | <b>XBACPTT4</b>               |
| Partition plate  | —     | —                   | 10/50         | <b>XBATPTT4</b>              | <b>XBATPTT4</b>             | —                              | —                             |
| Plug-in bridge—for cross connections in the bridge shaft | Red   | 2                   | 10            | <b>XBAFBS25</b>              | <b>XBAFBS26</b>             | <b>XBAFBS25</b>                | <b>XBAFBS26</b>               |
|  |       | 3                   | 10            | <b>XBAFBS35</b>              | <b>XBAFBS36</b>             | <b>XBAFBS35</b>                | <b>XBAFBS36</b>               |
|  |       | 5                   | 10            | <b>XBAFBS55</b>              | <b>XBAFBS56</b>             | <b>XBAFBS55</b>                | <b>XBAFBS56</b>               |
|  |       | 10                  | 10            | <b>XBAFBS105</b>             | <b>XBAFBS106</b>            | <b>XBAFBS105</b>               | <b>XBAFBS106</b>              |
|  |       | 50                  | 10            | <b>XBAFBS505</b>             | <b>XBAFBS506</b>            | <b>XBAFBS505</b>               | <b>XBAFBS506</b>              |
| Test adapter   | —     | —                   | 10            | <b>XBATSPAI4</b>             | <b>XBATSPAI4</b>            | —                              | —                             |
| Modular test plug  | —     | —                   | 10            | <b>XBATSPS5</b>              | <b>XBATSPS6</b>             | —                              | —                             |
| Blank marker strip (strip of 10)                         | White | —                   | 10            | <b>XBMZBF5</b> ①             | <b>XBMZBF6</b> ①            | <b>XBMZBF5</b> ①               | <b>XBMZBF6</b> ①              |

## Technical Data and Specifications

### Spring Cage Connection Double Level Blocks

| Description   | XBPTT25   | XBPTT4    | XBPTT25PE | XBPTT4PE  |
|---|-----------|-----------|-----------|-----------|
| <b>Technical Data in Accordance with IEC</b>                      |           |           |           |           |
| Maximum load current in A/cross-section in mm <sup>2</sup>        | 26/4      | 32/6      | —         | —         |
| Rated surge voltage in kV/contamination class                     | 6/3       | 6/3       | 6/3       | 6/3       |
| Surge voltage category/insulating material group                  | III/I     | III/I     | III/I     | III/I     |
| <b>Connection Capacity</b>  |           |           |           |           |
| Stranded with ferrule with plastic sleeve in mm <sup>2</sup>      | 0.25–2.5  | 0.25–4    | 0.25–2.5  | 0.25–4    |
| Stranded with ferrules without plastic sleeve in mm <sup>2</sup>  | 0.25–2.5  | 0.25–4    | 0.25–2.5  | 0.25–4    |
| Stranded with twin ferrule with plastic sleeve in mm <sup>2</sup> | 0.5       | 0.5–1     | 0.5       | 0.5–1     |
| Stripping length in inches (mm)                                   | 0.39 (10) | 0.39 (10) | 0.39 (10) | 0.39 (10) |

## Dimensions

Approximate Dimensions in Inches (mm)

### Spring Cage Connection Double Level Blocks

| Catalog Number   | Width      | Length      | Cover Width | Height for— |             |
|------------------|------------|-------------|-------------|-------------|-------------|
|                  |            |             |             | 35 x 7.5 in | 35 x 15 in  |
| <b>XBPTT25</b>   | 0.20 (5.2) | 2.66 (67.5) | 0.09 (2.2)  | 1.87 (47.5) | 2.17 (55.0) |
| <b>XBPTT4</b>    | 0.24 (6.2) | 3.29 (83.5) | 0.09 (2.2)  | 1.87 (47.5) | 2.17 (55.0) |
| <b>XBPTT25PE</b> | 0.20 (5.2) | 2.66 (67.5) | 0.09 (2.2)  | 1.87 (47.5) | 2.17 (55.0) |
| <b>XBPTT4PE</b>  | 0.24 (6.2) | 3.29 (83.5) | 0.09 (2.2)  | 1.87 (47.5) | 2.17 (55.0) |

#### Notes

① For information on Printed Marking Tag Options, see **Page V7-T8-98**.

For additional accessories, see **Page V7-T8-90**.

# 8.1

## Terminal Blocks, Fuse Blocks and Fuse Holders

IEC—XB Series

### Triple Level Blocks

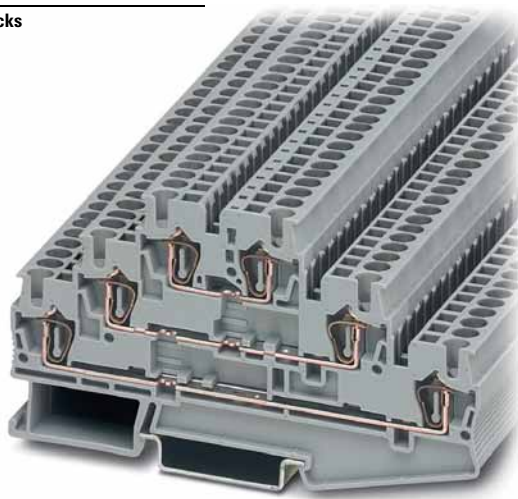

### Contents

#### Description

| <i>Description</i>                                 | <i>Page</i>     |
|--|-----------------|
| Single Level—Through-Feed . . . . .                | <b>V7-T8-32</b> |
| Single Level—Ground Blocks . . . . .               | <b>V7-T8-37</b> |
| Multi-Conductor Terminal Blocks . . . . .          | <b>V7-T8-39</b> |
| Multi-Conductor Ground Blocks . . . . .            | <b>V7-T8-42</b> |
| Double Level Blocks . . . . .                      | <b>V7-T8-44</b> |
| Triple Level Blocks                                |                 |
| Accessories . . . . .                              | <b>V7-T8-47</b> |
| Technical Data and Specifications . . . . .        | <b>V7-T8-47</b> |
| Dimensions . . . . .                               | <b>V7-T8-47</b> |
| Fuse Terminal Blocks . . . . .                     | <b>V7-T8-48</b> |
| Disconnect and Component Terminal Blocks . . . . . | <b>V7-T8-51</b> |
| Hybrid Terminal Blocks . . . . .                   | <b>V7-T8-54</b> |
| Mini Spring Cage . . . . .                         | <b>V7-T8-56</b> |

8

### Triple Level Blocks

#### Product Description

The spring cage triple level terminal block incorporates three feed-through levels in a 5.2 mm wide housing. This is ideal for high density wiring, especially important

when switchgear space is restricted. There is a bridge shaft on each level allowing use of this block as a compact potential distributor or as a sensor terminal.

The XBPTK25PV has all six terminal points interconnected. All the triple level blocks can be labeled on each level.

#### Product Selection

XBPTK25

#### Spring Cage Connection Triple Level Blocks



| Terminal Width | Maximum Wire Size          | IEC 60 947-7-1 in V/A/AWG | UL-cUL Ratings in V/A/AWG | Color | Standard Pack | Catalog Number     |
|----------------|----------------------------|---------------------------|---------------------------|-------|---------------|--------------------|
| 5.2 mm         | 12 AWG/2.5 mm <sup>2</sup> | 500/28/28-12              | 600/20/26-12              | Gray  | 50            | <b>XBPTK25</b>     |
| 5.2 mm         | 12 AWG/2.5 mm <sup>2</sup> | 500/28/28-12              | 600/20/26-12              | Gray  | 50            | <b>XBPTK25PV</b> ① |

#### Note

① Terminal block with potential distribution between the levels.

## Accessories

### Spring Cage Connection Triple Level Blocks

| Description  | Color | Number of Positions | Standard Pack | XBPTK25 Catalog Number | XBPTK25PV Catalog Number |
|--|-------|---------------------|---------------|------------------------|--------------------------|
| End cover  | Gray  | —                   | 10            | <b>XBACPT25K</b>       | <b>XBACPT25K</b>         |
| Plug-in bridge—for cross connections in the bridge shaft | Red   | 2                   | 10            | <b>XBAFBS25</b>        | <b>XBAFBS25</b>          |
|  |       | 3                   | 10            | <b>XBAFBS35</b>        | <b>XBAFBS35</b>          |
|  |       | 5                   | 10            | <b>XBAFBS55</b>        | <b>XBAFBS55</b>          |
|  |       | 10                  | 10            | <b>XBAFBS105</b>       | <b>XBAFBS105</b>         |
|  |       | 50                  | 10            | <b>XBAFBS505</b>       | <b>XBAFBS505</b>         |
| Test adapter   | —     | —                   | 10            | <b>XBATSPA14</b>       | <b>XBATSPA14</b>         |
| Modular test plug  | —     | —                   | 10            | <b>XBATSPS5</b>        | <b>XBATSPS5</b>          |
| Blank marker strip (strip of 10)                         | White | —                   | 10            | <b>XBMZBF5</b> ①       | <b>XBMZBF5</b> ①         |

## Technical Data and Specifications

### Spring Cage Connection Triple Level Blocks

| Description   | XBPTK25   | XBPTK25PV |
|---|-----------|-----------|
| <b>Technical Data in Accordance with IEC</b>                      |           |           |
| Maximum load current in A/cross-section in mm <sup>2</sup>        | 28/4      | 28/4      |
| Rated surge voltage in kV/contamination class                     | 6/3       | 6/3       |
| Surge voltage category/insulating material group                  | III/I     | III/I     |
| <b>Connection Capacity</b>  |           |           |
| Stranded with ferrule with plastic sleeve in mm <sup>2</sup>      | 0.25–2.5  | 0.25–2.5  |
| Stranded with ferrules without plastic sleeve in mm <sup>2</sup>  | 0.25–2.5  | 0.25–2.5  |
| Stranded with twin ferrule with plastic sleeve in mm <sup>2</sup> | 0.5       | 0.5       |
| Stripping length in inches (mm)                                   | 0.39 (10) | 0.39 (10) |

## Dimensions

Approximate Dimensions in Inches (mm)

### Spring Cage Connection Triple Level Blocks

| Catalog Number   | Width      | Length      | Cover Length | Height for— |             |
|------------------|------------|-------------|--------------|-------------|-------------|
|                  |            |             |              | 35 x 7.5 in | 35 x 15 in  |
| <b>XBPTK25</b>   | 0.20 (5.2) | 3.92 (99.5) | 0.09 (2.2)   | 2.28 (58.0) | 2.58 (65.5) |
| <b>XBPTK25PV</b> | 0.20 (5.2) | 3.92 (99.5) | 0.09 (2.2)   | 2.28 (58.0) | 2.58 (65.5) |

#### Notes

① For information on Printed Marking Tag Options, see **Page V7-T8-98**.

For additional accessories, see **Page V7-T8-90**.

# 8.1

## Terminal Blocks, Fuse Blocks and Fuse Holders

IEC—XB Series

### Fuse Terminal Blocks



8

### Contents

| <i>Description</i>                                 | <i>Page</i>     |
|--|-----------------|
| Single Level—Through-Feed . . . . .                | <b>V7-T8-32</b> |
| Single Level—Ground Blocks . . . . .               | <b>V7-T8-37</b> |
| Multi-Conductor Terminal Blocks . . . . .          | <b>V7-T8-39</b> |
| Multi-Conductor Ground Blocks . . . . .            | <b>V7-T8-42</b> |
| Double Level Blocks . . . . .                      | <b>V7-T8-44</b> |
| Triple Level Blocks . . . . .                      | <b>V7-T8-46</b> |
| Fuse Terminal Blocks                               |                 |
| Accessories . . . . .                              | <b>V7-T8-49</b> |
| Technical Data and Specifications . . . . .        | <b>V7-T8-50</b> |
| Dimensions . . . . .                               | <b>V7-T8-50</b> |
| Disconnect and Component Terminal Blocks . . . . . | <b>V7-T8-51</b> |
| Hybrid Terminal Blocks . . . . .                   | <b>V7-T8-54</b> |
| Mini Spring Cage . . . . .                         | <b>V7-T8-56</b> |

### Fuse Terminal Blocks

#### Product Description

The spring cage fuse terminal blocks act as a fuse carrier for 5 x 20 mm or 6.3 x 32 mm fuses. They also allow for potential distribution with the

double bridge shaft. For signaling a triggered fuse, fuse terminal blocks with light indicators are available (for both AC and DC voltage).

#### Product Selection

XBPT4FBE

#### Spring Cage Connection Fuse Terminal Blocks, for 5 x 20 mm Fuse



| Terminal Width  | Maximum Wire Size        | IEC 60 947-7-3 with Fuse in V/A/AWG | IEC 60 947-7-3 as Disconnect Terminal Blocks in V/A/AWG | UL-cUL Ratings in V/A/AWG | Color | Standard Pack | Catalog Number      |
|---|--------------------------|-------------------------------------|---|---------------------------|-------|---------------|---------------------|
| <b>Fuse Terminal Blocks</b>                             |                          |                                     |   |                           |       |               |                     |
| 6.2 mm  | 10 AWG/4 mm <sup>2</sup> | ①/①/28–10                           | 250/6.3/28–10   | 300/6.3/24–10             | Black | 50            | <b>XBPT4FBE</b>     |
| <b>Fuse Terminal Blocks with LED 15–30V, 3.5–8.1A</b>   |                          |                                     |   |                           |       |               |                     |
| 6.2 mm  | 10 AWG/4 mm <sup>2</sup> | ①/①/28–10                           | 250/6.3/28–10   | 300/6.3/24–10             | Black | 50            | <b>XBPT4FBEL24</b>  |
| <b>Fuse Terminal Blocks with LED 30–60V, 0.8–2.0A</b>   |                          |                                     |   |                           |       |               |                     |
| 6.2 mm  | 10 AWG/4 mm <sup>2</sup> | ①/①/28–10                           | 250/6.3/28–10   | 300/6.3/24–10             | Black | 50            | <b>XBPT4FBEL60</b>  |
| <b>Fuse Terminal Blocks with LED 110–250V, 0.5–1.0A</b> |                          |                                     |   |                           |       |               |                     |
| 6.2 mm  | 10 AWG/4 mm <sup>2</sup> | ①/①/28–10                           | 250/6.3/28–10   | 300/6.3/24–10             | Black | 50            | <b>XBPT4FBEL250</b> |

#### Notes

The cartridge fuse holders should be selected according to the maximum power dissipation (self-heating) of the cartridge fuse inserts. The thermal conditions in closed fuse holes should be checked according to the application and installation.

Higher ambient temperatures are an additional strain on fuse inserts. In applications of this kind, the shift of the rated current should be taken into consideration accordingly.

Maximum power dissipation at 73.4°F (23°C) (in accordance with IEC 60 947-7-3).

When selecting cartridge fuse inserts, please ensure that the maximum power dissipation specified at right is not exceeded. Details can be obtained from the fuse suppliers.

Cartridge Fuse Inserts 5 x 20 and 6.3 x 32 mm in accordance with IEC 60 947-7-3.

① The current is determined by the fuse used, the voltage by the selected light indicator. See **Page V7-T8-49**.

## XBPT4FBN



## Spring Cage Connection Fuse Terminal Blocks, for 6.3 x 32 mm (1/4 in x 1-1/4 in) Fuse

| Terminal Width  | Maximum Wire Size        | IEC 60 947-7-3 with Fuse in V/A/AWG | IEC 60 947-7-3 as Disconnect Terminal Blocks in V/A/AWG | UL-cUL Ratings in V/A/AWG | Color | Standard Pack | Catalog Number      |
|---|--------------------------|-------------------------------------|---|---------------------------|-------|---------------|---------------------|
| <b>Fuse Terminal Blocks</b>                               |                          |                                     |   |                           |       |               |                     |
| 8.2 mm  | 10 AWG/4 mm <sup>2</sup> | 400/10/28-10                        | 400/10/28-10  | 300/10/24-10              | Black | 50            | <b>XBPT4FBN</b>     |
| <b>Fuse Terminal Blocks with LED 12-30V, 1.0-2.5 mA</b>   |                          |                                     |   |                           |       |               |                     |
| 8.2 mm  | 10 AWG/4 mm <sup>2</sup> | 400/10/28-10                        | 400/10/28-10  | 300/10/24-10              | Black | 50            | <b>XBPT4FBNL24</b>  |
| <b>Fuse Terminal Blocks with LED 110-250V, 0.5-2.5 mA</b> |                          |                                     |   |                           |       |               |                     |
| 8.2 mm  | 10 AWG/4 mm <sup>2</sup> | 400/10/28-10                        | 400/10/28-10  | 300/10/24-10              | Black | 50            | <b>XBPT4FBNL250</b> |

## Accessories

## Spring Cage Connection Fuse Terminal Blocks

| Description  | Color | Number of Positions | Standard Pack | XBPT4FBE Catalog Number | XBPT4FBN Catalog Number |
|--|-------|---------------------|---------------|-------------------------|-------------------------|
| Partition plate  | —     | —                   | 10            | <b>XBATPT4</b>          | <b>XBATQTD12</b>        |
| Plug-in bridge—for cross connections in the bridge shaft | Red   | 2                   | 10            | <b>XBAFBS26</b>         | <b>XBAFBS28</b>         |
|  |       | 3                   | 10            | <b>XBAFBS36</b>         | —                       |
|  |       | 5                   | 10            | <b>XBAFBS56</b>         | —                       |
|  |       | 10                  | 10            | <b>XBAFBS106</b>        | —                       |
| Blank marker strip external labeling                     | White | —                   | 10            | <b>XBMZBF6</b> ①        | <b>XBMZBF8</b> ①        |
| Blank marker strip center labeling (strip of 10)         | White | —                   | 10            | <b>XBMZB5</b> ①         | <b>XBMZB6</b> ①         |

**Notes**

The cartridge fuse holders should be selected according to the maximum power dissipation (self-heating) of the cartridge fuse inserts. The thermal conditions in closed fuse holes should be checked according to the application and installation.

Higher ambient temperatures are an additional strain on fuse inserts. In applications of this kind, the shift of the rated current should be taken into consideration accordingly.

Maximum power dissipation at 73.4°F (23°C) (in accordance with IEC 60 947-7-3).

When selecting cartridge fuse inserts, please ensure that the maximum power dissipation specified at right is not exceeded. Details can be obtained from the fuse suppliers.

Cartridge Fuse Inserts 5 x 20 and 6.3 x 32 mm in accordance with IEC 60 947-7-3.

① For information on Printed Marking Tag Options, see **Page V7-T8-98**.

For additional accessories, see **Page V7-T8-90**.

# 8.1

## Terminal Blocks, Fuse Blocks and Fuse Holders

IEC—XB Series

### Technical Data and Specifications

#### Overload and Short-Circuit Protection

| Terminal Blocks | U (V) | Overload Protection |                | Short-Circuit Protection Only |                | I <sub>max</sub> (A) |
|-----------------|-------|---------------------|----------------|-------------------------------|----------------|----------------------|
|                 |       | Individual          | Interconnected | Individual                    | Interconnected |                      |
| <b>XBPT4FBN</b> | 400   | 1.6W                | 1.6W           | 4W                            | 2.5W           | 10.0                 |
| <b>XBPT4FBE</b> | 250   | 1.6W                | 1.6W           | 4W                            | 2.5W           | 6.3                  |

#### Spring Cage Connection Fuse Terminal Blocks

| Description  | XBPT4FBE      | XBPT4FBN      |
|--|---------------|---------------|
| <b>Technical Data in Accordance with IEC</b>                             |               |               |
| Fuse type/dimensions in mm <sup>2</sup>                                  | G/5 x 20      | G/6.3 x 32    |
| Maximum current with single arrangement in A                             | 6.3           | 10            |
| <b>Maximum Power Dissipation</b>   |               |               |
| At 73.4°F (23°C) in accordance with IEC 60 947-7-3 in W                  | ①             | ①             |
| Rated surge voltage in kV/contamination class                            | 4/3           | 6/3           |
| Surge voltage category/insulating material group                         | III/1         | III/1         |
| <b>Connection Capacity</b>   |               |               |
| Stranded with ferrule/with ferrule and plastic sleeve in mm <sup>2</sup> | 0.25–4/0.25–4 | 0.25–4/0.25–4 |
| Stranded with twin ferrule and plastic sleeve in mm <sup>2</sup>         | 0.5           | 0.5           |
| Stripping length in inches (mm)  | 0.39 (10)     | 0.39 (10)     |

### Dimensions

Approximate Dimensions in Inches (mm)

#### Spring Cage Connection Fuse Terminal Blocks

| Catalog Number  | Width      | Length      | Height for— |             |
|-----------------|------------|-------------|-------------|-------------|
|                 |            |             | 35 x 7.5 in | 35 x 15 in  |
| <b>XBPT4FBE</b> | 0.24 (6.2) | 2.42 (61.5) | 2.46 (62.5) | 2.76 (70.0) |
| <b>XBPT4FBN</b> | 0.32 (8.2) | 3.01 (76.5) | 2.72 (69.0) | 3.01 (76.5) |

#### Note

① The current is determined by the fuse used, the voltage by the selected light indicator. See **Page V7-T8-49**.

## Disconnect and Component Terminal Blocks



## Contents

| <b>Description</b>                          | <b>Page</b>     |
|---|-----------------|
| Single Level—Through-Feed . . . . .         | <b>V7-T8-32</b> |
| Single Level—Ground Blocks . . . . .        | <b>V7-T8-37</b> |
| Multi-Conductor Terminal Blocks . . . . .   | <b>V7-T8-39</b> |
| Multi-Conductor Ground Blocks . . . . .     | <b>V7-T8-42</b> |
| Double Level Blocks . . . . .               | <b>V7-T8-44</b> |
| Triple Level Blocks . . . . .               | <b>V7-T8-46</b> |
| Fuse Terminal Blocks . . . . .              | <b>V7-T8-48</b> |
| Disconnect and Component Terminal Blocks    |                 |
| Accessories . . . . .                       | <b>V7-T8-52</b> |
| Technical Data and Specifications . . . . . | <b>V7-T8-53</b> |
| Dimensions . . . . .                        | <b>V7-T8-53</b> |
| Hybrid Terminal Blocks . . . . .            | <b>V7-T8-54</b> |
| Mini Spring Cage . . . . .                  | <b>V7-T8-56</b> |

## Disconnect and Component Terminal Blocks

## Product Description

The XBPT knife disconnect terminal blocks feature narrow construction and high current carrying capacity. They also have a test connection parallel to the disconnect point for a 2.3 mm

diameter test plug. Potential distribution is easily accomplished with the Plug-in bridges. There are front connection spring cage terminal blocks available for multi-conductor connections

in the smallest possible space. The XBPT4TG disconnect terminal block accommodates component plugs for resistors, diodes, or capacitors, and fuse plugs with or without indication.

## Product Selection

XBPT25MT  
Knife Disconnect

## Disconnect and Component Terminal Blocks

| Terminal Width   | Maximum Wire Size          | IEC 60 947-7-1 in V/A/AWG | UL-cUL Ratings in V/A/AWG | Color | Standard Pack | Catalog Number     |
|--|----------------------------|---------------------------|---------------------------|-------|---------------|--------------------|
| <b>Single Level Knife Disconnect</b>                           |                            |                           |                           |       |               |                    |
| 5.2 mm   | 12 AWG/2.5 mm <sup>2</sup> | 400/16/28–12              | 600/16/26–12              | Gray  | 50            | <b>XBPT25MT</b>    |
| 6.2 mm   | 10 AWG/4 mm <sup>2</sup>   | 400/16/28–10              | 300/6.3/24–10             | Gray  | 50            | <b>XBPT4MT</b>     |
| <b>Three-Wire Knife Disconnect</b>                             |                            |                           |                           |       |               |                    |
| 5.2 mm   | 12 AWG/2.5 mm <sup>2</sup> | 400/16/28–12              | 600/16/26–12              | Gray  | 50            | <b>XBPT25D12MT</b> |
| <b>Four-Wire Knife Disconnect</b>                              |                            |                           |                           |       |               |                    |
| 5.2 mm   | 12 AWG/2.5 mm <sup>2</sup> | 400/16/28–12              | 600/16/26–12              | Gray  | 50            | <b>XBPT25D22MT</b> |
| <b>Spring Cage Disconnect/Component Plug</b>                   |                            |                           |                           |       |               |                    |
| 6.2 mm   | 10 AWG/4 mm <sup>2</sup>   | 400/16/28–10              | 300/6.3/24–10             | Gray  | 50            | <b>XBPT4TG</b>     |
| <b>Component Plug</b>  |                            |                           |                           |       |               |                    |
| 6.2 mm   | 10 AWG/4 mm <sup>2</sup>   | 400/16/28–10              | 300/6.3/24–10             | Gray  | 10            | <b>XBPC0</b>       |
| <b>Fuse Plug</b>   |                            |                           |                           |       |               |                    |
| 6.2 mm   | 10 AWG/4 mm <sup>2</sup>   | 400/16/28–10              | 300/6.3/24–10             | Black | 10            | <b>XBPFU</b>       |
| <b>Fuse Plug with Light Indicator for 12–30V, 1–2.5 mA</b>     |                            |                           |                           |       |               |                    |
| 6.2 mm   | 10 AWG/4 mm <sup>2</sup>   | 400/16/28–10              | 300/6.3/24–10             | Black | 10            | <b>XBPFUL24</b>    |
| <b>Fuse Plug with Light Indicator for 110–250V, 0.5–2.5 mA</b> |                            |                           |                           |       |               |                    |
| 6.2 mm   | 10 AWG/4 mm <sup>2</sup>   | 400/16/28–10              | 300/6.3/24–10             | Black | 10            | <b>XBPFUL250</b>   |

# 8.1

## Terminal Blocks, Fuse Blocks and Fuse Holders

IEC—XB Series

### Accessories

#### Spring Cage Connection Disconnect and Component Terminal Blocks

| Description   | Color | Number of Positions | Standard Pack | XBPT25MT<br>Catalog Number | XBPT25D12MT<br>Catalog Number | XBPT25D22MT<br>Catalog Number | XBPT4MT<br>Catalog Number | XBPT4TG<br>Catalog Number |
|---|-------|---------------------|---------------|----------------------------|-------------------------------|-------------------------------|---------------------------|---------------------------|
| End cover   | Gray  | —                   | 10            | <b>XBACPT25D12</b>         | <b>XBACPT25D22</b>            | <b>XBACPT25D22MT</b>          | ③                         | ③                         |
| End cover segment   | Gray  | —                   | 10            | —                          | <b>XBACPT25</b>               | <b>XBACPT25</b>               | —                         | —                         |
| Partition plate   | —     | —                   | —             | <b>XBATPTD12</b>           | <b>XBATPTD22</b>              | —                             | <b>XBATPT4</b>            | <b>XBATPT4</b>            |
| Plug-in bridge—for cross connections in the terminal center | Red   | 2                   | 10            | <b>XBAFBS25</b>            | <b>XBAFBS25</b>               | <b>XBAFBS25</b>               | <b>XBAFBS26</b>           | <b>XBAFBS26</b>           |
|   |       | 3                   | 10            | <b>XBAFBS35</b>            | <b>XBAFBS35</b>               | <b>XBAFBS35</b>               | <b>XBAFBS36</b>           | <b>XBAFBS36</b>           |
|   |       | 5                   | 10            | <b>XBAFBS55</b>            | <b>XBAFBS55</b>               | <b>XBAFBS55</b>               | <b>XBAFBS56</b>           | <b>XBAFBS56</b>           |
|   |       | 10                  | 10            | <b>XBAFBS105</b>           | <b>XBAFBS105</b>              | <b>XBAFBS105</b>              | <b>XBAFBS106</b>          | <b>XBAFBS106</b>          |
|   |       | 50                  | 10            | <b>XBAFBS505</b>           | <b>XBAFBS505</b>              | <b>XBAFBS505</b>              | <b>XBAFBS506</b>          | <b>XBAFBS506</b>          |
| Test adapter  | —     | —                   | 10            | <b>XBATSPA14</b>           | <b>XBATSPA14</b>              | <b>XBATSPA14</b>              | <b>XBATSPA14</b>          | <b>XBATSPA14</b>          |
| 2.3 mm diameter test plug                                   | —     | —                   | —             | <b>XBATSMPS_</b> ①         | <b>XBATSMPS_</b> ①            | <b>XBATSMPS_</b> ①            | <b>XBATSMPS_</b> ①        | <b>XBATSMPS_</b> ①        |
| Modular test plug   | —     | —                   | 10            | <b>XBATSPS5</b>            | <b>XBATSPS5</b>               | <b>XBATSPS5</b>               | <b>XBATSPS6</b>           | <b>XBATSPS6</b>           |
| Blank marker strip external labeling                        | White | —                   | 10            | <b>XBMZBF5</b> ②           | <b>XBMZBF5</b> ②              | <b>XBMZBF5</b> ②              | <b>XBMZBF6</b> ②          | <b>XBMZBF6</b> ②          |
| Blank marker strip center labeling (strip of 10)            | White | —                   | 10            | <b>XBMZB5</b> ②            | <b>XBMZB5</b> ②               | <b>XBMZB5</b> ②               | <b>XBMZB6</b> ②           | <b>XBMZB6</b> ②           |

#### Notes

- ① For ordering information, see **Page V7-T8-105**.
  - ② For information on Printed Marking Tag Options, see **Page V7-T8-98**.
  - ③ XBPT4MT and XBPT4TG have an enclosed design. The use of an end cover is not required.
- For additional accessories, see **Page V7-T8-90**.



## Technical Data and Specifications

### Spring Cage Connection Disconnect and Component Terminal Blocks, XBPT25MT, XBPT25D12MT and XBPT25D22MT

| Description   | XBPT25MT  | XBPT25D12MT | XBPT25D22MT |
|---|-----------|-------------|-------------|
| <b>Technical Data in Accordance with IEC</b>                      |           |             |             |
| Maximum load current in A/cross-section in mm <sup>2</sup>        | 16/4      | 16/4        | 16/4        |
| Rated surge voltage in kV/contamination class                     | 6/3       | 6/3         | 6/3         |
| Surge voltage category/insulating material group                  | III/1     | III/1       | III/1       |
| <b>Connection Capacity</b>  |           |             |             |
| Stranded with ferrule with plastic sleeve in mm <sup>2</sup>      | 0.25–2.5  | 0.25–2.5    | 0.25–2.5    |
| Stranded with ferrules without plastic sleeve in mm <sup>2</sup>  | 0.25–2.5  | 0.25–2.5    | 0.25–2.5    |
| Stranded with twin ferrule with plastic sleeve in mm <sup>2</sup> | 0.5       | 0.5         | 0.5         |
| Stripping length in inches (mm)                                   | 0.39 (10) | 0.39 (10)   | 0.39 (10)   |

### Spring Cage Connection Disconnect and Component Terminal Blocks, XBPT25D12MT and XBPT4TG

| Description   | XBPT4MT   | XBPT4TG   |
|---|-----------|-----------|
| <b>Technical Data in Accordance with IEC</b>                      |           |           |
| Maximum load current in A/cross-section in mm <sup>2</sup>        | 16/6      | 16/6      |
| Rated surge voltage in kV/contamination class                     | 6/3       | 6/3       |
| Surge voltage category/insulating material group                  | III/1     | III/1     |
| <b>Connection Capacity</b>  |           |           |
| Stranded with ferrule with plastic sleeve in mm <sup>2</sup>      | 0.25–4    | 0.25–4    |
| Stranded with ferrules without plastic sleeve in mm <sup>2</sup>  | 0.25–4    | 0.25–4    |
| Stranded with twin ferrule with plastic sleeve in mm <sup>2</sup> | 0.5       | 0.5       |
| Stripping length in inches (mm)                                   | 0.39 (10) | 0.39 (10) |

## Dimensions

Approximate Dimensions in Inches (mm)

### Spring Cage Connection Disconnect and Component Terminal Blocks

| Catalog Number | Width      | Length      | Cover Length | Height for— |             |
|----------------|------------|-------------|--------------|-------------|-------------|
|                |            |             |              | 35 x 7.5 in | 35 x 15 in  |
| XBPT25MT       | 0.20 (5.2) | 2.38 (60.5) | 0.09 (2.2)   | 1.44 (36.5) | 1.73 (44.0) |
| XBPT25D12MT    | 0.20 (5.2) | 2.83 (72.0) | 0.09 (2.2)   | 1.44 (36.5) | 1.73 (44.0) |
| XBPT25D22MT    | 0.20 (5.2) | 3.31 (84.0) | 0.09 (2.2)   | 1.44 (36.5) | 1.73 (44.0) |
| XBPT4MT        | 0.24 (6.2) | 2.42 (61.5) | —            | 1.44 (36.5) | 1.73 (44.0) |
| XBPT4TG        | 0.24 (6.2) | 2.42 (61.5) | —            | 1.44 (36.5) | 1.73 (44.0) |

# 8.1

## Terminal Blocks, Fuse Blocks and Fuse Holders

IEC—XB Series

### Hybrid Terminal Blocks



### Contents

| <i>Description</i>                                 | <i>Page</i>     |
|--|-----------------|
| Single Level—Through-Feed . . . . .                | <b>V7-T8-32</b> |
| Single Level—Ground Blocks . . . . .               | <b>V7-T8-37</b> |
| Multi-Conductor Terminal Blocks . . . . .          | <b>V7-T8-39</b> |
| Multi-Conductor Ground Blocks . . . . .            | <b>V7-T8-42</b> |
| Double Level Blocks . . . . .                      | <b>V7-T8-44</b> |
| Triple Level Blocks . . . . .                      | <b>V7-T8-46</b> |
| Fuse Terminal Blocks . . . . .                     | <b>V7-T8-48</b> |
| Disconnect and Component Terminal Blocks . . . . . | <b>V7-T8-51</b> |
| Hybrid Terminal Blocks                             |                 |
| Accessories . . . . .                              | <b>V7-T8-55</b> |
| Technical Data and Specifications . . . . .        | <b>V7-T8-55</b> |
| Dimensions . . . . .                               | <b>V7-T8-55</b> |
| Mini Spring Cage . . . . .                         | <b>V7-T8-56</b> |

### Hybrid Terminal Blocks

#### Product Description

The XBPU spring cage hybrid terminal blocks offer the best of both worlds. One side offers a spring cage connection and the other side offers the universal screw connection. Use the spring

cage connection on the internal (factory) control cabinet side and the screw connection on the end customer (field) side. Ground terminal blocks of the same shape are also available.

#### Product Selection

##### Spring Cage Hybrid Terminal Blocks



| Terminal Width | Maximum Wire Size              | IEC 60 947-7-1 with ... |                  | IEC 60 947-7-2 with ... |                  | UL-cUL Ratings with ... |                  | Color | Std. Pack | Catalog Number   |
|----------------|--------------------------------|-------------------------|------------------|-------------------------|------------------|-------------------------|------------------|-------|-----------|------------------|
|                |                                | Spring in V/A/AWG       | Screw in V/A/AWG | Spring in V/A/AWG       | Screw in V/A/AWG | Spring in V/A/AWG       | Screw in V/A/AWG |       |           |                  |
| 5.2 mm         | 12 AWG/<br>2.5 mm <sup>2</sup> | 800/28/28-12            | 800/28/26-14     | —                       | —                | 600/15/28-12            | 600/15/26-12     | Gray  | 50        | <b>XBPU25D12</b> |

##### Spring Cage Hybrid Ground Blocks



| Terminal Width | Maximum Wire Size              | IEC 60 947-7-1 with ... |                  | IEC 60 947-7-2 with ... |                  | UL-cUL Ratings with ... |                  | Color            | Std. Pack | Catalog Number     |
|----------------|--------------------------------|-------------------------|------------------|-------------------------|------------------|-------------------------|------------------|------------------|-----------|--------------------|
|                |                                | Spring in V/A/AWG       | Screw in V/A/AWG | Spring in V/A/AWG       | Screw in V/A/AWG | Spring in V/A/AWG       | Screw in V/A/AWG |                  |           |                    |
| 5.2 mm         | 12 AWG/<br>2.5 mm <sup>2</sup> | —                       | —                | —/—/28-12               | —/—/26-14        | —/—/28-12               | —/—/28-12        | Green/<br>Yellow | 50        | <b>XBPU25D12PE</b> |

## Accessories

### Spring Cage Hybrid Terminal/Ground Blocks

| Description   | Color | Number of Positions | Standard Pack | XBPU25D12                    | XBPU25D12PE                |
|---|-------|---------------------|---------------|------------------------------|----------------------------|
|   |       |                     |               | Catalog Number               | Catalog Number             |
| End cover   | Gray  | —                   | 10            | <b>XBACPU25D12</b>           | <b>XBACPU25D12</b>         |
| Plug-in bridge—for cross connections in the terminal center | Red   | 2                   | 10            | <b>XBAFBS25</b>              | <b>XBAFBS25</b>            |
|   |       | 3                   | 10            | <b>XBAFBS35</b>              | <b>XBAFBS35</b>            |
|   |       | 5                   | 10            | <b>XBAFBS55</b>              | <b>XBAFBS55</b>            |
|   |       | 10                  | 10            | <b>XBAFBS105</b>             | <b>XBAFBS105</b>           |
|   |       | 50                  | 10            | <b>XBAFBS505</b>             | <b>XBAFBS505</b>           |
| Test adapter  | —     | —                   | 10            | <b>XBATSPAI4</b>             | —                          |
| 2.3 mm diameter test plug                                   | —     | —                   | —             | <b>XBATSMPS-<sup>①</sup></b> | —                          |
| Modular test plug   | —     | —                   | 10            | <b>XBATSPS5</b>              | —                          |
| Blank marker strip external labeling                        | White | —                   | 10            | <b>XBMZBF5<sup>②</sup></b>   | <b>XBMZBF5<sup>②</sup></b> |
| Blank marker strip center labeling (strip of 10)            | White | —                   | 10            | <b>XBMZB5<sup>②</sup></b>    | <b>XBMZB5<sup>②</sup></b>  |

## Technical Data and Specifications

### Spring Cage Hybrid Blocks

| Description   | XBPU25D12 | XBPU25D12PE |
|---|-----------|-------------|
| <b>Technical Data in Accordance with IEC</b>                      |           |             |
| Maximum load current in A/cross-section in mm <sup>2</sup>        | 28/4      | —           |
| Rated surge voltage in kV/contamination class                     | 8/3       | 8/3         |
| Surge voltage category/insulating material group                  | III/1     | III/1       |
| <b>Connection Capacity</b>  |           |             |
| Stranded with ferrule with plastic sleeve in mm <sup>2</sup>      | 0.25–2.5  | 0.25–2.5    |
| Stranded with ferrules without plastic sleeve in mm <sup>2</sup>  | 0.25–2.5  | 0.25–2.5    |
| Stranded with twin ferrule with plastic sleeve in mm <sup>2</sup> | 0.5–1     | 0.5–1       |
| Stripping length in inches (mm)                                   | 0.39 (10) | 0.39 (10)   |

## Dimensions

Approximate Dimensions in Inches (mm)

### Spring Cage Hybrid Blocks

| Catalog Number     | Width      | Length      | Cover Length | Height for— |             |
|--------------------|------------|-------------|--------------|-------------|-------------|
|                    |            |             |              | 35 x 7.5 in | 35 x 15 in  |
| <b>XBPU25D12</b>   | 0.20 (5.2) | 2.57 (65.3) | 0.09 (2.2)   | 1.69 (42.8) | 1.98 (50.3) |
| <b>XBPU25D12PE</b> | 0.20 (5.2) | 2.57 (65.3) | 0.09 (2.2)   | 1.69 (42.8) | 1.98 (50.3) |

#### Notes

- ① For ordering information, see **Page V7-T8-105**.
  - ② For information on Printed Marking Tag Options, see **Page V7-T8-98**.
- For additional accessories, see **Page V7-T8-90**.

# 8.1

## Terminal Blocks, Fuse Blocks and Fuse Holders

IEC—XB Series

Mini Spring Cage



### Contents

| <i>Description</i>                                 | <i>Page</i>     |
|--|-----------------|
| Single Level—Through-Feed . . . . .                | <b>V7-T8-5</b>  |
| Single Level—Ground Blocks . . . . .               | <b>V7-T8-10</b> |
| Multi-Conductor Terminal Blocks . . . . .          | <b>V7-T8-12</b> |
| Multi-Conductor Ground Blocks . . . . .            | <b>V7-T8-14</b> |
| Double Level . . . . .                             | <b>V7-T8-16</b> |
| Triple Level Sensor/Actuator . . . . .             | <b>V7-T8-18</b> |
| Fuse Terminal Blocks . . . . .                     | <b>V7-T8-21</b> |
| Disconnect and Component Terminal Blocks . . . . . | <b>V7-T8-24</b> |
| High Current Blocks . . . . .                      | <b>V7-T8-27</b> |
| Mini Spring Cage                                   |                 |
| Accessories . . . . .                              | <b>V7-T8-57</b> |
| Technical Data and Specifications . . . . .        | <b>V7-T8-57</b> |
| Dimensions . . . . .                               | <b>V7-T8-57</b> |

8

### Mini Spring Cage

#### Product Description

The **XB** miniature terminal blocks have a connection cross-section from 1.5 mm<sup>2</sup> through 4 mm<sup>2</sup> and mount on 15 mm DIN rail. There is an

opening for bridging with a fixed bridge in the center of the terminal blocks. These miniature terminal blocks also offer the same accessories

that you would find with the larger blocks—including marking tags, end covers, end stop and ground blocks.

#### Product Selection

XBMPK15



#### Mini Spring Cage Terminal Blocks

| Terminal Width | Maximum Wire Size          | IEC 60 947-7-1 in V/A/AWG | IEC 60 947-7-2 in V/A/AWG | UL-cUL Ratings in V/A/AWG | Color | Standard Pack | Catalog Number   |
|----------------|----------------------------|---------------------------|---------------------------|---------------------------|-------|---------------|------------------|
| 5.2 mm         | 14 AWG/1.5 mm <sup>2</sup> | 800/24/26–14              | —                         | 600/15/26–14              | Gray  | 50            | <b>XBMPK15</b>   |
|                |                            |                           |                           |                           | Blue  | 50            | <b>XBMPK15BU</b> |

XBMPK15PE



#### Mini Spring Cage Ground Blocks

| Terminal Width | Maximum Wire Size          | IEC 60 947-7-1 in V/A/AWG | IEC 60 947-7-2 in V/A/AWG | UL-cUL Ratings in V/A/AWG | Color            | Standard Pack | Catalog Number   |
|----------------|----------------------------|---------------------------|---------------------------|---------------------------|------------------|---------------|------------------|
| 5.2 mm         | 14 AWG/1.5 mm <sup>2</sup> | —                         | —/—/26–14                 | —/—/26–14                 | Green/<br>Yellow | 50            | <b>XBMPK15PE</b> |

XBMPKK15



#### Mini Spring Cage Terminal Blocks—Double Level

| Terminal Width | Maximum Wire Size          | IEC 60 947-7-1 in V/A/AWG | UL-cUL Ratings in V/A/AWG | Color | Standard Pack | Catalog Number  |
|----------------|----------------------------|---------------------------|---------------------------|-------|---------------|-----------------|
| 5.2 mm         | 14 AWG/1.5 mm <sup>2</sup> | 500/20/26–14              | 600/15/26–14              | Gray  | 50            | <b>XBMPKK15</b> |

## Accessories

### Mini Spring Cage Terminal/Ground Blocks

| Description        | Color | Number of Positions | Standard Pack | XBMPK15 Catalog Number | XBMPK15PE Catalog Number | XBMPKK15 Catalog Number |
|--------------------|-------|---------------------|---------------|------------------------|--------------------------|-------------------------|
| End cover          | Gray  | —                   | 10            | XBACMPK15              | XBACMPK15                | XBACMPKK15              |
| Fixed bridge       | —     | 2                   | 10            | XBAFBR25N              | —                        | XBAFBR25N               |
| Separating plate   | —     | —                   | 10            | XBATMPKK15             | —                        | XBATMPKK15              |
| Blank marker strip | White | —                   | 10            | XBMZBF5 <sup>①</sup>   | XBMZBF5 <sup>①</sup>     | XBMZBF5 <sup>①</sup>    |

## Technical Data and Specifications

### Mini Spring Cage Terminal/Ground Blocks

| Description   | XBMPK15  | XBMPK15PE | XBMPKK15 |
|---|----------|-----------|----------|
| <b>Technical Data in Accordance with IEC</b>                      |          |           |          |
| Maximum load current in A/cross-section in mm <sup>2</sup>        | 24/2.5   | —         | 20/2.5   |
| Rated surge voltage in kV/contamination class                     | 8/3      | 8/3       | 6/3      |
| Surge voltage category/insulating material group                  | III/1    | III/1     | III/1    |
| <b>Connection Cross-Section</b>                                   |          |           |          |
| Stranded with ferrule with plastic sleeve in mm <sup>2</sup>      | 0.25–1.5 | 0.25–1.5  | 0.25–1.5 |
| Stranded with ferrule without plastic sleeve in mm <sup>2</sup>   | 0.25–1.5 | 0.25–1.5  | 0.25–1.5 |
| Stranded with twin ferrule with plastic sleeve in mm <sup>2</sup> | —        | —         | —        |
| Stripping length in Inches (mm)                                   | 0.35 (9) | 0.35 (9)  | 0.35 (9) |

## Dimensions

Approximate Dimensions in Inches (mm)

### Mini Spring Cage Terminal/Ground Blocks

| Catalog Number | Width      | Length      | Cover Length | Height for— |             |             |
|----------------|------------|-------------|--------------|-------------|-------------|-------------|
|                |            |             |              | 15 x 5.5 in | 35 x 7.5 in | 35 x 15 in  |
| XBMPK15        | 0.20 (5.2) | 1.57 (40.0) | 0.04 (1.1)   | 1.36 (34.5) | —           | —           |
| XBMPK15PE      | 0.20 (5.2) | 1.57 (40.0) | 0.04 (1.1)   | 1.36 (34.5) | —           | —           |
| XBMPKK15       | 0.20 (5.2) | 3.35 (85.0) | 0.04 (1.1)   | 1.65 (42.0) | 1.67 (42.5) | 1.97 (50.0) |

#### Notes

<sup>①</sup> For information on Printed Marking Tag Options, see **Page V7-T8-98**.

For additional accessories, see **Page V7-T8-90**.

# 8.1

## Terminal Blocks, Fuse Blocks and Fuse Holders

IEC—XB Series

### Pluggable Spring Cage Terminal Blocks

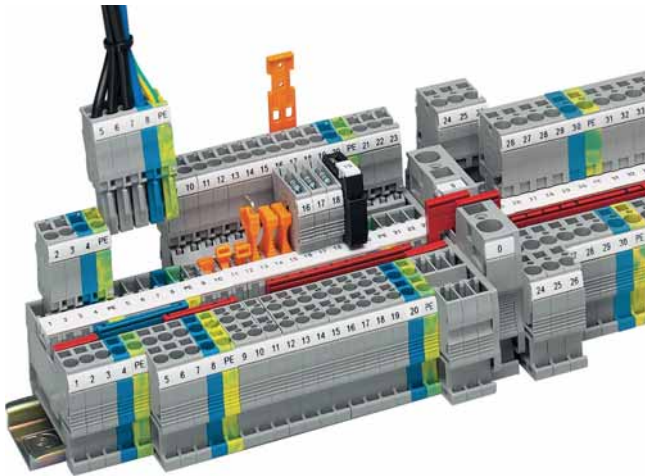

8

### Pluggable Spring Cage Terminal Blocks Overview

#### Product Description

The pluggable spring cage connection terminal blocks allow signal and power wiring to be made pluggable. This complete pluggable system has a spring that provides maximum connection space in a space-saving design. The pluggable system accommodates stranded conductors with a nominal cross-section of 2.5 mm<sup>2</sup>, with or without ferrules.

#### Application Description

For applications requiring pluggable wiring up to a rated current of 32A and a rated voltage of 800V. The integrated overspring meets the most stringent vibration requirements. Also ideal where safety is a concern and flexibility is required. The basic terminal blocks and the plugs are finger-safe, which also means the supply voltage can be input via either the terminal blocks or the plugs. With the XBAPSC receptacles, plug-in contacts can be accommodated safely in cable ducts and distributor shafts using minimal space. A test hole can accommodate a 2.3 mm diameter test plug in each receptacle, providing a practical solution. The XBAPSP plugs are intended for connecting one wire, while the XBAPSPDB plugs are designed to connect two wires and provide an optional bridge.

### Contents

#### Description

|                                       | <i>Page</i>     |
|---------------------------------------|-----------------|
| Pluggable Spring Cage Terminal Blocks |                 |
| Connection Terminal Blocks . . . . .  | <b>V7-T8-59</b> |
| Connection Plugs . . . . .            | <b>V7-T8-62</b> |
| Connection Receptacles . . . . .      | <b>V7-T8-64</b> |
| Connection Accessories . . . . .      | <b>V7-T8-66</b> |



Drawings  
Online

#### Features

- Space-saving design
- Powerful contact
- Finger-safe



Pluggability

#### Standards and Certifications

- UL recognized—File No. E67464
- CE approved
- LVD ①:
  - EN 60947-7-1
  - EN 60947-7-2
  - EN 60998-2-3
  - EN 60352-4/A1
- ATEX approval (Eex e applications)



#### Note

① Not all standards apply to all terminal blocks. Contact Eaton for details.

**Connection Terminal Blocks**



**Contents**

| <b>Description</b>                | <b>Page</b>     |
|-----------------------------------|-----------------|
| Connection Terminal Blocks        |                 |
| Accessories                       | <b>V7-T8-60</b> |
| Technical Data and Specifications | <b>V7-T8-60</b> |
| Dimensions                        | <b>V7-T8-61</b> |
| Connection Plugs                  | <b>V7-T8-62</b> |
| Connection Receptacles            | <b>V7-T8-64</b> |
| Connection Accessories            | <b>V7-T8-66</b> |

**Connection Terminal Blocks**

**Product Description**

Contact to the DIN rail is made by simply snapping the terminal block onto the rail.

These blocks act as the stationary position of the pluggable terminal blocks.

**Product Selection**

**XBPT25P**

**Pluggable Spring Cage Connection Terminal Blocks**



| Terminal Width      | Maximum Wire Size          | IEC 61 984 in V/A/AWG | UL-cUL Ratings in V/A/AWG | Color | Standard Pack | Catalog Number    |
|---------------------|----------------------------|-----------------------|---------------------------|-------|---------------|-------------------|
| <b>Single Level</b> |                            |                       |                           |       |               |                   |
| 5.2 mm              | 12 AWG/2.5 mm <sup>2</sup> | 500/24/28-12          | 300/20/26-12              | Gray  | 50            | <b>XBPT25P</b>    |
| <b>Three-Wire</b>   |                            |                       |                           |       |               |                   |
| 5.2 mm              | 12 AWG/2.5 mm <sup>2</sup> | 500/24/28-12          | 300/20/26-12              | Gray  | 50            | <b>XBPT25PD12</b> |

# 8.1

## Terminal Blocks, Fuse Blocks and Fuse Holders

IEC—XB Series

### Accessories

#### Pluggable Spring Cage Connection Terminal Blocks

| Description   | Color | Number of Positions | Standard Pack | XBPT25P Catalog Number | XBPT25PD12 Catalog Number |
|---|-------|---------------------|---------------|------------------------|---------------------------|
| End cover   | Gray  | —                   | 10            | XBACPT25               | XBACPT25D12               |
| End cover segment   | Gray  | —                   | 10            | —                      | XBASPT25                  |
| Partition plate   | —     | —                   | 10            | XBATPT4                | XBATPTD12                 |
| Plug-in bridge—for cross connections in the terminal center | Red   | 2                   | 10            | XBAFBS25               | XBAFBS25                  |
|   |       | 3                   | 10            | XBAFBS35               | XBAFBS35                  |
|   |       | 5                   | 10            | XBAFBS55               | XBAFBS55                  |
|   |       | 10                  | 10            | XBAFBS105              | XBAFBS105                 |
|   |       | 50                  | 10            | XBAFBS505              | XBAFBS505                 |
| Test adapter  | —     | —                   | 10            | XBATSPA14              | XBATSPA14                 |
| 2.3 mm diameter test plug                                   | —     | —                   | —             | XBATSMPS- <sup>①</sup> | XBATSMPS- <sup>①</sup>    |
| Modular test plug   | —     | —                   | 10            | XBATSPS5               | XBATSPS5                  |
| Blank marker strip external labeling                        | White | —                   | 10            | XBMZBF5 <sup>②</sup>   | XBMZBF5 <sup>②</sup>      |
| Blank marker strip center labeling (strip of 10)            | White | —                   | 10            | XBMZB5 <sup>②</sup>    | XBMZB5 <sup>②</sup>       |

8

### Technical Data and Specifications

#### Pluggable Spring Cage Connection Terminal Blocks

| Description   | XBPT25P   | XBPT25PD12 |
|---|-----------|------------|
| <b>Technical Data in Accordance with IEC</b>                      |           |            |
| Maximum load current in A/cross-section in mm <sup>2</sup>        | 24/4      | 24/4       |
| Rated surge voltage in kV/contamination class                     | 6/3       | 6/3        |
| Surge voltage category/insulating material group                  | III/1     | III/1      |
| <b>Connection Capacity</b>  |           |            |
| Stranded with ferrule with plastic sleeve in mm <sup>2</sup>      | 0.25–2.5  | 0.25–2.5   |
| Stranded with ferrules without plastic sleeve in mm <sup>2</sup>  | 0.25–2.5  | 0.25–2.5   |
| Stranded with twin ferrule with plastic sleeve in mm <sup>2</sup> | 0.5       | 0.5        |
| Stripping length in inches (mm)                                   | 0.39 (10) | 0.39 (10)  |

#### Derating Curve for Pluggable Terminal Blocks

##### XBPT25P and XBPT25PD12

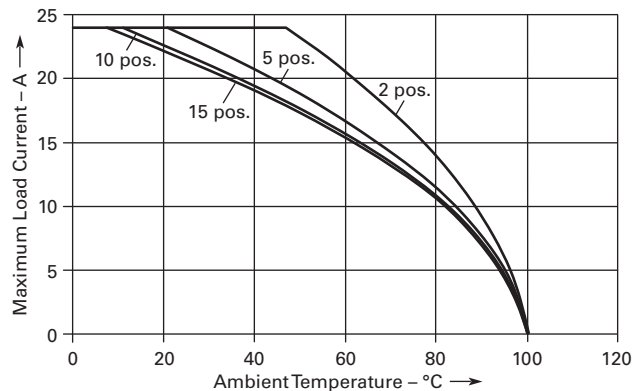

#### Notes

① For ordering information, see [Page V7-T8-105](#).

② For information on Printed Marking Tag Options, see [Page V7-T8-98](#).

For additional accessories, see [Page V7-T8-90](#).



## Dimensions

Approximate Dimensions in Inches (mm)

### Pluggable Spring Cage Connection Terminal Blocks—Without Plug

| Catalog Number    | Width      | Length      | Cover Length | Height for— |             |
|-------------------|------------|-------------|--------------|-------------|-------------|
|                   |            |             |              | 35 x 7.5 in | 35 x 15 in  |
| <b>XBPT25P</b>    | 0.20 (5.2) | 1.91 (48.5) | 0.09 (2.2)   | 1.44 (36.5) | 1.73 (44.0) |
| <b>XBPT25PD12</b> | 0.20 (5.2) | 2.38 (60.5) | 0.09 (2.2)   | 1.44 (36.5) | 1.73 (44.0) |

#### XBPT25P

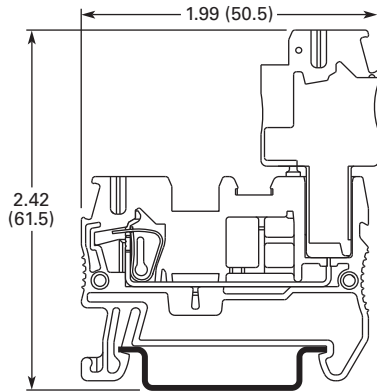

#### XBPT25PD12

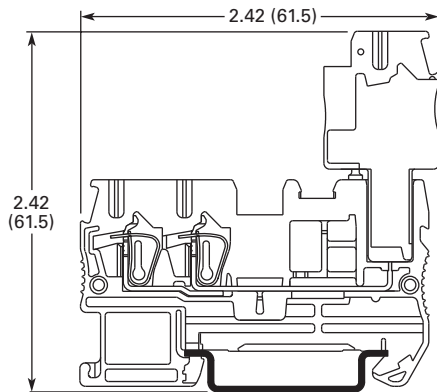

# 8.1

## Terminal Blocks, Fuse Blocks and Fuse Holders

IEC—XB Series

### Connection Plugs



8

### Contents

| <i>Description</i>                      | <i>Page</i>     |
|---|-----------------|
| Connection Terminal Blocks .....        | <b>V7-T8-59</b> |
| Connection Plugs                        |                 |
| Accessories .....                       | <b>V7-T8-63</b> |
| Technical Data and Specifications ..... | <b>V7-T8-63</b> |
| Dimensions .....                        | <b>V7-T8-63</b> |
| Connection Receptacles .....            | <b>V7-T8-64</b> |
| Connection Accessories .....            | <b>V7-T8-66</b> |

### Connection Plugs

#### Product Description

Just like the basic terminal blocks, the plugs also offer the perfect solution for every application. The XBAPSP25\_ plugs are designed for

connecting one conductor. The XBAPSPDB25\_ plug is designed for connecting two conductors and provides an additional bridging option.

#### Product Selection

XBAPSP25\_

#### Spring Cage Connection Plugs, Single, Not Bridgeable



| Terminal Width | Maximum Wire Size          | Connection Data in V/A/AWG | UL-cUL Ratings in V/A/AWG | Color | Number of Positions | Standard Pack | Catalog Number    |
|----------------|----------------------------|----------------------------|---------------------------|-------|---------------------|---------------|-------------------|
| 5.2 mm         | 12 AWG/2.5 mm <sup>2</sup> | 500/24/28-12               | 300/20/26-12              | Gray  | 1                   | 25            | <b>XBAPSP251</b>  |
|                |                            |                            |                           |       | 2                   | 25            | <b>XBAPSP252</b>  |
|                |                            |                            |                           |       | 3                   | 25            | <b>XBAPSP253</b>  |
|                |                            |                            |                           |       | 4                   | 25            | <b>XBAPSP254</b>  |
|                |                            |                            |                           |       | 5                   | 25            | <b>XBAPSP255</b>  |
|                |                            |                            |                           |       | 6                   | 25            | <b>XBAPSP256</b>  |
|                |                            |                            |                           |       | 7                   | 25            | <b>XBAPSP257</b>  |
|                |                            |                            |                           |       | 8                   | 25            | <b>XBAPSP258</b>  |
|                |                            |                            |                           |       | 9                   | 25            | <b>XBAPSP259</b>  |
|                |                            |                            |                           |       | 10                  | 25            | <b>XBAPSP2510</b> |
|                |                            |                            |                           |       | 11                  | 10            | <b>XBAPSP2511</b> |
|                |                            |                            |                           |       | 12                  | 10            | <b>XBAPSP2512</b> |

## XBAPSPDB25\_

## Spring Cage Connection Plugs, Double, Bridgeable



| Terminal Width | Maximum Wire Size          | Connection Data in V/A/AWG | UL-cUL Ratings in V/A/AWG | Color | Number of Positions | Standard Pack | Catalog Number      |
|----------------|----------------------------|----------------------------|---------------------------|-------|---------------------|---------------|---------------------|
| 5.2 mm         | 12 AWG/2.5 mm <sup>2</sup> | 500/24/28–12               | 300/20/26–12              | Gray  | 1                   | 25            | <b>XBAPSPDB251</b>  |
|                |                            |                            |                           |       | 2                   | 25            | <b>XBAPSPDB252</b>  |
|                |                            |                            |                           |       | 3                   | 25            | <b>XBAPSPDB253</b>  |
|                |                            |                            |                           |       | 4                   | 25            | <b>XBAPSPDB254</b>  |
|                |                            |                            |                           |       | 5                   | 25            | <b>XBAPSPDB255</b>  |
|                |                            |                            |                           |       | 6                   | 25            | <b>XBAPSPDB256</b>  |
|                |                            |                            |                           |       | 7                   | 25            | <b>XBAPSPDB257</b>  |
|                |                            |                            |                           |       | 8                   | 25            | <b>XBAPSPDB258</b>  |
|                |                            |                            |                           |       | 9                   | 25            | <b>XBAPSPDB259</b>  |
|                |                            |                            |                           |       | 10                  | 25            | <b>XBAPSPDB2510</b> |
|                |                            |                            |                           |       | 11                  | 10            | <b>XBAPSPDB2511</b> |
|                |                            |                            |                           |       | 12                  | 10            | <b>XBAPSPDB2512</b> |

## Accessories

## Spring Cage Connection Plugs

| Description   | Color  | Number of Positions | Standard Pack | XBAPSP25_ Catalog Number | XBAPSPDB25_ Catalog Number |
|---|--------|---------------------|---------------|--------------------------|----------------------------|
| Plug-in bridge—for cross connections in the terminal center | Red    | 2                   | 10            | —                        | <b>XBAFBS25</b>            |
|   |        | 3                   | 10            | —                        | <b>XBAFBS35</b>            |
|   |        | 5                   | 10            | —                        | <b>XBAFBS55</b>            |
|   |        | 10                  | 10            | —                        | <b>XBAFBS105</b>           |
| Snap-lock fitting and strain relief                         | Orange | 2                   | 10            | <b>XBAPPRZ</b>           | <b>XBAPPRZ</b>             |
| Snap-lock fitting   | Orange | 1                   | 10            | <b>XBAPPR</b>            | <b>XBAPPR</b>              |
|   | Orange | 2                   | 10            | <b>XBAPPR2</b>           | <b>XBAPPR2</b>             |
| Strain relief   | Black  | 2                   | 10            | <b>XBAPPZ2</b>           | <b>XBAPPD22</b>            |
|   | Black  | 4                   | 10            | <b>XBAPPZ4</b>           | <b>XBAPPD24</b>            |
| Blank marker strip  | White  | —                   | 10            | <b>XBMZBF5</b> ①         | <b>XBMZBF5</b> ①           |

## Technical Data and Specifications

## Spring Cage Connection Plugs

| Description   | XBAPSP25_ | XBAPSPDB25_ |
|---|-----------|-------------|
| <b>Technical Data in Accordance with IEC</b>                      |           |             |
| Maximum load current in A/cross-section in mm <sup>2</sup>        | 24/4      | 24/4        |
| Rated surge voltage in kV/contamination class                     | 6/3       | 6/3         |
| Surge voltage category/insulating material group                  | III/1     | III/1       |
| <b>Connection Capacity</b>  |           |             |
| Stranded with ferrule with plastic sleeve in mm <sup>2</sup>      | 0.25–2.5  | 0.25–2.5    |
| Stranded with ferrules without plastic sleeve in mm <sup>2</sup>  | 0.25–2.5  | 0.25–2.5    |
| Stranded with twin ferrule with plastic sleeve in mm <sup>2</sup> | 0.5       | 0.5         |
| Stripping length in inches (mm)                                   | 0.39 (10) | 0.39 (10)   |

## Dimensions

See **Page V7-T8-61** for dimensions.

## Notes

① For information on Printed Marking Tag Options, see **Page V7-T8-98**.

For additional accessories, see **Page V7-T8-90**.

# 8.1

## Terminal Blocks, Fuse Blocks and Fuse Holders

IEC—XB Series

### Connection Receptacles



8

### Contents

| <i>Description</i>                          | <i>Page</i>     |
|---|-----------------|
| Connection Terminal Blocks . . . . .        | <b>V7-T8-59</b> |
| Connection Plugs . . . . .                  | <b>V7-T8-62</b> |
| Connection Receptacles                      |                 |
| Accessories . . . . .                       | <b>V7-T8-65</b> |
| Technical Data and Specifications . . . . . | <b>V7-T8-65</b> |
| Dimensions . . . . .                        | <b>V7-T8-65</b> |
| Connection Accessories . . . . .            | <b>V7-T8-66</b> |

### Connection Receptacles

#### Product Description

With the XBAPSC25\_ Plug-in contacts can be accommodated safely in cable ducts and distributor shafts without using much

space. The standard strain reliefs can also be used. Large-surface labeling makes it possible to mark the terminal points and the entire

receptacle. A test hole can accommodate a 2.3 mm diameter test plug in each receptacle element, providing a practical solution.

#### Product Selection

XBAPSC25\_

#### Pluggable Spring Connection Receptacles



| Terminal Width | Maximum Wire Size          | Connection Data in V/A/AWG | UL-cUL Ratings in V/A/AWG | Color | Number of Positions | Standard Pack | Catalog Number    |
|----------------|----------------------------|----------------------------|---------------------------|-------|---------------------|---------------|-------------------|
| 5.2 mm         | 12 AWG/2.5 mm <sup>2</sup> | 500/24/28–12               | 300/20/26–12              | Gray  | 2                   | 25            | <b>XBAPSC252</b>  |
|                |                            |                            |                           |       | 3                   | 25            | <b>XBAPSC253</b>  |
|                |                            |                            |                           |       | 4                   | 25            | <b>XBAPSC254</b>  |
|                |                            |                            |                           |       | 5                   | 25            | <b>XBAPSC255</b>  |
|                |                            |                            |                           |       | 6                   | 25            | <b>XBAPSC256</b>  |
|                |                            |                            |                           |       | 7                   | 25            | <b>XBAPSC257</b>  |
|                |                            |                            |                           |       | 8                   | 25            | <b>XBAPSC258</b>  |
|                |                            |                            |                           |       | 9                   | 25            | <b>XBAPSC259</b>  |
|                |                            |                            |                           |       | 10                  | 25            | <b>XBAPSC2510</b> |
|                |                            |                            |                           |       | 11                  | 10            | <b>XBAPSC2511</b> |
|                |                            |                            |                           |       | 12                  | 10            | <b>XBAPSC2512</b> |

## Accessories

### Pluggable Spring Connection Receptacles

| Description               | Color | Number of Positions | Standard Pack | XBAPSC25_ Catalog Number |
|---------------------------|-------|---------------------|---------------|--------------------------|
| 2.3 mm diameter test plug | Red   | —                   | —             | XBATSMPS_- <sup>①</sup>  |
| Strain relief             | Black | 2                   | 10            | XBAPPDZ2                 |
|                           | Black | 4                   | 10            | XBAPPDZ4                 |
| Blank marker strip        | White | —                   | 10            | XBMZBF5 <sup>②</sup>     |

## Technical Data and Specifications

### Spring Cage Connection Plugs

| Description   | XBAPSP25_ |
|---|-----------|
| <b>Technical Data in Accordance with IEC</b>                      |           |
| Maximum load current in A/cross-section in mm <sup>2</sup>        | 24/4      |
| Rated surge voltage in kV/contamination class                     | 6/3       |
| Surge voltage category/insulating material group                  | III/I     |
| <b>Connection Capacity</b>  |           |
| Stranded with ferrule with plastic sleeve in mm <sup>2</sup>      | 0.25–2.5  |
| Stranded with ferrules without plastic sleeve in mm <sup>2</sup>  | 0.25–2.5  |
| Stranded with twin ferrule with plastic sleeve in mm <sup>2</sup> | 0.5       |
| Stripping length in inches (mm)                                   | 0.39 (10) |

## Dimensions

Approximate Dimensions in Inches (mm)

### Spring Cage Connection Plugs

| Catalog Number | Width      | Length      | Cover Length | Height      |
|----------------|------------|-------------|--------------|-------------|
| XBAPSP25_      | 0.20 (5.2) | 1.46 (37.2) | 0.09 (2.2)   | 0.71 (18.0) |

### Receptacle Widths

| Catalog Number | Width       | Catalog Number | Width       |
|----------------|-------------|----------------|-------------|
| XBAPSC252      | 0.41 (10.4) | XBAPSC258      | 1.64 (41.6) |
| XBAPSC253      | 0.61 (15.6) | XBAPSC259      | 1.84 (46.8) |
| XBAPSC254      | 0.82 (20.8) | XBAPSC2510     | 2.05 (52.0) |
| XBAPSC255      | 1.02 (26.0) | XBAPSC2511     | 2.25 (57.2) |
| XBAPSC256      | 1.23 (31.2) | XBAPSC2512     | 2.46 (62.4) |
| XBAPSC257      | 1.43 (36.4) |                |             |

#### Notes

① For ordering information, see [Page V7-T8-105](#).

② For information on Printed Marking Tag Options, see [Page V7-T8-98](#).

For additional accessories, see [Page V7-T8-90](#).

# 8.1

## Terminal Blocks, Fuse Blocks and Fuse Holders

IEC—XB Series

### Connection Accessories

#### Product Description





The pluggable XBPT series features an extensive range of application-oriented accessories. Strain reliefs are available for the plugs and

can be snapped on at the required points as an option. The snap-lock fitting can be used for all plug variants. It is snapped into the outside of

the plug housing as an option and hooks onto the terminal block housing when the plug is snapped on.

#### Product Selection

##### Pluggable Spring Cage Connection Accessories

|   | Description                                    | Number of Positions | Standard Pack | Catalog Number  |
|---|--|---------------------|---------------|-----------------|
| <b>XBAPPZ2</b><br>   | Strain relief for single plugs                 | 2                   | 10            | <b>XBAPPZ2</b>  |
|   |  | 4                   | 10            | <b>XBAPPZ4</b>  |
| <b>XBAPPDZ4</b><br>  | Strain relief for double plugs and receptacles | 2                   | 10            | <b>XBAPPDZ2</b> |
|   |  | 4                   | 10            | <b>XBAPPDZ4</b> |
| <b>XBAPPR2</b><br>  | Snap-lock fitting for plugs                    | 1                   | 10            | <b>XBAPPR</b>   |
|   |  | 2                   | 10            | <b>XBAPPR2</b>  |
| <b>XBAPPRZ</b><br> | Snap-lock fitting and strain relief for plugs  | 2                   | 10            | <b>XBAPPRZ</b>  |

#### Strain Relief



#### Snap-Lock Fitting



#### Optional Accessory Recommendations

| Number of Positions Receptacle | Strain Relief                            |
|--------------------------------|--|
| 2–4                            | <b>XBAPPZ2</b>                           |
| 5–10                           | <b>XBAPPZ4</b> or <b>(2) XBAPPZ2</b>     |
| 11–15                          | <b>(2) XBAPPZ4</b> or <b>(4) XBAPPZ2</b> |

## IDC Terminal Blocks



## Contents

**Description****Page**

|  |                 |
|--|-----------------|
| IDC Terminal Blocks                                |                 |
| Single Level . . . . .                             | <b>V7-T8-68</b> |
| Multi-Conductor . . . . .                          | <b>V7-T8-70</b> |
| Double Level . . . . .                             | <b>V7-T8-73</b> |
| Fuse Terminal Blocks . . . . .                     | <b>V7-T8-75</b> |
| Disconnect and Component Terminal Blocks . . . . . | <b>V7-T8-77</b> |
| Hybrid Terminal Blocks . . . . .                   | <b>V7-T8-79</b> |

Drawings  
Online**IDC (Insulation Displacement Connection) Terminal Blocks Overview****Product Description**

The superior design of Eaton's Insulation Displacement Connection (IDC) technology terminal blocks reduces wiring installation time and labor, especially in high-volume applications. IDC terminal blocks are suited for applications in automated equipment and machine tools, packaging and material handling machinery, railway/mass transit systems, petrochemical, and any other application requiring high-volume connections for low-voltage control and signal circuitry where labor cost reduction and ease of assembly is desired. These terminal blocks are designed for long-term use under demanding conditions.

The XBQT Series allows for wire to be connected without any prior stripping. The quick connection provides up to 60% reduction in wiring time. One turn of a standard screwdriver results in a simple, fast and reliable connection.

**Application Description**

The XBQT is operated with a standard screwdriver. The switching states are clearly signaled by engagement points in the start and end positions. Solid and stranded wires of 0.25 to 2.5 mm<sup>2</sup> can be wired without the use of ferrules. Stripping the wire is not required—the wire's insulation is cut open when it is properly connected. The wire is securely placed in the end position where it makes large-area, gas-tight contact. Connections are made in seconds!

**Features**

- Quick connection capability
- Global acceptance
- Flexible plug-in bridge system
- Large surface area for marking
- Standardized testing system

**Standards and Certifications**

- UL recognized—File No. E67464
- CE approved
- LVD <sup>①</sup>
  - EN 60947-7-1
  - EN 60947-7-2
  - EN 60998-2-3
  - EN 60352-4/A1
- ATEX approval (Eex e applications)

**Note**

- <sup>①</sup> Not all standards apply to all terminal blocks. Contact Eaton for details.

# 8.1

## Terminal Blocks, Fuse Blocks and Fuse Holders

IEC—XB Series

Single Level

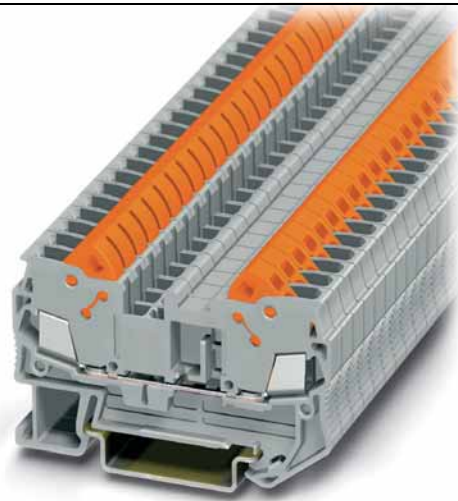

### Contents

| Description                              | Page     |
|--|----------|
| Single Level                             |          |
| Accessories                              | V7-T8-69 |
| Technical Data and Specifications        | V7-T8-69 |
| Dimensions                               | V7-T8-69 |
| Multi-Conductor                          | V7-T8-70 |
| Double Level                             | V7-T8-73 |
| Fuse Terminal Blocks                     | V7-T8-75 |
| Disconnect and Component Terminal Blocks | V7-T8-77 |
| Hybrid Terminal Blocks                   | V7-T8-79 |

8

### Single Level

#### Product Description

The XBQT IDC terminal block has the fastest connection time in a compact design. The space-saving front connection design offers additional space for wiring between the cable ducts. The double bridge shaft can

accommodate individual chain bridging and step-down bridging from other terminal blocks. The XBQT ground blocks are the same shape as the feed-through terminal blocks with the same wide range of cross-sections

available. They easily snap onto the DIN rail to make a reliable mechanical and electrical contact that meets all requirements of IEC 60-947-7-2.

#### Product Selection

XBQT25

#### IDC—Single Level Terminal Blocks



| Terminal Width | Maximum Wire Size          | Connection Data in V/A/AWG | EN 50 019 ① in V/A/AWG | UL-cUL Ratings in V/A/AWG | Color | Standard Pack | Catalog Number |
|----------------|----------------------------|----------------------------|------------------------|---------------------------|-------|---------------|----------------|
| 5.2 mm         | 16 AWG/1.5 mm <sup>2</sup> | 800/17.5/24–16             | 550/16/24–16           | 600/10/24–16              | Gray  | 50            | XBQT15         |
|                |                            |                            |                        |                           | Blue  | 50            | XBQT15BU       |
| 6.2 mm         | 14 AWG/2.5 mm <sup>2</sup> | 800/24/20–14               | —                      | 600/15/20–14              | Gray  | 50            | XBQT25         |
|                |                            |                            |                        |                           | Blue  | 50            | XBQT25BU       |

XBQT15PE

#### IDC—Single Level Terminal Ground Blocks



| Terminal Width | Maximum Wire Size          | Connection Data in V/A/AWG | EN 50 019 ① in V/A/AWG | UL-cUL Ratings in V/A/AWG | Color        | Standard Pack | Catalog Number |
|----------------|----------------------------|----------------------------|------------------------|---------------------------|--------------|---------------|----------------|
| 5.2 mm         | 16 AWG/1.5 mm <sup>2</sup> | —/—/24–16                  | —/—/24–16              | —/—/24–16                 | Green/Yellow | 50            | XBQT15PE       |
| 6.2 mm         | 14 AWG/2.5 mm <sup>2</sup> | —/—/20–14                  | —                      | —/—/20–14                 | Green/Yellow | 50            | XBQT25PE       |

#### Note

① EU type—examination certificate number: KEMA 05ATEX2157 U (XBQT15), KEMA 05ATEX2160 U (XBQT25).



## Accessories

## IDC—Single Level Terminal/Ground Blocks

| Description                                      | Color | Number of Positions | Standard Pack | XBQT15 Catalog Number        | XBQT25 Catalog Number        | XBQT15PE Catalog Number      | XBQT25PE Catalog Number      |
|--|-------|---------------------|---------------|------------------------------|------------------------------|------------------------------|------------------------------|
| End cover  | Gray  | —                   | 10            | <b>XBACQT15</b>              | <b>XBACQT25</b>              | <b>XBACQT15</b>              | <b>XBACQT25</b>              |
| Partition plate                                  | —     | —                   | 10            | <b>XBATQT25</b>              | <b>XBATQT25</b>              | <b>XBATQT25</b>              | <b>XBATQT25</b>              |
| Plug-in bridge                                   | Red   | 2                   | 10            | <b>XBAFBS25</b>              | <b>XBAFBS26</b>              | <b>XBAFBS25</b>              | <b>XBAFBS26</b>              |
|  |       | 3                   | 10            | <b>XBAFBS35</b>              | <b>XBAFBS36</b>              | <b>XBAFBS35</b>              | <b>XBAFBS36</b>              |
|  |       | 5                   | 10            | <b>XBAFBS55</b>              | <b>XBAFBS56</b>              | <b>XBAFBS55</b>              | <b>XBAFBS56</b>              |
|  |       | 10                  | 10            | <b>XBAFBS105</b>             | <b>XBAFBS106</b>             | <b>XBAFBS105</b>             | <b>XBAFBS106</b>             |
|  |       | 50                  | 10            | <b>XBAFBS505</b>             | <b>XBAFBS506</b>             | <b>XBAFBS505</b>             | <b>XBAFBS506</b>             |
| Test adapter                                     | —     | —                   | 10            | <b>XBATSPA14</b>             | <b>XBATSPA14</b>             | <b>XBATSPA14</b>             | <b>XBATSPA14</b>             |
| 2.3 mm diameter test plug                        | —     | —                   | —             | <b>XBATSMPS-<sup>①</sup></b> | <b>XBATSMPS-<sup>①</sup></b> | <b>XBATSMPS-<sup>①</sup></b> | <b>XBATSMPS-<sup>①</sup></b> |
| Modular test plug                                | —     | —                   | 10            | <b>XBATSPS5</b>              | <b>XBATSPS6</b>              | <b>XBATSPS5</b>              | <b>XBATSPS6</b>              |
| Blank marker strip center and external marking   | White | —                   | 10            | <b>XBMZBF5<sup>②</sup></b>   | <b>XBMZBF6<sup>②</sup></b>   | <b>XBMZBF5<sup>②</sup></b>   | <b>XBMZBF6<sup>②</sup></b>   |
| Blank marker strip center labeling (strip of 10) | White | —                   | 10            | <b>XBMZB5<sup>②</sup></b>    | <b>XBMZB6<sup>②</sup></b>    | <b>XBMZB5<sup>②</sup></b>    | <b>XBMZB6<sup>②</sup></b>    |

## Technical Data and Specifications

## IDC—Single Level Terminal/Ground Blocks

| Description  | XBQT15            | XBQT25    | XBQT15PE          | XBQT25PE  |
|--|-------------------|-----------|-------------------|-----------|
| <b>Technical Data in Accordance with IEC</b>               |                   |           |                   |           |
| Maximum load current in A/cross-section in mm <sup>2</sup> | 17.5/1.5          | 24/2.5    | —                 | —         |
| Rated surge voltage in kV/contamination class              | 8/3               | 8/3       | 8/3               | 8/3       |
| Surge voltage category/insulating material group           | III/I             | III/I     | III/I             | III/I     |
| <b>Connection Cross-Section</b>                            |                   |           |                   |           |
| Core insulation  | PVC/PE            | PVC/PE    | PVC/PE            | PVC/PE    |
| Single/multiple/fine strand in mm <sup>2</sup>             | 1.5               | 2.5       | 1.5               | 2.5       |
| Halogen-free in mm <sup>2</sup>                            | 1.5               | 2.5       | 1.5               | 2.5       |
| Fine strand/superfine strand in AWG (mm <sup>2</sup> )     | 24–16 (0.25–0.34) | 20–14 (—) | 24–16 (0.25–0.34) | 20–14 (—) |
| Repeated connections minimum 100 x in mm <sup>2</sup>      | 0.25–1.5          | 0.5–2.5   | 0.25–1.5          | 0.5–2.5   |

## Dimensions

Approximate Dimensions in Inches (mm)

## IDC—Single Level Terminal/Ground Blocks

| Catalog Number  | Width      | Length      | Cover Length | Height for— |             |
|-----------------|------------|-------------|--------------|-------------|-------------|
|                 |            |             |              | 35 x 7.5 in | 35 x 15 in  |
| <b>XBQT15</b>   | 0.20 (5.2) | 2.31 (58.8) | 0.09 (2.2)   | 1.55 (39.3) | 1.84 (46.8) |
| <b>XBQT25</b>   | 0.24 (6.2) | 2.46 (62.6) | 0.09 (2.2)   | 1.55 (39.3) | 1.84 (46.8) |
| <b>XBQT15PE</b> | 0.20 (5.2) | 2.31 (58.8) | 0.09 (2.2)   | 1.55 (39.3) | 1.84 (46.8) |
| <b>XBQT25PE</b> | 0.24 (6.2) | 2.46 (62.6) | 0.09 (2.2)   | 1.55 (39.3) | 1.84 (46.8) |

## Notes

① For ordering information, see **Page V7-T8-105**.② For information on Printed Marking Tag Options, see **Page V7-T8-98**.For additional accessories, see **Page V7-T8-90**.

# 8.1

## Terminal Blocks, Fuse Blocks and Fuse Holders

IEC—XB Series

### Multi-Conductor



### Contents

| Description                              | Page     |
|--|----------|
| Single Level                             | V7-T8-68 |
| Multi-Conductor                          |          |
| Accessories                              | V7-T8-71 |
| Technical Data and Specifications        | V7-T8-72 |
| Dimensions                               | V7-T8-72 |
| Double Level                             | V7-T8-73 |
| Fuse Terminal Blocks                     | V7-T8-75 |
| Disconnect and Component Terminal Blocks | V7-T8-77 |
| Hybrid Terminal Blocks                   | V7-T8-79 |

8

### Multi-Conductor

#### Product Description

The XBQT IDC terminal block has the fastest connection time in a compact design. The space-saving front connection design offers additional space for wiring between the cable ducts. The double bridge shaft can

accommodate individual chain bridging and step-down bridging from other terminal blocks. The XBQT ground blocks are the same shape as the feed-through terminal blocks with the same wide range of cross-sections

available. They easily snap onto the DIN rail to make a reliable mechanical and electrical contact that meets all requirements of IEC 60-947-7-2.

#### Product Selection

##### XBQT25D12



#### IDC—Multi-Conductor Terminal Blocks, Three-Wire

| Terminal Width | Maximum Wire Size          | Connection Data in V/A/AWG | EN 50 019 ① in V/A/AWG | UL-cUL Ratings in V/A/AWG | Color | Standard Pack | Catalog Number |
|----------------|----------------------------|----------------------------|------------------------|---------------------------|-------|---------------|----------------|
| 5.2 mm         | 16 AWG/1.5 mm <sup>2</sup> | 800/17.5/24–16             | 550/16/24–16           | 600/10/24–16              | Gray  | 50            | XBQT15D12      |
|                |                            |                            |                        |                           | Blue  | 50            | XBQT15D12BU    |
| 6.2 mm         | 14 AWG/2.5 mm <sup>2</sup> | 800/24/20–14               | —                      | 600/15/20–14              | Gray  | 50            | XBQT25D12      |
|                |                            |                            |                        |                           | Blue  | 50            | XBQT25D12BU    |

##### XBQT15D22PE



#### IDC—Multi-Conductor Terminal Blocks, Four-Wire

| Terminal Width | Maximum Wire Size          | Connection Data in V/A/AWG | EN 50 019 ① in V/A/AWG | UL-cUL Ratings in V/A/AWG | Color | Standard Pack | Catalog Number |
|----------------|----------------------------|----------------------------|------------------------|---------------------------|-------|---------------|----------------|
| 5.2 mm         | 16 AWG/1.5 mm <sup>2</sup> | 800/17.5/24–16             | 550/16/24–16           | 600/10/24–16              | Gray  | 50            | XBQT15D22      |
|                |                            |                            |                        |                           | Blue  | 50            | XBQT15D22BU    |

#### IDC—Multi-Conductor Terminal Blocks, Four-Wire Ground Blocks

| Terminal Width | Maximum Wire Size          | Connection Data in V/A/AWG | EN 50 019 ① in V/A/AWG | UL-cUL Ratings in V/A/AWG | Color        | Standard Pack | Catalog Number |
|----------------|----------------------------|----------------------------|------------------------|---------------------------|--------------|---------------|----------------|
| 5.2 mm         | 16 AWG/1.5 mm <sup>2</sup> | —/—/24–16                  | —/—/24–16              | —/—/24–16                 | Green/Yellow | 50            | XBQT15D22PE    |

#### Note

① EU type—examination certificate number: KEMA 05ATEX2157 U (XBQT15), KEMA 05ATEX2160 U (XBQT25).

## XBQT15D12PE



## IDC—Multi-Conductor Terminal Blocks, Three-Wire Ground Blocks

| Terminal Width | Maximum Wire Size          | Connection Data in V/A/AWG | EN 50 019 <sup>①</sup> in V/A/AWG | UL-cUL Ratings in V/A/AWG | Color        | Standard Pack | Catalog Number |
|----------------|----------------------------|----------------------------|-----------------------------------|---------------------------|--------------|---------------|----------------|
| 5.2 mm         | 16 AWG/1.5 mm <sup>2</sup> | —/—/24–16                  | —/—/24–16                         | —/—/24–16                 | Green/Yellow | 50            | XBQT15D12PE    |
| 6.2 mm         | 14 AWG/2.5 mm <sup>2</sup> | —/—/20–14                  | —                                 | —/—/20–14                 | Green/Yellow | 50            | XBQT25D12PE    |

## Accessories

## IDC—Multi-Conductor Terminal Blocks

| Description   | Color | Number of Positions | Standard Pack | XBQT15D12 Catalog Number | XBQT25D12 Catalog Number | XBQT15D22 Catalog Number |
|---|-------|---------------------|---------------|--------------------------|--------------------------|--------------------------|
| End cover   | Gray  | —                   | 10            | XBACQT15D12              | XBACQT25D12              | XBACQT15D22              |
| End cover segment   | Gray  | —                   | 10            | XBASQT15                 | XBASQT25                 | XBASQT15                 |
| Partition plate   | —     | —                   | 10            | XBATQTD12                | XBATQTD12                | XBATQTD22                |
| Plug-in bridge—for cross connections in the terminal center | Red   | 2                   | 10            | XBAFBS25                 | XBAFBS26                 | XBAFBS25                 |
|   |       | 3                   | 10            | XBAFBS35                 | XBAFBS36                 | XBAFBS35                 |
|   |       | 5                   | 10            | XBAFBS55                 | XBAFBS56                 | XBAFBS55                 |
|   |       | 10                  | 10            | XBAFBS105                | XBAFBS106                | XBAFBS105                |
|   |       | 50                  | 10            | XBAFBS505                | XBAFBS506                | XBAFBS505                |
| Test adapter  | —     | —                   | 10            | XBATSPA14                | XBATSPA14                | XBATSPA14                |
| 2.3 mm diameter test plug                                   | —     | —                   | —             | XBATSMPS- <sup>②</sup>   | XBATSMPS- <sup>②</sup>   | XBATSMPS- <sup>②</sup>   |
| Modular test plug   | —     | —                   | 10            | XBATSPS5                 | XBATSPS6                 | XBATSPS5                 |
| Blank marker strip center and external marking              | White | —                   | 10            | XBMZBF5 <sup>③</sup>     | XBMZBF6 <sup>③</sup>     | XBMZBF5 <sup>③</sup>     |
| Blank marker strip center labeling (strip of 10)            | White | —                   | 10            | XBMZB5 <sup>③</sup>      | XBMZB6 <sup>③</sup>      | XBMZB5 <sup>③</sup>      |

## IDC—Multi-Conductor Terminal/Ground Blocks

| Description   | Color | Number of Positions | Standard Pack | XBQT15D12PE Catalog Number | XBQT25D12PE Catalog Number | XBQT15D22PE Catalog Number |
|---|-------|---------------------|---------------|----------------------------|----------------------------|----------------------------|
| End cover   | Gray  | —                   | 10            | XBACQT15D12                | XBACQT25D12                | XBACQT15D22                |
| End cover segment   | Gray  | —                   | 10            | XBASQT15                   | XBASQT25                   | XBASQT15                   |
| Partition plate   | —     | —                   | 10            | XBATQTD12                  | XBATQTD12                  | XBATQTD22                  |
| Plug-in bridge—for cross connections in the terminal center | Red   | 2                   | 10            | XBAFBS25                   | XBAFBS26                   | XBAFBS25                   |
|   |       | 3                   | 10            | XBAFBS35                   | XBAFBS36                   | XBAFBS35                   |
|   |       | 5                   | 10            | XBAFBS55                   | XBAFBS56                   | XBAFBS55                   |
|   |       | 10                  | 10            | XBAFBS105                  | XBAFBS106                  | XBAFBS105                  |
|   |       | 50                  | 10            | XBAFBS505                  | XBAFBS506                  | XBAFBS505                  |
| Test adapter  | —     | —                   | 10            | XBATSPA14                  | XBATSPA14                  | XBATSPA14                  |
| 2.3 mm diameter test plug                                   | —     | —                   | —             | XBATSMPS- <sup>②</sup>     | XBATSMPS- <sup>②</sup>     | XBATSMPS- <sup>②</sup>     |
| Modular test plug   | —     | —                   | 10            | XBATSPS5                   | XBATSPS6                   | XBATSPS5                   |
| Blank marker strip center and external marking              | White | —                   | 10            | XBMZBF5 <sup>③</sup>       | XBMZBF6 <sup>③</sup>       | XBMZBF5 <sup>③</sup>       |
| Blank marker strip center labeling (strip of 10)            | White | —                   | 10            | XBMZB5 <sup>③</sup>        | XBMZB6 <sup>③</sup>        | XBMZB5 <sup>③</sup>        |

## Notes

① EU type—examination certificate number: KEMA 05ATEX2157 U (XBQT15PE), KEMA 05ATEX2160 U (XBQT25PE).

② For ordering information, see [Page V7-T8-105](#).

③ For information on Printed Marking Tag Options, see [Page V7-T8-98](#).

For additional accessories, see [Page V7-T8-90](#).

# 8.1

## Terminal Blocks, Fuse Blocks and Fuse Holders

IEC—XB Series

### Technical Data and Specifications

#### IDC—Multi-Conductor Terminal Blocks

| Description  | XBQT15D12         | XBQT25D12 | XBQT15D12PE       | XBQT25D12PE | XBQT15D22         | XBQT15D22PE       |
|--|-------------------|-----------|-------------------|-------------|-------------------|-------------------|
| <b>Technical Data in Accordance with IEC</b>               |                   |           |                   |             |                   |                   |
| Maximum load current in A/cross-section in mm <sup>2</sup> | 17.5/1.5          | 24/2.5    | —                 | —           | 17.5/1.5          | —                 |
| Rated surge voltage in kV/contamination class              | 8/3               | 8/3       | 8/3               | 8/3         | 8/3               | 8/3               |
| Surge voltage category/insulating material group           | III/I             | III/I     | III/I             | III/I       | III/I             | III/I             |
| <b>Connection Cross-Section</b>                            |                   |           |                   |             |                   |                   |
| Core insulation  | PVC/PE            | PVC/PE    | PVC/PE            | PVC/PE      | PVC/PE            | PVC/PE            |
| Single/multiple/fine strand in mm <sup>2</sup>             | 1.5               | 2.5       | 1.5               | 2.5         | 1.5               | 1.5               |
| Halogen-free in mm <sup>2</sup>                            | 1.5               | 2.5       | 1.5               | 2.5         | 1.5               | 1.5               |
| Fine strand/superfine strand in AWG (mm <sup>2</sup> )     | 24–16 (0.25–0.34) | 20–14 (—) | 24–16 (0.25–0.34) | 20–14 (—)   | 24–16 (0.25–0.34) | 24–16 (0.25–0.34) |
| Repeated connections minimum 100 x in mm <sup>2</sup>      | 0.25–1.5          | 0.5–2.5   | 0.25–1.5          | 0.5–2.5     | 0.25–1.5          | 0.25–1.5          |

### Dimensions

Approximate Dimensions in Inches (mm)

#### IDC—Multi-Conductor Terminal Blocks

| Catalog Number     | Width      | Length      | Cover Length | Height for— |             |
|--------------------|------------|-------------|--------------|-------------|-------------|
|                    |            |             |              | 35 x 7.5 in | 35 x 15 in  |
| <b>XBQT15D12</b>   | 0.20 (5.2) | 3.01 (76.4) | 0.09 (2.2)   | 1.55 (39.3) | 1.84 (46.8) |
| <b>XBQT25D12</b>   | 0.24 (6.2) | 3.25 (82.5) | 0.09 (2.2)   | 1.69 (42.8) | 1.98 (50.3) |
| <b>XBQT15D12PE</b> | 0.20 (5.2) | 3.01 (76.4) | 0.09 (2.2)   | 1.55 (39.3) | 1.84 (46.8) |
| <b>XBQT25D12PE</b> | 0.20 (5.2) | 3.25 (82.5) | 0.09 (2.2)   | 1.69 (42.8) | 1.98 (50.3) |
| <b>XBQT15D22</b>   | 0.20 (5.2) | 3.70 (94.0) | 0.09 (2.2)   | 1.55 (39.3) | 1.84 (46.8) |
| <b>XBQT15D22PE</b> | 0.20 (5.2) | 3.70 (94.0) | 0.09 (2.2)   | 1.55 (39.3) | 1.84 (46.8) |

Double Level

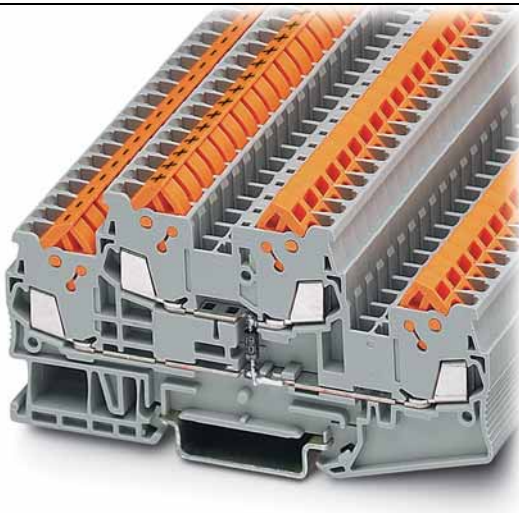

## Contents

| <b>Description</b>                                 | <b>Page</b>     |
|--|-----------------|
| Single Level . . . . .                             | <b>V7-T8-68</b> |
| Multi-Conductor . . . . .                          | <b>V7-T8-70</b> |
| Double Level                                       |                 |
| Accessories . . . . .                              | <b>V7-T8-74</b> |
| Technical Data and Specifications . . . . .        | <b>V7-T8-74</b> |
| Dimensions . . . . .                               | <b>V7-T8-74</b> |
| Fuse Terminal Blocks . . . . .                     | <b>V7-T8-75</b> |
| Disconnect and Component Terminal Blocks . . . . . | <b>V7-T8-77</b> |
| Hybrid Terminal Blocks . . . . .                   | <b>V7-T8-79</b> |

## Double Level

### Product Description

The XBQTT IDC terminal block has the fastest connection time in a compact design. The space-saving front connection design offers additional space for wiring between the cable ducts. The double bridge

shaft, found in each level, can accommodate individual chain bridging and step-down bridging from other terminal blocks. The XBQTT ground blocks are the same shape as the feed-through terminal blocks with the same wide

range of cross-sections available. They easily snap onto the DIN rail to make a reliable mechanical and electrical contact that meets all requirements of IEC 60-947-7-2.

## Product Selection

XBQTT15



### IDC—Double Level Terminal Blocks

| Terminal Width | Maximum Wire Size          | Connection Data in V/A/AWG | EN 50 019 ① in V/A/AWG | UL-cUL Ratings in V/A/AWG | Color | Standard Pack | Catalog Number   |
|----------------|----------------------------|----------------------------|------------------------|---------------------------|-------|---------------|------------------|
| 5.2 mm         | 16 AWG/1.5 mm <sup>2</sup> | 800/17.5/24–16             | 420/15/24–16           | 600/10/24–16              | Gray  | 50            | <b>XBQTT15</b>   |
|                |                            |                            |                        |                           | Blue  | 50            | <b>XBQTT15BU</b> |

XBQTT15PE



### IDC—Double Level Ground Blocks

| Terminal Width | Maximum Wire Size          | Connection Data in V/A/AWG | EN 50 019 ① in V/A/AWG | UL-cUL Ratings in V/A/AWG | Color        | Standard Pack | Catalog Number   |
|----------------|----------------------------|----------------------------|------------------------|---------------------------|--------------|---------------|------------------|
| 6.2 mm         | 14 AWG/2.5 mm <sup>2</sup> | —/—/24–16                  | —/—/24–16              | —/—/24–16                 | Green/Yellow | 50            | <b>XBQTT15PE</b> |

### Note

① EU type—examination certificate number: KEMA 05ATEX2157 U (XBQTT15), KEMA 05ATEX2160 U (XBQTT25).

# 8.1

## Terminal Blocks, Fuse Blocks and Fuse Holders

IEC—XB Series

### Accessories

#### IDC—Double Level Terminal/Ground Blocks

| Description   | Color | Number of Positions | Standard Pack | XBQTT15 Catalog Number | XBQTT15PE Catalog Number |
|---|-------|---------------------|---------------|------------------------|--------------------------|
| End cover   | Gray  | —                   | 10            | XBACQTT15              | XBACQTT15                |
| Partition plate   | —     | —                   | 10            | XBATQTT15              | XBATQTT15                |
| Plug-in bridge—for cross connections in the terminal center | Red   | 2                   | 10            | XBAFBS25               | XBAFBS25                 |
|   |       | 3                   | 10            | XBAFBS35               | XBAFBS35                 |
|   |       | 5                   | 10            | XBAFBS55               | XBAFBS55                 |
|   |       | 10                  | 10            | XBAFBS105              | XBAFBS105                |
|   |       | 20                  | 10            | XBAFBS505              | XBAFBS505                |
| Test adapter  | —     | —                   | 10            | XBATSPA14              | XBATSPA14                |
| 2.3 mm diameter test plug                                   | —     | —                   | —             | XBATSMPS- <sup>①</sup> | XBATSMPS- <sup>①</sup>   |
| Modular test plug   | —     | —                   | 10            | XBATSPS5               | XBATSPS5                 |
| Blank marker strip  | White | —                   | 10            | XBMZBF5 <sup>②</sup>   | XBMZBF5 <sup>②</sup>     |

### Technical Data and Specifications

#### IDC—Double Level Terminal/Ground Blocks

| Description  | XBQTT15           | XBQTT15PE         |
|--|-------------------|-------------------|
| <b>Technical Data in Accordance with IEC</b>               |                   |                   |
| Maximum load current in A/cross-section in mm <sup>2</sup> | 17.5/1.5          | —                 |
| Rated surge voltage in kV/contamination class              | 6/3               | 6/3               |
| Surge voltage category/insulating material group           | III/I             | III/I             |
| <b>Connection Cross-Section</b>                            |                   |                   |
| Core insulation  | PVC/PE            | PVC/PE            |
| Single/multiple/fine strand in mm <sup>2</sup>             | 1.5               | 1.5               |
| Halogen-free in mm <sup>2</sup>                            | 1.5               | 1.5               |
| Fine strand/superfine strand in AWG (mm <sup>2</sup> )     | 24–16 (0.25–0.34) | 24–16 (0.25–0.34) |
| Repeated connections minimum 100 x in mm <sup>2</sup>      | 0.25–1.5          | 0.25–1.5          |

### Dimensions

Approximate Dimensions in Inches (mm)

#### IDC—Double Level Terminal/Ground Blocks

| Catalog Number | Width      | Length      | Cover Length | Height for— |             |
|----------------|------------|-------------|--------------|-------------|-------------|
|                |            |             |              | 35 x 7.5 in | 35 x 15 in  |
| XBQTT15        | 0.20 (5.2) | 3.92 (99.6) | 0.09 (2.2)   | 1.96 (49.9) | 2.26 (57.4) |
| XBQTT15PE      | 0.20 (5.2) | 3.92 (99.6) | 0.09 (2.2)   | 1.96 (49.9) | 2.26 (57.4) |

#### Notes

- ① For ordering information, see **Page V7-T8-105**.
- ② For information on Printed Marking Tag Options, see **Page V7-T8-98**.

For additional accessories, see **Page V7-T8-90**.

## Fuse Terminal Blocks



## Contents

| Description  | Page     |
|--|----------|
| Single Level . . . . .                             | V7-T8-68 |
| Multi-Conductor . . . . .                          | V7-T8-70 |
| Double Level . . . . .                             | V7-T8-73 |
| Fuse Terminal Blocks                               |          |
| Accessories . . . . .                              | V7-T8-76 |
| Technical Data and Specifications . . . . .        | V7-T8-76 |
| Dimensions . . . . .                               | V7-T8-76 |
| Disconnect and Component Terminal Blocks . . . . . | V7-T8-77 |
| Hybrid Terminal Blocks . . . . .                   | V7-T8-79 |

## Fuse Terminal Blocks

## Product Description

The XBQT lever-type fuse terminal blocks perform two main functions. It is a carrier for a 5 x 20 mm cartridge fuse insert and can also allow for potential distribution via the double bridge shaft.

This means that two potentials can be carried separately alongside each other. Versions with light indication (AC and DC voltage) are available to signal a triggered fuse.

## Product Selection

## XBQT25FB



## IDC—Fuse Terminal Blocks

| Terminal Width  | Maximum Wire Size          | Connection Data in V/A/AWG | UL-cUL Ratings in V/A/AWG | Color | Standard Pack | Catalog Number       |
|---|----------------------------|----------------------------|---------------------------|-------|---------------|----------------------|
| <b>IDC Fuse Terminal Blocks</b>                               |                            |                            |                           |       |               |                      |
| 6.2 mm  | 14 AWG/2.5 mm <sup>2</sup> | ①/6.3/20–14                | 300/15/20–14              | Black | 50            | <b>XBQT25FBE</b>     |
| <b>IDC Fuse Terminal Blocks with LED 12–30V, 1–2.5 mA</b>     |                            |                            |                           |       |               |                      |
| 6.2 mm  | 14 AWG/2.5 mm <sup>2</sup> | ①/6.3/20–14                | 300/15/20–14              | Black | 50            | <b>XBQT25FBEL24</b>  |
| <b>IDC Fuse Terminal Blocks with LED 30–60V, 0.8–2.0 mA</b>   |                            |                            |                           |       |               |                      |
| 6.2 mm  | 14 AWG/2.5 mm <sup>2</sup> | ①/6.3/20–14                | 300/15/20–14              | Black | 50            | <b>XBQT25FBEL60</b>  |
| <b>IDC Fuse Terminal Blocks with LED 110–250V, 0.5–2.5 mA</b> |                            |                            |                           |       |               |                      |
| 6.2 mm  | 14 AWG/2.5 mm <sup>2</sup> | ①/6.3/20–14                | 300/15/20–14              | Black | 50            | <b>XBQT25FBEL250</b> |

**Note**

① As disconnect terminal block, 400V; as fuse terminal blocks 250V.

# 8.1

## Terminal Blocks, Fuse Blocks and Fuse Holders

IEC—XB Series

### Accessories

#### IDC—Fuse Terminal Blocks

| Description   | Color | Number of Positions | Standard Pack | XBQT25FBE          |   |
|---|-------|---------------------|---------------|--------------------|---|
|   |       |                     |               | Catalog Number     |   |
| End cover   | Gray  | —                   | 10            | <b>XBACQT25D12</b> |   |
| Partition plate   | —     | —                   | 10            | <b>XBATQTD12</b>   |   |
| Plug-in bridge—for cross connections in the terminal center | Red   | 2                   | 10            | <b>XBAFBS26</b>    |   |
|   |       | 3                   | 10            | <b>XBAFBS36</b>    |   |
|   |       | 5                   | 10            | <b>XBAFBS56</b>    |   |
|   |       | 10                  | 10            | <b>XBAFBS106</b>   |   |
| Test adapter  | —     | —                   | 10            | <b>XBATSPA14</b>   |   |
| 2.3 mm diameter test plug                                   | —     | —                   | —             | <b>XBATSMPS-</b>   | ① |
| Modular test plug   | —     | —                   | 10            | <b>XBATSPS5</b>    |   |
| Blank marker strip center and external marking              | White | —                   | 10            | <b>XBMZBF6</b>     | ② |
| Blank marker strip lever labeling                           | White | —                   | 10            | <b>XBMZB5</b>      | ② |
| Blank marker strip center labeling (strip of 10)            | White | —                   | 10            | <b>XBMZB6</b>      | ② |

### Technical Data and Specifications

#### IDC—Fuse Terminal Blocks

| Description  | XBQT25FBE |
|--|-----------|
| <b>Technical Data in Accordance with IEC</b>               |           |
| Maximum load current in A/cross-section in mm <sup>2</sup> | 6.3/2.5   |
| Rated surge voltage in kV/contamination class              | 4/3       |
| Surge voltage category/insulating material group           | III/I     |
| <b>Connection Cross-Section</b>                            |           |
| Core insulation  | PVC/PE    |
| Single/multiple/fine strand in mm <sup>2</sup>             | 2.5       |
| Halogen-free in mm <sup>2</sup>                            | 2.5       |
| Fine strand/superfine strand in AWG (mm <sup>2</sup> )     | 24–14 (—) |
| Repeated connections minimum 100 x in mm <sup>2</sup>      | 0.5–2.5   |

### Dimensions

Approximate Dimensions in Inches (mm)

#### IDC—Fuse Terminal Blocks

| Catalog Number   | Width      | Length      | Cover Length | Height for— |             |
|------------------|------------|-------------|--------------|-------------|-------------|
|                  |            |             |              | 35 x 7.5 in | 35 x 15 in  |
| <b>XBQT25FBE</b> | 0.24 (6.2) | 3.25 (82.5) | 0.09 (2.2)   | 1.69 (42.8) | 1.98 (50.3) |

#### Notes

① For ordering information, see **Page V7-T8-105**.

② For information on Printed Marking Tag Options, see **Page V7-T8-98**.

For additional accessories, see **Page V7-T8-90**.



## Disconnect and Component Terminal Blocks

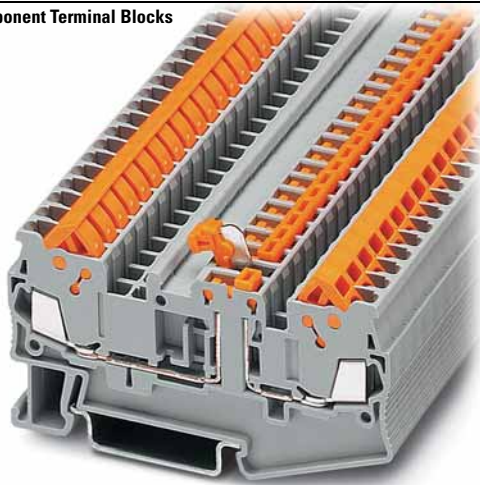

## Contents

| <b>Description</b>                          | <b>Page</b>     |
|---|-----------------|
| Single Level . . . . .                      | <b>V7-T8-68</b> |
| Multi-Conductor . . . . .                   | <b>V7-T8-70</b> |
| Double Level . . . . .                      | <b>V7-T8-73</b> |
| Fuse Terminal Blocks . . . . .              | <b>V7-T8-75</b> |
| Disconnect and Component Terminal Blocks    |                 |
| Accessories . . . . .                       | <b>V7-T8-78</b> |
| Technical Data and Specifications . . . . . | <b>V7-T8-78</b> |
| Dimensions . . . . .                        | <b>V7-T8-78</b> |
| Hybrid Terminal Blocks . . . . .            | <b>V7-T8-79</b> |

## Disconnect and Component Terminal Blocks

### Product Description

The **XB** Series includes application specific terminal blocks like disconnect blocks. The knife disconnect terminal blocks (XBQT15MT) has a fitted knife. The XBQT15TG

can accommodate component plugs for resistors or capacitors and fuse plugs for 5 x 20 mm fuses with or without a light indicator for signaling a triggered fuse.

Both terminal blocks have three bridge shafts—two in the standard positions and one on the other side of the disconnect point.

### Product Selection

**XBQT15MT**  
Knife Disconnect



### IDC—Disconnect and Component Terminal Blocks

| Terminal Width   | Maximum Wire Size          | Connection Data in V/A/AWG | UL-cUL Ratings in V/A/AWG | UL-cUL Ratings for Disconnect in V/A/AWG | UL-cUL Ratings for Disconnect with Test Sockets in V/A/AWG | Color | Standard Pack | Catalog Number   |
|--|----------------------------|----------------------------|---------------------------|--|--|-------|---------------|------------------|
| <b>Knife Disconnect</b>  |                            |                            |                           |  |  |       |               |                  |
| 5.2 mm   | 16 AWG/1.5 mm <sup>2</sup> | 400/16/24–16               | 600/10/24–16              | —  | —  | Gray  | 50            | <b>XBQT15MT</b>  |
| <b>Component Disconnect</b>                                    |                            |                            |                           |  |  |       |               |                  |
| 5.2 mm   | 16 AWG/1.5 mm <sup>2</sup> | 400/16/24–16               | 600/10/24–16              | —  | —  | Gray  | 50            | <b>XBQT15TG</b>  |
| 6.2 mm   | 14 AWG/2.5 mm <sup>2</sup> | 400/16/20–14               | 300/10/20–14              | —  | —  | Gray  | 50            | <b>XBQT25TG</b>  |
| <b>Component Plug</b>  |                            |                            |                           |  |  |       |               |                  |
| 6.2 mm   | 10 AWG/4 mm <sup>2</sup>   | 500/16/26–10               | —                         | 600/16/26–10                             | 300/16/26–10   | Gray  | 10            | <b>XBPCO</b>     |
| <b>Fuse Plug</b>   |                            |                            |                           |  |  |       |               |                  |
| 6.2 mm   | 10 AWG/4 mm <sup>2</sup>   | 500/16/26–10               | —                         | 600/16/26–10                             | 300/16/26–10   | Black | 10            | <b>XBPFU</b>     |
| <b>Fuse Plug with Light Indicator for 12–30V, 1–2.5 mA</b>     |                            |                            |                           |  |  |       |               |                  |
| 6.2 mm   | 10 AWG/4 mm <sup>2</sup>   | 500/16/26–10               | —                         | 600/16/26–10                             | 300/16/26–10   | Black | 10            | <b>XBPFUL24</b>  |
| <b>Fuse Plug with Light Indicator for 110–250V, 0.5–2.5 mA</b> |                            |                            |                           |  |  |       |               |                  |
| 6.2 mm   | 10 AWG/4 mm <sup>2</sup>   | 500/16/26–10               | —                         | 600/16/26–10                             | 300/16/26–10   | Black | 10            | <b>XBPFUL250</b> |

# 8.1

## Terminal Blocks, Fuse Blocks and Fuse Holders

IEC—XB Series

### Accessories

#### IDC—Disconnect and Component Terminal Blocks

| Description                                      | Color | Number of Positions | Standard Pack | XBQT15MT<br>Catalog Number | XBQT15TG<br>Catalog Number | XBQT25TG<br>Catalog Number |
|--|-------|---------------------|---------------|----------------------------|----------------------------|----------------------------|
| End cover  | Gray  | —                   | 10            | XBACQT15D12                | XBACQT15D12                | XBACQT25D12                |
| End cover segment                                | Gray  | —                   | 10            | XBASQT15                   | XBASQT15                   | XBASQT25                   |
| Partition plate                                  | —     | —                   | 10            | XBATQTD12                  | XBATQTD12                  | XBATQTD12                  |
| Plug-in bridge                                   | Red   | 2                   | 10            | XBAFBS25                   | XBAFBS25                   | XBAFBS26                   |
|  |       | 3                   | 10            | XBAFBS35                   | XBAFBS35                   | XBAFBS36                   |
|  |       | 5                   | 10            | XBAFBS55                   | XBAFBS55                   | XBAFBS56                   |
|  |       | 10                  | 10            | XBAFBS105                  | XBAFBS105                  | XBAFBS106                  |
| Test adapter                                     | —     | —                   | 10            | XBATSPA14                  | XBATSPA14                  | XBATSPA14                  |
| 2.3 mm diameter test plug                        | —     | —                   | —             | XBATSMPS_ <sup>①</sup>     | XBATSMPS_ <sup>①</sup>     | XBATSMPS_ <sup>①</sup>     |
| Modular test plug                                | —     | —                   | 10            | XBATSPS5                   | XBATSPS5                   | XBATSPS5                   |
| Blank marker strip center and external marking   | White | —                   | 10            | XBMZBF5 <sup>②</sup>       | XBMZBF5 <sup>②</sup>       | XBMZBF6 <sup>②</sup>       |
| Blank marker strip center labeling (strip of 10) | White | —                   | 10            | XBMZB5 <sup>②</sup>        | XBMZB5 <sup>②</sup>        | XBMZB6 <sup>②</sup>        |

### Technical Data and Specifications

#### IDC—Disconnect and Component Terminal Blocks

| Description  | XBQT15MT          | XBQT15TG          | XBQT25TG  |
|--|-------------------|-------------------|-----------|
| <b>Technical Data in Accordance with IEC</b>               |                   |                   |           |
| Maximum load current in A/cross-section in mm <sup>2</sup> | 16/1.5            | 16/1.5            | 16/2.5    |
| Rated surge voltage in kV/contamination class              | 6/3               | 6/3               | 6/3       |
| Surge voltage category/insulating material group           | III/I             | III/I             | III/I     |
| <b>Connection Cross-Section</b>                            |                   |                   |           |
| Core insulation  | PVC/PE            | PVC/PE            | PVC/PE    |
| Single/multiple/fine strand in mm <sup>2</sup>             | 1.5               | 1.5               | 2.5       |
| Halogen-free in mm <sup>2</sup>                            | 1.5               | 1.5               | 2.5       |
| Fine strand/superfine strand in AWG (mm <sup>2</sup> )     | 24–16 (0.25–0.34) | 24–16 (0.25–0.34) | 20–14 (—) |
| Repeated connections minimum 100 x in mm <sup>2</sup>      | 0.25–1.5          | 0.25–1.5          | 0.5–2.5   |

### Dimensions

Approximate Dimensions in Inches (mm)

#### IDC—Disconnect and Component Terminal Blocks

| Catalog Number | Width      | Length      | Cover Length | Height for— |             |
|----------------|------------|-------------|--------------|-------------|-------------|
|                |            |             |              | 35 x 7.5 in | 35 x 15 in  |
| XBQT15MT       | 0.20 (5.2) | 3.01 (76.4) | 0.09 (2.2)   | 1.55 (39.3) | 1.84 (46.8) |
| XBQT15TG       | 0.20 (5.2) | 3.01 (76.4) | 0.09 (2.2)   | 1.55 (39.3) | 1.84 (46.8) |
| XBQT25TG       | 0.24 (6.2) | 3.25 (82.5) | 0.09 (2.2)   | 1.69 (42.8) | 1.98 (50.3) |

#### Notes

① For ordering information, see **Page V7-T8-105**.

② For information on Printed Marking Tag Options, see **Page V7-T8-98**.

For additional accessories, see **Page V7-T8-90**.

**Hybrid Terminal Blocks**

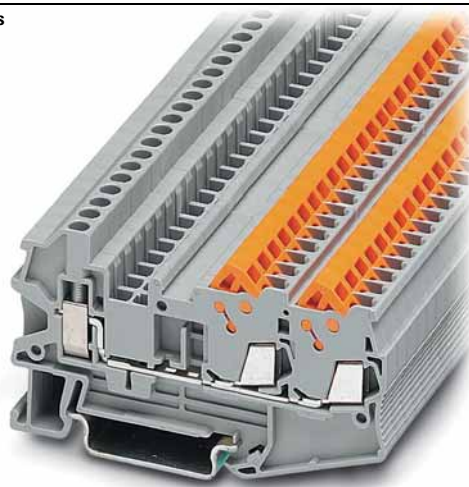

**Contents**

| <i>Description</i>                                 | <i>Page</i>     |
|--|-----------------|
| Single Level . . . . .                             | <b>V7-T8-68</b> |
| Multi-Conductor . . . . .                          | <b>V7-T8-70</b> |
| Double Level . . . . .                             | <b>V7-T8-73</b> |
| Fuse Terminal Blocks . . . . .                     | <b>V7-T8-75</b> |
| Disconnect and Component Terminal Blocks . . . . . | <b>V7-T8-77</b> |
| Hybrid Terminal Blocks                             |                 |
| Accessories . . . . .                              | <b>V7-T8-80</b> |
| Technical Data and Specifications . . . . .        | <b>V7-T8-81</b> |
| Dimensions . . . . .                               | <b>V7-T8-81</b> |

**Hybrid Terminal Blocks**

**Product Description**

The XBQT hybrid terminal blocks offer the best of both worlds. One side offers the time-saving advantage of our insulation displacement

connection technology, while the other side offers a universal screw connection. Use the IDC side on the internal (factory) control

cabinet side and the screw connection on the end customer (field) side. Ground terminal blocks of the same shape are also available

**Product Selection**

**XBQU25**



**IDC—Hybrid Terminal Blocks, Single Level**

| Terminal Width | Maximum Wire Size          | IEC Screw Connection in V/A/AWG | IEC IDC Connection in V/A/AWG | UL-cUL Screw Connection in V/A/AWG | UL-cUL IDC Connection in V/A/AWG | Color | Standard Pack | Catalog Number |
|----------------|----------------------------|---------------------------------|-------------------------------|------------------------------------|----------------------------------|-------|---------------|----------------|
| 5.2 mm         | 12 AWG/2.5 mm <sup>2</sup> | 800/17.5/26–12                  | 800/17.5/24–16                | 600/10/26–12                       | 600/10/24–16                     | Gray  | 50            | <b>XBQU15</b>  |
| 6.2 mm         | 10 AWG/4 mm <sup>2</sup>   | 800/24/26–10                    | 800/24/20–14                  | 600/15/26–10                       | 600/15/20–14                     | Gray  | 50            | <b>XBQU25</b>  |

**XBQU15D12**



**IDC—Hybrid Terminal Blocks, Three-Wire**

| Terminal Width | Maximum Wire Size          | IEC Screw Connection in V/A/AWG | IEC IDC Connection in V/A/AWG | UL-cUL Screw Connection in V/A/AWG | UL-cUL IDC Connection in V/A/AWG | Color | Standard Pack | Catalog Number   |
|----------------|----------------------------|---------------------------------|-------------------------------|------------------------------------|----------------------------------|-------|---------------|------------------|
| 5.2 mm         | 12 AWG/2.5 mm <sup>2</sup> | 800/17.5/26–12                  | 800/17.5/24–16                | 800/10/26–12                       | 800/10/24–16                     | Gray  | 50            | <b>XBQU15D12</b> |
| 6.2 mm         | 10 AWG/4 mm <sup>2</sup>   | 800/24/26–10                    | 800/24/20–14                  | 600/15/26–10                       | 600/15/20–14                     | Gray  | 50            | <b>XBQU25D12</b> |

**XBQU25PE**



**IDC—Hybrid Terminal/Ground Blocks**

| Terminal Width | Maximum Wire Size          | IEC Screw Connection in V/A/AWG | IEC IDC Connection in V/A/AWG | UL-cUL Screw Connection in V/A/AWG | UL-cUL IDC Connection in V/A/AWG | Color | Standard Pack | Catalog Number  |
|----------------|----------------------------|---------------------------------|-------------------------------|------------------------------------|----------------------------------|-------|---------------|-----------------|
| 5.2 mm         | 12 AWG/2.5 mm <sup>2</sup> | —/—/26–12                       | —/—/24–16                     | —/—/26–12                          | —/—/24–16                        | Gray  | 50            | <b>XBQU15PE</b> |
| 6.2 mm         | 10 AWG/4 mm <sup>2</sup>   | —/—/26–10                       | —/—/20–14                     | —/—/26–10                          | —/—/20–14                        | Gray  | 50            | <b>XBQU25PE</b> |

# 8.1

## Terminal Blocks, Fuse Blocks and Fuse Holders

IEC—XB Series

### Accessories

#### IDC—Hybrid Terminal Blocks

| Description  | Color | Number of Positions | Standard Pack | XBQU15 Catalog Number  | XBQU25 Catalog Number  | XBQU15D12 Catalog Number | XBQU25D12 Catalog Number |
|--|-------|---------------------|---------------|------------------------|------------------------|--------------------------|--------------------------|
| End cover  | Gray  | —                   | 10            | XBACQU15               | XBACQU25               | XBACQU15D12              | XBACQU25D12              |
| End segment  | Gray  | —                   | 10            | —                      | —                      | XBASQT15                 | XBASQT25                 |
| Partition plate  | —     | —                   | 10            | XBATQT25               | XBATQT25               | XBATQTD12                | XBATQTD12                |
| Plug-in bridge—for cross connections in the bridge shaft | Red   | 2                   | 10            | XBAFBS25               | XBAFBS26               | XBAFBS25                 | XBAFBS26                 |
|  |       | 3                   | 10            | XBAFBS35               | XBAFBS36               | XBAFBS35                 | XBAFBS36                 |
|  |       | 5                   | 10            | XBAFBS55               | XBAFBS56               | XBAFBS55                 | XBAFBS56                 |
|  |       | 10                  | 10            | XBAFBS105              | XBAFBS106              | XBAFBS105                | XBAFBS106                |
|  |       | 50                  | 10            | XBAFBS505              | XBAFBS506              | XBAFBS505                | XBAFBS506                |
| Test adapter   | —     | —                   | 10            | XBATSPAI4              | XBATSPAI4              | XBATSPAI4                | XBATSPAI4                |
| 2.3 mm diameter test plug                                | —     | —                   | —             | XBATSMPS- <sup>①</sup> | XBATSMPS- <sup>①</sup> | XBATSMPS- <sup>①</sup>   | XBATSMPS- <sup>①</sup>   |
| Modular test plug  | —     | —                   | 10            | XBATSPS5               | XBATSPS6               | XBATSPS5                 | XBATSPS6                 |
| Blank marker strip center and external marking           | White | —                   | 10            | XBMZBF5 <sup>②</sup>   | XBMZBF6 <sup>②</sup>   | XBMZBF5 <sup>②</sup>     | XBMZBF6 <sup>②</sup>     |
| Blank marker strip center labeling (strip of 10)         | —     | —                   | —             | XBMZB5 <sup>②</sup>    | XBMZB6 <sup>②</sup>    | XBMZB5 <sup>②</sup>      | XBMZB6 <sup>②</sup>      |

#### IDC—Hybrid Terminal/Ground Blocks

| Description  | Color | Number of Positions | Standard Pack | XBQU15PE Catalog Number | XBQU25PE Catalog Number |
|--|-------|---------------------|---------------|-------------------------|-------------------------|
| End cover  | Gray  | —                   | 10            | XBACQU15                | XBACQU25                |
| Partition plate  | —     | —                   | 10            | XBATQT25                | XBATQT25                |
| Plug-in bridge—for cross connections in the bridge shaft | Red   | 2                   | 10            | XBAFBS25                | XBAFBS26                |
|  |       | 3                   | 10            | XBAFBS35                | XBAFBS36                |
|  |       | 5                   | 10            | XBAFBS55                | XBAFBS56                |
|  |       | 10                  | 10            | XBAFBS105               | XBAFBS106               |
|  |       | 50                  | 10            | XBAFBS505               | XBAFBS506               |
| Test adapter   | —     | —                   | 10            | XBATSPAI4               | XBATSPAI4               |
| 2.3 mm diameter test plug                                | —     | —                   | —             | XBATSMPS- <sup>①</sup>  | XBATSMPS- <sup>①</sup>  |
| Modular test plug  | —     | —                   | 10            | XBATSPS5                | XBATSPS6                |
| Blank marker strip center and external marking           | White | —                   | 10            | XBMZBF5 <sup>②</sup>    | XBMZBF6 <sup>②</sup>    |
| Blank marker strip center labeling (strip of 10)         | —     | —                   | —             | XBMZB5 <sup>②</sup>     | XBMZB6 <sup>②</sup>     |

#### Notes

<sup>①</sup> For ordering information, see **Page V7-T8-105**.

<sup>②</sup> For information on Printed Marking Tag Options, see **Page V7-T8-98**.

For additional accessories, see **Page V7-T8-90**.

## Technical Data and Specifications

### Screw Connection Single Level—Through-Feed

| Description  | XBQU15            | XBQU25            | XBQU15PE          | XBQU25PE          | XBQU15D12         | XBQU25D12         |
|--|-------------------|-------------------|-------------------|-------------------|-------------------|-------------------|
| <b>Technical Data in Accordance with IEC</b>                             |                   |                   |                   |                   |                   |                   |
| Maximum load current in A/cross-section in mm <sup>2</sup>               | 17.5/1.5          | 24/2.5            | —                 | —                 | 17.5/1.5          | 24/2.5            |
| Rated surge voltage in kV/contamination class                            | 8/3               | 8/3               | 8/3               | 8/3               | 8/3               | 8/3               |
| Surge voltage category/insulating material group                         | III/I             | III/I             | III/I             | III/I             | III/I             | III/I             |
| <b>Connection Cross-Section</b>  |                   |                   |                   |                   |                   |                   |
| Core insulation  | PVC/PE            | PVC/PE            | PVC/PE            | PVC/PE            | PVC/PE            | PVC/PE            |
| Single/multiple/fine strand in mm <sup>2</sup>                           | 1.5               | 2.5               | 1.5               | 2.5               | 1.5               | 2.5               |
| Halogen-free in mm <sup>2</sup>  | 1.5               | 2.5               | 1.5               | 2.5               | 1.5               | 2.5               |
| Fine strand/superfine strand in AWG (mm <sup>2</sup> )                   | 24–16 (0.25–0.34) | 20–14 (—)         | 24–16 (0.25–0.34) | 20–14 (—)         | 24–16 (0.25–0.34) | 20–14 (—)         |
| Repeated connections minimum 100 x in mm <sup>2</sup>                    | 0.25–1.5          | 0.5–2.5           | 0.25–1.5          | 0.5–2.5           | 0.25–1.5          | 0.5–2.5           |
| <b>Connection Capacity—Screw Connection</b>                              |                   |                   |                   |                   |                   |                   |
| Stranded with ferrule/with ferrule and plastic sleeve in mm <sup>2</sup> | 0.25–2.5/0.25–2.5 | 0.25–4/0.25–4     | 0.25–2.5/0.25–2.5 | 0.25–4/0.25–4     | 0.25–2.5/0.25–2.5 | 0.25–4/0.25–4     |
| <b>Multi-Conductor Connection</b><br>(same cross-section)                |                   |                   |                   |                   |                   |                   |
| Solid/stranded in mm <sup>2</sup>  | 0.14–1.5/0.14–1.5 | 0.14–1.5/0.14–1.5 | 0.14–1.5/0.14–1.5 | 0.14–1.5/0.14–1.5 | 0.14–1.5/0.14–1.5 | 0.14–1.5/0.14–1.5 |
| Stranded with ferrules without plastic sleeve in mm <sup>2</sup>         | 0.25–1.5          | 0.25–1.5          | 0.25–1.5          | 0.25–1.5          | 0.25–1.5          | 0.25–1.5          |
| Stranded with twin ferrule with plastic sleeve in mm <sup>2</sup>        | 0.5–1.5           | 0.5–2.5           | 0.5–1.5           | 0.5–2.5           | 0.5–1.5           | 0.5–2.5           |
| Stripping length in inches (mm)  | 0.35 (9)          | 0.35 (9)          | 0.35 (9)          | 0.35 (9)          | 0.35 (9)          | 0.35 (9)          |
| Thread   | M3                | M3                | M3                | M3                | M3                | M3                |
| Torque in in-lb (Nm)   | 5.3–7.1 (0.6–0.8) | 5.3–7.1 (0.6–0.8) | 5.3–7.1 (0.6–0.8) | 5.3–7.1 (0.6–0.8) | 5.3–7.1 (0.6–0.8) | 5.3–7.1 (0.6–0.8) |

## Dimensions

Approximate Dimensions in Inches (mm)

### Screw Connection Single Level—Through-Feed

| Catalog Number | Width      | Length      | Cover Width | Height for— |             |
|----------------|------------|-------------|-------------|-------------|-------------|
|                |            |             |             | 35 x 7.5 in | 35 x 15 in  |
| XBQU15         | 0.20 (5.2) | 2.31 (58.8) | 0.09 (2.2)  | 1.69 (42.8) | 1.98 (50.3) |
| XBQU25         | 0.24 (6.2) | 2.46 (62.6) | 0.09 (2.2)  | 1.69 (42.8) | 1.98 (50.3) |
| XBQU15PE       | 0.20 (5.2) | 2.31 (58.8) | 0.09 (2.2)  | 1.69 (42.8) | 1.98 (50.3) |
| XBQU25PE       | 0.24 (6.2) | 2.46 (62.6) | 0.09 (2.2)  | 1.69 (42.8) | 1.98 (50.3) |
| XBQU15D12      | 0.20 (5.2) | 3.01 (76.4) | 0.09 (2.2)  | 1.69 (42.8) | 1.98 (50.3) |
| XBQU25D12      | 0.24 (6.2) | 3.25 (82.5) | 0.09 (2.2)  | 1.69 (42.8) | 1.98 (50.3) |

# 8.1

## Terminal Blocks, Fuse Blocks and Fuse Holders

IEC—XB Series

### Miniature Circuit Breakers



8

### Contents

#### Description

|  | <i>Page</i>     |
|--|-----------------|
| Miniature Circuit Breakers                 |                 |
| Circuit Breakers . . . . .                 | <b>V7-T8-83</b> |
| Flat-Type Fuse Terminal Blocks . . . . .   | <b>V7-T8-86</b> |
| Spring Cage Fuse Terminal Blocks . . . . . | <b>V7-T8-88</b> |

### Miniature Circuit Breakers Overview

#### Product Description

The new **XB** Series thermal miniature circuit breaker offers convenient overload protection. This space-saving single-pole circuit breaker, available up to 10 amps, can be inserted into a screw connection fuse terminal block, XBUK6FSI, or a spring cage fuse terminal block, XBPT4FSI, which is available with or without light indication. The XBATCP combines the

reclosing capability of a circuit breaker with the overload protection of a fuse. The integrated switching function makes it possible to switch the circuit breaker back on immediately, guaranteeing system availability. The device can also be used for switching purposes, as an ON/OFF switch. The Plug-in design allows for quick and efficient replacement.

#### Standards and Certifications

- UL and cUL recognized
- UL 1077—File No. E301915
- CE approved



**Circuit Breakers**



**Contents**

| <b>Description</b>                      | <b>Page</b>     |
|---|-----------------|
| Circuit Breakers                        |                 |
| Accessories .....                       | <b>V7-T8-84</b> |
| Technical Data and Specifications ..... | <b>V7-T8-84</b> |
| Time/Current Curve .....                | <b>V7-T8-85</b> |
| Dimensions .....                        | <b>V7-T8-85</b> |
| Flat-Type Fuse Terminal Blocks .....    | <b>V7-T8-86</b> |
| Spring Cage Fuse Terminal Blocks .....  | <b>V7-T8-88</b> |

**Circuit Breakers**

**Product Description**

The thermal miniature circuit breaker can be switched back on again, has a compact design, and is available

in 10 finely graded steps for nominal currents from 0.1 to 10A.

**Product Selection**

**XBAT**

**Thermal Miniature Circuit Breaker**



| Connection Data in Vac/Vdc | Nominal Current | Color | Standard Pack | Catalog Number  |
|----------------------------|-----------------|-------|---------------|-----------------|
| 250/65                     | 0.1A            | Black | 20            | <b>XBATCPT</b>  |
|                            | 0.25A           | Black | 20            | <b>XBATCPQ</b>  |
|                            | 0.5A            | Black | 20            | <b>XBATCPH</b>  |
|                            | 1.0A            | Black | 20            | <b>XBATCP1</b>  |
|                            | 2.0A            | Black | 20            | <b>XBATCP2</b>  |
|                            | 3.0A            | Black | 20            | <b>XBATCP3</b>  |
|                            | 4.0A            | Black | 20            | <b>XBATCP4</b>  |
|                            | 6.0A            | Black | 20            | <b>XBATCP6</b>  |
|                            | 8.0A            | Black | 20            | <b>XBATCP8</b>  |
|                            | 10.0A           | Black | 20            | <b>XBATCP10</b> |

# 8.1

## Terminal Blocks, Fuse Blocks and Fuse Holders

IEC—XB Series

### Accessories

#### Thermal Miniature Circuit Breaker

| Description               | Color | Number of Positions | Standard Pack | XBAT Catalog Number   |
|---------------------------|-------|---------------------|---------------|---|
| Blank marker strip        | White | —                   | 10            | <b>XBZBF5</b> ①   |
| Flat type terminal blocks | —     | —                   | —             | <b>XBK6FSI</b><br><b>XBK6FSIL12</b><br><b>XBK6FSIL24</b><br><b>XBPT4FSI</b><br><b>XBPT4FSIL12</b><br><b>XBPT4FSIL24</b> |

8

### Technical Data and Specifications

#### Thermal Miniature Circuit Breaker

| Description                                      | XBAT                                   |
|--|--|
| <b>Technical Data in Accordance with IEC</b>     |  |
| Nominal voltage in Vac/Vdc                       | 250/65                                 |
| Nominal current in A                             | 0.25–10                                |
| Ambient temperature                              | –4 to 140°F (–20 to 60°C)              |
| <b>Maximum Power Dissipation</b>                 |  |
| Rated surge voltage in kV/contamination class    | 2.5/2                                  |
| Surge voltage category/insulating material group | III/1                                  |
| <b>Switching Capacity</b>                        |  |
| Cycles with 1 x I <sub>N</sub> (low-induction)   | 6000                                   |
| Cycles with 1 x I <sub>N</sub> (induction)       | 3000                                   |
| Cycles with 2 x I <sub>N</sub> (induction)       | 500                                    |
| <b>Switching Capacity I CN</b>                   |  |
| For nominal currents of 0.25–4A/6–10A            | 6 x I <sub>N</sub> /8 x I <sub>N</sub> |
| Switching capacity (UL 1077) 250 Vac/65 Vdc      | 2000/200                               |

#### Nominal Currents and Internal Resistances

| Nominal Current (A) | Internal Resistance (3/4) |
|---------------------|---------------------------|
| 0.25                | 14                        |
| 0.5                 | 3.4                       |
| 1.0                 | 0.9                       |
| 2.0                 | 0.25                      |
| 3.0                 | 0.11                      |
| 4.0                 | 0.07                      |
| 6.0                 | ≤0.05                     |
| 8.0                 | ≤0.05                     |
| 10.0                | ≤0.05                     |

#### Note

① For information on Printed Marking Tag Options, see **Page V7-T8-98**.



## Time/Current Curve

### Total Switch-Off Period for Nominal Current, 73.4°F (23°C)

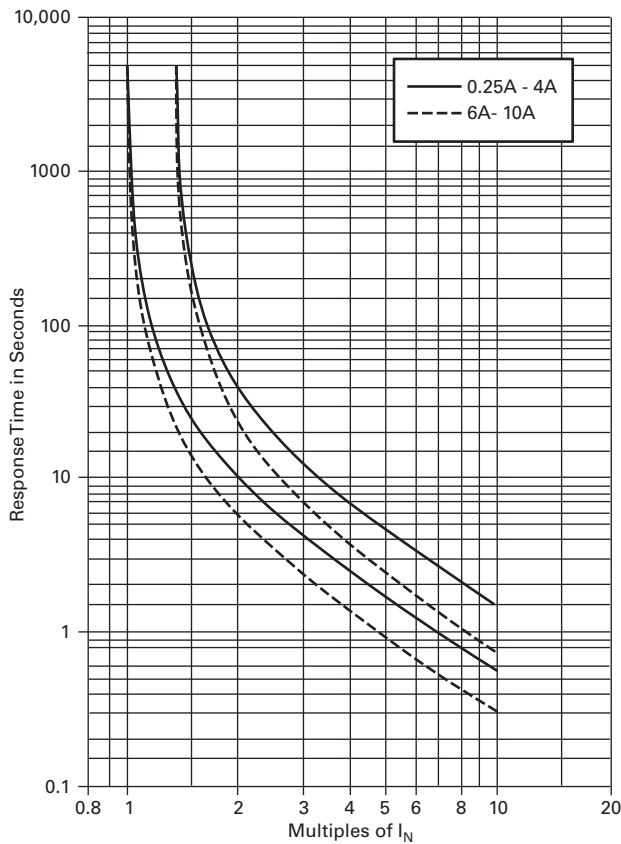

**Note:** When mounted in rows, the nominal current of the devices can only be transmitted at 80% or must be correspondingly over-dimensioned.

### Temperature Factor

| Ambient Temperature | Temperature Factor |
|---------------------|--------------------|
| -4°F (-20°C)        | 0.76               |
| 14°F (-10°C)        | 0.84               |
| 32°F (0°C)          | 0.91               |
| 73.4°F (23°C)       | 1.00               |
| 104°F (40°C)        | 1.08               |
| 122°F (50°C)        | 1.16               |
| 140°F (60°C)        | 1.24               |

## Dimensions

Approximate Dimensions in Inches (mm)

### XBUK6FSI with XBAT

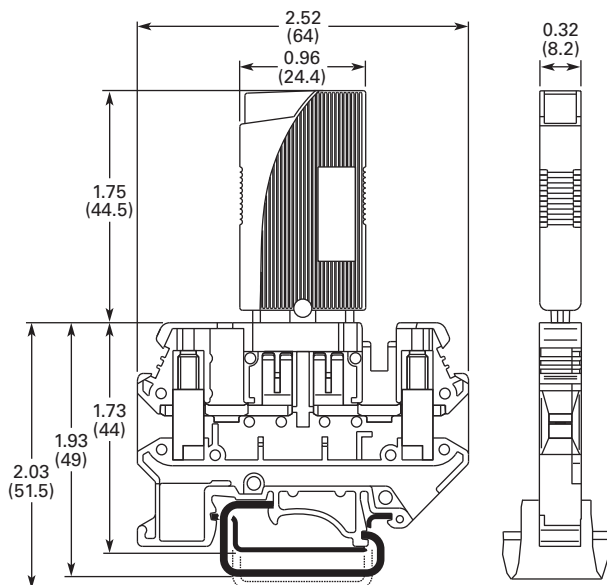

### XBPT4FSI with XBAT

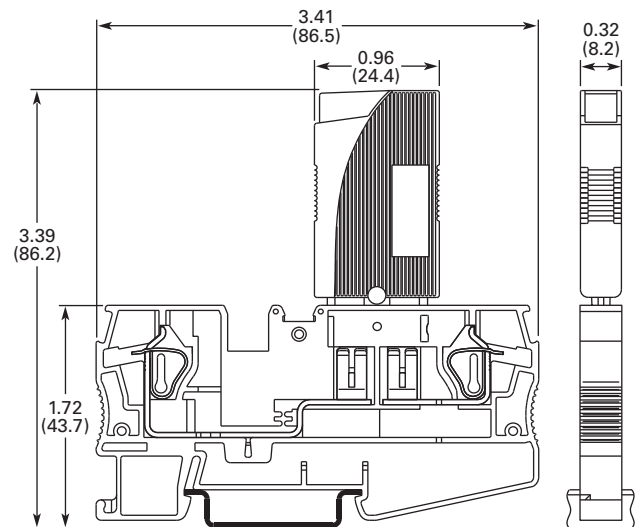

# 8.1

## Terminal Blocks, Fuse Blocks and Fuse Holders

IEC—XB Series

### Flat-Type Fuse Terminal Blocks

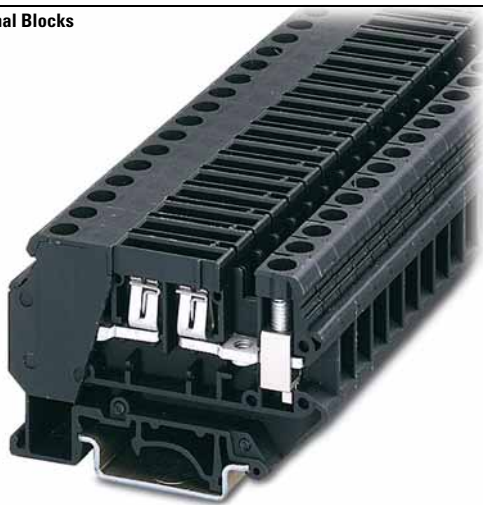

### Contents

| <i>Description</i>                      | <i>Page</i>     |
|---|-----------------|
| Circuit Breakers .....                  | <b>V7-T8-83</b> |
| Flat-Type Fuse Terminal Blocks          |                 |
| Accessories .....                       | <b>V7-T8-86</b> |
| Technical Data and Specifications ..... | <b>V7-T8-87</b> |
| Dimensions .....                        | <b>V7-T8-87</b> |
| Spring Cage Fuse Terminal Blocks .....  | <b>V7-T8-88</b> |

8

### Flat-Type Fuse Terminal Blocks

#### Product Description

The fuse terminal blocks can be used as a basic terminal blocks for the XBAT overload miniature circuit breaker, see **Page V7-T8-83**.

#### Product Selection

**XBUK6FSI**

#### Screw Connection Flat-Type Fuse Terminal Blocks



| Terminal Width  | Maximum Wire Size       | Connection Data in V/A/AWG | UL-cUL Ratings in V/A/AWG | Color | Standard Pack | Catalog Number     |
|---|-------------------------|----------------------------|---------------------------|-------|---------------|--------------------|
| <b>Flat-Type Fuse Terminal Block</b>                              |                         |                            |                           |       |               |                    |
| 8.2 mm  | 8 AWG/6 mm <sup>2</sup> | 250/—/24–8                 | 300/30/26–8               | Black | 50            | <b>XBUK6FSI</b>    |
| <b>Flat-Type Fuse Terminal Block with LED, Red 12 Vdc, 2.0 mA</b> |                         |                            |                           |       |               |                    |
| 8.2 mm  | 8 AWG/6 mm <sup>2</sup> | 250/—/24–8                 | 300/30/26–8               | Black | 50            | <b>XBUK6FSIL12</b> |
| <b>Flat-Type Fuse Terminal Block with LED, Red 24 Vdc, 2.0 mA</b> |                         |                            |                           |       |               |                    |
| 8.2 mm  | 8 AWG/6 mm <sup>2</sup> | 250/—/24–8                 | 300/30/26–8               | Black | 50            | <b>XBUK6FSIL24</b> |

#### Accessories

##### Flat-Type Fuse Terminal Blocks

| Description        | Color | Number of Positions | Standard Pack | XBUK6FSI Catalog Number | XBUK6FSIL_ Catalog Number |
|--------------------|-------|---------------------|---------------|-------------------------|---------------------------|
| Blank marker strip | White | —                   | 10            | <b>XBMZB8</b> ①         | <b>XBMZB8</b> ①           |

#### Note

① For information on Printed Marking Tag Options, see **Page V7-T8-98**.

## Technical Data and Specifications

### Flat-Type Fuse Terminal Blocks

| Description   | XBUK6FSI            | XBUK6FSIL <sub>2</sub> |
|---|---------------------|------------------------|
| <b>Technical Data in Accordance with IEC</b>                      |                     |                        |
| Fuse type ISO   | C                   | C                      |
| Maximum current with single arrangement in A                      | 30                  | 30                     |
| <b>Maximum Power Dissipation</b>                                  |                     |                        |
| Rated surge voltage in kV/contamination class                     | 4/3                 | 4/3                    |
| Surge voltage category/insulating material group                  | III/I               | III/I                  |
| <b>Connection Capacity</b>  |                     |                        |
| Stranded with ferrule with plastic sleeve in mm <sup>2</sup>      | 0.25–4              | 0.25–4                 |
| Stranded with ferrule without plastic sleeve in mm <sup>2</sup>   | 0.25–6              | 0.25–6                 |
| Stranded with twin ferrule with plastic sleeve in mm <sup>2</sup> | —                   | —                      |
| <b>Multi-Conductor Connection</b><br>(same cross-section)         |                     |                        |
| Solid/stranded in mm <sup>2</sup>                                 | 0.2–2.5/0.2–2.5     | 0.2–2.5/0.2–2.5        |
| Stranded with ferrules without plastic sleeve in mm <sup>2</sup>  | 0.25–2.5            | 0.25–2.5               |
| Stranded with twin ferrule with plastic sleeve in mm <sup>2</sup> | 0.5–4.0             | 0.5–4.0                |
| Stripping length in inches (mm)                                   | 0.39 (10)           | 0.39 (10)              |
| Thread  | M4                  | M4                     |
| Torque in in-lb (Nm)  | 13.3–14.2 (1.5–1.6) | 13.3–14.2 (1.5–1.6)    |

## Dimensions

Approximate Dimensions in Inches (mm)

### Flat-Type Fuse Terminal Blocks

| Catalog Number | Width      | Length      | Height for— |             |             |
|----------------|------------|-------------|-------------|-------------|-------------|
|                |            |             | 32 in       | 35 x 7.5 in | 35 x 15 in  |
| XBUK6FSI       | 0.32 (8.2) | 2.91 (74.0) | 2.24 (57.0) | 2.05 (52.0) | 2.34 (59.5) |
| XBUK6FSIL12    | 0.32 (8.2) | 2.91 (74.0) | 2.24 (57.0) | 2.05 (52.0) | 2.34 (59.5) |
| XBUK6FSIL24    | 0.32 (8.2) | 2.91 (74.0) | 2.24 (57.0) | 2.05 (52.0) | 2.34 (59.5) |

# 8.1

## Terminal Blocks, Fuse Blocks and Fuse Holders

IEC—XB Series

### Spring Cage Fuse Terminal Blocks



### Contents

| <i>Description</i>                          | <i>Page</i>     |
|---|-----------------|
| Circuit Breakers . . . . .                  | <b>V7-T8-83</b> |
| Flat-Type Fuse Terminal Blocks . . . . .    | <b>V7-T8-86</b> |
| Spring Cage Fuse Terminal Blocks            |                 |
| Accessories . . . . .                       | <b>V7-T8-88</b> |
| Technical Data and Specifications . . . . . | <b>V7-T8-89</b> |
| Dimensions . . . . .                        | <b>V7-T8-89</b> |

### Spring Cage Fuse Terminal Blocks

#### Product Description

Flat-type fuses or the XBAT miniature circuit breaker (see **Page V7-T8-83**) can be used as the fuse element in these XBPT

Spring Cage Fuse Terminal Blocks. Terminal blocks with a light indicator are available for quick error diagnosis.

#### Product Selection

##### XBPT4FSI

#### Spring Cage Fuse Terminal Blocks



| Terminal Width  | Maximum Wire Size        | Connection Data in V/A/AWG | UL-cUL Ratings in V/A/AWG | Color | Standard Pack | Catalog Number     |
|---|--------------------------|----------------------------|---------------------------|-------|---------------|--------------------|
| <b>Spring Cage Fuse Terminal Block</b>                              |                          |                            |                           |       |               |                    |
| 8.2 mm  | 10 AWG/4 mm <sup>2</sup> | 400/30/28–10               | 300/30/24–10              | Black | 50            | <b>XBPT4FSI</b>    |
| <b>Spring Cage Fuse Terminal Block with LED, Red 12 Vdc, 2.0 mA</b> |                          |                            |                           |       |               |                    |
| 8.2 mm  | 10 AWG/4 mm <sup>2</sup> | 400/30/28–10               | 300/30/24–10              | Black | 50            | <b>XBPT4FSIL12</b> |
| <b>Spring Cage Fuse Terminal Block with LED, Red 24 Vdc, 2.0 mA</b> |                          |                            |                           |       |               |                    |
| 8.2 mm  | 10 AWG/4 mm <sup>2</sup> | 400/30/28–10               | 300/30/24–10              | Black | 50            | <b>XBPT4FSIL24</b> |

### Accessories

#### Flat-Type Fuse Terminal Blocks

| Description                                      | Color | Number of Positions | Standard Pack | XBPT4FSI Catalog Number      | XBPT4FSIL_ Catalog Number    |
|--|-------|---------------------|---------------|------------------------------|------------------------------|
| Test adapter                                     | —     | —                   | 10            | <b>XBATSPA14</b>             | <b>XBATSPA14</b>             |
| 2.3 mm diameter test plug                        | —     | —                   | —             | <b>XBATSMPS-<sup>①</sup></b> | <b>XBATSMPS-<sup>①</sup></b> |
| Modular test plug                                | —     | —                   | 10            | <b>XBATSPS8</b>              | <b>XBATSPS8</b>              |
| Blank marker strip center and external marking   | White | —                   | 10            | <b>XBMZBF8<sup>②</sup></b>   | <b>XBMZBF8<sup>②</sup></b>   |
| Blank marker strip center labeling (strip of 10) | White | —                   | 10            | <b>XBMZB8<sup>②</sup></b>    | <b>XBMZB8<sup>②</sup></b>    |

#### Notes

- ① For ordering information, see **Page V7-T8-105**.
- ② For information on Printed Marking Tag Options, see **Page V7-T8-98**.

## Technical Data and Specifications

### Flat-Type Fuse Terminal Blocks

| Description   | XBPT4FSI  | XBPT4FSIL_ |
|---|-----------|------------|
| <b>Technical Data in Accordance with IEC</b>                      |           |            |
| Fuse type ISO   | C         | C          |
| Maximum current with single arrangement in A                      | 30        | 30         |
| <b>Maximum Power Dissipation</b>                                  |           |            |
| Rated surge voltage in kV/contamination class                     | 6/3       | 6/3        |
| Surge voltage category/insulating material group                  | III/I     | III/I      |
| <b>Connection Capacity</b>  |           |            |
| Stranded with ferrule with plastic sleeve in mm <sup>2</sup>      | 0.25–4    | 0.25–4     |
| Stranded with ferrule without plastic sleeve in mm <sup>2</sup>   | 0.25–4    | 0.25–4     |
| Stranded with twin ferrule with plastic sleeve in mm <sup>2</sup> | 0.5       | 0.5        |
| Stripping length in inches (mm)                                   | 0.39 (10) | 0.39 (10)  |

## Dimensions

Approximate Dimensions in Inches (mm)

### Flat-Type Fuse Terminal Blocks

| Catalog Number | Width      | Length      | Height for— |             |
|----------------|------------|-------------|-------------|-------------|
|                |            |             | 35 x 7.5 in | 35 x 15 in  |
| XBPT4FSI       | 0.32 (8.2) | 3.41 (86.5) | 1.71 (43.5) | 2.01 (51.0) |
| XBPT4FSIL12    | 0.32 (8.2) | 3.41 (86.5) | 1.71 (43.5) | 2.01 (51.0) |
| XBPT4FSIL24    | 0.32 (8.2) | 3.41 (86.5) | 1.71 (43.5) | 2.01 (51.0) |

# 8.1

## Terminal Blocks, Fuse Blocks and Fuse Holders

IEC—XB Series

XB Series Accessories

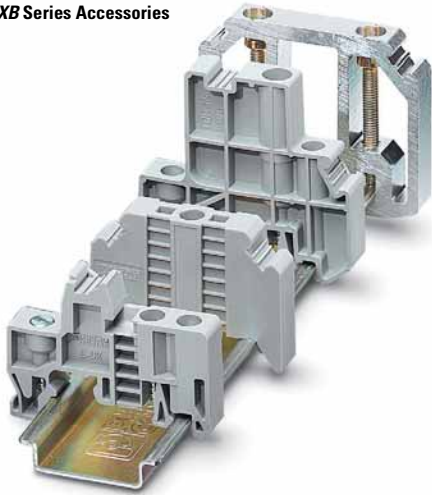

8

### Contents

| Description                           | Page      |
|---------------------------------------|-----------|
| XB Series Accessories                 |           |
| End Stops                             | V7-T8-91  |
| DIN Rails                             | V7-T8-92  |
| Angled Mounting Brackets              | V7-T8-93  |
| Ferrules                              | V7-T8-94  |
| Hand Tools                            | V7-T8-97  |
| Marking Accessories                   | V7-T8-98  |
| Testing Accessories                   | V7-T8-105 |
| Separating Plates, Covers and Bridges | V7-T8-105 |

### XB Series Accessories Overview

#### End Stops

The end stop provides an anchor point at each end of the rail assembly by attaching directly to the DIN rail. A wide range of end stop options are available, including those that mount with one or multiple screws and those that do not require screws for mounting. End stops also have a location for marking material to be placed.

#### DIN Rail

Eaton offers ways for time-saving and secure mounting of components needed for electrical connections. DIN rail provides the basis for the inner design of the control cabinet and ensures a firm hold of the rail-mountable components. Eaton offers a wide range of standard DIN rails sizes and materials, solid or slotted. Or, contact us about custom lengths of pre-cut rail or ordering pre-drilled rail. The DIN rails are designed in accordance with the European standard EN 60715.

#### Angled Mounting Brackets

Angled mounting brackets are used to mount DIN rail at a more accessible angle for wiring and troubleshooting.

#### Ferrules

Ferrules are available with or without an insulating sleeve. The plastic insulating sleeve simplifies the fitting of the conductor and the color indicates the size of the cross-section. The closer the connections are, the more reliable the insulation is and the less likely the wires are to splice. Twin ferrules are also available allowing two wires to be easily compressed in one ferrule. Chain bridging, frequently used in industry, becomes easier with twin ferrules.

#### Hand Tools

Eaton offers an array of hand tools to make it easier to work with our terminal blocks. The XBTCUTSTP tool is recommended for cutting and stripping PVC insulated wires. The ergonomically shaped crimping pliers, XBTCRMP66, result in fatigue-free work by spreading the manual force equally between the six jaws. The XBTDVR screwdrivers have a rotating cap that prevents user discomfort even at high torques and allows rapid rotation. The ergonomically shaped handle further aids the user's comfort. The blade is made from CVM steel, hardened and chrome-plated.

#### Marking Accessories

The marking system provides logical and clear identification of the modular terminal blocks and interface modules. The blank marker strip is designed for marking terminal blocks, equipment and smaller modules with marker grooves. The marker strip is available in all common pitches in printed and unprinted versions.

#### Testing Accessories

The range of test accessories available includes different test plugs, so that an optimum solution can be realized for every application. In addition to pre-assembled test plugs, plugs are also available that can be configured individually to form test adapters.

## End Stops

### Product Selection

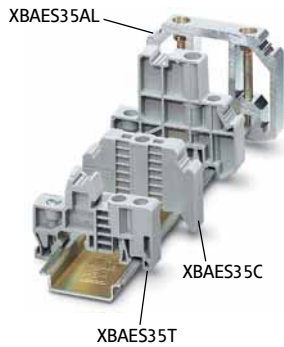

### Snap-On End Stop (15 mm)

| Standard Pack | Catalog Number |
|---------------|----------------|
| 50            | XBAES15N       |

### Snap-On End Stop (35 mm)

| Standard Pack | Catalog Number |
|---------------|----------------|
| 50            | XBAES35N       |

Snap-on end stops for 35 mm and 15 mm DIN rails can be fitted with blank marker strips and adjustable terminal strip markers, parking facility for bridges and testing accessories.

### Universal End Stop (15 mm)

| Standard Pack | Catalog Number |
|---------------|----------------|
| 50            | XBAES15C       |

### Universal End Stop (35 mm)

| Standard Pack | Catalog Number |
|---------------|----------------|
| 50            | XBAES35T       |
| 50            | XBAES35C       |

Screwed on, labeling with blank marker strips and terminal strip markers.

### Aluminum End

| Standard Pack | Catalog Number |
|---------------|----------------|
| 10            | XBAES35AL      |

Snaps on, for end support of 50–240 mm terminal blocks, labeling with XBMZB10.

### Cross-Reference of Terminal Blocks Marking, End Stops

| Catalog Number | XBMKLM2 | XBMGLMA | XBMUBE |
|----------------|---------|---------|--------|
| XBAES35N       | X       | —       | —      |
| XBAES35T       | —       | X       | X      |

### Dimensions

Approximate Dimensions in Inches (mm)

#### Snap-On End Stop

##### XBAES35N

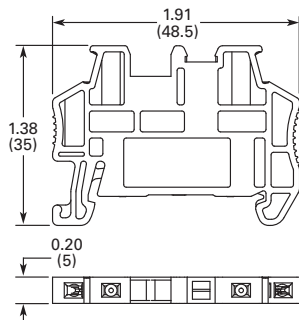

##### XBAES15N

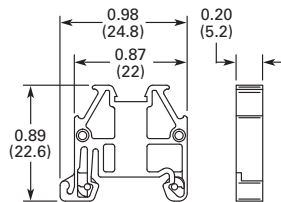

#### Aluminum End Stop

##### XBAES35AL

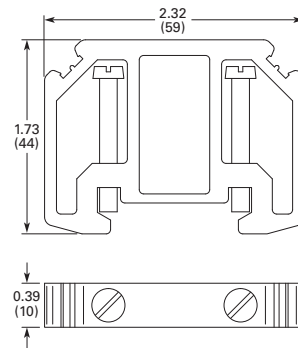

#### Universal End Stop

##### XBAES35T

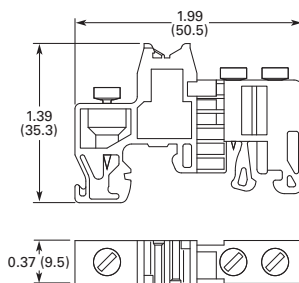

##### XBAES35C

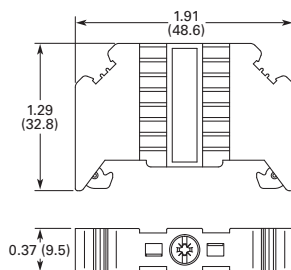

##### XBAES15C

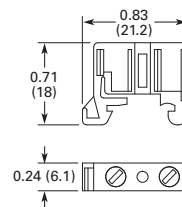

# 8.1

## Terminal Blocks, Fuse Blocks and Fuse Holders

IEC—XB Series

### DIN Rails

#### Product Selection



Perforated and unperforated DIN rails in accordance with E 60715.

#### Features

- High dimensional accuracy
- Restricted tolerances
- Double surface tempering, galvanized and chromated
- All 2m in length
- Customization available

#### 35 x 7.5 mm x 2m

| Standard Pack  | Catalog Number    |
|----------------|-------------------|
| <b>Slotted</b> |                   |
| 25             | <b>XBANS3575P</b> |
| <b>Solid</b>   |                   |
| 25             | <b>XBANS3575U</b> |

#### 35 x 15 mm x 2m

| Standard Pack  | Catalog Number    |
|----------------|-------------------|
| <b>Slotted</b> |                   |
| 25             | <b>XBANS3515P</b> |
| <b>Solid</b>   |                   |
| 25             | <b>XBANS3515U</b> |

#### 15 x 5.5 mm x 2m

| Standard Pack | Catalog Number  |
|---------------|-----------------|
| 25            | <b>XBANS15P</b> |

#### Aluminum DIN Rails (Perforated)

| Standard Pack    | Catalog Number     |
|------------------|--------------------|
| <b>35/7.5/2m</b> |                    |
| 25               | <b>XBANS3575PL</b> |
| <b>35/5.8/2m</b> |                    |
| 6                | <b>XBANS35PL</b>   |

8

### Dimensions

Approximate Dimensions in Inches (mm)

#### 35 x 7.5 mm DIN Rail

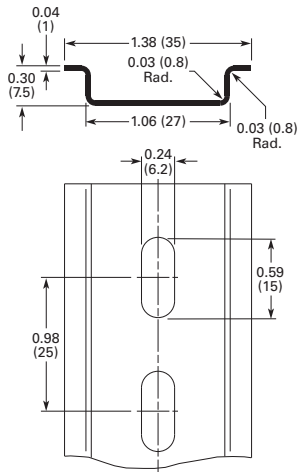

#### 35 x 15 mm DIN Rail

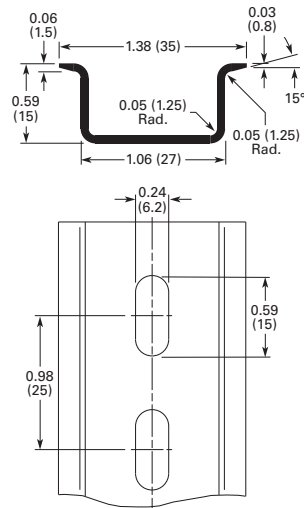

#### 15 x 5.5 mm x 2m DIN Rail

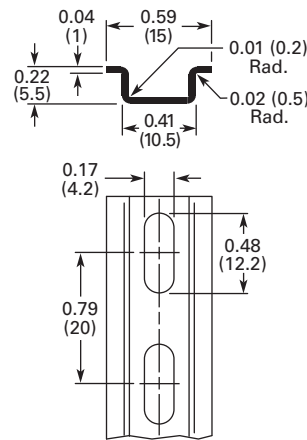

#### XBANS35PL Raised Rail

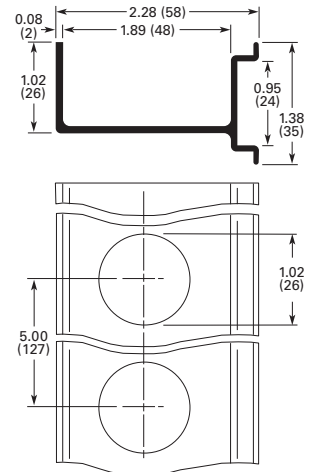



## Angled Mounting Brackets

### Product Selection



The angled brackets enable the DIN rail to be mounted with a spacing or at an angle of 30°.

### Features

- For mounting DIN rail at 30° angle
- For use with M6 screw
- Chromated steel
- Provides better visibility

### Angled Mounting Bracket

| Standard Pack                                   | Catalog Number  |
|---|-----------------|
| <b>Height Inches (mm)</b><br><b>1.39 (35.4)</b> |                 |
| 10  | <b>XBANBGS</b>  |
| <b>Height Inches (mm)</b><br><b>1.81 (46)</b>   |                 |
| 10  | <b>XBANBGSH</b> |

### Dimensions

Approximate Dimensions in Inches (mm)

#### XBANBGS

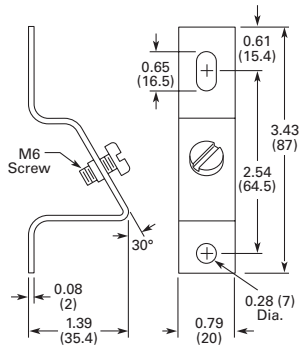

#### XBANBGSH

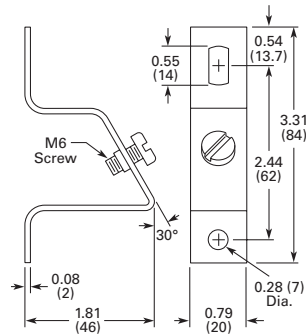

# 8.1

## Terminal Blocks, Fuse Blocks and Fuse Holders

IEC—XB Series

### Ferrules

#### Product Selection

Ferrules are offered in two basic designs—an insulated style available in models for wire sizes 20 through 4 AWG and a non-insulated type available in models for wire sizes 22 through 6 AWG.

**Note:** UL Ratings do not typically pertain to the use of Ferrules—Ferrules are covered under DIN VDE 0611.

#### Insulated

- Tube: soft electrolytic copper (E-CU), tin plated
- Plastic sleeve: polypropylene
  - Long-term temperature 105°C
  - Short-term temperature 120°C

#### XBAF1



#### Insulated Ferrules

| Wire Size AWG (mm <sup>2</sup> ) | Color <sup>①</sup> | Standard Pack <sup>②</sup> | Catalog Number |
|----------------------------------|--------------------|----------------------------|----------------|
| 20 (0.5)                         | White              | 100                        | XBAF1          |
| 18 (0.75)                        | Gray               | 100                        | XBAF3          |
| 18 (1)                           | Red                | 100                        | XBAF4          |
| 16 (1.5)                         | Black              | 100                        | XBAF6          |
| 14 (2.5)                         | Blue               | 100                        | XBAF9          |
| 14 (2.5)                         | Blue               | 100                        | XBAF10         |
| 12 (4)                           | Gray               | 100                        | XBAF11         |
| 12 (4)                           | Gray               | 100                        | XBAF12         |
| 10 (6)                           | Yellow             | 100                        | XBAF13         |
| 10 (6)                           | Yellow             | 100                        | XBAF14         |
| 8 (10)                           | Red                | 100                        | XBAF15         |
| 8 (10)                           | Red                | 100                        | XBAF16         |
| 6 (16)                           | Blue               | 100                        | XBAF17         |
| 6 (16)                           | Blue               | 100                        | XBAF18         |
| 4 (25)                           | Yellow             | 50                         | XBAF19         |

#### Non-Insulated

- Tube: soft electrolytic copper (E-CU), tin plated

#### XBAF20



#### Non-Insulated Ferrules

| Wire Size AWG (mm <sup>2</sup> ) | Standard Pack <sup>②</sup> | Catalog Number |
|----------------------------------|----------------------------|----------------|
| 20 (0.5)                         | 100                        | XBAF20         |
| 18 (0.75)                        | 100                        | XBAF21         |
| 18 (1)                           | 100                        | XBAF23         |
| 16 (1.5)                         | 100                        | XBAF24         |
| 14 (2.5)                         | 100                        | XBAF25         |
| 12 (4)                           | 100                        | XBAF26         |
| 10 (6)                           | 100                        | XBAF27         |
| 8 (10)                           | 100                        | XBAF28         |
| 6 (16)                           | 100                        | XBAF29         |

#### Special Applications

The twin ferrules allow two conductors to be compressed practically in one ferrule.

The colored coding of the various cross sections corresponds to DIN 46 228-4.

#### XBAFT1



#### Non-Insulated Twin Ferrules

| Wire Size AWG (mm <sup>2</sup> ) | Color <sup>①</sup> | Standard Pack <sup>②</sup> | Catalog Number |
|----------------------------------|--------------------|----------------------------|----------------|
| 20 (0.5)                         | White              | 100                        | XBAFT1         |
| 18 (0.75)                        | Gray               | 100                        | XBAFT3         |
| 18 (1)                           | Red                | 100                        | XBAFT4         |
| 16 (1.5)                         | Black              | 100                        | XBAFT6         |
| 14 (2.5)                         | Blue               | 100                        | XBAFT9         |
| 12 (4)                           | Gray               | 100                        | XBAFT11        |
| 10 (6)                           | Yellow             | 100                        | XBAFT13        |
| 8 (10)                           | Red                | 100                        | XBAFT15        |
| 6 (16)                           | Blue               | 50                         | XBAFT18        |

#### Notes

- <sup>①</sup> The colored coding of the various cross-sections corresponds to DIN 46 228-4.
- <sup>②</sup> Standard pack is the number of ferrules that come in each bag. Must order in multiples of standard pack.  
*Example: XBAF1*—an order for 200 pieces will receive 2 bags of ferrules, each with 100 pieces.

**Dimensions**

Approximate Dimensions in Inches (mm)

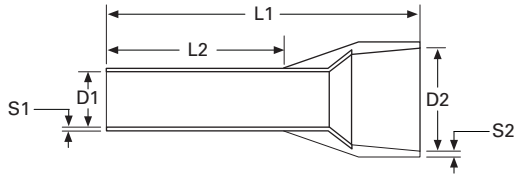
**Ferrules with Insulating Collar**

| Catalog Number | Approximate Dimensions |             |             |             |              |              |
|----------------|------------------------|-------------|-------------|-------------|--------------|--------------|
|                | D1                     | D2          | L1          | L2          | S1           | S2           |
| XBAF1          | 0.04 (1.1)             | 0.10 (2.5)  | 0.55 (14.0) | 0.31 (8.0)  | 0.006 (0.15) | 0.010 (0.25) |
| XBAF3          | 0.05 (1.3)             | 0.11 (2.8)  | 0.55 (14.0) | 0.31 (8.0)  | 0.006 (0.15) | 0.010 (0.25) |
| XBAF4          | 0.06 (1.5)             | 0.12 (3.0)  | 0.55 (14.0) | 0.31 (8.0)  | 0.006 (0.15) | 0.012 (0.30) |
| XBAF6          | 0.07 (1.8)             | 0.13 (3.4)  | 0.55 (14.0) | 0.31 (8.0)  | 0.006 (0.15) | 0.012 (0.30) |
| XBAF9          | 0.09 (2.3)             | 0.17 (4.2)  | 0.55 (14.0) | 0.31 (8.0)  | 0.006 (0.15) | 0.012 (0.30) |
| XBAF10         | 0.09 (2.3)             | 0.17 (4.2)  | 0.94 (24.0) | 0.71 (18.0) | 0.006 (0.15) | 0.012 (0.30) |
| XBAF11         | 0.11 (2.8)             | 0.19 (4.8)  | 0.67 (17.0) | 0.39 (10.0) | 0.008 (0.20) | 0.012 (0.30) |
| XBAF12         | 0.11 (2.8)             | 0.19 (4.8)  | 1.02 (26.0) | 0.71 (18.0) | 0.008 (0.20) | 0.012 (0.30) |
| XBAF13         | 0.14 (3.5)             | 0.24 (6.2)  | 0.79 (20.0) | 0.47 (12.0) | 0.008 (0.20) | 0.012 (0.30) |
| XBAF14         | 0.14 (3.5)             | 0.24 (6.2)  | 1.02 (26.0) | 0.71 (18.0) | 0.008 (0.20) | 0.012 (0.30) |
| XBAF15         | 0.18 (4.6)             | 0.30 (7.5)  | 0.87 (22.0) | 0.47 (12.0) | 0.008 (0.20) | 0.012 (0.30) |
| XBAF16         | 0.18 (4.6)             | 0.30 (7.5)  | 1.10 (28.0) | 0.71 (18.0) | 0.008 (0.20) | 0.012 (0.30) |
| XBAF17         | 0.23 (5.8)             | 0.35 (8.8)  | 0.94 (24.0) | 0.47 (12.0) | 0.008 (0.20) | 0.016 (0.40) |
| XBAF18         | 0.23 (5.8)             | 0.35 (8.8)  | 1.10 (28.0) | 0.71 (18.0) | 0.008 (0.20) | 0.016 (0.40) |
| XBAF19         | 0.29 (7.3)             | 0.43 (11.0) | 1.26 (32.0) | 0.71 (18.0) | 0.008 (0.20) | 0.020 (0.50) |

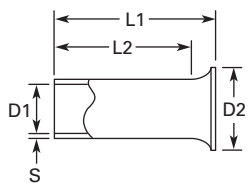
**Ferrules without Insulating Collar**

| Catalog Number | Approximate Dimensions |            |             |             |              |
|----------------|------------------------|------------|-------------|-------------|--------------|
|                | D1                     | D2         | L1          | L2          | S            |
| XBAF20         | 0.04 (1.0)             | 0.08 (2.1) | 0.24 (6.0)  | 0.21 (5.3)  | 0.006 (0.15) |
| XBAF21         | 0.05 (1.2)             | 0.09 (2.3) | 0.24 (6.0)  | 0.21 (5.3)  | 0.006 (0.15) |
| XBAF23         | 0.06 (1.4)             | 0.10 (2.5) | 0.24 (6.0)  | 0.21 (5.3)  | 0.006 (0.15) |
| XBAF24         | 0.07 (1.7)             | 0.11 (2.8) | 0.28 (7.0)  | 0.24 (6.0)  | 0.006 (0.15) |
| XBAF25         | 0.09 (2.2)             | 0.13 (3.4) | 0.28 (7.0)  | 0.24 (6.0)  | 0.006 (0.15) |
| XBAF26         | 0.11 (2.8)             | 0.16 (4.0) | 0.35 (9.0)  | 0.31 (8.0)  | 0.008 (0.20) |
| XBAF27         | 0.14 (3.5)             | 0.19 (4.7) | 0.47 (12.0) | 0.35 (9.0)  | 0.008 (0.20) |
| XBAF28         | 0.18 (4.5)             | 0.23 (5.8) | 0.47 (12.0) | 0.43 (10.8) | 0.008 (0.20) |
| XBAF29         | 0.23 (5.8)             | 0.30 (7.5) | 0.47 (12.0) | 0.41 (10.5) | 0.008 (0.20) |

# 8.1

## Terminal Blocks, Fuse Blocks and Fuse Holders

IEC—XB Series

Approximate Dimensions in Inches (mm)

### Twin Ferrules

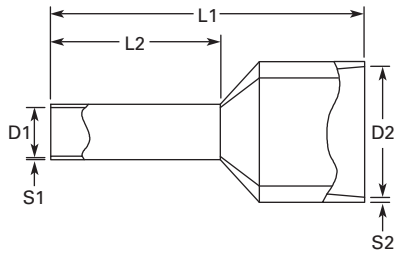

8

| Catalog Number | Approximate Dimensions |            | L1          | L2          | S1           | S2           |
|----------------|------------------------|------------|-------------|-------------|--------------|--------------|
|                | D1                     | D2         |             |             |              |              |
| <b>XBAFT1</b>  | 0.06 (1.5)             | 0.10 (2.5) | 0.59 (15.0) | 0.31 (8.0)  | 0.006 (0.15) | 0.010 (0.25) |
| <b>XBAFT3</b>  | 0.07 (1.8)             | 0.11 (2.8) | 0.59 (15.0) | 0.31 (8.0)  | 0.006 (0.15) | 0.010 (0.25) |
| <b>XBAFT4</b>  | 0.08 (2.1)             | 0.13 (3.4) | 0.59 (15.0) | 0.31 (8.0)  | 0.006 (0.15) | 0.012 (0.30) |
| <b>XBAFT6</b>  | 0.09 (2.3)             | 0.14 (3.6) | 0.63 (16.0) | 0.31 (8.0)  | 0.006 (0.15) | 0.012 (0.30) |
| <b>XBAFT9</b>  | 0.11 (2.9)             | 0.17 (4.2) | 0.73 (18.5) | 0.39 (10.0) | 0.008 (0.20) | 0.012 (0.30) |
| <b>XBAFT11</b> | 0.15 (3.8)             | 0.19 (4.9) | 0.91 (23.0) | 0.47 (12.0) | 0.008 (0.20) | 0.012 (0.30) |
| <b>XBAFT13</b> | 0.19 (4.9)             | 0.23 (5.9) | 0.98 (25.0) | 0.55 (14.0) | 0.008 (0.20) | 0.016 (0.40) |
| <b>XBAFT15</b> | 0.26 (6.5)             | 0.28 (7.2) | 1.02 (26.0) | 0.55 (14.0) | 0.008 (0.20) | 0.016 (0.40) |
| <b>XBAFT18</b> | 0.33 (8.5)             | 0.35 (8.8) | 1.22 (31.0) | 0.63 (16.0) | 0.008 (0.20) | 0.020 (0.50) |

**Hand Tools****Stripping Tools****Product Selection****Stripping Tools**

| Standard Pack | Catalog Number |
|---------------|----------------|
| 1             | XBTCUTSTP      |

**Technical Data and Specifications****Conductor/Cable Stripping Range**

| Description     | Specification                    |
|-----------------|----------------------------------|
| Conductor/cable | 0.2–6 mm <sup>2</sup> /24–10 AWG |
| Wire cutter     | 6 mm <sup>2</sup> /10 AWG        |

**Crimping Pliers**

The crimping pliers deform the ferrules hexagonally. For 0.25–6 mm<sup>2</sup> ferrules in accordance with DIN 46 228-1: 1992-08 and DIN 46 228-4: 1990-09.

**Product Selection****Crimping Pliers**

| Standard Pack | Catalog Number |
|---------------|----------------|
| 1             | XBTCRMP66      |

**Technical Data and Specifications****Areas of Application**

| Description | Specification          |
|-------------|------------------------|
| Conductor   | 0.25–6 mm <sup>2</sup> |
| Conductor   | 23–10 AWG              |

**Slotted Screwdrivers**

The crimping pliers deform the ferrules hexagonally. For 0.25–6 mm<sup>2</sup> ferrules in accordance with DIN 46 228-1: 1992-08 and DIN 46 228-4: 1990-09.

**Product Selection****Slotted Screwdrivers**

| Standard Pack | Catalog Number |
|---------------|----------------|
| <b>3.5 mm</b> |                |
| 1             | XBTDVR35       |
| <b>4.0 mm</b> |                |
| 1             | XBTDVR40       |

**Dimensions**

Approximate Dimensions in Inches (mm)

**Stripping Tools**

| Length     | Stripping Length | Weight In lbs (g) |
|------------|------------------|-------------------|
| 8.07 (205) | Up to 18 mm      | 0.44 (200)        |

**Dimensions**

Approximate Dimensions in Inches (mm)

**Crimping Pliers**

| Length     | Weight In lbs (g) |
|------------|-------------------|
| 6.85 (175) | 0.79 (360)        |

# 8.1

## Terminal Blocks, Fuse Blocks and Fuse Holders

IEC—XB Series

### Marking Accessories

#### Printed Marking Tag Options

##### Horizontally Printed Marking Tags and Marking Directions

|   |   |   |   |   |   |   |   |   |    |
|---|---|---|---|---|---|---|---|---|----|
| 1 | 2 | 3 | 4 | 5 | 6 | 7 | 8 | 9 | 10 |
|---|---|---|---|---|---|---|---|---|----|

Marking Direction: Horizontal

|   |   |   |   |   |   |   |   |   |    |
|---|---|---|---|---|---|---|---|---|----|
| 1 | 2 | 3 | 4 | 5 | 6 | 7 | 8 | 9 | 10 |
|---|---|---|---|---|---|---|---|---|----|

Marking Direction: Vertical

8

##### Marking Tags for 5.2 mm Wide Terminal Blocks

| Standard Pack                        | Number Sequence | Catalog Number     |
|--------------------------------------|-----------------|--------------------|
| <b>ZB5 Tags Vertically Numbered</b>  |                 |                    |
| 10                                   | 1–10 ①          | <b>XBMZB5V/1</b>   |
| 10                                   | 11–20           | <b>XBMZB5V/11</b>  |
| 10                                   | 21–30           | <b>XBMZB5V/21</b>  |
| 10                                   | 31–40           | <b>XBMZB5V/31</b>  |
| 10                                   | 41–50           | <b>XBMZB5V/41</b>  |
| 10                                   | 51–60           | <b>XBMZB5V/51</b>  |
| 10                                   | 61–70           | <b>XBMZB5V/61</b>  |
| 10                                   | 71–80           | <b>XBMZB5V/71</b>  |
| 10                                   | 81–90           | <b>XBMZB5V/81</b>  |
| 10                                   | 91–100          | <b>XBMZB5V/91</b>  |
| <b>ZBF5 Tags Vertically Numbered</b> |                 |                    |
| 10                                   | 1–10 ①          | <b>XBMZBF5V/1</b>  |
| 10                                   | 11–20           | <b>XBMZBF5V/11</b> |
| 10                                   | 21–30           | <b>XBMZBF5V/21</b> |
| 10                                   | 31–40           | <b>XBMZBF5V/31</b> |
| 10                                   | 41–50           | <b>XBMZBF5V/41</b> |
| 10                                   | 51–60           | <b>XBMZBF5V/51</b> |
| 10                                   | 61–70           | <b>XBMZBF5V/61</b> |
| 10                                   | 71–80           | <b>XBMZBF5V/71</b> |
| 10                                   | 81–90           | <b>XBMZBF5V/81</b> |
| 10                                   | 91–100          | <b>XBMZBF5V/91</b> |

##### Marking Tags for 6.2 mm Wide Terminal Blocks

| Standard Pack                        | Number Sequence | Catalog Number     |
|--------------------------------------|-----------------|--------------------|
| <b>ZB6 Tags Vertically Numbered</b>  |                 |                    |
| 10                                   | 1–10 ①          | <b>XBMZB6V/1</b>   |
| 10                                   | 11–20           | <b>XBMZB6V/11</b>  |
| 10                                   | 21–30           | <b>XBMZB6V/21</b>  |
| 10                                   | 31–40           | <b>XBMZB6V/31</b>  |
| 10                                   | 41–50           | <b>XBMZB6V/41</b>  |
| 10                                   | 51–60           | <b>XBMZB6V/51</b>  |
| 10                                   | 61–70           | <b>XBMZB6V/61</b>  |
| 10                                   | 71–80           | <b>XBMZB6V/71</b>  |
| 10                                   | 81–90           | <b>XBMZB6V/81</b>  |
| 10                                   | 91–100          | <b>XBMZB6V/91</b>  |
| <b>ZBF6 Tags Vertically Numbered</b> |                 |                    |
| 10                                   | 1–10 ①          | <b>XBMZBF6V/1</b>  |
| 10                                   | 11–20           | <b>XBMZBF6V/11</b> |
| 10                                   | 21–30           | <b>XBMZBF6V/21</b> |
| 10                                   | 31–40           | <b>XBMZBF6V/31</b> |
| 10                                   | 41–50           | <b>XBMZBF6V/41</b> |
| 10                                   | 51–60           | <b>XBMZBF6V/51</b> |
| 10                                   | 61–70           | <b>XBMZBF6V/61</b> |
| 10                                   | 71–80           | <b>XBMZBF6V/71</b> |
| 10                                   | 81–90           | <b>XBMZBF6V/81</b> |
| 10                                   | 91–100          | <b>XBMZBF6V/91</b> |

**Note**

① For text printed horizontally, change “V” in catalog number to “H.”

## Marking Tags for 8.2 mm Wide Terminal Blocks

| Standard Pack                        | Number Sequence | Catalog Number |
|--------------------------------------|-----------------|----------------|
| <b>ZB8 Tags Vertically Numbered</b>  |                 |                |
| 10                                   | 1–10 ①          | XBMZB8V/1      |
| 10                                   | 11–20           | XBMZB8V/11     |
| 10                                   | 21–30           | XBMZB8V/21     |
| 10                                   | 31–40           | XBMZB8V/31     |
| 10                                   | 41–50           | XBMZB8V/41     |
| 10                                   | 51–60           | XBMZB6V/51     |
| 10                                   | 61–70           | XBMZB8V/61     |
| 10                                   | 71–80           | XBMZB8V/71     |
| 10                                   | 81–90           | XBMZB8V/81     |
| 10                                   | 91–100          | XBMZB8V/91     |
| <b>ZBF8 Tags Vertically Numbered</b> |                 |                |
| 10                                   | 1–10 ①          | XBMZBF8V/1     |
| 10                                   | 11–20           | XBMZBF8V/11    |
| 10                                   | 21–30           | XBMZBF8V/21    |
| 10                                   | 31–40           | XBMZBF8V/31    |
| 10                                   | 41–50           | XBMZBF8V/41    |
| 10                                   | 51–60           | XBMZBF8V/51    |
| 10                                   | 61–70           | XBMZBF8V/61    |
| 10                                   | 71–80           | XBMZBF8V/71    |
| 10                                   | 81–90           | XBMZBF8V/81    |
| 10                                   | 91–100          | XBMZBF8V/91    |

## Marking Tags for 10.2 mm Wide Terminal Blocks

| Standard Pack                         | Number Sequence | Catalog Number |
|---------------------------------------|-----------------|----------------|
| <b>ZB10 Tags Vertically Numbered</b>  |                 |                |
| 10                                    | 1–10 ①          | XBMZB10V/1     |
| 10                                    | 11–20           | XBMZB10V/11    |
| 10                                    | 21–30           | XBMZB10V/21    |
| <b>ZBF10 Tags Vertically Numbered</b> |                 |                |
| 10                                    | 1–10 ①          | XBMZBF10V/1    |
| 10                                    | 11–20           | XBMZBF10V/11   |
| 10                                    | 21–30           | XBMZBF10V/21   |

## Marking Tags for 12 mm Wide Terminal Blocks

| Standard Pack                         | Number Sequence | Catalog Number |
|---------------------------------------|-----------------|----------------|
| <b>ZB12 Tags Vertically Numbered</b>  |                 |                |
| 10                                    | 1–10 ①          | XBMZB12V/1     |
| 10                                    | 11–20           | XBMZB12V/11    |
| 10                                    | 21–30           | XBMZB12V/21    |
| <b>ZBF12 Tags Vertically Numbered</b> |                 |                |
| 10                                    | 1–10 ①          | XBMZBF12V/1    |
| 10                                    | 11–20           | XBMZBF12V/11   |
| 10                                    | 21–30           | XBMZBF12V/21   |

## Marking Tags for 16 mm Wide Terminal Blocks

| Standard Pack                         | Number Sequence | Catalog Number |
|---------------------------------------|-----------------|----------------|
| <b>ZB15 Tags Vertically Numbered</b>  |                 |                |
| 10                                    | 1–10 ①          | XBMZB15V/1     |
| 10                                    | 11–20           | XBMZB15V/11    |
| 10                                    | 21–30           | XBMZB15V/21    |
| <b>ZBF15 Tags Vertically Numbered</b> |                 |                |
| 10                                    | 1–10 ①          | XBMZBF15V/1    |
| 10                                    | 11–20           | XBMZBF15V/11   |
| 10                                    | 21–30           | XBMZBF15V/21   |

**Note**

① For text printed horizontally, change “V” in catalog number to “H.”

# 8.1

## Terminal Blocks, Fuse Blocks and Fuse Holders

IEC—XB Series

### Pre-Printed Marking Tags

#### Terminal Blocks Marking Tags

The tags are made of white self-extinguishing polyamide 6.6 and the imprint is hot stamped with rubproof black ink.

- White marking strip available preprinted. Strip covers 10 terminals. Marking 1–10, 11–20, up to 991–999. Contact Eaton for more options.
  - XBMZB5 or XBMZBF5 for terminal blocks 5.2 mm wide
  - XBMZB6 or XBMZBF6 for terminal blocks 6.2 mm wide
  - XBMZB8 or XBMZBF8 for terminal blocks 8.2 mm wide
  - XBMZB10 or XBMZBF10 for terminal blocks 10.2 mm wide
  - XBMZB12 or XBMZBF12 for terminal blocks 12 mm wide
  - XBMZB15 or XBMZBF15 for terminal blocks 16 mm wide

8

### Marking Tag Sizes

**Note:** Marking Tag Sizes are for all catalog numbers starting with given prefix, EXCEPT FUSE TERMINAL Blocks.

#### Proper Marking Tag Size

| XBMZB5                 | XBMZBF5             | XBMZB6                 | XBMZBF6                | XBMZB8                | XBMZBF8               | XBMZB10              | XBMZBF10            | XBMZB12             | XBMZBF12            | XBMZB15             | XBMZBF15            | XBMSSZB |
|------------------------|---------------------|------------------------|------------------------|-----------------------|-----------------------|----------------------|---------------------|---------------------|---------------------|---------------------|---------------------|---------|
| XBUT25                 | XBPT25 <sup>②</sup> | XBUT4                  | XBPT4 <sup>②</sup>     | XBUT6                 | XBPT6 <sup>②</sup>    | XBUT10               | XBPT10 <sup>②</sup> | XBPT16 <sup>①</sup> | XBPT16 <sup>②</sup> | XBUT35              | XBPT35 <sup>②</sup> | XBMKLMZ |
| XBUT4FBE <sup>①</sup>  | XBPTT25             | XBUTT4                 | XBPTT4                 | XBPT6 <sup>①</sup>    | XBPT4FBN <sup>②</sup> | XBUT16               | —                   | —                   | —                   | XBPT35 <sup>①</sup> | —                   | —       |
| XBUT6FBN <sup>①</sup>  | XBPTK               | XB3UKA                 | XBPT4FBE <sup>②</sup>  | XBUK6                 | XBPT4FSI <sup>②</sup> | XBTK                 | —                   | —                   | —                   | —                   | —                   | —       |
| XBPT25 <sup>①</sup>    | XBPU25 <sup>②</sup> | XB3UKF                 | XBQT25 <sup>③</sup>    | XBPT4FSI <sup>①</sup> | —                     | XBUK50               | —                   | —                   | —                   | —                   | —                   | —       |
| XBPT4FBE <sup>①</sup>  | XBAP ...            | XBUT4FBE <sup>②</sup>  | XBQT25FBE <sup>③</sup> | —                     | —                     | XBUK150              | —                   | —                   | —                   | —                   | —                   | —       |
| XBPU25 <sup>①</sup>    | XBQT15 <sup>③</sup> | XBUT6FBN <sup>②</sup>  | XBQU25 <sup>③</sup>    | —                     | —                     | XBUK95               | —                   | —                   | —                   | —                   | —                   | —       |
| XBQT15 <sup>①</sup>    | XBQT15              | XBUK10                 | —                      | —                     | —                     | XBPT10 <sup>①</sup>  | —                   | —                   | —                   | —                   | —                   | —       |
| XBQT25FBE <sup>④</sup> | XBQU15 <sup>③</sup> | XBUK4                  | —                      | —                     | —                     | XBMKLMZ <sup>⑤</sup> | —                   | —                   | —                   | —                   | —                   | —       |
| XBQU15 <sup>①</sup>    | XBMPK15             | XBPT4 <sup>①</sup>     | —                      | —                     | —                     | —                    | —                   | —                   | —                   | —                   | —                   | —       |
| XBMUK25                | XBMPK15             | XBPT4FBN <sup>①</sup>  | —                      | —                     | —                     | —                    | —                   | —                   | —                   | —                   | —                   | —       |
| —                      | XBATCP...           | XBQT25 <sup>①</sup>    | —                      | —                     | —                     | —                    | —                   | —                   | —                   | —                   | —                   | —       |
| —                      | —                   | XBQT25FBE <sup>①</sup> | —                      | —                     | —                     | —                    | —                   | —                   | —                   | —                   | —                   | —       |
| —                      | —                   | XBQU25 <sup>①</sup>    | —                      | —                     | —                     | —                    | —                   | —                   | —                   | —                   | —                   | —       |
| —                      | —                   | XBMUK4                 | —                      | —                     | —                     | —                    | —                   | —                   | —                   | —                   | —                   | —       |

#### Notes

- ① For center labeling.
- ② For external labeling.
- ③ For center and outside labeling.
- ④ For lever labeling.
- ⑤ Two (2) XBMZB10 tags fit in one (1) XBMKLMZ.



**Marker Strips and Sheets (for use with XBAPLT2006K1 plotter)**

The **XB** Series marking system provides logical and clear identification of the modular terminal blocks and interface modules.

**Product Selection****XBMZB\_****Marker Strips (Strip of 10)**

| Terminal Width      | Standard Pack | Catalog Number              |
|---------------------|---------------|-----------------------------|
| <b>Blank Strips</b> |               |                             |
| 5.2 mm              | 10            | <b>XBMZB5</b>               |
| 6.2 mm              | 10            | <b>XBMZB6</b>               |
| 8.2 mm              | 10            | <b>XBMZB8</b>               |
| 10.2 mm             | 10            | <b>XBMZB10</b>              |
| 12 mm               | 10            | <b>XBMZB12</b>              |
| 16 mm               | 10            | <b>XBMZB15</b> <sup>①</sup> |
| <b>Flat Strips</b>  |               |                             |
| 5.2 mm              | 10            | <b>XBMZBF5</b>              |
| 6.2 mm              | 10            | <b>XBMZBF6</b>              |
| 8.2 mm              | 10            | <b>XBMZBF8</b>              |
| 10.2 mm             | 10            | <b>XBMZBF10</b>             |
| 12 mm               | 10            | <b>XBMZBF12</b>             |
| 16 mm               | 10            | <b>XBMZBF15</b>             |

**Marker Sheets (Strip of 10)**

| Terminal Width)                           | Color  | Standard Pack | Catalog Number    |
|---|--------|---------------|-------------------|
| <b>Marker Sheets (10 rows of 12)</b>      |        |               |                   |
| 5.2 mm                                    | White  | 50            | <b>XBMPZB5</b>    |
|   | Blue   | 50            | <b>XBMPZB5BU</b>  |
|   | Red    | 50            | <b>XBMPZB5RD</b>  |
|   | Yellow | 50            | <b>XBMPZB5YE</b>  |
|   | Green  | 50            | <b>XBMPZB5GN</b>  |
| <b>Marker Sheets (10 rows of 10)</b>      |        |               |                   |
| 6.2 mm                                    | White  | 50            | <b>XBMPZB6</b>    |
|   | Blue   | 50            | <b>XBMPZB6BU</b>  |
|   | Red    | 50            | <b>XBMPZB6RD</b>  |
|   | Yellow | 50            | <b>XBMPZB6YE</b>  |
|   | Green  | 50            | <b>XBMPZB6GN</b>  |
| <b>Flat Marker Sheets (10 rows of 10)</b> |        |               |                   |
| 5.2 mm                                    | White  | 10            | <b>XBMPZBF5</b>   |
|   | Orange | 10            | <b>XBMPZBF5OG</b> |
|   | White  | 10            | <b>XBMPZBF6</b>   |
|   | Orange | 10            | <b>XBMPZBF6OG</b> |
|   | White  | 10            | <b>XBMPZBF8</b>   |

**XBMPZB\_****XBMPZBF\_****Label Sheets for Laser Printers**

The XBM labels have been specially developed for laser printers and have considerable advantages:

- Can be printed on all commercially available laser printers
- Or can use plotter or pen for printing
- Good adhesive properties
- A4 size
- XBMKL25X12WH designed to fit XBGBS2512 group marker
- XBMLMAL447 is perforated for terminal strip marker XBMGLMA and is 44 x 7 mm

**Product Selection****XBM\_****Label Sheets**

| Standard Pack | Catalog Number      |
|---------------|---------------------|
| 10            | <b>XBMKL25X12WH</b> |
| 10            | <b>XBMLMAL447</b>   |

**Note**

<sup>①</sup> All markers are strips of 10, except XBMZB15, which is a strip of 5.

# 8.1

## Terminal Blocks, Fuse Blocks and Fuse Holders

IEC—XB Series

### Terminal Block Group Marking

Terminal block groups are marked using marking labels that are snapped into the marker strip groove of the terminal blocks. The group is marked using either labels or insert markers.

#### Product Selection

XBGBS2512



#### Terminal Block Group Marking <sup>①</sup>

| Standard Pack | Catalog Number |
|---------------|----------------|
| 100           | XBGBS2512      |

### Insert Markers for Laser Printers

One sheet = 56 labels. Lettering field is 40 x 17 mm.

#### Product Selection

XBMUBEL4017



#### Insert Markers for XBMUBE(D)

| Standard Pack | Catalog Number |
|---------------|----------------|
| 10            | XBMUBEL4017    |

8

### Terminal Strip Markers

Adjustable height for end bracket labeling.

#### Product Selection

XBM\_



#### Terminal Strip Markers <sup>①</sup>

| Standard Pack         | Catalog Number |
|-----------------------|----------------|
| <b>20 x 8 mm Wide</b> |                |
| 10                    | XBMKLM2        |
| <b>44 x 7 mm Wide</b> |                |
| 10                    | XBMGLMA        |

### Refillable Marker Pen

Refillable marker pen for manual labeling, line thickness 0.35 mm.

#### Product Selection

XBMXPEN



#### Terminal Strip Markers <sup>①</sup>

| Standard Pack        | Catalog Number |
|----------------------|----------------|
| <b>Pen</b>           |                |
| 1                    | XBMXPEN        |
| <b>Ink Cartridge</b> |                |
| 1                    | XBMINK         |

### Terminal Strip Marker Carriers

For labeling terminal groups, for mounting on DIN rail. Lettering field is 40 x 17 mm.

#### Product Selection

XBMUB\_



#### Terminal Strip Marker Carriers

| Standard Pack | Catalog Number |
|---------------|----------------|
| 10            | XBMUBE         |
| 10            | XBMUBED        |

### Non-Refillable Marker Pen

For manual labeling, line thickness 0.5 mm.

#### Product Selection

XBMUBE



#### Non-Refillable Marker Pen

| Standard Pack | Catalog Number |
|---------------|----------------|
| 1             | XBMBSTIFT      |

#### Note

<sup>①</sup> See Page V7-T8-101 for insert labels.

**Marking Plotter**

The automatic Prepare Pen function ensures optimum marking results right from the first character.

**Custom Marking Tag System**

This plotter system uses Windows®-based software to interface with a PC, allowing custom printing on standard terminal blocks marking tags. These standard marking tags provide circuit identification for Eaton DIN rail mount terminal blocks.

Pens can remain in the pen station even for prolonged intervals without drying out.

**Features**

- Enter tag text directly into EMARK software program or import file from AutoCAD or Excel®
- Selectable font sizes, types and colors including common symbols for circuit identification (ground, ~ etc.)
- Various text formatting options including copy, paste, increment functions, text alignment, etc.
- Durable templates allow printing of four different tag sizes at the same time
- Automatic prepare pen function for optimum results

**Technical Data and Specifications****Marking Plotter**

| Description                                | Specification   |
|--|---|
| <b>Plotter</b>                             |   |
| Plotter type                               | Flatbed plotter   |
| Maximum plotting surface                   | 440 mm x 296 mm   |
| Maximum material height                    | 10.5 mm   |
| Maximum plotting speed                     | 40 cm/sec   |
| Pen station                                | Four depots with double sealing                                     |
| Drive                                      | Two-phase impulse-driven motor                                      |
| Interfaces                                 | Parallel (Centronics)/USB Level 1.1                                 |
| <b>Electronics</b>                         |   |
| Command language                           | Based on HP-GL 7475A  |
| Data buffer                                | 16 MB   |
| Addressable resolution                     | 0.01 mm   |
| Repeat accuracy                            | 0.05 mm   |
| Repeat accuracy on pen change              | 0.05 mm with optimum pen  |
| <b>Power Supply</b>                        |   |
| Power supply                               | Via separate power supply unit with exchangeable mains feeder cable |
| Power supply unit input voltage            | 100–240 Vac/50–60 Hz  |
| Power supply unit input current (maximum)  | 0.3A at 230V~   |
| Power supply unit output voltage           | 24 Vdc  |
| Power supply unit output current (maximum) | 1.4A  |
| <b>Environmental conditions</b>            |   |
| Operation                                  | 50° to 95°F (10° to 35°C)<br>35% to 75% relative humidity           |
| Storage                                    | 14° to 122°F (–10° to 50°C)<br>10% to 90% relative humidity         |

**Dimensions**

Approximate Dimensions in Inches (mm)

**Marking Plotter**

| L           | W           | H          | Approx. Weight<br>In Lbs (kg) |
|-------------|-------------|------------|-------------------------------|
| 25.98 (660) | 17.32 (440) | 4.92 (125) | 18 (8)                        |

# 8.1

## Terminal Blocks, Fuse Blocks and Fuse Holders

IEC—XB Series

### Marking Plotter

| Description  | Standard Pack | Catalog Number        |
|--|---------------|-----------------------|
| Plotter kit <sup>①</sup>                           | 1             | <b>XBAPLT2006K1</b>   |
| Pen station sealing set                            | 1             | <b>XBMP1PENDEPOT</b>  |
| Plotter pen preparation plate                      | 1             | <b>XBMP1PREPLATES</b> |
| Template for marker strips                         | 1             | <b>XBMP1MZB</b>       |
| Template for flat marker strips                    | 1             | <b>XBMP1MZBF</b>      |
| Template for XBMPZB marker sheets                  | 1             | <b>XBMP1MPZB</b>      |
| Template for XBMPZBF marker sheets                 | 1             | <b>XBMP1MPZBF</b>     |
| Template for Weidmuller multiscard sheet           | 1             | <b>XBMP1MCSF46</b>    |
| Template for Weidmuller multiscard sheet universal | 1             | <b>XBMP1MCU</b>       |
| Template for Entrelec sheets                       | 1             | <b>XBMP1MRC</b>       |
| 0.25 mm disposal pen                               | 1             | <b>XBMDPEN25R</b>     |
| 0.35 mm disposal pen                               | 1             | <b>XBMDPEN35R</b>     |
| 0.25 mm pen  | 1             | <b>XBMPEN25</b>       |
| 0.35 mm pen  | 1             | <b>XBMPEN35</b>       |
| Ink Cartridge                                      | 2             | <b>XBMINK</b>         |
| Pen cleaning set                                   | 1             | <b>XBMRSET</b>        |
| Cleaning cartridges                                | 2             | <b>XBMRMEKFC2</b>     |

8

### EMARK Software

Eaton's EMARK software makes labeling your terminal blocks quick and simple. You can import your data from ECHART, any other CAD/CAE program, or enter text directly into EMARK. The software allows marking tags to be printed on the PLT2006 plotter in a professional manner.

#### Note

<sup>①</sup> Plotter kit includes PLT2006 plotter system with EMARK software and user manual, starter ink and cleaning sets, and templates for marking all XBMZB and XBMZBF tags.

## Testing Accessories

### Test Adapter

For 4 mm diameter test plug and 4 mm diameter safety test plug. Makes contact in the bridge shaft.

### Product Selection

| XBATSPA14   | Test Adapter  |                |
|---|---------------|----------------|
|   | Standard Pack | Catalog Number |
|  | 1             | XBATSPA14      |

### Modular Test Plugs

For individual assembly of test plug strips.



### Product Selection

| XBATS_   | Modular Test Plugs  |                |
|--|---------------------|----------------|
|  | Standard Pack       | Catalog Number |
|  | <b>Test Plugs</b>   |                |
|  | 10                  | XBATSPS5       |
|  | 10                  | XBATSPS6       |
|  | 10                  | XBATSPS8       |
|  | <b>Spacer Plate</b> |                |
|  | 10                  | XBATSDPPS5     |
|  | 10                  | XBATSDPPS6     |
|  | 10                  | XBATSDPPS8     |

### Test Plugs

Consisting of metal part for socket hole and insulating sleeve.

### Product Selection

| XBATSMP_  | Test Plugs    |                |
|---|---------------|----------------|
|   | Standard Pack | Catalog Number |
|  | <b>2.3 mm</b> |                |
|   | 10            | —              |
|   | 10            | Blue           |
|   | 10            | White          |
|   | 10            | Red            |
|   | 10            | Black          |
|  | <b>4 mm</b>   |                |
|   | 10            | —              |
|   | 10            | Blue           |
|   | 10            | White          |
|   | 10            | Red            |
|   | 10            | Black          |

## Separating Plates, Covers and Bridges

### End Cover

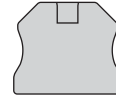

Used to cover an open end of terminal block when changing sizes within an assembly and/or for last terminal block in a row.

### Partition Plate

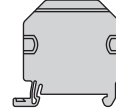

Protrudes over the terminal block and is used to increase electrical clearance between terminals. Also provides visual indications of the functions of terminal blocks. For example, terminal blocks between two partition plates may provide an exact location for test points.

### End Cover Segment



Covers protruding terminal block segments of three- and four-wire terminal blocks when next to a two wire blocks. This ensures that all is touch-proof and saves space over using a standard end cover.

### Jumper/Bridge

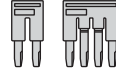

Provides the ability to electrically connect terminal blocks. Non-adjacent blocks may be bridged by snapping off the contact tabs of the standard bridge. The reducing bridge permits simple connection of terminal blocks with different nominal cross-sections.

### Note

See these accessories as listed with terminal blocks for more information.

# 8.2

## Terminal Blocks, Fuse Blocks and Fuse Holders

NEMA

NEMA



8

### Contents

#### Description

#### Page

NEMA

C381 Series Terminal Blocks, Rail Mounted . . .  
TB Series Terminal Blocks, Modular . . . . .

**V7-T8-107**  
**V7-T8-111**

### NEMA Overview

#### Product Description

NEMA terminal blocks provide a panel or DIN rail mount block that can be assembled from modular pieces. These blocks accommodate wire from 22 to 1/0 AWG and up to 175A and 600V.

#### Standards and Certifications

- UL File #E67464 and #E56797

## C381 Series Terminal Blocks, Rail Mounted



## Contents

| <b>Description</b>                        | <b>Page</b>      |
|---|------------------|
| C381 Series Terminal Blocks, Rail Mounted |                  |
| Product Selection .....                   | <b>V7-T8-108</b> |
| Accessories .....                         | <b>V7-T8-109</b> |
| Modifications .....                       | <b>V7-T8-109</b> |
| Technical Data and Specifications .....   | <b>V7-T8-110</b> |
| Dimensions .....                          | <b>V7-T8-110</b> |
| TB Series Terminal Blocks, Modular .....  | <b>V7-T8-111</b> |

## C381 Series Terminal Blocks, Rail Mounted

### Product Description

- 600V
- Snap-fit nylon sections
  - Control circuit blocks
  - Power circuit blocks
  - Fuse blocks
  - Switch blocks
- Sections can be interlocked in any quantity and any mixture for direct panel mounting or channel mounting
- Three terminal choices in control circuit blocks, up to 32 circuits per foot
- Power circuit blocks for heavy-duty applications, up to 16 circuits per foot
- Fuse blocks accommodate any 0.406 x 1.5 in (10.3 x 38.1 mm) ferrule type cartridge fuse up to 30A
- Switch blocks have removable blade for extra safety

### Standards and Certifications

- UL File #E67464



### A Typical Mixture of Control Circuit Blocks, Power Blocks, Switch and Fuse Blocks in a Mounting Channel

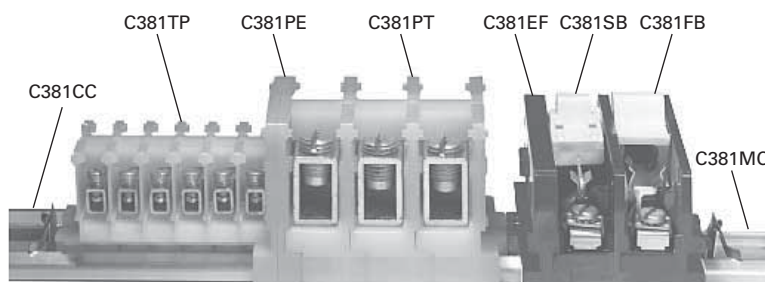

# 8.2

## Terminal Blocks, Fuse Blocks and Fuse Holders

NEMA

### Product Selection

#### When Ordering Specify

Catalog number and quantity, which must be in a multiple of the available minimum standard package.

Examples:









- 200 Cat. No. C381ST
- 20 Cat. No. C381PT
- 100 Cat. No. C381CC

Catalog number and quantity of end sections also in minimum quantity standard package.

Example:

- 25 Cat. No. C381ES

### Control, Power, Switch and Fuse Blocks <sup>①</sup>

|   | Description                                   | AWG Wire Size | Standard Pack <sup>②</sup> | Catalog Number |
|---|---|---------------|----------------------------|----------------|
| <b>Control Circuit Terminal Blocks—Rated 50A</b>                                    |   |               |                            |                |
|    | C381ST<br>Type ST (screw terminal)            | 22–14 AWG     | 100                        | C381ST         |
|    | C381TP<br>Type TP (tubular pressure plt)      | 22–10         | 100                        | C381TP         |
|    | C381TS<br>Type TS (tubular screw) end section | 18–8          | 100                        | C381TS         |
|  | C381ES<br>End section                         | —             | 25                         | C381ES         |
| <b>Power Circuit Terminal Blocks—Rated 155A</b>                                     |   |               |                            |                |
|  | C381PT<br>Type PT (tubular screw)             | 10–1/0        | 10                         | C381PT         |
|  | C381PE<br>End section                         | —             | 10                         | C381PE         |
| <b>Switch Blocks—Rated 15A and Fuse Blocks—Rated 30A</b>                            |   |               |                            |                |
|  | C381SB<br>Switch blocks                       | 18–8          | 10                         | C381SB         |
|  | C381FB<br>Fuse blocks                         | 18–8          | 10                         | C381FB         |
|  | C381EF<br>End section                         | —             | 10                         | C381EF         |

#### Notes

- ① Available only in minimum quantity standard packages.
- ② Must be ordered in standard package quantity or in multiples of these quantities.



## Accessories

### C381 Series Terminal Blocks, Rail Mounted <sup>①</sup>

| Description   | Standard Pack <sup>②</sup> | Catalog Number |
|---|----------------------------|----------------|
| Aluminum mounting channel—6 ft (1.8m) lengths   | 25                         | <b>C381MC</b>  |
| Screw type channel clamp (one required each end) <sup>③</sup>                         | 100                        | <b>C381VC</b>  |
| Spring type channel clamp (one required each end) <sup>③</sup>                        | 100                        | <b>C381CC</b>  |
| Vinyl marking strip—3/8 in x 25 ft (9.5 mm x 7.6m) coil                               | 1                          | <b>C381MS</b>  |
| Marking paper—pressure sensitive—5/16 x 11-11/16 in (7.9 x 296.9 mm), 24 strips/sheet | 5 sheets                   | <b>C381MP</b>  |
| Marking strip retainer (one required/grouping)  |                            |                |
| For use on control circuit blocks   | 100                        | <b>C381SR</b>  |
| For use on power circuit blocks   | 100                        | <b>C381SP</b>  |
| Fanning strip—for type TP and/or TS   | 50                         | <b>C381TF</b>  |
| Fanning strip—for type ST   | 50                         | <b>C381SF</b>  |
| Terminal jumper (two-pole) <sup>④</sup>   | 100                        | <b>C381TJ</b>  |
| Ganging rod—1/8 in x 6 in (3.2 mm x 152.4 mm) <sup>⑤</sup>                            | 10                         | <b>C381GR</b>  |

## Modifications

### Pull Apart Terminal Blocks <sup>①</sup>

| Description  | AWG Wire Size | Standard Pack <sup>②</sup> | Catalog Number |
|--|---------------|----------------------------|----------------|
| One-pole stationary section (tubular pressure plt)         | 22–10         | 100                        | <b>C381PS</b>  |
| Three-pole movable section (tubular pressure plt)          | 22–10         | 12                         | <b>C381PM</b>  |
| End section  | —             | 25                         | <b>C381ES</b>  |
| Polarizing plug (promotes alignment of poles) <sup>⑥</sup> | —             | 100                        | <b>C381PP</b>  |

### Pull Apart Terminal Blocks

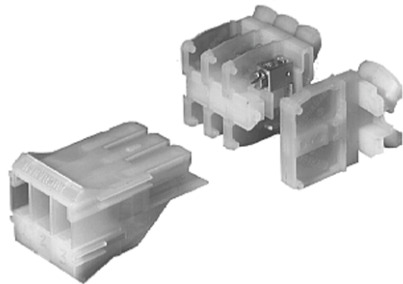

**Illustrates: One–Three-Pole Movable Section, Three–One-Pole Stationary Sections and One–End Piece**

#### Notes

- ① Available only in minimum quantity standard packages.
- ② Must be ordered in standard package quantity or in multiples of these quantities.
- ③ C381CC is a snap-in, one time use disposable type. C381VC can be readjusted or reused as desired.
- ④ For use on adjacent Type TP and/or TS control circuit sections.
- ⑤ May be used on section covers or to gang fuse and/or switch blocks.
- ⑥ L shaped plug installs in end of stationary section, Catalog Number C381PS, and prevents incorrect installation of movable section, Catalog Number C381PM.

# 8.2

## Terminal Blocks, Fuse Blocks and Fuse Holders

NEMA

### Technical Data and Specifications

#### Formulas for Calculating Blocks and Channel Lengths

N = Number of Blocks

#### C381 Series Terminal Blocks, Rail Mounted

| Description                               | Blocks Length                 |
|---|-------------------------------|
| Control blocks and pull apart blocks      | $0.762 + (0.375 \times N)$    |
| Power circuit blocks                      | $0.812 + (0.750 \times N)$    |
| Fuse and switch blocks                    | $0.812 + (0.755 \times N)$    |
| Mounting channel (minimum channel length) | $0.75 + \text{blocks length}$ |

### Dimensions

Approximate Dimensions in Inches (mm)

8

#### C381 Series Terminal Blocks, Rail Mounted

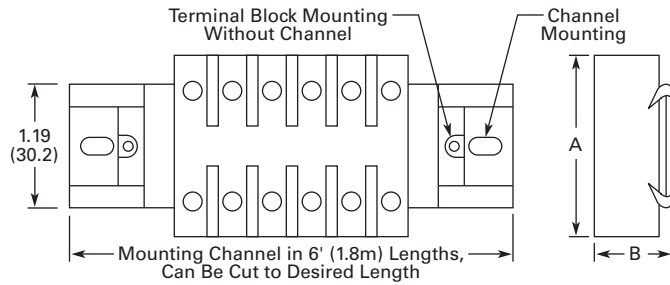

| Block                  | A           | B           |
|------------------------|-------------|-------------|
| Control circuit blocks | 1.25 (31.8) | 1.55 (39.4) |
| Power circuit blocks   | 1.75 (44.5) | 2.00 (50.8) |
| Fuse blocks            | 2.75 (69.9) | 2.00 (50.8) |
| Switch blocks          | 2.75 (69.9) | 2.00 (50.8) |
| Pull apart blocks      | 1.88 (47.8) | 2.75 (69.9) |

## TB Series Terminal Blocks, Modular



## Contents

| <i>Description</i>                                  | <i>Page</i> |
|---|-------------|
| C381 Series Terminal Blocks, Rail Mounted . . . . . | V7-T8-107   |
| TB Series Terminal Blocks, Modular                  |             |
| Product Selection . . . . .                         | V7-T8-112   |
| Accessories . . . . .                               | V7-T8-113   |
| Technical Data and Specifications . . . . .         | V7-T8-114   |
| Dimensions . . . . .                                | V7-T8-115   |

## TB Series Terminal Blocks, Modular

**Product Description**

TBA and TBD modular terminal blocks are designed to conserve space, while allowing maximum flexibility and ease of installation. Available as one-, two- and three-pole circuits, simple and uniform installation is possible because their design is based on 5/8 in (15.9 mm) modules. Standard blocks are white nylon.

**Breathing Action Clamping Collar**

The unique design of the clamping collar permits the collar to breathe as the wire expands and contracts, maintaining a constant and permanent clamping pressure. This eliminates loose connections resulting from the gradual flattening of conductors and joint deterioration caused by heating and cooling cycles.

**Features****Blocks—Design Features**

- Compact design permits mounting 48–600V or 90–300V terminals per foot
- Fully shielded construction, 600V spacings
- Nylon construction provides anti-tracking and impact resistance
- TBA types are available in rail mounted, base mounted and power distribution types
- Terminal blocks easily snap on or off mounting rails; not necessary to disturb adjacent units
- No end pieces or backing plates are needed when rail mounting
- A 12 circuit subminiature blocks, rated 20A at 300V, is available for “high density” applications
- Popular blocks are also available in dual mount for use with standard TBA or 35 mm DIN rails

**Terminals—Design Features**

- Insulated walls of lug guide wire into lug
- Blocks are shipped with clamping screw backed out
- Constant locking torque keeps terminal screws in position
- Terminal screws are captive; cannot be lost in shipment or handling
- Hardened stainless steel clamping collar eliminates stripped threads
- Large opening in clamping collar accommodates oversized conductors; smallest collar will accept three 14 AWG stranded conductors

**Standards and Certifications**

- UL recognized: File No. E56797
- CE approved



# 8.2

## Terminal Blocks, Fuse Blocks and Fuse Holders

NEMA

### Product Selection

#### TBA Modular Terminal Blocks

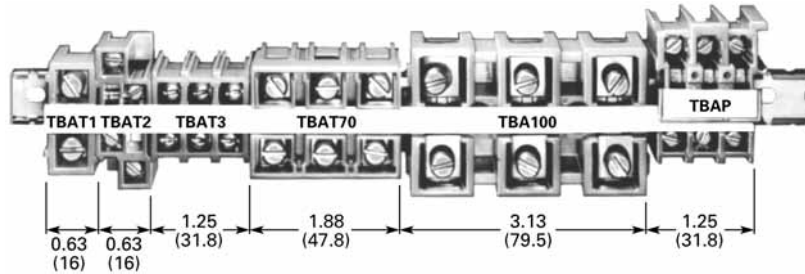

8

#### Rail and Base Mounted Terminal Blocks

| Description   | AWG Wire Size | Number of Poles | Ampacity (per Circuit) <sup>①</sup> | Carton Quantity <sup>②</sup> | TBA Rail Catalog Number | DIN Rail <sup>③</sup> Catalog Number |
|---|---------------|-----------------|-------------------------------------|------------------------------|-------------------------|--------------------------------------|
| <b>Rail Mounted—600V</b>  |               |                 |                                     |                              |                         |                                      |
| Subminiature blocks   | (2) 14–12     | 12              | 5A                                  | 100                          | TBDSM12 <sup>④</sup>    | TBDSM12 <sup>④</sup>                 |
| Miniature blocks  | 22–10         | 4               | 30A                                 | 100                          | TBDV4                   | TBDV4                                |
| Standard blocks—screw terminals with tang clamping collars                  | 18–2          | 1               | 90A                                 | 100                          | —                       | TBDT1                                |
|   | 22–8          | 2               | 40A                                 | 100                          | TBAT2                   | —                                    |
|   | 22–8          | 3               | 40A                                 | 20                           | TBAT3-20                | TBDT3-20                             |
|   | 18–4          | 3               | 90A                                 | 100                          | TBDT70                  | TBDT70                               |
| High current blocks   | 14–2/0        | 3               | 175A                                | 12                           | TBA100 <sup>⑤</sup>     | —                                    |
| Standard blocks—plug-in terminals   | 22–8          | 3               | 40A                                 | 20                           | TBAP                    | —                                    |
|   | 18–4          | 3               | 70A                                 | 20                           | TBAP70                  | —                                    |
|   | 14–8          | 3               | 40A                                 | 20                           | TBAPL70                 | —                                    |
| Panel mount blocks  | 22–10         | 3               | 30A                                 | 100                          | TBAL30                  | —                                    |
|   | 8–4           | 3               | 115A                                | 12                           | TBAL90                  | —                                    |
| Disconnect blocks—for 1/4 in (6.4 mm) dia. by 1–1/16 in (25.4–36.5 mm) fuse | 22–8          | 1               | 30A                                 | 50                           | TBAD                    | —                                    |
| Fuse blocks—for 13/32 in (10.3 mm) dia. by 1-1/2 in (38.1 mm) fuse          | 22–8          | 1               | 30A                                 | 50                           | TBDTF                   | TBDTF                                |
| <b>Base Mounted—600V</b>  |               |                 |                                     |                              |                         |                                      |
| Miniature blocks—screw terminals with tang clamping collars                 | 22–10         | 4               | 30A (600V)                          | 90                           | TBBT4                   | —                                    |
| Standard blocks—standard screw terminals                                    | 22–8          | 3               | 40A                                 | 80                           | TBAPT3                  | —                                    |
| Universal mounting blocks   | 8 maximum     | 4               | 50A <sup>⑥</sup>                    | 25                           | TBU4                    | —                                    |
|   | 8 maximum     | 6               | 50A <sup>⑥</sup>                    | 60                           | TBU6                    | —                                    |
|   | 8 maximum     | 8               | 50A <sup>⑥</sup>                    | 45                           | TBU8                    | —                                    |
|   | 8 maximum     | 12              | 50A <sup>⑥</sup>                    | 35                           | TBU12                   | —                                    |

#### Notes

- ① Based on 50°C rise, test at 25°C ambient while using maximum wire size.
- ② Must be ordered in standard package quantity or in multiples of these quantities.
- ③ Dual mounting blocks—mount on either TMR/TBA rail or 35 mm DIN rail.
- ④ May also be mounted on mini-DIN rail (15 mm). Catalog Number C383TS15.
- ⑤ May also be base mounted.
- ⑥ TBU Series = 60A with crimped wire.

**Accessories****TB Series Terminal Blocks, Modular**

| Description                               | Length <sup>①</sup> | Number of Poles | Carton Quantity <sup>②</sup> | Catalog Number     |
|---|---------------------|-----------------|------------------------------|--------------------|
| <b>Mounting Rail</b>                      |                     |                 |                              |                    |
| Aluminum                                  | 12.5 (317.5)        | —               | 25                           | <b>TMR12</b>       |
|   | 37.5 (952.5)        | —               | 25                           | <b>TMR37</b>       |
|   | 72.0 (1828.8)       | —               | 25                           | <b>TBATR72</b>     |
| 35 mm DIN—steel                           | 1m                  | —               | 20                           | <b>MC382MA1-20</b> |
| <b>Marking Strips</b>                     |                     |                 |                              |                    |
| Miniature blocks—TBDV4 and TBBT4          | 6.0 (152.4)         | —               | 50                           | <b>TMS6</b>        |
| TBU Series—matte finish                   | 7.5 (190.5)         | —               | 25                           | <b>TMSU</b>        |
| All other blocks                          | 12.5 (317.5)        | —               | 50                           | <b>TMS</b>         |
| <b>Jumpers</b>                            |                     |                 |                              |                    |
| TBAT1 and TBAP70                          | —                   | 2-pole          | 100                          | <b>TJ1</b>         |
| TBAT2                                     | —                   | 2-pole          | 100                          | <b>TJ2</b>         |
| TBAT3, TBABT3, TBAP and TBBP              | —                   | 2-pole          | 100                          | <b>TJ3</b>         |
| TBDV4 and TBBT4                           | —                   | 4-pole          | 100                          | <b>TJ4</b>         |
| TBAD and TBATF                            | —                   | 2-pole          | 100                          | <b>TJ5</b>         |
| TBAL30                                    | —                   | 2-pole          | 100                          | <b>TJ6</b>         |
| TBU                                       | —                   | 12-pole         | 10                           | <b>TJ7</b>         |
| TBDT3                                     | —                   | 2-pole          | 100                          | <b>TJ8</b>         |
| <b>Miscellaneous</b>                      |                     |                 |                              |                    |
| End piece for TBABT3 and TBBP             | —                   | —               | 50                           | <b>TAD</b>         |
| Lug shield for TBA100 and TBAL90          | —                   | —               | 50                           | <b>TAS</b>         |
| Fuse puller                               | —                   | —               | 50                           | <b>TBP</b>         |
| Lighted fuse puller—blown fuse indication | —                   | —               | 25                           | <b>TBLP</b>        |

**Notes**

- ① Length in inches (mm) except as noted.  
 ② Must be ordered in standard package quantity or in multiples of these quantities.

# 8.2

## Terminal Blocks, Fuse Blocks and Fuse Holders

NEMA

### Technical Data and Specifications

#### TB Series Terminal Blocks, Modular

| Description            | Specification      |
|------------------------|--------------------|
| Continuous temperature | 212°F (100°C)      |
| Tensile strength       | 10,000–12,000 psi  |
| Impact resistance      | 2.0 ft-lb/in (arc) |
| Arc resistance         | 140 seconds        |

- Chemical resistance to:
  - Acetone
  - Ammonia gas
  - Benzene
  - Gasoline
  - Mineral oil
  - Sodium bisulfate
  - Sodium chloride
  - Sodium nitrate
  - Water up to 50°C

#### Flashover Voltages

| Catalog Number | Vac rms, 60 Hz    |           |
|----------------|-------------------|-----------|
|                | Opposite Polarity | To Ground |
| <b>TBAT1</b>   | 9100              | 6600      |
| <b>TBAT2</b>   | 9600              | 7300      |
| <b>TBAT3</b>   | 8600              | 7300      |

#### Recommended Terminal Tightening Torque

| Wire Size     | Torque   |
|---------------|----------|
| Up to 8 AWG   | 20 lb-in |
| Up to 4 AWG   | 35 lb-in |
| Up to 2/0 AWG | 50 lb-in |

8

To find a current rating, place a straight edge horizontally at the value of anticipated maximum internal panel ambient (scale on the left), and read the current rating for the device on the bottom scale. *Example:* at 60°C, TBAT3 is rated 54 amperes.

Ampere rating is based on maximum allowable temperature—ambient temperature plus temperature rise due to current.

Ratings based on 90°C total temperature of a three-pole block with each pole carrying current and wired with largest size conductors.

#### Temperature Rating

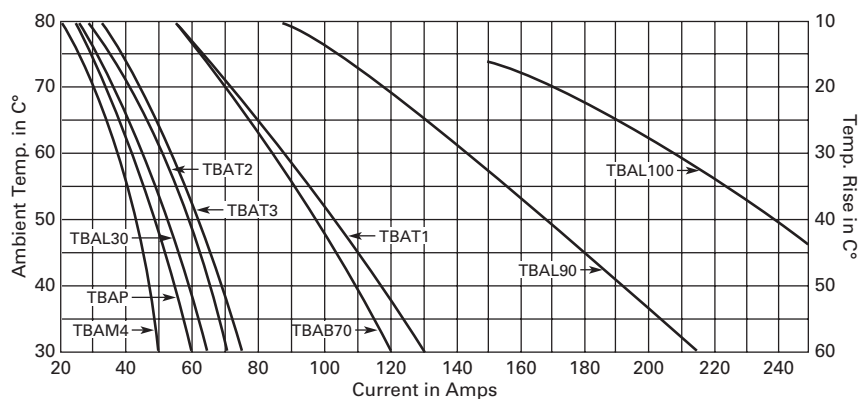

## Dimensions

Approximate Dimensions in Inches (mm)

### TB Series Terminal Blocks, Modular

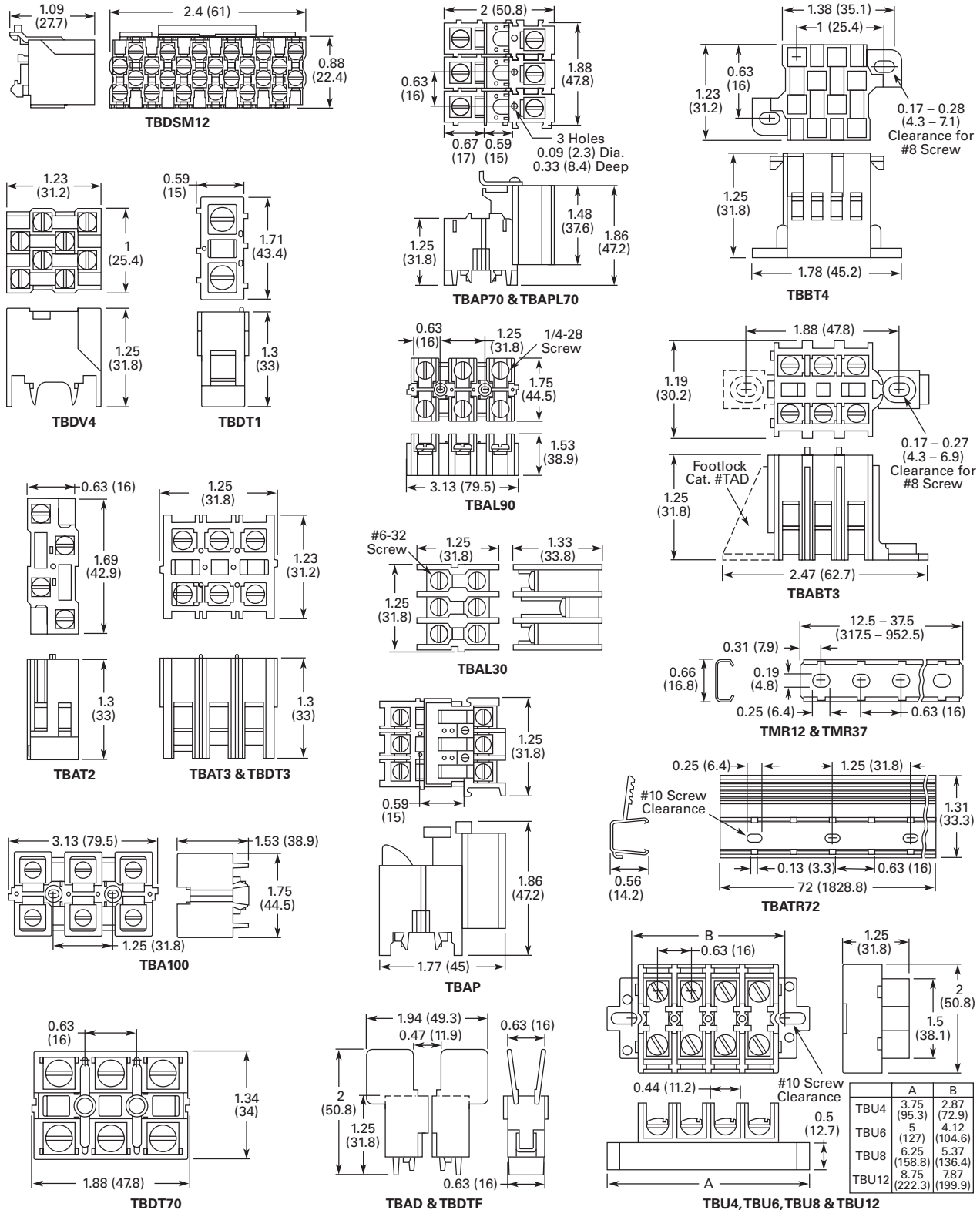

# 8.3

## Terminal Blocks, Fuse Blocks and Fuse Holders

### Power Distribution

#### Power Distribution Products



8

#### Contents

##### Description

##### Page

|   |                  |
|---|------------------|
| Power Distribution                            |                  |
| CHDB Series—Power Distribution Blocks . . . . | <b>V7-T8-117</b> |
| CH160 Series—Power Terminal Blocks . . . . .  | <b>V7-T8-123</b> |
| Power Terminal Block Accessories . . . . .    | <b>V7-T8-126</b> |

### Power Distribution Overview

#### Product Selection Guide

| Series       | Current Range | UL Certification   | High Short Circuit Current Rating <sup>①</sup> | UL 508A Approved for Industrial Control Panels |                 |              |
|--------------|---------------|--------------------|--|--|-----------------|--------------|
|              |               |                    |  | Branch Circuits                                | Feeder Circuits | HVAC UL 1995 |
| <b>CH162</b> | 115–175A      | UL 1059 Recognized | No   | Yes  | No <sup>②</sup> | Yes          |
| <b>CH163</b> | 175–420A      | UL 1059 Recognized | No   | Yes  | No <sup>②</sup> | Yes          |
| <b>CH165</b> | 620–840A      | UL 1059 Recognized | No   | Yes  | No <sup>②</sup> | Yes          |
| <b>CHDB</b>  | 175–570A      | UL 1953 Listed     | Yes  | Yes  | Yes             | Yes          |

#### Notes

- ① Refer to **Page V7-T8-118** to determine short circuit current ratings with fuses and **Pages V7-T8-119** and **V7-T8-120** to determine short circuit current ratings in conjunction with specific Eaton circuit breakers.
- ② Single-pole units, when installed with proper spacings, may meet requirements for UL 508A feeder circuits.



**CHDB Series—Power Distribution Blocks, Enclosed and Open****Contents**

| <b>Description</b>                           | <b>Page</b>      |
|--|------------------|
| CHDB Series—Power Distribution Blocks        |                  |
| Product Selection . . . . .                  | <b>V7-T8-118</b> |
| Technical Data and Specifications . . . . .  | <b>V7-T8-118</b> |
| Dimensions . . . . .                         | <b>V7-T8-121</b> |
| CH160 Series—Power Terminal Blocks . . . . . | <b>V7-T8-123</b> |
| Power Terminal Block Accessories . . . . .   | <b>V7-T8-126</b> |

**CHDB Series—Power Distribution Blocks****Product Description**

Eaton's CHDB Series of Power Distribution Blocks was designed for high short circuit current rating (SCCR) applications up to 200,000 amperes. They are assembled with the minimum spacing to meet UL 1953 requirements for feeder circuits in UL 508A industrial control panels, and provide significant wiring flexibility.

Available in three-pole open style and single-pole enclosed style with a variety of terminal arrangements and current-carrying capability up to 570 amperes.

**Features and Benefits****Enclosed Style**

- IP20 finger-safe enclosure
- 600 Vac or Vdc (UL 1953), 690 Vac or Vdc
- DIN rail or panel mount
- Captive termination screws prevent lost screws
- Single-pole, gang mountable for multi-pole applications
- Tin plated Al connections suitable for Cu conductors
- Flammability, UL 94V-0

**Open Style**

- 600 Vac or Vdc (UL 1953)
- Panel mount
- Three-pole open design for easy wiring
- Tin-plated Al connections suitable for Cu conductors
- Flammability, UL 94V-0
- Available covers for additional protection (does not meet IP20)

**Standards and Certifications**

- UL Listed 1953, Guide QPOS, File E256146
- CSA Certified, Class 6228-01, File 15364 (enclosed style)
- CE Component IEC 60947-7-1 (enclosed style)
- IEC 60529, IP20 (finger-safe) under specific wiring conditions (enclosed style)











# 8.3

## Terminal Blocks, Fuse Blocks and Fuse Holders

### Power Distribution

#### Product Selection

#### CHDB Series—Power Distribution Blocks

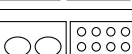
|   | Line Connection  | Load Connection                   | Configuration   | Amperes    | Style        | Poles  | Catalog Number       |
|---|------------------|-----------------------------------|---|------------|--------------|--------|----------------------|
|  | 2/0-#8 AWG       | (4) #4-#14 AWG                    |  | 175        | Open         | 3      | CHDB2203             |
|   | 2/0-#8 AWG       | (6) #4-#14 AWG                    |  | 175        | Open         | 3      | CHDB3213             |
|   | 300 kcmil-#4 AWG | (6) #4-#12 AWG                    |  | 310        | Open         | 3      | CHDB3233             |
|   | 300 kcmil-#4 AWG | (12) #4-#14 AWG                   |  | 310        | Open         | 3      | CHDB3703             |
|   | 300 kcmil-#4 AWG | (6) #2-#12 AWG<br>(3) 1/0-#12 AWG |  | 310<br>310 | Open<br>Open | 3<br>3 | CHDB3713<br>CHDB3713 |
|  | 2/0-#8 AWG       | 2/0-#8 AWG                        |  | 175        | Enclosed ①   | 1      | CHDB204F             |
|   | 500 kcmil-#6 AWG | (6) #2-#14 AWG                    |  | 380        | Enclosed ①   | 1      | CHDB330F             |
|   | 300 kcmil-#4 AWG | (12) #4-#14 AWG                   |  | 570        | Enclosed ①   | 1      | CHDB377F             |

8

#### Technical Data and Specifications

#### Power Terminal Block Short-Circuit Current Ratings (SCCR) with Fuses

| Catalog Number | Terminal Copper Conductors |            | Maximum Fuse Class and Amperes |           |                    |                  |           |
|----------------|----------------------------|------------|--------------------------------|-----------|--------------------|------------------|-----------|
|                |                            |            | J LPJ                          | T JJS/JJN | RK-1 LPS-RK/LPN-RK | RK-5 FRS-R/FRN-R | SCCR (kA) |
| CHDB2203       | 2/0-#8 AWG                 | #4-#12 AWG | 200                            | 200       | 200                | 60               | 200       |
|                |                            | #4-#14 AWG | 175                            | 175       | 100                | 60               | 100       |
|                |                            |            | 200                            | 200       | 100                | 60               | 50        |
| CHDB3213       | 2/0-#8 AWG                 | #4-#12 AWG | 400                            | 400       | 200                | 100              | 200       |
|                |                            |            | 400                            | 400       | 400                | 100              | 100       |
|                |                            | #4-#14 AWG | 175                            | 175       | 100                | 60               | 100       |
| CHDB3233       | 300 kcmil-#4 AWG           | #4-#8 AWG  | 400                            | 400       | 200                | 100              | 200       |
|                |                            |            | 400                            | 400       | 400                | 100              | 100       |
|                |                            | #4-#12 AWG | 175                            | 175       | 100                | 60               | 100       |
| CHDB3703       | 300 kcmil-#4 AWG           | #4-#8 AWG  | 400                            | 400       | 200                | 100              | 200       |
|                |                            | #4-#14 AWG | 400                            | 400       | 400                | 100              | 100       |
|                |                            |            | 175                            | 175       | 100                | 60               | 100       |
| CHDB3713       | 300 kcmil-#4 AWG           | 1/0-#6 AWG | 400                            | 400       | 200                | 100              | 200       |
|                |                            | #4-#12 AWG | 400                            | 400       | 400                | 100              | 100       |
|                |                            |            | 175                            | 175       | 100                | 60               | 100       |
| CHDB204F       | 2/0-#8 AWG                 | 2/0-#8 AWG | 200                            | 200       | 100                | 60               | 200       |
| CHDB330F       | 500 kcmil-#6 AWG           | #2-#6 AWG  | 400                            | 400       | 200                | 100              | 200       |
|                |                            | #2-#14 AWG | 200                            | 200       | 100                | 30               | 50        |
|                |                            |            | 175                            | 175       | 100                | 30               | 100       |
| CHDB377F       | 300 kcmil                  | #4-#8 AWG  | 600                            | 600       | 400                | 200              | 200       |
|                | 300 kcmil-#4 AWG           | #4 AWG     | 600                            | 600       | 400                | 200              | 50        |
|                |                            | #4-#14 AWG | 200                            | 200       | 100                | 30               | 50        |

**Note**

① Finger-safe.

## Power Terminal Block Short-Circuit Ratings (SCCR) for UL 508A Applications with Circuit Breakers

| Catalog Number | Description                   | Enclosure Size in Inches (mm)                   | Current Rating | Opening per Pole |      | Line Conductors Cu | Load Conductors Cu   | SCCR @ 480V (Load Side) | Eaton Breaker       | Available Breaker Current Ratings                              |
|----------------|-------------------------------|---|----------------|------------------|------|--------------------|----------------------|-------------------------|---------------------|--|
|                |                               |   |                | Line             | Load |                    |                      |                         |                     |  |
| CHDB2203       | Feeder Listed<br>Open PDB     | 16.00 x 16.00 x 6.75<br>(406.4 x 406.4 x 171.5) | 175            |                  |      | 2/0-#8             | #4-#10<br>#12<br>#14 | 18 kA<br>18 kA<br>14 kA | EGB125              | 15, 20, 25, 30, 35, 40,<br>45, 50, 60, 70, 80, 90,<br>100, 125 |
| CHDB2203       | Feeder Listed<br>Open PDB     | 16.00 x 16.00 x 6.75<br>(406.4 x 406.4 x 171.5) | 175            |                  |      | 2/0-#8             | #4-#10<br>#12<br>#14 | 25 kA<br>22 kA<br>14 kA | EGE125              | 15, 20, 25, 30, 35, 40,<br>45, 50, 60, 70, 80, 90,<br>100, 125 |
| CHDB2203       | Feeder Listed<br>Open PDB     | 16.00 x 16.00 x 6.75<br>(406.4 x 406.4 x 171.5) | 175            |                  |      | 2/0-#8             | #4-#10<br>#12<br>#14 | 50 kA<br>22 kA<br>14 kA | EGS125              | 15, 20, 25, 30, 35, 40,<br>45, 50, 60, 70, 80, 90,<br>100, 125 |
| CHDB2203       | Feeder Listed<br>Open PDB     | 16.00 x 16.00 x 6.75<br>(406.4 x 406.4 x 171.5) | 175            |                  |      | 2/0-#8             | #4-#10<br>#12<br>#14 | 65 kA<br>22 kA<br>14 kA | EGH125              | 15, 20, 25, 30, 35, 40,<br>45, 50, 60, 70, 80, 90,<br>100, 125 |
| CHDB2203       | Feeder Listed<br>Open PDB     | 16.00 x 16.00 x 6.75<br>(406.4 x 406.4 x 171.5) | 175            |                  |      | 2/0-#8             | #4-#10<br>#12<br>#14 | 65 kA<br>22 kA<br>14 kA | EGC125 <sup>①</sup> | 15, 20, 25, 30, 35, 40,<br>45, 50, 60, 70, 80, 90,<br>100, 125 |
| CHDB3213       | Feeder Listed<br>Open PDB     | 24.00 x 20.00 x 6.75<br>(609.6 x 508.0 x 171.5) | 175            |                  |      | 2/0-#8             | #4-#10<br>#12<br>#14 | 18 kA<br>18 kA<br>18 kA | EGB125              | 15, 20, 25, 30, 35, 40,<br>45, 50, 60, 70, 80, 90,<br>100, 125 |
| CHDB3213       | Feeder Listed<br>Open PDB     | 24.00 x 20.00 x 6.75<br>(609.6 x 508.0 x 171.5) | 175            |                  |      | 2/0-#8             | #4-#10<br>#12<br>#14 | 25 kA<br>22 kA<br>18 kA | EGE125              | 15, 20, 25, 30, 35, 40,<br>45, 50, 60, 70, 80, 90,<br>100, 125 |
| CHDB3213       | Feeder Listed<br>Open PDB     | 24.00 x 20.00 x 6.75<br>(609.6 x 508.0 x 171.5) | 175            |                  |      | 2/0-#8             | #4-#10<br>#12<br>#14 | 50 kA<br>22 kA<br>18 kA | EGS125              | 15, 20, 25, 30, 35, 40,<br>45, 50, 60, 70, 80, 90,<br>100, 125 |
| CHDB3213       | Feeder Listed<br>Open PDB     | 24.00 x 20.00 x 6.75<br>(609.6 x 508.0 x 171.5) | 175            |                  |      | 2/0-#8             | #4-#10<br>#12<br>#14 | 65 kA<br>22 kA<br>18 kA | EGH125              | 15, 20, 25, 30, 35, 40,<br>45, 50, 60, 70, 80, 90,<br>100, 125 |
| CHDB3213       | Feeder Listed<br>Open PDB     | 24.00 x 20.00 x 6.75<br>(609.6 x 508.0 x 171.5) | 175            |                  |      | 2/0-#8             | #4-#10<br>#12<br>#14 | 65 kA<br>22 kA<br>18 kA | EGC125 <sup>①</sup> | 15, 20, 25, 30, 35, 40,<br>45, 50, 60, 70, 80, 90,<br>100, 125 |
| CHDB204F       | Feeder Listed<br>Enclosed PDB | 16.00 x 16.00 x 6.75<br>(406.4 x 406.4 x 171.5) | 175            |                  |      | 2/0-#8             | 2/0-#8               | 18 kA                   | EGB125              | 15, 20, 25, 30, 35, 40,<br>45, 50, 60, 70, 80, 90,<br>100, 125 |
| CHDB204F       | Feeder Listed<br>Enclosed PDB | 16.00 x 16.00 x 6.75<br>(406.4 x 406.4 x 171.5) | 175            |                  |      | 2/0-#8             | 2/0-#8               | 25 kA                   | EGE125              | 15, 20, 25, 30, 35, 40,<br>45, 50, 60, 70, 80, 90,<br>100, 125 |
| CHDB204F       | Feeder Listed<br>Enclosed PDB | 16.00 x 16.00 x 6.75<br>(406.4 x 406.4 x 171.5) | 175            |                  |      | 2/0-#8             | 2/0-#8               | 35 kA                   | EGS125              | 15, 20, 25, 30, 35, 40,<br>45, 50, 60, 70, 80, 90,<br>100, 125 |
| CHDB204F       | Feeder Listed<br>Enclosed PDB | 16.00 x 16.00 x 6.75<br>(406.4 x 406.4 x 171.5) | 175            |                  |      | 2/0-#8             | 2/0-#8               | 65 kA                   | EGH125              | 15, 20, 25, 30, 35, 40,<br>45, 50, 60, 70, 80, 90,<br>100, 125 |
| CHDB204F       | Feeder Listed<br>Enclosed PDB | 16.00 x 16.00 x 6.75<br>(406.4 x 406.4 x 171.5) | 175            |                  |      | 2/0-#8             | 2/0-#8               | 65 kA                   | EGC125 <sup>①</sup> | 15, 20, 25, 30, 35, 40,<br>45, 50, 60, 70, 80, 90,<br>100, 125 |
| CHDB3233       | Feeder Listed<br>Open PDB     | 24.00 x 20.00 x 6.75<br>(609.6 x 508.0 x 171.5) | 310            |                  |      | 350 kmil-#4        | #4-#6<br>#8<br>#10   | 25 kA<br>25 kA<br>14 kA | JGE250              | 70, 90, 100, 125, 150,<br>175, 200, 225, 250                   |
| CHDB3233       | Feeder Listed<br>Open PDB     | 24.00 x 20.00 x 6.75<br>(609.6 x 508.0 x 171.5) | 310            |                  |      | 350 kmil-#4        | #4-#6<br>#8<br>#10   | 35 kA<br>35 kA<br>14 kA | JGS250              | 70, 90, 100, 125, 150,<br>175, 200, 225, 250                   |
| CHDB3233       | Feeder Listed<br>Open PDB     | 24.00 x 20.00 x 6.75<br>(609.6 x 508.0 x 171.5) | 310            |                  |      | 350 kmil-#4        | #4-#6<br>#8<br>#10   | 65 kA<br>42 kA<br>14 kA | JGH250              | 70, 90, 100, 125, 150,<br>175, 200, 225, 250                   |
| CHDB3233       | Feeder Listed<br>Open PDB     | 24.00 x 20.00 x 6.75<br>(609.6 x 508.0 x 171.5) | 310            |                  |      | 350 kmil-#4        | #4-#6<br>#8<br>#10   | 65 kA<br>42 kA<br>25 kA | JGC250 <sup>①</sup> | 70, 90, 100, 125, 150,<br>175, 200, 225, 250                   |

**Note**

① This breaker frame is marked current limiting and suitable for use as current limiting per UL 508A SB.4.3.2.

#### Power Terminal Block Short-Circuit Ratings (SCCR) for UL 508A Applications with Circuit Breakers, continued

| Catalog Number | Description                | Enclosure Size in Inches (mm)                | Current Rating | Opening per Pole |      | Line Conductors Cu | Load Conductors Cu | SCCR at 480V (Load Side) | Eaton Breaker       | Available Breaker Current Ratings         |
|----------------|----------------------------|--|----------------|------------------|------|--------------------|--------------------|--------------------------|---------------------|---|
|                |                            |  |                | Line             | Load |                    |                    |                          |                     |   |
| CHDB3703       | Feeder Listed Open PDB     | 24.00 x 20.00 x 6.75 (609.6 x 508.0 x 171.5) | 310            |                  |      | 350 kmil-#4        | #4-#6<br>#8<br>#10 | 25 kA<br>25 kA<br>14 kA  | JGE250              | 70, 90, 100, 125, 150, 175, 200, 225, 250 |
| CHDB3703       | Feeder Listed Open PDB     | 24.00 x 20.00 x 6.75 (609.6 x 508.0 x 171.5) | 310            |                  |      | 350 kmil-#4        | #4-#6<br>#8<br>#10 | 35 kA<br>35 kA<br>14 kA  | JGS250              | 70, 90, 100, 125, 150, 175, 200, 225, 250 |
| CHDB3703       | Feeder Listed Open PDB     | 24.00 x 20.00 x 6.75 (609.6 x 508.0 x 171.5) | 310            |                  |      | 350 kmil-#4        | #4-#6<br>#8<br>#10 | 65 kA<br>42 kA<br>14 kA  | JGH250              | 70, 90, 100, 125, 150, 175, 200, 225, 250 |
| CHDB3703       | Feeder Listed Open PDB     | 24.00 x 20.00 x 6.75 (609.6 x 508.0 x 171.5) | 310            |                  |      | 350 kmil-#4        | #4-#6<br>#8<br>#10 | 65 kA<br>42 kA<br>25 kA  | JGC250 <sup>Ⓢ</sup> | 70, 90, 100, 125, 150, 175, 200, 225, 250 |
| CHDB3713       | Feeder Listed Open PDB     | 24.00 x 20.00 x 6.75 (609.6 x 508.0 x 171.5) | 310            |                  |      | 350 kmil-#4        | #4-#6<br>#8<br>#10 | 25 kA<br>25 kA<br>14 kA  | JGE250              | 70, 90, 100, 125, 150, 175, 200, 225, 250 |
| CHDB3713       | Feeder Listed Open PDB     | 24.00 x 20.00 x 6.75 (609.6 x 508.0 x 171.5) | 310            |                  |      | 350 kmil-#4        | #4-#6<br>#8<br>#10 | 35 kA<br>35 kA<br>14 kA  | JGS250              | 70, 90, 100, 125, 150, 175, 200, 225, 250 |
| CHDB3713       | Feeder Listed Open PDB     | 24.00 x 20.00 x 6.75 (609.6 x 508.0 x 171.5) | 310            |                  |      | 350 kmil-#4        | #4-#6<br>#8<br>#10 | 50 kA<br>42 kA<br>14 kA  | JGH250              | 70, 90, 100, 125, 150, 175, 200, 225, 250 |
| CHDB3713       | Feeder Listed Open PDB     | 24.00 x 20.00 x 6.75 (609.6 x 508.0 x 171.5) | 310            |                  |      | 350 kmil-#4        | #4-#6<br>#8<br>#10 | 65 kA<br>50 kA<br>25 kA  | JGC250 <sup>Ⓢ</sup> | 70, 90, 100, 125, 150, 175, 200, 225, 250 |
| CHDB330F       | Feeder Listed Enclosed PDB | 24.00 x 20.00 x 6.75 (609.6 x 508.0 x 171.5) | 380            |                  |      | 500 kmil-#3        | #2-#8              | 14 kA                    | LGE400              | 250, 300, 350, 400                        |
| CHDB330F       | Feeder Listed Enclosed PDB | 24.00 x 20.00 x 6.75 (609.6 x 508.0 x 171.5) | 380            |                  |      | 500 kmil-#3        | #2-#8              | 14 kA                    | LGS400              | 250, 300, 350, 400                        |
| CHDB330F       | Feeder Listed Enclosed PDB | 24.00 x 20.00 x 6.75 (609.6 x 508.0 x 171.5) | 380            |                  |      | 500 kmil-#3        | #2-#8              | 14 kA                    | LGH400              | 250, 300, 350, 400                        |
| CHDB330F       | Feeder Listed Enclosed PDB | 24.00 x 20.00 x 6.75 (609.6 x 508.0 x 171.5) | 380            |                  |      | 500 kmil-#3        | #2-#8              | 25 kA                    | LGC400 <sup>Ⓢ</sup> | 250, 300, 350, 400                        |
| CHDB377F       | Feeder Listed Enclosed PDB | 24.00 x 20.00 x 6.75 (609.6 x 508.0 x 171.5) | 570            |                  |      | (2) 300 kmil-#2    | #4<br>#6<br>#8     | 30 kA<br>18 kA<br>14 kA  | LGE600              | 250, 300, 350, 400, 500, 600              |
| CHDB377F       | Feeder Listed Enclosed PDB | 24.00 x 20.00 x 6.75 (609.6 x 508.0 x 171.5) | 570            |                  |      | (2) 300 kmil-#2    | #4<br>#6<br>#8     | 30 kA<br>18 kA<br>14 kA  | LGS600              | 250, 300, 350, 400, 500, 600              |
| CHDB377F       | Feeder Listed Enclosed PDB | 24.00 x 20.00 x 6.75 (609.6 x 508.0 x 171.5) | 570            |                  |      | (2) 300 kmil-#2    | #4<br>#6<br>#8     | 30 kA<br>18 kA<br>14 kA  | LGH600              | 250, 300, 350, 400, 500, 600              |
| CHDB377F       | Feeder Listed Enclosed PDB | 24.00 x 20.00 x 6.75 (609.6 x 508.0 x 171.5) | 570            |                  |      | (2) 300 kmil-#2    | #4<br>#6<br>#8     | 42 kA<br>35 kA<br>14 kA  | LGC600 <sup>Ⓢ</sup> | 250, 300, 350, 400, 500, 600              |

**Note**

<sup>Ⓢ</sup> This breaker frame is marked current limiting and suitable for use as current limiting per UL 508A SB.4.3.2.

### Dimensions

Approximate Dimensions in Inches (mm)

#### CHDB2203

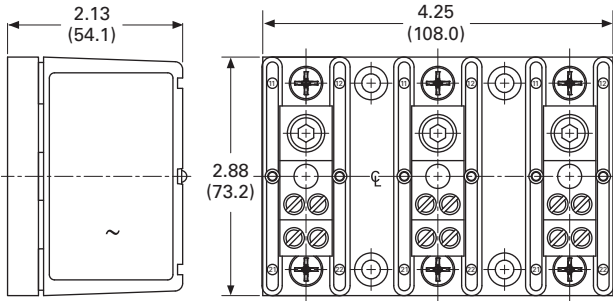

#### CHDB3713

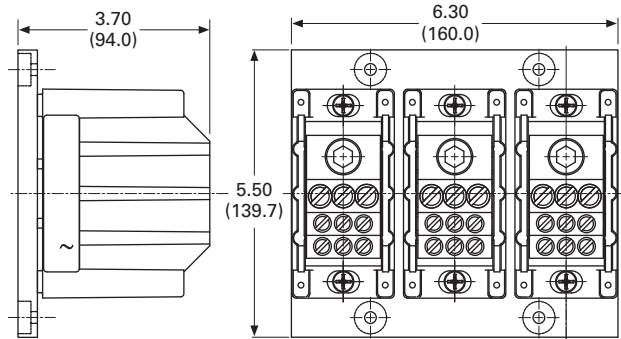

#### CHDB3213

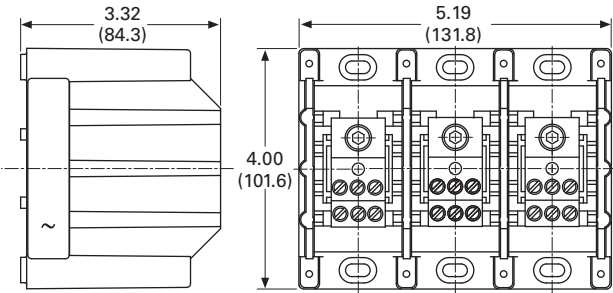

#### CHDB204F

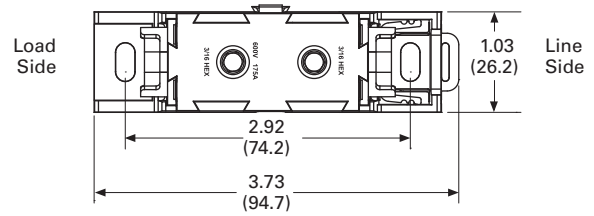

#### CHDB3233

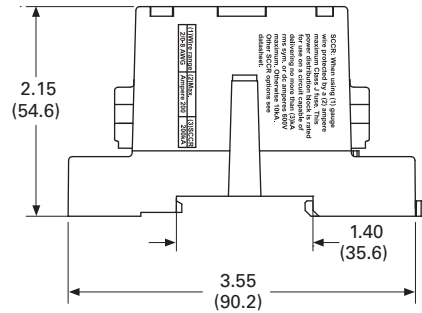
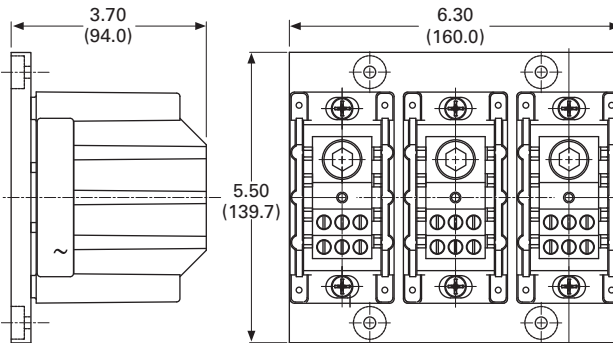

#### CHDB3703

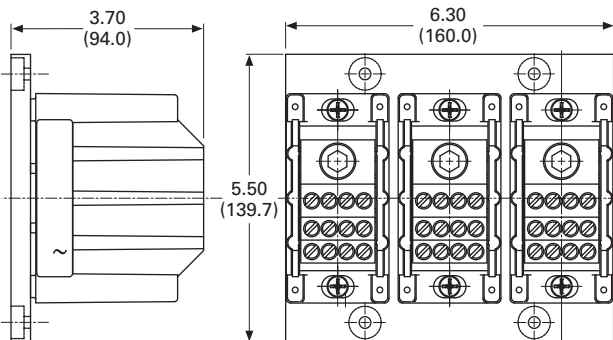

# 8.3

## Terminal Blocks, Fuse Blocks and Fuse Holders

### Power Distribution

Approximate Dimensions in Inches (mm)

**CHDB330F**

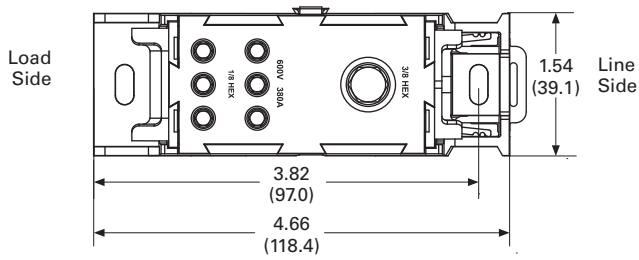

**CHDB377F**

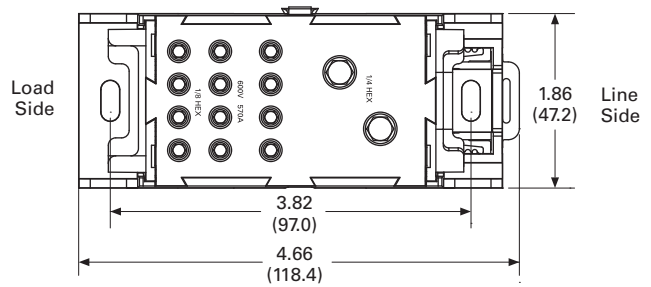

8

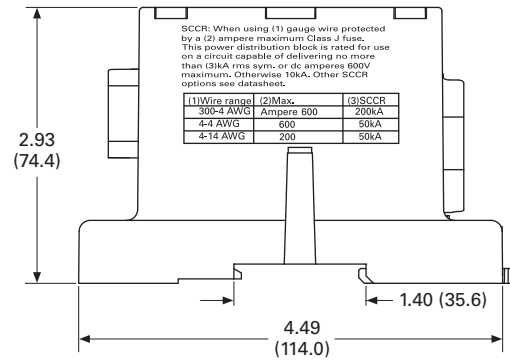
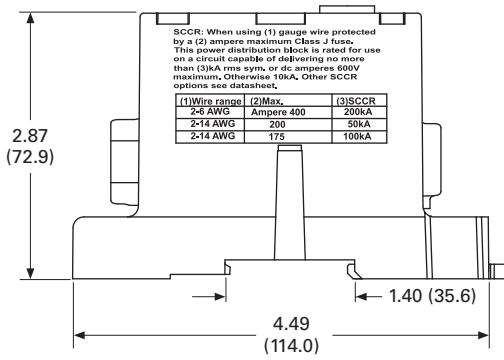

**CH160 Series—Power Terminal Blocks****Contents**

| <b>Description</b>                              | <b>Page</b>      |
|---|------------------|
| CHDB Series—Power Distribution Blocks . . . . . | <b>V7-T8-117</b> |
| CH160 Series—Power Terminal Blocks              |                  |
| Product Selection . . . . .                     | <b>V7-T8-124</b> |
| Technical Data and Specifications . . . . .     | <b>V7-T8-125</b> |
| Dimensions . . . . .                            | <b>V7-T8-125</b> |
| Power Terminal Block Accessories . . . . .      | <b>V7-T8-126</b> |

**CH160 Series—Power Terminal Blocks****Product Description**

The CH160 Series of Power Terminal Blocks are UL 1059 recognized power terminal blocks for branch circuit applications. All short circuit current ratings (SCCR) are 10 kA per UL 508A Table SB4.1. The blocks are available in a wide variety of wiring configurations, providing excellent flexibility.

**Features and Benefits**

- Ratings: To 840A, 600V
- Materials
  - Molded material; black, UL rated 94V-0 thermoplastic
- Operating temperature: 302°F (150°C)
- Optional cover:  
See **Page V7-T8-125**

**Standards and Certifications**

- UL Recognized
- CSA Certified



# 8.3

## Terminal Blocks, Fuse Blocks and Fuse Holders

### Power Distribution

#### Product Selection

##### When Ordering, Specify

- Catalog number
- Number of poles (up to three-pole available)

#### CH160 Power Terminal Blocks—CH162 Series

| Line Connection  | Load Connection     | Connector Material and Ampacity | Catalog Number <sup>①</sup> |
|------------------|---------------------|---------------------------------|-----------------------------|
| #2-#14 Cu/#8 Al  | #2-#14 Cu/#8 Al     | Al 115A                         | CH16200_                    |
| 1/0-#14 Cu       | 1/0-#14 Cu          | Cu 150A                         | CH16201_                    |
| 2/0-#8 Cu/Al     | 2/0-#8 Cu/Al        | Al 175A                         | CH16204_                    |
| 2/0-#14 Cu/#8 Al | (4) #4-#14 Cu/#8 Al | Al 175A                         | CH16220_                    |

8

#### CH160 Power Terminal Blocks—CH163 Series

| Line Connection      | Load Connection        | Connector Material and Ampacity | Catalog Number <sup>①</sup> |
|----------------------|------------------------|---------------------------------|-----------------------------|
| 250 kcmil-#6 Cu      | 250 kcmil-#6 Cu        | Cu 255A                         | CH16301_                    |
| 350 kcmil-#6 Cu/Al   | 350 kcmil-#6 Cu/Al     | Al 310A                         | CH16303_                    |
| 500 kcmil-#6 Cu/Al   | 500 kcmil-#6 Cu/Al     | Al 380A                         | CH16306_                    |
| 2/0-#14 Cu/Al        | (6) #4-#14 Cu/#8 Al    | Al 175A                         | CH16321_                    |
| 350 kcmil-#6 Cu/Al   | (6) #4-#14 Cu/#8 Al    | Al 310A                         | CH16323_                    |
| (2) 2/0-#14 Cu/#8 Al | (6) #4-#14 Cu/#8 Al    | Al 350A                         | CH16325_                    |
| 500 kcmil-#6 Cu/Al   | (6) #2-#14 Cu/#8 Al    | Al 380A                         | CH16330_                    |
| 350 kcmil-#6 Cu/Al   | (3) #2-#14 Cu/#8 Al    | Al 310A                         | CH16332_                    |
|                      | (2) 1/0-#14 Cu/#8 Al   | Al 310A                         | CH16332_                    |
| 350 kcmil-#6 Cu/Al   | (12) #4-#14 Cu/#8 Al   | Al 310A                         | CH16370_                    |
| 350 kcmil-#6 Cu/Al   | (6) #2-#14 Cu/#8 Al    | Al 310A                         | CH16371_                    |
|                      | (3) 1/0-#14 Cu/#8 Al   | Al 310A                         | CH16371_                    |
| 350 kcmil-#6 Cu/Al   | (21) #10-#14 Cu/#10 Al | Al 310A                         | CH16372_                    |
| 350 kcmil-#6 Cu/Al   | (3) 1/0-#14 Cu/#8 Al   | Al 310A                         | CH16373_                    |
|                      | (14) #10-#14 Cu/#8 Al  | Al 310A                         | CH16373_                    |
| 600 kcmil-#2 Cu/Al   | (12) #4-#14 Cu/#8 Al   | Al 420A                         | CH16375_                    |
| 600 kcmil-#2 Cu/Al   | (6) #2-#14 Cu/#8 Al    | Al 420A                         | CH16376_                    |
|                      | (3) 1/0-#14 Cu/#8 Al   | Al 420A                         | CH16376_                    |

#### CH160 Power Terminal Blocks—CH165 Series

| Line Connection        | Load Connection        | Connector Material and Ampacity | Catalog Number <sup>①</sup> |
|------------------------|------------------------|---------------------------------|-----------------------------|
| (2) 350 kcmil-4 Cu/Al  | (2) 350 kcmil-4 Cu/Al  | Al 620A                         | CH16500_                    |
| (2) 500 kcmil-#6 Cu/Al | (2) 500 kcmil-#6 Cu/Al | Al 760A                         | CH16504_                    |
| (2) 600 kcmil-#2 Cu/Al | (4) 3/0-#8 Cu/Al       | Al 840A                         | CH16528_                    |
|                        | (4) #4-#14 Cu/#8 Al    | Al 840A                         | CH16528_                    |
| (2) 500 kcmil-#6 Cu/Al | (12) #4-#14 Cu/#8 Al   | Al 760A                         | CH16530_                    |

##### Note

- <sup>①</sup> Incomplete catalog number—add code suffix **-1**, **-2**, **-3** for number of poles.  
Example: For a 150A 1/0-#14 Cu to 1/0-#14 Cu three-pole PDB, order CH16201-3.



### Technical Data and Specifications

#### CH160 Power Terminal Blocks

| Description           | Specification  |
|-----------------------|--|
| Ratings               | To 840A, 600V  |
| Materials             | Molded material; black, UL rated 94V-0 thermoplastic |
| Operating temperature | 302°F (150°C)  |

**Note:** For optional cover, see Power Terminal Block Accessories, **Page V7-T8-126**.

### Dimensions

Approximate Dimensions in Inches (mm)

#### Series CH163 (Single-, Two- and Three-Pole Available)

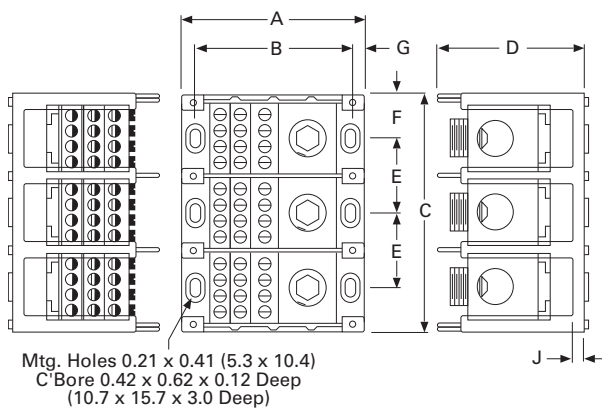

#### Series CH162 and CH165 (Single-, Two- and Three-Pole Available)

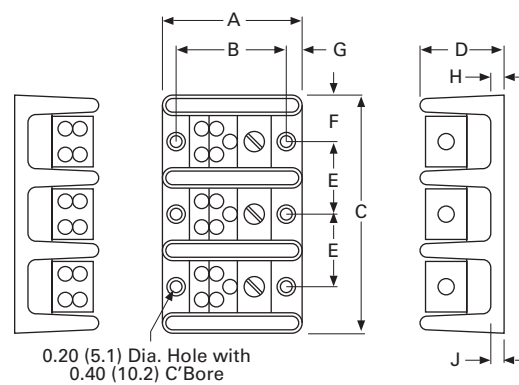

#### CH160 Power Terminal Block Dimensions

| Series | A            | B            | C           |              |              | D           | E4          | F           | G          | H           | J           |
|--------|--------------|--------------|-------------|--------------|--------------|-------------|-------------|-------------|------------|-------------|-------------|
|        |              |              | Single-Pole | Two-Pole     | Three-Pole   |             |             |             |            |             |             |
| CH162  | 2.87 (72.9)  | 2.25 (57.2)  | 1.06 (26.9) | 1.87 (47.5)  | 2.68 (68.1)  | 1.75 (44.5) | 0.81 (20.6) | 0.53 (13.5) | 0.31 (7.9) | 0.84 (21.3) | 0.31 (7.9)  |
| CH163  | 4.00 (101.6) | 3.37 (85.6)  | 1.96 (49.8) | 3.58 (90.9)  | 5.20 (132.1) | 3.32 (84.3) | 1.62 (41.1) | 0.97 (24.6) | 0.31 (7.9) | 0.87 (22.1) | 0.35 (8.9)  |
| CH165  | 5.50 (139.7) | 4.75 (120.7) | 3.12 (79.2) | 5.81 (147.6) | 8.50 (215.9) | 3.12 (79.2) | 2.68 (68.1) | 1.56 (39.6) | 0.37 (9.4) | 1.37 (34.8) | 0.62 (15.7) |

# 8.3

## Terminal Blocks, Fuse Blocks and Fuse Holders

### Power Distribution

#### Power Terminal Block Accessories



#### Contents

##### Description

##### Page

|   |                  |
|---|------------------|
| CHDB Series—Power Distribution Blocks . . . . . | <b>V7-T8-117</b> |
| CH160 Series—Power Terminal Blocks . . . . .    | <b>V7-T8-123</b> |
| Power Terminal Block Accessories                |                  |
| Technical Data and Specifications . . . . .     | <b>V7-T8-127</b> |
| Dimensions . . . . .                            | <b>V7-T8-127</b> |

### Power Terminal Block Accessories

#### Product Description

##### Protective Cover

- Guards against accidental contact
- Clear with write-on surface for field termination identification
- Available in single-, two- and three-pole

#### Standards and Certifications

##### TB Series Power Blocks

- Contact Eaton for the latest UL 508A short circuit ratings on terminal blocks
- UL Recognized: File No. E62622
- CSA Certified: File No. LR15364



#### Product Selection

##### When Ordering, Specify

- Catalog number

#### CH163 Series Cover

| Description       | Catalog Number |
|-------------------|----------------|
| Single-pole cover | CHCPDB-1 ①     |
| Two-pole cover    | CHCPDB-2 ①     |
| Three-pole cover  | CHCPDB-3 ①     |

#### TB Series Power Blocks

| Line Connection     | Load Connection    | Catalog Number |
|---------------------|--------------------|----------------|
| #300 kcmil-#6 Cu/Al | (6) #6-#14 Cu/#8Al | TBAN63         |

##### Note

① Standard pack, five pieces.

## Technical Data and Specifications

### TB Series Power Blocks

| Description           | Specification  |
|-----------------------|--|
| Ratings               | 285A, 600V; UL/CSA                                   |
| Materials             | Molded material; black, UL rated 94V-2 thermoplastic |
| Operating temperature | 257°F (125°C)  |

## Dimensions

Approximate Dimensions in Inches (mm)

### CH163 Series Cover

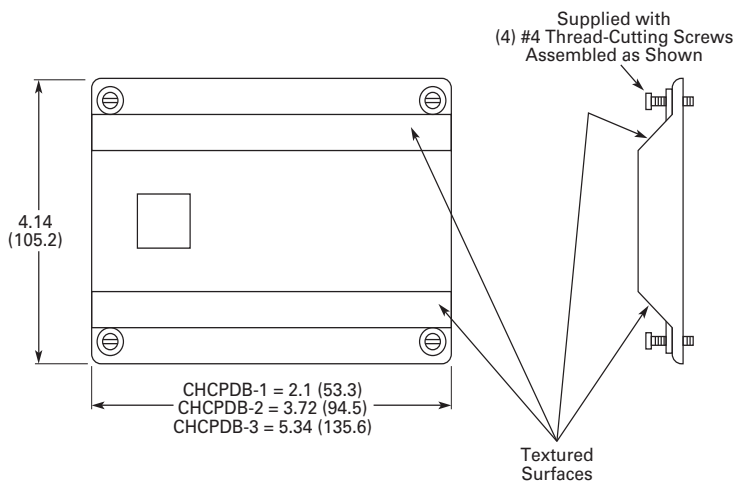

### TB Series Power Blocks

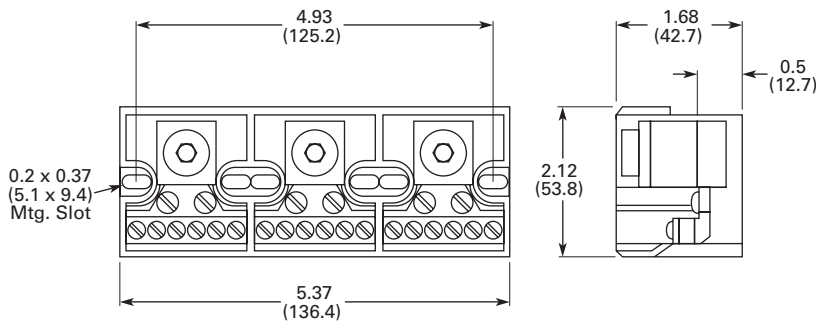

# 8.4

## Terminal Blocks, Fuse Blocks and Fuse Holders

### Fuse Blocks and Fuse Holders

#### Fuse Blocks and Fuse Holders



#### Contents

##### Description

##### Page

|  |                  |
|--|------------------|
| Fuse Blocks and Fuse Holders                                   |                  |
| C383 Series Disconnect Fuse Holders . . . . .                  | <b>V7-T8-129</b> |
| C350 Series Fuse Blocks and<br>W Series Fuse Holders . . . . . | <b>V7-T8-131</b> |

### Fuse Blocks and Fuse Holders Overview

#### Product Description

Available in compact finger safe (C383) and an open (C350) design. Eaton's fuse blocks and holders provide a simple DIN mounting device for protection in control circuits.

#### Application Description

Fuse holders and blocks available for Class CC, midget, H, M and R.

#### Standards and Certifications

- UL listed
- CSA certified (may not apply to all styles)



**C383 Series Fuse Holders****Contents**

| <b>Description</b>   | <b>Page</b>      |
|--|------------------|
| C383 Series Disconnect Fuse Holders                        |                  |
| Product Selection .....                                    | <b>V7-T8-130</b> |
| Accessories .....  | <b>V7-T8-130</b> |
| Technical Data and Specifications .....                    | <b>V7-T8-130</b> |
| Dimensions .....   | <b>V7-T8-130</b> |
| C350 Series Fuse Blocks and<br>W Series Fuse Holders ..... | <b>V7-T8-131</b> |

**C383 Series Disconnect Fuse Holders****Product Description**

Eaton's C383 Series disconnect fuse holders offer 600V fused circuit protection and subsequently "no load" switching.

These compact disconnects are designed as components in switchboards, panels and control consoles where positive and safe circuit protection is required and where space is at a premium.

The C383 fuse holders mount directly on standard TS35 DIN rails.

**Features**

- "Finger-Safe" design— Recessed termination screws and a fuse extraction door afford you IP20 grade protection and qualify as "finger-safe" per IEC standards
- Easy to adjust position on rail—Simply unlatch the DIN rail adapter, slide the holder to desired position and relock
- Quick change of fuse— A permanently attached pivoting fuse door simplifies and speeds fuse extraction. No tools or accessories needed
- Class CC model is UL listed and CSA certified for branch circuit protection. Midget models are UL Recognized and CSA certified for supplementary and high-speed protection
- Runs cool—The vented design provides adequate air flow around the holders at all times
- Self-extinguishing UL 94-VO rated polyester material

**Standards and Certifications**

Rated voltage:

- CSA/UL: 600 Vac/Vdc, 30A
- IEC (midget only): 690 Vac, 32A



# 8.4

## Terminal Blocks, Fuse Blocks and Fuse Holders

### Fuse Blocks and Fuse Holders

#### Product Selection

C383FH\_



#### Disconnect Fuse Holders

| Description                                  | Standard Pack | Catalog Number |
|--|---------------|----------------|
| <b>For Class CC Fuse</b>                     |               |                |
| Single-pole fuse holder                      | 12            | C383FHCC       |
| <b>For Midget Fuse (1-1/2 in x 13/32 in)</b> |               |                |
| Single-pole fuse holder                      | 12            | C383FHMD       |

#### Accessories

#### Disconnect Fuse Holders

| Description                           | Standard Pack | Catalog Number |
|---------------------------------------|---------------|----------------|
| <b>Midget or Class CC Fuse Holder</b> |               |                |
| Multi-pole connection links           | 100           | C383MPCL       |
| Multi-pole handle pins                | 100           | C383MPHP       |

#### Accessory Details

##### C383MPCL

Multi-pole connection links can be used to connect fuse holders together for multi-pole applications. Use two per connection.

##### C383MPHP

Handle pins can be used to connect handles in multi-pole applications.

#### Technical Data and Specifications

#### Disconnect Fuse Holders ①

| Description | Specification            |
|-------------|--------------------------|
| Housing     | Polyester UL 94-V0 rated |
| Color       | White                    |
| Wire size   | 8–18 AWG ②               |
| Torque      | 22 lb-in (2.5 Nm)        |
| Fuse size   | 0.41 x 1.5 in            |

#### Dimensions

Approximate Dimensions in Inches (mm)

#### CH163 Series Cover

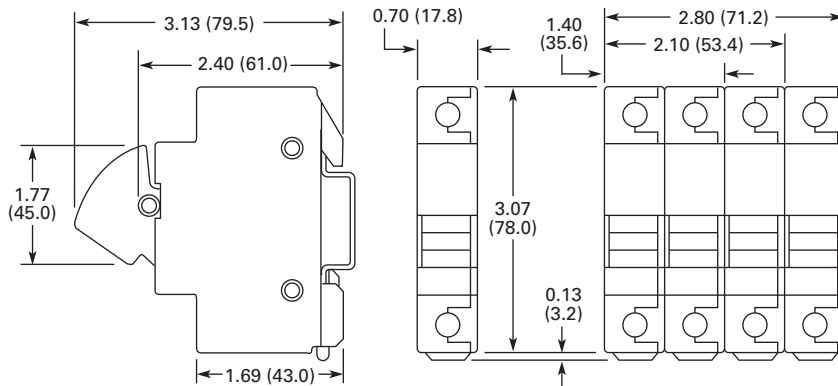

#### Notes

- ① For additional technical information, consult the Eaton web site or Customer Support Center.
- ② UL recognizes both solid and stranded wire. Ferrules are not required. CSA requires ferrules on stranded wire to achieve approval.

### C350 Series Fuse Blocks and W Series Fuse Holders



### Contents

| <i>Description</i>                                | <i>Page</i>      |
|---|------------------|
| C383 Series Disconnect Fuse Holders . . . . .     | <b>V7-T8-129</b> |
| C350 Series Fuse Blocks and W Series Fuse Holders |                  |
| Product Selection . . . . .                       | <b>V7-T8-132</b> |
| Accessories . . . . .                             | <b>V7-T8-133</b> |
| Technical Data and Specifications . . . . .       | <b>V7-T8-133</b> |
| Dimensions . . . . .                              | <b>V7-T8-133</b> |

### C350 Series Fuse Blocks and W Series Fuse Holders

#### Product Description

##### Fuse Blocks

These space-saving Type C350 Fuse Blocks are UL approved for motor loads and are rated 600V, 30A.

##### Fuse Holders

- Class H, M and R

#### Features

##### Fuse Blocks

- Mount to 35 mm flat and 32 mm asymmetrical DIN rails
- 600V, 30A rated captive pressure plate terminals with copper alloy fuse clips
- Interlocking fuse blocks permit single, double or three-pole application—reduce inventory
- Class CC fuses have an interrupting rating of 200,000A
- Rejection feature prevents insertion of fuses with lower interrupting or voltage ratings

##### Fuse Holders

- Break-resistant: molded of heat-stabilized nylon
- Fuse clips: spring-reinforced for cool operation
- Fuse clip terminations: one-piece construction
- Universal mounting dimensions, for easy assembly and retrofit
- Breathing action collar: maintenance-free
- Pressure wire connectors: vibration resistant

#### Standards and Certifications

Contact Eaton for the latest UL 508A short circuit ratings on terminal blocks.

##### Fuse Blocks

- UL listed
- CSA certified



##### Fuse Holders

- UL tested for OEM subfeed applications



#### Fuse Blocks and Adapters

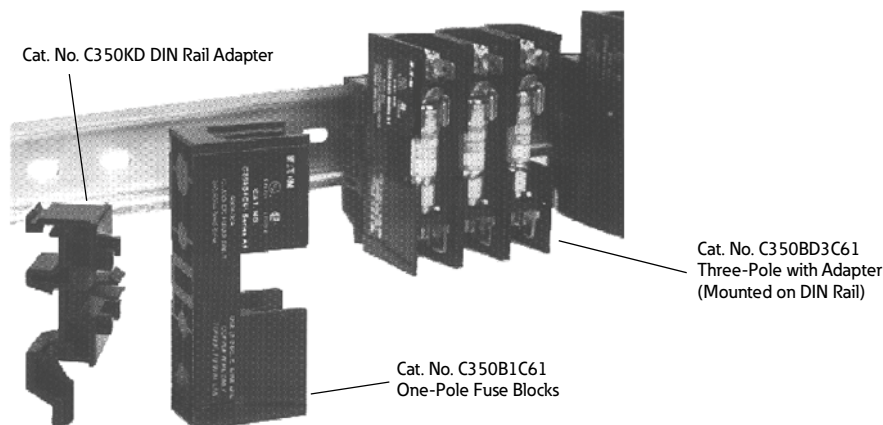

# 8.4

## Terminal Blocks, Fuse Blocks and Fuse Holders

### Fuse Blocks and Fuse Holders

#### Product Selection

##### Class CC Fuse Blocks

| Type                    | Catalog Number |
|-------------------------|----------------|
| Three-pole <sup>①</sup> | C350BD3C61     |
| Single-pole             | C350B1C61      |
| DIN adapter             | C350KD         |

Class R, Three-Pole Fuse Holder



##### Fuse Holders—250V

| Wire Termination                               |  | Number of Poles | Carton Qty. | 30A Catalog Number | Carton Qty. | 60A Catalog Number |
|--|--|-----------------|-------------|--------------------|-------------|--------------------|
| <b>Class H Fuse Holders</b>                    |  |                 |             |                    |             |                    |
| Single collar (box lug)—sized to ampere rating |  | 1               | 10          | W231HA             | 10          | W261HA             |
|  |  | 2               | 5           | W232HA             | 5           | W262HA             |
|  |  | 3               | 5           | W233HA             | 5           | W263HA             |
| <b>Class R Fuse Holders</b>                    |  |                 |             |                    |             |                    |
| Single collar (box lug)—sized to ampere rating |  | 1               | 10          | WR231HA            | —           | —                  |
|  |  | 2               | —           | —                  | —           | —                  |
|  |  | 3               | 5           | WR233HA            | 1           | WR263HA            |

##### Fuse Holders—600V

| Wire Termination   |  | Number of Poles | Carton Qty. | 30A Catalog Number | Carton Qty. | 60A Catalog Number |
|--|--|-----------------|-------------|--------------------|-------------|--------------------|
| <b>Class H Fuse Holders</b>  |  |                 |             |                    |             |                    |
| Single collar (box lug)—sized to ampere rating   |  | 1               | 10          | W631HA             | 1           | W661HA             |
|  |  | 2               | 5           | W632HA             | 1           | W662HA             |
|  |  | 3               | 1           | W633HA             | 2           | W663HA             |
| <b>Class M Fuse Holders</b>  |  |                 |             |                    |             |                    |
| Combination of double quick-connect, 20A max., and binding head screw, #10 max., Cu/Al     |  | 1               | 10          | WM631F             | —           | —                  |
|  |  | 2               | 8           | WM632F             | —           | —                  |
|  |  | 3               | 6           | WM633F             | —           | —                  |
| Combination of double quick-connect, 20A max., and pressure plate screw, #10 max., Cu only |  | 1               | 10          | WM631G             | —           | —                  |
|  |  | 2               | 8           | WM632G             | —           | —                  |
|  |  | 3               | 6           | WM633G             | —           | —                  |
| <b>Class R Fuse Holders</b>  |  |                 |             |                    |             |                    |
| Single collar (box lug)—sized to ampere rating   |  | 1               | 10          | WR631HA            | —           | —                  |
|  |  | 2               | 5           | WR632HA            | —           | —                  |
|  |  | 3               | 5           | WR633HA            | 5           | WR663HA            |
| Combination of double quick-connect, 20A max., and binding head screw, #10 max., Cu/Al     |  | 1               | —           | —                  | —           | —                  |
|  |  | 2               | 1           | WMR632F            | —           | —                  |
|  |  | 3               | 6           | WMR633F            | —           | —                  |
| Combination of double quick-connect, 20A max., and pressure plate screw, #10 max., Cu only |  | 1               | 10          | WMR631G            | —           | —                  |
|  |  | 3               | 6           | WMR633G            | —           | —                  |
| <b>Class R Fuse Holder, Type WRR Control Transformer Fuse Blocks</b>                       |  |                 |             |                    |             |                    |
| Combination of double quick-connect, 20A max., and pressure plate screw, #14–#10 Cu only   |  | 3               | 6           | WRR633G            | —           | —                  |

**Note**

<sup>①</sup> Three-pole device is supplied with DIN rail adapter.



### Accessories

#### Fuse Holder Accessories

| Description                   | Catalog Number |
|-------------------------------|----------------|
| Fuse puller                   | TBP            |
| Lighted fuse puller (120 Vac) | TBLP           |

### Technical Data and Specifications

#### Fuse Blocks

| Description                      | Specification                             |
|----------------------------------|---|
| Voltage rating                   | 600V                                      |
| Ampere rating                    | Pressure plate terminals rated for 30A    |
| Dielectric strength              | 1200V maximum                             |
| Ambient temperature              | 221°F (105°C) maximum                     |
| Clip/terminals                   | Tin-plated copper alloy                   |
| Screw and captive pressure plate | Zinc-plated steel                         |
| Base                             | Thermoplastic UL 94V0 flammability rating |
| DIN rail adapter                 | Thermoplastic UL 94V0 flammability rating |

### Dimensions

Approximate Dimensions in Inches (mm)

#### Fuse Blocks

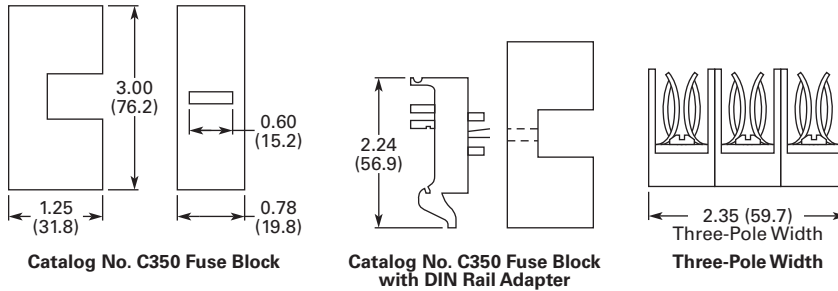

#### Fuse Holders

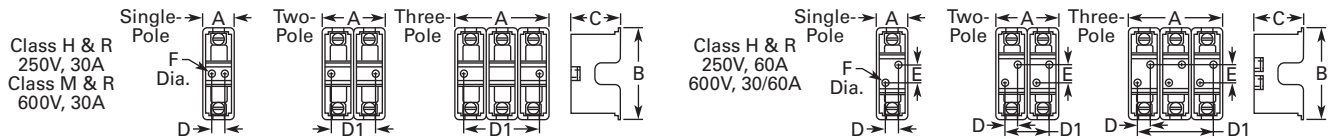

| Class | Volts/<br>Amperes | Width A         |              |                | Height<br>B  | Depth<br>C  | Mounting Holes |                |                  | Diameter<br>F | Number of Mounting Holes |                 |              |                |
|-------|-------------------|-----------------|--------------|----------------|--------------|-------------|----------------|----------------|------------------|---------------|--------------------------|-----------------|--------------|----------------|
|       |                   | Single-<br>Pole | Two-<br>Pole | Three-<br>Pole |              |             | D              | Two-Pole<br>D1 | Three-Pole<br>D1 |               | E                        | Single-<br>Pole | Two-<br>Pole | Three-<br>Pole |
| H, R  | 250V, 30A         | 1.00 (25.4)     | 2.00 (50.8)  | 3.00 (76.2)    | 3.13 (79.5)  | 1.56 (39.6) | 0.38 (9.7)     | 1.25 (31.8)    | 2.50 (63.5)      | —             | 0.22 (5.6)               | 2               | 2            | 2              |
|       | 250V, 60A         | 1.44 (36.6)     | 2.88 (73.2)  | 4.31 (109.5)   | 4.75 (120.7) | 2.06 (52.3) | 0.50 (12.7)    | 1.81 (46.0)    | 3.13 (79.5)      | 1.25 (31.8)   | 0.22 (5.6)               | 2               | 4            | 4              |
|       | 600V, 30/60A      | 1.69 (42.9)     | 3.38 (85.9)  | 5.06 (128.5)   | 6.94 (176.3) | 2.63 (66.8) | 0.63 (16.0)    | 2.19 (55.6)    | 3.75 (95.3)      | 3.13 (79.5)   | 0.28 (7.1)               | 2               | 4            | 4              |
| M, R  | 600V, 30A         | 0.84 (21.3)     | 1.63 (41.4)  | 2.41 (61.2)    | 3.00 (76.2)  | 1.28 (32.5) | 0.38 (9.7)     | 0.75 (19.1)    | 1.50 (38.1)      | —             | 0.17 (4.3)               | 2               | 2            | 2              |

SmartWire-DT



XV Series HMI-PLC with SmartWire-DT



Machine Mount (IP67) I/O Modules



## 9.1 SmartWire-DT In-Panel and On-Machine Wiring Solution

|   |          |
|---|----------|
| System Overview                                     |          |
| System Components                                   | V7-T9-3  |
| System Overview Diagram                             | V7-T9-5  |
| Gateway Modules and System Controllers              |          |
| Gateway Modules                                     | V7-T9-7  |
| System Controllers                                  | V7-T9-8  |
| XV Series HMI-PLC with SmartWire-DT                 | V7-T9-8  |
| XC152 Series PLC with SmartWire-DT                  | V7-T9-8  |
| easy802/806 Programmable Relays with SmartWire-DT   | V7-T9-8  |
| I/O, Powerfeed Modules, and Connectivity Components |          |
| Powerfeed Modules                                   | V7-T9-14 |
| I/O Modules   | V7-T9-14 |
| System Connectivity Components                      | V7-T9-15 |
| Motor Control Modules                               |          |
| Product Identification                              | V7-T9-18 |
| Contactor Modules                                   | V7-T9-19 |
| Electronic Motor Starters                           | V7-T9-20 |
| Soft Start Controllers                              | V7-T9-21 |
| Variable Speed Starters/Variable Frequency Drives   | V7-T9-22 |
| Pilot Device Modules                                |          |
| Product Description                                 | V7-T9-24 |
| Features  | V7-T9-24 |
| Product Selection                                   | V7-T9-25 |
| Stacklight Modules with SmartWire-DT                |          |
| Product Description                                 | V7-T9-27 |
| Features  | V7-T9-27 |
| Benefits  | V7-T9-27 |
| Standards and Certifications                        | V7-T9-27 |
| Product Selection                                   | V7-T9-28 |
| On-Machine Components                               |          |
| Machine Mount I/O Modules                           | V7-T9-30 |
| I/O Splitters                                       | V7-T9-30 |
| Other I/O Connections                               | V7-T9-31 |
| Machine Mount Powerfeed Modules                     | V7-T9-31 |
| Panel Transition Components                         | V7-T9-32 |
| SmartWire-DT Round Bus Cables                       | V7-T9-32 |
| Other System Components                             | V7-T9-33 |
| Technical Data and Specifications                   | V7-T9-38 |
| Dimensions  | V7-T9-62 |

SmartWire-DT In-Panel and On-Machine Wiring Solution

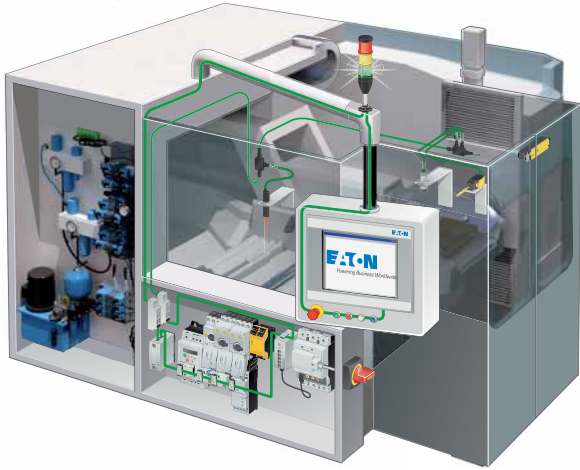

### System Overview

#### Product Description

The SmartWire-DT® In-Panel and On-Machine wiring system uses a single green cable inside a machine control cabinet and across the machine itself to connect motor starters, variable frequency drives, soft starters, pushbuttons, sensors, pneumatic and hydraulic valves, stacklights and other indicator lights.

Inside the machine control cabinet the continuous SmartWire-DT green cable is flat. The flat cable connects directly to in-panel motor starters, variable frequency drives, soft starters, panel-mounted pushbutton actuators, stacklights and other indicator lights. It eliminates the need for most of the conventional point-to-point control wiring done in a traditionally wired control panel—and even integrates 24 Vdc control power for contactor coils on the single SmartWire-DT cable. The start of the SmartWire-DT system is either an Eaton PLC or a combination HMI/PLC with SmartWire-DT embedded or a simple gateway.

These SmartWire-DT gateways establish the connection between a SmartWire-DT system and standard programmable logic controller (PLC) fieldbuses, such as EtherNet/IP, Modbus TCP, EtherCAT, PROFINET, POWERLINK, PROFIBUS-DP and CANopen. The gateway works without any conventional PLC I/O required because SmartWire-DT directly integrates the input/output (I/O) level in the switching devices.

Inside the control cabinet, typical faults such as loose connections and miswired terminations are eliminated using the flat cable and the specialized connectors. Outside the cabinet on the machine, the SmartWire-DT digital machine mount I/O modules connect using industry standard keyed M12 connectors to eliminate the possibility of miswiring. Further, dramatic wiring reductions are possible given the single SmartWire-DT cable connection that brings 24 Vdc power to and carries signals to and from devices.

### Contents

#### Description

| System Overview               | <i>Page</i>    |
|-------------------------------|----------------|
| System Components .....       | <b>V7-T9-3</b> |
| System Overview Diagram ..... | <b>V7-T9-5</b> |

Each SmartWire-DT machine mount I/O module has diagnostic LEDs built in, reducing commissioning time and troubleshooting in the field.

Nodes on the SmartWire-DT network both inside and outside the main control cabinet are automatically assigned addresses by the gateway or the HMI/PLC device with the simple push of a button—assigning addresses in the order that the nodes are connected. The system employs time monitoring and a watchdog timeout using the established target configuration as a reference—safely monitoring the integrity of the control scheme. SmartWire-DT has a maximum network length of 2000 feet and can connect up to 99 nodes per gateway. A software program called SWD-Assist enables the layout, planning and system configuration of a SmartWire-DT network.

#### Features

Connects directly to:

- Standard XTCE contactors
- XTRE control relays
- DS7 soft start controllers
- DC1 VFDs
- DA1 VFDs
- M22 pilot devices
- SL4 and SL7 stacklights

Supports:

- EtherNet/IP
- Modbus TCP
- EtherCAT
- PROFINET
- POWERLINK
- PROFIBUS-DP
- CANopen fieldbuses
- Supports up to 99 nodes (58 nodes when connected to PROFIBUS-DP Gateway)
- Automatically assigns node addresses
- Integrates and supplies 24 Vdc power to contactor coils
- Includes diagnostic bi-color LEDs on each node connection

**System Components**



**Contents**

| <i>Description</i>                | <i>Page</i>    |
|-----------------------------------|----------------|
| System Overview                   |                |
| System Overview . . . . .         | <b>V7-T9-2</b> |
| System Overview Diagram . . . . . | <b>V7-T9-5</b> |

**System Components**

**Product Description**

The start of the SmartWire-DT system is usually a gateway module connected to a PLC or controller fieldbus. This means that SmartWire-DT connected components will work with most third-party PLCs without having to create a new program. These devices are typically located within the main control cabinet for a machine.

To plan and lay out a SmartWire-DT network, an MS Windows-compatible software program called SWD-Assist is available as a free download from the Eaton website. The SWD-Assist configuration software allows a user to drag-and-drop system components like motor starters, drives, pushbuttons and indicator lights, and will calculate the control power requirements needed and generate a bill of materials of all the required components.

**In-Panel Components**

**PLC and HMI/PLC Modules**

These modules serve as Programmable Logic Controllers, Human Machine Interface devices or both, and control the machine's SmartWire-DT system. Details of these devices are found in Tab 4 of this volume.

**Gateway Modules**

Gateway modules connect the SmartWire-DT system to the PLC. They are connected as nodes to the existing PLC fieldbus and are the start of the SmartWire-DT connection system. Gateways are available with EtherNet/IP, Modbus TCP, EtherCAT, PROFINET, POWERLINK, PROFIBUS-DP and CANopen protocols.

**Motor Control Modules**

Contactors fit into standard XT contactors and control relays directly on top, in place of a top-mounted auxiliary contact block. The modules fit all XTCE size B and C frame contactors and XTRE control relays.

Soft Start Controllers, Variable Speed Starters and Variable Frequency Drives connect to the SmartWire-DT system with plug-in modules similar to the approach with Contactor Modules.

Electronic Motor Starters with built-in SmartWire-DT functionality connect directly to the SmartWire-DT flat cable without the need for a supplemental module.

**Pilot Device Modules**

Pilot device modules fit into standard M22 pilot devices in both front-mount and base-mount configurations and replace the standard contact block and light units. Single and double contact modules with and without LEDs are available to meet a wide variety of control circuit requirements.

**Stacklight Modules**

Stacklight modules connect into Eaton SL4 and SL7 Series stacklights when mounted to the control cabinet with Eaton's Fast Mount Base. A variety of incandescent, LED, high-power LED and audible signal modules are available to meet machine indication requirements.

**In-Panel Components****Digital and Analog I/O Modules**

Digital and analog I/O modules are connected as nodes on the SmartWire-DT network and allow standard or generic devices to be connected to the SmartWire-DT system. They can be connected anywhere along the flat cable network and can therefore be positioned in the control panel to help reduce I/O wiring.

**Powerfeed Modules**

Powerfeed modules feed auxiliary 24 Vdc power and/or 15 Vdc network power into the SmartWire-DT flat cable. The auxiliary 24 Vdc power is needed for the power supply of contactors and the 15 Vdc network power is used for supplying power to additional SmartWire-DT nodes. Powerfeed modules are also used to create zone control or groups of devices controlled by a single Emergency Stop.

**SmartWire-DT Flat Cable**

The flat cable is an 8-conductor cable that is flexible, durable and rated for 600 V so that it can be placed in the panel wiring duct along with 480 V or 600 V power conductors. It has two prominent features: (a) arrows indicating the front of the cable and the direction away from the gateway and (b) black edging indicating the polarity of the flat cable, the 15 Vdc wire and the reference mark for installing the device plugs and flat plugs.

**Other System Accessories**

Other accessories for the SmartWire-DT system include connectors, jumpers, bushings, plugs and sockets, terminating resistors and crimping tools.

**On-Machine Components**

At the edge of the control cabinet the SmartWire-DT system transitions from the 8-conductor flat cable to a 5-conductor round cable with standard DC M12 barrel connectors, using simple transition adapters that mount through the panel wall.

**SmartWire-DT Round Cable**

The round cable has 5 conductors, uses standard DC M12 barrel connectors, and is 300 V rated. It is used outside the control panel to connect SmartWire-DT digital machine mount I/O modules for use with peripherals such as sensors, enclosed pushbuttons, pneumatic and hydraulic valves, stacklights and other remote devices. This single cable is used both to provide power to connected devices and to carry I/O signals.

**Digital Machine Mount I/O Modules**

Digital machine-mountable IP67 I/O modules are connected as nodes on the SmartWire-DT network and allow standard or generic devices to be connected to the SmartWire-DT system. They can be connected anywhere around the machine with up to 2000 feet and 99 devices possible with a single cable connection.

**Accessory Cables**

A variety of accessory cables are available to make the connection between remote devices (including sensors, stacklights, hydraulic and pneumatic valves, enclosed pilot devices, and other command and control devices) to the SmartWire-DT digital machine mount I/O modules.

**Enclosed Pilot Device Stations**

Pilot device modules mounted in IP67 enclosures for use in remote machine locations can be assembled from standard components supplied by Eaton, and contacts can be wired for direct connection to a SmartWire-DT digital machine mount I/O module using a standard DC M12 cordset. Examples of such devices include pilot lights, pushbuttons, illuminated pushbuttons, selector switches and key switches.

**Remote Stacklights**

Stacklights for use in remote machine locations can be assembled from standard components supplied by Eaton with contacts wired for direct connection to a SmartWire-DT digital machine mount I/O module using a standard DC M12 cordset.

**Machine Mount Powerfeed Modules**

Powerfeed modules feed 4 A of auxiliary 24 Vdc power into the SmartWire-DT round cable when needed to supply power to additional SmartWire-DT nodes. Eaton's SmartWire-DT Assist software can be used to quickly and easily calculate the need for powerfeed modules in a round cable system.



### System Overview Diagram

#### SmartWire-DT Contactor Modules

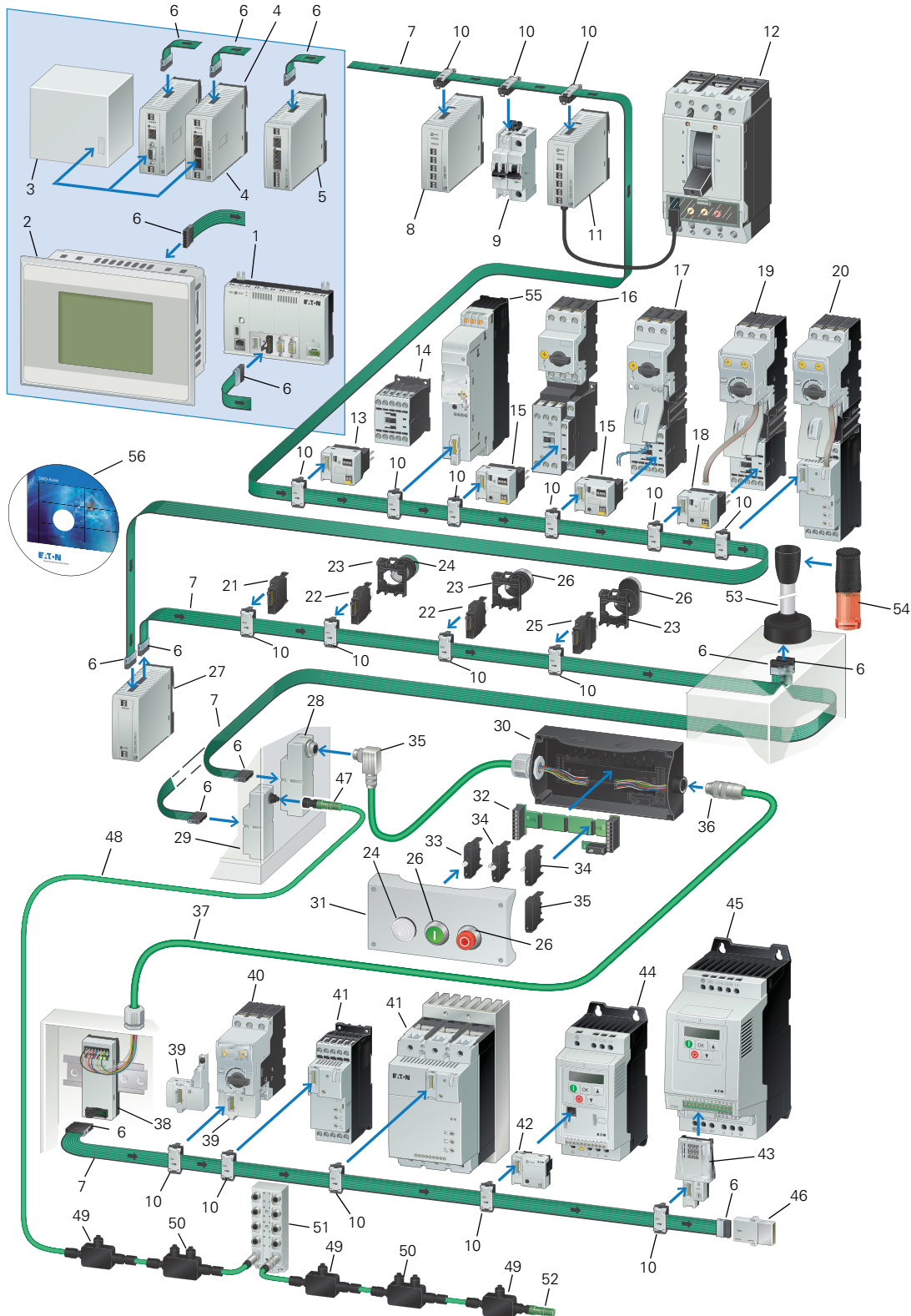

| Item Number | Description   |
|-------------|---|
| 1           | SmartWire-DT PLC XC-152   |
| 2           | SmartWire-DT HMI-PLC  |
| 3           | PLC with field bus interface  |
| 4           | SmartWire-DT Gateways   |
| 5           | Control relay easy800 with SmartWire-DT   |
| 6           | SmartWire-DT blade terminal, 8-pole   |
| 7           | SmartWire-DT 8-pin ribbon cable   |
| 8           | SmartWire-DT I/O module   |
| 9           | SmartWire-DT module for miniature circuit-breakers and residual-current circuit breakers      |
| 10          | SmartWire-DT external device plug, 8-pole   |
| 11          | SmartWire-DT connection for NZM   |
| 12          | NZM circuit-breakers  |
| 13          | SmartWire-DT contactor module   |
| 14          | DILM contactor  |
| 15          | SmartWire-DT contactor module with Hand-Off-Automatic switch                                  |
| 16          | Motor protective circuit-breakers   |
| 17          | Motor starter MSC   |
| 18          | SmartWire-DT PKE module (motor starter)   |
| 19          | Motor starter with PKE electronic motor protection  |
| 20          | Soft starter DS7 with electronic motor protection from PKE                                    |
| 21          | SmartWire-DT universal module, front mount  |
| 22          | SmartWire-DT LED elements, front mount  |
| 23          | RMQ-Titan mounting clamp for flush mounting plates  |
| 24          | RMQ-Titan indicator light   |
| 25          | SmartWire-DT function elements for front mount  |
| 26          | SmartWire-DT operating elements   |
| 27          | SmartWire-DT powerfeed card   |
| 28          | SmartWire-DT enclosure cable gland for converting a ribbon cable to an 8-pin round cable, M20 |

| Item Number | Description  |
|-------------|--|
| 29          | SmartWire-DT enclosure cable gland for converting a ribbon cable to a 5-pin round cable, M12 |
| 30          | Surface mounting enclosure RMQ-Titan   |
| 31          | Surface mounting enclosure RMQ-Titan   |
| 32          | SmartWire-DT card for function elements, base fixing   |
| 33          | SmartWire-DT LED elements for base fixing  |
| 34          | SmartWire-DT function elements for base fixing   |
| 35          | SmartWire-DT Universal slave for base fixing   |
| 36          | SmartWire-DT 8-pin connector   |
| 37          | SmartWire-DT round cable, 8-pole   |
| 38          | SmartWire-DT adapter for flat/round cable for top-hat rail mounting                          |
| 39          | SmartWire-DT PKE (motor-protective circuit-breaker)  |
| 40          | PKE motor-protective circuit-breakers  |
| 41          | DS7 soft starter   |
| 42          | SmartWire-DT function element for DC1 variable frequency drives                              |
| 43          | SmartWire-DT function element for DA1 variable frequency drives                              |
| 44          | DC1 variable frequency drives  |
| 45          | DA1 variable frequency drives  |
| 46          | SmartWire-DT bus termination resistor for 8-pin ribbon cable                                 |
| 47          | 5-pin M12 plug connector   |
| 48          | Round cable, 5-pole  |
| 49          | SmartWire-DT IP67 I/O module, 2 I/O  |
| 50          | SmartWire-DT IP67 I/O module, 4 I/O  |
| 51          | SmartWire-DT IP67 I/O module, max. 16 I/O  |
| 52          | SmartWire-DT IP67 bus termination resistor for 5-pin round cable, M12                        |
| 53          | SmartWire-DT connection to SL4/SL7 signal tower  |
| 54          | Signal towers SL4 /SL7   |
| 55          | Electronic motor starter EMS   |
| 56          | SmartWire-DT planning and ordering aid, SWD-Assist   |

### Gateway Modules and System Controllers

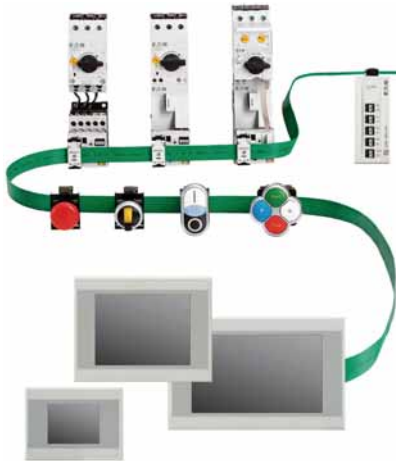

### Contents

| <b>Description</b>   | <b>Page</b>    |
|--|----------------|
| Gateway Modules and System Controllers                     |                |
| Gateway Modules .....                                      | <b>V7-T9-7</b> |
| System Controllers .....                                   | <b>V7-T9-8</b> |
| XV Series HMI-PLC with SmartWire-DT .....                  | <b>V7-T9-8</b> |
| XC152 Series PLC with SmartWire-DT .....                   | <b>V7-T9-8</b> |
| easy802/806 Programmable Relays<br>with SmartWire-DT ..... | <b>V7-T9-8</b> |

## Gateway Modules and System Controllers

### Gateway Modules

#### Product Description

SmartWire-DT Gateway Modules allow easy connection to a wide variety of systems using fieldbus standards.

Gateways can be used to connect the SmartWire-DT communication system to PLCs and operating systems from any manufacturer using standardized fieldbus interfaces. SmartWire-DT can communicate via EtherNet/IP, Modbus-TCP, EtherCAT, PROFINET, POWERLINK, PROFIBUS-DP and CANopen with simple connection and configuration and with no changes required to the core PLC program in use.

#### Features

- Easy plug & play connection to the SmartWire-DT network
- Models available for all standard fieldbus protocols
- Simple interface to third-party PLCs
- Allow OEMs to easily transition between customer-specified PLCs without changing underlying in-panel and on-machine wiring system



## System Controllers

### XV Series HMI-PLC with SmartWire-DT

#### Product Description

The XV HMI-PLC controller with SmartWire-DT master is a powerful combination of logic, visualization and connectivity to motor control devices. It is ideal for small to mid-range PLC applications where integrated logic and visualization is advantageous and/or where remote administration is critical. The SmartWire-DT master can accept 99 nodes on a 2000 foot-long network.

#### Features

- Built-in SmartWire-DT master for 99 nodes
- Brilliant image display with 65,536 colors
- High resolution resistive touch TFT displays
- 3.5 in, 5.7 in or 7 in widescreen displays in robust plastic housings and bezels, or
- 5.7 in, 8.4 in or 10.4 in displays in high-end aluminum front bezels and metal housings
- Ethernet and RS-485 serial ports on all models
- PROFIBUS-DP or CANopen master on all models larger than 3.5 in
- Programmable with IEC 61131-3 compliant XSoft-CoDeSys software
- Easy connection direct to motor control and other I/O both inside and outside the machine control cabinet using the SmartWire-DT machine wiring system

#### Standards and Certifications

- CE
- UL
- cUL
- RoHS



### XC152 Series PLC with SmartWire-DT

#### Product Description

The XC152 compact PLC combines plenty of processing power with a large number of communication interfaces. This makes the device particularly well-suited to standardized automation solutions in modular machine building applications.

The XC152 not only provides machine segment control functions that can be programmed with CoDeSys, but it can store module-specific visualizations. These visualizations can be retrieved and displayed on a central HMI or a computer as needed.

In addition, the XC152 connects SmartWire-DT systems to standard fieldbus systems via its interfaces. This enables the XC152 PLC to support Eaton's Lean Automation strategy while enabling users to design automation systems in a flexible manner and run them cost-effectively.

#### Features

- CoDeSys PLC and Web visualization
- Galileo/CoDeSys remote visualization
- Ethernet port on all models
- Windows® CE 5 operating system
- 32-bit RISC CPU at 400 MHz
- 64 MB internal memory
- SD card slot for external memory
- Run/Stop switch
- Optional: Integrated SmartWire-DT master for 99 nodes
- Optional: RS-232, RS-485, PROFIBUS-DP/MPI, CANopen/easyNet

#### Standards and Certifications

- IEC/EN 61131-2, EN 50178
- EN 61000-6-2, EN 61000-6-4
- cULus
- CE



### easy802/806 Programmable Relays with SmartWire-DT

#### Product Description

On the new easy800 with integrated SmartWire-DT master, up to 99 SmartWire-DT devices in total with up to 166 inputs/outputs can be connected via the SmartWire-DT line.

The easy802 features a POW power feeder for regulating power to the device as well as the SmartWire-DT devices. A second AUX power feeder provides the connected contactors with 24 Vdc. A separate 24 Vdc power supply is required to provide 24 Vdc power to the easy802 or easy806 controllers. The configuration of the SmartWire-DT devices is undertaken at a touch of the provided Configuration button. LEDs provide feedback on the connecting states on the device and the SmartWire-DT line. The serial interface serves for programming as well as for connection of a remote text display, touch panel or for connection to the Ethernet.

In addition to the functionality of the easy802, the easy806 also features four fast inputs (5 kHz). Two of the four inputs can also be configured as fast outputs (5 kHz) (transistor 24 Vdc, 0.1A). In addition to the additional inputs/outputs on easy806, there is a connection option to the easyNet. Up to eight EASY806-DC-SWD controllers can be connected via easyNet, allowing up to 1360 inputs/outputs.

#### Standards

- EN 50178
- IEC/EN 60947
- UL 508

#### Certifications

- cULus
- CE
- C-Tick



### System Control Overview

#### Lean Solution Architecture #1

##### Gateway SmartWire-DT to any PLC

- Advantages of SmartWire-DT without changing your control architecture
- Optimize and standardize your control cabinet
- Simplify PLC transitions



#### Lean Solution Architecture #2

##### XV HMI-PLC with Integrated SmartWire-DT

- Fully optimize your machine design
- Powerful control and visualization capabilities
- Combine SmartWire-DT with broad fieldbus and enterprise networking capabilities



#### Lean Solution Architecture #3

##### XC152 SmartWire-DT PLC

- When local visualization is not required
- Powerful CoDeSys based control
- Combine SmartWire-DT with broad fieldbus and enterprise networking capabilities
- Web visualization and remote access



#### Lean Solution Architecture #4

##### easy802/806 Programmable Relays with SmartWire-DT

- Bring the value of SmartWire-DT to small machines
- Simple configuration using easySoft-Pro ladder logic programming software with integrated SWD-Assist



# 9.1

## Connectivity Solutions

### SmartWire-DT In-Panel and On-Machine Wiring Solution

#### Product Selection

##### Gateway Modules

Gateway modules connect the SmartWire-DT system to the programmable logic controller (PLC). They are connected as nodes to the existing PLC fieldbus and are the start of the SmartWire-DT connection system.

##### Ethernet Gateway

##### EtherNet/IP Modbus-TCP Gateway



| Description  | Baud Rates    | Number of SmartWire-DT Nodes | Catalog Number             |
|--|---------------|------------------------------|----------------------------|
| For connection to EtherNet/IP or Modbus TCP fieldbus<br>Connection via two-port Ethernet switch (RJ45)<br>Separate RS-232 diagnostics interface (RJ45) | 10/100 MBit/s | Max. 99                      | <b>EU5C-SWD-EIP-MODTCP</b> |

##### PROFINET Gateway

##### PROFINET Gateway



| Description  | Baud Rates | Number of SmartWire-DT Nodes | Catalog Number           |
|--|------------|------------------------------|--------------------------|
| For connection to PROFINET fieldbus<br>Connection via two-port Ethernet switch (RJ45)<br>Separate USB diagnostics interface (Mini USB) | 100 MBit/s | Max. 99                      | <b>EU5C-SWD-PROFINET</b> |

##### POWERLINK Gateway

##### POWERLINK Gateway



| Description   | Baud Rates | Number of SmartWire-DT Nodes | Catalog Number            |
|---|------------|------------------------------|---------------------------|
| For connection to POWERLINK fieldbus<br>Connection via two-port Ethernet switch (RJ45)<br>Separate USB diagnostics interface (Mini USB) | 100 MBit/s | Max. 99                      | <b>EU5C-SWD-POWERLINK</b> |

##### EtherCAT Gateway

##### EtherCAT Gateway



| Description  | Baud Rates | Number of SmartWire-DT Nodes | Catalog Number           |
|--|------------|------------------------------|--------------------------|
| For connection to EtherCAT fieldbus<br>Connection via two-port Ethernet switch (RJ45)<br>Separate USB diagnostics interface (Mini USB) | 100 MBit/s | Max. 99                      | <b>EU5C-SWD-ETHERCAT</b> |

##### PROFIBUS-DP Gateway

##### PROFIBUS-DP Gateway



| Description   | Baud Rates      | Number of SmartWire-DT Nodes | Catalog Number     |
|---|-----------------|------------------------------|--------------------|
| For connection to PROFIBUS-DP fieldbuses<br>Connection via 9-pin Sub-D socket<br>Separate RS-232 diagnostics interface (RJ45) | Up to 12 MBit/s | Max. 58                      | <b>EU5C-SWD-DP</b> |

##### CANopen Gateway

##### CANopen Gateway



| Description   | Baud Rates     | Number of SmartWire-DT Nodes | Catalog Number      |
|---|----------------|------------------------------|---------------------|
| For connection to CANopen fieldbus<br>Connection via 9-pin Sub-D socket<br>Separate RS-232 diagnostics interface (RJ45) | Up to 1 MBit/s | Max. 99                      | <b>EU5C-SWD-CAN</b> |

**XV HMI/PLC**

**XV HMI/PLC with SmartWire-DT**



**XV HMI/PLC with SmartWire-DT**

| Display Size/Type      | Display Resolution | Programming Software  | Fieldbus Type | RS-485 (DB9) | Ethernet (RJ45) | SmartWire-DT | Catalog Number             |
|------------------------|--------------------|-----------------------|---------------|--------------|-----------------|--------------|----------------------------|
| <b>Plastic Housing</b> |                    |                       |               |              |                 |              |                            |
| 3.5 in TFT             | QVGA 320x240       | XSoft CoDeSys-2 or -3 | None          | None         | Yes             | Yes          | <b>XV-102-BE-35TQRC-10</b> |
| 5.7 in TFT             | VGA 640x480        | XSoft CoDeSys-2 or -3 | CANopen       | Yes          | Yes             | Yes          | <b>XV-102-E6-57TVRC-10</b> |
|                        |                    | XSoft CoDeSys-2 or -3 | PROFIBUS-DP   | Yes          | Yes             | Yes          | <b>XV-102-E8-57TVRC-10</b> |
| 7.0 in TFT             | WGA 800x480        | XSoft CoDeSys-2 or -3 | CANopen       | Yes          | Yes             | Yes          | <b>XV-102-E6-70TWRC-10</b> |
|                        |                    | XSoft CoDeSys-2 or -3 | PROFIBUS-DP   | Yes          | Yes             | Yes          | <b>XV-102-E8-70TWRC-10</b> |
| <b>Metal Housing</b>   |                    |                       |               |              |                 |              |                            |
| 5.7 in TFT             | VGA 640x480        | XSoft CoDeSys-2 or -3 | CANopen       | Yes          | Yes             | Yes          | <b>XV-152-E6-57TVRC-10</b> |
|                        |                    | XSoft CoDeSys-2 or -3 | PROFIBUS-DP   | Yes          | Yes             | Yes          | <b>XV-152-E8-57TVRC-10</b> |
| 8.4 in TFT             | VGA 640x480        | XSoft CoDeSys-2 or -3 | CANopen       | Yes          | Yes             | Yes          | <b>XV-152-E6-84TVRC-10</b> |
|                        |                    | XSoft CoDeSys-2 or -3 | PROFIBUS-DP   | Yes          | Yes             | Yes          | <b>XV-152-E8-84TVRC-10</b> |
| 10.4 in TFT            | VGA 640x480        | XSoft CoDeSys-2 or -3 | CANopen       | Yes          | Yes             | Yes          | <b>XV-152-E6-10TVRC-10</b> |
|                        |                    | XSoft CoDeSys-2 or -3 | PROFIBUS-DP   | Yes          | Yes             | Yes          | <b>XV-152-E8-10TVRC-10</b> |

**XC152 PLC**

**XC152 PLC SmartWire-DT**



**XC152 PLC SmartWire-DT**

| Programming Software  | Fieldbus Type | RS-232 (DB9) | RS-485 (DB9) | Ethernet (RJ45) | SmartWire-DT | Catalog Number      |
|-----------------------|---------------|--------------|--------------|-----------------|--------------|---------------------|
| XSoft CoDeSys-2 or -3 | None          | Yes          | None         | Yes             | Yes          | <b>XC-152-E3-11</b> |
| XSoft CoDeSys-2 or -3 | CANopen       | None         | Yes          | Yes             | Yes          | <b>XC-152-E6-11</b> |
| XSoft CoDeSys-2 or -3 | PROFIBUS-DP   | None         | Yes          | Yes             | Yes          | <b>XC-152-E8-11</b> |

**XV and XC Accessories**

**XV HMI/PLC and XC PLC Accessories**

| Description                                     | Catalog Number              |
|---|-----------------------------|
| PLC programming software, single seat license   | <b>SW-XSOFT-CODESYS-3-S</b> |
| PLC programming software, multiple seat license | <b>SW-XSOFT-CODESYS-3-M</b> |
| SD memory card                                  | <b>MEMORY-SD-A1-S</b>       |

# 9.1

## Connectivity Solutions

### SmartWire-DT In-Panel and On-Machine Wiring Solution

#### easy800 with SmartWire-DT

##### EASY802-DC-SWD



#### easy800 with SmartWire-DT

| Programming Software | Fieldbus Type | RS-232 (RJ45) | Inputs<br>24 Vac<br>5 kHz | Outputs<br>24 Vdc <sup>①</sup> | SmartWire-DT | Catalog Number        |
|----------------------|---------------|---------------|---------------------------|--------------------------------|--------------|-----------------------|
| easysoft-Pro         | None          | Yes           | None                      | None                           | Yes          | <b>EASY802-DC-SWD</b> |

##### EASY806-DC-SWD



|              |         |     |   |                |     |                       |
|--------------|---------|-----|---|----------------|-----|-----------------------|
| easysoft-Pro | easyNet | Yes | 4 | 2 <sup>①</sup> | Yes | <b>EASY806-DC-SWD</b> |
|--------------|---------|-----|---|----------------|-----|-----------------------|

9

#### Remote Displays

Both the EASY802 and EASY806 controllers can be connected to a MFD remote display or a XV touch panel display with Galileo.

#### Note

<sup>①</sup> Use of outputs will result in a decrease in an equal number of available inputs.

### I/O and Powerfeed Modules, System Connectivity Components



### Contents

| <i>Description</i>  | <i>Page</i>     |
|---|-----------------|
| I/O and Powerfeed Modules, System Connectivity Components |                 |
| Powerfeed Modules . . . . .                               | <b>V7-T9-14</b> |
| I/O Modules . . . . .                                     | <b>V7-T9-14</b> |
| System Connectivity Components . . . . .                  | <b>V7-T9-15</b> |

## I/O and Powerfeed Modules, System Connectivity Components

### Product Description

I/O and powerfeed modules mount easily to DIN rail inside the control cabinet and connect directly to the SmartWire-DT system with snap-in connections to the 8-conductor flat SmartWire-DT cable.

I/O modules provide a means of easy connection of digital and analog devices to the SmartWire-DT network. Powerfeed modules allow the insertion of 24 Vdc and/or 15 Vdc power where necessary based on the power demands of components connected to the SmartWire-DT network.

Connectivity components are designed to make connection of devices to the 8-conductor flat SmartWire-DT cable simple and trouble-free.

### Features

- I/O modules available in digital input and output, analog input and output, and RTD input versions in various combinations to simplify panel configuration
- Relay output version available for high-current loads
- Temperature input versions have wide operating ranges to support a variety of application requirements
- Powerfeed modules can be used to create zoned control arrangements to support integration of Emergency Stop devices into a network

#### Product Selection

##### Powerfeed Modules

###### Powerfeed Module



##### Powerfeed Modules

Powerfeed modules feed auxiliary 24 Vdc power and/or 15 Vdc network power into the SmartWire-DT flat cable. The auxiliary 24 Vdc power is needed for the power supply of contactors and the 15 Vdc network power is used for supplying power to additional SmartWire-DT nodes. Powerfeed modules are also used to create zone control or groups of devices controlled by a single Emergency Stop.

| Description  | Pkg. Qty. | Catalog Number |
|--|-----------|----------------|
| Powerfeed module 1 (for 24 Vdc auxiliary power)                          | 1         | EU5C-SWD-PF1-1 |
| Powerfeed module 2 (for 24 Vdc auxiliary power and 15 Vdc network power) | 1         | EU5C-SWD-PF2-1 |

##### I/O Modules

9

###### Digital I/O Module



##### Digital I/O Modules

Digital input/output (I/O) modules are connected as nodes on the SmartWire-DT network and allow standard or generic devices to be connected to the SmartWire-DT system. They can be connected anywhere along the flat cable network and can therefore be positioned in the control panel to help reduce the I/O wiring.

| Description   | Pkg. Qty. | Catalog Number |
|---|-----------|----------------|
| Digital module with 8 digital inputs 24 Vdc                                       | 1         | EU5E-SWD-8DX   |
| Digital module with 8 digital outputs 24 Vdc / 0.5 A                              | 1         | EU5E-SWD-X8D   |
| Digital module with 4 digital inputs 24 Vdc and 4 transistor outputs 24 Vdc/0.5 A | 1         | EU5E-SWD-4D4D  |
| Digital module with 4 digital inputs 24 Vdc and 2 relay outputs 250 Vac/3 A       | 1         | EU5E-SWD-4D2R  |
| For Sensor Inputs   |           |                |
| Digital module with 4 digital inputs 24 Vdc three-wire connections                | 1         | EU5E-SWD-4DX   |

###### Analog I/O Module



##### Analog I/O Modules

Analog input/output (I/O) modules are connected as nodes on the SmartWire-DT network and allow standard or generic devices to be connected to the SmartWire-DT system. They can be connected anywhere along the flat cable network and can therefore be positioned in the control panel to help reduce the I/O wiring.

| Description   | Pkg. Qty. | Catalog Number |
|---|-----------|----------------|
| Analog module with 4 analog inputs 0–10 V or 0–20 mA  | 1         | EU5E-SWD-4AX   |
| Analog module with 2 analog inputs 0–10 V or 0–20 mA and 2 analog outputs 0–10 V or 0–20 mA | 1         | EU5E-SWD-2A2A  |

###### Temperature Input Module



##### Temperature Input Modules





Temperature input modules are connected as nodes on the SmartWire-DT network and allow standard or generic devices to be connected to the SmartWire-DT system. They can be connected anywhere along the flat cable network and can therefore be positioned in the control panel to help reduce the I/O wiring.

| Description  | Pkg. Qty. | Catalog Number |
|--|-----------|----------------|
| RTD module with 4 temperature inputs Pt100, Pt 1000 or Ni1000; +32 to +292 °F (0 to +200 °C)     | 1         | EU5E-SWD-4PT   |
| RTD module with 4 temperature inputs Pt100, Pt 1000 or Ni1000; –148 to +752 °F (–100 to +400 °C) | 1         | EU5E-SWD-4PT-2 |

### System Connectivity Components

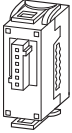
System connectivity components for the SmartWire-DT system includes cables, connectors, jumpers, bushings, plugs, sockets, flat to round cable adapters, and crimping tools.

#### In-Cabinet Components

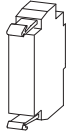
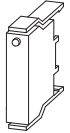
|   | Description  | Length           | Pkg. Qty. | Catalog Number          |
|---|--|------------------|-----------|-------------------------|
| <b>Flat Cable</b><br>  | <b>Flat Cable, 8 AWG 24, 600 V</b>   |                  |           |                         |
|   | For SmartWire-DT network <b>inside</b> the control panel   | 328.1 ft (100 m) | 1         | <b>SWD4-100LF8-24</b>   |
|   | Complete with flat plugs SWD4-8MF2 installed at both ends  | 9.8 ft (3 m)     | 1         | <b>SWD4-3LF8-24-2S</b>  |
|   |  | 16.4 ft (5 m)    | 1         | <b>SWD4-5LF8-24-2S</b>  |
|   |  | 32.8 ft (10 m)   | 1         | <b>SWD4-10LF8-24-2S</b> |
| <b>Device Plug</b><br>   | <b>Device Plugs</b>  |                  |           |                         |
|   | For connection to SmartWire-DT modules or nodes  | —                | 10        | <b>SWD4-8SF2-5</b>      |
| <b>Flat Plug</b><br>   | <b>Flat Plugs</b>  |                  |           |                         |
|   | For connection to SmartWire-DT system components: gateways, powerfeed modules, coupling and terminating resistor | —                | 10        | <b>SWD4-8MF2</b>        |
| <b>Device Plug Jumper</b><br>   | <b>Device Plug Jumpers</b>   |                  |           |                         |
|   | For bridging open, spare or inverted device plugs  | —                | 5         | <b>SWD4-SEL8-10</b>     |
| <b>PCB Jumper</b><br>  | <b>Control Station PCB Jumpers</b>   |                  |           |                         |
|   | For bridging open mounting locations on the control station printed circuit board                                | —                | 5         | <b>M22-SWD-SEL8-10</b>  |
| <b>Universal Modules</b><br> <br><i>Front Mount</i> <i>Base Mount</i> | <b>Universal (Placeholder) Modules</b>   |                  |           |                         |
|   | Front mount  | —                | 20        | <b>M22-SWD-NOP</b>      |
|   | Base mount   | —                | 20        | <b>M22-SWD-NOPC</b>     |





# 9.1

## Connectivity Solutions

### SmartWire-DT In-Panel and On-Machine Wiring Solution

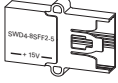
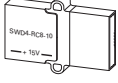
#### In-Cabinet Components, continued

|   | Description  | Pkg. Qty. | Catalog Number      |
|---|--|-----------|---------------------|
| <b>Coupling</b>   | <b>Coupling</b>  |           |                     |
|  | For connecting or joining flat cables with flat plugs  | 1         | <b>SWD4-8SFF2-5</b> |
| <b>Terminating Resistor</b>   | <b>Terminating Resistors</b>                           |           |                     |
|  | For terminating the end of the network on a flat cable | 1         | <b>SWD4-RC8-10</b>  |
| <b>Device Plug Tool</b>   | <b>Crimping Tools</b>                                  |           |                     |
|  | Device plug crimping tool                              | 1         | <b>SWD4-CRP-1</b>   |
| <b>Flat Plug Tool</b>   | Flat plug crimping tool                                | 1         | <b>SWD4-CRP-2</b>   |
|  |  |           |                     |

**Motor Control Modules**



**Contents**

| <b>Description</b>  | <b>Page</b>     |
|---|-----------------|
| Motor Control Modules                                       |                 |
| Product Identification .....                                | <b>V7-T9-18</b> |
| Contactor Modules .....                                     | <b>V7-T9-19</b> |
| Electronic Motor Starters .....                             | <b>V7-T9-20</b> |
| Soft Start Controllers .....                                | <b>V7-T9-21</b> |
| Variable Speed Starters/<br>Variable Frequency Drives ..... | <b>V7-T9-22</b> |

**Motor Control Modules**

**Product Description**

Contactor modules fit onto standard XT contactors and control relays directly on top, in place of a top mounted auxiliary contact block. The modules fit all XTCE size B and C frame contactors and XTRE control relays.

Soft Start Controllers, Variable Speed Starters and Variable Frequency Drives connect to the SmartWire-DT system with plug-in modules similar to the approach with Contactor Modules.

Electronic Motor Starters with built-in SmartWire-DT functionality connect directly to the SmartWire-DT flat cable without the need for a supplemental module.

These modules facilitate direct connection to the SmartWire-DT flat cable and eliminate the traditional point-to-point wiring to the PLC input and output modules as well as wiring to the contactor coils.

**Features**

- Integrated 24 Vdc coil power on network and plug-in modules
- Integrated switch position polling and mechanical switch position display on contactor modules
- Integrated feedback circuit to PLC
- Built-in diagnostic bi-color LEDs on each module
- Connection to SmartWire-DT flat cable via quick disconnect device plugs

# 9.1

## Connectivity Solutions

### SmartWire-DT In-Panel and On-Machine Wiring Solution

#### Product Identification

#### SmartWire-DT Contactor Modules

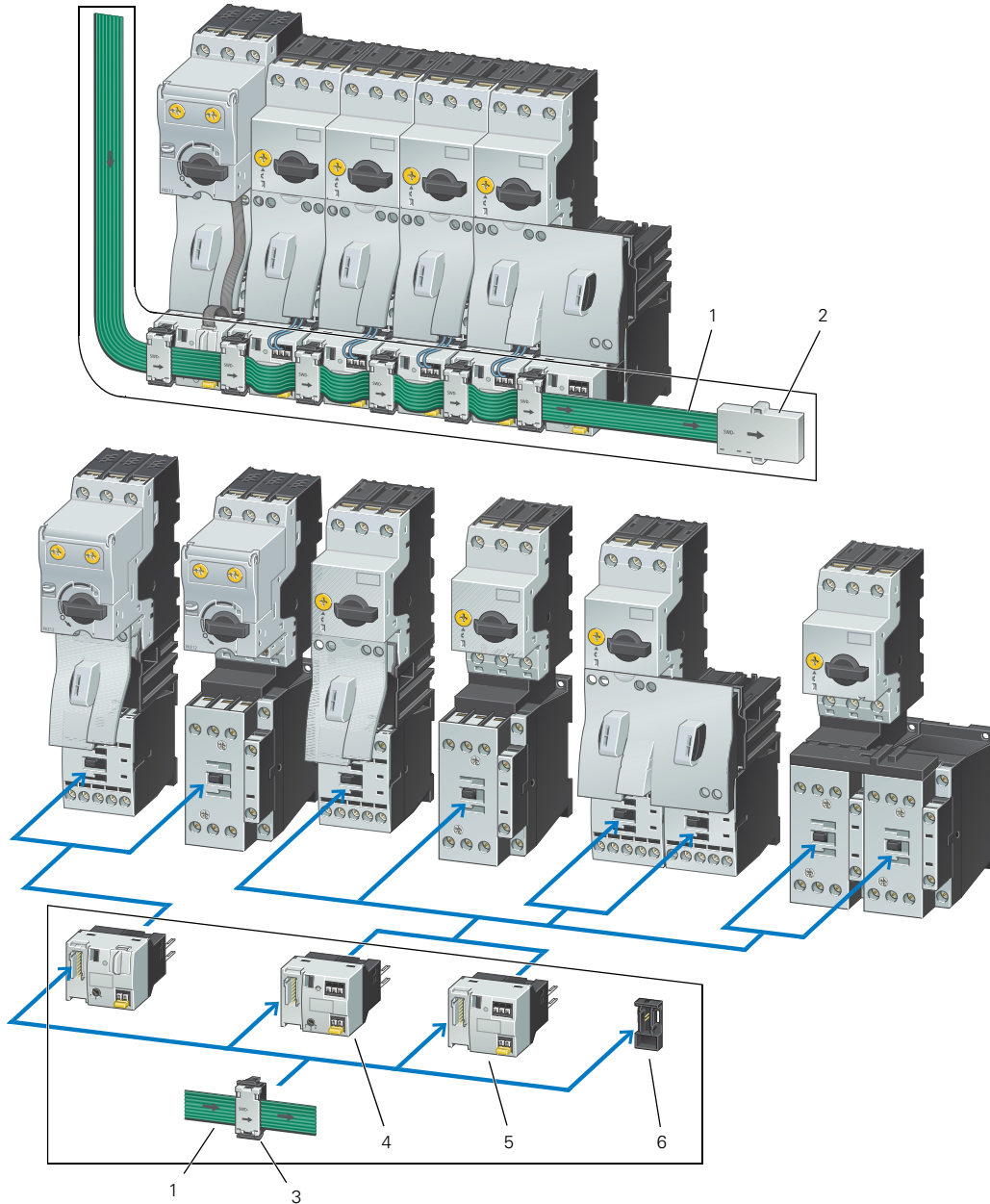

| Item Number | Description   |
|-------------|---|
| 1           | Flat cable  |
| 2           | Terminating resistor (SWD4-RC8-10)  |
| 3           | Device plug (SWD4-85F2-5)   |
| 4           | Modules for XT contactors with XTPR manual motor protectors, with 1-0-A switch (DIL-SWD-32-002) |
| 5           | Modules for XT contactors with XTPR manual motor protectors (DIL-SWD-32-001)                    |
| 6           | Device plug jumper (SWD4-SEL8-10)   |

**Contactors Modules**

**Product Selection**

**Contactors Modules**

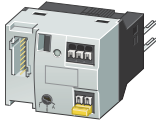

**Contactors Modules** ①②③

SmartWire-DT module for attachment to XTCE007–XTCE032 contactors and XTRE control relays. One module is required per contactor.

| Description  | Pkg. Qty. | Catalog Number |
|--|-----------|----------------|
| Two digital inputs for voltage-free contacts.<br>One electrical interlock for the surface mounting of reversing combinations.<br>Messages: Switch status contactor, status of the digital inputs 1 and 2.<br>Commands: Contactor actuation.  | 5         | DIL-SWD-32-001 |
| Two digital inputs for voltage-free contacts.<br>One electrical interlock for the surface mounting of reversing combinations.<br>1-0-A switch for manual or automatic operation.<br>Messages: Contactor switching position, status of the digital inputs 1 and 2, 1-0-A switch position.<br>Commands: Contactor actuation. | 5         | DIL-SWD-32-002 |

**PKE Contactor Module**

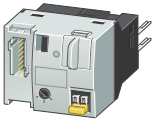

**PKE Contactor Module**

SmartWire-DT module for connection of XTPE manual motor controllers. One module is required per contactor and XTPE manual motor protector.

| Description   | Pkg. Qty. | Catalog Number |
|---|-----------|----------------|
| Connecting cable between module and XTPE trip block included as standard.<br>One electrical interlock for the surface mounting of reversing starters.<br>1-0-A switch for manual or automatic operation.<br>Selectable overload relay function for connecting the contactor on overload.<br>Messages:<br>Switch position contactor/PKE/1-0-A switch<br>Motor current in %<br>Thermal motor image in %<br>Trip-indicating auxiliary contact (Overload, Short-circuit,...)<br>Set value of overload releases<br>Set value Verification time (CLASS), Part no. Trip block.<br>Commands: Contactor actuation, activation of overload relay function (ZMR) | 4         | PKE-SWD-32     |

**Design Note**

The number of motor starters or XTCE contactors that can be connected is dependent upon the power consumption of the contactor coils. To increase the number of SmartWire-DT modules that can be connected. Powerfeed modules can be used.

| 24 Vdc        |   | XTCE007 | XTCE009 | XTCE012 | XTCE015 | XTCE018 | XTCE025 | XTCE032 |
|---------------|---|---------|---------|---------|---------|---------|---------|---------|
| Pick-up power | W | 3       | 3       | 4.5     | 4.5     | 12      | 12      | 12      |
| Sealing power | W | 3       | 3       | 4.5     | 4.5     | 0.5     | 0.5     | 0.5     |

**Notes**

- ① Take account of the maximum current consumption of the contactor coils per SmartWire-DT line.
- ② A2 connections must not be linked.
- ③ Connection terminals for electrical interlocking are not suitable for safety technology.

## Electronic Motor Starters

### Product Selection

EMS-DO-...



SmartWire-DT Connection



### Electronic Motor Starters—Complete Devices

Electronic Motor Starters with SmartWire-DT built in do not require a separate module for connection to the SmartWire-DT network. Connection is made directly to the SmartWire-DT flat cable.

| Description  | Max. Rating for Three-Phase Motors, 50–60 Hz AC-53a<br>380/400/415 V<br>P kW | Setting Range of Overload Releases<br>$I_r$<br>A  | DC Operation<br>24 Vdc<br>Catalog Number                 |
|--|--|---|--|
| DOL starting,<br>Motor protection,<br>Circuit design: Safety output stage with bypass,<br>three-phase disconnect.  | 0.06–0.75<br>0.55–3.00   | 0.18–2.4<br>1.5–6.5 (AC-53a)<br>9 (AC-51)   | <b>EMS-DO-T-2,4-24VDC</b><br><b>EMS-DO-T-9-24VDC</b>     |
| DOL starting,<br>Motor protection,<br>Emergency-stop actuator.<br>Circuit design: Safety output stage with bypass,<br>three-phase disconnect.                            | 0.06–0.75<br>0.55–3.00   | 0.18–2.4<br>1.5–6.5 (AC-53a)<br>9 (AC-51)   | <b>EMS-DOS-T-2,4-24VDC</b><br><b>EMS-DOS-T-9-24VDC</b>   |
| DOL starting,<br>Motor protection,<br>For connecting to SmartWire-DT.<br>Circuit design: Safety output stage with bypass,<br>three-phase disconnect.                     | 0.06–0.75<br>0.55–3.00   | 0.18–2.4<br>1.5–6.5 (AC-53a)<br>9 (AC-51)   | <b>EMS-DO-T-2,4-SWD-ADP</b><br><b>EMS-DO-T-9-SWD-ADP</b> |
| DOL starting,<br>Reversing start,<br>Motor protection,<br>Circuit design: Safety output stage with bypass,<br>three-phase disconnect.                                    | 0.06–0.75<br>0.55–3.00   | 0.18–2.4<br>1.5–6.5 (AC-53a)<br>9 (AC-51)   | <b>EMS-RO-T-2,4-24VDC</b><br><b>EMS-RO-T-9-24VDC</b>     |
| DOL starting,<br>Reversing start,<br>Motor protection,<br>Emergency-stop actuator.<br>Circuit design: Safety output stage with bypass,<br>three-phase disconnect.        | 0.06–0.75<br>0.55–3.00   | 0.18–2.4<br>1.5–6.5 (AC-53a)<br>9 (AC-51)   | <b>EMS-ROS-T-2,4-24VDC</b><br><b>EMS-ROS-T-9-24VDC</b>   |
| DOL starting,<br>Reversing start,<br>Motor protection,<br>For connecting to SmartWire-DT.<br>Circuit design: Safety output stage with bypass,<br>three-phase disconnect. | 0.06–0.75<br>0.55–3.00   | 0.18–2.4<br>1.5–6.5 (AC-53a)<br>9 (AC-51)   | <b>EMS-RO-T-2,4-SWD-ADP</b><br><b>EMS-RO-T-9-SWD-ADP</b> |

Soft Start Controllers

Product Selection

Soft Start Controllers

DS7-...



4 to 12 A



16 to 32 A



41 to 100 A



135 to 200 A

DS7 Series Soft Start Controllers with SmartWire-DT built in do not require a separate module for connection to the SmartWire-DT network. Connection is made directly to the SmartWire-DT flat cable.

Soft starters for three-phase loads. Mains supply voltage (50/60 Hz).  $U_{LN}$  200–480 Vac.

| Rated Operational Current Device (AC-53)<br>$I_e$<br>A | Assigned Motor Rating      |                            | $U_C$ 24 V AC/DC<br>$U_S$ 24 Vac/Vdc<br>Standard Temperature Range | $U_C$ 24 V AC/DC<br>$U_S$ 24 Vac/Vdc<br>Expanded Temperature Range (Down to -40 °C) |
|--|----------------------------|----------------------------|--|---|
|  | At 400 V, 50 Hz<br>P<br>kW | At 480 V, 60 Hz<br>P<br>hp | Catalog Number   | Catalog Number  |
| 4  | 1.5                        | 2                          | DS7-340SX004N0-N   | DS7-340SX004N0-L  |
| 7  | 3                          | 5                          | DS7-340SX007N0-N   | DS7-340SX007N0-L  |
| 9  | 4                          | 5                          | DS7-340SX009N0-N   | DS7-340SX009N0-L  |
| 12   | 5.5                        | 10                         | DS7-340SX012N0-N   | DS7-340SX012N0-L  |
| 16   | 7.5                        | 10                         | DS7-340SX016N0-N   | DS7-340SX016N0-L  |
| 24   | 11                         | 15                         | DS7-340SX024N0-N   | DS7-340SX024N0-L  |
| 32   | 15                         | 25                         | DS7-340SX032N0-N   | DS7-340SX032N0-L  |
| 41   | 22                         | 30                         | DS7-340SX041N0-N   | DS7-340SX041N0-L  |
| 55   | 30                         | 40                         | DS7-340SX055N0-N   | DS7-340SX055N0-L  |
| 70   | 37                         | 50                         | DS7-340SX070N0-N   | DS7-340SX070N0-L  |
| 81   | 45                         | 60                         | DS7-340SX081N0-N   | DS7-340SX081N0-L  |
| 100  | 55                         | 75                         | DS7-340SX100N0-N   | DS7-340SX100N0-L  |
| 135  | 75                         | 100                        | DS7-340SX135N0-N   | DS7-340SX135N0-L  |
| 160  | 90                         | 125                        | DS7-340SX160N0-N   | DS7-340SX160N0-L  |
| 200  | 110                        | 150                        | DS7-340SX200N0-N   | DS7-340SX200N0-L  |
|  |                            |                            | $U_C$ 110–230 Vac<br>$U_S$ 110/230 Vac                             | $U_C$ 24 Vdc<br>$U_S$ 24 Vdc  |
| 4  | 1.5                        | 2                          | DS7-342SX004N0-N   | DS7-34DSX004N0-D  |
| 7  | 3                          | 5                          | DS7-342SX007N0-N   | DS7-34DSX007N0-D  |
| 9  | 4                          | 5                          | DS7-342SX009N0-N   | DS7-34DSX009N0-D  |
| 12   | 5.5                        | 10                         | DS7-342SX012N0-N   | DS7-34DSX012N0-D  |
| 16   | 7.5                        | 10                         | DS7-342SX016N0-N   | DS7-34DSX016N0-D  |
| 24   | 11                         | 15                         | DS7-342SX024N0-N   | DS7-34DSX024N0-D  |
| 32   | 15                         | 25                         | DS7-342SX032N0-N   | DS7-34DSX032N0-D  |
| 41   | 22                         | 30                         | DS7-342SX041N0-N   | DS7-34DSX041N0-D  |
| 55   | 30                         | 40                         | DS7-342SX055N0-N   | DS7-34DSX055N0-D  |
| 70   | 37                         | 50                         | DS7-342SX070N0-N   | DS7-34DSX070N0-D  |
| 81   | 45                         | 60                         | DS7-342SX081N0-N   | DS7-34DSX081N0-D  |
| 100  | 55                         | 75                         | DS7-342SX100N0-N   | DS7-34DSX100N0-D  |
| 135  | 75                         | 100                        | DS7-342SX135N0-N   | DS7-34DSX135N0-D  |
| 160  | 90                         | 125                        | DS7-342SX160N0-N   | DS7-34DSX160N0-D  |
| 200  | 110                        | 150                        | DS7-342SX200N0-N   | DS7-34DSX200N0-D  |

#### Variable Speed Starters/Variable Frequency Drives

##### Product Selection

DE1



#### Variable Speed Starters—DE1

DE1 Series Variable Speed Starters utilize a simple plug-in module for connection to the SmartWire-DT network.

FS1



FS2

**Rated Operational  
Current Variable  
Frequency Drives**

**Assigned Motor**

| $I_e$<br>A | P<br>kW | P<br>hp | Radio Interference<br>Suppression Filter | Frame Size | Degree of<br>Protection | Catalog Number |
|------------|---------|---------|--|------------|-------------------------|----------------|
|------------|---------|---------|--|------------|-------------------------|----------------|

$U_e$  230 Vac, Single-phase /  $U_2$  230 Vac, Three-phase.  
Mains Voltage (50/60 Hz).  $U_{LN}$  200 (-10%) to 240 (+10%) V.

|     |      |      |   |     |             |                  |
|-----|------|------|---|-----|-------------|------------------|
| 1.4 | 0.25 | -    | ✓ | FS1 | IP20/NEMA 0 | DE1-121D4FN-N20N |
| 2.3 | 0.37 | 0.5  | ✓ |     |             | DE1-122D3FN-N20N |
| 2.7 | 0.55 | 0.5  | ✓ |     |             | DE1-122D7FN-N20N |
| 4.3 | 0.75 | 0.75 | ✓ |     |             | DE1-124D3FN-N20N |
| 7   | 1.5  | 2    | ✓ |     |             | DE1-127D0FN-N20N |
| 9.6 | 2.2  | 3    | ✓ | FS2 |             | DE1-129D6FN-N20N |

$U_e$  400 Vac, Three-Phase /  $U_2$  400 Vac, Three-Phase.  
Mains Voltage (50/60 Hz).  $U_{LN}$  380 (-10%) to 480 (+10%) V.

|      |      |     |   |     |             |                  |
|------|------|-----|---|-----|-------------|------------------|
| 1.3  | 0.37 | 0.5 | ✓ | FS1 | IP20/NEMA 0 | DE1-341D3FN-N20N |
| 2.1  | 0.75 | 1   | ✓ |     |             | DE1-342D1FN-N20N |
| 3.6  | 1.5  | 2   | ✓ |     |             | DE1-343D6FN-N20N |
| 5    | 2.2  | 3   | ✓ | FS2 |             | DE1-345D0FN-N20N |
| 6.6  | 3    | 3   | ✓ |     |             | DE1-346D6FN-N20N |
| 8.5  | 4    | 5   | ✓ |     |             | DE1-348D5FN-N20N |
| 11.3 | 5.5  | 7.5 | ✓ |     |             | DE1-34011FN-N20N |
| 16   | 7.5  | 10  | ✓ |     |             | DE1-34016FN-N20N |

### Variable Speed Starters—DC1, DA1

DC1/DA1 Variable Frequency Drives utilize a simple plug-in module for connection to the SmartWire-DT network.

|   | Description  | For Use With ... | Catalog Number        |                           |
|---|--|------------------|-----------------------|---------------------------|
|  <b>DXC-EXT-IO230</b>      | <b>220 V Coupling Module</b><br>230 V input (electrically isolated)  | DC1              | <b>DXC-EXT-IO230</b>  |                           |
|  <b>DXC-EXT-LOCSIM</b>     | <b>Simulator</b><br>3 digital inputs<br>1 relay output<br>1 potentiometer  | DC1              | <b>DXC-EXT-LOCSIM</b> |                           |
|  <b>DXA-EXT-ENCOD</b>      | <b>Encoder Module</b><br>2-channel, max. 500 kHz<br>5 V TTL, A & B, /A & /B, 5 Vdc, max. 200 mA<br>24 V HTL, A & B, /A & /B, 24 Vdc, external power supply required, max. 30 Vdc | DA1              | <b>DXA-EXT-ENCOD</b>  |                           |
|  <b>DXE-EXT-SET</b>        | <b>Configuration Module</b><br>—   | DE1              | <b>DXE-EXT-SET</b>    |                           |
|  <b>DX-NET_</b>          | <b>Fieldbus Modules</b>  |                  |                       |                           |
|   | 2 x RJ45, 8-pole   | EtherNet/IP      | DA1                   | <b>DX-NET-ETHERNET-2</b>  |
|   | 2 x RJ45, 8-pole   | PROFINET         | DA1                   | <b>DX-NET-PROFINET-2</b>  |
|   | 2 x RJ45, 8-pole   | Modbus-TCP       | DA1                   | <b>DX-NET-MOVBUSTCP-2</b> |
|   | 2 x RJ45, 8-pole   | EtherCAT         | DA1                   | <b>DX-NET-ETHERCAT-2</b>  |
|   | 2 x RJ45, 8-pole   | BACnet/IP        | DA1                   | <b>DX-NET-BACNETIP-2</b>  |
|  <b>DX-NET-DEVICENET</b> | Terminal strip, plug-in, 6-terminal  | DeviceNet        | DA1                   | <b>DX-NET-DEVICENET</b>   |
|  <b>DX-NET-PROFIBUS</b>  | SUB-D socket, 9-pole   | PROFIBUS-DP      | DA1                   | <b>DX-NET-PROFIBUS</b>    |
|  <b>DX-NET-SWD_</b>      | <b>SmartWire-DT Modules</b>  |                  |                       |                           |
|   | With slot for SWD4-8SF2-5  | SmartWire-DT     | DA1 (IP20)            | <b>DX-NET-SWD1</b>        |
|   | —  | SmartWire-DT     | DC1/DA1 (IP55/IP66)   | <b>DX-NET-SWD2</b>        |
|  <b>DX-NET-SWD3</b>      | With slot for SWD4-8SF2-5  | SmartWire-DT     | DC1 (IP20)            | <b>DX-NET-SWD3</b>        |



# 9.1

## Connectivity Solutions

### SmartWire-DT In-Panel and On-Machine Wiring Solution

Pilot Device Modules



### Contents

#### Description

#### Page

Pilot Device Modules

Product Selection

M22 Contact Modules, without LEDs . . . . **V7-T9-25**

M22 Contact Modules, with LEDs . . . . . **V7-T9-26**

M22 LED Modules . . . . . **V7-T9-26**

### Pilot Device Modules

#### Product Description

Pilot device modules fit onto standard M22 pilot devices in both front mount and base mount configurations. Single and double contact modules with and without LEDs are available to meet a wide variety of control circuit requirements.

These modules facilitate direct connection to the SmartWire-DT flat cable and eliminate the traditional point-to-point wiring to the PLC input and output modules.











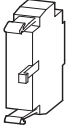

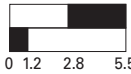
#### Features

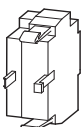
- Front or base mount modules
- Built-in diagnostic bi-color LEDs on each module
- Connection to SmartWire-DT flat cable via quick disconnect device plugs

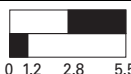

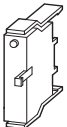

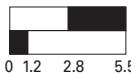
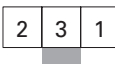
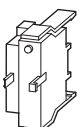

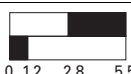
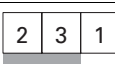

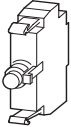

**Product Selection**

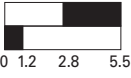
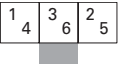
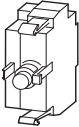
**M22 Pilot Device Modules Connections**

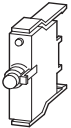

**M22 Contact Modules, without LEDs**

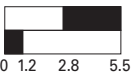
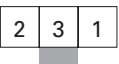
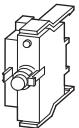
|  | Number of Changeover Contacts | Contact Sequence  | Contact Travel Diagram Stroke in Connection with Front Element                                       | Configuration   | Pkg. Qty. | Catalog Number      |
|--|-------------------------------|---|--|---|-----------|---------------------|
| <b>Front Mount</b>   |                               |   |  |   |           |                     |
|  <p><b>M22-SWD-K11</b></p>    | 1                             |    | <br>0 1.2 2.8 5.5   |    | 20        | <b>M22-SWD-K11</b>  |
|  <p><b>M22-SWD-K22</b></p>    | 2                             |    | <br>0 1.2 2.8 5.5   |    | 10        | <b>M22-SWD-K22</b>  |
| <b>Base Mount</b>  |                               |   |  |   |           |                     |
|  <p><b>M22-SWD-KC11</b></p>  | 1                             |    | <br>0 1.2 2.8 5.5   |    | 20        | <b>M22-SWD-KC11</b> |
|  <p><b>M22-SWD-KC22</b></p> | 2                             |  | <br>0 1.2 2.8 5.5 |  | 10        | <b>M22-SWD-KC22</b> |

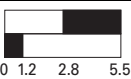
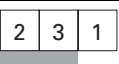
#### M22 Contact Modules, with LEDs

|   | Number of Changeover Contacts | Contact Sequence  | Contact Travel Diagram Stroke in Connection with Front Element                      | Configuration   | Color LED | Pkg. Qty. | Catalog Number    |
|---|-------------------------------|---|---|---|-----------|-----------|-------------------|
| <b>Front Mount</b>  |                               |   |   |   |           |           |                   |
|    | 1                             |    |    |    | ○         | 20        | M22-SWD-K11LED-W  |
|   |                               |   |   |   | ●         |           | M22-SWD-K11LED-B  |
|   |                               |   |   |   | ●         |           | M22-SWD-K11LED-G  |
|   |                               |   |   |   | ●         |           | M22-SWD-K11LED-R  |
|    | 2                             |    |    |    | ○         | 10        | M22-SWD-K22LED-W  |
|   |                               |   |   |   | ●         |           | M22-SWD-K22LED-B  |
|   |                               |   |   |   | ●         |           | M22-SWD-K22LED-G  |
|   |                               |   |   |   | ●         |           | M22-SWD-K22LED-R  |
| <b>Base Mount</b>   |                               |   |   |   |           |           |                   |
|    | 1                             |    |    |    | ○         | 20        | M22-SWD-K11LEDC-W |
|   |                               |   |   |   | ●         |           | M22-SWD-K11LEDC-B |
|   |                               |   |   |   | ●         |           | M22-SWD-K11LEDC-G |
|   |                               |   |   |   | ●         |           | M22-SWD-K11LEDC-R |
|  | 2                             |  |  |  | ○         | 10        | M22-SWD-K22LEDC-W |
|   |                               |   |   |   | ●         |           | M22-SWD-K22LEDC-B |
|   |                               |   |   |   | ●         |           | M22-SWD-K22LEDC-G |
|   |                               |   |   |   | ●         |           | M22-SWD-K22LEDC-R |

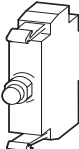
#### M22 LED Modules

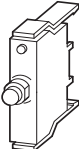
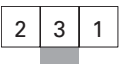
|   | Configuration   | Color LED | Pkg. Qty. | Catalog Number |
|---|---|-----------|-----------|----------------|
| <b>Front Mount</b>  |   |           |           |                |
|  |  | ○         | 20        | M22-SWD-LED-W  |
|   |   | ●         |           | M22-SWD-LED-B  |
|   |   | ●         |           | M22-SWD-LED-G  |
|   |   | ●         |           | M22-SWD-LED-R  |
| <b>Base Mount</b>   |   |           |           |                |
|  |  | ○         | 20        | M22-SWD-LEDC-W |
|   |   | ●         |           | M22-SWD-LEDC-B |
|   |   | ●         |           | M22-SWD-LEDC-G |
|   |   | ●         |           | M22-SWD-LEDC-R |

Stacklight Modules with SmartWire-DT



Contents

| <i>Description</i>                   | <i>Page</i>     |
|--------------------------------------|-----------------|
| Stacklight Modules with SmartWire-DT |                 |
| SL7 Series Stacklight .....          | <b>V7-T9-28</b> |
| SL4 Series Stacklight .....          | <b>V7-T9-28</b> |

Stacklight Modules with SmartWire-DT

**Product Description**

SL7 and SL4 Stacklights from Eaton provide reliable control over all key processes and machine availability. Now available in two sizes, 70 mm (SL7) and 40 mm (SL4), the new stacklights are engineered to keep you informed about potential material requirements, downtime and hazards. Modules are available in a wide selection of audible, illuminating and mounting options that are well suited to adapt to any industrial application.

**Highly Modular and Versatile Line**

- Easily configurable components
- Simple bayonet mounting mechanism for quick assembly
- Flexible mounting and lighting options
- Volume-adjustable alarms

**Optimal Performance in Rugged Applications**

- All elements have IP66 and UL Type 4/4X/13 ratings for protection against strong jets of water
- Bright and efficient LEDs with a lifespan of up to 100,000 hours
- High-performance LEDs for maximum illumination in direct sunlight
- Acoustic modules with up to 100 dB sound levels
- Operating temperatures: -22° to +140°F (-30° to +60°C)

**Features**

- Six lens colors: red, amber, yellow, green, blue, white
- Continuous, flashing, strobe and multi-strobe lighting functions
- Mono-tone, dual-tone and multi-tone audible alarms
- LED or incandescent lighting options
- Control up to five modules on a single stack, 10 with dual-arm base
- 24V, 120 Vac and 230 Vac operating voltages

**Benefits**

- Simplified twist-and-lock assembly, no tools required
- Compact components reduce inventory requirements and increase flexibility
- Versatile hardware for quick installation and minimized downtime
- New slim 40 mm size is ideal for applications with constrained space
- Lean automation with SmartWire-DT connectivity
- Ideal for indoor and outdoor usage

**Standards and Certifications**

- UL 508—File No. E29184
- IEC/EN 60947-5-1
- CSA C22.2 No. 14-10
- CSA C22.2 No. 94-91
- CSA Class No. NKCR7



# 9.1

## Connectivity Solutions

### SmartWire-DT In-Panel and On-Machine Wiring Solution

#### Stacklight Modules

##### Product Selection

SL4-FMS\_



#### SL7 and SL4—SmartWire-DT Versions for Control Cabinet Mounting

SL7 and SL4 Series Stacklights with SmartWire-DT built in connect directly to the SmartWire-DT flat cable.

| Description   | Tube Length | For Use With | Catalog Number | For Use With | Catalog Number |
|---|-------------|--------------|----------------|--------------|----------------|
| Base with base adapter for slipping onto place (rapid mounting and wiring system)<br>Blade terminal SWD4-BMF2<br>Max. 0.3 A per module<br>External power supply connectable (24 Vdc)<br>Configurable with SWD-Assist (planning and ordering help) | 100 mm      |              | SL7-SWD        |              | SL4-SWD        |

### On-Machine Components



### Contents

| <i>Description</i>                        | <i>Page</i>     |
|---|-----------------|
| On-Machine Components                     |                 |
| Machine Mount I/O Modules . . . . .       | <b>V7-T9-30</b> |
| I/O Splitters . . . . .                   | <b>V7-T9-30</b> |
| Other I/O Connections . . . . .           | <b>V7-T9-31</b> |
| Machine Mount Powerfeed Modules . . . . . | <b>V7-T9-31</b> |
| Panel Transition Components . . . . .     | <b>V7-T9-32</b> |
| SmartWire-DT Round Bus Cables . . . . .   | <b>V7-T9-32</b> |
| Other System Components . . . . .         | <b>V7-T9-33</b> |

## On-Machine Components

### Product Description

At the edge of the control cabinet, the SmartWire-DT system transitions from the 8-conductor flat cable to a 5-conductor round cable with standard DC M12 barrel connectors, using simple transition adapters that mount through the panel wall.

This round cable has five conductors, uses standard DC M12 barrel connectors, and is 300 V rated. It is used outside the control panel to connect machine mount (IP67) I/O modules to the SmartWire-DT system for use with peripherals such as sensors, enclosed pushbuttons, remote enclosed contactors, pneumatic and hydraulic valves, stacklights and other remote devices. This single cable is used both to provide power to connected devices and to carry I/O signals.

Digital machine-mountable IP67 I/O modules are connected as nodes on the SmartWire-DT network and allow standard or generic devices to be connected to the SmartWire-DT system. They can be connected anywhere around the machine with up to 2000 ft and 99 machine mount I/O modules possible with a single cable connection.



### Features

- Digital modules available in single connector and dual connector versions to size exactly to your machine I/O needs at a particular device mounting location
- Compatible with a wide range of sensors and actuators for easy integration into any machine design
- Single-connector versions with up to 2 I/O channels and dual connector versions with up to 4 I/O channels using accessory splitters
- Versions with configurable I/O channels to allow for selection as input or output in any combination
- Integrated 24 Vdc power and communications with single 5-conductor cable using standard DC M12 connectors
- Complete Plug & Play solution, integrated with in-panel SmartWire-DT wiring components including auto-addressing feature
- Connection of up to 99 modules and up to 2000 feet of cable on a single branch of the wiring system
- Built-in diagnostic bi-color LEDs on each module
- IP67 enclosure rating
- Tool-free mounting options
- Vertical and flat mounting possible

#### Product Selection

##### Machine Mount I/O Modules

SmartWire-DT I/O modules for connection to most digital input and output devices.

|   | Description  | Number of Dedicated Inputs | Number of Dedicated Outputs | Number of Configurable Input/Output Channels | Catalog Number |
|---|--|----------------------------|-----------------------------|--|----------------|
|  | Two digital input channels<br>Messages: Status of the digital inputs 1 and 2<br>Commands: None   | 2                          | 0                           | 0  | EU1E-SWD-2DX   |
|   | Two configurable digital input/output channels<br>Messages: Status of the digital inputs 1 and/or 2 (if configured as inputs)<br>Commands: Actuation of outputs 1 and/or 2 (if configured as outputs)                                      | 0                          | 0                           | 2  | EU1E-SWD-2DD   |
|  | Four digital input channels<br>Messages: Status of the digital inputs 1, 2, 3 and 4<br>Commands: None  | 4                          | 0                           | 0  | EU2E-SWD-4DX   |
|   | Four configurable digital input/output channels<br>Messages: Status of the digital inputs 1 and/or 2 and/or 3 and/or 4 (if configured as inputs)<br>Commands: Actuation of outputs 1 and/or 2 and/or 3 and/or 4 (if configured as outputs) | 0                          | 0                           | 4  | EU2E-SWD-4DD   |





##### I/O Splitters

To allow for use of both available channels on applicable digital input/output modules.

|  | Description  | Package Quantity | Catalog Number |
|--|--|------------------|----------------|
|  | Combines two devices into a single I/O connection point. Both device connections are 4-pin DC M12. Power is common between devices, and the splitter module is wired to Pin 4 for each connected sensor, actuator or other device. | 1                | SWD4-SP-4124   |
|  | Combines two devices into a single I/O connection point. Both device connections are 4-pin DC M12. Power is common between devices, and the splitter module is wired to Pin 2 for each connected sensor, actuator or other device. | 1                | SWD4-SP-4122   |
|  | Combines two devices into a single I/O connection point. Both device connections are 4-pin M8. Power is common between devices, and the splitter module is wired to Pin 4 for each connected sensor, actuator or other device.     | 1                | SWD4-SP-4084   |
|  | Combines two devices into a single I/O connection point. Both device connections are 4-pin M8. Power is common between devices, and the splitter module is wired to Pin 2 for each connected sensor, actuator or other device.     | 1                | SWD4-SP-4082   |
|  | Combines two devices into a single I/O connection point. Both device connections are 3-pin M8. Power is common between devices, and the splitter module is wired to Pin 2 for each connected sensor, actuator or other device.     | 1                | SWD4-SP-3084   |

**Other I/O Connections**

For connection to I/O devices with and without built-in M12 connections.

|   | Description   | Package Quantity      | Catalog Number         |
|---|---|-----------------------|------------------------|
|    | <b>Enclosure and Remote Device M12 Receptacles</b>  |                       |                        |
|   | M12 5-pin male receptacle, 1/2 inch NPT back threads, 3.2 ft (1 m) wiring leads For use with Eaton SL4/SL7 Series Stacklights with post-mount bases. Also for connection of remote panel Contactor and other devices to On-Machine I/O modules. | 1                     | <b>SWD4-PRM5-1-S</b>   |
|   | M12 5-pin female receptacle, 1/2 inch NPT back threads, 3.2 ft (1 m) wiring leads For use where needed in remote panel wiring situations.   | 1                     | <b>SWD4-PRF5-1-S</b>   |
|   | M12 5-pin male receptacle, M20 front threads, 5 inch wiring leads For use with Eaton SL4/SL7 Series Stacklights with fast-mount bases. Also for use with Eaton M22 Series remote pushbutton enclosures.   | 1                     | <b>SWD4-PRM5-2-S</b>   |
|   | M12 5-pin female receptacle, M20 front threads, 5 inch wiring leads For use where needed in remote enclosure wiring situations.   | 1                     | <b>SWD4-PRF5-2-S</b>   |
|    | <b>I/O Device Cables Double-Ended</b>   |                       |                        |
|   | 6 in (0.1 m) length   | 1                     | <b>SWD4-M1LR5-1-2S</b> |
|   | 1 ft (0.3 m) length   | 1                     | <b>SWD4-M3LR5-1-2S</b> |
|   | 2 ft (0.6 m) length   | 1                     | <b>SWD4-M6LR5-1-2S</b> |
|   | 3.2 ft (1 m) length   | 1                     | <b>SWD4-1LR5-1-2S</b>  |
| 6.5 ft (2 m) length   | 1   | <b>SWD4-2LR5-1-2S</b> |                        |
|    | <b>I/O Device Cables Single-Ended</b>   |                       |                        |
|   | 1 ft (0.3 m) length   | 1                     | <b>SWD4-M3LR5-S</b>    |
|   | 2 ft (0.6 m) length   | 1                     | <b>SWD4-M6LR5-S</b>    |
|   | 3.2 ft (1 m) length   | 1                     | <b>SWD4-1LR5-S</b>     |
|   | 6.5 ft (2 m) length   | 1                     | <b>SWD4-2LR5-S</b>     |
|  | <b>Cord Grips</b>   |                       |                        |
|   | Round cable cord grip, M20  | 1                     | <b>V-M20</b>           |
|   | Round cable cord grip, 1/2 inch NPT   | 1                     | <b>V-12NPT</b>         |

**EU1S-SWD-PF1-2**





**Machine Mount Powerfeed Modules**

Machine mount powerfeed modules feed auxiliary 24 Vdc power into the On-Machine SmartWire-DT round cable system. Supplemental 24 Vdc power is only needed if the total power consumption of devices connected to the On-Machine SmartWire-DT system exceeds the available power from the main control cabinet connection. The module can be connected at any location in the system.



| Description   | Package Quantity | Catalog Number        |
|---|------------------|-----------------------|
| Provides connection point for external 24 Vdc power supply input. | 1                | <b>EU1S-SWD-PF1-2</b> |









#### Panel Transition Components

|   | Description  | Package Quantity | Catalog Number      |
|---|--|------------------|---------------------|
|  | <b>SWD4-SFL8-12 Flat-to-Round Cabinet Transition Adapter</b><br>To transition between in-cabinet flat cabling and on-machine round cabling. Wiring terminals allow external 24 Vdc power supply at this location if desired. Jumper these terminals to utilize 24 Vdc power from the incoming flat cable.  | 1                | <b>SWD4-SFL8-12</b> |
|  | <b>SWD4-SML8-12 Round-to-Flat Cabinet Transition Adapter</b><br>To transition between on-machine round cabling and in-cabinet flat cabling. Wiring terminals allow external 24 Vdc power supply at this location if desired. Jumper these terminals to utilize 24 Vdc power from the incoming round cable. | 1                | <b>SWD4-SML8-12</b> |
|  | <b>SWD4-SML5-12 Cabinet Cable Pass-Through Adapter</b><br>For passing the SmartWire-DT round cable connection easily through a panel or a cabinet wall.  | 1                | <b>SWD4-SML5-12</b> |

#### SmartWire-DT Round Bus Cables

|   | Description   | Package Quantity | Catalog Number        |
|---|---|------------------|-----------------------|
|  | <b>SWD4- Round Cable</b><br>For SmartWire-DT network outside of the control panel. Each cable is 5-conductor, with one male DC M12 and one female DC M12 connector at each end. |                  |                       |
|   | 6 in (0.1 m) length   | 1                | <b>SWD4-M1LR5-2S</b>  |
|   | 1 ft (0.3 m) length   | 1                | <b>SWD4-M3LR5-2S</b>  |
|   | 2 ft (0.6 m) length   | 1                | <b>SWD4-M6LR5-2S</b>  |
|   | 3.2 ft (1 m) length   | 1                | <b>SWD4-1LR5-2S</b>   |
|   | 4.9 ft (1.5 m) length   | 1                | <b>SWD4-1M5LR5-2S</b> |
|   | 6.5 ft (2 m) length   | 1                | <b>SWD4-2LR5-2S</b>   |
|   | 9.8 ft (3 m) length   | 1                | <b>SWD4-3LR5-2S</b>   |
|   | 13.1 ft (4 m) length  | 1                | <b>SWD4-4LR5-2S</b>   |
|   | 16.4 ft (5 m) length  | 1                | <b>SWD4-5LR5-2S</b>   |
|   | 32.8 ft (10 m) length   | 1                | <b>SWD4-10LR5-2S</b>  |
|   | 65.6 ft (20 m) length   | 1                | <b>SWD4-20LR5-2S</b>  |
|   | Raw cable (to build non-standard lengths)   | Order in meters  | <b>SWD4-XXXLR5</b>    |
|   | <b>Field-Wireable Connector</b>   |                  |                       |
|  | <b>SWD4-SF5-67</b><br>Female (to terminate raw cable)   | 1                | <b>SWD4-SF5-67</b>    |
|  | <b>SWD4-SM5-67</b><br>Male (to terminate raw cable)   | 1                | <b>SWD4-SM5-67</b>    |

### Other System Components

|  | Description  | Package Quantity | Catalog Number      |
|--|--|------------------|---------------------|
| <b>SWD4-RC5-10</b><br>    | <b>Bus Termination Module</b><br>To terminate the end of an on-machine SmartWire-DT round cable network branch   | 1                | <b>SWD4-RC5-10</b>  |
| <b>SWD4-ACAP</b><br>      | <b>Connector Caps</b><br>Active cap—Allows for remote monitoring of the health of an unused device connection on a machine mount I/O module over the SmartWire-DT network  | 1                | <b>SWD4-ACAP</b>    |
| <b>SWD4-PCAP-F</b><br>    | Passive cap—To provide physical protection and sealing if nothing is connected to the female M12 connector on a machine mount I/O module   | 1                | <b>SWD4-PCAP-F</b>  |
| <b>SWD4-PCAP-M</b><br>    | Passive cap—To provide physical protection and sealing if nothing is connected to the male M12 connector on a machine mount I/O module   | 1                | <b>SWD4-PCAP-M</b>  |
| <b>SWD4-MNT-VER</b><br>  | <b>Mounting Accessories</b><br>Clip mount—For easy mounting of a machine mount I/O module to any flat or channeled surface, including cylinders and other mounting situations where T-channels are present. Once the bracket is mounted, the I/O Module can be removed and reinstalled without tools |                  | <b>SWD4-MNT-VER</b> |
| <b>SWD4-MNT-DIN</b><br> | DIN rail mount—For easy mounting of a machine mount I/O module to DIN rail   |                  | <b>SWD4-MNT-DIN</b> |

#### Enclosed (IP67) Pilot Devices



#### Contents

##### Description

##### Page

|  |                 |
|--|-----------------|
| Enclosed (IP67) Pilot Devices                |                 |
| Enclosed M22 Pilot Device Examples . . . . . | <b>V7-T9-35</b> |
| Enclosures . . . . .                         | <b>V7-T9-35</b> |
| M12 Wiring Receptacles . . . . .             | <b>V7-T9-35</b> |

#### Enclosed (IP67) Pilot Devices

##### Product Description

Many remote pilot devices of various types and from various manufacturers can be connected to a machine's control cabinet using the SmartWire-DT On-Machine wiring system. This section describes a series of easy to assemble versions of a range of pilot devices from within Eaton's M22 standard catalog family to make this connection quick and easy. With simple assembly using standard catalog components, enclosed devices can simply be connected to the SmartWire-DT On-Machine wiring system at any mounting location on the machine. This approach to remote device wiring can help the OEM eliminate wiring, terminal block and PLC input/output modules in the machine control cabinet.

##### Features

- Simple assembly with catalog components achieves IP67 sealing and offers plug & play connection to the SmartWire-DT network
- Base-mount contact blocks and LED modules allow for simple removal of the enclosure cover without disturbing switch wiring
- Simple connection via standard cable accessories to SmartWire-DT machine mount (IP67) digital I/O modules
- Wide variety of enclosures, pushbuttons, selector switches, key switches, pilot lights, and other devices make solving a range of machine applications easy

**Product Selection**

M22 operators and indicating lights including momentary and maintained pushbuttons, pilot lights, hand and key operated selector switches, and mushroom switches.

**Enclosed M22 Pilot Device Examples**



|                   |                          |                        |                            |                    |
|-------------------|--------------------------|------------------------|----------------------------|--------------------|
| <b>Pushbutton</b> | <b>Double Pushbutton</b> | <b>Selector Switch</b> | <b>Key Selector Switch</b> | <b>Palm Switch</b> |
|-------------------|--------------------------|------------------------|----------------------------|--------------------|

**M22-I\_**



**Enclosures**

Sealed mounting enclosures for M22 devices. Receptacles in the next section require M20 enclosure knockouts, which are present in all M22 enclosures offered by Eaton but are most common in the enclosures listed in this section.

| Description             | Catalog Number |
|-------------------------|----------------|
| One-element enclosure   | <b>M22-I1</b>  |
| Two-element enclosure   | <b>M22-I2</b>  |
| Three-element enclosure | <b>M22-I3</b>  |
| Four-element enclosure  | <b>M22-I4</b>  |
| Six-element enclosure   | <b>M22-I6</b>  |

**SWD4-PRM5-...**



**M12 Wiring Receptacles**

Panel-mount M12 connector receptacles designed expressly for mounting in M20 enclosure knockouts in sealed M22 mounting enclosures listed in the previous section.

| Description                             | Catalog Number       |
|---|----------------------|
| 5-inch wiring leads, M20 front threads  | <b>SWD4-PRM5-2-S</b> |
| 1-meter wiring leads, M20 front threads | <b>SWD4-PRM5-1-S</b> |

**Assembly Instructions**

1. Select pushbutton or pilot light operator and required contact blocks/light modules from catalog Volume 7 Tab 1.
2. Select enclosure from above listing.
3. Select receptacle from above listing.
4. Mount receptacle in enclosure knockout.
5. Wire receptacle to contact blocks and/or light modules as follows:
  - a. To wire a pushbutton or other pilot device as an input to the SmartWire-DT system
    - 1) The receptacle brown lead is wired to one side of the switch contact
    - 2) The receptacle black, white or gray <sup>Ⓢ</sup> lead is wired to the other side of the switch contact
  - b. To wire an indicating light or actuator as an output from the SmartWire-DT system
    - 1) The receptacle blue lead is wired to one side of the actuator or pilot light contact
    - 2) The receptacle black, white, or gray <sup>Ⓢ</sup> lead is wired to the other side of the actuator or pilot light contact

**Note**

<sup>Ⓢ</sup> SmartWire-DT machine mounted I/O modules (see **Page V7-T9-30**) are offered in versions with multiple input and output channels per M12 connection point. In the receptacle wiring scheme, one channel is available on the black wire, the second channel is available on the white wire, and a third channel (if available) is carried on the gray wire.

#### Remote Machine Mount Stacklights



9

#### Contents

##### Description

##### Page

|  |                 |
|--|-----------------|
| Remote Machine Mount Stacklights                           |                 |
| Stacklight Mounting Modules—<br>Fast Mounting System ..... | <b>V7-T9-37</b> |
| Stacklight Mounting Modules—<br>Post Mounting System ..... | <b>V7-T9-37</b> |

### Remote Machine Mount Stacklights

#### Product Description

Stacklights located remotely on a machine can be easily connected to a machine's logic control using SmartWire-DT. This section describes how to easily add an M12 connector to the base of the SL4 and SL7 standard catalog stacklight families to make this SmartWire-DT connection quick and easy.

These assembled stacklights can then be directly connected to SmartWire-DT machine mount I/O modules. This plug & play connection scheme speeds machine assembly, installation and commissioning, and helps the OEM eliminate wiring, terminal block and PLC input/output modules in the control cabinet.

#### Features

- Simple wiring receptacle mounts directly to stacklight base units to provide IP67 sealing for stacklights remotely located on the machine
- Wiring receptacles fully compatible with Eaton's rapid mount and aluminum tube bases
- A single cable connection operates up to 2 light or audible modules from the SL7 or SL4 families in any combination
- Simple connection with a single standard cable to SmartWire-DT machine mount (IP67) I/O modules
- Plug & play wiring and auto-addressing means no special setup is required

**Stacklight Mounting Modules—Fast Mounting System**

SLx-FMS



**For Horizontal Mounting—Includes Cover, Maximum 3 Modules**

| Description  | Tube Length | Color      | Standard Pack | For use with ...         | Catalog Number     |
|--|-------------|------------|---------------|--------------------------|--------------------|
| Base with base adapter for slipping onto place (rapid mounting and wiring system)<br>Screw terminals<br>SL7 Series Stacklights | 100 mm      | Black      | 1             | SL7-L-...                | <b>SL7-FMS-100</b> |
|  | 250 mm      | aluminum   |               | SL7-BL-...               | <b>SL7-FMS-250</b> |
|  | 400 mm      | color tube |               | SL7-FL-...<br>SL7-AP-... | <b>SL7-FMS-400</b> |
| Base with base adapter for slipping onto place (rapid mounting and wiring system)<br>Screw terminals<br>SL4 Series Stacklights | 100 mm      | Black      | 1             | SL4-L-...                | <b>SL4-FMS-100</b> |
|  | 250 mm      | aluminum   |               | SL4-BL-...               | <b>SL4-FMS-250</b> |
|  | 400 mm      | color tube |               | SL4-FL-...<br>SL4-AP-... | <b>SL4-FMS-400</b> |

SWD4-PRM5-1-S



**M12 Wiring Receptacles**

| Description   | Detail  | Catalog Number       |
|---|---|----------------------|
| For wiring an SL7/SL4 Stacklight with a Fast Mount (FMS) base | M12 5-pin male receptacle, M20 front threads, 5-inch wiring leads | <b>SWD4-PRM5-2-S</b> |

**Stacklight Mounting Modules—Post Mounting System**

SLx-PIB/CB-T



**For Horizontal Mounting—Includes Cover, Maximum 3 Modules**

| Description   | Tube Length | Color      | Standard Pack | For use with ...         | Catalog Number       |
|---|-------------|------------|---------------|--------------------------|----------------------|
| Base with aluminum tube and 3/4 in NPT threaded base<br>Spring-loaded terminals<br>SL7 Series Stacklights | 100 mm      | Black      | 1             | SL7-L-...                | <b>SL7-CB-T-100</b>  |
|   | 250 mm      | aluminum   |               | SL7-BL-...               | <b>SL7-CB-T-250</b>  |
|   | 400 mm      | color tube |               | SL7-FL-...<br>SL7-AP-... | <b>SL7-CB-T-400</b>  |
| Base with aluminum tube and 3/4 in NPT threaded base<br>Spring-loaded terminals<br>SL4 Series Stacklights | 100 mm      | Black      | 1             | SL4-L-...                | <b>SL4-PIB-T-100</b> |
|   | 250 mm      | aluminum   |               | SL4-BL-...               | <b>SL4-PIB-T-250</b> |
|   | 400 mm      | color tube |               | SL4-FL-...<br>SL4-AP-... | <b>SL4-PIB-T-400</b> |

SL7/4-FW-T



**Stacklight Mounting Adapter**

| Description  | Detail                            | Catalog Number    |
|--|-----------------------------------|-------------------|
| Mounting adapter to allow wiring receptacle to mount to stacklight post mount base | M20 3/4 inch NPT mounting adapter | <b>SL7/4-FW-T</b> |

SWD4-PRM5-1-S



**M12 Wiring Receptacles**

| Description   | Detail  | Catalog Number       |
|---|---|----------------------|
| For wiring an SL7/SL4 Stacklight with post-mount base | M12 5-pin male receptacle, 1/2 inch NPT back threads, 1-meter leads | <b>SWD4-PRM5-1-S</b> |

**Assembly Instructions**

1. Select Stacklight light modules from catalog Volume 7 Tab 2.
2. Select Stacklight mounting base from above listings.
3. Select receptacle appropriate for chosen Stacklight mounting base from above listing.  
If using the Post Mount base, also select a Stacklight Mounting Adapter from that section above.
4. Mount receptacle in Fast Mount base or Post Mount base adapter.
5. Wire receptacle to Stacklight terminals as follows:
  - a. The receptacle blue lead is wired to Terminal #0 on the Stacklight
  - b. The receptacle black, white or gray <sup>Ⓢ</sup> lead is wired to the numbered terminal for the light module in question

**Note**

<sup>Ⓢ</sup> SmartWire-DT machine mounted I/O modules (see **Page V7-T9-30**) are offered in versions with multiple input and output channels per M12 connection point. In the receptacle wiring scheme, one channel is available on the black wire, the second channel is available on the white wire, and a third channel (if available) is carried on the gray wire.

## Technical Data and Specifications

### Gateway Modules

| Description  | Unit     | EU5C-SWD-EIP-MODTCP Gateway        | EU5C-SWD-PROFINET Gateway          | EU5C-SWD-DP Gateway               | EU5C-SWD-ETHERCAT Gateway         | EU5C-SWD-CAN Gateway              | EU5C-SWD-POWERLINK Gateway        |
|--|----------|------------------------------------|------------------------------------|-----------------------------------|-----------------------------------|-----------------------------------|-----------------------------------|
| <b>General</b>   |          |                                    |                                    |                                   |                                   |                                   |                                   |
| Standards  |          | IEC/EN 61131-2 EN 50178            | IEC/EN 61131-2 EN 50178            | IEC/EN 61131-2 EN 50178           | IEC/EN 61131-2 EN 50178           | IEC/EN 61131-2 EN 50178           | IEC/EN 61131-2 EN 50178           |
| Dimensions (W x H x D)   | in (mm)  | 1.38 x 3.54 x 4.88 (35 x 90 x 124) | 1.38 x 3.54 x 4.88 (35 x 90 x 124) | 1.38 x 3.54 x 5.0 (35 x 90 x 127) | 1.38 x 3.54 x 5.0 (35 x 90 x 127) | 1.38 x 3.54 x 5.0 (35 x 90 x 127) | 1.38 x 3.54 x 5.0 (35 x 90 x 127) |
| Weight   | lbs (kg) | 0.37 (0.17)                        | 0.37 (0.17)                        | 0.35 (0.16)                       | 0.35 (0.16)                       | 0.35 (0.16)                       | 0.35 (0.16)                       |
| Mounting   |          | DIN rail IEC/EN 60715, 35 mm       |                                    | DIN rail IEC/EN 60715, 35 mm      |                                   | DIN rail IEC/EN 60715, 35 mm      |                                   |
| Mounting position  |          | Vertical                           | Vertical                           | Vertical                          | Vertical                          | Vertical                          | Vertical                          |
| <b>Ambient Conditions, Mechanical</b>                                      |          |                                    |                                    |                                   |                                   |                                   |                                   |
| Degree of protection (IEC/EN 60529)  |          | IP20                               | IP20                               | IP20                              | IP20                              | IP20                              | IP20                              |
| Vibrations (IEC/EN 61131-2:2008)   |          |                                    |                                    |                                   |                                   |                                   |                                   |
| Constant amplitude 3.5 mm  | Hz       | 5–8.4                              | 5–8.4                              | 5–8.4                             | 5–8.4                             | 5–8.4                             | 5–8.4                             |
| Constant acceleration 1 g  | Hz       | 8.4–150                            | 8.4–150                            | 8.4–150                           | 8.4–150                           | 8.4–150                           | 8.4–150                           |
| Mechanical shock resistance (IEC/EN 60068-2-27) semi-sinusoidal 15 g/11 ms | Impacts  | 9                                  | 9                                  | 9                                 | 9                                 | 9                                 | 9                                 |
| Drop to IEC/EN 60068-2-31 (drop height)                                    | in (mm)  | 1.97 (50)                          | 1.97 (50)                          | 1.97 (50)                         | 1.97 (50)                         | 1.97 (50)                         | 1.97 (50)                         |
| Free fall, packaged (IEC/EN 60068-2-32)                                    | ft (m)   | 1.0 (0.3)                          | 1.0 (0.3)                          | 1.0 (0.3)                         | 1.0 (0.3)                         | 1.0 (0.3)                         | 1.0 (0.3)                         |
| <b>Electromagnetic Compatibility (EMC)</b>                                 |          |                                    |                                    |                                   |                                   |                                   |                                   |
| Overvoltage category   |          | II                                 | II                                 | II                                | II                                | II                                | II                                |
| Pollution degree   |          | 2                                  | 2                                  | 2                                 | 2                                 | 2                                 | 2                                 |
| Electrostatic discharge (IEC/EN 61131-2:2008)                              |          |                                    |                                    |                                   |                                   |                                   |                                   |
| Air discharge (Level 3)  | kV       | 8                                  | 8                                  | 8                                 | 8                                 | 8                                 | 8                                 |
| Contact discharge (Level 2)  | kV       | 4                                  | 4                                  | 4                                 | 4                                 | 4                                 | 4                                 |
| Electromagnetic fields (IEC/EN 61131-2:2008)                               |          |                                    |                                    |                                   |                                   |                                   |                                   |
| 80–1000 MHz  | V/m      | 10                                 | 10                                 | 10                                | 10                                | 10                                | 10                                |
| 1.4–2 GHz  | V/m      | 3                                  | 3                                  | 3                                 | 3                                 | 3                                 | 3                                 |
| 2–7 GHz  | V/m      | 1                                  | 1                                  | 1                                 | 1                                 | 1                                 | 1                                 |
| Radio interference suppression (SmartWire-DT)                              |          | EN 55011 Class A                   |                                    | EN 55011 Class A                  |                                   | EN 55011 Class A                  |                                   |
| Burst (IEC/EN 61131-2:2008, Level 3)                                       |          |                                    |                                    |                                   |                                   |                                   |                                   |
| Supply cables  | kV       | 2                                  | 2                                  | 2                                 | 2                                 | 2                                 | 2                                 |
| CAN/DP bus cable   | kV       | 1                                  | 1                                  | 1                                 | 1                                 | 1                                 | 1                                 |
| SmartWire-DT cables  | kV       | 1                                  | 1                                  | 1                                 | 1                                 | 1                                 | 1                                 |
| Surge (IEC/EN 61131-2:2008, Level 1)                                       |          |                                    |                                    |                                   |                                   |                                   |                                   |
| Supply cables  | kV       | 0.5                                | 0.5                                | 0.5                               | 0.5                               | 0.5                               | 0.5                               |
| CAN/DP bus cable   | kV       | 1                                  | 1                                  | 1                                 | 1                                 | 1                                 | 1                                 |
| Radiated RFI (IEC/EN 61131-2:2008, Level 3)                                | V        | 10                                 | 10                                 | 10                                | 10                                | 10                                | 10                                |
| <b>Climatic Environmental Conditions</b>                                   |          |                                    |                                    |                                   |                                   |                                   |                                   |
| Operating ambient temperature (IEC 60068-2)                                | °F (°C)  | –13° to 131° (–25° to 55°)         |                                    | –13° to 131° (–25° to 55°)        |                                   | –13° to 131° (–25° to 55°)        |                                   |
| Condensation   |          | Prevent with suitable measures     |                                    | Prevent with suitable measures    |                                   | Prevent with suitable measures    |                                   |
| Storage  | °F (°C)  | –40° to 158° (–40° to 70°)         |                                    | –40° to 158° (–40° to 70°)        |                                   | –40° to 158° (–40° to 70°)        |                                   |
| Relative humidity, noncondensing (IEC/EN 60068-2-30)                       | %        | 5–95                               | 5–95                               | 5–95                              | 5–95                              | 5–95                              | 5–95                              |
| <b>Supply Voltage U<sub>Aux</sub></b>                                      |          |                                    |                                    |                                   |                                   |                                   |                                   |
| SM Puffer Bremer   | V        | 24 Vdc (–15%/+20%)                 |                                    | 24 Vdc (–15%/+20%)                |                                   | 24 Vdc (–15%/+20%)                |                                   |
| Residual ripple on the input voltage                                       | %        | ≤5                                 | ≤5                                 | 5                                 | 5                                 | 5                                 | 5                                 |
| Protection against polarity reversal                                       |          | Yes                                | Yes                                | Yes                               | Yes                               | Yes                               | Yes                               |
| Max. current (I <sub>max</sub> )   | A        | 3 ①                                | 3 ①                                | 3 ①                               | 3 ①                               | 3 ①                               | 3 ①                               |
| Short-circuit rating   |          | No, external fuse FAZ Z3           |                                    | No, external fuse FAZ Z3          |                                   | No, external fuse FAZ Z3          |                                   |
| Power loss   | W        | Normally 1                         | Normally 1                         | Normally 1                        | Normally 1                        | Normally 1                        | Normally 1                        |
| Potential isolation  |          | No                                 | No                                 | No                                | No                                | No                                | No                                |
| Rated operating voltage of 24 Vdc modes                                    | V        | Typ. U <sub>Aux</sub> –0.2         | Typ. U <sub>Aux</sub> –0.2         | Typ. U <sub>Aux</sub> –0.2        | Typ. U <sub>Aux</sub> –0.2        | Typ. U <sub>Aux</sub> –0.2        | Typ. U <sub>Aux</sub> –0.2        |

#### Note

① If contactors with a total current consumption >3 A are connected, a powerfeed module EU5C-SWD-PF1/2 has to be used.

## SmartWire-DT In-Panel and On-Machine Wiring Solution

## Gateway Modules, continued

| Description   | Unit            | EU5C-SWD-EIP-MODTCP Gateway                                | EU5C-SWD-PROFINET Gateway                                  | EU5C-SWD-DP Gateway         | EU5C-SWD-ETHERCAT Gateway   | EU5C-SWD-CAN Gateway      | EU5C-SWD-POWERLINK Gateway |
|---|-----------------|--|--|-----------------------------|-----------------------------|---------------------------|----------------------------|
| <b>Supply Voltage U<sub>Pow</sub></b>   |                 |  |  |                             |                             |                           |                            |
| Supply voltage  | V               | 24 Vdc (–15%/+20%)   |  | 24 Vdc (–15%/+20%)          |                             | 24 Vdc (–15%/+20%)        |                            |
| Input voltage ripple  | %               | ≤5   | ≤5   | ≤5                          | ≤5                          | ≤5                        | ≤5                         |
| Siemens MPI, (optional)   |                 | Yes  | Yes  | Yes                         | Yes                         | Yes                       | Yes                        |
| Rated current (I)   | A               | 0.7  | 0.7  | 0.7                         | 0.7                         | 0.7                       | 0.7                        |
| Overload proof  |                 | Yes  | Yes  | Yes                         | Yes                         | Yes                       | Yes                        |
| Inrush current and duration   | A               | 12.5 A/6 ms  | 12.5 A/6 ms  | 12.5 A/6 ms                 | 12.5 A/6 ms                 | 12.5 A/6 ms               | 12.5 A/6 ms                |
| Heat dissipation at 24 Vdc  | W               | 3.8  | 3.8  | 3.8                         | 3.8                         | 3.8                       | 3.8                        |
| Potential isolation between U <sub>Pow</sub> and 15 V SmartWire-DT supply voltage |                 | No   | No   | No                          | No                          | No                        | No                         |
| Bridging voltage dips   | ms              | 10   | 10   | 10                          | 10                          | 10                        | 10                         |
| Repetition rate   | s               | 1  | 1  | 1                           | 1                           | 1                         | 1                          |
| Status indication (LED)   |                 | Yes  | Yes  | Yes                         | Yes                         | Yes                       | Yes                        |
| <b>SmartWire-DT Supply Voltage</b>  |                 |  |  |                             |                             |                           |                            |
| Rated operating voltage (U <sub>0</sub> )   | V               | 14.5 ±3%   | 14.5 ±3%   | 14.5 ±3%                    | 14.5 ±3%                    | 14.5 ±3%                  | 14.5 ±3%                   |
| Max. current (I <sub>max</sub> )  | A               | 0.7 ①  | 0.7 ①  | 0.7 ①                       | 0.7 ①                       | 0.7 ①                     | 0.7 ①                      |
| Short-circuit proof   |                 | Yes  | Yes  | Yes                         | Yes                         | Yes                       | Yes                        |
| <b>Connection Supply Voltages</b>   |                 |  |  |                             |                             |                           |                            |
| Connection type   |                 | Push in terminals  | Push in terminals  | Push in terminals           | Push in terminals           | Push in terminals         | Push in terminals          |
| Solid   | mm <sup>2</sup> | 0.2–1.5 (AWG 24–16)  | 0.2–1.5 (AWG 24–16)  | 0.2–1.5 (AWG 24–16)         | 0.2–1.5 (AWG 24–16)         | 0.2–1.5 (AWG 24–16)       | 0.2–1.5 (AWG 24–16)        |
| Flexible with ferrule   | mm <sup>2</sup> | 0.25–1.5   | 0.25–1.5   | 0.25–1.5                    | 0.25–1.5                    | 0.25–1.5                  | 0.25–1.5                   |
| <b>SmartWire-DT Network</b>   |                 |  |  |                             |                             |                           |                            |
| Station type  |                 | SmartWire-DT master  | SmartWire-DT master  | SmartWire-DT master         | SmartWire-DT master         | SmartWire-DT master       | SmartWire-DT master        |
| Number of SmartWire-DT modes  |                 | 99   | 99   | 58                          | 58                          | 99                        | 99                         |
| Baud rates  |                 | 125<br>250   | 125<br>250   | 125                         | 125                         | 125                       | 125                        |
| Address allocation  |                 | Automatic  | Automatic  | Automatic                   | Automatic                   | Automatic                 | Automatic                  |
| Status indication (LED)   |                 |  |  |                             |                             |                           |                            |
| SmartWire-DT master   |                 | Green  | Green  | Green                       | Green                       | Green                     | Green                      |
| Configurations  |                 | Red  | Red  | Red                         | Red                         | Red                       | Red                        |
| Connections   |                 | Plug, 8-pole   | Plug, 8-pole   | Plug, 8-pole                | Plug, 8-pole                | Plug, 8-pole              | Plug, 8-pole               |
| Plug connectors   |                 | Blade terminal<br>SWD4-8MF2                                | Blade terminal<br>SWD4-8MF2                                | Flat plug<br>SWD4-8MF2      | Flat plug<br>SWD4-8MF2      | Flat plug<br>SWD4-8MF2    | Flat plug<br>SWD4-8MF2     |
| <b>Fieldbus Interface</b>   |                 |  |  |                             |                             |                           |                            |
| Bus protocol  |                 | Ethernet IP/Modbus TCP slave                               | Ethernet IP/Modbus TCP slave                               | PROFIBUS-DP                 | PROFIBUS-DP                 | CANopen                   | CANopen                    |
| Baud rates  |                 | 10/100 mB  | 10/100 mB  | Up to 12 mB                 | Up to 12 mB                 | To 1 mB                   | To 1 mB                    |
| Address allocation  |                 | Automatic  | Automatic  | Automatic                   | Automatic                   | Automatic                 | Automatic                  |
| Station address   |                 | —  | —  | 2–125                       | 2–125                       | 2–32                      | 2–32                       |
| Address allocation  |                 | DIP switch/DHCP/BOOTP selection via DIP switch             | DIP switch/DHCP/BOOTP selection via DIP switch             | DIP switch                  | DIP switch                  | DIP switch                | DIP switch                 |
| Status display fieldbus interface (LED)   |                 | Link status:<br>yellow (10 mB),<br>green (100 mB) flashing | Link status:<br>yellow (10 mB),<br>green (100 mB) flashing | Two-colored red/green       | Two-colored red/green       | Two-colored red/green     | Two-colored red/green      |
| Terminating resistor  |                 | —  | —  | Switchable via plug         | Switchable via plug         | DIP switches              | DIP switches               |
| Connection design for field bus   |                 | 2 x RJ45<br>(2-channel switch)                             | 2 x RJ45<br>(2-channel switch)                             | 1 x SUB-D socket,<br>9-pole | 1 x SUB-D socket,<br>9-pole | 1 x SUB-D plug,<br>9-pole | 1 x SUB-D plug,<br>9-pole  |
| Potential isolation   |                 | Yes  | Yes  | Yes                         | Yes                         | Yes                       | Yes                        |

**Note**

① If contactors with a total current consumption >0.7 A are connected, a Power Feeder module EU5C-SWD-PF2 has to be used.



## Powerfeed Modules

| Description   | Unit       | EU5C-SWD-PF1-1<br>Powerfeed           | EU5C-SWD-PF2-1<br>Powerfeed           |
|---|------------|---------------------------------------|---------------------------------------|
| <b>General</b>  |            |                                       |                                       |
| Standards   |            | IEC/EN 61131-2<br>EN 50178            | IEC/EN 61131-2<br>EN 50178            |
| Dimensions (W x H x D)  | in<br>(mm) | 1.38 x 3.54 x 4.88<br>(35 x 90 x 124) | 1.38 x 3.54 x 4.88<br>(35 x 90 x 124) |
| Weight  | lbs (kg)   | 0.24 (0.11)                           | 0.37 (0.17)                           |
| Mounting  |            | DIN rail IEC/EN 60715, 35 mm          | DIN rail IEC/EN 60715, 35 mm          |
| Mounting position   |            | Vertical                              | Vertical                              |
| <b>Ambient Conditions, Mechanical</b>   |            |                                       |                                       |
| Degree of protection (IEC/EN 60529)   |            | IP20                                  | IP20                                  |
| Vibrations (IEC/EN 61131-2:2008)  |            |                                       |                                       |
| Constant amplitude 3.5 mm   | Hz         | 5–8.4                                 | 5–8.4                                 |
| Constant acceleration 1 g   | Hz         | 8.4–150                               | 8.4–150                               |
| Mechanical shock resistance (IEC/EN 60068-2-27)<br>semi-sinusoidal 15 g/11 ms | Impacts    | 9                                     | 9                                     |
| Drop to IEC/EN 60068-2-31 (drop height)                                       | in (mm)    | 1.97 (50)                             | 1.97 (50)                             |
| Free fall, packaged (IEC/EN 60068-2-32)                                       | ft (m)     | 1.0 (0.3)                             | 1.0 (0.3)                             |
| <b>Electromagnetic Compatibility (EMC)</b>                                    |            |                                       |                                       |
| Overvoltage category  |            | II                                    | II                                    |
| Pollution degree  |            | 2                                     | 2                                     |
| Electrostatic discharge (IEC/EN 61131-2:2008)                                 |            |                                       |                                       |
| Air discharge (Level 3)   | kV         | 8                                     | 8                                     |
| Contact discharge (Level 2)   | kV         | 4                                     | 4                                     |
| Electromagnetic fields (IEC/EN 61131-2:2008)                                  |            |                                       |                                       |
| 80–1000 MHz   | V/m        | 10                                    | 10                                    |
| 1.4–2 GHz   | V/m        | 3                                     | 3                                     |
| 2–7 GHz   | V/m        | 1                                     | 1                                     |
| Radio interference suppression (SmartWire-DT)                                 |            | EN 55011 Class A                      | EN 55011 Class A                      |
| Burst (IEC/EN 61131-2:2008, Level 3)  |            |                                       |                                       |
| Supply cables   | kV         | 2                                     | 2                                     |
| CAN/DP bus cable  | kV         | —                                     | —                                     |
| SmartWire-DT cables   | kV         | 1                                     | 1                                     |
| Surge (IEC/EN 61131-2:2008, Level 1)  |            |                                       |                                       |
| Supply cables   | kV         | 0.5                                   | 0.5                                   |
| CAN/DP bus cable  | kV         | 1                                     | 1                                     |
| Radiated RFI (IEC/EN 61131-2:2008, Level 3)                                   | V          | 10                                    | 10                                    |
| <b>Climatic Environmental Conditions</b>                                      |            |                                       |                                       |
| Operating ambient temperature (IEC 60068-2)                                   | °F (°C)    | –13° to 131° (–25° to 55°)            | –13° to 131° (–25° to 55°)            |
| Condensation  |            | Prevent with suitable measures        | Prevent with suitable measures        |
| Storage   | °F (°C)    | –40° to 158° (–40° to 70°)            | –40° to 158° (–40° to 70°)            |
| Relative humidity, noncondensing (IEC/EN 60068-2-30)                          | %          | 5–95                                  | 5–95                                  |
| <b>Supply Voltage U<sub>Aux</sub></b>   |            |                                       |                                       |
| SM Puffer Bremer  | V          | 24 Vdc (–15%/+20%)                    | 24 Vdc (–15%/+20%)                    |
| Residual ripple on the input voltage  | %          | 5                                     | 5                                     |
| Protection against polarity reversal  |            | Yes                                   | Yes                                   |
| Max. current (I <sub>max</sub> )  | A          | 3                                     | 3                                     |
| Short-circuit rating  |            | No, external fuse FAZ Z3              | No, external fuse FAZ Z3              |
| Power loss  | W          | Normally 1                            | Normally 1                            |
| Potential isolation   |            | No                                    | No                                    |
| Rated operating voltage of 24 Vdc modes                                       | V          | Typ. U <sub>Aux</sub> –0.2            | Typ. U <sub>Aux</sub> –0.2            |

## Powerfeed Modules, continued

| Description  | Unit            | EU5C-SWD-PF1-1<br>Powerfeed | EU5C-SWD-PF2-1<br>Powerfeed |
|--|-----------------|-----------------------------|-----------------------------|
| <b>Supply Voltage <math>U_{Pow}</math></b>                                 |                 |                             |                             |
| Supply voltage   | V               | 24 Vdc (–15%/+20%)          | 24 Vdc (–15%/+20%)          |
| Input voltage ripple   | %               | ≤5                          | ≤5                          |
| Siemens MPI, (optional)  |                 | —                           | Yes                         |
| Rated current ( $I$ )  | A               | 0.7                         | 0.7                         |
| Overload proof   |                 | Yes                         | Yes                         |
| Inrush current and duration  | A               | 12.5 A/6 ms                 | 12.5 A/6 ms                 |
| Heat dissipation at 24 Vdc   | W               | 3.8                         | 3.8                         |
| Potential isolation between $U_{Pow}$ and 15 V SmartWire-DT supply voltage |                 | —                           | Yes                         |
| Bridging voltage dips  | ms              | —                           | 10                          |
| Repetition rate  | s               | —                           | 1                           |
| Status indication (LED)  |                 | No                          | Yes                         |
| <b>SmartWire-DT Supply Voltage</b>   |                 |                             |                             |
| Rated operating voltage ( $U_g$ )  | V               | 14.5 ±3%                    | 14.5 ±3%                    |
| Max. current ( $I_{max}$ )   | A               | 0.7                         | 0.7                         |
| Short-circuit proof  |                 | No                          | Yes                         |
| <b>Connection Supply Voltages</b>  |                 |                             |                             |
| Connection type  |                 | Push in terminals           | Push in terminals           |
| Solid  | mm <sup>2</sup> | 0.2–1.5 (AWG 24–16)         | 0.2–1.5 (AWG 24–16)         |
| Flexible with ferrule  | mm <sup>2</sup> | 0.25–1.5                    | 0.25–1.5                    |
| <b>SmartWire-DT Network</b>  |                 |                             |                             |
| Station type   |                 | —                           | —                           |
| Number of SmartWire-DT modes   |                 | —                           | —                           |
| Baud rates   |                 | —                           | —                           |
| Address allocation   |                 | None                        | None                        |
| Status indication (LED)  |                 |                             |                             |
| SmartWire-DT master  |                 | Green                       | Green                       |
| Configurations   |                 | Red                         | Red                         |
| Connections  |                 | 2 x plug, 8-pole            | 2 x plug, 8-pole            |
| Plug connectors  |                 | Two flat plugs SWD4-8MF2    | Two flat plugs SWD4-8MF2    |
| <b>Fieldbus Interface</b>  |                 |                             |                             |
| Bus protocol   |                 | —                           | —                           |
| Baud rates   |                 | —                           | —                           |
| Address allocation   |                 | —                           | —                           |
| Station address  |                 | —                           | —                           |
| Address allocation   |                 | —                           | —                           |
| Status display fieldbus interface (LED)                                    |                 | —                           | —                           |
| Terminating resistor   |                 | —                           | —                           |
| Connection design for field bus  |                 | —                           | —                           |
| Potential isolation  |                 | —                           | —                           |

**Note**

① If contactors with a total current consumption >0.7 A are connected, a Power Feeder module EU5C-SWD-PF2 has to be used.

## XV-102 Series HMI-PLCs and XC-152 Series PLCs

| Model  | XV-102   |   |                         | XC-152   |                         |                         |
|--|--|---|-------------------------|--|-------------------------|-------------------------|
|  | 3.5 in   | 5.7 in  | 7.0 in                  | 5.7 in   | 8.4 in                  | 10.4 in                 |
| Operating system   | WinCE 5.0 Professional   | WinCE 5.0 Professional                                  | WinCE 5.0 Professional  | WinCE 5.0 Professional   | WinCE 5.0 Professional  | WinCE 5.0 Professional  |
| Touchscreen technology                                       | Resistive  | Resistive   | Resistive               | Resistive  | Resistive               | Resistive               |
| Display, colors  | Color TFT, 64 k colors   | Color TFT, 64 k colors                                  | Color TFT, 64 k colors  | Color TFT, 64 k colors   | Color TFT, 64 k colors  | Color TFT, 64 k colors  |
| Pixel resolution (landscape)<br>portrait mode also available | QVGA 320 x 240   | VGA 640 x 480   | WVGA 800 x 480          | VGA 640 x 480  | VGA 640 x 480           | VGA 640 x 480           |
| Brightness (cd/m <sup>2</sup> )                              | 250  | 250   | 250                     | 350  | 350                     | 350                     |
| Backlight  | LED, selectable dimming  | LED, selectable dimming                                 | LED, selectable dimming | LED, selectable dimming  | LED, selectable dimming | LED, selectable dimming |
| Lifespan of backlight (half-life)                            | 40,000 hrs   | 40,000 hrs  | 40,000 hrs              | 40,000 hrs   | 40,000 hrs              | 40,000 hrs              |
| Processor  | 32 bit RISC, 400 MHz   | 32 bit RISC, 400 MHz                                    | 32 bit RISC, 400 MHz    | 32 bit RISC, 400 MHz   | 32 bit RISC, 400 MHz    | 32 bit RISC, 400 MHz    |
| Volatile memory  | 64 MB DRAM   | 64 MB DRAM  | 64 MB DRAM              | 64 MB DRAM   | 64 MB DRAM              | 64 MB DRAM              |
| Non-volatile memory  | 125 KB NVRAM/64 MB NAND, 1 SD card slot  | 125 KB NVRAM/64 MB NAND/<br>2 MB NOR, 1 SD card slot    |                         | 125 KB NVRAM/64 MB NAND/<br>2 MB NOR, 1 SD card slot   |                         |                         |
| Real time clock  | Yes  | Yes   | Yes                     | Yes  | Yes                     | Yes                     |
| Communication ports  | Ethernet 10/100, RS-485<br>or RS-232 USB Device  | Ethernet 10/100, RS-485, RS-232<br>USB Host, USB Device |                         | Ethernet 10/100, RS-485, RS-232 USB Host, USB Device   |                         |                         |
| Slots for COMM modules                                       | None   | None  | None                    | None   | None                    | None                    |
| Power supply rated voltage                                   | 24 Vdc nominal (–20%/+25%) with polarity protection  |   |                         | 24 Vdc nominal (–20%/+25%) with polarity protection  |                         |                         |
| Continuous current consumption<br>(max. amps)                | 0.2  | 0.4   | 0.4                     | 0.4  | 0.6                     | 0.6                     |
| Starting current inrush (A <sup>2</sup> s)                   | 1.5  | 1.5   | 1.5                     | 1.5  | 1.5                     | 1.5                     |
| Ambient conditions   |  |   |                         |  |                         |                         |
| Operation—relative humidity,<br>noncondensing                | 0 to 50 °C, 10 to 95%  | 0 to 50 °C, 10 to 95%                                   | 0 to 50 °C, 10 to 95%   | 0 to 50 °C, 10 to 95%  | 0 to 50 °C, 10 to 95%   | 0 to 50 °C, 10 to 95%   |
| Storage/transport—relative<br>humidity, noncondensing        | –20 to 60 °C, 10 to 95%  | –20 to 60 °C, 10 to 95%                                 | –20 to 60 °C, 10 to 95% | –20 to 60 °C, 10 to 95%  | –20 to 60 °C, 10 to 95% | –20 to 60 °C, 10 to 95% |
| Shock  | IEC 60068-2-27 15 g for 11 ms duration   |   |                         | IEC 60068-2-27 15 g for 11 ms duration   |                         |                         |
| Vibration  | IEC 60068-2-6<br>5–9 Hz: 3.5 mm displacement<br>9–60 Hz: 0.15 mm displacement<br>60–150 Hz: 2 g acceleration |   |                         | IEC 60068-2-6<br>5–9 Hz: 3.5 mm displacement<br>9–60 Hz: 0.15 mm displacement<br>60–150 Hz: 2 g acceleration |                         |                         |
| Agency certifications and<br>standards                       | CE, UL/cUL, CSA (pending), RoHS  |   |                         | CE, UL/cUL, CSA (pending), RoHS  |                         |                         |
| Protection type  |  |   |                         |  |                         |                         |
| Front  | IP65, NEMA 4X (indoor)   | IP65, NEMA 4X (indoor)                                  | IP65, NEMA 4X (indoor)  | IP65, NEMA 4X (indoor)   | IP65, NEMA 4X (indoor)  | IP65, NEMA 4X (indoor)  |
| Rear   | IP20, NEMA 1   | IP20, NEMA 1  | IP20, NEMA 1            | IP20, NEMA 1   | IP20, NEMA 1            | IP20, NEMA 1            |
| Housing material   | Plastic  | Plastic   | Plastic                 | Metal  | Metal                   | Metal                   |
| Dimensions WxHxD (mm)  | 136 x 100 x 30   | 170 x 130 x 39  | 210 x 135 x 38          | 212 x 156 x 53   | 275 x 208 x 53          | 345 x 260 x 54          |
| Mounting cutout WxH (mm)                                     | 123 x 87   | 157 x 117   | 197 x 122               | 198 x 142  | 261 x 194               | 329 x 238               |
| Approximate weight lbs (kg)                                  | 0.7 (0.3)  | 1.3 (0.6)   | 1.3 (0.6)               | 2.9 (1.3)  | 4.3 (2.1)               | 6.1 (3.0)               |
| Ability to run third party<br>software                       | No   | No  | No                      | No   | No                      | No                      |
| XSoft-CoDeSys-2 development<br>software                      | SW-XSOFT-CODESYS-2-S (seat)<br>SW-XSOFT-CODESYS-2-M (multi-seat)   |   |                         | SW-XSOFT-CODESYS-2-S (seat)<br>SW-XSOFT-CODESYS-2-M (multi-seat)   |                         |                         |
| XSoft-CoDeSys-3 development<br>software                      | SW-XSOFT-CODESYS-3-S (seat)<br>SW-XSOFT-CODESYS-3-M (multi-seat)   |   |                         | SW-XSOFT-CODESYS-3-S (seat)<br>SW-XSOFT-CODESYS-3-M (multi-seat)   |                         |                         |

## Digital I/O Modules

| Description   | Unit       | EU5E-SWD-8DX                          | EU5E-SWD-4DX                          | EU5E-SWD-4D4D                         | EU5E-SWD-4D2R                         | EU5E-SWD-X8D                          |
|---|------------|---------------------------------------|---------------------------------------|---------------------------------------|---------------------------------------|---------------------------------------|
| <b>General</b>  |            |                                       |                                       |                                       |                                       |                                       |
| Standards   |            | IEC/EN 61131-2;<br>EN 50178           | IEC/EN 61131-2;<br>EN 50178           | IEC/EN 61131-2;<br>EN 50178           | IEC/EN 61131-2;<br>EN 50178           | IEC/EN 61131-2;<br>EN 50178           |
| Dimensions (W x H x D)  | in<br>(mm) | 1.38 x 3.54 x 3.97<br>(35 x 90 x 101) | 1.38 x 3.54 x 3.97<br>(35 x 90 x 101) | 1.38 x 3.54 x 3.97<br>(35 x 90 x 101) | 1.38 x 3.54 x 3.97<br>(35 x 90 x 101) | 1.38 x 3.54 x 3.97<br>(35 x 90 x 101) |
| Weight  | lbs (kg)   | 0.22 (0.10)                           | 0.22 (0.10)                           | 0.22 (0.10)                           | 0.22 (0.10)                           | 0.22 (0.10)                           |
| Mounting  |            | DIN rail IEC/EN 60715,<br>35 mm       | Top-hat rail IEC/<br>EN 60715, 35 mm  | DIN rail IEC/EN 60715,<br>35 mm       | DIN rail IEC/EN 60715,<br>35 mm       | Top-hat rail IEC/<br>EN 60715, 35 mm  |
| Mounting position   |            | Vertical                              | Vertical                              | Vertical                              | Vertical                              | Vertical                              |
| <b>Ambient Conditions, Mechanical</b>   |            |                                       |                                       |                                       |                                       |                                       |
| Degree of protection (IEC/EN 60529)   |            | IP20                                  | IP20                                  | IP20                                  | IP20                                  | IP20                                  |
| Vibrations (IEC/EN 61131-2:2008)  |            |                                       |                                       |                                       |                                       |                                       |
| Constant amplitude 3.5 mm   | Hz         | 5–8.4                                 | 5–8.4                                 | 5–8.4                                 | 5–8.4                                 | 5–8.4                                 |
| Constant acceleration 1 g   | Hz         | 8.4–150                               | 8.4–150                               | 8.4–150                               | 8.4–150                               | 8.4–150                               |
| Mechanical shock resistance (IEC/EN 60068-2-27)<br>semi-sinusoidal 15 g/11 ms | Impacts    | 9                                     | 9                                     | 9                                     | 9                                     | 9                                     |
| Drop to IEC/EN 60068-2-31 (drop height)                                       | in (mm)    | 1.97 (50)                             | 1.97 (50)                             | 1.97 (50)                             | 1.97 (50)                             | 1.97 (50)                             |
| Free fall, packaged (IEC/EN 60068-2-32)                                       | ft (m)     | 1.0 (0.3)                             | 1.0 (0.3)                             | 1.0 (0.3)                             | 1.0 (0.3)                             | 1.0 (0.3)                             |
| <b>Electromagnetic Compatibility (EMC)</b>                                    |            |                                       |                                       |                                       |                                       |                                       |
| Overvoltage category  |            | II                                    | II                                    | II                                    | II                                    | II                                    |
| Pollution degree  |            | 2                                     | 2                                     | 2                                     | 2                                     | 2                                     |
| Electrostatic discharge (IEC/EN 61131-2:2008)                                 |            |                                       |                                       |                                       |                                       |                                       |
| Air discharge (Level 3)   | kV         | 8                                     | 8                                     | 8                                     | 8                                     | 8                                     |
| Contact discharge (Level 2)   | kV         | 4                                     | 4                                     | 4                                     | 4                                     | 4                                     |
| Electromagnetic fields (IEC/EN 61131-2:2008)                                  |            |                                       |                                       |                                       |                                       |                                       |
| 80–1000 MHz   | V/m        | 10                                    | 10                                    | 10                                    | 10                                    | 10                                    |
| 1.4–2 GHz   | V/m        | 3                                     | 3                                     | 3                                     | 3                                     | 3                                     |
| 2–2.7 GHz   | V/m        | 1                                     | 1                                     | 1                                     | 1                                     | 1                                     |
| Radio interference suppression (SmartWire-DT)                                 |            | EN 55011 Class A                      | EN 55011 Class A                      | EN 55011 Class A                      | EN 55011 Class A                      | EN 55011 Class A                      |
| Burst (IEC/EN 61131-2:2008, Level 3)  |            |                                       |                                       |                                       |                                       |                                       |
| Supply cables   | kV         | 2                                     | 2                                     | 2                                     | 2                                     | 2                                     |
| Signal lines  | kV         | 1                                     | 1                                     | 1                                     | 1                                     | 1                                     |
| SmartWire-DT cables   | kV         | 1                                     | 1                                     | 1                                     | 1                                     | 1                                     |
| Surge (IEC/EN 61131-2:2008, Level 1)  |            |                                       |                                       |                                       |                                       |                                       |
| Supply cables   | kV         | 0.5                                   | 0.5                                   | 0.5                                   | 0.5                                   | 0.5                                   |
| Radiated RFI (IEC/EN 61131-2:2008, Level 3)                                   | V          | 10                                    | 10                                    | 10                                    | 10                                    | 10                                    |
| <b>Climatic Environmental Conditions</b>                                      |            |                                       |                                       |                                       |                                       |                                       |
| Operating ambient temperature (IEC 60068-2)                                   | °F (°C)    | –13° to 131°<br>(–25° to 55°)         | –13° to 131°<br>(–25° to 55°)         | –13° to 131°<br>(–25° to 55°)         | –13° to 131°<br>(–25° to 55°)         | –13° to 131°<br>(–25° to 55°)         |
| Condensation  |            | Prevent with suitable<br>measures     | Prevent with suitable<br>measures     | Prevent with suitable<br>measures     | Prevent with suitable<br>measures     | Prevent with suitable<br>measures     |
| Storage   | °F (°C)    | –40° to 158°<br>(–40° to 70°)         | –40° to 158°<br>(–40° to 70°)         | –40° to 158°<br>(–40° to 70°)         | –40° to 158°<br>(–40° to 70°)         | –40° to 158°<br>(–40° to 70°)         |
| Relative humidity, noncondensing (IEC/<br>EN 60068-2-30)                      | %          | 5–95                                  | 5–95                                  | 5–95                                  | 5–95                                  | 5–95                                  |
| <b>SmartWire-DT Network</b>   |            |                                       |                                       |                                       |                                       |                                       |
| Station type  |            | SmartWire-DT (node)                   | SmartWire-DT (slave)                  | SmartWire-DT (node)                   | SmartWire-DT (node)                   | SmartWire-DT (slave)                  |
| Address allocation  |            | Automatic                             | Automatic                             | Automatic                             | Automatic                             | Automatic                             |
| SmartWire-DT status (LED)   |            | Green                                 | Green                                 | Green                                 | Green                                 | Green                                 |
| Connection  |            |                                       |                                       |                                       |                                       |                                       |
| Plug  |            | 8-pole                                | Plug, 8-pole                          | 8-pole                                | 8-pole                                | Plug, 8-pole                          |
| Connection plug   |            | External device plug<br>SWD4-8SF2-5   | External device plug<br>SWD4-8SF2-5   | External device plug<br>SWD4-8SF2-5   | External device plug<br>SWD4-8SF2-5   | External device plug<br>SWD4-8SF2-5   |
| Current consumption (15 V SWD supply)   |            | See <b>Page V7-T9-61</b>              | See <b>Page V7-T9-61</b>              | See <b>Page V7-T9-61</b>              | See <b>Page V7-T9-61</b>              | See <b>Page V7-T9-61</b>              |

**Note**

① Minimum length 8 mm.

## Digital I/O Modules, continued

| Description                            | Unit            | EU5E-SWD-8DX             | EU5E-SWD-4DX          | EU5E-SWD-4D4D                           | EU5E-SWD-4D2R        | EU5E-SWD-X8D                            |
|--|-----------------|--------------------------|-----------------------|---|----------------------|---|
| <b>Connection Supply and I/O</b>       |                 |                          |                       |   |                      |   |
| Connection type                        |                 | Push in terminals        | Push in terminals     | Push in terminals                       | Push in terminals    | Push in terminals                       |
| Solid                                  | mm <sup>2</sup> | 0.2–1.5 (AWG 24–16)      | 0.2–1.5 (AWG 24–16)   | 0.2–1.5 (AWG 24–16)                     | 0.2–1.5 (AWG 24–16)  | 0.2–1.5 (AWG 24–16)                     |
| Flexible with ferrule <sup>①</sup>     | mm <sup>2</sup> | 0.25–1.5 (AWG 24–16)     | 0.25–1.5              | 0.25–1.5                                | 0.25–1.5             | 0.25–1.5 (AWG 24–16)                    |
| <b>24 Vdc Supply for Output Supply</b> |                 |                          |                       |   |                      |   |
| Rated operational voltage ( $U_e$ )    | V               | 24 Vdc (–15%/+20%)       | 24 Vdc (–15%/+20%)    | 24 Vdc (–15%/+20%)                      | 24 Vdc (–15%/+20%)   | 24 Vdc (–15%/+20%)                      |
| Residual ripple on the input voltage   | %               | —                        | ≤5                    | 5                                       | —                    | ≤5                                      |
| Protection against polarity reversal   |                 | —                        | Yes                   | Yes                                     | —                    | Yes                                     |
| <b>Digital Inputs</b>                  |                 |                          |                       |   |                      |   |
| Quantity                               |                 | 8                        | 4 <sup>①</sup>        | 4                                       | 4                    | —                                       |
| Input current                          | mA              | Typ. 4 at 24 Vdc         | Typ. 4 at 24 Vdc      | Typ. 4 at 24 Vdc                        | Typ. 4 at 24 Vdc     | Typ. 4 at 24 Vdc                        |
| Voltage level to IEC/EN 61131-2        |                 |                          |                       |   |                      |   |
| Limit value type 1                     |                 | Low <5 Vdc; High >15 Vdc |                       |   |                      |   |
| Input delay                            |                 |                          |                       |   |                      |   |
| High                                   |                 | <0.2 ms                  | <0.2 ms               | <0.2 ms                                 | <0.2 ms              | <0.2 ms                                 |
| Low                                    |                 | <0.2 ms                  | <0.2 ms               | <0.2 ms                                 | <0.2 ms              | <0.2 ms                                 |
| SmartWire-DT status (LED)              |                 | Yellow                   | Yellow                | Yellow                                  | Yellow               | —                                       |
| <b>Power Supply I+, I-</b>             |                 |                          |                       |   |                      |   |
| Overload proof                         |                 | —                        | Yes, with diagnostics | —                                       | —                    | —                                       |
| Output current per input supply        | A               | —                        | ≤0.5                  | —                                       | —                    | —                                       |
| Supply voltage                         | V               | —                        | $U_e$ 0.16 V          | —                                       | —                    | —                                       |
| <b>Transistor Outputs</b>              |                 |                          |                       |   |                      |   |
| Number                                 |                 | —                        | —                     | 4                                       | —                    | 8                                       |
| Output current                         | A               | —                        | —                     | Normally 0.5 at 24 Vdc                  | —                    | Normally 0.5 at 24 Vdc                  |
| Short-circuit tripping current         | A               | —                        | —                     | Max. 1.2 over 3 ms                      | —                    | Max. 1.2 over 3 ms                      |
| Lamp load ( $R_{LL}$ )                 | W               | —                        | —                     | 3                                       | —                    | ≤3                                      |
| Overload proof                         |                 | —                        | —                     | Yes, with diagnostics                   | —                    | Yes, with diagnostics                   |
| Switching capacity                     |                 | —                        | —                     | EN 60947-5-1 utilization category DC-13 | —                    | EN 60947-5-1 utilization category DC-13 |
| Status display                         | LED             | —                        | —                     | —                                       | —                    | Yellow                                  |
| <b>Relay Outputs</b>                   |                 |                          |                       |   |                      |   |
| Number                                 |                 | —                        | —                     | —                                       | 2                    | —                                       |
| Contact type art                       |                 | —                        | —                     | —                                       | N/O contact          | —                                       |
| Operations                             |                 |                          |                       |   |                      |   |
| Utilization category AC-1, 250 V, 6 A  |                 | —                        | —                     | —                                       | >6 x 10 <sup>4</sup> | —                                       |
| Utilization category AC-15, 250 V, 3 A |                 | —                        | —                     | —                                       | >5 x 10 <sup>4</sup> | —                                       |
| Utilization category DC-13, 24 V, 1 A  |                 | —                        | —                     | —                                       | >2 x 10 <sup>5</sup> | —                                       |
| Safe isolation                         | Vac             | —                        | —                     | —                                       | 230                  | —                                       |
| Minimum load current                   | mA              | —                        | —                     | —                                       | 100 mA, 12 Vdc       | —                                       |
| Pick-up/drop-out time                  | ms              | —                        | —                     | —                                       | 5/2.5                | —                                       |
| Bounce duration                        | ms              | —                        | —                     | —                                       | Normally 1.5         | —                                       |
| Short-circuit protection               |                 | —                        | —                     | —                                       | External 4A gL/gG    | —                                       |
| Status display outputs (LED)           |                 | —                        | —                     | Yellow                                  | Yellow               | —                                       |
| <b>Potential Isolation</b>             |                 |                          |                       |   |                      |   |
| Inputs for SmartWire-DT                |                 | Yes                      | Yes                   | Yes                                     | Yes                  | Yes                                     |
| Transistor outputs for SmartWire-DT    |                 | —                        | Yes                   | Yes                                     | —                    | —                                       |
| Transistor outputs for inputs          |                 | —                        | —                     | No                                      | —                    | —                                       |
| Relays for SmartWire-DT                |                 | —                        | —                     | —                                       | Yes                  | —                                       |
| Relays for inputs                      |                 | —                        | —                     | —                                       | Yes                  | —                                       |
| Relays for relays                      |                 | —                        | —                     | —                                       | Yes                  | —                                       |

**Note**

<sup>①</sup> Three-wire connection with power supply I+, I-.

## SmartWire-DT In-Panel and On-Machine Wiring Solution

## Analog I/O Modules

| Description   | Unit            | EU5E-SWD-4AX   | EU5E-SWD-2A2A                      | EU5E-SWD-4PT                       | EU5E-SWD-4PT-2                     |
|---|-----------------|--|------------------------------------|------------------------------------|------------------------------------|
| <b>General</b>  |                 |  |                                    |                                    |                                    |
| Standards   |                 | IEC/EN 61131-2/EN 50178  | IEC/EN 61131-2/EN 50178            | IEC/EN 61131-2/EN 50178            | IEC/EN 61131-2/EN 50178            |
| Dimensions (W x H x D)  | in (mm)         | 1.38 x 3.54 x 3.97 (35 x 90 x 101)                             | 1.38 x 3.54 x 3.97 (35 x 90 x 101) | 1.38 x 3.54 x 3.97 (35 x 90 x 101) | 1.38 x 3.54 x 3.97 (35 x 90 x 101) |
| Weight  | lbs (kg)        | 0.22 (0.10)  | 0.22 (0.10)                        | 0.22 (0.10)                        | 0.22 (0.10)                        |
| Mounting  |                 | Top-hat rail IEC/EN 60715, 35 mm                               | Top-hat rail IEC/EN 60715, 35 mm   | Top-hat rail IEC/EN 60715, 35 mm   | Top-hat rail IEC/EN 60715, 35 mm   |
| Mounting position   |                 | Vertical   | Vertical                           | Vertical                           | Vertical                           |
| <b>Ambient Conditions, Mechanical</b>   |                 |  |                                    |                                    |                                    |
| Protection type (IEC/EN 60529)  |                 | IP20   | IP20                               | IP20                               | IP20                               |
| Vibrations (IEC/EN 61131-2:2008)  |                 |  |                                    |                                    |                                    |
| Constant amplitude 3.5 mm   | Hz              | 5–8.4  | 5–8.4                              | 5–8.4                              | 5–8.4                              |
| Constant acceleration 1 g   | Hz              | 8.4–150  | 8.4–150                            | 8.4–150                            | 8.4–150                            |
| Mechanical shock resistance (IEC/EN 60068-2-27)<br>semi-sinusoidal 15 g/11 ms | Impacts         | 9  | 9                                  | 9                                  | 9                                  |
| Drop to IEC/EN 60068-2-31 (drop height)                                       | in (mm)         | 1.97 (50)  | 1.97 (50)                          | 1.97 (50)                          | 1.97 (50)                          |
| Free fall, packaged (IEC/EN 60068-2-32)                                       | ft (m)          | 1.0 (0.3)  | 1.0 (0.3)                          | 1.0 (0.3)                          | 1.0 (0.3)                          |
| <b>Electromagnetic Compatibility (EMC)</b>                                    |                 |  |                                    |                                    |                                    |
| Overvoltage category  |                 | II   | II                                 | II                                 | II                                 |
| Pollution degree  |                 | 2  | 2                                  | 2                                  | 2                                  |
| Electrostatic discharge (IEC/EN 61131-2:2008)                                 |                 |  |                                    |                                    |                                    |
| Air discharge (Level 3)   | kV              | 8  | 8                                  | 8                                  | 8                                  |
| Contact discharge (Level 2)   | kV              | 4  | 4                                  | 4                                  | 4                                  |
| Electromagnetic fields (IEC/EN 61131-2:2008)                                  |                 |  |                                    |                                    |                                    |
| 80–1000 MHz   | V/m             | 10   | 10                                 | 10                                 | 10                                 |
| 1.4–2 GHz   | V/m             | 3  | 3                                  | 3                                  | 3                                  |
| 2–2.7 GHz   | V/m             | 1  | 1                                  | 1                                  | 1                                  |
| Radio interference suppression (SmartWire-DT)                                 |                 | EN 55011 Class A   | EN 55011 Class A                   | EN 55011 Class A                   | EN 55011 Class A                   |
| Burst (IEC/EN 61131-2:2008, Level 3)  |                 |  |                                    |                                    |                                    |
| Supply cables   | kV              | 2  | 2                                  | 2                                  | 2                                  |
| Signal lines  | kV              | 2  | 2                                  | 2                                  | 2                                  |
| SmartWire-DT cables   | kV              | 2  | 2                                  | 2                                  | 2                                  |
| Surge (IEC/EN 61131-2:2008, Level 1)  |                 | Supply cables 1.0 kV   | Supply cables 1.0 kV               | Supply cables 1.0 kV               | Supply cables 1.0 kV               |
| Radiated RFI (IEC/EN 61131-2:2008, Level 3)                                   | V               | 10   | 10                                 | 10                                 | 10                                 |
| <b>Climatic Environmental Conditions</b>                                      |                 |  |                                    |                                    |                                    |
| Operating ambient temperature (IEC 60068-2)                                   | °F (°C)         | 13° to 131° (–25° to 55°)                                      | 13° to 131° (–25° to 55°)          | 13° to 131° (–25° to 55°)          | 13° to 131° (–25° to 55°)          |
| Condensation  |                 | Prevent with suitable measures                                 | Prevent with suitable measures     | Prevent with suitable measures     | Prevent with suitable measures     |
| Storage   | °F (°C)         | –40° to 158° (–40° to 70°)                                     | –40° to 158° (–40° to 70°)         | –40° to 158° (–40° to 70°)         | –40° to 158° (–40° to 70°)         |
| Relative humidity, noncondensing (IEC/EN 60068-2-30)                          | %               | 5–95   | 5–95                               | 5–95                               | 5–95                               |
| <b>SmartWire-DT Network</b>   |                 |  |                                    |                                    |                                    |
| Station type  |                 | SmartWire-DT slave   | SmartWire-DT slave                 | SmartWire-DT slave                 | SmartWire-DT slave                 |
| Baud rate setting   |                 | Automatic  | Automatic                          | Automatic                          | Automatic                          |
| SmartWire-DT status LED   | LED             | Green  | Green                              | Green                              | Green                              |
| Connection  |                 | Plug: 8-pole/Connection plug: External device plug SWD4-8SF2-5 |                                    |                                    |                                    |
| Current consumption (15 V SWD supply)   |                 | See <a href="#">Page V7-T9-61</a>                              | See <a href="#">Page V7-T9-61</a>  | See <a href="#">Page V7-T9-61</a>  | See <a href="#">Page V7-T9-61</a>  |
| <b>Connection Supply and I/O</b>  |                 |  |                                    |                                    |                                    |
| Connection type   |                 | Push in terminals  | Push in terminals                  | Push in terminals                  | Push in terminals                  |
| Solid   | mm <sup>2</sup> | 0.25–1.5 (AWG 24–16)   | 0.25–1.5 (AWG 24–16)               | 0.25–1.5 (AWG 24–16)               | 0.25–1.5 (AWG 24–16)               |
| Flexible with ferrule <sup>Ⓢ</sup>  | mm <sup>2</sup> | 0.25–1.5 (AWG 24–16)   | 0.25–1.5 (AWG 24–16)               | 0.25–1.5 (AWG 24–16)               | 0.25–1.5 (AWG 24–16)               |
| <b>24 Vdc Supply for Output Supply</b>  |                 |  |                                    |                                    |                                    |
| Rated operational voltage (U <sub>o</sub> )                                   | V               | 24 Vdc –15%/+20%   | 24 Vdc –15%/+20%                   | 24 Vdc –15%/+20%                   | 24 Vdc –15%/+20%                   |
| Residual ripple on the input voltage  | %               | ≤5   | ≤5                                 | ≤5                                 | ≤5                                 |
| Current consumption   | mA              | 10   | 50                                 | —                                  | —                                  |
| Protection against polarity reversal  |                 | Yes  | Yes                                | Yes                                | Yes                                |

**Note**

<sup>Ⓢ</sup> Minimum length 8 mm.

## Analog I/O Modules, continued

| Description                      | Unit    | EU5E-SWD-4AX                                      | EU5E-SWD-2A2A                                    | EU5E-SWD-4PT  | EU5E-SWD-4PT-2  |
|----------------------------------|---------|---|--|---|---|
| <b>Analog Inputs</b>             |         |   |  |   |   |
| Quantity                         |         | Four (two-wire connection, screened, length <10m) | Two (two-wire connection, screened, length <10m) | —   | —   |
| Parameterization                 |         |   |  |   |   |
| Part no.                         |         | Voltage, current                                  | Voltage, current                                 | —   | —   |
| Averaging                        |         | Adjustable  | Adjustable                                       | —   | —   |
| Voltage                          |         |   |  |   |   |
| Input voltage                    | V       | 0–10  | 0–10   | —   | —   |
| Input impedance                  | k ohms  | 13.3  | 13.3   | —   | —   |
| Maximum current                  |         |   |  |   |   |
| Input current                    | mA      | 0–20  | 0–20   | —   | —   |
| Input impedance                  | ohms    | < 250   | < 250  | —   | —   |
| Resolution                       | Bit     | 12  | 12   | —   | —   |
| Conversion time                  | ms      | 20  | 20   | —   | —   |
| Total error                      | %       | ±1  | ±1   | —   | —   |
| Repetition accuracy              | %       | ±0.5  | ±0.5   | —   | —   |
| Dielectric strength              | V       | ±30   | ±30  | —   | —   |
| <b>Analog Outputs</b>            |         |   |  |   |   |
| Number                           |         | —   | Two (two-wire connection, screened)              | —   | —   |
| Parameterization                 |         |   |  |   |   |
| Part no.                         |         | —   | Voltage, current                                 | —   | —   |
| Averaging                        |         | —   | —  | —   | —   |
| Voltage                          |         |   |  |   |   |
| Output voltage                   | V       | —   | 0–10   | —   | —   |
| Maximum output current           | mA      | —   | 10   | —   | —   |
| Maximum current                  |         |   |  |   |   |
| Output current                   | mA      | —   | 0–20   | —   | —   |
| Load resistance                  | ohms    | —   | <500   | —   | —   |
| Overload and short-circuit proof |         | —   | Yes  | —   | —   |
| Resolution                       | Bit     | —   | 12   | —   | —   |
| Conversion time                  | ms      | —   | 20   | —   | —   |
| Total error                      | %       | —   | ±1   | —   | —   |
| Repetition accuracy              | %       | —   | ±0.5   | —   | —   |
| <b>Temperature Inputs</b>        |         |   |  |   |   |
| Number                           |         | —   | —  | Four (two-, three-wire connection, screened, length <10m)                               | Four (two-, three-wire connection, screened, length <10m)                               |
| Parameterization                 |         |   |  |   |   |
| Averaging                        |         | —   | —  | Adjustable  | Adjustable  |
| Temperature sensor               |         | —   | —  | PT100, PT1000, Ni1000   | PT100, PT1000, Ni1000   |
| Temperature range                | °F (°C) | —   | —  | PT100, PT1000:<br>–58° to 392° (–50° to 200°)<br>Ni1000:<br>–58° to 302° (–50° to 150°) | PT100, PT1000:<br>–58° to 392° (–50° to 200°)<br>Ni1000:<br>–58° to 302° (–50° to 150°) |
| Resolution                       | °F (°C) | —   | —  | 32° (0.1°)  | 32° (0.1°)  |
| Conversion time                  | ms      | —   | —  | 250   | 250   |
| Display                          |         | —   | —  | °C, °F, raw value   | °C, °F, raw value   |
| Total error                      | %       | —   | —  | ±1  | ±1  |
| Repetition accuracy              | %       | —   | —  | ±0.5  | ±0.5  |
| <b>Potential Isolation</b>       |         |   |  |   |   |
| Inputs for SmartWire-DT          |         | Yes   | Yes  | Yes   | Yes   |
| Outputs to SmartWire-DT          |         | —   | Yes  | —   | —   |
| Input to input                   |         | No  | No   | No  | No  |
| Output to input                  |         | —   | No   | —   | —   |
| Output to output                 |         | —   | No   | —   | —   |

## Accessories

| Description   | Unit       | SWD4-RC8-10<br>Resistor                  | SWD4-8SF2-5<br>Plug                      | SWD4-8SFF2-5<br>Coupling                 | SWD4-SF8-20<br>Bushing                |
|---|------------|--|--|--|---------------------------------------|
| <b>General</b>  |            |  |  |  |                                       |
| Standards   |            | IEC/EN 61131-2; EN 50178                 | IEC/EN 61131-2; EN 50178                 | IEC/EN 61131-2; EN 50178                 | IEC/EN 61131-2; EN 50178              |
| Dimensions (W x H x D)  | in<br>(mm) | 1.91 x 1.36 x 0.34<br>(48.5 x 34.5 x 10) | 0.59 x 1.44 x 0.69<br>(15 x 36.5 x 17.5) | 1.91 x 1.36 x 0.34<br>(48.5 x 34.5 x 10) | 0.94 x 1.02 x 6.34<br>(24 x 26 x 162) |
| Weight  | lbs (g)    | 0.022 (10)                               | 0.012.1 (5.5)                            | 0.010 (4.5)                              | 0.044 (20)                            |
| Mounting position   |            | As required                              | As required                              | As required                              | As required                           |
| <b>Ambient Conditions, Mechanical</b>   |            |  |  |  |                                       |
| Degree of protection (IEC/EN 60529)   |            | IP20                                     | IP20                                     | IP20                                     | IP67                                  |
| Vibrations (IEC/EN 61131-2:2008)  |            |  |  |  |                                       |
| Constant amplitude 3.5 mm   | Hz         | 5–8.4                                    | 5–8.4                                    | 5–8.4                                    | —                                     |
| Constant acceleration 1 g   | Hz         | 8.4–150                                  | 8.4–150                                  | 8.4–150                                  | —                                     |
| Mechanical shock resistance (IEC/EN 60068-2-27)<br>semi-sinusoidal 15 g/11 ms | Impacts    | 9  | 9  | 9  | —                                     |
| Drop to IEC/EN 60068-2-31 (drop height)                                       | in (mm)    | 1.97 (50)                                | —  | —  | —                                     |
| Free fall, packaged (IEC/EN 60068-2-32)                                       | ft (m)     | 1.0 (0.3)                                | —  | —  | —                                     |
| <b>Electromagnetic Compatibility (EMC)</b>                                    |            |  |  |  |                                       |
| Overvoltage category  |            | II                                       | —  | —  | —                                     |
| Pollution degree  |            | 2  | —  | —  | —                                     |
| Electrostatic discharge (IEC/EN 61131-2:2008)                                 |            |  |  |  |                                       |
| Air discharge (Level 3)   | kV         | 8  | —  | —  | —                                     |
| Contact discharge (Level 2)   | kV         | 4  | —  | —  | —                                     |
| Electromagnetic fields (IEC/EN 61131-2:2008)                                  |            |  |  |  |                                       |
| 80–1000 MHz   | V/m        | 10                                       | —  | —  | —                                     |
| 1.4–2 GHz   | V/m        | 3  | —  | —  | —                                     |
| 2–2.7 GHz   | V/m        | 1  | —  | —  | —                                     |
| Radio interference suppression (SmartWire-DT)                                 |            | EN 55011 Class A                         | —  | —  | —                                     |
| Burst (IEC/EN 61131-2:2008, Level 3)  |            |  |  |  |                                       |
| SmartWire-DT cables   | kV         | 1  | —  | —  | —                                     |
| Radiated RFI (IEC/EN 61131-2:2008, Level 3)                                   | V          | 10                                       | —  | —  | —                                     |
| <b>Climatic Environmental Conditions</b>                                      |            |  |  |  |                                       |
| Operating ambient temperature (IEC 60068-2)                                   | °F (°C)    | –13° to 131° (–25° to 55°)               | –13° to 131° (–25° to 55°)               | –13° to 131° (–25° to 55°)               | –13° to 131° (–25° to 55°)            |
| Condensation  |            | Prevent with suitable measures           |  |  |                                       |
| Storage   | °F (°C)    | –40° to 158° (–40° to 70°)               | –40° to 158° (–40° to 70°)               | –40° to 158° (–40° to 70°)               | –40° to 158° (–40° to 70°)            |
| Relative humidity, noncondensing (IEC/EN 60068-2-30)                          | %          | 5–95                                     | 5–95                                     | 5–95                                     | 5–95                                  |
| <b>Connection Options</b>   |            |  |  |  |                                       |
| SWD-In  |            | Plug, 8-pole                             | Plug connector                           | Plug, 8-pole                             | —                                     |
| Number of insertion cycles  |            | ≥200                                     | 1  | >200                                     | —                                     |
| SWD-Out   |            | —  | Socket, 8-pole                           | Plug, 8-pole                             | Socket, 8-pole                        |
| Number of insertion cycles  |            | —  | ≥200                                     | ≥200                                     | ≥500                                  |
| Current consumption (15 V SWD supply)   |            | See <b>Page V7-T9-61</b>                 | See <b>Page V7-T9-61</b>                 | See <b>Page V7-T9-61</b>                 | See <b>Page V7-T9-61</b>              |



## Accessories, continued

| Description   | Unit       | SWD4-SM8-20<br>Bushing                | SWD4-8FRF-10<br>Adapter              | SWD4-SFL8-20<br>Adapter              | SWD4-SML8-20<br>Adapter              |
|---|------------|---------------------------------------|--------------------------------------|--------------------------------------|--------------------------------------|
| <b>General</b>  |            |                                       |                                      |                                      |                                      |
| Standards   |            | IEC/EN 61131-2; EN 50178              | IEC/EN 61131-2; EN 50178             | IEC/EN 61131-2; EN 50178             | IEC/EN 61131-2; EN 50178             |
| Dimensions (W x H x D)  | in<br>(mm) | 0.94 x 1.02 x 6.69<br>(24 x 26 x 170) | 1.38 x 3.54 x 1.38<br>(35 x 90 x 35) | 1.38 x 3.27 x 1.57<br>(35 x 83 x 40) | 1.38 x 3.27 x 1.82<br>(35 x 83 x 46) |
| Weight  | lbs (g)    | 0.050 (22.5)                          | 0.093 (42)                           | 0.110 (50)                           | 0.110 (50)                           |
| Mounting position   |            | As required                           | As required                          | As required                          | As required                          |
| <b>Ambient Conditions, Mechanical</b>   |            |                                       |                                      |                                      |                                      |
| Degree of protection (IEC/EN 60529)   |            | IP67                                  | IP20                                 | IP67                                 | IP67                                 |
| Vibrations (IEC/EN 61131-2:2008)  |            |                                       |                                      |                                      |                                      |
| Constant amplitude 3.5 mm   | Hz         | —                                     | 5–8.4                                | 5–8.4                                | 5–8.4                                |
| Constant acceleration 1 g   | Hz         | —                                     | 8.4–150                              | 8.4–150                              | 8.4–150                              |
| Mechanical shock resistance (IEC/EN 60068-2-27)<br>semi-sinusoidal 15 g/11 ms | Impacts    | —                                     | 9                                    | 9                                    | 9                                    |
| Drop to IEC/EN 60068-2-31 (drop height)                                       | in (mm)    | —                                     | —                                    | —                                    | —                                    |
| Free fall, packaged (IEC/EN 60068-2-32)                                       | ft (m)     | —                                     | —                                    | —                                    | —                                    |
| <b>Electromagnetic Compatibility (EMC)</b>                                    |            |                                       |                                      |                                      |                                      |
| Overvoltage category  |            | —                                     | —                                    | —                                    | —                                    |
| Pollution degree  |            | —                                     | —                                    | —                                    | —                                    |
| Electrostatic discharge (IEC/EN 61131-2:2008)                                 |            |                                       |                                      |                                      |                                      |
| Air discharge (Level 3)   | kV         | —                                     | 8                                    | 8                                    | 8                                    |
| Contact discharge (Level 2)   | kV         | —                                     | 4                                    | 4                                    | 4                                    |
| Electromagnetic fields (IEC/EN 61131-2:2008)                                  |            |                                       |                                      |                                      |                                      |
| 80–1000 MHz   | V/m        | —                                     | —                                    | 10                                   | 10                                   |
| 1.4–2 GHz   | V/m        | —                                     | —                                    | 3                                    | 3                                    |
| 2–2.7 GHz   | V/m        | —                                     | —                                    | 1                                    | 1                                    |
| Radio interference suppression (SmartWire-DT)                                 |            |                                       |                                      |                                      |                                      |
| Burst (IEC/EN 61131-2:2008, Level 3)  |            | —                                     | —                                    | —                                    | —                                    |
| SmartWire-DT cables   | kV         | —                                     | —                                    | —                                    | —                                    |
| Radiated RFI (IEC/EN 61131-2:2008, Level 3)                                   | V          | —                                     | —                                    | 10                                   | 10                                   |
| <b>Climatic Environmental Conditions</b>                                      |            |                                       |                                      |                                      |                                      |
| Operating ambient temperature (IEC 60068-2)                                   | °F (°C)    | –13° to 131° (–25° to 55°)            | –13° to 131° (–25° to 55°)           | –13° to 131° (–25° to 55°)           | –13° to 131° (–25° to 55°)           |
| Condensation  |            | Prevent with suitable measures        |                                      |                                      |                                      |
| Storage   | °F (°C)    | –40° to 158° (–40° to 70°)            | –40° to 158° (–40° to 70°)           | –40° to 158° (–40° to 70°)           | –40° to 158° (–40° to 70°)           |
| Relative humidity, noncondensing (IEC/EN 60068-2-30)                          | %          | 5–95                                  | 5–95                                 | 5–95                                 | 5–95                                 |
| <b>Connection Options</b>   |            |                                       |                                      |                                      |                                      |
| SWD-In  |            | Plug, 8-pole                          | Plug, 8-pole                         | Plug, 8-pole                         | Plug, 8-pole                         |
| Number of insertion cycles  |            | ≥500                                  | ≥200                                 | ≥200                                 | ≥500                                 |
| SWD-Out   |            | —                                     | Push in terminals                    | Socket, 8-pole                       | Plug, 8-pole                         |
| Number of insertion cycles  |            | —                                     | —                                    | ≥500                                 | ≥200                                 |
| Current consumption (15 V SWD supply)   |            | See <b>Page V7-T9-61</b>              | See <b>Page V7-T9-61</b>             | See <b>Page V7-T9-61</b>             | See <b>Page V7-T9-61</b>             |

## SmartWire-DT In-Panel and On-Machine Wiring Solution

## Machine Mount I/O Modules

| Description  | Unit       | EU1E-SWD-2DX  | EU1E-SWD-2DD   | EU2E-SWD-4DX   | EU2E-SWD-4DD   |
|--|------------|---|--|--|--|
| <b>General</b>   |            |   |  |  |  |
| Standards  |            | IEC/EN 61131-2, EN50178, IEC/EN 60529               | IEC/EN 61131-2, EN50178, IEC/EN 60529                | IEC/EN 61131-2, EN50178, IEC/EN 60529                | IEC/EN 61131-2, EN50178, IEC/EN 60529                |
| Dimensions (W x H x L) reference only  | mm         | 41 x 20 x 59  | 41 x 20 x 59   | 41 x 20 x 71   | 41 x 20 x 71   |
| Weight   | g / oz     | 65 / 2.3  | 65 / 2.3   | 85 / 3.0   | 85 / 3.0   |
| Form factor  |            | IP67 tee (single)                                   | IP67 tee (single)                                    | IP67 tee (single)                                    | IP67 tee (single)                                    |
| Enclosure material   | Tee        | MM 6208 (black)                                     | MM 6208 (black)                                      | MM 6208 (black)                                      | MM 6208 (black)                                      |
| Mounting   | Qty        | 2 mounting holes or with bracket accessory          | 2 mounting holes or with bracket accessory           | 2 mounting holes or with bracket accessory           | 2 mounting holes or with bracket accessory           |
| <b>Ambient Conditions, Mechanical</b>  |            |   |  |  |  |
| Protection type  | Type       | IP67  | IP67   | IP67   | IP67   |
| EN/IEC 60529   | Type       | IP6X /IPX7  | IP6X /IPX7   | IP6X /IPX7   | IP6X /IPX7   |
| UL type  |            | 1   | 1  | 1  | 1  |
| <b>Vibrations</b>  |            |   |  |  |  |
| Displacement 3.5 mm  | Hz         | 5–8.4   | 5–8.4  | 5–8.4  | 5–8.4  |
| Acceleration 1 g   | Hz         | 8.4–150   | 8.4–150  | 8.4–150  | 8.4–150  |
| Shock IEC 60068-2-27 1/2 sine 30 g/11 ms   | Impacts    | 9   | 9  | 9  | 9  |
| Drop to  | Height, mm | 50  | 50   | 50   | 50   |
| Drop freefall  | m          | 0.3   | 0.3  | 0.3  | 0.3  |
| <b>EMC</b>   |            |   |  |  |  |
| Overvoltage category   |            | II  | II   | II   | II   |
| Pollution degree   |            | 3   | 3  | 3  | 3  |
| Electrostatic discharge  |            | Performance Criterion B                             | Performance Criterion B                              | Performance Criterion B                              | Performance Criterion B                              |
| Air discharge (level 3)  | kV         | 8   | 8  | 8  | 8  |
| Contact discharge (level 2)  | kV         | 4   | 4  | 4  | 4  |
| Electromagnetic fields   |            | Performance Criterion A                             | Performance Criterion A                              | Performance Criterion A                              | Performance Criterion A                              |
| 80–1000 MHz  | V/m        | 10  | 10   | 10   | 10   |
| 1.4–2 G  | V/m        | 3   | 3  | 3  | 3  |
| 2–2.7 G  | V/m        | 1   | 1  | 1  | 1  |
| Radio Interference suppression (SmartWire-DT) (emission and conducted interface voltage) | EN 55011   | Class A   | Class A  | Class A  | Class A  |
| Burst (level 3)  |            | Performance Criterion B                             | Performance Criterion B                              | Performance Criterion B                              | Performance Criterion B                              |
| Supply cables  | kV         | 2   | 2  | 2  | 2  |
| Signal cables  | kV         | 1   | 1  | 1  | 1  |
| SmartWire-DT cables  | kV         | 1   | 1  | 1  | 1  |
| Surge (level 1)  |            | Performance Criterion B                             | Performance Criterion B                              | Performance Criterion B                              | Performance Criterion B                              |
| Supply cables  | kV         | 0.5   | 0.5  | 0.5  | 0.5  |
| I/O cables   | kV         | 1   | 1  | 1  | 1  |
| SmartWire-DT cables  | kV         | 1kV (not possible according to EN61000-6-2 Table 2) | 1 kV (not possible according to EN61000-6-2 Table 2) | 1 kV (not possible according to EN61000-6-2 Table 2) | 1 kV (not possible according to EN61000-6-2 Table 2) |
| Radiated RFI (level 3) (150 kHz–80 MHz)  |            | Performance Criterion A                             | Performance Criterion A                              | Performance Criterion A                              | Performance Criterion A                              |
| Supply cables  | V          | 10  | 10   | 10   | 10   |
| I/O cables   | V          | 10  | 10   | 10   | 10   |
| SmartWire-DT cables  | V          | 10  | 10   | 10   | 10   |
| Voltage drops and interrupts   | mS         | 10  | 10   | 10   | 10   |
| <b>Climatic Environmental Conditions</b>   |            |   |  |  |  |
| Ambient temperature  | °C         | –25 to +70  | –25 to +70   | –25 to +70   | –25 to +70   |
| Storage temperature  | °C         | –40 to +70  | –40 to +70   | –40 to +70   | –40 to +70   |
| Humidity   | % RH       | 95 at 55 °C /5–95 condensation permitted            | 95 at 55 °C /5–95 condensation permitted             | 95 at 55 °C /5–95 condensation permitted             | 95 at 55 °C /5–95 condensation permitted             |

## Machine Mount I/O Modules, continued

| Description                            | Unit         | EU1E-SWD-2DX          | EU1E-SWD-2DD          | EU2E-SWD-4DX          | EU2E-SWD-4DD          |
|--|--------------|-----------------------|-----------------------|-----------------------|-----------------------|
| <b>SmartWire-DT Network</b>            |              |                       |                       |                       |                       |
| Stations type                          |              | SmartWire-DT slave    | SmartWire-DT slave    | SmartWire-DT slave    | SmartWire-DT slave    |
| Baud rate setting                      |              | Automatic             | Automatic             | Automatic             | Automatic             |
| Maximum                                | Bit/sec      | 2 M                   | 2 M                   | 2 M                   | 2 M                   |
| SW-DT status LED                       |              | Green (625 nm)        | Green (625 nm)        | Green (625 nm)        | Green (625 nm)        |
| Connectors (IEC-61076-2-101)           | M12 A coding |                       |                       |                       |                       |
| SW-DT network input connector          |              | M12-M / 5-pole        | M12-M / 5-pole        | M12-M / 5-pole        | M12-M / 5-pole        |
| Pin 1                                  |              | 24 Vdc                | 24 Vdc                | 24 Vdc                | 24 Vdc                |
| Pin 2                                  |              | Data A                | Data A                | Data A                | Data A                |
| Pin 3                                  |              | GND                   | GND                   | GND                   | GND                   |
| Pin 4                                  |              | Data B                | Data B                | Data B                | Data B                |
| Pin 5                                  |              | SEL (IN)              | SEL (IN)              | SEL (IN)              | SEL (IN)              |
| SW-DT network output connector         |              | M12-F / 5-pole        | M12-F / 5-pole        | M12-F / 5-pole        | M12-F / 5-pole        |
| Pin 1                                  |              | 24 Vdc                | 24 Vdc                | 24 Vdc                | 24 Vdc                |
| Pin 2                                  |              | Data A                | Data A                | Data A                | Data A                |
| Pin 3                                  |              | GND                   | GND                   | GND                   | GND                   |
| Pin 4                                  |              | Data B                | Data B                | Data B                | Data B                |
| Pin 5                                  |              | SEL (OUT)             | SEL (OUT)             | SEL (OUT)             | SEL (OUT)             |
| <b>24 Vdc Power (SWD-T Bus 24 Vdc)</b> |              |                       |                       |                       |                       |
| Rated operational voltage              | V / Ue       | 24 V -15% +20%        | 24 V -15% +20%        | 24 V -15% +20%        | 24 V -15% +20%        |
| Residual ripple on the input voltage   | %            | ≤5                    | ≤5                    | ≤5                    | ≤5                    |
| Reverse Polarity Protection            |              | Yes                   | Yes                   | yes                   | yes                   |
| Rated supply current                   | mA           | 55                    | 58                    | 75                    | TBD                   |
| <b>Digital Inputs</b>                  |              |                       |                       |                       |                       |
| Input current                          | mA           | Nominal 4 at 24 Vdc   | Nominal 4 at 24 Vdc   | Nominal 4 at 24 Vdc   | Nominal 4 at 24 Vdc   |
| Voltage level to (IEC/EN 61131-2)      |              |                       |                       |                       |                       |
| Limit value type 1                     |              | L < 5 Vdc; H > 15 Vdc | L < 5 Vdc; H > 15 Vdc | L < 5 Vdc; H > 15 Vdc | L < 5 Vdc; H > 15 Vdc |
| Input delay                            |              | H->L or L->H < 0.2 ms | H->L or L->H < 0.2 ms | H->L or L->H < 0.2 ms | H->L or L->H < 0.2 ms |
| Status display                         | LED          | Yellow                | Yellow                | Yellow                | Yellow                |
| <b>Digital Outputs</b>                 |              |                       |                       |                       |                       |
| Output driver circuit power source     | Bus/Ext      | —                     | Bus                   | —                     | Bus                   |
| Output current                         | A            | —                     | 0.5 at 24 Vdc         | —                     | 0.5 at 24 Vdc         |
| Trip current SC                        | A            | —                     | 1.2 over 3 ms         | —                     | 1.2 over 3 ms         |
| Lamp load                              | W            | —                     | ≤3                    | —                     | ≤3                    |
| Overload proof (IEC/EN 61131-2)        |              | —                     | Yes w/diag            | —                     | Yes w/diag            |
| Switching capacity IEC 60947-5-1       |              | —                     | DC-13                 | —                     | DC-13                 |
| Status display                         | LED          | —                     | Yellow                | —                     | Yellow                |
| Total current all outputs              | A            | —                     | 1                     | —                     | 2                     |

## Machine Mount I/O Modules, continued

| Description                         | Unit         | EU1E-SWD-2DX      | EU1E-SWD-2DD      | EU2E-SWD-4DX      | EU2E-SWD-4DD      |
|-------------------------------------|--------------|-------------------|-------------------|-------------------|-------------------|
| <b>I/O Configurations</b>           |              |                   |                   |                   |                   |
| 24 Vdc bus power to I/O devices     | Y/N          | Yes               | Yes               | Yes               | Yes               |
| Galvanic isolation of I/O circuitry | Y/N          | No                | No                | No                | No                |
| Operating power per connection      | A            | 0.3               | 0.3               | 0.3               | 0.3               |
| Internally power limited (PTC)      | Y/N          | Yes               | Yes               | Yes               | Yes               |
| Overload threshold per connection   | A            | 0.6               | 0.6               | 0.6               | 0.6               |
| Overload recovery time              | S            | TBD               | TBD               | TBD               | TBD               |
| Maximum allowed total current       | A            | 1                 | 1                 | 2                 | 2                 |
| I/O types                           |              |                   |                   |                   |                   |
| Configurable (digital I/O)          | I/O point    |                   | 2                 | —                 | 4                 |
| Digital IN (sinking)                | I/O point    | 2                 | Up to 2           | 4                 | Up to 4           |
| Digital OUT (sourcing)              | I/O point    |                   | Up to 2           | —                 | Up to 4           |
| Analog IN                           | I/O point    |                   | —                 | —                 | —                 |
| Analog OUT                          | I/O point    |                   | —                 | —                 | —                 |
| Encoder IN                          | I/O point    |                   | —                 | —                 | —                 |
| Temperature sensor input            | I/O point    |                   | —                 | —                 | —                 |
| I/O connectors (IEC-61076-2-101)    | M12 A Coding | 1x M12-F / 5-pole | 1x M12-F / 5-pole | 2x M12-F / 5-pole | 2x M12-F / 5-pole |
| Active circuits loaded in connector | Circuits     | 4                 | 4                 | 5                 | 5                 |
| I/O connector pin outs              |              |                   |                   |                   |                   |
| I/O Connector–1                     |              |                   |                   |                   |                   |
| Pin 1                               |              | 24 Vdc            | 24 Vdc            | 24 Vdc            | 24 Vdc            |
| Pin 2                               |              | Input Ch 1        | I/O Ch 1          | In Ch 1           | I/O Ch 1          |
| Pin 3                               |              | GND               | GND               | GND               | GND               |
| Pin 4                               |              | Input Ch 0        | I/O Ch 0          | In Ch 0           | I/O Ch 0          |
| Pin 5                               |              | N/C               | N/C               | In Ch 3           | N/C               |
| Pin 6                               |              | —                 | —                 | —                 | —                 |
| Pin 7                               |              | —                 | —                 | —                 | —                 |
| Pin 8                               |              | —                 | —                 | —                 | —                 |
| I/O Connector–2                     |              |                   |                   |                   |                   |
| Pin 1                               |              | —                 | —                 | 24 Vdc            | 24 Vdc            |
| Pin 2                               |              | —                 | —                 | In Ch 3           | I/O Ch 3          |
| Pin 3                               |              | —                 | —                 | GND               | GND               |
| Pin 4                               |              | —                 | —                 | In Ch 2           | I/O Ch 2          |
| Pin 5                               |              | —                 | —                 | In Ch 1           | N/C               |

# 9.1

## Connectivity Solutions

### SmartWire-DT In-Panel and On-Machine Wiring Solution

#### SWD Accessories

| Description                                | Unit    | IP67 Tee (Single)                          | Plug/Cap                              |                                       | Cabinet Entry M12                     | Cabinet Exit M12                      | Mounting                              |                                       |
|--|---------|--|---------------------------------------|---------------------------------------|---------------------------------------|---------------------------------------|---------------------------------------|---------------------------------------|
|  |         | EU1S-SWD-PF1-2                             | SWD4-RC5-10                           | SWD4-ACAP-10                          | SWD4-SML8-12                          | SWD4-SFL8-12                          | SWD4-MNT-VER                          | SWD4-MNT-DIN                          |
| <b>General</b>                             |         |  |                                       |                                       |                                       |                                       |                                       |                                       |
| Standards                                  |         | IEC/EN 61131-2, EN50178, IEC/EN 60529      | IEC/EN 61131-2, EN50178, IEC/EN 60529 | IEC/EN 61131-2, EN50178, IEC/EN 60529 | IEC/EN 61131-2, EN50178, IEC/EN 60529 | IEC/EN 61131-2, EN50178, IEC/EN 60529 | IEC/EN 61131-2, EN50178, IEC/EN 60529 | IEC/EN 61131-2, EN50178, IEC/EN 60529 |
| Dimensions (W x H x L) reference only      | mm      | 41 x 20 X 59                               | 41 x 20 x 15                          | 13 (dia) x 20 (len)                   | 35 x 83 x 46                          | 35 x 83 x 46                          | 16.1 x 30.7 x 15.5                    | 10.2 x 43 x 19                        |
| M12 I/O connector spacing (L)              | mm      | —  | —                                     | —                                     | —                                     | —                                     | —                                     | —                                     |
| Weight                                     | g / oz  | 65 / 2.3                                   | 13 / 0.45                             | 15 / 0.525                            | TBD                                   | TBD                                   | 3.4 / 0.12                            | 6.8 / 0.24                            |
| Form factor                                |         | IP67 tee (single)                          | IP67 Bus Term                         | M12-M Overmold                        | IP20 Enclosure                        | IP20 Enclosure                        | OBO Clip                              | DIN rail clips                        |
| Enclosure material                         | Tee     | MM 6208 (black)                            | MM 6208 (black)                       | TPV                                   | —                                     | —                                     | —                                     | —                                     |
| Mounting                                   | Qty     | 2 mounting holes or with bracket accessory | Integral M12-M                        | Integral M12-M                        | Panel mount M12-M                     | Panel mount M12-F                     | Single mounting hole                  | to DIN rail                           |
| <b>Ambient Conditions, Mechanical</b>      |         |  |                                       |                                       |                                       |                                       |                                       |                                       |
| Protection type                            | Type    | IP67                                       | IP67                                  | IP67                                  | IP67                                  | IP67                                  | —                                     | —                                     |
| EN/IEC 60529                               | Type    | IP6X / IPX7                                | IP6X / IPX7                           | IP6X / IPX7                           | IP20                                  | IP20                                  | —                                     | —                                     |
| UL Type                                    |         | 1  | 1                                     | 1                                     |                                       |                                       | —                                     | —                                     |
| <b>Vibrations</b>                          |         |  |                                       |                                       |                                       |                                       |                                       |                                       |
| Displacement 3.5 mm                        | Hz      | 5–8.4                                      | 5–8.4                                 | 5–8.4                                 | 5–8.4                                 | 5–8.4                                 | 5–8.4                                 | 5–8.4                                 |
| Acceleration 1 g                           | Hz      | 8.4–150                                    | 8.4–150                               | 8.4–150                               | 8.4–150                               | 8.4–150                               | 8.4–150                               | 8.4–150                               |
| Shock IEC 60068-2-27 1/2 sine 30 g / 11 ms | Impacts | 9  | 9                                     | 9                                     | 9                                     | 9                                     | 9                                     | 9                                     |
| Drop to (height)                           | mm      | 50   | 50                                    | 50                                    | 50                                    | 50                                    | 50                                    | 50                                    |
| Drop freefall                              | m       | 0.3  | 0.3                                   | 0.3                                   | 0.3                                   | 0.3                                   | 0.3                                   | 0.3                                   |
| <b>EMC</b>                                 |         |  |                                       |                                       |                                       |                                       |                                       |                                       |
| Overvoltage category                       |         | II   | II                                    | II                                    | II                                    | II                                    | —                                     | —                                     |
| Pollution degree                           |         | 3  | 3                                     | 3                                     | 2                                     | 2                                     | —                                     | —                                     |
| <b>Electrostatic discharge</b>             |         |  |                                       |                                       |                                       |                                       |                                       |                                       |
| Air discharge (level 3)                    | kV      | 8  | 8                                     | 8                                     | 8                                     | 8                                     | —                                     | —                                     |
| Contact discharge (level 2)                | kV      | 4  | 4                                     | 4                                     | 4                                     | 4                                     | —                                     | —                                     |
| <b>Electromagnetic fields</b>              |         |  |                                       |                                       |                                       |                                       |                                       |                                       |
|  |         | Performance Criterion A                    | Performance Criterion A               | Performance Criterion A               | Performance Criterion A               | Performance Criterion A               | —                                     | —                                     |
| 80–1000 MHz                                | V/m     | 10   | 10                                    | 10                                    | 10                                    | 10                                    | —                                     | —                                     |
| 1.4–2 G                                    | V/m     | 3  | 3                                     | 3                                     | 3                                     | 3                                     | —                                     | —                                     |
| 2–2.7 G                                    | V/m     | 1  | 1                                     | 1                                     | 1                                     | 1                                     | —                                     | —                                     |

## SWD Accessories, continued

| Description  | Unit         | IP67 Tee (Single)                                   | Plug/Cap  | Cabinet Entry M12                                   |   | Cabinet Exit M12                                    | Mounting                                   |  |
|--|--------------|---|---|---|---|---|--|--|
|  |              | EU1S-SWD-PF1-2                                      | SWD4-RC5-10   | SWD4-ACAP-10  | SWD4-SML8-12  | SWD4-SFL8-12  | SWD4-MNT-VER                               | SWD4-MNT-DIN                               |
| <b>EMC, continued</b>  |              |   |   |   |   |   |  |  |
| Radio interference suppression (SmartWire-DT) (emission and conducted interface voltage) | EN55011      | Class A   | Class A   | Class A   | Class A   | Class A   | —  | —  |
| Burst (level 3)  |              | Performance Criterion B                             | Performance Criterion B                             | Performance Criterion B                             | Performance Criterion B                             | Performance Criterion B                             | —  | —  |
| Supply cables  | kV           | 2   | 2   | 2   | 2   | 2   | —  | —  |
| Signal cables  | kV           | 1   | 2   | 2   | 1   | 1   | —  | —  |
| SmartWire-DT cables  | kV           | 1   | 2   | 2   | 1   | 1   | —  | —  |
| Surge (level 1)  |              | Performance Criterion B                             | Performance Criterion B                             | Performance Criterion B                             | Performance Criterion B                             | Performance Criterion B                             | —  | —  |
| Supply cables  | kV           | 0.5   | 1   | 1   | 0.5   | 0.5   | —  | —  |
| I/O cables   | kV           | 1   | 1   | 1   | 1   | 1   | —  | —  |
| SmartWire-DT cables  | kV           | 1kV (not possible according to EN61000-6-2 Table 2) | 1kV (not possible according to EN61000-6-2 Table 2) | 1kV (not possible according to EN61000-6-2 Table 2) | 1kV (not possible according to EN61000-6-2 Table 2) | 1kV (not possible according to EN61000-6-2 Table 2) | —  | —  |
| Radiated RFI (level 3) (150 kHz–80 MHz)  |              | Performance Criterion A                             | Performance Criterion A                             | Performance Criterion A                             | Performance Criterion A                             | Performance Criterion A                             | —  | —  |
| Supply cables  | V            | 10  | 10  | 10  | 10  | 10  | —  | —  |
| I/O cables   | V            | 10  | 10  | 10  | 10  | 10  | —  | —  |
| SmartWire-DT cables  | V            | 10  | 10  | 10  | 10  | 10  | —  | —  |
| Voltage drops and interrupts   | mS           | 10  | 10  | 10  | 10  | 10  | —  | —  |
| <b>Climatic Environmental Conditions</b>   |              |   |   |   |   |   |  |  |
| Ambient temperature  | °C           | –25 to +70  | –25 to +70  | –25 to +70  | –25 to +70  | –25 to +70  | –25 to +70                                 | –25 to +70                                 |
| Storage temperature  | °C           | –40 to +70  | –40 to +70  | –40 to +70  | –40 to +70  | –40 to +70  | –40 to +70                                 | –40 to +70                                 |
| Humidity   | % RH         | 95 at 55 °C / 5–95% condensation permitted          | 95 at 55 °C / 5–95% condensation permitted          | 95 at 55 °C / 5–95% condensation permitted          | 95 at 55 °C / 5–95% condensation permitted          | 95 at 55 °C / 5–95% condensation permitted          | 95 at 55 °C / 5–95% condensation permitted | 95 at 55 °C / 5–95% condensation permitted |
| <b>SmartWire-DT Network</b>  |              |   |   |   |   |   |  |  |
| Stations type  |              | N/A   | N/A   | N/A   | N/A   | N/A   | —  | —  |
| Baud rate setting  |              |   |   |   |   |   |  |  |
| Maximum  | Bit / sec    | —   | —   | —   | —   | —   | —  | —  |
| SW-DT status LED   |              | —   | —   | —   | —   | —   | —  | —  |
| Connectors, (IEC-61076-2-101)  | M12 A coding |   |   |   |   |   |  |  |
| SW-DT network input connector  |              | 1x M12-M / 5-pole                                   | 1x M12-M / 5-pole                                   | 1x M12-M / 5-pole                                   | 1x M12-M / 5-pole                                   | 1x Lumberg (LT-307.597.1)                           | —  | —  |
| Pin 1  |              | N/C   | 24 Vdc  | 24 Vdc  | 24 Vdc  | 15 V  | —  | —  |
| Pin 2  |              | Data A  | Data A  | N/C   | Data A  | SEL   | —  | —  |
| Pin 3  |              | GND   | GND   | GND   | GND   | GND   | —  | —  |
| Pin 4  |              | Data B  | Data B  | N/C   | Data B  | Data A  | —  | —  |
| Pin 5  |              | SEL (IIN)   | SEL (IIN)   | N/C   | SEL (IIN)   | Data B  | —  | —  |
| Pin 6  |              | —   | —   | —   | —   | GND   | —  | —  |
| Pin 7  |              | —   | —   | —   | —   | 0V  | —  | —  |
| Pin 8  |              | —   | —   | —   | —   | 24 Vdc  | —  | —  |

#### SWD Accessories, continued

| Description                            | Unit         | IP67 Tee (Single) | Plug/Cap      |              | Cabinet Entry M12         | Cabinet Exit M12  | Mounting     |              |
|--|--------------|-------------------|---------------|--------------|---------------------------|-------------------|--------------|--------------|
|  |              | EU1S-SWD-PF1-2    | SWD4-RC5-10   | SWD4-ACAP-10 | SWD4-SML8-12              | SWD4-SFL8-12      | SWD4-MNT-VER | SWD4-MNT-DIN |
| <b>SmartWire-DT Network, continued</b> |              |                   |               |              |                           |                   |              |              |
| SW-DT network output connector         |              | 1x M12-F / 5-pole | —             | —            | 1x Lumberg (LT-307.597.1) | 1x M12-F / 5-pole | —            | —            |
| Pin 1                                  |              | 24 Vdc            | —             | —            | 15 V                      | 24 Vdc            | —            | —            |
| Pin 2                                  |              | Data A            | —             | —            | SEL                       | Data A            | —            | —            |
| Pin 3                                  |              | GND               | —             | —            | GND                       | GND               | —            | —            |
| Pin 4                                  |              | Data B            | —             | —            | Data A                    | Data B            | —            | —            |
| Pin 5                                  |              | SEL (OUT)         | —             | —            | Data B                    | SEL (OUT)         | —            | —            |
| Pin 6                                  |              | —                 | —             | —            | GND                       | —                 | —            | —            |
| Pin 7                                  |              | —                 | —             | —            | 0V                        | —                 | —            | —            |
| Pin 8                                  |              | —                 | —             | —            | 24 Vdc                    | —                 | —            | —            |
| SW-DT network branch connector         |              | —                 | —             | —            | —                         | —                 | —            | —            |
| Pin 1                                  |              | —                 | —             | —            | —                         | —                 | —            | —            |
| Pin 2                                  |              | —                 | —             | —            | —                         | —                 | —            | —            |
| Pin 3                                  |              | —                 | —             | —            | —                         | —                 | —            | —            |
| Pin 4                                  |              | —                 | —             | —            | —                         | —                 | —            | —            |
| Pin 5                                  |              | —                 | —             | —            | —                         | —                 | —            | —            |
| Pin 6                                  |              | —                 | —             | —            | —                         | —                 | —            | —            |
| Pin 7                                  |              | —                 | —             | —            | —                         | —                 | —            | —            |
| Pin 8                                  |              | —                 | —             | —            | —                         | —                 | —            | —            |
| <b>24 Vdc Supply (SWD4-R)</b>          |              |                   |               |              |                           |                   |              |              |
| Rated operational voltage              | V / Ue       | —                 | 24 V–15% +20% | —            | —                         | —                 | —            | —            |
| Residual ripple on the input voltage   | %            | —                 | ≤5            | —            | —                         | —                 | —            | —            |
| Reverse polarity                       |              | —                 | Yes           | —            | —                         | —                 | —            | —            |
| Rated supply current                   | mA           | —                 | 12            | —            | —                         | —                 | —            | —            |
| <b>24 Vdc Supply (PF1-2)</b>           |              |                   |               |              |                           |                   |              |              |
| Rated operational voltage              | V / Ue       | 24 V–15% +20%     | —             | —            | —                         | —                 | —            | —            |
| Residual ripple on the input voltage   | %            | ≤5                | —             | —            | —                         | —                 | —            | —            |
| Rated supply current                   | A            | 4                 | —             | —            | —                         | —                 | —            | —            |
| Connectors (IEC-61076-2-101)           | M12 A Coding | —                 | —             | —            | —                         | —                 | —            | —            |
| PF1 24 Vdc input connector             |              | 1x M12-M / 5-pole | —             | —            | —                         | —                 | —            | —            |
| Pin 1                                  |              | 24 Vdc            | —             | —            | —                         | —                 | —            | —            |
| Pin 2                                  |              | N/C               | —             | —            | —                         | —                 | —            | —            |
| Pin 3                                  |              | GND               | —             | —            | —                         | —                 | —            | —            |
| Pin 4                                  |              | N/C               | —             | —            | —                         | —                 | —            | —            |
| Pin 5                                  |              | N/C               | —             | —            | —                         | —                 | —            | —            |
| Power indicator LED                    |              | Green (625 nm)    | —             | —            | —                         | —                 | —            | —            |

SWD Accessories, continued

| Description                           | Unit         | IP67 Tee (Single) | Plug/Cap    | SWD4-ACAP-10      | Cabinet Entry M12 | Cabinet Exit M12 | Mounting     |              |
|---------------------------------------|--------------|-------------------|-------------|-------------------|-------------------|------------------|--------------|--------------|
|                                       |              | EU1S-SWD-PF1-2    | SWD4-RC5-10 |                   | SWD4-SML8-12      | SWD4-SFL8-12     | SWD4-MNT-VER | SWD4-MNT-DIN |
| <b>Active Cap (-ACAP-10)</b>          |              |                   |             |                   |                   |                  |              |              |
| Rated operational voltage             | V / Ue       | —                 | —           | 24 V-15% +20%     | —                 | —                | —            | —            |
| Reverse polarity                      |              | —                 | —           | N/A               | —                 | —                | —            | —            |
| Rated supply current                  | mA           | —                 | —           | ≥1 mA             | —                 | —                | —            | —            |
| Connectors (IEC-61076-2-101)          | M12 A Coding | —                 | —           | —                 | —                 | —                | —            | —            |
| Active cap M12-M                      |              | —                 | —           | 1x M12-M / 2 Pole | —                 | —                | —            | —            |
| Pin 1                                 |              | —                 | —           | 24 Vdc            | —                 | —                | —            | —            |
| Pin 2                                 |              | —                 | —           | N/C               | —                 | —                | —            | —            |
| Pin 3                                 |              | —                 | —           | GND               | —                 | —                | —            | —            |
| Pin 4                                 |              | —                 | —           | N/C               | —                 | —                | —            | —            |
| Pin 5                                 |              | —                 | —           | N/C               | —                 | —                | —            | —            |
| Parameter                             |              |                   |             |                   |                   |                  |              |              |
| Diagnostic per M12 I/O connector      |              | —                 | —           | On/Off            | —                 | —                | —            | —            |
| <b>15 Vdc supply (to flat cable)</b>  |              |                   |             |                   |                   |                  |              |              |
| Rated operational voltage             | V / Ue       | —                 | —           | —                 | 14.5 V +/-3%      | —                | —            | —            |
| Residual ripple on the input voltage  | %            | —                 | —           | —                 | ≤5                | —                | —            | —            |
| Short circuit protection              |              | —                 | —           | —                 | Yes               | —                | —            | —            |
| Output power                          | mA           | —                 | —           | —                 | 120               | —                | —            | —            |
| <b>24 Vdc OUT (Push in Terminals)</b> |              |                   |             |                   |                   |                  |              |              |
| Rated operational voltage             | V / Ue       | —                 | —           | —                 | 24 V              | 24 V             | —            | —            |
| Short circuit protection              |              | —                 | —           | —                 | No                | No               | —            | —            |
| Connectors                            |              |                   |             |                   |                   |                  |              |              |
| 24 V OUT 1                            |              | —                 | —           | —                 | LSF-SMT3.5        | LSF-SMT3.5       | —            | —            |
| Pin 1                                 |              | —                 | —           | —                 | 24 Vdc            | 24 Vdc           | —            | —            |
| Pin 2                                 |              | —                 | —           | —                 | 0 V               | 0 V              | —            | —            |
| 24 V OUT 2                            |              | —                 | —           | —                 | LSF-SMT3.5        | —                | —            | —            |
| Pin 1                                 |              | —                 | —           | —                 | 24 Vdc            | —                | —            | —            |
| Pin 2                                 |              | —                 | —           | —                 | 0 V               | —                | —            | —            |
| <b>24 Vdc IN (Push in Terminals)</b>  |              |                   |             |                   |                   |                  |              |              |
| Rated operational voltage             | V / Ue       | —                 | —           | —                 | —                 | 24 Vdc -15%/+20% | —            | —            |
| Residual ripple on the input voltage  | %            | —                 | —           | —                 | —                 | ≤5               | —            | —            |
| Reverse polarity protection           |              | —                 | —           | —                 | —                 | Yes              | —            | —            |
| Rated current                         | A            | —                 | —           | —                 | —                 | 4                | —            | —            |
| Short circuit protection              |              | —                 | —           | —                 | —                 | No               | —            | —            |
| Connectors                            |              |                   |             |                   |                   |                  |              |              |
| 24 V IN 1                             |              | —                 | —           | —                 | —                 | LSF-SMT3.5       | —            | —            |
| Pin 1                                 |              | —                 | —           | —                 | —                 | 24 Vdc           | —            | —            |
| Pin 2                                 |              | —                 | —           | —                 | —                 | 0 V              | —            | —            |



## Contactors Modules

| Description   | Unit       | DIL-SWD-32-001                             | DIL-SWD-32-002                             | PKE-SWD-32                                 |
|---|------------|--|--|--|
| <b>General</b>  |            |  |  |  |
| Standards   |            | IEC/EN 61131-2<br>EN 50178<br>IEC/EN 60947 | IEC/EN 61131-2<br>EN 50178<br>IEC/EN 60947 | IEC/EN 61131-2<br>EN 50178<br>IEC/EN 60947 |
| Dimensions (W x H x D)  | in<br>(mm) | 1.77 x 1.50 x 3.0<br>(45 x 38 x 76)        | 1.77 x 1.50 x 3.0<br>(45 x 38 x 76)        | 1.77 x 1.50 x 3.0<br>(45 x 38 x 76)        |
| Weight  | lbs (kg)   | 0.9 (0.04)                                 | 0.9 (0.04)                                 | 0.9 (0.04)                                 |
| Mounting  |            | on XTCE007–XTCE032                         | on XTCE007–XTCE032                         | —  |
| Mounting position   |            | as XTCE007–XTCE032                         | as XTCE007–XTCE032                         | —  |
| <b>Ambient Conditions, Mechanical</b>   |            |  |  |  |
| Degree of protection (IEC/EN 60529)   |            | IP20                                       | IP20                                       | —  |
| Vibrations (IEC/EN 61131-2:2008)  |            |  |  |  |
| Constant amplitude 3.5 mm   | Hz         | 5–8.4                                      | 5–8.4                                      | 5–8.4                                      |
| Constant acceleration 1 g   | Hz         | 8.4–150                                    | 8.4–150                                    | 8.4–150                                    |
| Mechanical shock resistance (IEC/EN 60068-2-27)<br>semi-sinusoidal 15 g/11 ms | Impacts    | 9  | 9  | 9  |
| Drop to IEC/EN 60068-2-31 (drop height)                                       | in (mm)    | 1.97 (50)                                  | 1.97 (50)                                  | 1.97 (50)                                  |
| Free fall, packaged (IEC/EN 60068-2-32)                                       | ft (m)     | 1.0 (0.3)                                  | 1.0 (0.3)                                  | 1.0 (0.3)                                  |
| <b>Electromagnetic Compatibility (EMC)</b>                                    |            |  |  |  |
| Overvoltage category  |            | II   | II   | II   |
| Pollution degree  |            | 2  | 2  | 2  |
| Electrostatic discharge (IEC/EN 61131-2:2008)                                 |            |  |  |  |
| Air discharge (Level 3)   | kV         | 8  | 8  | 8  |
| Contact discharge (Level 2)   | kV         | 4  | 4  | 4  |
| Electromagnetic fields (IEC/EN 61131-2:2008)                                  |            |  |  |  |
| 80–1000 MHz   | V/m        | 10   | 10   | 10   |
| 1.4–2 GHz   | V/m        | 3  | 3  | 3  |
| 2–2.7 GHz   | V/m        | 1  | 1  | 1  |
| Radio interference suppression (SmartWire-DT)                                 |            | EN 55011 Class A                           | EN 55011 Class A                           | EN 55011 Class A                           |
| Burst (IEC/EN 61131-2:2008, Level 3)  |            |  |  |  |
| CAN/DP bus cable  | kV         | 1  | 1  | 1  |
| SmartWire-DT cables   | kV         | 1  | 1  | 1  |
| Radiated RFI (IEC/EN 61131-2:2008, Level 3)                                   | V          | 10   | 10   | 10   |
| <b>Climatic Environmental Conditions</b>                                      |            |  |  |  |
| Operating ambient temperature (IEC 60068-2)                                   | °F (°C)    | –13° to 140° (–25° to 60°)                 | –13° to 140° (–25° to 60°)                 | –13° to 140° (–25° to 60°)                 |
| Condensation  |            | Prevent with suitable measures             | Prevent with suitable measures             | Prevent with suitable measures             |
| Storage   | °F (°C)    | –22° to 158° (–30° to 70°)                 | –22° to 158° (–30° to 70°)                 | –22° to 158° (–30° to 70°)                 |
| Relative humidity, noncondensing (IEC/EN 60068-2-30)                          | %          | 5–95                                       | 5–95                                       | 5–95                                       |

## Contactor Modules, continued

| Description                           | Unit            | DIL-SWD-32-001                   | DIL-SWD-32-002                   | PKE-SWD-32                       |
|---------------------------------------|-----------------|----------------------------------|----------------------------------|----------------------------------|
| <b>SmartWire-DT Network</b>           |                 |                                  |                                  |                                  |
| Station type                          |                 | SmartWire-DT station (mode)      | SmartWire-DT station (mode)      | SmartWire-DT (slave)             |
| Address allocation                    |                 | Automatic                        | Automatic                        | Automatic                        |
| SmartWire-DT status LED               |                 | Green/orange                     | Green/orange                     | Green/orange                     |
| Connections                           |                 |                                  |                                  |                                  |
| Plug                                  |                 | 8-pole                           | 8-pole                           | 8-pole                           |
| Plug connectors                       |                 | External device plug SWD4-8SF2-5 | External device plug SWD4-8SF2-5 | External device plug SWD4-8SF2-5 |
| Current consumption (15 V SWD supply) |                 | See <b>Page V7-T9-61</b>         | See <b>Page V7-T9-61</b>         | See <b>Page V7-T9-61</b>         |
| <b>Mode Parameter</b>                 |                 |                                  |                                  |                                  |
| Manual/automatic mode                 |                 | No                               | Yes                              | Yes                              |
| Setting                               |                 | —                                | Rotary switch                    | Rotary switch                    |
| <b>Connection Auxiliary Contact</b>   |                 |                                  |                                  |                                  |
| Number                                |                 | 2                                | 2                                | —                                |
| Rated voltage ( $U_p$ ) <sup>①</sup>  | Vdc             | 15                               | 15                               | —                                |
| Input current at 1 signal, typical    | mA              | 3                                | 3                                | —                                |
| Potential isolation                   |                 | No                               | No                               | —                                |
| Cable length                          | ft (m)          | ≤9.2 (2.8)                       | ≤9.2 (2.8)                       | ≤9.2 (2.8)                       |
| Connection type                       |                 | Push in terminals                | Push in terminals                | Push in terminals                |
| <b>Terminal Capacities</b>            |                 |                                  |                                  |                                  |
| Solid                                 | mm <sup>2</sup> | 0.2–1.5 (AWG 24–16)              | 0.2–1.5 (AWG 24–16)              | 0.2–1.5 (AWG 24–16)              |
| Flexible with ferrule <sup>②</sup>    | mm <sup>2</sup> | 0.25–1.5                         | 0.25–1.5                         | 0.25–1.5                         |

**Notes**

① Own supply.

② Minimum length: 8 mm.

## Pilot Device Modules

| Description  | Unit       | M22-SWD-K11                          | M22-SWD-KC11                         | M22-SWD-LED_                         | M22-SWD-LEDC_                        | M22-SWD-K11-LED_                     |
|--|------------|--------------------------------------|--------------------------------------|--------------------------------------|--------------------------------------|--------------------------------------|
| <b>General</b>   |            |                                      |                                      |                                      |                                      |                                      |
| Standards  |            | IEC/EN 61131-2<br>EN 50178           | IEC/EN 61131-2<br>EN 50178           | IEC/EN 61131-2<br>EN 50178           | IEC/EN 61131-2<br>EN 50178           | IEC/EN 61131-2<br>EN 50178           |
| Dimensions (W x H x D)   | in<br>(mm) | 0.47 x 1.65 x 1.54<br>(12 x 42 x 39) | 0.47 x 1.77 x 1.46<br>(12 x 45 x 37) | 0.39 x 1.65 x 1.77<br>(10 x 42 x 45) | 0.39 x 1.77 x 1.65<br>(10 x 45 x 42) | 0.47 x 1.65 x 1.77<br>(12 x 42 x 45) |
| Weight   | lbs (g)    | 0.022 (10)                           | 0.022 (10)                           | 0.022 (10)                           | 0.022 (10)                           | 0.022 (10)                           |
| Mounting position  |            | As required                          | As required                          | As required                          | As required                          | As required                          |
| <b>Ambient Conditions, Mechanical</b>                                      |            |                                      |                                      |                                      |                                      |                                      |
| Degree of protection (IEC/EN 60529)  |            | IP20                                 | IP20                                 | IP20                                 | IP20                                 | IP20                                 |
| Vibrations (IEC/EN 61131-2:2008)   |            |                                      |                                      |                                      |                                      |                                      |
| Constant amplitude 3.5 mm  | Hz         | 5–8.4                                | 5–8.4                                | 5–8.4                                | 5–8.4                                | 5–8.4                                |
| Constant acceleration 1 g  | Hz         | 8.4–150                              | 8.4–150                              | 8.4–150                              | 8.4–150                              | 8.4–150                              |
| Mechanical shock resistance (IEC/EN 60068-2-27) semi-sinusoidal 15 g/11 ms |            |                                      |                                      |                                      |                                      |                                      |
| Drop to IEC/EN 60068-2-31 (drop height)                                    | in (mm)    | 1.97 (50)                            | 1.97 (50)                            | 1.97 (50)                            | 1.97 (50)                            | 1.97 (50)                            |
| Free fall, packaged (IEC/EN 60068-2-32)                                    | ft (m)     | 1.0 (0.3)                            | 1.0 (0.3)                            | 1.0 (0.3)                            | 1.0 (0.3)                            | 1.0 (0.3)                            |
| <b>Electromagnetic Compatibility (EMC)</b>                                 |            |                                      |                                      |                                      |                                      |                                      |
| Overvoltage category   |            | Not applicable                       | Not applicable                       | Not applicable                       | Not applicable                       | Not applicable                       |
| Pollution degree   |            | 2                                    | 2                                    | 2                                    | 2                                    | 2                                    |
| Electrostatic discharge (IEC/EN 61131-2:2008)                              |            |                                      |                                      |                                      |                                      |                                      |
| Air discharge (Level 3)  | kV         | 8                                    | 8                                    | 8                                    | 8                                    | 8                                    |
| Contact discharge (Level 2)  | kV         | 4                                    | 4                                    | 4                                    | 4                                    | 4                                    |
| Electromagnetic fields (IEC/EN 61131-2:2008)                               |            |                                      |                                      |                                      |                                      |                                      |
| 80–1000 MHz  | V/m        | 10                                   | 10                                   | 10                                   | 10                                   | 10                                   |
| 1.4–2 GHz  | V/m        | 3                                    | 3                                    | 3                                    | 3                                    | 3                                    |
| 2–2.7 GHz  | V/m        | 1                                    | 1                                    | 1                                    | 1                                    | 1                                    |
| Radio interference suppression (SmartWire-DT)                              |            | EN 55011 Class A                     | EN 55011 Class A                     | EN 55011 Class A                     | EN 55011 Class A                     | EN 55011 Class A                     |
| Burst (IEC/EN 61131-2:2008, Level 3)                                       |            |                                      |                                      |                                      |                                      |                                      |
| Supply cables  | kV         | 2                                    | 2                                    | 2                                    | 2                                    | 2                                    |
| SmartWire-DT cables  | kV         | 1                                    | 1                                    | 1                                    | 1                                    | 1                                    |
| Radiated RFI (IEC/EN 61131-2:2008, Level 3)                                | V          | 10                                   | 10                                   | 10                                   | 10                                   | 10                                   |
| <b>Climatic Environmental Conditions</b>                                   |            |                                      |                                      |                                      |                                      |                                      |
| Operating ambient temperature (IEC 60068-2)                                | °F (°C)    | –22° to 131° (–30° to 55°)           | –22° to 131° (–30° to 55°)           | –22° to 131° (–30° to 55°)           | –22° to 131° (–30° to 55°)           | –22° to 131° (–30° to 55°)           |
| Condensation   |            | Prevent with suitable measures       |                                      |                                      |                                      |                                      |
| Storage  | °F (°C)    | –40° to 176° (–40° to 80°)           | –40° to 176° (–40° to 80°)           | –40° to 176° (–40° to 80°)           | –40° to 176° (–40° to 80°)           | –40° to 176° (–40° to 80°)           |
| Relative humidity, noncondensing (IEC/EN 60068-2-30)                       | %          | 9–95                                 | 9–95                                 | 9–95                                 | 9–95                                 | 9–95                                 |
| <b>SmartWire-DT Network</b>  |            |                                      |                                      |                                      |                                      |                                      |
| Station type   |            | SmartWire-DT station (node)          |                                      |                                      |                                      |                                      |
| Address allocation   |            | Automatic                            | Automatic                            | Automatic                            | Automatic                            | Automatic                            |
| SmartWire-DT status LED  |            | Green                                | Green                                | Green                                | Green                                | Green                                |
| Connections  |            |                                      |                                      |                                      |                                      |                                      |
| Plug   |            | 8-pole                               | 8-pole                               | 8-pole                               | 8-pole                               | 8-pole                               |
| Plug connectors  |            | SWD4-8SF2-5                          | M22-SWD-I_LP                         | SWD4-8SF2-5                          | M22-SWD-I_LP                         | SWD4-8SF2-5                          |
| Number of insertion cycles   |            | ≥50                                  | ≥50                                  | ≥50                                  | ≥50                                  | ≥50                                  |
| Current consumption (15 V SWD supply)                                      |            | See <b>Page V7-T9-61</b>             | See <b>Page V7-T9-61</b>             | See <b>Page V7-T9-61</b>             | See <b>Page V7-T9-61</b>             | See <b>Page V7-T9-61</b>             |
| <b>Function Element</b>  |            |                                      |                                      |                                      |                                      |                                      |
| Contacts   |            | 1 changeover contact                 | 1 changeover contact                 | —                                    | —                                    | 1 changeover contact                 |
| Lifespan mechanical/electrical (operations)                                |            | 1 x 10 <sup>6</sup>                  | 1 x 10 <sup>6</sup>                  | —                                    | —                                    | 1 x 10 <sup>6</sup>                  |
| LED display  |            | No                                   | No                                   | Yes                                  | Yes                                  | Yes                                  |
| Diagnostics  |            | Yes                                  | Yes                                  | No                                   | No                                   | Yes                                  |
| Mounting   |            | Front mount                          | Base mount                           | Front mount                          | Base mount                           | Front mount                          |

## Pilot Device Modules, continued

| Description  | Unit       | M22-SWD-K11LEDC_                     | M22-SWD-K22                          | M22-SWD-KC22                         | M22-SWD-K22-LED_                     | M22-SWD-K22LEDC_                     |
|--|------------|--------------------------------------|--------------------------------------|--------------------------------------|--------------------------------------|--------------------------------------|
| <b>General</b>   |            |                                      |                                      |                                      |                                      |                                      |
| Standards  |            | IEC/EN 61131-2<br>EN 50178           | IEC/EN 61131-2<br>EN 50178           | IEC/EN 61131-2<br>EN 50178           | IEC/EN 61131-2<br>EN 50178           | IEC/EN 61131-2<br>EN 50178           |
| Dimensions (W x H x D)   | in<br>(mm) | 0.47 x 1.77 x 1.65<br>(12 x 45 x 42) | 0.67 x 1.65 x 1.54<br>(17 x 42 x 39) | 0.67 x 1.77 x 1.46<br>(17 x 45 x 37) | 0.67 x 1.65 x 1.77<br>(17 x 42 x 45) | 0.67 x 1.77 x 1.65<br>(17 x 45 x 42) |
| Weight   | lbs (g)    | 0.022 (10)                           | 0.030 (14)                           | 0.030 (14)                           | 0.030 (14)                           | 0.030 (14)                           |
| Mounting position  |            | As required                          | As required                          | As required                          | As required                          | As required                          |
| <b>Ambient Conditions, Mechanical</b>  |            |                                      |                                      |                                      |                                      |                                      |
| Degree of protection (IEC/EN 60529)  |            | IP20                                 | IP20                                 | IP20                                 | IP20                                 | IP20                                 |
| Vibrations (IEC/EN 61131-2:2008)   |            |                                      |                                      |                                      |                                      |                                      |
| Constant amplitude 3.5 mm  | Hz         | 5–8.4                                | 5–8.4                                | 5–8.4                                | 5–8.4                                | 5–8.4                                |
| Constant acceleration 1 g  | Hz         | 8.4–150                              | 8.4–150                              | 8.4–150                              | 8.4–150                              | 8.4–150                              |
| Mechanical shock resistance<br>(IEC/EN 60068-2-27) semi-sinusoidal<br>15 g/11 ms | Impacts    | 9                                    | 9                                    | 9                                    | 9                                    | 9                                    |
| Drop to IEC/EN 60068-2-31 (drop height)  | in (mm)    | 1.97 (50)                            | 1.97 (50)                            | 1.97 (50)                            | 1.97 (50)                            | 1.97 (50)                            |
| Free fall, packaged (IEC/EN 60068-2-32)  | ft (m)     | 1.0 (0.3)                            | 1.0 (0.3)                            | 1.0 (0.3)                            | 1.0 (0.3)                            | 1.0 (0.3)                            |
| <b>Electromagnetic Compatibility (EMC)</b>                                       |            |                                      |                                      |                                      |                                      |                                      |
| Overvoltage category   |            | Not applicable                       | Not applicable                       | Not applicable                       | Not applicable                       | Not applicable                       |
| Pollution degree   |            | 2                                    | 2                                    | 2                                    | 2                                    | 2                                    |
| Electrostatic discharge (IEC/EN 61131-2:2008)                                    |            |                                      |                                      |                                      |                                      |                                      |
| Air discharge (Level 3)  | kV         | 8                                    | 8                                    | 8                                    | 8                                    | 8                                    |
| Contact discharge (Level 2)  | kV         | 4                                    | 4                                    | 4                                    | 4                                    | 4                                    |
| Electromagnetic fields (IEC/EN 61131-2:2008)                                     |            |                                      |                                      |                                      |                                      |                                      |
| 80–1000 MHz  | V/m        | 10                                   | 10                                   | 10                                   | 10                                   | 10                                   |
| 1.4–2 GHz  | V/m        | 3                                    | 3                                    | 3                                    | 3                                    | 3                                    |
| 2–2.7 GHz  | V/m        | 1                                    | 1                                    | 1                                    | 1                                    | 1                                    |
| Radio interference suppression (SmartWire-DT)                                    |            | EN 55011 Class A                     | EN 55011 Class A                     | EN 55011 Class A                     | EN 55011 Class A                     | EN 55011 Class A                     |
| Burst (IEC/EN 61131-2:2008, Level 3)   |            |                                      |                                      |                                      |                                      |                                      |
| Supply cables  | kV         | 2                                    | 2                                    | 2                                    | 2                                    | 2                                    |
| SmartWire-DT cables  | kV         | 1                                    | 1                                    | 1                                    | 1                                    | 1                                    |
| Radiated RFI (IEC/EN 61131-2:2008, Level 3)                                      | V          | 10                                   | 10                                   | 10                                   | 10                                   | 10                                   |
| <b>Climatic Environmental Conditions</b>   |            |                                      |                                      |                                      |                                      |                                      |
| Operating ambient temperature (IEC 60068-2)                                      | ° F (°C)   | –22° to 131° (–30° to 55°)           | –22° to 131° (–30° to 55°)           | –22° to 131° (–30° to 55°)           | –22° to 131° (–30° to 55°)           | –22° to 131° (–30° to 55°)           |
| Condensation   |            | Prevent with suitable measures       |                                      |                                      |                                      |                                      |
| Storage  | ° F (°C)   | –40° to 176° (–40° to 80°)           | –40° to 176° (–40° to 80°)           | –40° to 176° (–40° to 80°)           | –40° to 176° (–40° to 80°)           | –40° to 176° (–40° to 80°)           |
| Relative humidity, noncondensing<br>(IEC/EN 60068-2-30)                          | %          | 9–95                                 | 5–95                                 | 5–95                                 | 5–95                                 | 5–95                                 |
| <b>SmartWire-DT Network</b>  |            |                                      |                                      |                                      |                                      |                                      |
| Station type   |            | SmartWire-DT station (node)          |                                      |                                      |                                      |                                      |
| Address allocation   |            | Automatic                            | Automatic                            | Automatic                            | Automatic                            | Automatic                            |
| SmartWire-DT status LED  |            | Green                                | Green                                | Green                                | Green                                | Green                                |
| Connections  |            |                                      |                                      |                                      |                                      |                                      |
| Plug   |            | 8-pole                               | 8-pole                               | 8-pole                               | 8-pole                               | 8-pole                               |
| Plug connectors  |            | M22-SWD-I_LP                         | SWD4-8SF2-5                          | M22-SWD-I_LP                         | SWD4-8SF2-5                          | M22-SWD-I_LP                         |
| Number of insertion cycles   |            | ≥50                                  | ≥50                                  | ≥50                                  | ≥50                                  | ≥50                                  |
| Current consumption (15 V SWD supply)  |            | See <b>Page V7-T9-61</b>             | See <b>Page V7-T9-61</b>             | See <b>Page V7-T9-61</b>             | See <b>Page V7-T9-61</b>             | See <b>Page V7-T9-61</b>             |
| <b>Function Element</b>  |            |                                      |                                      |                                      |                                      |                                      |
| Contacts   |            | 1 contact                            | 2 contacts                           | 2 contacts                           | 2 contacts                           | 2 contacts                           |
| Lifespan mechanical/electrical (operations)                                      |            | 1 x 10 <sup>6</sup>                  | 1 x 10 <sup>6</sup>                  | 1 x 10 <sup>6</sup>                  | 1 x 10 <sup>6</sup>                  | 1 x 10 <sup>6</sup>                  |
| LED display  |            | Yes                                  | No                                   | No                                   | Yes                                  | Yes                                  |
| Diagnostics  |            | Yes                                  | Yes                                  | Yes                                  | Yes                                  | Yes                                  |
| Mounting   |            | Base mount                           | Front mount                          | Base mount                           | Front mount                          | Base mount                           |

**Stacklight Modules—SL4/SL7 Series****SL4/SL7 General Specifications**

| Description   | Specification  |
|---|--|
| Standards   | IEC/EN 60947-5-1   |
| Lens color  | Blue, green, red, clear, yellow, amber   |
| Number of signal elements                           | Max. 5 with standard base<br>Max. 10 with base for mounting on both sides      |
| <b>Mechanical Ratings</b>                           |  |
| Shock (IEC 68-2-27)                                 | 11 ms, 15g   |
| Vibration (IEC 68-2-6)                              | 20 sweeps 10–150 Hz, 1g  |
| <b>Climate Conditions</b>                           |  |
| Climatic proofing                                   | Damp heat, constant, to IEC 60068-2-78<br>Damp heat, cyclic, to IEC 60069-2-30 |
| Operating temperature                               | –22° to +140°F (–30° to +60°C)   |
| Storage temperature                                 | –22° to +185°F (–30° to +85°C)   |
| <b>Environmental Ratings</b>                        |  |
| IEC degree of protection                            | UL Type 4/4X/13, IP66<br>IEC/EN 60529  |
| Protection type UL                                  | Type 4/4X/13   |
| <b>Materials</b>                                    |  |
| Cover   | Polycarbonate  |
| Lenses  | Polycarbonate  |
| Stacklight base                                     | Polycarbonate  |
| Tubes   | Aluminum   |
| <b>Terminal Capacity</b>                            |  |
| Solid or flexible conductor                         | 0.13–2.5 mm <sup>2</sup>   |
| Flexible with ferrule with plastic collar           | 0.25–1.5 mm <sup>2</sup><br>AWG 24–AWG 14                                      |
| <b>Contacts</b>                                     |  |
| Rated impulse withstand voltage (U <sub>imp</sub> ) | 4000 Vac   |
| Rated insulation voltage (U <sub>i</sub> )          | 250V   |
| Overvoltage category/pollution degree               | III/3  |

**Current Consumption Ratings****Power Consumption/Current Consumption  
24 Vdc Control Voltage  $U_{AUX}$** 

| Description            | Unit | DIL-SWD-32-__ |
|------------------------|------|---------------|
| <b>Pick-Up Power</b>   |      |               |
| For XTCE007–XTCE009    | W    | 3             |
| For XTCE012–XTCE015    | W    | 4,5           |
| For XTCE018–XTCE032    | W    | 12            |
| <b>Pick-Up Current</b> |      |               |
| For XTCE007–XTCE009    | mA   | 125           |
| For XTCE012–XTCE015    | mA   | 188           |
| For XTCE018–XTCE032    | mA   | 500           |
| <b>Holding Power</b>   |      |               |
| For XTCE007–XTCE009    | W    | 3             |
| For XTCE012–XTCE015    | W    | 4,5           |
| For XTCE018–XTCE032    | W    | 0,5           |
| <b>Holding Current</b> |      |               |
| For XTCE007–XTCE009    | mA   | 125           |
| For XTCE012–XTCE015    | mA   | 188           |
| For XTCE018–XTCE032    | mA   | 21            |

**Current Consumption 15 Vdc Supply Voltage**

| Catalog Number    | Current Consumption (mA) | Catalog Number    | Current Consumption (mA) |
|-------------------|--------------------------|-------------------|--------------------------|
| DIL-SWD-32-001    | 40                       | M22-SWD-K22       | 7                        |
| DIL-SWD-32-002    | 40                       | M22-SWD-K22LED-B  | 19                       |
| EU5E-SWD-4D2R     | 45                       | M22-SWD-K22LED-G  | 19                       |
| EU5E-SWD-4D4D     | 45                       | M22-SWD-K22LED-R  | 19                       |
| EU5E-SWD-8DX      | 12                       | M22-SWD-K22LED-W  | 19                       |
| M22-SWD-I1-LP01 ① | 17                       | M22-SWD-K22LEDC-B | 19                       |
| M22-SWD-I2-LP01 ① | 17                       | M22-SWD-K22LEDC-G | 19                       |
| M22-SWD-I3-LP01 ① | 17                       | M22-SWD-K22LEDC-R | 19                       |
| M22-SWD-I4-LP01 ① | 17                       | M22-SWD-K22LEDC-W | 19                       |
| M22-SWD-I6-LP01 ① | 17                       | M22-SWD-KC11      | 7                        |
| M22-SWD-K11       | 7                        | M22-SWD-KC22      | 7                        |
| M22-SWD-K11LED-B  | 19                       | M22-SWD-LED-B     | 19                       |
| M22-SWD-K11LED-G  | 19                       | M22-SWD-LED-G     | 19                       |
| M22-SWD-K11LED-R  | 19                       | M22-SWD-LED-R     | 19                       |
| M22-SWD-K11LED-W  | 19                       | M22-SWD-LED-W     | 19                       |
| M22-SWD-K11LEDC-B | 19                       | M22-SWD-LEDC-B    | 19                       |
| M22-SWD-K11LEDC-G | 19                       | M22-SWD-LEDC-G    | 19                       |
| M22-SWD-K11LEDC-R | 19                       | M22-SWD-LEDC-R    | 19                       |
| M22-SWD-K11LEDC-W | 19                       | M22-SWD-LEDC-W    | 19                       |
|                   |                          | SWD4-RC8-10       | 17                       |

**Note**

① With terminating resistor switched on.

# 9.1

## Connectivity Solutions

### SmartWire-DT In-Panel and On-Machine Wiring Solution

#### Dimensions

Approximate Dimensions in Inches (mm)

#### Gateways

##### EU5C-SWD\_

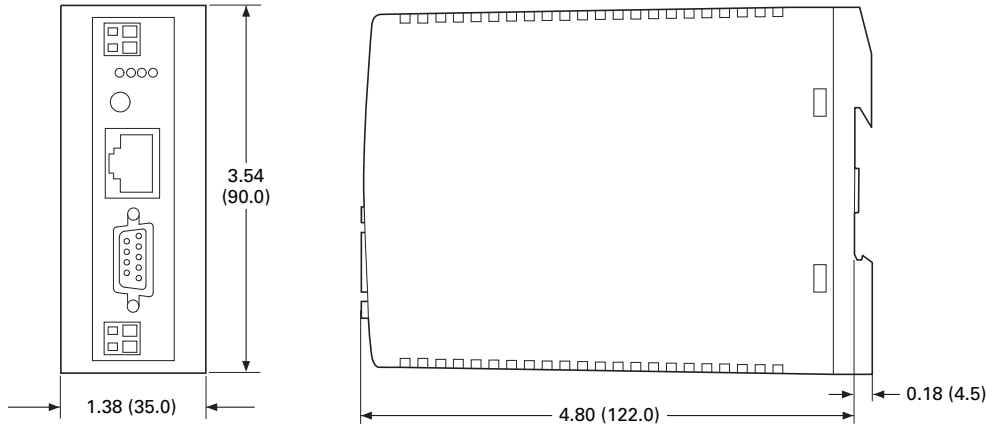

#### Powerfeed Modules

##### EU5C-SWD-PF\_

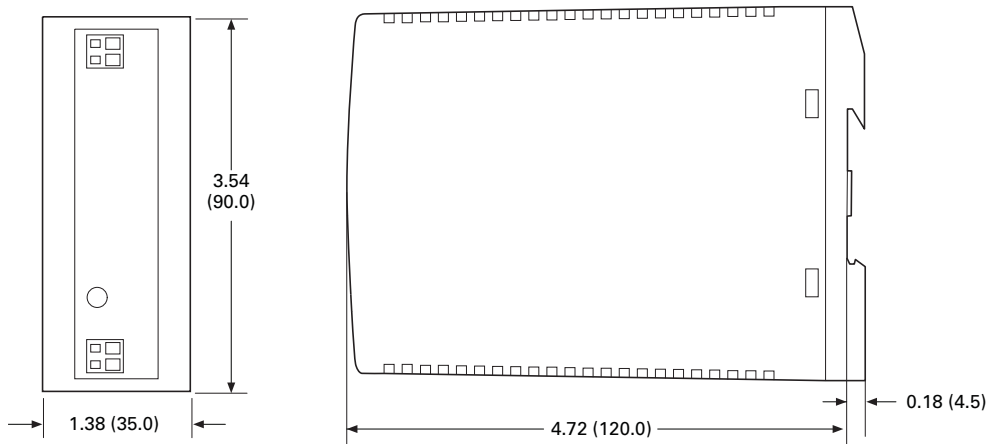

#### I/O Modules

##### EU5E-SWD\_

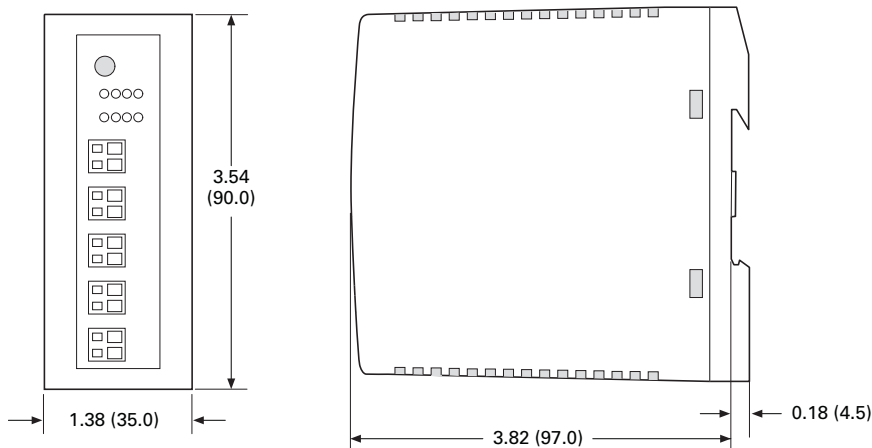

Approximate Dimensions in Inches (mm)

### Terminating Resistor

**SWD4-RC8-10**

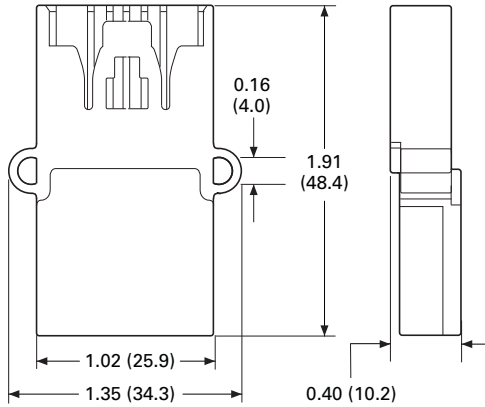

### Coupling

**SWD4-8SFF2-5**

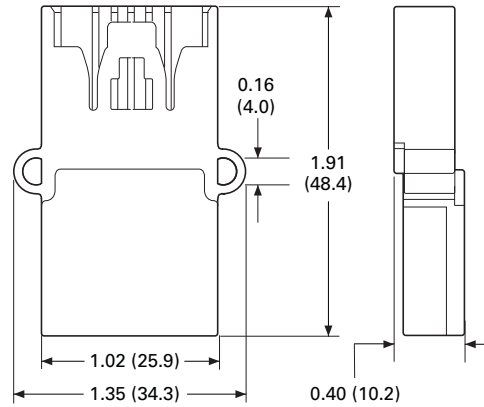

### Enclosure Bushing Plug

**SWD4-SM8-20**

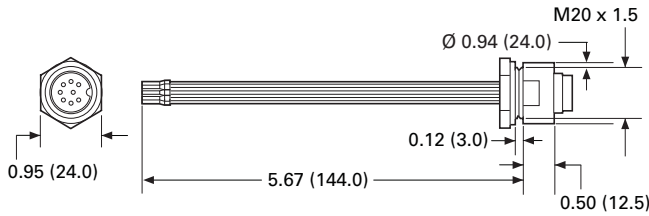

### Enclosure Bushing Socket

**SWD4-SF8-20**

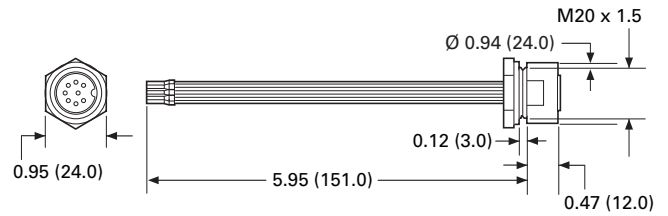

### Cabinet Cable Adapter Plug

**SWD4-SML8-20**

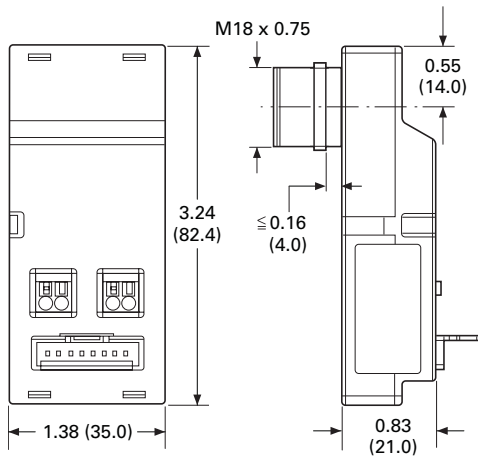

### Cabinet Cable Adapter Socket

**SWD4-SFL8-20**

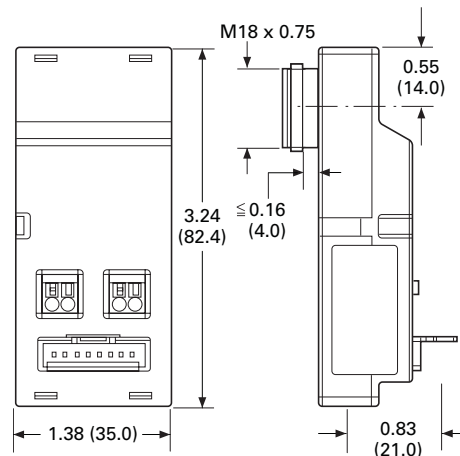



# 9.1

## Connectivity Solutions

### SmartWire-DT In-Panel and On-Machine Wiring Solution

Approximate Dimensions in Inches (mm)

#### Panel Cable Adapter

SWD4-8FRF-10

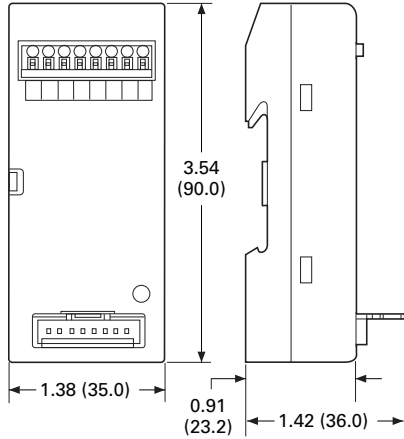

#### Round Cable Socket

SWD4-SF8-67

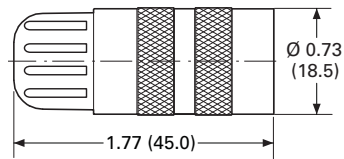

#### Round Cable Plug

SWD4-SM8-67

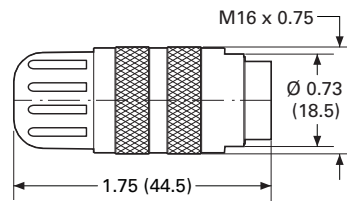

#### Right Angle Round Cable Socket

SWD4-SF8-67W

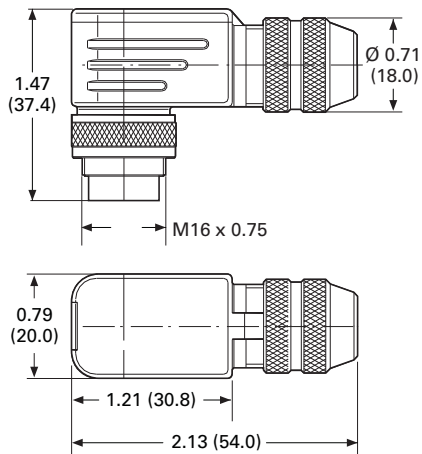

#### Right Angle Round Cable Plug

SWD4-SM8-67W

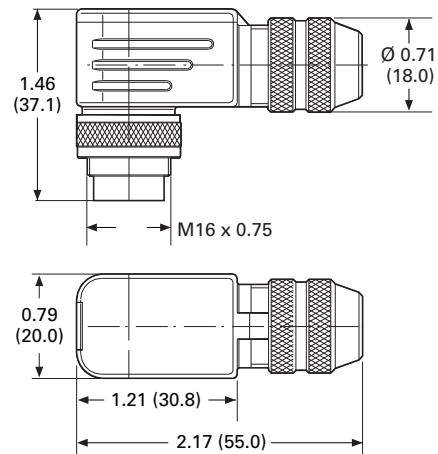

Approximate Dimensions in Inches (mm)

**Contactor Modules**

**DIL-SWD-32-001 and DIL-SWD-32-002**

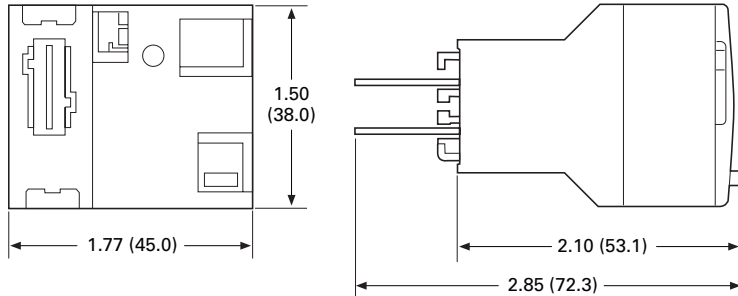

**SmartWire-DT PKE Modules**

**PKE-SWD-32**

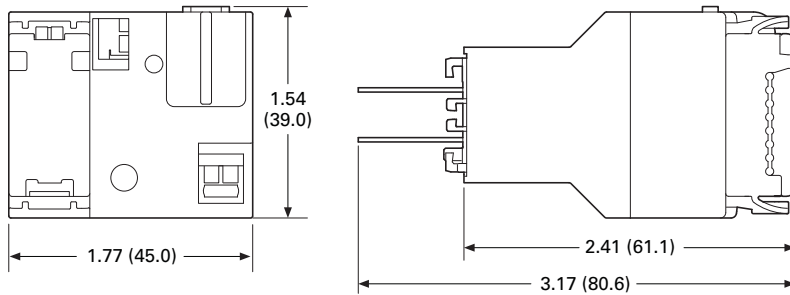

**Pilot Device Modules**

**M22-SWD-K\_, M22-SWD-LED\_**

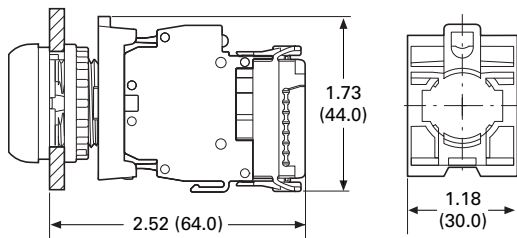

# 9.1

## Connectivity Solutions

### SmartWire-DT In-Panel and On-Machine Wiring Solution

Approximate Dimensions in Inches (mm)

#### Stacklight Modules

##### SL7-SWD, SL4-SWD

###### SL7-FMS-...

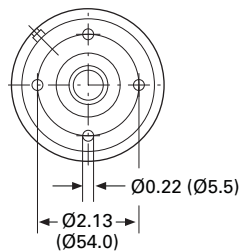
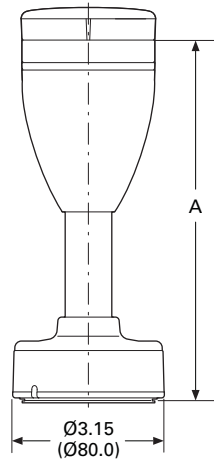

###### SL7-SWD ①

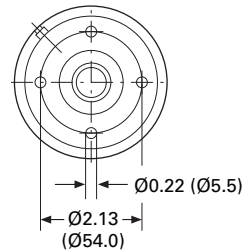
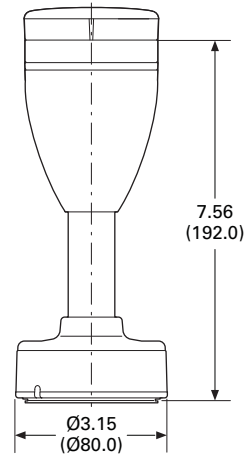

###### SL4-FMS-...

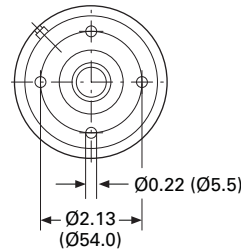
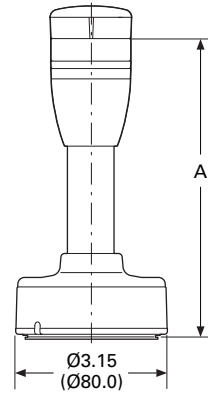

###### SL4-SWD ①

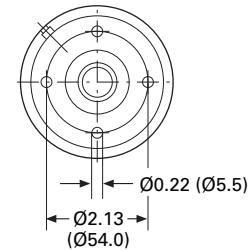
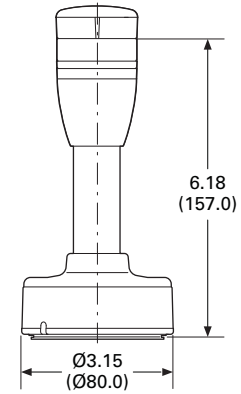

| Catalog Number | A             |
|----------------|---------------|
| SL7-FMS-100    | 7.55 (192.0)  |
| SL7-FMS-250    | 13.46 (342.0) |
| SL7-FMS-400    | 19.37 (192.0) |

**Note**

① For connecting to SmartWire-DT.

| Catalog Number | A             |
|----------------|---------------|
| SL4-FMS-100    | 6.18 (157.0)  |
| SL4-FMS-250    | 12.09 (307.0) |
| SL4-FMS-400    | 17.99 (457.0) |

**Note**

① For connecting to SmartWire-DT.

#### Device Plug

##### SWD4-8SF2-5

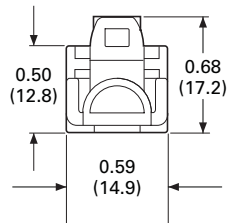
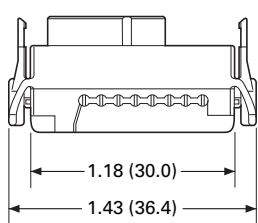



# 9.1

## Connectivity Solutions

### SmartWire-DT In-Panel and On-Machine Wiring Solution

Approximate Dimensions in Inches (mm)

#### Powerfeed T Connector

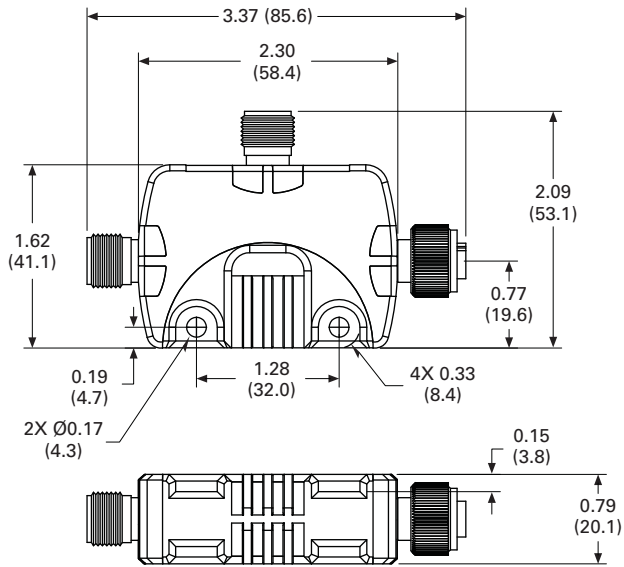

Approximate Dimensions in Inches (mm)

**Panel Adapters**

**SWD4-SFL8-12**

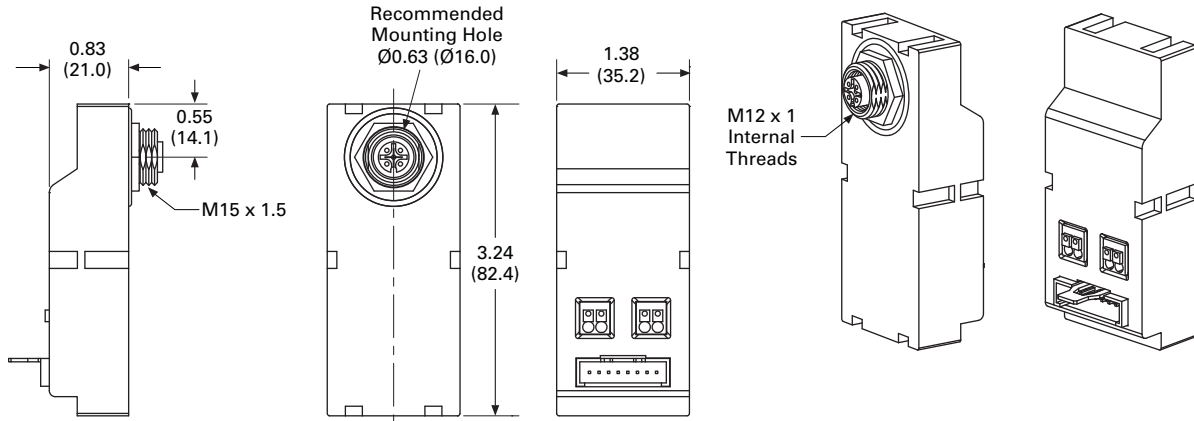

**SWD4-SML8-12**

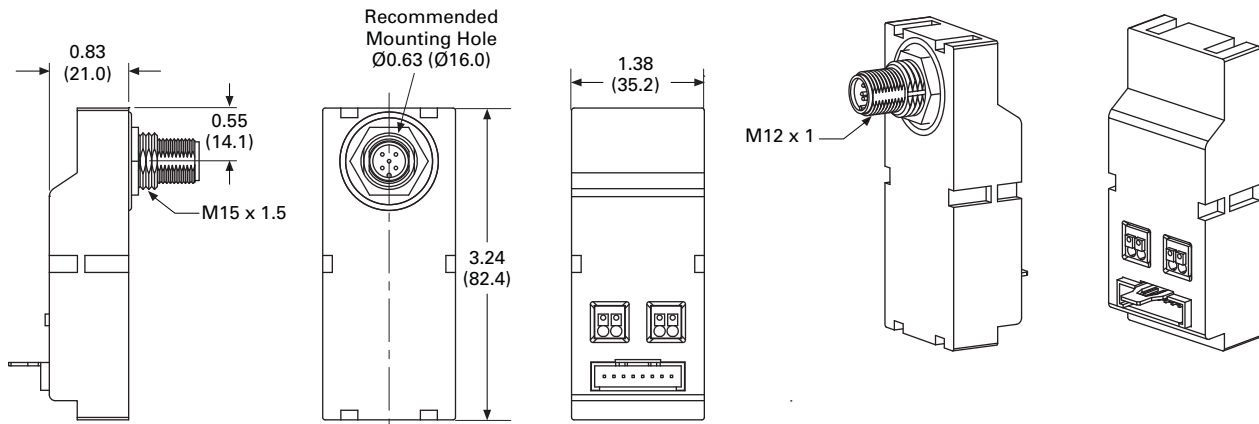

**SWD4-SML5-12**

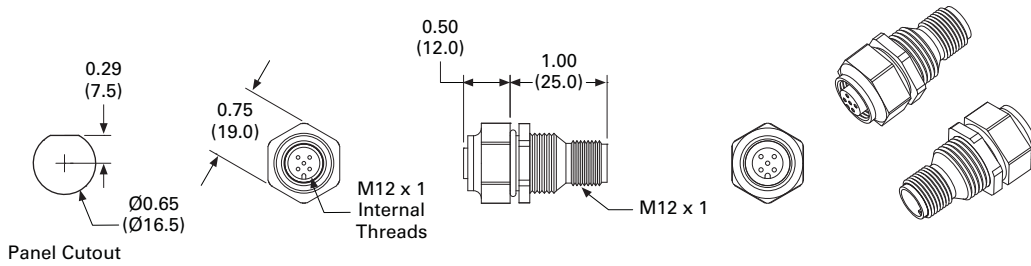

# 9.1

## Connectivity Solutions

### SmartWire-DT In-Panel and On-Machine Wiring Solution

Approximate Dimensions in Inches (mm)

#### Receptacles

##### SWD4-PRM5-1-S

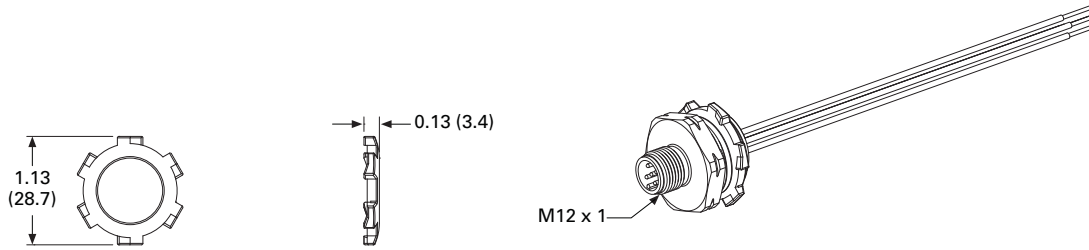

9

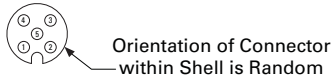
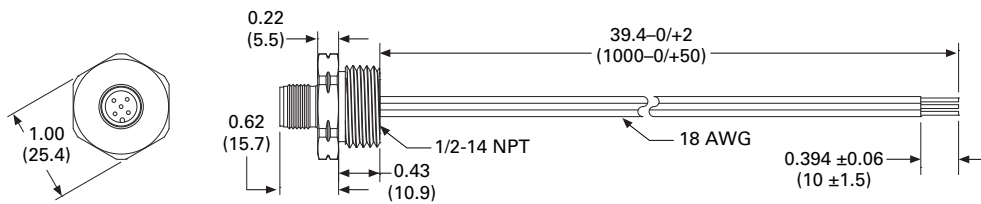

##### SWD4-PRM5-2-S

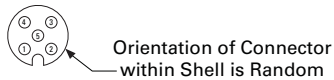
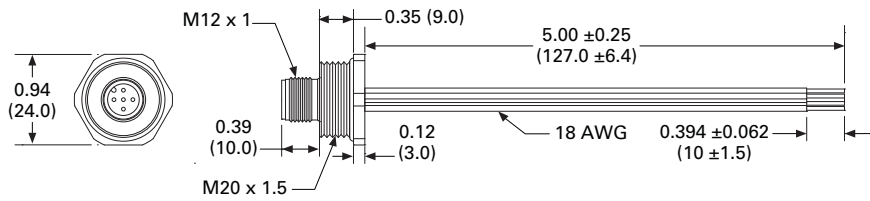
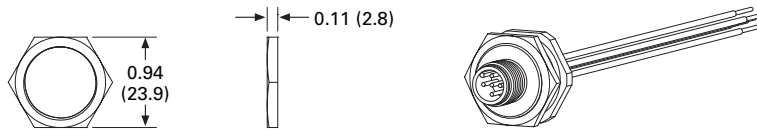

Approximate Dimensions in Inches (mm)

### SWD4-PRF5-1-S

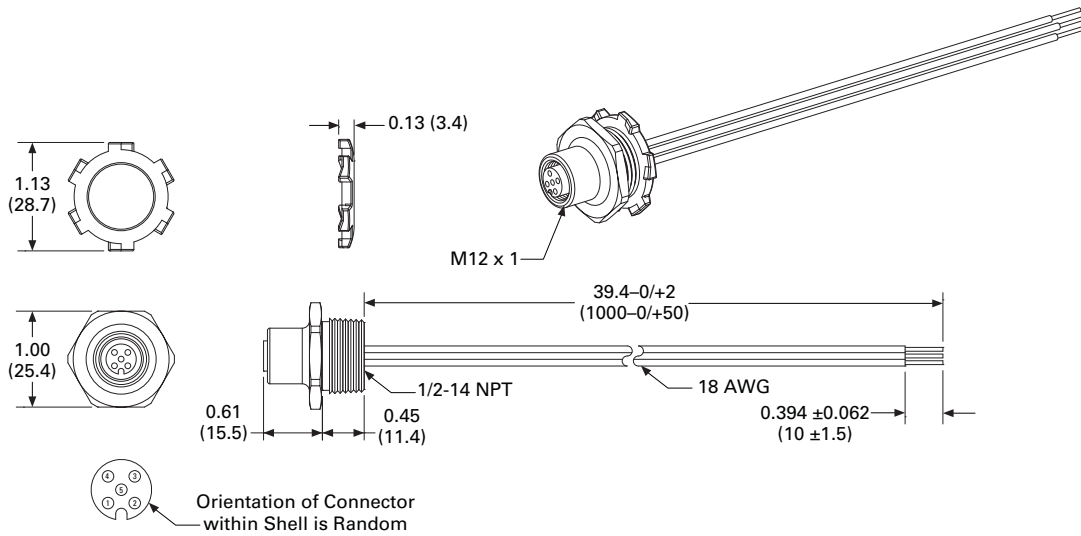

### SWD4-PRF5-2-S

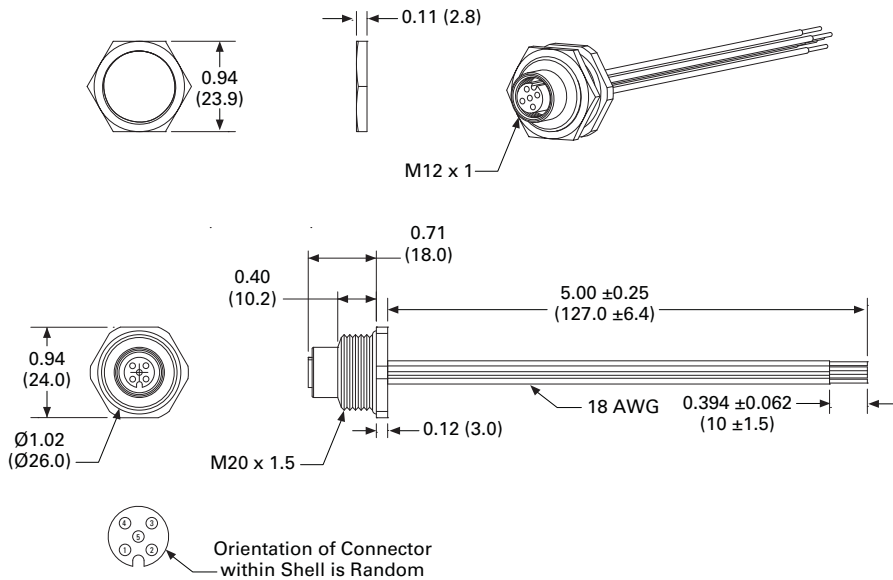



# 9.1

## Connectivity Solutions

### SmartWire-DT In-Panel and On-Machine Wiring Solution

Approximate Dimensions in Inches (mm)

#### Mounting Brackets

##### SWD4-MNT-VER

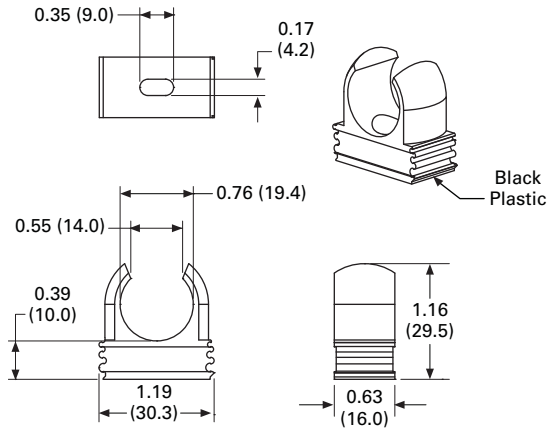

##### SWD4-MNT-DIN

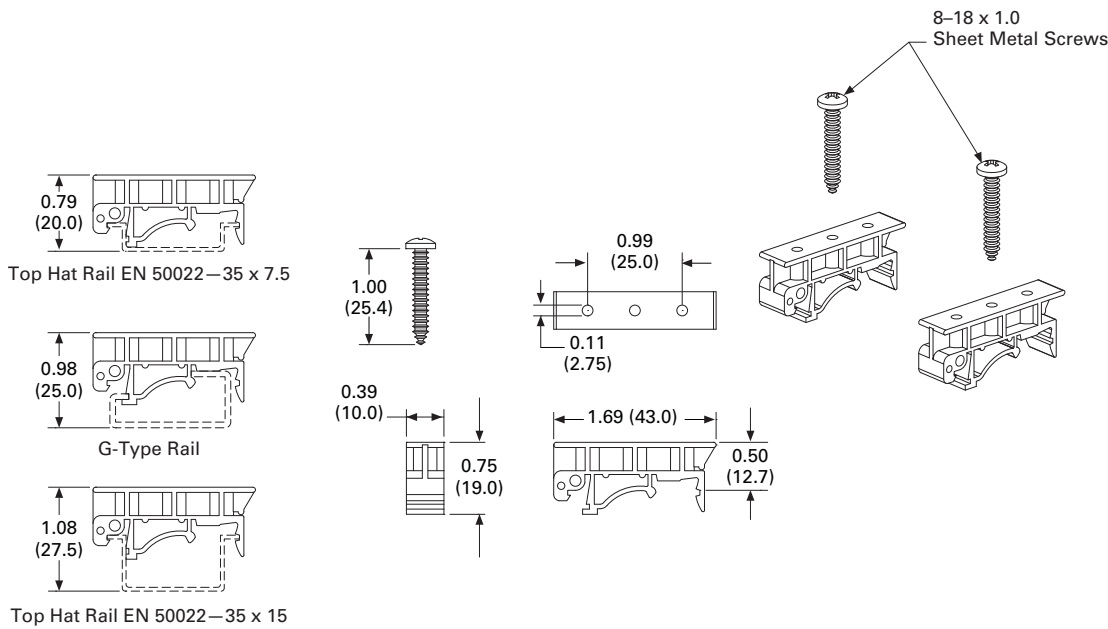

Approximate Dimensions in Inches (mm)

### Splitters

#### SWD4-SP-4122

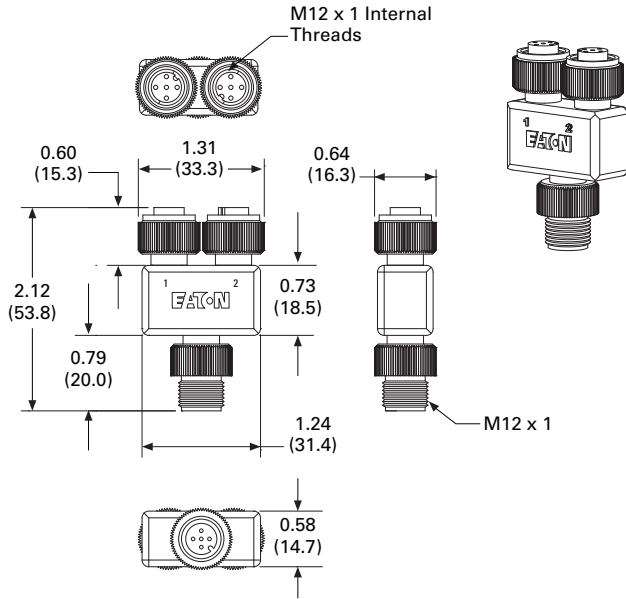

#### SWD4-SP-3084

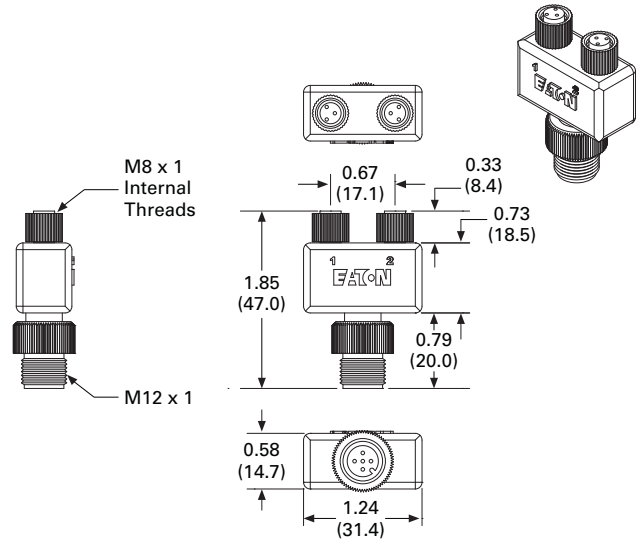

#### SWD4-SP-4124

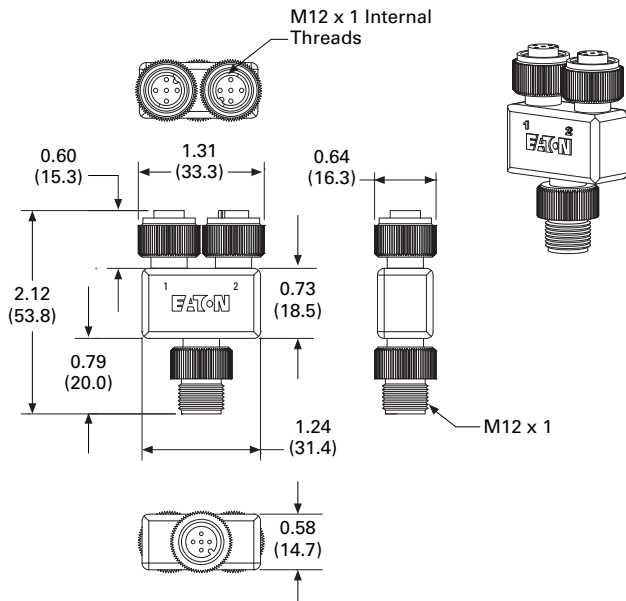

# 9.1

## Connectivity Solutions

### SmartWire-DT In-Panel and On-Machine Wiring Solution

Approximate Dimensions in Inches (mm)

#### SWD4-SP-4082

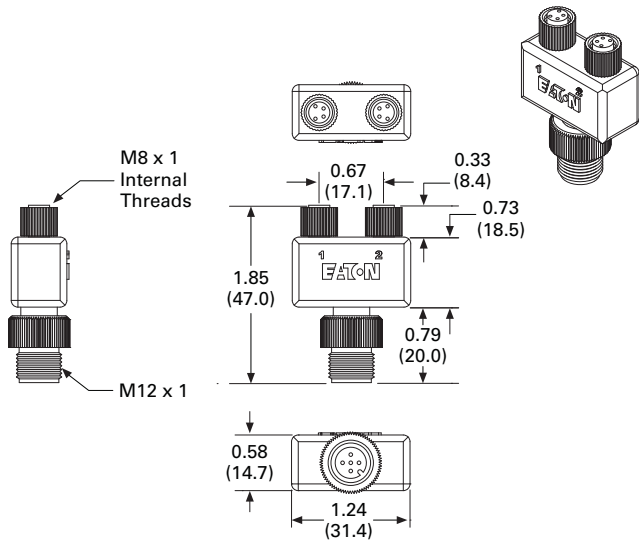

#### SWD4-SP-4084

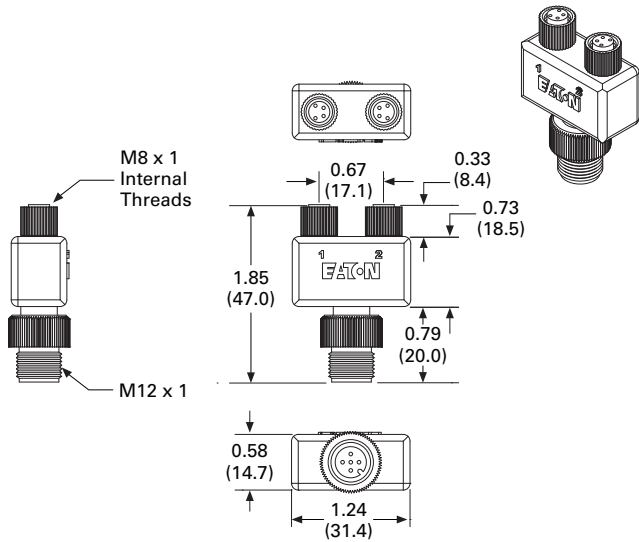

#### Other

#### SWD4-RC5-10

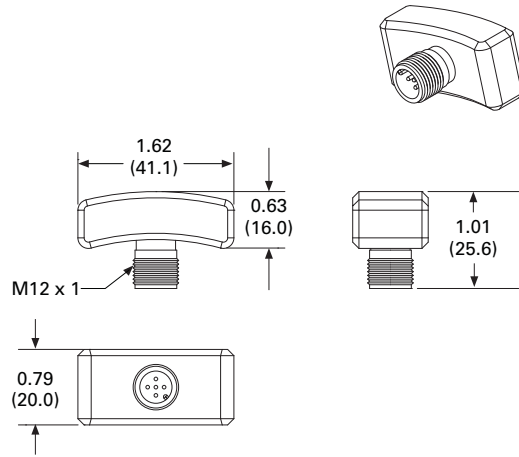

#### SWD4-ACAP-10

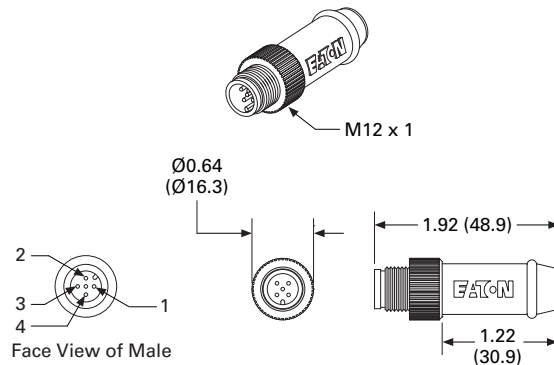

#### SWD4-SM5-67

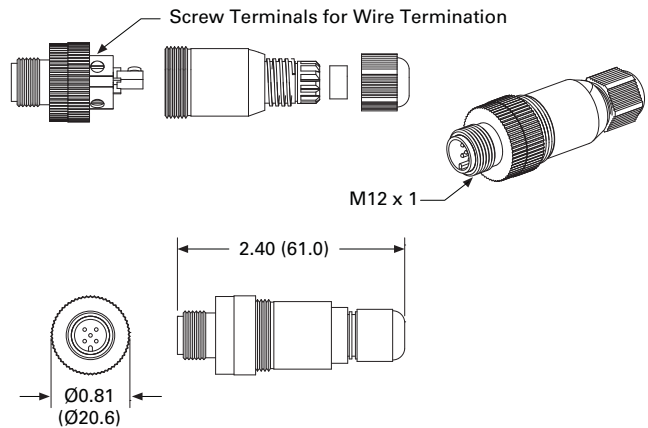

Approximate Dimensions in Inches (mm)

### SWD4-SF5-67

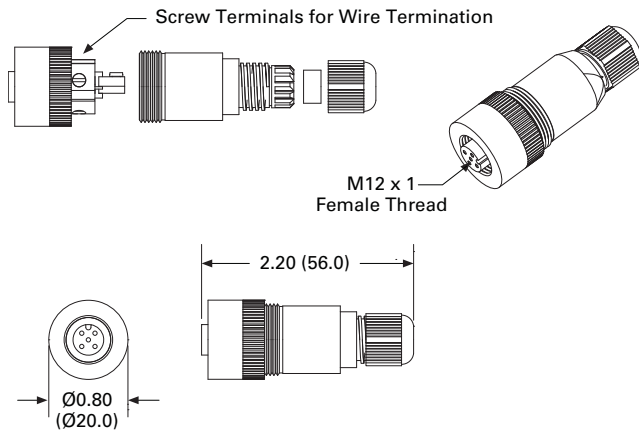

### V-12NPT

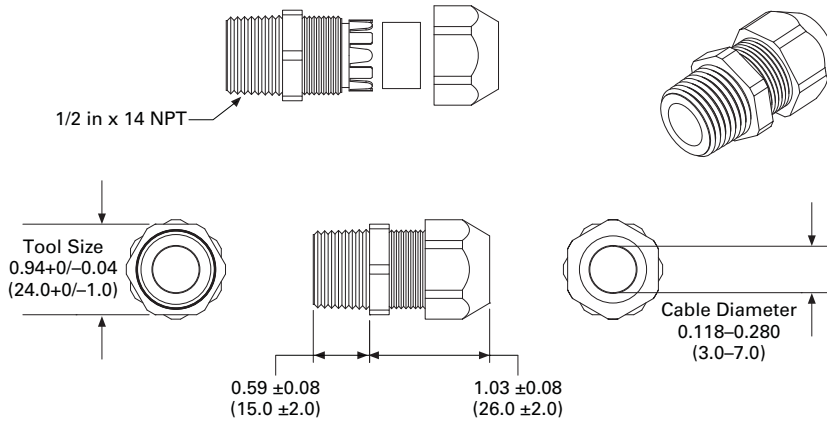

Eaton Terms & Conditions

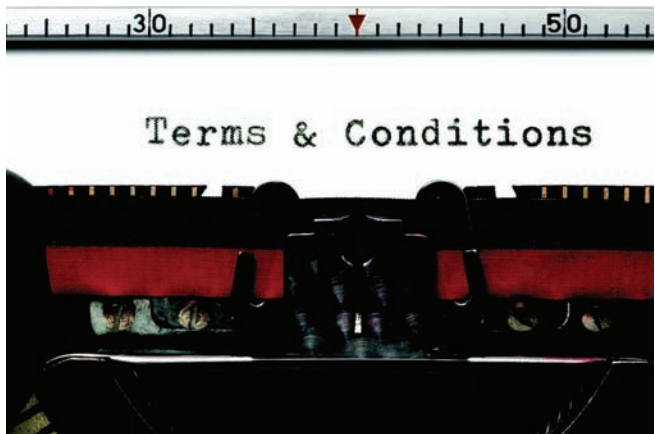

## Contents

| <i>Description</i>                     | <i>Page</i> |
|--|-------------|
| Terms and Conditions of Sale . . . . . | V7-A1-1     |
| Terms of Payment . . . . .             | V7-A1-2     |
| Freight . . . . .                      | V7-A1-3     |
| Warranty . . . . .                     | V7-A1-3     |

## Selling Policy (Supersedes Selling Policy 25-000, dated February 20, 2006)

### Terms and Conditions of Sale

The Terms and Conditions of Sale set forth herein, and any supplements which may be attached hereto, constitute the full and final expression of the contract for the sale of products or services (hereinafter referred to as Product(s) or Services by Eaton Corporation (hereinafter referred to as Seller) to the Buyer, and supersedes all prior quotations, purchase orders, correspondence or communications whether written or oral between the Seller and the Buyer. Notwithstanding any contrary language in the Buyer's purchase order, correspondence or other form of acknowledgment, Buyer shall be bound by these Terms and Conditions of Sale when it sends a purchase order or otherwise indicates acceptance of this contract, or when it accepts delivery from Seller of the Products or Services.

THE CONTRACT FOR SALE OF THE PRODUCTS OR SERVICES IS EXPRESSLY LIMITED TO THE TERMS AND CONDITIONS OF SALE STATED HEREIN. ANY ADDITIONAL OR DIFFERENT TERMS PROPOSED BY BUYER ARE REJECTED UNLESS EXPRESSLY AGREED TO IN WRITING BY SELLER. No contract shall exist except as herein provided.

### **Complete Agreement**

No amendment or modification hereto nor any statement, representation or warranty not contained herein shall be binding on the Seller unless made in writing by an authorized representative of the Seller. Prior dealings, usage of the trade or a course of performance shall not be relevant to determine the meaning of this contract even though the accepting or acquiescing party had knowledge of the nature of the performance and opportunity for objection.

### **Quotations**

Written quotations are valid for 30 days from its date unless otherwise stated in the quotation or terminated sooner by notice.

Verbal quotations, unless accepted, expire the same day they are made.

A complete signed order must be received by Seller within 20 calendar days of notification of award, otherwise the price and shipment will be subject to re-negotiation.

### **Termination and Cancellation**

Any order may be terminated by the Buyer only by written notice and upon payment of reasonable termination charges, including all costs plus profit.

Seller shall have the right to cancel any order at any time by written notice if Buyer breaches any of the terms hereof, becomes the subject of any proceeding under state or federal law for the relief of debtors, or otherwise becomes insolvent or bankrupt, generally does not pay its debts as they become due or makes an assignment for the benefit of creditors.

# Appendix 1—Eaton Terms & Conditions

Effective Date: November 1, 2008

## **Prices**

All prices are subject to change without notice. In the event of a price change, the effective date of the change will be the date of the new price or discount sheet, letter or telegram. All quotations made or orders accepted after the effective date will be on the new basis. For existing orders, the price of the unshipped portion of an order will be the price in effect at time of shipment.

## **Price Policy—Products and Services**

When prices are quoted as firm for quoted shipment, they are firm provided the following conditions are met:

1. The order is released with complete engineering details.
2. Shipment of Products are made, and Services purchased are provided within the quoted lead time.
3. When drawings for approval are required for any Products, the drawings applicable to those Products must be returned within 30\* calendar days from the date of the original mailing of the drawings by Seller. The return drawings must be released for manufacture and shipment and must be marked "APPROVED" or "APPROVED AS NOTED." Drawing re-submittals which are required for any other reason than to correct Seller errors will not extend the 30-day period.

\* 60 days for orders through contractors to allow time for their review and approval before and after transmitting them to their customers.

If the Buyer initiates or in any way causes delays in shipment, provision of Services or return of approval drawings beyond the periods stated above, the price of the Products or Services will be increased 1% per month or fraction thereof up to a maximum of 18 months from the date of the Buyer's order. For delays resulting in shipment or provision of Services beyond 18 months from the date of the Buyer's order, the price must be renegotiated.

## **Price Policy—BLS**

Refer to Price Policy 25-050.

## **Minimum Billing**

Orders less than \$1,000 will be assessed a shipping and handling charge of 5% of the price of the order, with a minimum charge of \$25.00 unless noted differently on Product discount sheets.

## **Taxes**

The price does not include any taxes. Buyer shall be responsible for the payment of all taxes applicable to, or arising from the transaction, the Products, its sale, value, or use, or any Services performed in connection therewith regardless of the person or entity actually taxed.

## **Terms of Payment**

### **Products**

Acceptance of all orders is subject to the Buyer meeting Seller's credit requirements. Terms of payment are subject to change for failure to meet such requirements. Seller reserves the right at any time to demand full or partial payment before proceeding with a contract of sale as a result of changes in the financial condition of the Buyer. Terms of Payment are either Net 30 days from the date of invoice of each shipment or carry a cash discount based on Product type. Specific payment terms for Products are outlined in the applicable Product discount schedules.

### **Services**

Terms of payment are net within 30 days from date of invoice for orders amounting to less than \$50,000.00.

Terms of payment for orders exceeding \$50,000.00 shall be made according to the following:

1. Twenty percent (20%) of order value with the purchase order payable 30 days from date of invoice.
2. Eighty percent (80%) of order value in equal monthly payments over the performance period payable 30 days from date of invoice.

Except for work performed (i) under a firm fixed price basis or (ii) pursuant to terms of a previously priced existing contract between Seller and Buyer, invoices for work performed by Seller shall have added and noted on each invoice a charge of 3% (over and above the price of the work) which is related to Seller compliance with present and proposed environmental, health, and safety regulations associated with prescribed requirements covering hazardous materials management and employee training, communications, personal protective equipment, documentation and record keeping associated therewith.

### **Adequate Assurances**

If, in the judgment of Seller, the financial condition of the Buyer, at any time during the period of the contract, does not justify the terms of payment specified, Seller may require full or partial payment in advance.

### **Delayed Payment**

If payments are not made in accordance with these terms, a service charge will, without prejudice to the right of Seller to immediate payment, be added in an amount equal to the lower of 1.5% per month or fraction thereof or the highest legal rate on the unpaid balance.

**Freight**

Freight policy will be listed on the Product discount sheets, or at option of Seller one of the following freight terms will be quoted.

**F.O.B.—P/S—Frt./Ppd. and Invoiced**

Products are sold F.O.B. point of shipment freight prepaid and invoiced to the Buyer.

**F.O.B.—P/S—Frt./Ppd. and Allowed**

Products sold are delivered F.O.B. point of shipment, freight prepaid and included in the price.

**F.O.B. Destination—Frt./Ppd. and Allowed**

At Buyer's option, Seller will deliver the Products F.O.B. destination freight prepaid and 2% will be added to the net price.

The term "freight prepaid" means that freight charges will be prepaid to the accessible common carrier delivery point nearest the destination for shipments within the United States and Puerto Rico unless noted differently on the Product discount sheets. For any other destination contact Seller's representative.

**Shipment and Routing**

Seller shall select the point of origin of shipment, the method of transportation, the type of carrier equipment and the routing of the shipment.

If the Buyer specifies a special method of transportation, type of carrier equipment, routing, or delivery requirement, Buyer shall pay all special freight and handling charges.

When freight is included in the price, no allowance will be made in lieu of transportation if the Buyer accepts shipment at factory, warehouse, or freight station or otherwise supplies its own transportation.

**Risk of Loss**

Risk of loss or damage to the Products shall pass to Buyer at the F.O.B. point.

**Concealed Damage**

Except in the event of F.O.B. destination shipments, Seller will not participate in any settlement of claims for concealed damage.

When shipment has been made on an F.O.B. destination basis, the Buyer must unpack immediately and, if damage is discovered must:

1. Not move the Products from the point of examination.
2. Retain shipping container and packing material.
3. Notify the carrier in writing of any apparent damage.
4. Notify Seller representative within 72 hours of delivery.
5. Send Seller a copy of the carrier's inspection report.

**Witness Tests/Customer Inspection**

Standard factory tests may be witnessed by the Buyer at Seller's factory for an additional charge calculated at the rate of \$2,500 per day (not to exceed eight (8) hours) per Product type. Buyer may final inspect Products at the Seller's factory for \$500 per day per Product type.

Witness tests will add one (1) week to the scheduled shipping date. Seller will notify Buyer fourteen (14) calendar days prior to scheduled witness testing or inspection. In the event Buyer is unable to attend, the Parties shall mutually agree on a rescheduled date. However, Seller reserves the right to deem the witness tests waived with the right to ship and invoice Products.

**Held Orders**

For any order held, delayed or rescheduled at the request of the Buyer, Seller may, at its sole option (1) require payment to be based on any reasonable basis, including but not limited to the contract price, and any additional expenses, or cost resulting from such a delay; (2) store Products at the sole cost and risk of loss of the Buyer; and/ or (3) charge to the Buyer those prices under the applicable price policy. Payment for such price, expenses and costs, in any such event, shall be due by Buyer within thirty (30) days from date of Seller's invoice. Any order so held delayed or rescheduled beyond six (6) months will be treated as a Buyer termination.

**Drawing Approval**

Seller will design the Products in line with, in Seller's judgment, good commercial practice. If at drawing approval Buyer makes changes outside of the design as covered in their specifications, Seller will then be paid reasonable charges and allowed a commensurate delay in shipping date based on the changes made.

**Drawing Re-Submittal**

When Seller agrees to do so in its quotation, Seller shall provide Buyer with the first set of factory customer approval drawing(s) at Seller's expense. The customer approval drawing(s) will be delivered at the quoted delivery date. If Buyer requests drawing changes or additions after the initial factory customer approval drawing(s) have been submitted by Seller, the Seller, at its option, may assess Buyer drawing charges. Factory customer approval drawing changes required due to misinterpretation by Seller will be at Seller's expense. Approval drawings generated by Bid Manager are excluded from this provision.

**Warranty****Warranty for Products**

Seller warrants that the Products manufactured by it will conform to Seller's applicable specifications and be free from failure due to defects in workmanship and material for one (1) year from the date of installation of the Product or eighteen (18) months from the date of shipment of the Product, whichever occurs first.

In the event any Product fails to comply with the foregoing warranty Seller will, at its option, either (a) repair or replace the defective Product, or defective part or component thereof, F.O.B. Seller's facility freight prepaid, or (b) credit Buyer for the purchase price of the Product. All warranty claims shall be made in writing.

Seller requires all non-conforming Products be returned at Seller's expense for evaluation unless specifically stated otherwise in writing by Seller.

This warranty does not cover failure or damage due to storage, installation, operation or maintenance not in conformance with Seller's recommendations and industry standard practice or due to accident, misuse, abuse or negligence. This warranty does not cover reimbursement for labor, gaining access, removal, installation, temporary power or any other expenses, which may be incurred in connection with repair or replacement.

This warranty does not apply to equipment not manufactured by Seller. Seller limits itself to extending the same warranty it receives from the supplier.

# Appendix 1—Eaton Terms & Conditions

Effective Date: November 1, 2008

## **Extended Warranty for Products**

If requested by the Buyer and specifically accepted in writing by Seller, the foregoing standard warranty for Products will be extended from the date of shipment for the period and price indicated below:

- 24 months—2% of Contract Price
- 30 months—3% of Contract Price
- 36 months—4% of Contract Price

## **Special Warranty (In and Out) for Products**

If requested by the Buyer and specifically accepted in writing by Seller, Seller will, during the warranty period for Products, at an additional cost of 2% of the contract price, be responsible for the direct cost of:

1. Removing the Product from the installed location.
2. Transportation to the repair facility and return to the site.
3. Reinstallation on site.

The total liability of Seller for this Special Warranty for Products is limited to 50% of the contract price of the particular Product being repaired and excludes expenses for removing adjacent apparatus, walls, piping, structures, temporary service, etc.

## **Warranty for Services**

Seller warrants that the Services performed by it hereunder will be performed in accordance with generally accepted professional standards.

The Services, which do not so conform, shall be corrected by Seller upon notification in writing by the Buyer within one (1) year after completion of the Services.

Unless otherwise agreed to in writing by Seller, Seller assumes no responsibility with respect to the suitability of the Buyer's, or its customer's, equipment or with respect to any latent defects in equipment not supplied by Seller. This warranty does not cover damage to Buyer's, or its customer's, equipment, components or parts resulting in whole or in part from improper maintenance or operation or from their deteriorated condition. Buyer will, at its cost, provide Seller with unobstructed access to the defective Services, as well as adequate free working space in the immediate vicinity of the defective Services and such facilities and systems, including, without limitation, docks, cranes and utility disconnects and connects, as may be necessary in order that Seller may perform its warranty obligations. The conducting of any tests shall be mutually agreed upon and Seller shall be notified of, and may be present at, all tests that may be made.

## **Warranty for Power Systems Studies**

Seller warrants that any power systems studies performed by it will conform to generally accepted professional standards. Any portion of the study, which does not so conform, shall be corrected by Seller upon notification in writing by the Buyer within six (6) months after completion of the study. All warranty work shall be performed in a single shift straight time basis Monday through Friday. In the event that the study requires correction of warranty items on an overtime schedule, the premium portion of such overtime shall be for the Buyer's account.

## **Limitation on Warranties for Products, Services and Power Systems Studies**

THE FOREGOING WARRANTIES ARE EXCLUSIVE EXCEPT FOR WARRANTY OF TITLE. SELLER DISCLAIMS ALL OTHER WARRANTIES INCLUDING ANY IMPLIED WARRANTIES OF MERCHANTABILITY AND FITNESS FOR A PARTICULAR PURPOSE.

CORRECTION OF NON-CONFORMITIES IN THE MANNER AND FOR THE PERIOD OF TIME PROVIDED ABOVE SHALL CONSTITUTE SELLER'S SOLE LIABILITY AND BUYER'S EXCLUSIVE REMEDY FOR FAILURE OF SELLER TO MEET ITS WARRANTY OBLIGATIONS, WHETHER CLAIMS OF THE BUYER ARE BASED IN CONTRACT, IN TORT (INCLUDING NEGLIGENCE OR STRICT LIABILITY), OR OTHERWISE.

## **Asbestos**

Federal Law requires that building or facility owners identify the presence, location and quantity of asbestos containing material (hereinafter "ACM") at work sites. Seller is not licensed to abate ACM. Accordingly, for any contract which includes the provision of Services, prior to (i) commencement of work at any site under a specific Purchase Order, (ii) a change in the work scope of any Purchase Order, the Buyer will certify that the work area associated with the Seller's scope of work includes the handling of Class II ACM, including but not limited to generator wedges and high temperature gaskets which include asbestos materials. The Buyer shall, at its expense, conduct abatement should the removal, handling, modification or reinstallation, or some or all of them, of said Class II ACM be likely to generate airborne asbestos fibers; and should such abatement affect the cost of or time of performance of the work then Seller shall be entitled to an equitable adjustment in the schedule, price and other pertinent affected provisions of the contract.

## **Compliance with Nuclear Regulation**

Seller's Products are sold as commercial grade Products not intended for application in facilities or activities licensed by the United States Nuclear Regulatory Commission for atomic purposes. Further certification will be required for use of the Products in any safety-related application in any nuclear facility licensed by the U.S. Nuclear Regulatory Commission.



**Returning Products**

Authorization and shipping instructions for the return of any Products must be obtained from Seller before returning the Products.

When return is occasioned due to Seller error, full credit including all transportation charges will be allowed.

**Product Notices**

Buyer shall provide the user (including its employees) of the Products with all Seller supplied Product notices, warnings, instructions, recommendations, and similar materials.

**Force Majeure**

Seller shall not be liable for failure to perform or delay in performance due to fire, flood, strike or other labor difficulty, act of God, act of any governmental authority or of the Buyer, riot, embargo, fuel or energy shortage, car shortage, wrecks or delays in transportation, or due to any other cause beyond Seller's reasonable control. In the event of delay in performance due to any such cause, the date of delivery or time for completion will be extended by a period of time reasonably necessary to overcome the effect of such delay.

**Liquidated Damages**

Contracts which include liquidated damage clauses for failure to meet shipping or job completion promises are not acceptable or binding on Seller, unless such clauses are specifically accepted in writing by an authorized representative of the Seller at its headquarters office.

**Patent Infringement**

Seller will defend or, at its option, settle any suit or proceeding brought against Buyer, or Buyer's customers, to the extent it is based upon a claim that any Product or part thereof, manufactured by Seller or its subsidiaries and furnished hereunder, infringes any United States patent, other than a claim of infringement based upon use of a Product or part thereof in a process, provided Seller is notified in reasonable time and given authority, information and assistance (at Seller's expense) for the defense of same. Seller shall pay all legal and court costs and expenses and court-assessed damages awarded therein against Buyer resulting from or incident to such suit or proceeding. In addition to the foregoing, if at any time Seller determines there is a substantial question of infringement of any United States patent, and the use of such Product is or may be enjoined, Seller may, at its option and expense: either (a) procure for Buyer the right to continue using and selling the Product; (b) replace the Product with non-infringing apparatus; (c) modify the Product so it becomes non-infringing; or (d) as a last resort, remove the Product and refund the purchase price, equitably adjusted for use and obsolescence. In no case does Seller agree to pay any recovery based upon its Buyer's savings or profit through use of Seller's Products whether the use be special or ordinary. The foregoing states the entire liability of Seller for patent infringement.

The preceding paragraph does not apply to any claim of infringement based upon: (a) any modification made to a Product other than by Seller; (b) any design and/or specifications of Buyer to which a Product was manufactured; or (c) the use or combination of Product with other products where the Product does not itself infringe. As to the above-identified claim situations where the preceding paragraph does not apply, Buyer shall defend and hold Seller harmless in the same manner and to the extent as Seller's obligations described in the preceding paragraph. Buyer shall be responsible for obtaining (at Buyer's expense) all license rights required for Seller to be able to use software products in the possession of Buyer where such use is required in order to perform any Service for Buyer.

With respect to a Product or part thereof not manufactured by Seller or its subsidiaries, Seller will attempt to obtain for Buyer, from the supplier(s), the patent indemnification protection normally provided by the supplier(s) to customers.

**Compliance with OSHA**

Seller offers no warranty and makes no representation that its Products comply with the provisions or standards of the Occupational Safety and Health Act of 1970, or any regulation issued thereunder. In no event shall Seller be liable for any loss, damage, fines, penalty or expenses arising under said Act.

**Limitation of Liability**

THE REMEDIES OF THE BUYER SET FORTH IN THIS CONTRACT ARE EXCLUSIVE AND ARE ITS SOLE REMEDIES FOR ANY FAILURE OF SELLER TO COMPLY WITH ITS OBLIGATIONS HEREUNDER.

NOTWITHSTANDING ANY PROVISION IN THIS CONTRACT TO THE CONTRARY, IN NO EVENT SHALL SELLER BE LIABLE IN CONTRACT, IN TORT (INCLUDING NEGLIGENCE OR STRICT LIABILITY) OR OTHERWISE FOR DAMAGE TO PROPERTY OR EQUIPMENT OTHER THAN PRODUCTS SOLD HEREUNDER, LOSS OF PROFITS OR REVENUE, LOSS OF USE OF PRODUCTS, COST OF

CAPITAL, CLAIMS OF CUSTOMERS OF THE BUYER OR ANY SPECIAL, INDIRECT, INCIDENTAL OR CONSEQUENTIAL DAMAGES WHATSOEVER, REGARDLESS OF WHETHER SUCH POTENTIAL DAMAGES ARE FORESEEABLE OR IF SELLER HAS BEEN ADVISED OF THE POSSIBILITY OF SUCH DAMAGES.

THE TOTAL CUMULATIVE LIABILITY OF SELLER ARISING FROM OR RELATED TO THIS CONTRACT WHETHER THE CLAIMS ARE BASED IN CONTRACT, IN TORT (INCLUDING NEGLIGENCE OR STRICT LIABILITY) OR OTHERWISE, SHALL NOT EXCEED THE PRICE OF THE PRODUCT OR SERVICES ON WHICH SUCH LIABILITY IS BASED.

**A**

APP ..... V7-T5-17  
 AR ..... V7-T3-154  
 ARA ..... V7-T3-155  
 ARC ..... V7-T3-154  
 ARD ..... V7-T3-154, V7-T3-155  
 ARM ..... V7-T3-155  
 ARO ..... V7-T3-154  
 ARS ..... V7-T3-155

**B**

BF ..... V7-T3-148, V7-T3-149  
 BFD ..... V7-T3-148, V7-T3-149  
 BFM ..... V7-T3-150

**C**

CE0 ..... V7-T7-19, V7-T7-20  
 CE1 ..... V7-T7-20  
 CE2 ..... V7-T7-20  
 CE3 ..... V7-T7-20  
 CE5 ..... V7-T7-20  
 CHCP ..... V7-T8-126  
 CHD ..... V7-T8-118  
 CH16 ..... V7-T8-124  
 C0 ..... V7-T7-14  
 C00 ..... V7-T7-5-V7-T7-9, V7-T7-26  
 C01 ..... V7-T7-5-V7-T7-9  
 C02 ..... V7-T7-5-V7-T7-9  
 C03 ..... V7-T7-5-V7-T7-9  
 C05 ..... V7-T7-5-V7-T7-9  
 C07 ..... V7-T7-5-V7-T7-8  
 C1 ..... V7-T7-14  
 C10 ..... V7-T7-5-V7-T7-7  
 C15 ..... V7-T7-5-V7-T7-7  
 C2 ..... V7-T7-14  
 C22 ..... V7-T1-141-V7-T1-148  
 C22-L ..... V7-T1-150  
 C22-P ..... V7-T1-152, V7-T1-153  
 C22S ..... V7-T1-141-V7-T1-148  
 C22S-W ..... V7-T1-155-V7-T1-158  
 C22-W ..... V7-T1-155-V7-T1-158  
 C3 ..... V7-T7-14  
 C320 ..... V7-T3-143, V7-T3-144  
 C321 ..... V7-T3-144  
 C350 ..... V7-T8-132  
 C381 ..... V7-T8-108, V7-T8-109  
 C383 ..... V7-T8-130  
 C5 ..... V7-T7-14

**D**

DIL-SWD ..... V7-T9-19  
 D1RA ..... V7-T3-54  
 D1RF ..... V7-T3-54  
 D15C ..... V7-T3-143  
 D2PA ..... V7-T3-60  
 D2PJ ..... V7-T3-60, V7-T3-116  
 D2PR ..... V7-T3-59

D26 ..... V7-T3-164, V7-T3-165  
 D26M ..... V7-T3-159-V7-T3-161  
 D3PA ..... V7-T3-70, V7-T3-177, V7-T3-180, V7-T3-184,  
 V7-T3-189  
 D3PF ..... V7-T3-69  
 D3PJ ..... V7-T3-70, V7-T3-83, V7-T3-116  
 D4PA ..... V7-T3-77  
 D4PR ..... V7-T3-77  
 D5PA ..... V7-T3-83, V7-T3-177  
 D5PF ..... V7-T3-82  
 D5PR ..... V7-T3-82  
 D65C ..... V7-T3-180, V7-T3-184, V7-T3-189  
 D7PA ..... V7-T3-92  
 D8PA ..... V7-T3-104  
 D8PR ..... V7-T3-104  
 D851 ..... V7-T3-189  
 D852 ..... V7-T3-189  
 D9PR ..... V7-T3-109  
 D93 ..... V7-T3-124  
 D96 ..... V7-T3-131  
 D99 ..... V7-T3-136

**E**

EASY ..... V7-T3-23, V7-T3-31, V7-T3-40, V7-T3-43,  
 V7-T3-45, V7-T6-26  
 EASY-LINK ..... V7-T3-45  
 EASY-NT ..... V7-T4-37  
 EASYSOFT ..... V7-T3-44  
 EASY802 ..... V7-T9-12  
 EASY806 ..... V7-T9-12  
 ELC ..... V7-T4-11-V7-T4-15, V7-T5-7-V7-T5-9, V7-T5-17,  
 V7-T6-23  
 ELC-AC ..... V7-T4-17  
 ELC-ACC ..... V7-T4-18  
 ELC-BAT ..... V7-T4-18  
 ELC-CB ..... V7-T4-17  
 ELC-IO ..... V7-T4-18  
 ELCM ..... V7-T4-4, V7-T4-5  
 ELC-PS ..... V7-T4-17  
 ELCSOFT ..... V7-T4-16  
 ELC-SP ..... V7-T4-18  
 ELC2 ..... V7-T4-9, V7-T4-10  
 ESR5 ..... V7-T3-194  
 ES16 ..... V7-T1-41  
 ES4P ..... V7-T3-200  
 EU1E ..... V7-T9-30  
 EU4A-RJ45 ..... V7-T4-37  
 EU5 ..... V7-T9-10  
 EU5C ..... V7-T9-10, V7-T9-14  
 EU5E ..... V7-T9-14  
 E01 ..... V7-T1-40  
 E10 ..... V7-T1-40  
 E10E ..... V7-T1-4, V7-T1-5, V7-T1-9  
 E10P ..... V7-T1-5  
 E10T ..... V7-T1-4, V7-T1-5, V7-T1-9  
 E22B ..... V7-T2-40  
 E22C ..... V7-T1-175, V7-T1-229, V7-T1-280  
 E22L ..... V7-T1-239, V7-T1-271, V7-T1-343

## Appendix 2—Catalog Parent Number Index

|          |  |          |   |
|----------|--|----------|---|
| E26B     | V7-T2-36, V7-T2-38, V7-T2-39   | HT8G     | V7-T1-298, V7-T1-300–V7-T1-305, V7-T1-311   |
| E26S     | V7-T2-37, V7-T2-38, V7-T2-40   | HT8H     | V7-T1-304, V7-T1-305  |
| E26X     | V7-T2-35   | HT8J     | V7-T1-298, V7-T1-308, V7-T1-309   |
| E29K     | V7-T1-229  | HT8L     | V7-T1-309, V7-T1-311–V7-T1-313, V7-T1-315   |
| E30A     | V7-T1-166, V7-T1-167   | HT8P     | V7-T1-312   |
| E30B     | V7-T1-167  | HT8R     | V7-T1-312   |
| E30C     | V7-T1-167  | HT8S     | V7-T1-312, V7-T1-313  |
| E30D     | V7-T1-168  | HT8W     | V7-T1-311   |
| E30E     | V7-T1-168  | HT8X     | V7-T1-311   |
| E30J     | V7-T1-168  |          |   |
| E30K     | V7-T1-169–V7-T1-175, V7-T1-178, V7-T1-229  |          |   |
| E34A     | V7-T1-277, V7-T1-351   | <b>I</b> |   |
| E34C     | V7-T1-262, V7-T1-264, V7-T1-270, V7-T1-333,<br>V7-T1-336, V7-T1-342  | ISH      | V7-T1-40  |
| E34E     | V7-T1-260, V7-T1-261, V7-T1-328  | I8       | V7-T1-40  |
| E34EX    | V7-T1-23, V7-T1-324, V7-T1-325, V7-T1-327,<br>V7-T1-330, V7-T1-331, V7-T1-335–V7-T1-339,<br>V7-T1-344, V7-T1-345 | <b>L</b> |   |
| E34F     | V7-T1-260, V7-T1-262, V7-T1-284, V7-T1-332,<br>V7-T1-333   | LEDWB    | V7-T1-40  |
| E34G     | V7-T1-263–V7-T1-268, V7-T1-332, V7-T1-334,<br>V7-T1-340  | LIC-OPT  | V7-T5-31  |
| E34H     | V7-T1-263, V7-T1-334   |          |   |
| E34J     | V7-T1-260, V7-T1-261, V7-T1-264, V7-T1-270,<br>V7-T1-329, V7-T1-336, V7-T1-342                                   | <b>M</b> |   |
| E34K     | V7-T1-276, V7-T1-277, V7-T1-350, V7-T1-351   | MC       | V7-T8-113   |
| E34L     | V7-T1-202, V7-T1-260, V7-T1-261, V7-T1-267,<br>V7-T1-277, V7-T1-281, V7-T1-282, V7-T1-329,<br>V7-T1-351          | MFD      | V7-T3-35, V7-T3-44  |
| E34M     | V7-T1-265, V7-T1-270, V7-T1-337, V7-T1-342   | MOD      | V7-T3-54, V7-T3-60, V7-T3-70, V7-T3-83,<br>V7-T3-92, V7-T3-113  |
| E34N     | V7-T1-233, V7-T1-262, V7-T1-283, V7-T1-333,<br>V7-T1-356   | M22-A    | V7-T1-106, V7-T1-108, V7-T1-112, V7-T1-117  |
| E34P     | V7-T1-260, V7-T1-261, V7-T1-263, V7-T1-267,<br>V7-T1-282, V7-T1-328  | M22-B    | V7-T1-117   |
| E34R     | V7-T1-260, V7-T1-262, V7-T1-282, V7-T1-332,<br>V7-T1-333   | M22-C    | V7-T1-16, V7-T1-55, V7-T1-57, V7-T1-59,<br>V7-T1-61, V7-T1-65, V7-T1-67, V7-T1-69,<br>V7-T1-71, V7-T1-77, V7-T1-83, V7-T1-87,<br>V7-T1-91, V7-T1-95, V7-T1-97, V7-T1-101,<br>V7-T1-103, V7-T1-105, V7-T1-110, V7-T1-112,<br>V7-T1-113 |
| E34S     | V7-T1-262, V7-T1-278, V7-T1-281, V7-T1-282,<br>V7-T1-333, V7-T1-353  | M22-D    | V7-T1-51, V7-T1-53–V7-T1-71,<br>V7-T1-94–V7-T1-97, V7-T1-99, V7-T1-100,<br>V7-T1-103, V7-T1-107   |
| E34T     | V7-T1-260, V7-T1-262, V7-T1-279, V7-T1-280,<br>V7-T1-332, V7-T1-333  | M22-E    | V7-T1-77, V7-T1-91, V7-T1-116   |
| E34V     | V7-T1-263, V7-T1-272, V7-T1-276, V7-T1-278,<br>V7-T1-330, V7-T1-331, V7-T1-334, V7-T1-350,<br>V7-T1-353          | M22-G    | V7-T1-117   |
| E34X     | V7-T1-262, V7-T1-333   | M22G-X   | V7-T1-77, V7-T1-117   |
| E8       | V7-T1-40   | M22-H    | V7-T1-116   |
|          |  | M22-I    | V7-T1-116, V7-T1-117  |
|          |  | M22-K    | V7-T1-55, V7-T1-57, V7-T1-59, V7-T1-61,<br>V7-T1-65, V7-T1-67, V7-T1-69, V7-T1-71,<br>V7-T1-77, V7-T1-83, V7-T1-87, V7-T1-91,<br>V7-T1-95, V7-T1-97, V7-T1-101, V7-T1-103,<br>V7-T1-105, V7-T1-110, V7-T1-112, V7-T1-117              |
| <b>F</b> |  | M22-L    | V7-T1-51, V7-T1-65, V7-T1-67, V7-T1-69,<br>V7-T1-71–V7-T1-73, V7-T1-77, V7-T1-87,<br>V7-T1-101, V7-T1-112, V7-T1-113  |
| FAK      | V7-T1-109, V7-T1-110   | M22-M    | V7-T1-117   |
| FSK      | V7-T7-10, V7-T7-21   | M22M-D   | V7-T1-53–V7-T1-71, V7-T1-94–V7-T1-97  |
|          |  | M22M-W   | V7-T1-80–V7-T1-91   |
| <b>H</b> |  | M22-P    | V7-T1-51, V7-T1-75–V7-T1-77   |
| HMI      | V7-T5-15–V7-T5-17  | M22-R    | V7-T1-106, V7-T1-107  |
| HMIVU    | V7-T5-15   | M22S-B   | V7-T1-117   |
| HT8A     | V7-T1-298, V7-T1-299, V7-T1-311, V7-T1-314   | M22S-D   | V7-T1-53–V7-T1-71, V7-T1-94–V7-T1-97,<br>V7-T1-99, V7-T1-100, V7-T1-103   |
| HT8B     | V7-T1-314, V7-T1-315   | M22S-R   | V7-T1-106, V7-T1-117  |
| HT8C     | V7-T1-298, V7-T1-306, V7-T1-314  | M22S-S   | V7-T1-114, V7-T1-115  |
| HT8D     | V7-T1-306, V7-T1-314   | M22S-T   | V7-T1-68  |
| HT8E     | V7-T1-314  | M22S-W   | V7-T1-80–V7-T1-91, V7-T1-104  |
| HT8F     | V7-T1-298, V7-T1-307, V7-T1-311  |          |   |

M22-SWD . . . . . V7-T9-15, V7-T9-25, V7-T9-26  
M22-T . . . . . V7-T1-68, V7-T1-117  
M22-U . . . . . V7-T1-116  
M22-W . . . . . V7-T1-51, V7-T1-80–V7-T1-91, V7-T1-104  
M22-X . . . . . V7-T1-55, V7-T1-57, V7-T1-59, V7-T1-61,  
V7-T1-65, V7-T1-67, V7-T1-69, V7-T1-71,  
V7-T1-73, V7-T1-77, V7-T1-83, V7-T1-87,  
V7-T1-91, V7-T1-95, V7-T1-97, V7-T1-106,  
V7-T1-107, V7-T1-111–V7-T1-117  
M22(S) . . . . . V7-T1-118

**P**

PFC . . . . . V7-T3-54, V7-T3-60, V7-T3-92, V7-T3-117  
PFK . . . . . V7-T7-10  
PFP . . . . . V7-T3-54, V7-T3-60, V7-T3-70, V7-T3-83,  
V7-T3-92, V7-T3-104  
PKE-SWD . . . . . V7-T9-19  
PMC . . . . . V7-T3-54, V7-T3-92, V7-T3-114, V7-T3-115  
POC . . . . . V7-T3-60, V7-T3-70, V7-T3-83, V7-T3-92,  
V7-T3-114, V7-T3-115  
PS2 . . . . . V7-T6-30  
PWC . . . . . V7-T3-60, V7-T3-115  
PWF . . . . . V7-T3-70, V7-T3-83, V7-T3-116  
PYC . . . . . V7-T3-60, V7-T3-92

**Q**

Q18B . . . . . V7-T1-40  
Q18D . . . . . V7-T1-32  
Q18DR . . . . . V7-T1-32  
Q18LF . . . . . V7-T1-34  
Q18LH . . . . . V7-T1-34  
Q18LT . . . . . V7-T1-33  
Q18LTR . . . . . V7-T1-33  
Q18S1 . . . . . V7-T1-38, V7-T1-39  
Q18S3 . . . . . V7-T1-38, V7-T1-39  
Q18S3R . . . . . V7-T1-38  
Q18WK . . . . . V7-T1-36  
Q25A . . . . . V7-T1-40  
Q25B . . . . . V7-T1-40  
Q25D . . . . . V7-T1-32  
Q25DR . . . . . V7-T1-32  
Q25LF . . . . . V7-T1-34  
Q25LH . . . . . V7-T1-34  
Q25LPV . . . . . V7-T1-35  
Q25LT . . . . . V7-T1-33  
Q25LTR . . . . . V7-T1-33  
Q25PV . . . . . V7-T1-35  
Q25S1 . . . . . V7-T1-38, V7-T1-39  
Q25S3 . . . . . V7-T1-38, V7-T1-39  
Q25S3R . . . . . V7-T1-39  
Q25TS . . . . . V7-T1-41  
Q25WK . . . . . V7-T1-36

**S**

SFC . . . . . V7-T7-10, V7-T7-21  
SKF . . . . . V7-T3-45  
SL4-AP . . . . . V7-T2-16  
SL4-BL . . . . . V7-T2-15

SL4-FL . . . . . V7-T2-15, V7-T2-16  
SL4-FMS . . . . . V7-T2-18  
SL4-L . . . . . V7-T2-14, V7-T2-16, V7-T2-19  
SL4-PIB . . . . . V7-T2-17, V7-T2-18  
SL4-SWD . . . . . V7-T2-18  
SL4-100 . . . . . V7-T2-14  
SL7-AP . . . . . V7-T2-9  
SL7-BL . . . . . V7-T2-7  
SL7-CB . . . . . V7-T2-10, V7-T2-11  
SL7-FL . . . . . V7-T2-7, V7-T2-8  
SL7-FMS . . . . . V7-T2-11, V7-T9-37  
SL7-L . . . . . V7-T2-6, V7-T2-8, V7-T2-19  
SL7-SWD . . . . . V7-T2-11  
SL7-100 . . . . . V7-T2-6  
SL7/4 . . . . . V7-T2-19  
SQT . . . . . V7-T1-41  
SRA . . . . . V7-T1-40  
SRT . . . . . V7-T1-41  
SWD4 . . . . . V7-T9-15, V7-T9-16, V7-T9-30  
SW-GALILEO . . . . . V7-T5-37  
SW-XSOFT . . . . . V7-T4-38, V7-T4-58, V7-T4-62, V7-T5-38,  
V7-T9-11

**T**

TA . . . . . V7-T8-113  
TB . . . . . V7-T8-112, V7-T8-113, V7-T8-126, V7-T8-133  
TBAN . . . . . V7-T8-126  
TBLP . . . . . V7-T8-133  
TBP . . . . . V7-T8-133  
TJ . . . . . V7-T8-113  
TM . . . . . V7-T8-113  
TMRP . . . . . V7-T3-186  
TMR5 . . . . . V7-T3-180  
TMR6 . . . . . V7-T3-184  
TRF . . . . . V7-T3-177  
TRL . . . . . V7-T3-173  
TRN . . . . . V7-T3-177  
TRW . . . . . V7-T3-173

**V**

V-M20 . . . . . V7-T1-116  
VS . . . . . V7-T1-40

**W**

WBG . . . . . V7-T1-40  
WBLED . . . . . V7-T1-40  
WMR . . . . . V7-T8-132  
WM63 . . . . . V7-T8-132  
WRR . . . . . V7-T8-132  
WR23 . . . . . V7-T8-132  
WR26 . . . . . V7-T8-132  
WR63 . . . . . V7-T8-132  
WR66 . . . . . V7-T8-132  
W23 . . . . . V7-T8-132  
W26 . . . . . V7-T8-132  
W63 . . . . . V7-T8-132  
W66 . . . . . V7-T8-132

## Appendix 2—Catalog Parent Number Index

|                 |  |
|-----------------|--|
| <b>X</b>        |  |
| XBAC.....       | V7-T8-7, V7-T8-11, V7-T8-13, V7-T8-15, V7-T8-17, V7-T8-26, V7-T8-30, V7-T8-34, V7-T8-38, V7-T8-40, V7-T8-43, V7-T8-45, V7-T8-47, V7-T8-52, V7-T8-55, V7-T8-57, V7-T8-60, V7-T8-69, V7-T8-71, V7-T8-74, V7-T8-76, V7-T8-78, V7-T8-80  |
| XBAD.....       | V7-T8-26   |
| XBAE.....       | V7-T8-19, V7-T8-28, V7-T8-91   |
| XBAF.....       | V7-T8-7, V7-T8-11, V7-T8-13, V7-T8-15, V7-T8-17, V7-T8-23, V7-T8-26, V7-T8-28, V7-T8-30, V7-T8-34, V7-T8-38, V7-T8-40, V7-T8-45, V7-T8-47, V7-T8-49, V7-T8-52, V7-T8-55, V7-T8-57, V7-T8-60, V7-T8-63, V7-T8-69, V7-T8-71, V7-T8-74, V7-T8-76, V7-T8-78, V7-T8-80, V7-T8-94  |
| XBAN.....       | V7-T3-144, V7-T8-92, V7-T8-93  |
| XBAP.....       | V7-T8-62–V7-T8-66, V7-T8-104   |
| XBAR.....       | V7-T8-8, V7-T8-35  |
| XBAS.....       | V7-T8-13, V7-T8-15, V7-T8-40, V7-T8-43, V7-T8-60, V7-T8-71, V7-T8-78, V7-T8-80   |
| XBAT.....       | V7-T8-7, V7-T8-11, V7-T8-13, V7-T8-15, V7-T8-17, V7-T8-26, V7-T8-30, V7-T8-34, V7-T8-40, V7-T8-45, V7-T8-47, V7-T8-49, V7-T8-52, V7-T8-55, V7-T8-57, V7-T8-60, V7-T8-65, V7-T8-69, V7-T8-71, V7-T8-74, V7-T8-76, V7-T8-78, V7-T8-80, V7-T8-83, V7-T8-88, V7-T8-105   |
| XBDP.....       | V7-T8-17   |
| XBGB.....       | V7-T8-102  |
| XBMB.....       | V7-T8-102  |
| XBMD.....       | V7-T8-104  |
| XBMG.....       | V7-T8-102  |
| XBMI.....       | V7-T8-102, V7-T8-104   |
| XBMK.....       | V7-T8-101, V7-T8-102   |
| XBML.....       | V7-T8-101  |
| XBMP.....       | V7-T8-56, V7-T8-101, V7-T8-104   |
| XBMR.....       | V7-T8-104  |
| XBMU.....       | V7-T8-29, V7-T8-102  |
| XBMX.....       | V7-T8-102  |
| XBMZ.....       | V7-T8-7, V7-T8-11, V7-T8-13, V7-T8-15, V7-T8-17, V7-T8-19, V7-T8-23, V7-T8-26, V7-T8-28, V7-T8-30, V7-T8-34, V7-T8-38, V7-T8-40, V7-T8-43, V7-T8-45, V7-T8-47, V7-T8-49, V7-T8-52, V7-T8-55, V7-T8-57, V7-T8-60, V7-T8-63, V7-T8-65, V7-T8-69, V7-T8-71, V7-T8-74, V7-T8-76, V7-T8-78, V7-T8-80, V7-T8-84, V7-T8-86, V7-T8-88, V7-T8-98, V7-T8-99, V7-T8-101 |
| XBPC.....       | V7-T8-25, V7-T8-51, V7-T8-77   |
| XBPF.....       | V7-T8-25, V7-T8-51, V7-T8-77   |
| XBPT.....       | V7-T8-33, V7-T8-37, V7-T8-39, V7-T8-40, V7-T8-42, V7-T8-44, V7-T8-46, V7-T8-48, V7-T8-49, V7-T8-51, V7-T8-59, V7-T8-84, V7-T8-88   |
| XBPU.....       | V7-T8-54   |
| XBQT.....       | V7-T8-68, V7-T8-70, V7-T8-71, V7-T8-73, V7-T8-75, V7-T8-77   |
| XBQU.....       | V7-T8-79   |
| XBTC.....       | V7-T8-97   |
| XBTD.....       | V7-T8-97   |
| XBTK.....       | V7-T8-25   |
| XBUK.....       | V7-T8-22, V7-T8-25, V7-T8-27, V7-T8-84, V7-T8-86   |
| XBUT.....       | V7-T8-6, V7-T8-10, V7-T8-12, V7-T8-14, V7-T8-16, V7-T8-21, V7-T8-22, V7-T8-25  |
| XB3U.....       | V7-T8-18, V7-T8-19   |
| XC-CPU.....     | V7-T4-33, V7-T4-34   |
| XC-152.....     | V7-T9-11   |
| XIO.....        | V7-T4-33   |
| XIOC.....       | V7-T4-34–V7-T4-37  |
| XN.....         | V7-T4-73–V7-T4-79  |
| XN-ANBZ.....    | V7-T4-80   |
| XNE.....        | V7-T4-71, V7-T4-72   |
| XN-KO.....      | V7-T4-80   |
| XN-LABEL.....   | V7-T4-80   |
| XN-PS.....      | V7-T4-80   |
| XN-QV.....      | V7-T4-80   |
| XN-WEW.....     | V7-T4-80   |
| XRA.....        | V7-T3-18   |
| XRP.....        | V7-T3-5  |
| XRR.....        | V7-T3-5, V7-T3-13, V7-T3-16  |
| XRU.....        | V7-T3-5, V7-T3-13, V7-T3-16  |
| XT-CAT.....     | V7-T4-37   |
| XT-CPU.....     | V7-T4-37   |
| XT-FIL.....     | V7-T4-37   |
| XT-MEM.....     | V7-T4-36   |
| XT-RJ45.....    | V7-T4-37   |
| XT-SUB.....     | V7-T4-37   |
| XV-10.....      | V7-T5-28   |
| XV-102.....     | V7-T4-62, V7-T5-29, V7-T9-11   |
| XV-152.....     | V7-T4-62, V7-T5-28   |
| <b>Z</b>        |  |
| ZB4.....        | V7-T3-45   |
| <b>Numerics</b> |  |
| 10250ED.....    | V7-T1-18, V7-T1-19, V7-T1-188, V7-T1-190, V7-T1-191, V7-T1-197, V7-T1-199, V7-T1-204, V7-T1-207, V7-T1-212, V7-T1-226, V7-T1-228, V7-T1-239, V7-T1-287, V7-T1-349  |
| 10250H.....     | V7-T1-18–V7-T1-20, V7-T1-23, V7-T1-27  |
| 10250T.....     | V7-T1-269  |
| 10250TA.....    | V7-T1-189, V7-T1-190, V7-T1-217, V7-T1-225–V7-T1-229, V7-T1-240, V7-T1-279, V7-T1-280, V7-T1-288   |
| 10250TB.....    | V7-T1-21, V7-T1-197, V7-T1-198, V7-T1-206, V7-T1-336, V7-T1-342  |
| 10250TC.....    | V7-T1-195, V7-T1-200, V7-T1-206, V7-T1-213, V7-T1-330–V7-T1-332, V7-T1-334, V7-T1-337, V7-T1-342   |
| 10250TD.....    | V7-T1-354  |
| 10250TE.....    | V7-T1-215, V7-T1-230, V7-T1-278, V7-T1-281, V7-T1-352, V7-T1-353   |
| 10250TF.....    | V7-T1-215, V7-T1-228, V7-T1-234, V7-T1-278, V7-T1-280, V7-T1-352, V7-T1-353  |
| 10250TG.....    | V7-T1-21   |
| 10250TJ.....    | V7-T1-197, V7-T1-198, V7-T1-206, V7-T1-218, V7-T1-232, V7-T1-336, V7-T1-342  |
| 10250TK.....    | V7-T1-213, V7-T1-227   |
| 10250TL.....    | V7-T1-213, V7-T1-230, V7-T1-232, V7-T1-281   |

## Appendix 2—Catalog Parent Number Index

|                   |   |                 |                                 |
|-------------------|---|-----------------|---------------------------------|
| 10250TM . . . . . | V7-T1-228, V7-T1-230–V7-T1-232, V7-T1-280   | 16-19 . . . . . | V7-T1-26                        |
| 10250TN . . . . . | V7-T1-232, V7-T1-233, V7-T1-283, V7-T1-356  | 16-20 . . . . . | V7-T1-179, V7-T1-240, V7-T1-288 |
| 10250TP . . . . . | V7-T1-231, V7-T1-232  | 16-34 . . . . . | V7-T1-240                       |
| 10250TR . . . . . | V7-T1-231, V7-T1-232, V7-T1-240, V7-T1-288  | 17-16 . . . . . | V7-T1-27                        |
| 10250TS . . . . . | V7-T1-213, V7-T1-230–V7-T1-232, V7-T1-234,<br>V7-T1-281, V7-T1-284  | 17-19 . . . . . | V7-T1-27                        |
| 10250T1 . . . . . | V7-T1-17, V7-T1-187, V7-T1-188, V7-T1-193,<br>V7-T1-194, V7-T1-198, V7-T1-201, V7-T1-204,<br>V7-T1-211, V7-T1-212, V7-T1-218,<br>V7-T1-236–V7-T1-238, V7-T1-286, V7-T1-287,<br>V7-T1-328, V7-T1-329, V7-T1-332, V7-T1-333,<br>V7-T1-340, V7-T1-349, V7-T1-354 | 24-50 . . . . . | V7-T1-240                       |
| 10250T2 . . . . . | V7-T1-17, V7-T1-186, V7-T1-187, V7-T1-193,<br>V7-T1-194, V7-T1-207, V7-T1-218–V7-T1-220,<br>V7-T1-236–V7-T1-238, V7-T1-286, V7-T1-287,<br>V7-T1-332, V7-T1-333  | 24-65 . . . . . | V7-T1-240                       |
| 10250T3 . . . . . | V7-T1-17, V7-T1-21, V7-T1-186, V7-T1-187,<br>V7-T1-192–V7-T1-194, V7-T1-202, V7-T1-212,<br>V7-T1-216, V7-T1-220, V7-T1-236–V7-T1-238,<br>V7-T1-286, V7-T1-287, V7-T1-333, V7-T1-349   | 25-18 . . . . . | V7-T1-240, V7-T1-288            |
| 10250T4 . . . . . | V7-T1-186, V7-T1-191, V7-T1-192, V7-T1-194,<br>V7-T1-198, V7-T1-201, V7-T1-204, V7-T1-207,<br>V7-T1-213, V7-T1-215–V7-T1-218,<br>V7-T1-236–V7-T1-238, V7-T1-286, V7-T1-287,<br>V7-T1-333, V7-T1-340   | 28-10 . . . . . | V7-T1-179                       |
| 10250T5 . . . . . | V7-T1-17, V7-T1-186, V7-T1-188, V7-T1-196,<br>V7-T1-197, V7-T1-199, V7-T1-204, V7-T1-214,<br>V7-T1-216, V7-T1-236–V7-T1-238, V7-T1-286,<br>V7-T1-287, V7-T1-328, V7-T1-340, V7-T1-352   | 28-15 . . . . . | V7-T1-179                       |
| 10250T6 . . . . . | V7-T1-205, V7-T1-214, V7-T1-236, V7-T1-238,<br>V7-T1-286, V7-T1-341, V7-T1-352  | 28-22 . . . . . | V7-T1-239, V7-T1-287            |
| 10250T7 . . . . . | V7-T1-22, V7-T1-192, V7-T1-193, V7-T1-205,<br>V7-T1-219, V7-T1-236–V7-T1-238, V7-T1-286,<br>V7-T1-287, V7-T1-324–V7-T1-326, V7-T1-335,<br>V7-T1-336, V7-T1-341, V7-T1-344, V7-T1-345  | 28-30 . . . . . | V7-T1-239, V7-T1-287            |
| 10250T8 . . . . . | V7-T1-205, V7-T1-330, V7-T1-331,<br>V7-T1-337–V7-T1-339, V7-T1-341  | 28-37 . . . . . | V7-T1-239, V7-T1-287            |
| 10250T9 . . . . . | V7-T1-198, V7-T1-201, V7-T1-204, V7-T1-205,<br>V7-T1-340, V7-T1-341   | 28-49 . . . . . | V7-T1-27, V7-T1-239, V7-T1-287  |
| 11-11 . . . . .   | V7-T1-240, V7-T1-288  | 28-51 . . . . . | V7-T1-239, V7-T1-287            |
| 11-16 . . . . .   | V7-T1-240, V7-T1-288  | 28-88 . . . . . | V7-T1-27                        |
| 11-20 . . . . .   | V7-T1-26, V7-T1-27, V7-T1-240, V7-T1-288  | 28-90 . . . . . | V7-T1-27                        |
| 11-21 . . . . .   | V7-T1-26  | 28-94 . . . . . | V7-T1-179                       |
| 11-45 . . . . .   | V7-T1-240, V7-T1-288  | 29-37 . . . . . | V7-T1-240, V7-T1-288            |
| 11-46 . . . . .   | V7-T1-27  | 30-44 . . . . . | V7-T1-240, V7-T1-288            |
| 11-54 . . . . .   | V7-T1-240, V7-T1-288  | 32-25 . . . . . | V7-T1-27                        |
| 11-57 . . . . .   | V7-T1-27  | 32-80 . . . . . | V7-T1-240, V7-T1-288            |
| 11-95 . . . . .   | V7-T1-27  | 35-15 . . . . . | V7-T1-179                       |
| 15-15 . . . . .   | V7-T1-240, V7-T1-288  | 41-78 . . . . . | V7-T1-240, V7-T1-288            |
| 15-18 . . . . .   | V7-T1-179   | 42-26 . . . . . | V7-T1-179                       |
| 15-19 . . . . .   | V7-T1-240, V7-T1-288  | 49-34 . . . . . | V7-T1-26                        |
| 16-MS . . . . .   | V7-T1-40  | 49-35 . . . . . | V7-T1-26                        |
| 16-15 . . . . .   | V7-T1-240, V7-T1-288  | 4977 . . . . .  | V7-T3-150                       |
|                   |   | 52-11 . . . . . | V7-T1-179                       |
|                   |   | 52-12 . . . . . | V7-T1-240                       |
|                   |   | 52-91 . . . . . | V7-T1-240                       |
|                   |   | 53-11 . . . . . | V7-T1-26                        |
|                   |   | 53-12 . . . . . | V7-T1-26                        |
|                   |   | 53-13 . . . . . | V7-T1-240, V7-T1-288            |
|                   |   | 53-31 . . . . . | V7-T1-240                       |
|                   |   | 54-12 . . . . . | V7-T1-240                       |
|                   |   | 54-71 . . . . . | V7-T1-240                       |
|                   |   | 54-72 . . . . . | V7-T1-240                       |
|                   |   | 56-10 . . . . . | V7-T1-240, V7-T1-288            |
|                   |   | 56-93 . . . . . | V7-T1-227                       |
|                   |   | 57-25 . . . . . | V7-T1-179                       |
|                   |   | 69-25 . . . . . | V7-T1-26                        |
|                   |   | 73-13 . . . . . | V7-T1-27                        |
|                   |   | 79-66 . . . . . | V7-T1-26, V7-T1-27              |
|                   |   | 80-55 . . . . . | V7-T1-240, V7-T1-288            |
|                   |   | 86-25 . . . . . | V7-T1-26, V7-T1-27              |
|                   |   | 86-35 . . . . . | V7-T1-27                        |
|                   |   | 911-3 . . . . . | V7-T1-27                        |
|                   |   | 9575 . . . . .  | V7-T3-119                       |

## A

|   |                              |
|---|------------------------------|
| Accessories                                       |                              |
| ELC2 Series PLCs                                  | V7-T4-17                     |
| M22 and Commercial Control Stations               | V7-T1-111–V7-T1-117          |
| Power Distribution Blocks                         | V7-T8-126                    |
| Pushbutton Control Stations                       | V7-T1-111–V7-T1-117          |
| M22 and Commercial                                | V7-T1-23                     |
| Pushbuttons                                       |                              |
| 10250T 30.5 mm Heavy-Duty                         |                              |
| Watertight/Oiltight                               | V7-T1-225–V7-T1-229          |
| E30 30.5 mm Square Multifunction                  |                              |
| Watertight/Oiltight                               | V7-T1-175                    |
| E34 30.5 mm Corrosion Resistant                   |                              |
| Watertight/Oiltight                               | V7-T1-279                    |
| HT800 30.5 mm Watertight/Oiltight                 | V7-T1-311                    |
| RMQ   | V7-T1-40                     |
| SmartWire-DT Panel Wiring System                  | V7-T9-1–V7-T9-16             |
| Stacklights                                       |                              |
| SL7 and SL4 Series                                | V7-T2-19                     |
| Toggle Switches                                   |                              |
| E10   | V7-T1-5                      |
| <b>XB</b> Series Terminal Blocks                  | V7-T8-90–V7-T8-105           |
| DIN Rails   | V7-T8-92                     |
| End Stops   | V7-T8-91                     |
| Ferrules  | V7-T8-94                     |
| Hand Tools  | V7-T8-97                     |
| Marking Accessories                               | V7-T8-98–V7-T8-104           |
| Mounting Brackets                                 | V7-T8-93                     |
| Plates, Covers and Bridges                        | V7-T8-105                    |
| Software, EMARK                                   | V7-T8-104                    |
| Testing Accessories                               | V7-T8-105                    |
| XC Series PLCs                                    | V7-T4-36                     |
| XI/ON Series I/O Modules                          | V7-T4-80                     |
| XV Series HMI-PLCs                                | V7-T4-58, V7-T4-62, V7-T9-11 |
| Acoustic Devices                                  |                              |
| Buzzers   | V7-T1-106                    |
| Complete Devices                                  | V7-T1-106                    |
| ASi Adapter Modules                               | V7-T1-108                    |
| <b>B</b>  |                              |
| Bulkhead Interfaces                               | V7-T1-107                    |
| Button Plates                                     |                              |
| RMQ   | V7-T1-42                     |
| <b>C</b>  |                              |
| CE Marked   |                              |
| Industrial Control Transformers                   | V7-T7-18                     |
| Commercial Control Stations                       |                              |
| 10250H Series Heavy-Duty                          | V7-T1-20, V7-T1-21           |
| Class I Division 2 10250T Series Heavy-Duty       | V7-T1-22                     |
| Class I Division 2 E34 Series Corrosion Resistant | V7-T1-23                     |
| Custom Assembled                                  | V7-T1-24                     |
| General Purpose                                   | V7-T1-18                     |
| Key Specifications                                | V7-T1-17                     |
| Special Purpose                                   | V7-T1-19                     |
| Connectivity Solutions                            |                              |
| SmartWire-DT                                      | V7-T9-1                      |

|  |  |
|--|--|
| Control Relays and Timers                  |  |
| Alternating Relays                         | V7-T3-188                              |
| Catalog Number Selection                   | V7-T3-3                                |
| EZ Programmable Relays                     | V7-T3-19–V7-T3-48                      |
| General Purpose Plug-In Relays             | V7-T3-49–V7-T3-117                     |
| Machine Tool Relays                        | V7-T3-141–V7-T3-166                    |
| Product Overview                           | V7-T3-2                                |
| Solid-State Relays                         | V7-T3-122–V7-T3-140                    |
| Timing Relays                              | V7-T3-167–V7-T3-187                    |
| <b>XR</b> Series Terminal Block Relays     | V7-T3-3–V7-T3-18                       |
| Control Station Components, M22            |  |
| Acoustic Devices                           | V7-T1-106                              |
| ASi Adapter Modules                        | V7-T1-108                              |
| Bulkhead Interfaces                        | V7-T1-107                              |
| Double Pushbuttons                         | V7-T1-99                               |
| Emergency Stops, Illuminated               | V7-T1-76                               |
| Four-Way Pushbuttons                       | V7-T1-103                              |
| Indicating Lights, Flush                   | V7-T1-73                               |
| Joysticks                                  | V7-T1-104                              |
| Mushroom Head Pushbuttons, Non-Illuminated | V7-T1-95, V7-T1-97                     |
| Palm Switches                              | V7-T1-109                              |
| Potentiometers                             | V7-T1-106                              |
| Pushbuttons                                |  |
| Illuminated                                | V7-T1-65, V7-T1-67, V7-T1-69, V7-T1-71 |
| Non-Illuminated                            | V7-T1-55, V7-T1-57, V7-T1-59, V7-T1-61 |
| Selector Switches, Illuminated             | V7-T1-85, V7-T1-86                     |
| Selector Switches, Key-Operated            | V7-T1-88–V7-T1-91                      |
| Selector Switches, Non-Illuminated         | V7-T1-81–V7-T1-83                      |
| Symbols Library                            | V7-T1-129                              |
| Through-the-Door Operators                 | V7-T1-107                              |
| Control Stations—Assembled                 | V7-T1-14–V7-T1-131                     |
| <b>D</b>                                   |  |
| Double Pushbutton Components               | V7-T1-99                               |
| Double Pushbuttons                         |  |
| Catalog Number Selection                   | V7-T1-98                               |
| Extended and Flush, Center Light           | V7-T1-100                              |
| <b>E</b>                                   |  |
| E10  |  |
| Hesitation Switches, Heavy-Duty            | V7-T1-5                                |
| Pushbuttons, Non-Illuminated               | V7-T1-5                                |
| Toggle Switches, General Purpose Toggles   | V7-T1-4                                |
| E10E                                       |  |
| Econoswitch                                | V7-T1-9                                |
| Molded-In Screw Terminal                   | V7-T1-9                                |
| Switch Guard                               | V7-T1-9                                |
| EASY Programmable Relays                   |  |
| EASY MFD (Multi-Function Displays)         | V7-T3-33                               |
| EASY/MFD Accessories                       | V7-T3-43                               |
| EASY/MFD Communication Modules             | V7-T3-40                               |
| EASY/MFD Expansion Modules                 | V7-T3-30                               |
| EASY/MFD Power Supplies                    | V7-T3-43                               |
| EASY/MFD Software                          | V7-T3-43                               |
| easySafety Relays and Timers               | V7-T3-199–V7-T3-204                    |

# Appendix 3—Alphabetical Product Index

|  |                     |
|--|---------------------|
| Eaton Terms & Conditions                             |                     |
| Freight . . . . .                                    | V7-A1-3             |
| Limitation of Liability . . . . .                    | V7-A1-5             |
| Terms and Conditions of Sale . . . . .               | V7-A1-1             |
| Terms of Payment . . . . .                           | V7-A1-2             |
| Warranty . . . . .                                   | V7-A1-3             |
| ELC Graphics Panels . . . . .                        | V7-T5-5             |
| Cable . . . . .                                      | V7-T5-8             |
| Products . . . . .                                   | V7-T5-7             |
| Protocols . . . . .                                  | V7-T5-5             |
| Software and Accessories . . . . .                   | V7-T5-8             |
| Technical Data . . . . .                             | V7-T5-10            |
| ELC2 Series Programmable Logic Controllers           |                     |
| Digital Expansion Modules (Right Side Bus) . . . . . | V7-T4-14            |
| ELC Modular PLCs . . . . .                           | V7-T4-6             |
| ELCM Modular Brick PLCs . . . . .                    | V7-T4-4             |
| Master Communication Modules . . . . .               | V7-T4-12            |
| Remote I/O Adapters . . . . .                        | V7-T4-13            |
| Emergency Stop Components                            |                     |
| Illuminated . . . . .                                | V7-T1-76            |
| Emergency Stops                                      |                     |
| Catalog Number Selection . . . . .                   | V7-T1-74            |
| Illuminated . . . . .                                | V7-T1-75, V7-T1-76  |
| Non-Illuminated . . . . .                            | V7-T1-75, V7-T1-76  |
| RMQ . . . . .  | V7-T1-35            |
| <b>F</b>   |                     |
| Four-Way Pushbutton Components . . . . .             | V7-T1-103           |
| Four-Way Pushbuttons                                 |                     |
| Catalog Number Selection . . . . .                   | V7-T1-102           |
| Fuse Blocks and Fuse Holders . . . . .               | V7-T8-128–V7-T8-134 |
| C350 Series Fuse Blocks . . . . .                    | V7-T8-131           |
| C383 Series Fuse Holders . . . . .                   | V7-T8-129           |
| W Series Fuse Holders . . . . .                      | V7-T8-131           |
| <b>G</b>   |                     |
| Galileo Software . . . . .                           | V7-T5-37            |
| General Purpose Plug-In Relays                       |                     |
| Accessories . . . . .                                | V7-T3-112–V7-T3-117 |
| D1PR/D1PF Series . . . . .                           | V7-T3-54            |
| D2PR/D2PF Series . . . . .                           | V7-T3-60            |
| D3PR/D3PF Series . . . . .                           | V7-T3-70            |
| D5PR/D5PF Series . . . . .                           | V7-T3-83            |
| D7PR/D7PF Series . . . . .                           | V7-T3-92            |
| D1RR/D1RF Series . . . . .                           | V7-T3-53            |
| D2PR/D2PF Series . . . . .                           | V7-T3-57            |
| D3PR/D3PF Series . . . . .                           | V7-T3-67            |
| D4 Series . . . . .                                  | V7-T3-76            |
| D5PR/D5PF Series . . . . .                           | V7-T3-80            |
| D7PR/D7PF Series . . . . .                           | V7-T3-89            |
| D8 Series . . . . .                                  | V7-T3-103           |
| D9 Series . . . . .                                  | V7-T3-108           |

|                              |           |
|------------------------------|-----------|
| General Purpose Relays       |           |
| 9575H Series 3000 . . . . .  | V7-T3-118 |
| Accessories                  |           |
| Type AA . . . . .            | V7-T3-119 |
| Type AA . . . . .            | V7-T3-118 |
| Type AA, AC and DC . . . . . | V7-T3-118 |

|                          |         |
|--------------------------|---------|
| Graphics Panels          |         |
| Power Supplies . . . . . | V7-T5-9 |

## H

|   |          |
|---|----------|
| <b>HMI</b> Operator Interface . . . . . | V7-T5-13 |
| Products . . . . .                      | V7-T5-15 |
| Protocols . . . . .                     | V7-T5-14 |
| Software and Accessories . . . . .      | V7-T5-16 |
| Technical Data . . . . .                | V7-T5-18 |

## I

|  |                   |
|--|-------------------|
| IEC— <b>XB</b> Series Terminal Blocks              |                   |
| IDC (Insulation Displacement Connection) . . . . . | V7-T8-67–V7-T8-81 |
| Miniature Circuit Breakers . . . . .               | V7-T8-82–V7-T8-89 |
| Pluggable Spring Cage . . . . .                    | V7-T8-58–V7-T8-66 |
| Product Overview . . . . .                         | V7-T8-2           |
| Screw Connection . . . . .                         | V7-T8-4–V7-T8-30  |
| Spring Cage . . . . .                              | V7-T8-31–V7-T8-57 |

## Indicating Lights

|   |                     |
|---|---------------------|
| 10250T/E34 30.5 mm Class I Division 2       |                     |
| Hazardous Locations . . . . .               | V7-T1-321–V7-T1-359 |
| E34 30.5 mm Class I Division 2 . . . . .    | V7-T1-332           |
| HT800 30.5 mm Watertight/Oiltight . . . . . | V7-T1-296–V7-T1-317 |
| M22, Flush . . . . .                        | V7-T1-72            |
| Catalog Number Selection . . . . .          | V7-T1-72            |
| Components . . . . .                        | V7-T1-73            |
| Ratings . . . . .                           | V7-T1-360           |
| RMQ . . . . .                               | V7-T1-34            |
| Symbols Library . . . . .                   | V7-T1-129           |

|   |                  |
|---|------------------|
| Industrial Control Transformers . . . . . | V7-T7-2–V7-T7-26 |
| CE Marked . . . . .                       | V7-T7-18         |
| Type AP . . . . .                         | V7-T7-25         |
| Type MTE . . . . .                        | V7-T7-4          |
| Type MTK . . . . .                        | V7-T7-13         |

## J

|                                     |                      |
|-------------------------------------|----------------------|
| Joystick Components . . . . .       | V7-T1-104            |
| Joysticks                           |                      |
| 10250T 30.5 mm Heavy-Duty . . . . . | V7-T1-216            |
| M22 . . . . .                       | V7-T1-104, V7-T1-105 |

## K

|   |                   |
|---|-------------------|
| Key-Operated Selector Switch Components . . . . . | V7-T1-88–V7-T1-91 |
| Key-Operated Selector Switches . . . . .          | V7-T1-88–V7-T1-91 |
| Catalog Number Selection . . . . .                | V7-T1-88          |



## M

|                                     |                    |
|-------------------------------------|--------------------|
| M22 Assembled Control Stations      | V7-T1-16           |
| Machine Tool Relays                 |                    |
| Accessories                         |                    |
| AR/ARD Series                       | V7-T3-155          |
| D15 Series                          | V7-T3-144          |
| AR/ARD Series                       | V7-T3-153          |
| BF/BFD Series                       | V7-T3-147          |
| D15 Series                          | V7-T3-142          |
| D26 Series—Type M, 600 Vac          | V7-T3-158          |
| D26 Series—Type M, DC               | V7-T3-163          |
| Options                             |                    |
| AR/ARD Series                       | V7-T3-155          |
| BF/BFD Series                       | V7-T3-150          |
| Mushroom Head Pushbutton Components |                    |
| Non-Illuminated                     |                    |
| Maintained                          | V7-T1-97           |
| Momentary                           | V7-T1-95           |
| Mushroom Head Pushbuttons           |                    |
| Catalog Number Selection            | V7-T1-93           |
| Non-Illuminated                     |                    |
| Maintained                          | V7-T1-96, V7-T1-97 |
| Momentary                           | V7-T1-94, V7-T1-95 |

## N

|                 |                     |
|-----------------|---------------------|
| NEMA            |                     |
| Terminal Blocks | V7-T8-106–V7-T8-115 |

## O

|                                       |                     |
|---------------------------------------|---------------------|
| Operator Components                   |                     |
| E30, Square Multifunction             | V7-T1-169–V7-T1-173 |
| Operator Interface Products           | V7-T5-1             |
| ELC Graphics Panels                   | V7-T5-5–V7-T5-12    |
| <b>HMI</b> Operator Interface         | V7-T5-13–V7-T5-20   |
| Visual Designer Software              | V7-T5-34            |
| XP and XV Operator Interface          | V7-T5-21–V7-T5-38   |
| XP and XV Operator Interface with     |                     |
| Visual Designer and XSoft-CoDeSys-2   | V7-T5-38            |
| XP with Visual Designer               | V7-T5-21–V7-T5-23   |
| Operators                             |                     |
| 10250T 30.5 mm Heavy-Duty             |                     |
| Watertight/Oiltight                   | V7-T1-182–V7-T1-247 |
| 10250T/E34 30.5 mm Class I Division 2 |                     |
| Hazardous Locations                   | V7-T1-321–V7-T1-359 |
| E30 30.5 mm Square Multifunction      |                     |
| Watertight/Oiltight                   | V7-T1-164–V7-T1-181 |
| E30 Square Multifunction Components   | V7-T1-169–V7-T1-173 |
| E30, Square Multifunction             | V7-T1-166           |
| E30, Square Multifunction and         |                     |
| Indicating Lights                     | V7-T1-169–V7-T1-173 |
| E30, Square Multifunction Components  | V7-T1-174           |
| E34 30.5 mm Corrosion Resistant       |                     |
| Watertight/Oiltight                   | V7-T1-254–V7-T1-293 |
| Symbols Library                       | V7-T1-129           |

## Options

|                                       |                     |
|---------------------------------------|---------------------|
| 10250T/E34 30.5 mm Class I Division 2 |                     |
| Hazardous Locations                   | V7-T1-354           |
| Pushbuttons                           |                     |
| 10250T 30.5 mm Heavy-Duty             |                     |
| Watertight/Oiltight                   | V7-T1-230           |
| E30 30.5 mm Square Multifunction      |                     |
| Watertight/Oiltight                   | V7-T1-176–V7-T1-178 |
| E34 30.5 mm Corrosion Resistant       |                     |
| Watertight/Oiltight                   | V7-T1-281           |
| HT800 30.5 mm Watertight/Oiltight     | V7-T1-312           |
| Toggle Switches                       |                     |
| E10E                                  | V7-T1-8             |

## P

|                                     |                     |
|-------------------------------------|---------------------|
| Palm Switches                       |                     |
| Catalog Number Selection            | V7-T1-109           |
| Complete Devices                    | V7-T1-109           |
| Components                          | V7-T1-110           |
| Panel Wiring                        |                     |
| SmartWire-DT                        | V7-T9-1             |
| Contactor Modules Diagram           | V7-T9-5             |
| PanelMate Operator Interface        |                     |
| Product Selection Guide             | V7-T5-2             |
| PLC, I/O and Communication Products | V7-T4-1             |
| ELC Series Programmable             |                     |
| Logic Controllers                   | V7-T4-2–V7-T4-28    |
| XC Series Programmable              |                     |
| Logic Controllers                   | V7-T4-29–V7-T4-56   |
| XI/ON Series Remote I/O             | V7-T4-63–V7-T4-109  |
| XV Series HMI-PLCs                  | V7-T4-61, V7-T4-62  |
| Potentiometers                      |                     |
| Complete Devices                    | V7-T1-106           |
| Components                          | V7-T1-106           |
| Power Distribution Blocks           | V7-T8-116–V7-T8-127 |
| CH160 Series                        | V7-T8-123           |
| CHDB Series                         | V7-T8-117           |
| Terminal Block Accessories          | V7-T8-126           |
| Power Supplies                      | V7-T6-1–V7-T6-31    |
| ELC Series                          | V7-T6-22            |
| EZ Power Supply                     | V7-T6-25            |
| PSG Series                          | V7-T6-3             |
| Sensor Power Supply                 | V7-T6-29            |
| Programmable Relays                 |                     |
| easy500/700/800                     | V7-T3-20            |
| easy802/806 with SmartWire-DT       | V7-T3-26            |
| Pushbutton Components, M22          |                     |
| Illuminated                         |                     |
| Extended, Maintained                | V7-T1-71            |
| Extended, Momentary                 | V7-T1-69            |
| Flush, Maintained                   | V7-T1-67            |
| Flush, Momentary                    | V7-T1-65            |
| Non-Illuminated                     |                     |
| Extended, Maintained                | V7-T1-61            |
| Extended, Momentary                 | V7-T1-59            |
| Flush, Maintained                   | V7-T1-57            |
| Flush, Momentary                    | V7-T1-55            |

# Appendix 3—Alphabetical Product Index

|   |                      |
|---|----------------------|
| Pushbutton Control Stations                       |                      |
| Coding Adapter Guide                              | V7-T1-118            |
| Commercial  | V7-T1-17             |
| 10250H Series Heavy-Duty                          | V7-T1-20             |
| 10250T Series Heavy-Duty                          | V7-T1-21             |
| Class I Division 2 10250T Series Heavy-Duty       | V7-T1-22             |
| Class I Division 2 E34 Series Corrosion Resistant | V7-T1-23             |
| General Purpose                                   | V7-T1-18             |
| Special Purpose                                   | V7-T1-19             |
| Custom Assembled                                  | V7-T1-24             |
| Pushbutton Control Stations—Assembled             | V7-T1-14–V7-T1-131   |
| Pushbuttons                                       |                      |
| 10250T  |                      |
| Catalog Number Selection                          | V7-T1-184, V7-T1-185 |
| Point-of-Purchase Packaging                       | V7-T1-186            |
| 10250T 30.5 mm Heavy-Duty                         |                      |
| Emergency Stops                                   | V7-T1-196–V7-T1-201  |
| Indicating Light Units                            | V7-T1-193, V7-T1-194 |
| Joystick Units                                    | V7-T1-215–V7-T1-217  |
| Key Operators                                     | V7-T1-211            |
| Operators and Pushbutton Units                    | V7-T1-190            |
| Potentiometers                                    | V7-T1-202            |
| Push-Pull Operators                               | V7-T1-203            |
| Roto-Push   | V7-T1-219–V7-T1-224  |
| Selector Switches                                 | V7-T1-207            |
| 10250T 30.5 mm Heavy-Duty                         |                      |
| Watertight/Oiltight                               | V7-T1-182–V7-T1-247  |
| 10250T/E34 30.5 mm Class I Division 2             |                      |
| Hazardous Locations                               | V7-T1-321–V7-T1-359  |
| E30 30.5 mm Square Multifunction                  |                      |
| Watertight/Oiltight                               | V7-T1-164–V7-T1-181  |
| E34 30.5 mm Corrosion Resistant                   |                      |
| Watertight/Oiltight                               | V7-T1-254–V7-T1-293  |
| HT800 30.5 mm Watertight/Oiltight                 | V7-T1-296–V7-T1-317  |
| Illuminated                                       |                      |
| E34   | V7-T1-262            |
| E34 30.5 mm Class I Division 2                    | V7-T1-330            |
| HT800   | V7-T1-300            |
| Key Operators, E34                                | V7-T1-276            |
| M22   |                      |
| Button Plates                                     | V7-T1-111            |
| Double  | V7-T1-98             |
| Emergency Stops                                   | V7-T1-74             |
| Four-Way  | V7-T1-102            |
| Illuminated                                       |                      |
| Catalog Number Selection                          | V7-T1-62             |
| Extended, Maintained                              | V7-T1-70, V7-T1-71   |
| Extended, Momentary                               | V7-T1-68, V7-T1-69   |
| Flush, Maintained                                 | V7-T1-66, V7-T1-67   |
| Flush, Momentary                                  | V7-T1-63–V7-T1-65    |
| Key-Operated Selector Switches                    | V7-T1-88             |
| Mushroom Head                                     | V7-T1-92             |
| Non-Illuminated                                   |                      |
| Catalog Number Selection                          | V7-T1-53             |
| Extended, Maintained                              | V7-T1-60, V7-T1-61   |
| Extended, Momentary                               | V7-T1-58, V7-T1-59   |
| Flush, Maintained                                 | V7-T1-56, V7-T1-57   |
| Flush, Momentary                                  | V7-T1-53–V7-T1-55    |
| Product Selection Guide                           | V7-T1-48–V7-T1-51    |
| Selector Switches                                 | V7-T1-78             |

|                                   |           |
|-----------------------------------|-----------|
| Pushbuttons, continued            |           |
| Momentary Units                   |           |
| E34 30.5 mm Class I Division 2    | V7-T1-324 |
| Non-Illuminated                   |           |
| E34                               | V7-T1-260 |
| E34 30.5 mm Class I Division 2    | V7-T1-328 |
| HT800                             | V7-T1-298 |
| Push-Pull Units                   |           |
| E34                               | V7-T1-264 |
| E34 30.5 mm Class I Division 2    | V7-T1-335 |
| HT800                             | V7-T1-306 |
| Ratings                           | V7-T1-360 |
| RMQ                               |           |
| Button Plates                     | V7-T1-42  |
| Illuminated                       | V7-T1-33  |
| Non-Illuminated                   | V7-T1-32  |
| Product Selection Guide           | V7-T1-31  |
| Selector Switches                 |           |
| E34                               | V7-T1-272 |
| E34 30.5 mm Class I Division 2    | V7-T1-344 |
| HT800                             | V7-T1-308 |
| Symbols Library                   | V7-T1-129 |
| Pushbuttons and Indicating Lights | V7-T1-1   |

## R

|                                     |                     |
|-------------------------------------|---------------------|
| Relays and Timers                   |                     |
| easySafety                          | V7-T3-199–V7-T3-204 |
| Renewal Parts                       |                     |
| M22 and Commercial Control Stations | V7-T1-26            |
| Replacement Parts                   |                     |
| Pushbuttons                         |                     |
| 10250T 30.5 mm Heavy-Duty           |                     |
| Watertight/Oiltight                 | V7-T1-239           |
| E30 30.5 mm Square Multifunction    |                     |
| Watertight/Oiltight                 | V7-T1-179           |
| E34 30.5 mm Corrosion Resistant     |                     |
| Watertight/Oiltight                 | V7-T1-287           |
| HT800 30.5 mm Watertight/Oiltight   | V7-T1-315           |
| Stacklights, E26 Series             | V7-T2-40            |
| RMQ                                 |                     |
| 16.22 mm Pushbuttons                | V7-T1-30–V7-T1-46   |
| Accessories                         | V7-T1-40            |

## S

|                                       |                     |
|---------------------------------------|---------------------|
| Selector Switch Components            |                     |
| Illuminated                           | V7-T1-85, V7-T1-86  |
| Non-Illuminated                       | V7-T1-81–V7-T1-83   |
| Selector Switches                     |                     |
| 10250T 30.5 mm Heavy-Duty             |                     |
| Watertight/Oiltight                   | V7-T1-182–V7-T1-247 |
| 10250T/E34 30.5 mm Class I Division 2 |                     |
| Hazardous Locations                   | V7-T1-321–V7-T1-359 |
| E34 30.5 mm Corrosion Resistant       |                     |
| Watertight/Oiltight                   | V7-T1-254–V7-T1-293 |
| HT800 30.5 mm Watertight/Oiltight     | V7-T1-296–V7-T1-317 |

## Selector Switches, continued

|                           |                    |
|---------------------------|--------------------|
| M22                       |                    |
| Catalog Number Selection  |                    |
| Illuminated . . . . .     | V7-T1-84           |
| Non-Illuminated . . . . . | V7-T1-79           |
| Illuminated . . . . .     | V7-T1-85           |
| Non-Illuminated . . . . . | V7-T1-80–V7-T1-83  |
| RMQ                       |                    |
| Illuminated . . . . .     | V7-T1-37           |
| Keyed . . . . .           | V7-T1-38, V7-T1-39 |
| Non-Illuminated . . . . . | V7-T1-36           |

|                               |          |
|-------------------------------|----------|
| Sensor Power Supply . . . . . | V7-T6-29 |
|-------------------------------|----------|

## SmartWire-DT

|  |          |
|--|----------|
| I/O and Powerfeed Modules, System              |          |
| Connectivity Components . . . . .              | V7-T9-13 |
| Motor Control Modules . . . . .                | V7-T9-17 |
| Pilot Device Modules . . . . .                 | V7-T9-24 |
| Stacklight Modules with SmartWire-DT . . . . . | V7-T9-27 |
| System Components . . . . .                    | V7-T9-3  |
| System Control                                 |          |
| easy800 . . . . .                              | V7-T9-12 |
| Gateway Modules . . . . .                      | V7-T9-10 |
| XC152 PLC . . . . .                            | V7-T9-11 |
| XV HMI/PLC . . . . .                           | V7-T9-11 |
| System Controllers . . . . .                   | V7-T9-7  |
| System Overview . . . . .                      | V7-T9-2  |

## Solid-State Relays

|                                    |           |
|------------------------------------|-----------|
| Accessories                        |           |
| D93 Series . . . . .               | V7-T3-124 |
| D93 Series . . . . .               | V7-T3-123 |
| D93, D96 and D99 Series            |           |
| Catalog Number Selection . . . . . | V7-T3-122 |
| Overview . . . . .                 | V7-T3-122 |
| D96 Series . . . . .               | V7-T3-130 |
| D99 Series . . . . .               | V7-T3-135 |

## Stacklights

|  |                    |
|--|--------------------|
| E26 Series . . . . .                     | V7-T2-32           |
| Assembled Units . . . . .                | V7-T2-35           |
| Components . . . . .                     | V7-T2-38           |
| LEDs—Cylindrical or Cluster . . . . .    | V7-T2-37           |
| Light and Xenon Strobe Modules . . . . . | V7-T2-36           |
| SL4 Series                               |                    |
| Acoustic Modules . . . . .               | V7-T2-16           |
| Base Modules . . . . .                   | V7-T2-17, V7-T2-18 |
| Complete Devices . . . . .               | V7-T2-14           |
| Component Identification . . . . .       | V7-T2-12, V7-T2-13 |
| Light Modules . . . . .                  | V7-T2-14–V7-T2-16  |
| SL7 Series                               |                    |
| Acoustic Modules . . . . .               | V7-T2-9            |
| Base Modules . . . . .                   | V7-T2-10, V7-T2-11 |
| Complete Devices . . . . .               | V7-T2-6            |
| Component Identification . . . . .       | V7-T2-4, V7-T2-5   |
| Light Modules . . . . .                  | V7-T2-6–V7-T2-8    |

## T

### Terminal Blocks

|  |                     |
|--|---------------------|
| IDC (Insulation Displacement Connection) . . . . . | V7-T8-67–V7-T8-81   |
| Miniature Circuit Breakers . . . . .               | V7-T8-82–V7-T8-89   |
| NEMA . . . . .                                     | V7-T8-106–V7-T8-115 |
| C381 Series . . . . .                              | V7-T8-107           |
| TB Series . . . . .                                | V7-T8-111           |
| Pluggable Spring Cage . . . . .                    | V7-T8-58–V7-T8-66   |
| Screw Connection . . . . .                         | V7-T8-4–V7-T8-30    |
| Spring Cage . . . . .                              | V7-T8-31–V7-T8-57   |

|   |         |
|---|---------|
| Terminal Blocks, Fuse Blocks and Fuse Holders . . . . . | V7-T8-1 |
|---|---------|

### Through-the-Door Operators

|                            |           |
|----------------------------|-----------|
| Complete Devices . . . . . | V7-T1-107 |
| Components . . . . .       | V7-T1-107 |

### Timing Relays

|                                   |           |
|-----------------------------------|-----------|
| Accessories                       |           |
| TMR5 Series . . . . .             | V7-T3-180 |
| TMR6 Series . . . . .             | V7-T3-184 |
| TR Series . . . . .               | V7-T3-177 |
| Product Selection Guide . . . . . | V7-T3-167 |
| TMR5 Series . . . . .             | V7-T3-179 |
| TMR6 Series . . . . .             | V7-T3-183 |
| TMRP Series . . . . .             | V7-T3-185 |
| TR Series . . . . .               | V7-T3-176 |
| Universal TR Series . . . . .     | V7-T3-172 |

### Toggle Switches

|                                       |                  |
|---------------------------------------|------------------|
| E10 . . . . .                         | V7-T1-2–V7-T1-7  |
| Accessories . . . . .                 | V7-T1-5          |
| E10E Environmentally Sealed . . . . . | V7-T1-8–V7-T1-11 |
| Options . . . . .                     | V7-T1-8          |

### Transformers

|                              |                  |
|------------------------------|------------------|
| Industrial Control . . . . . | V7-T7-1–V7-T7-26 |
|------------------------------|------------------|

### Type AP

|   |          |
|---|----------|
| Industrial Control Transformers . . . . . | V7-T7-25 |
|---|----------|

### Type MTE

|   |         |
|---|---------|
| Industrial Control Transformers . . . . . | V7-T7-4 |
|---|---------|

### Type MTK

|   |          |
|---|----------|
| Industrial Control Transformers . . . . . | V7-T7-13 |
|---|----------|

## V

|                                    |          |
|------------------------------------|----------|
| Visual Designer Software . . . . . | V7-T5-34 |
| Products . . . . .                 | V7-T5-35 |

## X

### XC Series Programmable Logic Controllers

|                                      |          |
|--------------------------------------|----------|
| XC101 Modular PLCs . . . . .         | V7-T4-33 |
| XC121 Compact PLC CPU . . . . .      | V7-T4-33 |
| XC121 I/O Expansion Module . . . . . | V7-T4-33 |
| XC201 Modular PLCs . . . . .         | V7-T4-34 |
| XC202 Modular PLCs . . . . .         | V7-T4-34 |

# Appendix 3—Alphabetical Product Index

|   |                              |
|---|------------------------------|
| XI/ON Series Remote I/O                           |                              |
| Base Modules . . . . .                            | V7-T4-77                     |
| XN Series . . . . .                               | V7-T4-73                     |
| XNE Series . . . . .                              | V7-T4-71                     |
| XP and XV Operator Interface . . . . .            | V7-T5-21                     |
| XP and XV Operator Interface with Visual Designer |                              |
| Product Selection Guide . . . . .                 | V7-T5-26                     |
| XP Operator Interface                             |                              |
| Products . . . . .                                | V7-T5-22                     |
| XP with Visual Designer . . . . .                 | V7-T5-21                     |
| Technical Data. . . . .                           | V7-T5-23                     |
| <b>XR</b> Series Terminal Block Relays            |                              |
| Accessories. . . . .                              | V7-T3-18                     |
| High Current . . . . .                            | V7-T3-15                     |
| OptoCoupler . . . . .                             | V7-T3-12                     |
| Standard . . . . .                                | V7-T3-4                      |
| XSoft-CoDeSys-2. . . . .                          | V7-T5-24                     |
| Products . . . . .                                | V7-T5-38                     |
| XSoft-CoDeSys-3. . . . .                          | V7-T5-38                     |
| XV Operator Interface                             |                              |
| Products . . . . .                                | V7-T5-28, V7-T5-29, V7-T5-30 |
| XV Series HMI-PLCs . . . . .                      | V7-T4-61                     |
| XV with Visual Designer . . . . .                 | V7-T5-24                     |
| XV with Visual Designer or XSoft-CoDeSys          |                              |
| Technical Data. . . . .                           | V7-T5-32                     |
| XV with XSoft-CoDeSys-3. . . . .                  | V7-T5-24                     |