

Industrial relays
Standard type

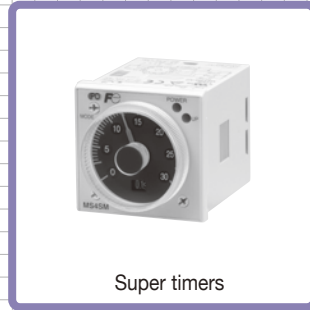

Industrial relays
Mechanically latch type



Super timers



Super timers

■ INDUSTRIAL RELAYS

■ INDUSTRIAL CONTROL RELAYS

■ ANNUNCIATOR RELAY UNIT

■ TIME DELAY RELAYS

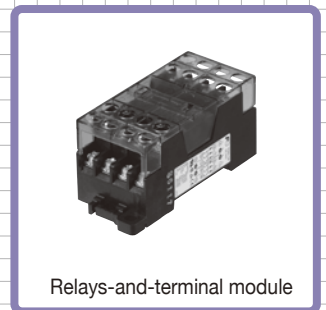

Relays-and-terminal module

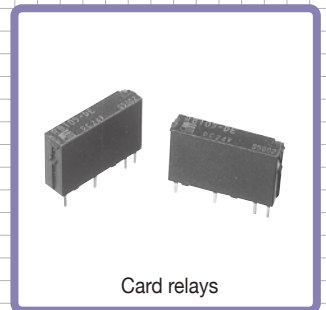

Card relays

LOW
VOLTAGE
EQUIPMENT
Up to 600 Volts



Annunciator relay units

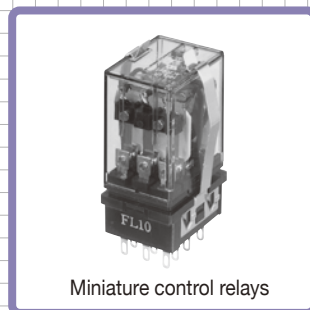

Miniature control relays

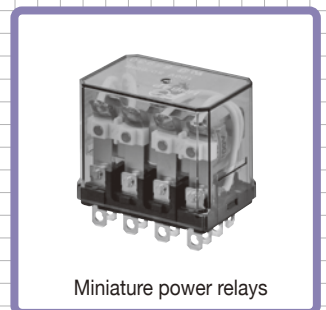

Miniature power relays

INDIVIDUAL CATALOG **03**
from D&C CATALOG 20th Edition

01 02 **03** 04 05 06 07 08 09 10 11 12

03

Industrial Relays Industrial Control Relays Time Delay Relays



Page

Industrial Relays	SH series	
	General information	03/1
	Optional units	03/2
	Standard type	03/3
	DC-operated type	03/6
	UL and CSA approved	03/8
	TÜV and CCC approved	03/9
	Off-delay release type	03/10
	Mechanical latch type	03/11
	With extra pick-up operating coil	03/13
	With quick terminals	03/14
Industrial Control Relays	Card relays RB104,105	03/15
	Relays-and-terminal module	03/16
	Miniature control relays HH52, HH53, HH54	03/25
	Miniature power relays HH62, HH63, HH64	03/37
	General purpose relays HH22, HH23, HH24	03/41
Annunciator Relay Units	RV, JH13PN-Flicker relays	03/46
Time Delay Relays	General information	03/49
	Ordering code system	03/50
	Selection guide	03/51
	Super Timers	
	MS4S series	03/52
	ST7P, 7B	03/60

MINIMUM ORDERS

Orders amounting to **less than ¥10,000** net per order will be charged as ¥10,000 net per order plus freight and other charges.

WEIGHTS AND DIMENSIONS

Weights and dimensions appearing in this catalog are the best information available at the time of going to press.

FUJI ELECTRIC FA has a policy of continuous product improvement, and design changes may make this information out of date.

Please confirm such details before planning actual construction.

INFORMATION IN THIS CATALOG IS SUBJECT TO CHANGE WITHOUT NOTICE.

Bifurcated contacts with excellent electrical conductivity/SH-4, SH-5

■ **Description**

SH series industrial relays are designed to increase contact reliability and make them easy to use. The relays' highly reliable, bifurcated contacts allow them to be used in low-level circuits of 5V, 3mA. Various optional function units such as auxiliary contact blocks, coil surge suppression units can be added to the relays, allowing fast and field modification.

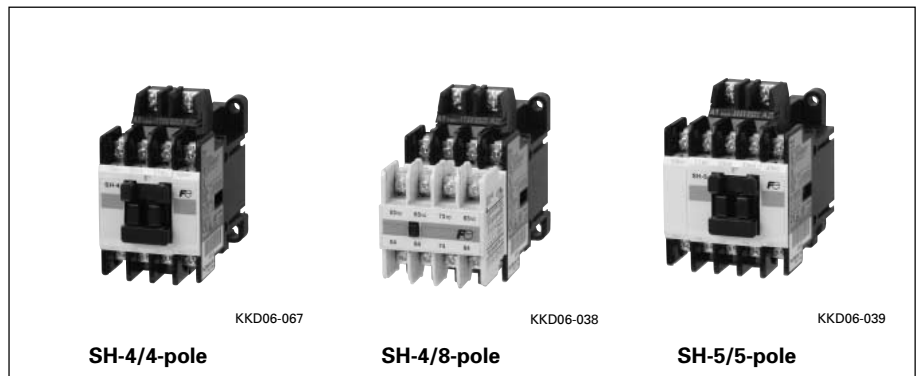

■ **Types and ratings**

Type	SH-4			SH-5		
Pole (No.of contacts)	4			8		
Contact arrangement	4NO, 3NO+1NC, 2NO+2NC			8NO, 7NO+1NC, 6NO+2NC 5NO+3NC, 4NO+4NC		
Thermal current (A)	10			10		
Rated operational current (A)	Volts	AC-15 (ind.)	AC-12 (res.)	Volts	DC-13 (ind.)	DC-12 (res.)
	110V AC	6	10	24V DC	3	5
	220V AC	3	8	48V DC	1.5	3
	440V AC	1.5	5	110V DC	0.55	2.5
	550V AC	1.2	5	220V DC	0.27	1
Standard operating coil voltage	100V 50Hz/100-110V 60Hz, 200V 50Hz/200-220V 60Hz, 380V-400V 50Hz/400-440V 60Hz					
Mechanical durability	10 million operations					
Electrical durability (AC-15)	500,000 operations (at operational current)					
Operating cycles per hour	1,800					
Ambient temperature	-5 to +50°C					

■ **Ordering code system**

S H 04 A A-1 22

① ② ③④ ⑤ ⑥ ⑦ ⑧⑨

① **Product category**

Description	Code
Industrial relay	S

② **Series category**

Description	Code
SH series	H

③④ **Frame size**

Frame size	Code	
	③	④
SH-4	0	4
SH-5	0	5

⑤ **Version**

Description	Code
Standard	A

⑥ **Coil/contact specification**

Description	Code
Standard	
AC operated	A
DC operated	G
With extra pick-up coil	U
Mechanical latch	
AC operated	V
DC operated	D
With single-button contact	H

⑦ **Coil voltage**

Coil voltage	Code
24V 50Hz/24-26V 60Hz	E
48V 50Hz/48-52V 60Hz	F
100V 50Hz/100-110V 60Hz	1
100-110V 50Hz/110-120V 60Hz	H
110-120V 50Hz/120-130V 60Hz	K
200V 50Hz/200-220V 60Hz	2
200-220V 50Hz/220-240V 60Hz	M
220-240V 50Hz/240-260V 60Hz	P
346-380V 50Hz/380-420V 60Hz	S
380-400V 50Hz/400-440V 60Hz	4
415-440V 50Hz/440-480V 60Hz	T
480-500V 50Hz/500-550V 60Hz	5
24V DC	E
48V DC	F
100V DC	1
110V DC	H
200V DC	2
220V DC	M

⑧⑨ **Contact arrangement**

Contact arrangement	Code	
	⑧	⑨
4NO	4	0
3NO+1NC	3	1
2NO+2NC	2	2
8NO	8	0
7NO+1NC	7	1
6NO+2NC	6	2
5NO+3NC	5	3
4NO+4NC	4	4
5NO	5	0
4NO+1NC	4	1
3NO+2NC	3	2
2NO+3NC	2	3
1NO+4NC	1	4
5NC	0	5

Industrial Relays

SH series

General information

Optional units

Front mounting

Auxiliary contact block

2 or 4-pole

Highly reliable bifurcated contact can be used in low-level circuit of 5V, 3mA.

Operation counter

This counter indicates the number of relay ON-OFF operations to ensure easy maintenance and inspection.

Terminal cover

The relay can easily be fitted with terminal covers for finger safety.

Top mounting

Coil drive unit

This unit controls ON-OFF operation for industrial relay with output from electronic equipment.

Coil surge suppression unit

This unit absorbs coil surge voltage due to relay ON-OFF operations.

Side mounting

Auxiliary contact block

2-pole (1NO+1NC)

Separate mounting

Off-delay release unit

This industrial relay can be held in closed position even when the instantaneous power failure occurs.

Easy modular system

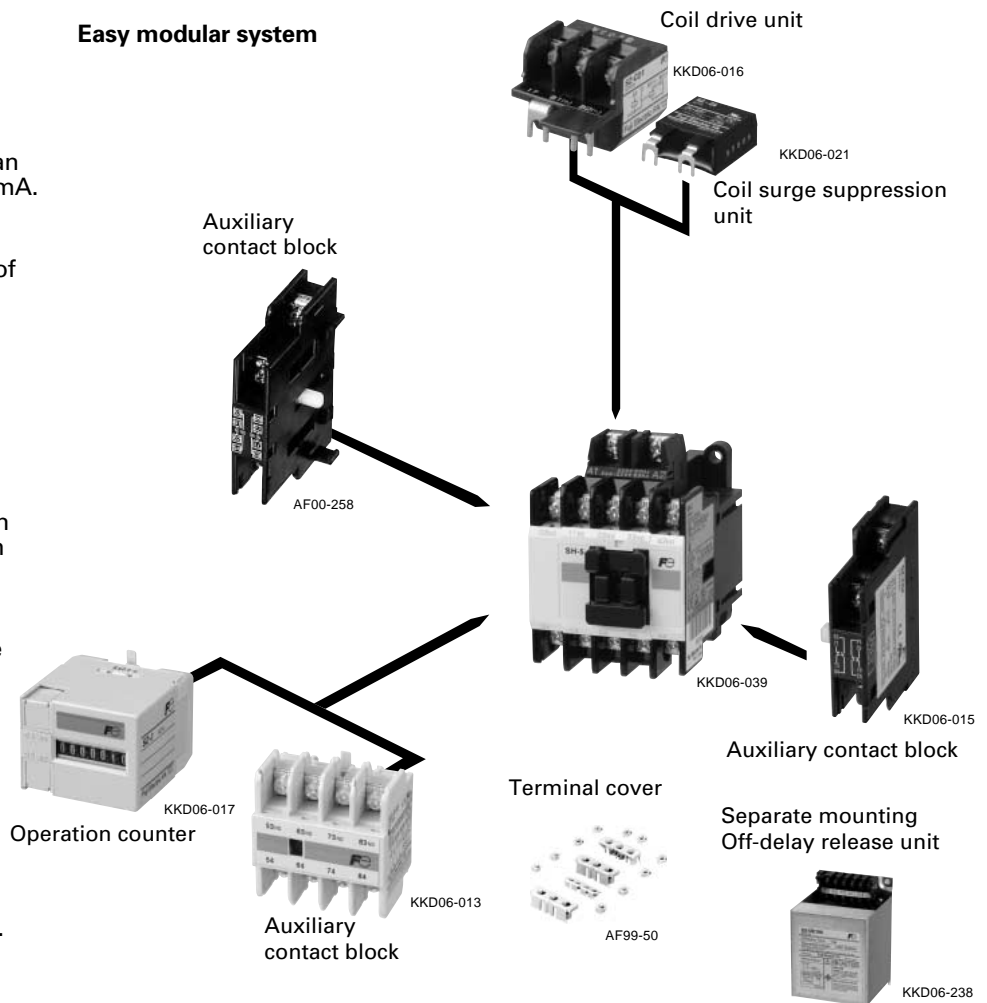

Description		Type	Ordering code	Description		Type	Ordering code	
Auxiliary contact block	For SH-4, SH-5			Terminal cover	For SH-4, SH-4H	SZ-T1	SZ1T1	
	Front mounting (Bifurcated)				For SH-5, SH-5H	SZ-T2	SZ1T2	
	4NO	SZ-A40	SZ1A40		For front mounting contact block 4-pole	SZ-T5	SZ1T5	
	3NO+1NC	SZ-A31	SZ1A31	2-pole	SZ-T6	SZ1T6		
	2NO+2NC	SZ-A22	SZ1A22	1-pole	SZ-T7	SZ1T7		
	2NO	SZ-A20	SZ1A20	Coil drive unit	24V DC Relay contact	SZ-CD1	SZ1CD1	
	1NO+1NC	SZ-A11	SZ1A11		24V DC Solid-state contact	SZ-03/CD2-24	SZ103CD224	
	2NC	SZ-A02	SZ1A02		Coil surge suppression unit	Varistor 24-48V AC/DC	SZ-Z1	SZ1Z1
	1NO+1NC *	SZ-A111	SZ1A111			100-250V AC/DC	SZ-Z2	SZ1Z2
	2NO+2NC *	SZ-A222	SZ1A222			380-440V AC/DC	SZ-Z3	SZ1Z3
	Front mounting (Single button)					24-48V AC/DC with LED	SZ-Z6	SZ1Z6
	4NO	SZ-A40H	SZ1A40H	100-240V AC/DC with LED		SZ-Z7	SZ1Z7	
3NO+1NC	SZ-A31H	SZ1A31H	C-R	24-48V AC/DC		SZ-Z4	SZ1Z4	
2NO+2NC	SZ-A22H	SZ1A22H		100-250V AC/DC	SZ-Z5	SZ1Z5		
Side mounting (Bifurcated)				24-48V AC/DC with LED	SZ-Z8	SZ1Z8		
1NO+1NC	SZ-AS1	SZ1AS1		100-240V AC/DC with LED	SZ-Z9	SZ1Z9		
Side mounting (Single button)				Off-delay release unit	100V AC 50/60Hz	SZ-DE100	SZ1DE100	
1NO+1NC	SZ-AS1H	SZ1AS1H			110V AC 50/60Hz	SZ-DE110	SZ1DE110	
Operation counter	Without alarm contact	SZ-J	SZ1J		200V AC 50/60Hz	SZ-DE200	SZ1DE200	
	With alarm contact				220V AC 50/60Hz	SZ-DE220	SZ1DE220	
	At 1-million operations	SZ-J1	SZ1J1		Up to 240V AC available			
	At 2-million operations	SZ-J2	SZ1J2		Live section cover	For SH-4, SH-4H	SZ-JC1	SZ1JC1
	At 3-million operations	SZ-J3	SZ1J3	For SH-5, SH-5H		SZ-JC2	SZ1JC2	
	At 4-million operations	SZ-J4	SZ1J4					
	At 5-million operations	SZ-J5	SZ1J5					
	At 6-million operations	SZ-J6	SZ1J6					
At 7-million operations	SZ-J7	SZ1J7						
At 8-million operations	SZ-J8	SZ1J8						

Note: * Overlapping contact

Standard type industrial relays

■ Description

They are compact and highly efficient and have a long service life, and are suited for industrial electrical control applications. Typical applications include machine tools, process lines, conveyors and automatic and semi-automatic equipment.

The maximum contact ratings are 550 volts AC and 220 volts DC. Operating coils with rating of up to 600 volts AC are available.

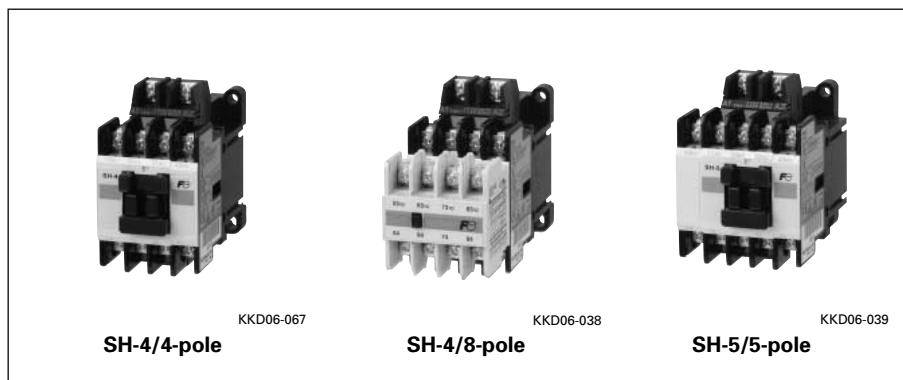

■ Features

- Mounting compatible with conventional SRC50 series industrial relays
- Employing of bifurcated contact to increase high contact reliability in low-level circuit use (5V, 3mA) and single button auxiliary contact applicable for large current circuit use.

- Variety of optional function units available
Auxiliary contact block (2 or 4-pole)
Off-delay release unit
Coil surge suppression unit
Operation counter

- Snap-on 35mm IEC and DIN rail mounting available
- Meets JIS, IEC, BS, NEMA and VDE Standards
UL, CSA, TÜV, CCC, BV and LR approved
- Terminal numbers meet IEC

■ Contact ratings

Type	Ordering code *2	Contact	Pole	Rated thermal current (A)	Make and break capacity AC (A)	Rated operational current (A)					
						AC Voltage (V)	Ind. AC-15	Res. AC-12	DC Voltage (V)	Ind. *1 DC-13	Res. DC-12
SH-4	SH04AA-■□	Bifurcated contact	4 8	10	60	110	6	10	24	3	5
					30	220	3	8	48	1.5	3
					15	440	1.5	5	110	0.55	2.5
					12	550	1.2	5	220	0.27	1
SH-5	SH05AA-■□	Bifurcated contact	5	10	60	110	6	10	24	3	5
					30	220	3	8	48	1.5	3
					15	440	1.5	5	110	0.55	2.5
					12	550	1.2	5	220	0.27	1
SH-4H	SH04AH-■□	Single contact	4 8	10	60	110	6	10	24	5	10
					60	220	6	10	48	1.5	5
					40	440	4	10	110	0.7	4
					40	550	4	10	220	0.27	1
SH-5H	SH05AH-■□	Single contact	5	10	60	110	6	10	24	5	10
					60	220	6	10	48	1.5	5
					40	440	4	10	110	0.7	4
					40	550	4	10	220	0.27	1

Notes: *1 Time constant is less than 70ms.

*2 Enter the coil voltage code in the ■ mark.

Enter the contact arrangement code in the □ mark.

• 8-pole type SH-4(H) is a combination of 4-pole type SH-4(H) and add-on auxiliary contact block SZ-A□(H).

■ Coil voltage

Type	Operating coil voltage *1	Coil voltage code *2	Operating voltage range	Wiring
SH-4 SH-5	24V 50Hz/24 to 26V 60Hz 48V 50Hz/48 to 52V 60Hz	E F	0.85 to 1.1 times coil rated voltage	
SH-4H SH-5H	100V 50Hz/100 to 110V 60Hz 110 to 120V 50Hz/120 to 130V 60Hz	1 K		
	200V 50Hz/200 to 220V 60Hz 220 to 240V 50Hz/240 to 260V 60Hz	2 P		
	346 to 380V 50Hz/380 to 420V 60Hz 380 to 400V 50Hz/400 to 440V 60Hz 415 to 440V 50Hz/440 to 480V 60Hz 480 to 500V 50Hz/500 to 550V 60Hz	S 4 T 5		

Notes: *1 Other voltages between 24V and 600V AC are available on request.

*2 When ordering, specify the coil voltage code.

Industrial Relays

SH series

Standard type

■ Coil characteristics

Type	Pole	Power consumption		Pick-up voltage (V)		Drop-out voltage (V)		Watt loss (W)	
		Inrush (VA)	Sealed (VA)	200V 50Hz	220V 60Hz	200V 50Hz	220V 60Hz	200V 50Hz	220V 60Hz
SH-4, 4H	4	95	9	105-125	116-136	70-98	80-110	2.7	2.8
SH-4, 4H	8	95	9	105-125	116-136	70-98	80-110	2.7	2.8
SH-5, 5H	5	95	9	105-125	116-136	70-98	80-110	2.7	2.8

Note: Coil rating 200V 50Hz/200-220V 60Hz

■ Operating characteristics

Type	Pole	Contact arrangement	Voltage (V)	Frequency (Hz)	Pick-up time(ms.)		Drop-out time(ms.)	
					NO contact ON	NC contact OFF	NO contact OFF	NC contact ON
SH-4, 4H	4	2NO+2NC	200	50	9-20	5-15	5-15	9-20
SH-4, 4H	8	4NO+4NC	200	50	9-20	5-15	5-15	9-20
SH-5, 5H	5	3NO+2NC	200	50	9-20	5-15	5-15	9-20

Note: Coil rating 200V 50Hz/200-220V 60Hz

■ Performance data (AC-15)

Type	Pole	Making current	Breaking current	Operating cycles per hour	Voltage	Life expectancy(operations)	
						Electrical	Mechanical
SH-4, 4H	4	10 le	1 le	1800	220V/440V	500,000	10 million
SH-4, 4H	8	10 le	1 le	1800	220V/440V	500,000	10 million
SH-5, 5H	5	10 le	1 le	1800	220V/440V	500,000	10 million

Note: le: Rated operational current (A)

■ Combination of industrial relay and auxiliary contact block

The standard type industrial relays can be used according to the combination with the auxiliary contact blocks shown below.

Industrial relay		Add-on auxiliary contact block						Side mounting	
Bifurcated contacts		Front mounting						SZ-AS1x2	
Type	Contact arrangement	SZ-A40	SZ-A31	SZ-A22	SZ-A20	SZ-A11	SZ-A02	SZ-AS1	SZ-AS1
		4NO	3NO+1NC	2NO+2NC	2NO	1NO+1NC	2NC	2NO+2NC	1NO+1NC
SH-4	4NO	8NO	7NO+1NC	6NO+2NC	6NO	5NO+1NC	4NO+2NC	6NO+2NC	5NO+1NC
	3NO+1NC	7NO+1NC	6NO+2NC	5NO+3NC	5NO+1NC	4NO+2NC	3NO+3NC	5NO+3NC	4NO+2NC
	2NO+2NC	6NO+2NC	5NO+3NC	4NO+4NC	4NO+2NC	3NO+3NC	2NO+4NC	4NO+4NC	3NO+3NC
	8NO	-	-	-	-	-	-	-	-
	7NO+1NC	-	-	-	-	-	-	-	-
	6NO+2NC	-	-	-	-	-	-	-	-
	5NO+3NC	-	-	-	-	-	-	-	-
4NO+4NC	-	-	-	-	-	-	-	-	
SH-5	5NO	9NO	8NO+1NC	7NO+2NC	7NO	6NO+1NC	5NO+2NC	7NO+2NC	6NO+1NC
	4NO+1NC	8NO+1NC	7NO+2NC	6NO+3NC	6NO+1NC	5NO+2NC	4NO+3NC	6NO+3NC	5NO+2NC
	3NO+2NC	7NO+2NC	6NO+3NC	5NO+4NC	5NO+2NC	4NO+3NC	3NO+4NC	5NO+4NC	4NO+3NC
	2NO+3NC	6NO+3NC	5NO+4NC	-	4NO+3NC	3NO+4NC	-	-	3NO+4NC
	1NO+4NC	5NO+4NC	-	-	3NO+4NC	-	-	-	-
	5NC	4NO+5NC	-	-	2NO+5NC	-	-	-	-

Industrial relay		Add-on auxiliary contact block		
Single contact		Front mounting		
Type	Contact arrangement	SZ-A40H	SZ-A31H	SZ-A22H
		4NO	3NO+1NC	2NO+2NC
SH-4H	4NO	8NO	7NO+1NC	6NO+2NC
	3NO+1NC	-	-	-
	2NO+2NC	-	5NO+3NC	4NO+4NC
SH-5H	5NO	9NO	8NO+1NC	7NO+2NC
	4NO+1NC	-	-	-
	3NO+2NC	-	6NO+3NC	5NO+4NC
	2NO+3NC	-	-	-
	1NO+4NC	-	-	-
	5NC	4NO+5NC	-	-

Notes:

- Both front mounting and side mounting auxiliary contact blocks cannot be mounted on a relay at a time.
- Any auxiliary contact blocks cannot be mounted on 8-pole type SH-4 and SH-4H relays.
- Side mounting contact blocks (SZ-AS1), with bifurcated contacts, can be mounted on SH-4H and SH-5H.

■ Ordering information

Specify the following:

1. Ordering code

■ Dimensions, mm
SH-4, 4H/4-pole

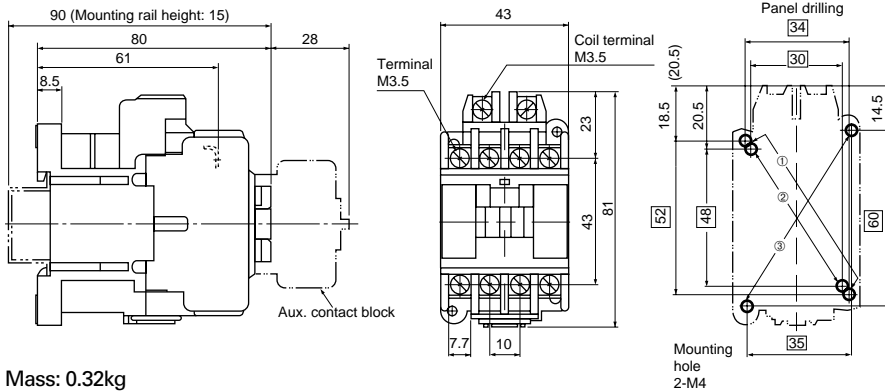

Mass: 0.32kg

SH-4, 4H/8-pole

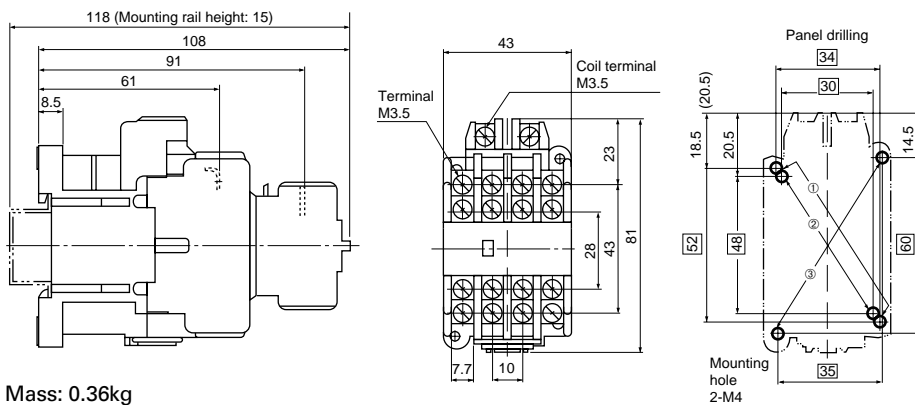

Mass: 0.36kg

SH-5, 5H/5-pole

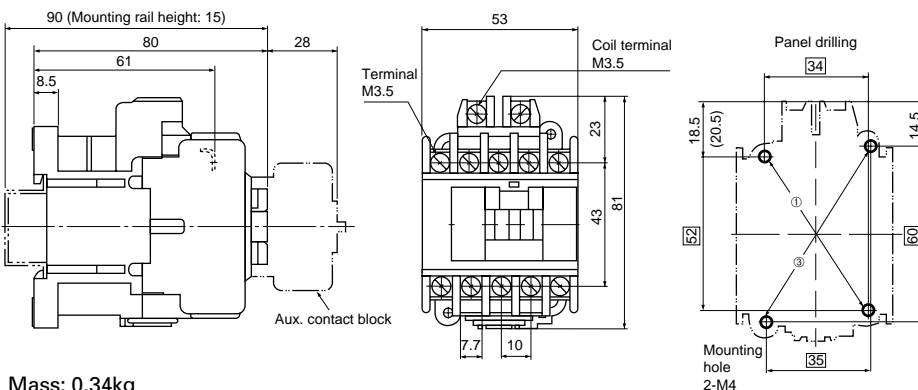

Mass: 0.34kg

- Notes on panel drilling
- Use the two mounting holes on a diagonal line to mount a relay.
 - Mounting holes indicated by ① and ② are compatible with those of SRC type.
 - Mounting holes indicated by ③ conform to IEC Standards.

■ Contact arrangement

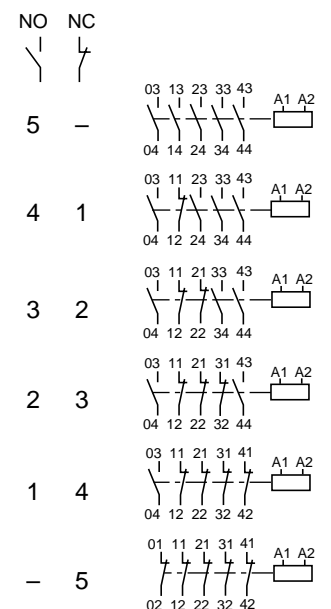
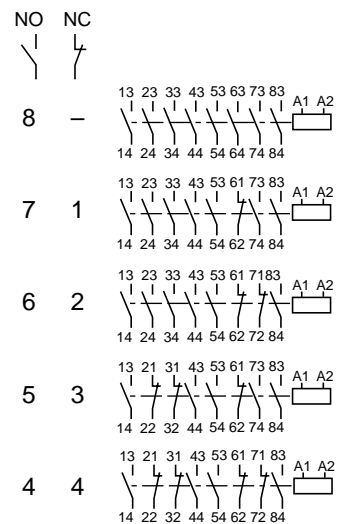
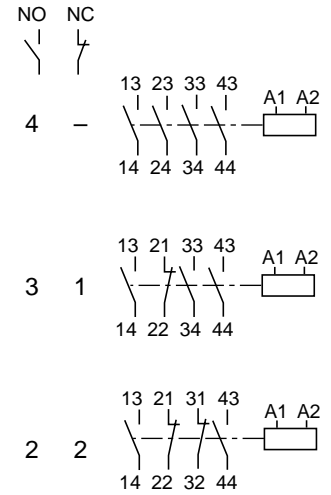

Industrial Relays

SH series

DC-operated type

DC-operated industrial relays

■ Description

The operating coil is a DC type instead of AC and is energized by a DC power source.

The coil ratings from 24V DC to 220V DC. The maximum contact ratings are 550V AC or 220V DC.

These relays are typically used where DC is used as a power source on switchboards. Where AC is used as a power source, sequence control is frequently lost due to the troubles such as power failure or momentary voltage drop.

In the case of DC-control, a battery power supply is frequently used because it is not susceptible to external influences. DC-operated relays are highly suitable for important control applications.

■ Features

- Employing of bifurcated contact to increase high contact reliability in low-level circuit use (5V, 3mA)
- Variety of optional function units available

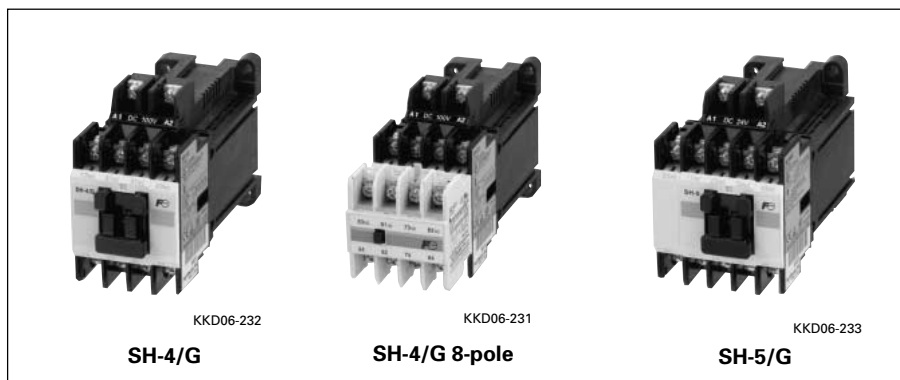

- Auxiliary contact block (2 or 4-pole)
- Coil surge suppression unit
- Operation counter
- Snap-on 35mm IEC and DIN rail mountings available
- Meets JIS, IEC, BS, NEMA and VDE Standards
- UL, CSA, TÜV, CCC and BV approved
- Terminal numbers meet IEC

■ Performance data

- Mechanical durability: 10 million operations
- Electrical durability: 500,000 operations (at AC-15 rated operational current)
- Operating cycles per hour: 1800
- Allowable ambient temp.: -5° to +50°C

■ Contact ratings

Type	Ordering code *2	Pole	Rated thermal current (A)	Make and break capacity AC (A)	Rated operational current (A)			DC Voltage (V)	Ind. *1 DC-13	Res. DC-14
					AC Voltage (V)	Ind. AC-15	Res. AC-12			
SH-4/G	SH04AG-■□	4	10	60	110	6	10	24	3	5
				30	220	3	8	48	1.5	3
				15	440	1.5	5	110	0.55	2.5
				12	550	1.2	5	220	0.27	1
		8	10	60	110	6	10	24	3	5
				30	220	3	8	48	1.5	3
				15	440	1.5	5	110	0.55	2.5
				12	550	1.2	5	220	0.27	1
SH-5/G	SH05AG-■□	5	10	60	110	6	10	24	3	5
				30	220	3	8	48	1.5	3
				15	440	1.5	5	110	0.55	2.5
				12	550	1.2	5	220	0.27	1

Notes: *1 Time constant is less than 70ms.

*2 Enter the coil voltage code in the ■ mark.

Enter the contact arrangement code in the □ mark.

■ Coil ratings

Type	Pole	Contact arrangement	Operating coil voltage (V DC)	Code	Power consumption(W)
SH-4/G	4	4NO, 3NO+1NC, 2NO+2NC	24	E	7
			48	F	
	8	8NO, 7NO+1NC, 6NO+2NC 5NO+3NC, 4NO+4NC	100	1	
			110	H	
SH-5/G	5	5NO, 4NO+1NC, 3NO+2NC 2NO+3NC, 1NO+4NC, 5NC	200	2	
			220	M	

■ Ordering information

- Specify the following:
1. Ordering code

■ Combination with auxiliary contact blocks

- Same as standard type.
See page 03/4.

■ Operating characteristics

Type	Pole	Contact arrangement	Voltage	Pick-up time (ms.)		Drop-out time (ms.)	
				NO contact ON	NC contact OFF	NO contact OFF	NC contact ON
SH-4/G	4	2NO+2NC	100V DC	45-50	35-40	20-25	25-30
	8	4NO+4NC	100V DC	45-50	35-40	20-25	25-30
SH-5/G	5	3NO+2NC	100V DC	45-50	35-40	20-25	25-30

Note: Coil rating 100V DC

■ Dimensions, mm

SH-4/G, 4-pole

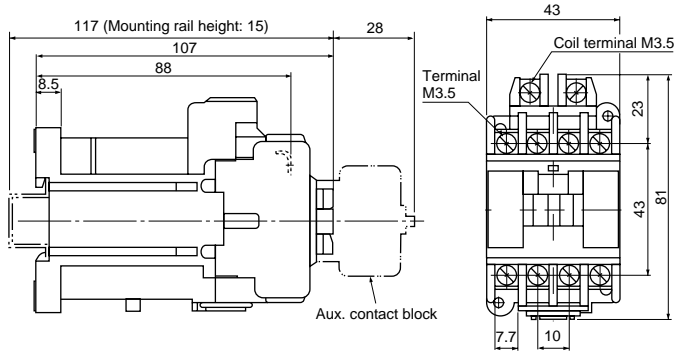

Mass: 0.55kg

■ Contact arrangement

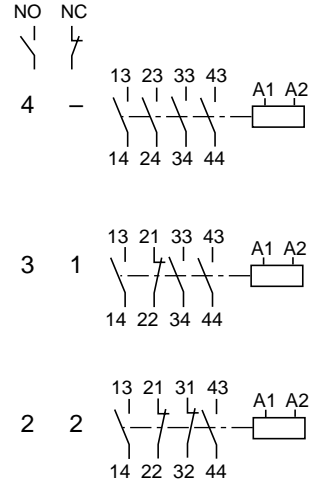

SH-4/G, 8-pole

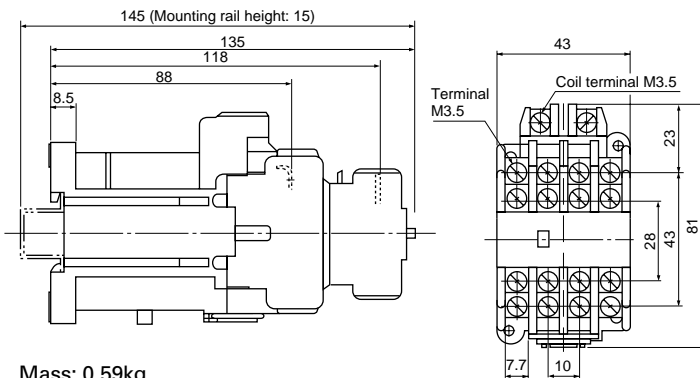

Mass: 0.59kg

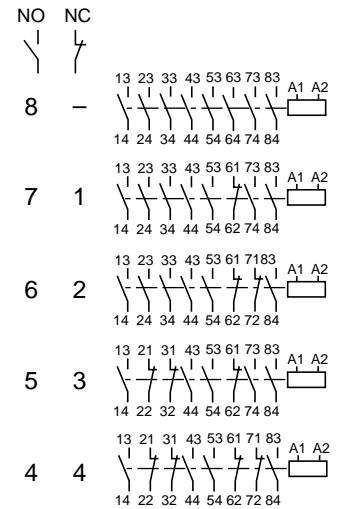

SH-5/G, 5-pole

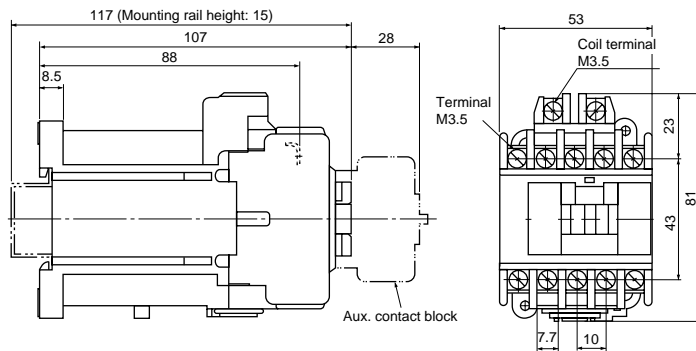

Mass: 0.58kg

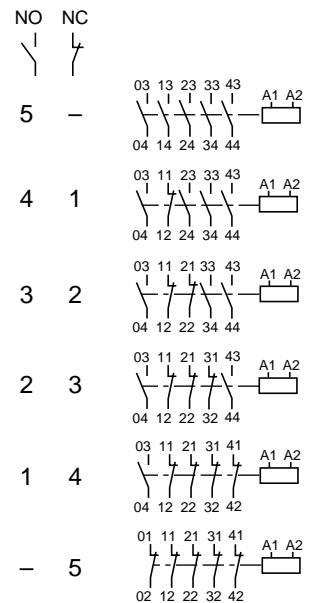

Notes on panel drilling
 • Use the two mounting holes on a diagonal line to mount a relay.
 • Mounting holes indicated by ① and ② are compatible with those of SRC type.
 • Mounting holes indicated by ③ conform to IEC Standards.

Industrial Relays

SH series

UL and CSA approved

UL and CSA approved



UL file No. E44592
CSA file No. LR20479

Types and ratings

AC operated

Type	Ordering code	Pole	Continuous current (A)	Rated operational current (A)						Rating code		Contact arrangement	Operating coil
				AC			DC			AC	DC		
				Volts	Make	Break	Volts	Make	Break				
SH-4	SH04AA-■□	4	10	120	60	6	125	0.55	0.55	A600	Q300	4NO 3NO+1NC 2NO+2NC	Available for 24V to 600V AC 50/60Hz
				240	30	3	250	0.27	0.27				
		8	10	480	15	1.5						8NO, 7NO+1NC 6NO+2NC 5NO+3NC 4NO+4NC	
				600	12	1.2							
SH-5	SH05AA-■□	5	10	120	60	6	125	0.55	0.55	A600	Q300	5NO, 4NO+1NC 3NO+2NC 2NO+3NC 1NO+4NC, 5NO	
				240	30	3	250	0.27	0.27				
				480	15	1.5							
				600	12	1.2							

Notes: • SH-4 type with 8-pole is a combination of SH-4 type industrial relay with 4-pole and SZ-A□ (Front mounting) type auxiliary contact block with 4-pole.

• Enter the coil voltage code in the ■ mark. See page 03/1.

Enter the contact arrangement code in the □ mark. See page 03/1.

DC operated

Type	Ordering code	Pole	Continuous current (A)	Rated operational current (A)						Rating code		Contact arrangement	Operating coil
				AC			DC			AC	DC		
				Volts	Make	Break	Volts	Make	Break				
SH-4/G	SH04AG-■□	4	10	120	60	6	125	0.55	0.55	A600	Q300	4NO 3NO+1NC 2NO+2NC	Available for 24V to 220V DC
				240	30	3	250	0.27	0.27				
		8	10	480	15	1.5						8NO, 7NO+1NC 6NO+2NC 5NO+3NC 4NO+4NC	
				600	12	1.2							
SH-5/G	SH05AG-■□	5	10	120	60	6	125	0.55	0.55	A600	Q300	5NO, 4NO+1NC 3NO+2NC 2NO+3NC 1NO+4NC, 5NC	
				240	30	3	250	0.27	0.27				
				480	15	1.5							
				600	12	1.2							

Notes: • SH-4/G type with 8-pole is a combination of SH-4/G type industrial relay with 4-pole and SZ-A□ (Front mounting) type auxiliary contact block with 4-pole.

• Enter the coil voltage code in the ■ mark.

Enter the contact arrangement code in the □ mark.

Ordering information

Specify the following:

1. Ordering code

Dimensions

Same as standard type industrial relay.

See page 03/5 and 03/7.

Combination with auxiliary contact blocks

Same as standard type.

See page 03/4.

TÜV and CCC approved



TÜV license No. R9151523
CCC Certificated No. 2003010309087 168

Types and ratings

AC operated, bifurcated contact

Type	Ordering code *2	Contact	Pole	Rated thermal current (A)	Make and break capacity AC (A)	Rated operational current (A)					
						AC Voltage (V)	Ind. AC-15	Res. AC-12	DC Voltage (V)	Ind. *1 DC-13	Res. DC-12
SH-4	SH04AA-■□	Bifurcated contact	4 8	10	60 30 15 12	110	6	10	24	3	5
						220	3	8	48	1.5	3
						440	1.5	5	110	0.55	2.5
						550	1.2	5	220	0.27	1
SH-5	SH05AA-■□	Bifurcated contact	5	10	60 30 15 12	110	6	10	24	3	5
						220	3	8	48	1.5	3
						440	1.5	5	110	0.55	2.5
						550	1.2	5	220	0.27	1

Notes: *1 Time constant is less than 70ms.

*2 Enter the coil voltage code in the ■ mark.

Enter the contact arrangement code in the □ mark.

• 8-pole type SH-4(H) is a combination of 4-pole type SH-4(H) and add-on auxiliary contact block SZ-A□(H).

DC operated

Type	Ordering code *2	Pole	Rated thermal current (A)	Make and break capacity AC (A)	Rated operational current (A)					
					AC Voltage (V)	Ind. AC-15	Res. AC-12	DC Voltage (V)	Ind. *1 DC-13	Res. DC-14
SH-4/G	SH04AG-■□	4 8	10	60 30 15 12	110	6	10	24	3	5
					220	3	8	48	1.5	3
					440	1.5	5	110	0.55	2.5
					550	1.2	5	220	0.27	1
SH-5/G	SH05AG-■□	5	10	60 30 15 12	110	6	10	24	3	5
					220	3	8	48	1.5	3
					440	1.5	5	110	0.55	2.5
					550	1.2	5	220	0.27	1

Notes: *1 Time constant is less than 70ms.

*2 Enter the coil voltage code in the ■ mark.

Enter the contact arrangement code in the □ mark.

CCC approved

AC operated, single contact

Type	Certificate No.
SH-4H SH-5H	2003010309087168

With extra pick-up operating coil

Type	Certificate No.
SH-4/U SH-5/U	2003010309087168

Ordering information

Specify the following:

1. Ordering code
2. CCC approved

Auxiliary contact blocks/optional

Description	Type	Applicable type	Certificate No.
Front mounting, bifurcated	SZ-A40	SH-4, SH-5	Certified according to an applicable industrial type
	SZ-A31		
	SZ-A22		
	SZ-A20		
	SZ-A11		
Front mounting, single button	SZ-A40H	SH-4, SH-5	
	SZ-A31H		
	SZ-A22H		
Side mounting, bifurcated	SZ-AS1	SH-4, SH-5	
Side mounting, single button	SZ-AS1H	SH-4, SH-5	

Industrial Relays

SH series

Off-delay release type

Off-delay release industrial relays

■ Description

This type of control relay has a capacitor connected in parallel with the operating coil, and the contacts are released with a delay of 1 to 5 seconds after the coil has been de-energized. If a momentary voltage drop or a power failure in AC control power supply of standard type control relay takes place, the operating coils are de-energized. Reclosing of the contacts must be carried out every time. The off-delay release relay is so designed that in the event of a brief power outage the coil will not release the contacts and control sequence is maintained.

■ Operation

The power supply is fed to the rectifier which in turn charges the capacitor. When a power failure takes place, the discharge current flows into the magnetic coil which holds the relay closed for 1 to 5 seconds. When the switch (SW) is opened the contacts will immediately open without delay.

Off-delay release unit (SZ-DE)

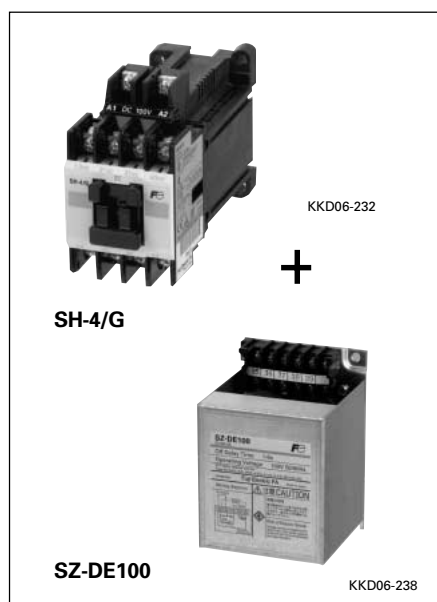
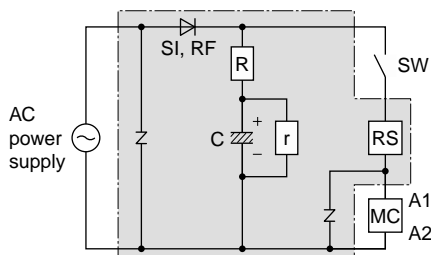

■ Types and ordering codes

Type Contactor	Off-delay release unit	Ordering code Contactor	Off-delay release unit	Contact arrangement	Rated thermal current (A)	Make and break capacity at AC (A)
SH-4/G	SZ-DE100	SH04AG-■□	SZ1DE100	4NO, 3NO+1NC, 2NO+2NC	10	66
	SZ-DE110		SZ1DE110			33
	SZ-DE200		SZ1DE200	8NO, 7NO+1NC, 6NO+2NC 5NO+3NO, 4NO+4NC		16.5
	SZ-DE220		SZ1DE220			13.2
SH-5/G	SZ-DE100	SH05AG-■□	SZ1DE100	5NO, 4NO+1NC, 3NO+2NC 2NO+3NC, 1NO+4NC, 5NC	10	66
	SZ-DE110		SZ1DE110			33
	SZ-DE200		SZ1DE200			16.5
	SZ-DE220		SZ1DE220			13.2

Notes: • Enter the coil voltage code in the ■ mark.
• Enter the contact arrangement code in the □ mark.
• Rated operational current: Same as DC-operated type. See page 03/6.

■ Performance data

Type	Hold time	Operating cycles per hour	Capacitor life
SH-4/G+SZ-DE□ SH-5/G+SZ-DE□	1 to 5 sec.	600	100,000 operations

■ Operating voltage and frequency

● Magnetic coil

Type	Voltage	Code
SH-4/G	100V DC	1
SH-5/G	110V DC	H
	200V DC	2
	220V DC	M

● OFF-delay release unit

Type	Input voltage
SZ-DE100	100V AC 50/60Hz
SZ-DE110	110V AC 50/60Hz
SZ-DE200	200V AC 50/60Hz
SZ-DE220	220V AC 50/60Hz

■ Combination with auxiliary contact blocks

Same as standard type.
See page 03/4.

■ Dimensions, mm

● Off-delay release unit

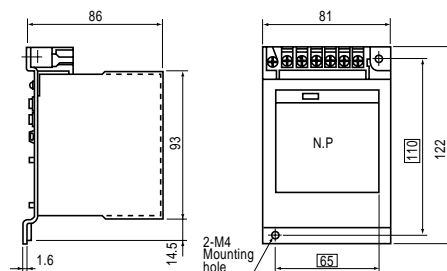

Mass: 0.85kg

● Industrial relay:

See page 03/7, DC-operated industrial relay

■ Wiring diagram

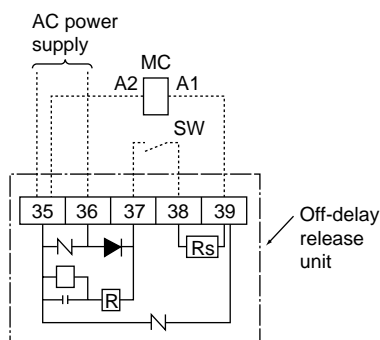

■ Ordering information

Specify the following:
1. Ordering code

Note:
When ordering, make sure that the input voltage (AC) of the OFF-delay release unit is equal to the operating voltage (DC) of the industrial relay.
Example:
SZ-DE 100V AC 50Hz+SH-5/G 100V DC
(OFF-delay release unit)+(Relay)

Mechanical latch industrial relays

■ **Description**

Mechanical latch relays are used where operating sequence continuity must be maintained regardless of any outside interruptions, such as power failures or momentary voltage drop.

These relays are provided with two coils.

One is a closing coil (CC) and the other is a trip coil (TC). An interlocking circuit is provided between the CC coil and TC coil. Since no coil voltage is applied during operation it is extremely economical and also quiet.

■ **Operating method**

● **Closing**

When the closing coil is energized the latch mechanism interlocks to latch and the NC contact connected in series with the closing coil opens and the coil is de-energized.

■ **Operating notes**

- When carrying out a sequence operating check make sure that the load is disconnected.
- The electrical signal time for closing and tripping should be 0.3 sec. or more.
- Both the closing and tripping coils are short time rating.
Closing coil: Max. 30 seconds
Trip coil: Max. 15 seconds
- Since the relay and the latch mechanisms are adjusted at the time of assembly, do not strip nor replace the contacts in the field.
- If current is applied simultaneously to both the closing and tripping circuits, the coils may be heated and damaged. An interlocking circuit is required to prevent this.

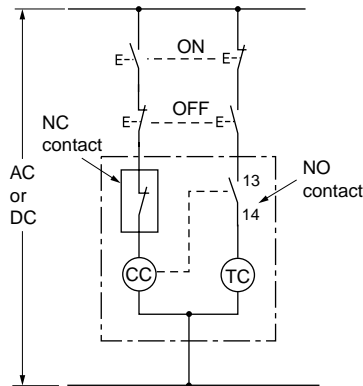

● **Tripping**

When the trip coil is energized the latch is released and tripping is carried out by means of the back spring. At this time the NO contact connected in series with the tripping coil opens.

■ **Performance data**

- Mechanical durability: 1 million operations
- Electrical durability: 500,000 operations (at AC-15 rated operational current)
- Operating cycles per hour: 1200
- Allowable ambient temp.: -5°C to +50°C

■ **Ordering information**

Specify the following:

1. Ordering code

Notes:

1. Mechanical latch units cannot be sold separately.
2. Do not detach mechanical latch units from relays and do not make modifications such as attaching mechanical latch units to other industrial relays.

■ **Types and ordering code**

AC operated Type	Ordering code	DC operated Type	Ordering code	Contact arrangement	Rated thermal current (A)	Make/break capacity AC (A)
SH-4/V	SH04AV-■□	SH-4/VG	SH04AD-■□	3NO, 2NO+1NC, 1NO+2NC	10	60
				5NO+2NC, 4NO+3NC, 3NO+4NC		30
SH-5/V	SH05AV-■□	SH-5/VG	SH05AD-■□	4NO, 3NO+1NC, 2NO+2NC	10	15
						12

Notes: • Enter the coil voltage code in the ■ mark.
Enter the contact arrangement code in the □ mark.
• Rated operational current: Same as standard type, see page 03/3.

■ **Coil ratings**

Type	Operating coil Voltage	Code	Power consumption AC operated		DC operated		Minimum energized time	Time rating		Operating voltage range
			Closing	Tripping	Closing	Tripping		Closing	Tripping	
SH-4/V	100V/100-110V AC 50Hz/60Hz	1	95VA	150VA	7W	150W	0.3 sec.	30 sec.	15 sec.	0.85 to 1.1 times coil rated voltage
SH-5/V	200V/200-220V AC 50Hz/60Hz	2								
SH-4/VG	100V DC	1								
SH-5/VG	110V DC	H								
	200V DC	2								
	220V DC	M								

Note: Coil voltage range from 24V to 220V AC and 24V to 220V DC is available.

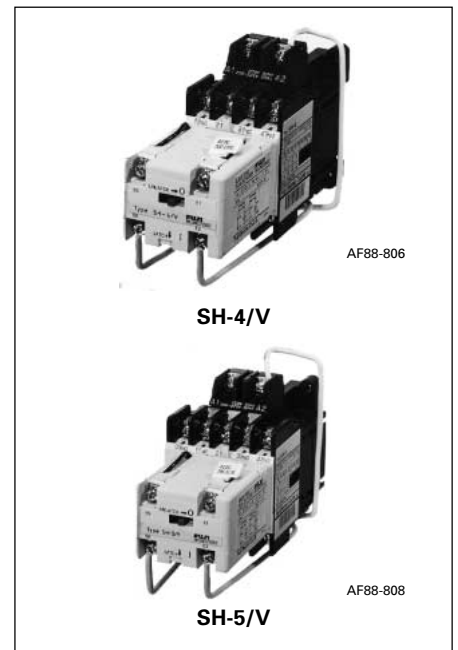

- **Manual operating sequence**
Closing: Press the button in the direction of the arrow.
Tripping: Push the lever in the direction of the arrow.

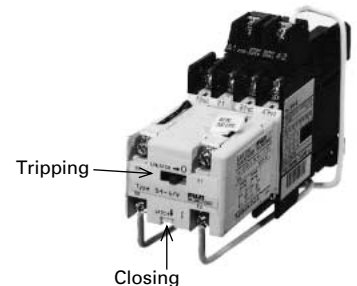

Industrial Relays

SH series

Mechanical latch type

■ Dimensions, mm

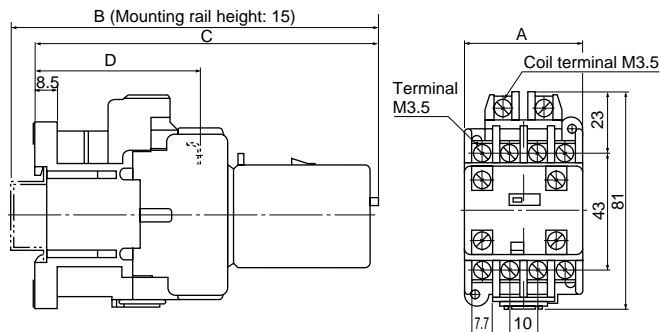

Panel drilling SH-4/V, VG

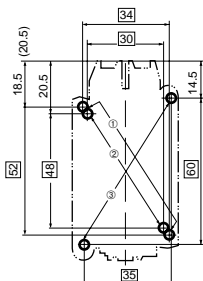

SH-5/V, VG

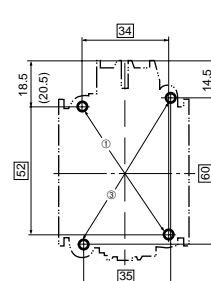

Type	No. of contact	A	B	C	D	Mass (kg)
SH-4/V	3	43	138	128	61	0.42
SH-4/V	7	67	138	128	61	0.47
SH-5/V	4	53	138	128	61	0.44
SH-4/VG	3	43	165	155	88	0.66
SH-4/VG	7	67	165	155	88	0.72
SH-5/VG	4	53	165	155	88	0.69

Note on panel drilling

- Use the two mounting holes on a diagonal line to mount a relay.
- Mounting holes indicated by ① and ② are compatible with those of SRC type.
- Mounting holes indicated by ③ conform to IEC Standards.

■ Wiring diagrams

SH-4/V, SH-4/VG (3-contact) 3NO

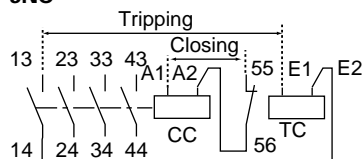

SH-4/V, SH-4/VG (7-contact) 5NO+2NC

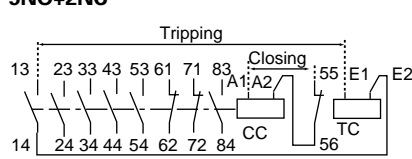

SH-5/V, SH-5/VG 4NO

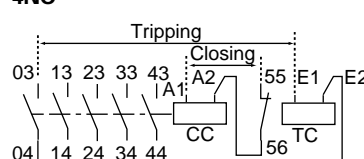

2NO+1NC

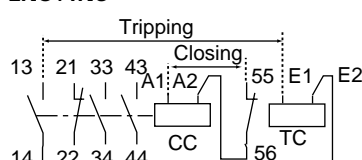

4NO+3NC

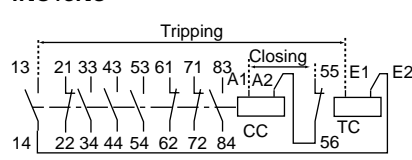

3NO+1NC

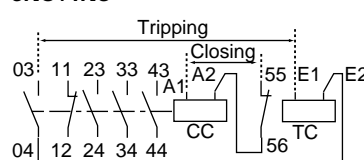

1NO+2NC

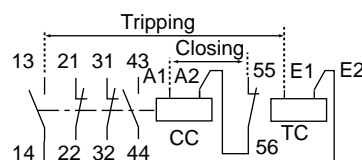

3NO+4NC

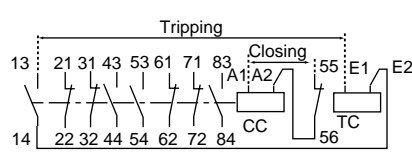

2NO+2NC

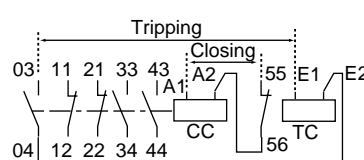

CC: Closing coil
TC: Tripping coil

■ Combination of industrial relay and auxiliary contact block

The mechanical latch industrial relays can be used according to the combination with the side mounting auxiliary contact blocks as shown on the right.

Mechanical latch industrial relay Type	Contact arrangement	Auxiliary contact block (Side mounting) SZ-AS1Vx2	SZ-AS1V
SH-4/V	3NO	5NO+2NC	4NO+1NC
SH-4/VG	2NO+1NC	4NO+3NC	3NO+2NC
	1NO+2NC	3NO+4NC	2NO+3NC
	5NO+2NC	-	-
	4NO+3NC	-	-
	3NO+4NC	-	-
SH-5/V	4NO	6NO+2NC	5NO+1NC
SH-5/VG	3NO+1NC	5NO+3NC	4NO+2NC
	2NO+2NC	4NO+4NC	3NO+3NC

Industrial relays with extra pick-up operating coil

■ Description

Generally, ordinary control relays are designed to operate within 85–110% of the rated voltage. However, relays with extra pick-up operating coils have a wider operating range of 75–110% of their normal rated voltage. They are used where the control power source is low and occasional voltage drops can be expected. Their performance is dependable in spite of low voltage conditions. Their outer dimensions and performance are similar to the standard type relay. They have a mechanical durability of 2.5 million operations.

■ Ordering information

Specify the following:
1. Ordering code

■ Performance data

- Same as standard type. See page 03/4.
- Mechanical durability: 2.5 million operations

■ Dimensions

Same as standard type.
See page 03/5.

■ Combination of contact blocks

Same as standard type.
See page 03/4.



03

■ Types and ordering codes

Type	Ordering code	Pole	Contact arrangement	Rated thermal current (A)	Make and break capacity AC (A)	Rated operational current (A)					
						AC Volts (V)		DC Volts (V)		Res. DC-12	
SH-4/U	SH04AU-■□	4	4NO, 3NO+1NC 2NO+2NC	10	60 30 15 12	110	6	10	24	3	5
						220	3	8	48	1.5	3
						440	1.5	5	110	0.55	2.5
		8	8NO, 7NO+1NC 6NO+2NC, 5NO+3NC 5NO+3NC 4NO+4NC	10	60 30 15 12	110	6	10	24	3	5
						220	3	8	48	1.5	3
						440	1.5	5	110	0.55	2.5
SH-5/U	SH05AU-■□	5	5NO, 4NO+1NC 3NO+2NC 2NO+3NC 1NO+4NC, 5NC	10	60 30 15 12	110	6	10	24	3	5
						220	3	8	48	1.5	3
						440	1.5	5	110	0.55	2.5
						550	1.2	5	220	0.27	1

- Notes: 1. * Time constant is less than 70ms.
2. 8-pole type SH-4/U is a combination of 4-pole type SH-4/U and 4-pole auxiliary contact block SZ-A□.
3. Enter the coil voltage code in the ■ mark.
Enter the contact arrangement code in the □ mark.

■ Coil voltage

Type	Operating coil voltage	Coil voltage code	Wiring
SH-4/U	100V AC 50Hz/100–110V AC 60Hz	1	
SH-5/U	110-120V AC 50Hz/120–130V AC 60Hz	K	
	200V AC 50Hz/200–220V AC 60Hz	2	
	200-240V AC 50Hz/240–260V AC 60Hz	P	
	380-400V AC 50Hz/400–440V AC 60Hz	4	

Note: The above is the normal voltage. Other voltages between 24V and 550V AC are available on request.

■ Coil characteristics

Type	Pole	Power consumption (VA)		Watt loss (W)		Pick-up voltage		Drop-out voltage		Operating time (ms)	
		Inrush	Sealed	200V 50Hz	200V 60Hz	50Hz	60Hz	50Hz	60Hz	Coil ON→ Contact ON	Coil OFF→ Contact OFF
SH-4/U	4	120	15	4	4	93–115	102–124	58–88	66–96	9–16	6–13
	8	120	15	4	4	93–116	102–126	58–90	66–99	8–15	6–13
SH-5/U	5	120	15	4	4	93–116	102–126	58–90	66–99	9–17	6–13

Note: Coil ratings: 200V 50Hz/200–220V 60Hz
Operating time is based on 200V 50Hz

Industrial Relays

SH series

With quick terminals

Industrial relays with newly developed quick terminals

■ Description

The product and terminal structure comply with international safety standards. It complies with VGB4, DIN57106, and VDE0106 Teil 100 which are recommendation for preventing the exposure of charging current part.

Components such fork crimp terminals, and ring crimp terminals are inserted and secured by tightening the terminal screw. See Figures 1 to 3.

■ Features

- Easy wiring
Wiring time is at least 50% shorter than the conventional screw type terminal.
- Safety
The finger protection feature protects the charging current part during maintenance and check (complying with EN60947-4-1, and IEC60947-4-1)

■ Types and ordering codes

Type	Ordering code	Pole	Contact arrangement	Rated thermal current (A)
SH-4Y	SH04ZA- ■40	4	4NO	10
	SH04ZA- ■31	4	3NO+1NC	10
	SH04ZA- ■22	4	2NO+2NC	10
	SH04ZA- ■80	8*	8NO	10
	SH04ZA- ■71	8*	7NO+1NC	10
	SH04ZA- ■62	8*	6NO+2NC	10
	SH04ZA- ■53	8*	5NO+3NC	10
	SH04ZA- ■44	8*	4NO+4NC	10

Note: * 8-pole type SH-4Y is combination of 4-pole type SH-4Y and 4-pole auxiliary contact block SZ-A■
* Enter the coil voltage code in the ■ mark.

■ Dimensions, mm

SH-4Y (4-pole)

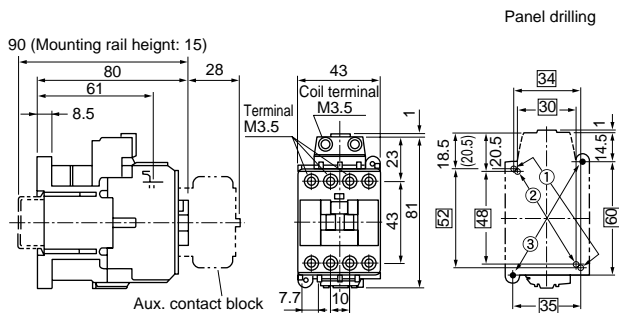

Mass: 0.32kg

■ Contact arrangement

Same as standard type.
See page 03/5.

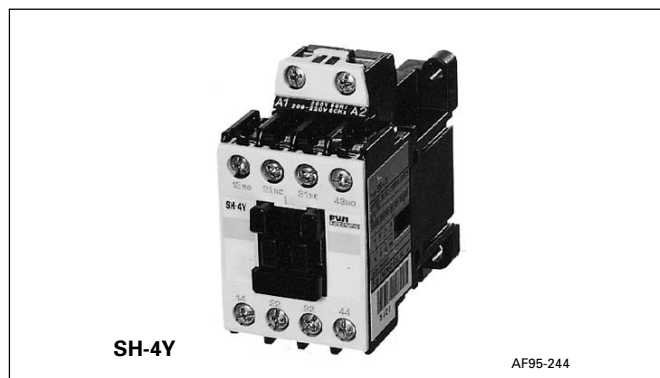

- Standard UL, CSA and TÜV approved

When one crimp terminal is used (Fig. 2)

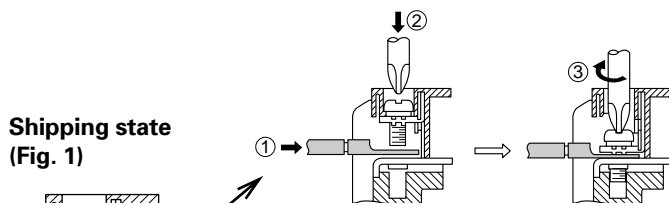

When two crimp terminals are used (Fig. 3)

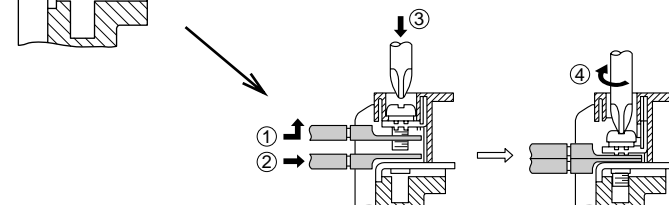

■ Ordering information

Specify the following

1. Ordering code

SH-4Y (8-pole)

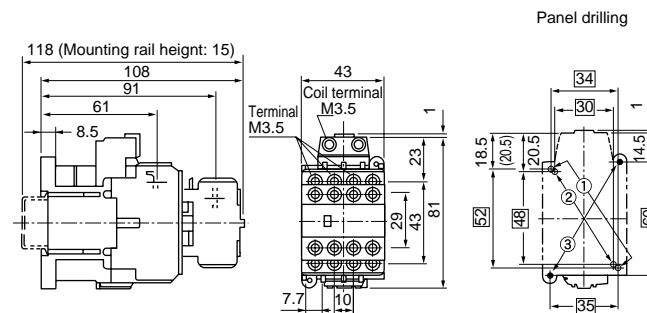

Mass: 0.36kg

Notes on panel drilling

- Use the two mounting holes on a diagonal line to mount a relay.
- Mounting holes indicated by ① and ② are compatible with those of SRC type.
- Mounting holes indicated by ③ conform to IEC Standards.

DC operated slim type card relays

Rated thermal current 5 Amps.

Description

The RB104 and 105 relays are designed for printed circuit board use. These relays are extremely thin (5mm) and so, can be densely mounted on PC boards. As a result, PC board size and cost can be greatly reduced. Employing of bifurcated contacts ensure high contact reliability, allowing the RB104,105 relays to be used in low-level circuits. Coil voltages are available in ranges from 4.5V to 24V DC.

Features

- Thin, miniature size and light weight
The mounting space on the PC board can be reduced.
- UL, CSA and TÜV approved
- Low power consumption
They can be operated by means of non-polarity magnet.
- SIL terminal arrangement
SIL (Single-side In-Line lead) package allows the relays to be mounted easily on PC board.
- Fluxtight construction
- Immersion cleanable

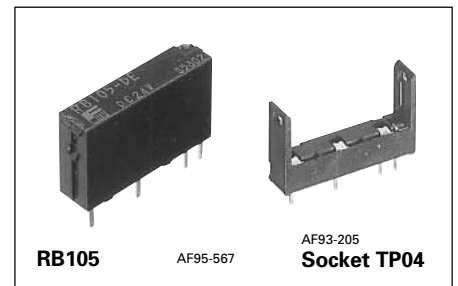

Ordering information

Specify the following:
1. Type number

Types and ratings

Type	Ordering code	Power consumption	Rated voltage	Pick-up voltage	Thermal current	Make and break current (res.load)
RB104	RB104-■	120mW	4.5, 5, 6	70% of rated voltage or less	5A	5A at 250V AC 5A at 30V DC
RB105	RB105-■	200mW	9, 12, 24V DC			

Note: Enter the coil voltage code in the ■ mark as follow
4.5V DC: DC, 5V DC: DY, 6V DC: DA, 9V DC: DD, 12V DC: DB, 24V DC: DE

Specifications

Operating time		10ms or less at rated voltage
Release time		5ms or less at rated voltage
Dielectric strength		750V AC rms. 1 min. between open contacts 2,000V AC rms. 1 min. between contact and coil
Stray electrostatic capacity		Approx. 1.4pF between contact and coil
Impulse		4,500V or more 1.2 × 50μs between contact and coil
Insulation resistance		100MΩ at 500V DC megger
Electrical durability	AC	100,000 operations at 220V AC 2A, inductive load
	DC	130,000 operations at 220V AC 3A, resistive load 150,000 operations at 24V DC 1A, inductive load 100,000 operations at 24V DC 5A, resistive load
Mechanical durability		20 million operations
Ambient temperature		-40°C to +70°C (no icing)

Type number nomenclature

RB 10 4-DE

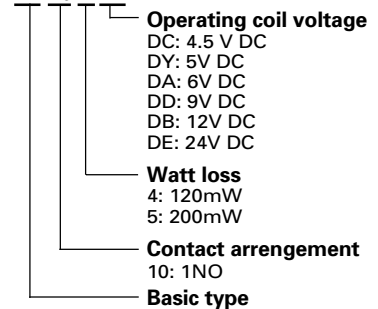

Approvals

- UL, CSA and TÜV
UL file No. E44592
CSA file No. LR20479
TUV license No. R9551729

● Ratings

Voltage	Resistive load	Inductive load
120V AC	-	1A
240V AC	5A	-
30V DC	5A	2A (15ms)
120V DC	0.5A	0.2A (15ms)

Dimensions, mm

RB104,105

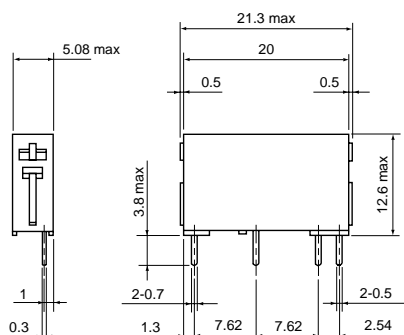

PC board drilling (View from back side)

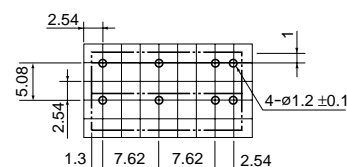

Internal wiring diagram

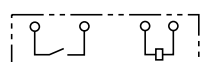

Socket TP04

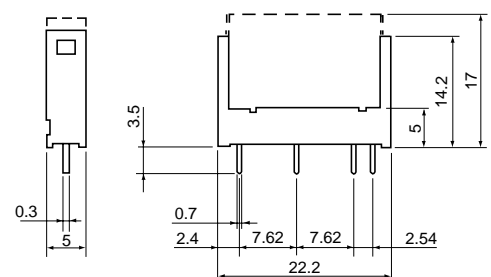

PC board drilling (View from back side)

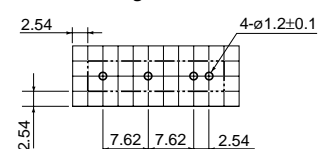

Mass: 3g

Industrial Control Relays

Relays-and-terminal module

RS type

Relays-and-terminal module RS4□, 6N

A very compact, space-saving terminal module containing four or six relays with one NO contact.

■ Features

- The RS series relays-and-terminal module consists of four or six plug-in relays (RB105, 1NO contact or RB011, 1NC contact) and a terminal module with screw terminals. This relays-and-terminal module is ideal for interfacing electronic control devices (such as PLCs or photoelectric sensors) with output devices (such as solenoid valves and magnetic contactors).
- The use of ultra-small, high-sensitive relays has realized a compact size of

34mm wide and 69mm long, including screw terminals (RS4N type).

- Input terminals are located in the upper part and output terminals in the lower part of the module to separate them from each other, thereby making wiring easy.
- The terminal module uses RB105 or RB101 card relays. For replacement, please specify the card relay type and coil voltage.
- Built-in coil-surge suppression diodes and operation indicator LEDs simplify circuit design and maintenance.
- The module is quickly-mountable on a DIN 35mm rail.
- The RS4N module includes two standard accessory jumper plates, which are convenient for common wiring of terminals.

■ Specifications

Type	RS4N, RS41, RS42, RS6N, RS6NP	
Contact	1NO	1NC
Contact resistance	30mΩ or less (before use)	
Contact material	Silver alloy (Au-plated)	
Min. operating voltage and current	0.1V DC, 1mA	1V DC, 1mA
Rated thermal current	5A	
Max. make/break current	250V AC, 5A 30V DC, 5A	250V AC, 1A 30V DC, 1A
Operating time	10ms. or less at rated voltage	
Release time	10ms. or less at rated voltage	
Insulation resistance	100MΩ (at 500V DC megger)	
Dielectric strength:		
Between contact and coil	2000V AC 1 minute	
Between contacts of same pole	750V AC 1 minute	
Between contacts of different pole	2000V AC 1 minute	
Between coils of different pole	500V AC 1 minute	
Vibration: Malfunction durability	10 to 55Hz, 1mm double amplitude	
Mechanical durability	10 to 55Hz, 1.5mm double amplitude	
Shock: Malfunction durability	100m/s ²	
Mechanical durability	1000m/s ²	
Durability: Mechanical	20 million operations	
Electrical	See page 03/17	
Ambient temperature	-25 to +55°C (no icing)	

■ Operating coil of card relays

Relay	Coil voltage	Pick-up voltage	Drop-out voltage	Power consumption	Coil resistance
RB105 (1NO)	4.5V DC	70% or less of rated coil voltage	5% or more of rated coil voltage	200mW	100Ω
	5V DC				125Ω
	6V DC				180Ω
	9V DC				405Ω
	12V DC				720Ω
RB011 (1NC)	24V DC			2880Ω	
	4.5V DC			360mW	56Ω
	5V DC				70Ω
	6V DC				100Ω
	9V DC				225Ω
12V DC	400Ω				
24V DC	1600Ω				

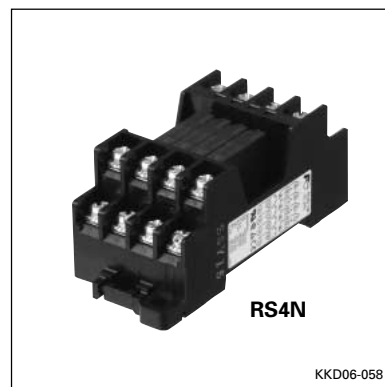

■ Type number nomenclature

RS 4N-DE P

- Connector side polarity (For RS6N type only)
 - NPN type (+common): Blank
 - PNP type (-common): P
- Rated voltage
 - DC: 4.5V DC
 - DY: 5V DC
 - DA: 6V DC
 - DD: 9V DC
 - DB: 12V DC
 - DE: 24V DC
- Output contact
 - 4N: 4NO
 - 41: 3NO+1NC
 - 42: 2NO+2NC
 - 6N: 6NO
- Relay and terminal

■ Relay remover

To remove a relay from the terminal module, use the type TY3 relay remover sold separately. Pull the relay in a direction perpendicular to the terminal module surface. Incorrectly removing or mounting a relay may damage the relay pins and pin jacks of the module.



AF93-206

■ Ordering information

Specify the following:
1. Type number

■ **Electrical durability**
 ● **NO output contact**

Voltage	Make current (A)	Break current (A)	Operations
220V AC (inductive load)	20 (cos ϕ = 0.7)	2 (cos ϕ = 0.3-0.4)	100,000
220V AC (resistive load)	3 (cos ϕ = 1.0)	3 (cos ϕ = 1.0)	130,000
24V DC (inductive load)	1 (T= 15ms)	1 (T= 15ms)	150,000
24V DC (resistive load)	5 (T= 1ms or less)	5 (T= 1ms or less)	100,000

● **NC output contact**

Voltage	Make current (A)	Break current (A)	Operations
220V AC (resistive load)	1 (cos ϕ = 1)	1 (cos ϕ = 1)	100,000
24V DC (resistive load)	1 (L/R= 0ms)	1 (L/R= 0ms)	120,000

■ **Dimensions, mm**
 ● **RS4N, RS41, RS42 (RS4A, RS4D)**

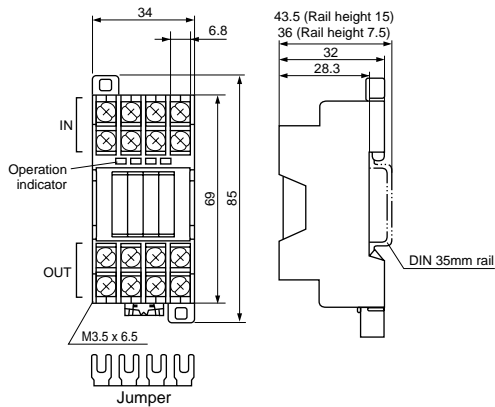

■ **Wiring diagrams**

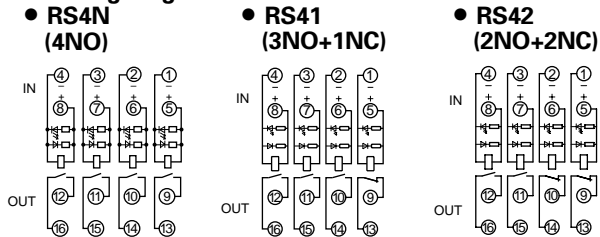

● **RS6N, RS6N-P (RS6A, RS6D)**

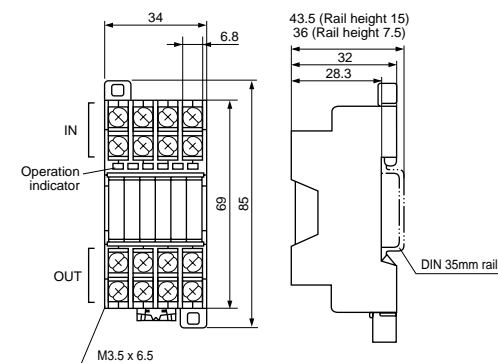

● **RS6N (6NO)**

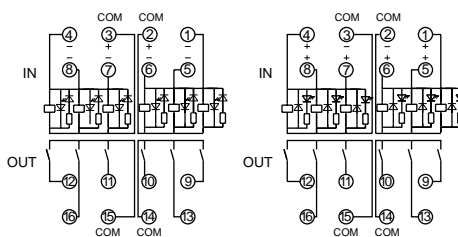

● **RS6N-P (6NO)**

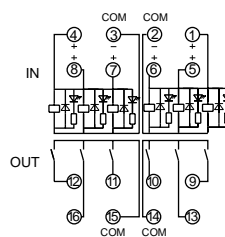

■ **Finger protection cover**
 ● **RZ4N**

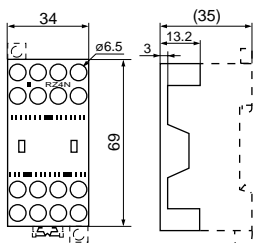

See page 03/23.

Industrial Control Relays

Relays-and-terminal module

RS type

Relays-and-terminal module RS16

16-point relays-and-terminal module with the smallest width in its class

■ Features

- Most compact in its class
Outside dimensions are 110mm (W), 52mm (D), and 37mm (H).
The width is the smallest in this class.
- Push-to-set (quick-connect) terminals for easy wire connection
A unique terminal structure enables quick and easy crimp terminal connections without removal of screws. (No more lost screws)
- Clear LEDs indicate relay output status.
Each relay has an LED to indicate its ON/OFF status.
- A surge suppressing diode is provided for each relay coil.
- Terminal cover with label for marking device Nos.
- Built-in relay remover
- DIN rail quick mount and panel-surface mount using screws

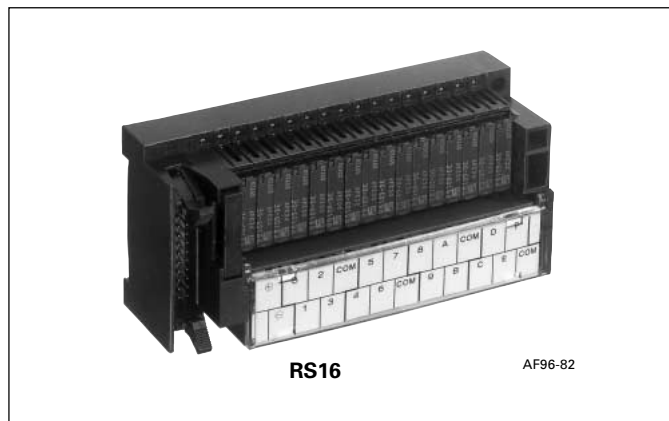

■ Type number nomenclature

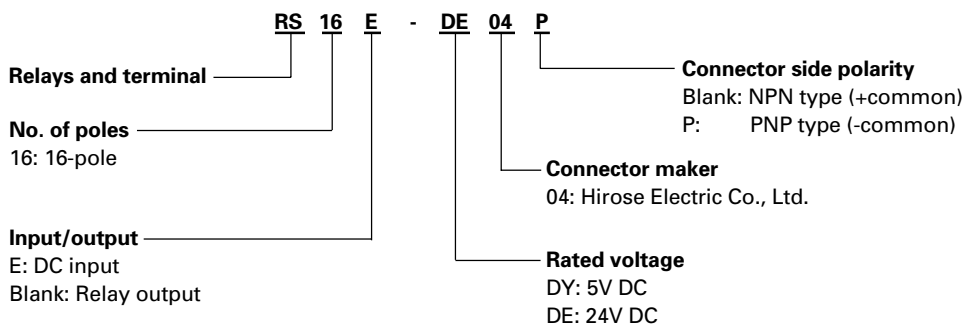

■ Ordering information

Specify the following:
1. Type number

■ Types

Type	Input/output	No. of poles	Rated voltage	Connector side polarity
RS16-□04	Output	16(1NO×16)	5V DC	NPN type (+common)
RS16-□04P			24V DC	PNP type (-common)
RS16E-□04	Input			NPN type (+common)

Note: Enter the rated voltage code in the □ mark as follow. 5V DC: DY, 24V DC: DE

■ Ratings

● Operating coil

Rated voltage	Rated operational current (mA)	Coil resistance (Ω)	Pick-up voltage	Drop-out voltage	Power consumption (W)
24V DC	8.3	2,880±10%	70% or less	10% or more	0.2/1NO contact
5V DC	40	125±10%	of coil rated voltage	of coil rated voltage	3.2/16NO contacts

Note: An LED flows approx. 1mA. To calculate the power requirements, calculate the total coil and LED currents of all relays installed in the terminal module.

● Contact

Terminal relay type	RS16 (output)	RS16E (input)
Rated current	220V AC (Res. load)	—
	220V AC (Ind. load)	—
	24V DC (Res. load)	1A
	24V DC (Ind. load)	1A
Rated thermal current*	2A	1A
Electrical durability (operations)	200,000 at 200V AC, 2A 300,000 at 24V DC, 2A	
Mechanical durability (operations)	20,000,000	

Note * The contact current rating of the RB105 relay used in this module is 5A. The thermal current rating of this terminal module, however, is 2A or 1A due to limitations of the terminal module (RS16) rating.

■ Performance data

Operating time		10ms or less
Release time		10ms or less
Vibration	Malfunctions durability	10–55Hz 1mm double amplitude
	Mechanical durability	10–55Hz 1mm double amplitude
Operating ambient temperature		-25–55°C(no icing)
Operating ambient humidity		35-85%RH
Terminal screw size		M3
Tightening torque		0.5–0.7N · m
Mounting		Rail mounting (screw mounting also available)
Applicable crimp terminal		R1.25–3 (Max. 6mm wide)
Applicable wire size		Max. φ1.4
LED color	Operation indication	Red
	Power source indication	Green
Coil surge suppressor		Diode
Insulation resistance (before use)		100MΩ (500V DC megger)
Dielectric strength	Between contact and coil	2000V AC, 1 minutes
	Between open contacts	750V AC, 1 minutes
	Between contacts of opposite polarity	2000V AC, 1 minutes
Mass		200g

■ Cable types

Type		Cable length	Type (Ordering code)
Cable with applicable crimp terminal (ring)		1,000mm	RS910B1-0104
		2,000mm	RS910B1-0204
		3,000mm	RS910B1-0304
Cable with connectors (1:2)	FUJI ELECTRIC FA PLC	1,000mm	RS910F2-0104
		2,000mm	RS910F2-0204
		3,000mm	RS910F2-0304
	Mitsubishi electric Corp. PLC	1,000mm	RS910M2-0104
		2,000mm	RS910M2-0204
		3,000mm	RS910M2-0304
	OMRON PLC	1,000mm	RS910T2-0104
		2,000mm	RS910T2-0204
		3,000mm	RS910T2-0304
Cable with connectors (1:1)	Multicore cable	1,000mm	AUX014-201(LP914-201)
		2,000mm	AUX014-202(LP914-202)
		3,000mm	AUX014-203(LP914-203)
	Flat cable	1,000mm	AUX024-201(LP924-201)
		2,000mm	AUX024-202(LP924-202)
		3,000mm	AUX024-203(LP924-203)

Note: The ordering codes of the cables with connectors (1:1) differ from the type.
The ordering codes are in parentheses.

Industrial Control Relays

Relays and terminal module

RS type

■ Wiring diagrams

● RS16-DE04 (Output, NPN type)

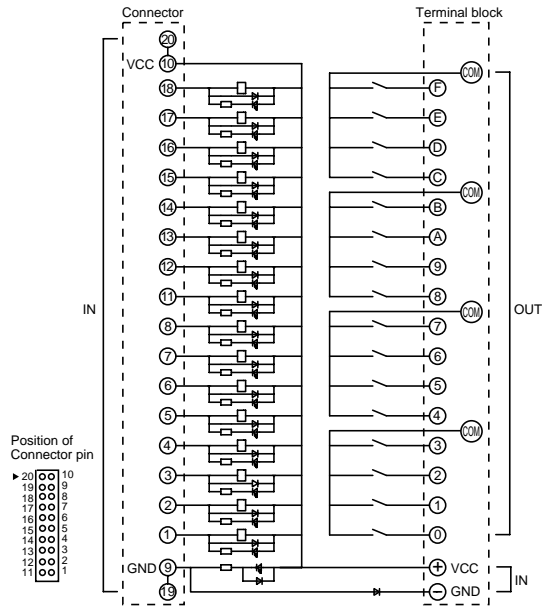

● RS16-DE04P (Output, PNP type)

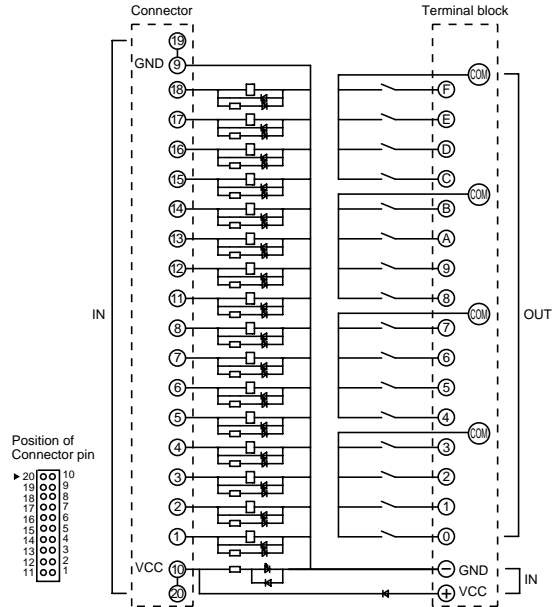

● RS16E-DE04 (Input, NPN type)

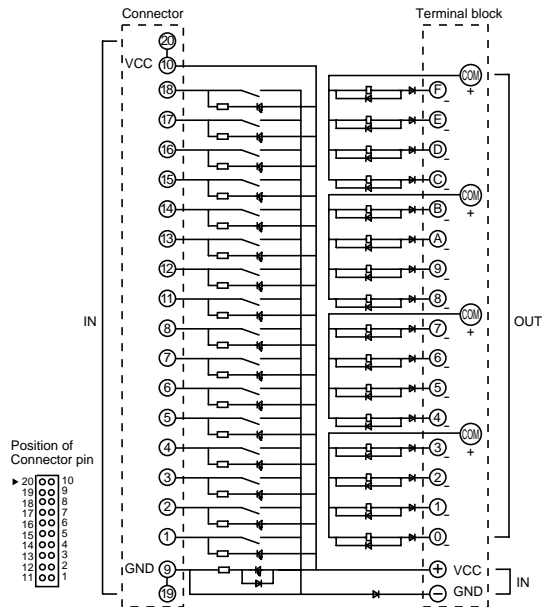

■ How to use a push-to-set terminal (Quick-connect terminal)

Lift the screw head up with a screw driver tip.

Insert the crimp terminal of the wire into the slot under the screw.

Use a screwdriver to tighten the screw.

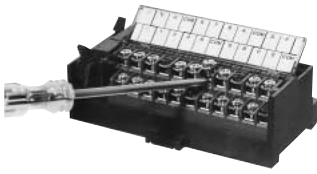

03

■ Dimensions, mm

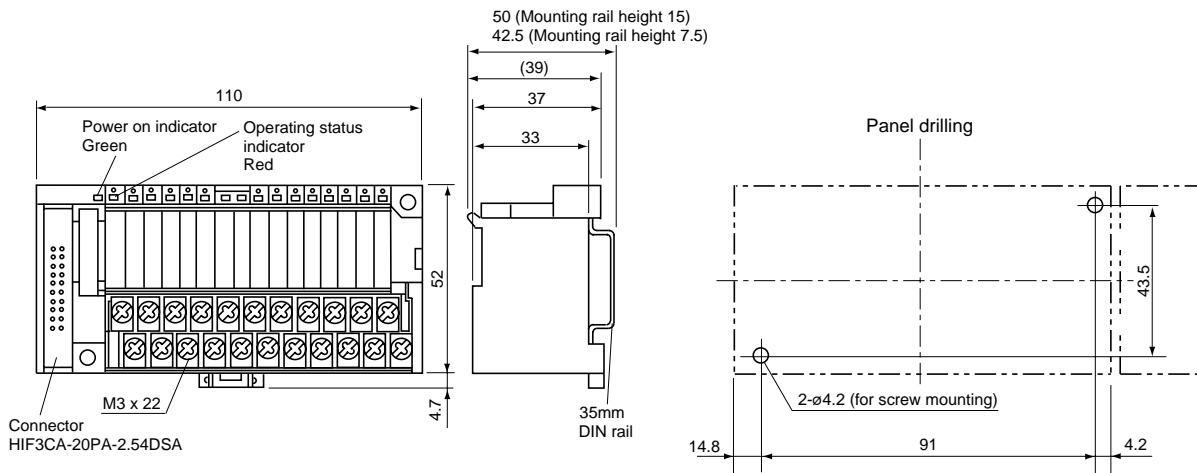

Industrial Control Relays

Relays-and-terminal module

RS type

Relays-and-terminal module with SSR output

■ Features

- SSR output (AC and DC)
Provided with a miniature SSR with the same dimensions as the RB-series miniature card relay resulting in a longer service life and making it ideal for highly frequent switching.
- Slim 34-mm body
Slim 34-mm design for all models up

■ Type number nomenclature

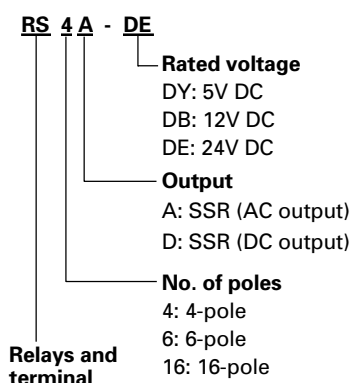

- to 16-pole models allowing significant space savings within the panel.
- Both surface mounting and DIN rail mounting are possible
- Provided with operation indicators
- Easy relay maintenance with special socket (type TP04)
- RZ4N finger protector also available. (Sold separately.)

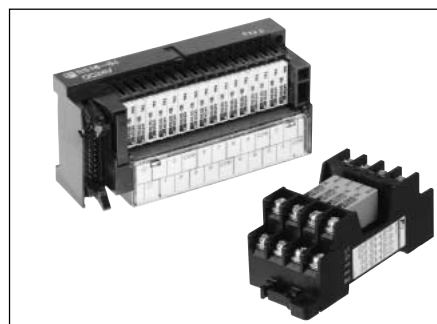

■ Types

Type (Ordering code)	Replace the □ mark by the rated voltage (code)	Output
RS4A-□	5V DC: DY, 12V DC: DB	SSR (AC output)
RS4D-□	24V DC: DE	SSR (DC output)
RS6A-□		SSR (AC output)
RS6D-□		SSR (DC output)
RS16A-□		SSR (AC output)
RS16D-□		SSR (DC output)

■ Ordering information

- Specify the following:
1. Type number

■ Specifications

Type	RS4A, RS6A	RS16A	RS4D, RS6D	RS16D				
	DC input-AC output		DC input-DC output					
Main circuit (output)	Rated insulation voltage		250V					
	Rated voltage Vn		100–240V AC					
	Operating voltage range		70–250V AC					
	Rated frequency		50/60Hz					
	Rated thermal current		0.3A	0.15A	0.3A			
	Leakage current at OFF state (max)		1mA or less		0.1mA or less			
	Minimum load current		20mA		1mA			
	Voltage drop at ON state (max)		1.6V or less		1V or less			
	Zero-cross function		-		-			
	Surge-on current		15A (20ms, 1 shot)		3A (10ms, 1 shot)			
Control circuit (input)	Isolation method		Phototriac		Photocoupler			
	Rated voltage Vn		5V DC	12V DC	24V DC	5V DC	12V DC	24V DC
	Operating voltage range		3.5–5.5V DC	8.4–13.2V DC	16.8–26.4V DC	3.5–5.5V DC	8.4–13.2V DC	16.8–26.4V DC
	Pick-up voltage		70%Vn or less		70%Vn or less			
	Drop-out voltage		10%Vn or more		10%Vn or more			
Input impedance		Approx.390Ω	Approx.1kΩ	Approx.2.7kΩ	Approx.390Ω	Approx.1kΩ	Approx.2.7kΩ	
General specification	Ambient temperature (operate)		-25 – +55°C (no icing)		-25 – +55°C (no icing)			
	Ambient temperature (storage)		-25 – +80°C (no condensation)		-25 – +80°C (no condensation)			
	Relative humidity		35 – 85%RH		35 – 85%RH			
	Dielectric strength		Between input and output terminals 2000V AC 1 min.		Between input and output terminals 2000V AC 1 min.			
	Insulation resistance		Over 100MΩ at 500V DC megger		Over 100MΩ at 500V DC megger			
	Operating time		1ms or less		1ms or less			
	Release time		1/2 cycle +1ms or less		1ms or less			
	Vibration resistance		10 – 55Hz, 1.5mm double amplitude	1mm	10 – 55Hz, 1.5mm double amplitude	1mm		
	Shock resistance		100m/s ²		100m/s ²			
	Mass		Approx. 64g	Approx. 200g	Approx. 64g	Approx. 200g		

■ **Dimensions, mm**

- **RS4A, 4D** ● **RS6A, 6D** ● **RS16A, 16D**
- Same as RS4N Same as RS6N Same as RS16N
- See page 03/17 See page 03/17 See page 03/21

■ **Wiring diagrams**

● **RS4A**

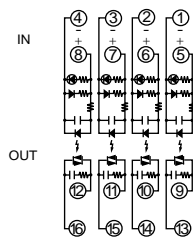

● **RS6A**

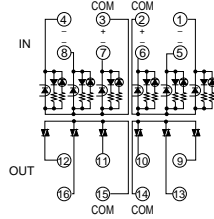

● **RS4D**

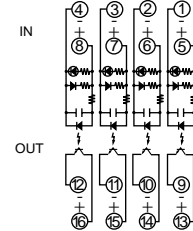

● **RS6D**

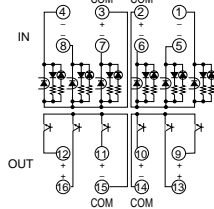

● **RS16A**

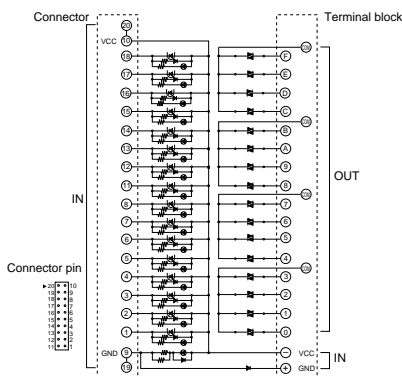

● **RS16D**

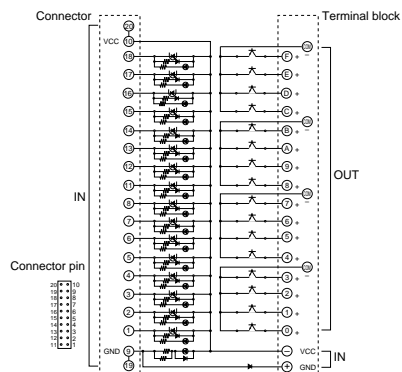

■ **RZ finger protection cover for RS series relays-and-terminal module**

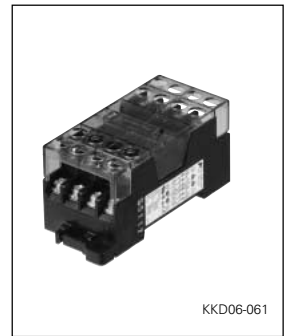

■ **Features**

- Ensures safety and prevent dust
This cover prevent persons from touching, by mistake, live conductor parts of the terminal module and receiving an electric shock. The cover also protect relays from dust.
- Hold the relay remover
The cover surface has two holes to hold the type TY3 relay remover. When the remover is not being used, it can be attached to the cover so that it is not lost.
- The cover is quick-mount
The cover can be quickly mounted on or removed from the TP04 socket used with RS series relays-and-terminal module.
- The cover can be mounted at any time
The cover can be mounted on or removed from the socket at any time before or after wiring the terminals.
- Crimp terminal is also available
It is possible to use a crimp terminal as well as terminal jumper for wiring.

■ **Type**

Type	Used with
RZ4N	RS4N, 4-pole relays-and-terminal module RS6N, 6-pole relays-and-terminal module

■ **Dimensions, mm**

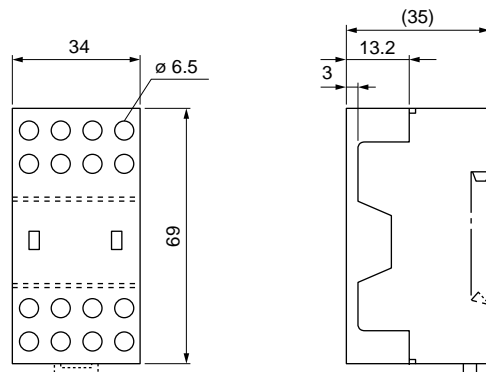

Mass: Approx. 3.2g

Industrial Control Relays

Relays-and-terminal module

RS type

■ Notes on use

● Mounting direction

This product can be mounted in any direction. However, to mount the product in a direction which each relay is horizontal, it is recommended that the product will be mounted so that the cable connector is positioned at the bottom. This position ensures the optimal vibration resistance of the relay.

Use optional end clamps (TS-XT) as needed to prevent the relays-and-terminal module from failing off and to ensure correct positioning of the relays.

● Installing and removing a relay

Installing a relay: While holding the relay perpendicular to the socket, insert the relay into the socket as shown below. Incorrect insertion may bend the relay terminals or damage the socket.

Removing a relay: Use the accessory remover to remove the relay from the socket.

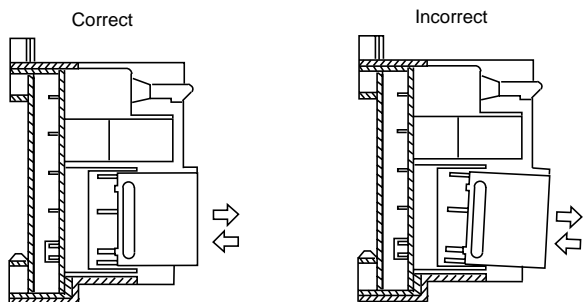
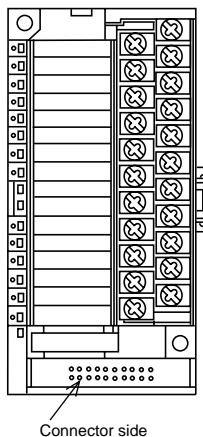

● Component relay

This product uses the RB105 series of card relays as components. When replacing a relay, use a relay of the same type with the same voltage rating as that of the original.

● Make spaces between nearby devices

When mounting this product on a panel, be sure there is adequate space between the product and nearby devices and cable ducts, as shown in the figure at right.

This space enables operation of the connector-ejecting levers.

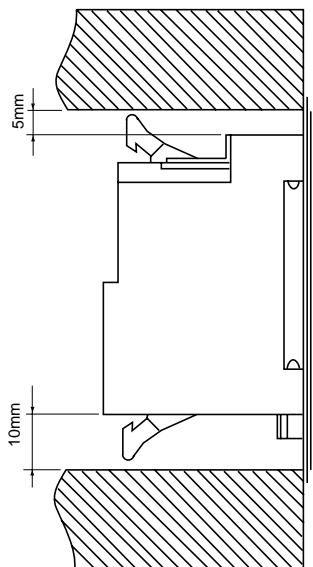

● Applicable cable connectors

Use Fuji Electric's connectors for cable connections (optional). Use of any other connector may damage the module connector or cause faulty connections.

Miniature control relays

■ **Description**

The HH52, 53 and 54 are a series of miniature general purpose relays specially designed for users demanding small size, sturdy construction and high electrical capacity. Mechanisms are furnished in polycarbonate dust-proof enclosures and are recommended for a multitude of electrical control applications for their reliability and compact size. Continuous duty coils, either AC or DC are available for voltages up to 240V AC or 120V DC. Contacts can be supplied in 2PDT, 3PDT, 4PDT arrangements. Continuous current ratings are 3, 5 and 7 Amps. Many terminal types are available for solder, plug-in or printed circuit board mounting.

■ **Features**

- 3, 5 and 7 Amp. contacts
- 2PDT, 3PDT and 4PDT
- Reliable operation, long service life
- High dielectric strength
- Solder, PC board, wire wrap and screw terminal socket
- AC or DC coils
- Barrired contacts for opposite polarity available
- Dust proof enclosures
- Approved by UL, CSA and TÜV
 UL recognized File No:
 E42419, E90265 (Socket)
 CSA: LR 20479
 TÜV:
 License No. R9251339 (HH52)
 R9251340 (HH53)
 R9251341 (HH54)
 T9251612 (TP58, 511, 514)
 T9251425 (RZ, FX)

■ **General information**

● **Contacts**

Miniature relays can be supplied with contacts that meet most electrical and mechanical contact requirements. The standard HH52, 53 and 54 series are of the single contact type as illustrated. The HH52W (2PDT) and HH54W (4PDT) relays are supplied with bifurcated contacts. These bifurcated contacts are with good conducting characteristics and are recommended where limited control power is available. The dielectric strength is 1000 volts rms 50/60Hz (between open contacts) which makes them more than adequate for power circuit use.

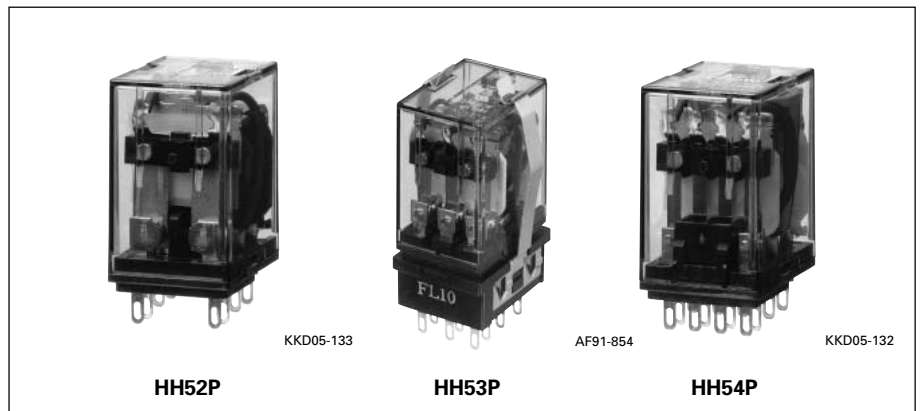

Contact arrangement are as follows:

Type	Contact arrangement	Rated thermal current
HH52U	2PDT	7 Amps
HH52, 52W	2PDT	5 Amps
HH53	3PDT	5 Amps
HH54U	4PDT	5 Amps
HH54, 54W	4PDT	3 Amps

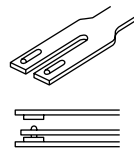

Bifurcated contact

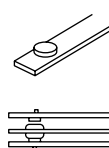

Single contact

● **Coils**

Coils are available with nominal voltages within the following ranges.

Coil voltage	Power consumption
6 to 120V DC	Approx. 0.9W
6 to 240V AC	Approx. 1.0VA
(50/60Hz)	(60Hz)

Special purpose relays can be supplied with diode for surge suppression, for operating display devices such as LED's, and magnetically held type.

● **Enclosures**

All miniature relays are enclosed in sturdy heat-resistant polycarbonate covers providing protection against dust and dirt.



Standard



Flange mounting

● **Terminals**

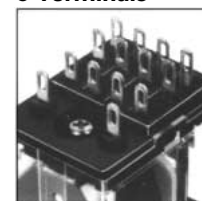

Plug-in type terminal

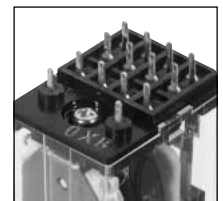

PC board type terminal

● **Sockets**

There is almost infinite choice of sockets. They can be adapted to all types of wiring including solder type, standard screw terminals, wire wrap and printed circuit. Sockets for rail mounting use are also available.

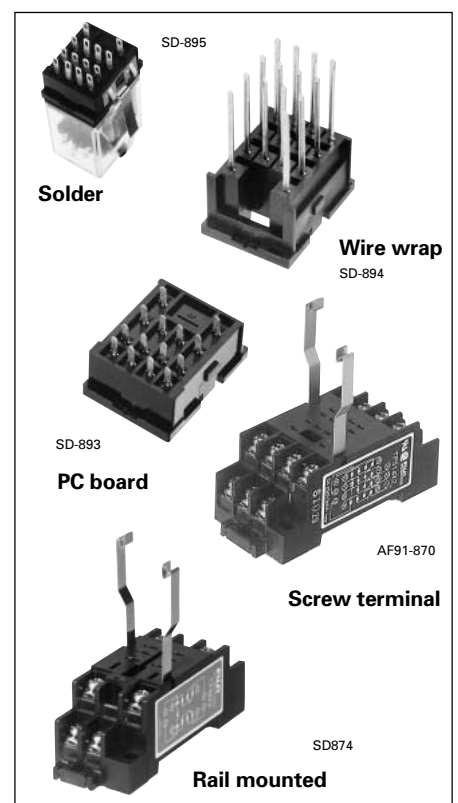

Industrial Control Relays

Miniature control relays

HH52, 53, 54

■ Versions

Operating status indicator

All relays can be supplied on request with a visual indicating signal—a light emitting diode (LED).

LED's are fitted to relays with nominal operating voltages up to 240 volts. The LED emits highly visible red light for AC and green light for DC when power is applied to the relay coil, an extremely useful signal when trouble shooting either equipment or a system.

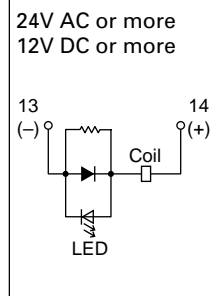
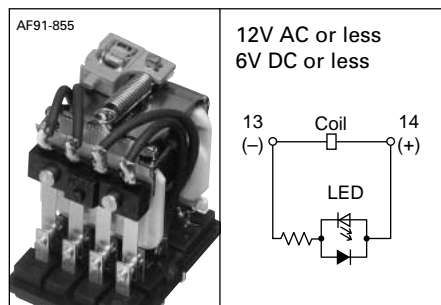

Surge suppression

We can also supply relays with a diode (or CR) for surge suppression. The highly efficient diode (or CR) is connected in parallel with the coil in order to suppress the surge generated within the coil. Consequently this coil can be used in electric circuits which include highly sensitive relays or transistors, etc. without interfering with their operation, so increasing the dependability of the equipment.

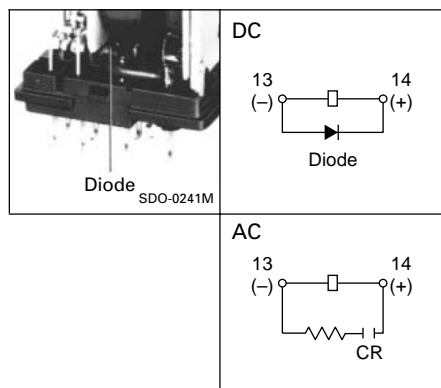

With operation indicator and surge suppression device

This type has a built-in operation indicator and surge suppressor.

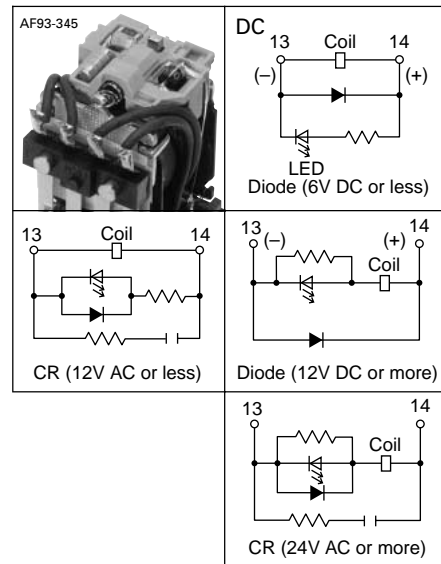

Dual coil magnetically held

One coil firmly holds the contacts in one position, the second coil releases them.

This relay has a good memory stability because it will maintain the ON condition during loss of power. It operates on a momentary pulse to either coil. The relay saves space as well as power, since a single unit occupies half the space of a mechanically interlocking latching relay of the same rating.

Voltages: 6V–110V AC, 6V–48V DC

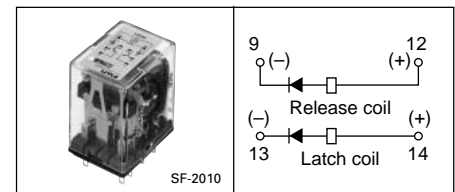

With extra pick-up operating coil

This type is recommended for use in poor power supply environments.
Pick-up voltage: 65% of rated voltage (at 20°C)
Drop-out voltage: 10% of rated voltage (at 20°C)

Mechanical durability: 10 million operations

Other specifications are the same as those of the basic model.

High capacity type

This type is suitable for switching a load like solenoid. The current rating of the contacts is 7A for HH52PU and 5A for HH54PU. Other specifications are the same as those of the basic model.

With Au-plated Ag contact

Type HH □-J has gold-plated contacts. (Note: Models with bifurcated contacts and 4PDT high-capacity models are provided with gold-plated contacts as standard, even if their type number has no J.)

■ **Ordering code system**

● **Relay**

R M 2C P W R F-AH

① ② ③④ ⑤ ⑥ ⑦ ⑧ ⑨⑩

① **Product category**

Code	Description
R	Control relay

② **Series category**

Code	Description
M	Miniature control relay (HH52 to HH54)
P	Miniature power relay (HH62 to HH64)
C	General purpose relay (HH22 to HH24)

③④ **Contact arrangement**

Code	Contact arrangement
2 C	2PDT
3 C	3PDT
4 C	4PDT
3 M	1NO+1NC+SPDT
4 M	2NO+1NC+SPDT
4 2	2PDT with extra pick-up coil

⑤ **Mounting**

Code	Mounting
P	Plug-in mounting
B	PC board mounting
S	Flange mounting

⑥ **Contact form**

Code	Form
Blank	Single
W	Bifurcated
U	High capacity (HH52, 54)
J	Single (Au-plated)

⑦ **Version**

Code	Description
Blank	Standard
R	Magnetically held

⑧ **Accessory**

Code	Description
Blank	Not provided
F	With surge suppression diode (DC)
G	With LED indicator and surge suppression diode (DC)
L	With LED indicator
C	With surge suppression (CR)
A	With LED indicator and surge suppression CR (AC)

⑨⑩ **Operating coil**

Code	Coil voltage
A A	6V AC 50/60Hz
A B	12V AC 50/60Hz
A E	24V AC 50/60Hz
A F	48V AC 50/60Hz
A 1	100–110V AC 50/60Hz
A H	110–120V AC 50/60Hz
A 2	200–220V AC 50/60Hz
A M	220–240V AC 50/60Hz
D A	6V DC
D B	12V DC
D E	24V DC
D F	48V DC
D 1	100–110V DC

● **Socket**

R X 58 X2-CR ZT

① ② ③④ ⑤⑥ ⑦⑧ ⑨⑩

① **Product category**

Code	Description
R	Control relay

② **Series category**

Code	Description
X	Socket

③④ **Application**

Code	Type
5 8	TP58 (For HH52P)
5 1	TP511 (For HH53P)
5 4	TP514 (For HH54P)
6 8	TP68 (For HH62P)
6 1	TP611 (For HH63P)
6 4	TP614 (For HH64P)
8 G	8GB (For HH22P)
3 8	TP38 (For HH22P)
1 G	11GB (For HH23P)
3 1	TP311 (For HH23P)

⑤⑥ **Mounting and wiring**

Code	Description
Blank	Soldering
B 1	PC board
R 2	Wire wrap
	Surface mounting screw terminal (M3.5)
S 0	For HH22, 23, 24 Rail mounting screw terminal (M3.5)
X 0	For HH22, 23, 24
X 2	For HH52, 53, 54, HH62, 63, 64 Rail mounting screw terminal (M3)
X 1	For HH52, 53, 54

⑦⑧ **Socket with surge suppression device**

Code	Description
C R	Provided with CR circuit
C 1	Provided with 100V Z-trap (diode)
C 2	Provided with 200V Z-trap (diode)

⑨⑩ **Approvals**

Code	Standards
Z U	UL
Z S	UL/CSA
Z T	TÜV
Z L	Lloyd

Industrial Control Relays

Miniature control relays

HH52, 53, 54

■ Versions Relay

Classification		Contact form and arrangement		Mounting Plug-in Type	Ordering code	PC board Type	Ordering code	Flange Type	Ordering code
Standard	Without LED	Single	2PDT	HH52P	RM2CP-■	HH52B	RM2CB-■	HH52S	RM2CS-■
			3PDT	HH53P	RM3CP-■	HH53B	RM3CB-■	HH53S	RM3CS-■
		Bifurcated	4PDT	HH54P	RM4CP-■	HH54B	RM4CB-■	HH54S	RM4CS-■
			2PDT	HH52PW	RM2CPW-■	HH52BW	RM2CBW-■	HH52SW	RM2CSW-■
	With LED	Single	2PDT	HH52P-L	RM2CPL-■	HH52B-L	RM2CBL-■		
			3PDT	HH53P-L	RM3CPL-■	HH53B-L	RM3CBL-■		
		Bifurcated	4PDT	HH54P-L	RM4CPL-■	HH54B-L	RM4CBL-■		
			2PDT	HH52PW-L	RM2CPWL-■	HH52BW-L	RM2CBWL-■		
	With surge suppression diode	Single	2PDT	HH52P-F	RM2CPF-■	HH52B-F	RM2CBF-■	HH52S-F	RM2CSF-■
			3PDT	HH53P-F	RM3CPF-■	HH53B-F	RM3CBF-■	HH53S-F	RM3CSF-■
		Bifurcated	4PDT	HH54P-F	RM4CPF-■	HH54B-F	RM4CBF-■	HH54S-F	RM4CSF-■
			2PDT	HH52PW-F	RM2CPWF-■	HH52BW-F	RM2CBWF-■	HH52SW-F	RM2CSWF-■
With surge suppression diode and LED	Single	2PDT	HH52P-FL	RM2CPG-■	HH52B-FL	RM2CBG-■			
		3PDT	HH53P-FL	RM3CPG-■	HH53B-FL	RM3CBG-■			
	Bifurcated	4PDT	HH54P-FL	RM4CPG-■	HH54B-FL	RM4CBG-■			
		2PDT	HH52PW-FL	RM2CPWG-■	HH52BW-FL	RM2CBWG-■			
With surge suppression CR	Single	2PDT	HH52P-CR	RM2CPC-■	HH52B-CR	RM2CBC-■	HH52S-CR	RM2CSC-■	
		3PDT	HH53P-CR	RM3CPC-■	HH53B-CR	RM3CBC-■	HH53S-CR	RM3CSC-■	
	Bifurcated	4PDT	HH54P-CR	RM4CPC-■	HH54B-CR	RM4CBC-■	HH54S-CR	RM4CSC-■	
		2PDT	HH52PW-CR	RM2CPWC-■	HH52BW-CR	RM2CBWC-■	HH52SW-CR	RM2CSWC-■	
With surge suppression CR and LED	Single	2PDT	HH52P-CRL	RM2CPA-■	HH52B-CRL	RM2CBA-■			
		3PDT	HH53P-CRL	RM3CPA-■	HH53B-CRL	RM3CBA-■			
	Bifurcated	4PDT	HH54P-CRL	RM4CPA-■	HH54B-CRL	RM4CBA-■			
		2PDT	HH52PW-CRL	RM2CPWA-■	HH52BW-CRL	RM2CBWA-■			
Magnetically held	Single	2PDT	HH52P-R	RM2CPR-■	HH52B-R	RM2CBR-■	HH52S-R	RM2CSR-■	
	Bifurcated	2PDT	HH52PW-R	RM2CPWR-■	HH52BW-R	RM2CBWR-■	HH52SW-R	RM2CSWR-■	
High capacity	Without LED	Single	2PDT	HH52PU	RM2CPU-■	HH52BU	RM2CBU-■	HH52SU	RM2CSU-■
			4PDT	HH54PU	RM4CPU-■	HH54BU	RM4CBU-■	HH54SU	RM4CSU-■
	With LED	Single	2PDT	HH52PU-L	RM2CPUL-■	HH52BU-L	RM2CBUL-■		
			4PDT	HH54PU-L	RM4CPUL-■	HH54BU-L	RM4CBUL-■		
	With surge suppression diode	Single	2PDT	HH52PU-F	RM2CPUF-■	HH52BU-F	RM2CBUF-■	HH52SU-F	RM2CSUF-■
			4PDT	HH54PU-F	RM4CPUF-■	HH54BU-F	RM4CBUF-■	HH54SU-F	RM4CSUF-■
	With surge suppression diode and LED	Single	2PDT	HH52PU-FL	RM2CPUG-■	HH52BU-FL	RM2CBUG-■		
			4PDT	HH54PU-FL	RM4CPUG-■	HH54BU-FL	RM4CBUG-■		
	With surge suppression CR	Single	2PDT	HH52PU-CR	RM2CPUC-■	HH52BU-CR	RM2CBUC-■	HH52SU-CR	RM2CSUC-■
			4PDT	HH54PU-CR	RM4CPUC-■	HH54BU-CR	RM4CBUC-■	HH54SU-CR	RM4CSUC-■
With surge suppression CR and LED	Single	2PDT	HH52PU-CRL	RM2CPUA-■	HH52BU-CRL	RM2CBUA-■			
		4PDT	HH54PU-CRL	RM4CPUA-■	HH54BU-CRL	RM4CBUA-■			

- Notes: 1. UL, CSA, and TÜV approved.
2. Bifurcated contacts are all gold-plated silver contacts.
3. Enter the coil voltage code in the ■ mark.
4. For types with single contact other than high-capacity types, types with gold-plated silver contact are available on request. To order these types, add J to the ordering code. Refer to the ordering code system.
Example: RM2CPJ-■ (with gold-plated silver contact)
RM2CP-■ (with silver contact: standard)

Classification		Contact form and arrangement	Mounting Plug-in Type	Ordering code	PC board Type	Ordering code	Flange Type	Ordering code
With extra pick-up coil	Without LED	Single 2PDT	HH54-2P	RM42P-■	HH54-2B	RM42B-■	HH54-2S	RM42S-■
		Bifurcated 2PDT	HH54-2PW	RM42PW-■	HH54-2BW	RM42BW-■	HH54-2SW	RM42SW-■
		Single 2PDT	HH54-2P-L	RM42PL-■	HH54-2B-L	RM42BL-■		
	With LED	Bifurcated 2PDT	HH54-2PW-L	RM42PWL-■	HH54-2BW-L	RM42BWL-■		
		Single 2PDT	HH54-2P-F	RM42PF-■	HH54-2B-F	RM42BF-■	HH54-2S-F	RM42SF-■
		Bifurcated 2PDT	HH54-2PW-F	RM42PWF-■	HH54-2BW-F	RM42BWF-■	HH54-2SW-F	RM42SWF-■
	With surge suppression diode	Single 2PDT	HH54-2P-FL	RM42PG-■	HH54-2B-FL	RM42BG-■		
		Bifurcated 2PDT	HH54-2PW-FL	RM42PWG-■	HH54-2BW-FL	RM42BWG-■		
	With surge suppression CR	Single 2PDT	HH54-2P-CR	RM42PC-■	HH54-2B-CR	RM42BC-■	HH54-2S-CR	RM42SC-■
		Bifurcated 2PDT	HH54-2PW-CR	RM42PWC-■	HH54-2BW-CR	RM42BWC-■	HH54-2SW-CR	RM42SWC-■
	With surge suppression CR and LED	Single 2PDT	HH54-2P-CRL	RM42PA-■	HH54-2B-CRL	RM42BA-■		
		Bifurcated 2PDT	HH54-2PW-CRL	RM42PWA-■	HH54-2BW-CRL	RM42BWA-■		

- Notes:
- Bifurcated contacts are all gold-plated silver contacts.
 - Enter the coil voltage code in the ■ mark.
 - For types with single contact other than high-capacity types, types with gold-plated silver contact are available on request. To order these types, add J to the ordering code. Refer to the ordering code system.
- Example: RM2CPJ-■ (with gold-plated silver contact)
 RM2CP-■ (with silver contact: standard)

03

Industrial Control Relays

Miniature control relays

HH52, 53, 54

■ Sockets

Description	Standard *			With surge suppression device				Mass (g)	Used with		
	Type	Ordering code	Mass (g)	CR circuit Type	Ordering code	100V Z-trap Type	Ordering code			200V Z-trap Type	Ordering code
Soldering	TP58	RX58	9	-	-	-	-	-	-	HH52P	
	TP511	RX51	10	-	-	-	-	-	-	HH53P	
	TP514	RX54	10	-	-	-	-	-	-	HH54P	
PC board	TP58B	RX58B1	9	-	-	-	-	-	-	HH52P	
	TP511B	RX51B1	9.5	-	-	-	-	-	-	HH53P	
	TP514B	RX54B1	9.5	-	-	-	-	-	-	HH54P	
Wire wrap	TP58R2	RX58R2	10.5	-	-	-	-	-	-	HH52P	
	TP511R2	RX51R2	11.5	-	-	-	-	-	-	HH53P	
	TP514R2	RX54R2	12.5	-	-	-	-	-	-	HH54P	
Rail mounting screw terminal M3.5	TP58X2	RX58X2	49	TP58X2-CR	RX58X2-CR	TP58X2-Z/100	RX58X2-C1	TP58X2-Z/200	RX58X2-C2	49	HH52P
	TP511X2	RX51X2	50	TP511X2-CR	RX51X2-CR	TP511X2-Z/100	RX51X2-C1	TP511X2-Z/200	RX51X2-C2	50	HH53P
	TP514X2	RX54X2	62	TP514X2-CR	RX54X2-CR	TP514X2-Z/100	RX54X2-C1	TP514X2-Z/200	RX54X2-C2	62	HH54P
Rail mounting screw terminal M3.0	TP58X1	RX58X1	32	TP58X1-CR	RX58X1-CR	-	-	-	-	32	HH52P
	-	-	-	-	-	-	-	-	-	-	-
	TP514X1	RX54X1	49	TP514X1-CR	RX54X1-CR	-	-	-	-	49	HH54P

Note: *UL, CSA and TÜV approved

■ Mounting plates and rails

Type	Ordering code	Socket capacity* (Max.)
TX01	RZ01	1 pc.
TX16	RZ16	16 pcs.
TX19	RZ19	19 pcs.
TX18C	RZ18C	18 pcs.
TX36C1	RZ36C1	36 pcs.

Mounting plate

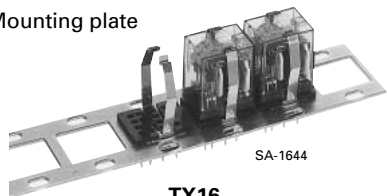

TX16

Mounting rail 900mm

TH35-7.5	RR7F
TH35-7.5AL	RR7A
TH35-15AL	RR15A

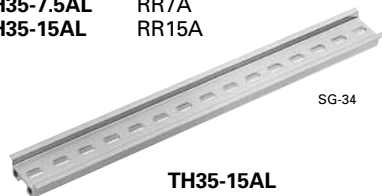

TH35-15AL

Minimum ordering quantity: 10 pcs. (1 pack)

Notes: Plates will accept both soldering terminal and wire wrap terminal sockets.

* No. of relays to be mounted directly.

■ Type number nomenclature

Relays

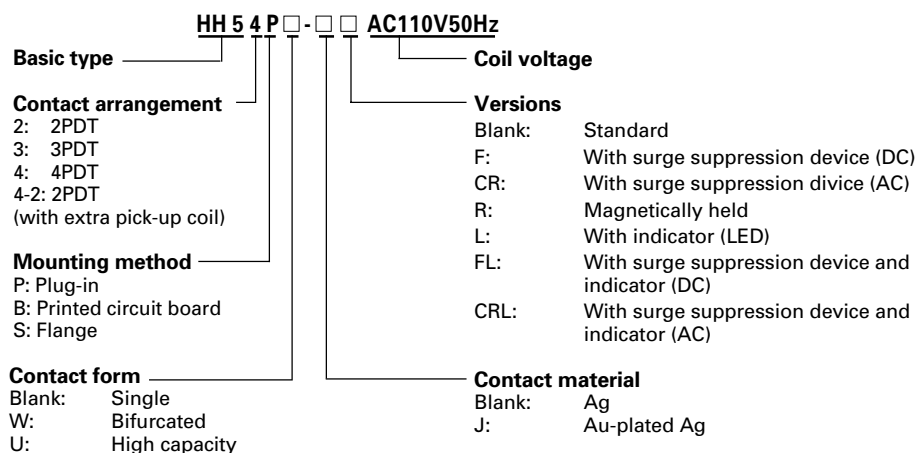

Sockets

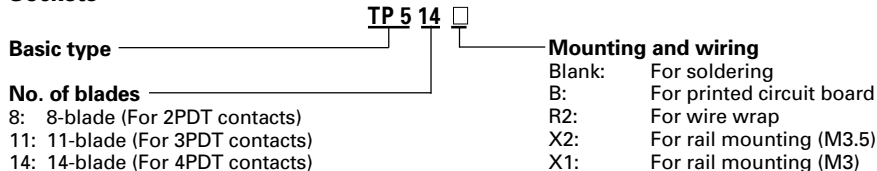

■ Ordering information

- Specify the following:
1. Ordering code or type number
 2. Coil voltage
 3. Socket type number

■ Specifications

Basic type		HH52 HH53	HH54	HH52U	HH54U	HH52W	HH54W
Contact form	Single					Bifurcated	
Rated thermal current (A)		5	3	7	5	5	3
Rated insulation voltage	250V						
Pick-up voltage (at 20° C)	AC	80% of rated voltage					
	DC	75% of rated voltage					
Drop-out voltage (at 20° C)	AC	30% of rated voltage					
	DC	10% of rated voltage					
Max. power supply voltage	110% of rated voltage						
Operating temperature	-55 to +70°C, no icing (-25 to +60°C for with operating indicator)						
Dielectric strength	2000V AC rms, 1 minute between coil and contact 2000V AC rms, 1 minute between poles 1000V AC rms, 1 minute between open contacts 2000V AC rms, 1 minute between socket terminals						
Insulation resistance	100MΩ (500V DC megger)						
Operating time	20ms or less						
Vibration	Mechanical and malfunction durability: 10 to 55Hz, 1mm double amplitude						
Shock	Malfunction durability: 200m/s ² Mechanical durability: 1000m/s ²						
Durability	Mechanical	AC ratings: 50 million operations DC ratings: 100 million operations					
Contact resistance (before use)	50mΩ max.						
Mass	Approx. 33g						

Notes: HH52PW, 54PW, HH54PU: Au-plated Ag contact as standard
 HH52P, 53P, 54P: Ag contact as standard

■ Coil characteristics

- AC coil

Order voltage code	Rated voltage (V)	Rated current (mA)		Coil resistance (Ω)	Coil color	Power consumption (VA)	
		50Hz	60Hz			50Hz	60Hz
AC6	6	200	167	10	Clear	1.2	1.0
AC12	12	100	83	46	Clear		
AC24	24	50	42	187	Clear		
AC48	48	25	21	746	Clear		
AC100	100/110	12/12.7	10/10.9	3680	Green	1.2/1.4	1.0/1.2
AC110	110/120	10.9/11.7	9.1/10	4320	Clear		
AC200	200/220	6/6.4	5/5.5	13400	Yellow		
AC220	220/240	5.5/5.8	4.5/5	17200	Clear		

Note: Other voltages up to 240V AC are also available, contact FUJI.

- DC coil

Order voltage code	Voltage (V)	Rated current (mA)	Coil resistance (Ω)	Coil color	Power consumption (W)
DC6	6	150	40	Clear	0.9
DC12	12	75	160	Black	
DC24	24	37	650	Grape	
DC48	48	18.5	2600	Red	
DC100	100/110	9.1/10	11000	Blue	

Note: Other voltages up to 130V DC are also available on request, contact FUJI.

Industrial Control Relays

Miniature control relays

HH52, 53, 54

■ Operating current and electrical durability

Voltage	Make Current (A)	Power factor or time constant	Break Current (A)	Power factor or time constant	Electrical life ($\times 10^3$ operations)				
					HH52U	HH52, HH53	HH54 HH54U	HH52W	HH54W
200V AC Ind. load	10	$\text{Cos}\phi = 0.7$	1	$\text{Cos}\phi = 0.3$ to 0.4	1000	400	80	150	–
	5		0.5		2000	1000	200	400	–
	3		0.3		3500	1700	330	660	80
100V AC Ind. load	10	$\text{Cos}\phi = 0.7$	1	$\text{Cos}\phi = 0.3$ to 0.4	1500	700	130	260	–
	5		0.5		3300	1500	280	560	70
	3		0.3		6000	2800	500	1000	120
200V AC Res. load	3	$\text{Cos}\phi = 1$	3	$\text{Cos}\phi = 1$	1200	600	150	300	–
	1		1		4000	2000	500	1000	130
100V AC Res. load	3	$\text{Cos}\phi = 1$	3	$\text{Cos}\phi = 1$	1700	1000	250	500	60
	1		1		6000	3400	900	1800	120
24V DC Ind. load	1	T=15msec.	1	T=15msec.	1000	500	150	300	–
	0.2		0.2		8400	4000	1200	2400	400
24V DC Res. load	3	T=0msec.	3	T=0msec.	1000	400	100	200	–
	1		1		4500	1600	400	800	100

■ Ratings (UL and CSA)

Basic type	Voltage	Single-phase* motor (HP)	Resistive load (A)	Inductive load (A)	Remarks (polarity)
HH52P, 52B 52S HH53P, 53B 53S	120V AC	1/6	5	1.5	Same polarity between adjacent contacts for inductive load Opposite polarity for others
	240V AC	1/4	5	–	
	30V DC	–	5	2(15ms)	
	120V DC	–	0.3	0.2(15ms)	
HH54P, 54B, 54S	120V AC	1/10	3	1	Same polarity between adjacent contacts for inductive load Opposite polarity for others
	240V AC	1/4	3	–	
	30V DC	–	3	2(15ms)	
	120V DC	–	0.3	0.2(15ms)	
HH52PU, 52BU, 52SU	120V AC	1/4	7	1.5	Same polarity between adjacent contacts for inductive load Opposite polarity for others
	240V AC	3/4	7	–	
	30V DC	–	7	2(15ms)	
	120V DC	–	0.3	0.2(15ms)	
HH54PU, 54BU, 54SU	120V AC	1/8	5	1	Same polarity between adjacent contacts for inductive load Opposite polarity for others
	240V AC	1/4	5	–	
	30V DC	–	5	2(15ms)	
	120V DC	–	0.3	0.2(15ms)	
HH52PW, 52BW, 52SW	120V AC	1/6	5	1.5	Same polarity between adjacent contacts for inductive load Opposite polarity for others
	240V AC	1/4	5	–	
	30V DC	–	5	2(15ms)	
	120V DC	–	0.3	0.2(15ms)	
HH54PW, 54BW, 54SW	120V AC	–	3	1	Same polarity between adjacent contacts for inductive load Opposite polarity for others
	240V AC	–	3	–	
	30V DC	–	3	2(15ms)	
	120V DC	–	0.2	0.2(15ms)	

Note: *UL and CSA approvals only.

■ Dimensions, mm/Relays

Plug-in

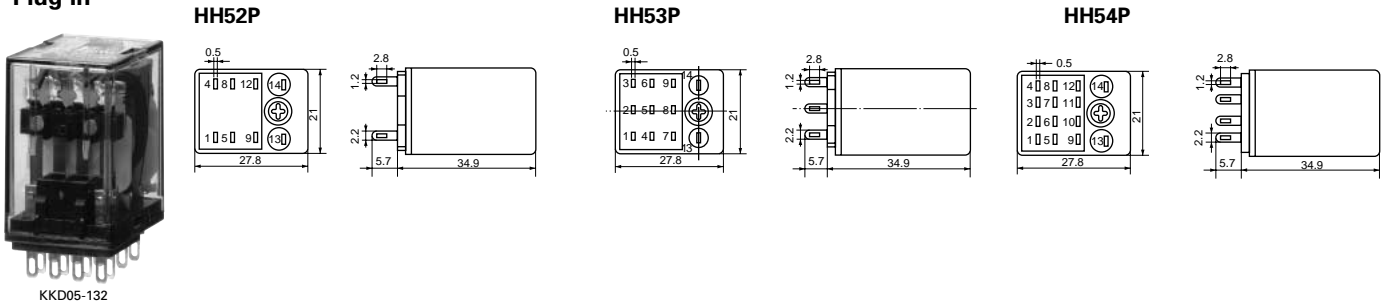

03

P.C. board

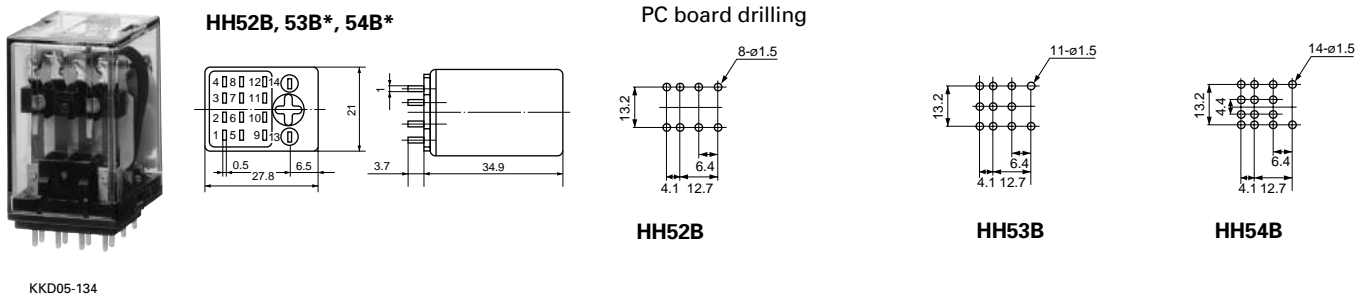

* Number of terminals are different from HH52B.

Flange

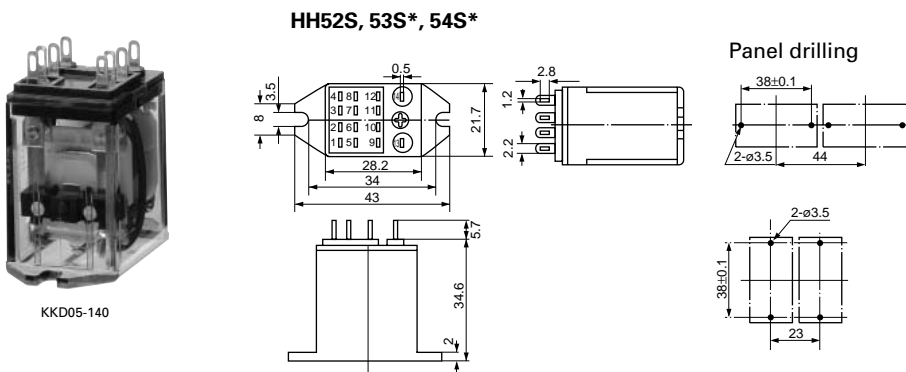

* Number of terminals are different from HH52S.

■ Wiring diagrams

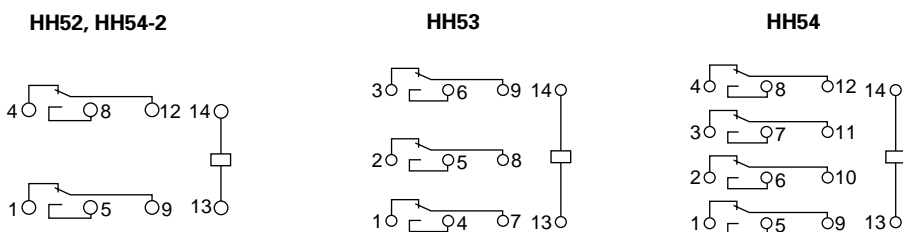

Industrial Control Relays

Miniature control relays

HH52, 53, 54

■ Dimensions, mm/Sockets

Soldering

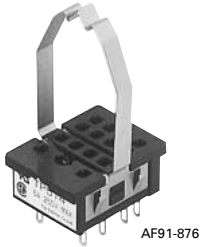

TP511

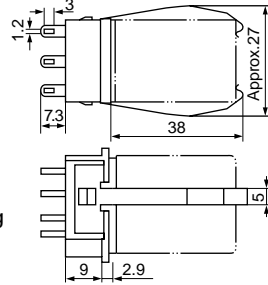
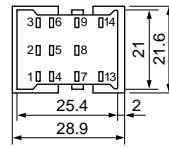

Mass: Approx. 10g

Panel cutting

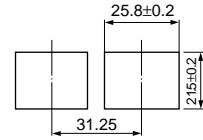

TP58

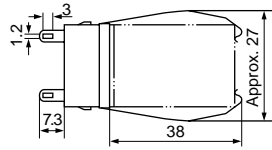
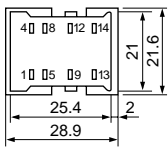

Mass: Approx. 10g

TP514

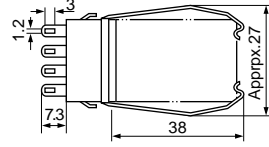
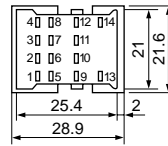

Mass: Approx. 10g

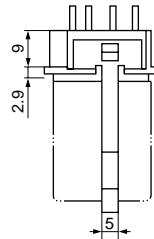
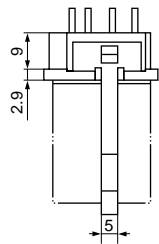

P.C. board



TP58B, TP511B, TP514B

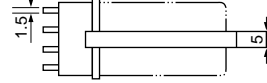
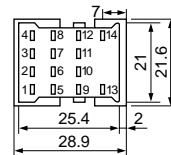

PC board drilling

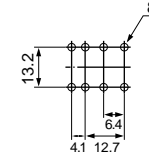

TP58B

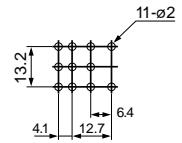

TP511B

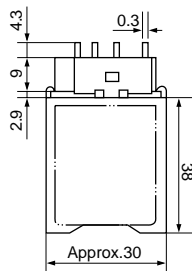

Mass: 58B Approx. 9g
511B, 514B Approx. 9.5g

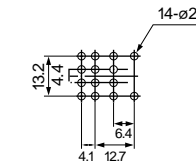

TP514B

Wire-wrap

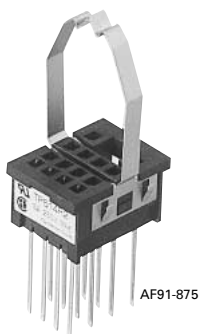

TP58R2

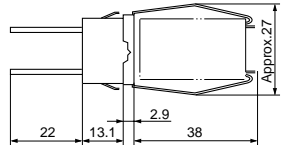
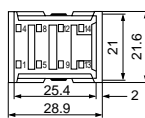

TP511R2

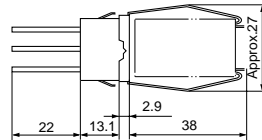
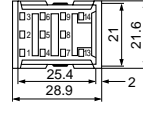

Panel cutting

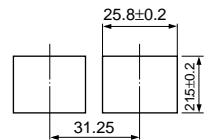

TP514R2

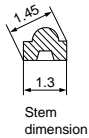
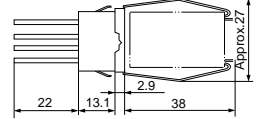
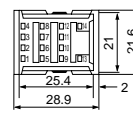

Mass: Approx. 10.5g

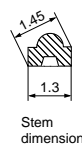

Mass: Approx. 11.5g

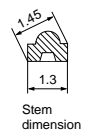

Mass: Approx. 12.5g

Mounting plates

FUJI can supply very convenient mounting plates which can accept either 1, 16, 18, 19, or 36 panel mounting miniature relays.

These mounting plates use plug-in relays with sockets, which are held in position by "snap-in" clips.

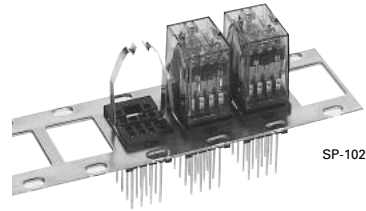

TX01

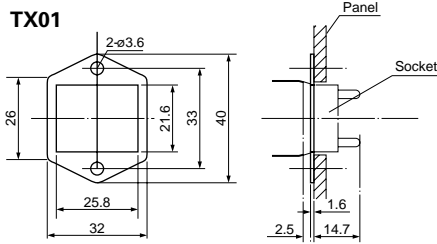

Mass: Approx. 5.8g

TX16, TX19

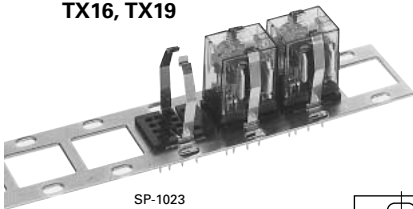

Mass: TX16 Approx. 130g
 TX19 Approx. 160g

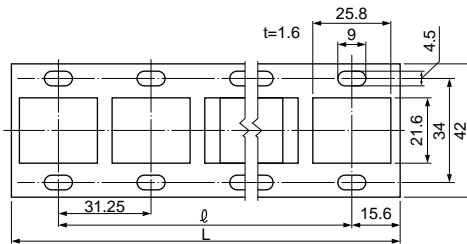

Panel cutting

Description	Type	
	TX16	TX19
Hole	16	19
L distance	500	594
l distance	468.7	562.5

TX18C

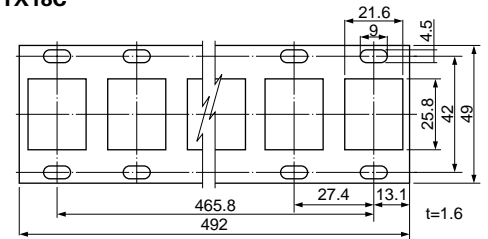

Mass: Approx. 155g

TX36C1

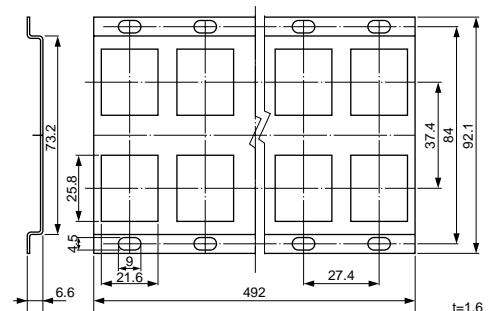

Mass: Approx. 325g

● **Finger protection covers**

- Quick-mounting type cover
 The cover can be quickly mounted on or removed from the TP series socket used with HH series control relay, even if sockets are mounted side-by-side.
- Mountable any time
 The cover can be mounted on or removed from the socket at any time before or after wiring the terminals.

■ **Types**

Type	Used with
RZ52X1	TP58X1 Socket for HH52P miniature control relay
RZ54X1	TP514X1 Socket for HH54P miniature control relay
FX14X2	TP58X2 socket for HH52P miniature control relay TP514X2 socket for HH54P miniature control relay

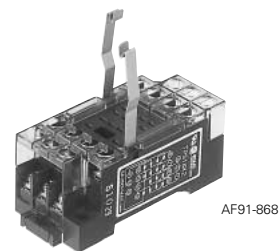

FX14X2

■ **Dimensions, mm**

RZ52X1

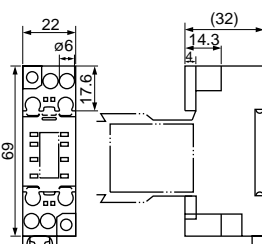

Mass: Approx. 2g

RZ54X1

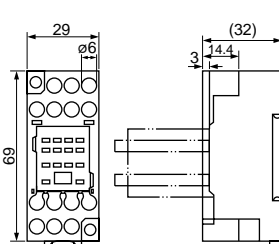

Mass: Approx. 2.5g

FX14X2

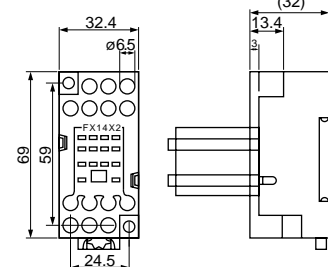

Mass: Approx. 2.7g

Industrial Control Relays

Miniature control relays

HH52, 53, 54

■ Dimensions, mm

Socket for rail mounting

● Screw terminal M3.5

TP58X2 (for HH52P)

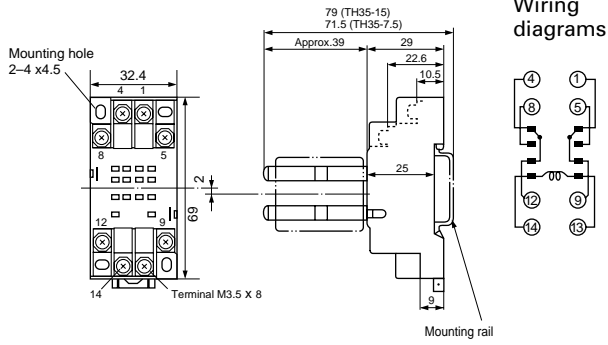

Mass: 49g

TP511X2 (for HH53P)

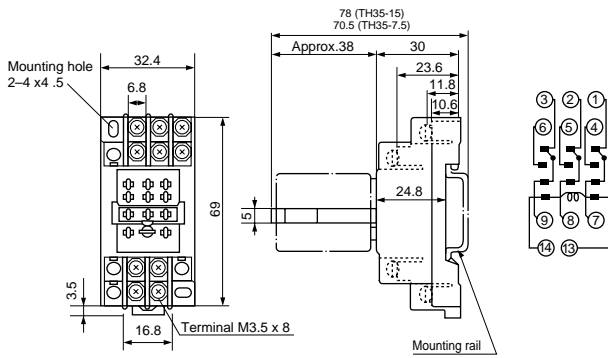

Mass: 50g

TP514X2 (for HH54P)

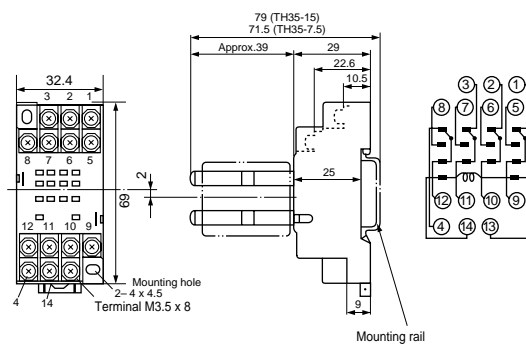

Mass: 62g

● Screw terminal M3

TP58X1 (for HH52P)

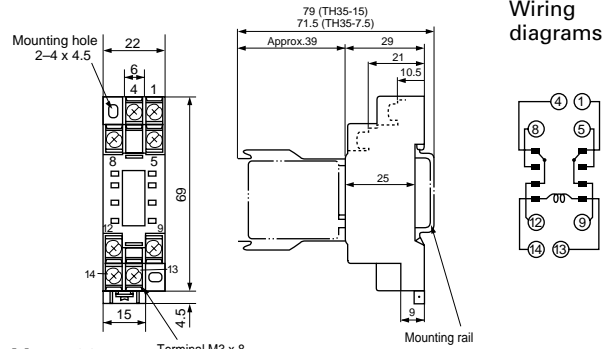

Mass: 32g

TP514X1 (for HH54P)

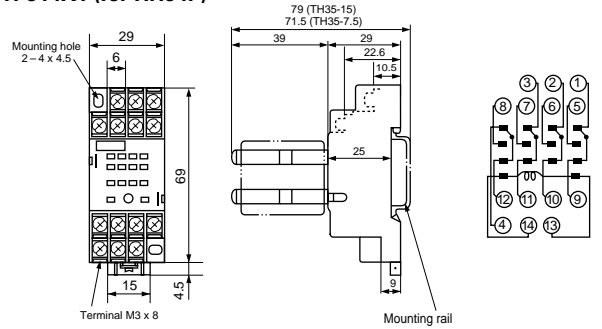

Mass: 49g

● Mounting rails

TH35-7.5

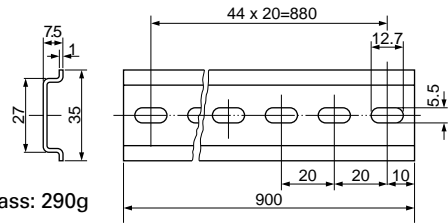

TH35-7.5AL

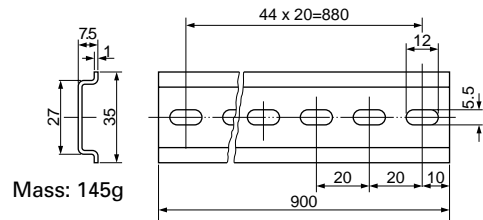

TH35-15AL

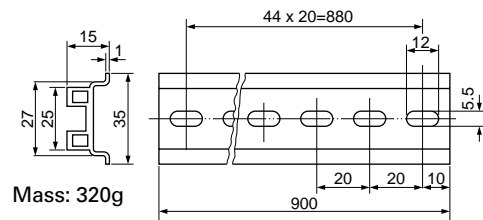

Compact, lightweight, and economical power relay with a high contact rating HH62, 63, 64

■ **Features**

- High contact rating
 Although compact and lightweight, this power relay has a contact rating of 10A. This relay is ideal for many kinds of electrical control equipment.
- High dielectric strength
 Though very compact, this relay has a dielectric strength of 2,000V AC for 1 minute.
- Easy socket mounting
 The input and output terminal arrangement makes the relay easy to mount on a control panel and easy to maintain and checks.
- Easy-to-identify coil voltages
 Different coil voltages are shown by different insulating tape colors. The coil voltages can be seen at a glance.

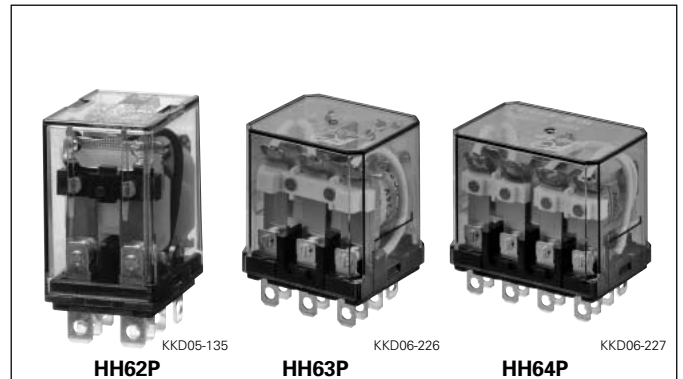

● **UL recognized, CSA and TÜV approved**

UL file No.

HH62: E42419
 HH63: E142976
 HH64: E142975

TÜV license No.

HH62: R9251342
 TP68: T9150891

CSA file No.

HH62: LR20479
 HH63, 64: LR35144

Relays

Classification		Contact form and arrangement	Mounting Plug-in Type	Ordering code	PC board Type	Ordering code	Frange Type	Ordering code
Standard	Without LED	Single 2PDT	HH62P	RP2CP-■	HH62B	RP2CB-■	HH62S	RP2CS-■
		3PDT	HH63P	RP3CP-■				
		4PDT	HH64P	RP4CP-■				
	With LED	Bifurcated 2PDT	HH62PW	RP2CPW-■	HH62BW	RP2CBW-■	HH62SW	RP2CSW-■
		Single 2PDT	HH62P-L	RP2CPL-■	HH62B-L	RP2CBL-■		
		3PDT	HH63P-L	RP3CPL-■				
With surge suppression device	Without LED	4PDT	HH64P-L	RP4CPL-■				
		Bifurcated 2PDT	HH62PW-L	RP2CPWL-■	HH62BW-L	RP2CBWL-■		
		Single 2PDT	HH62P-F	RP2CPF-■	HH62B-F	RP2CBF-■	HH62S-F	RP2CSF-■
	With LED	Single 2PDT	HH62P-CR	RP2CPC-■	HH62B-CR	RP2CBC-■		
		Bifurcated 2PDT	HH62PW-F	RP2CPWF-■	HH62BW-F	RP2CBWF-■	HH62SW-F	RP2CSWF-■
		Bifurcated 2PDT	HH62PW-CR	RP2CPWC-■	HH62BW-CR	RP2CBWC-■		
		Single 2PDT	HH62P-FL	RP2CPG-■	HH62B-FL	RP2CBG-■		
		Single 2PDT	HH62P-CRL	RP2CPA-■	HH62B-CRL	RP2CBA-■		
		Bifurcated 2PDT	HH62PW-FL	RP2CPWG-■	HH62BW-FL	RP2CBWG-■		
		Bifurcated 2PDT	HH62PW-CRL	RP2CPWA-■	HH62BW-CRL	RP2CBWA-■		

Notes: • Enter the coil voltage code in the ■ mark. • UL, CSA and TÜV approved.

■ **Specifications**

Rated insulation voltage		250V
Pick-up voltage (at 20°C)	AC DC	80% of rated voltage HH62: 75% of rated voltage HH63, 64: 80% of rated voltage
Drop-out voltage (at 20°C)	AC DC	30% of rated voltage 10% of rated voltage
Max. power supply voltage		110% of rated voltage
Operating temperature		HH62: -55 to +70°C, no icing (-25 to +50°C for with operating indicator) HH63, 64: -25 to +40°C, no icing (up to +55°C at 4A or less)
Dielectric strength		2000V AC rms., 1 minute between coil and contact 2000V AC rms., 1 minute between poles 1000V AC rms., 1 minute between open contacts 2000V AC rms., 1 minute between socket terminals
Insulation resistance		100MΩ (500V DC megger)
Operating time		HH62: 20ms or less HH63, 64: 25ms or less
Vibration		Mechanical and malfunction durability: 10 to 55Hz, 1mm double amplitude
Shock		Malfunction durability HH62: 200m/s ² , HH63, 64: 100m/s ² Mechanical durability 1000m/s ²
Durability	Mechanical Electrical	50 million operations (with bifurcated contact: 20 million operations) See "Electrical durability curve"
Contact resistance		50mΩ max. before use
Contact material		Silver-alloy

Industrial Control Relays

Miniature power relays

HH62, 63, 64

■ Coil characteristics

● AC coil

Type	Rated voltage (V AC)	Coil voltage code	Exciting current (mA)		Coil color	Power consumption (VA)	
			50Hz	60Hz		50Hz	60Hz
HH62	6	AA	200	167	Clear	1.2	1
	12	AB	100	83			
	24	AE	50	42			
	48	AF	25	21			
	100/110	A1	12/12.7	10/10.9			
HH62	110/120	AH	10.9/11.7	9.1/10	Clear	2	1.7
	200/220	A2	6/6.4	5/5.5	Yellow		
	220/240	AM	5.5/5.8	4.5/5	Clear		
HH63	100	A1	20	17	Green	2	1.7
	200	A2	9.8	8.5	Yellow		
HH64	100	A1	24	20	Green	2.5	2
	200	A2	11.8	10	Yellow		

■ Electrical durability

● HH62

AC Voltage

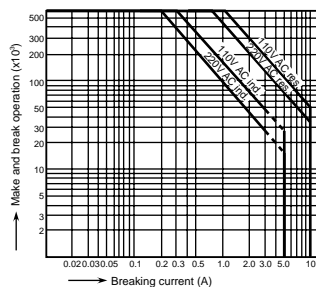

DC Voltage

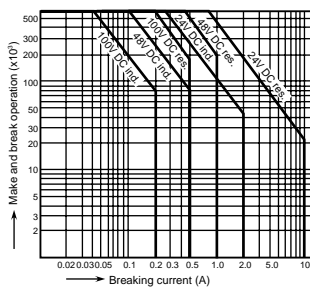

Sockets

Description	Type	Ordering code	Mass (g)	Used with
Soldering	TP68	RX68	10	HH62
PC board	TP68B	RX68B1	9.5	
Wire wrap	TP68R	RX68R2	11	
Rail mounting, screw terminal	TP68X2	RX68X2	46	HH62
	TP611X2	RX61X2	60	HH63
	TP614X2	RX64X2	76	HH64
Finger protection cover	RZ62X2	RZ62X2	2.4	TP68X2
	RZ64X2	RZ64X2	3.5	TP614X2

Mounting rails, 900mm long

Description	Type	Ordering code	Mass (g)	Socket
7.5mm high, Steel	TH35-7.5	RR7F	290	TP68X2,
7.5mm high, Aluminium	TH35-7.5AL	RR7A	145	TP611X2
15mm high, Aluminium	TH35-15AL	RR15A	320	or TP614X2

■ Ordering information

- Specify the following:
- Ordering code or type number
 - Accessory (socket, mounting rail)

● DC coil

Type	Coil voltage code	Rated voltage (V DC)	Exciting current (mA)	Coil resistance (Ω)	Coil color	Power consumption (W)
HH62	DA	6	150	40	Clear	0.9
	DB	12	75	160	Black	
	DE	24	37	650	Reddish brown	
	DF	48	18.5	2600	Red	
	D1	100/110	9.1/10	11000	Blue	
HH63	DE	24	60	400	Reddish brown	1.5
HH64	DE	24	62	388	Reddish brown	1.5

Note: Other voltages up to 240V AC/130V DC are available on request, contact FUJI.

● HH63, 64

AC Voltage

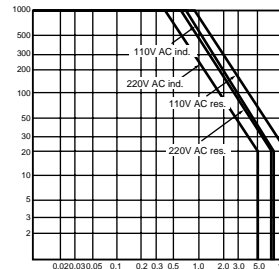

DC Voltage

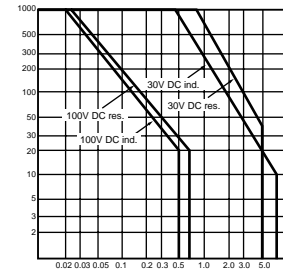

■ Type number nomenclature

Relays

HH6 2 P □ - □ □ AC110V 50Hz

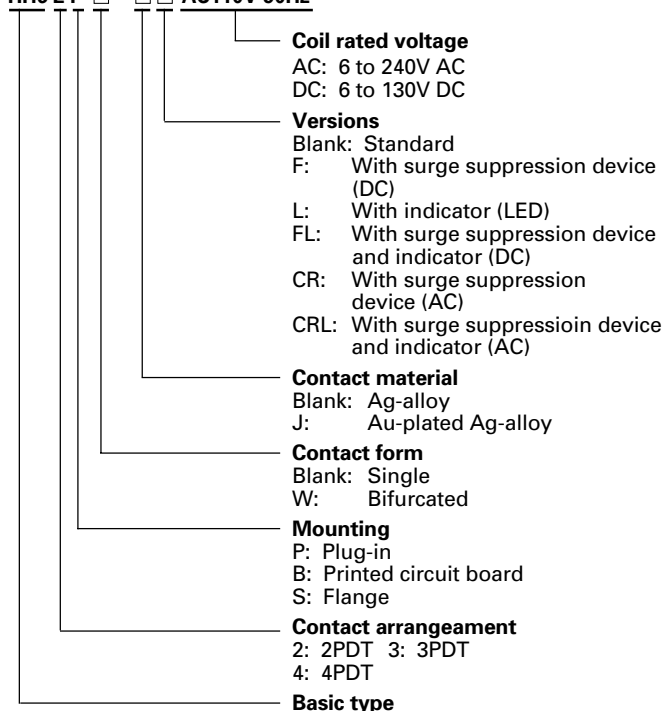

■ **Contact ratings (UL, CSA and TÜV)**

Basic type	Voltage	Single-phase motor (HP)*	Continuous current (A)	Resistive load (A)	Inductive load (A)	Remarks (polarity)
HH62P (HH62PW)	120V AC	1/3 (1/6)	10 (7)	10 (5)	1.5	Opposite polarity
	240V AC	1 (1/4)	10 (7)	10 (5)	—	
	30V DC	—	10 (7)	8 (5)	2(15ms)	
	120V DC	—	10 (7)	0.3 (0.3)	0.2(15ms)	
HH63P* HH64P*	120V AC	1/6	10	10	1.5	Opposite polarity
	240V AC	1/3	10	10	—	
	30V DC	—	10	8	2(15ms)	
	120V DC	—	10	0.3	0.2(15ms)	

Note: *UL and CSA approvals only (): HH62PW

■ **Dimensions, mm**

Relays

HH62P

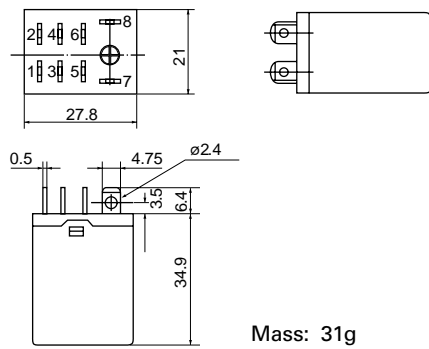

HH63P

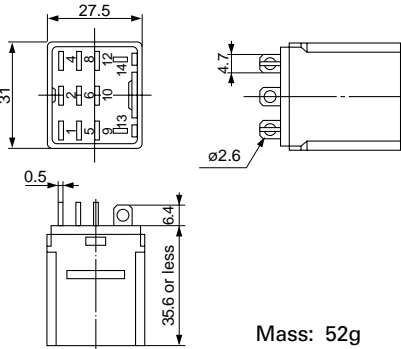

HH64P

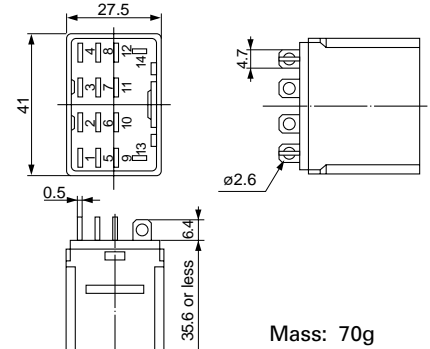

HH62B

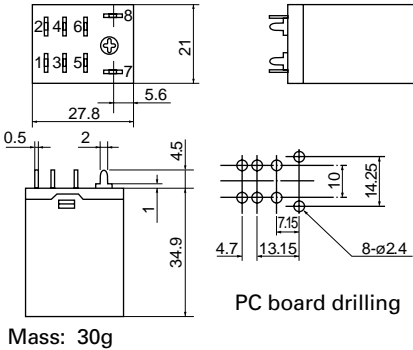

HH62S

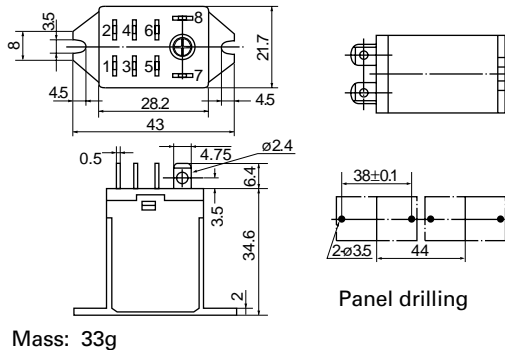

Sockets

TP68 (Soldering)

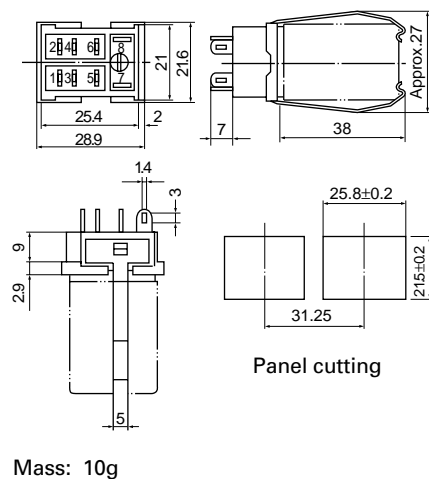

TP68B (PC board)

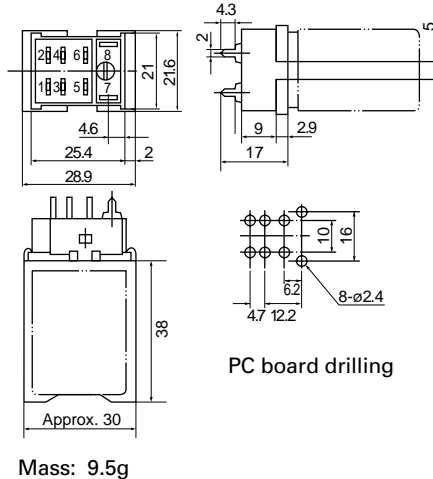

TP68R (Wire wrap)

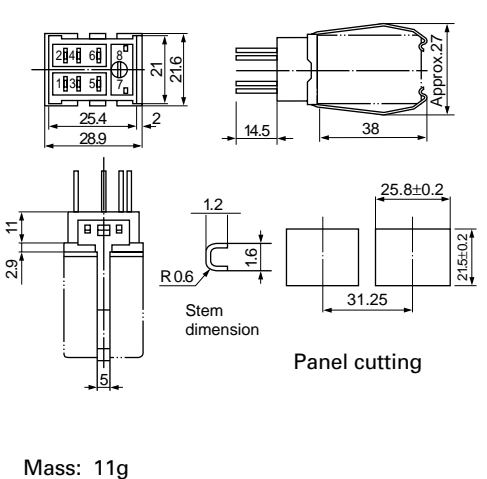

Industrial Control Relays

Miniature power relays

HH62, 63, 64

■ Dimensions, mm

Sockets

TP68X2

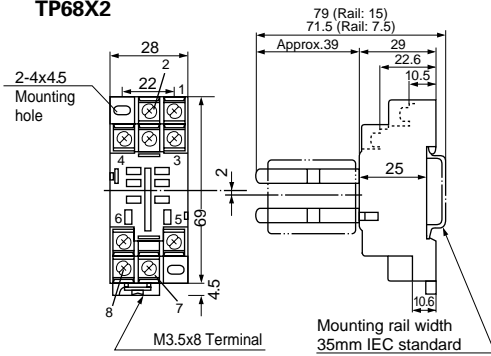

Mass: 46g

TP611X2

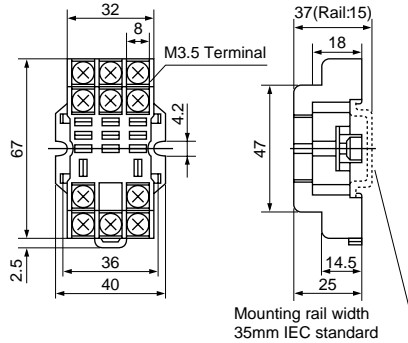

Mass: 60g

TP614X2

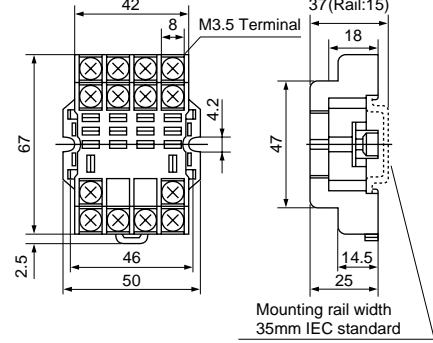

Mass: 76g

Panel drilling

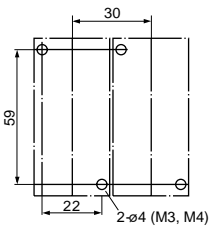

Wiring diagram

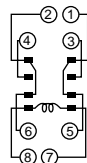

Panel drilling

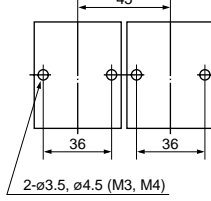

Wiring diagram

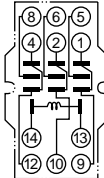

Panel drilling

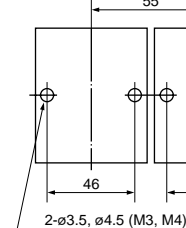

Wiring diagram

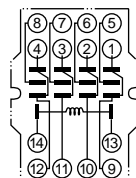

Finger protection covers

RZ62X2

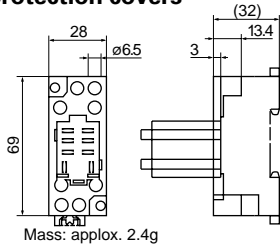

RZ64X2

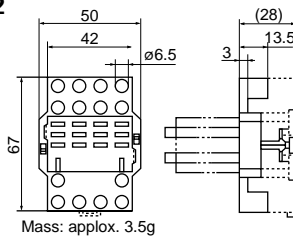

Type	Used with
RZ62X2	TP68X2 Socket for HH62P power relay
RZ64X2	TP614X2 Socket for HH62P power relay

■ Wiring diagrams

• HH62□ (standard)

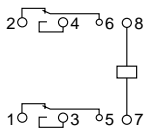

• HH62□-L (with indicator)

Coil : 6V, 12V AC, 6V DC

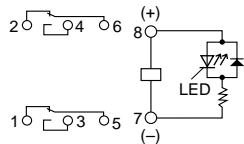

Coil : 24V to 240V AC, 12 to 120V DC

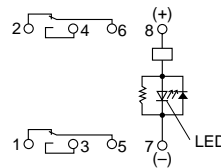

• HH62□-F (with surge suppressor)

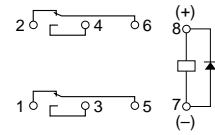

• HH63P (standard)

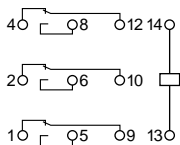

• HH63P-L (with indicator)

Coil : 24V DC

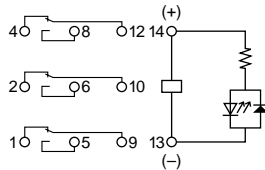

Coil : 100, 200V AC

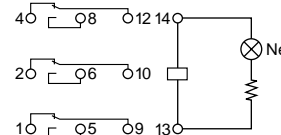

• HH64P (standard)

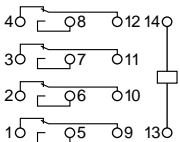

• HH64P-L (with indicator)

Coil : 24V DC

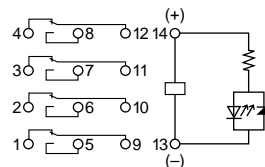

Coil : 100, 200V AC

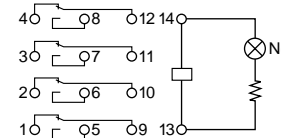

General purpose relays
HH22, 23, 24

■ **Description**

These high quality general purpose relays are suitable for multi-pole switching and, although economically priced, are dependable and sturdily constructed. They are available with coil voltages 24–130V DC and 24–240V AC with continuous current ratings of either 4 or 6 Amps. Standard contact buttons are silver. Contact arrangements are 2PDT, 3PDT and SPDT+2NO+1NC. Relays are enclosed in a polycarbonate dust cover with octal type 8 or 11 pin plugs.

■ **Versions**

Operating status indicator

SF-2016 LED indicator Up to 48V DC

SF-2017 Neon lamp indicator Over 48V AC

These relays can be supplied with a visual operating indicator which greatly simplifies troubleshooting in all types of electrical control equipment.

Dual coil magnetically held

11 (-) 1 (+)
 (-) Release coil (+)
 10 Latch coil 2 (+)

A momentary pulse to one of two coils results in the contacts being firmly held in one of two positions without further flow of current.

This gives this class of relays a good memory stability since it will retain a permanent latch position despite a loss of power.

Coil ratings are 24–220V AC and 24–110V DC.



Surge suppression

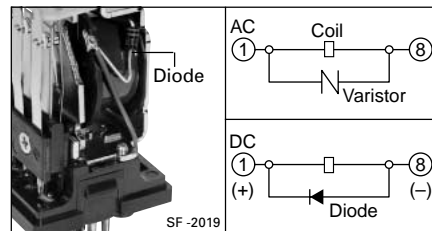

We can supply the relays with surge suppression device.

These relays can be applied for AC and DC operation.

Arc-barrier

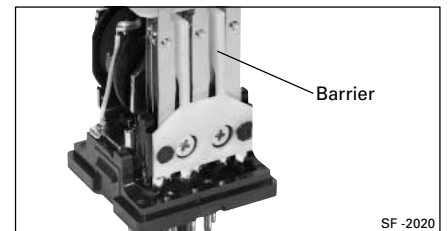

The HH23PN-B is provided with arc-barriers which gives it protection from excessive loads.

It can safely be used on polarized circuits and even small motor loads.

■ **Type number nomenclature**

HH23PN-JBL AC110V50Hz

Basic type HH23PN-JBL AC110V50Hz

Contact arrangement 2: 2PDT, 3: 3PDT, 4: SPDT+2NO+1NC

Mounting method P: Plug-in

Contact form N: Single, W: Bifurcated

Wiring Blank: Wiring A (Standard), T: Wiring B, K: Wiring C (See page 03/44.)

Coil voltage AC: 24 to 240V AC, DC: 24 to 130V DC

Indicators Blank: Without indicator, L: With indicator (neon-lamp or LED)

Versions B: With arc-barrier, F: With surge suppression device, BF: With arc barrier and surge suppression device, R: Magnetically held type, RB: Magnetically held type with arc barrier

Contact Blank: Ag (standard), J: Au-plated Ag

Note: HH24PN type and relays with bifurcated contacts cannot be provided with arc barrier.

■ **Ordering information**

Specify the following:
 1. Ordering code or type number

Industrial Control Relays

General purpose relays

HH22, 23, 24

■ Versions (Plug-in mounting)

Relays

Classification		Contact form and arrangement		Wiring diagram A		Wiring diagram B		Wiring diagram C	
				Type	Ordering code	Type	Ordering code	Type	Ordering code
Standard	Without LED	Single	2PDT 3PDT	HH22PN HH23PN	RC2CP-■ RC3CP-■	HH22PN-T HH23PN-T	RC2CPT-■ RC3CPT-■	HH22PN-K HH23PN-K	RC3CPK-■
		Bifurcated	2NO+1NC+SPDT 2PDT 3PDT	HH24PN HH22PW HH23PW HH24PW	RC4MP-■ RC2CPW-■ RC3CPW-■ RC4MPW-■	- HH22PW-T HH23PW-T	RC2CPWT-■ RC3CPWT-■	- HH22PW-K HH23PW-K	RC3CPWK-■
	With LED	Single	2PDT 3PDT	HH22PN-L HH23PN-L	RC2CPL-■ RC3CPL-■	HH22PN-TL HH23PN-TL	RC2CPTL-■ RC3CPTL-■	HH22PN-KL HH23PN-KL	RC3CPKL-■
		Bifurcated	2NO+1NC+SPDT 2PDT 3PDT	HH24PN-L HH22PW-L HH23PW-L HH24PW-L	RC4MPL-■ RC2CPWL-■ RC3CPWL-■ RC4MPWL-■	- HH22PW-TL HH23PW-TL	RC2CPWL-■ RC3CPWL-■	- HH22PW-KL HH23PW-KL	RC3CPWKL-■
With surge suppression device	Without LED	Single	2PDT 3PDT	HH22PN-F HH23PN-F	RC2CPF-■ RC3CPF-■	HH22PN-TF HH23PN-TF	RC2CPTF-■ RC3CPTF-■	HH22PN-KF HH23PN-KF	RC3CPKF-■
		Bifurcated	2NO+1NC+SPDT 2PDT 3PDT	HH24PN-F HH22PW-F HH23PW-F HH24PW-F	RC4MPF-■ RC2CPWF-■ RC3CPWF-■ RC4MPWF-■	- HH22PW-TF HH23PW-TF	RC2CPWTF-■ RC3CPWTF-■	- HH22PW-KF HH23PW-KF	RC3CPWKF-■
	With LED	Single	2PDT 3PDT	HH22PN-FL HH23PN-FL	RC2CPG-■ RC3CPG-■	HH22PN-TFL HH23PN-TFL	RC2CPTG-■ RC3CPTG-■	HH22PN-KFL HH23PN-KFL	RC3CPKG-■
		Bifurcated	2NO+1NC+SPDT 2PDT 3PDT	HH24PN-FL HH22PW-FL HH23PW-FL HH24PW-FL	RC4MPG-■ RC2CPWG-■ RC3CPWG-■ RC4MPWG-■	- HH22PW-TFL HH23PW-TFL	RC2CPWTG-■ RC3CPWTG-■	- HH22PW-KFL HH23PW-KFL	RC3CPWKG-■
With arc barrier	Without LED	Single	2PDT 3PDT	(HH22PN HH23PN-B	RC2CP-■ RC3CPB-■	(HH22PN-T HH23PN-TB	RC2CPT-■ RC3CPBT-■	(HH22PN-K HH23PN-KB	RC3CPBK-■
		Bifurcated	2PDT	(HH22PW	RC2CPW-■	(HH22PW-T	RC2CPWT-■	(HH22PW-K	
	With LED	Single	2PDT 3PDT	(HH22PN-L HH23PN-BL	RC2CPL-■ RC3CPBL-■	(HH22PN-TL HH23PN-TBL	RC2CPTL-■ RC3CPBTL-■	(HH22PN-KL HH23PN-KBL	RC3CPBKL-■
		Bifurcated	2PDT	(HH22PW-L	RC2CPWL-■	(HH22PW-TL	RC2CPWTL-■	(HH22PW-KL	
With arc barrier and surge suppression device	Without LED	Single	2PDT 3PDT	(HH22PN-F HH23PN-BF	RC2CPF-■ RC3CPBF-■	(HH22PN-TF HH23PN-TBF	RC2CPTF-■ RC3CPBTF-■	(HH22PN-KF HH23PN-KBF	RC3CPBKF-■
		Bifurcated	2PDT	(HH22PW-F	RC2CPWF-■	(HH22PW-TF	RC2CPWTF-■	(HH22PW-KF	
	With LED	Single	2PDT 3PDT	(HH22PN-FL HH23PN-BFL	RC2CPG-■ RC3CPBG-■	(HH22PN-TFL HH23PN-TBFL	RC2CPTG-■ RC3CPBTG-■	(HH22PN-KFL HH23PN-KBFL	RC3CPBKG-■
		Bifurcated	2PDT	(HH22PW-FL	RC2CPWG-■	(HH22PW-TFL	RC2CPWTG-■	(HH22PW-KFL	
Magnetically held	Without LED	Single	2PDT	HH22PN-R	RC2CPR-■	-	-	-	-
		Bifurcated	1NO+1NC+SPDT 2PDT	HH23PN-R HH22PW-R	RC3MPR-■ RC2CPWR-■	-	-	-	-
		Bifurcated	1NO+1NC+SPDT	HH23PW-R	RC3MPWR-■	-	-	-	-
Magnetically held with arc barrier	Without LED	Single	2PDT	(HH22PN-R HH23PN-RB	RC2CPR-■ RC3MPRB-■	-	-	-	-
		Bifurcated	1NO+1NC+SPDT 2PDT	(HH22PW-R	RC2CPWR-■	-	-	-	-

Notes: • Enter the coil voltage code in the ■ mark.

• Although the type in parenthesis denotes a relay having no arc barriers, it has good insulation performance equal to the relay with arc barriers, as it has enough insulation distance between contacts.

Sockets

Description	Type	Ordering code	Used with
Soldering	8-pin	8GB	RX8G
	11-pin	11GB	RX1G
Surface mounting screw terminal	8-pin	TP38S	RX38S0
	11-pin	TP311S	RX31S0
Rail mounting, screw terminal	8-pin	TP38X	RX38X0
	11-pin	TP311X	RX31X0
Hold-down Spring		FX1B	RZ1B
		FX1C	RZ1C

■ Operating current and electrical durability

Voltage	Current (A)		Electrical durability (×10 ³ operations)	
	Make	Break	HH22PN, 23PN, 24PN HH22PW, 23PW	HH24PW
200V AC Ind. load	15 * ₁	3 * ₂	200	100
	10	1	600	300
	3	0.3	2400	1200
200V AC Res. load	3	3	800	400
	1	1	3000	1500
24V DC Ind. load	1 * ₃	1 * ₃	600	300
	0.3	0.3	3000	1500
100V DC Res. load	0.5	0.5	1000	500
	0.1	0.1	5000	4000
24V DC Res. load	3	3	600	300
	0.5	0.5	5000	3000

Note: Power factor: *₁ cosφ=0.7 *₂ cosφ=0.3 to 0.4

Time constant: *₃ T=15ms

■ Specifications

Basic type		HH22P	HH23P	HH24P
Rated thermal current (A)		6	6	4
Rated insulation voltage		250V		
Pick-up voltage (at 20°C)	AC DC	80% of rated voltage 75% of rated voltage		
Drop-out voltage (at 20°C)	AC DC	30% of rated voltage 10% of rated voltage		
Max. power supply voltage	AC DC	110% of rated voltage 130% of rated voltage		
Operating temperature		-20 to +40°C, avoid icing		
Dielectric strength		2000V AC rms., 1minute between coil and contact 2000V AC rms., 1minute between poles 1500V AC rms., 1minute between open contacts 2000V AC rms., 1minute between socket terminals		
Insulation resistance		100MΩ (500V DC megger)		
Operating time		20ms or less		
Vibration		Mechanical and malfunction durability: 10 to 55Hz, 0.75mm double amplitude		
Shock		Malfunction durability: 60m/s ² Mechanical durability: 500m/s ²		
Durability	Mechanical Electrical	50 million operations See page 03/42		
Contact resistance Contact material		50mΩ max. before use Silver-alloy		

■ Coil characteristics

• AC coil

Rated voltage (V)	Coil voltage code	Rated current (mA)		Coil resistance (Ω)	Coil color	Power consumption (VA)	
		50Hz	60Hz			50Hz	60Hz
24	AE	137	125	53	Clear	3.3	3
48	AF	69	63	230	Clear		
100	A1	33	30	900	Green		
200	A2	16	15	3960	Yellow		
220	AM	15	13	4520	Clear		

Note: Other voltages between 24V and 240V AC are available.

• DC coil

Rated voltage (V)	Code voltage code	Rated current (mA)	Coil resistance (Ω)	Coil color	Power consumption (W)
24	DE	67	360	Reddish brown	1.6
48	DF	33	1460	Red	
100	D1	16	6260	Blue	
110	DH	16	7570	Clear	

Note: Other voltages between 24V and 130V DC are available.

■ UL and CSA approved

UL file No. E42419
CSA file No. LR20479

● Relays

Contact	Wiring	Type	Ordering code
2PDT	Single	A	HH22PN-UL RC2CP-■ZU
		C	HH22PN-K-UL RC2CPK-■ZU
	Bifurcated	A	HH22PW-UL RC2CPW-■ZU
		C	HH22PW-K-UL RC2CPWK-■ZU
3PDT	Single	A	HH23PN-UL RC3CP-■ZU
	Single	B	HH23PN-T-UL RC3CPT-■ZU
	Single	C	HH23PN-K-UL RC3CPK-■ZU
		A	HH23PW-UL RC3CPW-■ZU
	Bifurcated	B	HH23PW-T-UL RC3CPWT-■ZU
		C	HH23PW-K-UL RC3CPWK-■ZU

Note: Enter the coil voltage code in the ■ mark.

● Socket

Type	Ordering code	Used with	Type	Ordering code	Used with
8GB-UL	RX8G-ZU	HH22P	11GB-UL	RX1G-ZU	HH23P

● Ratings

Type	Contact ratings			
	Voltage	Single-phase motor (HP)	Resistive load (A)	Inductive load (A)
HH22P□-UL	120V AC	1/4	6	2
HH22P□-T-UL	240V AC	1/2	6	-
HH23P□-UL	30V DC	-	6	3 (15ms)
HH23P□-T-UL	120V DC	-	0.5	0.3 (15ms)

Note: () : Time constant

Industrial Control Relays

General purpose relays

HH22, 23, 24

■ Lloyd approved

Type	Ordering code	Voltage	Contact Arrangement	Form	Continuous current (A)	Approved No.
HH22PN HH23PN HH24PN	RX2CP-■ZL RX3CP-■ZL RX4MP-■ZL	6 to 220V AC 50/60Hz 6 to 110V DC	2PDT 3PDT 2NO+1NC+SPDT	Single	6	YKA052811
HH22PN-T HH23PN-T	RX2CPT-■ZL RX3CPT-■ZL		2PDT 3PDT		4	
HH22PW HH23PW HH24PW	RX2CPW-■ZL RX3CPW-■ZL RX4MPW-■ZL		2PDT 3PDT 2NO+1NC+SPDT		6	
HH22PW-T HH23PW-T	RX2CPWT-■ZL RX3CPWT-■ZL		2PDT 3PDT	4		
				6		

Note: Enter the coil voltage code in the ■ mark.

■ Internal wirings

● Standard

Wiring A

HH22PN
HH22PW

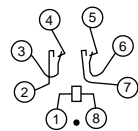

HH23PN
HH23PW

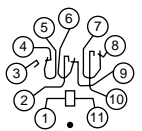

HH24PN
HH24PW

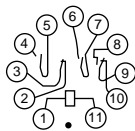

Wiring B

HH22PN-T
HH22PW-T

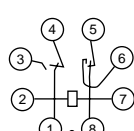

HH23PN-T
HH23PW-T

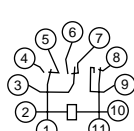

Wiring C

HH23PN-K
HH23PW-K

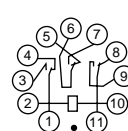

● With operation indicator

HH22PN-L
HH22PW-L

100, 200V

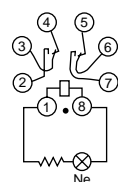

HH23PN
HH23PW

24, 48V*

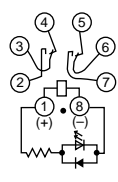

HH22PN-TL
HH22PW-TL

100, 200V

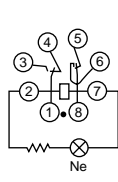

HH22PN-T
HH22PW-T

24, 48V*

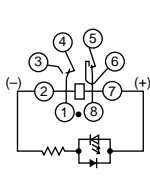

HH23PN-L
HH23PW-L

100, 200V

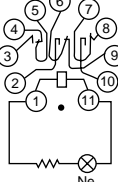

HH23PN-TL
HH23PW-TL

24, 48V*

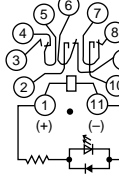

HH23PN-L
HH23PW-L

100, 200V

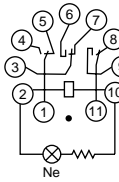

HH23PN-TL
HH23PW-TL

24, 48V*

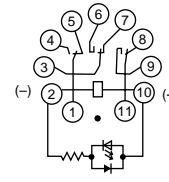

*Be careful that DC coil terminals have polarity

● With surge suppression device (DC coil)

HH22PN-F
HH22PW-F

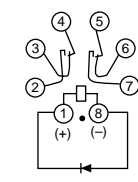

HH22PN-TF
HH22PW-TF

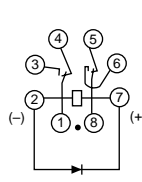

HH23PN-F
HH23PW-F

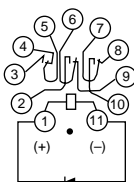

HH23PN-TF
HH23PW-TF

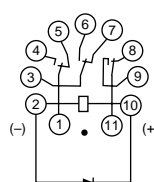

● With surge suppression device (AC coil)

HH22PN-F
HH22PW-F

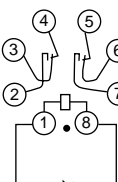

HH22PN-TF
HH22PW-TF

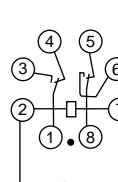

HH23PN-F
HH23PW-F

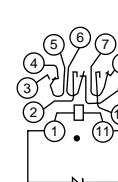

HH23PN-TF
HH23PW-TF

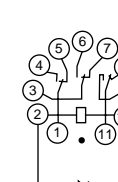

■ **Dimensions, mm**

• **Relays**

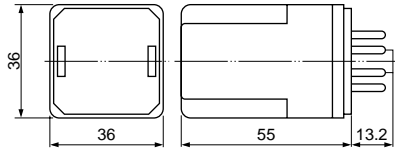

Mass: Approx. 100g

• **Hold-down spring**
FX1B

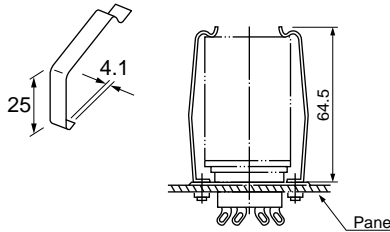

FX1C

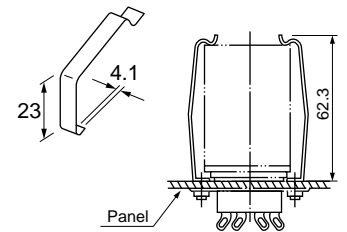

■ **Dimensions, mm**

• **Sockets**

Soldering/8GB, 11GB

8GB

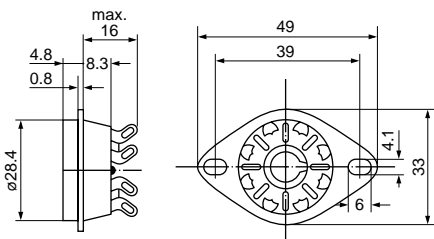

11GB

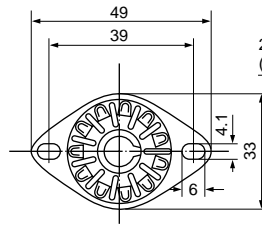

Panel cutting

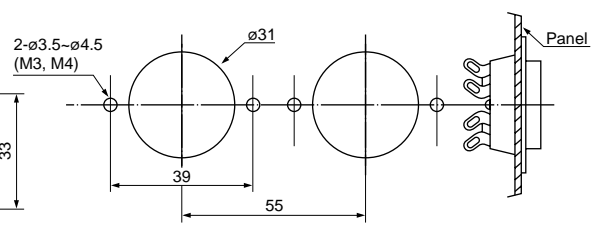

Screw terminal/TP38S, TP311S

TP38S

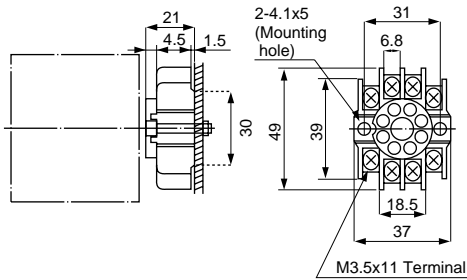

TP311S

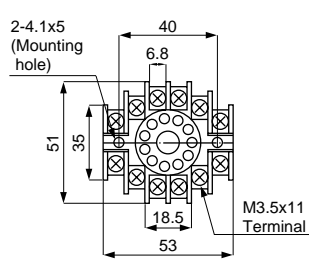

Panel drilling

TP38S

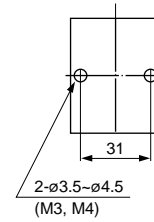

TP311S

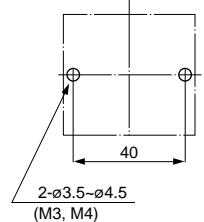

Screw terminal/Rail mounting

TP38X

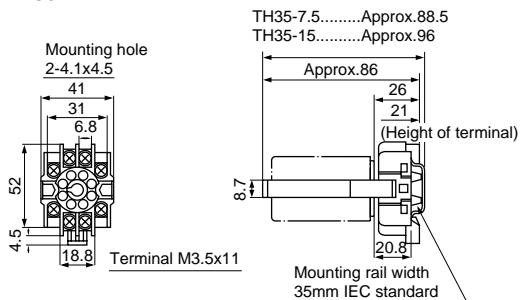

TP311X

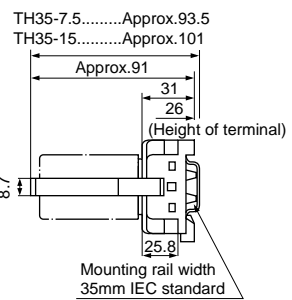
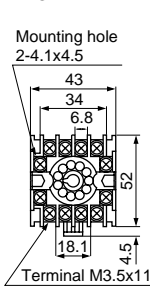

Mass (Approx.)

8-pin		11-pin	
8GB	12.5g	11GB	13g
TP38S	33g	TP311S	46g
TP38X	45g	TP311X	59g

Annunciator Relay Units

RV and JH13PN

Plug-in type annunciator relay units RV and JH13PN

■ Description

RV series are plug-in octal base-type relays designed for modular use. They combine the necessary functions for annunciator systems and simplify the connection to bells, buzzers, alarm lights, flicker relays and lamp test pushbuttons, etc. in alarm systems. Alarm systems require many types of annunciators i.e. alarm lights which flash on and off, or which light in the case of trouble, and trouble pilot lamps with a MEMORY. Thus the relay unit varies according to its usage and the type of annunciator used. FUJI can supply a wide range of relay units to meet the needs of clients. A flicker relay JH13PN is now available. Schematic diagrams of alarm circuits can be supplied.

■ Features

- A relay unit is available to match your alarm system and to permit a simplified circuit.

■ Specifications

● Annunciator relays

Type	RV1□	RV2□	RV3□	RV4□	RV5□	RV1-Z□	RV2-Z□	RV3-Z□	RV4-Z□	RV5-Z□
Ordering code *	RV1A-□	RV2A-□	RV3A-□	RV4A-□	RV5A-□	RV1Z-□	RV2Z-□	RV3Z-□	RV4Z-□	RV5Z-□
Operating coil rated voltage	24 to 240V AC, 50/60Hz		24 to 110V DC			24 to 110V DC				
Input Output	24 to 240V AC, 50/60Hz		24 to 110V DC			24 to 240V AC, 50/60Hz				
Power consumption	AC: Approx. 3.8VA, DC: Approx. 2.4W					AC: Approx. 3.8VA, DC: Approx. 2.4W				
Operating voltage range	85% to 110% of rated voltage					85% to 110% of rated voltage				
Contact rated thermal current	3A	3A	3A	3A	3A	3A	3A	3A	3A	3A
Auxiliary contact arrangement	-	SPDT	1NO	1NC	1NC	-	SPDT	1NO	1NC	1NC
Mechanical durability	50 million operations									
Operating time at rated voltage	Max. 20msec. (AC coils of RV3 and RV4: Max. 25ms.)									
Release time	AC: Max. 20msec. DC: Max. 50msec.									
Ambient temperature	-10°C to +40°C (no icing)									
Insulation resistance	100MΩ at 500V DC megger									
Dielectric strength	2000V AC rms 1 minute between input and output 1000V AC rms 1 minute between each live part									

Note * Enter the operating coil voltage code in the □ mark as follow:
 24V AC:AE, 48V AC:AF, 100V AC:A1, 110V AC:AH, 200V AC:A2, 220V AC:AM, 240V AC:AP
 24V DC:DE, 48V DC:DF, 100V DC:D1, 110V DC:DH

● Flicker relay

Type (Ordering code)	JH13PN-□ (RF1-□)	
Coil	Rated operating voltage	100-110/200-220V AC, DC (selectable) 24, 48V AC/DC
	Operating voltage range	85 to 120% of rated voltage
Output contact arrangement	SPDT	
Flickering period	600msec.	
Contact rated thermal current	6A	
Insulation voltage	250V	
Mechanical durability	10 million operations	
Ambient temperature	-10°C to +40°C (no icing)	
Insulation resistance	100MΩ at 500V DC megger	
Dielectric strength	2000V AC rms 1 minute between control circuit and contact 1000V AC rms 1 minute between open contacts	

Note: Enter the operating coil voltage code in the □ mark as follow:
 24V AC/DC:CE, 48V AC/DC:CF, 100/110V AC/DC, 200/220V AC/DC:CH

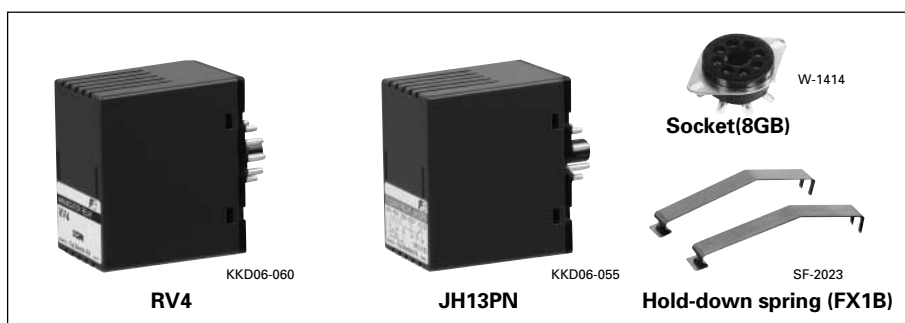

- We can supply 10 different kinds of relay units which meet every situation.
- The compact design allows density mounting and so even if a number of units are installed together the space they occupy is small.
- Low power consumption
- The contact has a rated thermal current of 3 Amps.
- Highly dependable and trouble-free Relay units use the highly dependable FUJI miniature relay HH54B.
- Either lock or non-lock systems are available.
- Relay has a dielectric strength of 2000V AC for 1 minute.
- Alarm input contacts can be either normally open or normally closed.
- With surge suppression device Surges are suppressed by a surge suppressor. Therefore high sensitive relays or semiconductors can be connected to an annunciator circuit without malfunctions or damage.
- Available for uses input and output circuits in opposite polarity.

■ Timing and wiring diagrams/Flicker indication system

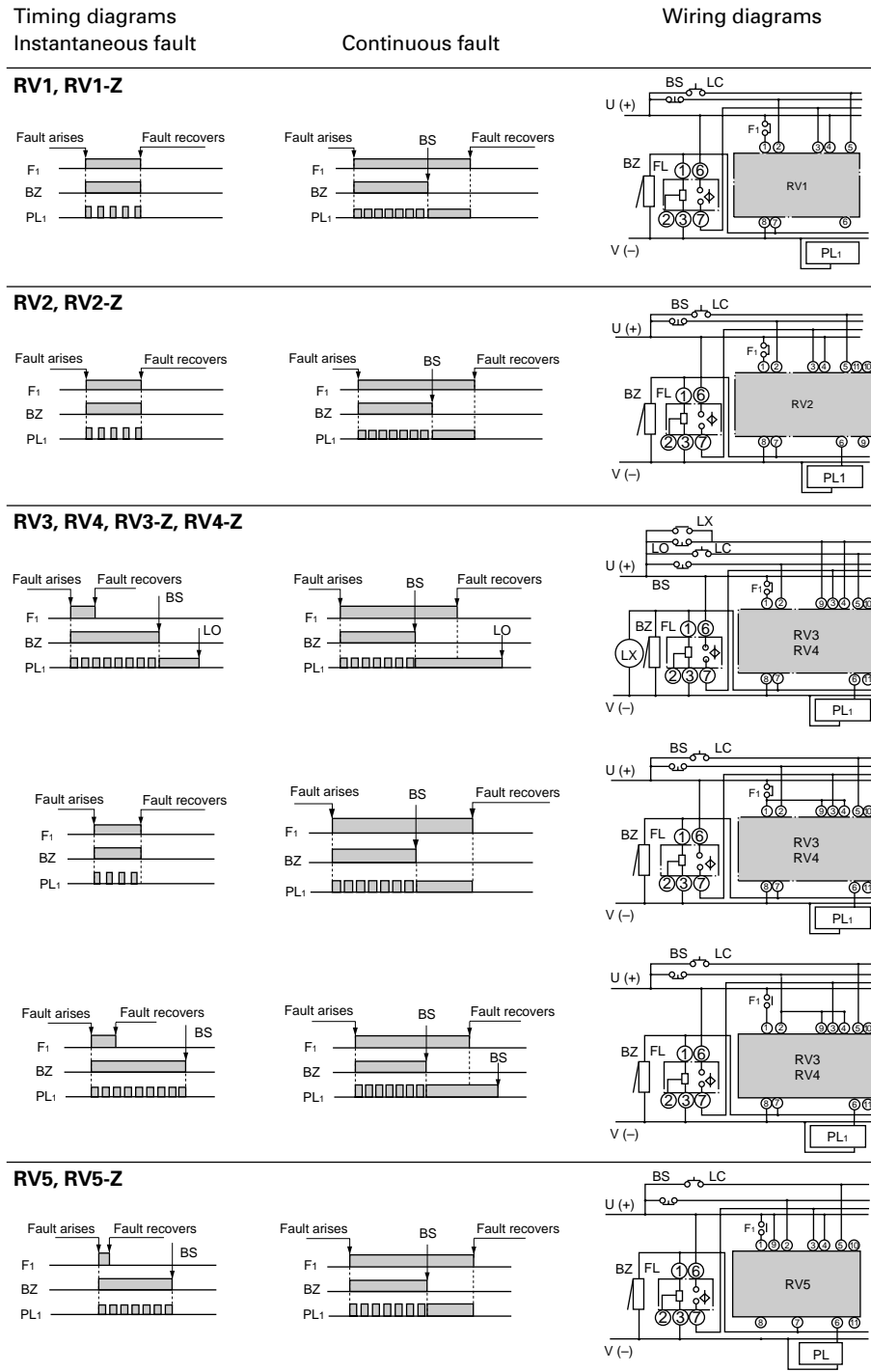

F1: Fault signal input contact
 BZ: Buzzer (or bell)
 PL: Indicating lamp
 FL: Flicker relay
 BS: Buzzer stop switch
 LO: Lamp off switch
 LC: Lamp checking switch
 LX: Lock relay

■ Dimensions, mm

● Annunciator relay/RV

RV1, RV1-Z: 8-pin
 Other types: 11-pin

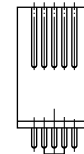
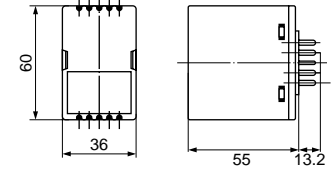

Mass: 110g

Hold-down spring FX1B

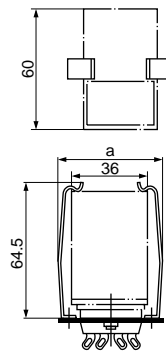

Socket type		a
Soldering terminal	8 GB (8-pin)	47mm
	11GB (11-pin)	
Screw terminal	TP38S (8-pin)	41mm
	TP311S (11-pin)	

● Flicker relay/JH13PN

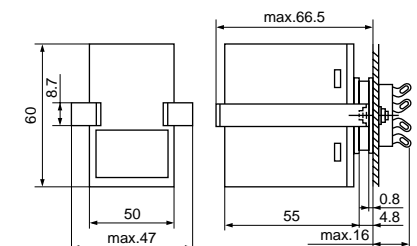

Mass: 94g

■ Ordering information

Specify the following:

1. Type number
2. Type number of sockets and hold-down spring
3. Type number of flicker relay for flickering indication system

Annunciator Relay Units

RV series and JH13PN

■ Wiring diagrams

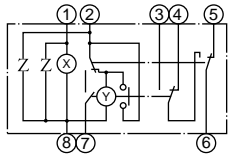
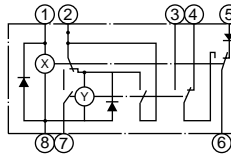
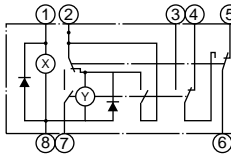
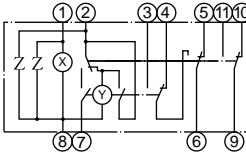
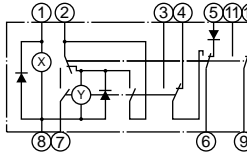
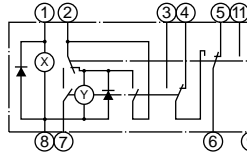
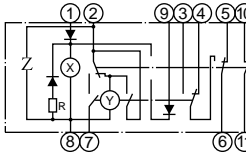
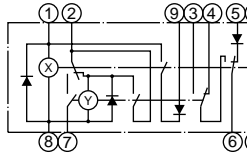
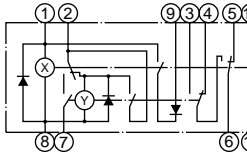
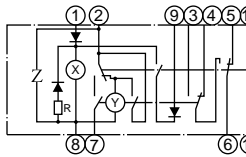
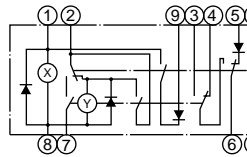
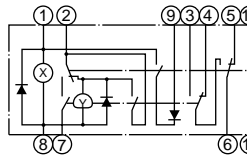
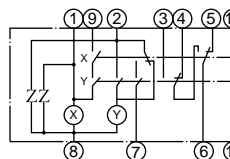
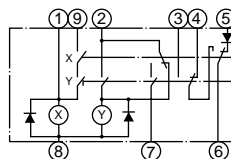
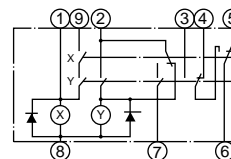
Type	AC rating (Input/output: AC)	DC rating (Input/output: DC)	Z type (Input: DC, output: AC)
RV1			
RV2			
RV3			
RV4			
RV5			

■ Sockets

Annunciator relay	Flicker relay	Applicable socket		
Type	Type	Type	Mass (Approx.)	
RV1, RV1-Z	JH13PN	Rear connection soldering terminal (for 8-pin)	8GB	12.5g
		Front connection screw terminal (for 8-pin)	TP38S	33g
		Rail mounting screw terminal (for 8-pin)	TP38X	45g
RV2, RV2-Z		Rear connection soldering terminal (for 11-pin)	11GB	13g
RV3, RV3-Z		Front connection screw terminal (for 11-pin)	TP311S	46g
RV4, RV4-Z		Rail mounting screw terminal (for 11-pin)	TP311X	59g
RV5, RV5-Z				
	Hold-down spring/Front connection		FX1B	3g
	Hold-down spring/Rear connection		FX1C	3g

■ Dimensions of sockets: See page 03/45.

Time delay relays

FUJI time delay relays feature top performance and dependability. These compact industrial time delay relays are specifically designed for process control, machine tools, safety device control, and other applications in which space is at a premium and reliability essential.

FUJI manufactures a wide variety of highly versatile time delay relays, which include Super Timers and digital timers that meet diverse needs in industry.



KKD05-126

■ Super Timers

● MS4S/Multimode and compact body

The MS4S is a timer with four operation modes. The on-delay, flicker, one-shot or signal off-delay operation modes can be selected.

See page 03/52 for further information.



KKD05-145

● ST7P/Miniature size

The ST7P is a highly efficient miniaturized on-delay timer.

The maximum timing interval is 12 hours.

See page 03/60 for further information.

Time Delay Relays

Ordering code system

■ Ordering code system

- Super Timer MS4S series

M S 4 S M-AP 1T

① ② ③ ④ ⑤⑥ ⑦⑧

① Product category

Code	Description
M	Timer, counter

② Series category

Code	Description
S	Super timer

③ Timer size

Code	Description
4S	DIN 48mm square

④ Version

Code	Operation
M	Multimode operation
A	On-delay operation
C	On-delay operation with instantaneous contact
F	Off-delay operation
Y	For star-delta starting
R	Repeat operation

⑤⑥ Input voltage

Code	Input voltage
A P	100-240V AC
C E	24V AC/DC
D L	48-127V DC

⑦⑧ Timing range

Code	Timing range
1 T	0.6 – 12s (MS4SF)
1 N	0.6 – 12min (MS4SF)

● Super Timer ST7P series

M S 7 P 2-AP 1T

① ② ③ ④ ⑤ ⑥⑦ ⑧⑨

① Product category

Code	Description
M	Timer, counter

② Series category

Code	Description
S	Super timer

③ Timer size

Code	Description
7	Miniature type

④ Mounting

Code	Mounting
P	Plug-in
B	Printed circuit board

⑤ Output contact

Code	Contact arrangement
2	Timed, 2PDT
4	Timed, 4PDT
Blank	Timed, SPDT (ST7PF only)

⑥⑦ Input voltage

Code	Input voltage
A 2	200-230V AC
A 1	100-120V AC
A P	240V AC
A E	24V AC
D 1	100-110V DC
D F	48V DC
D E	24V DC
D B	12V DC

⑧⑨ Timing range

Code	Timing range
P 5	0.06 – 0.5s (MS7P□, 7B□)
1 S	0.1 – 1s (MS7P□, 7B□)
3 S	0.3 – 3s (MS7P□, 7B□)
5 S	0.4 – 5s (MS7P□, 7B□)
1 T	1 – 10s (MS7P□, 7B□)
3 T	2 – 30s (MS7P□, 7B□)
6 T	4 – 60s (MS7P□, 7B□)
3 M	0.25 – 3min (MS7P□, 7B□)
1 N	1 – 10min (MS7P□, 7B□)
3 N	2 – 30min (MS7P□, 7B□)
6 N	4 – 60min (MS7P□, 7B□)
2 H	0.2 – 2h (MS7P□, 7B□)
6 H	0.5 – 6h (MS7P□, 7B□)
1 J	1 – 12h (MS7P□, 7B□)
2 J	2 – 24h (MS7P□, 7B□)

● Socket (For MS4S)

Mounting	Terminal	Type	Ordering code
Surface	Screw	TP411X	MX41X2
Surface	Screw	TP48X	MX48X2
Flush	Screw	TP411SBA	MX41N1A
Flush	Screw	TP48SB	MX48N1
Flush	Soldering	ATX1NS	MX48NS
Flush	Soldering	ATX2NS	MX41NS

● Socket (For ST7P)

Mounting	Terminal	Type	Ordering code
Surface	Soldering	TP88	MX58
Surface	Soldering	TP814	MX54
Surface	Wire wrap	TP88R2	MX58R2
Surface	Wire wrap	TP814R2	MX54R2
Surface	P. C. board	TP88B	MX58B
Surface	P. C. board	TP814B	MX54B
Surface	Screw	TP88X2	MX58X2
Surface	Screw	TP814X2	MX54X2
Surface	Screw	TP88X1	MX58X1
Surface	Screw	TP814X1	MX54X1

● Accessory

Description	Type	Ordering code
Hold-down spring	FX3	MZ24
Adaptor	TX4	MZ34

■ Types

Description	Operation	Contact arrangement		Timer body Type	Required socket type		
		Timed	Instant.		Surface mounting Type	Flush mounting Type	Rail mounting Type
Super Timer Multi-range, compact body	Multi-mode • On-delay • Flicker • One-shot • Signal off-delay	2PDT	–	MS4SM	TP411X 11GB + FX3 (Hold-down spring)	TP411SBA+TX4 (Adaptor) ATX2NS+TX4 (Adaptor)	TP411X
	On-delay	2PDT SPDT	– SPDT	MS4SA MS4SC	TP48X 8GB + FX3 (Hold-down spring)	TP48SB+TX4 (Adaptor) ATX1NS+TX4 (Adaptor)	TP48X
	Off-delay	2PDT SPDT	–	MS4SF MS4SF-R			
	Star-delta	2NO	1NO	MS4SY			
	On-off repetitive operation	2PDT	–	MS4SR			
Super Timer Miniature size	On-delay	2PDT	–	ST7P-2	TP88 TP88R2 TP88B	–	TP88X2 TP88X1
	On-delay	4PDT	–	ST7P-4	TP814 TP814R2 TP814B	–	TP814X2 TP814X1

Time Delay Relays

Super Timers

MS4S

Direct-reading time-scale and compact body MS4S Super Timer

MS4S series Super Timers feature an easy setting and direct-reading system of four time-scale.

MS4SM timer is multimode operation type and MS4SA and MS4SC timers are on-delay operation type.

■ Features

- Time-scale indication window and time-scale selector
By turning a time-scale selector, the timing-scales appear in the indication windows one set a time. Although this is a multimode timer, the optional times such as 56 or 27 minutes can be easily set with the direct-reading time-scale.
- Compact timer with instantaneous contact
On-delay timers with instantaneous contact, as well as multimode and on-delay timers, are compact. The front to back length of the timers is only 66.5mm.
- Operation mode indication window and operation mode selector
Four operation modes are provided (MS4SM type only). By turning the operation mode selector, the on-delay, flicker, one-shot, or signal off-delay operation mode can be selected. The present mode is shown in the operation mode indication window with the marks PO, FL, OS or SF.

- LED power ON and output indicator
The power-source lamp (Green) is lit when power is on and flickers during timer operation. The output lamp (Red) is lit when the timed NO contact is on.
- Wide range of AC supply voltage
Supply voltages of 100 to 240V AC are commonly available (ordering code: AP type only).
- Instantaneous operation function with 0 indication
When the timer dial is set at 0, output is given instantaneously, allowing sequence checks to be performed easily.
- Time unit indication window and time unit selector
By turning the time selector, time units of 0.1 sec., sec., min, and hours. can be selected and made to appear in the indication window.
- Improvement of resistance to waveform distortion
The resistance to distortion of secondary voltage waveform of the power supply caused by inverters and uninterruptible power supplies (UPS) is improved.

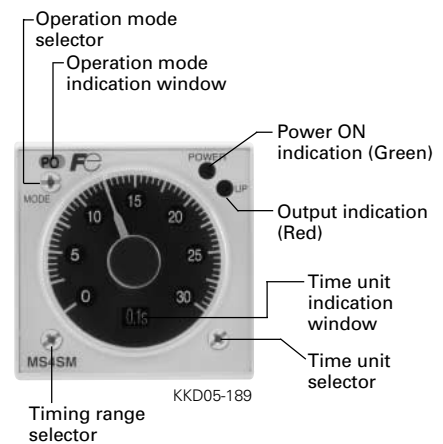

- UL, cULus and TÜV approved

■ Timing range/16 ranges

Time-scale	Time unit indication window			
	0.1s	sec	min	hrs
0 1 2 3 4 5 6	0.05 – 0.6s	0.05 – 6s	0.5 – 6min	0.5 – 6h
0 2 4 6 8 10 12	0.1 – 1.2s	1 – 12s	1 – 12min	1 – 12h
0 5 10 15 20 25 30	0.25 – 3s	2.5 – 30s	2.5 – 30min	2.5 – 30h
0 10 20 30 40 50 60	0.5 – 6s	5 – 60s	5 – 60min	5 – 60h

■ Type number nomenclature

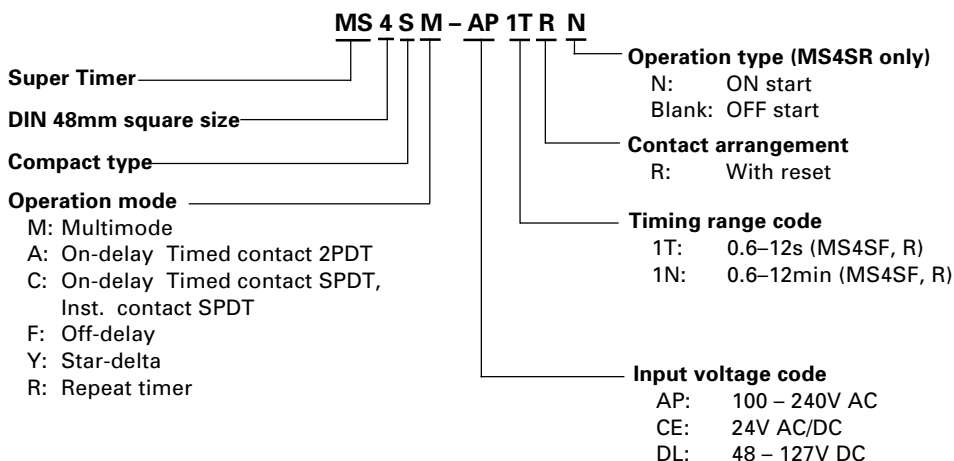

■ Ordering information

Specify the following
1. Ordering code or type number of body and socket.

■ Specifications (MS4SM, MS4SA, MS4SC)

Type	Ordering code	Input voltage	Operation	Contact	Timing range	Socket *
MS4SM	MS4SM-AP MS4SM-CE MS4SM-DL	100 – 240V AC 24V AC/DC 48 – 127V DC	On-delay Flicker One-shot Signal off-delay	Timed: 2PDT 5A	Total 16 ranges 0.05 – 0.6s 0.1 – 1.2s 0.25 – 3s 0.05 – 6s 0.5 – 6 (s, min, h) 1 – 12 (s, min, h) 2.5 – 30 (s, min, h) 5 – 60 (s, min, h)	Surface mounting: TP411X 11GB(RX1G)+FX3(MZ24)
MS4SA	MS4SA-AP MS4SA-CE MS4SA-DL	100 – 240V AC 24V AC/DC 48 – 127V DC	On-delay	Timed: 2PDT 5A		Flush mounting: TP411SBA ATX2NS(MX41NS)
MS4SC	MS4SC-AP MS4SC-CE MS4SC-DL	100 – 240V AC 24V AC/DC 48 – 127V DC	On-delay	Timed: SPDT Instant: SPDT 5A		Surface mounting: TP48X(MX48X2) 8GB(RX8G)+FX3(MZ24)
						Flush mounting: TP48SB(MX48N1) ATX1NS(MX48NS)

* (): Ordering code

■ Technical data (MS4SM, MS4SA, MS4SC)

Repeat accuracy	±0.3% at max. setting time
Reset time	0.1s or less
Operating voltage range	0.85 to 1.1 times rated input voltage
Operating temperature range	–10 to +55°C (No icing)
Humidity	35 to 85% (No condensation)
Contact ratings	5A at 250V AC resistive load
Power consumption	Approx. 10VA at AC, Approx. 1W at DC,
Insulation resistance	100MΩ at 500 DC megger
Dielectric strength	2000V AC 1min. between current carrying part and non-current carrying part 2000V AC 1min. between output contact and control circuit 1000V AC 1min. between open contacts
Vibration	Malfunction durability: 10 to 55Hz, 0.5mm double amplitude Mechanical durability: 10 to 55Hz, 0.75mm double amplitude
Shock	Malfunction durability: 100m/s ² Mechanical durability: 500m/s ²
Durability	Mechanical: 20 million operations Electrical: 100000 operations at 240V AC 5A resistive load
Mass	Approx. 100g

■ Standards

UL file No.: E44592
TÜV License No.: R50007315 (MS4SM)
R50006667 (MS4SA, MS4SC)

Time Delay Relays

Super Timers

MS4S

■ Timing and wiring diagrams

MS4SM

1. On-delay **PO**

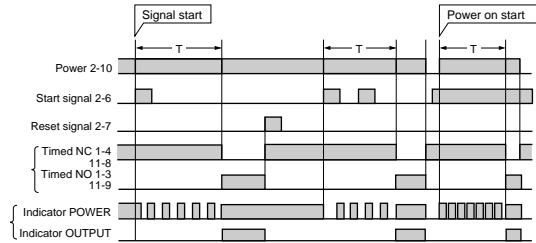

- Turn the mode selector until **PO** is displayed.
- When power is on, applying the start signal turns the timed NO (Normally open) contact on after the set time has elapsed.
- For the power-on start, the start signal pins (2 and 6) must be connected in advance.

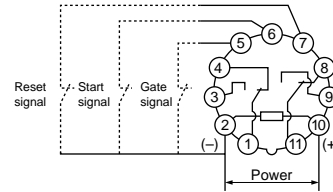

2. Flicker **FL**

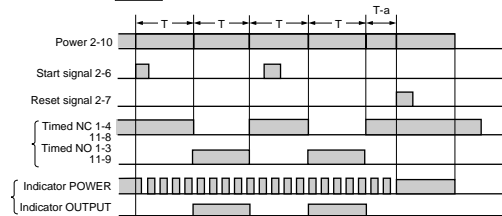

- Turn the mode selector until **FL** is displayed.
- When power is on, applying the start signal turns the timed contact on and off repeatedly at the set time intervals.

3. One-shot **OS**

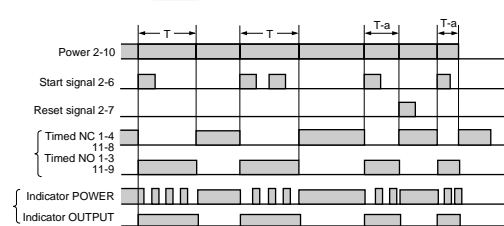

- Turn the mode selector until **OS** is displayed.
- When power is on, applying the start signal instantly turns the timed NO contact on and turns it off after the set time has elapsed.

4. Signal off-delay **SF**

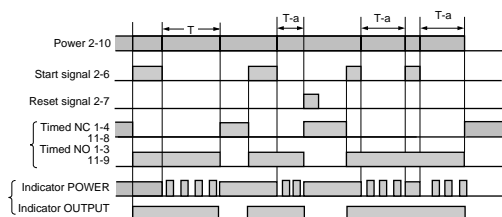

- Turn the mode selector until **SF** is displayed.
- When power is on, applying the start signal instantly turns the timed NO contact on. Removing the start signal turns the contact off after the set time has elapsed.

MS4SA

● On-delay

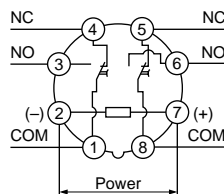
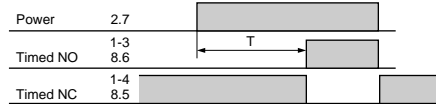

- When power is applied, the timed NO contacts make after the set time has elapsed.
- When power is removed, the contacts reset.

MS4SC

● On-delay

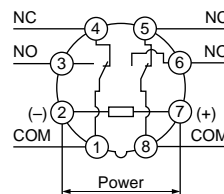
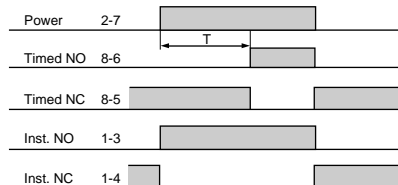

- Timed contact
When power is applied, the NO contact makes after the set time has elapsed. When power is removed, the contacts reset.
- Instantaneous contact
When power is applied, the NO contact makes instantly. When power is removed, the contacts reset.

Notes: • T=Set time. T-a=Time period within the set time
• The gate signal is used to interrupt the elapsing of timing operation.

■ **Specifications (MS4SF, MS4SF-R, MS4SY)**

Type	Ordering Code	Input voltage	Operation	Contact	Timing range
MS4SF	MS4SF-AP■ MS4SF-CE■ MS4SF-DL■	100-240V AC 24V AC/DC 48-127V DC	OFF-delay	Timed: 2PDT 5A	0.05-0.6 (s, min) 0.1-1.2 (s, min) 0.5-6 (s, min) 1-12 (s, min)
	MS4SF-AP■R MS4SF-CE■R MS4SF-DL■R	100-240V AC 24V AC/DC 48-127V DC		Timed: SPDT with inst. reset: SPDT	
MS4SY	MS4SY-AP	100-240V AC	Star-delta	Timed 1 NO (star output) Timed 1 NO (delta output) + Instant 1NO	Star starting time 0.5-6s, 1-12s, 5-60s, 10-120s Star-delta chengeover time 0.05s, 0.1s, 0.25s, 0.5s

Note: Enter the timing range code in the ■ mark, see page 03/50.

■ **Technical data**

Type	MS4SF	MS4SF-R	MS4SY
Repeat accuracy	±0.3% at max. setting time		
Reset time	-		0.5s or less
Operating voltage range	0.85 to 1.1 times rated input voltage		
Operating temperature range	-10 to +55°C(No icing)		
Humidity	35 to 85% RH (No condensation)		
Contact ratings	3A at 250V AC resistive load	5A at 250V AC resistive load	
Power consumption	Approx. 1VA at AC, Approx. 1W at DC		
Insulation resistance	100MΩ at 500V DC megger		
Dielectric strength	2000V AC 1min. between current carrying part and non-current carrying part 2000V AC 1min. between output contact and control circuit 1000V AC 1min. between open contacts		
Vibration	Malfunction durability: 10 to 55Hz, 0.5mm double amplitude		
Shock	Mechanical durability: 10 to 55Hz, 0.75mm double amplitude Malfunction durability: 100m/s ² Mechanical durability: 500m/s ²		
Durability	Mechanical	10 million operations	
	Electrical	100000 operations at 250V AC 3A res. load	80000 operations at 250V AC 5A res. load
Mass	Approx. 100g		

■ **Standards**

UL file No. : E44592

Time Delay Relays

Super Timers

MS4S

■ Timing and wiring diagrams

● MS4SF type off-delay timer

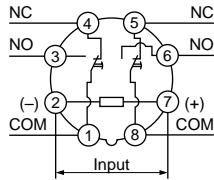

MS4SF-R type off-delay timer

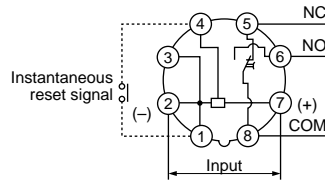

MS4SY type star-delta timer

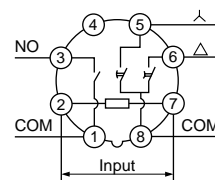

Note: Do not use terminal ③ of the MS4SF-R as a relay terminal because it is connected to terminals ① and ② in the timer.

● MS4SF type

Operation	Operation pattern	Remarks
Off-delay (Timed 2PDT contacts)	<p>T=set time</p>	<ul style="list-style-type: none"> When power is on, timed NO contact on. When power is off, timed NO contact off after the set time has elapsed.

● MS4SF-R type

Operation	Operation pattern	Remarks
Off-delay (Timed SPDT contact)	<p>T-a=Time within a set time</p>	<ul style="list-style-type: none"> When power is on, timed NO contact on. When power is off, timed NO contact off after the set time has elapsed. When the instantaneous reset signal is on, timed NO contact immediately off.

Notes: • T-a indicates some time within a set time.
 • Each signal can be input by shorting the terminals.
 • For the MS4SF-R, apply the instantaneous reset signal for 100 ms or longer.

● MS4SY type

Operation	Operation pattern	Remarks
λ -Δ (with instantaneous contact 1NO)	<p>T1=Set time T2=Changeover time</p>	<ul style="list-style-type: none"> Timed contact <ul style="list-style-type: none"> Timed contact λ on when the power is on, and off after a set time. Timed contact Δ on after a changeover time has elapsed and opens when the power turns off. Instantaneous contact <ul style="list-style-type: none"> When the power is turned on, instantaneous NO contact on. It opens when the power turns off.

■ Specifications (MS4SR)

Type	Ordering code	Input voltage	Operation mode		Contact	Timing range
MS4SR	MS4SR-AP	100-240V AC	Off-start	On-off repetitive operation	Timed: 2PDT 5A	0.5-6 (×0.1s, s, min, h)
	MS4SR-CE	24V AC/DC				1-12 (×0.1s, s, min, h)
	MS4SR-DL	48-127V DC				2.5-30 (×0.1s, s, min, h)
	MS4SR-APN	100-240V AC	On-start			5-60 (×0.1s, s, min, h)
	MS4SR-CEN	24V AC/DC				
	MS4SR-DLN	48-127V DC				

■ Technical data (MS4SR)

Repeat accuracy	±0.3%±0.01s at max. setting time
Reset time	0.1s or less
Operating voltage range	0.85 to 1.1 times rated input voltage
Operating temperature range	-10 to +55°C(No icing)
Humidity	35 to 85% RH (No condensation)
Contact ratings	5A at 250V AC resistive load
Power consumption	Approx. 10VA at AC, Approx. 1W at DC
Insulation resistance	100MΩ at 500V DC megger
Dielectric strength	2000V AC 1min. between current carrying part and non-current carrying part 2000V AC 1min. between output contact and control circuit 1000V AC 1min. between open contacts
Vibration	Malfunction durability: 10 to 55Hz, 0.5mm double amplitude Mechanical durability: 10 to 55Hz, 0.75 mm double amplitude
Shock	Malfunction durability: 100m/s ² Mechanical durability: 500m/s ²
Durability	Mechanical: 20 million operations Electrical: 100000 operations at 250V AC 5A resistive load
Mass	Approx. 100g

■ Wiring diagram

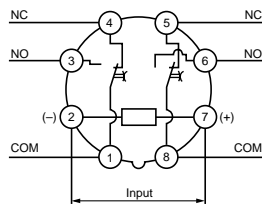

■ Operation pattern

MS4SR

Operation	Operation pattern	Remarks
Repeat (Off-start)		<ul style="list-style-type: none"> When power is on, timed contacts on and off every set time interval. The contacts reset when the power is removed.

MS4SR-N

Operation	Operation pattern	Remarks
Repeat (On-start)		<ul style="list-style-type: none"> When power is on, timed contacts on and off every set time interval. The contacts reset when the power is removed.

Time Delay Relays

Super Timers

MS4S

■ Dimensions, mm

● Bodies

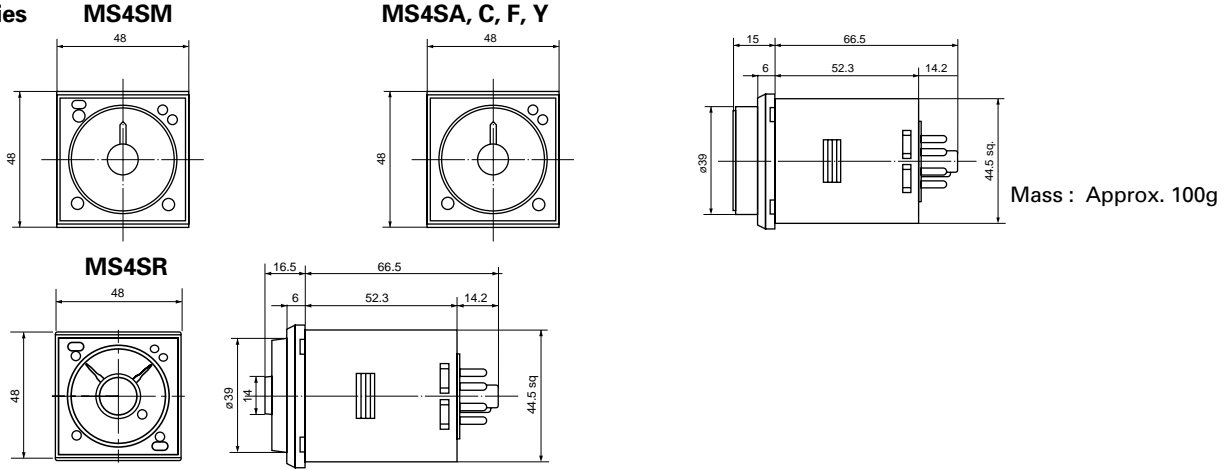

● Sockets for surface mounting

TP411X (11-pin) for MS4SM

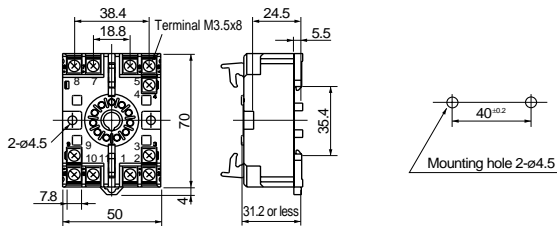

Mass: Approx. 70g

TP48X (8-pin) for MS4S□

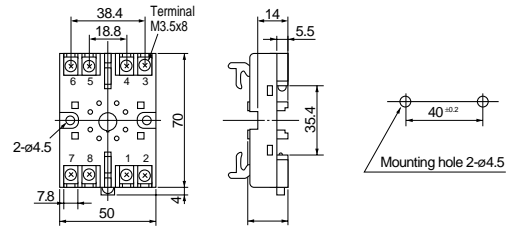

Mass: Approx. 59g

8GB, 11GB (Soldering sockets)

8GB

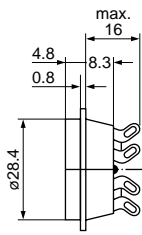

Mass: Approx. 13g

11GB

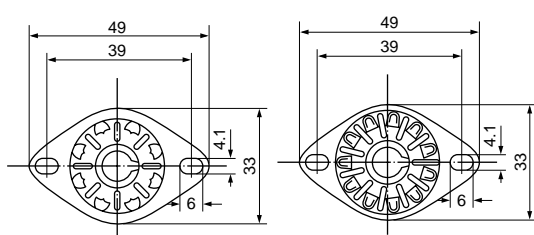

Approx. 13g

Note: Where ordering the 8GB and 11GB types of surface mounting socket, specify hold-down spring FX3 separately.

Where mounted from back side of mounting plate

Panel cutting

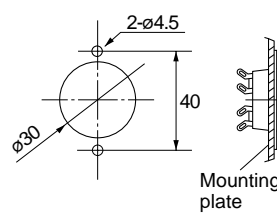

Hold-down spring/FX3

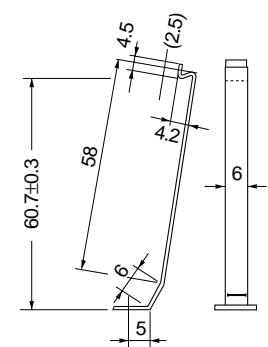

Mounting rails

TH35-7.5

Steel

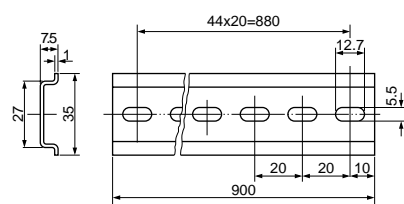

Mass: 290g

TH35-7.5AL

Aluminum

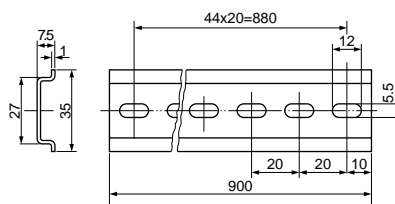

Mass: 145g

TH35-15AL

Aluminum

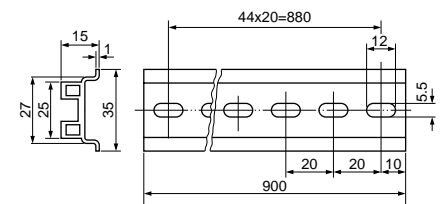

Mass: 320g

- Dimensions, mm
- Sockets for flush mounting

TX4

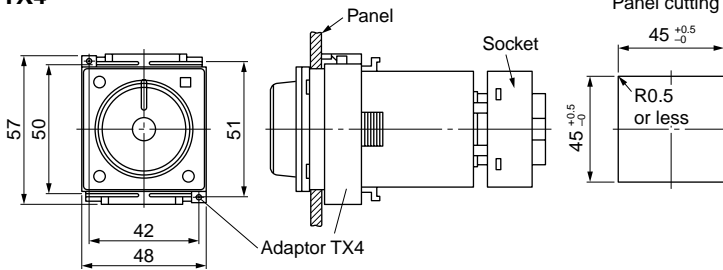

Mass : Approx. 15g

For flush mounting, an adaptor TX4 (sold separately) is required to fix the timer to the panel.
 The illustration shows a timer being fixed to a panel, using the adapter TX4.

- Accessories (supplied)

TX4 adaptor

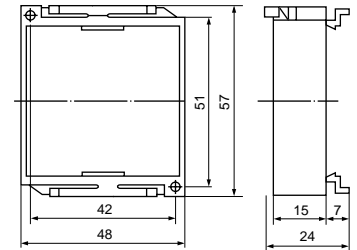

TP411SBA (11-pin) for MS4SM

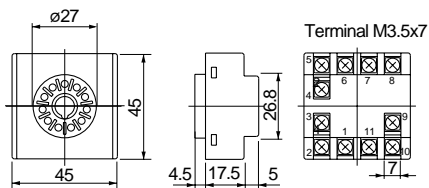

Mass : Approx. 43g

TP48SB (8-pin) for MS4SA, MS4SC

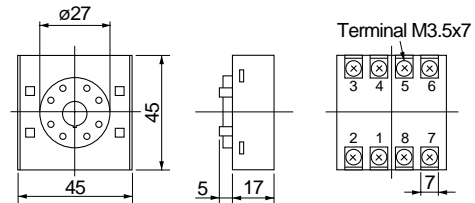

Mass : Approx. 38g

ATX2NS (Soldering socket)

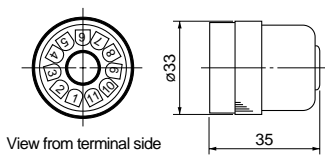

Mass : Approx. 20g

ATX1NS (Soldering socket)

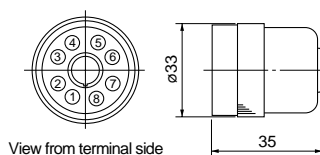

Mass : Approx. 18g

- Notes on use
- Refer to the instruction manual.

Time Delay Relays

Super Timers

ST7P, 7B

Miniature size Super Timer ST7P series

The ST7P and ST7B series are compact and highly accurate Super Timers.

The ST7P and ST7B are on-delay operation types.

■ Features

- These Super Timers are highly accurate. Their repeat accuracy is less than $\pm 1\%$ at maximum setting time.

- Timing range
ST7P and ST7B are the single timing range types; 0.06 sec. to 24 hours.
- The large setting dial makes time setting easy.
- The LED indicators make it easy to check timer operation.
- The ST7P has been approved by the UL,  us and TÜV.

■ Standards

UL file No. Body: E44592
 Socket: E90265
 TÜV License No.: R50004818



■ Specifications

Single timing range types

Type	Ordering code	Contact	Operation	Timing range (Refer to Page 03/50)	Input voltage	Socket
ST7P-2	MS7P2-■□	Timed: 2PDT	On-delay	0.06-0.5s 4-60s 0.5-6h 0.1-1s 0.25-3min 1-12h 0.3-3s 1-10min 2-24h	200-230V AC 50/60Hz 100-120V AC 50/60Hz 240V AC 50/60Hz	Screw Soldering Wire wrap PC board
ST7P-4	MS7P4-■□	Timed: 4PDT		0.4-5s 2-30min 1-10s 4-60min 2-30s 0.2-2h	100-110V DC 24V DC 12V DC	
ST7B-2	MS7B2-■□	Timed: 2PDT				
ST7B-4	MS7B4-■□	Timed: 4PDT				

Notes: Enter the input voltage code in the ■ mark and timing range code in the □ mark. * Other voltages are available on request, contact FUJI.

■ Technical data

Repeat accuracy	$\pm 1\%$ at max. setting time
Reset time	0.1s or less
Max. operating cycle	1800 cycles/h
Operating temperature range	-10°C to 50°C
Mechanical durability	50 million operations
Electrical durability	500000 operations at 220V AC 3A resistive load (ST7P-2, 7B-2) 100000 operations at 220V AC 3A resistive load (ST7P-4, 7B-4)
Operating voltage range	0.85 to 1.1 times input voltage
Contact ratings	3A at 220V AC resistive load
Power consumption	1.2VA at 100V AC, 1.5VA at 200V AC, 1.1W at 24V DC
Dielectric strength	2000V AC rms. 1min. between current carrying part and non current carrying part 1500V AC rms. 1min. between output contacts and control circuit 1000V AC rms. 1min. between open contacts
Insulation resistance	100M Ω at 500V DC megger
Vibration	Mechanical durability: 10 to 55Hz, 0.75mm double amplitude Malfunction durability: 10 to 55Hz, 0.5mm double amplitude
Shock	Mechanical durability: 1000m/s ² Malfunction durability: 50m/s ²

■ Timing diagrams ST7P-2, 7B-2

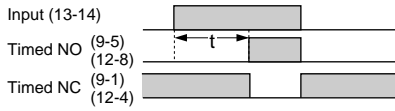

ST7P-4, 7B-4

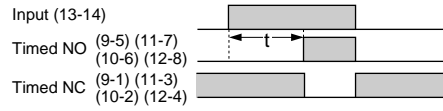

■ Wiring diagrams ST7P-2, 7B-2

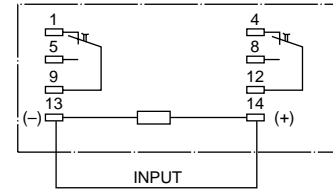

■ Dimensions, mm ● Bodies

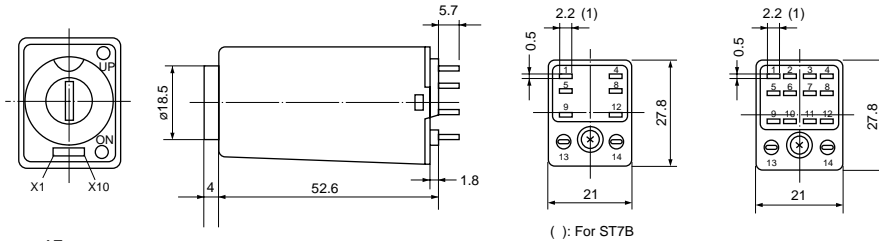

Mass: 45g

● Sockets/Screw terminal and rail mounting TP88X1 (M3)

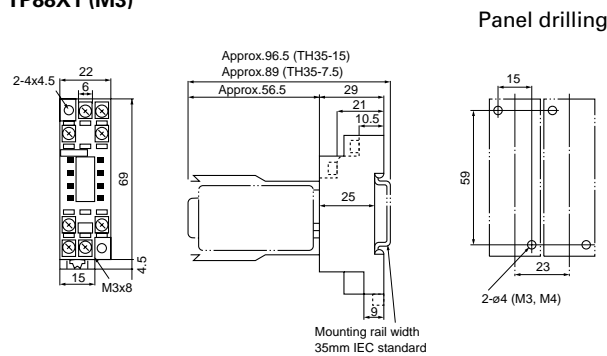

TP814X1 (M3)

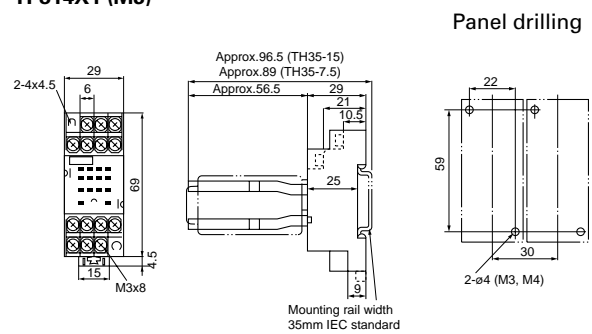

TP88X2 (M3.5)

TP814X2 (M3.5)

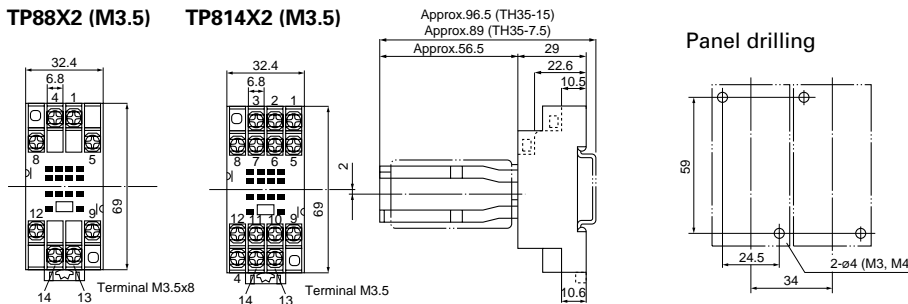

■ Socket's terminal arrangement

TP88X1, TP88X2

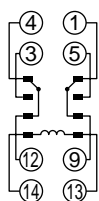

TP814X1, TP814X2

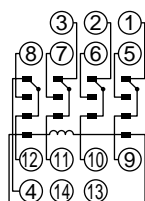

Time Delay Relays Super Timers ST7P, 7B

■ Dimensions, mm ● Sockets/soldering

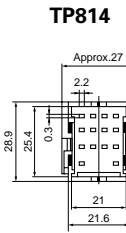
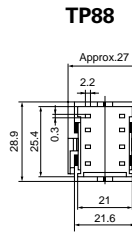
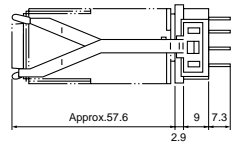

Terminal



Panel cutting
TP88, 814
TP88R2, 814R2

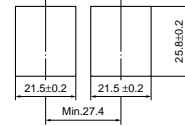

● Sockets/Wire wrap

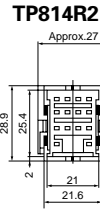
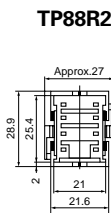
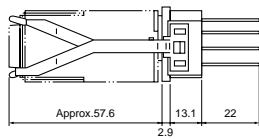

Terminal



● Sockets/PC board

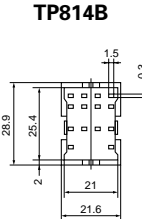
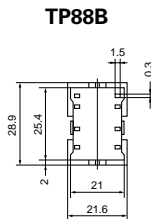
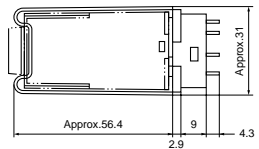

PC board drilling
TP88B TP814B

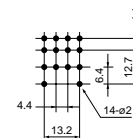
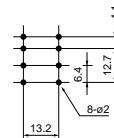

Sockets

Terminal	For ST7P-2, ST7B-2			For ST7P-4, ST7B-4			Finger protection cover	
	Type	Ordering code	Mass (g)	Type	Ordering code	Mass (g)	Type	Ordering code
Screw terminal, rail mounting	TP88X1(M3)	MX58X1	35	TR814X1(M3)	MX54X1	54	RZ52X1	RZ52X1
Screw terminal, rail mounting	TP88X2(M3.5)	MX58X2	47	TP814X2(M3.5)	MX54X2	51	RZ54X1	RZ54X1
Soldering	TP88	MX58	9	TP814	MX54	10	FX14X2	RZ54X2
Wire wrap	TP88R2	MX58R2	11	TP814R2	MX54R2	13		
PC board	TP88B	MX58B1	9	TP814B	MX54B	10		

● Mounting rails: See page 03/58.

■ Type number nomenclature

ST 7 P - 2 AC100V 5S

Super Timer

Size

Mounting

P: Plug-in (using sockets)

B: PC board

Contact

2: Timed 2PDT contact (8 terminals)

4: Timed 4PDT contact (11 terminals)

Timing range

● ST7P-□, 7B□

0.5S: 0.06–0.5s 3M: 0.25–3min

1S: 0.1–1s 10M: 1–10min

3S: 0.3–3s 30M: 2–30min

5S: 0.4–5s 60M: 4–60min

10S: 1–10s 2H: 0.2–2h

30S: 2–30s 6H: 0.5–6h

60S: 4–60s 12H: 1–12h

Input voltage

● ST7P, 7B

AC200V: 200–230V AC

AC100V: 100–120V AC

AC240V: 240V AC

DC100V: 100–110V DC

DC24V: 24V DC

DC12V: 12V DC

■ Ordering information

Specify the following:

- Ordering code or type number of body (add a suffix of the timing range) and socket. (Socket is sold separately.)

Catalog Disclaimer

The information contained in this catalog does not constitute an express or implied warranty of quality, any warranty of merchantability or fitness for a particular purpose is hereby disclaimed.

Since the user's product information, specific use application, and conditions of use are all outside of Fuji Electric FA Components & Systems' control, **it shall be the responsibility of the user to determine the suitability of any of the products mentioned for the user's application.**

One Year Limited Warranty

The products identified in this catalog shall be sold pursuant to the terms and conditions identified in the "Conditions of Sale" issued by Fuji Electric FA with each order confirmation.

Except to the extent otherwise provided for in the Conditions of Sale issued by Fuji Electric FA, Fuji Electric FA warrants that the Fuji Electric FA products identified in this catalog shall be free from significant defects in materials and workmanship provided the product has not been: 1) repaired or altered by others than Fuji Electric FA; 2) subjected to negligence, accident, misuse, or damage by circumstances beyond Fuji Electric FA's control; 3) improperly operated, maintained or stored; or 4) used in other than normal use or service. This warranty shall apply only to defects appearing within one (1) year from the date of shipment by Fuji Electric FA, and in such case, only if such defects are reported to Fuji Electric FA within thirty (30) days of discovery by purchaser. Such notice should be submitted in writing to Fuji Electric FA at 5-7, Nihonbashi Odemma-cho, Chuo-ku, Tokyo, Japan. The sole and exclusive remedy with respect to the above warranty whether such claim is based on warranty, contract, negligence, strict liability or any other theory, is limited to the repair or replacement of such product or, at Fuji Electric FA's option reimbursement by Fuji Electric FA of the purchase price paid to Fuji Electric FA for the particular product. **Fuji Electric FA does not make any other representations or warranties, whether oral or in writing, expressed or implied, including but not limited to any warranty regarding merchantability or fitness for a particular purpose.** Except as provided in the Conditions of Sale, no agent or representative of Fuji Electric FA is authorized to modify the terms of this warranty in writing or orally.

In no event shall Fuji Electric FA be liable for special, indirect or consequential damages, including but not limited to, loss of use of the product, other equipment, plant and power system which is installed with the product, loss of profits or revenues, cost of capital, or claims against the purchaser or user of the product by its customers resulting from the use of information, recommendations and descriptions contained herein. The purchaser agrees to pass on to its customers and users, in writing at the time inquiries and orders are received by buyer, Fuji Electric FA's warranty as set forth above.

Caution "Safety precautions"

- Operate (keep) in the environment specified in the operating instructions and manual. High temperature, high humidity, condensation, dust, corrosive gases, oil, organic solvents, excessive vibration or shock might cause electric shock, fire, erratic operation or failure.
- Follow the regulations of industrial wastes when the product is to be discarded.
- The products covered in this catalog have not been designed or manufactured for use in equipment or systems which, in the event of failure, can lead to loss of human life.
- If you intend to use the products covered in this catalog for special applications, such as for nuclear energy control, aerospace, medical, or transportation, please consult our Fuji Electric FA agent.
- Be sure to provide protective measures when using the product covered in these catalogs in equipment which, in the event of failure, may lead to loss of human life or other grave results.
- Follow the directions of the operating instructions when mounting the product.

D&C CATALOG DIGEST INDEX

Individual catalog No. **LOW VOLTAGE PRODUCTS Up to 600 Volts**

01 Magnetic Contactors and Starters
Thermal Overload Relays, Solid-state Contactors

02 Manual Motor Starters and Contactors
Combination Starters

03 Industrial Relays, Industrial Control Relays
Annunciator Relay Unit, Time Delay Relays

04 Pushbuttons, Selector Switches, Pilot Lights
Rotary Switches, Cam Type Selector Switches
Panel Switches, Terminal Blocks, Testing Terminals

05 Limit Switches, Proximity Switches
Photoelectric Switches

06 Molded Case Circuit Breakers
Air Circuit Breakers

07 Earth Leakage Circuit Breakers
Earth Leakage Protective Relays

08 Circuit Protectors
Low Voltage Current-Limiting Fuses

09 Measuring Instruments, Arresters, Transducers
Power Factor Controllers
Power Monitoring Equipment (F-MPC)

10 AC Power Regulators
Noise Suppression Filters
Control Power Transformers

HIGH VOLTAGE PRODUCTS Up to 36kV

11 Disconnecting Switches, Power Fuses
Air Load Break Switches
Instrument Transformers — VT, CT

12 Vacuum Circuit Breakers, Vacuum Magnetic Contactors
Protective Relays

INDIVIDUAL CATALOG 03

from D&C CATALOG 20th Edition

Fuji Electric FA Components & Systems Co., Ltd.

5-7, Nihonbashi Odemma-cho, Chuo-ku, Tokyo, 103-0011, Japan

URL <http://www.fujielectric.co.jp/fcs/eng>

Information in this catalog is subject to change without notice.