



Description

The MT-GD2 family is a robust, tongue-operated (or key-operated) safety-interlock switch designed to fit at the leading edge of sliding, hinged or lift-off guards. With its dual entry slots and rotatable head, the MT-GD2 can offer eight different options for actuator entry.

The MT-GD2 features a compact housing of only 117 x 40 x 43 mm (4.60 x 1.57 x 1.69 in.) with DIN 50041 standard fixing centres and includes forced guided contacts and a tamper-resistant mechanism.

The MT-GD2 is available with a variety of contact configurations enabling it to be used as part of a system for higher-risk applications. Operation of the switch is achieved by the insertion of the specially-profiled stainless-steel actuator which should be permanently fixed to the leading edge of the guard door. An optional flexible actuator allows the MT-GD2 to operate on smaller-radius doors (≥ 60 mm) and a flat actuator gives additional mounting options, for example, on a chain.

A style incorporating a latch release mechanism allows manual retention of the actuator in the switch until the release mechanism is manually activated.

Features

- Strong and versatile, can be used in most applications
- Eight possible actuator entry points, easy to install
- Variety of contact configurations
- Snap acting MT-GD2 gives a min. break contact force of 40 N
- Optional latch release styles
- Industry standard fixing centers to DIN/EN50041

MT-GD2 Latch Release Style

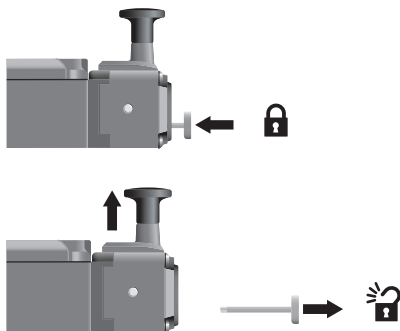

Specifications

Safety Ratings	
Standards	EN954-1, ISO13849-1, IEC/EN60204-1, NFPA79, EN1088, ISO14119, IEC/EN60947-5-1, ANSI B11.19, AS4024.1
Safety Classification	Cat. 1 device per EN 954-1 dual channel interlocks suitable for Cat. 3 or 4 systems
Functional Safety Data *	B10d: > 2 x 10 ⁶ operations at min. load PFH _D : > 3 x 10 ⁻⁷ MTTFD: > 385 years Dual channel interlock may be suitable for performance levels Pl _e or Pl _d (according to ISO 13849-1:2006) and for use in SIL2 or SIL3 systems (according to IEC 62061) depending on application characteristics
Note:	For up-to-date information, visit http://www.ab.com/Safety/
Certifications	CE Marked for all applicable directives, cULus, TÜV, and CCC
Outputs	
Safety Contacts *	Standard: 3 N.C. or 2 N.C. direct opening action Snap acting: 2 N.C. direct opening forced disconnection
Auxiliary Contacts	Standard: 1 N.O. or 2 N.O. Snap Acting: 2 N.O.
Thermal Current I _{th}	10 A
Rated Insulation Voltage	(U _i) 500V
Switching Current @ Voltage, Min.	5 mA @ 5V DC
Utilization Category	
A600/AC-15	(U _e) 600V 500V 240V 120V (I _e) 1.2 A 1.4 A 3 A 6 A
Standard—DC-13	(U _e) 24V (I _e) 2 A
Snap-Acting—A300/AC-15	(U _e) 240V 120V (I _e) 3 A 6 A
Snap-Acting—DC-13	(U _e) 24V (I _e) 2 A
Operating Characteristics	
Break Contact Force, Min.	BBM & MBB: 12 N (2.7 lbf) BBM & Extended Flat Actuator: 32 N (7.2 lbf) Snap acting: 40 N (9.0 lbf)
Actuation Speed, Max.	160 mm (6.29 in.)/s
Actuation Frequency, Max.	2 cycles/s
Operating Life @ 100 mA load	1 x 10 ⁶ operations
Environmental	
Enclosure Type Rating	IP67
Operating Temperature [C (F)]	-20...+80° (-4...+176°)
Physical Characteristics	
Housing Material	Painted zinc
Actuator Material	Stainless Steel
Weight [g (lb)]	520 (1.15)
Color	Yellow or Red

* Usable for ISO 13849-1:2006 and IEC 62061. Data other than B10d is based on:
 - Usage rate of 1op/10 mins., 24 hrs/day, 360 days/year, representing 51840 operations per year
 - Mission time/Proof test interval of 38 years

* The safety contacts are described as normally closed (N.C.) i.e., with the guard closed, actuator in place (where relevant) and the machine able to be started.

Product Selection
Red Body Switches

Type	Contact			Actuator Type	Cat. No.					
	Safety	Auxiliary	Action		Conduit		Connector§			
					M20	1/2 in NPT	12-Pin M23	8-Pin Micro (M12)*	Connect to ArmorBlock Guard I/O 5-Pin Micro (M12)*	
MT-GD2	3 N.C.	1 N.O.	BBM	—	440K-MT55002	440K-MT55085	440K-MT55094	—	—	
				GD2 Standard	440K-MT55074	440K-MT55022	440K-MT55095	—	—	
				Fully Flexible	440K-MT55075	440K-MT55029	440K-MT55096	—	—	
			MBB	—	440K-MT55004	440K-MT55088	440K-MT55100	—	—	
				—	440K-MT55005	440K-MT55086	440K-MT55097	440K-M21BNDH	—	
				GD2 Standard	440K-MT55076	440K-MT55026	440K-MT55098	—	—	
	2 N.C.	2 N.O.	BBM	Fully Flexible	440K-MT55077	440K-MT55087	440K-MT55099	—	—	
				MBB	—	440K-MT55006	440K-MT55089	440K-MT55101	—	—
					—	—	440K-M22ANDT	440K-M22ANDL	440K-M21ANDH	440K-M2NNNDS
			Snap Acting		Extended Flat	440K-M22AEDM	440K-M22AEDT	—	—	—
				GD2 Standard	440K-M22ASDM	440K-M22ASDT	—	—	—	
				Fully Flexible	440K-M22ABDM	440K-M22ABDT	—	—	—	

§ For connector ratings see page 3-9.

* With a 5-pin micro (M12) connector, not all contacts are connected. See *Typical Wiring Diagram* on page 3-32 for wiring details.

⊗ With an 8-pin micro (M12) connector, not all contacts are connected. See *Typical Wiring Diagram* on page 3-32 for wiring details.

Yellow Body Switches

Type	Contact			Actuator Type	Cat. No.		
	Safety	Auxiliary	Action		Conduit	Connector§	
					1/2 in NPT	12-Pin M23	5-Pin Micro (M12)*
MT-GD2	2 N.C.	2 N.O.	Snap Acting	—	440K-M22ANYT	—	—
				Extended Flat	440K-M22AEYT	440K-M22AEYL	440K-M2NAEYS
—	2 N.C.	2 N.O.	MBB	—	440K-M22MNYT-N5	—	440K-M2NNNYS-N5

§ For connector ratings see page 3-9.

* With a 5-pin micro (M12) connector, not all contacts are connected. See *Typical Wiring Diagram* on page 3-32 for wiring details.

⊗ With an 8-pin micro (M12) connector, not all contacts are connected. See *Typical Wiring Diagram* on page 3-32 for wiring details.

3-Interlock
Switches

Safety Switches

Tongue Switches

MT-GD2

Recommended Logic Interfaces

Description	Safety Outputs	Auxiliary Outputs	Terminals	Reset Type	Power Supply	Cat. Page No.	Cat. No.
Single-Function Safety Relays							
MSR127RP	3 N.O.	1 N.C.	Removable (Screw)	Monitored Manual	24V AC/DC	5-24	440R-N23135
MSR127TP	3 N.O.	1 N.C.	Removable (Screw)	Auto./Manual	24V AC/DC	5-24	440R-N23132
MSR126T	2 N.O.	None	Fixed	Auto./Manual	24V AC/DC	5-22	440R-N23117
MSR30RT	2 N.O. Solid State	1 N.O. Solid State	Removable	Auto./Manual or Monitored Manual	24V DC	5-16	440R-N23198
Modular Safety Relays							
MSR210P Base 2 N.C. only	2 N.O.	1 N.C. and 2 PNP Solid State	Removable	Auto./Manual or Monitored Manual	24V DC from the base unit	5-74	440R-H23176
MSR220P Input Module	—	—	Removable	—	24V DC	5-78	440R-H23178
MSR310P Base	MSR300 Series Output Modules	3 PNP Solid State	Removable	Auto./Manual Monitored Manual	24V DC	5-94	440R-W23219
MSR320P Input Module	—	2 PNP Solid State	Removable	—	24V DC from the base unit	5-98	440R-W23218







Note: For additional Safety Relays connectivity, see the Safety Relays section (page 5-8) of this catalog.
 For additional Safety I/O and Safety PLC connectivity, see the Programmable Safety System section (page 5-107) of this catalog.
 For application and wiring diagrams, see the Safety Applications section (page 10-1) of this catalog.

Connection Systems

Description	4-Pin Micro (M12)	5-Pin Micro (M12)	8-Pin Micro (M12)	12-Pin M23
Cordset	889D-F4AC-*	—	889D-F8AB-*	889M-FX9AE-*
Patchcord	889D-F4ACDM-*	889D-F5ACDM-*	889D-F8ABDM-*	—
Distribution Box	898D-P4†LT-DM4	—	—	—
Shorting Plug	898D-41LU-DM	—	—	—
T-Port	898D-43LY-D4	—	—	—

* Replace symbol with 2 (2 m), 5 (5 m), or 10 (10 m) for standard cable lengths.
 * Replace symbol with 1 (1 m), 2 (2 m), 3 (3 m), 5 (5 m), or 10 (10 m) for standard cable lengths.
 † Replace symbol with 4 or 8 for number of ports.
Note: For additional information, see the Safety Connection System section (page 7-1) of this catalog.

Accessories

	Description	Dimensions	Cat. No.
	GD2 standard actuator	3-50	440G-A27011
	GD2 flat actuator	3-51	440K-A11112
	Fully flex actuator	3-50	440G-A27143
	Sliding bolt actuator	3-55	440G-A27163
	Extended flat actuator	3-51	440K-A17116
	Dust Cover	—	440K-A17180

Approximate Dimensions

Dimensions are shown in mm (in.). Dimensions are not intended to be used for installation purposes.

MT-GD2 Latch Release

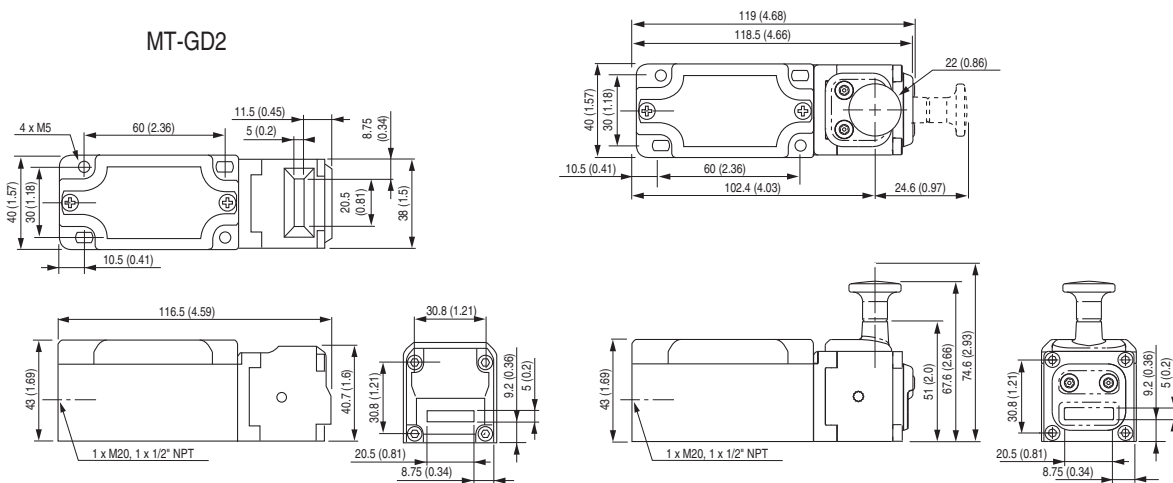

Note: 2D, 3D and electrical drawings are available on www.ab.com.

Safety Switches
Tongue Switches
 MT-GD2

Typical Wiring Diagrams

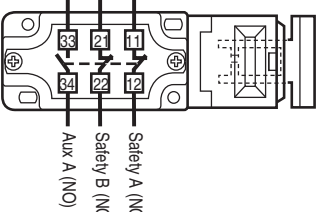
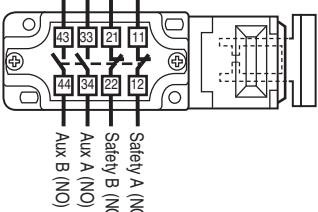
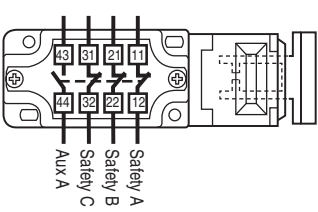
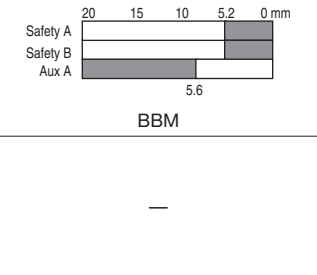
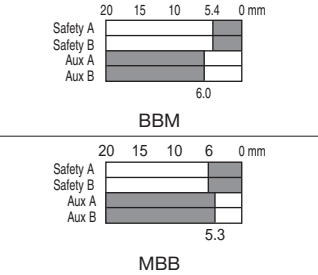
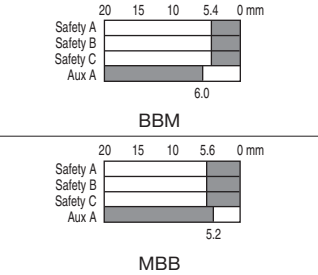
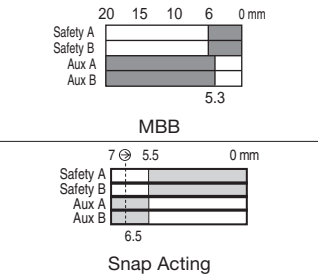
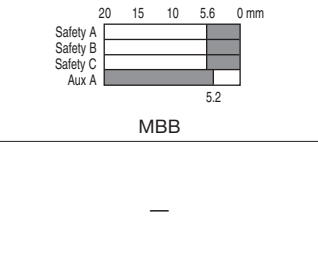
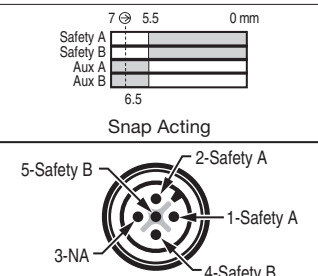
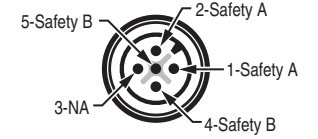
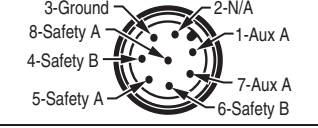
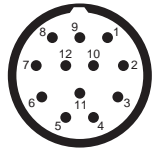
Description		2 N.C. & 1 N.O.	2 N.C. & 2 N.O.	3 N.C. & 1 N.O.
Contact Configuration				
Contact Action				
		BBM	BBM	BBM
		—		
		—	MBB	MBB
		—		—
		—	Snap Acting	—
5-Pin Micro (M12) for Connection to ArmorBlock Guard I/O		—		—
8-Pin Micro (M12)		—		—
12-Pin Cordset				
	1 and 3	Safety A	Safety A	Safety A
	4 and 6	Safety B	Safety B	Safety B
	7 and 8	NC	Aux A	Safety C
	9 and 10	Aux A	Aux B	Aux A
Pins 2, 5 and 11 are not connected.	12	Ground	Ground	Ground
8-Pin Cordset 889D-F8AB-*	Grey Red	—	Safety A	—
	Yellow Pink	—	Safety B	—
	White Blue	—	Aux A	—
	Green	—	Ground	—
	Brown	—	Not Used	—
12-Pin Cordset 889M-FX9AE-*	Brown Blue	Safety A	Safety A	Safety A
	White Green	Safety B	Safety B	Safety B
	Yellow Grey	Not Used	Aux A	Safety C
	Pink Red	Aux A	Aux B	Aux A
	Green/Yellow	Ground	Ground	Ground

* Replace symbol with 2 (2 m), 5 (5 m) or 10 (10 m) for standard cable lengths.

3-Interlock Switches