

Size A1 to A4 Offset Bolted Tag Fuse Links for General Industrial Applications

2A to 200A, 440-550-660-690Vac/250-350-460Vdc NIT, NET, TIA, TIS, TCP and TFP Red Spot Series



Catalogue Symbol:

NIT (amp rating)
NET (amp rating)
TIA (amp rating)
TIS (amp rating)
TCP (amp rating)
TFP (amp rating)

Class of Operation:

gG and gM

Fuse Size:

BS88 ref A1 to A4

Alternative Fuse Links:

See technical data page 5

Standards/Approvals:

BS88-2 and IEC 60269-2

Compatible Fuse Holders:

See technical data page 5

Description:

A range of BS fuse links in sizes A1 to A4 specifically designed for the protection of general industrial applications e.g. power distribution, cable protection, motor protection.

Packaging: MOQ: NIT, NET, TIA and TIS 20 per pack
TCP and TFP 10 per pack
Packaging 100% recyclable

Technical Data:

Rated Voltage: 550/660/690Vac and 250-460Vdc
Rated Current: 2A to 200A
Rated Breaking Capacity:
AC: ASTA 20 certified to 80kA, generally at 660Volts to BS88 Part 2 1988 (IEC 60269-2)
Min Interrupting Rating: $1.6 \times I_n$

Features:

- Good peak and let-through current limitation
- 1:1:6 Selective coordinate ratio between 'minor' and 'major' fuse
- All Red Spot fuse links are suitable for motor protection as gM ratings enhance the breaking capacity capability
- All Red Spot fuse links have power loss values well within the limits of IEC 60269

Size A1 to A4 Offset Bolted Tag Fuse Links for General Industrial Applications
2A to 200A, 440-550-660-690Vac/250-350-460Vdc NIT, NET, TIA, TIS, TCP and TFP Red Spot Series

Dimensions - mm
NIT and NET

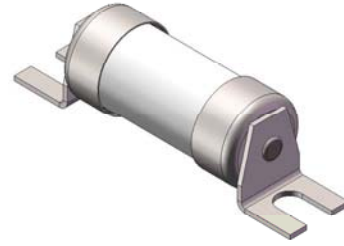
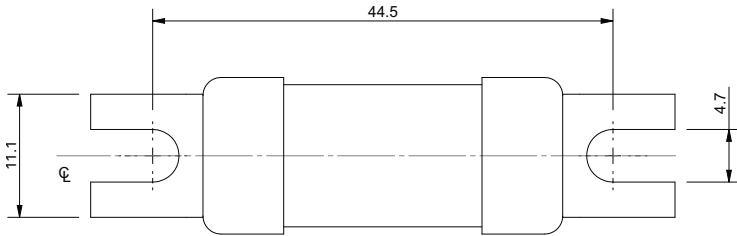
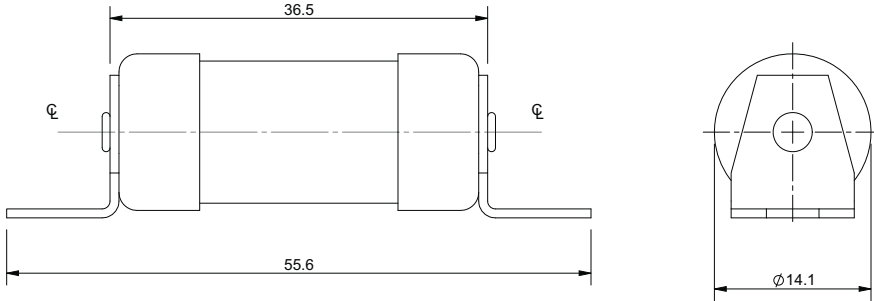

TIA

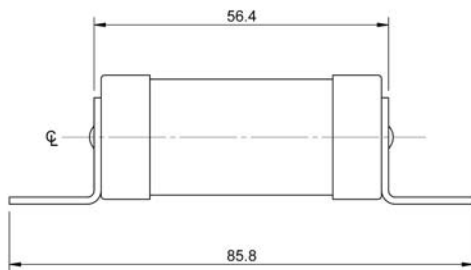
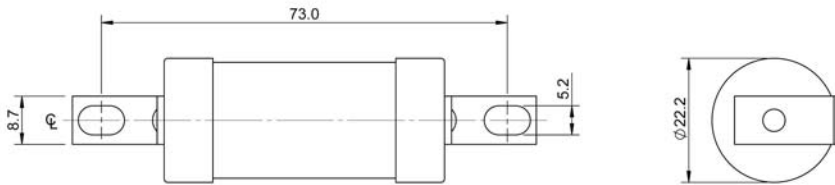

Size A1 to A4 Offset Bolted Tag Fuse Links for General Industrial Applications
 2A to 200A, 440-550-660-690Vac/250-350-460Vdc NIT, NET, TIA, TIS, TCP and TFP Red Spot Series

Dimensions - mm

TIS

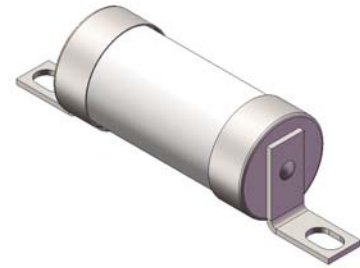
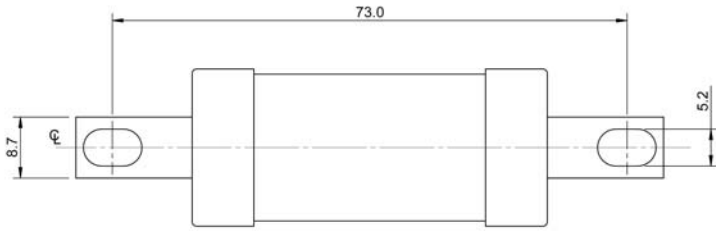
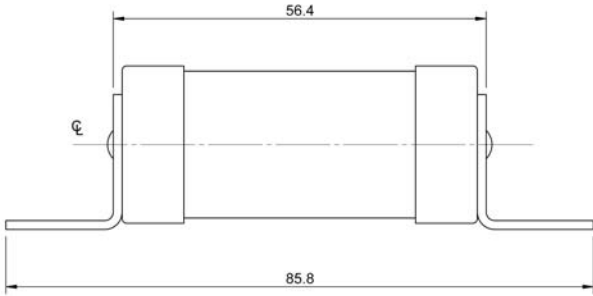

TCP

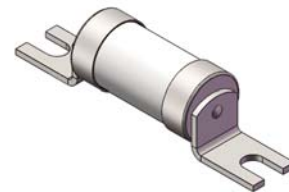
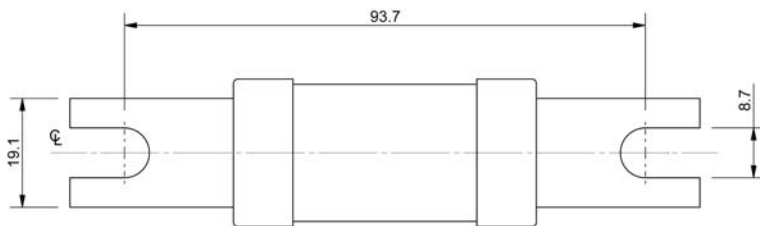
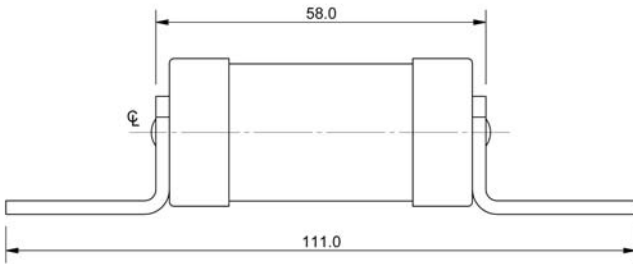

Size A1 to A4 Offset Bolted Tag Fuse Links for General Industrial Applications 2A to 200A, 440-550-660-690Vac/250-350-460Vdc NIT, NET, TIA, TIS, TCP and TFP Red Spot Series

Dimensions - mm

TFP

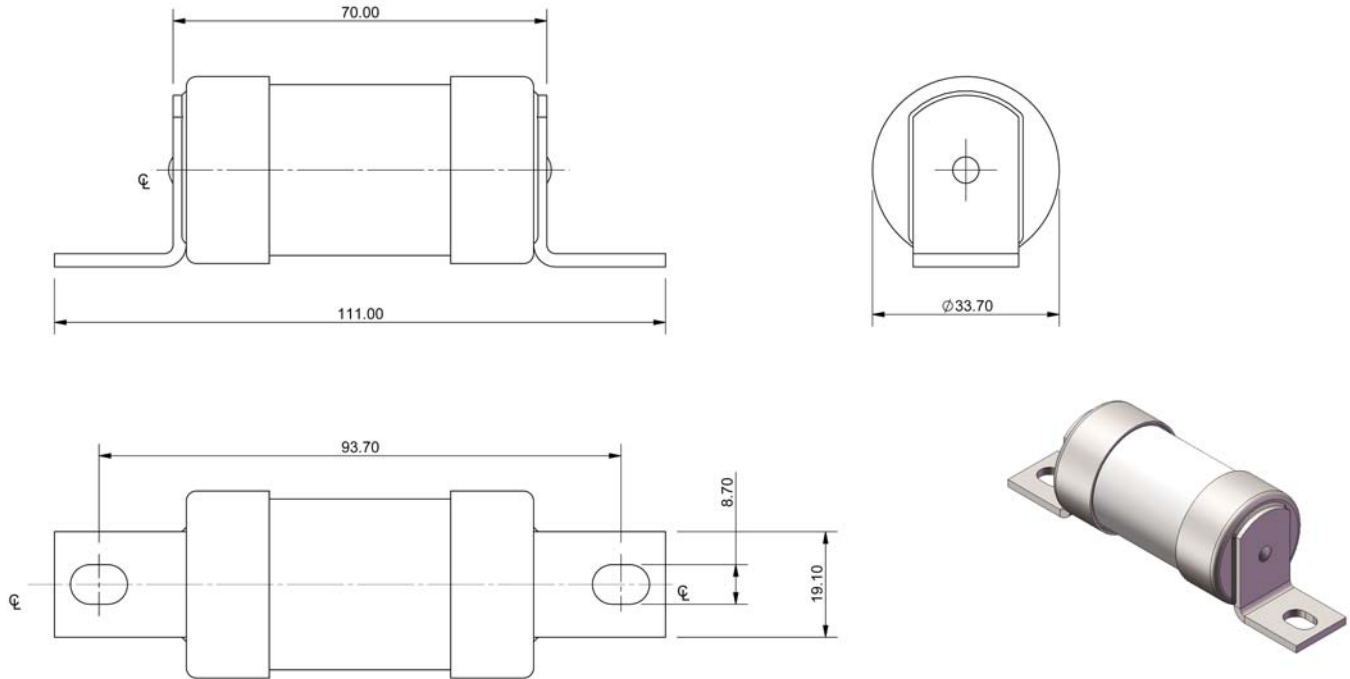

Size A1 to A4 Offset Bolted Tag Fuse Links for General Industrial Applications

2A to 200A, 440-550-660-690Vac/250-350-460Vdc NIT, NET, TIA, TIS, TCP and TFP Red Spot Series

Technical Data

Catalogue Numbers	BS88 reference	Rated Current (Amps)	Rated Voltage (Vac/dc)	Class of Operation	I ² t (A ² s)		Alternative Fuse Links	Compatible Fuse Holders					
					Pre-Arcing	Total at Rated Voltage							
NIT2	A1	2	550Vac/ 250Vdc	gG	1.3	5	NITD	RS20H or CM32FC					
NIT4		4			8	30							
NIT6		6			29	115							
NIT10		10			120	490							
NIT16		16			120	730							
NIT20		20			260	1700							
NET25		A1	25	440Vac/ 250Vdc	gG	650		2900	CM32FC				
NET32			32			600		4050					
NET32M40			32M40		gM	2400		12,000					
NET32M50			32M50			3200		15,000					
NET32M63			32M63			5400		25,000					
TIA2			A2			2		660-690Vac/ 460Vdc		gG	2	15	H07-660 or AAO*
TIA4	4	7		50									
TIA6	6	22		150									
TIA10	10	170		1000									
TIA16	16	150		1100									
TIA20	20	300		1670									
TIA25	25	500		3400									
TIA32	32	1080		5900									
TIA32M35	32M35	gM		1380	6500								
TIA32M40	32M40			1920	8380								
TIA32M50	32M50			3410	13,260								
TIA32M63	32M63			6500	25,000								
TIS35	A3			35	660-690Vac/ 460Vdc	gG	1380		6500	K07-660 or BAO*	RS63H or CM63F		
TIS40				40			1920		8380				
TIS50		50		3410			13,260						
TIS63		63		6500		25,000							
TIS63M80		63M80		gM		14,000	66,000						
TIS63M100		63M100				17,000	100,000						
TCP32	A4	32	660-690Vac/ 460Vdc	gG	1080	5900	L14-660 or CEO*	RS100H					
TCP40		40			1920	8380							
TCP50		50			3410	13,260							
TCP63		63			6500	25,000							
TCP80		80			14,000	66,000							
TCP100		100			17,000	100,000							
TCP100M125		100M125		gM	25,000	140,000							
TCP100M160		100M160			62,000	270,000							
TCP100M200		100M200			105,000	430,000							
TFP125		N/A			125	660-690Vac/ 350Vdc			gG	25,000	140,000	M14-660 or DEO*	N/A
TFP160	160		62,000	270,000									
TFP200	200		105,000	430,000									
TFP200M250	200M250		gM	200,000	870,000								

* AAO, BAO,CEO and DEO rated at 550Vac.

Size A1 to A4 Offset Bolted Tag Fuse Links for General Industrial Applications
2A to 200A, 440-550-660-690Vac/250-350-460Vdc NIT, NET, TIA, TIS, TCP and TFP Red Spot Series

Time-Current Characteristics NIT (2 to 20A only)

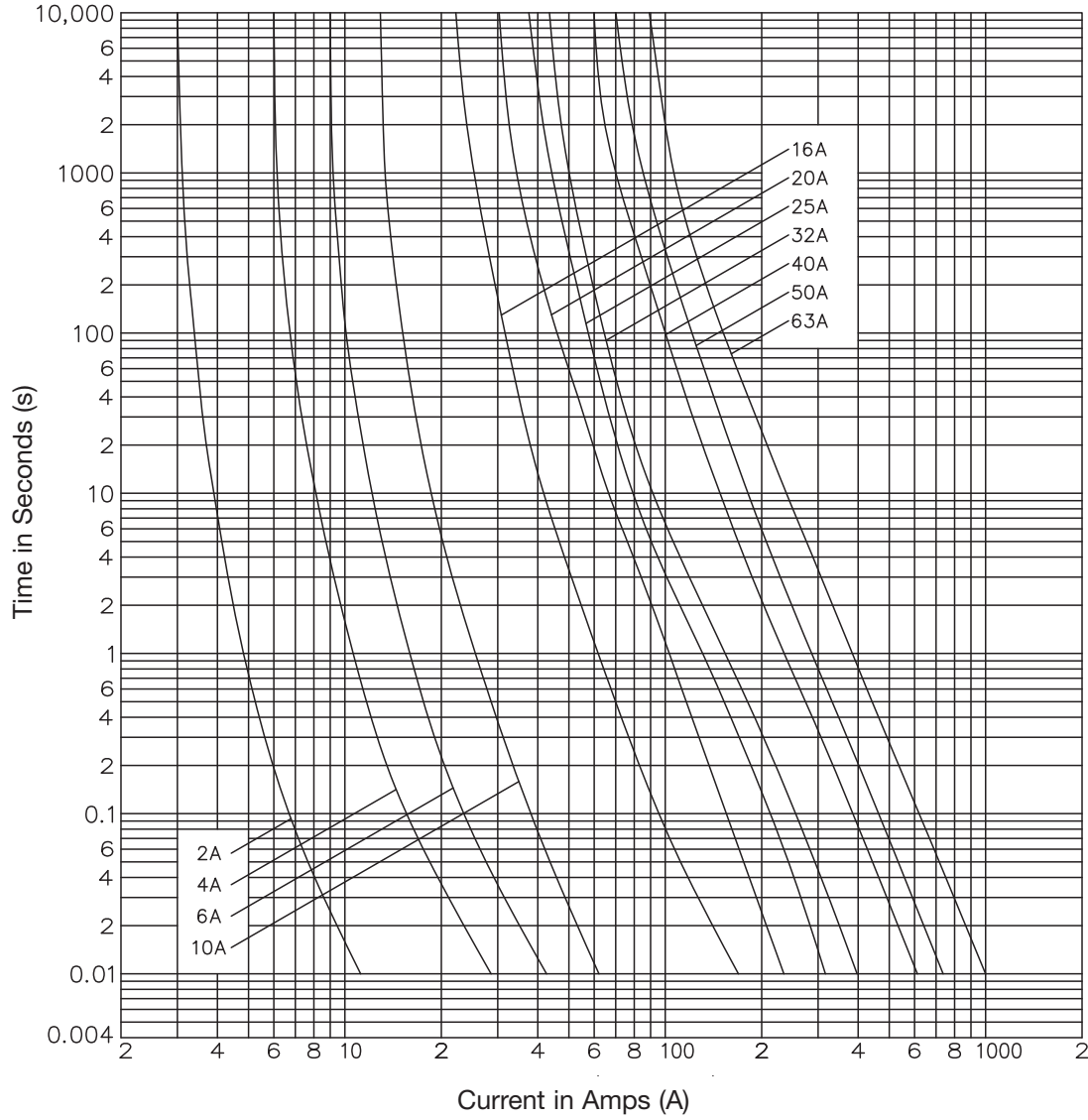

Size A1 to A4 Offset Bolted Tag Fuse Links for General Industrial Applications
2A to 200A, 440-550-660-690Vac/250-350-460Vdc NIT, NET, TIA, TIS, TCP and TFP Red Spot Series

Time-Current Characteristics NET

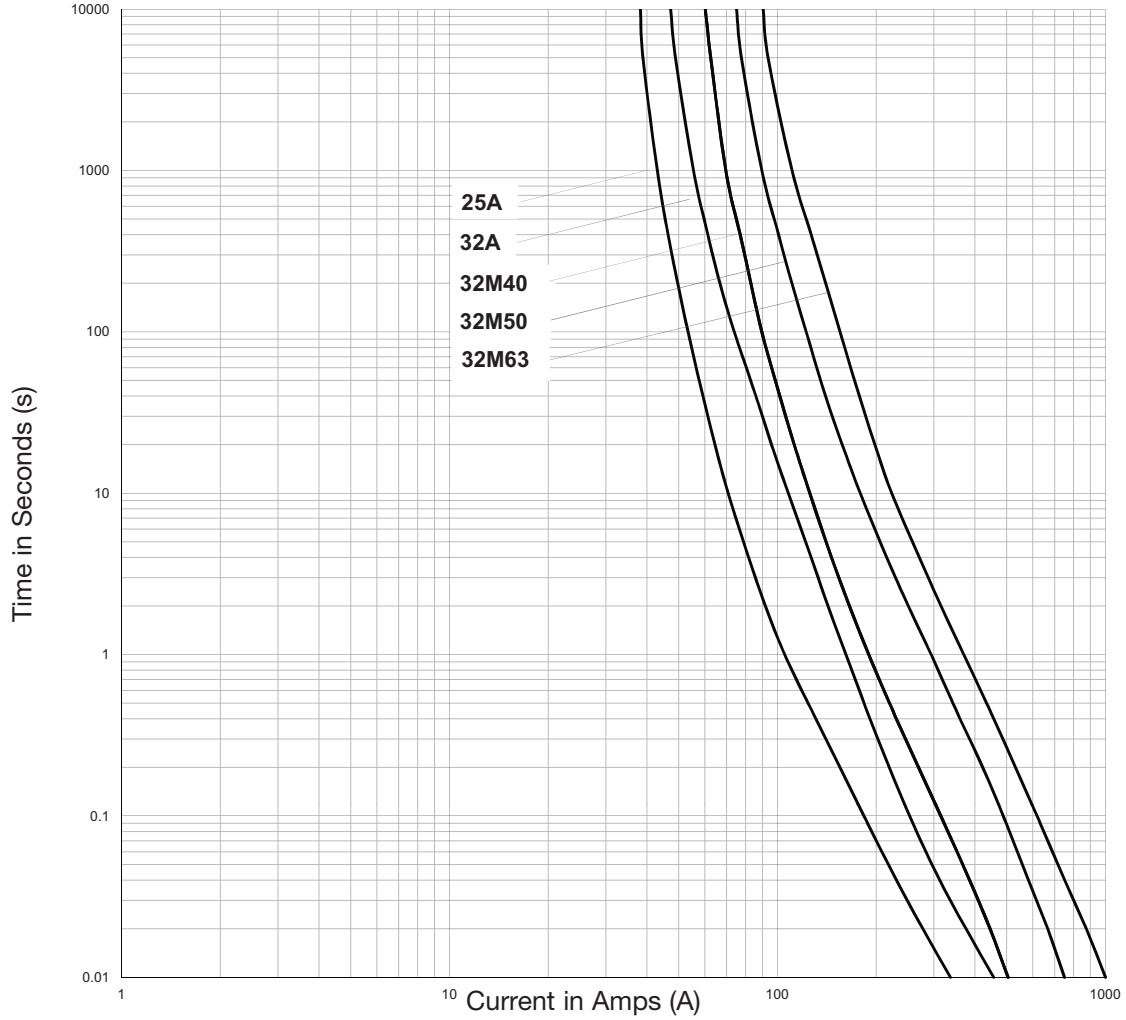

Size A1 to A4 Offset Bolted Tag Fuse Links for General Industrial Applications
2A to 200A, 440-550-660-690Vac/250-350-460Vdc NIT, NET, TIA, TIS, TCP and TFP Red Spot Series

Time-Current Characteristics TIA and TCP32

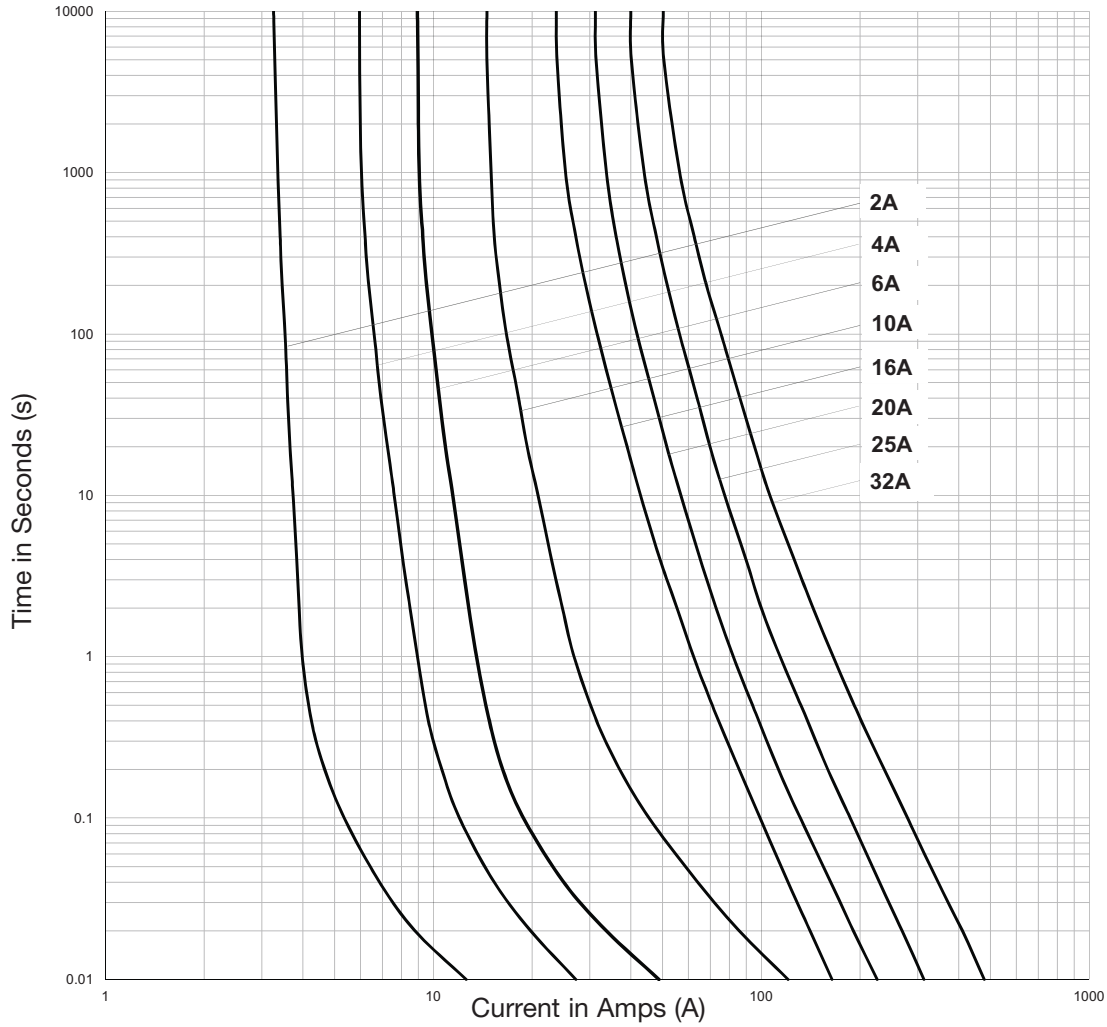

Size A1 to A4 Offset Bolted Tag Fuse Links for General Industrial Applications
2A to 200A, 440-550-660-690Vac/250-350-460Vdc NIT, NET, TIA, TIS, TCP and TFP Red Spot Series

Time-Current Characteristics - TIA32M, TIS35 to TIS63 and TCP40 to TCP63

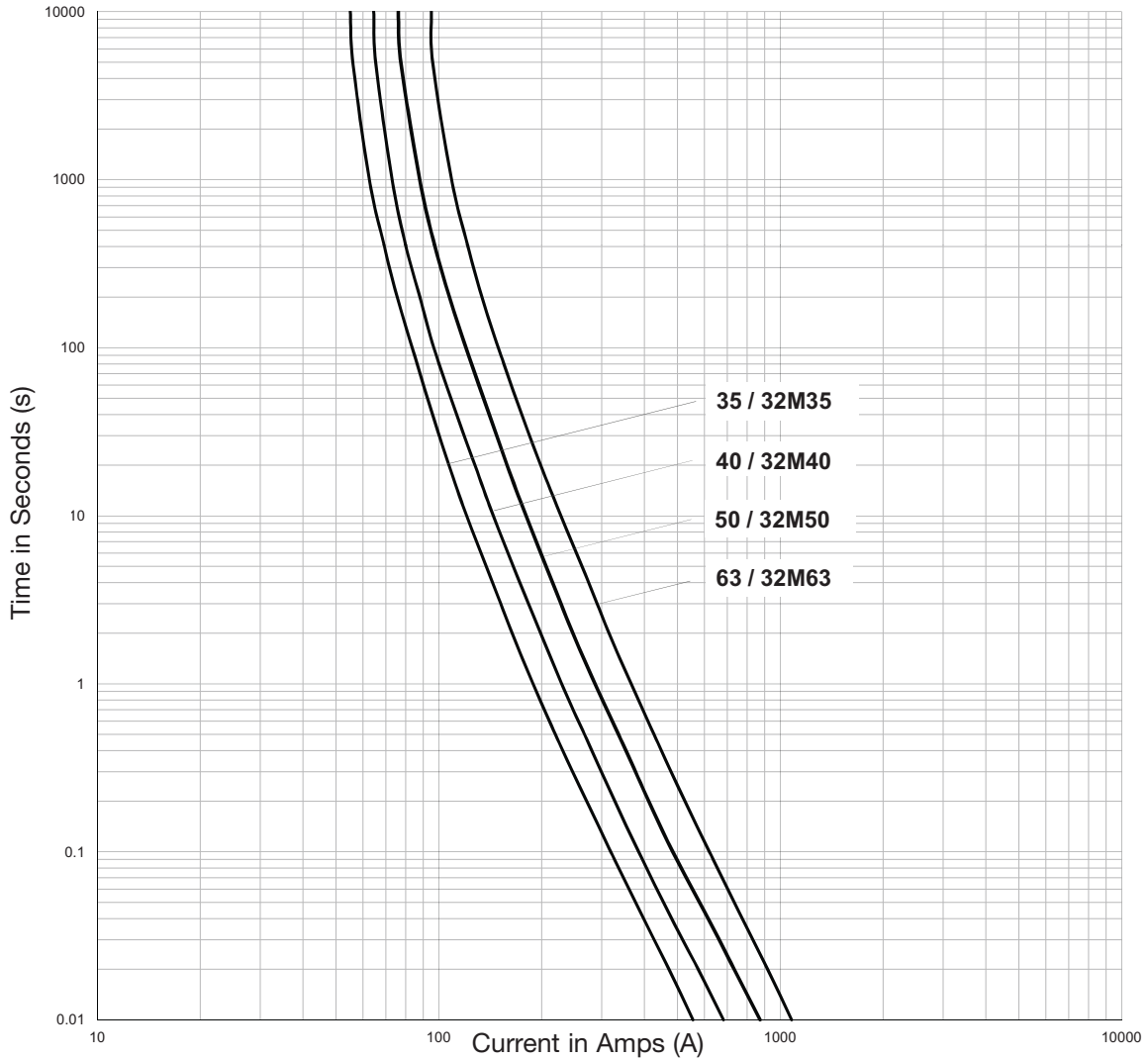

Size A1 to A4 Offset Bolted Tag Fuse Links for General Industrial Applications
2A to 200A, 440-550-660-690Vac/250-350-460Vdc NIT, NET, TIA, TIS, TCP and TFP Red Spot Series

Time-Current Characteristics - TCP80 to TCP100 and TFP125 to TFP200

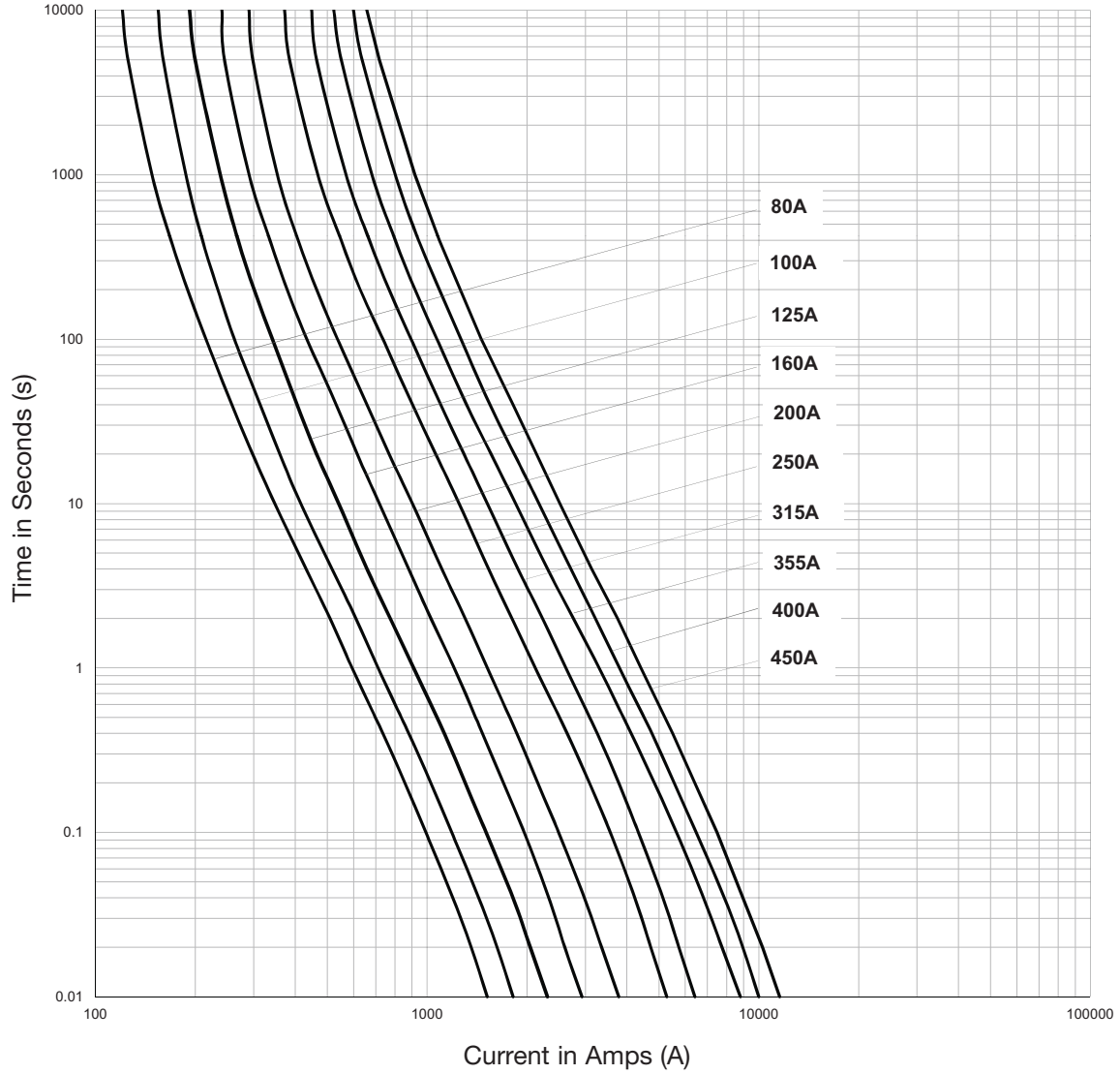

Size A1 to A4 Offset Bolted Tag Fuse Links for General Industrial Applications
2A to 200A, 440-550-660-690Vac/250-350-460Vdc NIT, NET, TIA, TIS, TCP and TFP Red Spot Series

Time-Current Characteristics - TIS63M, TCP100M and TFP200M

