



DS60-P21311

Dx60

MID RANGE DISTANCE SENSORS

SICK
Sensor Intelligence.



Ordering information

| Type | Part no. |
|-------------|----------|
| DS60-P21311 | 1016393 |

Other models and accessories → www.sick.com/Dx60



Detailed technical data

Performance

| | |
|--|---|
| Measuring range | 80 mm ... 6,000 mm, 90 % remission ¹⁾ 80 mm ... 4,600 mm, 18 % remission ¹⁾ 80 mm ... 2,400 mm, 6 % remission ¹⁾ |
| Response time | 10 ms |
| Switching frequency | 50 Hz |
| Light source | Laser, infrared |
| Laser class | 1 (EN 60825-1) |
| Typ. light spot size (distance) | 12 mm x 12 mm (at 6 m) |
| Additional function | Invertable switching output |
| Average laser service life (at 25 °C) | 50,000 h |

¹⁾ Teach-in from 200 ... 6,000 mm.

Interfaces

| | |
|-------------------------|----------------------------------|
| Switching output | 2x PNP (100 mA) ^{1) 2)} |
|-------------------------|----------------------------------|

¹⁾ Output Q short-circuit protected.

²⁾ PNP: HIGH = $V_S - (< 2.5 V)$ / LOW = 0 V.

Mechanics/electronics

| | |
|--|--------------------------------|
| Supply voltage V_S | DC 18 V ... 30 V ¹⁾ |
| Ripple | $\leq 5 V_{pp}$ ²⁾ |
| Power consumption | $\leq 3 W$ ³⁾ |
| Connection type | Male connector, M12, 5-pin |
| Weight | 202 g |
| Enclosure rating | IP 67 |

¹⁾ Limit values, reverse-polarity protected, operation in short-circuit protected network: max. 8 A.

²⁾ May not fall short of or exceed V_S tolerances.

³⁾ Without load.

| | |
|-------------------------|----|
| Protection class | II |
|-------------------------|----|

- 1) Limit values, reverse-polarity protected, operation in short-circuit protected network: max. 8 A.
- 2) May not fall short of or exceed V_S tolerances.
- 3) Without load.

Ambient data

| | |
|--|--|
| Electromagnetic compatibility (EMC) | EN 61000-6-2 EN 60947-5-2 |
| Ambient temperature | Operation: -25 °C ... +55 °C Storage: -25 °C ... +75 °C |

Classifications

| | |
|-----------------------|----------|
| ECl@ss 5.0 | 27270801 |
| ECl@ss 5.1.4 | 27270801 |
| ECl@ss 6.0 | 27270801 |
| ECl@ss 6.2 | 27270801 |
| ECl@ss 7.0 | 27270801 |
| ECl@ss 8.0 | 27270801 |
| ECl@ss 8.1 | 27270801 |
| ECl@ss 9.0 | 27270801 |
| ETIM 5.0 | EC001825 |
| ETIM 6.0 | EC001825 |
| UNSPSC 16.0901 | 41111613 |

Dimensional drawing (Dimensions in mm (inch))

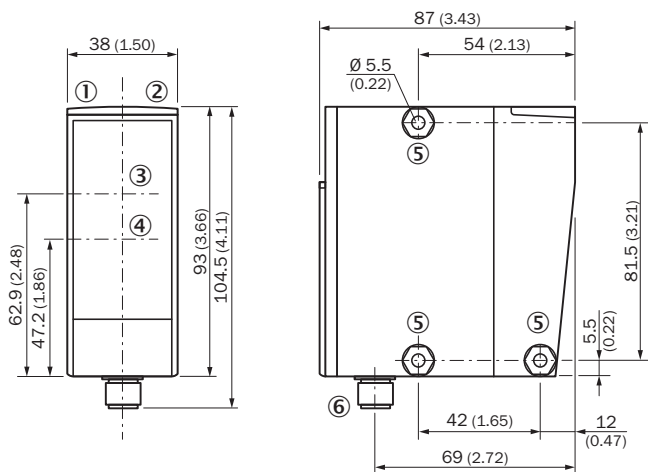

- ① Status indicator switching output 1
- ② Status indicator switching output 2
- ③ Optical axis sender
- ④ Optical axis receiver
- ⑤ Mounting hole, \varnothing 5.2 mm
- ⑥ Male connector M12, 5-pin

Connection type

Male connector M12, 5-pin

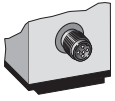

Connection diagram



Adjustment possible

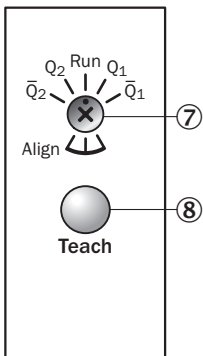

- ⑦ Rotary switch
- ⑧ Control element

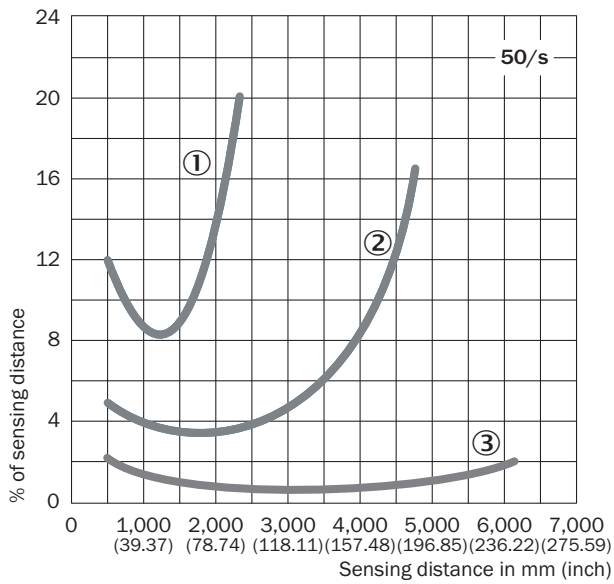

Sensing distance



- ① 6 % / 90 %
- ② 18 % / 90 %
- ③ 90 % / 90 %

Recommended accessories

Other models and accessories → www.sick.com/Dx60

| | Brief description | Type | Part no. |
|---|---|---------------|----------|
| Mounting brackets and plates | | | |
| | Mounting bracket, steel, zinc coated, without mounting hardware | BEF-WN-DS60 | 4032937 |
| Plug connectors and cables | | | |
|  | Head A: female connector, M12, 5-pin, straight Head B: cable Cable: PVC, unshielded, 2 m | DOL-1205-G02M | 6008899 |
|  | Head A: female connector, M12, 5-pin, straight Head B: cable Cable: PVC, unshielded, 5 m | DOL-1205-G05M | 6009868 |
| | Head A: female connector, M12, 5-pin, straight Head B: cable Cable: PVC, unshielded, 10 m | DOL-1205-G10M | 6010544 |
|  | Head A: female connector, M12, 5-pin, angled Head B: cable Cable: PVC, unshielded, 2 m | DOL-1205-W02M | 6008900 |
| | Head A: female connector, M12, 5-pin, angled Head B: cable Cable: PVC, unshielded, 5 m | DOL-1205-W05M | 6009869 |

1) Customizable length by sheet. Width max. 74.9 cm, length max. 91.4 cm.

| | Brief description | Type | Part no. |
|---|--|---------------|----------|
| | Head A: female connector, M12, 5-pin, angled Head B: cable Cable: PVC, unshielded, 10 m | DOL-1205-W10M | 6010542 |
| Reflectors | | | |
|  | "Diamond grade" reflective tape, self-adhesive, ready to assemble from the sheet, 74.9 cm x 91.4 cm ¹⁾ , self-adhesive | REF-DG-K | 4019634 |

¹⁾ Customizable length by sheet. Width max. 74.9 cm, length max. 91.4 cm.

SICK AT A GLANCE

SICK is one of the leading manufacturers of intelligent sensors and sensor solutions for industrial applications. A unique range of products and services creates the perfect basis for controlling processes securely and efficiently, protecting individuals from accidents and preventing damage to the environment.

We have extensive experience in a wide range of industries and understand their processes and requirements. With intelligent sensors, we can deliver exactly what our customers need. In application centers in Europe, Asia and North America, system solutions are tested and optimized in accordance with customer specifications. All this makes us a reliable supplier and development partner.

Comprehensive services complete our offering: SICK LifeTime Services provide support throughout the machine life cycle and ensure safety and productivity.

For us, that is “Sensor Intelligence.”

WORLDWIDE PRESENCE:

Contacts and other locations –www.sick.com