

Plunger valve 3/2 way direct-acting



- Direct-acting, compact small-format valve with diameter of up to DN 1.6
- Screwed coil system
- Banjo threaded connection for direct mounting on pneumatic valves
- Simple and quick push-in, flange, or manifold installation
- Service-friendly manual override

Valve 6012 is a direct-acting plunger valve. The stopper and plunger guide tube are welded together to enhance pressure resistance and leak-tightness. Various seal material combinations are available depending on the application. A Bürkert-specific flange design (SFB) enables space-saving arrangement of valves on a manifold. Push-in fittings can be selected for flexible hose connection. A banjo connection with banjo bolt is the ideal solution for easy direct mounting on a pneumatic drive. Optional manual actuation enables quick commissioning and optimal maintenance. In combination with a plug in accordance with DIN EN 17301-803 Form B or C, the valves satisfy protection class IP65.

Circuit function C

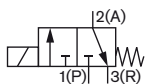

3/2 way direct-acting solenoid valve, normally closed

Circuit function D

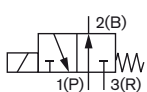

3/2 way direct-acting solenoid valve, normally open

Technical data	
Body material	Brass, polyamide (PA), stainless steel 1.4305 Polyamide (PA)
Seal material	FKM / NBR
Medium	Neutral gases and liquids (e.g. compressed air, water, hydraulic oil, technical Vacuum) neutral gases (z.B. compressed air)
Medium temperature	Type 6012 -10 to +100 °C Type 6012, banjo version -10 to +60 °C
Ambient temperature	max. +55 °C
Type 6012, banjo version	-10 to +40 °C
Viscosity	max. 21 mm ² /s
Port connection	Type 6012 M5, G 1/8, Flange Type 6012, banjo version G 1/8, G 1/4 and tube fitting Ø 6 mm
Operating voltages	24 V DC 24 V / 50 Hz 110 / 230 V / 50 Hz
Voltage tolerance	± 10 %
Duty cycle/single valve for block assembly on multiple manifold	100 % continuous rating Intermittent operation 60 % (30 min) With 2 W coil 100 % (on request)
Electrical connection	<ul style="list-style-type: none"> • Acc. to DIN EN 175301-803* Form C for cable plug Type 2516 (see ordering chart for accessories) • Acc. to DIN 43650 Form B (Industrial standard) for cable plug Type 2507 (see ordering chart for accessories) • Flying leads on request
Manual override	Optional, as a standard feature (for Type 6012, banjo version)
Installation	As required, preferably with actuator upright
Weight: Type 6012 / 6012P	125 g (G 1/8) / 135 g
Protection class	IP65 with cable plug
Thermic isolation class	Polyamide class B Coil Epoxy class H

¹⁾ Pressure data [bar]: Overpressure with respect to atmospheric pressure

* Previously DIN 43650

Response times

Type 6012

Orifice [mm]	K _v value water [m ³ /h]	Pressure range		Coil power	Power consumption		Response times	
		WWC [bar] ¹⁾	WWD [bar] ¹⁾		Inrush	Hold	Opening [ms]	Closing [ms]
1.2	0.045	0-10	0-10	4 W AC or 4 W DC	9 VA 4 W	6 VA (4 W) 4 W	7-10	9-12
1.6	0.06	0-6	0-6				7-12	7-12

¹⁾ Pressure data [bar]:
Overpressure with
respect to atmospheric
pressure

- K_v value [m³/h]: Flow rate value for water, measured at +20 °C, 1 bar¹⁾ Pressure at valve inlet and 1 bar pressure difference

Type 6012, banjo version

Orifice [mm]	Q _{Nn} value air [l/min]	Pressure range [bar] ¹⁾	Coil power	Power consumption		Response times	
				Inrush	Hold	Opening [ms]	Closing [ms]
			4 W AC or 4 W DC	9 VA 4 W	6 VA (4 W) 4 W	7-10 7-12	9-12 7-12
1.2	48	0-10					

¹⁾ Pressure data [bar]:
Overpressure with
respect to atmospheric
pressure

- Q_{Nn} value [l/min]: Flow rate value for air, measured at +20 °C, 6 bar¹⁾ Pressure at valve inlet and 1 bar pressure difference
- Response times [ms]: Measures at valve outlet at 6 bar¹⁾ and +20 °C acc. to ISO 12238
Opening: Pressure build up 0 to 90 %
Closing: Pressure relief 100 to 10 %

Material

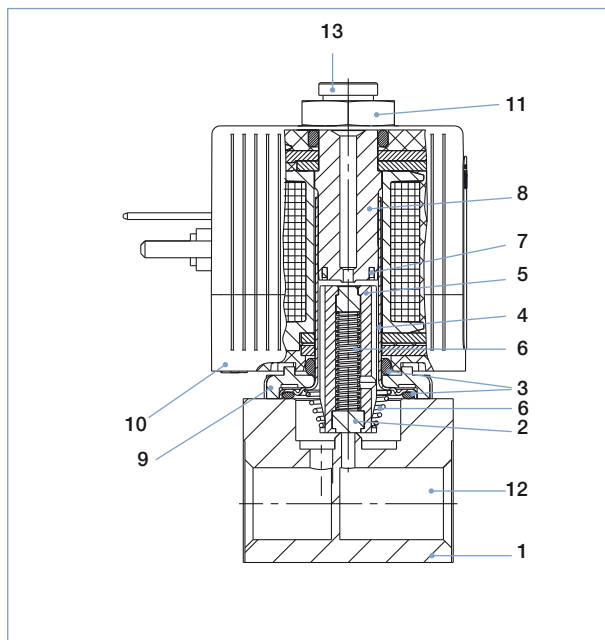

1	Body	Brass, stainless steel 1.4305 PA (polyamide)
2	Armature seal	FKM/EPDM
3	O-Ring	FKM/EPDM
4	Guide tube	Stainless steel 1.4303
5	Core	Stainless steel 1.4105
6	Spring	Stainless steel 1.4310
7	Shading ring	Copper (silver optional)
8	Stopper	Stainless steel 1.4105
9	Sub-base	Zn3 gl cC surface (brass version) Nickel-plated surface (St. st. version)
10	Coil	DIN EN 175301-803* Form C PA Form B (Industrial standard) Epoxy
11	Locknut	DIN176-9SMnPb28K (surface Zn5glcA)
12	Pressure inlet P with	Circuit function C
13	Pressure inlet P with	Circuit function D

* previously DIN 43650

Dimensions [mm] - Type 6012

Coil connection acc. to DIN EN 175301-803* Form C (Cable Plug Type 2516)

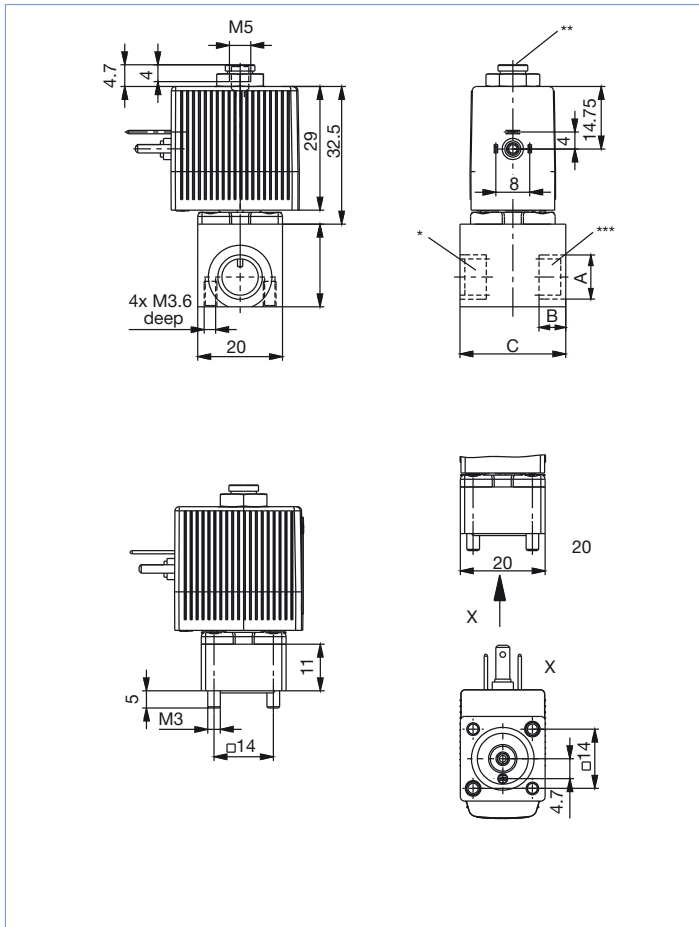

Coil connection acc. to DIN EN 43650 Form B Industrial standard (cable plug 2507)

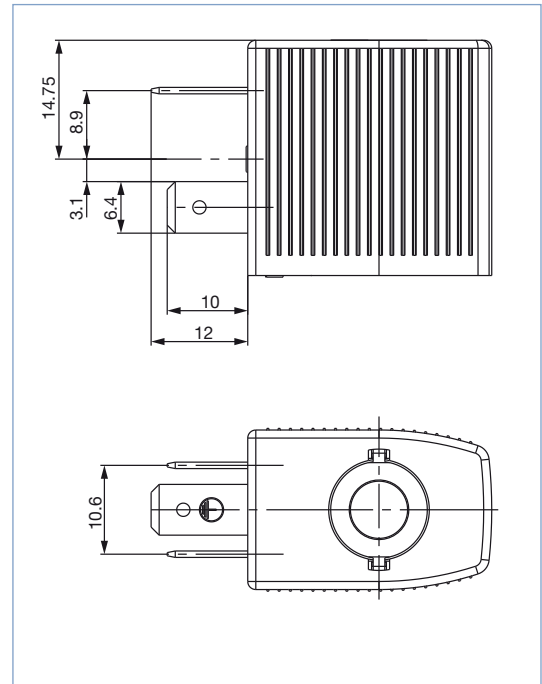

Port connection	A	B	C	D
Sleeve	M5	5	20	14
Sleeve	G 1/8	8	25	19.5
sub-base	-	-	20	11

* previously DIN 43650

Connections

For the positions marked with *, ** or *** in the drawing, the connections are marked with the letters shown in the table above, depending on the circuit function. Unused connections in circuit functions A or B will be closed off with a blanking plug or cap nut.

Circuit function	Connection Type		
	*	**	***
A	P	blank off	A
B	blank off	B	P
C	P	R	A
D	R	P	B
T	P	R	A

Ordering chart

Type 6012: Solenoid valve in threaded port or sub-base version with polyamide electrical coil acc. to DIN EN 175301-803* Form C for cable plug Type 2516

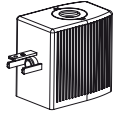

Circuit function	Orifice [mm]	Port Connection	K _v value water [m ³ /h]	Pressure range [bar] ¹⁾	Voltage/frequency [V/Hz]	Article no. brass body without manual override	Article no. brass body with manual override	Article no. St. st. body without manual override	Article no. PA body with manual override	
C 3/2 way valve NC 	1.2	M5	0.045	0-10	24/DC	134143	-	-	-	
					24/50	134144	-	-	-	
					110/50	134145	-	-	-	
	1.6	M5	0.06	0-6	24/DC	134147	-	-	-	-
					24/50	134148	-	-	-	
					110/50	134149	-	-	-	
	1.2	G 1/8	0.045	0-10	24/DC	134151	134159	134167	-	
					24/50	134152	134160	134168	-	
					110/50	134153	134161	134169	-	
	1.6	G 1/8	0.06	0-6	24/DC	134155	134163	134171	-	
					24/50	134156	134164	134172	-	
					110/50	134157	134165	134173	-	
	1.2	sub-base	0.045	0-10	24/DC	134175	-	134183	134191	
					24/50	134176	-	134184	134192	
					110/50	134177	-	134185	134193	
	1.6	sub-base	0.06	0-6	24/DC	134179	-	134187	134195	
					24/50	134180	-	134188	134196	
					110/50	134181	-	134189	134197	
	D 3/2 way valve NO 	1.2	M5	0.045	0-10	24/DC	134199	-	-	-
						24/50	134200	-	-	-
						110/50	134201	-	-	-
		1.6	M5	0.06	0-6	24/DC	134204	-	-	-
						24/50	134205	-	-	-
						110/50	134206	-	-	-
1.2		G 1/8	0.045	0-10	24/DC	134208	-	134216	-	
					24/50	134209	-	134217	-	
					110/50	134210	-	134218	-	
1.6		G 1/8	0.06	0-6	24/DC	134212	-	134220	-	
					24/50	134213	-	134221	-	
					110/50	134214	-	134222	-	
						230/50	134215	-	134223	-

¹⁾ Pressure data [bar]: Overpressure with respect to atmospheric pressure
 * previously DIN 43650

- All valves with FKM seal; without cable plug.
- other versions on request.

Ordering chart

Type 6012: Solenoid Valve with threaded port or sub-base version with polyamide electrical coil acc. to DIN 43650 Form B (Industrial standard) for cable plug Type 2507

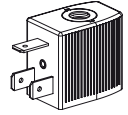

Circuit function	Orifice [mm]	Port Connection	K _v value water [m ³ /h]	Pressure range [bar] ¹⁾	Voltage/frequency [V/Hz]	Article no. brass body without manual override	Article no. brass body with manual override	Article no. St. st. body without manual override	Article no. PA body with manual override
C 3/2 way valve NC 	1.2	M5	0.045	0-10	24/DC	163569	-	-	-
					24/50	163570	-	-	-
					110/50	163571	-	-	-
					230/50	163572	-	-	-
	1.6	M5	0.06	0-6	24/DC	163573	-	-	-
					24/50	163574	-	-	-
					110/50	163575	-	-	-
	1.2	G 1/8	0.045	0-10	24/DC	161904	163584	163592	-
					24/50	163577	163585	163593	-
					110/50	163578	163586	163594	-
	1.6	G 1/8	0.06	0-6	24/DC	163580	163588	163596	-
					24/50	163581	163589	163597	-
					110/50	163582	163590	163598	-
					230/50	163583	163591	163599	-
	1.2	sub-base	0.045	0-10	24/DC	163600	-	163608	161063
					24/50	163601	-	163609	163616
110/50					163602	-	163610	163617	
230/50					163603	-	163611	163618	
1.6	sub-base	0.06	0-6	24/DC	163604	-	163612	163619	
				24/50	163605	-	163613	163620	
				110/50	163606	-	163614	163621	
				230/50	217634	-	163615	163622	
D 3/2 way valve NO 	1.2	M5	0.045	0-10	24/DC	163623	-	-	-
					24/50	163624	-	-	-
					110/50	163625	-	-	-
					230/50	163626	-	-	-
	1.6	M5	0.06	0-6	24/DC	163627	-	-	-
					24/50	163628	-	-	-
					110/50	163629	-	-	-
	1.2	G 1/8	0.045	0-10	24/DC	163631	-	163639	-
					24/50	163632	-	163640	-
					110/50	163633	-	163641	-
					230/50	163634	-	163642	-
	1.6	G 1/8	0.06	0-6	24/DC	163635	-	163643	-
					24/50	163636	-	163644	-
					110/50	163637	-	163645	-
					230/50	163638	-	163646	-

¹⁾ Pressure data [bar]: Overpressure with respect to atmospheric pressure
 * previously DIN 43650

- All valves with FKM seal; without cable plug.
- other versions on request.

Materials - Banjo version

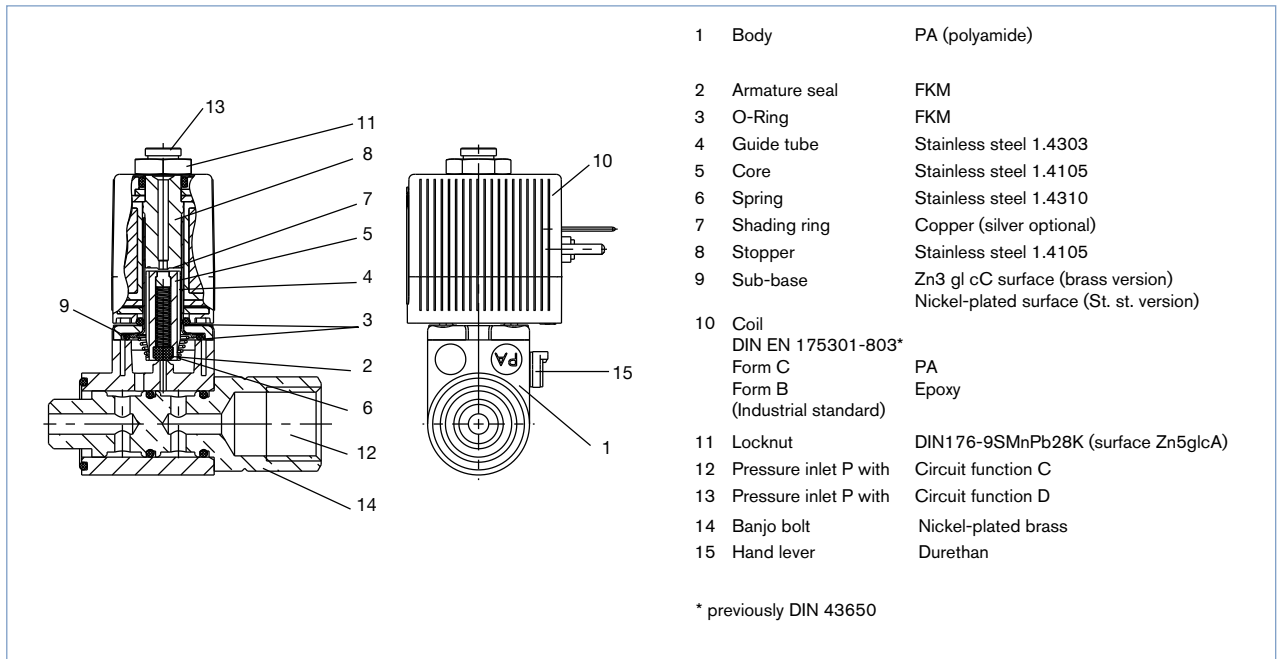

Dimensions [mm] - Type 6012, banjo version

Version with coil connection acc. to DIN EN 175301-803* Form C (cable plug Type 2516)

Threaded port for compressed air

G	L
G 1/8	6.5
G 1/4	9.5

Push-in connection for compressed air

Pressure inlet P can be rotated through 360°.

G	L
G 1/8	6.5
G 1/4	9.5

Version with coil connection acc. to DIN 43650 Form B Industrial standard (cable plug Type 2507)

Threaded port for compressed air

G	L
G 1/8	6.5
G 1/4	9.5









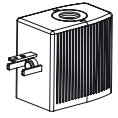

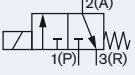









Push-in connection for compressed air

* previously DIN 43650

Ordering chart

Type 6012, banjo version: for direct mounting on to pneumatic actuator with polyamide coil acc. to DIN EN 175301-803* Form C for cable plug Type 2516











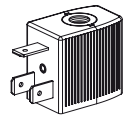

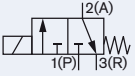









Circuit function	Orifice [mm]	Pressure inlet P (valve body)	Service port A (banjo bolt)	Q _{in} value air [l/min]	Pressure range [bar] ¹⁾	Voltage/frequency [V/Hz]	Article no.
C 3/2 way valve NC 	1.2	G 1/8	G 1/8	48	0-10	24/DC	429112 
						24/50	429113 
						110/50	429115 
						230/50	429117 
		G 1/4	G 1/8	48	0-10	24/DC	429126 
						24/50	429127 
						110/50	429128 
						230/50	429129 
		G 1/4	G 1/4	48	0-10	24/DC	427919 
						24/50	427920 
						110/50	427921 
						230/50	427922 
	Tube fitting Ø 6 mm	G 1/8	48	0-10	24/DC	425299 	
					24/50	425300 	
					110/50	428570 	
					230/50	425304 	
Tube fitting Ø 6 mm	G 1/4	48	0-10	24/DC	425285 		
				24/50	425286 		
				110/50	428569 		
				230/50	425290 		

¹⁾ Pressure values [bar]: Measured as overpressure to the atmospheric pressure * previously DIN 43650

- All valves with PA body, NBR seal and manual override; without cable plug.
- other versions on request

Type 6012, banjo version: for direct mounting on to pneumatic actuator with epoxy coil acc. to DIN EN 43650* Form B Industrial standard for cable plug Type 2507



Circuit function	Orifice [mm]	Pressure inlet P (valve body)	Service port A (Banjo bolt)	Q _{in} value air [l/min]	Pressure range [bar] ¹⁾	Voltage/frequency [V/Hz]	Article no.
C 3/2 way valve NC 	1.2	G 1/8	G 1/8	48	0-10	24/DC	552299 
						24/50	552300 
						110/50	552301 
						230/50	552302 
		G 1/4	G 1/8	48	0-10	24/DC	552295 
						24/50	552296 
						110/50	552297 
						230/50	552298 
		G 1/4	G 1/4	48	0-10	24/DC	552291 
						24/50	552292 
						110/50	552293 
						230/50	552294 
	Tube fitting Ø 6 mm	G 1/8	48	0-10	24/DC	552287 	
					24/50	552288 	
					110/50	552289 	
					230/50	552290 	
Tube fitting Ø 6 mm	G 1/4	48	0-10	24/DC	552283 		
				24/50	552284 		
				110/50	552285 		
				230/50	552286 		

¹⁾ Pressure values [bar]: Overpressure with respect to atmospheric pressure

- All valves with PA body, NBR seal and manual override; without cable plug.
- other versions on request

Dimensionsfor manifolds (SFB)

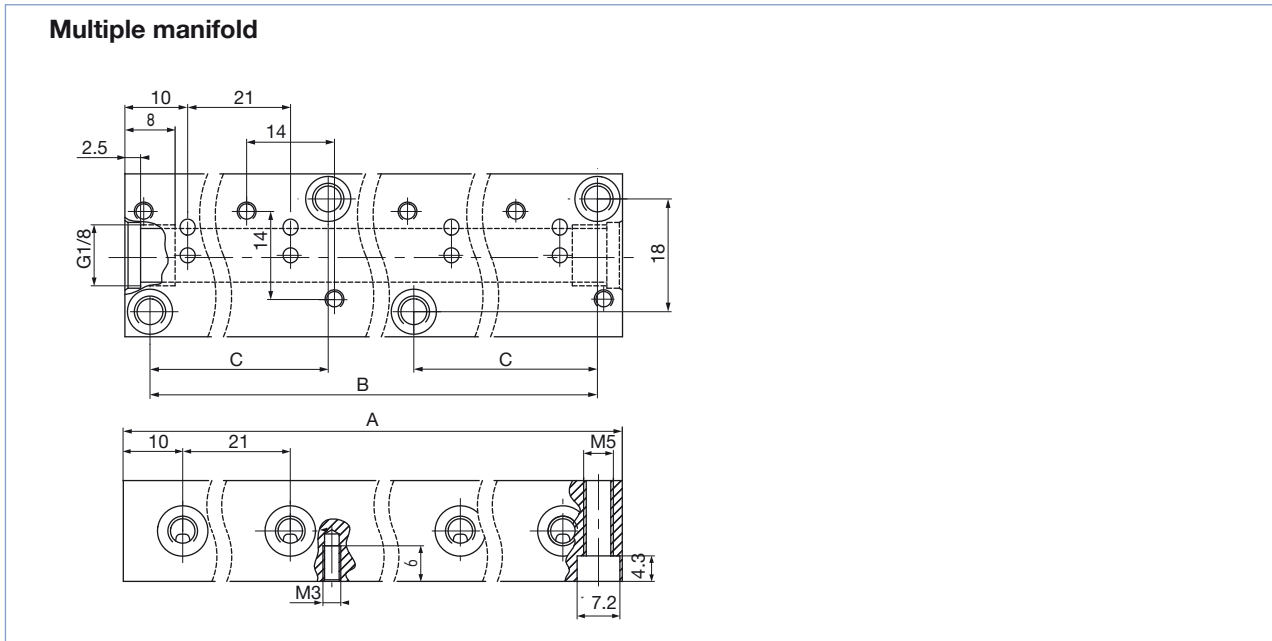

Ordering chart for manifold

Material	No. of valves	A [mm]	B [mm]	C [mm]	Article no.
Aluminium	1	20	12	-	005312
	2	41	33	-	005355
	3	62	54	-	005313
	4	83	75	-	005314
	5	104	96	-	005315
	6	125	117	-	005316
	7	146	138	-	005893
	8	167	159	54	005166
	9	188	180	54	005241
	10	209	201	75	005819
	11	230	222	75	005242
	12	251	243	96	005222





- only available with circuit function C (normally closed).

Manifold accessories

Accessory	Features	Article no.
Blanking plug	with seal ring, G 1/8	005041
Covering plate	for unused valves	005100

Ordering chart for accessories





Cable plug type 2516 to DIN EN 175301-803* form C

	Circuitry	Voltage	Article no.
	None (standard)	0-250 V AC/DC	303141 
	with LED	12-24 V AC/DC	303145 
	with LED and varistor	12-24 V AC/DC	303148 
	with rectifier, LED and varistor	12-24 V AC/DC	303142 

- Supplied with cable plug: flat seal and fixing screw.
- Other versions of cable plug with circuitry acc. to DIN EN 175301-803* Form C as well as detailed technical data - see datasheet Type 2516

^{*)} previously DIN 43650

Cable plug Type 2507 acc. to DIN 43650 Form B (Industrial standard)

	Circuitry	Voltage	Article no.
	None (Standard)	2-250 V AC/DC	423845 
	with LED	24 V AC/DC	423849 
	with LED and freewheeling diode	12-24 V DC	423851 
	with rectifier, LED and varistor	12-24 V AC/DC	423853 

- Supplied with cable plug, flat seal and fixing screw.
- Further versions of cable plug with circuitry acc. to DIN EN 43650* Form B as well as detailed technical data - see datasheet Type 2507

To find your nearest Bürkert facility, click on the orange box →

www.burkert.com

In case of special application conditions,
please consult for advice

Subject to alterations
© Christian Bürkert GmbH & Co. KG

1805/11_EU-en_00891725