



ICR840-2C1020

ICR840-2

IMAGE-BASED CODE READERS

SICK
Sensor Intelligence.



Ordering information

Type	Part no.
ICR840-2C1020	1042885

Other models and accessories → www.sick.com/ICR840-2



Detailed technical data

Features

Version	Mid Range
Reading field	Side
Focus	Fixed focus
Focus position	115 mm
Sensor	CMOS Mono
Sensor resolution	1,280 px x 1,024 px (1.3 Mpixel)
Light source	Visible red light (lighting LEDs, 617 nm, ± 15 nm)
MTBF	75,000 h
Laser class	1 (EN 60825-1, IEC 60825-1)
Scanning frequency	25 Hz, With resolution of 1.3 megapixels
Code resolution	≥ 0.15 mm ¹⁾
Reading distance	70 mm ... 210 mm ^{1) 2)}

¹⁾ Valid for Data Matrix, PDF417, and 1D codes with good print quality.

²⁾ For details see reading field diagram.

Performance

Bar code types	GS1-128 / EAN 128, UPC / GTIN / EAN, Interleaved 2 of 5, Pharmacode, Code 39, Code 128, Codabar
2D code types	Data Matrix ECC200, GS1 Data-Matrix, QR code
No. of codes per scan	1 ... 50
No. of codes per reading interval	1 ... 50
No. of characters per reading interval	4,000

Interfaces

Ethernet	✓, TCP/IP
Function	Host, AUX
Data transmission rate	10/100 MBit/s
PROFINET	✓

Type of fieldbus integration	Optional, over external connection module CDM
Serial	✓, RS-232
Function	Host, AUX
Data transmission rate	300 Baud ... 57,600 Baud, AUX: 9,600 baud
CAN	✓
Function	SICK CAN sensor network (Master/Slave, Multiplexer)
Data transmission rate	10 kbit/s ... 1 Mbit/s
CANopen	✓
Data transmission rate	10 kbit/s ... 1 Mbit/s
PROFIBUS DP	✓
Type of fieldbus integration	Optional, over external connection module CDM + CMF
DeviceNet™	✓
Type of fieldbus integration	Optional, over external connection module CDM + CMF
Switching inputs	2
Switching outputs	2 (Result 1 NPN, Result 2 PNP)
Reading pulse	Switching inputs, non-powered, serial interface
Optical indicators	6 LEDs (status displays)
Acoustic indicators	Beeper/buzzer (can be switched off, can be assigned a function to signal a result)

Mechanics/electronics

Electrical connection	1 x RJ45 female connector on the device, cables with 15-pin D-Sub HD male connector (0.9 m, ± 5%)
Operating voltage	15 V DC ... 30 V DC
Power consumption	13 W
Housing	Die-cast zinc
Housing color	Light blue (RAL 5012)
Enclosure rating	IP65 (EN 60529) ¹⁾ IP30 ²⁾
Protection class	III (EN 61140)
Weight	900 g, with connecting cable
Dimensions (L x W x H)	112 mm x 80 mm x 39 mm

¹⁾ For installed adapter frame and IP65 Ethernet cable or for installed adapter frame and IP65 cover.

²⁾ Without covered Ethernet connection or with standard Ethernet cable.

Ambient data

Electromagnetic compatibility (EMC)	EN 61000-6-2 / EN 61000-6-4
Vibration resistance	EN 60068-2-6
Shock resistance	EN 60068-2-27
Ambient operating temperature	0 °C ... +40 °C
Storage temperature	-20 °C ... +70 °C
Permissible relative humidity	± 90 %, Non-condensing
Ambient light immunity	2,000 lx, on bar code

Classifications

ECI@ss 5.0	27280103
-------------------	----------

ECl@ss 5.1.4	27280103
ECl@ss 6.0	27280103
ECl@ss 6.2	27280103
ECl@ss 7.0	27280103
ECl@ss 8.0	27280103
ECl@ss 8.1	27280103
ECl@ss 9.0	27280103
ETIM 5.0	EC002550
ETIM 6.0	EC002550
UNSPSC 16.0901	43211701

Dimensional drawing (Dimensions in mm (inch))

ICR840-2, ICR845-2

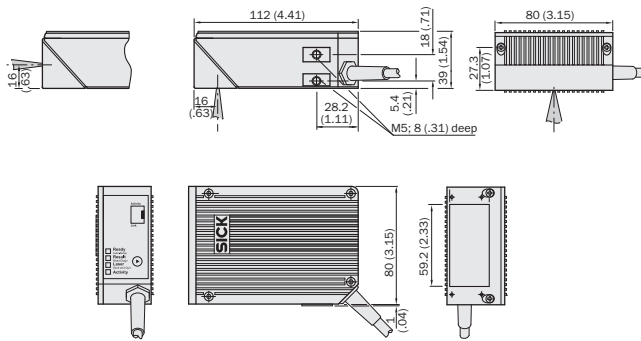



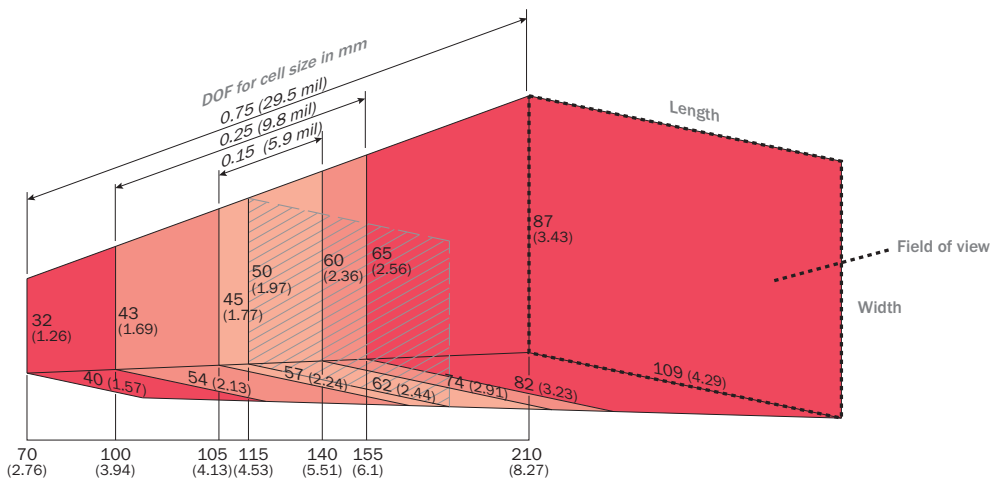

Reading field diagram



Recommended accessories

Other models and accessories → www.sick.com/ICR840-2

	Brief description	Further accessories	Type	Part no.
Mounting brackets and plates				
	Mounting bracket, adjustable skew angle, mounting hardware included		Mounting bracket	2039465
Plug connectors and cables				
	Head A: male connector, RJ45 Head B: male connector, RJ45 Cable: Ethernet, unshielded, 3 m		Ethernet crossover cable	6026084
	Head A: male connector, RJ45, 4-pin Head B: male connector, RJ45, 4-pin Cable: Ethernet, unshielded Ethernet connection possible when screw-mounted		Ethernet patch cable (male connector-male connector)	2039986
	Small connection module for one sensor, 4 cable glands, base for CMC600	Modules	CDB620-001	1042256
	Modular connection module for one sensor		CDM420-0001	1025362

SICK AT A GLANCE

SICK is one of the leading manufacturers of intelligent sensors and sensor solutions for industrial applications. A unique range of products and services creates the perfect basis for controlling processes securely and efficiently, protecting individuals from accidents and preventing damage to the environment.

We have extensive experience in a wide range of industries and understand their processes and requirements. With intelligent sensors, we can deliver exactly what our customers need. In application centers in Europe, Asia and North America, system solutions are tested and optimized in accordance with customer specifications. All this makes us a reliable supplier and development partner.

Comprehensive services complete our offering: SICK LifeTime Services provide support throughout the machine life cycle and ensure safety and productivity.

For us, that is “Sensor Intelligence.”

WORLDWIDE PRESENCE:

Contacts and other locations –www.sick.com