

Electrical Sector Solutions

Volume 7: Logic Control, Operator Interface and Connectivity Solutions

EATON

Powering Business Worldwide

Volume 1—Residential and Light Commercial

1

Volume 2—Commercial Distribution

2

Volume 3—Power Distribution and Control Assemblies

3

Volume 4—Circuit Protection

4

Volume 5—Motor Control and Protection

5

Volume 6—Solid-State Motor Control

6

**Volume 7—Logic Control, Operator Interface
and Connectivity Solutions**

7

Tab 1—Pushbuttons and Indicating Lights	V7-T1-1
Tab 2—Stacklights	V7-T2-1
Tab 3—Control Relays and Timers	V7-T3-1
Tab 4—PLC, I/O and Communications Products	V7-T4-1
Tab 5—Operator Interface Products	V7-T5-1
Tab 6—Power Supplies	V7-T6-1
Tab 7—Industrial Control Transformers	V7-T7-1
Tab 8—Terminal Blocks, Fuse Blocks and Fuse Holders	V7-T8-1
Tab 9—Connectivity Solutions	V7-T9-1
Appendix 1—Eaton Terms & Conditions	V7-A1-1
Appendix 2—Catalog Parent Number Index	V7-A2-1
Appendix 3—Alphabetical Product Index	V7-A3-1



Dimensions, Weights and Ratings

Dimensions, weights and ratings given in this catalog **are approximate and should not be used for construction purposes**. Drawings containing exact dimensions are available upon request. All listed product specifications and ratings are subject to change without notice. Photographs are representative of production units.

Terms and Conditions

All prices and discounts are subject to change without notice. When price changes occur, they are published in Eaton's *Price and Availability Digest* (PAD). All orders accepted by Eaton's Electrical Sector are subject to the general terms and conditions as set forth in Appendix 1—Eaton Terms & Conditions.

Technical and Descriptive Publications

This catalog contains brief technical data for proper selection of products. Further information is available in the form of technical information publications and illustrated brochures. If additional product information is required, contact your local Eaton Products Distributor, call **1-800-525-2000** or visit our website at **www.eaton.com**.

Compliance with Nuclear Regulation 10 CFR 21

Eaton products are sold as commercial grade products not intended for application in facilities or activities licensed by the United States Nuclear Regulatory Commission for atomic purposes, under 10 CFR 21. Further certification will be required for use of these products in a safety-related application in any nuclear facility licensed by the U.S. Nuclear Regulatory Commission.

WARNING

The installation and use of Eaton products should be in accordance with the provisions of the U.S. National Electrical Code® and/or other local codes or industry standards that are pertinent to the particular end use. Installation or use not in accordance with these codes and standards could be hazardous to personnel and/or equipment.

These catalog pages do not purport to cover all details or variations in equipment, nor to provide for every possible contingency to be met in connection with installation, operation or maintenance. Should further information be desired or should particular problems arise which are not covered sufficiently for the purchaser's purposes, the matter should be referred to the local Eaton Products Distributor or Sales Office. The contents of this catalog shall not become part of or modify any prior or existing agreement, commitment or relationship. The sales contract contains the entire obligation of Eaton's Electrical Sector. The warranty contained in the contract between the parties is the sole warranty of Eaton. Any statements contained herein do not create new warranties or modify the existing warranty.



Powering Business Worldwide

Eaton is a global leader in power distribution, power quality, control and automation, and monitoring products.

At Eaton, we believe a reliable, efficient and safe power system is the foundation of every successful enterprise. Through innovative technologies, cutting-edge products and our highly skilled services team, we empower businesses around the world to achieve a powerful advantage.

In addition, Eaton is committed to creating and maintaining powerful customer relationships built on a foundation of excellence. From the products we manufacture to our dedicated customer service and support, we know what's important to you.

Solutions

Eaton takes the complexity out of power systems management with a holistic and strategic approach, leveraging our industry-leading technology, solutions and services. We focus on the following three areas in all we do:

- Reliability—maintain the appropriate level of power continuity without disruption or unexpected downtime
- Efficiency—minimize energy usage, operating costs, equipment footprint and environmental impact
- Safety—identify and mitigate electrical hazards to protect what you value most

Using the Eaton Catalog Library

As we grow, it becomes increasingly difficult to include all products in one or two comprehensive catalogs. Knowing that each user has their specific needs, we have created a library of catalogs for our products that when complete, will contain 15 volumes. Since the volumes will continuously be a work in progress and updated, each volume will stand alone. Refer to our volume directory, MZ08100001E, for a quick glance of where to look for the products you need. The 15 volumes include:

- Volume 1—Residential and Light Commercial (CA08100002E)
- Volume 2—Commercial Distribution (CA08100003E)
- Volume 3—Power Distribution and Control Assemblies (CA08100004E)
- Volume 4—Circuit Protection (CA08100005E)
- Volume 5—Motor Control and Protection (CA08100006E)
- Volume 6—Solid-State Motor Control (CA08100007E)
- Volume 7—Logic Control, Operator Interface and Connectivity Solutions (CA08100008E)
- Volume 8—Sensing Solutions (CA08100010E)
- Volume 9—Original Equipment Manufacturer (CA08100011E)
- Volume 10—Enclosed Control (CA08100012E)
- Volume 11—Vehicle and Commercial Controls (CA08100013E)
- Volume 12—Aftermarket, Renewal Parts and Life Extension Solutions (CA08100014E)
- Volume 13—Counters, Timers and Tachometers (CA08100015E)—Available in electronic format only
- Volume 14—Fuses (CA08100016E)—Available in electronic format only
- Volume 15—Solar Inverters and Electrical Balance of System (CA08100018E)

These volumes are not all-inclusive of every product, but they are meant to be an overview of our product lines. For our full range of product solutions and additional product information, consult Eaton.com/electrical and other catalogs and product guides in our literature library. These references include:

- The Consulting Application Guide (CA08104001E)
- The Eaton Power Quality Product Guide (COR01FYA)

If you don't have the volume that contains the product or information that you are looking for, not to worry. You can access every volume of the catalog library at Eaton.com/electrical in the Literature Library.

By installing our Automatic Tab Updater (ATU), you can be sure you always have the most recent version of each volume and tab.

Icons



Green Leaf

Eaton Green Solutions are products, systems or solutions that represent Eaton benchmarks for environmental performance. The green leaf symbol is our promise that the solution has been reviewed and documented as offering exceptional, industry-leading environmental benefits to customers, consumers and our communities. Though all of Eaton's products and solutions are designed to meet or exceed applicable government standards related to protecting the environment, our products with the Green Leaf designation further provide "exceptional environmental benefit."



Learn Online

When you see the Learn Online icon, go to Eaton.com/electrical and search for the product or training page. There you will find 100-level training courses, podcasts, webcasts or games and puzzles to learn more.



Drawings Online

When you see the Drawings Online icon, go to Eaton.com/electrical and find the products page. There you will find a tab that includes helpful product drawings and illustrations.

Contact Us

If you need additional help, you can find contact information under the Customer Care heading of Eaton.com/electrical.

10250T Pushbuttons



RMQ-Titan M22 Series



RMQ Compact C22 Series



1.1	Toggle Switches—E10	
	Product Description	V7-T1-2
	Product Selection	V7-T1-4
1.2	Environmentally Sealed Toggle Switches—E10E	
	Product Description	V7-T1-8
	Product Selection	V7-T1-9
1.3	Pushbutton Control Stations—Assembled	
	Product Description	V7-T1-14
	Product Selection	V7-T1-16
1.4	16.2 mm Pushbuttons—RMQ-16	
	Product Selection Guide	V7-T1-31
	Product Selection	V7-T1-32
1.5	22.5 mm RMQ-Titan Modular Pushbuttons—M22	
	Product Selection Guide	V7-T1-48
	Product Selection	V7-T1-53
1.6	22.5 mm RMQ Compact Pushbuttons—C22	
	Product Selection Guide	V7-T1-139
	Product Selection	V7-T1-141
1.7	Global Modular 30 mm Pilot Devices—M30 Flat Operators	
	Product Description	V7-T1-174
	Product Selection	V7-T1-178
1.8	Global Compact 30 mm Pilot Devices—C30 Flat with Pigtail	
	Product Description	V7-T1-192
	Product Selection	V7-T1-194
1.9	30.5 mm Square Multifunction Watertight/Oiltight—E30	
	Product Description	V7-T1-201
	Product Selection	V7-T1-203
1.10	30.5 mm Heavy-Duty Watertight/Oiltight—10250T	
	Product Description	V7-T1-219
	Product Selection	V7-T1-223
1.11	30.5 mm Corrosion Resistant Watertight/Oiltight—E34	
	Product Description	V7-T1-290
	Product Selection	V7-T1-296
1.12	30.5 mm Watertight/Oiltight—HT800	
	Product Description	V7-T1-332
	Product Selection	V7-T1-334
1.13	30.5 mm Class I Division 2 Hazardous Locations—10250T/E34	
	Product Description	V7-T1-357
	Catalog Number Selection	V7-T1-359



Contents

<i>Description</i>	<i>Page</i>
Toggle Switches—E10	
Standards and Certifications	V7-T1-3
Catalog Number Selection	V7-T1-3
Product Selection	
Toggle Switches	V7-T1-4
Hesitation Switches	V7-T1-5
Pushbuttons	V7-T1-5
Accessories	V7-T1-5
Technical Data and Specifications	V7-T1-6
Circuit Diagrams	V7-T1-6
Dimensions	V7-T1-7

Product Description

The E10 switches from Eaton’s Electrical Sector are intended for general purpose light industrial use. Designed for retrofit and OEM applications.

Features

General Purpose Toggles

- Various circuit functions include maintained and momentary
- Poles include from single-pole single-throw to four-pole double-throw
- Spade, screw, and solder terminations available
- Numerous ratings
- Short 11/32 in and tall 15/32 in bat lever available
- Standard 15/32–32 thd.
- Hardware furnished assembled

Heavy-Duty Hesitation Switches

- One-hole panel mount
- Three position switch offers unique positive center stop feature to assure lever cannot be thrown from one side through the center OFF position without stopping
 - Design feature is a major acceptance for motor reversing and speed control applications
 - Prevents motor damage resulting from high current generation by counter EMF of the armature at the time of reversing
 - Known as anti-plugging, hesitation, positive stop or positive off switch

Non-Illuminated AC Rated Pushbuttons

- One-hole panel mount
- Medium-duty
- Spade and screw terminations available
- Various bushing lengths and button extensions
- Numerous ampere ratings with horsepower ratings

Standards and Certifications

- UL Recognized
- CSA—File No. LR40068



Catalog Number Selection

Catalog Number Selection is for illustrative purposes only and not to be used to create new catalog numbers.

Toggle Switches—E10 Series



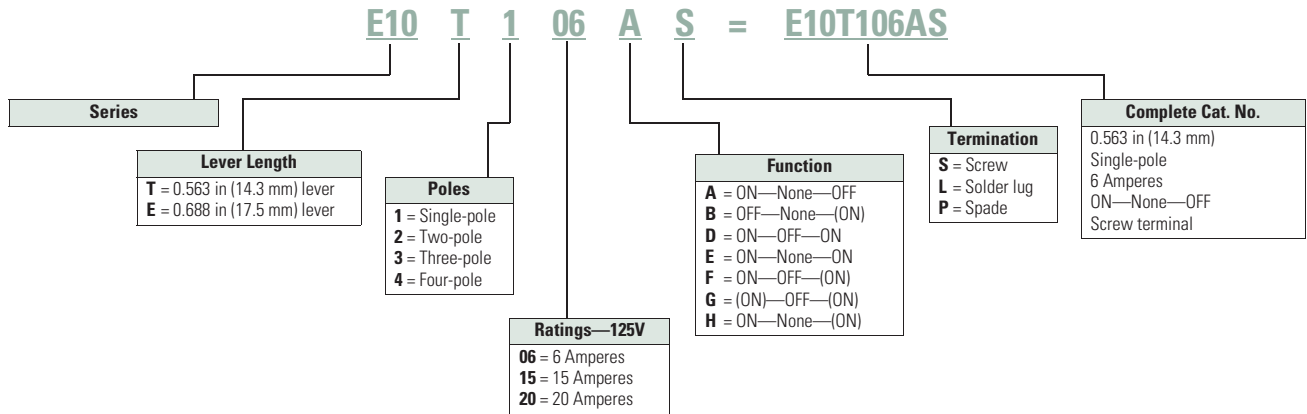

Not to be used for ordering purposes



Product Selection

Toggle Switches

E10 Series—AC Rated—Minimum Order Quantity 10 Pieces

	Nominal AC Ratings			Poles and Throw ①	Function—Circuit with Lever In			Screw Terminal Catalog Number	0.250 in (6.4 mm) Spade Terminal Catalog Number	Solder Lug Catalog Number
	Amperes 125V	hp 250V	hp 50V		UP Position	CENTER Position	DOWN Position—Keyway			
Single-Pole										
	Single-Pole									
	6	3	—	1 P.S.T.	ON	None	OFF	E10T106AS	E10T106AP	E10T106AL
	15	10	3/4					E10T115AS	E10T115AP	E10T115AL
	20	10	3/4					E10E120AS	E10E120AP	E10E120AL
	6	3	—	1 P.D.T.	ON	OFF	ON	E10T106DS	E10T106DP	—
	15	10	3/4					E10T115DS	E10T115DP	E10T115DL
	20	10	3/4					E10E120DS	—	—
	6	3	—	1 P.D.T.	ON	None	ON	E10T106ES	—	—
	15	10	3/4					E10T115ES	E10T115EP	E10T115EL
	20	10	3/4					E10E120ES	—	—
	—	10	1/2	1 P.S.T.	OFF	None	(ON)	E10T115BS	E10T115BP	—
				1 P.D.T.	ON	OFF	(ON)	E10T115FS	E10T115FP	—
				1 P.D.T.	ON	None	(ON)	E10T115HS	E10T115HP	—
			1 P.D.T.	(ON)	OFF	(ON)	E10T115GS	E10T115GP	—	
Two-Pole										
	Two-Pole									
	6	3	—	2 P.S.T.	ON	None	OFF	E10T206AS	E10T206AP	—
	15	10	3/4					E10T215AS	E10T215AP	E10T215AL
	20	10	3/4					E10E220AS	E10E220AP	E10E220AL
	6	3	—	2 P.D.T.	ON	OFF	ON	E10T206DS	E10T206DP	—
	15	10	3/4					E10T215DS	E10T215DP	E10T215DL
	20	10	3/4					E10E220DS	E10E220DP	—
	6	3	—	2 P.D.T.	ON	None	ON	E10T206ES	—	—
	15	10	3/4					E10T215ES	E10T215EP	E10T215EL
	20	10	3/4					E10E220ES	—	—
	15	10	1/2	2 P.S.T.	OFF	None	(ON)	E10T215BS	—	—
				2 P.D.T.	ON	None	(ON)	E10T215HS	E10T215HP	—
				2 P.D.T.	(ON)	OFF	(ON)	E10T215GS	E10T215GP	—
Three-Pole										
	Three-Pole									
	15	10	3/4	3 P.S.T.	ON	None	OFF	E10E315AS	E10E315AP	—
				3 P.D.T.	ON	OFF	ON	E10E315DS	E10E315DP	E10E315DL
			3 P.D.T.	ON	None	ON	E10E315ES	E10E315EP	E10E315EL	
Four-Pole										
	Four-Pole									
	15	10	3/4	4 P.S.T.	ON	None	OFF	E10E415AS	—	E10E415AL
				4 P.D.T.	ON	OFF	ON	E10E415DS	—	E10E415DL
			4 P.D.T.	ON	None	ON	E10E415ES	—	E10E415EL	

Note

① See Circuit Diagrams on Page V7-T1-6.

Hesitation Switches

Heavy-Duty Hesitation Switch



E10 Series—Special Purpose—Minimum Order Quantity 10 Pieces

Nominal Ratings				Function—Circuit with Lever In...					Poles and Throw ①	Screw Terminal Catalog Number
Amperes		hp		Operation	UP Position	CENTER Position	DOWN Position—Keyway			
28 Vdc	125 Vac	250 Vac	250 Vac							
15	15	10	3/4	Maintained	ON	OFF	ON	2 P.D.T.	E10E215SS	
								3 P.D.T.	E10E315SS	
								4 P.D.T.	E10E415SS	

Pushbuttons

One-Hole Mounted Medium-Duty, Mom. Contact



E10 Series—Minimum Order Quantity 10 Pieces

Nominal Ratings				Poles and Throw ①	Contacts	Bushing Length in (mm) Dim. "A"	Button Extension in (mm) Dim. "B"	Typical Maximum Operating Force	Screw Terminal Catalog Number	Spade Terminal 0.250 in (6.4 mm) Catalog Number	
Amperes		hp									
125 Vac	250 Vac	125–250V									
NO	NC	NO	NC								
6	—	3	—	—	1 P.S.T.	NO	0.69 (17.5) 0.34 (8.6)	0.53 (13.5) 0.25 (6.4)	0.9 lbs	E10P106RS E10P106JS	E10P106RP —
15	—	10	—	1/3	1 P.S.T.	NO	0.69 (17.5) 0.34 (8.6)	0.53 (13.5) 0.25 (6.4)	0.9 lbs	E10P115RS E10P115JS	E10P115RP —
15	10	10	5	1/4 ②	1 P.D.T.	NO, NC	0.69 (17.5)	0.53 (13.5)	1.0 lbs	E10P115LS	—

Accessories

Toggle Switches Accessories—Minimum Order Quantity 100 Pieces

Description	Material/Notes	Catalog Number
Hexagon locknut	Zinc-chromate treated steel	E10TA101
Knurled face nut	Zinc-chromate treated steel	E10TA102
Internal tooth lockwasher	Cadmium plated steel	E10TA103
Terminal screws	#6-32 x 3/16 in binding head	E10TA201
Spade terminal adapter—0.250 in (6.4 mm)	Assembles to screw terminals	E10TA202
ON-OFF indicating plate—vertical orientation	Burnished nickel finish steel	E10TA301
OFF-ON indicating plate—horizontal orientation	Burnished nickel finish steel	E10TA302

E10TA104

Flip-up guard for toggle switches **E10TA104**



E10TA105

Fixed shroud for toggle switches **E10TA105**



Notes

Interlock mechanism prevents operation of lever through the center position until pressure is momentarily relieved. Designed for control and protection of reversing motors.

① See Circuit Diagrams on **Page V7-T1-6**.

② Rated 1/4 hp at 125V, 1/2 hp at 250V.

Technical Data and Specifications

Toggle Switches

Description	Specification
AC ratings	6–20A, 125 Vac 3–10A, 250 Vac Max. 3/4 hp at 250 Vac
DC ratings	6–20A, 28 Vdc
Electrical life	6,000 cycles make/break at switch ampere rating
Operation	Slow make/slow break mechanism with butt action for AC and low voltage DC applications Maintained and momentary contacts
Poles/throws	1 through 4, single and double throw
Mounting	One hole with threaded 0.468 in-32 bushing and 0.068 x 0.035 in (1.7 x 0.9 mm) deep keyway that serves as anti-rotational feature
Lever lengths	0.563 in (14.3 mm) or 0.688 in (17.5 mm), bright nickel plated
Terminals	Screw, 0.250 in (6.4 mm) spade and solder lug

Hesitation Switches

Description	Specification
Operation	Slow make/slow break mechanism with butt action for AC and low voltage DC applications; maintained contacts; ideal for reversing motor applications; interlock mechanism prevents operation of lever through center position until manual pressure is momentarily relieved
AC ratings	15A, 125 Vac 10A, 250 Vac Max. 3/4 hp at 250 Vac
DC ratings	15A, 28 Vdc
Poles/throws	2, 3 and 4, double throw only
Mounting	Single-pole with threaded 0.468 in-32 bushing and 0.068 x 0.049 in (1.7 x 1.2 mm) deep keyway
Lever length	0.687 in (17.4 mm), stainless steel
Terminals	Screw

Pushbutton Actuators

Description	Specification
AC ratings	6–15A, 125 Vac (NO) 3–10A, 250 Vac (NO) Max. 1/3 hp at 125/250 Vac
Operation	Slow make/slow break mechanism Normally open contacts
Poles/throws	Single, single and double throw
Mounting	One hole with 0.468 in-32 threaded bushing and 0.068 x 0.035 in (1.7 x 0.9 mm) deep keyway Two bushing heights: 11/16 in (17.5 mm) and 11/32 in (8.7 mm)
Button extensions	17/32 in (13.5 mm) and 1/4 in (6.4 mm), bright nickel plated
Terminals	Screw

Circuit Diagrams

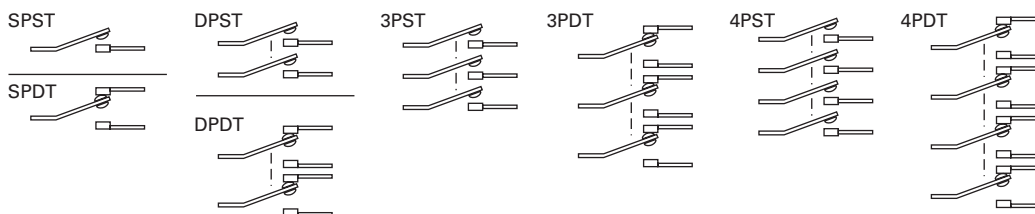

Dimensions

Approximate Dimensions in Inches (mm)

Toggle Switch Dimensions

No. of Poles	Operation	Bushing Length A	Lever Length B	Screw Terminals			Spade Terminals			Solder Lug		
				C	D	E	C ^①	D	E	C	D	E
1	Momentary and maintained	0.47 (11.9)	0.56 (14.2)	1.00 (25.4)	1.17 (29.7)	0.63 (16.0)	1.13 (28.7)	1.13 (28.7)	0.63 (16.0)	1.00 (25.4)	1.13 (28.7)	0.63 (16.0)
2	Maintained	0.47 (11.9)	0.56 (14.2)	1.06 (26.9)	1.31 (33.3)	0.75 (19.1)	1.19 (30.2)	1.31 (33.3)	0.75 (19.1)	1.06 (26.9)	1.31 (33.3)	0.75 (19.1)
	Momentary	0.47 (11.9)	0.56 (14.2)	1.25 (31.8)	1.31 (33.3)	0.75 (19.1)	1.31 (33.3)	1.31 (33.3)	0.75 (19.1)	1.25 (31.8)	1.31 (33.3)	0.75 (19.1)
3	Maintained	0.47 (11.9)	0.69 (17.5)	1.27 (32.3)	1.34 (34.0)	1.44 (36.6)	1.37 (34.8)	1.34 (34.0)	1.44 (36.6)	1.23 (31.2)	1.34 (34.0)	1.44 (36.6)
4	Maintained	0.47 (11.9)	0.69 (17.5)	1.20 (30.5)	1.30 (33.0)	1.40 (35.6)	1.30 (33.0)	1.34 (34.0)	1.40 (35.6)	1.23 (31.2)	1.34 (34.0)	1.44 (36.6)

Toggle Switch

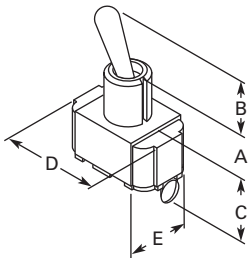

Hesitation Switch

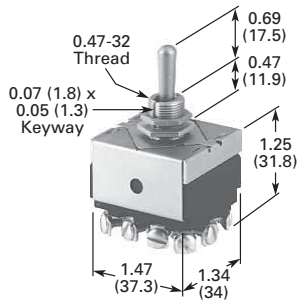

Pushbutton Actuator

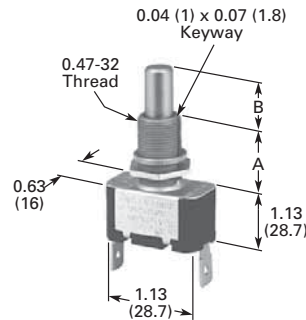

Accessories

E10TA101 Hexagon Locknut

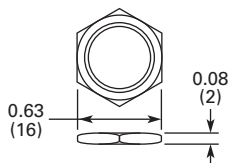

E10TA102 Knurled Face Nut

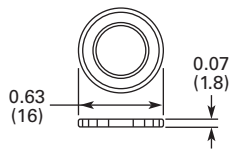

E10TA301 ON-OFF Indicating Plate—Vertical Orientation

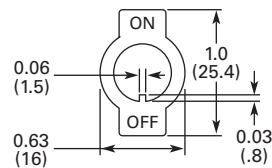

E10TA302 ON-OFF Indicating Plate—Horizontal Orientation



Note

① Spade terminal adapters are used on 6 ampere and momentary screw terminal switches, adding 0.42 in (10.7 mm) to dimension C.



Product Description

Designed for general purpose and OEM applications, this line of toggle switches provides a high IP68 rating for demanding environments.

Features

Molded-In Screw Terminal

- Completely sealed against dust, moisture and other contaminants
- One-hole mounted bushing for easy installation
- Multi-circuits offered
- Two- and three-position with maintained and momentary action
- Molded-in terminal inserts and terminals numbers
- Single- and two-pole circuitry

Econoswitch

- Environmentally sealed
- Single- and two-pole circuitry
- One-hole mounting for easy installation
- Multi-circuits
- Two- and three-position with maintained and momentary action
- Three types of termination offered as standard

Contents

Description

	<i>Page</i>
Environmentally Sealed Toggle Switches—E10E	
Product Selection	
Molded-In Screw Terminal	V7-T1-9
Econoswitch	V7-T1-9
Switch Guard	V7-T1-9
Technical Data and Specifications	V7-T1-10
Dimensions	V7-T1-11

Switch Guard

- For use with two-position switch
- Cover closure transfers switch toggle lever to OFF position
- One-hole mounted mounting style
- Cover is molded out of red thermoset molding material
- Guard cover is spring-loaded to either close or lock in open position
- Prevents accidental operation at switches

Options

Note: Contact your local Eaton Sales Representative for more information.

- Non-UL Recognized devices
 - Alternate toggle levers
 - Locking toggle levers
 - Rocker buttons
- Special mounting hardware
- Mounting hardware furnished assembled
- Terminal screws furnished assembled
- Special circuits
- Panel seal, part number 32-341
- Spade terminal adapters available

Standards and Certifications

- UL—File number E15346; Guide card number is WOYR2
- CSA—LR40068, class number 6241







UL and CSA Nominal Ratings

Catalog Number	125 Vac	250 Vac
Amperes		
E10E118xx	18	9
E10E218xx	18	9
Single-Phase hp		
E10E118xx	1/4	1/2
E10E218xx	1/2	1
Three-Phase hp		
E10E118xx	—	—
E10E218xx	—	—

Product Selection





Molded-In Screw Terminal

E10E Series—Molded-In Screw Terminal

	Nominal AC Ratings					Circuit with Lever Position			Catalog Number
	Amperes		Single-Phase hp		Three-Phase hp	Up	Center	Down (Keyway)	
	125V	250V	125V	250V	125/250V				
Single-Pole	Single-Pole								
	18	9	1/4	1/2	—	ON	OFF	ON	E10E118DM
						ON	NONE	OFF	E10E118AM
						ON	NONE	ON	E10E118EM
Two-Pole	Two-Pole								
	18	9	1/2	1	—	ON	OFF	ON	E10E218DM
						ON	NONE	OFF	E10E218AM
						ON	NONE	ON	E10E218EM

Econoswitch

E10E Series—Econoswitch

	Current Ratings—Amperes							Circuit with Lever Position			Screw Terminal Catalog Number	Solder Lug Terminal Catalog Number	Spade Terminal Catalog Number
	Type of Operation	28 Vdc			115 Vac, 60 or 400 Hz			Up	Center	Down (Keyway)			
		Lamp Load	Resistive Load	Inductive Load	Lamp Load	Resistive Load	Inductive Load						
Single-Pole	Single-Pole												
	Maintained	5	20	15	3	15	10	ON	OFF	ON	E10E118DS	E10E118DL	E10E118DP
	Maintained	5	20	15	3	15	10	ON	NONE	OFF	E10E118AS	E10E118AL	E10E118AP
	Maintained	5	20	15	3	15	10	ON	NONE	ON	E10E118ES	E10E118EL	E10E118EP
	Momentary	4	15	10	2	15	7	ON [Ⓢ]	OFF	ON [Ⓢ]	E10E118GS	E10E118GL	E10E118GP
	Momentary	4	15	10	2	15	7	OFF	NONE	ON [Ⓢ]	E10E118BS	E10E118BL	E10E118BP
Two-Pole	Two-Pole												
	Maintained	7	20	15	4	15	15	ON	OFF	ON	E10E218DS	E10E218DL	E10E218DP
	Maintained	7	20	15	4	15	15	ON	NONE	OFF	E10E218AS	E10E218AL	E10E218AP
	Maintained	7	20	15	4	15	15	ON	NONE	ON	E10E218ES	E10E218EL	E10E218EP
	Momentary	5	18	10	2	11	8	ON [Ⓢ]	OFF	ON [Ⓢ]	—	E10E218GL	E10E218GP
	Momentary	5	18	10	2	11	8	OFF	NONE	ON [Ⓢ]	E10E218BS	E10E218BL	E10E218BP

Switch Guard

Switch Guard

E10E Series—Switch Guard



	Catalog Number
Switch Guard	E10TA104

Note

Ⓢ Momentary contact.

Technical Data and Specifications**E10E Series—Molded-In Screw Terminal**

Description	Specification
Watertight seal	Per MIL-STD-108E and designed to meet IP68
Thermoset molding materials	Meet flame retardant requirements
Temperature range	–50° to 150°F (–46° to 66°C)
Life	20,000 operations at rated load; 40,000 operations mechanical life; 6,000 operations at hp ratings per UL and CSA requirements
Bushings	15/32 in-32 thread

E10E Series—Econoswitch

Description	Specification
Watertight seal	Per MIL-STD-108E and designed to meet IP68
Type of terminal	Screws—6-32 UNC-22A Solder lug—0.125 in (3.17 mm) dia. hole Spade—0.250 in (6.35 mm) x 0.032 in (0.81 mm) thick
Life	50,000 operations at rated load; 100,000 operations mechanical life
Temperature range	–50° to 150°F (–46° to 66°C)

Dimensions

Approximate Dimensions in Inches (mm)

Single-Pole Molded-In Screw Terminal E10E Series

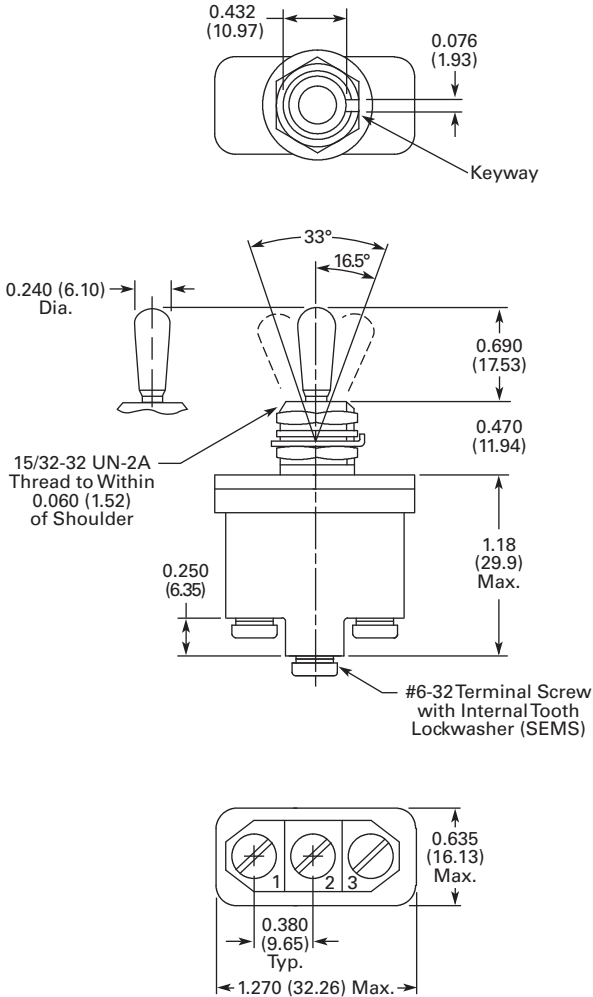

Two-Pole Molded-In Screw Terminal E10E Series

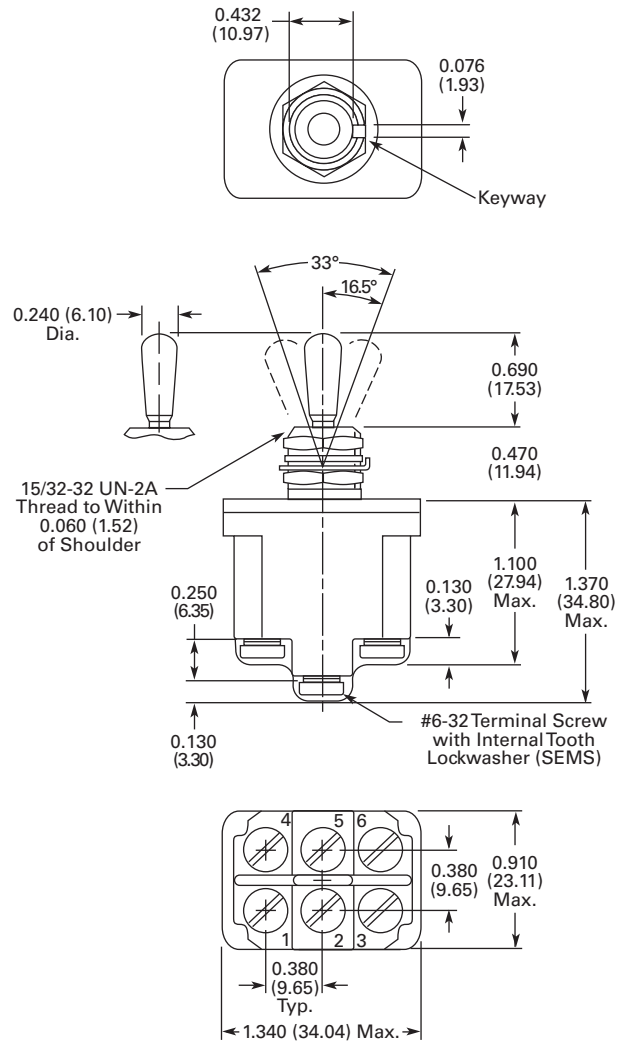

Toggle Switch Panel Cutout

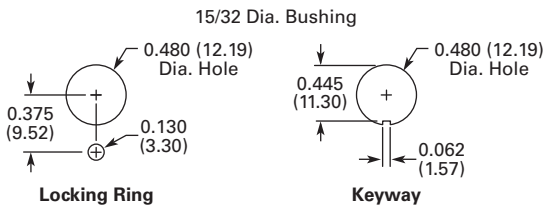

1.2

Pushbuttons and Indicating Lights

Environmentally Sealed Toggle Switches—E10E

1

Approximate Dimensions in Inches (mm)

Single-Pole Econoswitch E10E Series

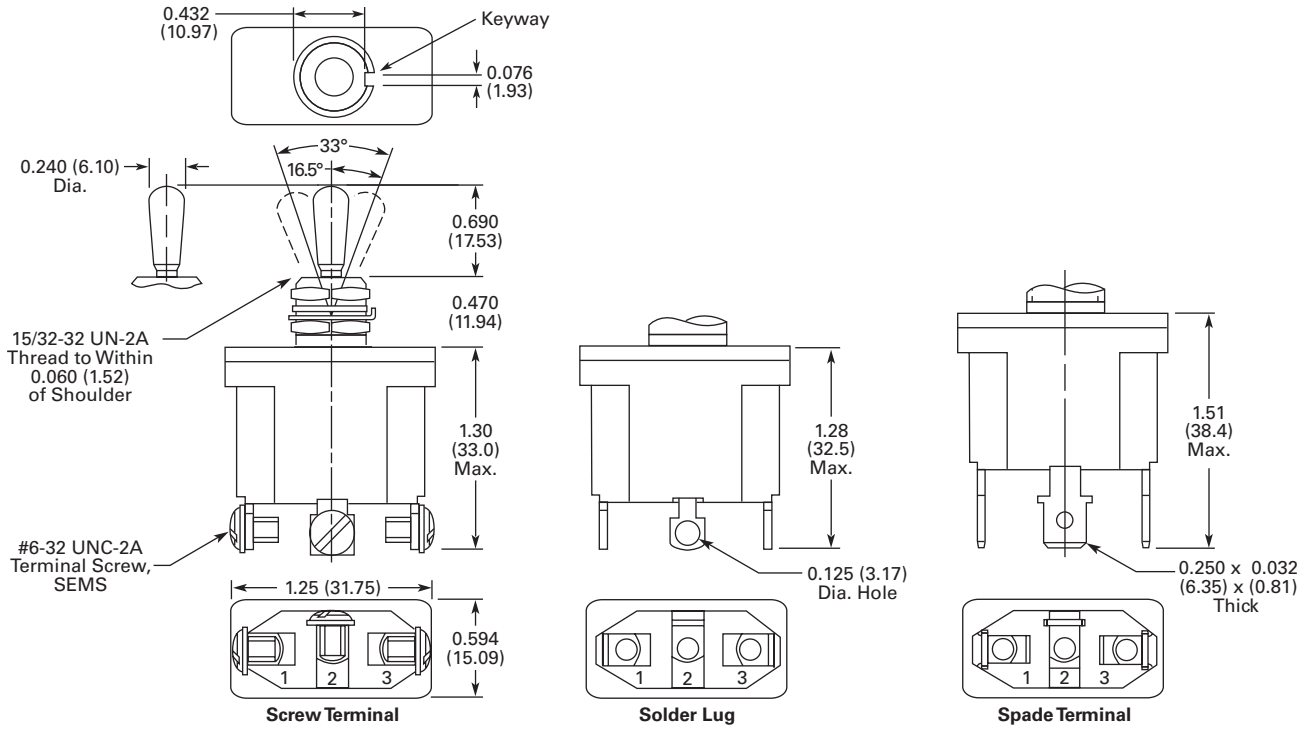

Two-Pole Econoswitch E10E Series

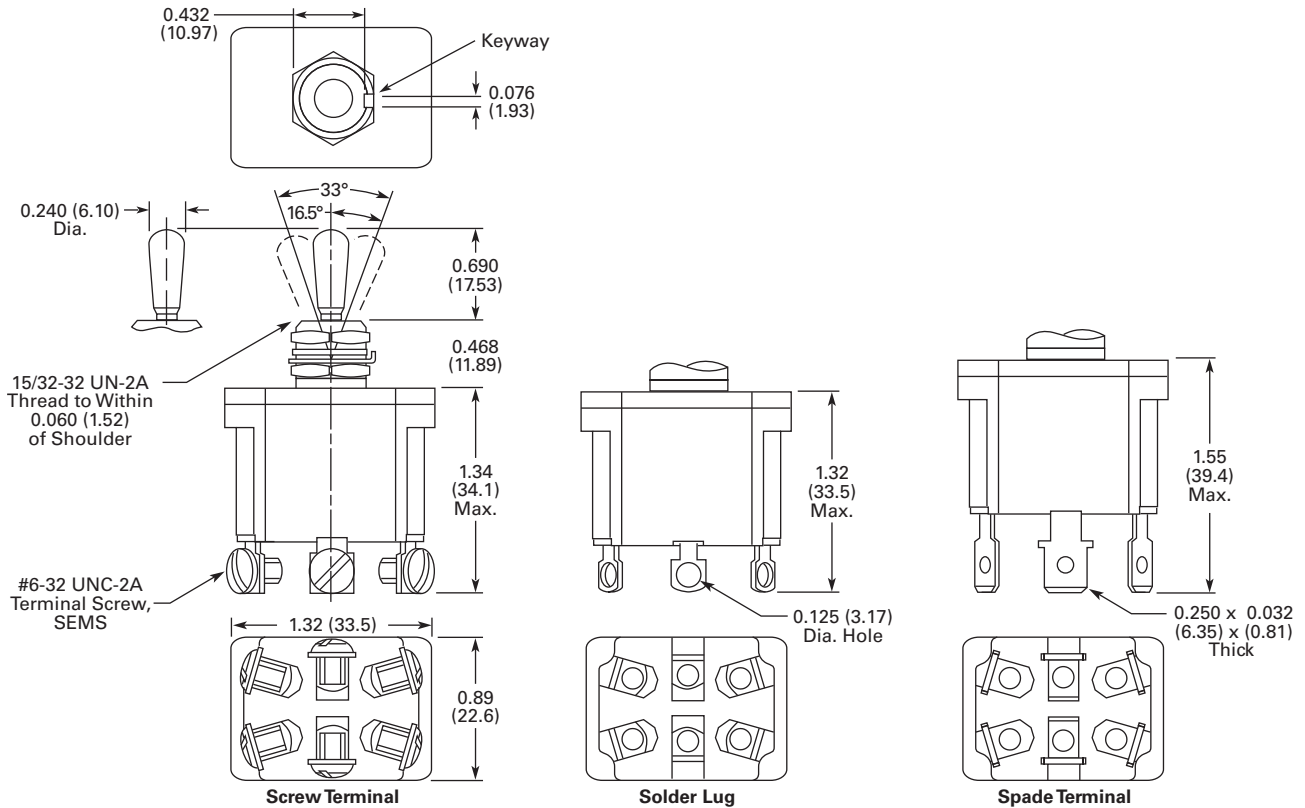

Approximate Dimensions in Inches (mm)

Switch Guard

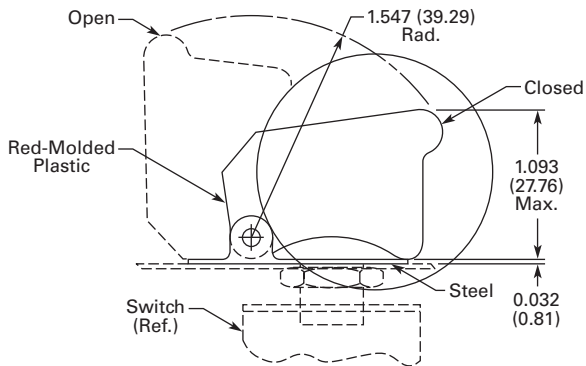
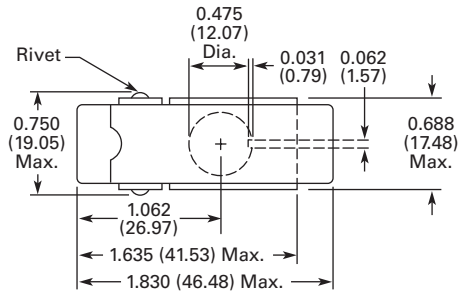
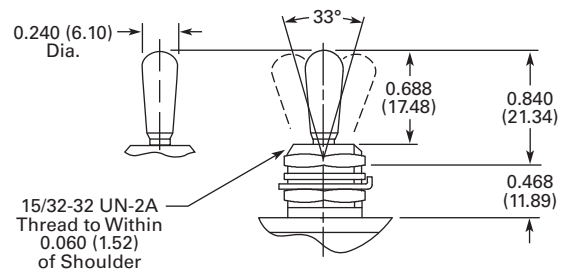

Pushbutton Control Stations



Contents

<i>Description</i>	<i>Page</i>
Pushbutton Control Stations—Assembled	
Features	V7-T1-15
Product Selection	
M22 Assembled Control Stations	V7-T1-16
Commercial Control Stations	V7-T1-17
General Purpose Control Stations	V7-T1-18
Special Purpose Control Stations	V7-T1-19
10250H Series Heavy-Duty Control Stations	V7-T1-20
10250T Series Heavy-Duty 30.5 mm Control Stations	V7-T1-21
Class I Division 2 10250T Series Heavy-Duty 30.5 mm Control Stations	V7-T1-22
Class I Division 2 E34 Series Corrosion Resistant 30.5 mm Control Stations	V7-T1-23
Accessories	V7-T1-23
Custom Assembled Stations	
Specification Form	V7-T1-24
Renewal Parts	V7-T1-26
Technical Data and Specifications	V7-T1-28
Dimensions	V7-T1-28

Product Description

M22 Assembled Control Stations

- M22 series operators
- Available in horizontal and vertical configurations
- Impact resistant polycarbonate enclosures
- Optional yellow covers
- Base mounting contact blocks and light units for quick wiring and vibration resistance

Commercial Control Stations

- 10250T series operators
- Full front label
- Specific function labels on front of enclosure

General Purpose Control Stations

- Construction grade
- General purpose wall mount
- Popular with contractors
- UL (NEMA) Type 1

Special Purpose Control Stations

- Standard grade
- Polyester enclosure
- UL (NEMA) Type 3, 3R, 4, 4X, 13

10250H Series Heavy-Duty Control Stations

- 10250H Series operators
- Dark brown polyester enclosure
- Protective rubber gaskets provide NEMA 3S rating on pushbuttons
- Top and bottom 3/4 in NPT conduit entrances
- Includes alternate legend plates and spare mounting screws

10250T Series Heavy-Duty 30.5 mm Control Stations

- 10250T Series operators
- ASA 61 gray die-cast zinc enclosures
- Surface or flush mounting
- Single 3/4 in NPT conduit entrance on one and two element stations
- Single 1 in NPT conduit entrance on three element stations

Class I Division 2 10250T Series Heavy-Duty 30.5 mm Control Stations

- 10250T Series operators
- Factory sealed contact blocks
- Die-cast, polyester or stainless steel enclosures
- Approved for NEC Class I Division 2, Groups B, C and D or Class I Zone 2 Group IIB plus Hydrogen type hazardous locations

Class I Division 2 E34 Series Corrosion Resistant 30.5 mm Control Stations

- E34 Series operators
- Factory sealed contact blocks
- Die-cast, polyester or stainless steel enclosures
- Approved for NEC Class I Division 2 Groups B, C and D or Class I Zone 2 Group IIB plus Hydrogen type hazardous locations

Features

M22 Assembled Control Stations

- IP66, UL (NEMA) Type 4X, 13
- Impact resistant polycarbonate enclosures
- Optional yellow cover
- 25% smaller depth than most competitor enclosures
- Base mounting contact blocks and light units for faster wiring and vibration resistance

Commercial Control Stations

- ASA 61 gray die-cast zinc enclosures
- Pre-assembled and labeled for functions such as “Fuel Shut-Off”
- Great for commercial applications

General Purpose Control Stations

- Construction grade
- General purpose wall mount
- Popular with contractors
- UL (NEMA) Type 1

Special Purpose Control Stations

- Standard grade
- Polyester enclosure
- UL (NEMA) Type 3, 3R, 4, 4X, 13

10250H Series Heavy-Duty Control Stations

- Industrial grade
- Extra heavy-duty
- Polyester enclosure
- Booted buttons
- Outdoor installation
- UL (NEMA) Type 3, 3R, 3S, 4, 4X, 12, 13

10250T Series Heavy-Duty 30.5 mm Control Stations

- 30.5 mm operators
- Industrial grade
- Zinc die cast enclosure
- Popular with industrial end users
- UL (NEMA) Type 4, 4X, 12, 13

Class I Division 2 Control Stations

- Available with 10250T or E34 30.5 mm operators
- Zinc die cast, polyester or stainless steel enclosures
- Factory-sealed contact blocks
- Popular with industrial end users
- UL (NEMA) Type 4, 4X, 12, 13
- NEC Class I Division 2 Groups B, C and D

Product Selection

M22 Assembled Control Stations



One Element Control Stations

Orientation	Description	Color	①	Inscription	Enclosure Cover Color	Catalog Number
Horizontal	40 mm mushroom head push-pull emergency stop operator	Red	NC	—	Yellow	M22-C1-M1H
Horizontal	40 mm illuminated mushroom head push-pull emergency stop operator, 85–264 Vac	Red	NO-NC	—	Yellow	M22-C1-M2H
Horizontal	40 mm mushroom head twist-to-release emergency stop operator	Red	NC	—	Yellow	M22-C1-M3H
Horizontal	40 mm mushroom head key-release emergency stop operator	Red	NC	—	Yellow	M22-C1-M4H
Horizontal	Flush pushbutton	Green	NO	①	Gray	M22-C1-M5H
Horizontal	Flush pushbutton	Green	NO	START	Gray	M22-C1-M6H
Horizontal	Extended pushbutton	Red	NC	Ⓢ	Gray	M22-C1-M7H
Horizontal	Extended pushbutton	Red	NC	STOP	Gray	M22-C1-M8H
Horizontal	Key-operated selector switch, two-position maintained	—	NO	OFF-ON	Gray	M22-C1-M9H
Horizontal	Knob type selector switch, three-position maintained	—	2NO	HAND 0 AUTO	Gray	M22-C1-M10H
Horizontal	Double pushbutton	Green	NO	START	Gray	M22-C1-M11H
		Red	NC	STOP		

Two Element Control Stations

Orientation	Element 1 Description	Color	①	Inscription	Element 2 Description	Color	①	Inscription	Enclosure Cover Color	Catalog Number
Horizontal	Extended pushbutton	Red	NC	Ⓢ	Flush pushbutton	Green	NO	①	Gray	M22-C2-M1H
Vertical	Flush pushbutton	Green	NO	START	Extended pushbutton	Red	NC	STOP	Gray	M22-C2-M2V
Vertical	Flush pushbutton	Black	NO	FORWARD	Flush pushbutton	Black	NO	REVERSE	Gray	M22-C2-M3V

Three Element Control Stations

Orientation	Element 1 Description	Color	①	Inscription	Element 2 Description	Color	①	Inscription	Element 3 Description	Color	①	Inscription	Enclosure Cover Color	Catalog Number
Horizontal	Extended pushbutton	Red	NC	Ⓢ	Indicating light	White	85–264 Vac	—	Flush pushbutton	Green	NO	①	Gray	M22-C3-M1H
Vertical	Indicating light	White	85–264 Vac	—	Flush pushbutton	Green	NO	START	Extended pushbutton	Red	NC	STOP	Gray	M22-C3-M2V
Horizontal	Flush pushbutton	Green	NO	①	Extended pushbutton	Red	NC	Ⓢ	Flush pushbutton	Green	NO	Ⓢ	Gray	M22-C3-M3H
Vertical	Flush pushbutton	Black	NO	OPEN	Extended pushbutton	Red	NC	STOP	Flush pushbutton	Black	NO	CLOSE	Gray	M22-C3-M4V
Vertical	Flush pushbutton	Black	NO	FORWARD	Flush pushbutton	Red	NC	STOP	Flush pushbutton	Black	NO	REVERSE	Gray	M22-C3-M5V
Vertical	Flush pushbutton	Black	NO	UP	Flush pushbutton	Red	NC	STOP	Flush pushbutton	Black	NO	DOWN	Gray	M22-C3-M6V

Notes

For assembled control stations not found in this selection, please contact the Eaton Technical Resource Center at 1-877-ETN CARE (386-2273) or TRC@eaton.com.

① Contact block configuration.

Commercial Control Stations



Key Specifications

- 30.5 mm (10250T series) operators
- ASA 61 gray die-cast zinc enclosures
- Industrial grade
- UL® Type 4, 4X, 12, 13
- Single 3/4 in NPT conduit entrance
- Dimensions—in (mm)
 - Enclosure: 3.88 W x 4.00 H x 3.00 D (98.6 x 101.6 x 76.3)
 - Operator: 1.63 D (to enclosure) x 1.50 diameter (41.4 x 38.1)

What is included?

Eaton’s pre-assembled, enclosed emergency stop pushbutton stations include an operator, an enclosure, contact blocks and a variety of unique labels. Each label has white lettering on a red background indicating the function and red lettering on a white background indicating the operator type.

Available Catalog Numbers

Catalog Number ①	Operator	Enclosure Color	Label
10250T5B62-S101	Push-Pull	Gray	EMERGENCY STOP
10250T5B62-S102	Push-Pull	Gray	EMERGENCY SHUT-OFF
10250T5B62-S103	Push-Pull	Gray	EMERGENCY GENERATOR STOP
10250T5B62-S104	Push-Pull	Gray	EMERGENCY HVAC SHUT-DOWN
10250T5B62-S105	Push-Pull	Gray	EMERGENCY ELECTRICAL DISCONNECT
10250T5B62-S106	Push-Pull	Gray	EMERGENCY BOILER SHUT-DOWN
10250T5B62-S107	Push-Pull	Gray	EMERGENCY CHILLER STOP
10250T5B62-S108	Push-Pull	Gray	EMERGENCY FUEL SHUT-OFF
10250T5B62-S109	Push-Pull	Gray	EMERGENCY REFRIGERATION STOP
10250T5B62-S110	Push-Pull	Gray	EMERGENCY POWER OFF
10250T5B62-S111	Push-Pull	Gray	EMERGENCY GAS SHUT-OFF
10250T5B62-S112	Push-Pull	Gray	EMERGENCY VENTILATION SHUT-DOWN
10250T5B62-S113	Push-Pull	Gray	GENERATOR

Additional Contact Blocks

(Sold Separately)

Catalog Number	Circuit Configuration
10250T51	1NC
10250T53	1NO
10250T1	NO-NC
10250T3	2NC
10250T2	2NO















Note

① Includes 1NO-1NC contact block.

1

General Purpose Control Stations

Type N Control Stations—UL (NEMA) Type 1



	Contact Symbol	Button Type/Color	Legends	Catalog Number
Single Button Station for Padlock Attachment ^① 	One Element Enclosure Type			
		Flush/green	START	10250H5100
		Flush/red	STOP	10250H5101
		Extended/red	STOP	10250H5104
		Palm operated/black	None	10250H89 ^②
Selector Switch 		Three-position selector switch/black knob	RUN/OFF/AUTO	10250H289 ^②
Two Button Station 	Two Element Enclosure Type			
		Flush/red	START/STOP	10250H5200
		Flush/green extended/red	START/STOP	10250H5207
		Flush/black (all)	RAISE/LOWER	10250H5201
			FOR/REV	10250H5202
			OPEN/CLOSE	10250H5203
			UP/DOWN	10250H5204
		HIGH/LOW	10250H5205	
	FAST/SLOW	10250H5208		
Three Button Station 	Three Element Enclosure Type			
		Flush/black (all)	FOR/REV/STOP	10250H5300
			UP/DOWN/STOP	10250H5301
			RAISE/LOWER/STOP	10250H5302
			OPEN/CLOSE/STOP	10250H5303
FAST/SLOW/STOP			10250H5304	
Three Button Station with Indicating Light 		110/220V neon indicating light	START/STOP	
		Clear—flush/green; flush/red		10250H5310
		Red—flush/green; flush/red		10250ED853
		Amber—flush/green; flush/red		10250ED853-2

Notes

① Padlock attachment (10250H5110) must be purchased separately.





② Round button.

Type N Control Stations—Open Type Construction (No Cover)

Contact Symbol	Button Type/Color	Legends	Catalog Number
Selector Switch			
One Element Enclosure Type			
	Three-position selector switch/black knob	RUN/OFF/AUTO	10250H2538
Two Button Station			
Two Element Enclosure Type			
	Flush/green	START/STOP	10250H2747
	Flush/black (all) mech. interlocked	None ①	10250H2544

Special Purpose Control Stations

Special Purpose Control Stations—UL (NEMA) Type 3, 3R, 4, 4X, 13



Contact Symbol	Feature	Legends	Catalog Number
10250H_			
One Element Pushbutton Type			
	Flush	START	10250H2738
		STOP	10250H658
	With lock hasp	STOP	10250H665
10250H_			
Two Element Pushbutton Type			
	Flush	START/STOP	10250H364
	With lock hasp	START/STOP	10250H671
	Buttons interlocked	FAST/SLOW	10250ED664
		FOR/REV	10250H2740
		UP/DOWN	10250H2741
		OPEN/CLOSE	10250H2742

Note

① No legend on buttons. Specify any standard legend.





10250H Series Heavy-Duty Control Stations

Type H Control Stations—UL (NEMA) Type 3, 3S, 4, 4X, 12, 13

Element Type	Feature	Circuit	Assembled Legend Plate	Unassembled Alternate Legend Plate	Catalog Number	
10250H_ One Element						
	Pushbuttons	Without padlock hasp	1NO-1NC	JOG	START STOP RUN	10250H1881
		With padlock hasp	1NC	STOP	—	10250H4239
Knob selector switch	Two-position	1NO-1NC	OFF/ON	—	10250H4526	
	Three-position	1NO-1NC	MAN/OFF/AUTO	—	10250H4527	
10250H_ Two Element						
	Pushbuttons	Standard	1NO-2NC	START/STOP	—	10250H1884
			2NO-2NC	RAISE/LOWER	FORWARD REVERSE OPEN CLOSE	10250H1885
		Standard and standard with padlock hasp	1NO-2NC	START/STOP	—	10250H4240
10250H_ Three Element						
	Pushbuttons	Standard	2NO-3NC	FOR/REV/STOP	START OPEN	10250H1890
		Two standard and standard with padlock hasp			JOG CLOSE RAISE FAST LOWER SLOW	10250H4241
Indicating light and pushbuttons	120V	Light-red lens and two plain	1NO-2NC	MOTOR RUNNING START/STOP	—	10250H1913

10250T Series Heavy-Duty 30.5 mm Control Stations

Complete Assembled Stations—UL (NEMA) Type 4, 4X, 12, 13

Element Type ^①	Features	Contact Block(s)	Legend	Surface Mounting Catalog Number	Flush Mounting ^② Catalog Number		
Break Glass Station							
	Break glass station ^③	Gray enclosure	NC (logic level)	EMERG. OFF	10250TGS	—	
		Red enclosure			10250TGR	—	
One Element							
	Pushbutton	Standard	NO-NC	START	10250T3516	10250T3573	
			NC	STOP	10250T3518	10250T3575	
			NO-NC	None		10250T3540	10250T3597
		Mushroom head	NO-NC	START	10250T3517	10250T3574	
		NC	STOP	10250T3519	10250T3576		
		With lock hasp ^④	NC	STOP	10250T3520	10250T3577	
	Selector switch	Two-position black knob	NO-NC	OFF/ON	10250T3523	10250T3580	
		Three-position black knob	2NO	MAN/OFF/AUTO	10250T3524	10250T3581	
Push-pull three-position	Momentary red button	2NC	START/STOP	10250T3545	10250T3602		
Two Element							
	Pushbuttons	Standard	1NO-2NC	START/STOP	10250T3525	10250T3582	
			2NO-2NC	RAISE/LOWER	10250T3672	10250T3673	
			2NO-2NC	None		10250T3541	10250T3598
		With lock hasp ^④	1NO-2NC	START/STOP	10250T3542	10250T3599	
		Standard and mushroom head	1NO-2NC	START/STOP	10250T3526	10250T3583	
		Standard with maintained contact ^⑤	NO-NC Plus NC	START/STOP	10250T3528	10250T3585	
Three Element							
	Pushbuttons	Standard	2NO-3NC	FOR, REV, STOP	10250T3532	10250T3589	
			2NO-3NC	UP, DOWN, STOP	10250T3615	—	
			2NO-3NC	OPEN, CLOSE, STOP	10250T3614	—	
			2NO-3NC	None, None, STOP	10250T3543	10250T3600	
		Two standard and with lock hasp	2NO-3NC	None, None, STOP	10250T3544	10250T3601	
	Indicating light (transformer type) and pushbuttons	Red lens — 120V	1NO-2NC	MOTOR RUN, START/STOP	10250T3536	10250T3593	
		Red lens — 240V			10250T3537	10250T3594	
		Red lens — 480V			10250T3538	10250T3595	
Red lens — 600V				10250T3539	10250T3596		

Break Glass Operator ^⑥



Break Glass Kit











Description	Catalog Number
Operator with hammer and five glass discs	10250TBG
Glass discs only (5)	10250TGL

Notes

- ① Stop buttons are red—all others are black.
- ② NEMA 4–13, if properly mounted on a flat surface. Consists of front plate, legend, operator and contact blocks.
- ③ Break glass stations will not function with Normally Open contact blocks.
- ④ Lock is 10250TA2.
- ⑤ Uses deep cover instead of shallow cover. Switch component is 10250TA67—mechanically interlocked operators.
- ⑥ Shown assembled to contact block (contact block supplied separately).

Class I Division 2 10250T Series Heavy-Duty 30.5 mm Control Stations

Complete Assembled Stations— UL (NEMA) Type 4, 4X, 12, 13; NEC Class I Division 2, Groups B, C and D







Contact Symbol	Button Type/Color	Legend Marking	Die Cast Enclosure Catalog Number	Polyester Molded Enclosure Catalog Number	Stainless Steel Enclosure Catalog Number
10250T7007					
Single Pushbutton					
	Flush/green	START	10250T7003	10250T7003P	10250T7003S
	Extended/red	STOP	10250T7005	10250T7005P	10250T7005S
	Alum. jumbo mushroom/red	EMER. STOP (engraved button)	10250T7007	10250T7007P	10250T7007S
	Flush/black	No legend	10250T7009	10250T7009P	10250T7009S
10250T7023P					
Two Pushbuttons					
	Flush/green	START	10250T7023	10250T7023P	10250T7023S
	Extended/red	STOP			
Each Button	Flush/black	No legend	10250T7025	10250T7025P	10250T7025S
	Flush/black	No legend			
10250T7033S					
Single Pilot Light—Two Pushbuttons					
	120 Vac red	No legend	10250T7033	10250T7033P	10250T7033S
	Flush/green	START			
	Extended/red	STOP			
Each Button	120 Vac red	No legend	10250T7035	10250T7035P	10250T7035S
	Flush/black				
	Flush/black				
Three-Position Selector Switch					
	Maintained knob/black	HAND/OFF/AUTO	10250T7011	10250T7011P	10250T7011S
	Maintained knob/black	No legend	10250T7013	10250T7013P	10250T7013S
Single Pushbutton Maintained					
	Push-pull with jumbo mushroom/red	EMER. STOP (engraved button)	10250T7019	10250T7019P	10250T7019S
Pull	O	X			
Push	X	O			

Class I Division 2 E34 Series Corrosion Resistant 30.5 mm Control Stations

E34EX_



Complete Assembled Stations— UL (NEMA) Type 4, 4X, 12, 13; NEC Class I Division 2, Groups B, C and D

Contact Symbol	Button Type/Color	Legend Marking	Die Cast Enclosure Catalog Number	Polyester Molded Enclosure Catalog Number	Stainless Steel Enclosure Catalog Number
Single Pushbutton					
 1NO	Flush/green	START	E34EX7003	E34EX7003P	E34EX7003S
 1NC	Extended/red	STOP	E34EX7005	E34EX7005P	E34EX7005S
	Alum. jumbo mushroom/red	EMER. STOP (engraved button)	E34EX7007	E34EX7007P	E34EX7007S
	Flush/black	No legend	E34EX7009	E34EX7009P	E34EX7009S
Two Pushbuttons					
 1NO	Flush/green	START	E34EX7023	E34EX7023P	E34EX7023S
 1NC	Extended/red	STOP			
Each Button	Flush/black	No legend	E34EX7025	E34EX7025P	E34EX7025S
	Flush/black	No legend			
Three-Position Selector Switch					
 2NO	Maintained knob/black	HAND/OFF/AUTO	E34EX7011	E34EX7011P	E34EX7011S
 2NC	Maintained knob/black	No legend	E34EX7013	E34EX7013P	E34EX7013S
Single Pushbutton Maintained					
 Pull Push O X 1NO X O 1NC	Push-pull with jumbo mushroom/red	EMER. STOP (engraved button)	E34EX7019	E34EX7019P	E34EX7019S

Accessories

Padlock Attachment



Type N Control Stations

Description	Catalog Number
Padlock attachment—For field assembly on square button type (except extended button types)	10250H5110

Note

Use NEMA 4X 10250T operators where exposed to ultraviolet light, see [Page V7-T1-22](#).

1 Custom Assembled Stations Specification Form

Ordering Instructions

Step 1

Copy this ordering guide from catalog.

Step 2

Specify 10250T or E34 pushbutton lines in the corresponding box on the following page.

10250T	Pages V7-T1-219 to V7-T1-289
E34	Pages V7-T1-290 to V7-T1-331
10250T and E34 Class I Div. 2	Pages V7-T1-357 to V7-T1-397

Step 3

Check back of panel dimensions—specify single or double depth enclosure in the corresponding box on the following page.

Step 4

Specify enclosure catalog number and price in the corresponding box on the following page. Enclosures can be found on **Pages V7-T1-116, V7-T1-269** and **V7-T1-319**. For pricing, reference the most recent PAD or VISTA-line.

Step 5

Specify catalog numbers for desired operator, legend plate, light unit, accessory and contact block(s) for each location in the enclosure in the corresponding box on the following page. (See position locations on this page.)

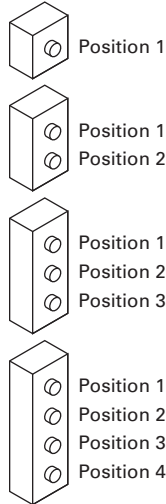

Position Locations

Step 6

For non-standard legends, specify legend desired, letter size and location on the layout sketches on the following page. For limitations see **Page V7-T1-268**. For pricing, use the blank legend catalog number and "STAMP" Suffix (Ex.: **10250TS36STAMP**) and reference the most recent PAD or VISTA-line.

Example: 10250TS36

Special Legend for Position # _____

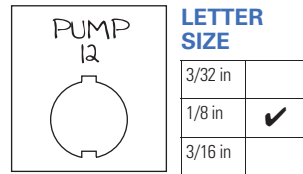

Step 7

Fax Sheet 2 of this form to Eaton's TRC, Technical Resource Center, at 828-651-0549 to the attention of—**Custom Stations Order** or email to TRC@eaton.com.

Within a few days you will receive a confirmation fax with the custom station part number and price.

Step 8

Place your order over the VISTA System.

For Selector and Roto-Push Operators

10250T or E34

For single contact blocks or 1NO-1NC contact blocks, the mounting position of contacts must be specified. For example: If a 1NO-1NC contact block is required, specify if NO is to be mounted in Top A position or Bottom B position.



To — **Eaton's TRC, Custom Station Order**
(828) 651-0549 FAX, or email to TRC@eaton.com

FACTORY USE ONLY	
Part Number	
Product Code	
Suffix	
Date	
Engineer	

From — Customer Name _____
 Customer Contact _____
 Phone Number _____
 Fax Number _____
 Email Address _____

Step 2)

10250T **STD** **Class I Division 2**
E34 **STD** **Class I Division 2**

Step 3) ✓

Single Depth Enclosure	
Double Depth Enclosure	

Step 4)

Enclosure Catalog Number	Price

Step 5)

Position	Operator	Price U.S. \$	Light Unit	Price U.S. \$	Contact Block	Price U.S. \$	A/L	B/R	Contact Block	Price U.S. \$	A/L	B/R	Total Price
1													
2													
3													
4													

Position	Legend Plate	Price U.S. \$	Lens or Caps	Price U.S. \$	Accessory	Price U.S. \$	Total Price
1							
2							
3							
4							

Total:

--

**10% Adder
for Assembled Stations**

Step 6) Non-standard Legends

Special Legend for Position # _____

Special Legend for Position # _____

Special Legend for Position # _____

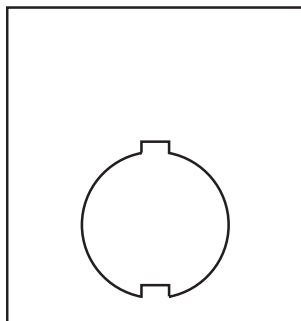

LETTER SIZE ✓

3/32 inch (2.4 mm)	
1/8 inch (3.2 mm)	
3/16 inch (4.8 mm)	

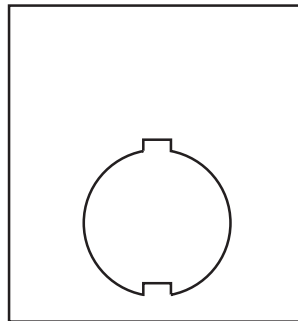

LETTER SIZE ✓

3/32 inch (2.4 mm)	
1/8 inch (3.2 mm)	
3/16 inch (4.8 mm)	

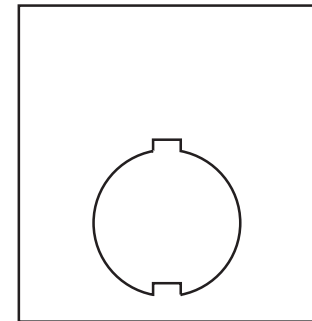

LETTER SIZE ✓

3/32 inch (2.4 mm)	
1/8 inch (3.2 mm)	
3/16 inch (4.8 mm)	

1.3

Pushbuttons and Indicating Lights

Pushbutton Control Stations—Assembled

1

Renewal Parts

Type N Renewal Parts

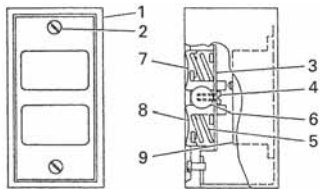

One and Two Element Station

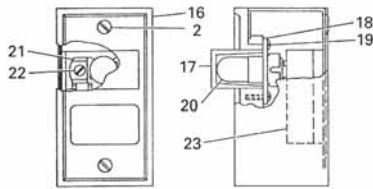

One Element Indicating Light

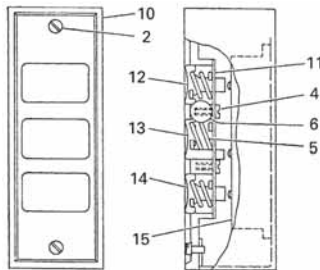

Three Element Station

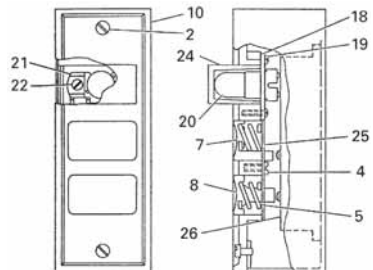

Two Element Station with Indicating Light



Open Type Two Element

Assembled Stations—Type N

Item No.	Description	No. Req.	Part Number
Type N—Square Buttons			
1	Cover	1	
	Two element		49-3524
	One element—top button		49-3524-2
	One element—bottom button		49-3524-3
2	Cover screw	2	11-2168
3	Pushbutton support bracket	1	79-6649
4	Pushbutton support bracket screw	1	11-2090
5	Pushbutton spring	2	69-2571
6	Disc (when used—two element assembly)	2	16-1960
7	Pushbutton—top position	1	
	START/green		53-1169-3
	RAISE/black		53-1169-66
	FORWARD/black		53-1169-7
	OPEN/black		53-1169-9
	UP/blank		53-1169-11
	Blank/green		53-1169
8	Pushbutton—bottom position	1	
	STOP/red		53-1202-2
	Extended STOP/red		53-1202-5
	REVERSE/black		53-1169-8
	CLOSE/black		53-1169-10
	DOWN/black		53-1169-12
	LOWER/black		53-1169-6
	Blank/red		53-1202

Item No.	Description	No. Req.	Part Number
Type N—Square Buttons, continued			
9	Pushbutton element	1	
	1NO-1NC		86-2588
	2NO		86-2588-2
	1NO		86-2588-3
	1NC		86-2588-4
10	Cover	1	49-3464
11	Pushbutton support bracket	1	79-6650
12	Pushbutton—top position	1	
	FORWARD/black		53-1170-7
	UP/black		53-1170-4
	RAISE/black		53-1170-5
	OPEN/black		53-1170-9
	FAST/black		53-1170-6
13	Pushbutton middle position	1	
	REVERSE/black		53-1169-15
	DOWN/black		53-1169-18
	LOWER/black		53-1169-16
	CLOSE/black		53-1169-17
	SLOW/black		53-1169-13
14	Pushbutton—bottom position	1	
	STOP/red		53-1201-2
15	Pushbutton element	1	
	2NO-3NC		86-2593
16	Cover	1	49-3524-4

Assembled Stations—Type N, continued

Item No.	Description	No. Req.	Part Number
Type N—Square Buttons, continued			
17	Lens	1	
	Clear		28-494
	Red		28-887-2
	Amber		28-887-3
18	Shield	1	73-1337
19	Shield screws	4	11-2012
20	Lamp (neon NE48)	1	28-494
21	Lamp receptacle	1	28-902
22	Lamp receptacle screw	1	911-330F1
23	Pilot light terminal base	1	86-2586
24	Lens	1	
	Clear		28-887
	Red		28-887-2
	Amber		28-887-3
25	Pushbutton support bracket	1	79-6650-2
26	Pushbutton element	1	
	1NO-1NC		86-2594

Item No.	Description	No. Req.	Part Number
Type N—Round Buttons			
Similar to 27	Pushbutton assembly and element for:		
	10250H289	1	10250H2538
	10250H364	1	86-353
	10250H685	1	86-353-8
	10250H665	1	86-353-8
	10250H671	1	86-353
	10250H2738	1	86-353-3
	10250H2740	1	86-356
	10250H2741	1	86-356
	10250H2742	1	86-356

Type H Renewal Parts

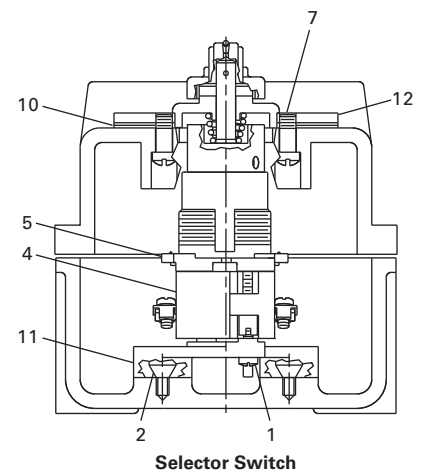
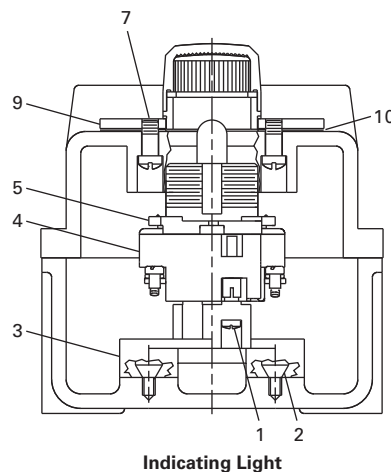
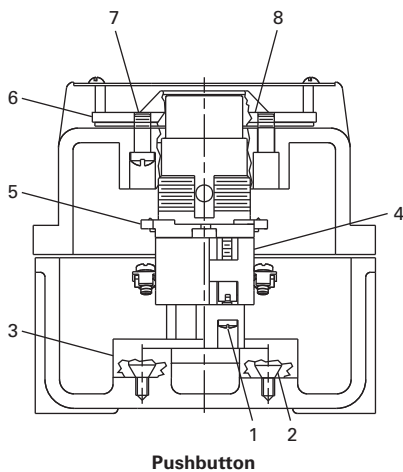

Assembled Stations—Type H

Item No.	Description	No. Req.	Part Number
Type H—Assembled Stations			
1	Screw	2	11-4654
2	Screw	2	11-5719
3	Base	1	17-16560
4	Contact blocks	See Page V7-T1-271	
5	10250T operator	See Pages V7-T1-225 to V7-T1-261	
6	Mounting plate	1	17-19524

Item No.	Description	No. Req.	Part Number
Type H—Assembled Stations			
7	Screw	4	11-953
8	Diaphragm	1	32-253-2
9	Mounting plate	1	17-19522
10	Gasket	1	32-254
11	Base	1	17-16561
12	Mounting plate	1	17-19523

Technical Data and Specifications

Ratings

Maximum Ampere Ratings for Type N Control Stations

Description	Volts AC				Volts DC		
	110	220	440	550	120	240	600
Make and emergency interrupt capacity	30	15	7.5	6	1.0	0.5	0.1
Normal load break	3	1.5	0.75	0.6	1.0	0.5	0.1
Continuous current	10	10	10	10	10	10	10

Maximum Ampere Ratings for Type H Control Stations

Description	Volts AC 50/60 Hz				Volts DC	
	120	240	480	600	125	250
Make and emergency interrupt capacity	60	30	15	12	1.1	0.55
Normal load break	6	3	1.5	1.2	1.1	0.55
Continuous amperes	10	10	10	10	10	10
Voltamperes —						
Make and emergency interrupt capacity	7200	7200	7200	7200	138	138
Normal load break	720	720	720	720	138	138

Dimensions

Approximate Dimensions in Inches (mm)

Type N Control Stations

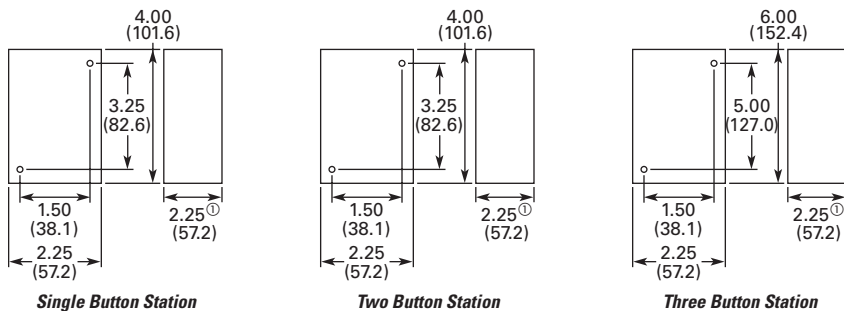

Special Purpose Control Stations

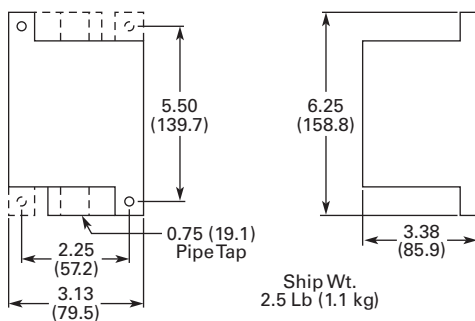

Note

⊙ 2.38 (60.5) for neon indicating light.

Approximate Dimensions in Inches (mm)

Type H Control Stations

NEMA Type 3, 3R, 3S, 4, 4X, 13

No. of Elements	Dimensions		
	Wide	High	Deep
1 and 2	4.50 (114.3)	8.25 (209.6)	4.50 (114.3)
3	4.50 (114.3)	10.75 (273.1)	4.25 (108.0)

10250T and E34

Approximate Enclosure Dimensions

Number of Elements	Surface Mounting Dimensions in In (mm)			Mounting D	E	Conduit Entrance
	Wide A	High B	Deep C			
Cast						
1	3.88 (98.6)	4.00 (101.6)	3.00 (76.3)	2.69 (68.3)	3.25 (82.6)	3/4
2	3.88 (98.6)	5.88 (149.4)	3.00 (76.3)	2.69 (68.3)	5.13 (130.3)	3/4
3	3.88 (98.6)	7.75 (196.9)	3.00 (76.3)	2.69 (68.3)	7.00 (177.8)	1
4	33.88 (98.6)	9.63 (244.6)	3.00 (76.3)	2.69 (68.3)	8.88 (225.6)	1
Polyester						
1	3.81 (96.8)	6.63 (168.4)	3.38 (85.9)	2.94 (74.7)	4.88 (124.0)	①
2	3.81 (96.8)	6.63 (168.4)	3.38 (85.9)	2.94 (74.7)	4.88 (124.0)	①
3	3.81 (96.8)	8.88 (225.6)	3.38 (85.9)	2.94 (74.7)	7.13 (181.1)	①
4	3.81 (96.8)	6.63 (168.4)	3.38 (85.9)	2.94 (74.7)	4.88 (124.0)	①
Stainless Steel						
1	3.00 (76.2)	3.50 (88.9)	3.00 (76.2)	1.50 (38.1)	4.25 (108.0)	①
2	3.50 (88.9)	6.75 (171.5)	3.00 (76.2)	1.50 (38.1)	7.50 (190.5)	①
3	3.50 (88.9)	9.00 (228.6)	3.00 (76.2)	1.50 (38.1)	9.00 (228.6)	①
4	3.50 (88.9)	11.25 (285.8)	3.00 (76.2)	1.50 (38.1)	12.00 (304.8)	①

Note

① No conduit entrance holes provided. Drill as required.

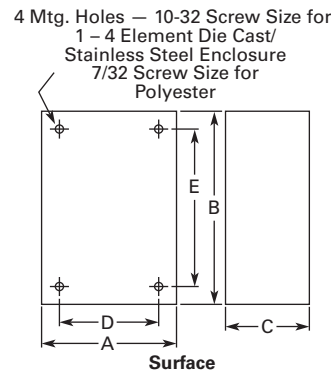

16.2 mm Pushbuttons—RMQ-16



Contents

<i>Description</i>	<i>Page</i>
16.2 mm Pushbuttons—RMQ-16	
Product Selection Guide	V7-T1-31
Pushbuttons—Non-Illuminated and Illuminated	V7-T1-32
Indicating Lights	V7-T1-34
Emergency Stops	V7-T1-35
Selector Switches—Non-Illuminated, Illuminated and Keyed	V7-T1-36
Accessories	V7-T1-40
Technical Data and Specifications	V7-T1-43
Dimensions	V7-T1-45

Product Overview

Product Description

The RMQ-16 pushbutton line offers a wide array of functional and attractively designed illuminated and non-illuminated pushbuttons, selector switches, emergency stops and indicating lights. The illuminated line is offered with either incandescent or LED. RMQ-16 devices are designed with two front-of-panel operator sizes. The 18 x 18 mm or 25 x 25 mm square operators can help the user achieve over three times the information density compared with 22 mm ranges.

Features

- *Wide product breadth:* RMQ-16 offers illuminated and non-illuminated pushbuttons, keyed, non-keyed, and illuminated selector switches, emergency stops, and a large variety of accessories
- *Custom laser etching:* Hundreds of standard markings available in addition to infinite possible custom images with laser etching
- *High durability:* Pushbuttons and selector switches rated for 3 million mechanical operations
- *High information density:* Square operators (18 mm or 25 mm) allow for side-by-side mounting and achieve over three times the information density of typical 22 mm installations

Standards and Certifications

- UL Listed
- CSA Certified
- IEC/EN 60947-5 VDE-0660
- IP65



Product Selection Guide

Pushbuttons



Description	Non-Illuminated	Illuminated
Product Selection	Page V7-T1-32	Page V7-T1-33

Indicating Lights



Description	Flush	Extended
Product Selection	Page V7-T1-34	Page V7-T1-34

Emergency Stops



Description	Non-Illuminated	Illuminated
Product Selection	Page V7-T1-35	Page V7-T1-35

Selector Switches



Description	Non-Illuminated	Illuminated	Keyed
Product Selection	Page V7-T1-36	Page V7-T1-37	Page V7-T1-38

1.4

Pushbuttons and Indicating Lights

16.2 mm Pushbuttons—RMQ-16

1 Pushbuttons—Non-Illuminated and Illuminated

Catalog Number Selection

Catalog Number Selection is for illustrative purposes only and not to be used to create new catalog numbers.

Pushbuttons—Non-Illuminated and Illuminated

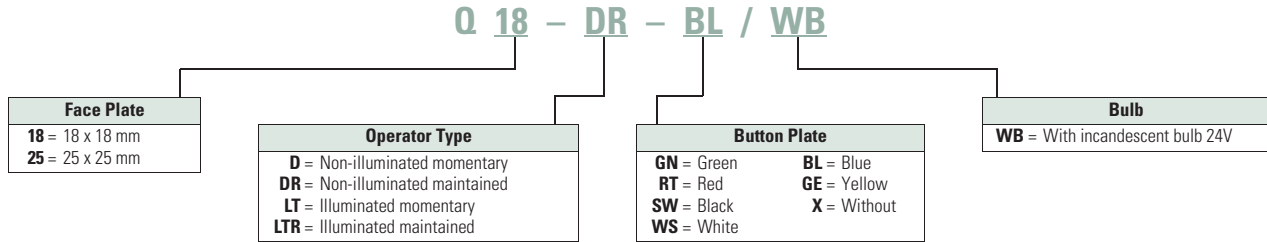

Product Selection

Non-Illuminated Pushbuttons

- Momentary or maintained
- Customizable laser etched pushbutton operators
- 18 mm or 25 mm square operator
- 3 million mechanical operations
- IEC/EN 60947-5
- IP65

Q18-D-GN



Non-Illuminated Pushbuttons

Type	Button Color	Catalog Number	
		18 x 18 mm	25 x 25 mm
Momentary	Green	Q18D-GN	Q25D-GN
	Red	Q18D-RT	Q25D-RT
	Black	Q18D-SW	Q25D-SW
	White	Q18D-WS	Q25D-WS
	Blue	Q18D-BL	Q25D-BL
	Yellow	Q18D-GE	Q25D-GE
	Without	Q18D-X ①	Q25D-X ①
Maintained	Green	Q18DR-GN	Q25DR-GN
	Red	Q18DR-RT	Q25DR-RT
	Black	Q18DR-SW	Q25DR-SW
	White	Q18DR-WS	Q25DR-WS
	Blue	Q18DR-BL	Q25DR-BL
	Yellow	Q18DR-GE	Q25DR-GE
	Without	Q18DR-X ①	Q25DR-X ①

Note

① To order separate button plates, see Page V7-T1-42.

Illuminated Pushbuttons

- Momentary or maintained
- LED or incandescent
- 18 mm or 25 mm square operator
- 3 million mechanical operations
- IEC/EN 60947-5
- IP65

Q18-LT-GE



Illuminated Pushbuttons Without Bulb ^①

Type	Button Color	Catalog Number ^②	
		18 x 18 mm	25 x 25 mm
Momentary	Green	Q18LT-GN	Q25LT-GN
	Red	Q18LT-RT	Q25LT-RT
	Black	Q18LT-SW	Q25LT-SW
	White	Q18LT-WS	Q25LT-WS
	Blue	Q18LT-BL	Q25LT-BL
	Yellow	Q18LT-GE	Q25LT-GE
Maintained	Green	Q18LTR-GN	Q25LTR-GN
	Red	Q18LTR-RT	Q25LTR-RT
	Black	Q18LTR-SW	Q25LTR-SW
	White	Q18LTR-WS	Q25LTR-WS
	Blue	Q18LTR-BL	Q25LTR-BL
	Yellow	Q18LTR-GE	Q25LTR-GE

Notes

^① To order with incandescent 24V bulb, insert a **/WB** at the end of the catalog number. Example, Q18LT-GN/**WB**.

^② For a complete selection of incandescent 24V bulbs and LEDs, see **Page V7-T1-40**.

1

Indicating Lights

Catalog Number Selection

Catalog Number Selection is for illustrative purposes only and not to be used to create new catalog numbers.

Indicating Lights—Flush and Extended

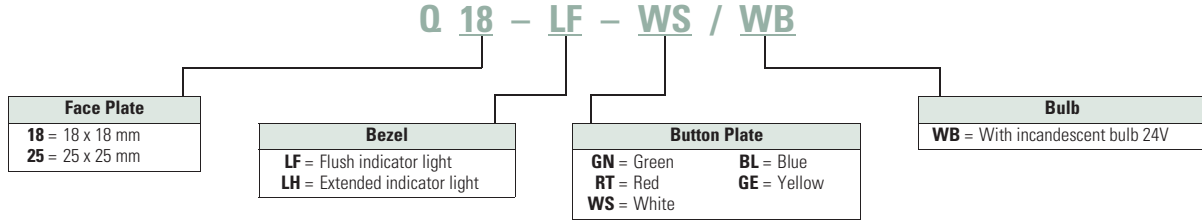



Product Selection

Indicating Lights

- LED or incandescent
- Flush and extended lenses
- 18 mm or 25 mm square operator
- 3 million mechanical operations
- IEC/EN 60947-5
- IP65

Indicating Lights Without Bulb ^①

	Type	Button Color	Catalog Number ^②	
			18 x 18 mm	25 x 25 mm
Q18-LF-GE 	Flush	Green	Q18LF-GN	Q25LF-GN
		Red	Q18LF-RT	Q25LF-RT
		White	Q18LF-WS	Q25LF-WS
		Blue	Q18LF-BL	Q25LF-BL
		Yellow	Q18LF-GE	Q25LF-GE
Q18-LH-BL 	Extended	Green	Q18LH-GN	Q25LH-GN
		Red	Q18LH-RT	Q25LH-RT
		White	Q18LH-WS	Q25LH-WS
		Blue	Q18LH-BL	Q25LH-BL
		Yellow	Q18LH-GE	Q25LH-GE

Notes

- ^① To order with incandescent 24V bulb, insert a /WB at the end of the catalog number. Example, Q18-LF-GN/WB.
- ^② For a complete selection of incandescent 24V bulbs and LEDs, see **Page V7-T1-40**.

Emergency Stops

Catalog Number Selection

Catalog Number Selection is for illustrative purposes only and not to be used to create new catalog numbers.

Emergency Stops—Non-Illuminated and Illuminated

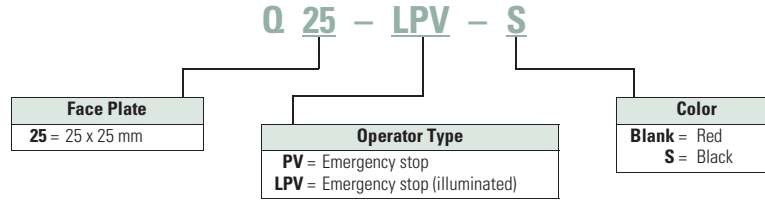

Product Selection

Emergency Stops

- Push/pull operation
- Illuminated or non-illuminated
- Emergency stop (red) or Machine stop (black) available
- Suitable for use in safety applications
- IEC/EN 60947-5
- IP65

Q25PV

Emergency Stops—Non-Illuminated

Button Color	Catalog Number
Red	Q25PV
Black	Q25PV-S



Q25LPV

Emergency Stops—Illuminated ①

Button Color	Catalog Number
Red	Q25LPV
Black	Q25LPV-S



Note

① Includes built-in multiple LED 24 Vdc.

1

Selector Switches—Non-Illuminated, Illuminated and Keyed

Catalog Number Selection

Catalog Number Selection is for illustrative purposes only and not to be used to create new catalog numbers.

Selector Switches—Non-Illuminated

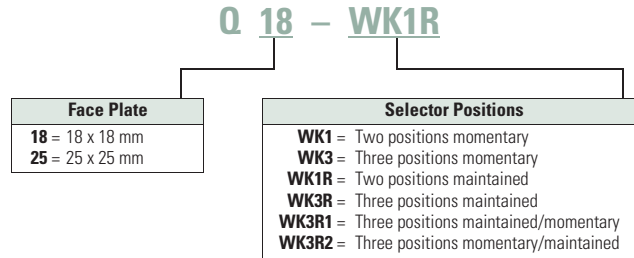

Product Selection

Non-Illuminated Selector Switches

- Momentary or maintained
- 18 mm or 25 mm square operator
- VS Anti-rotation feature
- 3 million mechanical operations
- IP65

Q18WK1



Selector Switches—Non-Illuminated

Function	Position	Switch Position	Catalog Number	
			18 x 18 mm	25 x 25 mm
Momentary	2		Q18WK1	Q25WK1
Maintained			Q18WK1R	Q25WK1R
Momentary	3		Q18WK3	Q25WK3
Maintained			Q18WK3R	Q25WK3R
Maintained/momentary			Q18WK3R1	Q25WK3R1
Momentary/maintained			Q18WK3R2	Q25WK3R2

Catalog Number Selection

Catalog Number Selection is for illustrative purposes only and not to be used to create new catalog numbers.

Selector Switches—Illuminated

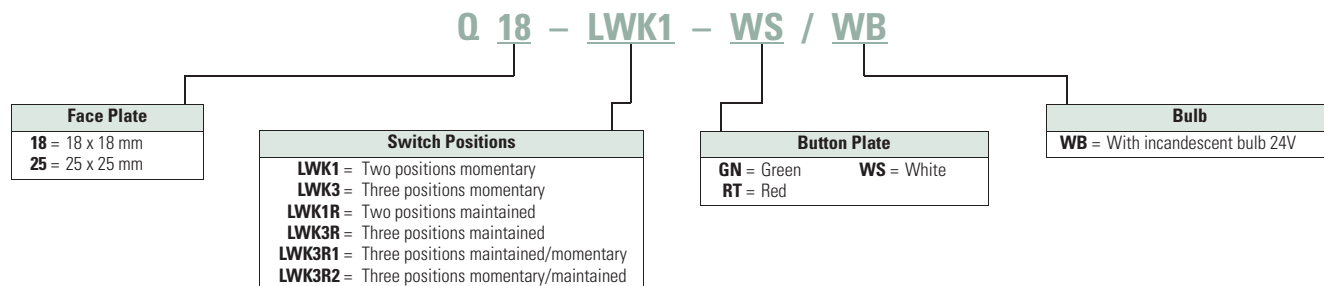

Product Selection

Illuminated Selector Switches

- LED or incandescent
- Momentary or maintained
- 18 mm or 25 mm square operator
- VS Anti-rotation feature
- 3 million mechanical operations
- IP65

Q18LWK1-GN



Selector Switches—Illuminated without Bulb ①

Function	Position	Button Color	Switch Position	Catalog Number ②	
				18 x 18 mm	25 x 25 mm
Momentary	2	Green		Q18LWK1-GN	Q25LWK1-GN
		Red		Q18LWK1-RT	Q25LWK1-RT
		White		Q18LWK1-WS	Q25LWK1-WS
Maintained		Green		Q18LWK1R-GN	Q25LWK1R-GN
		Red		Q18LWK1R-RT	Q25LWK1R-RT
		White		Q18LWK1R-WS	Q25LWK1R-WS
Momentary	3	Green		Q18LWK3-GN	Q25LWK3-GN
		Red		Q18LWK3-RT	Q25LWK3-RT
		White		Q18LWK3-WS	Q25LWK3-WS
Maintained		Green		Q18LWK3R-GN	Q25LWK3R-GN
		Red		Q18LWK3R-RT	Q25LWK3R-RT
		White		Q18LWK3R-WS	Q25LWK3R-WS
Maintained/ momentary		Green		Q18LWK3R1-GN	Q25LWK3R1-GN
		Red		Q18LWK3R1-RT	Q25LWK3R1-RT
		White		Q18LWK3R1-WS	Q25LWK3R1-WS
Momentary/ maintained		Green		Q18LWK3R2-GN	Q25LWK3R2-GN
		Red		Q18LWK3R2-RT	Q25LWK3R2-RT
		White		Q18LWK3R2-WS	Q25LWK3R2-WS

Notes

- ① To order with incandescent 24V bulb, insert a /WB at the end of the catalog number. Example, Q18LWK1-GN/WB.
- ② For a complete selection of incandescent 24V bulbs and LEDs, see Page V7-T1-40.

1.4

Pushbuttons and Indicating Lights

16.2 mm Pushbuttons—RMQ-16

1

Catalog Number Selection

Catalog Number Selection is for illustrative purposes only and not to be used to create new catalog numbers.

Keyed Selector Switches—Two- and Three-Position

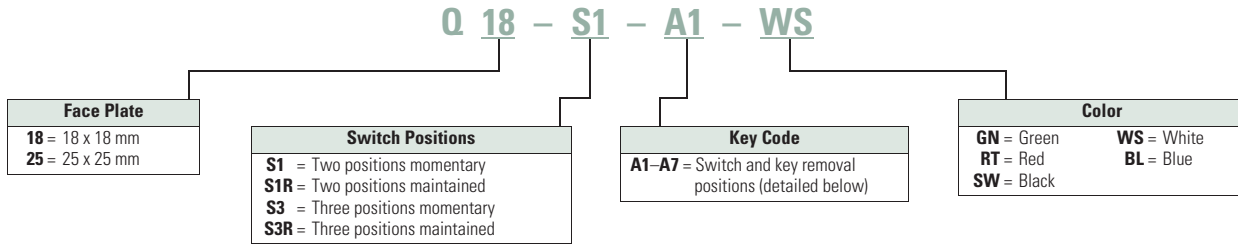

Product Selection

Keyed Selector Switches

- 5 color options
- Momentary or maintained
- 18 mm or 25 mm square operator
- VS Anti-rotation feature
- 3 million mechanical operations
- IP65

Q18S1



Keyed Selector Switches—Two-Position

Function	Button Color	Switch Position	Key Removal Position ①	Catalog Number	
				18 x 18 mm	25 x 25 mm
Momentary	Black		0	Q18S1	Q25S1
Maintained	Black		0	Q18S1R	Q25S1R
Maintained	Black		0	Q18S1R-A1	Q25S1R-A1

Keyed Selector Switches—Three-Position

Function	Button Color	Switch Position	Key Removal Position ①	Catalog Number	
				18 x 18 mm	25 x 25 mm
Momentary	Black		0	Q18S3	Q25S3
Maintained			0, II	Q18S3R	Q25S3R
Maintained			0	Q18S3R-A1	Q25S3R-A1
			I, 0	Q18S3R-A2	Q25S3R-A2
			0, II	Q18S3R-A3	Q25S3R-A3
Maintained/momentary			I, 0	Q18S3R-A4	Q25S3R-A4
			0	Q18S3R-A5	Q25S3R-A5
Momentary/maintained			0, II	Q18S3R-A6	Q25S3R-A6
			0	Q18S3R-A7	Q25S3R-A7

Note

- ① I = Key is removed at the left.
- 0 = Key is removed at the center.
- II = Key is removed at the right.

Q18S1-BL

Keyed Selector Switches, Multicolor—Two-Position



Function	Button Color	Switch Position	Key Removal Position ①	Catalog Number	
				18 x 18 mm	25 x 25 mm
Momentary	Green		0	Q18S1-GN	Q25S1-GN
	Red			Q18S1-RT	Q25S1-RT
	White			Q18S1-WS	Q25S1-WS
	Blue			Q18S1-BL	Q25S1-BL
Maintained	Green		0	Q18S1R-GN	Q25S1R-GN
	Red			Q18S1R-RT	Q25S1R-RT
	White			Q18S1R-WS	Q25S1R-WS
	Blue			Q18S1R-BL	Q25S1R-BL

Q18S3-RT

Keyed Selector Switches, Multicolor—Three-Position



Function	Button Color	Switch Position	Key Removal Position ①	Catalog Number	
				18 x 18 mm	25 x 25 mm
Momentary	Green		0	Q18S3-GN	Q25S3-GN
	Red			Q18S3-RT	Q25S3-RT
	White			Q18S3-WS	Q25S3-WS
	Blue			Q18S3-BL	Q25S3-BL
Maintained	Green		0, II	Q18S3R-GN	Q25S3R-GN
	Red			Q18S3R-RT	Q25S3R-RT
	White			Q18S3R-WS	Q25S3R-WS
	Blue			Q18S3R-BL	Q25S3R-BL

Note

- ① I = Key is removed at the left.
- 0 = Key is removed at the center.
- II = Key is removed at the right.

Accessories

E10



Contact Elements

Feature	Catalog Number
Normally open (N/O)	E10

E01



Normally closed (N/C)	E01
-----------------------	-----

SRA10



Screw Adapter

Feature	Catalog Number
Normally open (N/O)	SRA10
Normally closed (N/C)	SRA01
Lamp sockets	SRAL

WBGL6



Incandescent 24V Bulbs

Voltage	Current	Color	Catalog Number
6V	1W	White	WBGL6
12V			WBGL12
24–28V			WBGL24

WBLED-GN6



LEDs (AC/DC)

Voltage	Current	Color	Catalog Number
Multiple Chip LED			
6V	45 mA	Green	WBLED-GN6
12V	24 mA		WBLED-GN12
6V	45 mA	Red	WBLED-RT6
12V	24 mA		WBLED-RT12
6V	45 mA	Yellow	WBLED-GE6
12V	24 mA		WBLED-GE12
Single Chip LED ①			
18–30V	7–12.5 mA	Green	LEDWB-G
		Red	LEDWB-R
		White	LEDWB-W
		Blue	LEDWB-B
		Yellow	LEDWB-Y

ISH2,8



Insulated Ferrule

Description	Catalog Number
Insulated ferrule	ISH2,8

R16-MS



Combination Box Spanner

Description	Catalog Number
Mounting ring tool	16-MS

VS



Anti-Rotation Tab

Description	Catalog Number
Guard ring	VS

E8-SW



Housing

Description	Color	Catalog Number
Surface mount enclosure	White	I8
Flush mount panel	White	E8
	Black	E8-SW

Q18BS



Blanking Plug

Size	Catalog Number
18 x 18 mm	Q18BS
25 x 25 mm	Q25BS

Q25AGR



Cover Plate

Size	Color	Catalog Number
25 x 38 mm	Black	Q25AS
	Gray	Q25AGR

Note

① Positive pole to X1. Integral suppressor circuit up to 1000V.

Q2SQ25



Insert Plate

Size		Catalog Number
10 x 22 mm	BLANK	Q2SQ25

Q25TS-X



Legend Plate

Size	Color	Catalog Number
25 x 38 mm	Black	Q25TS-X
	Gray	Q25TGR-X

Q25TS_



Legend Plate—Complete

Size	Etching	Catalog Number
25 x 38	START	Q25TS-111
	STOP	Q25TS-110
	FAULT	Q25TS-250
	HAND 0 AUTO	Q25TS-197
	MAN 0 AUTO	Q25TS-397
	0	Q25TS-10
	I	Q25TS-11
	0 I	Q25TS-90
	I 0 II	Q25TS-93

SQT11



Emergency Stop Labels

Type	Feature	Catalog Number
Square	4 Languages	SQT11
	Blank	SQT-GE
Circle	4 Languages	SRT11
	Blank	SRT-GE

SRT11



Extra Keys

ES16



Codes for Extra Keys

Color	Catalog Number
Green	ES16-GN
Red	ES16-RT
Black	ES16
White	ES16-WS
Blue	ES16-BL

Technical Data and Specifications

RMQ-16

Description	Unit	Specification Contact Elements	Illuminated Pushbutton Operators (Maintained)	Illuminated Selector Switches	Indicating Lights
General Technical Data					
Standards					UL, CSA, IEC/EN 60 947, VDE 0660, CE
Lifespan, mechanical (operations)	x 10 ⁵	100	30 (3)	3	—
Maximum operating frequency	Ops/h	3600	3600 (1800)	1800	—
Operating force	N	3	4	—	—
Operating torque	Nm		—	≤ 0.2	—
Degree of protection to IEC/EN 60 529		IP20 with ISH2,8	IP65	IP65	IP65
Climatic proofing			Damp heat, constant, to IEC 60 068-2-3/Damp heat, cyclical, to IEC 60 068-2-30		
Ambient temperature					
Open	°C	–25 to 60	–25 to 60	–25 to 60	–25 to 60
Enclosed	°C	–25 to 40	–25 to 40	–25 to 40	–25 to 40
Mounting position		As required	As required	As required	As required
Mechanical shock resistance to IEC 60 068-2-27 (half-sinusoidal shock, duration 11 ms)	g	40	40	40	40
Terminal capacity (min./max.)	mm ²	0.5/1.0	0.5/1.0	0.5/1.0	0.5/1.0
Blade terminal			2.8 mm x 0.8 mm to DIN 46 244		
Ferrule			2.8 mm x 0.8 mm to DIN 46 247 and IEC 60 760		
Dimensions		See Page V7-T1-45	See Page V7-T1-45	See Page V7-T1-45	See Page V7-T1-45
Contacts					
Rated impulse withstand voltage U_{imp}	V	4000	800	800	800
Rated insulation voltage U_i	V	250	250	250	250
Overvoltage category/pollution degree		III/3	III/3	III/3	III/3
Rated operational voltage U_e (max.)	V	250	24	24	24
Rated operational current I_e (max.)	A	4	—	—	—
Control circuit reliability at					
24 Vdc/5 mA (Fault probability Hr)			<10 ⁻⁷ , <1 fault in 10 ⁷ operations		
5 Vdc/1 mA (Fault probability Hr)			<5 x 10 ⁻⁶ , < fault in 5 x 10 ⁶ operations		
Use of insulated ferrule ISH 2.8					
From U_e		>24 Vac/dc recommended	>24 Vac/dc recommended	>24 Vac/dc recommended	>24 Vac/dc recommended
From U_e			>50 Vac or 120 Vdc is mandatory, even on unused blade terminals		
Maximum short-circuit protective device					
Fuseless	Type	FAZ-B6	—	—	—
Fuse	A gG/gL	10	—	—	—
Switching Capacity					
Rated operational current I_e					
AC-15					
24V	A	4	—	—	—
48V	A	4	—	—	—
110V	A	4	—	—	—
230V	A	4	—	—	—
DC-13					
24V	A	3	—	—	—
42V	A	1.0	—	—	—
60V	A	0.8	—	—	—
110V	A	0.5	—	—	—
220V	A	0.2	—	—	—
UL/CSA Data					
		UL listed File No. E 29 184, Guide No. NKCR/CSA certified File No. 46 552 Class No. 321103			
Blade terminal		0.110 x 0.032 in	0.110 x 0.032 in	0.110 x 0.032 in	0.110 x 0.032 in
Fast-on connector		0.110 x 0.032 in AMP #60 197-1, 62 050-1 or equivalent			
Rated voltage maximum AC	Vac	300	24	24	24
Contact rating code AC	E10/E01	C300/Q300	—	—	—
Thermal continuous test current	A	2.5	—	—	—
Rated voltage maximum DC	Vdc	300	—	—	—
Contact rating code DC	E10/E01	C300/R300	—	—	—
Thermal continuous test current	A	2.5	—	—	—

1.4

Pushbuttons and Indicating Lights

16.2 mm Pushbuttons—RMQ-16

1

RMQ-16, continued

Description	Unit	Specification			Emergency Stop Operators	Emergency Stop Operators (Illuminated) ①
		Pushbutton Operators (Maintained)	Selector Switches	Key-Released Operators		
General Technical Data						
Standards					UL, CSA, IEC/EN 60 947, VDE 0660, CE	
Lifespan, mechanical (operations)	x 10 ⁵	30 (3)	3	3	0.5	0.5
Maximum operating frequency	Ops/h	3600 (1800)	1800	1800	600	600
Operating force	N	4	—	—	25	25
Operating torque	Nm	—	≤ 0.2	≤ 0.4	—	—
Degree of protection to IEC/EN 60 529		IP65	IP65	IP65	IP65	IP65
Climatic proofing					Damp heat, constant, to IEC 60 068-2-3 Damp heat, cyclical, to IEC 60 068-2-30	
Ambient temperature						
Open	°C	–25 to 60	–25 to 60	–25 to 60	–25 to 60	–25 to 60
Enclosed	°C	–25 to 40	–25 to 40	–25 to 40	–25 to 40	–25 to 40
Mounting position		As required	As required	As required	As required	As required
Mechanical shock resistance to IEC 60 068-2-27 (half-sinusoidal shock, duration 11 ms)	g	40	40	40	40	40
Terminal capacity (min./max.)	mm ²	—	—	—	—	0.5/1.0
Blade terminal		—	—	—	—	2.8 x 0.8 mm
Ferrule		—	—	—	—	2.8 x 0.8 mm
Dimensions		See Page V7-T1-45	See Page V7-T1-45	See Page V7-T1-45	See Page V7-T1-45	See Page V7-T1-45

Lifespan, Electrical AC-15 to IEC/EN 60 947-5-1 at 230V

I_e = Rated operational current

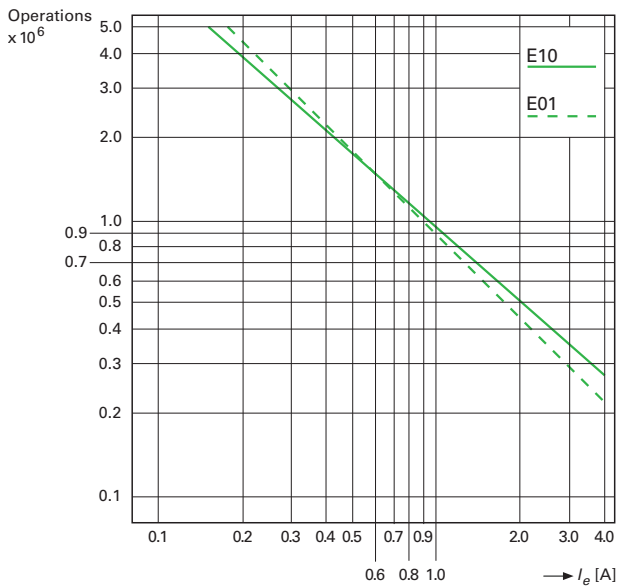

Note

① See illuminated selector switches on Page V7-T1-37 for contact values.

Dimensions

Approximate Dimensions in mm [in]

Actuating and Indicator Elements

Square Style

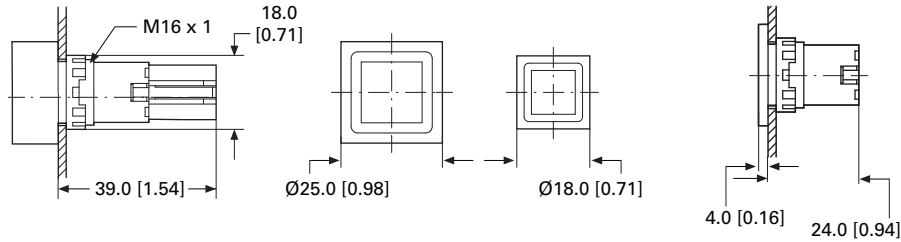

**Q...D-_, Q...DR-_
Q...S_**

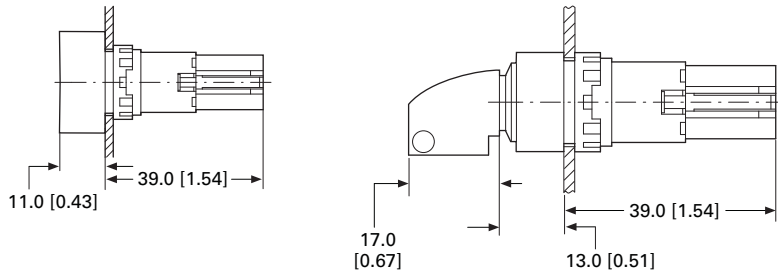

Q...WK_

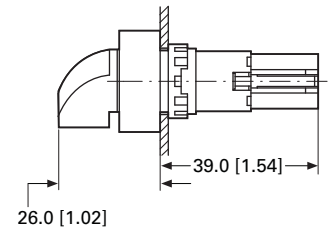

**Q...LT-_, Q...LTR-_, Q...LF-_
Q...LH-_
Q...LWK_**

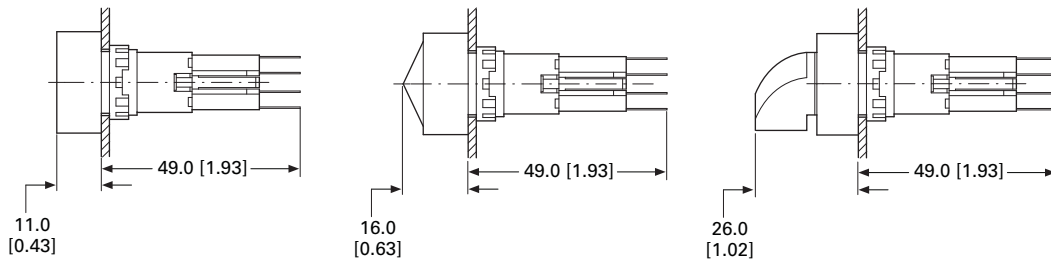

Q25PV_ , Q25LPV_

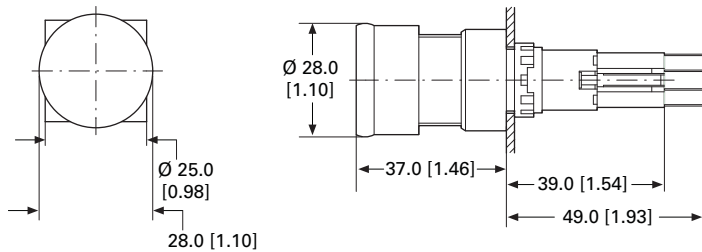

1.4

Pushbuttons and Indicating Lights

16.2 mm Pushbuttons—RMQ-16

1

Approximate Dimensions in mm [in]

Front Fixing

Q18, Q25, E89, SRA, VS, M16

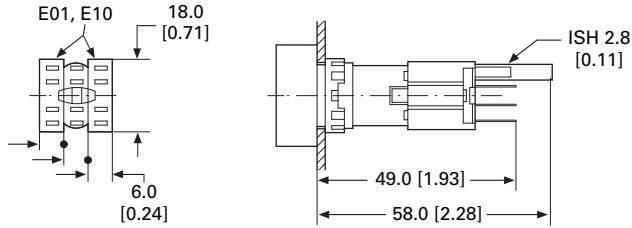

Drilling Dimensions

Drilling

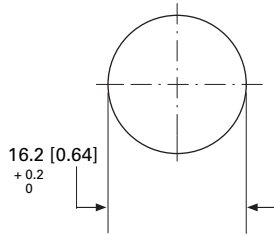

Grid Dimension to IEC/EN 60947

Q25

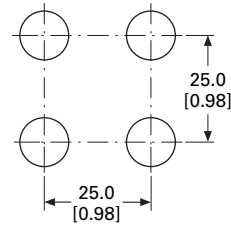

Minimum Grid Spacing Dimension

Q18

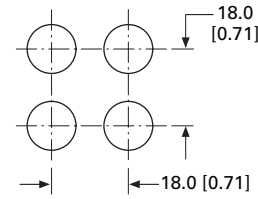

Mounting Distance

Mounting

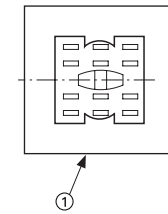

RMQ Screw Adapter

SRA_

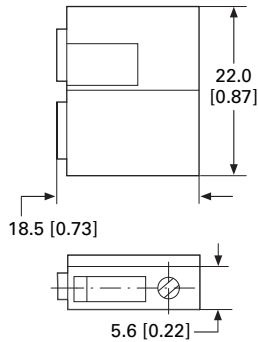

Anti-Rotation Feature

VS

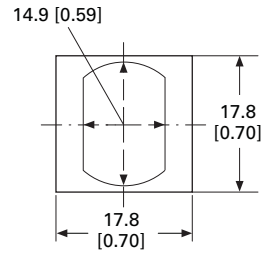

RMQ-16 Label Mount

Q25TS_

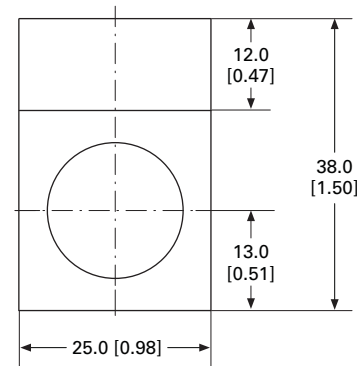

Blanking Plates

Q25AS

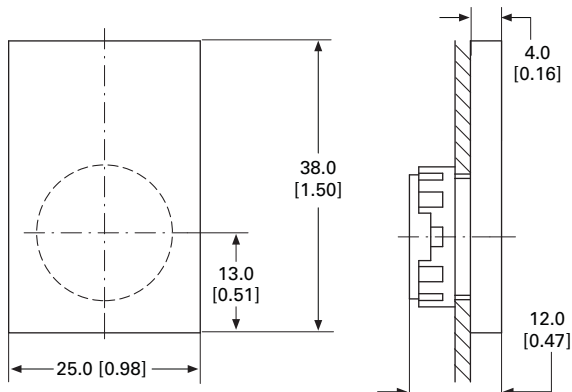

Note

① Exposed conductive part (metal).

22.5 mm RMQ-Titan Modular Pushbuttons—M22



Contents

Description

	<i>Page</i>
22.5 mm RMQ-Titan Modular Pushbuttons—M22	
Product Selection Guide	V7-T1-48
Accessories	V7-T1-111
Coding Adapter Guide	V7-T1-118
Technical Data and Specifications	V7-T1-119
Dimensions	V7-T1-123
Symbols Library.	V7-T1-129



Product Description

Eaton's M22 industrial heavy-duty pushbutton line offers a wide array of functional, attractive and ergonomically designed illuminated and non-illuminated pushbuttons, selector switches, push-pulls, alternate action and twist-to-release operators. The complete illuminated line is only offered in LED light units to ensure high-quality brightness and up to 100,000 hours of LED illumination. M22 operators are available with either a silver or black nylon colored or chrome metal bezel. The space-saving modular construction of the M22 line makes on-the-job assembly fast and simplifies the stocking of both components and complete devices.

NEW

Eaton has expanded M22 pilot devices with a metal bezel option. The new M22M pushbutton is an elegant chrome metal bezel that is attractive, durable and rugged for heavy-duty environments. M22M devices are configurable and complement components within the M22 line.

Highly Modular and Versatile Line

- Field convertible functions (pushbuttons and selector switches), maintained to momentary
- Customizable laser engraving capabilities

LED Indicators

- 100,000 hours of life in high-vibration environments
- Lenses specifically designed for LED illumination
- Multi-color LED in the flat contact family allows versatility in design and reduces installation costs and footprint

Rugged Design

- Most pushbutton operators and contact blocks exceed 5 million mechanical operations
- All components have IP66 rating, and some carry IP67 and IP69K for washdown environment; see **Page V7-T1-119** for further technical data

Innovative Technologies

- ASi communicating devices
- Palm switches

Standards and Certifications

All operators and components are IEC/EN 60947 VDE 0660.

All operators carry an IP66 rating with some rated for washdown environment with IP67 and IP69K.

All pushbuttons, emergency-stops, indicating lights, potentiometers and selector switches carry NEMA 4X, 13.

Marine classification societies: Bureau Veritas (BV), Germanischer Lloyd (GL), and Lloyd's Register of Shipping (LR) approved.



1.5

Pushbuttons and Indicating Lights

22.5mm 22.5 mm RMQ-Titan Modular Pushbuttons—M22

1

Features

- Field convertible pushbuttons and mushroom operators from maintained to momentary status
- Field convertible selector switches from momentary to maintained operation and vice versa
- LED offering only for all illuminated operators
- Laser engraved pushbuttons, lenses and enclosures
- Heavy-duty construction with a minimum of IP66 and UL NEMA® type 4X / 13 on front of panel operators. Many operators even carry IP67 and IP69K, for the toughest applications
- Silver, black or chrome metal bezel now available
- Snap-lock contact blocks and light units for front or base mounting
- Notched hole mounting with anti-rotation tab and central nut mounting on each operator
- Over 5 million mechanical operations and 1.6 million electrical (reference specification sheet)
- Direct opening action normally closed contacts
- Unique and innovative offerings, such as four-way pushbuttons and USB/ RJ45 bulkhead interfaces
- Screw or spring-cage terminals

Benefits

- Modular construction makes assembly fast and simplifies stocking of components and complete devices
- Field convertibility of operator status for pushbuttons and selector switches helps distributors and customers reduce inventory and increase functionality
- LED offering only for improved brightness quality and up to 100,000 hours of operation
- Plastic construction is corrosion resistant. Operators are designed for rugged environments, ideal for washdown applications (reference each operator's IP ratings and IEC/EN 60529 for ingress protection definition)
- Anti-rotation tab saves installation time and prevents operator rotation
- High mechanical and electrical life allows for use in tough and challenging applications
- Laser inscription capabilities allow for high-quality, wear-resistant markings
- All normally closed (NC) contacts are direct opening action, i.e., NC contacts are physically forced open by direct linkage with the pushbutton operator in the unlikely event of contact weld
- Some M22 operators are capable of communication via ASi protocol
- M22 offers USB and RJ45 connections

Product Selection Guide

Pushbuttons



Description	Non-illuminated, flush		Non-illuminated, extended		Illuminated, flush		Illuminated, extended	
Operator	Momentary	Maintained	Momentary	Maintained	Momentary	Maintained	Momentary	Maintained
Product Selection	Pages V7-T1-53 to V7-T1-55	Pages V7-T1-56, V7-T1-57	Pages V7-T1-58, V7-T1-59	Pages V7-T1-60, V7-T1-61	Pages V7-T1-63 to V7-T1-65	Pages V7-T1-66, V7-T1-67	Pages V7-T1-68, V7-T1-69	Pages V7-T1-70, V7-T1-71

Indicating Lights



Description	Flat	Conical
Product Selection	Pages V7-T1-72, V7-T1-73	Pages V7-T1-72, V7-T1-73

Emergency Stops



Description	Non-illuminated	Illuminated	Key release	Mechanical indication
Product Selection	Page V7-T1-75	Page V7-T1-75	Page V7-T1-76	Page V7-T1-76

Selector Switches



Description	Non-illuminated knob type	Non-illuminated rotary type	Illuminated	Key-operated
Product Selection	Pages V7-T1-80, V7-T1-81	Pages V7-T1-82, V7-T1-83	Pages V7-T1-85 to V7-T1-87	Pages V7-T1-88 to V7-T1-91

Mushroom Head Pushbuttons



Description	Non-illuminated	Non-illuminated
Operator	Momentary	Maintained
Product Selection	Pages V7-T1-94, V7-T1-95	Pages V7-T1-96, V7-T1-97

Double Pushbuttons



Description	Extended pushbuttons and center light	Flush top and center light, extended bottom	Flush pushbuttons and center light
Operator	Momentary	Momentary	—
Product Selection	Page V7-T1-99	Page V7-T1-100	Page V7-T1-100

Four-Way Pushbuttons



Description	Non-interlocked	Interlocked
Operator	Momentary	Maintained
Product Selection	Page V7-T1-103	Page V7-T1-103

Joysticks



Description	Joysticks
Product Selection	Page V7-T1-104

Potentiometers



Description	Potentiometers
Product Selection	Page V7-T1-106

Acoustic Devices



Description	Acoustic devices
Product Selection	Page V7-T1-106

Through-the-Door Operators



Description	Through-the-door operators
Product Selection	Page V7-T1-107

Bulkhead Interfaces



Description	Bulkhead interfaces
Product Selection	Page V7-T1-107

ASi Adapter Modules



Description	ASi adapter modules
Product Selection	Page V7-T1-108

Palm Switches



Description	Palm switches
Product Selection	Page V7-T1-109

Assembled Control Stations



Description	Assembled control stations
Product Selection	Page V7-T1-16

M22_



Point-of-Purchase Units

Color	Type	Contact Configuration ^①	Catalog Number
Black	Flush momentary	NO/NC	M22-D-S-K11-P
Red	Extended momentary	NO/NC	M22-DH-R-K11-P
Green	Flush momentary	NO/NC	M22-D-G-K11-P
Red	Ext. illuminated (12–30V) momentary	NO/NC	M22-DLH-R-K11-R-P
Red	Ext. illuminated (85–264V) momentary	NO/NC	M22-DLH-R-K11-230R-P
White	Flush illuminated (12–30V) maintained	NO/NC	M22-DRL-W-K11-W-P
White	Flush illuminated (85–264V) maintained	NO/NC	M22-DRL-W-K11-230W-P
Red	Indicating light (12–30V)	—	M22-L-R-R-P
Green	Indicating light (12–30V)	—	M22-L-G-G-P
Red	Indicating light (85–264V)	—	M22-L-R-230R-P
Green	Indicating light (85–264 Vac)	—	M22-L-G-230G-P
Red	Twist-to-release E-stop	1NO/2NC	M22-PVT-K12-P
Red	Illuminated (12–30V) push-pull E-stop	1NO/2NC	M22-PVL-K12-R-P
Red	Illuminated (85–264V) push-pull E-stop	1NO/2NC	M22-PVL-K12-230R-P
—	Two-position maintained V selector switch	NO/NC	M22-WKV-K11-P
—	Three-position momentary selector switch	NO/NC	M22-WK3-K22-P

Note

^① All NC contact blocks are positively driven contact. ⊖

Pushbuttons—Non-Illuminated and Illuminated



Contents

Description

Page

Pushbuttons—Non-Illuminated and Illuminated	
Non-Illuminated, Flush, Momentary	V7-T1-53
Non-Illuminated, Flush, Maintained	V7-T1-56
Non-Illuminated, Extended, Momentary	V7-T1-58
Non-Illuminated, Extended, Maintained	V7-T1-60
Illuminated, Flush, Momentary	V7-T1-63
Illuminated, Flush, Maintained	V7-T1-66
Illuminated, Extended, Momentary	V7-T1-68
Illuminated, Extended, Maintained	V7-T1-70

Pushbuttons—Non-Illuminated and Illuminated

Product Description

Eaton’s M22 pushbutton line is a complete, modular and versatile offering. From field-convertible maintained operators to customizable laser engraved buttons, the M22 pushbutton line provides endless opportunity for flexibility and reduced inventory. Each operator type provides options for ordering as complete or component parts allowing for a perfect fit for each application. All of this flexibility comes in a very rugged design.

Features

- Field convertible from maintained to momentary (available on maintained pushbuttons only)
- Customizable laser engraving on all buttons
- LED offering only for improved brightness quality and up to 100,000 hours of operation
- More than five million mechanical operations on momentary and 1 million on maintained pushbuttons
- Modular construction makes assembly fast and simplifies stocking of components and complete devices
- Capable of communicating via ASi protocol with ASi adapter modules

Protection Type

- IP67, IP69K
- NEMA 4X, 13

Catalog Number Selection

Catalog Number Selection is for illustrative purposes only and not to be used to create new catalog numbers.

Non-Illuminated Pushbuttons

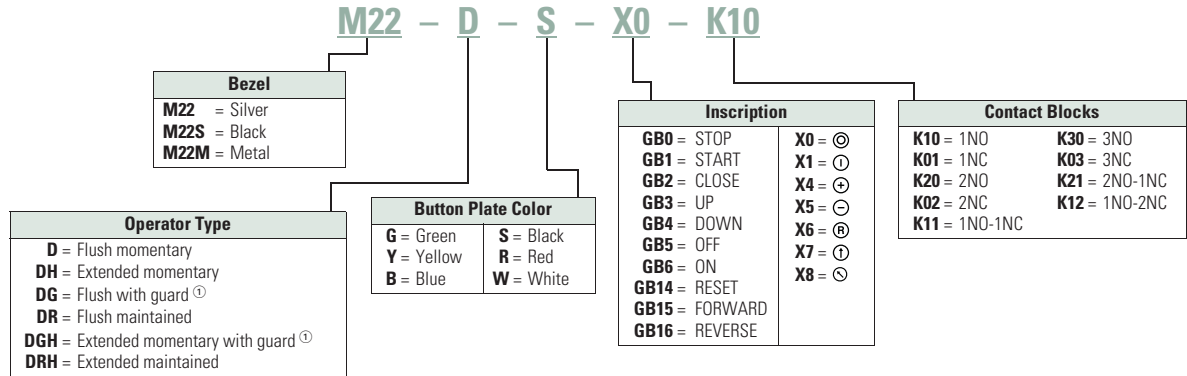

Product Selection

Non-Illuminated Pushbuttons, Flush, Momentary

M22-D-G-K10



M22S-D-G-K10



M22M-D-G-K10



Complete Devices

Button Color	Contact Block Configuration ^①	Silver Bezel Catalog Number	Black Bezel Catalog Number	Metal Bezel Catalog Number
Black	NO	M22-D-S-K10	M22S-D-S-K10	M22M-D-S-K10
	NC	M22-D-S-K01	M22S-D-S-K01	M22M-D-S-K01
	2NO	M22-D-S-K20	M22S-D-S-K20	M22M-D-S-K20
	2NC	M22-D-S-K02	M22S-D-S-K02	M22M-D-S-K02
	1NO-1NC	M22-D-S-K11	M22S-D-S-K11	M22M-D-S-K11
Red	NO	M22-D-R-K10	M22S-D-R-K10	M22M-D-R-K10
	NC	M22-D-R-K01	M22S-D-R-K01	M22M-D-R-K01
	2NO	M22-D-R-K20	M22S-D-R-K20	M22M-D-R-K20
	2NC	M22-D-R-K02	M22S-D-R-K02	M22M-D-R-K02
	1NO-1NC	M22-D-R-K11	M22S-D-R-K11	M22M-D-R-K11
Green	NO	M22-D-G-K10	M22S-D-G-K10	M22M-D-G-K10
	NC	M22-D-G-K01	M22S-D-G-K01	M22M-D-G-K01
	2NO	M22-D-G-K20	M22S-D-G-K20	M22M-D-G-K20
	2NC	M22-D-G-K02	M22S-D-G-K02	M22M-D-G-K02
	1NO-1NC	M22-D-G-K11	M22S-D-G-K11	M22M-D-G-K11

Note

^① All NC contact blocks are positively driven contact. ⊖

1

Non-Illuminated Pushbuttons, Flush, Momentary

M22-D-G

Operators Only ^①

Button Color	Inscription	Silver Bezel Catalog Number	Black Bezel Catalog Number	Metal Bezel Catalog Number
Black	—	M22-D-S	M22S-D-S	M22M-D-S
Red	—	M22-D-R	M22S-D-R	M22M-D-R
	STOP	M22-D-R-GB0	M22S-D-R-GB0	—
	Ⓢ	M22-D-R-X0	M22S-D-R-X0	M22M-D-R-X0
Green	—	M22-D-G	M22S-D-G	M22M-D-G
	START	M22-D-G-GB1	M22S-D-G-GB1	M22M-D-G-GB1
	Ⓢ	M22-D-G-X1	M22S-D-G-X1	M22M-D-G-X1
White	—	M22-D-W	M22S-D-W	M22M-D-W
Blue	—	M22-D-B	M22S-D-B	M22M-D-B
Yellow	—	M22-D-Y	M22S-D-Y	M22M-D-Y
—	—	M22-D-X-SRSG ^②	M22S-D-X-SRSG ^②	M22M-D-X-SRSG ^②
—	—	M22-D-X-SWRGYB ^③	M22S-D-X-SWRGYB ^③	M22M-D-X-SWRGYB ^③

M22S-D-G



M22M-D-G



M22-DG-G



Silver Guarded

Button Color	Inscription	Silver Bezel Catalog Number
Black	—	M22-DG-S
Red	—	M22-DG-R
Green	—	M22-DG-G
White	—	M22-DG-W
Blue	—	M22-DG-B
Yellow	—	M22-DG-Y
—	—	M22-DG-X-SRSG ^②
—	—	M22-DG-X-SWRGYB ^③

Notes

- ^① Includes contact block mounting adapter.
- ^② Buttonless operator comes with three color buttons (black, red, green).
- ^③ Buttonless operator comes with all six color buttons (black, white, red, green, yellow, blue).

Non-Illuminated Pushbuttons, Flush, Momentary

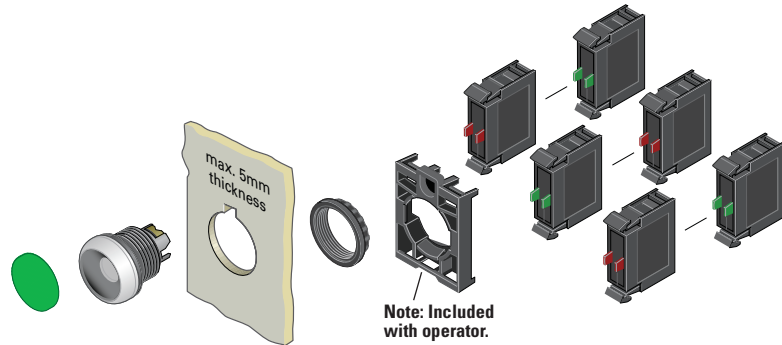

Components

M22-XD-G



Button Plates ^①

Color	Inscription	Catalog Number
Black	—	M22-XD-S ^②
	Custom	M22-XD-S-ETCH ^③
	STOP	M22-XD-S-GB0
	START	M22-XD-S-GB1
	CLOSE	M22-XD-S-GB2
	UP	M22-XD-S-GB3
	DOWN	M22-XD-S-GB4
	OFF	M22-XD-S-GB5
	ON	M22-XD-S-GB6
	TEST	M22-XD-S-GB9
	FORWARD	M22-XD-S-GB15
	REVERSE	M22-XD-S-GB16
	RAISE	M22-XD-S-GB17
	LOWER	M22-XD-S-GB18
	⊙	M22-XD-S-X0
	⓪	M22-XD-S-X1
	Ⓛ	M22-XD-S-X2
	+	M22-XD-S-X4
	−	M22-XD-S-X5
	Ⓛ	M22-XD-S-X7
Red	—	M22-XD-R ^②
	Custom	M22-XD-R-ETCH ^③
	STOP	M22-XD-R-GB0
	OFF	M22-XD-R-GB5
	⊙	M22-XD-R-X0
Green	—	M22-XD-G ^②
	Custom	M22-XD-G-ETCH ^③
	START	M22-XD-G-GB1
	ON	M22-XD-G-GB6
Blue	—	M22-XD-B ^②
	Custom	M22-XD-B-ETCH ^③
	RESET	M22-XD-B-GB14
	Ⓜ	M22-XD-B-X6
White	—	M22-XD-W ^②
	Custom	M22-XD-W-ETCH ^③
	START	M22-XD-W-GB1
Yellow	—	M22-XD-Y ^②
	Custom	M22-XD-Y-ETCH ^③
Black, red, green	—	M22-XD-SRG
Black, white, red, green, yellow, blue	—	M22-XD-SWRGYB

Buttonless Operator



Silver Bezel
Catalog Number ^④

M22-D-X



Black Bezel
Catalog Number ^④

M22S-D-X



Metal Bezel
Catalog Number ^④

M22M-D-X

Silver Guarded



Silver Bezel
Catalog Number ^④

M22-DG-X

M22-K10



M22-FK01



Contact Blocks ^①

Terminal Type	Contact Configuration ^⑤	Catalog Number
Screw	NO	M22-K10
	NO, early-make	M22-K10P
	NC	M22-K01
	NC, late-break	M22-K01D
Spring-cage	NO	M22-CK10
	NC	M22-CK01
	NC, late-break	M22-CK01D
	2NO	M22-CK20
	2NC	M22-CK02
	NO-NC	M22-CK11
	NC	M22-FK01 ^⑥
	NO	M22-FK10 ^⑥

Notes

- ① For complete listing of available button plates and contact blocks, see Accessories, Pages V7-T1-111 to V7-T1-116.
- ② Minimum order quantity of (10).
- ③ When ordering, specify inscription per catalog number suffix from the Symbols Library (see Pages V7-T1-129 to V7-T1-136) into the Order Notes. For example, M22-XD-S-ETCH; Order Notes: Mark with symbol X91, Line item #_.
- ④ Includes contact block mounting adapter.
- ⑤ All NC contact blocks are positively driven contact. ⊖
- ⑥ Additional contacts may not be stacked behind M22-F type contact blocks, M22-F can be stacked behind standard M22 contacts only.

1

Non-Illuminated Pushbuttons, Flush, Maintained ^①

M22-DR-S



M22S-DR-S



M22M-DR-S



Operators Only ^②

Button Color	Silver Bezel Catalog Number	Black Bezel Catalog Number	Metal Bezel Catalog Number
Black	M22-DR-S	M22S-DR-S	M22M-DR-S
Red	M22-DR-R	M22S-DR-R	M22M-DR-R
Green	M22-DR-G	M22S-DR-G	M22M-DR-G
White	M22-DR-W	M22S-DR-W	M22M-DR-W
Blue	M22-DR-B	M22S-DR-B	M22M-DR-B
Yellow	M22-DR-Y	M22S-DR-Y	M22M-DR-Y
③	M22-DR-X-SRG	M22S-DR-X-SRG	M22M-DR-X-SRG
④	M22-DR-X-SWRGYB	M22S-DR-X-SWRGYB	M22M-DR-X-SWRGYB

Notes

- ① Maintained pushbuttons can be converted in the field to momentary operation by switching the locking ring, which is accessible through the side of the operator body.
- ② Includes contact block mounting adapter.
- ③ Buttonless operator comes with three color buttons (black, red, green).
- ④ Buttonless operator comes with all six color buttons (black, white, red, green, yellow, blue).

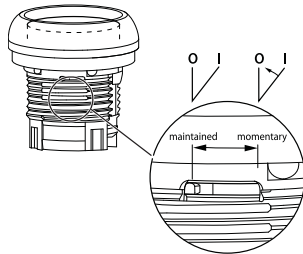

Note: This pilot device features a selectable function switch that enables the device to be set to either maintained or momentary operation.

Non-Illuminated Pushbuttons, Flush, Maintained ^①

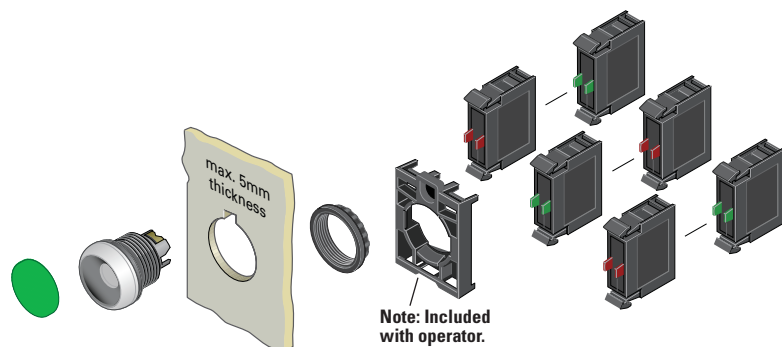

Components

M22-XD-S



Button Plates ^②

Color	Inscription	Catalog Number
Black	—	M22-XD-S ^③
	Custom	M22-XD-S-ETCH ^④
	STOP	M22-XD-S-GB0
	START	M22-XD-S-GB1
	CLOSE	M22-XD-S-GB2
	UP	M22-XD-S-GB3
	DOWN	M22-XD-S-GB4
	OFF	M22-XD-S-GB5
	ON	M22-XD-S-GB6
	TEST	M22-XD-S-GB9
	FORWARD	M22-XD-S-GB15
	REVERSE	M22-XD-S-GB16
	RAISE	M22-XD-S-GB17
	LOWER	M22-XD-S-GB18
	⊙	M22-XD-S-X0
	⓪	M22-XD-S-X1
	Ⓛ	M22-XD-S-X2
	⊕	M22-XD-S-X4
⊖	M22-XD-S-X5	
Ⓛ	M22-XD-S-X7	
Red	—	M22-XD-R ^③
	Custom	M22-XD-R-ETCH ^④
	STOP	M22-XD-R-GB0
	OFF	M22-XD-R-GB5
	⊙	M22-XD-R-X0
	⊕	M22-XD-R-X4
Green	—	M22-XD-G ^③
	Custom	M22-XD-G-ETCH ^④
	START	M22-XD-G-GB1
	ON	M22-XD-G-GB6
	⓪	M22-XD-G-X1
Blue	—	M22-XD-B ^③
	Custom	M22-XD-B-ETCH ^④
	RESET	M22-XD-B-GB14
White	—	M22-XD-W ^③
	Custom	M22-XD-W-ETCH ^④
	START	M22-XD-W-GB1
Yellow	—	M22-XD-Y ^③
	Custom	M22-XD-Y-ETCH ^④
	—	M22-XD-SRG
Black, red, green	—	M22-XD-SWRGBYB

Buttonless Operator



M22-K10



M22-FK01



Contact Blocks ^②

Terminal Type	Contact Configuration ^⑥	Catalog Number
Screw	NO	M22-K10
	NO, early-make	M22-K10P
	NC	M22-K01
	NC, late-break	M22-K01D
Spring-cage	NO	M22-CK10
	NC	M22-CK01
	NC, late-break	M22-CK01D
	2NO	M22-CK20
	2NC	M22-CK02
	NO-NC	M22-CK11
NC	M22-FK01 ^⑦	
NO	M22-FK10 ^⑦	

Notes

- ① Maintained pushbuttons can be converted in the field to momentary operation by switching the locking ring, which is accessible through the side of the operator body.
- ② For complete listing of available button plates and contact blocks, see Accessories, Pages V7-T1-111 to V7-T1-116.
- ③ Minimum order quantity of (10).
- ④ When ordering, specify inscription per catalog number suffix from the Symbols Library (see Pages V7-T1-129 to V7-T1-136) into the Order Notes. For example, M22-XD-S-ETCH; Order Notes: Mark with symbol X91, Line item #_.
- ⑤ Includes contact block mounting adapter.
- ⑥ All NC contact blocks are positively driven contact. ⊖
- ⑦ Additional contacts may not be stacked behind M22-F type contact blocks, M22-F can be stacked behind standard M22 contacts only.

1 Non-Illuminated Pushbuttons, Extended, Momentary

M22-DH-R-K10



M22S-DH-R-K10



M22M-DH-R-K10



Complete Devices

Button Color	Contact Block Configuration ^①	Silver Bezel Catalog Number	Black Bezel Catalog Number	Metal Bezel Catalog Number
Red	NO	M22-DH-R-K10	M22S-DH-R-K10	M22M-DH-R-K10
	NC	M22-DH-R-K01	M22S-DH-R-K01	M22M-DH-R-K01
	2NO	M22-DH-R-K20	M22S-DH-R-K20	M22M-DH-R-K20
	2NC	M22-DH-R-K02	M22S-DH-R-K02	M22M-DH-R-K02
	1NO-1NC	M22-DH-R-K11	M22S-DH-R-K11	M22M-DH-R-K11

M22-DGH-R-K10



Silver Guarded

Button Color	Contact Block Configuration ^①	Silver Bezel Catalog Number
Red	NO	M22-DGH-R-K10
	NC	M22-DGH-R-K01
	2NO	M22-DGH-R-K20
	2NC	M22-DGH-R-K02
	1NO-1NC	M22-DGH-R-K11

M22-DH-R



M22S-DH-R



M22M-DH-R



Operators Only ^②

Button Color	Inscription	Silver Bezel Catalog Number	Black Bezel Catalog Number	Metal Bezel Catalog Number
Black	—	M22-DH-S	M22S-DH-S	M22M-DH-S
Red	—	M22-DH-R	M22S-DH-R	M22M-DH-R
	STOP	M22-DH-R-GB0	M22S-DH-R-GB0	M22M-DH-R-GB0
	⊙	M22-DH-R-X0	M22S-DH-R-X0	M22M-DH-R-X0
Green	—	M22-DH-G	M22S-DH-G	M22M-DH-G
White	—	M22-DH-W	M22S-DH-W	M22M-DH-W
Blue	—	M22-DH-B	M22S-DH-B	M22M-DH-B
Yellow	—	M22-DH-Y	M22S-DH-Y	M22M-DH-Y
③	—	M22-DH-X-SRGR	M22S-DH-X-SRGR	M22M-DH-X-SRGR
④	—	M22-DH-X-SWRGRYB	M22S-DH-X-SWRGRYB	M22M-DH-X-SWRGRYB

M22-DGH-R-K10



Silver Guarded

Button Color	Inscription	Silver Bezel Catalog Number
Black	—	M22-DGH-S
Red	—	M22-DGH-R
	STOP	M22-DGH-R-GB0
	⊙	M22-DGH-R-X0
Green	—	M22-DGH-G
White	—	M22-DGH-W
Blue	—	M22-DGH-B
Yellow	—	M22-DGH-Y

Notes

- ① All NC contact blocks are positively driven contact. ⊖
- ② Includes contact block mounting adapter.
- ③ Buttonless operator comes with three color buttons (black, red, green).
- ④ Buttonless operator comes with all six color buttons (black, white, red, green, yellow, blue).

Non-Illuminated Pushbuttons, Extended, Momentary

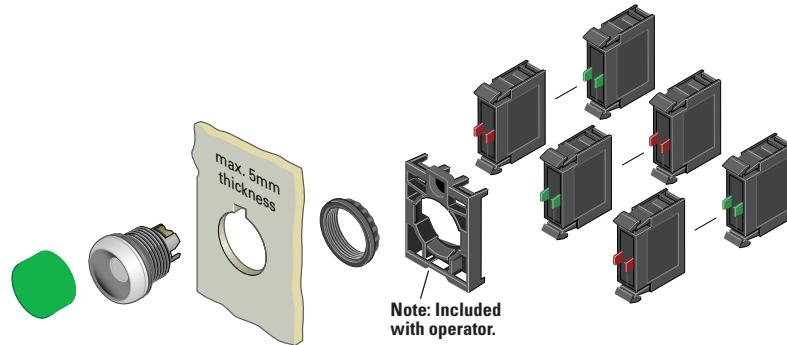

Components

M22-XDH-R



Button Plates ^①

Color	Inscription	Catalog Number
Black	—	M22-XDH-S ^②
	Custom	M22-XDH-S-ETCH ^③
	STOP	M22-XDH-S-GB0
	START	M22-XDH-S-GB1
	CLOSE	M22-XDH-S-GB2
	UP	M22-XDH-S-GB3
	DOWN	M22-XDH-S-GB4
	OFF	M22-XDH-S-GB5
	ON	M22-XDH-S-GB6
	TEST	M22-XDH-S-GB9
	FORWARD	M22-XDH-S-GB15
	REVERSE	M22-XDH-S-GB16
	RAISE	M22-XDH-S-GB17
	LOWER	M22-XDH-S-GB18
	⊙	M22-XDH-S-X0
	①	M22-XDH-S-X1
	②	M22-XDH-S-X2
	+	M22-XDH-S-X4
	−	M22-XDH-S-X5
①	M22-XDH-S-X7	
Red	—	M22-XDH-R ^②
	Custom	M22-XDH-R-ETCH ^③
	STOP	M22-XDH-R-GB0
	OFF	M22-XDH-R-GB5
Green	—	M22-XDH-G ^②
	Custom	M22-XDH-G-ETCH ^③
	START	M22-XDH-G-GB1
Blue	ON	M22-XDH-G-GB6
	①	M22-XDH-G-X1
	—	M22-XDH-B ^②
	Custom	M22-XDH-B-ETCH ^③
White	RESET	M22-XDH-B-GB14
	Ⓜ	M22-XDH-B-X6
	—	M22-XDH-W ^②
Yellow	Custom	M22-XDH-W-ETCH ^③
	START	M22-XDH-W-GB1
	①	M22-XDH-W-X1
Black, red, green	—	M22-XDH-Y ^②
	Custom	M22-XDH-Y-ETCH ^③
Black, white, red, green, yellow, blue	—	M22-XDH-SRG
	—	M22-XDH-SWRGYB

Buttonless Operator



Silver Bezel
Catalog
Number ^④

M22-D-X



Black Bezel
Catalog
Number ^④

M22S-D-X



Metal Bezel
Catalog
Number ^④

M22M-D-X

Silver Guarded



Silver Bezel
Catalog
Number ^④

M22-DG-X

M22-K10



M22-FK01



Contact Blocks ^①

Terminal Type	Contact Configuration ^⑤	Catalog Number
Screw	NO	M22-K10
	NO, early-make	M22-K10P
	NC	M22-K01
	NC, late-break	M22-K01D
Spring-cage	NO	M22-CK10
	NC	M22-CK01
	NC, late-break	M22-CK01D
	2NO	M22-CK20
	2NC	M22-CK02
	NO-NC	M22-CK11
	NC	M22-FK01 ^⑥
	NO	M22-FK10 ^⑥

Notes

- ① For complete listing of available button plates and contact blocks, see Accessories, Pages V7-T1-111 to V7-T1-116.
- ② Minimum order quantity of (10).
- ③ When ordering, specify inscription per catalog number suffix from the Symbols Library (see Pages V7-T1-129 to V7-T1-136) into the Order Notes. For example, M22-XDH-S-ETCH; Order Notes: Mark with symbol X91, Line item #...
- ④ Includes contact block mounting adapter.
- ⑤ All NC contact blocks are positively driven contact. ⊖
- ⑥ Additional contacts may not be stacked behind M22-F type contact blocks, M22-F can be stacked behind standard M22 contacts only.

1 Non-Illuminated Pushbuttons, Extended, Maintained ^①

Operators Only ^②

M22-DRH-W



M22S-DRH-W



M22M-DRH-W



Button Color	Silver Bezel Catalog Number	Black Bezel Catalog Number	Metal Bezel Catalog Number
Black	M22-DRH-S	M22S-DRH-S	M22M-DRH-S
Red	M22-DRH-R	M22S-DRH-R	M22M-DRH-R
Green	M22-DRH-G	M22S-DRH-G	M22M-DRH-G
White	M22-DRH-W	M22S-DRH-W	M22M-DRH-W
Blue	M22-DRH-B	M22S-DRH-B	M22M-DRH-B
Yellow	M22-DRH-Y	M22S-DRH-Y	M22M-DRH-Y
^③	M22-DRH-X-SRG	M22S-DRH-X-SRG	M22M-DRH-X-SRG
^④	M22-DRH-X-SWRGYB	M22S-DRH-X-SWRGYB	M22M-DRH-X-SWRGYB

Notes

- ^① Maintained pushbuttons can be converted in the field to momentary operation by switching the locking ring, which is accessible through the side of the operator body.
- ^② Includes contact block mounting adapter.
- ^③ Buttonless operator comes with three color buttons (black, red, green).
- ^④ Buttonless operator comes with all six color buttons (black, white, red, green, yellow, blue).

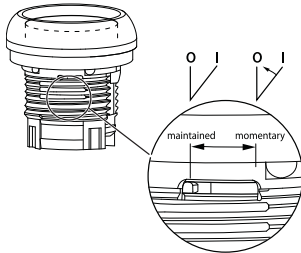

Note: This pilot device features a selectable function switch that enables the device to be set to either maintained or momentary operation.

Non-Illuminated Pushbuttons, Extended, Maintained ^①

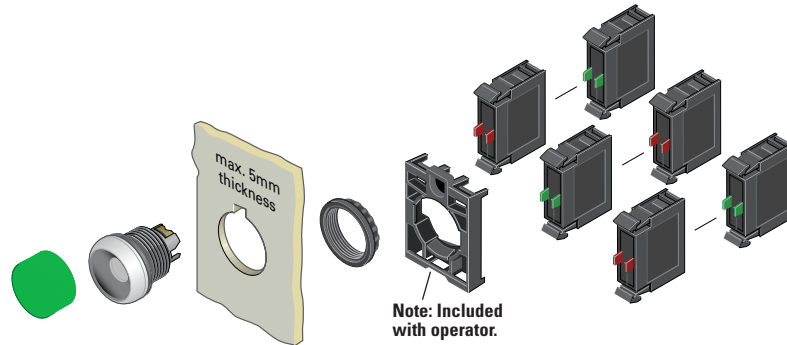

Components

M22-XDH-W



Button Plates ^②

Color	Inscription	Catalog Number
Black	—	M22-XDH-S ^③
	Custom	M22-XDH-S-ETCH ^④
	STOP	M22-XDH-S-GB0
	START	M22-XDH-S-GB1
	CLOSE	M22-XDH-S-GB2
	UP	M22-XDH-S-GB3
	DOWN	M22-XDH-S-GB4
	OFF	M22-XDH-S-GB5
	ON	M22-XDH-S-GB6
	TEST	M22-XDH-S-GB9
	FORWARD	M22-XDH-S-GB15
	REVERSE	M22-XDH-S-GB16
	RAISE	M22-XDH-S-GB17
	LOWER	M22-XDH-S-GB18
	⊙	M22-XDH-S-X0
	⓪	M22-XDH-S-X1
	Ⓛ	M22-XDH-S-X2
⊕	M22-XDH-S-X4	
⊖	M22-XDH-S-X5	
Ⓜ	M22-XDH-S-X7	
Red	—	M22-XDH-R ^③
	Custom	M22-XDH-R-ETCH ^④
	STOP	M22-XDH-R-GB0
	OFF	M22-XDH-R-GB5
	⊙	M22-XDH-R-X0
	Green	—
Blue	Custom	M22-XDH-G-ETCH ^④
	START	M22-XDH-G-GB1
	ON	M22-XDH-G-GB6
	⓪	M22-XDH-G-X1
	RESET	M22-XDH-B-ETCH ^④
White	RESET	M22-XDH-B-GB14
	Ⓜ	M22-XDH-B-X6
	—	M22-XDH-W ^③
Yellow	Custom	M22-XDH-W-ETCH ^④
	START	M22-XDH-W-GB1
	⓪	M22-XDH-W-X1
	—	M22-XDH-Y ^③
Black, red, green	—	M22-XDH-Y-ETCH ^④
Black, red, green	—	M22-XDH-SRG
Black, white, red, green, yellow, blue	—	M22-XDH-SWRGYB

Buttonless Operator



Silver Bezel
Catalog Number ^⑤

M22-DR-X



Black Bezel
Catalog Number ^⑤

M22S-DR-X



Metal Bezel
Catalog Number ^⑤

M22M-DR-X

M22-K10



M22-FK01



Contact Blocks ^②

Terminal Type	Contact Configuration ^⑥	Catalog Number
Screw	NO	M22-K10
	NO, early-make	M22-K10P
	NC	M22-K01
	NC, late-break	M22-K01D
Spring-cage	NO	M22-CK10
	NC	M22-CK01
	NC, late-break	M22-CK01D
	2NO	M22-CK20
	2NC	M22-CK02
	NO-NC	M22-CK11
	NC	M22-FK01 ^⑦
	NO	M22-FK10 ^⑦

Notes

- ^① Maintained pushbuttons can be converted in the field to momentary operation by switching the locking ring, which is accessible through the side of the operator body.
- ^② For complete listing of available button plates and contact blocks, see Accessories, Pages V7-T1-111 to V7-T1-116.
- ^③ Minimum order quantity of (10).
- ^④ When ordering, specify inscription per catalog number suffix from the Symbols Library (see Pages V7-T1-129 to V7-T1-136) into the Order Notes. For example, M22-XDH-S-ETCH; Order Notes: Mark with symbol X91, Line item #_.
- ^⑤ Includes contact block mounting adapter.
- ^⑥ All NC contact blocks are positively driven contact. ⊖
- ^⑦ Additional contacts may not be stacked behind M22-F type contact blocks, M22-F can be stacked behind standard M22 contacts only.

1

Catalog Number Selection

Catalog Number Selection is for illustrative purposes only and not to be used to create new catalog numbers.

Illuminated Pushbuttons

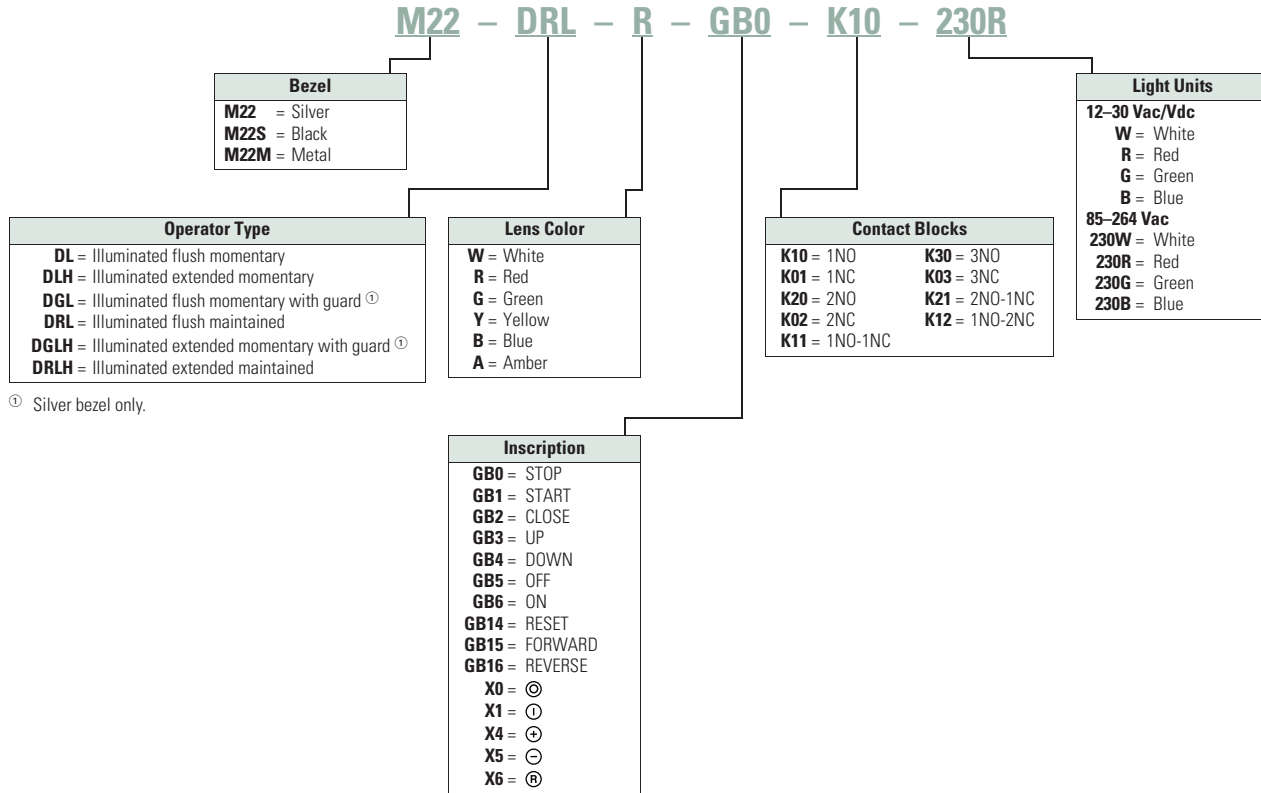

Product Selection

Illuminated Pushbuttons, Flush, Momentary

M22-DL-G-K01-G



M22S-DL-G-K01-G



M22M-DL-G-K01-G



Complete Devices

Button Color	Contact Block Configuration ^①	Light Unit Voltage	Silver Bezel Catalog Number	Black Bezel Catalog Number	Metal Bezel Catalog Number
Red	NC	12–30 Vac/Vdc	M22-DL-R-K01-R	M22S-DL-R-K01-R	M22M-DL-R-K01-R
	NC	85–264 Vac	M22-DL-R-K01-230R	M22S-DL-R-K01-230R	M22M-DL-R-K01-230R
	2NC	12–30 Vac/Vdc	M22-DL-R-K02-R	M22S-DL-R-K02-R	M22M-DL-R-K02-R
	2NC	85–264 Vac	M22-DL-R-K02-230R	M22S-DL-R-K02-230R	M22M-DL-R-K02-230R
	1NO/1NC	12–30 Vac/Vdc	M22-DL-R-K11-R	M22S-DL-R-K11-R	M22M-DL-R-K11-R
	1NO/1NC	85–264 Vac	M22-DL-R-K11-230R	M22S-DL-R-K11-230R	M22M-DL-R-K11-230R
Green	NO	12–30 Vac/Vdc	M22-DL-G-K10-G	M22S-DL-G-K10-G	M22M-DL-G-K10-G
	NO	85–264 Vac	M22-DL-G-K10-230G	M22S-DL-G-K10-230G	M22M-DL-G-K10-230G
	2NO	12–30 Vac/Vdc	M22-DL-G-K20-G	M22S-DL-G-K20-G	M22M-DL-G-K20-G
	2NO	85–264 Vac	M22-DL-G-K20-230G	M22S-DL-G-K20-230G	M22M-DL-G-K20-230G
	1NO/1NC	12–30 Vac/Vdc	M22-DL-G-K11-G	M22S-DL-G-K11-G	M22M-DL-G-K11-G
	1NO/1NC	85–264 Vac	M22-DL-G-K11-230G	M22S-DL-G-K11-230G	M22M-DL-G-K11-230G
White	NO	12–30 Vac/Vdc	M22-DL-W-K10-W	M22S-DL-W-K10-W	—
	NO	85–264 Vac	M22-DL-W-K10-230W	M22S-DL-W-K10-230W	M22M-DL-W-K10-230W
	2NO	12–30 Vac/Vdc	M22-DL-W-K20-W	M22S-DL-W-K20-W	—
	2NO	85–264 Vac	M22-DL-W-K20-230W	M22S-DL-W-K20-230W	M22M-DL-W-K20-230W
	1NO/1NC	12–30 Vac/Vdc	M22-DL-W-K11-W	M22S-DL-W-K11-W	—
	1NO/1NC	85–264 Vac	M22-DL-W-K11-230W	M22S-DL-W-K11-230W	M22M-DL-W-K11-230W

Note

^① All NC contact blocks are positively driven contact. ⊖

1

Illuminated Pushbuttons, Flush, Momentary

M22-DL-G



M22S-DL-G



M22M-DL-G



Operators Only [Ⓢ]

Button Color	Silver Bezel Catalog Number	Black Bezel Catalog Number	Metal Bezel Catalog Number
Red	M22-DL-R	M22S-DL-R	M22M-DL-R
Green	M22-DL-G	M22S-DL-G	M22M-DL-G
White	M22-DL-W	M22S-DL-W	M22M-DL-W
Blue	M22-DL-B	M22S-DL-B	M22M-DL-B
Yellow	M22-DL-Y	M22S-DL-Y	M22M-DL-Y
Amber	M22-DL-A	M22S-DL-A	M22M-DL-A

M22-DGL-G



Silver Guarded

Button Color	Silver Bezel Catalog Number
Red	M22-DGL-R
Green	M22-DGL-G
White	M22-DGL-W
Blue	M22-DGL-B
Yellow	M22-DGL-Y

Note

[Ⓢ] Includes contact block mounting adapter.

Illuminated Pushbuttons, Flush, Momentary

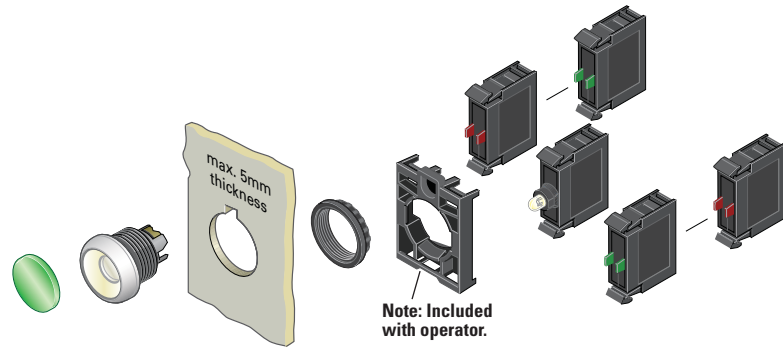

Components

M22-XDL-G



Button Lenses ^①

Color	Inscription	Catalog Number
Red	—	M22-XDL-R ^②
	Custom	M22-XDL-R-ETCH ^③
	STOP	M22-XDL-R-GB0
	OFF	M22-XDL-R-GB5
	Ⓞ	M22-XDL-R-X0
Green	—	M22-XDL-G ^②
	Custom	M22-XDL-G-ETCH ^③
	START	M22-XDL-G-GB1
	ON	M22-XDL-G-GB6
	Ⓛ	M22-XDL-G-X1
Blue	—	M22-XDL-B ^②
	Custom	M22-XDL-B-ETCH ^③
	RESET	M22-XDL-B-GB14
	Ⓜ	M22-XDL-B-X6
White	—	M22-XDL-W ^②
Yellow	Custom	M22-XDL-W-ETCH ^③
	—	M22-XDL-Y ^②
Amber	Custom	M22-XDL-Y-ETCH ^③
	—	M22-XDL-A
	Custom	M22-XDL-A-ETCH

M22-DL-X



Buttonless Operator

Silver Bezel Catalog Number ^④	Black Bezel Catalog Number ^④	Metal Bezel Catalog Number ^④
M22-DL-X	M22S-DL-X	M22M-DL-X

M22S-DL-X



M22M-DL-X



M22-DGL-X



Silver Guarded

Silver Bezel Catalog Number ^④
M22-DGL-X

M22-LED-W



Light Units ^①

Terminal Type	LED Color	Light Unit Voltage	Catalog Number
Screw	White	12–30 Vac/Vdc	M22-LED-W
	Red		M22-LED-R
	Green		M22-LED-G
	Blue		M22-LED-B
Screw	White	85–264 Vac	M22-LED230-W
	Red		M22-LED230-R
	Green		M22-LED230-G
Spring-cage	Blue		M22-LED230-B
	White	12–30 Vac/Vdc	M22-FLED-W
	Red		M22-FLED-R
	Green		M22-FLED-G
	Blue		M22-FLED-B
	Red/Green/Yellow	24 Vdc	M22-FLED-RG ^⑤
	Red, Green, Blue, Yellow, White, Violet, Turquoise		M22-FLED-RGB ^⑤

M22-FLED-



M22-K10



Contact Blocks ^①

Terminal Type	Contact Configuration ^⑥	Catalog Number
Screw	NO	M22-K10
	NO, early-make	M22-K10P
	NC	M22-K01
	NC, late-break	M22-K01D
Spring-cage	NO	M22-CK10
	NC	M22-CK01
	NC, late-break	M22-CK01D
	2NO	M22-CK20
	2NC	M22-CK02
	NO-NC	M22-CK11
	NC	M22-FK01 ^⑦
	NO	M22-FK10 ^⑦

M22-FK01



Notes

- For complete listing of available button lenses, light units and contact blocks, see Accessories, **Pages V7-T1-111 to V7-T1-116**.
- Minimum order quantity of (10).
- When ordering, specify inscription per catalog number suffix from the Symbols Library (see **Pages V7-T1-129 to V7-T1-136**) into the Order Notes. For example, M22-XDL-R-ETCH; Order Notes: Mark with symbol X91, Line item #_.
- Includes contact block mounting adapter.
- Please see color input key on **Page V7-T1-114**.
- All NC contact blocks are positively driven contact. Ⓞ
- Additional contacts may not be stacked behind M22-F type contact blocks, M22-F can be stacked behind standard M22 contacts only.

1

Illuminated Pushbuttons, Flush, Maintained^①

M22-DRL-W-K10-W



M22S-DRL-W-K10-W



M22M-DRL-W-K10-W



Complete Devices

Button Color	Contact Block Configuration ^②	Light Unit Voltage	Silver Bezel Catalog Number	Black Bezel Catalog Number	Metal Bezel Catalog Number
White	NO	12–30 Vac/Vdc	M22-DRL-W-K10-W	M22S-DRL-W-K10-W	M22M-DRL-W-K10-W
	NO	85–264 Vac	M22-DRL-W-K10-230W	M22S-DRL-W-K10-230W	M22M-DRL-W-K10-230W
	NC	12–30 Vac/Vdc	M22-DRL-W-K01-W	M22S-DRL-W-K01-W	M22M-DRL-W-K01-W
	NC	85–264 Vac	M22-DRL-W-K01-230W	M22S-DRL-W-K01-230W	M22M-DRL-W-K01-230W
	2NO	12–30 Vac/Vdc	M22-DRL-W-K20-W	M22S-DRL-W-K20-W	M22M-DRL-W-K20-W
	2NO	85–264 Vac	M22-DRL-W-K20-230W	M22S-DRL-W-K20-230W	M22M-DRL-W-K20-230W
	2NC	12–30 Vac/Vdc	M22-DRL-W-K02-W	M22S-DRL-W-K02-W	M22M-DRL-W-K02-W
	2NC	85–264 Vac	M22-DRL-W-K02-230W	M22S-DRL-W-K02-230W	M22M-DRL-W-K02-230W
	1NO/1NC	12–30 Vac/Vdc	M22-DRL-W-K11-W	M22S-DRL-W-K11-W	M22M-DRL-W-K11-W
	1NO/1NC	85–264 Vac	M22-DRL-W-K11-230W	M22S-DRL-W-K11-230W	M22M-DRL-W-K11-230W

M22-DRL-W



M22S-DRL-W



M22M-DRL-W



Operators Only^③

Button Color	Silver Bezel Catalog Number	Black Bezel Catalog Number	Metal Bezel Catalog Number
Red	M22-DRL-R	M22S-DRL-R	M22M-DRL-R
Green	M22-DRL-G	M22S-DRL-G	M22M-DRL-G
White	M22-DRL-W	M22S-DRL-W	M22M-DRL-W
Blue	M22-DRL-B	M22S-DRL-B	M22M-DRL-B
Yellow	M22-DRL-Y	M22S-DRL-Y	M22M-DRL-Y
Amber	M22-DRL-A	M22S-DRL-A	M22M-DRL-A

Notes

- ① Maintained pushbuttons can be converted in the field to momentary operation by switching the locking ring, which is accessible through the side of the operator body.
- ② All NC contact blocks are positively driven contact.
- ③ Includes contact block mounting adapter.

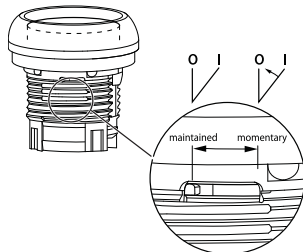

Note: This pilot device features a selectable function switch that enables the device to be set to either maintained or momentary operation.

Illuminated Pushbuttons, Flush, Maintained ①

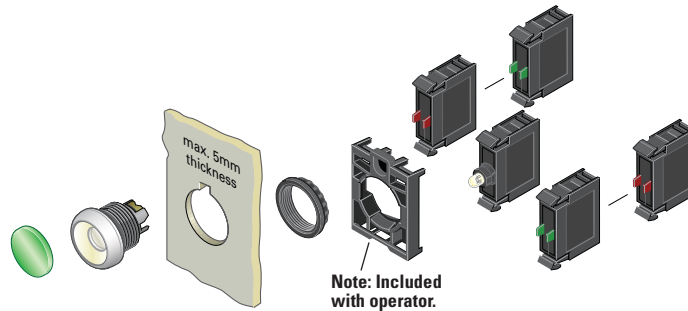

Components

M22-XDL-W



Button Lenses ②

Color	Inscription	Catalog Number
Red	—	M22-XDL-R ③
	Custom	M22-XDL-R-ETCH ④
	STOP	M22-XDL-R-GB0
	OFF	M22-XDL-R-GB5
	Ⓞ	M22-XDL-R-X0
Green	—	M22-XDL-G ③
	Custom	M22-XDL-G-ETCH ④
	START	M22-XDL-G-GB1
	ON	M22-XDL-G-GB6
	Ⓛ	M22-XDL-G-X1
Blue	—	M22-XDL-B ③
	Custom	M22-XDL-B-ETCH ④
	RESET	M22-XDL-B-GB14
	Ⓟ	M22-XDL-B-X6
	White	—
Yellow	Custom	M22-XDL-W-ETCH ④
	—	M22-XDL-Y ③
Amber	Custom	M22-XDL-Y-ETCH ④
	—	M22-XDL-A
	Custom	M22-XDL-A-ETCH

M22-LED-W



Light Units ②

Terminal Type	LED Color	Light Unit Voltage	Catalog Number
Screw	White	12–30 Vac/Vdc	M22-LED-W
	Red		M22-LED-R
	Green		M22-LED-G
	Blue		M22-LED-B
Screw	White	85–264 Vac	M22-LED230-W
	Red		M22-LED230-R
	Green		M22-LED230-G
Spring-cage	Blue	12–30 Vac/Vdc	M22-LED230-B
	White		M22-FLED-W
	Red		M22-FLED-R
	Green		M22-FLED-G
	Blue		M22-FLED-B
	Red/Green/Yellow		24 Vdc
	Red, Green, Blue, Yellow, White, Violet, Turquoise	M22-FLED-RGB ⑥	

M22-FLED-



M22-K10



Contact Blocks ②

Terminal Type	Contact Configuration ⑦	Catalog Number
Screw	NO	M22-K10
	NO, early-make	M22-K10P
	NC	M22-K01
	NC, late-break	M22-K01D
Spring-cage	NO	M22-CK10
	NC	M22-CK01
	NC, late-break	M22-CK01D
	2NO	M22-CK20
	2NC	M22-CK02
	NO-NC	M22-CK11
	NC	M22-FK01 ⑧
	NO	M22-FK10 ⑧

M22-DRL-X



Buttonless Operator

Silver Bezel Catalog Number ⑤	Black Bezel Catalog Number ⑤	Metal Bezel Catalog Number ⑤
M22-DRL-X	M22S-DRL-X	M22M-DRL-X

M22S-DRL-X



M22M-DRL-X



M22-FK01



Notes

- ① Maintained pushbuttons can be converted in the field to momentary operation by switching the locking ring, which is accessible through the side of the operator body.
- ② For complete listing of available button lenses, light units and contact blocks, see Accessories, Pages V7-T1-111 to V7-T1-116.
- ③ Minimum order quantity of (10).
- ④ When ordering, specify inscription per catalog number suffix from the Symbols Library (see Pages V7-T1-129 to V7-T1-136) into the Order Notes. For example, M22-XDL-R-ETCH; Order Notes: Mark with symbol X91, Line item #_.
- ⑤ Includes contact block mounting adapter.
- ⑥ Please see color input key on Page V7-T1-114.
- ⑦ All NC contact blocks are positively driven contact. Ⓞ
- ⑧ Additional contacts may not be stacked behind M22-F type contact blocks, M22-F can be stacked behind standard M22 contacts only.

1

Illuminated Pushbuttons, Extended, Momentary

M22-DLH-R-K11-R



M22S-DLH-R-K11-R



Complete Devices

Button Color	Contact Block Configuration ^①	Light Unit Voltage	Silver Bezel Catalog Number	Black Bezel Catalog Number	Metal Bezel Catalog Number
Red	1NO/1NC	12–30 Vac/Vdc	M22-DLH-R-K11-R	M22S-DLH-R-K11-R	M22M-DLH-R-K11-R
	1NO/1NC	85–264 Vac	M22-DLH-R-K11-230R	M22S-DLH-R-K11-230R	M22M-DLH-R-K11-230R
Green	2NO	12–30 Vac/Vdc	M22-DLH-G-K20-G	M22S-DLH-G-K20-G	M22M-DLH-G-K20-G
	2NO	85–264 Vac	M22-DLH-G-K20-230G	M22S-DLH-G-K20-230G	M22M-DLH-G-K20-230G
White	2NO	12–30 Vac/Vdc	M22-DLH-W-K20-W	M22S-DLH-W-K20-W	M22M-DLH-W-K20-W
	2NO	85–264 Vac	M22-DLH-W-K20-230W	M22S-DLH-W-K20-230W	M22M-DLH-W-K20-230W

Complete Press-to-Test Units

Button Color	Light Unit Voltage	Silver Bezel Catalog Number	Black Bezel Catalog Number
Red	12–30 Vac/Vdc	M22-T-R-R	M22S-T-R-R
Blue		M22-T-B-B	M22S-T-B-B
Yellow		M22-T-Y-W	M22S-T-Y-W
Green		M22-T-G-G	M22S-T-G-G
White		M22-T-W-W	M22S-T-W-W
Red	85–264 Vac	M22-T-R-230R	M22S-T-R-230R
Blue		M22-T-R-230B	M22S-T-B-230B
Yellow		M22-T-Y-230W	M22S-T-Y-230W
Green		M22-T-G-230G	M22S-T-G-230G
White		M22-T-W-230W	M22S-T-W-230W

Operators Only ^②

Button Color	Silver Bezel Catalog Number	Black Bezel Catalog Number	Metal Bezel Catalog Number
Red	M22-DLH-R	M22S-DLH-R	M22M-DLH-R
Green	M22-DLH-G	M22S-DLH-G	M22M-DLH-G
White	M22-DLH-W	M22S-DLH-W	M22M-DLH-W
Blue	M22-DLH-B	M22S-DLH-B	M22M-DLH-B
Yellow	M22-DLH-Y	M22S-DLH-Y	M22M-DLH-Y
Amber	M22-DLH-A	M22S-DLH-A	M22M-DLH-A

M22-DLH-R



M22S-DLH-R



M22M-DLH-R



M22-DGLH-R



Silver Guarded

Button Color	Silver Bezel Catalog Number
Red	M22-DGLH-R
Green	M22-DGLH-G
White	M22-DGLH-W
Blue	M22-DGLH-B
Yellow	M22-DGLH-Y

Notes

- ① All NC contact blocks are positively driven contact. ⊖
- ② Includes contact block mounting adapter.

Illuminated Pushbuttons, Extended, Momentary

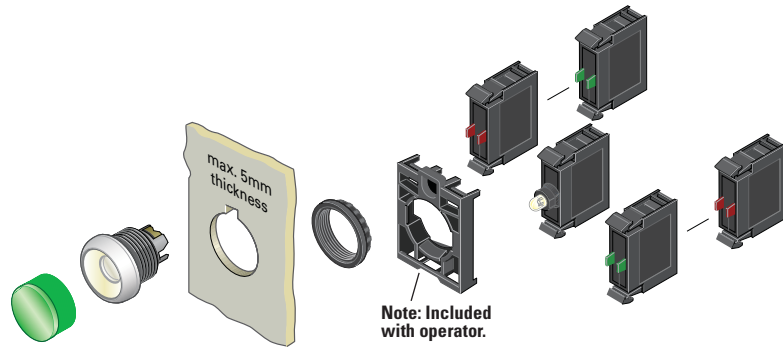

Components

M22-XDH-R



Button Lenses ①

Color	Inscription	Catalog Number
Red	—	M22-XDLH-R ②
	Custom	M22-XDLH-R-ETCH ③
	STOP	M22-XDLH-R-GB0
	OFF	M22-XDLH-R-GB5
	Ⓞ	M22-XDLH-R-X0
Green	—	M22-XDLH-G ②
	Custom	M22-XDLH-G-ETCH ③
	START	M22-XDLH-G-GB1
	ON	M22-XDLH-G-GB6
	Ⓛ	M22-XDLH-G-X1
Blue	—	M22-XDLH-B ②
	Custom	M22-XDLH-B-ETCH ③
	RESET	M22-XDLH-B-GB14
	Ⓜ	M22-XDLH-B-X6
White	—	M22-XDLH-W ②
Yellow	Custom	M22-XDLH-W-ETCH ③
	—	M22-XDLH-Y ②
Amber	Custom	M22-XDLH-Y-ETCH ③
	—	M22-XDLH-A
	Custom	M22-XDLH-A-ETCH

M22-DL-X



Buttonless Operator

Silver Bezel Catalog Number ④	Black Bezel Catalog Number ④	Metal Bezel Catalog Number ④
M22-DL-X	M22S-DL-X	M22M-DL-X

M22S-DL-X



M22M-DL-X



M22-DGL-X



Silver Guarded

Silver Bezel Catalog Number ④
M22-DGL-X

M22-LED-W



M22-FLED-__



Light Units ①

Terminal Type	LED Color	Light Unit Voltage	Catalog Number
Screw	White	12–30 Vac/Vdc	M22-LED-W
	Red		M22-LED-R
	Green		M22-LED-G
	Blue		M22-LED-B
Screw	White	85–264 Vac	M22-LED230-W
	Red		M22-LED230-R
	Green		M22-LED230-G
Spring-cage	White	12–30 Vac/Vdc	M22-FLED-W
	Red		M22-FLED-R
	Green	M22-FLED-G	
	Blue	M22-FLED-B	
	Red/Green/Yellow	24 Vdc	M22-FLED-RG ⑤
	Red, Green, Blue, Yellow, White, Violet, Turquoise		M22-FLED-RGB ⑤

M22-K10



M22-FK01



Contact Blocks ①

Terminal Type	Contact Configuration ⑥	Catalog Number
Screw	NO	M22-K10
	NO, early-make	M22-K10P
	NC	M22-K01
	NC, late-break	M22-K01D
Spring-cage	NO	M22-CK10
	NC	M22-CK01
	NC, late-break	M22-CK01D
	2NO	M22-CK20
	2NC	M22-CK02
	NO-NC	M22-CK11
	NC	M22-FK01 ⑦
NO	M22-FK10 ⑦	

Notes

- ① For complete listing of available button lenses, light units and contact blocks, see Accessories, Pages V7-T1-111 to V7-T1-116.
- ② Minimum order quantity of (10).
- ③ When ordering, specify inscription per catalog number suffix from the Symbols Library (see Pages V7-T1-129 to V7-T1-136) into the Order Notes. For example, M22-XDH-S-ETCH; Order Notes: Mark with symbol X91, Line item # __.
- ④ Includes contact block mounting adapter.
- ⑤ Please see color input key on Page V7-T1-114.
- ⑥ All NC contact blocks are positively driven contact. ⊖
- ⑦ Additional contacts may not be stacked behind M22-F type contact blocks, M22-F can be stacked behind standard M22 contacts only.

1

Illuminated Pushbuttons, Extended, Maintained ^①

M22-DRLH-W



M22S-DRLH-W



M22M-DRLH-W



Operators Only ^②

Button Color	Silver Bezel Catalog Number	Black Bezel Catalog Number	Metal Bezel Catalog Number
Red	M22-DRLH-R	M22S-DRLH-R	M22M-DRLH-R
Green	M22-DRLH-G	M22S-DRLH-G	M22M-DRLH-G
White	M22-DRLH-W	M22S-DRLH-W	M22M-DRLH-W
Blue	M22-DRLH-B	M22S-DRLH-B	M22M-DRLH-B
Yellow	M22-DRLH-Y	M22S-DRLH-Y	M22M-DRLH-Y
Amber	M22-DRLH-A	M22S-DRLH-A	M22M-DRLH-A

Notes

- ① Maintained pushbuttons can be converted in the field to momentary operation by switching the locking ring, which is accessible through the side of the operator body.
- ② Includes contact block mounting adapter.

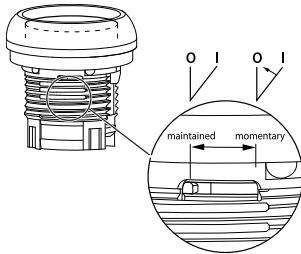

Note: This pilot device features a selectable function switch that enables the device to be set to either maintained or momentary operation.

Illuminated Pushbuttons, Extended, Maintained ^①

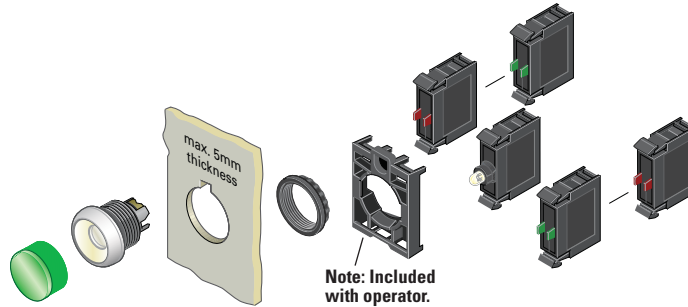

Components

M22-XDLH-W



Button Lenses ^②

Color	Inscription	Catalog Number
Red	—	M22-XDLH-R ^③
	Custom	M22-XDLH-R-ETCH ^④
	STOP	M22-XDLH-R-GB0
	OFF	M22-XDLH-R-GB5
	⊙	M22-XDLH-R-X0
Green	—	M22-XDLH-G ^③
	Custom	M22-XDLH-G-ETCH ^④
	START	M22-XDLH-G-GB1
	ON	M22-XDLH-G-GB6
	⓪	M22-XDLH-G-X1
Blue	—	M22-XDLH-B ^③
	Custom	M22-XDLH-B-ETCH ^④
	RESET	M22-XDLH-B-GB14
	Ⓜ	M22-XDLH-B-X6
White	—	M22-XDLH-W ^③
Yellow	Custom	M22-XDLH-W-ETCH ^④
	—	M22-XDLH-Y ^③
Amber	—	M22-XDLH-A
	Custom	M22-XDLH-A-ETCH

Buttonless Operator

Silver Bezel Catalog Number ^⑤	Black Bezel Catalog Number ^⑤	Metal Bezel Catalog Number ^⑤
M22-DRL-X	M22S-DRL-X	M22M-DRL-X

M22-DRL-X



M22S-DRL-X



M22M-DRL-X



M22-LED-W



M22-FLED-__



Light Units ^②

Terminal Type	LED Color	Light Unit Voltage	Catalog Number
Screw	White	12–30 Vac/Vdc	M22-LED-W
	Red		M22-LED-R
	Green		M22-LED-G
	Blue		M22-LED-B
Screw	White	85–264 Vac	M22-LED230-W
	Red		M22-LED230-R
	Green		M22-LED230-G
Spring-cage	White	12–30 Vac/Vdc	M22-FLED-W
	Red		M22-FLED-R
	Green	M22-FLED-G	
	Blue	M22-FLED-B	
	Red/Green/ Yellow	24 Vdc	M22-FLED-RG ^⑥
	Red, Green, Blue, Yellow, White, Violet, Turquoise		M22-FLED-RGB ^⑥

M22-K10



M22-FK01



Contact Blocks ^②

Terminal Type	Contact Configuration ^⑦	Catalog Number
Screw	NO	M22-K10
	NO, early-make	M22-K10P
	NC	M22-K01
	NC, late-break	M22-K01D
Spring-cage	NO	M22-CK10
	NC	M22-CK01
	NC, late-break	M22-CK01D
	2NO	M22-CK20
	2NC	M22-CK02
	NO-NC	M22-CK11
	NC	M22-FK01 ^⑧
	NO	M22-FK10 ^⑧

Notes

- ① Maintained pushbuttons can be converted in the field to momentary operation by switching the locking ring, which is accessible through the side of the operator body.
- ② For complete listing of available button lenses, light units and contact blocks, see Accessories, **Pages V7-T1-111 to V7-T1-116**.
- ③ Minimum order quantity of (10).
- ④ When ordering, specify inscription per catalog number suffix from the Symbols Library (see **Pages V7-T1-129 to V7-T1-136**) into the Order Notes. For example, M22-XDLH-S-ETCH; Order Notes: Mark with symbol X91, Line item #_.
- ⑤ Includes contact block mounting adapter.
- ⑥ Please see color input key on **Page V7-T1-114**.
- ⑦ All NC contact blocks are positively driven contact. ⊖
- ⑧ Additional contacts may not be stacked behind M22-F type contact blocks, M22-F can be stacked behind standard M22 contacts only.

1

Indicating Lights

Product Description

Eaton's M22 indicating lights use the combination of a durable, bright LED unit and modern lenses designed specifically for this type of LED to create a bright and visible indicating light.

As with the pushbuttons, the indicating light lenses can be laser engraved. Indicating lights can be ordered as complete devices, including lens and LED unit, or as modular components.

Features

- Customizable laser engraving on all lenses
- LED offering only for improved brightness quality and up to 100,000 hours of operation
- Lenses designed specifically for LED illumination
- Modular construction makes assembly fast and simplifies stocking of components and complete devices
- Capable of communicating via ASi protocol with ASi adapter modules

Protection Type

- IP67, IP69K
- NEMA 4X, 13

Catalog Number Selection

Catalog Number Selection is for illustrative purposes only and not to be used to create new catalog numbers.

Indicating Lights

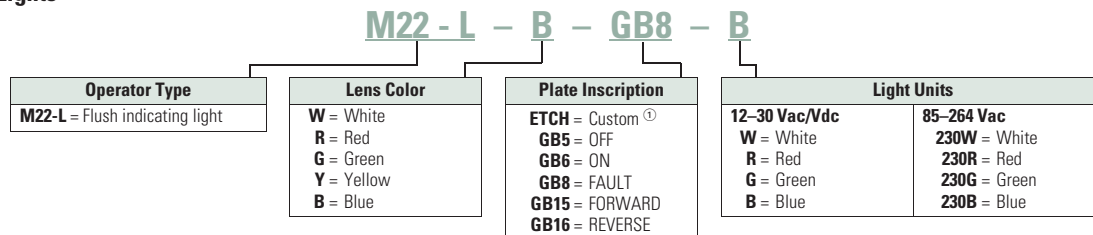

Note: Light unit should match color of lens. Use white light unit with yellow lens.

^① When ordering, specify inscription per catalog number suffix from the Symbols Library (see **Pages V7-T1-129 to V7-T1-136**) into the Order Notes. For example, M22-L-B-ETCH; Order Notes: Mark with symbol X91, Line item #_.

Product Selection

Indicating Lights, Flush

M22-L-R-R



Complete Devices

Lens Color	Light Color	Light Unit Voltage	Catalog Number
White	White	12–30 Vac/Vdc	M22-L-W-W
Red	Red		M22-L-R-R
Green	Green		M22-L-G-G
Yellow	White		M22-L-Y-W
Blue	Blue		M22-L-B-B
Amber	White		M22-L-A-W
White	White	85–264 Vac	M22-L-W-230W
Red	Red		M22-L-R-230R
Green	Green		M22-L-G-230G
Yellow	White		M22-L-Y-230W
Blue	Blue		M22-L-B-230B
Amber	White		M22-L-A-230W

Operators Only ^①

M22-L-R



Lens Color	Catalog Number
Flat	
White	M22-L-W
Red	M22-L-R
Green	M22-L-G
Yellow	M22-L-Y
Blue	M22-L-B
Amber	M22-L-A

M22-LH-R



Lens Color	Catalog Number
Conical	
White	M22-LH-W
Red	M22-LH-R
Green	M22-LH-G
Yellow	M22-LH-Y
Blue	M22-LH-B
Amber	M22-LH-A

Note

^① Includes contact block mounting adapter.

Indicating Lights, Flush

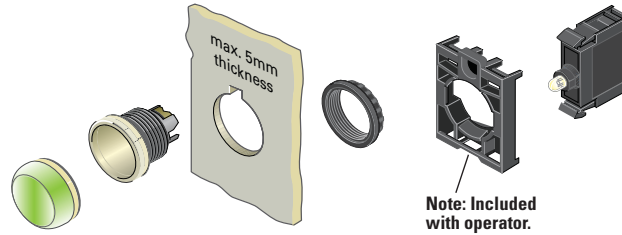

Components

M22-XL-R



Lenses ①

Color	Inscription	Catalog Number
Flat		
Red	—	M22-XL-R ②
	Custom	M22-XL-R-ETCH ③
	OFF	M22-XL-R-GB5
Green	—	M22-XL-G ②
	Custom	M22-XL-G-ETCH ③
	ON	M22-XL-G-GB6
	REVERSE	M22-XL-G-GB16
Blue	—	M22-XL-B ②
	Custom	M22-XL-B-ETCH ③
	FAULT	M22-XL-B-GB8
White	—	M22-XL-W ②
	Custom	M22-XL-W-ETCH ③
	OFF	M22-XL-W-GB5
	ON	M22-XL-W-GB6
	FAULT	M22-XL-W-GB8
Yellow	—	M22-XL-Y ②
	Custom	M22-XL-Y-ETCH ③
	FORWARD	M22-XL-W-GB15
Amber	—	M22-XL-A ②
	Custom	M22-XL-A-ETCH ③
Conical		
Red	—	M22-XLH-R
Green	—	M22-XLH-G
Blue	—	M22-XLH-B
White	—	M22-XLH-W
Yellow	—	M22-XLH-Y
Amber	—	M22-XLH-A

M22-LED-W



M22-FLED-__



Light Units ③④

Terminal Type	LED Color	Light Unit Voltage	Catalog Number
Screw	White	12–30	M22-LED-W
	Red	Vac/Vdc	M22-LED-R
	Green		M22-LED-G
	Blue		M22-LED-B
Screw	White	85–264	M22-LED230-W
	Red	Vac	M22-LED230-R
	Green		M22-LED230-G
	Blue		M22-LED230-B
Spring-cage	White	12–30	M22-FLED-W
	Red	Vac/Vdc	M22-FLED-R
	Green		M22-FLED-G
	Blue		M22-FLED-B
	Red/Green/Yellow	24 Vdc	M22-FLED-RG ⑤
	Red, Green, Blue, Yellow, White, Violet, Turquoise		M22-FLED-RGB ⑤

Notes

- ① For complete listing of available lenses and light units, see Accessories, **Pages V7-T1-111 to V7-T1-116**.
- ② Minimum order quantity of (10).
- ③ When ordering, specify inscription per catalog number suffix from the Symbols Library (see **Pages V7-T1-129 to V7-T1-136**) into the Order Notes. For example, M22-XL-R-ETCH; Order Notes: Mark with symbol X91, Line item # __.
- ④ Select the same color LED element as lens color; for yellow and amber lenses, choose a white LED.
- ⑤ Please see color input key on **Page V7-T1-114**.

M22-L-X



Lensless Indicating Light

Catalog Number

M22-L-X

1

Emergency Stops

Product Description

Eaton's M22 emergency stops are a durable and reliable solution to a variety of e-stop applications. With standard push-pull, as well as twist-to-release and key-release, illuminated options and red or black operators, the M22 e-stop is a robust solution. As with all operators, they can be ordered as a ready to install complete device or as modular components for the perfect fit.

Features

- Push-pull and twist to release options available as well as illuminated and keyed release
- LED offering only for improved brightness quality and up to 100,000 hours of operation
- More than 100,000 mechanical operations
- Capable of communicating via ASi protocol with ASi adapter modules
- Suitable for use in safety applications up to Category-4 or Sil-3

Protection Type

- IP67, IP69K (IP66 key-release)
- NEMA 4X, 13

Catalog Number Selection

Catalog Number Selection is for illustrative purposes only and not to be used to create new catalog numbers.

Emergency Stops

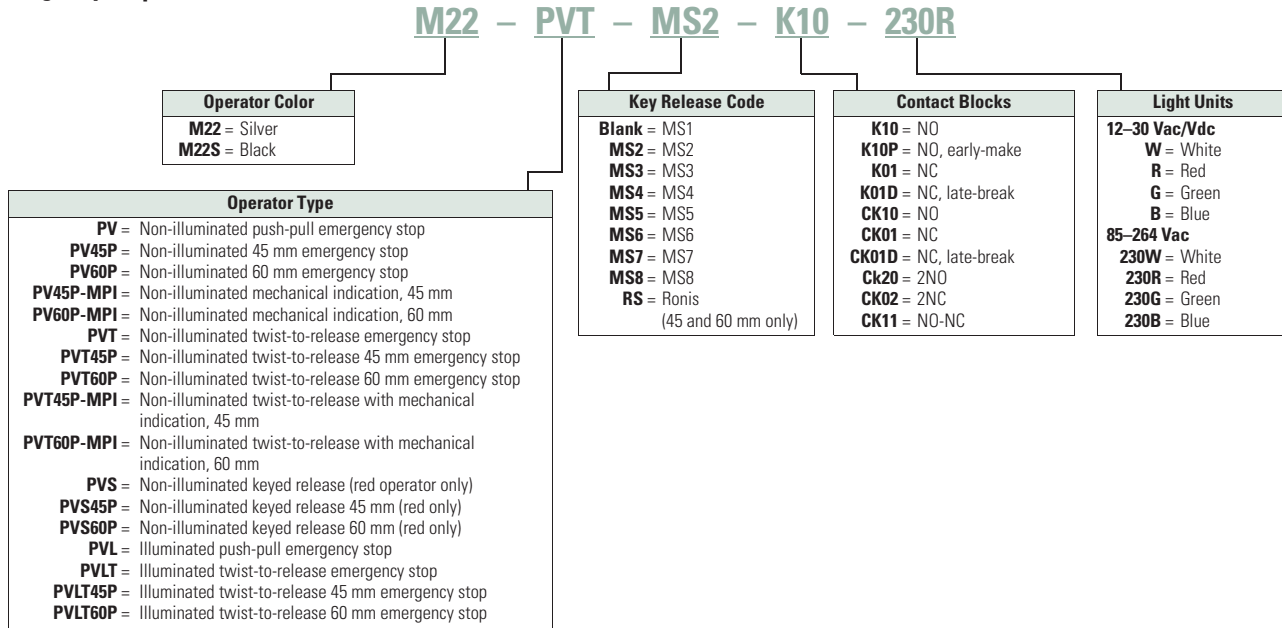

Product Selection

Non-Illuminated and Illuminated Emergency Stops

Complete Devices

Type	Button Color	LED Color	Contact Block Configuration ^①	Light Unit Voltage	Catalog Number		
M22-PV-K01							
	Non-Illuminated						
	Push-pull	Red	—	NC	—	M22-PV-K01	
				2NC		M22-PV-K02	
				1NO-2NC		M22-PV-K12	
	Twist-to-release	Red	—	NC	—	M22-PVT-K01	
				2NC		M22-PVT-K02	
				1NO-2NC		M22-PVT-K12	
	Key release	Red	—	NC	—	M22-PVS-K01	
				2NC		M22-PVS-K02	
1NO-2NC				M22-PVS-K12			
M22-PVL-K01-R							
	Illuminated						
	Push-pull	Red	Red	NC	12–30 Vac/Vdc	M22-PVL-K01-R	
				2NC		M22-PVL-K02-R	
				1NO-2NC		M22-PVL-K12-R	
				NC		85–264 Vac	M22-PVL-K01-230R
				2NC			M22-PVL-K02-230R
				1NO-2NC			M22-PVL-K12-230R
	Twist-to-release	Red	Red	NC	12–30 Vac/Vdc	M22-PVLT-K01-R	
				2NC		M22-PVLT-K02-R	
				1NO-2NC		M22-PVLT-K12-R	
				NC		85–264 Vac	M22-PVLT-K01-230R
				2NC			M22-PVLT-K02-230R
1NO-2NC				M22-PVLT-K12-230R			

Note

① All NC contact blocks are positively driven contact. ⊖

Non-Illuminated and Illuminated Emergency Stops

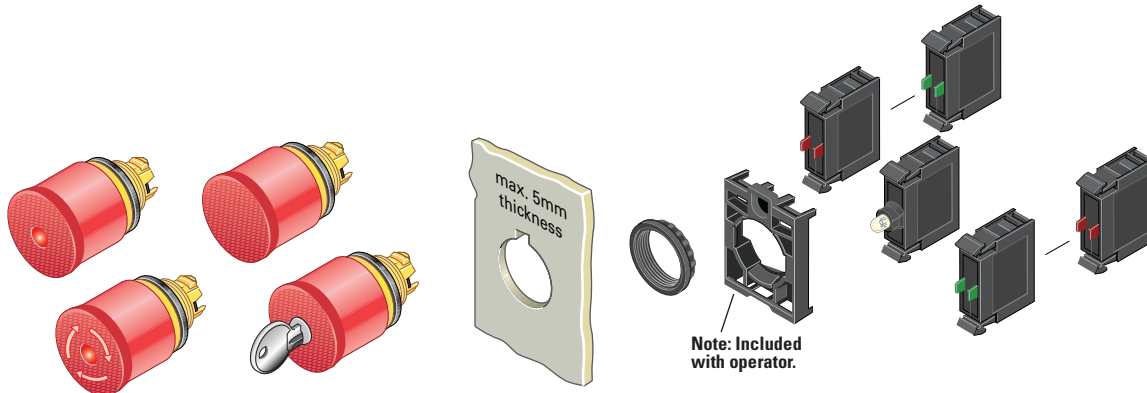

Components

M22-PVL



Push-Pull Emergency Stops

Illumination/Indication	Actuator Size	Catalog Number
None	35 mm	M22-PV
	45 mm	M22-PV45P
	60 mm	M22-PV60P
LED illumination	35 mm	M22-PVL
	45 mm	M22-PVL45P
	60 mm	M22-PVL60P
Mechanical indication	45 mm	M22-PV45P-MPI
	60 mm	M22-PV60P-MPI

M22-PVS60P-MS1



Key Release Emergency Stops ③

Actuator Size	Key Code	Catalog Number	
35 mm	MS1	M22-PVS ③	
	MS2	M22-PVS-MS2	
	MS3	M22-PVS-MS3	
	MS4	M22-PVS-MS4	
	MS5	M22-PVS-MS5	
	MS6	M22-PVS-MS6	
	MS7	M22-PVS-MS7	
	MS8	M22-PVS-MS8	
45 mm	MS1	M22-PVS45P	
	MS2	M22-PVS45P-MS2	
	MS3	M22-PVS45P-MS3	
	MS4	M22-PVS45P-MS4	
	MS5	M22-PVS45P-MS5	
	MS6	M22-PVS45P-MS6	
	MS7	M22-PVS45P-MS7	
	MS8	M22-PVS45P-MS8	
	Ronis	M22-PVS45P-RS	
	60 mm	MS1	M22-PVS60P
		MS2	M22-PVS60P-MS2
		MS3	M22-PVS60P-MS3
		MS4	M22-PVS60P-MS4
		MS5	M22-PVS60P-MS5
		MS6	M22-PVS60P-MS6
		MS7	M22-PVS60P-MS7
MS8		M22-PVS60P-MS8	
Ronis	M22-PVS60P-RS		

M22-PVT45P-MPI



Twist-to-Release Emergency Stops

Illumination/Indication	Actuator Size	Catalog Number
None	35 mm	M22-PVT
	45 mm	M22-PVT45P
	60 mm	M22-PVT60P
LED illumination	35 mm	M22-PVLT
	45 mm	M22-PVLT45P
	60 mm	M22-PVLT60P
Mechanical indication	45 mm	M22-PVT45P-MPI
	60 mm	M22-PVT60P-MPI

M22S-PVLT



Machine Stop Operators (Black) ①





Illumination	Type	Actuator Size	Catalog Number
Non-illuminated	Push-pull	35 mm	M22S-PV
	Twist-to-release	35 mm	M22S-PVT
LED illumination	Push-pull	35 mm	M22S-PVL
	Twist-to-release	35 mm	M22S-PVLT

Notes



- ① Includes contact block mounting adapter.
- ② Key included. For identical locks and keys, use the same key code. One key is included with actuator; additional keys are available as accessories.
- ③ Includes Key Code MS1.

Maximum number of contacts: four M22-(C)K01, ...10, or two M22-(C)K02, ...20, ...11. Refer to IL or technical data sheet for more information.

Contact Blocks ①

	Terminal Type	Mounting Location ②	Contact Configuration ③	Catalog Number	
M22-K10 	Screw	Front	NO	M22-K10	
			NO, early-make	M22-K10P	
			NC	M22-K01	
			NC, late-break	M22-K01D	
			NC ④	M22-K01PV6	
			SMCB, NC	M22-K01SMC10	
			SMCB, 2NC	M22-K02SMC10	
			Base	SMCB, NC	M22-KC01SMC10
			SMCB, 2NC	M22-KC02SMC10	
			M22-K01SMC10 	Self-monitoring (1NC and 1NO in series)	Front
2NC	M22-K02SMC10				
Base	1NC	M22-KC01SMC10			
	2NC	M22-KC02SMC10			
FK01SMC10 	Self-monitoring spring-cage		NC	M22-FK01SMC10	
			3NC	M22-AFK03SMC10	
M22-FK01 	Spring-cage	Front	NO	M22-CK10	
			NC	M22-CK01	
			NC, late-break	M22-CK01D	
			2NO	M22-CK20	
			2NC	M22-CK02	
			NO-NC	M22-CK11	
			NC	M22-FK01 ⑤	
			NO	M22-FK10 ⑤	

Light Units ①

	Terminal Type	LED Color	Light Unit Voltage	Catalog Number
M22-LED-W 	Screw	White	12–30 Vac/Vdc	M22-LED-W
		Red	12–30 Vac/Vdc	M22-LED-R
	Screw	White	85–264 Vac	M22-LED230-W
		Red	85–264 Vac	M22-LED230-R
M22-FLED- 	Screw	White	207–264 Vac	M22-LED230H-W
		Red	207–264 Vac	M22-LED230H-R
	Spring-cage	White	12–30 Vac/Vdc	M22-FLED-W
		Red	12–30 Vac/Vdc	M22-FLED-R





M22-ES-MS1



Extra Keys ⑥

For Key Code	Catalog Number
MS1	M22-ES-MS1
MS2	M22-ES-MS2
MS3	M22-ES-MS3
MS4	M22-ES-MS4
MS5	M22-ES-MS5
MS6	M22-ES-MS6
MS7	M22-ES-MS7
MS8	M22-ES-MS8

Accessories

Description	Voltage	Catalog Number
M22-XGVP 	—	M22-XGVP
M22G-XGPV 	—	M22G-XGPV
M22-MGTA 	—	M22-MGTA
M22-PL-PV 	—	M22-PL-PV
M22-XPV60-Y-120 	24 Vac/Vdc	M22-XPV60-Y-24
	120 Vac	M22-XPV60-Y-120
	230 Vac	M22-XPV60-Y-230

Notes

- ① For complete listing of available contact blocks, see Accessories, Pages V7-T1-111 to V7-T1-116.
- ② Self-monitoring contact blocks (SMCB type) cannot be used with illuminated emergency stops.
- ③ All NC contact blocks are positively driven contact. ⊖
- ④ Allows up to six contact blocks to be utilized, For use only with only M22-PV_.
- ⑤ Additional contacts may not be stacked behind M22-F type contact blocks, M22-F can be stacked behind standard M22 contacts only.
- ⑥ For use with key release operators only. One key included with operator.

Maximum number of contacts: four M22-(C)K01,...,10, or two M22-(C)K02,...,20, ...11. Refer to IL or technical data sheet for more information.

Selector Switches



Contents

Description

	<i>Page</i>
Selector Switches	
Non-Illuminated Switches	V7-T1-79
Illuminated Switches	V7-T1-84
Key Operated	V7-T1-88

Selector Switches

Product Description

Eaton’s M22 selector switch line offers an almost endless variety of options in maintained/momentary, key-removal and illuminated devices. The coding adapters used for maintained/momentary and key removal positions make the M22 stand out from competitive devices. By simply adding or removing a coding adapter from inside the operator, the end-user can change the function of the button. Operator options include standard knob, rotary head, illuminated and keyed versions. As with all operators, they can be ordered as a ready to install complete device or as modular components to meet application specific requirements.

Features

- Adding or removing coding adapters allows for field convertibility of maintained/momentary and key removal positions
- LED offering only for improved brightness quality and up to 100,000 hours of operation
- More than 100,000 mechanical operations
- Coding adapter options make assembly fast and simplify stocking of different configurations of selector switches
- Capable of communicating via ASi protocol with ASi adapter modules

Protection Type

- IP66
- NEMA 4X, 13

Catalog Number Selection

Catalog Number Selection is for illustrative purposes only and not to be used to create new catalog numbers.

Non-Illuminated Selector Switches

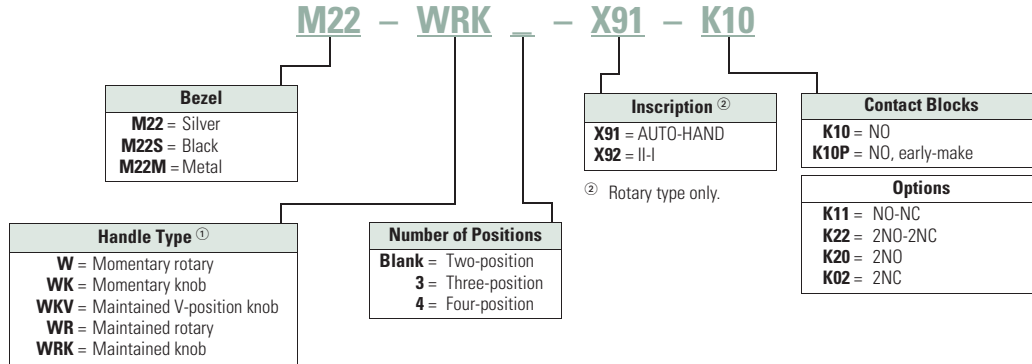

^① All momentary selector switches can be converted in the field to maintained operation with the removal of a color-coded adapter.

1

Product Selection

Non-Illuminated Selector Switches

M22-WKV-K10



M22M-WKV-K10



Complete Devices, Knob Type ①

Type	Switching Position	Contact Block Configuration ②	Silver Bezel Catalog Number	Black Bezel Catalog Number	Metal Bezel Catalog Number
Two-position	Maintained 40°	NO	M22-WRK-K10	M22S-WRK-K10	M22M-WRK-K10
		1NO-1NC	M22-WRK-K11	M22S-WRK-K11	M22M-WRK-K11
		2NO-2NC	M22-WRK-K22	M22S-WRK-K22	M22M-WRK-K22
	Maintained V 60°	NO	M22-WKV-K10	M22S-WKV-K10	M22M-WKV-K10
		1NO-1NC	M22-WKV-K11	M22S-WKV-K11	M22M-WKV-K11
		2NO-2NC	M22-WKV-K22	M22S-WKV-K22	M22M-WKV-K22
Three-position	Maintained 60° I 0 II 60°	2NO	M22-WRK3-K20	M22S-WRK3-K20	M22M-WRK3-K20
		2NO-2NC	M22-WRK3-K22	M22S-WRK3-K22	M22M-WRK3-K22

Notes

- ① Includes contact block mounting adapter.
- ② All NC contact blocks are positively driven contact. ⊖

Non-Illuminated Selector Switches

Components

M22-WK



M22M-WK



Operators Only, Knob Type ①

Type	Switching Position	Silver Bezel Catalog Number	Black Bezel Catalog Number	Metal Bezel Catalog Number
Two-position	Momentary ② 	M22-WK	M22S-WK	M22M-WK
	Maintained 	M22-WRK	M22S-WRK	M22M-WRK
	Maintained V 	M22-WKV	M22S-WKV	M22M-WKV
Three-position	Momentary ② 	M22-WK3	M22S-WK3	M22M-WK3
	Maintained 	M22-WRK3	M22S-WRK3	M22M-WRK3
	Maintained, return from left 	M22-WRK3-2	M22S-WRK3-2	M22M-WRK3-2
	Maintained, return from right 	M22-WRK3-1	M22S-WRK3-1	M22M-WRK3-1
	Maintained, return from left 	M22-WRK3-2	M22S-WRK3-2	M22M-WRK3-2
	Maintained, return from right 	M22-WRK3-1	M22S-WRK3-1	M22M-WRK3-1
Four-position	Maintained 	M22-WRK4	M22S-WRK4	M22M-WRK4

Notes

- ① Includes contact block mounting adapter.
- ② Momentary selector switches can be converted in the field to maintained operation with the removal of a color coded adapter. See **Page V7-T1-118**.

1

Non-Illuminated Selector Switches

Components

M22S-WR3-X94

Operators Only, Rotary Type ①



Type	Switching Position	Inscription	Silver Bezel Catalog Number	Black Bezel Catalog Number	Metal Bezel Catalog Number
Two-position	Momentary ②	I-O	M22-W	M22S-W	M22M-W
	Maintained	I-O	M22-WR	M22S-WR	M22M-WR
		Custom	M22-WR-ETCH ③	M22S-WR-ETCH ③	M22M-WR-ETCH ③
		AUTO-HAND	M22-WR-X91	M22S-WR-X91	M22M-WR-X91
		II-I	M22-WR-X92	M22S-WR-X92	M22M-WR-X92
Three-position	Momentary ②	I-O-II	M22-W3	M22S-W3	M22M-W3
	Maintained	I-O-II	M22-WR3	M22S-WR3	M22M-WR3
		Custom	M22-WR3-ETCH ③	M22S-WR3-ETCH ③	M22M-WR3-ETCH ③
		AUTO-O-MAN	M22-WR3-X94	M22S-WR3-X94	M22M-WR3-X94
Four-position	Maintained	0-1-0-2-0-3-0-4	M22-WR4	M22S-WR4	M22M-WR4

Notes

- ① Includes contact block mounting adapter.
- ② Momentary selector switches can be converted in the field to maintained operation with the removal of a color coded adapter. See [Page V7-T1-118](#).
- ③ When ordering, specify inscription per catalog number suffix from the Symbols Library (see [Pages V7-T1-129 to V7-T1-136](#)) into the Order Notes. For example, M22-WR3-ETCH; Order Notes: Mark with symbol X88, Line item #_.

Non-Illuminated Selector Switches

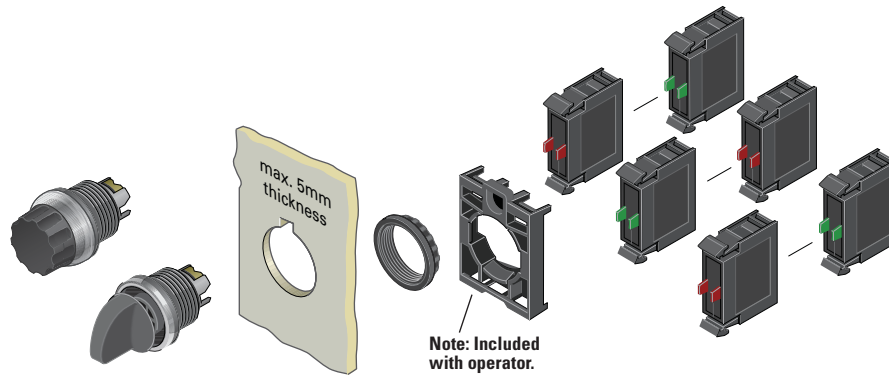

Components

M22-K10







M22-FK01



Contact Blocks ^①

Terminal Type	Contact Configuration ^②	Catalog Number
Screw	NO	M22-K10
	NO, early-make	M22-K10P
	NC	M22-K01
	NC, late-break	M22-K01D
Spring-cage	NO	M22-CK10
	NC	M22-CK01
	NC, late-break	M22-CK01D
	2NO	M22-CK20
	2NC	M22-CK02
	NO-NC	M22-CK11
	NC	M22-FK01 ^③
	NO	M22-FK10 ^③

Accessories

	Description	Catalog Number
M22-XW 	Plunger bridge ^④	M22-XW
M22-XWS 	Key cover	M22-XWS
M22-XC-R 	Key withdraw adapter ^⑤	M22-XC-R
M22-XC-Y 	Coding adapter	M22-XC-Y
M22-XGWK 	Guard ring	M22-XGWK

Notes

- ① For complete listing of available contact blocks, see Accessories, Pages V7-T1-111 to V7-T1-116.
- ② All NC contact blocks are positively driven contact. ⊖
- ③ Additional contacts may not be stacked behind M22-F type contact blocks, M22-F can be stacked behind standard M22 contacts only.
- ④ Plunger needed to actuate center-mounted contact blocks. Used for non-illuminated three-position selector switches only.
- ⑤ Enables a keyed selector switch to be set to user-selected key withdraw position.

1

Catalog Number Selection

Catalog Number Selection is for illustrative purposes only and not to be used to create new catalog numbers.

Illuminated Selector Switches

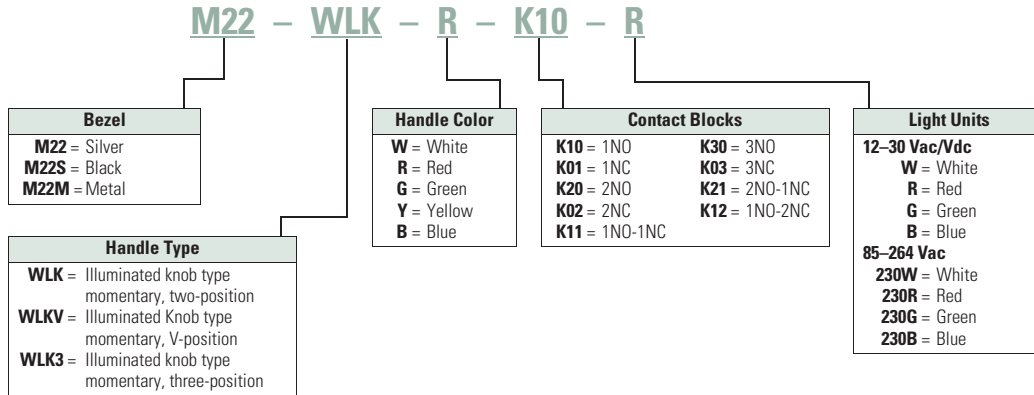

Product Selection



Illuminated Selector Switches

Components

M22-WLK-W

Operators Only, Knob Type ^①



Type	Switching Position	Button Color	Silver Bezel Catalog Number	Black Bezel Catalog Number	Metal Bezel Catalog Number
Two-position	Momentary ^② 	White	M22-WLK-W	M22S-WLK-W	M22M-WLK-W
		Red	M22-WLK-R	M22S-WLK-R	M22M-WLK-R
		Green	M22-WLK-G	M22S-WLK-G	M22M-WLK-G
		Yellow	M22-WLK-Y	M22S-WLK-Y	M22M-WLK-Y
		Blue	M22-WLK-B	M22S-WLK-B	M22M-WLK-B
	Maintained 	White	M22-WRLK-W	M22S-WRLK-W	M22M-WRLK-W
		Red	M22-WRLK-R	M22S-WRLK-R	M22M-WRLK-R
		Green	M22-WRLK-G	M22S-WRLK-G	M22M-WRLK-G
		Yellow	M22-WRLK-Y	M22S-WRLK-Y	M22M-WRLK-Y
		Blue	M22-WRLK-B	M22S-WRLK-B	M22M-WRLK-B
	Maintained V 	White	M22-WLKV-W	M22S-WLKV-W	M22M-WLKV-W
		Red	M22-WLKV-R	M22S-WLKV-R	M22M-WLKV-R
		Green	M22-WLKV-G	M22S-WLKV-G	M22M-WLKV-G
		Yellow	M22-WLKV-Y	M22S-WLKV-Y	M22M-WLKV-Y
		Blue	M22-WLKV-B	M22S-WLKV-B	M22M-WLKV-B

Notes

^① Includes contact block mounting adapter.

^② Momentary selector switches can be converted in the field to maintained operation with the removal of a color coded adapter. See **Page V7-T1-118**.

1



Illuminated Selector Switches

Components

M22-WLK3-W

Operators Only, Knob Type ①

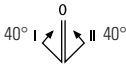
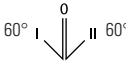

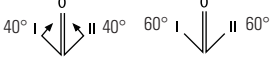
Type	Switching Position	Button Color	Silver Bezel Catalog Number	Black Bezel Catalog Number	Metal Bezel Catalog Number
Three-position	Momentary ② 	White	M22-WLK3-W	M22S-WLK3-W	M22M-WLK3-W
		Red	M22-WLK3-R	M22S-WLK3-R	M22M-WLK3-R
		Green	M22-WLK3-G	M22S-WLK3-G	M22M-WLK3-G
		Yellow	M22-WLK3-Y	M22S-WLK3-Y	M22M-WLK3-Y
		Blue	M22-WLK3-B	M22S-WLK3-B	M22M-WLK3-B
	Maintained 	White	M22-WRLK3-W	M22S-WRLK3-W	M22M-WRLK3-W
		Red	M22-WRLK3-R	M22S-WRLK3-R	M22M-WRLK3-R
		Green	M22-WRLK3-G	M22S-WRLK3-G	M22M-WRLK3-G
		Yellow	M22-WRLK3-Y	M22S-WRLK3-Y	M22M-WRLK3-Y
		Blue	M22-WRLK3-B	M22S-WRLK3-B	M22M-WRLK3-B
	Maintained, return from right 	White	M22-WRLK3-1-W	M22S-WRLK3-1-W	M22M-WRLK3-1-W
		Red	M22-WRLK3-1-R	M22S-WRLK3-1-R	M22M-WRLK3-1-R
Green		M22-WRLK3-1-G	M22S-WRLK3-1-G	M22M-WRLK3-1-G	
Yellow		M22-WRLK3-1-Y	M22S-WRLK3-1-Y	M22M-WRLK3-1-Y	
Blue		M22-WRLK3-1-B	M22S-WRLK3-1-B	M22M-WRLK3-1-B	
Maintained, return from left 	White	M22-WRLK3-2-W	M22S-WRLK3-2-W	M22M-WRLK3-2-W	
	Red	M22-WRLK3-2-R	M22S-WRLK3-2-R	M22M-WRLK3-2-R	
	Green	M22-WRLK3-2-G	M22S-WRLK3-2-G	M22M-WRLK3-2-G	
	Yellow	M22-WRLK3-2-Y	M22S-WRLK3-2-Y	M22M-WRLK3-2-Y	
	Blue	M22-WRLK3-2-B	M22S-WRLK3-2-B	M22M-WRLK3-2-B	

Notes

① Includes contact block mounting adapter.

② Momentary selector switches can be converted in the field to maintained operation with the removal of a color coded adapter. See [Page V7-T1-118](#).

Illuminated Selector Switches

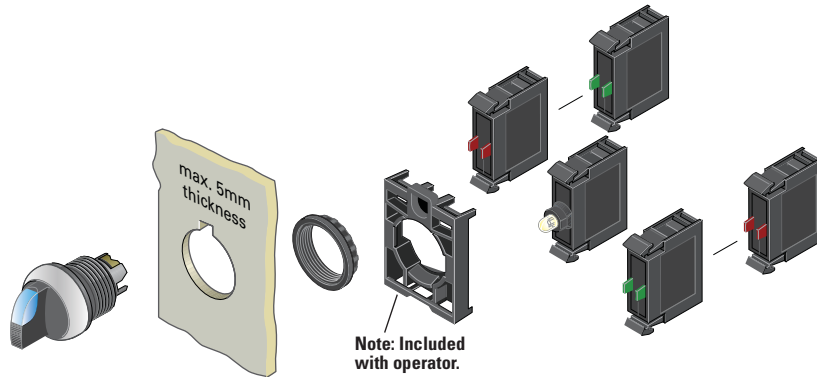

M22-LED-W



M22-FLED-__



Light Units ^①

Terminal Type	LED Color ^②	Light Unit Voltage	Catalog Number
Screw	White	12–30 Vac/Vdc	M22-LED-W
	Red		M22-LED-R
	Green		M22-LED-G
	Blue		M22-LED-B
Screw	White	85–264 Vac	M22-LED230-W
	Red		M22-LED230-R
	Green		M22-LED230-G
	Blue		M22-LED230-B
Spring-cage	White	12–30 Vac/Vdc	M22-FLED-W
	Red		M22-FLED-R
	Green		M22-FLED-G
	Blue	M22-FLED-B	
	Red/Green/ Yellow	24 Vdc	M22-FLED-RG ^③
	Red, Green, Blue, Yellow, White, Violet, Turquoise		M22-FLED-RGB ^③

Accessories

	Description	Catalog Number
M22-XW	Plunger bridge ^⑥	M22-XW
M22-XWS	Key cover	M22-XWS
M22-XC-R	Key withdraw adapter ^⑦	M22-XC-R
M22-XC-Y	Coding adapter	M22-XC-Y
M22-XGWK	Guard ring	M22-XGWK

M22-K10



M22-FK01



Contact Blocks ^①

Terminal Type	Contact Configuration ^④	Catalog Number
Screw	NO	M22-K10
	NO, early-make	M22-K10P
	NC	M22-K01
	NC, late-break	M22-K01D
Spring-cage	NO	M22-CK10
	NC	M22-CK01
	NC, late-break	M22-CK01D
	2NO	M22-CK20
	2NC	M22-CK02
	NO-NC	M22-CK11
	NC	M22-FK01 ^⑤
	NO	M22-FK10 ^⑤

Notes

- ① For complete listing of available light units and contact blocks, see Accessories, Pages V7-T1-111 to V7-T1-116.
- ② Select the same color LED element as lens color; for yellow lens, choose a white LED. Select a white lens if utilizing multi-color LED, M22-FLED-RG or M22-FLED-RGB.
- ③ Please see color input key on Page V7-T1-114.
- ④ All NC contact blocks are positively driven contact. ⊖
- ⑤ Additional contacts may not be stacked behind M22-F type contact blocks, M22-F can be stacked behind standard M22 contacts only.
- ⑥ Plunger needed to actuate center-mounted contact blocks. Used for non-illuminated three-position selector switches only.
- ⑦ Enables a keyed selector switch to be set to user-selected key withdraw position.

1

Catalog Number Selection

Catalog Number Selection is for illustrative purposes only and not to be used to create new catalog numbers.

Key-Operated Selector Switches

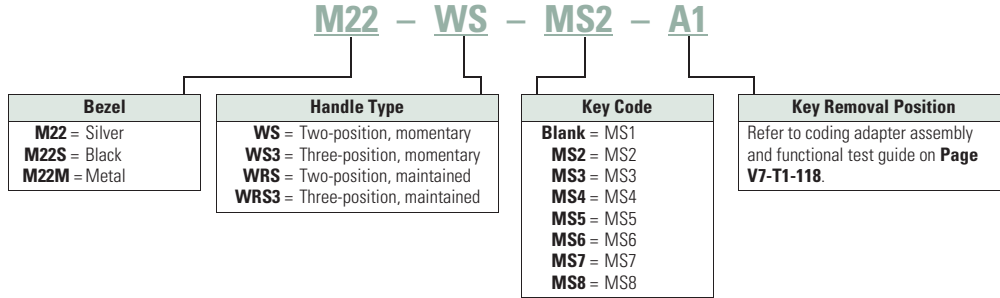

Product Selection

Key-Operated Selector Switches ^{①②}

Components

M22-WS



Operators Only ^③

Type	Switching Position	Key Removal Position	Key Code	Silver Bezel Catalog Number	Black Bezel Catalog Number	Metal Bezel Catalog Number	
Two-position	Momentary ^④ 40°	Return from right, key removable left	MS1	M22-WS	M22S-WS	M22M-WS	
			MS2	M22-WS-MS2	M22S-WS-MS2	M22M-WS-MS2	
			MS3	M22-WS-MS3	M22S-WS-MS3	M22M-WS-MS3	
			MS4	M22-WS-MS4	M22S-WS-MS4	M22M-WS-MS4	
			MS5	M22-WS-MS5	M22S-WS-MS5	M22M-WS-MS5	
			MS6	M22-WS-MS6	M22S-WS-MS6	M22M-WS-MS6	
			MS7	M22-WS-MS7	M22S-WS-MS7	M22M-WS-MS7	
			MS8	M22-WS-MS8	M22S-WS-MS8	M22M-WS-MS8	
Two-position	Maintained 40°	Key removable left	MS1	M22-WRS-A1	M22S-WRS-A1	M22M-WRS-A1	
			MS2	M22-WRS-MS2-A1	M22S-WRS-MS2-A1	M22M-WRS-MS2-A1	
			MS3	M22-WRS-MS3-A1	M22S-WRS-MS3-A1	M22M-WRS-MS3-A1	
			MS4	M22-WRS-MS4-A1	M22S-WRS-MS4-A1	M22M-WRS-MS4-A1	
			MS5	M22-WRS-MS5-A1	M22S-WRS-MS5-A1	M22M-WRS-MS5-A1	
			MS6	M22-WRS-MS6-A1	M22S-WRS-MS6-A1	M22M-WRS-MS6-A1	
			MS7	M22-WRS-MS7-A1	M22S-WRS-MS7-A1	M22M-WRS-MS7-A1	
			MS8	M22-WRS-MS8-A1	M22S-WRS-MS8-A1	M22M-WRS-MS8-A1	
	Key removable left/right			MS1	M22-WRS	M22S-WRS	M22M-WRS
				MS2	M22-WRS-MS2	M22S-WRS-MS2	M22M-WRS-MS2
				MS3	M22-WRS-MS3	M22S-WRS-MS3	M22M-WRS-MS3
				MS4	M22-WRS-MS4	M22S-WRS-MS4	M22M-WRS-MS4
				MS5	M22-WRS-MS5	M22S-WRS-MS5	M22M-WRS-MS5
				MS6	M22-WRS-MS6	M22S-WRS-MS6	M22M-WRS-MS6
				MS7	M22-WRS-MS7	M22S-WRS-MS7	M22M-WRS-MS7
				MS8	M22-WRS-MS8	M22S-WRS-MS8	M22M-WRS-MS8

Notes

- ① Includes one key.
- ② Key removal positions can be modified in the field using coding adapters; see chart on **Page V7-T1-118**.
- ③ Includes contact block mounting adapter.
- ④ Momentary selector switches can be converted in the field to maintained operation with the removal of a color coded adapter. See **Page V7-T1-118**.

Key-Operated Selector Switches ①②

Components

M22-WS3-X93



Operators Only, continued ③

M22M-WS3-X93

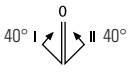
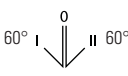

Type	Switching Position	Key Removal Position	Key Code	Silver Bezel Catalog Number	Black Bezel Catalog Number	Metal Bezel Catalog Number
Three-position	Momentary ④ 	Return from left/right, key removable center	MS1	M22-WS3	M22S-WS3	M22M-WS3
			MS2	M22-WS3-MS2	M22S-WS3-MS2	M22M-WS3-MS2
			MS3	M22-WS3-MS3	M22S-WS3-MS3	M22M-WS3-MS3
			MS4	M22-WS3-MS4	M22S-WS3-MS4	M22M-WS3-MS4
			MS5	M22-WS3-MS5	M22S-WS3-MS5	M22M-WS3-MS5
			MS6	M22-WS3-MS6	M22S-WS3-MS6	M22M-WS3-MS6
			MS7	M22-WS3-MS7	M22S-WS3-MS7	M22M-WS3-MS7
			MS8	M22-WS3-MS8	M22S-WS3-MS8	M22M-WS3-MS8
			Three-position	Maintained 	Key removable left/center/right	MS1
MS2	M22-WRS3-MS2-A1	M22S-WRS3-MS2-A1				M22M-WRS3-MS2-A1
MS3	M22-WRS3-MS3-A1	M22S-WRS3-MS3-A1				M22M-WRS3-MS3-A1
MS4	M22-WRS3-MS4-A1	M22S-WRS3-MS4-A1				M22M-WRS3-MS4-A1
MS5	M22-WRS3-MS5-A1	M22S-WRS3-MS5-A1				M22M-WRS3-MS5-A1
MS6	M22-WRS3-MS6-A1	M22S-WRS3-MS6-A1				M22M-WRS3-MS6-A1
MS7	M22-WRS3-MS7-A1	M22S-WRS3-MS7-A1				M22M-WRS3-MS7-A1
MS8	M22-WRS3-MS8-A1	M22S-WRS3-MS8-A1				M22M-WRS3-MS8-A1
Key removable center/left	MS1	M22-WRS3-A2			M22S-WRS3-A2	M22M-WRS3-A2
	MS2	M22-WRS3-MS2-A2			M22S-WRS3-MS2-A2	M22M-WRS3-MS2-A2
	MS3	M22-WRS3-MS3-A2			M22S-WRS3-MS3-A2	M22M-WRS3-MS3-A2
	MS4	M22-WRS3-MS4-A2			M22S-WRS3-MS4-A2	M22M-WRS3-MS4-A2
	MS5	M22-WRS3-MS5-A2			M22S-WRS3-MS5-A2	M22M-WRS3-MS5-A2
	MS6	M22-WRS3-MS6-A2			M22S-WRS3-MS6-A2	M22M-WRS3-MS6-A2
	MS7	M22-WRS3-MS7-A2			M22S-WRS3-MS7-A2	M22M-WRS3-MS7-A2
	MS8	M22-WRS3-MS8-A2			M22S-WRS3-MS8-A2	M22M-WRS3-MS8-A2
Key removable center/right	MS1	M22-WRS3-A3			M22S-WRS3-A3	M22M-WRS3-A3
	MS2	M22-WRS3-MS2-A3			M22S-WRS3-MS2-A3	M22M-WRS3-MS2-A3
	MS3	M22-WRS3-MS3-A3			M22S-WRS3-MS3-A3	M22M-WRS3-MS3-A3
	MS4	M22-WRS3-MS4-A3			M22S-WRS3-MS4-A3	M22M-WRS3-MS4-A3
	MS5	M22-WRS3-MS5-A3			M22S-WRS3-MS5-A3	M22M-WRS3-MS5-A3
	MS6	M22-WRS3-MS6-A3			M22S-WRS3-MS6-A3	M22M-WRS3-MS6-A3
	MS7	M22-WRS3-MS7-A3			M22S-WRS3-MS7-A3	M22M-WRS3-MS7-A3
	MS8	M22-WRS3-MS8-A3			M22S-WRS3-MS8-A3	M22M-WRS3-MS8-A3
Key removable left/right	MS1	M22-WRS3			M22S-WRS3	M22M-WRS3
	MS2	M22-WRS3-MS2			M22S-WRS3-MS2	M22M-WRS3-MS2
	MS3	M22-WRS3-MS3			M22S-WRS3-MS3	M22M-WRS3-MS3
	MS4	M22-WRS3-MS4			M22S-WRS3-MS4	M22M-WRS3-MS4
	MS5	M22-WRS3-MS5			M22S-WRS3-MS5	M22M-WRS3-MS5
	MS6	M22-WRS3-MS6			M22S-WRS3-MS6	M22M-WRS3-MS6
	MS7	M22-WRS3-MS7			M22S-WRS3-MS7	M22M-WRS3-MS7
	MS8	M22-WRS3-MS8			M22S-WRS3-MS8	M22M-WRS3-MS8

Notes

- ① Includes one key.
- ② Key removal positions can be modified in the field using coding adapters; see chart on Page V7-T1-118.
- ③ Includes contact block mounting adapter.
- ④ Momentary selector switches can be converted in the field to maintained operation with the removal of a color coded adapter. See Page V7-T1-118.

1

Key-Operated Selector Switches ^{①②}

Components

M22-WS3-X93



M22M-WS3-X93



Operators Only, continued ^③

Type	Switching Position	Key Removal Position	Key Code	Silver Bezel Catalog Number	Black Bezel Catalog Number	Metal Bezel Catalog Number
Three-position	Maintained 	Return from left, key removable center	MS1	M22-WRS3-A7	M22S-WRS3-A7	M22M-WRS3-A7
			MS2	M22-WRS3-MS2-A7	M22S-WRS3-MS2-A7	M22M-WRS3-MS2-A7
			MS3	M22-WRS3-MS3-A7	M22S-WRS3-MS3-A7	M22M-WRS3-MS3-A7
			MS4	M22-WRS3-MS4-A7	M22S-WRS3-MS4-A7	M22M-WRS3-MS4-A7
			MS5	M22-WRS3-MS5-A7	M22S-WRS3-MS5-A7	M22M-WRS3-MS5-A7
			MS6	M22-WRS3-MS6-A7	M22S-WRS3-MS6-A7	M22M-WRS3-MS6-A7
			MS7	M22-WRS3-MS7-A7	M22S-WRS3-MS7-A7	M22M-WRS3-MS7-A7
			MS8	M22-WRS3-MS8-A7	M22S-WRS3-MS8-A7	M22M-WRS3-MS8-A7
	Return from left, key removable center/right	MS1	M22-WRS3-A6	M22S-WRS3-A6	M22M-WRS3-A6	
		MS2	M22-WRS3-MS2-A6	M22S-WRS3-MS2-A6	M22M-WRS3-MS2-A6	
		MS3	M22-WRS3-MS3-A6	M22S-WRS3-MS3-A6	M22M-WRS3-MS3-A6	
		MS4	M22-WRS3-MS4-A6	M22S-WRS3-MS4-A6	M22M-WRS3-MS4-A6	
		MS5	M22-WRS3-MS5-A6	M22S-WRS3-MS5-A6	M22M-WRS3-MS5-A6	
		MS6	M22-WRS3-MS6-A6	M22S-WRS3-MS6-A6	M22M-WRS3-MS6-A6	
		MS7	M22-WRS3-MS7-A6	M22S-WRS3-MS7-A6	M22M-WRS3-MS7-A6	
		MS8	M22-WRS3-MS8-A6	M22S-WRS3-MS8-A6	M22M-WRS3-MS8-A6	
Three-position	Maintained 	Return from right, key removable left/center	MS1	M22-WRS3-A4	M22S-WRS3-A4	M22M-WRS3-A4
			MS2	M22-WRS3-MS2-A4	M22S-WRS3-MS2-A4	M22M-WRS3-MS2-A4
			MS3	M22-WRS3-MS3-A4	M22S-WRS3-MS3-A4	M22M-WRS3-MS3-A4
			MS4	M22-WRS3-MS4-A4	M22S-WRS3-MS4-A4	M22M-WRS3-MS4-A4
			MS5	M22-WRS3-MS5-A4	M22S-WRS3-MS5-A4	M22M-WRS3-MS5-A4
			MS6	M22-WRS3-MS6-A4	M22S-WRS3-MS6-A4	M22M-WRS3-MS6-A4
			MS7	M22-WRS3-MS7-A4	M22S-WRS3-MS7-A4	M22M-WRS3-MS7-A4
			MS8	M22-WRS3-MS8-A4	M22S-WRS3-MS8-A4	M22M-WRS3-MS8-A4
	Return from right, key removable center	MS1	M22-WRS3-A5	M22S-WRS3-A5	M22M-WRS3-A5	
		MS2	M22-WRS3-MS2-A5	M22S-WRS3-MS2-A5	M22M-WRS3-MS2-A5	
		MS3	M22-WRS3-MS3-A5	M22S-WRS3-MS3-A5	M22M-WRS3-MS3-A5	
		MS4	M22-WRS3-MS4-A5	M22S-WRS3-MS4-A5	M22M-WRS3-MS4-A5	
		MS5	M22-WRS3-MS5-A5	M22S-WRS3-MS5-A5	M22M-WRS3-MS5-A5	
		MS6	M22-WRS3-MS6-A5	M22S-WRS3-MS6-A5	M22M-WRS3-MS6-A5	
		MS7	M22-WRS3-MS7-A5	M22S-WRS3-MS7-A5	M22M-WRS3-MS7-A5	
		MS8	M22-WRS3-MS8-A5	M22S-WRS3-MS8-A5	M22M-WRS3-MS8-A5	

Notes

- ① Includes one key.
- ② Key removal positions can be modified in the field using coding adapters; see chart on [Page V7-T1-118](#).
- ③ Includes contact block mounting adapter.

Key-Operated Selector Switches

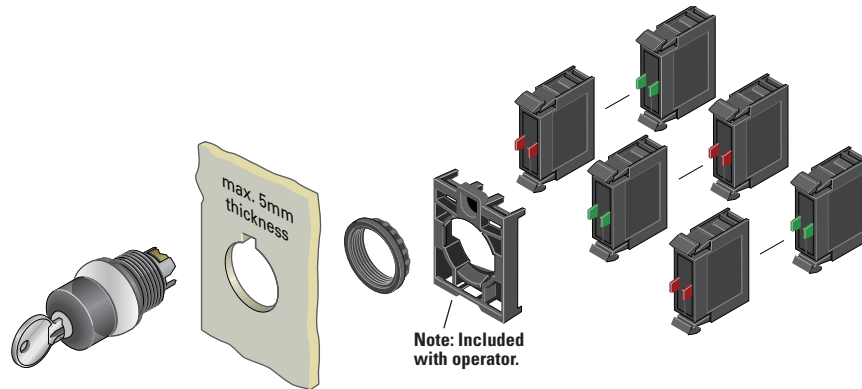

Components

M22-K10



M22-FK01



M22-ES-MS1



Contact Blocks ^①

Terminal Type	Contact Configuration ^②	Catalog Number
Screw	NO	M22-K10
	NO, early-make	M22-K10P
	NC	M22-K01
	NC, late-break	M22-K01D
Spring-cage	NO	M22-CK10
	NC	M22-CK01
	NC, late-break	M22-CK01D
	2NO	M22-CK20
	2NC	M22-CK02
	NO-NC	M22-CK11
	NC	M22-FK01 ^③
	NO	M22-FK10 ^③

Extra Keys

Key Code	Catalog Number
MS1	M22-ES-MS1
MS2	M22-ES-MS2
MS3	M22-ES-MS3
MS4	M22-ES-MS4
MS5	M22-ES-MS5
MS6	M22-ES-MS6
MS7	M22-ES-MS7
MS8	M22-ES-MS8

Accessories

	Description	Catalog Number
M22-XW 	Plunger bridge ^④	M22-XW
M22-XWS 	Key cover	M22-XWS
M22-XC-R 	Key withdraw adapter ^⑤	M22-XC-R
M22-XC-Y 	Coding adapter	M22-XC-Y
M22-XGWK 	Guard ring	M22-XGWK

Notes

- ① For complete listing of available contact blocks, see Accessories, **Pages V7-T1-111 to V7-T1-116.**
- ② All NC contact blocks are positively driven contact. ⊖
- ③ Additional contacts may not be stacked behind M22-F type contact blocks, M22-F can be stacked behind standard M22 contacts only.
- ④ Plunger needed to actuate center-mounted contact blocks. Used for non-illuminated three-position selector switches only.
- ⑤ Enables a keyed selector switch to be set to user-selected key withdraw position.

1

Mushroom Head Pushbuttons**Product Description**

Eaton's M22 mushroom head operators are a durable and unique way to include standard pushbutton functionality. Like the standard pushbutton line, the maintained pushbuttons are field convertible to momentary. They also offer laser engraving and a robust five million mechanical operations on the standard momentary operator. As with all operators, they can be ordered as a ready to install complete device or as modular components.

Features

- Field convertible from maintained to momentary (available on maintained pushbuttons only)
- Customizable laser engraving on all buttons
- More than five million mechanical operations on momentary and one million on maintained pushbuttons
- Modular construction makes assembly fast and simplifies stocking of components and complete devices
- Capable of communicating via ASi protocol with ASi adapter modules

Protection Type

- IP67, IP69K
- NEMA 4X, 13

Catalog Number Selection

Catalog Number Selection is for illustrative purposes only and not to be used to create new catalog numbers.

Mushroom Head Pushbuttons

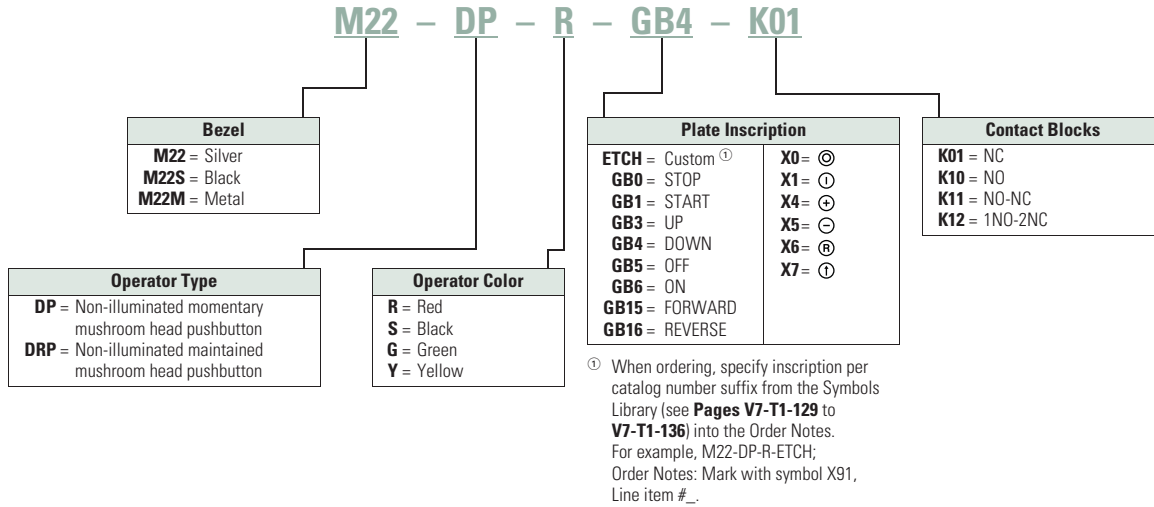

1

Product Selection

Mushroom Head Pushbuttons, Momentary ^①

M22-DP-R-K01



M22S-DP-R-K01



M22M-DP-R-K01



Complete Devices

Button Color	Contact Block Configuration ^②	Silver Bezel Catalog Number	Black Bezel Catalog Number	Metal Bezel Catalog Number
Red	NC	M22-DP-R-K01	M22S-DP-R-K01	M22M-DP-R-K01
	2NC	M22-DP-R-K02	M22S-DP-R-K02	M22M-DP-R-K02
	1NO-2NC	M22-DP-R-K12	M22S-DP-R-K12	M22M-DP-R-K12
	1NO-1NC	M22-DP-R-K11	M22S-DP-R-K11	M22M-DP-R-K11

M22-DP-G



M22S-DP-G



M22M-DP-G



Operators Only ^②

Button Color	Silver Bezel Catalog Number	Black Bezel Catalog Number	Metal Bezel Catalog Number
Black	M22-DP-S	M22S-DP-S	M22M-DP-S
Red	M22-DP-R	M22S-DP-R	M22M-DP-R
Green	M22-DP-G	M22S-DP-G	M22M-DP-G
Yellow	M22-DP-Y	M22S-DP-Y	M22M-DP-Y

Notes

- ① 35 mm diameter mushroom head button.
- ② Includes contact block mounting adapter.

Non-Illuminated Mushroom Head Pushbuttons, Momentary ①

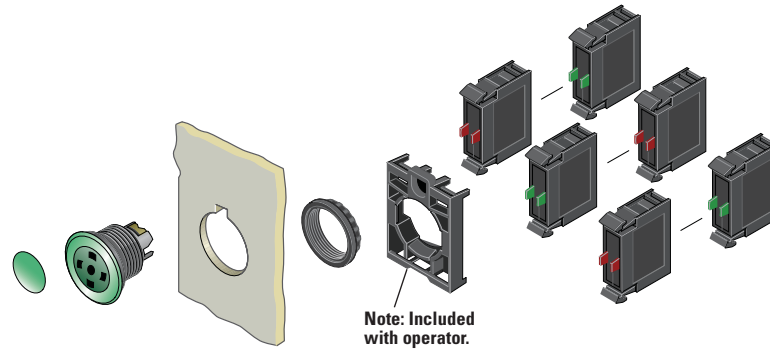

Components

M22-XDP-G



Mushroom Head Plates

Color	Inscription	Catalog Number
Black	—	M22-XDP-S ②
	Custom	M22-XDP-S-ETCH ③
	STOP	M22-XDP-S-GB0
	START	M22-XDP-S-GB1
	FORWARD	M22-XDP-S-GB15
	REVERSE	M22-XDP-S-GB16
	UP	M22-XDP-S-GB3
	DOWN	M22-XDP-S-GB4
	OFF	M22-XDP-S-GB5
	ON	M22-XDP-S-GB6
	⊙	M22-XDP-S-X0
	①	M22-XDP-S-X1
	+	M22-XDP-S-X4
	−	M22-XDP-S-X5
①	M22-XDP-S-X7	
Red	—	M22-XDP-R ②
	Custom	M22-XDP-R-ETCH ③
	STOP	M22-XDP-R-GB0
	OFF	M22-XDP-R-GB5
Green	—	M22-XDP-G ②
	Custom	M22-XDP-G-ETCH ③
	START	M22-XDP-G-GB1
	ON	M22-XDP-G-GB6
	⊙	M22-XDP-G-X0
White	—	M22-XDP-W ②
	Custom	M22-XDP-W-ETCH ③
Yellow	—	M22-XDP-Y ②
	Custom	M22-XDP-Y-ETCH ③

M22-DP-G-X



Insertless Mushroom Head Operators

Bezel	Color	Catalog Number
Silver	Black	M22-DP-S-X
	Red	M22-DP-R-X
	Green	M22-DP-G-X
	Yellow	M22-DP-Y-X
Black	Black	M22S-DP-S-X
	Red	M22S-DP-R-X
	Green	M22S-DP-G-X
	Yellow	M22S-DP-Y-X
Metal	Black	M22M-DP-S-X
	Red	M22M-DP-R-X
	Green	M22M-DP-G-X
	Yellow	M22M-DP-Y-X

M22-K10



Contact Blocks ④

Terminal Type	Contact Configuration ⑤	Catalog Number
Screw	NO	M22-K10
	NO, early-make	M22-K10P
	NC	M22-K01
	NC, late-break	M22-K01D
Spring-cage	NO	M22-CK10
	NC	M22-CK01
	NC, late-break	M22-CK01D
	2NO	M22-CK20
	2NC	M22-CK02
	NO-NC	M22-CK11
	NC	M22-FK01 ⑥
	NO	M22-FK10 ⑥

M22-FK01



Notes

- ① 35 mm diameter mushroom head button.
- ② Minimum order quantity of (10).
- ③ When ordering, specify inscription per catalog number suffix from the Symbols Library (see **Pages V7-T1-129 to V7-T1-136**) into the Order Notes. For example, M22-XDP-S-ETCH; Order Notes: Mark with symbol X91, Line item #_.
- ④ For complete listing of available contact blocks, see Accessories, **Pages V7-T1-111 to V7-T1-116**.
- ⑤ All NC contact blocks are positively driven contact. ⊖
- ⑥ Additional contacts may not be stacked behind M22-F type contact blocks, M22-F can be stacked behind standard M22 contacts only.

1

Product Selection

Non-Illuminated Mushroom Head Pushbuttons, Maintained ^{①②}

M22-DRP-R-K01



M22S-DRP-R-K01



M22M-DRP-R-K01



Complete Devices

Button Color	Contact Block Configuration ^③	Silver Bezel Catalog Number	Black Bezel Catalog Number	Metal Bezel Catalog Number
Red	NC	M22-DRP-R-K01	M22S-DRP-R-K01	M22M-DRP-R-K01
	2NC	M22-DRP-R-K02	M22S-DRP-R-K02	M22M-DRP-R-K02
	1NO-2NC	M22-DRP-R-K12	M22S-DRP-R-K12	M22M-DRP-R-K12
	1NO-1NC	M22-DRP-R-K11	M22S-DRP-R-K11	M22M-DRP-R-K11

M22-DRP-G



M22S-DRP-G



M22M-DRP-G



Operators Only

Button Color	Silver Bezel Catalog Number	Black Bezel Catalog Number	Metal Bezel Catalog Number
Black	M22-DRP-S	M22S-DRP-S	M22M-DRP-S
Red	M22-DRP-R	M22S-DRP-R	M22M-DRP-R
Green	M22-DRP-G	M22S-DRP-G	M22M-DRP-G
Yellow	M22-DRP-Y	M22S-DRP-Y	M22M-DRP-Y

Notes

- ① 35 mm diameter mushroom head button.
- ② Maintained pushbuttons can be converted in the field to momentary operation by switching the locking ring, which is accessible through the side of the operator body.
- ③ All NC contact blocks are positively driven contact. ⊖

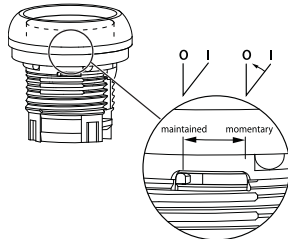

Note: This pilot device features a selectable function switch that enables the device to be set to either maintained or momentary operation.

Non-Illuminated Mushroom Head Pushbuttons, Maintained ^{①②}

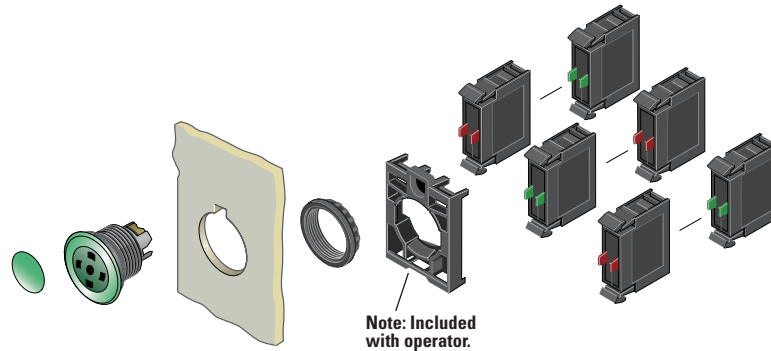

Components

M22-XDP-G



Mushroom Head Plates ^③

Color	Inscription	Catalog Number
Black	—	M22-XDP-S ^④
	Custom	M22-XDP-S-ETCH ^⑤
	STOP	M22-XDP-S-GB0
	START	M22-XDP-S-GB1
	FORWARD	M22-XDP-S-GB15
	REVERSE	M22-XDP-S-GB16
	UP	M22-XDP-S-GB3
	DOWN	M22-XDP-S-GB4
	OFF	M22-XDP-S-GB5
	ON	M22-XDP-S-GB6
	⊙	M22-XDP-S-X0
	Ⓛ	M22-XDP-S-X1
	+	M22-XDP-S-X4
	−	M22-XDP-S-X5
	Ⓛ	M22-XDP-S-X7
Red	—	M22-XDP-R ^④
	Custom	M22-XDP-R-ETCH ^⑤
	STOP	M22-XDP-R-GB0
	OFF	M22-XDP-R-GB5
	⊙	M22-XDP-R-X0
Green	—	M22-XDP-G ^④
	Custom	M22-XDP-G-ETCH ^⑤
	START	M22-XDP-G-GB1
	ON	M22-XDP-G-GB6
	⊙	M22-XDP-G-X0
White	—	M22-XDP-W ^④
	Custom	M22-XDP-W-ETCH ^⑤
	—	M22-XDP-Y ^④
Yellow	—	M22-XDP-Y ^④
	Custom	M22-XDP-Y-ETCH ^⑤

M22-DRP-G-X



Insertless Mushroom Head Operators

Bezel	Color	Catalog Number
Silver	Black	M22-DRP-S-X
	Red	M22-DRP-R-X
	Green	M22-DRP-G-X
	Yellow	M22-DRP-Y-X
Black	Black	M22S-DRP-S-X
	Red	M22S-DRP-R-X
	Green	M22S-DRP-G-X
	Yellow	M22S-DRP-Y-X
Metal	Black	M22M-DRP-S-X
	Red	M22M-DRP-R-X
	Green	M22M-DRP-G-X
	Yellow	M22M-DRP-Y-X

M22-K10



Contact Blocks ^③

Terminal Type	Contact Configuration ^⑥	Catalog Number
Screw	NO	M22-K10
	NO, early-make	M22-K10P
	NC	M22-K01
	NC, late-break	M22-K01D
Spring-cage	NO	M22-CK10
	NC	M22-CK01
	NC, late-break	M22-CK01D
	2NO	M22-CK20
	2NC	M22-CK02
	NO-NC	M22-CK11
	NC	M22-FK01 ^⑦
	NO	M22-FK10 ^⑦

M22-FK01



Notes

- ① 35 mm diameter mushroom head button.
- ② Maintained pushbuttons can be converted in the field to momentary operation by switching the locking ring, which is accessible through the side of the operator body.
- ③ For complete listing of available button plates and contact blocks, see Accessories, Pages V7-T1-111 to V7-T1-116.
- ④ Minimum order quantity of (10).
- ⑤ When ordering, specify inscription per catalog number suffix from the Symbols Library (see Pages V7-T1-129 to V7-T1-136) into the Order Notes. For example, M22-XDP-S-ETCH; Order Notes: Mark with symbol X91, Line item #_.
- ⑥ All NC contact blocks are positively driven contact. ⊖
- ⑦ Additional contacts may not be stacked behind M22-F type contact blocks, M22-F can be stacked behind standard M22 contacts only.

1

Double Pushbuttons

Product Description

Eaton's M22 double pushbutton line is perfect for applications such as motor and pump starting, as well as anytime space is limited. In addition to the two buttons that fit in one 22 mm hole is the integrated white indicating light between them. These three operators allow for multiple functions to occur in a single space. Green/red, black/white and black/black color options along with laser engraving allow for further custom applications.

Features

- Flush and extended, as well as color options allow for the perfect combination button
- Integrated indicating light adds even more functionality in one standard 22 mm hole
- Customizable laser engraving on all buttons
- LED offering only for improved brightness quality and up to 100,000 hours of operation
- More than 200,000 mechanical operations
- Capable of communicating via ASi protocol with ASi adapter modules

Protection Type

- IP66
- NEMA 4X, 13

Catalog Number Selection

Catalog Number Selection is for illustrative purposes only and not to be used to create new catalog numbers.

Double Pushbuttons

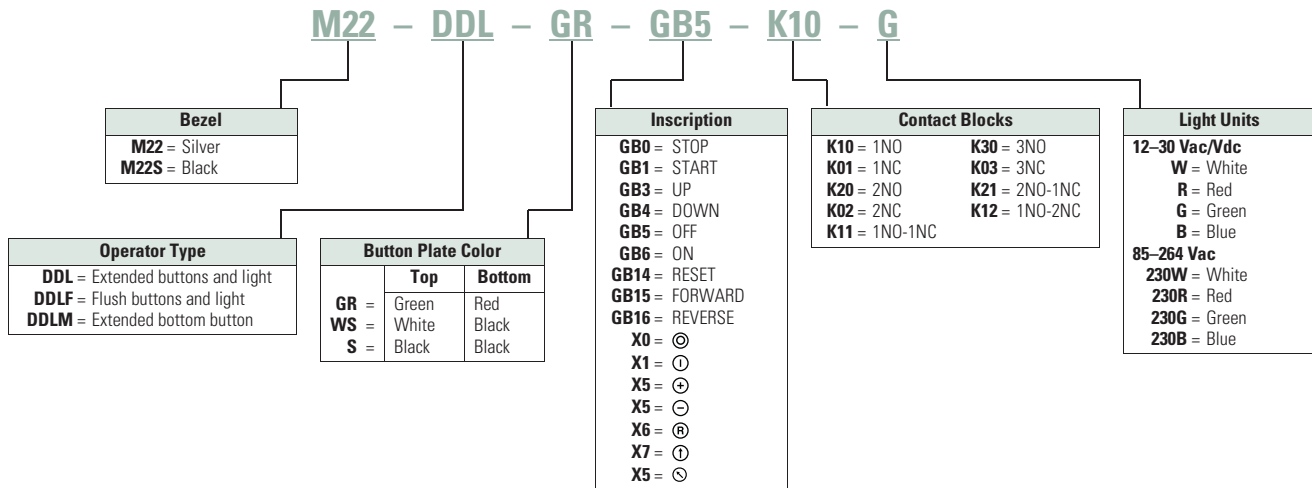



Product Selection

Components

Double Pushbuttons, Extended Pushbuttons and Center Light, Momentary

Operators Only ^①

	Bezel	Color Top	Bottom	Inscription Top	Bottom	Catalog Number	
	M22-DDL-GR-GB1-GB0	Silver	Green	Red	—	M22-DDL-GR	
					Custom	Custom	M22-DDL-GR-ETCH ^②
					Ⓜ	Ⓜ	M22-DDL-GR-X1-X0
					START	STOP	M22-DDL-GR-GB1-GB0
					—	—	M22-DDL-WS
					Custom	Custom	M22-DDL-WS-ETCH ^②
			White	Black	—	—	M22-DDL-WS-X1-X0
					Custom	Custom	M22-DDL-WS-GB1-GB0
					START	STOP	M22-DDL-WS-GB1-GB0
					—	—	M22-DDL-S
					Custom	Custom	M22-DDL-S-ETCH ^②
					—	—	M22-DDL-S-X4-X5
	M22S-DDL-GR-X1-X0	Black	Green	Red	—	M22S-DDL-GR	
					Custom	Custom	M22S-DDL-GR-ETCH ^②
					Ⓜ	Ⓜ	M22S-DDL-GR-X1-X0
					START	STOP	M22S-DDL-GR-GB1-GB0
					—	—	M22S-DDL-WS
					Custom	Custom	M22S-DDL-WS-ETCH ^②
			White	Black	—	—	M22S-DDL-WS-X1-X0
					Custom	Custom	M22S-DDL-WS-GB1-GB0
					START	STOP	M22S-DDL-WS-GB1-GB0
					—	—	M22S-DDL-S
					Custom	Custom	M22S-DDL-S-ETCH ^②
					+	—	M22S-DDL-S-X4-X5
Black	Black	—	—	M22S-DDL-S-X7-X7			
		Ⓜ	Ⓜ	M22S-DDL-S-X7-X7			



Notes

- ① Includes contact block mounting adapter.
- ② When ordering, specify inscription per catalog number suffix from the Symbols Library (see **Pages V7-T1-129 to V7-T1-136**) into the Order Notes. For example, M22-DDL-S-ETCH; Order Notes: Mark with symbol X91, Line item #_.

1



Double Pushbuttons, Flush Top Pushbuttons and Center Light, Momentary

Operators Only ^①

	Bezel	Color Top	Bottom	Inscription Top	Bottom	Catalog Number
M22-DDLF-GR 	Silver	Green	Red	—	—	M22-DDLF-GR
				Custom	Custom	M22-DDLF-GR-ETCH ^②
		White	Black	—	—	M22-DDLF-WS
				Custom	Custom	M22-DDLF-WS-ETCH ^②
				Green	Red	⓪
White	Black	⓪	⓪	M22-DDLF-WS-X1-X0		
M22S-DDLF-GR-X1-X0 	Black	Green	Red	—	—	M22S-DDLF-GR
				Custom	Custom	M22S-DDLF-GR-ETCH ^②
		White	Black	—	—	M22S-DDLF-WS
				Custom	Custom	M22S-DDLF-WS-ETCH ^②
				Green	Red	⓪
White	Black	⓪	⓪	M22S-DDLF-WS-X1-X0		

Double Pushbuttons, Flush Top Pushbutton and Center Light, Extended Bottom Pushbutton, Momentary

Operators Only ^①

	Bezel	Color Top	Bottom	Inscription Top	Bottom	Catalog Number
M22-DDLM-GR 	Silver	Green	Red	—	—	M22-DDLM-GR
				Custom	Custom	M22-DDLM-GR-ETCH ^②
		White	Black	—	—	M22-DDLM-WS
				Custom	Custom	M22-DDLM-WS-ETCH ^②
				Green	Red	⓪
White	Black	⓪	⓪	M22-DDLM-WS-X1-X0		
M22S-DDLM-GR-X1-X0 	Black	Green	Red	—	—	M22S-DDLM-GR
				Custom	Custom	M22S-DDLM-GR-ETCH ^②
		White	Black	—	—	M22S-DDLM-WS
				Custom	Custom	M22S-DDLM-WS-ETCH ^②
				Green	Red	⓪
White	Black	⓪	⓪	M22S-DDLM-WS-X1-X0		

Notes

- ① Includes contact block mounting adapter.
- ② When ordering, specify inscription per catalog number suffix from the Symbols Library (see **Pages V7-T1-129 to V7-T1-136**) into the Order Notes. For example, M22-DDLM-GR-ETCH; Order Notes: Mark with symbol X91, Line item #_.

Double Pushbuttons

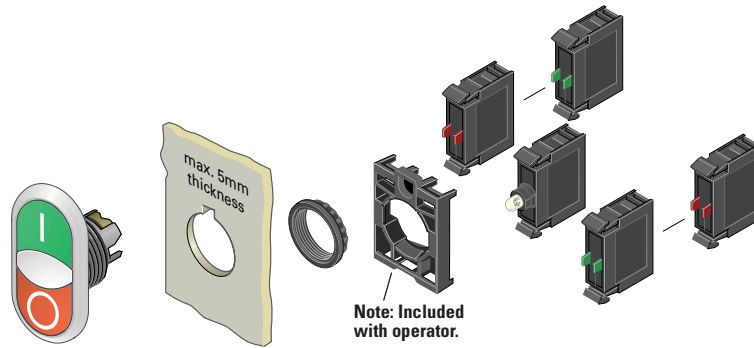

M22-LED-W



Light Units ^①

Terminal Type	LED Color	Light Unit Voltage	Catalog Number
Screw	White	12–30	M22-LED-W
	Red	Vac/Vdc	M22-LED-R
	Green		M22-LED-G
	Blue		M22-LED-B
Screw	White	85–264	M22-LED230-W
	Red	Vac	M22-LED230-R
	Green		M22-LED230-G
	Blue		M22-LED230-B
Spring-cage	White	12–30	M22-FLED-W
	Red	Vac/Vdc	M22-FLED-R
	Green		M22-FLED-G
	Blue		M22-FLED-B
	Red/Green/ Yellow	24 Vdc	M22-FLED-RG ^②
	Red, Green, Blue, Yellow, White, Violet, Turquoise		M22-FLED-RGB ^②

M22-FLED-



M22-K10



Contact Blocks ^①

Terminal Type	Contact Configuration ^③	Catalog Number
Screw	NO	M22-K10
	NO, early-make	M22-K10P
	NC	M22-K01
	NC, late-break	M22-K01D
Spring-cage	NO	M22-CK10
	NC	M22-CK01
	NC, late-break	M22-CK01D
	2NO	M22-CK20
	2NC	M22-CK02
	NO-NC	M22-CK11
	NC	M22-FK01 ^④
	NO	M22-FK10 ^④

M22-FK01



Notes

- ① For complete listing of available light units and contact blocks, see Accessories, **Pages V7-T1-111 to V7-T1-116.**
- ② Please see color input key on **Page V7-T1-114.**
- ③ All NC contact blocks are positively driven contact. ⊖
- ④ Additional contacts may not be stacked behind M22-F type contact blocks, M22-F can be stacked behind standard M22 contacts only.

1

Four-Way Pushbuttons

Product Description

Eaton's M22 four-way pushbutton is a truly unique offering. A four-way pushbutton offers four different buttons mounted in a single 22 mm hole. This is ideal not only for an application with limited space, but also directional applications (when ordered with the four arrow engraving option). Another unique option is the interlocked version, which prevents two opposite buttons from being actuated at the same time.

Features

- Four buttons in one operator allows for increased functionality in limited space
- Optional interlocking option, which prevents two buttons from being actuated at the same time
- Customizable laser engraving on all buttons for directional or other applications
- Capable of communicating via ASi protocol with ASi adapter modules

Protection Type

- IP66

Catalog Number Selection

Catalog Number Selection is for illustrative purposes only and not to be used to create new catalog numbers.

Four-Way Pushbuttons

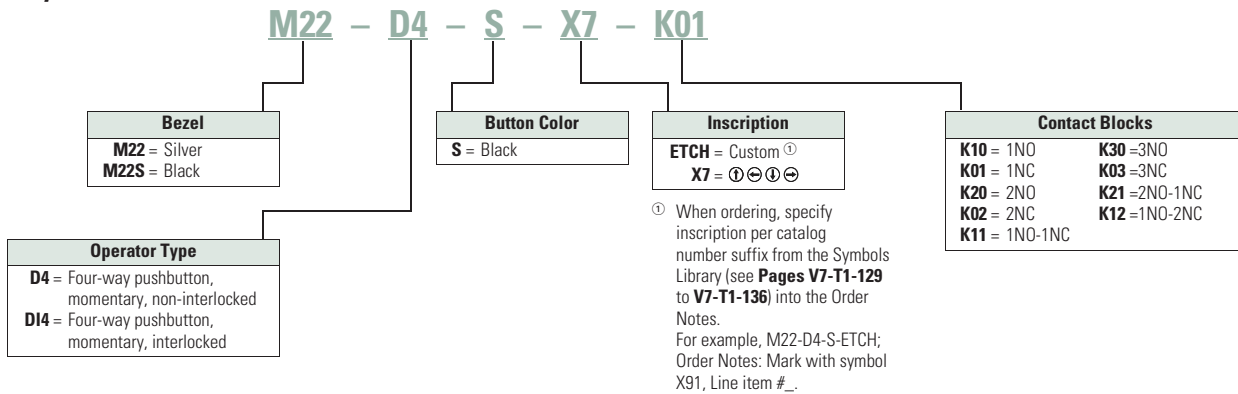

Product Selection

Four-Way Pushbuttons, Momentary

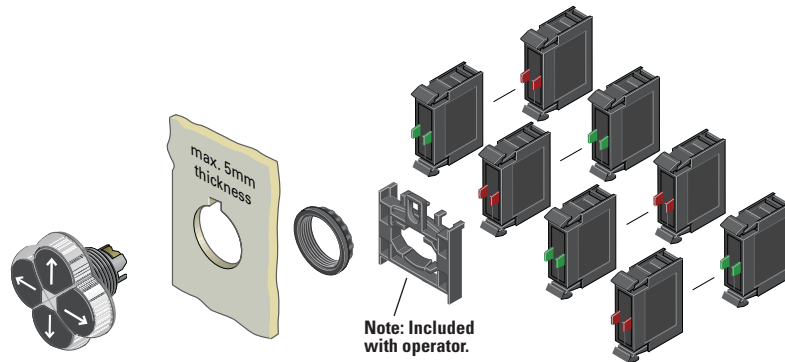

Components

M22-D4-S-X7



Operators Only ^①

Type	Bezel	Color	Inscription	Catalog Number
Non-interlocked	Silver	Black	—	M22-D4-S
			Custom	M22-D4-S-ETCH ^③
			Directional arrows	M22-D4-S-X7
	Black	Black	—	M22S-D4-S
			Custom	M22S-D4-S-ETCH ^③
			Directional arrows	M22S-D4-S-X7
Interlocked	Silver	Black	—	M22-DI4-S
			Custom	M22-DI4-S-ETCH ^③
			Directional arrows	M22-DI4-S-X7
	Black	Black	—	M22S-DI4-S
			Custom	M22S-DI4-S-ETCH ^③
			Directional arrows	M22S-DI4-S-X7

M22-K10



Contact Blocks ^{①②}

Terminal Type	Contact Configuration ^④	Catalog Number
Screw	NO	M22-K10
	NO, early-make	M22-K10P
	NC	M22-K01
	NC, late-break	M22-K01D
Spring-cage	NO	M22-CK10
	NC	M22-CK01
	NC, late-break	M22-CK01D
	2NO	M22-CK20
	2NC	M22-CK02
	NO-NC	M22-CK11
	NC	M22-FK01 ^⑤
NO	M22-FK10 ^⑤	

M22-FK01



Notes

- ① Includes contact block mounting adapter.
- ② For complete listing of available contact blocks, see Accessories, **Pages V7-T1-111 to V7-T1-116**.
- ③ When ordering, specify inscription per catalog number suffix from the Symbols Library (see **Pages V7-T1-129 to V7-T1-136**) into the Order Notes.
For example, M22-D4-S-ETCH; Order Notes: Mark with symbol X91, Line item #_.
- ④ All NC contact blocks are positively driven contact.
- ⑤ Additional contacts may not be stacked behind M22-F type contact blocks, M22-F can be stacked behind standard M22 contacts only.

1

Joysticks

Product Description

Eaton's M22 joystick line comes in a wide variety of options. From vertical and horizontal two-position switches to the maintained four-position, these operators fit a variety of applications. An additional option, two switch points, allows for eight isolated circuits to be actuated individually on a single operator.

Features

- Available in four-position and two-position
- Two switch point option allows for two contacts in each direction (up to eight total contacts in one operator)
- Capable of communicating via ASi protocol with ASi adapter modules

Protection Type

- IP66

Product Selection

Joysticks

Components

M22-WJ2H



M22M-WJ2H



Operators ^①

Number of Directions	Switching Position	Silver Bezel Catalog Number	Black Bezel Catalog Number	Metal Bezel Catalog Number
Two-position horizontal	Momentary	M22-WJ2H	M22S-WJ2H	M22M-WJ2H
Two switch points		M22-WJ2H-2P	M22S-WJ2H-2P	M22M-WJ2H-2P
Two-position horizontal	Maintained	M22-WRJ2H	M22S-WRJ2H	M22M-WRJ2H
Two-position vertical	Momentary	M22-WJ2V	M22S-WJ2V	M22M-WJ2V
Two switch points		M22-WJ2V-2P	M22S-WJ2V-2P	M22M-WJ2V-2P
Two-position vertical	Maintained	M22-WRJ2V	M22S-WRJ2V	M22M-WRJ2V
Four-position	Momentary	M22-WJ4	M22S-WJ4	M22M-WJ4
Two switch points		M22-WJ4-2P	M22S-WJ4-2P	M22M-WJ4-2P
Four-position	Maintained	M22-WRJ4	M22S-WRJ4	M22M-WRJ4

Note

^① Includes contact block mounting adapter.

Joysticks

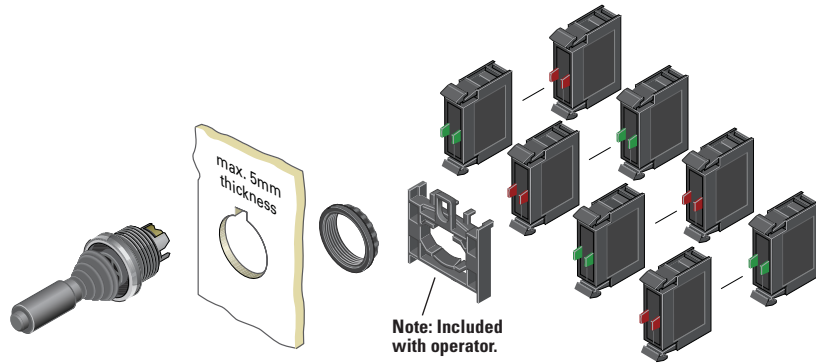

M22-K10



M22-FK01



Contact Blocks ^{①②}

Terminal Type	Contact Configuration ^③	Catalog Number
Screw	NO	M22-K10
	NO, early-make	M22-K10P
	NC	M22-K01
	NC, late-break	M22-K01D
Spring-cage	NO	M22-CK10
	NC	M22-CK01
	NC, late-break	M22-CK01D
	2NO	M22-CK20
	2NC	M22-CK02
	NO-NC	M22-CK11
	NC	M22-FK01 ^④
	NO	M22-FK10 ^④

Joystick with Double Contact

The joystick allows the control of up to four directions of movement on machines. Different variants of the joystick have two/four-positions and other variants have two settings for each position. This allows, for example, two-speed settings for each direction. For this application, a standard normally open contact and an early-make contact are fitted in series. Momentary contact and latching contact versions are available.

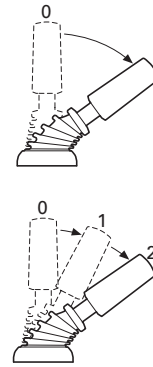

Notes

- ① Includes contact block mounting adapter.
- ② For complete listing of available contact blocks, see Accessories, **Pages V7-T1-111 to V7-T1-116**.
- ③ All NC contact blocks are positively driven contact.
- ④ Additional contacts may not be stacked behind M22-F type contact blocks, M22-F can be stacked behind standard M22 contacts only.

1

Potentiometers

Product Description

Eaton's M22 potentiometers allow for a ready to use operator in a conveniently sized package. M22 potentiometers include the resistive element, instead of just a knob, and a built in legend surrounding the knob. The slim design, with integrated contacts and the range of resistances available, allows for a quick install.

Features

- Scale markings on the knob allows the operator to be used without an additional legend plate
- Oversized knob option available
- Slim design allows for space saving and simple wiring and installation

Protection Type

- IP66
- NEMA 4X, 13

Product Selection

Potentiometers

M22-R10K



M22M-R10K



Complete Devices

Bezel	Resistance Rk	Catalog Number
Silver	1	M22-R1K
	4.7	M22-R4K7
	10	M22-R10K
	47	M22-R47K
	100	M22-R100K
Black	470	M22-R470K
	1	M22S-R1K
	4.7	M22S-R4K7
	10	M22S-R10K
	47	M22S-R47K
Metal	100	M22S-R100K
	470	M22S-R470K
	1	M22M-R1K
	4.7	M22M-R4K7
	10	M22M-R10K
Oversized Knob	47	M22M-R47K
	100	M22M-R100K
	470	M22M-R470K
	1	M22-R1K-RH
	4.7	M22-R4K7-RH
Black	10	M22-R10K-RH
	47	M22-R47K-RH
	100	M22-R100K-RH
	470	M22-R470K-RH
	1	M22S-R1K-RH
Metal	4.7	M22S-R4K7-RH
	10	M22S-R10K-RH
	47	M22S-R47K-RH
	100	M22S-R100K-RH
	470	M22S-R470K-RH
Metal	1	M22M-R1K-RH
	4.7	M22M-R4K7-RH
	10	M22M-R10K-RH
	47	M22M-R47K-RH
	100	M22M-R100K-RH
470	M22M-R470K-RH	

Acoustic Devices

Product Description

Eaton's M22 acoustic devices are a simple and aesthetic way to add a buzzer or indicator to any application. Fitting in the same 22 mm hole, these devices can be ordered in continuous or pulsed tone and with or without the IP40 enclosure.

Features

- Continuous or pulsed tone available
- 83 dB / 10 cm decibel rating
- Slim design allows for space saving and simple wiring and installation

Protection Type

- IP40
- NEMA 12

Product Selection

Acoustic Devices

M22-AMC-XAM



Complete Devices

Description	Decibel Rating	Catalog Number
Indicator with buzzer, black continuous tone, 18–30 Vac/Vdc	83 dB/10 cm	M22-AMC-XAM
Indicator with buzzer, black pulsed tone, 18–30 Vac/Vdc	83 dB/10 cm	M22-AMC-XAMP

M22-XAM



Buzzers

Description	Decibel Rating	Catalog Number
Indicator without buzzer, black	83 dB/10 cm	M22-AMC
Buzzer only, continuous tone, 18–30 Vac/Vdc	83 dB/10 cm	M22-XAM
Buzzer only, pulsed tone, 18–30 Vac/Vdc	83 dB/10 cm	M22-XAMP

Through-the-Door Operators

Product Description

Eaton's M22 through-the-door operators use the same familiar flush pushbutton look with the addition of a cut-to-length rod that allows for a simple reset operator.

Features

- Customizable laser engraving on all buttons
- More than five million mechanical operations
- Pushrod can be cut to length

Protection Type

- IP67, IP69K
- NEMA 4X, 13

Product Selection

Through-the-Door Operators ^①

M22-DZ-B-X6



Complete Devices

Color	Inscription	Catalog Number
Blue	—	M22-DZ-B
	RESET	M22-DZ-B-GB14
	Ⓡ	M22-DZ-B-X6
Red	—	M22-DZ-R
	Ⓢ	M22-DZ-R-X0
	STOP	M22-DZ-R-GB0

M22-DZ-X



Buttonless Operator

Bezel	Catalog Number
Silver	M22-DZ-X
Metal	M22M-DZ-X

M22-XD-B



Button Plates ^②

Color	Inscription	Catalog Number
Blue	—	M22-XD-B ^③
	RESET	M22-XD-B-GB14
	Ⓡ	M22-XD-B-X6
Red	—	M22-XD-R ^③
	Ⓢ	M22-XD-R-X0
	STOP	M22-XD-R-GB0

Bulkhead Interfaces

Product Description

Eaton's M22 bulkhead interfaces are another unique offering in the M22 line. This device allows for a secure connection to any USB or RJ45 connected device within an enclosure or panel. With an IP65 rating when closed, these devices are not only convenient, but robust and reliable.

Features

- Convenient and safe way to make a data connection to inside of the panel without opening the panel door

Protection Type

- IP65 when closed, IP20 when connected

Product Selection

Bulkhead Interfaces

M22-USB-SA



USB Socket ^{④⑤}

Used for USB connection plug IP65 when closed, IP20 when connected.

Bezel	Catalog Number
Silver	M22-USB-SA

M22-RJ45-SA



RJ45 Socket ^⑥

Used for RJ45 Ethernet connection IP65 when closed, IP20 when connected.

Bezel	Catalog Number
Silver	M22-RJ45-SA

Notes

- ① The pushrod is 3.24 in long and can be cut to length.
- ② Any combination of plate color and inscription is available.
- ③ Minimum order quantity of (10).
- ④ USB interface is complete with 2-ft-long USB cable.
- ⑤ USB interface is UL Listed, CSA approved and USB 3.0.
- ⑥ RJ45 interface is an eight-wire connector.

1

ASi Adapter Modules**Product Description**

Eaton's M22 ASi adapter modules add functionality to every operator in the M22 line. These devices can be connected to any operator that uses contact blocks or LED units. The simple snap-on design allows for a quick integration of an entire application of operators to a communicating network.

Features

- Allows compatible operators to communicate on an ASi network
- Not only can the status of a contact block be read, but LEDs can be illuminated by an ASi adapter
- ASi adapters simply clip on to the back of the contact blocks and LEDs
- Insulation displacement connectors allow for installation of adapters without any tools
- Two integrated LEDs indicate status of communications

Protection Type

- IP20

Product Selection**ASi Adapter Modules****M22-ASi****Complete Devices**

Description	Catalog Number
ASi adapter module	M22-ASi
ASi adapter module for base mounting	M22-ASi-C
ASi adapter module for E-stop	M22-ASi-S
ASi adapter module for E-stop base mounting	M22-ASi-CS

Palm Switches

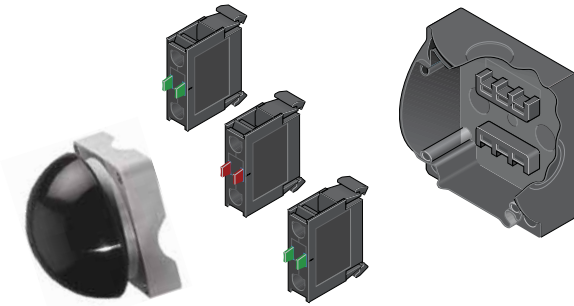

Product Description

Eaton’s M22 palm switches are an oversized button that mount directly to an enclosure base. This allows for a standalone button that can be mounted anywhere. The enclosure uses base-mounted contact blocks, which allows for quick wiring and mounting. The palm switches come in momentary or maintained versions. As with other M22 operators, the palm switches are available as complete devices, including the enclosure and contact blocks or as modular components.

Features

- Oversized operator in black, red and yellow color options
- Button integrated directly into an enclosure
- Base mounting contact blocks allow for simple wiring and installation
- More than one million mechanical operations on momentary and 100,000 on maintained operators

Protection Type

- IP67, IP69K
- NEMA 4X, 13

Catalog Number Selection

Catalog Number Selection is for illustrative purposes only and not to be used to create new catalog numbers.

Palm Switches, Type 4X/13 Enclosure

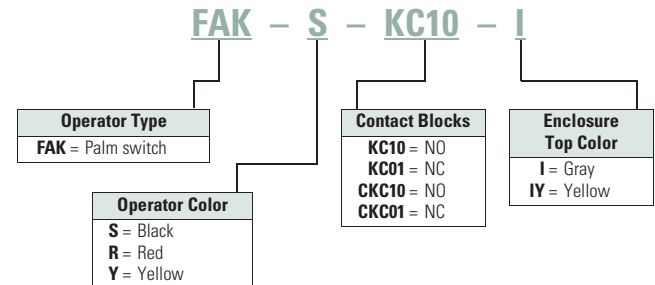

Product Selection

Complete Devices

Operator, Base and Contact Blocks ①

Button Color	Contact Block Configuration ②	Catalog Number
FAK-S-KC11-I		
Momentary		
Black	1NO-1NC	FAK-S-KC11-I
Red	1NO-1NC	FAK-R-KC11-I
Yellow	1NO-1NC	FAK-Y-KC11-I
FAK-R-V-KC01-IY		
Maintained		
Red	NC	FAK-R-V-KC01-IY
	2NC	FAK-R-V-KC02-IY
	1NO-2NC	FAK-R-V-KC12-IY
	1NO-1NC	FAK-R-V-KC11-IY

Notes

① For complete listing of available contact blocks, see Accessories, Pages V7-T1-111 to V7-T1-116.

② All NC contact blocks are positively driven contact. ⊖

1

Components

FAK-S



Operators Only

Type	Button Color	Catalog Number
Momentary	Black	FAK-S
	Red	FAK-R
	Yellow	FAK-Y
Maintained	Red	FAK-R-V-Y

FAK-IU



Palm Switch Enclosure Base

Catalog Number

FAK-IU

M22-K10



Contact Blocks ^①

Terminal Type	Contact Configuration ^②	Catalog Number
Screw	NO	M22-KC10
	NC	M22-KC01
Spring-cage	NO	M22-CKC10
	NC	M22-CKC01
	NC	M22-FK01 ^③
	NO	M22-FK10 ^③

M22-FK01



Notes

^① For complete listing of available contact blocks, see Accessories, **Pages V7-T1-111 to V7-T1-116.**

^② All NC contact blocks are positively driven contact. 

^③ Additional contacts may not be stacked behind M22-F type contact blocks, M22-F can be stacked behind standard M22 contacts only.

Accessories

M22-XD-S



M22-XDH-R



M22-XDP-G



Button Plates

Color	Inscription	Catalog Number Flush Pushbutton	Catalog Number Extended Pushbutton	Catalog Number Mushroom Head Button
Black	—	M22-XD-S	M22-XDH-S	M22-XDP-S
White	—	M22-XD-W	M22-XDH-W	M22-XDP-W
Red	—	M22-XD-R	M22-XDH-R	M22-XDP-R
Green	—	M22-XD-G	M22-XDH-G	M22-XDP-G
Yellow	—	M22-XD-Y	M22-XDH-Y	M22-XDP-Y
Blue	—	M22-XD-B	M22-XDH-B	—
Black, white, red, green, yellow, blue	—	M22-XD-SWRGYB	M22-XDH-SWRGYB	—
Black, red, green	—	M22-XD-SRG	M22-XDH-SRG	—
Black	Custom	M22-XD-S-ETCH	M22-XDH-S-ETCH	M22-XDP-S-ETCH
White	Custom	M22-XD-W-ETCH	M22-XDH-W-ETCH	M22-XDP-W-ETCH
Red	Custom	M22-XD-R-ETCH	M22-XDH-R-ETCH	M22-XDP-R-ETCH
Green	Custom	M22-XD-G-ETCH	M22-XDH-G-ETCH	M22-XDP-G-ETCH
Yellow	Custom	M22-XD-Y-ETCH	M22-XDH-Y-ETCH	M22-XDP-Y-ETCH
Blue	Custom	M22-XD-B-ETCH	M22-XDH-B-ETCH	—
Black	STOP	M22-XD-S-GB0	M22-XDH-S-GB0	M22-XDP-S-GB0
Red	STOP	M22-XD-R-GB0	M22-XDH-R-GB0	M22-XDP-R-GB0
Black	START	M22-XD-S-GB1	M22-XDH-S-GB1	M22-XDP-S-GB1
White	START	M22-XD-W-GB1	M22-XDH-W-GB1	—
Green	START	M22-XD-G-GB1	M22-XDH-G-GB1	M22-XDP-G-GB1
Black	CLOSE	M22-XD-S-GB2	M22-XDH-S-GB2	—
Black	UP	M22-XD-S-GB3	M22-XDH-S-GB3	M22-XDP-S-GB3
Black	DOWN	M22-XD-S-GB4	M22-XDH-S-GB4	M22-XDP-S-GB4
Black	OFF	M22-XD-S-GB5	M22-XDH-S-GB5	M22-XDP-S-GB5
Red	OFF	M22-XD-R-GB5	M22-XDH-R-GB5	M22-XDP-R-GB5
Black	ON	M22-XD-S-GB6	M22-XDH-S-GB6	M22-XDP-S-GB6
Green	ON	M22-XD-G-GB6	M22-XDH-G-GB6	M22-XDP-G-GB6
Black	TEST	M22-XD-S-GB9	M22-XDH-S-GB9	—
Blue	RESET	M22-XD-B-GB14	M22-XDH-B-GB14	—
Black	FORWARD	M22-XD-S-GB15	M22-XDH-S-GB15	M22-XDP-S-GB15
Black	REVERSE	M22-XD-S-GB16	M22-XDH-S-GB16	M22-XDP-S-GB16
Black	RAISE	M22-XD-S-GB17	M22-XDH-S-GB17	—
Black	LOWER	M22-XD-S-GB18	M22-XDH-S-GB18	—
Black	⊙	M22-XD-S-X0	M22-XDH-S-X0	M22-XDP-S-X0
Red	⊙	M22-XD-R-X0	M22-XDH-R-X0	M22-XDP-R-X0
Green	⊙	—	—	M22-XDP-G-X0
Black	⓪	M22-XD-S-X1	M22-XDH-S-X1	M22-XDP-S-X1
White	⓪	M22-XD-W-X1	M22-XDH-W-X1	—
Green	⓪	M22-XD-G-X1	M22-XDH-G-X1	M22-XDP-G-X1
Black	⓪	M22-XD-S-X2	M22-XDH-S-X2	—
Green	⓪	M22-XD-G-X2	M22-XDH-G-X2	—
Black	+	M22-XD-S-X4	M22-XDH-S-X4	M22-XDP-S-X4
Black	−	M22-XD-S-X5	M22-XDH-S-X5	M22-XDP-S-X5
Blue	Ⓜ	M22-XD-B-X6	M22-XDH-B-X6	—
Black	⓪	M22-XD-S-X7	M22-XDH-S-X7	M22-XDP-S-X7
Black	⓪	M22-XD-S-X8	M22-XDH-S-X8	—
Black	See ① below	M22-XD-S-X9	M22-XDH-S-X9	—
Black	See ① below	M22-XD-S-X10	M22-XDH-S-X10	—
Black	See ① below	M22-XD-S-X11	M22-XDH-S-X11	—
Black	See ① below	M22-XD-S-X12	M22-XDH-S-X12	—
Black	See ① below	M22-XD-S-X13	M22-XDH-S-X13	—
Black	See ① below	M22-XD-S-X14	M22-XDH-S-X14	—
Black	See ① below	M22-XD-S-X15	M22-XDH-S-X15	—
Black	See ① below	M22-XD-S-X16	M22-XDH-S-X16	—
Black	See ① below	M22-XD-S-X17	M22-XDH-S-X17	—

Note

① Refer to the Symbols Library, (see Pages V7-T1-129 to V7-T1-136), for symbol image.

1

M22-XDLH-W



M22-XDL-G



Button Lenses

Color	Inscription	Catalog Number Flush	Catalog Number Extended	Color	Inscription	Catalog Number Flush	Catalog Number Extended
White	—	M22-XDL-W	M22-XDLH-W	Blue	Custom	M22-XDL-B-ETCH	M22-XDLH-B-ETCH
Red	—	M22-XDL-R	M22-XDLH-R	Red	STOP	M22-XDL-R-GB0	M22-XDLH-R-GB0
Green	—	M22-XDL-G	M22-XDLH-G	Green	START	M22-XDL-G-GB1	M22-XDLH-G-GB1
Yellow	—	M22-XDL-Y	M22-XDLH-Y	Red	OFF	M22-XDL-R-GB5	M22-XDLH-R-GB5
Blue	—	M22-XDL-B	M22-XDLH-B	Green	ON	M22-XDL-G-GB6	M22-XDLH-G-GB6
White	Custom	M22-XDL-W-ETCH	M22-XDLH-W-ETCH	Blue	RESET	M22-XDL-B-GB14	M22-XDLH-B-GB14
Red	Custom	M22-XDL-R-ETCH	M22-XDLH-R-ETCH	Red	Ⓢ	M22-XDL-R-X0	M22-XDLH-R-X0
Green	Custom	M22-XDL-G-ETCH	M22-XDLH-G-ETCH	Green	Ⓛ	M22-XDL-G-X1	M22-XDLH-G-X1
Yellow	Custom	M22-XDL-Y-ETCH	M22-XDLH-Y-ETCH	Blue	Ⓡ	M22-XDL-B-X6	M22-XDLH-B-X6

Mounting Adapters

Description	Catalog Number
-------------	----------------

M22-A



Contact block mounting adapter

M22-A

M22-A4



Contact block mounting adapter, four-position (for use with four-way pushbuttons, joysticks and four-position selector switches only).

M22-A4

M22-LS



Allows mounting of M22 pushbuttons to LS-Titan limit switch bodies (for the full LS-Titan catalog section, see **PG08301004E**).

M22-LS

Contact Blocks

M22-K10



M22-FK01



Mounting Location	Terminal Type	Contact Configuration ^①	Package Qty.	Catalog Number		
Front	Screw	NO	1	M22-K10		
		NO	25	M22-K10-B25		
		NO	100	M22-K10-B100		
		NO, early-make	1	M22-K10P		
		NC	1	M22-K01		
		NC	25	M22-K01-B25		
		NC	100	M22-K01-B100		
		NC, late-break	1	M22-K01D		
		SMCB, NC	1	M22-K01SMC10		
		SMCB, 2NC	1	M22-K02SMC10		
		Base	Spring-cage	NO	1	M22-KC10
				NO	25	M22-KC10-B25
				NO	100	M22-KC10-B100
				NC	1	M22-KC01
				NC	25	M22-KC01-B25
				NC	100	M22-KC01-B100
SMCB, NC	1			M22-KC01SMC10		
SMCB, 2NC	1			M22-KC02SMC10		
Front	Spring-cage			NO	1	M22-CK10
				NC	1	M22-CK01
		NC, late-break	1	M22-CK01D		
		2NO ^②	1	M22-CK20		
		2NC ^②	1	M22-CK02		
		NO-NC ^②	1	M22-CK11		
		NC	20	M22-FK01 ^③		
		NO	20	M22-FK10 ^③		
		Base	Spring-cage	NO	1	M22-CKC10
				NC	1	M22-CKC01

Notes

^① All NC contact blocks are positively driven contact. Ⓢ

^② Not stackable.

^③ Additional contacts may not be stacked behind M22-F type contact blocks, M22-F can be stacked behind standard M22 contacts only.

M22-LED-W



Light Units

Terminal Type	Mounting Location	LED Color	Light Unit Voltage	Catalog Number		
Screw	Front	White	12–30 Vac/Vdc	M22-LED-W		
		Red		M22-LED-R		
		Green		M22-LED-G		
		Blue		M22-LED-B		
		White	85–264 Vac	M22-LED230-W		
		Red		M22-LED230-R		
		Green		M22-LED230-G		
		Blue		M22-LED230-B		
		White	207–264 Vac	M22-LED230H-W		
		Red		M22-LED230H-R		
		Green		M22-LED230H-G		
		Blue		M22-LED230H-B		
	Base	Front	White	12–30 Vac/Vdc	M22-LEDC-W	
			Red		M22-LEDC-R	
			Green		M22-LEDC-G	
			Blue		M22-LEDC-B	
			White	85–264 Vac	M22-LEDC230-W	
			Red		M22-LEDC230-R	
			Green		M22-LEDC230-G	
			Blue		M22-LEDC230-B	
White			207–264 Vac	M22-LEDC230H-W		
Red				M22-LEDC230H-R		
Green				M22-LEDC230H-G		
Blue				M22-LEDC230H-B		
Spring-cage		Front	White	12–30 Vac/Vdc	M22-CLED-W	
			Red		M22-CLED-R	
			Green		M22-CLED-G	
			Blue		M22-CLED-B	
			White	85–264 Vac	M22-CLED230-W	
			Blue		M22-CLED230-B	
Base	Front	White	12–30 Vac/Vdc	M22-CLEDC-W		
		Red		M22-CLEDC-R		
		Green		M22-CLEDC-G		
		Blue		M22-CLEDC-B		
		White	85–264 Vac	M22-CLEDC230-W		
		Red		M22-CLEDC230-R		
		Green		M22-CLEDC230-G		
		Blue		M22-CLEDC230-B		
		Front	Front	White	12–30 Vac/Vdc	M22-FLED-W
				Red		M22-FLED-R
				Green		M22-FLED-G
				Blue		M22-FLED-B
	Red/Green/Yellow			24 Vdc	M22-FLED-RG ^①	
	Red, Green, Blue, Yellow, White, Violet, Turquoise				M22-FLED-RGB ^①	

M22-FLED-



M22-XLED60



LED Resistor and Test Elements

Terminal Type	Mounting Location	Element Type	Voltage	Catalog Number
Screw	Front	Resistor ^{②③}	42–60 Vac/Vdc	M22-XLED60
			220 Vdc	M22-XLED220
		Test	12–240 Vac/Vdc	M22-XLED-T
			85–264 Vac	M22-XLED230-T



Notes

- ① Please see color input key on **Page V7-T1-114**.
- ② Resistor units to be used with 12–30V light units.
- ③ Refer to **IL04716002E** for use of resistor elements in series for higher DC voltage.

Multi-Color LED Input Guide

Catalog Number		Terminal Color			
		X1 +R	X2 +G	X3 +B	X4 GND
M22-FLED-RG	Red	■	—	—	■
	Green	—	■	—	■
	Yellow	■	■	—	■
M22-FLED-RGB	Red	■	—	—	■
	Green	—	■	—	■
	Yellow	■	■	—	■
	White	■	■	■	■
	Blue	—	—	■	■
	Violet	■	—	■	■
	Turquoise	—	■	■	■

Legend Plate Holders and Inserts, Pushbuttons and Double Pushbuttons ^①

	Description	Inscription	Catalog Number
M22S-ST-X 	Legend plate holder, without legend plate insert, for pushbuttons	—	M22S-ST-X
	Legend plate holder, without legend plate insert, for double pushbuttons	—	M22S-STDD-X
M22-XST-GB0 	Legend plate insert	—	M22-XST
		Custom	M22-XST-ETCH ^②
		STOP	M22-XST-GB0
		START	M22-XST-GB1
		OFF	M22-XST-GB5
		ON	M22-XST-GB6
		RUN	M22-XST-GB7
		FAULT	M22-XST-GB8
		OFF ON	M22-XST-GB10
		MAN. AUTO	M22-XST-GB11
		MAN. O AUTO	M22-XST-GB12
		HAND AUTO	M22-XST-D11
		HAND O AUTO	M22-XST-D12
		1	M22-XST-X52
		2	M22-XST-X53
	O I	M22-XST-X88	
	O - I	M22-XST-X89	
	I O II	M22-XST-X93	

Notes

^① Legend plates are IP66 and NEMA 4X/13.

^② When ordering, specify inscription per catalog number suffix from the Symbols Library (see **Pages V7-T1-129 to V7-T1-136**) into the Order Notes.







For example, M22-XD-S-ETCH; Order Notes: Mark with symbol X91, Line item # __.

Example

To order a legend plate for a pushbutton with non-standard markings (FORWARD):

1. Select legend plate holder—M22S-ST-X.
2. Select legend plate insert—M22-XST-ETCH.
3. Select FORWARD from the Symbols Library, **Pages V7-T1-129 to V7-T1-136**, identified by GB15 suffix.
4. Indicate on the order form in the order notes—suffix GB15, line item # __.

Legend Plates, Complete ①

	Description	Inscription	Catalog Number	
M22S-ST-GB0 	For use with pushbuttons and indicating lights	Legend plate holder with insert	M22S-ST-GB0	
			STOP	M22S-ST-GB1
			START	M22S-ST-GB5
			OFF	M22S-ST-GB6
			ON	M22S-ST-GB7
			RUN	M22S-ST-GB8
			FAULT	M22S-ST-GB8
			1	M22S-ST-X52
			2	M22S-ST-X53
		M22S-ST-GB0 	Selector switches	—
	OFF ON			M22S-ST-GB11
	MAN. AUTO			M22S-ST-GB12
	MAN. 0 AUTO			M22S-ST-D11
	HAND AUTO			M22S-ST-D12
	HAND 0 AUTO			M22S-ST-X88
	O I			M22S-ST-X89
	O - I			M22S-ST-X93
	I O II			M22S-ST-X93
M22-XZK 	Emergency-stop operators			Rectangular yellow legend plate
			—	M22-XZK-ETCH ②
			EMERGENCY-STOP	M22-XZK-GB99
M22-XYK 	Emergency-stop operators	Square yellow legend plate	M22-XYK	
			—	M22-XYK-ETCH ②
			EMERGENCY-STOP four-language	M22-XYK1
			EMERGENCY-STOP (top and bottom)	M22-XYK5
			—	M22-XAK
M22-XYK 	Emergency-stop operators	Round yellow legend plate, 90 mm	M22-XAK	
			—	M22-XAK-ETCH ②
			EMERGENCY-STOP four-language	M22-XAK1
			EMERGENCY-STOP (top and bottom)	M22-XAK5
			—	M22-XBK
M22-XBK1 	Emergency-stop operators	Round yellow legend plate, 60 mm	M22-XBK	
			—	M22-XBK-ETCH ②
			EMERGENCY-STOP four-language	M22-XBK1
			EMERGENCY-STOP (top and bottom)	M22-XBK5
			—	M22-XCK
M22-XCK1 	Four-way pushbutton, joystick and four-position selector switches	Silver square legend plate	M22-XCK	
			—	M22-XCK-ETCH ②
			Custom	M22-XCK1
			Four directional arrows	M22-XCK2
			0-1-0-2-0-3-0-4	M22-XCK3
	Two directional arrows	M22-XCK3		

Notes

- ① Legend plates are IP66 and NEMA 4X/13.
- ② When ordering, specify inscription per catalog number suffix from the Symbols Library (see **Pages V7-T1-129 to V7-T1-136**) into the Order Notes. For example, M22-XD-S-ETCH; Order Notes: Mark with symbol X91, Line item #_.

Surface Mounting Enclosures ^①

Description	Catalog Number
M22-IY1-PG Yellow top, black base for emergency-stop operators	M22-IY1-PG
M22-IY-PG One-element enclosure	M22-I1-PG
Two-element enclosure	M22-I2-PG
Three-element enclosure	M22-I3-PG
Four-element enclosure	M22-I4-PG
Six-element enclosure	M22-I6-PG
M20 connecting screw	M22-XI
M20 cord grip	V-M20

Flush Mounting Plates, Aluminum

Finish	Rating	Catalog Number
One Hole		
Yellow paint for emergency-stop operators	—	M22-EY1
Gray anodized	IP65	M22-E1
Two Holes		
Gray anodized	IP65	M22-E2
Three Holes		
Gray anodized	IP65	M22-E3
Four Holes		
Gray anodized	IP65	M22-E4
Five Holes		
Gray anodized	IP65	M22-E5
Six Holes		
Anodized	IP40	M22-E6

Shrouds, Plastic

Description	Rating	Catalog Number
M22-H1 One-element	IP55	M22-H1
Two-element	IP55	M22-H2
Three-element	IP55	M22-H3
Four-element	IP40	M22-H4
Five-element	IP40	M22-H5
Six-element	IP40	M22-H6
Mounting plate	—	M22-XE5
Plaster keys for flush mounting	—	M22-UPE





Selector Switch Accessories

Description	Catalog Number
M22-XW Plunger bridge ^②	M22-XW
M22-XWS Key cover	M22-XWS
M22-XC-R Key withdraw adapter ^③	M22-XC-R
M22-XC-Y Coding adapter	M22-XC-Y
M22-XGWK Guard ring	M22-XGWK

Notes

- ① Requires use of base mounted contact blocks.
- ② Plunger needed to actuate center-mounted contact blocks. Used for non-illuminated three-position selector switches only.
- ③ Enables a keyed selector switch to be set to user-selected key withdraw position.

Emergency Stop Operator Accessories

	Description	Voltage	Catalog Number
	Yellow guard ring	—	M22-XGPV
	Gray guard ring	—	M22G-XGPV
	Rectangular guard	—	M22-MGTA
	Sealing shroud	—	M22-PL-PV
	Illuminated ring	24 Vac/Vdc	M22-XPV60-Y-24
		120 Vac	M22-XPV60-Y-120
		230 Vac	M22-XPV60-Y-230

Blanking Plugs





M22-B	Color	Catalog Number
	Gray	M22-B
	Black	M22S-B

Notching Tool

Punching tool used to produce the cutout for the anti-rotation tab as defined in IEC/EN 60947-5-1.

Description	Unit	Article Number	Catalog Number
St 37 sheet steel: Max. 3 mm thickness	1	028144	M22-NT
Stainless steel: Max. 1.5 mm thickness			

Mounting Accessories

	Description	Catalog Number
	Telescopic clip with top-hat rail	M22-TC
	Telescopic clip	M22-TA
	Telescopic clip extension	M22-TCV
	DIN rail mounting adapter	M22-IVS
	Mounting ring	M22-GR
	Mounting ring tool	M22-MS
	Adapter ring set for 30 mm holes	M22S-R30

Protective Diaphragm

M22-T-D and M22-T-DD	For Use with ...	Catalog Number
	Flush pushbuttons and indicating lights	M22-T-D
	Double pushbuttons	M22-T-DD

Dust Covers

M22-ADC4	Description	Catalog Number
	Contact block dust cover	M22-XKDP
	Operator dust cover, max three contact blocks	M22-ADC
	Operator dust cover, max four contact blocks	M22-ADC4

Kits

Description	Catalog Number
Includes one each: M22-XW, M22-XC-R, M22-XC-Y, M22S-B, M22-A, M22-XD-SWRGYB	M22-KT1

Coding Adapter Guide Selector Switches

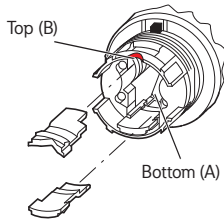

Two-Position Selector Switch

Top (B)	Bottom (A)	Catalog Number	Function
		M22(S)-W(L)(K)	Momentary
		M22(S)-WR(L)(K)	Maintained

Three-Position Selector Switch

Top (B)	Bottom (A)	Catalog Number	Function Left	Right
		M22(S)-W(L)(K)3	Momentary	Momentary
		M22(S)-WR(L)(K)3	Maintained	Maintained
		M22(S)-WR(L)(K)3-1	Maintained	Momentary
		M22(S)-WR(L)(K)3-2	Momentary	Maintained

Two-Position Key-Operated Selector Switch

Top (B)	Bottom (A)	Catalog Number	Center Key Withdraw	Right Function	Key Withdraw
		M22(S)-WS	Yes	Momentary	No
		M22(S)-WRS	Yes	Maintained	Yes
		M22(S)-WRS-A1	Yes	Maintained	No

Three-Position Key-Operated Selector Switch

Top (B)	Bottom (A)	Catalog Number	Left Function	Key Withdraw	Center Key Withdraw	Right Function	Key Withdraw
		M22(S)-WS3	Momentary	No	Yes	Momentary	No
		M22(S)-WRS3	Maintained	Yes	Yes	Maintained	Yes
		M22(S)-WRS3-A1	Maintained	No	Yes	Maintained	No
		M22(S)-WRS3-A2	Maintained	Yes	Yes	Maintained	No
		M22(S)-WRS3-A3	Maintained	No	Yes	Maintained	Yes
		M22(S)-WRS3-A4	Maintained	Yes	Yes	Momentary	No
		M22(S)-WRS3-A5	Maintained	No	Yes	Momentary	No
		M22(S)-WRS3-A6	Momentary	No	Yes	Maintained	Yes
		M22(S)-WRS3-A7	Momentary	No	Yes	Maintained	No

Technical Data and Specifications

Pushbuttons, Indicating Lights, Selector Switches and Emergency-Stop Operators

Description		Momentary Pushbuttons	Maintained Pushbuttons	Indicating Lights, Buzzers and Potentiometers	Emergency-Stop Operators	Selector Switches	Key-Operated Operators	Double Pushbuttons
General								
Standards		IEC/EN 60947 VDE 0660 UL #E29184	IEC/EN 60947 VDE 0660 UL #E29184	IEC/EN 60947 VDE 0660 UL #E29184	IEC/EN 60947 VDE 0660 UL #340491	IEC/EN 60947 VDE 0660 UL #E29184	IEC/EN 60947 VDE 0660 UL #E29184	IEC/EN 60947 VDE 0660 UL #E29184
Lifespan, mechanical	Operations	x 10 ⁶	>5	>1	—	>0.1	>0.1	>0.2
Operating frequency	Operations/h		≥3600	≥1800	—	≥600	≥2000	≥3600
Actuating force	n		≥5	≥5	—	≥50	—	≥5
Operating torque (screw terminals)	Nm		—	—	—	≥0.3	≥0.5	—
Protection Type								
IP		IP67, IP69K	IP67, IP69K	Indicating lights: IP67, 69K Buzzers: IP40 Potentiometers: IP66	IP67, IP69K	IP66	IP66	IP66
UL type		4X, 13	4X, 13	Indicating lights: 4X/13 Buzzers: 12 Potentiometers: 4X/13	4X, 13	4X, 13	4X, 13	4X, 13
Climatic proofing		Damp heat, constant, according to IEC 60068-2-78 Damp heat, cyclical to IEC 60068-2-30						
Ambient temperature, operating		°F (°C)	–13 to 158 (–25 to 70)	–13 to 158 (–25 to 70)	–13 to 158 (–25 to 70)	–13 to 158 (–25 to 70)	–13 to 158 (–25 to 70)	–13 to 158 (–25 to 70)
Mounting position			As required	As required	As required	As required	As required	As required
Mechanical shock resistance to IEC 60068-2-27 shock duration 11 ms, half-sinusoidal		g	>30	>30	>30	>50	>30	>30
Terminal Capacities								
Solid		AWG	—	—	20-16	—	—	—
		mm ²	—	—	0.5–1.5	—	—	—
Stranded		AWG	—	—	20-16	—	—	—
		mm ²	—	—	0.5–1.5	—	—	—
Contacts								
Rated impulse withstand voltage		U _{imp}	Vac	—	4000	—	—	—
Rated insulation voltage		U _i	V	—	2500	—	—	—
Overvoltage category/pollution degree			—	—	III/3	—	—	—

Contact Blocks and Light Units

Description			Contact Blocks	LED Light Units
General				
Standards			IEC/EN 60947 VDE 0660 UL #E29184	IEC/EN 60947 VDE 0660 UL #E29184
Lifespan, mechanical	Operations	$\times 10^6$	>5	—
Operating frequency	Operations/h		≥ 3600	—
Actuating force	n		≥ 5	—
Operating torque (screw terminals)	Nm		≤ 0.8	—
Protection Type				
IP			IP20	IP20
UL type			—	—
Climatic proofing			Damp heat, constant, according to IEC 60068-2-78 Damp heat, cyclical to IEC 60068-2-30	
Ambient temperature, operating		°F (°C)	–13 to 158 (–25 to 70)	–13 to 158 (–25 to 70)
Mounting position			As required	As required
Mechanical shock resistance to IEC 60068-2-27 shock duration 11 ms, half-sinusoidal		g	>30	>30
Terminal Capacities				
Solid		AWG	18–14	18–14
		mm ²	0.75–2.5	0.75–2.5
Stranded		AWG	20–14	20–14
		mm ²	0.5–2.5	0.5–2.5
Contacts				
Rated impulse withstand voltage	U_{imp}	Vac	6000	6000
Rated insulation voltage	U_i	V	500	500
Overvoltage category/ pollution degree			III/3	III/3
NEMA contact ratings			A600, Q300	—
Current draw			—	5–15 mA
Control Circuit Reliability				
at 24 Vdc/5 mA	H_f	Fault probability	$<10^{-7}$, <1 fault in 10^7 operations	—
at 5 Vdc/1 mA	H_f	Fault probability	$<5 \times 10^{-6}$, <1 fault in 5×10^6 operations	—
Max. Short-Circuit Protective Device				
Fuse	gG/gL	A	10	—
Switching Capacity				
Rated Operational Current				
AC-15				
115V	I_e	A	6	—
230V	I_e	A	6	—
400V	I_e	A	4	—
500V	I_e	A	2	—
DC-13				
24V	I_e	A	3	—
42V	I_e	A	1.7	—
60V	I_e	A	1.2	—
110V	I_e	A	0.6	—
220V	I_e	A	0.3	—
Lifespan, Electrical				
AC-15				
230V/0.5A	Operations	$\times 10^6$	1.6	—
230V/1.0A	Operations	$\times 10^6$	1	—
230V/3.0A	Operations	$\times 10^6$	0.7	—
DV-13				
12V/2.8A	Operations	$\times 10^6$	1.2	—

Contact Element Note: >200 Vac/60 Hz: –25/55°C

Palm Switches

Description		Momentary	Maintained	FAK-R-V-KC11-I
General				
Standards		IEC/EN 60947 VDE 0660	IEC/EN 60947 VDE 0660	IEC/EN 60947 VDE 0660
Lifespan, mechanical	Operations x 10 ⁶	>1	>0.1	>0.1
Operating frequency	Operations/h	≥3600	≥600	≥600
Actuating force	n	20–40	40–60	15–25
Operating torque	Nm	—	—	—
Degree of protection, IEC/EN 60529	IP	IP67, IP69K	IP67, IP69K	IP65
	UL Type	4X, 13	4X, 13	4X, 13
Climatic proofing		Damp heat, constant, to IEC 60068-2-78 Damp heat, cyclic, to IEC 60068-2-30		
Ambient temperature, operating	°F (°C)	–73 to 104 (–25 to 40)	–73 to 104 (–25 to 40)	–73 to 104 (–25 to 40)
Mounting position		As required		
Mechanical shock resistance to IEC 60068-2-27 shock duration 11 ms, half-sinusoidal	g	>15	>15	>15

ASi Adapter Modules

Description		M22-ASI	M22-ASI-C
General			
Standards		IEC/EN 60947, DIN EN 50295	IEC/EN 60947, DIN EN 50295
Radio interference suppression		EN 55011, EN 55022	EN 55011, EN 55022
Limit value class		—	—
Protection type		IP20	IP00
Climatic proofing		Damp heat, constant, to IEC 60068-2-78, cyclical, to IEC 60068-2-30	
Ambient temperature, operating	°F (°C)	–13 to 131 (–25 to 55)	–13 to 131 (–25 to 55)
Shock resistance shock duration 11 ms	g	>30	>30
Vibration to IEC 60068-2-27 (amplitude 1 mm)	Hz	—	—
Dimensions	mm	—	—
Weight	kg	—	—
Mounting		Front mounting	Front mounting
Mounting position		As required	As required
Power Supply			
Rated voltage to AS-interface specification	Vdc	26.5–31.6	26.5–31.6
Connection technique		Yellow plug-in terminal as insulation piercing terminal	Two cables onboard
Power supply		Completely from the AS-interface cable	
Addressing		Via connection to AS-interface cable	
Total power consumption of the AS-interface	mA	≥40	≥40
AS-interface		—	—
Rated operational current at full load	mA	—	—
Rated operational current when idle (no I, O set)	mA	—	—
Status LEDs		POWER AS-interface cable: green LED on the rear side of the element ERROR AS-interface, AS-interface master failure: red LED on the rear side of the element	POWER AS-interface cable: green LED on the board ERROR AS-interface, AS-interface master failure: red LED on the board

ASI-S Adapter Modules

Description		M22-ASI-S	M22-ASI-CS
Inputs			
Inputs, protected against short-circuit	Number	Two (normally 22V/5 mA)	Two (normally 22V/5 mA)
Voltage range	Vdc	—	—
Rated current per input	mA	—	—
High signal level	V	—	—
Low signal	mA	—	—
Length of connecting cables	cm	—	—
Outputs			
Outputs, protected against short-circuit	Number	One (normally 19V/8 mA)	One (normally 19V/8 mA)
Voltage range	Vdc	—	—
Max. Current Carrying Capacity			
All outputs		—	—
∑ three external outputs		—	—
Length of connecting cables	cm	—	—
Profile		S-3.A.E	S-3.A.E
Specification		2.1	2.1
Addresses	Number	62	62
Emergency-Stop Circuits			
Connection of the AS-interface line		Yellow plug terminal with insulation piercing	Two cables on the circuit board
Power supply		Complete from AS-interface, cable 26.5–31.6 Vdc	Complete from AS-interface, cable 26.5–31.6 Vdc
Fixing		Front mounted	Base mounted
Addressing		Via AS-interface cable	Via AS-interface cable
Max. total current	A	45 mA	45 mA
Ambient temperature, operating	°F (°C)	–13 to 131 (–25 to 55)	–13 to 131 (–25 to 55)
Shock resistance		30g/11 ms as per IEC 60068-2-27	30g/11 ms as per IEC 60068-2-27
Protection type		IP20	IP00
Climatic proofing		Damp heat, constant, to IEC 60068-2-78, cyclical, to IEC 60068-2-30	Damp heat, constant, to IEC 60068-2-78, cyclical, to IEC 60068-2-30
Mounting position		As required	As required
Standards		EN 50178 EN 50 295	EN 50178 EN 50 295
Inputs		Two-channel input (22V/5 mA) (moduled by code sequence) (two break contact sets M22-K01)	Two-channel input (22V/5 mA) (moduled by code sequence) (two break contact sets M22-K01)
Outputs		One output, typically 19V/8 mA, short-circuit proof	One output, typically 19V/8 mA, short-circuit proof
Status Displays			
Power, AS-interface cable		Green LED on the back	Green LED on the back
AS-interface error, AS-interface master failure		Red LED on the back	Red LED on the back
Profile		S-7.B.E	S-7.B.E

Dimensions

Approximate Dimensions in Inches (mm)

Operators and Indicating Lights

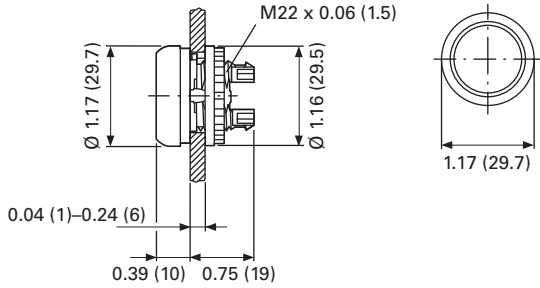

Pushbuttons

M22...-D-

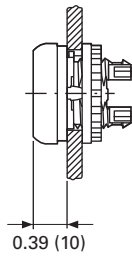

M22...-DH-

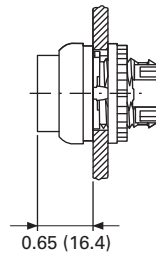

M22-DG(L)-

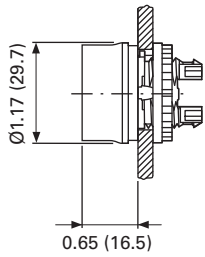

M22...-DD-

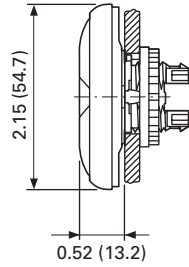

M22-D, Base Mounted

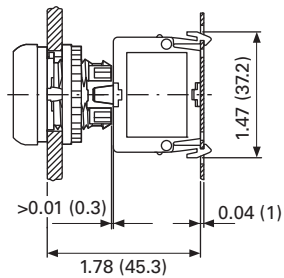

Selector Switches Operators

M22...-W-

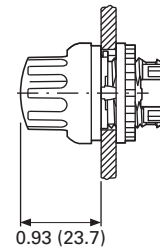

M22...-WL-

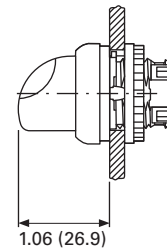

Key-Operated Selector Switches

M22...-W(R)S-

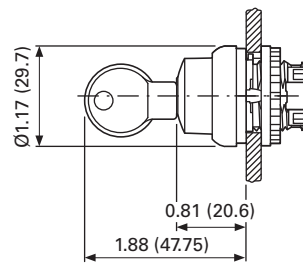

Indicating Light

M22-L

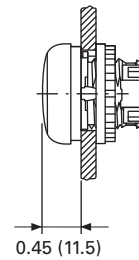

1.5

Pushbuttons and Indicating Lights

22.5 mm RMQ-Titan Modular Pushbuttons—M22

1

Approximate Dimensions in Inches (mm)

Illuminated Pushbuttons

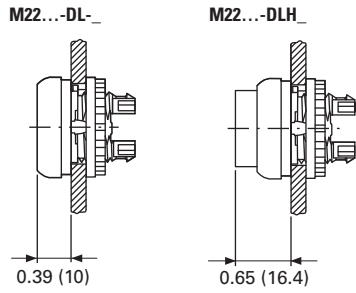

Mushroom Head Pushbutton

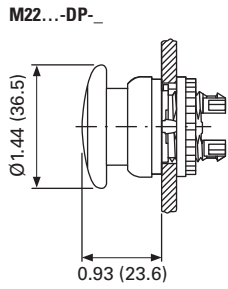

Emergency-Stop Operators

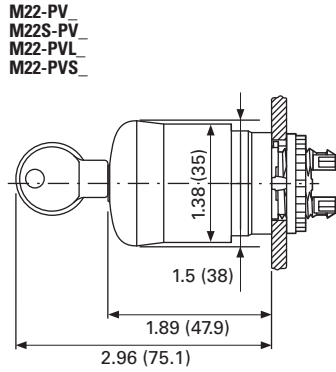

Potentiometer

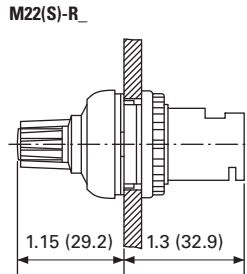

Contact Block Mounting Adapter

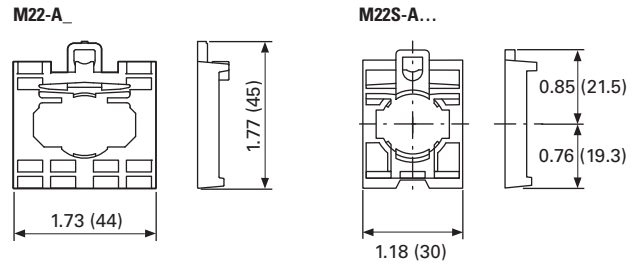

Front Mounted Centering Adapter

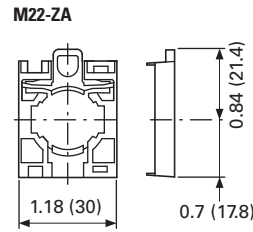

Front Mounted Indicating Light

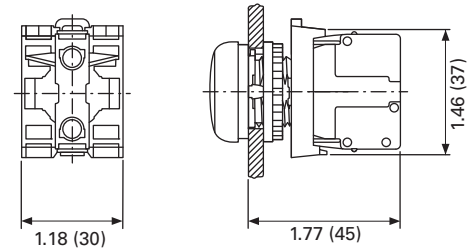

Pushbutton, Complete Devices

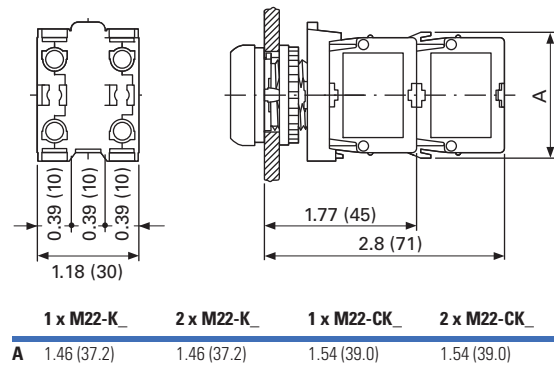

Approximate Dimensions in Inches (mm)

DIN-Rail Mounting Adapter

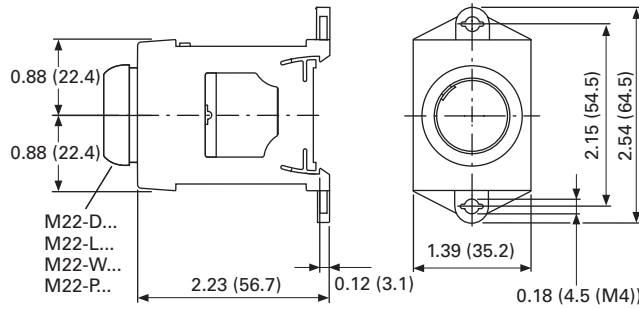

Pushbuttons and Indicating Lights with M22-TC Telescopic Clip and M22-TVC Extension

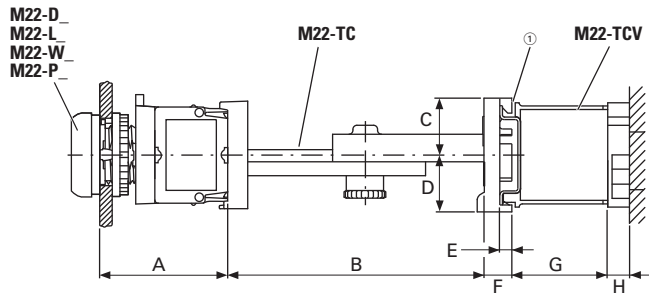

A	B	C	D	E	F	G	H
1.77 (45)	2.36–3.94 (60–100)	0.79 (20)	0.79 (20)	0.18 (4.5)	0.39 (10)	154 (39)	0.39 (10)

① Top-hat rail to IEC/EN 60715.

Palm Switches

FAK_

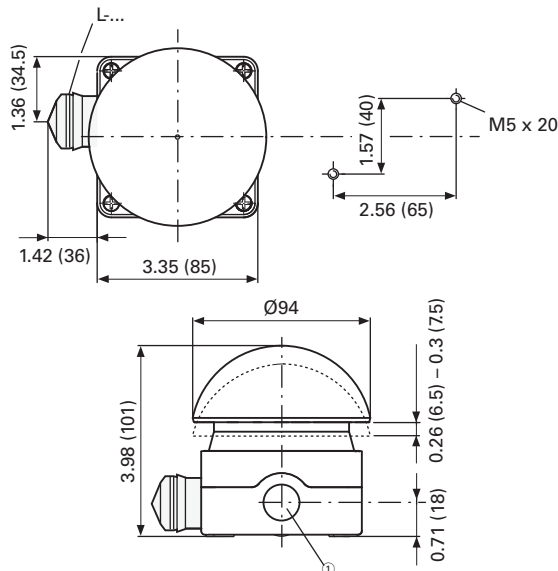

① 3 x M20 lateral, 1 x M16 in bottom.

Front Mounted Mounting Plate

M22-E_

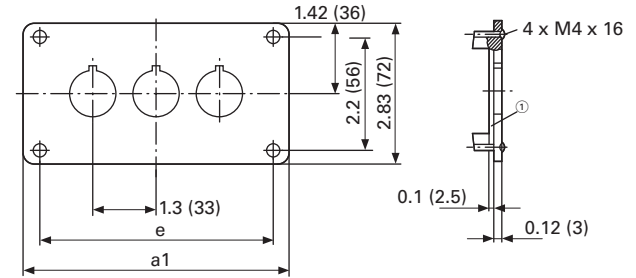

Catalog Number	a1	e
M22-E(Y) ①	2.83 (72)	2.21 (56)
M22-E2	4.13 (105)	3.50 (89)
M22-E3	5.43 (138)	4.80 (122)

Catalog Number	a1	e
M22-E4	6.73 (171)	6.10 (155)
M22-E5	8.03 (204)	7.40 (188)
M22-E6	9.33 (237)	8.70 (221)

Base Mounted Surface Mounting Enclosure

M22-I_

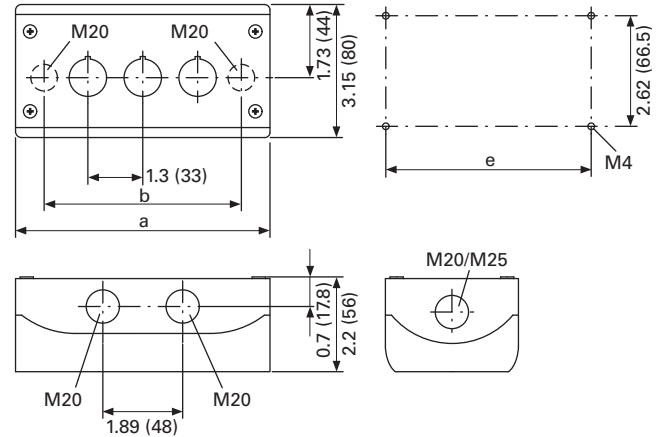

Catalog Number	Mounting Locations	a	b	e	Cable Entries
M22-I(Y)1	1	2.83 (72.0)	1.68 (42.6)	2.30 (58.5)	2 x M16 3 x M20 2 x M25
M22-I2	2	4.72 (120.0)	3.37 (85.6)	4.19 (106.5)	2 x M20 3 x M20 2 x M25
M22-I3	3	6.02 (153.0)	4.67 (118.6)	5.49 (139.5)	2 x M20 2 x M25 4 x M20
M22-I4	4	7.32 (186.0)	5.97 (151.6)	6.79 (172.5)	2 x M20 2 x M25 4 x M20
M22-I6	6	9.92 (252.0)	8.57 (217.6)	9.39 (238.5)	2 x M20 2 x M25 4 x M20

1.5

Pushbuttons and Indicating Lights

22.5 mm RMQ-Titan Modular Pushbuttons—M22

1

Approximate Dimensions in Inches (mm)

Covers

M22-H_

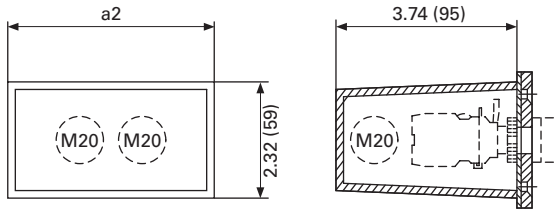

Catalog Number	a2	Cable Entry	Style
M22-H1	1.65 (42)	3 x M20	One-piece
M22-H2	2.95 (75)	4 x M20	
M22-H3	4.25 (108)	4 x M20	
M22-H4	5.55 (141)	4 x M20	Split
M22-H5	6.85 (174)	5 x M20	
M22-HE6	8.15 (207)	6 x M20	

Connecting Screw

M22-XI

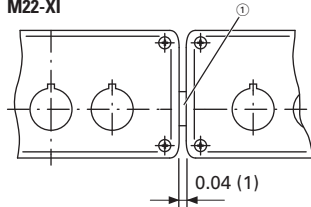

① Gasket.

Shroud with Plaster Keys

M22-UPE

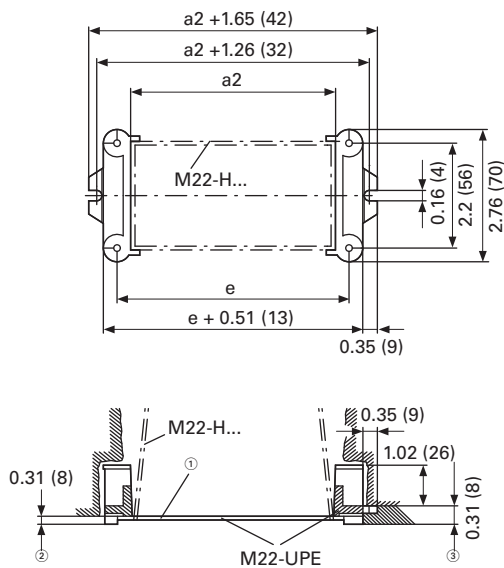

- ② Box for closing off when plastering.
- ③ Plaster thickness less than 8 mm.
- ④ Plaster thickness more than 8 mm.

Legend Plates

M22S-ST_

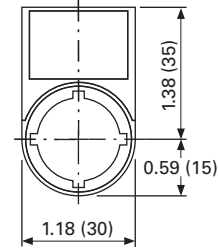

M22S-STDD-X

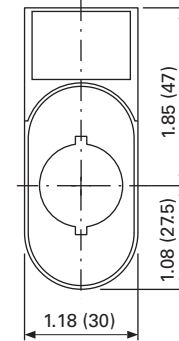

Mounting Hole with Lug Slot

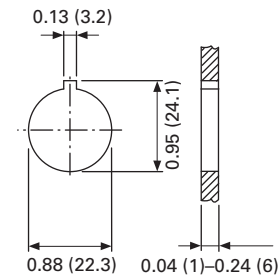

Approximate Dimensions in Inches (mm)

Grid Dimension to IEC/EN 60947

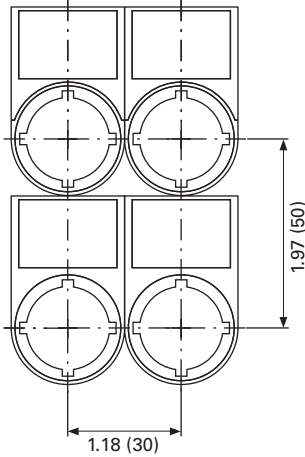

Grid Dimension for Various Combinations

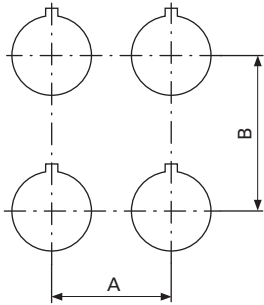

Pushbutton Diaphragm

Pushbutton diaphragm cannot be combined with label mount.

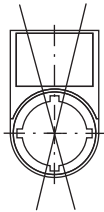

Catalog Number	A ≥	B ≥
M22(S)-_ (IEC/EN 60947)	1.18 (30.0)	1.97 (50.0)
RMQ-Titan min.	1.18 (30.0)	1.58 (40.0)
M22-D_ + M22-T-D	1.30 (33.0)	1.58 (40.0)
M22-D(R)P_	1.50 (38.0)	1.58 (40.0)
M22-PV_	1.50 (38.0)	1.58 (40.0)
M22-PV(L) + M22-PL-PV	1.89 (48.0)	2.20 (56.0)
M22-PV(L)(S)_ + M22-D_	1.30 (33.0)	1.58 (40.0)
M22-DDL_	1.18 (30.0)	2.17 (55.0)
M22-DDL_ + M22-T-DD	1.30 (33.0)	2.28 (58.0)
M22-ST_	1.18 (30.0)	1.97 (50.0)
M22-STDD_	1.18 (30.0)	2.95 (75.0)
M22-CK_	1.18 (30.0)	1.77 (45.0)
M22-CLED_	1.18 (30.0)	1.77 (45.0)
M22-XAK_	3.54 (90.0)	3.54 (90.0)
M22-XZK_	1.30 (33.0)	2.04 (52.0)
M22-XBK_	2.36 (60.0)	2.36 (60.0)
M22-XYK_	1.97 (50.0)	1.97 (50.0)
M22-D4	2.17 (55.0)	2.17 (55.0)
M22-WR...4	1.97 (50.0)	1.97 (50.0)
M22-W...J4	1.97 (50.0)	1.97 (50.0)

Grid Dimension for M22-DD_

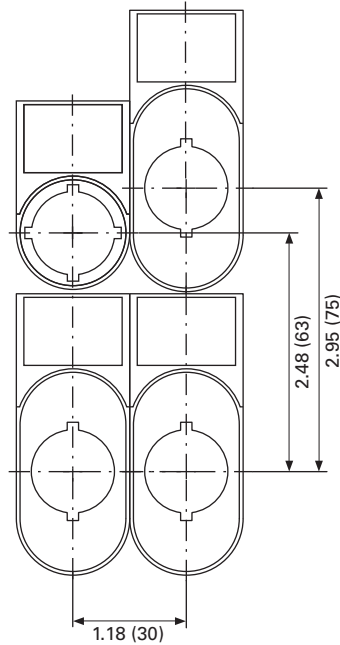

Grid Dimension for M22-DDL_

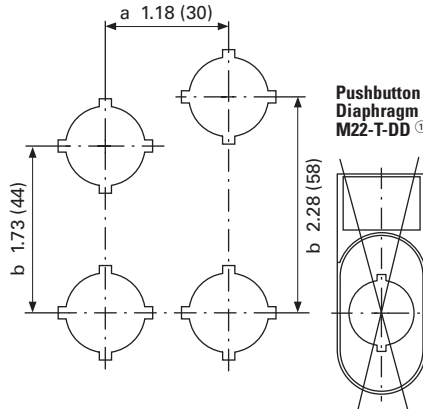

Emergency Stop Sealing Cover

M22-PL-PV

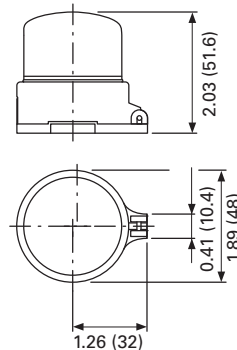

1.5

Pushbuttons and Indicating Lights

22.5 mm RMQ-Titan Modular Pushbuttons—M22

1

Approximate Dimensions in Inches (mm)

Blanking Plugs

M22...B-₋

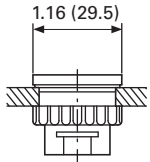

Pushbutton Diaphragm

M22-T-D

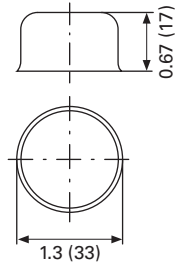

M22-T-D

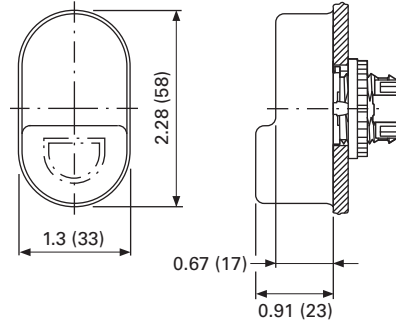

Guard Ring

M22-XGWK

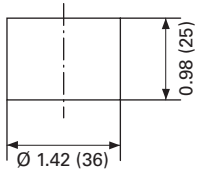

M22-XGPV

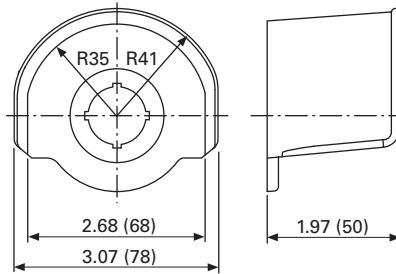

Key Cover

M22-XWS

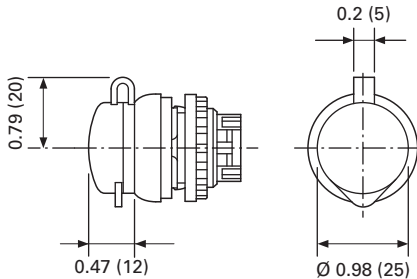

Emergency Stop Legend Plate

M22-XAK-₋

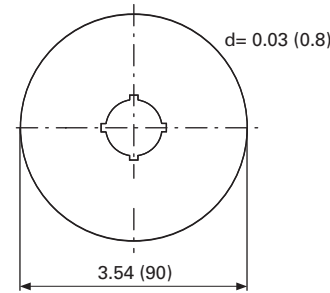

M22-X(Y)ZK-₋

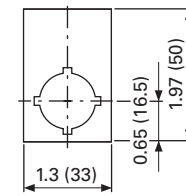

M22-XBK-₋

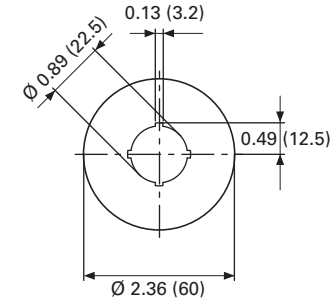

M22-XYK-₋

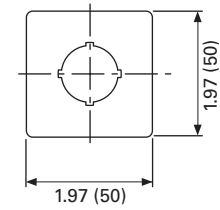

Joystick

M22...W...J-₋

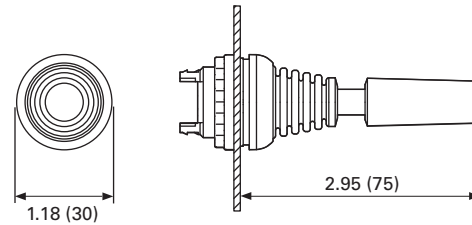

Four-Way Pushbutton

M22...D...4-₋

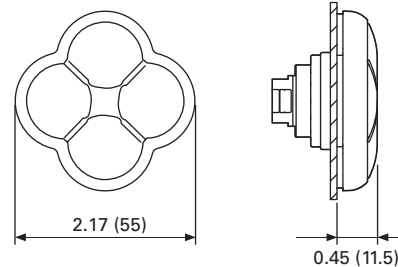

Symbols Library

Instructions for Ordering Laser Inscriptions

1. Identify part number to be inscribed.
2. Pick symbol from library and identify suffix code associated with the symbol.
3. Order part number already listed in the catalog with -ETCH suffix.
4. When placing an order by fax or Vistaline on the Web, reference order item number and indicate appropriate suffix code.

Example

To order a green flush button plate with the inscription AUTO HAND:

Order Catalog Number: M22-XD-G-ETCH (see **Page V7-T1-55**).

AUTO HAND inscription is found on **Page V7-T1-133** in the Symbols Library, suffix code is X91.

In the order notes, reference item number and suffix X91.

Letter height 3 mm: max. three lines, max. 12 characters per line.

Letter height 5 mm: max. two lines, max. eight characters per line.

Note: For symbols or text not found in the Symbols Library, please contact the Eaton Technical Resource Center at 1-877-ETN CARE (386-2273) or TRC@eaton.com.

Letter Height Specifications: ≤ five characters; letter height = 0.197 in (5 mm). > five characters; letter height = 0.118 in (3 mm).

Text—English

Inscription	Catalog Number Suffix
STOP	GB0
START	GB1
CLOSE	GB2
UP	GB3
DOWN	GB4
OFF	GB5
ON	GB6
RUN	GB7
FAULT	GB8
TEST	GB9
OFF ON	GB10
MAN. AUTO	GB11
MAN. 0 AUTO	GB12
RESET	GB14
FORWARD	GB15
REVERSE	GB16
RAISE	GB17

Text—German

Inscription	Catalog Number Suffix
LOWER	GB18
LEFT	GB19
RIGHT	GB20
BRAKE	GB21
HIGH	GB22
LOW	GB23
FAST	GB24
SLOW	GB25
FASTER	GB26
SLOWER	GB27
OPEN	GB32
PROG	GB62
CALL	GB63
OCCUPIED	GB64
BYPASS 0 1	GB65
BYPASS UP	GB66
EMERGENCY-STOP	GB99

Inscription	Catalog Number Suffix
Halt	D0
Start	D1
Zu	D2
Auf	D3
Ab	D4
Aus	D5
En	D6
Betrieb	D7
Störung	D8
Prüfung	D9
Aus Ein	D10
HAND AUTO	D11
HAND 0 AUTO	D12
Antrieb	D13
Entsperren	D14
Vorwärts	D15
Rückwärts	D16
Heben	D17
Senken	D18
Links	D19
Rechts	D20
Bremsen	D21
Hoch	D22
Niedrig	D23
Schnell	D24

Inscription	Catalog Number Suffix
Langsam	D25
HAND	D28
AUTO	D29
Einrichten	D30
Tippen	D31
Öffnen	D32
Steuerspannung	D33
Start Automatik	D34
Lampentest	D35
Phasenkontrolle	D36
Alarm	D37
Alarm - Reset	D38
Sammelstörung	D39
Quittieren	D40
Quittierung	D41
Steuerung Ein	D42
Steuerung Aus	D43
Störung quittieren	D44
FÜHLER int. ext.	D72
HEIZUNG 1 2	D73
AUS- BLASEN	D74
SOLLWERT int. ext.	D75
Not-Aus	D99
Not - Aus quittieren	D100

Text Size: 3 mm—Max. eight characters in first line; 10 characters in second line; eight characters in third line.



Text Size: 5 mm—Max. five characters per line.



Letter Height Specifications: ≤ five characters; letter height = 0.197 in (5 mm). > five characters; letter height = 0.118 in (3 mm).

Text—French

Inscription	Catalog Number Suffix
ARRÊT	F0
MARCHE	F1
FERMÉ	F2
MONTÉE	F3
DESCENTE	F4
ARRÊT	F5
MARCHE	F6
EN SERVICE	F7
PANNE	F8
ESSAI	F9
ARRÊT MARCHÉ	F10
MAN. AUTO	F11
MAN. 0 AUTO	F12
REARM.	F14
AVANT	F15
ARRIÈRE	F16
MONTER	F17
DESCENDRE	F18
GAUCHE	F19
DROITE	F20
DEFAULT	F67
SOUS TENSION	F68
ARRÊT D'URGENCE	F99

Text—Swedish

Inscription	Catalog Number Suffix
STOPP	S0
START	S1
STÄNG	S2
UPP	S3
NED	S4
FRÅN	S5
TILL	S6
KÖR	S7
FEL	S8
PROV	S9
FRÅN TILL	S10
MAN. AUTO	S11
MAN. 0 AUTO	S12
ÅTERSTÄLLNING	S14
FRAM	S15
BACK	S16
ÖKA	S17
MINSKA	S18
VÄNSTER	S19
HÖGER	S20
BROMS	S21
HÖG	S22
LÅG	S23
ÖPPNA	S32
IN	S45
UT	S46
NÖDSTOPP	S99

Symbols

Inscription	Catalog Number Suffix
	X0
	X1
	X2
	X3
	X4
	X5
	X6
	X7
	X8
	X9
	X10
	X11
	X12

Inscription	Catalog Number Suffix
	X13
	X14
	X15
	X16
	X17
	X18
	X19
	X20
	X21
	X22
	X23
	X24
	X25

Text Size: 3 mm—Max. eight characters in first line; 10 characters in second line; eight characters in third line.



Text Size: 5 mm—Max. five characters per line.



Inscription	Catalog Number Suffix	Inscription	Catalog Number Suffix	Inscription	Catalog Number Suffix	Inscription	Catalog Number Suffix
	X82		X104		X118		X132
	X83		X105		X119		X133
	X88		X106		X120		X134
	X89		X107		X121		X135
	X90		X108		X122		X136
AUTO HAND	X91		X109		X123		X137
	X92		X110		X124		X138
	X93		X111		X125		X139
Auto 0 Man.	X94		X112		X126		X140
	X95		X113		X127		X141
	X100		X114		X128		X142
	X101		X115		X129		X143
	X102		X116		X130		X144
	X103		X117		X131		X145

Text Size: 3 mm—Max. eight characters in first line; 10 characters in second line; eight characters in third line.



Text Size: 5 mm—Max. five characters per line.













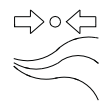



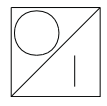
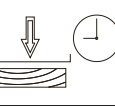

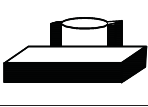
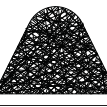
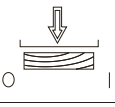

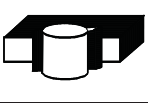
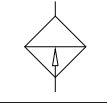

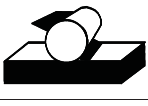
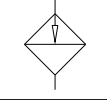
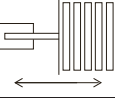

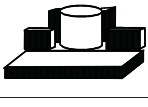
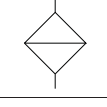
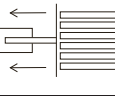

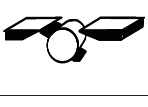
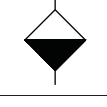
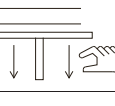

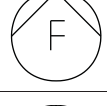



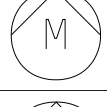

1.5

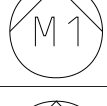
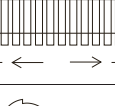
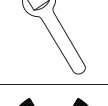
Pushbuttons and Indicating Lights

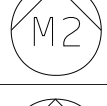
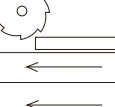
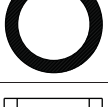
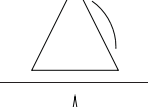
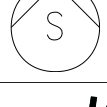
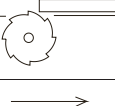
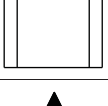
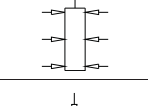
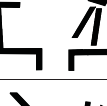
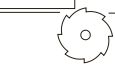
22.5 mm RMQ-Titan Modular Pushbuttons—M22

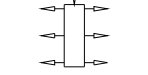
1











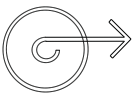



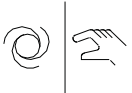

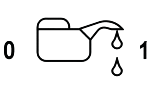
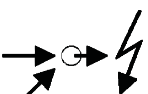











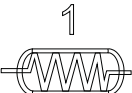















Inscription	Catalog Number Suffix	Inscription	Catalog Number Suffix	Inscription	Catalog Number Suffix	Inscription	Catalog Number Suffix
	X146		X160		X174		X188
	X147		X161		X175		X189
	X148		X162		X176		X190
	X149		X163		X177		X191
	X150		X164		X178		X192
	X151		X165		X179		X193
	X152		X166		X180		X194
	X153		X167		X181		X195
	X154		X168		X182		X196
	X155		X169		X183		X197
	X156		X170		X184		X198
	X157		X171		X185		X199
	X158		X172		X186		X200
	X159		X173		X187		X201

Text Size: 3 mm—Max. eight characters in first line; 10 characters in second line; eight characters in third line.



Text Size: 5 mm—Max. five characters per line.



Inscription	Catalog Number Suffix	Inscription	Catalog Number Suffix	Inscription	Catalog Number Suffix	Inscription	Catalog Number Suffix
	X202		X216		X230		X244
	X203		X217		X231		X245
L 1	X204		X218		X232		X246
L 2	X205		X219		X233		X247
L 3	X206		X220		X234		X248
↑ A	X207		X221		X235		X249
↓ A	X208		X222		X236		X250
↓ B	X209		X223		X237		X251
↑ B	X210		X224		X238		X252
I	X211		X225		X239		X253
II	X212		X226		X240		X254
III	X213		X227		X241		X255
	X214		X228		X242		X256
	X215		X229		X243		X257

Text Size: 3 mm—Max. eight characters in first line; 10 characters in second line; eight characters in third line.



Text Size: 5 mm—Max. five characters per line.















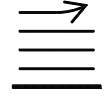



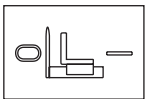





1.5

Pushbuttons and Indicating Lights

22.5 mm RMQ-Titan Modular Pushbuttons—M22

1

Inscription	Catalog Number Suffix	Inscription	Catalog Number Suffix	Inscription	Catalog Number Suffix	Inscription	Catalog Number Suffix
	X258		X265	CHEM II	X272		X279
	X259		X266	CHEM III	X273		X280
	X260		X267		X274	OUT OF SERVICE	X281
	X261		X268		X275		X282
	X262		X269	CONTI	X276		X283
	X263		X270	CUT	X277		X284
	X264		X271		X278		X285
		CHEM I					

Text Size: 3 mm—Max. eight characters in first line; 10 characters in second line; eight characters in third line.



Text Size: 5 mm—Max. five characters per line.



22.5 mm RMQ Compact Pushbuttons—C22



Contents

Description

Page

22.5 mm RMQ Compact Pushbuttons—C22	
Product Selection Guide	V7-T1-139
Pushbuttons—Non-Illuminated and Illuminated	V7-T1-140
Indicating Lights	V7-T1-153
Emergency Stops	V7-T1-156
Selector Switches	V7-T1-159
Technical Data and Specifications	V7-T1-166
Dimensions	V7-T1-168

Product Overview

Product Description

Eaton's C22 compact pushbutton line offers an industry leading array of functional, attractive, and ergonomically designed "all-in-one" illuminated and non-illuminated pushbuttons, selector switches, emergency stops and indicating lights. The complete illuminated line is only offered in LED light units to ensure high-quality brightness and up to 100,000 hours of LED illumination. C22 operators are available with either a silver or black bezel and share the exact same front of the panel look and feel as Eaton's M22 line. The C22's compact, "all-in-one" design with the contact block(s) and operators integral provides the user with a simple solution.

The 2017 product extension C22 with pigtail has more than doubled the portfolio. The C22 with pigtail now allows customers the ability to directly mount the product without the need for pushbutton enclosures. With three different connection methods and multiple lengths, the C22 with pigtail can be used for a wide range of applications.

Wide Product Breadth

- In addition to the standard compact offering of indicating lights and pushbuttons, Eaton's C22 offers keyed and non-keyed operators and emergency stops
- Hundreds of styles with standard laser etch markings with the ability to use custom M22 laser etched buttons in conjunction with C22 buttonless operators
- Pigtail lengths vary from 0.2 to 3.5 m and allow three connection options—M8, M12 and flying lead

LED Indicators

- 100,000 hours of life in high-vibration environments
- Lenses specifically designed for LED illumination

Rugged Design

- Pushbuttons (momentary) rated for 5 million mechanical operations and selector switches (non-keyed) rated for 1 million mechanical operations
- All components have IP65 rating, and some carry IP67 and IP69K for wash-down environment, which also means oil tight
- C22 with pigtail has an IP65 rear rating, eliminating the need for an enclosure in dust and water jet applications

Standards and Certifications

All operators are IEC/EN 60947 VDE 0660, UL Listed, and CSA Certified.

All operators carry an IP65, IP66, IP67 or IP69K rating.

All products carry ratings of NEMA 1, 3R, 4X, 12 and 13



1.6

Pushbuttons and Indicating Lights

22.5 mm RMQ Compact Pushbuttons—C22

1

Features

- Field convertible maintained pushbuttons from maintained to momentary
- Field convertible selector switches from momentary to maintained operation and vice versa
- LED offering only for all illuminated operators
- Laser engraved pushbuttons and lenses
- Heavy-duty construction with a minimum of IP65 and UL NEMA® Type 4X/13 on front of panel operators. Many operators even carry IP67 and IP69K, for the toughest applications
- Silver or black colored nylon bezels
- Notched hole mounting with anti-rotation tab and central nut mounting on each operator
- Pushbuttons (momentary) rated for 5 million mechanical operations and selector switches (non-keyed) rated for 1 million mechanical operations
- Unique compact offerings, including keyed and non-keyed operators and emergency stops

Benefits

- Compact, “all-in-one” operator and contact block design simplifies product selection, inventory, and installation
- Field convertibility of pushbuttons and selector switches helps distributors and customers reduce inventory and increase functionality
- LED offering only for improved brightness quality and up to 100,000 hours of operation
- Plastic construction is corrosion resistant
- Eliminate enclosure, on machine installations
- Operators are designed for rugged environments, ideal for wash-down applications (reference each operator’s IP ratings for ingress protection definition)
- Anti-rotation tab saves installation time and prevents operator rotation
- High mechanical and electrical life allows for use in tough and challenging applications
- Laser inscription capabilities allow for high quality, wear-resistant markings
- By having a compact design emergency stop, the C22 design eliminates the need for self-monitoring contact blocks
- M12/M8 connections allow connection directly into communications systems such as SmartWire-DT or AS6

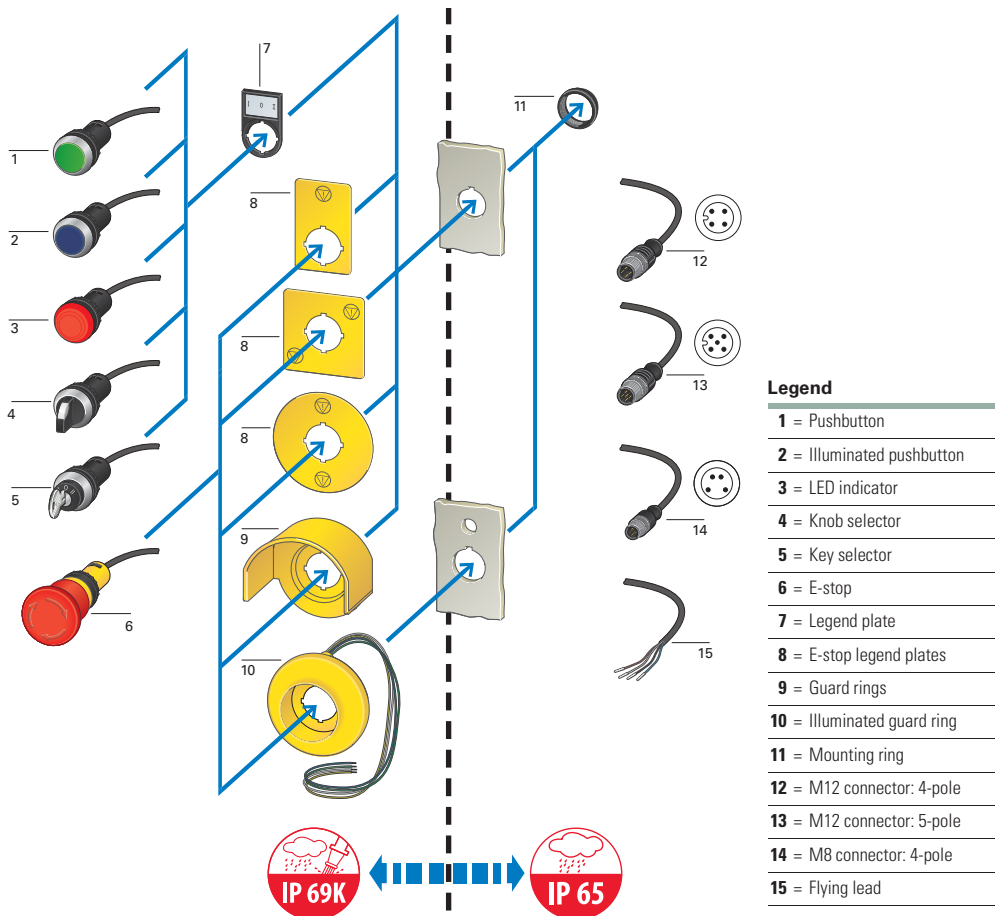

Product Selection Guide

Pushbuttons



Description	Non-illuminated, flush		Non-illuminated, flush, pigtail (M8/M12/flying lead)		Illuminated, flush		Illuminated, flush, pigtail (M8/M12/flying lead)	
Operator	Momentary	Maintained	Momentary	Maintained	Momentary	Maintained	Momentary	Maintained
Product Selection	Page V7-T1-141	Page V7-T1-143	Page V7-T1-142	Page V7-T1-144	Page V7-T1-147	Page V7-T1-149	Page V7-T1-148	Page V7-T1-150

Extended Pushbuttons



Description	Non-illuminated, extended		Illuminated, extended	
Operator	Momentary	Maintained	Momentary	Maintained
Product Selection	Page V7-T1-145	Page V7-T1-146	Page V7-T1-151	Page V7-T1-152

Indicating Lights



Description	Indicating lights	Indicating lights with pigtail (M8/M12/flying lead)
Product Selection	Page V7-T1-154	Page V7-T1-155

Emergency Stops



Description	Twist release	Keyed-release	Twist release with or without indicator and flying lead/M12	Push-Pull with Pigtail (flying lead/M12)
Product Selection	Page V7-T1-157	Page V7-T1-157	Page V7-T1-158	Page V7-T1-158

Selector Switches



Description	Non-illuminated, knob type	Key-operated	Non-illuminated, knob type, with pigtail	Key-operated with pigtail
Product Selection	Page V7-T1-160	Page V7-T1-162	Page V7-T1-161	Page V7-T1-164

1.6

Pushbuttons and Indicating Lights

22.5 mm RMQ Compact Pushbuttons—C22

1

Pushbuttons—Non-Illuminated and Illuminated



Contents

Description	Page
Pushbuttons—Non-Illuminated and Illuminated	
Non-Illuminated Pushbuttons, Flush, Momentary	V7-T1-141
Non-Illuminated Pushbuttons, Flush, Momentary, with Pigtail	V7-T1-142
Non-Illuminated Pushbuttons, Flush, Maintained	V7-T1-143
Non-Illuminated Pushbuttons, Flush, Maintained, with Pigtail	V7-T1-144
Non-Illuminated Pushbuttons, Extended, Momentary	V7-T1-145
Non-Illuminated Pushbuttons, Extended, Maintained	V7-T1-146
Illuminated, Flush, Momentary	V7-T1-147
Illuminated Pushbuttons, Flush, Momentary, with Pigtail	V7-T1-148
Illuminated Pushbuttons, Flush, Maintained	V7-T1-149
Illuminated Pushbuttons, Flush, Maintained, with Pigtail	V7-T1-150
Illuminated Pushbuttons, Extended, Momentary	V7-T1-151
Illuminated Pushbuttons, Extended, Maintained	V7-T1-152
Indicating Lights	V7-T1-153
Emergency Stops	V7-T1-156
Selector Switches	V7-T1-159
Technical Data and Specifications	V7-T1-166
Dimensions	V7-T1-168

Pushbuttons—Non-Illuminated and Illuminated

Product Description

Eaton's C22 Compact Pushbuttons are a complete line of monoblock type pushbuttons with the contact blocks, mounting adapter, and operator all-in-one. The C22 pushbuttons offer the same look and feel as their modular counterpart, the M22. They also carry many of the same rugged ratings and options, such as laser etching, field convertibility, and LED technology. They also feature IP65 rear ratings when purchased with pigtail, M8/M12/flying lead.

Note: For additional accessories, please see **Pages V7-T1-111 to V7-T1-117**, 22.5 mm Modular Pushbuttons—M22 Accessories.

Features

- Field convertible maintained pushbuttons from maintained to momentary
- LED offering only for improved brightness quality and up to 100,000 hours of operation
- Laser engraved pushbuttons and lenses
- Pushbuttons (momentary) rated for 5 million mechanical operations
- Pigtail option allows direct machine mounting

Protection Type

- IP67/IP69K
- NEMA 4X, 13
- IP65 rear (pigtail devices)

Catalog Number Selection

Catalog Number Selection is for illustrative purposes only and not to be used to create new catalog numbers.

Non-Illuminated Pushbuttons

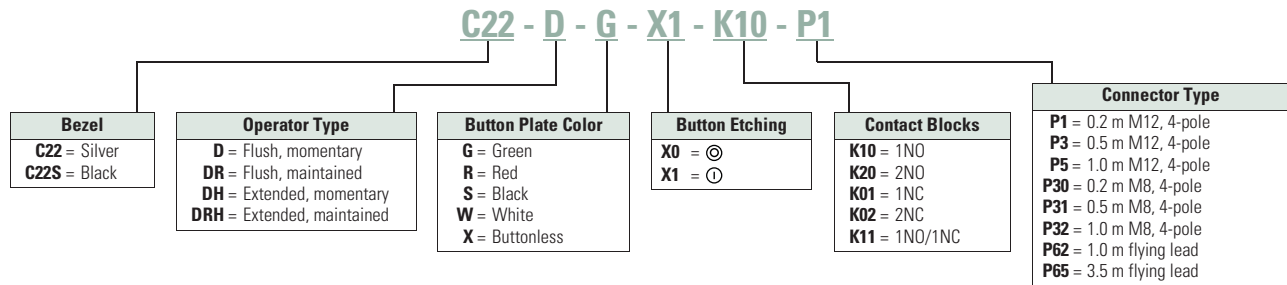

Product Selection

Non-Illuminated Pushbuttons, Flush, Momentary

C22(S)-D-__

Non-Illuminated Pushbuttons, Flush, Momentary



Button Color	Button Etching	Contact Block Configuration	Silver Bezel Catalog Number	Black Bezel Catalog Number	
Green	—	1NO	C22-D-G-K10	C22S-D-G-K10	
	—	2NO	C22-D-G-K20	C22S-D-G-K20	
	—	1NO/1NC	C22-D-G-K11	C22S-D-G-K11	
	X1	1NO	C22-D-G-X1-K10	C22S-D-G-X1-K10	
	X1	2NO	C22-D-G-X1-K20	C22S-D-G-X1-K20	
	X1	1NO/1NC	C22-D-G-X1-K11	C22S-D-G-X1-K11	
	Red	—	1NC	C22-D-R-K01	C22S-D-R-K01
		—	2NC	C22-D-R-K02	C22S-D-R-K02
		—	1NO/1NC	C22-D-R-K11	C22S-D-R-K11
X0		1NC	C22-D-R-X0-K01	C22S-D-R-X0-K01	
X0		2NC	C22-D-R-X0-K02	C22S-D-R-X0-K02	
X0		1NO/1NC	C22-D-R-X0-K11	C22S-D-R-X0-K11	
Black	—	1NC	C22-D-S-K01	C22S-D-S-K01	
	—	2NC	C22-D-S-K02	C22S-D-S-K02	
	—	1NO/1NC	C22-D-S-K11	C22S-D-S-K11	
	X0	1NC	C22-D-S-X0-K01	C22S-D-S-X0-K01	
	X0	2NC	C22-D-S-X0-K02	C22S-D-S-X0-K02	
	X0	1NO/1NC	C22-D-S-X0-K11	C22S-D-S-X0-K11	
White	—	1NO	C22-D-W-K10	C22S-D-W-K10	
	—	2NO	C22-D-W-K20	C22S-D-W-K20	
	—	1NO/1NC	C22-D-W-K11	C22S-D-W-K11	
	X1	1NO	C22-D-W-X1-K10	C22S-D-W-X1-K10	
	X1	2NO	C22-D-W-X1-K20	C22S-D-W-X1-K20	
	X1	1NO/1NC	C22-D-W-X1-K11	C22S-D-W-X1-K11	
Buttonless	—	1NO	C22-D-X-K10	C22S-D-X-K10	
	—	2NO	C22-D-X-K20	C22S-D-X-K20	
	—	1NC	C22-D-X-K01	C22S-D-X-K01	
	—	2NC	C22-D-X-K02	C22S-D-X-K02	
	—	1NO/1NC	C22-D-X-K11	C22S-D-X-K11	

1.6

Pushbuttons and Indicating Lights

22.5 mm RMQ Compact Pushbuttons—C22

1 Non-Illuminated Pushbuttons, Flush, Momentary, with Pigtail

C22-D-



Non-Illuminated Pushbuttons, Flush, Momentary, with Pigtail

Button Color	Contacts	Connector Length	Connector Type	Silver Bezel Catalog Number
Green	1NO	0.2	M8	C22-D-G-K10-P30
	1NO	0.2	M12	C22-D-G-K10-P1
	1NO	0.5	M8	C22-D-G-K10-P31
	1NO	0.5	M12	C22-D-G-K10-P3
	1NO	1	M8	C22-D-G-K10-P32
	1NO	1	M12	C22-D-G-K10-P5
	1NO	1	Flying lead	C22-D-G-K10-P62
	1NO	3.5	Flying lead	C22-D-G-K10-P65
Red	1NC	0.2	M8	C22-D-R-K01-P30
	1NC	0.2	M12	C22-D-R-K01-P1
	1NC	0.5	M8	C22-D-R-K01-P31
	1NC	0.5	M12	C22-D-R-K01-P3
	1NC	1	M8	C22-D-R-K01-P32
	1NC	1	M12	C22-D-R-K01-P5
	1NC	1	Flying lead	C22-D-R-K01-P62
	1NC	3.5	Flying lead	C22-D-R-K01-P65
Black	1NC	0.2	M8	C22-D-S-K01-P30
	1NC	0.2	M12	C22-D-S-K01-P1
	1NC	0.5	M8	C22-D-S-K01-P31
	1NC	0.5	M12	C22-D-S-K01-P3
	1NC	1	M8	C22-D-S-K01-P32
	1NC	1	M12	C22-D-S-K01-P5
	1NC	1	Flying lead	C22-D-S-K01-P62
	1NC	3.5	Flying lead	C22-D-S-K01-P65
White	1NO	0.2	M8	C22-D-W-K10-P30
	1NO	0.2	M12	C22-D-W-K10-P1
	1NO	0.5	M8	C22-D-W-K10-P31
	1NO	0.5	M12	C22-D-W-K10-P3
	1NO	1	M8	C22-D-W-K10-P32
	1NO	1	M12	C22-D-W-K10-P5
	1NO	1	Flying lead	C22-D-W-K10-P62
	1NO	3.5	Flying lead	C22-D-W-K10-P65
Buttonless	1NO	0.2	M8	C22-D-X-K10-P30
	1NO	0.2	M12	C22-D-X-K10-P1
	1NO	0.5	M8	C22-D-X-K10-P31
	1NO	0.5	M12	C22-D-X-K10-P3
	1NO	1	M8	C22-D-X-K10-P32
	1NO	1	M12	C22-D-X-K10-P5
	1NO	1	Flying lead	C22-D-X-K10-P62
	1NO	3.5	Flying lead	C22-D-X-K10-P65
	2NO	1	Flying lead	C22-D-X-K20-P62
	2NO	3.5	Flying lead	C22-D-X-K20-P65
	1NC/1NO	1	Flying lead	C22-D-X-K11-P62
	1NC/1NO	3.5	Flying lead	C22-D-X-K11-P65
	1NC	0.2	M8	C22-D-X-K01-P30
	1NC	0.2	M12	C22-D-X-K01-P1
	1NC	0.5	M8	C22-D-X-K01-P31
	1NC	0.5	M12	C22-D-X-K01-P3
	1NC	1	M8	C22-D-X-K01-P32
	1NC	1	M12	C22-D-X-K01-P5
	1NC	1	Flying lead	C22-D-X-K01-P62
	1NC	3.5	Flying lead	C22-D-X-K01-P65
	2NC	1	Flying lead	C22-D-X-K02-P62
	2NC	3.5	Flying lead	C22-D-X-K02-P65

Non-Illuminated Pushbuttons, Flush, Maintained

C22(S)-DR-



Non-Illuminated Pushbuttons, Flush, Maintained

Button Color	Button Etching	Contact Block Configuration	Silver Bezel Catalog Number	Black Bezel Catalog Number
Green	—	1NO	C22-DR-G-K10	C22S-DR-G-K10
	—	2NO	C22-DR-G-K20	C22S-DR-G-K20
	—	1NO/1NC	C22-DR-G-K11	C22S-DR-G-K11
	X1	1NO	C22-DR-G-X1-K10	C22S-DR-G-X1-K10
	X1	2NO	C22-DR-G-X1-K20	C22S-DR-G-X1-K20
	X1	1NO/1NC	C22-DR-G-X1-K11	C22S-DR-G-X1-K11
Red	—	1NC	C22-DR-R-K01	C22S-DR-R-K01
	—	2NC	C22-DR-R-K02	C22S-DR-R-K02
	—	1NO/1NC	C22-DR-R-K11	C22S-DR-R-K11
	X0	1NC	C22-DR-R-X0-K01	C22S-DR-R-X0-K01
	X0	2NC	C22-DR-R-X0-K02	C22S-DR-R-X0-K02
	X0	1NO/1NC	C22-DR-R-X0-K11	C22S-DR-R-X0-K11
Black	—	1NC	C22-DR-S-K01	C22S-DR-S-K01
	—	2NC	C22-DR-S-K02	C22S-DR-S-K02
	—	1NO/1NC	C22-DR-S-K11	C22S-DR-S-K11
	X0	1NC	C22-DR-S-X0-K01	C22S-DR-S-X0-K01
	X0	2NC	C22-DR-S-X0-K02	C22S-DR-S-X0-K02
	X0	1NO/1NC	C22-DR-S-X0-K11	C22S-DR-S-X0-K11
White	—	1NO	C22-DR-W-K10	C22S-DR-W-K10
	—	2NO	C22-DR-W-K20	C22S-DR-W-K20
	—	1NO/1NC	C22-DR-W-K11	C22S-DR-W-K11
	X1	1NO	C22-DR-W-X1-K10	C22S-DR-W-X1-K10
	X1	2NO	C22-DR-W-X1-K20	C22S-DR-W-X1-K20
	X1	1NO/1NC	C22-DR-W-X1-K11	C22S-DR-W-X1-K11
Buttonless	—	1NO	C22-DR-X-K10	C22S-DR-X-K10
	—	2NO	C22-DR-X-K20	C22S-DR-X-K20
	—	1NC	C22-DR-X-K01	C22S-DR-X-K01
	—	2NC	C22-DR-X-K02	C22S-DR-X-K02
	—	1NO/1NC	C22-DR-X-K11	C22S-DR-X-K11

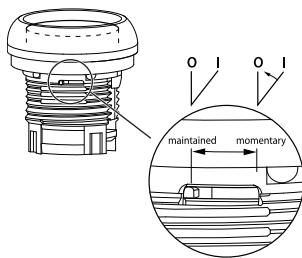

Note: Maintained pushbuttons can be converted in the field to momentary operation by switching the locking ring, which is accessible through the side of the operator body.

1.6

Pushbuttons and Indicating Lights

22.5 mm RMQ Compact Pushbuttons—C22

1 Non-Illuminated Pushbuttons, Flush, Maintained, with Pigtail

C22-DR_



Non-Illuminated Pushbuttons, Flush, Maintained, with Pigtail

Button Color	Contacts	Connector Length	Connector Type	Silver Bezel Catalog Number
Green	1NO	0.2	M8	C22-DR-G-K10-P30
	1NO	0.2	M12	C22-DR-G-K10-P1
	1NO	0.5	M8	C22-DR-G-K10-P31
	1NO	0.5	M12	C22-DR-G-K10-P3
	1NO	1	M8	C22-DR-G-K10-P32
	1NO	1	M12	C22-DR-G-K10-P5
	1NO	1	Flying lead	C22-DR-G-K10-P62
	1NO	3.5	Flying lead	C22-DR-G-K10-P65
Red	1NC	0.2	M8	C22-DR-R-K01-P30
	1NC	0.2	M12	C22-DR-R-K01-P1
	1NC	0.5	M8	C22-DR-R-K01-P31
	1NC	0.5	M12	C22-DR-R-K01-P3
	1NC	1	M8	C22-DR-R-K01-P32
	1NC	1	M12	C22-DR-R-K01-P5
	1NC	1	Flying lead	C22-DR-R-K01-P62
	1NC	3.5	Flying lead	C22-DR-R-K01-P65
Black	1NC	0.2	M8	C22-DR-S-K01-P30
	1NC	0.2	M12	C22-DR-S-K01-P1
	1NC	0.5	M8	C22-DR-S-K01-P31
	1NC	0.5	M12	C22-DR-S-K01-P3
	1NC	1	M8	C22-DR-S-K01-P32
	1NC	1	M12	C22-DR-S-K01-P5
	1NC	1	Flying lead	C22-DR-S-K01-P62
	1NC	3.5	Flying lead	C22-DR-S-K01-P65
White	1NO	0.2	M8	C22-DR-W-K10-P30
	1NO	0.2	M12	C22-DR-W-K10-P1
	1NO	0.5	M8	C22-DR-W-K10-P31
	1NO	0.5	M12	C22-DR-W-K10-P3
	1NO	1	M8	C22-DR-W-K10-P32
	1NO	1	M12	C22-DR-W-K10-P5
	1NO	1	Flying lead	C22-DR-W-K10-P62
	1NO	3.5	Flying lead	C22-DR-W-K10-P65
Buttonless	1NO	0.2	M8	C22-DR-X-K10-P30
	1NO	0.2	M12	C22-DR-X-K10-P1
	1NO	0.5	M8	C22-DR-X-K10-P31
	1NO	0.5	M12	C22-DR-X-K10-P3
	1NO	1	M8	C22-DR-X-K10-P32
	1NO	1	M12	C22-DR-X-K10-P5
	1NO	1	Flying lead	C22-DR-X-K10-P62
	1NO	3.5	Flying lead	C22-DR-X-K10-P65
	2NO	1	Flying lead	C22-DR-X-K20-P62
	2NO	3.5	Flying lead	C22-DR-X-K20-P65
	1NC/1NO	1	Flying lead	C22-DR-X-K11-P62
	1NC/1NO	3.5	Flying lead	C22-DR-X-K11-P65
	1NC	0.2	M8	C22-DR-X-K01-P30
	1NC	0.2	M12	C22-DR-X-K01-P1
	1NC	0.5	M8	C22-DR-X-K01-P31
	1NC	0.5	M12	C22-DR-X-K01-P3
	1NC	1	M8	C22-DR-X-K01-P32
	1NC	1	M12	C22-DR-X-K01-P5
	1NC	1	Flying lead	C22-DR-X-K01-P62
	1NC	3.5	Flying lead	C22-DR-X-K01-P65
	2NC	1	Flying lead	C22-DR-X-K02-P62
	2NC	3.5	Flying lead	C22-DR-X-K02-P65

Non-Illuminated Pushbuttons, Extended, Momentary

C22(S)-DH-



Non-Illuminated Pushbuttons, Extended, Momentary

Button Color	Button Etching	Contact Block Configuration	Silver Bezel Catalog Number	Black Bezel Catalog Number
Green	—	1NO	C22-DH-G-K10	C22S-DH-G-K10
	—	2NO	C22-DH-G-K20	C22S-DH-G-K20
	—	1NO/1NC	C22-DH-G-K11	C22S-DH-G-K11
	X1	1NO	C22-DH-G-X1-K10	C22S-DH-G-X1-K10
	X1	2NO	C22-DH-G-X1-K20	C22S-DH-G-X1-K20
	X1	1NO/1NC	C22-DH-G-X1-K11	C22S-DH-G-X1-K11
Red	—	1NC	C22-DH-R-K01	C22S-DH-R-K01
	—	2NC	C22-DH-R-K02	C22S-DH-R-K02
	—	1NO/1NC	C22-DH-R-K11	C22S-DH-R-K11
	X0	1NC	C22-DH-R-X0-K01	C22S-DH-R-X0-K01
	X0	2NC	C22-DH-R-X0-K02	C22S-DH-R-X0-K02
	X0	1NO/1NC	C22-DH-R-X0-K11	C22S-DH-R-X0-K11
Black	—	1NC	C22-DH-S-K01	C22S-DH-S-K01
	—	2NC	C22-DH-S-K02	C22S-DH-S-K02
	—	1NO/1NC	C22-DH-S-K11	C22S-DH-S-K11
	X0	1NC	C22-DH-S-X0-K01	C22S-DH-S-X0-K01
	X0	2NC	C22-DH-S-X0-K02	C22S-DH-S-X0-K02
	X0	1NO/1NC	C22-DH-S-X0-K11	C22S-DH-S-X0-K11
White	—	1NO	C22-DH-W-K10	C22S-DH-W-K10
	—	2NO	C22-DH-W-K20	C22S-DH-W-K20
	—	1NO/1NC	C22-DH-W-K11	C22S-DH-W-K11
	X1	1NO	C22-DH-W-X1-K10	C22S-DH-W-X1-K10
	X1	2NO	C22-DH-W-X1-K20	C22S-DH-W-X1-K20
	X1	1NO/1NC	C22-DH-W-X1-K11	C22S-DH-W-X1-K11

1.6

Pushbuttons and Indicating Lights

22.5 mm RMQ Compact Pushbuttons—C22

1 Non-Illuminated Pushbuttons, Extended, Maintained

C22(S)-DRH_



Non-Illuminated Pushbuttons, Extended, Maintained

Button Color	Button Etching	Contact Block Configuration	Silver Bezel Catalog Number	Black Bezel Catalog Number
Green	—	1NO	C22-DRH-G-K10	C22S-DRH-G-K10
	—	2NO	C22-DRH-G-K20	C22S-DRH-G-K20
	—	1NO/1NC	C22-DRH-G-K11	C22S-DRH-G-K11
	X1	1NO	C22-DRH-G-X1-K10	C22S-DRH-G-X1-K10
	X1	2NO	C22-DRH-G-X1-K20	C22S-DRH-G-X1-K20
	X1	1NO/1NC	C22-DRH-G-X1-K11	C22S-DRH-G-X1-K11
Red	—	1NC	C22-DRH-R-K01	C22S-DRH-R-K01
	—	2NC	C22-DRH-R-K02	C22S-DRH-R-K02
	—	1NO/1NC	C22-DRH-R-K11	C22S-DRH-R-K11
	X0	1NC	C22-DRH-R-X0-K01	C22S-DRH-R-X0-K01
	X0	2NC	C22-DRH-R-X0-K02	C22S-DRH-R-X0-K02
	X0	1NO/1NC	C22-DRH-R-X0-K11	C22S-DRH-R-X0-K11
Black	—	1NC	C22-DRH-S-K01	C22S-DRH-S-K01
	—	2NC	C22-DRH-S-K02	C22S-DRH-S-K02
	—	1NO/1NC	C22-DRH-S-K11	C22S-DRH-S-K11
	X0	1NC	C22-DRH-S-X0-K01	C22S-DRH-S-X0-K01
	X0	2NC	C22-DRH-S-X0-K02	C22S-DRH-S-X0-K02
	X0	1NO/1NC	C22-DRH-S-X0-K11	C22S-DRH-S-X0-K11
White	—	1NO	C22-DRH-W-K10	C22S-DRH-W-K10
	—	2NO	C22-DRH-W-K20	C22S-DRH-W-K20
	—	1NO/1NC	C22-DRH-W-K11	C22S-DRH-W-K11
	X1	1NO	C22-DRH-W-X1-K10	C22S-DRH-W-X1-K10
	X1	2NO	C22-DRH-W-X1-K20	C22S-DRH-W-X1-K20
	X1	1NO/1NC	C22-DRH-W-X1-K11	C22S-DRH-W-X1-K11

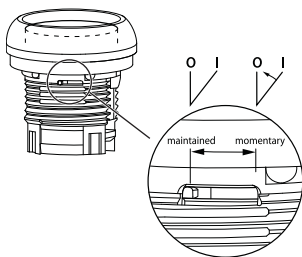

Note: Maintained pushbuttons can be converted in the field to momentary operation by switching the locking ring, which is accessible through the side of the operator body.

Catalog Number Selection

Catalog Number Selection is for illustrative purposes only and not to be used to create new catalog numbers.

Illuminated Pushbuttons

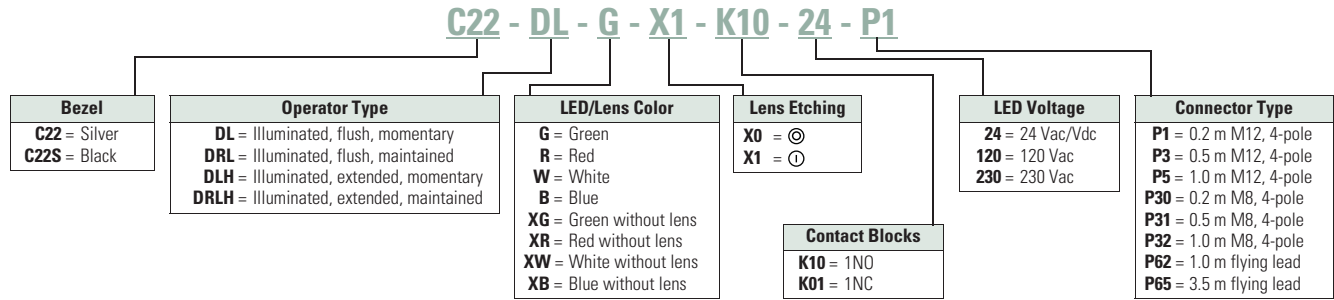

Product Selection

Illuminated, Flush, Momentary

C22(S)-DL- _ Illuminated Pushbuttons, Flush, Momentary



LED Color	Button Color	Voltage	Button Etching	Contact Block Configuration	Silver Bezel Catalog Number	Black Bezel Catalog Number
Green	Green	24 Vac/Vdc	—	1NO	C22-DL-G-K10-24	C22S-DL-G-K10-24
		120 Vac	—	1NO	C22-DL-G-K10-120	C22S-DL-G-K10-120
		230 Vac	—	1NO	C22-DL-G-K10-230	C22S-DL-G-K10-230
		24 Vac/Vdc	X1	1NO	C22-DL-G-X1-K10-24	C22S-DL-G-X1-K10-24
		120 Vac	X1	1NO	C22-DL-G-X1-K10-120	C22S-DL-G-X1-K10-120
		230 Vac	X1	1NO	C22-DL-G-X1-K10-230	C22S-DL-G-X1-K10-230
	Buttonless	24 Vac/Vdc	—	1NO	C22-DL-XG-K10-24	C22S-DL-XG-K10-24
		120 Vac	—	1NO	C22-DL-XG-K10-120	C22S-DL-XG-K10-120
		230 Vac	—	1NO	C22-DL-XG-K10-230	C22S-DL-XG-K10-230
		24 Vac/Vdc	X0	1NC	C22-DL-R-X0-K01-24	C22S-DL-R-K01-24
		120 Vac	X0	1NC	C22-DL-R-X0-K01-120	C22S-DL-R-K01-120
		230 Vac	X0	1NC	C22-DL-R-X0-K01-230	C22S-DL-R-K01-230
Red	Red	24 Vac/Vdc	—	1NC	C22-DL-R-K01-24	C22S-DL-R-K01-24
		120 Vac	—	1NC	C22-DL-R-K01-120	C22S-DL-R-K01-120
		230 Vac	—	1NC	C22-DL-R-K01-230	C22S-DL-R-K01-230
		24 Vac/Vdc	X0	1NC	C22-DL-R-X0-K01-24	C22S-DL-R-X0-K01-24
		120 Vac	X0	1NC	C22-DL-R-X0-K01-120	C22S-DL-R-X0-K01-120
		230 Vac	X0	1NC	C22-DL-R-X0-K01-230	C22S-DL-R-X0-K01-230
	Buttonless	24 Vac/Vdc	—	1NC	C22-DL-XR-K01-24	C22S-DL-XR-K01-24
		120 Vac	—	1NC	C22-DL-XR-K01-120	C22S-DL-XR-K01-120
		230 Vac	—	1NC	C22-DL-XR-K01-230	C22S-DL-XR-K01-230
		24 Vac/Vdc	X1	1NO	C22-DL-W-X1-K10-24	C22S-DL-W-X1-K10-24
		120 Vac	X1	1NO	C22-DL-W-X1-K10-120	C22S-DL-W-X1-K10-120
		230 Vac	X1	1NO	C22-DL-W-X1-K10-230	C22S-DL-W-X1-K10-230
White	White	24 Vac/Vdc	—	1NO	C22-DL-W-K10-24	C22S-DL-W-K10-24
		120 Vac	—	1NO	C22-DL-W-K10-120	C22S-DL-W-K10-120
		230 Vac	—	1NO	C22-DL-W-K10-230	C22S-DL-W-K10-230
		24 Vac/Vdc	X1	1NO	C22-DL-W-X1-K10-24	C22S-DL-W-X1-K10-24
		120 Vac	X1	1NO	C22-DL-W-X1-K10-120	C22S-DL-W-X1-K10-120
		230 Vac	X1	1NO	C22-DL-W-X1-K10-230	C22S-DL-W-X1-K10-230
	Buttonless	24 Vac/Vdc	—	1NO	C22-DL-XW-K10-24	C22S-DL-XW-K10-24
		120 Vac	—	1NO	C22-DL-XW-K10-120	C22S-DL-XW-K10-120
		230 Vac	—	1NO	C22-DL-XW-K10-230	C22S-DL-XW-K10-230
		24 Vac/Vdc	—	1NO	C22-DL-B-K10-24	C22S-DL-B-K10-24
		120 Vac	—	1NO	C22-DL-B-K10-120	C22S-DL-B-K10-120
		230 Vac	—	1NO	C22-DL-B-K10-230	C22S-DL-B-K10-230
Blue	Blue	24 Vac/Vdc	—	1NO	C22-DL-B-K10-24	C22S-DL-B-K10-24
		120 Vac	—	1NO	C22-DL-B-K10-120	C22S-DL-B-K10-120
		230 Vac	—	1NO	C22-DL-B-K10-230	C22S-DL-B-K10-230
	Buttonless	24 Vac/Vdc	—	1NO	C22-DL-XB-K10-24	C22S-DL-XB-K10-24
		120 Vac	—	1NO	C22-DL-XB-K10-120	C22S-DL-XB-K10-120
		230 Vac	—	1NO	C22-DL-XB-K10-230	C22S-DL-XB-K10-230

1.6

Pushbuttons and Indicating Lights

22.5 mm RMQ Compact Pushbuttons—C22

1 Illuminated Pushbuttons, Flush, Momentary, with Pigtail

C22-DL-__



Illuminated Pushbuttons, Flush, Momentary, with Pigtail

Button Color	Contacts	Connector Length	Connector Type	Silver Bezel Catalog Number
Green	1NO	0.2	M8	C22-DL-G-K10-24-P30
	1NO	0.2	M12	C22-DL-G-K10-24-P1
	1NO	0.5	M8	C22-DL-G-K10-24-P31
	1NO	0.5	M12	C22-DL-G-K10-24-P3
	1NO	1	M8	C22-DL-G-K10-24-P32
	1NO	1	M12	C22-DL-G-K10-24-P5
	1NO	1	Flying lead	C22-DL-G-K10-24-P62
	1NO	3.5	Flying lead	C22-DL-G-K10-24-P65
Red	1NC	0.2	M8	C22-DL-R-K01-24-P30
	1NC	0.2	M12	C22-DL-R-K01-24-P1
	1NC	0.5	M8	C22-DL-R-K01-24-P31
	1NC	0.5	M12	C22-DL-R-K01-24-P3
	1NC	1	M8	C22-DL-R-K01-24-P32
	1NC	1	M12	C22-DL-R-K01-24-P5
	1NC	1	Flying lead	C22-DL-R-K01-24-P62
	1NC	3.5	Flying lead	C22-DL-R-K01-24-P65
Blue	1NO	0.2	M8	C22-DL-B-K10-24-P30
	1NO	0.2	M12	C22-DL-B-K10-24-P1
	1NO	0.5	M8	C22-DL-B-K10-24-P31
	1NO	0.5	M12	C22-DL-B-K10-24-P3
	1NO	1	M8	C22-DL-B-K10-24-P32
	1NO	1	M12	C22-DL-B-K10-24-P5
	1NO	1	Flying lead	C22-DL-B-K10-24-P62
	1NO	3.5	Flying lead	C22-DL-B-K10-24-P65
White	1NO	0.2	M8	C22-DL-W-K10-24-P30
	1NO	0.2	M12	C22-DL-W-K10-24-P1
	1NO	0.5	M8	C22-DL-W-K10-24-P31
	1NO	0.5	M12	C22-DL-W-K10-24-P3
	1NO	1	M8	C22-DL-W-K10-24-P32
	1NO	1	M12	C22-DL-W-K10-24-P5
	1NO	1	Flying lead	C22-DL-W-K10-24-P62
	1NO	3.5	Flying lead	C22-DL-W-K10-24-P65

Illuminated Pushbuttons, Flush, Maintained

C22(S)-DRL_

Illuminated Pushbuttons, Flush, Maintained



LED Color	Button Color	Voltage	Contact Block Configuration	Silver Bezel Catalog Number	Black Bezel Catalog Number		
Green	Green	24 Vac/Vdc	1NO	C22-DRL-G-K10-24	C22S-DRL-G-K10-24		
		120 Vac	1NO	C22-DRL-G-K10-120	C22S-DRL-G-K10-120		
		230 Vac	1NO	C22-DRL-G-K10-230	C22S-DRL-G-K10-230		
	Buttonless	24 Vac/Vdc	1NO	C22-DRL-XG-K10-24	C22S-DRL-XG-K10-24		
			120 Vac	1NO	C22-DRL-XG-K10-120	C22S-DRL-XG-K10-120	
			230 Vac	1NO	C22-DRL-XG-K10-230	C22S-DRL-XG-K10-230	
		Red	24 Vac/Vdc	1NC	C22-DRL-R-K01-24	C22S-DRL-R-K01-24	
				120 Vac	1NC	C22-DRL-R-K01-120	C22S-DRL-R-K01-120
				230 Vac	1NC	C22-DRL-R-K01-230	C22S-DRL-R-K01-230
Buttonless	24 Vac/Vdc	1NC	C22-DRL-XR-K01-24	C22S-DRL-XR-K01-24			
		120 Vac	1NC	C22-DRL-XR-K01-120	C22S-DRL-XR-K01-120		
		230 Vac	1NC	C22-DRL-XR-K01-230	C22S-DRL-XR-K01-230		
	White	White	24 Vac/Vdc	1NO	C22-DRL-W-K10-24	C22S-DRL-W-K10-24	
			120 Vac	1NO	C22-DRL-W-K10-120	C22S-DRL-W-K10-120	
			230 Vac	1NO	C22-DRL-W-K10-230	C22S-DRL-W-K10-230	
Buttonless		24 Vac/Vdc	1NO	C22-DRL-XW-K10-24	C22S-DRL-XW-K10-24		
			120 Vac	1NO	C22-DRL-XW-K10-120	C22S-DRL-XW-K10-120	
			230 Vac	1NO	C22-DRL-XW-K10-230	C22S-DRL-XW-K10-230	
		Blue	Blue	24 Vac/Vdc	1NO	C22-DRL-B-K10-24	C22S-DRL-B-K10-24
				120 Vac	1NO	C22-DRL-B-K10-120	C22S-DRL-B-K10-120
				230 Vac	1NO	C22-DRL-B-K10-230	C22S-DRL-B-K10-230
Buttonless	24 Vac/Vdc		1NO	C22-DRL-XB-K10-24	C22S-DRL-XB-K10-24		
			120 Vac	1NO	C22-DRL-XB-K10-120	C22S-DRL-XB-K10-120	
			230 Vac	1NO	C22-DRL-XB-K10-230	C22S-DRL-XB-K10-230	

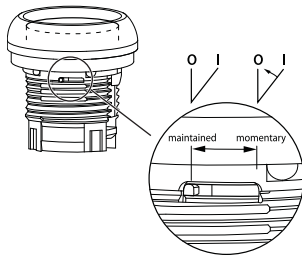

Note: Maintained pushbuttons can be converted in the field to momentary operation by switching the locking ring, which is accessible through the side of the operator body.

1.6

Pushbuttons and Indicating Lights

22.5 mm RMQ Compact Pushbuttons—C22

1 Illuminated Pushbuttons, Flush, Maintained, with Pigtail

C22_DRL-G-



Illuminated Pushbuttons, Flush, Maintained, with Pigtail

Button Color	Contacts	Connector Length	Connector Type	Silver Bezel Catalog Number
Green	1NO	0.2	M8	C22-DRL-G-K10-24-P30
	1NO	0.2	M12	C22-DRL-G-K10-24-P1
	1NO	0.5	M8	C22-DRL-G-K10-24-P31
	1NO	0.5	M12	C22-DRL-G-K10-24-P3
	1NO	1	M8	C22-DRL-G-K10-24-P32
	1NO	1	M12	C22-DRL-G-K10-24-P5
	1NO	1	Flying lead	C22-DRL-G-K10-24-P62
	1NO	3.5	Flying lead	C22-DRL-G-K10-24-P65
Red	1NC	0.2	M8	C22-DRL-R-K01-24-P30
	1NC	0.2	M12	C22-DRL-R-K01-24-P1
	1NC	0.5	M8	C22-DRL-R-K01-24-P31
	1NC	0.5	M12	C22-DRL-R-K01-24-P3
	1NC	1	M8	C22-DRL-R-K01-24-P32
	1NC	1	M12	C22-DRL-R-K01-24-P5
	1NC	1	Flying lead	C22-DRL-R-K01-24-P62
	1NC	3.5	Flying lead	C22-DRL-R-K01-24-P65
Blue	1NO	0.2	M8	C22-DRL-B-K10-24-P30
	1NO	0.2	M12	C22-DRL-B-K10-24-P1
	1NO	0.5	M8	C22-DRL-B-K10-24-P31
	1NO	0.5	M12	C22-DRL-B-K10-24-P3
	1NO	1	M8	C22-DRL-B-K10-24-P32
	1NO	1	M12	C22-DRL-B-K10-24-P5
	1NO	1	Flying lead	C22-DRL-B-K10-24-P62
	1NO	3.5	Flying lead	C22-DRL-B-K10-24-P65
White	1NO	0.2	M8	C22-DRL-W-K10-24-P30
	1NO	0.2	M12	C22-DRL-W-K10-24-P1
	1NO	0.5	M8	C22-DRL-W-K10-24-P31
	1NO	0.5	M12	C22-DRL-W-K10-24-P3
	1NO	1	M8	C22-DRL-W-K10-24-P32
	1NO	1	M12	C22-DRL-W-K10-24-P5
	1NO	1	Flying lead	C22-DRL-W-K10-24-P62
	1NO	3.5	Flying lead	C22-DRL-W-K10-24-P65

Illuminated Pushbuttons, Extended, Momentary

C22(S)-DLH_

Illuminated Pushbuttons, Extended, Momentary



LED Color	Button Color	Voltage	Button Etching	Contact Block Configuration	Silver Bezel Catalog Number	Black Bezel Catalog Number
Green	Green	24 Vac/Vdc	—	1NO	C22-DLH-G-K10-24	C22S-DLH-G-K10-24
		120 Vac	—	1NO	C22-DLH-G-K10-120	C22S-DLH-G-K10-120
		230 Vac	—	1NO	C22-DLH-G-K10-230	C22S-DLH-G-K10-230
		24 Vac/Vdc	X1	1NO	C22-DLH-G-X1-K10-24	C22S-DLH-G-X1-K10-24
		120 Vac	X1	1NO	C22-DLH-G-X1-K10-120	C22S-DLH-G-X1-K10-12
		230 Vac	X1	1NO	C22-DLH-G-X1-K10-230	C22S-DLH-G-X1-K10-23
		24 Vac/Vdc	—	1NC	C22-DLH-R-K01-24	C22S-DLH-R-K01-24
		120 Vac	—	1NC	C22-DLH-R-K01-120	C22S-DLH-R-K01-120
		230 Vac	—	1NC	C22-DLH-R-K01-230	C22S-DLH-R-K01-230
Red	Red	24 Vac/Vdc	X0	1NC	C22-DLH-R-X0-K01-24	C22S-DLH-R-X0-K01-24
		120 Vac	X0	1NC	C22-DLH-R-X0-K01-120	C22S-DLH-R-X0-K01-12
		230 Vac	X0	1NC	C22-DLH-R-X0-K01-230	C22S-DLH-R-X0-K01-23
		24 Vac/Vdc	—	1NO	C22-DLH-W-K10-24	C22S-DLH-W-K10-24
		120 Vac	—	1NO	C22-DLH-W-K10-120	C22S-DLH-W-K10-120
		230 Vac	—	1NO	C22-DLH-W-K10-230	C22S-DLH-W-K10-230
White	White	24 Vac/Vdc	X1	1NO	C22-DLH-W-X1-K10-24	C22S-DLH-W-X1-K10-24
		120 Vac	X1	1NO	C22-DLH-W-X1-K10-120	C22S-DLH-W-X1-K10-12
		230 Vac	X1	1NO	C22-DLH-W-X1-K10-230	C22S-DLH-W-X1-K10-23
		24 Vac/Vdc	—	1NO	C22-DLH-B-K10-24	C22S-DLH-B-K10-24
		120 Vac	—	1NO	C22-DLH-B-K10-120	C22S-DLH-B-K10-120
		230 Vac	—	1NO	C22-DLH-B-K10-230	C22S-DLH-B-K10-230
Blue	Blue	24 Vac/Vdc	—	1NO	C22-DLH-B-K10-24	C22S-DLH-B-K10-24
		120 Vac	—	1NO	C22-DLH-B-K10-120	C22S-DLH-B-K10-120
		230 Vac	—	1NO	C22-DLH-B-K10-230	C22S-DLH-B-K10-230

1.6

Pushbuttons and Indicating Lights

22.5 mm RMQ Compact Pushbuttons—C22

1

Illuminated Pushbuttons, Extended, Maintained

C22(S)-DRLH-

Illuminated Pushbuttons, Flush Extended, Maintained



LED Color	Button Color	Voltage	Button Etching	Contact Block Configuration	Silver Bezel Catalog Number	Black Bezel Catalog Number
Green	Green	24 Vac/Vdc	—	1NO	C22-DRLH-G-K10-24	C22S-DRLH-G-K10-24
		120 Vac	—	1NO	C22-DRLH-G-K10-120	C22S-DRLH-G-K10-120
		230 Vac	—	1NO	C22-DRLH-G-K10-230	C22S-DRLH-G-K10-230
		24 Vac/Vdc	X1	1NO	C22-DRLH-G-X1-K10-24	C22S-DRLH-G-X1-K10-24
		120 Vac	X1	1NO	C22-DRLH-G-X1-K10-120	C22S-DRLH-G-X1-K10-120
		230 Vac	X1	1NO	C22-DRLH-G-X1-K10-230	C22S-DRLH-G-X1-K10-230
Red	Red	24 Vac/Vdc	—	1NC	C22-DRLH-R-K01-24	C22S-DRLH-R-K01-24
		120 Vac	—	1NC	C22-DRLH-R-K01-120	C22S-DRLH-R-K01-120
		230 Vac	—	1NC	C22-DRLH-R-K01-230	C22S-DRLH-R-K01-230
		24 Vac/Vdc	X0	1NC	C22-DRLH-R-X0-K01-24	C22S-DRLH-R-X0-K01-24
		120 Vac	X0	1NC	C22-DRLH-R-X0-K01-120	C22S-DRLH-R-X0-K01-120
		230 Vac	X0	1NC	C22-DRLH-R-X0-K01-230	C22S-DRLH-R-X0-K01-230
White	White	24 Vac/Vdc	—	1NO	C22-DRLH-W-K10-24	C22S-DRLH-W-K10-24
		120 Vac	—	1NO	C22-DRLH-W-K10-120	C22S-DRLH-W-K10-120
		230 Vac	—	1NO	C22-DRLH-W-K10-230	C22S-DRLH-W-K10-230
		24 Vac/Vdc	X1	1NO	C22-DRLH-W-X1-K10-24	C22S-DRLH-W-X1-K10-24
		120 Vac	X1	1NO	C22-DRLH-W-X1-K10-120	C22S-DRLH-W-X1-K10-120
		230 Vac	X1	1NO	C22-DRLH-W-X1-K10-230	C22S-DRLH-W-X1-K10-230
Blue	Blue	24 Vac/Vdc	—	1NO	C22-DRLH-B-K10-24	C22S-DRLH-B-K10-24
		120 Vac	—	1NO	C22-DRLH-B-K10-120	C22S-DRLH-B-K10-120
		230 Vac	—	1NO	C22-DRLH-B-K10-230	C22S-DRLH-B-K10-230

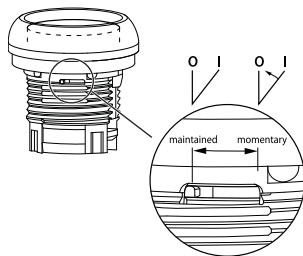

Note: Maintained pushbuttons can be converted in the field to momentary operation by switching the locking ring, which is accessible through the side of the operator body.

Indicating Lights



Contents

Description	Page
Pushbuttons—Non-Illuminated and Illuminated	V7-T1-140
Indicating Lights	
Catalog Number Selection	V7-T1-154
Product Selection	V7-T1-154
Emergency Stops	V7-T1-156
Selector Switches	V7-T1-159
Technical Data and Specifications	V7-T1-166
Dimensions	V7-T1-168

Indicating Lights

Product Description

C22 indicating lights use a combination of a durable, bright LED unit and modern lenses designed specifically for this type of LED to create a bright and visible indicating light. As with the pushbuttons, the indicating light lenses can be laser etched, simply order without lens and order M22/C22 custom etched lenses to attach.

Indicating lights with pigtail have options for M12, M8, or flying lead connectors, providing high degree of protection options.

Note: For additional accessories, please see **Pages V7-T1-111 to V7-T1-117**, 22.5 mm Modular Pushbuttons—M22 Accessories.

Features

- LED offering only for improved brightness quality and up to 100,000 hours of operation
- Lenses specifically designed for LED illumination
- Lenses capable of being laser etched for custom solutions that last
- Units with pigtail allow for direct machine mounting with high degree of protection backside

Protection Type

- IP67/IP69K
- NEMA 4X, 13
- IP65 rear rating with pigtail

1.6

Pushbuttons and Indicating Lights

22.5 mm RMQ Compact Pushbuttons—C22

1

Catalog Number Selection

Catalog Number Selection is for illustrative purposes only and not to be used to create new catalog numbers.

Indicating Lights

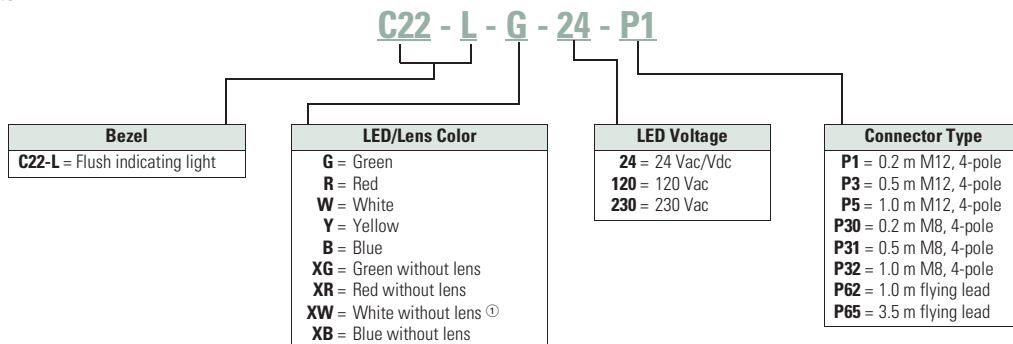

Product Selection

Indicating Lights

C22-L-

Indicating Lights



Lens Color	LED Color	Voltage	Catalog Number
Green	Green	24 Vac/Vdc	C22-L-G-24
		120 Vac	C22-L-G-120
		230 Vac	C22-L-G-230
Red	Red	24 Vac/Vdc	C22-L-R-24
		120 Vac	C22-L-R-120
		230 Vac	C22-L-R-230
White	White	24 Vac/Vdc	C22-L-W-24
		120 Vac	C22-L-W-120
		230 Vac	C22-L-W-230
Yellow	White	24 Vac/Vdc	C22-L-Y-24
		120 Vac	C22-L-Y-120
		230 Vac	C22-L-Y-230
Blue	Blue	24 Vac/Vdc	C22-L-B-24
		120 Vac	C22-L-B-120
		230 Vac	C22-L-B-230
Without Lens	Green	24 Vac/Vdc	C22-L-XG-24
		120 Vac	C22-L-XG-120
		230 Vac	C22-L-XG-230
	Red	24 Vac/Vdc	C22-L-XR-24
		120 Vac	C22-L-XR-120
		230 Vac	C22-L-XR-230
	White	24 Vac/Vdc	C22-L-XW-24
		120 Vac	C22-L-XW-120
		230 Vac	C22-L-XW-230
	Blue	24 Vac/Vdc	C22-L-XB-24
		120 Vac	C22-L-XB-120
		230 Vac	C22-L-XB-230

Note

Ⓞ Use white LED for both white and yellow lenses.

C22 with Pigtail LED Options

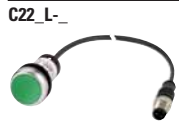

C22 with Pigtail LED Options

24 Vac/Vdc only indicating lights.

Color	Connector Type	0.2 m Catalog Number	0.5 m Catalog Number	1.0 m Catalog Number	3.5 m Catalog Number
Green	M8	C22-L-G-24-P30	C22-L-G-24-P31	C22-L-G-24-P32	—
	M12	C22-L-G-24-P1	C22-L-G-24-P3	C22-L-G-24-P5	—
	Flying lead	—	—	C22-L-G-24-P62	C22-L-G-24-P65
Red	M8	C22-L-R-24-P30	C22-L-R-24-P31	C22-L-R-24-P32	—
	M12	C22-L-R-24-P1	C22-L-R-24-P3	C22-L-R-24-P5	—
	Flying lead	—	—	C22-L-R-24-P62	C22-L-R-24-P65
White	M8	C22-L-W-24-P30	C22-L-W-24-P31	C22-L-W-24-P32	—
	M12	C22-L-W-24-P1	C22-L-W-24-P3	C22-L-W-24-P5	—
	Flying lead	—	—	C22-L-W-24-P62	C22-L-W-24-P65
Yellow	M8	C22-L-Y-24-P30	C22-L-Y-24-P31	C22-L-Y-24-P32	—
	M12	C22-L-Y-24-P1	C22-L-Y-24-P3	C22-L-Y-24-P5	—
	Flying lead	—	—	C22-L-Y-24-P62	C22-L-Y-24-P65
Blue	M8	C22-L-B-24-P30	C22-L-B-24-P31	C22-L-B-24-P32	—
	M12	C22-L-B-24-P1	C22-L-B-24-P3	C22-L-B-24-P5	—
	Flying lead	—	—	C22-L-B-24-P62	C22-L-B-24-P65

1.6

Pushbuttons and Indicating Lights

22.5 mm RMQ Compact Pushbuttons—C22

1

Emergency Stops



Emergency Stops

Product Description

C22 emergency stops are a durable and reliable solution to a variety of e-stop applications. This compact e-stop, available as twist-to-release and keyed-release, is a simple product that eliminates the need for self-monitoring contact blocks, all while still meeting almost all of the industry safety standards.

E-stops with pigtails allow for direct machine mounting, eliminating the need for an enclosure with high degree of rear protection. Flying leads also allow for quick termination to nearby controls or functional safety devices.

Note: For additional accessories, please see **Pages V7-T1-111 to V7-T1-117**, 22.5 mm Modular Pushbuttons—M22 Accessories.

Features

- Available in push-pull, twist-release, twist-release with indicator, and key release 38 mm through 60 mm operators
- Available with M12 or flying lead pigtails, allowing direct machine mounting and easy reliable connections
- Meet functional safety requirements for E-stops

Contents

Description

	<i>Page</i>
Pushbuttons—Non-Illuminated and Illuminated	V7-T1-140
Indicating Lights	V7-T1-153
Emergency Stops	
Non-Illuminated, Twist-Release	V7-T1-157
Non-Illuminated, Keyed-Release	V7-T1-157
Selector Switches	V7-T1-159
Technical Data and Specifications	V7-T1-166
Dimensions	V7-T1-168

Protection Type

- Twist-Release
 - IP67/IP69K
- Keyed-Release
 - IP66
- NEMA 4X, 13
- With pigtail
 - IP65 rear rating

Catalog Number Selection

Catalog Number Selection is for illustrative purposes only and not to be used to create new catalog numbers.

Emergency Stops

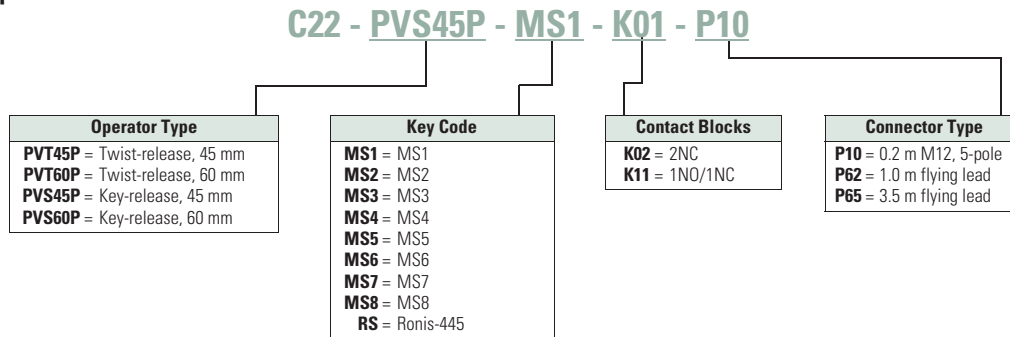

Product Selection

Non-Illuminated, Twist-Release

C22-PVT_ Non-Illuminated Emergency Stops, Twist-Release



Release Method	Operator Size	Contact Block Configuration	Catalog Number
Twist-release	45 mm	2NC	C22-PVT45P-K02
		1NO/1NC	C22-PVT45P-K11
	60 mm	2NC	C22-PVT60P-K02
		1NO/1NC	C22-PVT60P-K11

Non-Illuminated, Keyed-Release

C22-PVS_ Non-Illuminated Emergency Stops, Keyed-Release



Release Method	Operator Size	Key Code	Contact Block Configuration	Catalog Number
Keyed-release	45 mm	MS1	2NC	C22-PVS45P-MS1-K02
			1NO/1NC	C22-PVS45P-MS1-K11
		MS2	2NC	C22-PVS45P-MS2-K02
			1NO/1NC	C22-PVS45P-MS2-K11
		MS3	2NC	C22-PVS45P-MS3-K02
			1NO/1NC	C22-PVS45P-MS3-K11
		MS4	2NC	C22-PVS45P-MS4-K02
			1NO/1NC	C22-PVS45P-MS4-K11
		MS5	2NC	C22-PVS45P-MS5-K02
			1NO/1NC	C22-PVS45P-MS5-K11
		MS6	2NC	C22-PVS45P-MS6-K02
			1NO/1NC	C22-PVS45P-MS6-K11
		MS7	2NC	C22-PVS45P-MS7-K02
			1NO/1NC	C22-PVS45P-MS7-K11
		MS8	2NC	C22-PVS45P-MS8-K02
			1NO/1NC	C22-PVS45P-MS8-K11
Ronis	2NC	C22-PVS45P-RS-K02		
	1NO/1NC	C22-PVS45P-RS-K11		

Note: ⊕ = Safety function implemented with positive opening as defined in IEC/EN 60947-5-1.

C22-PVS_





Non-Illuminated Emergency Stops, Keyed-Release, continued

Release Method	Operator Size	Key Code	Contact Block Configuration	Catalog Number
Keyed-release	60 mm	MS1	2NC	C22-PVS60P-MS1-K02
			1NO/1NC	C22-PVS60P-MS1-K11
		MS2	2NC	C22-PVS60P-MS2-K02
			1NO/1NC	C22-PVS60P-MS2-K11
		MS3	2NC	C22-PVS60P-MS3-K02
			1NO/1NC	C22-PVS60P-MS3-K11
		MS4	2NC	C22-PVS60P-MS4-K02
			1NO/1NC	C22-PVS60P-MS4-K11
		MS5	2NC	C22-PVS60P-MS5-K02
			1NO/1NC	C22-PVS60P-MS5-K11
		MS6	2NC	C22-PVS60P-MS6-K02
			1NO/1NC	C22-PVS60P-MS6-K11
		MS7	2NC	C22-PVS60P-MS7-K02
			1NO/1NC	C22-PVS60P-MS7-K11
		MS8	2NC	C22-PVS60P-MS8-K02
			1NO/1NC	C22-PVS60P-MS8-K11
Ronis	2NC	C22-PVS60P-RS-K02		
	1NO/1NC	C22-PVS60P-RS-K11		

E-stop

E-stop

Release Method	Operator Size	Contacts	Connector Length	Connector Type	Catalog Number
C22-PV-K11-P62 Push-pull 	38 mm	2NC	1	Flying lead	C22-PV-K02-P62
	38 mm	2NC	3.5	Flying lead	C22-PV-K02-P65
	38 mm	1NO/1NC	1	Flying lead	C22-PV-K11-P62
	38 mm	1NO/1NC	3.5	Flying lead	C22-PV-K11-P65
	45 mm	2NC	0.2	M12, 5-pole	C22-PV-K02-P10
C22-PVT-K02-P65 Twist release 	38 mm	2NC	1	Flying lead	C22-PVT-K02-P62
	38 mm	2NC	3.5	Flying lead	C22-PVT-K02-P65
	38 mm	1NO/1NC	1	Flying lead	C22-PVT-K11-P62
	38 mm	1NO/1NC	3.5	Flying lead	C22-PVT-K11-P65
	45 mm	2NC	1	Flying lead	C22-PVT45P-K02-P62
	45 mm	2NC	3.5	Flying lead	C22-PVT45P-K02-P65
	45 mm	1NO/1NC	1	Flying lead	C22-PVT45P-K11-P62
	45 mm	1NO/1NC	3.5	Flying lead	C22-PVT45P-K11-P65
	45 mm	2NC	0.2	M12, 5-pole	C22-PVT45P-K02-P10
C22-PVT45PMPPIK02-P65 Twist release mechanical indication 	45 mm	2NC	1	Flying lead	C22-PVT45PMPPIK02-P62
	45 mm	2NC	3.5	Flying lead	C22-PVT45PMPPIK02-P65
	45 mm	1NO/1NC	1	Flying lead	C22-PVT45PMPPIK11-P62
	45 mm	1NO/1NC	3.5	Flying lead	C22-PVT45PMPPIK11-P65

Note: ⊕ = Safety function implemented with positive opening as defined in IEC/EN 60947-5-1.

Selector Switches



Contents

<i>Description</i>	<i>Page</i>
Pushbuttons—Non-Illuminated and Illuminated	V7-T1-140
Indicating Lights	V7-T1-153
Emergency Stops	V7-T1-156
Selector Switches	
Non-Illuminated, Knob Type	V7-T1-160
Non-Illuminated, Key Operated	V7-T1-162
Technical Data and Specifications	V7-T1-166
Dimensions	V7-T1-168

Selector Switches

Product Description

With over 20 variations of operation and 8 varieties of key codes, the C22 line offers a very complete line of selector switches.

Pigtail units come in M12, M8 or flying lead options.

Note: For additional accessories, please see **Pages V7-T1-111 to V7-T1-117**, 22.5 mm Modular Pushbuttons—M22 Accessories.

Features

- Selector switch (non-keyed) rated for 1 million mechanical operations
- Momentary selector switches are field convertible from momentary to maintained
- Rear pigtails provide IP65 front and rear ratings, eliminating enclosure requirements and reducing installation times

Protection Type

- IP65
- NEMA 4X, 13

1.6

Pushbuttons and Indicating Lights

22.5 mm RMQ Compact Pushbuttons—C22

1

Catalog Number Selection

Catalog Number Selection is for illustrative purposes only and not to be used to create new catalog numbers.

Selector Switches—Non-Keyed

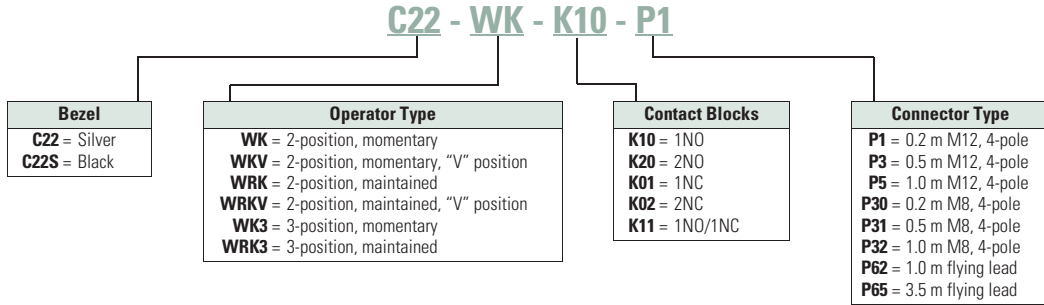

Product Selection

Non-Illuminated, Knob Type

C22(S)-WK- /
C22(S)-WRK_



Non-Illuminated Selector Switches, Knob Type

Type	Switching Position	Contact Block Configuration	Silver Bezel Catalog Number	Black Bezel Catalog Number		
Two-position	Momentary 40°	1NO	C22-WK-K10	C22S-WK-K10		
		2NO	C22-WK-K20	C22S-WK-K20		
		1NC	C22-WK-K01	C22S-WK-K01		
		2NC	C22-WK-K02	C22S-WK-K02		
		1NO/1NC	C22-WK-K11	C22S-WK-K11		
		1NO	C22-WKV-K10	C22S-WKV-K10		
	Momentary 60°	2NO	C22-WKV-K20	C22S-WKV-K20		
		1NC	C22-WKV-K01	C22S-WKV-K01		
		2NC	C22-WKV-K02	C22S-WKV-K02		
		1NO/1NC	C22-WKV-K11	C22S-WKV-K11		
		Maintained 40°	1NO	C22-WRK-K10	C22S-WRK-K10	
			2NO	C22-WRK-K20	C22S-WRK-K20	
1NC	C22-WRK-K01		C22S-WRK-K01			
2NC	C22-WRK-K02		C22S-WRK-K02			
1NO/1NC	C22-WRK-K11		C22S-WRK-K11			
1NO	C22-WRKV-K10		C22S-WRKV-K10			
Two-position	Maintained 60°	2NO	C22-WRKV-K20	C22S-WRKV-K20		
		1NC	C22-WRKV-K01	C22S-WRKV-K01		
		2NC	C22-WRKV-K02	C22S-WRKV-K02		
		1NO/1NC	C22-WRKV-K11	C22S-WRKV-K11		
		Three-position	Momentary 40°	2NO	C22-WK3-K20	C22S-WK3-K20
				2NC	C22-WK3-K02	C22S-WK3-K02
	1NO/1NC			C22-WK3-K11	C22S-WK3-K11	
	Maintained 60°		2NO	C22-WRK3-K20	C22S-WRK3-K20	
			2NC	C22-WRK3-K02	C22S-WRK3-K02	
			1NO/1NC	C22-WRK3-K11	C22S-WRK3-K11	

Note: Momentary selector switches can be field converted to maintained.

Non-Illuminated Selector Switches, Knob Type, with Pigtail

C22-W_



Non-Illuminated Selector Switches, Knob Type, with Pigtail

Type	Switching Position	Contacts	Connector Length	Connector Type	Silver Bezel Catalog Number	
Two-position	Momentary	1NC	1	Flying lead	C22-WK-K01-P62	
		1NC	3.5	Flying lead	C22-WK-K01-P65	
		1NO	0.5	M8	C22-WK-K10-P30	
		1NO	0.5	M12	C22-WK-K10-P1	
		1NO	1	M8	C22-WK-K10-P32	
		1NO	1	M12	C22-WK-K10-P5	
		1NO	1	Flying lead	C22-WK-K10-P62	
		1NO	3.5	Flying lead	C22-WK-K10-P65	
		1NO/1NC	1	Flying lead	C22-WK-K11-P62	
		1NO/1NC	3.5	Flying lead	C22-WK-K11-P65	
		2NC	1	Flying lead	C22-WK-K02-P62	
		2NC	3.5	Flying lead	C22-WK-K02-P65	
		2NO	1	Flying lead	C22-WK-K20-P62	
		2NO	3.5	Flying lead	C22-WK-K20-P65	
		Maintained	1NC	1	Flying lead	C22-WRK-K01-P62
	1NC		3.5	Flying lead	C22-WRK-K01-P65	
	1NO		0.5	M8	C22-WRK-K10-P30	
	1NO		0.5	M12	C22-WRK-K10-P1	
	1NO		1	M8	C22-WRK-K10-P32	
	1NO		1	M12	C22-WRK-K10-P5	
	1NO		1	Flying lead	C22-WRK-K10-P62	
	1NO		3.5	Flying lead	C22-WRK-K10-P65	
	1NO/1NC		1	Flying lead	C22-WRK-K11-P62	
	1NO/1NC		3.5	Flying lead	C22-WRK-K11-P65	
	2NC		1	Flying lead	C22-WRK-K02-P62	
	2NC		3.5	Flying lead	C22-WRK-K02-P65	
	2NO		1	Flying lead	C22-WRK-K20-P62	
	2NO		3.5	Flying lead	C22-WRK-K20-P65	
	Three-position		Momentary	1NO/1NC	1	Flying lead
		1NO/1NC		3.5	Flying lead	C22-WK3-K11-P65
2NC		1		Flying lead	C22-WK3-K02-P62	
2NC		3.5		Flying lead	C22-WK3-K02-P65	
2NO		1		Flying lead	C22-WK3-K20-P62	
2NO		3.5		Flying lead	C22-WK3-K20-P65	
Maintained		1NO/1NC		1	Flying lead	C22-WRK3-K11-P62
		1NO/1NC	3.5	Flying lead	C22-WRK3-K11-P65	
		2NC	1	Flying lead	C22-WRK3-K02-P62	
		2NC	3.5	Flying lead	C22-WRK3-K02-P65	
		2NO	1	Flying lead	C22-WRK3-K20-P62	
		2NO	3.5	Flying lead	C22-WRK3-K20-P65	

1.6

Pushbuttons and Indicating Lights

22.5 mm RMQ Compact Pushbuttons—C22

1

Catalog Number Selection

Catalog Number Selection is for illustrative purposes only and not to be used to create new catalog numbers.

Selector Switches—Keyed

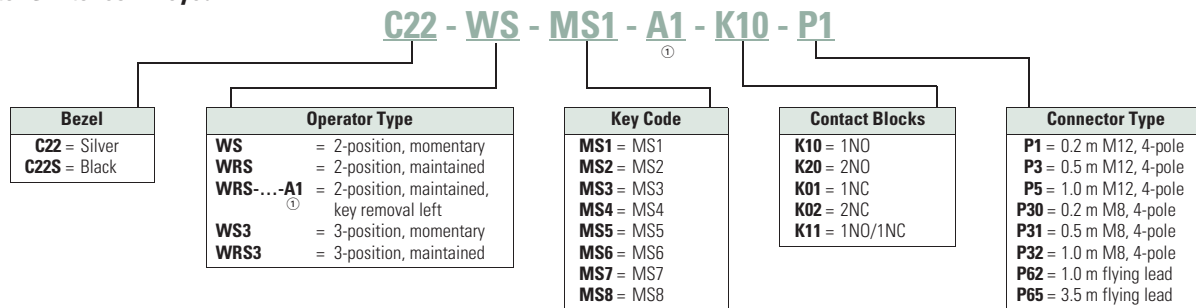

Non-Illuminated, Key Operated

C22(S)-WS-MS_ Non-Illuminated Selector Switches, Key Operated



Position	Type	Key Code	Contact Block Configuration	Silver Bezel Catalog Number	Black Bezel Catalog Number
Two-position	Momentary key removal left 40°	MS1	1NO	C22-WS-MS1-K10	C22S-WS-MS1-K10
			2NO	C22-WS-MS1-K20	C22S-WS-MS1-K20
			1NC	C22-WS-MS1-K01	C22S-WS-MS1-K01
			2NC	C22-WS-MS1-K02	C22S-WS-MS1-K02
			1NO/1NC	C22-WS-MS1-K11	C22S-WS-MS1-K11
		MS2	1NO	C22-WS-MS2-K10	C22S-WS-MS2-K10
			2NO	C22-WS-MS2-K20	C22S-WS-MS2-K20
			1NC	C22-WS-MS2-K01	C22S-WS-MS2-K01
			2NC	C22-WS-MS2-K02	C22S-WS-MS2-K02
			1NO/1NC	C22-WS-MS2-K11	C22S-WS-MS2-K11
		MS3	1NO	C22-WS-MS3-K10	C22S-WS-MS3-K10
			2NO	C22-WS-MS3-K20	C22S-WS-MS3-K20
			1NC	C22-WS-MS3-K01	C22S-WS-MS3-K01
			2NC	C22-WS-MS3-K02	C22S-WS-MS3-K02
			1NO/1NC	C22-WS-MS3-K11	C22S-WS-MS3-K11
		MS4	1NO	C22-WS-MS4-K10	C22S-WS-MS4-K10
			2NO	C22-WS-MS4-K20	C22S-WS-MS4-K20
			1NC	C22-WS-MS4-K01	C22S-WS-MS4-K01
			2NC	C22-WS-MS4-K02	C22S-WS-MS4-K02
			1NO/1NC	C22-WS-MS4-K11	C22S-WS-MS4-K11
MS5	1NO	C22-WS-MS5-K10	C22S-WS-MS5-K10		
	2NO	C22-WS-MS5-K20	C22S-WS-MS5-K20		
	1NC	C22-WS-MS5-K01	C22S-WS-MS5-K01		
	2NC	C22-WS-MS5-K02	C22S-WS-MS5-K02		
	1NO/1NC	C22-WS-MS5-K11	C22S-WS-MS5-K11		

Note: Momentary selector switches can be field converted to maintained.

C22(S)-WRS-MS_

Non-Illuminated Selector Switches, Key Operated, continued



Position	Type	Key Code	Contact Block Configuration	Silver Bezel Catalog Number	Black Bezel Catalog Number
Two-position, continued	Momentary key removal left 40°	MS6	1NO	C22-WS-MS6-K10	C22S-WS-MS6-K10
			2NO	C22-WS-MS6-K20	C22S-WS-MS6-K20
			1NC	C22-WS-MS6-K01	C22S-WS-MS6-K01
			2NC	C22-WS-MS6-K02	C22S-WS-MS6-K02
			1NO/1NC	C22-WS-MS6-K11	C22S-WS-MS6-K11
		MS7	1NO	C22-WS-MS7-K10	C22S-WS-MS7-K10
			2NO	C22-WS-MS7-K20	C22S-WS-MS7-K20
			1NC	C22-WS-MS7-K01	C22S-WS-MS7-K01
			2NC	C22-WS-MS7-K02	C22S-WS-MS7-K02
			1NO/1NC	C22-WS-MS7-K11	C22S-WS-MS7-K11
		MS8	1NO	C22-WS-MS8-K10	C22S-WS-MS8-K10
			2NO	C22-WS-MS8-K20	C22S-WS-MS8-K20
			1NC	C22-WS-MS8-K01	C22S-WS-MS8-K01
			2NC	C22-WS-MS8-K02	C22S-WS-MS8-K02
			1NO/1NC	C22-WS-MS8-K11	C22S-WS-MS8-K11
Two-position	Maintained key removal left/right 40°	MS1	1NO	C22-WRS-MS1-K10	C22S-WRS-MS1-K10
			2NO	C22-WRS-MS1-K20	C22S-WRS-MS1-K20
			1NC	C22-WRS-MS1-K01	C22S-WRS-MS1-K01
			2NC	C22-WRS-MS1-K02	C22S-WRS-MS1-K02
			1NO/1NC	C22-WRS-MS1-K11	C22S-WRS-MS1-K11
		MS2	1NO	C22-WRS-MS2-K10	C22S-WRS-MS2-K10
			2NO	C22-WRS-MS2-K20	C22S-WRS-MS2-K20
			1NC	C22-WRS-MS2-K01	C22S-WRS-MS2-K01
			2NC	C22-WRS-MS2-K02	C22S-WRS-MS2-K02
			1NO/1NC	C22-WRS-MS2-K11	C22S-WRS-MS2-K11
		MS3	1NO	C22-WRS-MS3-K10	C22S-WRS-MS3-K10
			2NO	C22-WRS-MS3-K20	C22S-WRS-MS3-K20
			1NC	C22-WRS-MS3-K01	C22S-WRS-MS3-K01
			2NC	C22-WRS-MS3-K02	C22S-WRS-MS3-K02
			1NO/1NC	C22-WRS-MS3-K11	C22S-WRS-MS3-K11





Note: Momentary selector switches can be field converted to maintained.

1

C22(S)-WRS...-MS1

Non-Illuminated Selector Switches, Key Operated, continued



Position	Type	Key Code	Contact Block Configuration	Silver Bezel Catalog Number	Black Bezel Catalog Number
Two-position, continued	Maintained key removal left/right 40° 	MS4	1NO	C22-WRS-MS4-K10	C22S-WRS-MS4-K10
			2NO	C22-WRS-MS4-K20	C22S-WRS-MS4-K20
			1NC	C22-WRS-MS4-K01	C22S-WRS-MS4-K01
			2NC	C22-WRS-MS4-K02	C22S-WRS-MS4-K02
			1NO/1NC	C22-WRS-MS4-K11	C22S-WRS-MS4-K11
		MS5	1NO	C22-WRS-MS5-K10	C22S-WRS-MS5-K10
			2NO	C22-WRS-MS5-K20	C22S-WRS-MS5-K20
			1NC	C22-WRS-MS5-K01	C22S-WRS-MS5-K01
			2NC	C22-WRS-MS5-K02	C22S-WRS-MS5-K02
			1NO/1NC	C22-WRS-MS5-K11	C22S-WRS-MS5-K11
	MS6	1NO	C22-WRS-MS6-K10	C22S-WRS-MS6-K10	
		2NO	C22-WRS-MS6-K20	C22S-WRS-MS6-K20	
		1NC	C22-WRS-MS6-K01	C22S-WRS-MS6-K01	
		2NC	C22-WRS-MS6-K02	C22S-WRS-MS6-K02	
		1NO/1NC	C22-WRS-MS6-K11	C22S-WRS-MS6-K11	
	MS7	1NO	C22-WRS-MS7-K10	C22S-WRS-MS7-K10	
		2NO	C22-WRS-MS7-K20	C22S-WRS-MS7-K20	
		1NC	C22-WRS-MS7-K01	C22S-WRS-MS7-K01	
		2NC	C22-WRS-MS7-K02	C22S-WRS-MS7-K02	
		1NO/1NC	C22-WRS-MS7-K11	C22S-WRS-MS7-K11	
MS8	1NO	C22-WRS-MS7-K10	C22S-WRS-MS7-K10		
	2NO	C22-WRS-MS7-K20	C22S-WRS-MS7-K20		
	1NC	C22-WRS-MS7-K01	C22S-WRS-MS7-K01		
	2NC	C22-WRS-MS7-K02	C22S-WRS-MS7-K02		
	1NO/1NC	C22-WRS-MS7-K11	C22S-WRS-MS7-K11		
Two-position	Maintained key removal left 40° 	MS1	1NO	C22-WRS-MS1-A1-K10	C22S-WRS-MS1-A1-K10
			2NO	C22-WRS-MS1-A1-K20	C22S-WRS-MS1-A1-K20
			1NC	C22-WRS-MS1-A1-K01	C22S-WRS-MS1-A1-K01
			2NC	C22-WRS-MS1-A1-K02	C22S-WRS-MS1-A1-K02
			1NO/1NC	C22-WRS-MS1-A1-K11	C22S-WRS-MS1-A1-K11
Three Position	Momentary Key Removal Center 40° 	MS1	2NO	C22-WRS3-MS1-K20	C22S-WRS3-MS1-K20
			2NC	C22-WRS3-MS1-K02	C22S-WRS3-MS1-K02
			1NO/1NC	C22-WRS3-MS1-K11	C22S-WRS3-MS1-K11
	Maintained Key Removal Left/Right 60° 	MS1	2NO	C22-WRS3-MS1-K20	C22S-WRS3-MS1-K20
			2NC	C22-WRS3-MS1-K02	C22S-WRS3-MS1-K02
			1NO/1NC	C22-WRS3-MS1-K11	C22S-WRS3-MS1-K11

Note: Momentary selector switches can be field converted to maintained.

Non-Illuminated Selector Switches, Key Operated, with Pigtail

C22-W_



Non-Illuminated Selector Switches, Key Operated, with Pigtail

Position	Switching Position	Contacts	Connector Length	Connector Type	Silver Bezel Catalog Number
Two-position	Momentary 40°	1NC	1 m	Flying lead	C22-WS-MS1-K01-P62
		1NC	3.5 m	Flying lead	C22-WS-MS1-K01-P65
		1NO	0.2 m	M12	C22-WS-MS1-K10-P1
		1NO	0.2 m	M8	C22-WS-MS1-K10-P30
		1NO	1 m	M12	C22-WS-MS1-K10-P5
		1NO	1 m	M8	C22-WS-MS1-K10-P32
		1NO	1 m	Flying lead	C22-WS-MS1-K10-P62
		1NO	3.5 m	Flying lead	C22-WS-MS1-K10-P65
		1NO/1NC	1 m	Flying lead	C22-WS-MS1-K11-P62
		1NO/1NC	3.5 m	Flying lead	C22-WS-MS1-K11-P65
		2NC	1 m	Flying lead	C22-WS-MS1-K02-P62
		2NC	3.5 m	Flying lead	C22-WS-MS1-K02-P65
	2NO	1 m	Flying lead	C22-WS-MS1-K20-P62	
	2NO	3.5 m	Flying lead	C22-WS-MS1-K20-P65	
	Maintained 60°	1NC	1 m	Flying lead	C22-WRS-MS1-K01-P62
		1NC	3.5 m	Flying lead	C22-WRS-MS1-K01-P65
		1NO	0.2 m	M12	C22-WRS-MS1-K10-P1
		1NO	0.2 m	M8	C22-WRS-MS1-K10-P30
		1NO	1 m	M12	C22-WRS-MS1-K10-P5
		1NO	1 m	M8	C22-WRS-MS1-K10-P32
		1NO	1 m	Flying lead	C22-WRS-MS1-K10-P62
		1NO	3.5 m	Flying lead	C22-WRS-MS1-K10-P65
		1NO/1NC	1 m	Flying lead	C22-WRS-MS1-K11-P62
		1NO/1NC	3.5 m	Flying lead	C22-WRS-MS1-K11-P65
2NC		1 m	Flying lead	C22-WRS-MS1-K02-P62	
2NC		3.5 m	Flying lead	C22-WRS-MS1-K02-P65	
2NO	1 m	Flying lead	C22-WRS-MS1-K20-P62		
2NO	3.5 m	Flying lead	C22-WRS-MS1-K20-P65		
Three-position	Momentary 40°	1NO/1NC	1 m	Flying lead	C22-WS3-MS1-K11-P62
		1NO/1NC	3.5 m	Flying lead	C22-WS3-MS1-K11-P65
		2NC	1 m	Flying lead	C22-WS3-MS1-K02-P62
		2NC	3.5 m	Flying lead	C22-WS3-MS1-K02-P65
		2NO	1 m	Flying lead	C22-WS3-MS1-K20-P62
		2NO	3.5 m	Flying lead	C22-WS3-MS1-K20-P65
	Maintained 60°	1NO/1NC	1 m	Flying lead	C22-WRS3-MS1-K11-P62
		1NO/1NC	3.5 m	Flying lead	C22-WRS3-MS1-K11-P65
		2NC	1 m	Flying lead	C22-WRS3-MS1-K02-P62
		2NC	3.5 m	Flying lead	C22-WRS3-MS1-K02-P65
		2NO	1 m	Flying lead	C22-WRS3-MS1-K20-P62
		2NO	3.5 m	Flying lead	C22-WRS3-MS1-K20-P65

1.6

Pushbuttons and Indicating Lights

22.5 mm RMQ Compact Pushbuttons—C22

1

Technical Data and Specifications

22.5 mm RMQ Compact Pushbuttons—C22

Description	Unit	Pushbutton Actuators Illuminated Pushbuttons C22		Indicator Lights C22	Selector Switch Actuators C22	Key-Operated Buttons C22	Emergency Stop/ Emergency Switching OFF Pushbuttons C22	
		Momentary	Maintained					
General								
Standards	IEC/EN 60947 VDE 0660							
Lifespan, mechanical	Operations	x 10 ⁶	5	1	—	1	0.1	0.05
Operating frequency	Operations/h		≥3600	≥3600	—	≥2000	≥100	≥300
Actuating force	N		≥5	≥5	—	—	—	≥50
Operating torque	Nm		—	—	—	≥0.3	≥0.5	—
Terminal screw tightening torque	Nm		0.8	0.8	0.8	0.8	0.8	0.8
Threaded ring tightening torque	Nm		2	2	2	2	2	2
Protection type			IP67, IP69K	IP67, IP69K	IP67, IP69K	IP65	IP66	IP67, IP69K
Climatic proofing	Damp heat, constant, to IEC 60068-2-78 Damp heat, cyclic, to IEC 60068-2-30							
Ambient temperature								
Open	°C		–25° to 70°	–25° to 70°	–25° to 70°	–25° to 70°	–25° to 70°	–25° to 70°
Storage	°C		–30° to 80°	–30° to 80°	–30° to 80°	–30° to 80°	–30° to 80°	–30° to 80°
Mounting position			As required	As required	As required	As required	As required	As required
Mechanical shock resistance to IEC 60068-2-27 Shock duration 11 ms, half-sinusoidal	g		30	30	30	30	30	30
Terminal capacities								
Solid	mm ²		2 x 0.5–1.5	2 x 0.5–1.5	2 x 0.5–1.5	2 x 0.5–1.5	2 x 0.5–1.5	2 x 0.5–1.5
Flexible with ferrule	mm ²		2 x 0.5–1.5	2 x 0.5–1.5	2 x 0.5–1.5	2 x 0.5–1.5	2 x 0.5–1.5	2 x 0.5–1.5
Contacts								
Rated impulse withstand voltage	U _{imp}	Vac	4000	4000	4000	4000	4000	4000
Rated insulation voltage	U _i	V	250	250	250	250	250	250
Overtoltage category/pollution degree			III/3	III/3	III/3	III/3	III/3	III/3
Control circuit reliability								
at 5 Vdc/1 mA	H _F	Fault probability	Values follow	Values follow	—	Values follow	Values follow	Values follow
at 17 Vdc/7 mA	H _F	Fault probability	N/O contact: statistically determined 1 failure per 17 x 10 ⁶ operations N/C contact: statistically determined 1 failure per 0.9 x 10 ⁶ operations		—	N/O contact: statistically determined 1 failure per 17 x 10 ⁶ operations N/C contact: statistically determined 1 failure per 0.9 x 10 ⁶ operations		
at 24 Vdc/5 mA	H _F	Fault probability	Values follow	Values follow	—	Values follow	Values follow	Values follow
Max. short-circuit protective device								
Fuse	gG/gL	A	10	10	—	10	10	10

22.5 mm RMQ Compact Pushbuttons—C22, continued

Description	Unit	Push-button Actuators		Indicator Lights C22	Selector Switch Actuators C22	Key-Operated Buttons C22	Emergency Stop/ Emergency Switching OFF Pushbuttons C22
		Illuminated Pushbuttons C22	Momentary				
Switching Capacity							
Rated operational current							
AC-15							
24V	I_e	A	4	4	—	4	4
110V	I_e	A	2	2	—	2	2
230V	I_e	A	1.5	1.5	—	1.5	1.5
DC-13							
24V	I_e	A	3	3	—	3	3
60V	I_e	A	1	1	—	1	1
110V	I_e	A	0.6	0.6	—	0.6	0.6
220V	I_e	A	0.3	0.3	—	0.3	0.3
Lifespan, electrical							
AC-15							
230V/0.5A	Operations	$\times 10^6$	0.4	0.4	—	0.4	0.4
230V/1.0A		$\times 10^6$	0.6	0.6	—	0.6	0.6

Contact Travel

Contact Travel Diagram

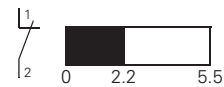
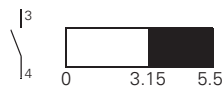

- Contact closed
- Contact open

1.6

Pushbuttons and Indicating Lights

22.5 mm RMQ Compact Pushbuttons—C22

1

Dimensions

Approximate Dimensions in mm [in]

Illuminated Pushbuttons

Flat

C22(S)-DRL_/C22(S)-DL_

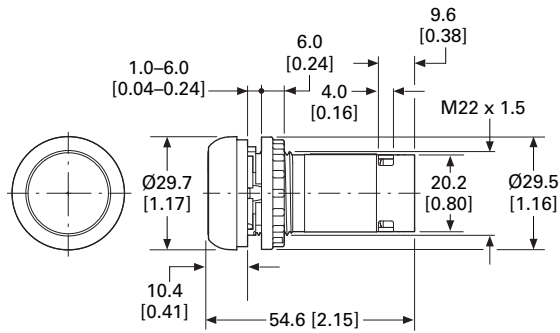

Extended

C22(S)-DRLH_/C22(S)-DLH_

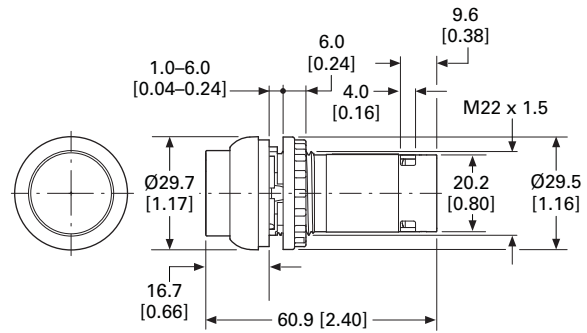

Pushbutton Actuators

Flat

C22(S)-DR_/C22(S)-D_

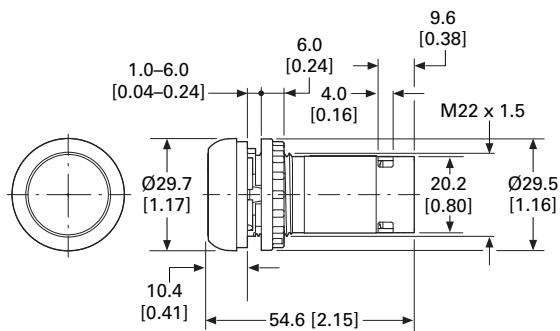

Extended

C22(S)-DRH_/C22(S)-DH_

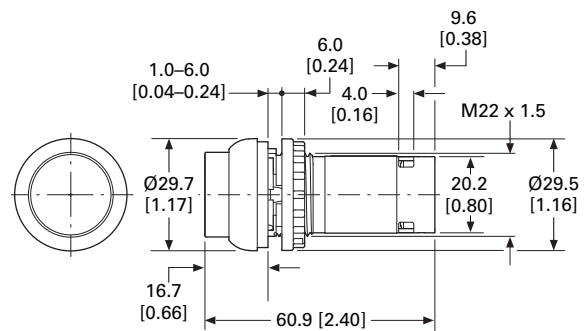

Indicating Lights

Flat

C22-L_

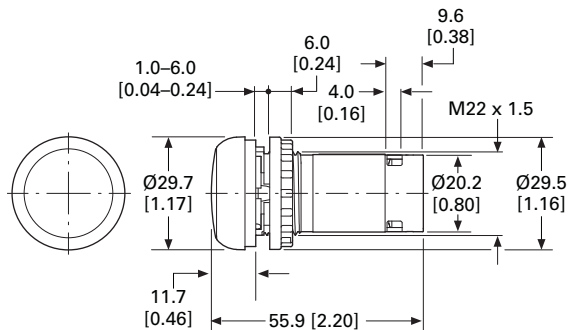

Approximate Dimensions in mm [in]

Emergency Stop/Emergency Switching OFF Pushbuttons

C22-PVT45P_

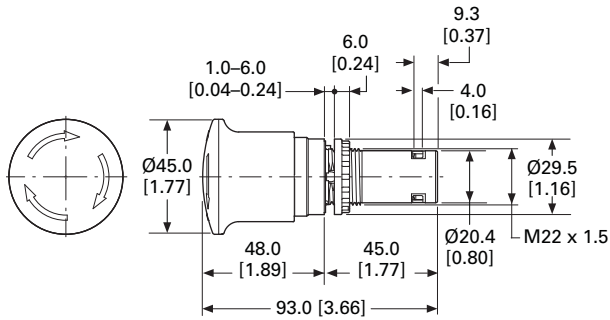

C22-PVT60P_

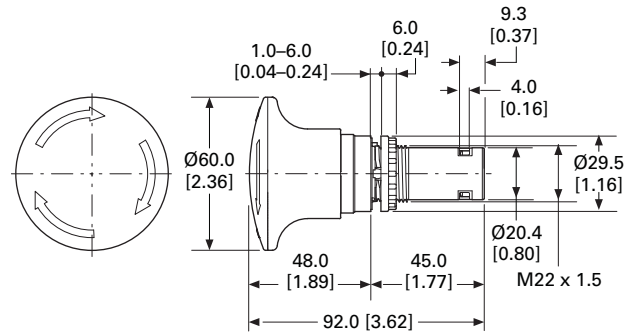

C22-PVT45P-MS_

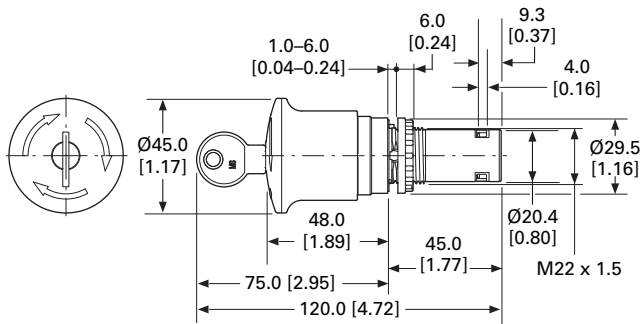

C22-PVT45P-RS_

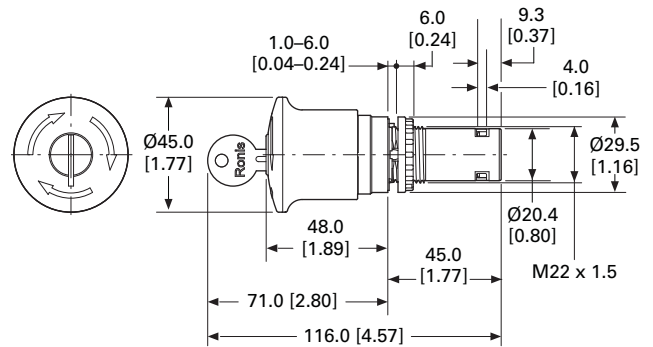

C22-PVT60P-MS_

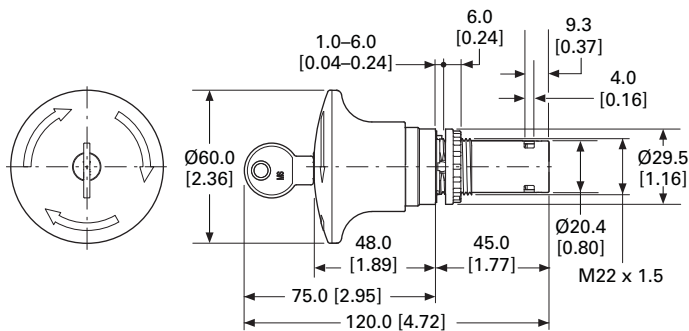

C22-PVT60P-RS_

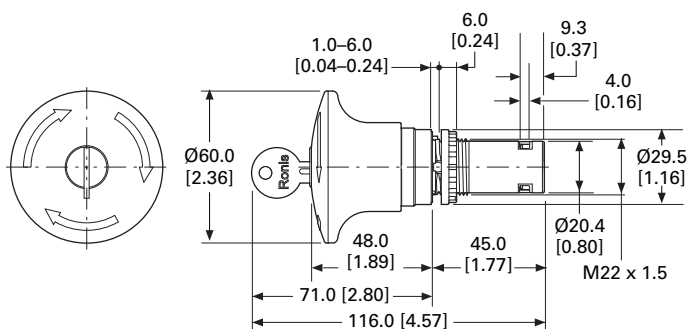

1.6

Pushbuttons and Indicating Lights

22.5 mm RMQ Compact Pushbuttons—C22

1

Approximate Dimensions in mm [in]

Selector Switch Actuators

C22(S)-W(R)K_

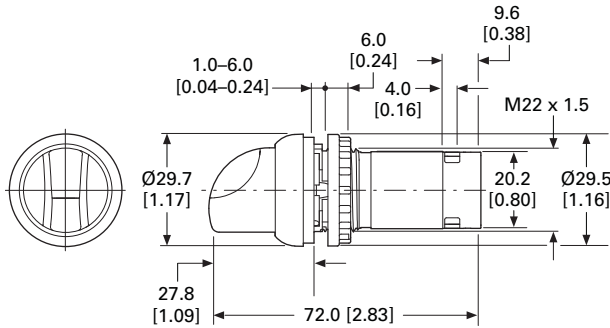

Selector Switch Actuators/V Position

C22(S)-W(R)KV_

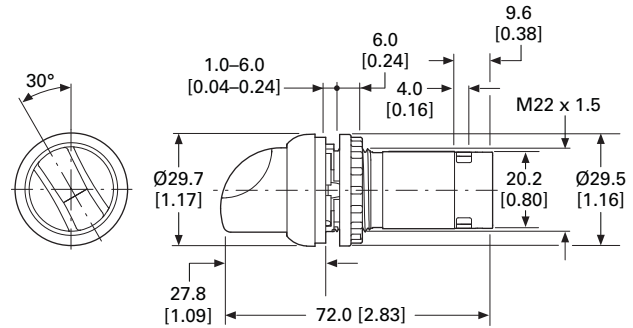

Key Operated Actuators

C22(S)-WS(3)-MS_/C22(S)-WRS(3)-MS_

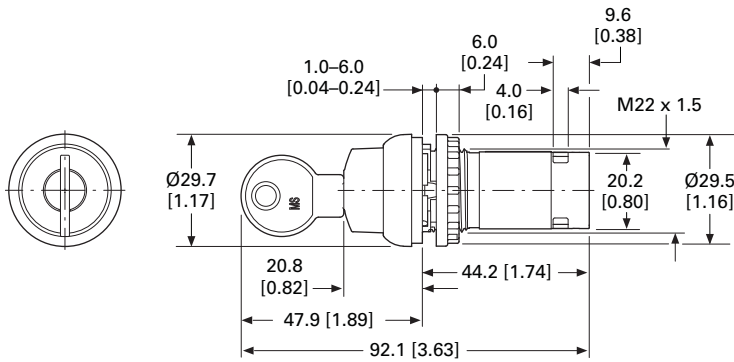

C22(S)-WS(3)-RS_/C22(S)-WRS(3)-RS_

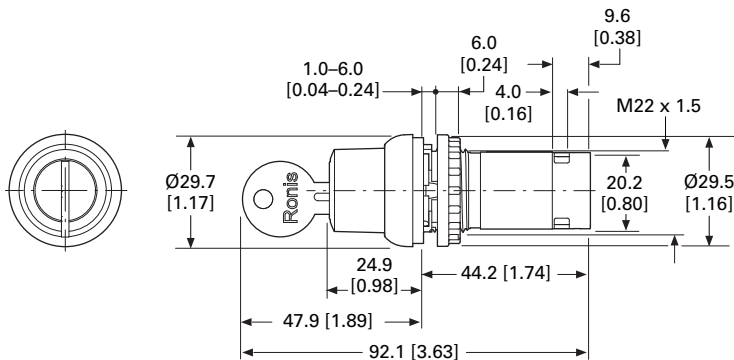

Approximate Dimensions in mm [in]

Pushbuttons, M12A

C22-D...-P1/-P3/-P5

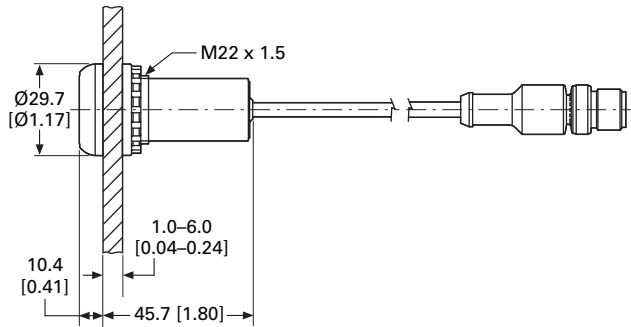

Pushbuttons, M8

C22-D...-P30/-P31/-P32

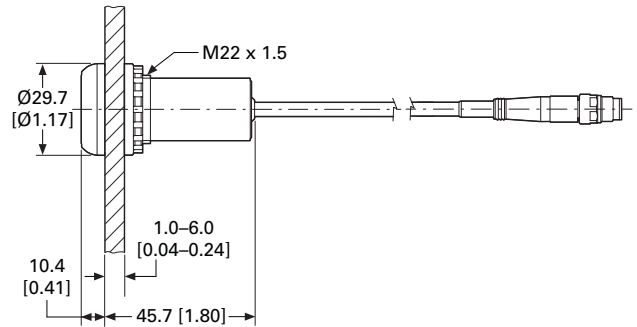

Pushbuttons, Underterminated Cable End, Flying Lead

C22-D...-P/-P62/-P65

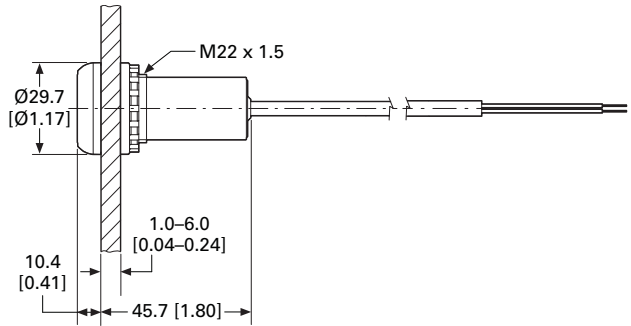

Indicator Lights, M12A

C22-L...-P1/-P3/-P5

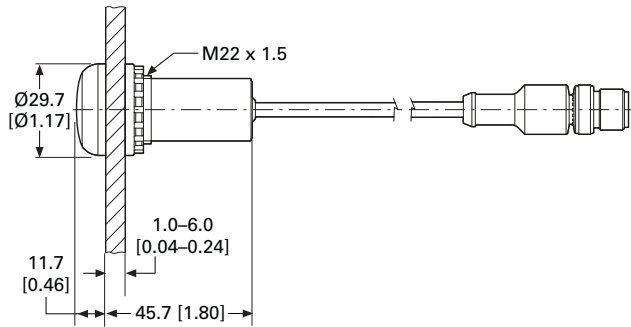

Indicator Lights, M8

C22-L...-P30/-P31/-P32

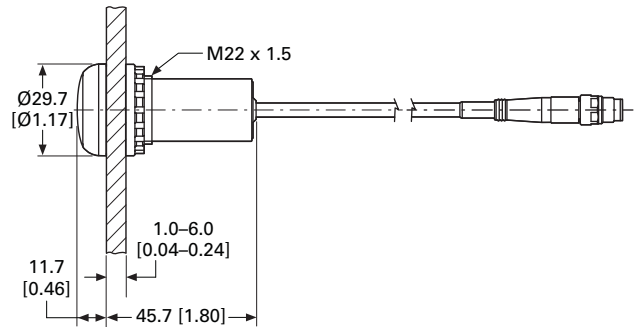

Indicator Lights, Underterminated Cable End, Flying Lead

C22-L...-P62/-P65

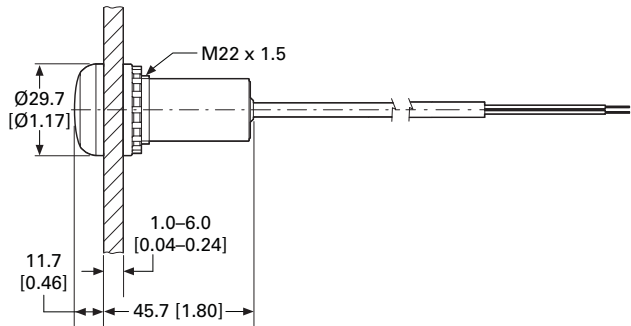

1.6

Pushbuttons and Indicating Lights

22.5 mm RMQ Compact Pushbuttons—C22

1

Approximate Dimensions in mm [in]

Emergency Switching Off, M12A

C22-PVT...-P10

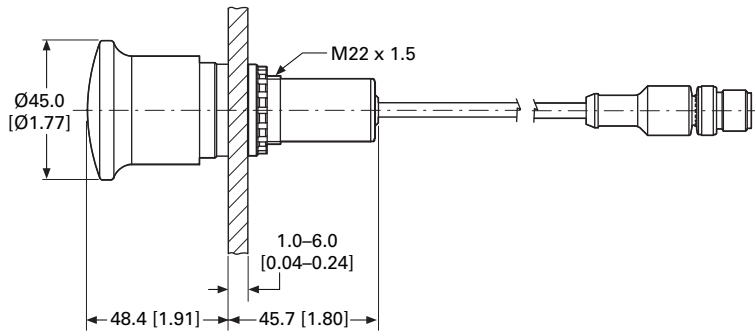

Emergency Switching Off, Underterminated Cable End, Flying Lead

C22-PVT...-P62/-P65

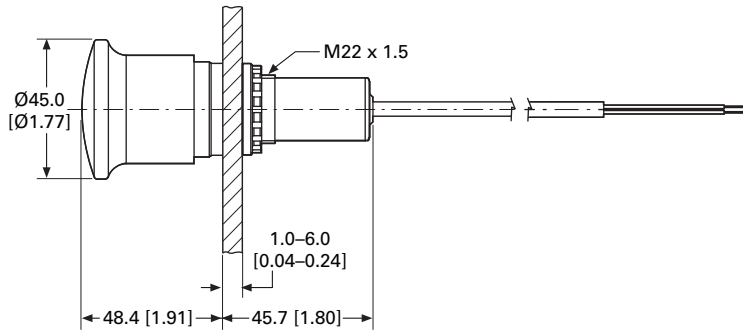

Emergency Switching Off, M12

C22-PV...-P10

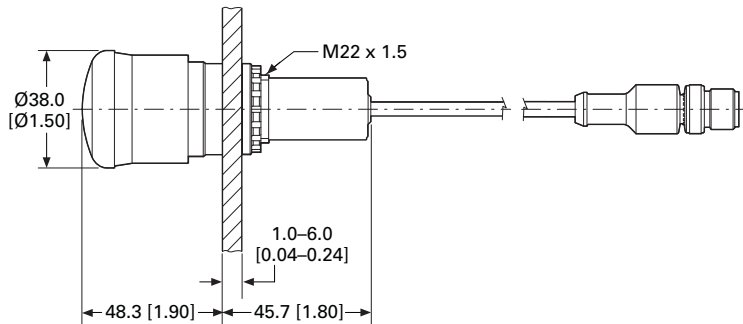

Emergency Switching Off, Underterminated Cable End, Flying Lead

C22-PV...-P62/-P65

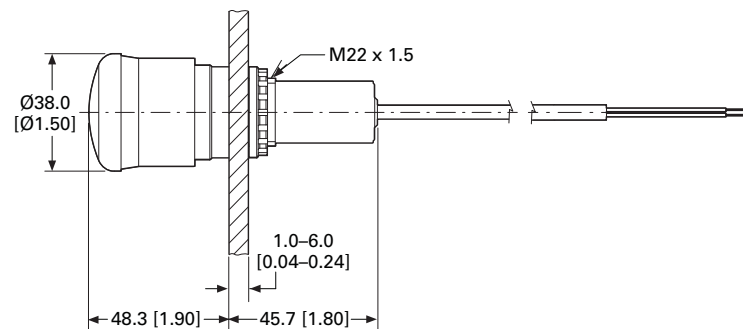

Approximate Dimensions in mm [in]

Key-Operated Buttons, M12A

C22-W(R)S(3)-MS1-...-P1/-P5

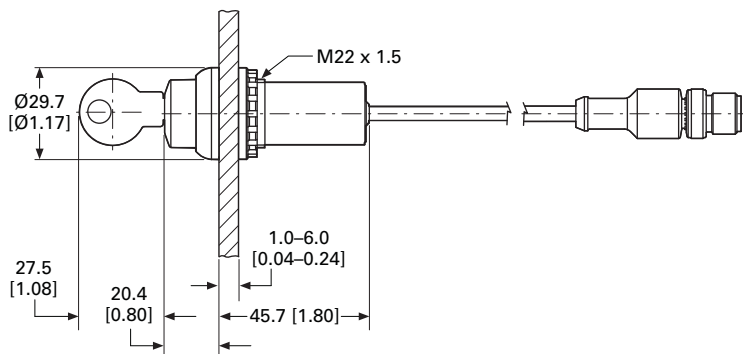

Key-Operated Buttons, M8

C22-W(R)S(3)-MS1-...-P30/-P32

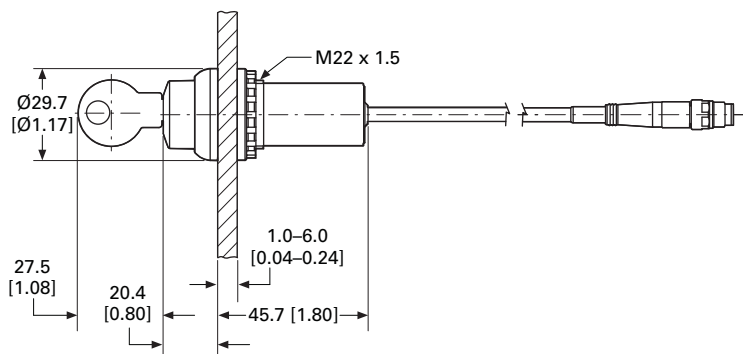

Key-Operated Buttons, Unterminated Cable End, Flying Lead

C22-W(R)S(3)-MS1-...-P62/-P65

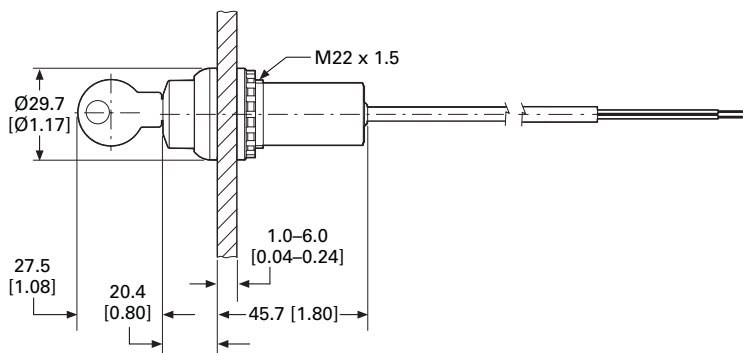



Contents

Description

Description	Page
Global Modular 30 mm Pilot Devices— M30 Flat Operators	
System Overview	V7-T1-176
Product Selection	V7-T1-178
Technical Data	V7-T1-186
Dimensions	V7-T1-189

Product Description

The new and modern M30 30 mm operators of the Global pilot devices offer a flat design and functionality while withstanding exposure to oil, dirt and water. Ability to be combined with existing traditional and flat designed M22 contact blocks and indicating lights, M30 operators provide modularity, simplicity and elegance for more demanding commercial and industrial applications.

Our new offering includes stainless steel bezel (M30I) options for extended corrosion protection along with the metal bezel (M30C) options for everyday operations.

Features

- Flat design for modern look and smooth transition between the machine and the operator
- Compatible with existing M22 contact blocks (M22-K...) and indicating lights for enhanced modularity (M22-LED...) and sustainable inventory management
- Compatible with the new M22 flat contact blocks (M22-FK...) and indicating lights for optimized footprint (M22-FLED-...)
- Stainless steel bezel (M30I) options for extended corrosion protection along with the metal bezel (M30C) options for everyday operations
- AFX mounting system for easy and secure installation
- Robust against vandalism
- Up to IP69K for increased protection
- For M30 CAD drawings, please visit the 3D drawings section under the documentation tab at www.eaton.com/m30
- Refer to Instruction Leaflet IL047019ZU for further details

Standards and Certifications

- All operators and components are IEC/EN 60947 VDE 0660
- All M30 flat operators (for enclosed type devices or flat-front surface mounted devices only) are environmentally rated as Type 1, 3R, 4X, 12 or 13 UL File #: E29184
- All operators carry an IP66 rating with some rated for washdown environments with IP67 and IP69K
- Marine classification societies: Bureau Veritas (BV), Germanischer Lloyd (GL) and Lloyd's Register of Shipping (LR) approved



M30 Flat Operators Use M22 Contact Blocks and Indicating Lights

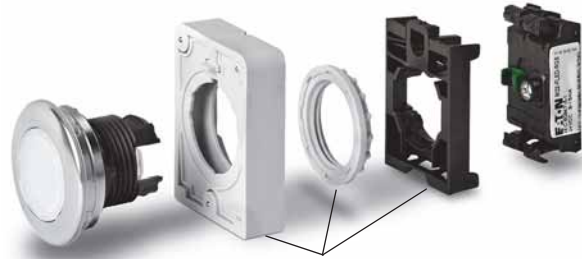

Note: When an M30 part number is ordered, the operator comes standard with the AFX mounting system, ring and adapter.

M22-LED-W



Light Units ①

Terminal Type	LED Color	Light Unit Voltage	Catalog Number
Screw	White	12–30 Vac/Vdc	M22-LED-W
	Red		M22-LED-R
	Green		M22-LED-G
	Blue		M22-LED-B
Screw	White	85–264 Vac	M22-LED230-W
	Red		M22-LED230-R
	Green		M22-LED230-G
	Blue		M22-LED230-B
Spring-cage	White	12–30 Vac/Vdc	M22-FLED-W
	Red		M22-FLED-R
	Green		M22-FLED-G
	Blue		M22-FLED-B
	Red/Green/ Yellow	24 Vdc	M22-FLED-RG ②
	Red, Green, Blue, Yellow, White, Violet, Turquoise		M22-FLED-RGB ②

M22-FLED-



M22-K10



Contact Blocks ①

Terminal Type	Contact Configuration ③	Catalog Number
Screw	NO	M22-K10
	NO, early-make	M22-K10P
	NC	M22-K01
	NC, late-break	M22-K01D
Spring-cage	NO	M22-CK10
	NC	M22-CK01
	NC, late-break	M22-CK01D
	2NO	M22-CK20
	2NC	M22-CK02
	NO-NC	M22-CK11
	NC	M22-FK01 ④
NO	M22-FK10 ④	

M22-FK01



Notes

- ① For complete listing of available light units and contact blocks, see Accessories, **Pages V7-T1-111 to V7-T1-118**.
- ② Please see color input key on **Page V7-T1-114**.
- ③ All NC contact blocks are positively driven contact. ⊖
- ④ Additional contacts may not be stacked behind M22-F type contact blocks, M22-F can be stacked behind standard M22 contacts only.

1 System Overview Global Modular 30 mm Pilot Devices—M30 Flat Operators

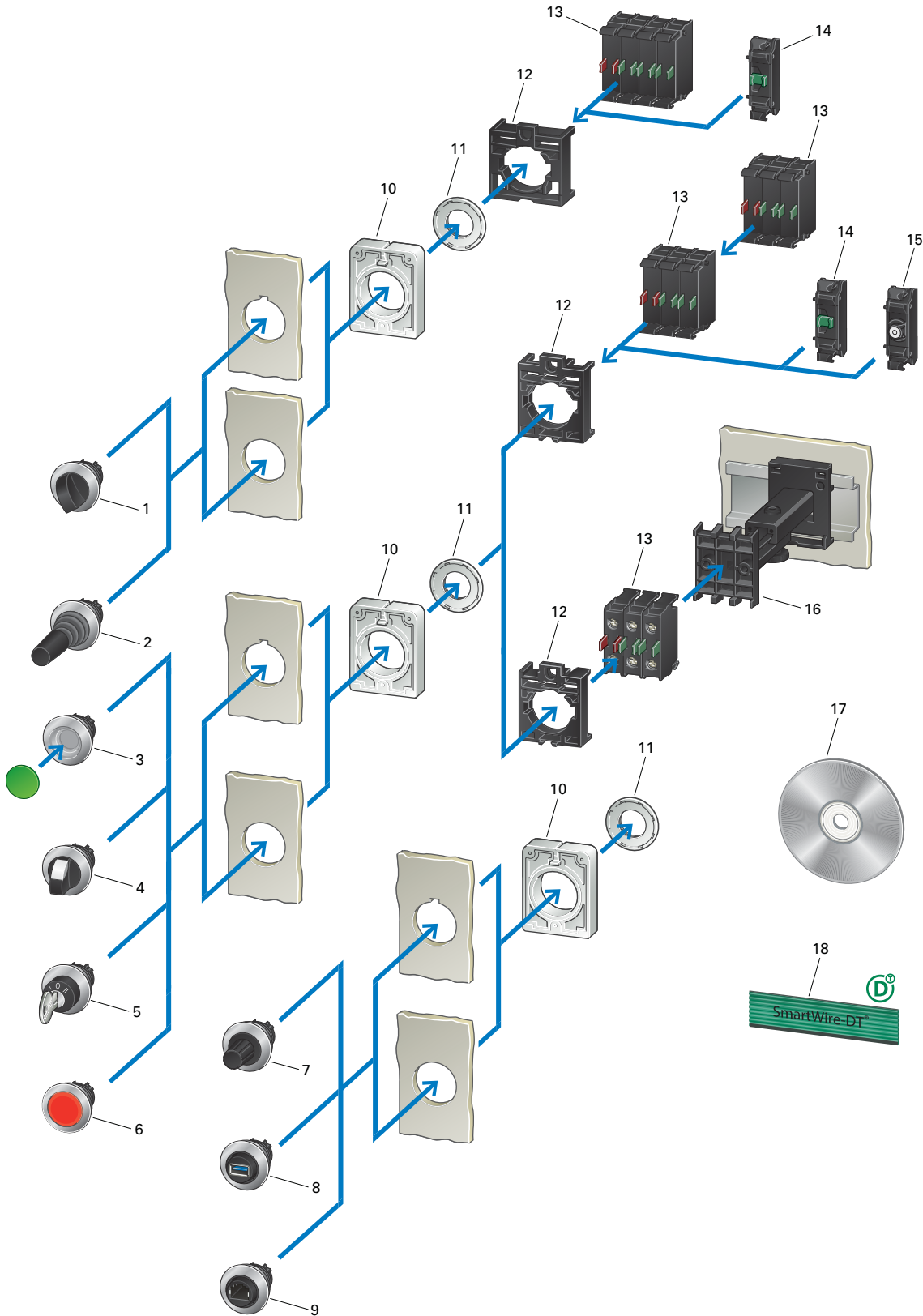

Global Modular 30 mm Pilot Devices—M30 Flat Operators (Legend)

Item	Description
1	M30 4-Way Selector Switches 4-positions With rotary head or thumb-grip 0-1-0-2-0-3-0-4 maintained action See Page V7-T1-179
2	M30 Joysticks 2- or 4-positions See Page V7-T1-183
3	M30 Pushbuttons Momentary and maintained Flush Colors: White, green, red, yellow, blue, black Illuminated pushbutton actuators Colors: White, green, red, yellow, blue, orange See Page V7-T1-178
4	M30 Selector Switches 2- and 3-positions With rotary head, thumb-grip Programmable maintained/momentary action Illuminated selector switches with transparent thumb-grip Colors: White, green, red, yellow, blue See Page V7-T1-179
5	M30 Key-Operated Buttons For individual lock mechanisms 2- or 3-positions Programmable momentary/maintained action and key withdraw Suitable for master key systems See Page V7-T1-180
6	M30 Indicator Lights Colors: White, green, red, yellow, blue, orange See Page V7-T1-183
7	SmartWire-DT Encoders, M30 Potentiometers Resistances of 1 kΩ–1 MΩ Three individual connections See Page V7-T1-185
8	M30 Panel Mount Connectors USB 3.0
9	M30 Panel Mount Connectors RJ45

Item	Description
10	Blanking Plugs See Page V7-T1-186
11	RMQ-AFX Anti-rotation tab Included with the equipment supplied with M30 front elements
12	Threaded Rings See Pages V7-T1-116 and V7-T1-117
13	Mounting Adapters For flush mounting For contact and LED elements See Page V7-T1-187
14	Traditional and flat contact blocks M30 flat operators are compatible with M22 traditional and flat contact blocks N/C and N/O Universal contacts suitable for use with electronic devices Safety function implemented with positive opening as defined in IEC/EN 60947-5-1 Traditional contact blocks: 2 levels See Page V7-T1-112
15	Traditional and flat LED indicating lights Cage clamp with push-in terminals M30 flat operators are compatible with M22 traditional and flat indicating lights See Page V7-T1-113 and V7-T1-114
16	Telescopic Clip For adjusting the depth of rear mounting devices in CI and CI-K enclosures and cabinets See Pages V7-T1-117 and V7-T1-125
17	Convenient Labeling A laser inscription with any text and/or symbol can be added to illuminated and non-illuminated pushbuttons. When ordering, specify inscription per catalog number suffix from the Symbols Library. See Pages V7-T1-129 through V7-T1-136
18	SmartWire-DT Product Characteristics <ul style="list-style-type: none"> • Clip-fit assembly modular system • Metal bezel, flus • Mounting hole diameter: 30.5 mm • Minimum grid dimension: 40 x 50 mm • Min. degree of protection: IP66 • Up to 6 contacts per mounting location • For switching differing potential • Approved throughout the world

1

















Product Selection











M30—Pushbuttons

IP67, IP69K—Metal Bezel—Flush

Front Dimensions: 36 mm Diameter

NEMA Type 1, 3R, 4X, 12 or 13

	Button Plate	Std. Pack	Catalog Number
M30C-FD- 	Momentary ①②		
		1 unit	M30C-FD-S
			M30C-FD-W
			M30C-FD-R
			M30C-FD-G
			M30C-FD-Y
			M30C-FD-B
			M30C-FD-GR
			M30C-FD-S-X0
			M30C-FD-W-X1
			M30C-FD-W-X11
			M30C-FD-R-X0
			M30C-FD-G-X1
			M30C-FD-B-X217
			M30C-FD-GR-X66
Custom		M30C-FD-ETCH ③	
M30C-FD-X	Without button plate	1 unit	M30C-FD-X
			

	Button Plate	Std. Pack	Catalog Number	
M30C-FDR-S 	Maintained ①②			
		1 unit	M30C-FDR-S	
			M30C-FDR-W	
			M30C-FDR-R	
			M30C-FDR-G	
			M30C-FDR-Y	
			M30C-FDR-B	
			M30C-FDR-S-X0	
			M30C-FDR-W-X1	
			M30C-FDR-R-X0	
			M30C-FDR-G-X1	
	Custom		M30C-FDR-ETCH ③	
	M30C-FDR-X	Without button plate	1 unit	M30C-FDR-X
				

Notes

- ① Maintained/momentary action can be changed on device.
- ② Includes contact block mounting adapter.
- ③ When ordering, specify inscription per catalog number suffix from the Symbols Library (see **Pages V7-T1-129 to V7-T1-136**).

M30—Selector Switches

IP64, Metal Bezel

Front dimensions: 36 mm diameter





















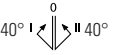

NEMA Type 1, 3R, 4X, 12 or 13

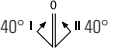
Maintained/momentary action can be changed with M22-XC-Y configuration adapters

Action

▷ = Momentary (MO)

∟ = Maintained (MA)

		Button Plate	Std. Pack	Catalog Number
With Rotary Head 	Two-Position			
	▷ 40°		1 unit	M30C-FW
	∟ 60°			M30C-FWR
		AUTO HAND 		M30C-FWR-X91
				M30C-FWR-X92
With Thumb-Grip 	▷ 40°		1 unit	M30C-FWK
	∟ 60°			M30C-FWRK
With Thumb-Grip 	∨ 60°		1 unit	M30C-FWKV
With Rotary Head 	Three-Position ①			
	40° ∟∟ 40°		1 unit	M30C-FW
	60° ∟∟ 60°			M30C-FWR3
				M30C-FWR3-X7
				M30C-FWR3-X94
With Thumb-Grip 	40° ∟∟ 40°		1 unit	M30C-FWK3
	60° ∟∟ 60°			M30C-FWRK3
	Selectable	Maintained, return from left		M30C-FWRK3-1
		 		M30C-FWRK3-2
		Maintained, return from right  		
With Rotary Head 	Four-Position ②③			
			1 unit	M30C-FWR4
With Thumb-Grip 				M30C-FWRK4

Notes

- ① With plunger bridge for middle contact.
- ② Not compatible with configuration adapters.
- ③ Use M22-A4 mounting adapter, see [Page V7-T1-186](#).

1

M30—Key-Operated Buttons

Key-Operated Buttons for Individual Lock Mechanisms

IP64, Metal Bezel

Front dimensions: 36 mm diameter

NEMA Type 1, 3R, 4X, 12 or 13

Maintained/momentary action can be changed with M22-XC-Y configuration adapters

Key withdraw can be changed with M22-XC-... configuration adapters

Action

▷ = Momentary (M0)

∨ = Maintained (MA)

Two-Position



		Lock Mechanism	Key Withdrawable at Position		Equipment Supplied	Key Code	Std. Pack	Catalog Number
Two-Position								
▷ 40°	—	0	—	—	With one key	MS1	1 unit	M30C-FWS
						MS2		M30C-FWS-MS2
						MS3		M30C-FWS-MS3
						MS4		M30C-FWS-MS4
						MS5		M30C-FWS-MS5
						MS6		M30C-FWS-MS6
						MS7		M30C-FWS-MS7
						MS8		M30C-FWS-MS8
						MS10		M30C-FWS-MS10
						∨ 60°		—
MS2	M30C-FWRS-MS2							
MS3	M30C-FWRS-MS3							
MS4	M30C-FWRS-MS4							
MS5	M30C-FWRS-MS5							
MS6	M30C-FWRS-MS6							
MS7	M30C-FWRS-MS7							
MS8	M30C-FWRS-MS8							
MS10	M30C-FWRS-MS10							
—	—	0	—	—			MS1	
						MS2	M30C-FWRS-MS2-A1	
						MS3	M30C-FWRS-MS3-A1	
						MS4	M30C-FWRS-MS4-A1	
						MS5	M30C-FWRS-MS5-A1	
						MS6	M30C-FWRS-MS6-A1	
						MS7	M30C-FWRS-MS7-A1	
						MS8	M30C-FWRS-MS8-A1	
						MS10	M30C-FWRS-MS10-A1	
						—	I	—
MS1	M30C-FWRS-RS							
∨ 60°	Ronis 455	0	—	I	With two keys	MS1	1 unit	M30C-FWRS-RS
						MS1		M30C-FWRS-RS-A1

Two-Position (Ronis 455)



IP64, Metal Bezel, continued

Front dimensions: 36 mm diameter

NEMA Type 1, 3R, 4X, 12 or 13

Maintained/momentary action can be changed with M22-XC-Y configuration adapters

Key withdraw can be changed with M22-XC-... configuration adapters

Action

▷ = Momentary (MO)

∟ = Maintained (MA)

Three-Position



Three-Position

	Lock Mechanism	Key Withdrawable at Position	Equipment Supplied	Key Code	Std. Pack	Catalog Number	
40° ∟ ∟ 40°	—	0	With one key	MS1	1 unit	M30C-FWS3	
				MS2		M30C-FWS3-MS2	
				MS3		M30C-FWS3-MS3	
				MS4		M30C-FWS3-MS4	
				MS5		M30C-FWS3-MS5	
				MS6		M30C-FWS3-MS6	
				MS7		M30C-FWS3-MS7	
				MS8		M30C-FWS3-MS8	
60° ∟ ∟ 60°	Selectable	—	Selectable	—		MS1	M30C-FWRS3-MS1-A1
						MS2	M30C-FWRS3-MS2-A1
						MS3	M30C-FWRS3-MS3-A1
						MS4	M30C-FWRS3-MS4-A1
						MS5	M30C-FWRS3-MS5-A1
						MS6	M30C-FWRS3-MS6-A1
						MS7	M30C-FWRS3-MS7-A1
						MS8	M30C-FWRS3-MS8-A1
—	—	Selectable	—			MS1	M30C-FWRS3-MS1-A2
						MS2	M30C-FWRS3-MS2-A2
						MS3	M30C-FWRS3-MS3-A2
						MS4	M30C-FWRS3-MS4-A2
						MS5	M30C-FWRS3-MS5-A2
						MS6	M30C-FWRS3-MS6-A2
						MS7	M30C-FWRS3-MS7-A2
						MS8	M30C-FWRS3-MS8-A2
—	—	Selectable	—			MS1	M30C-FWRS3-MS1-A3
						MS2	M30C-FWRS3-MS2-A3
						MS3	M30C-FWRS3-MS3-A3
						MS4	M30C-FWRS3-MS4-A3
						MS5	M30C-FWRS3-MS5-A3
						MS6	M30C-FWRS3-MS6-A3
						MS7	M30C-FWRS3-MS7-A3
						MS8	M30C-FWRS3-MS8-A3
—	—	Selectable	—			MS1	M30C-FWRS3-MS1-A4
						MS2	M30C-FWRS3-MS2-A4
						MS3	M30C-FWRS3-MS3-A4
						MS4	M30C-FWRS3-MS4-A4
						MS5	M30C-FWRS3-MS5-A4
						MS6	M30C-FWRS3-MS6-A4
						MS7	M30C-FWRS3-MS7-A4
						MS8	M30C-FWRS3-MS8-A4

IP64, Metal Bezel, continued

Front dimensions: 36 mm diameter

NEMA Type 1, 3R, 4X, 12 or 13

Maintained/momentary action can be changed with M22-XC-Y configuration adapters

Key withdraw can be changed with M22-XC-... configuration adapters

Action

▷ = Momentary (MO)

◁ = Maintained (MA)

Three-Position



Three-Position, continued

	Lock Mechanism	Key Withdrawable at Position	Equipment Supplied	Key Code	Std. Pack	Catalog Number	
60° ↓ 60°	Selectable	—	Selectable	—	With one key	MS1	
						MS2	
						MS3	
						MS4	
						MS5	
						MS6	
						MS7	
						MS8	
	—	—	Selectable	—		1 unit	M30C-FWRS3-MS1-A5
							M30C-FWRS3-MS2-A5
							M30C-FWRS3-MS3-A5
							M30C-FWRS3-MS4-A5
							M30C-FWRS3-MS5-A5
							M30C-FWRS3-MS6-A5
							M30C-FWRS3-MS7-A5
							M30C-FWRS3-MS8-A5
60° ↓ 60°	—	—	Selectable	—		MS1	
						MS2	
						MS3	
						MS4	
						MS5	
						MS6	
						MS7	
						MS8	
	—	—	Selectable	—		1 unit	M30C-FWRS3-MS1-A6
							M30C-FWRS3-MS2-A6
							M30C-FWRS3-MS3-A6
							M30C-FWRS3-MS4-A6
							M30C-FWRS3-MS5-A6
							M30C-FWRS3-MS6-A6
							M30C-FWRS3-MS7-A6
							M30C-FWRS3-MS8-A6
60° ↓ 60°	—	—	Selectable	—		MS1	
						MS2	
						MS3	
						MS4	
						MS5	
						MS6	
						MS7	
						MS8	
	—	—	Selectable	—		1 unit	M30C-FWRS3-MS1-A7
							M30C-FWRS3-MS2-A7
							M30C-FWRS3-MS3-A7
							M30C-FWRS3-MS4-A7
							M30C-FWRS3-MS5-A7
							M30C-FWRS3-MS6-A7
							M30C-FWRS3-MS7-A7
							M30C-FWRS3-MS8-A7

Three-Position (Ronis 455)



60° ↓ 60°	Ronis 455	0	—	—	With two keys	—	1 unit	M30C-FWRS3-RS
						—		M30C-FWRS3-RS-A1

Two- or Three-Position



Two- or Three-Position							
60° ↓ 60°	—	—	Selectable	—	With two keys	MS1	
						MS2	
						MS3	
						MS4	
						MS5	
						MS6	
						MS7	
						MS10	
						1 unit	M30C-FWRS3-A1
							M30C-FWRS3-A2
	M30C-FWRS3-A3						
	M30C-FWRS3-A4						
	M30C-FWRS3-A5						
	M30C-FWRS3-A6						
	M30C-FWRS3-A7						
	M30C-FWRS3-A10						

M30—Joysticks, Indicator Lights and Illuminated Operators

Joystick



Joysticks—IP66, Metal Bezel

With one operating point per operating direction
 NEMA Type 1, 3R, 4X, 12 or 13
 With metal shaft
 Front dimensions: 36 mm diameter

Description	Action		Std. Pack	Catalog Number
	—	⏏		
Two-position	—	⏏	1 unit	M30C-FWRJS2H
Three-position	—	⏏		M30C-FWRJS2V
Four-position	—	⏏		M30C-FWJS4

Indicator Lights



Indicator Lights—IP67, Metal Bezel

Front dimensions: 36 mm diameter
 NEMA Type 1, 3R, 4X, 12 or 13

Lens	Std. Pack	Catalog Number
○	1 unit	M30C-FL-W
●		M30C-FL-R
●		M30C-FL-G
●		M30C-FL-Y
●		M30C-FL-B
●		M30C-FL-A

Illuminated Pushbuttons

IP67, IP69K, Metal Bezel, Flush

Front dimensions: 36 mm diameter
 NEMA Type 1, 3R, 4X, 12 or 13

	Button Plate	Std. Pack	Catalog Number
Momentary 	○	1 unit	M30C-FDL-W
	●		M30C-FDL-R
	●		M30C-FDL-G
	●		M30C-FDL-Y
	●		M30C-FDL-B
	●		M30C-FDL-A
	⊙		M30C-FDL-W-X0
	⊏		M30C-FDL-W-X1
	◇		M30C-FDL-W-X100
	⊙		M30C-FDL-R-X0
	⊏		M30C-FDL-G-X1
	⊏		M30C-FDL-G-X32
	⊏		M30C-FDL-Y-X162
	Custom		M30C-FDL-ETCH ①
	Momentary 	Without button plate	1 unit

IP67, IP69K, Metal Bezel, Flush

Front dimensions: 36 mm diameter
 NEMA Type 1, 3R, 4X, 12 or 13

	Button Plate	Std. Pack	Catalog Number	
Maintained 	○	1 unit	M30C-FDRL-W	
	●		M30C-FDRL-R	
	●		M30C-FDRL-G	
	●		M30C-FDRL-Y	
	●		M30C-FDRL-B	
	●		M30C-FDRL-A	
	⊙		M30C-FDRL-W-X0	
	⊏		M30C-FDRL-W-X1	
	⊙		M30C-FDRL-R-X0	
	⊏		M30C-FDRL-G-X1	
	Custom		M30C-FDRL-ETCH ①	
	Maintained 	Without button plate	1 unit	M30C-FDRL-X

Note

① When ordering, specify inscription per catalog number suffix from the Symbols Library (see Pages V7-T1-129 to V7-T1-136).

1

Illuminated Selector Switches

IP64, Metal Bezel, with Thumb-Grip

Front dimensions: 36 mm diameter
 NEMA Type 1, 3R, 4X, 12 or 13
 Maintained/momentary action can be changed with M22-XC-Y configuration adapters

Action

▷ = Momentary (MO)

∨ = Maintained (MA)

Momentary



Two-Position

Action	Angle	Button Plate	Std. Pack	Catalog Number
▷ 40°	40°	○	1 unit	M30C-FWLK-W
		●		M30C-FWLK-R
		●		M30C-FWLK-G
		●		M30C-FWLK-Y
		●		M30C-FWLK-B
∨ 60°	60°	○	1 unit	M30C-FWRLK-W
		●		M30C-FWRLK-R
		●		M30C-FWRLK-G
		●		M30C-FWRLK-Y
		●		M30C-FWRLK-B

Momentary



Two-Position (V-Configuration)

Action	Angle	Button Plate	Std. Pack	Catalog Number
∨ 60°	60°	○	1 unit	M30C-FWLKV-W
		●		M30C-FWLKV-R
		●		M30C-FWLKV-G
		●		M30C-FWLKV-Y
		●		M30C-FWLKV-B

IP64, Metal Bezel, with Thumb-Grip

Front dimensions: 36 mm diameter
 NEMA Type 1, 3R, 4X, 12 or 13
 Maintained/momentary action can be changed with M22-XC-Y configuration adapters

Action

▷ = Momentary (MO)

∨ = Maintained (MA)

Momentary



Three-Position

Action	Angle	Button Plate	Std. Pack	Catalog Number
▷ 40°	40°	○	1 unit	M30C-FWLK3-W
		●		M30C-FWLK3-R
		●		M30C-FWLK3-G
		●		M30C-FWLK3-Y
		●		M30C-FWLK3-B
∨ 60°	60°	○	1 unit	M30C-FWRLK3-W
		●		M30C-FWRLK3-R
		●		M30C-FWRLK3-G
		●		M30C-FWRLK3-Y
		●		M30C-FWRLK3-B
Maintained, return from left	40°	○	1 unit	M30C-FWRLK3-1-W
		●		M30C-FWRLK3-1-R
		●		M30C-FWRLK3-1-G
		●		M30C-FWRLK3-1-Y
		●		M30C-FWRLK3-1-B
Maintained, return from right	40°	○	1 unit	M30C-FWRLK3-2-W
		●		M30C-FWRLK3-2-R
		●		M30C-FWRLK3-2-G
		●		M30C-FWRLK3-2-Y
		●		M30C-FWRLK3-2-B

Potentiometers

IP66, Metal Bezel Potentiometer

Three individual screw connections

NEMA Type 1, 3R, 4X, 12 or 13

Resistance accuracy: $\pm 10\%$ (linear) / Rated power $P = 0.5\text{ W}$

Potentiometer



Resistance (R) kOhm	Scale/Inscription	Contact Sequence	Std. Pack	Catalog Number
1	Standard scale/inscription		1 unit	M30C-FR1K
4.7				M30C-FR4K7
10				M30C-FR10K
47				M30C-FR47K
100				M30C-FR100K
470				M30C-FR470K
2.2				M30C-FR2K2
22				M30C-FR22K
1000				M30C-FR1M
1				Without scale/inscription
2.2	M30C-FR2K2-BLANK			
4.7	M30C-FR4K7-BLANK			
10	M30C-FR10K-BLANK			
22	M30C-FR22K-BLANK			
47	M30C-FR47K-BLANK			
100	M30C-FR100K-BLANK			
470	M30C-FR470K-BLANK			
1000	M30C-FR1M-BLANK			

IP65, SmartWire-DT Potentiometer

Only in conjunction with M22-SWD-R function element

NEMA Type 1, 3R, 4X, 12 or 13

M22-R-SWD



Bezel	Contact Sequence	Std. Pack	Catalog Number
Silver bezel (M22)		1 unit	M22-R-SWD
Metal bezel (flat front)		1 unit	M30C-FR-SWD

IP65, SmartWire-DT Encoders

With actuation function

NEMA Type 1, 3R, 4X, 12 or 13

Only in conjunction with M22-SWD-INC function element

M30C-FINC-SWD









Bezel	Contact Sequence	Std. Pack	Catalog Number
Silver bezel (M22)	—	1 unit	M22-INC-SWD
Metal bezel (flat front)	—	1 unit	M30C-FINC-SWD

Blanking Plugs

Round design, IP67, IP69K

For sealing spare mounting locations

	For use with ...	Color	Std. Pack	Catalog Number
	M22		50 units	M22-B216388
			250 units	M22-B-GVP216389
			50 units	M22S-B216390
			250 units	M22S-B-GVP216391
	M30		1 unit	M30C-FB187028

Technical Data**Global Modular 30 mm Pilot Devices**

Description	Unit	Contact Elements		Double Contact Elements	LED Elements	M22-FLED...	(Illuminated) Pushbuttons, Mushroom Pushbuttons	
		M22-(C)K...	M22-FK...	M22-CK20/02/11	M22(C)-LED...		Momentary	Maintained
General								
Standards		IEC/EN 60947-5-1	—	IEC/EN 60947-5-1	IEC/EN 60947-5-1	—	EC/EN 60947-5-1	—
Lifespan, mechanical (operations)	x 10 ⁶	5	1	—	—	—	5	1
Operating frequency (operations)	h	≤ 3600	≤ 3600	≤ 3600	—	—	≤ 3600	≤ 1800
Operating force	N	5	4.5	10	—	—	5	5
Operating torque (screw terminals)	Nm	0.8	—	—	0.8	—	—	—
Degree of protection (IEC/EN 60529)		IP20	IP20	IP20	IP20	IP20	IP67, IP69K	IP67, IP69K
Climatic proofing		Damp heat, constant as defined in IEC 60068-2-7; Damp heat, cyclic as defined in IEC 60068-2-3						
Ambient air temperature, open	°C	-25 to +70	-25 to +70	-25 to +70	-25 to +70	-25 to +70	-25 to +70	-25 to +70
Mounting position		Any	Any	Any	Any	Any	Any	Any
Mechanical shock resistance as defined in IEC 60068-2-27 Shock duration: 11 ms, half sine shock	g	30	50	30	30	50	M22: 30 M30: 15	M22: 30 M30: 15
Terminal capacities								
Solid	mm ²	0.75–2.5	2 x 1 (0.2–1.5) 2 x 1 (0.75–1.5) ^①	0.5–1.5	0.75–2.5	1 x 1 (0.2–1.5) 1 x 1 (0.75–1.5) ^①	—	—
Stranded	mm ²	0.5–2.5	—	0.5–1.5	0.5–2.5	1 x 1 (0.2–1.5)	—	—
Flexible with ferrule	mm ²	0.5–1.5	2 x 1 (0.25–1) ^②	0.5–1.5	—	1 x 1 (0.25–1) ^②	—	—

Notes^① Can be plugged without tools.^② Use WAGO Variocrimp 4 crimping tool; please enquire for others.

Global Modular 30 mm Pilot Devices, continued

Description	Unit	Contact Elements		Double Contact	LED Elements	(Illuminated) Pushbuttons, Mushroom Pushbuttons		
		M22-(C)K...	M22-FK...	Elements M22-CK20/02/11	M22(C)-LED...	M22-FLED...	Momentary	Maintained
Contacts								
Rated impulse withstand voltage (U_{imp})	Vac	6000	4000	—	6000	4000	—	—
Rated insulation voltage (U_i)	V	500	250	—	500	250	—	—
Overtoltage category/ degree of pollution		III/3	III/3	—	III/3	III/3	—	—
Control circuit reliability								
At 24 Vdc/5 mA (failure rate)	H _F	< 10 ⁻⁷ ①	—	—	—	—	—	—
At 5 Vdc/1 mA (failure rate)	H _F	< 5 x 10 ⁻⁶ ②	—	—	—	—	—	—
Max. short-circuit protective device								
Fuseless (part no.)	A	PKZM0-10/FAZ-B6/1	FAZ-B4	—	—	—	—	—
Fuse (gG/gL)		10	4	—	—	—	—	—
Switching Capacity								
Rated operational current								
AC-15: 24 V I _e	A	—	4	—	—	—	—	—
60 V I _e	A	—	4	—	—	—	—	—
100 V I _e	A	—	2	—	—	—	—	—
115 V I _e	A	6	—	—	—	—	—	—
230 V I _e	A	6	1.5	—	—	—	—	—
400 V I _e	A	4	—	—	—	—	—	—
500 V I _e	A	2	—	—	—	—	—	—
DC-13: 24 V I _e	A	3	1.5	—	—	—	—	—
42 V I _e	A	1.7	—	—	—	—	—	—
60 V I _e	A	1.2	0.8	—	—	—	—	—
110 V I _e	A	0.6 (M22-CK...: 0.8)	0.4	—	—	—	—	—
220 V I _e	A	0.3	0.2	—	—	—	—	—
Lifespan, electrical								
AC-15: 230 V/0.5 A (operations)	x 10 ⁶	1.6	—	—	—	—	—	—
230 V/1.0 A (operations)	x 10 ⁶	1	—	—	—	—	—	—
230 V/3.0 A (operations)	x 10 ⁶	0.7	—	—	—	—	—	—
DC-15: 12 V/2.8 A (operations)	x 10 ⁶	1.2	—	—	—	—	—	—

Notes

- ① < 10⁻⁷ (i.e., one failure every 107 operations).
- ② < 5 x 10⁻⁶ (i.e., one failure every 5 x 106 operations).

Global Modular 30 mm Pilot Devices, continued

Description	Unit	Double Actuator Pushbuttons	(Illuminated) Selector Switches	Joysticks	Key-Operated Buttons	Indicator Lights Acoustic Devices Potentiometers	Controlled Stop/Emergency Stop
General							
Standards		IEC/EN 60947-5-1	IEC/EN 60947-5-1	IEC/EN 60947-5-1	IEC/EN 60947-5-1	IEC/EN 60947-5-1	IEC/EN 60947-5-5
Lifespan, mechanical (operations)	x 10 ⁶	0.2	0.1	0.1	0.1	—	0.1
Operating frequency (operations)	h	≤ 3600	≤ 2000	≤ 2000	≤ 100	—	≤ 600
Operating force	N	5	—	5	—	—	50
Operating torque (screw terminals)	Nm	—	0.3	—	0.5	—	—
Degree of protection (IEC/EN 60529)		IP66	M22: IP66 M30: IP64	IP66	M22: IP66 M30: IP64	Indicator lights: IP67 Acoustic devices: IP40 Potentiometers: IP66	IP67, IP69K
Climatic proofing		Damp heat, constant as defined in IEC 60068-2-7; Damp heat, cyclic as defined in IEC 60068-2-3					
Ambient air temperature, open	°C	–25 to +70	–25 to +70	–25 to +70	–25 to +70	–25 to +70	–25 to +70
Mounting position		Any	Any	Any	Any	Any	Any
Mechanical shock resistance as defined in IEC 60068-2-27 Shock duration: 11 ms, half sine shock	g	30	M22: 30 M30: 15	M22: 30 M30: 15	M22: 30 M30: 15	M22: 30 M30: —	50
Terminal capacities							
Solid	mm ²	—	—	—	—	0.5–1.5	—
Stranded	mm ²	—	—	—	—	0.5–1.5	—
Flexible with ferrule	mm ²	—	—	—	—	—	—
Contacts							
Rated impulse withstand voltage (U _{imp})	Vac	—	—	—	—	4000	—
Rated insulation voltage (U _i)	V	—	—	—	—	250	—
Overvoltage category/degree of pollution		—	—	—	—	III/3	—
Control circuit reliability							
At 24 Vdc/5 mA (failure rate)	H _f	—	—	—	—	—	—
At 5 Vdc/1 mA (failure rate)	H _f	—	—	—	—	—	—
Max. short-circuit protective device							
Fuseless (part no.)	A	—	—	—	—	—	—
Fuse (gG/gL)		—	—	—	—	—	—
Switching Capacity							
	A	N/A	N/A	N/A	N/A	N/A	N/A

Dimensions

Approximate Dimensions in mm [inches]

M30... with 2 M22-K... Standard Contact Elements

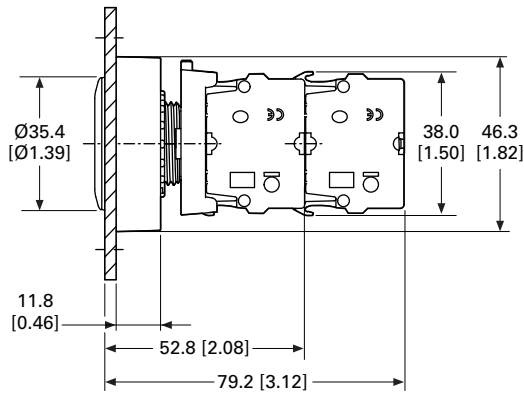

M30... with M22-FK... Flat Rear Contact Elements

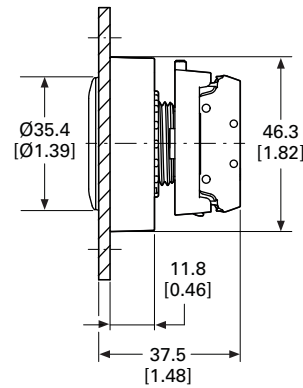

Pushbuttons, Blanking Plug

M30C-FD..., M30C-FB

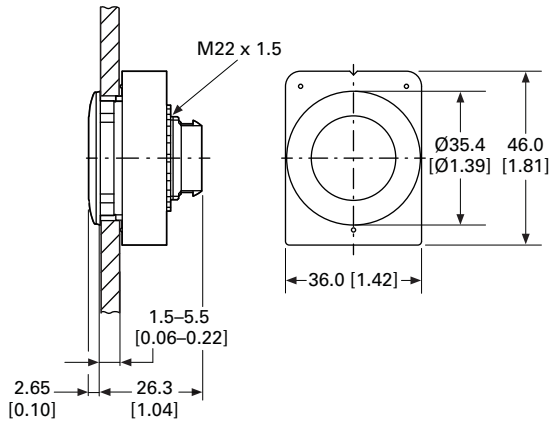

Indicator Lights

M30C-FL...

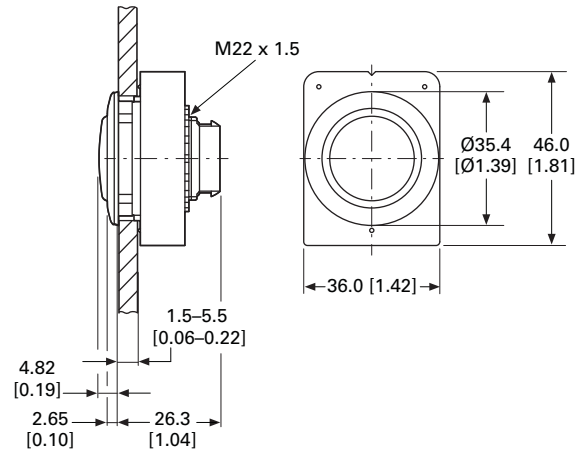

Selector Switches

With Rotary Head M30C-FW...

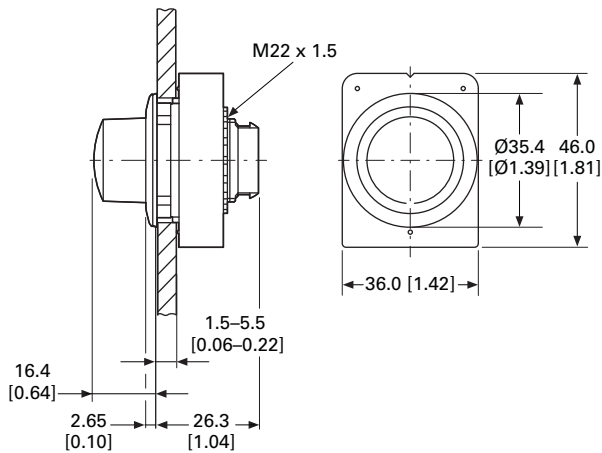

Illuminated Selector Switches

With Thumb-Grip, Four-Way M30C-FW(L)K(V)-...

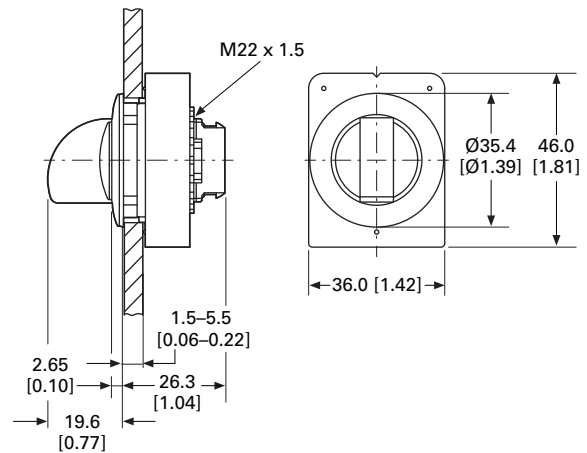

1.7

Pushbuttons and Indicating Lights

Global Modular 30 mm Pilot Devices—M30 Flat Operators

1

Approximate Dimensions in mm [inches]

Key-Operated Buttons

M30C-FW(R)S(3)-MS...

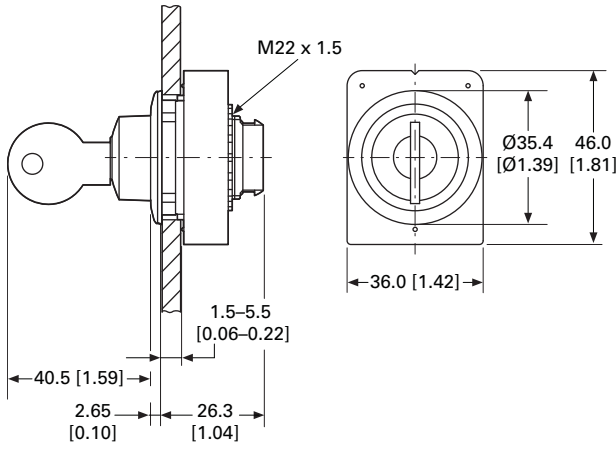

Key-Operated Buttons

M30C-FW(R)S(3)-RS...

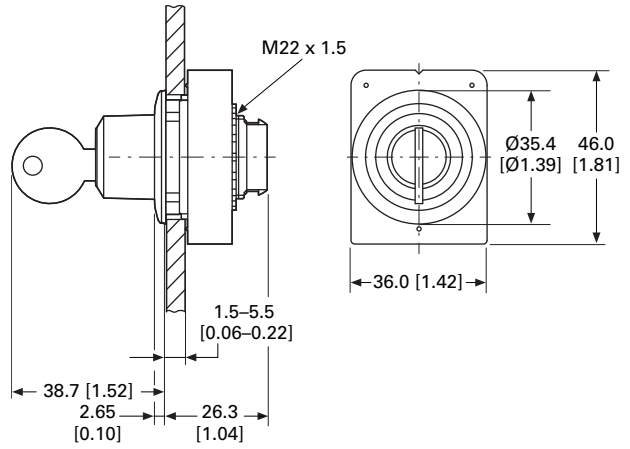

Key-Operated Buttons

M30C-FW(R)S(3)-SA...

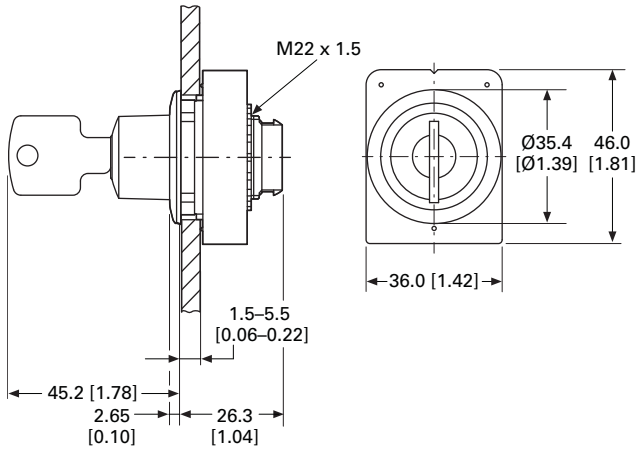

Potentiometers

M30C-FR...

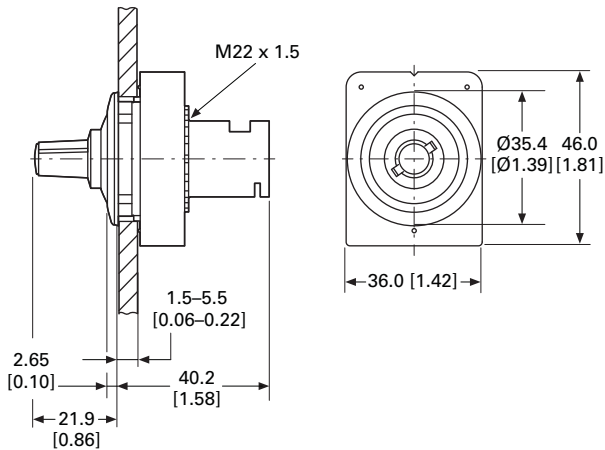

Potentiometers, SmartWire-DT

M30C-FR-SWD

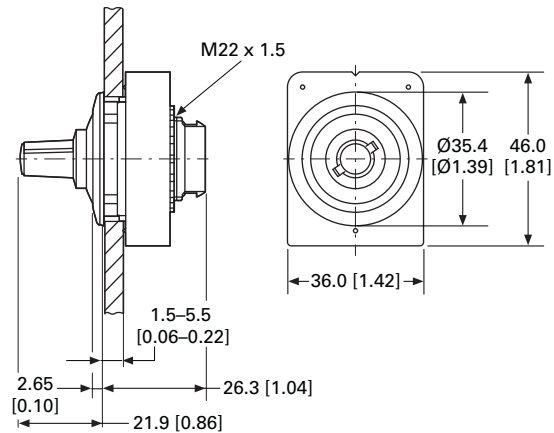

Approximate Dimensions in mm [inches]

Encoders, SmartWire-DT

M30C-FINC-SWD

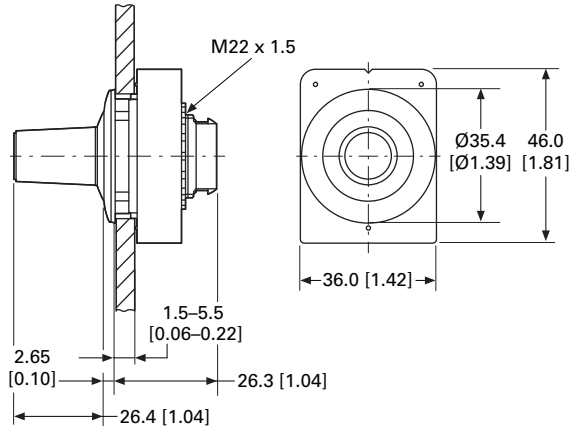

Joysticks

M30C-FW(R)JS...

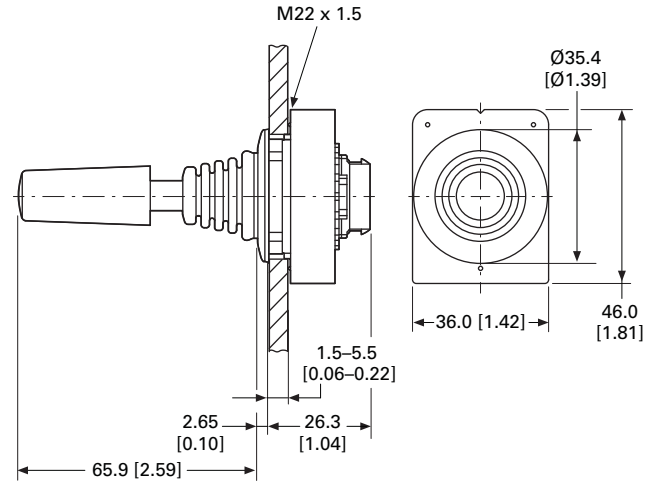

Mounting hole without key slot

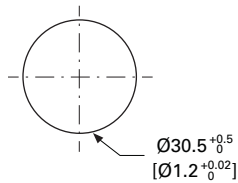

Mounting hole with key slot

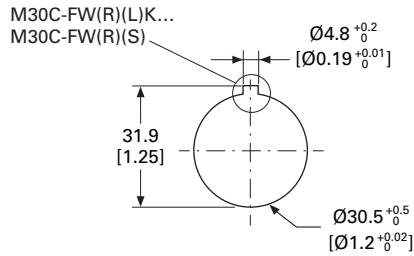

Grid dimensions for various combinations

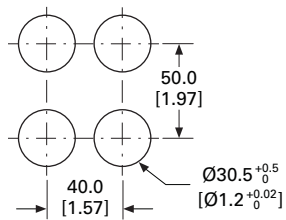

Global Compact 30 mm Pilot Devices —C30 Flat with Pigtail



Contents

Description

Page

Global Compact 30 mm Pilot Devices— C30 Flat with Pigtail	
System Overview	V7-T1-193
Product Selection	V7-T1-194
Technical Data	V7-T1-198
Dimensions	V7-T1-199

Product Description

The new and modern all-in-one C30 compact and flat 30 mm pilot devices with pigtail integrate the required cable, connector and housing in one single device.

Ability to provide protection up to IP69K at the front and IP65 at the back make these devices the perfect choice for applications where oil-tight protection from dirt and liquid is a must.

Features

Our product offering includes momentary and maintained operators; illuminated and non-illuminated pushbuttons; illuminated and non-illuminated selector switches and indicating lights. C30 pilot devices come with the following pigtail options:

- P5 for 1 m cable with M12
- P32 for 1 m cable with M8
- P62 for 1 m cable with open wire
- P65 for 3.5 m

C30 compact and flat with pigtail 30 mm pilot devices offer modern look and smooth transition between the machine and the operator.

The cable, plug connector and housing are already integrated and permanently installed for plug and play.

C30 pilot devices are also fully assembled for easy stocking and sustainable inventory management.

Standards and Certifications

- All operators and components are IEC/EN 60947 VDE 0660
- All C30 flat operators (for enclosed type devices or flat-front surface mounted devices only) are environmentally rated as Type 1, 3R, 4X, 12 or 13 UL File #: E29184
- All operators carry an IP66 rating with some rated for washdown environments with IP67 and IP69K
- Marine classification societies: Bureau Veritas (BV), Germanischer Lloyd (GL) and Lloyd's Register of Shipping (LR) approved



System Overview

Global Compact 30 mm Pilot Devices—C30 Flat with Pigtail

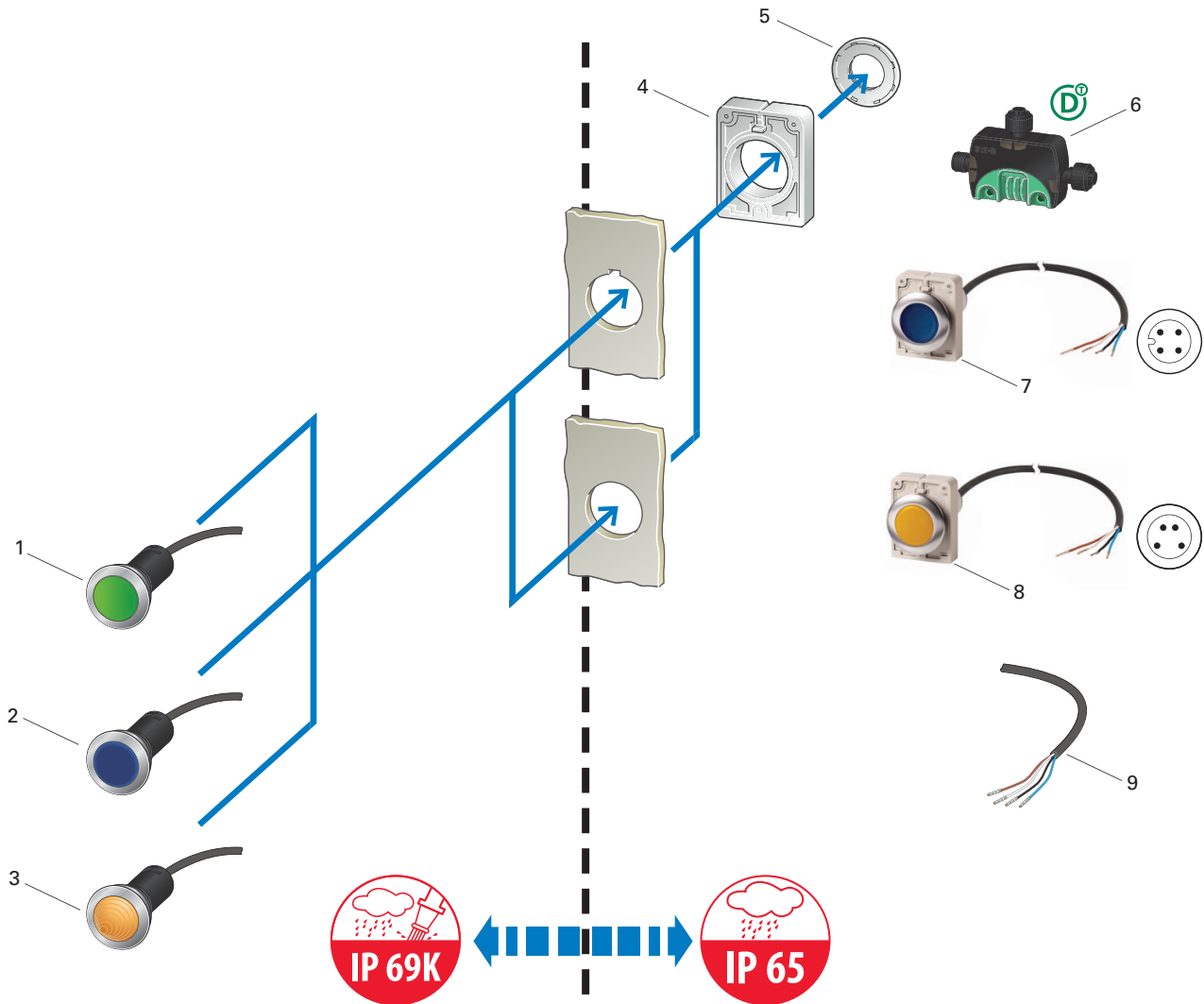

Global Compact 30 mm Pilot Devices—C30 Flat with Pigtail (Legend)

Item	Description
1	C30 Pushbuttons Momentary and maintained Flush Colors: white, green, red, black With cable (1.5 or 3 m) and plug (M12A or M8, 4-pole) or unterminated cable end (4-pole) See Page V7-T1-194
2	C30 Illuminated Pushbutton Actuators Momentary and maintained Flush Colors: white, green, red, blue With cable (1.5 or 3 m) and plug (M12A or M8, 4-pole) or unterminated cable end (4-pole) 24 Vac/Vdc See Page V7-T1-197

Item	Description
3	C30 Indicator Lights Flush Colors: white, green, red, blue, yellow With cable (1.5 or 3 m) and plug (M12A or M8, 4-pole) or unterminated cable end (4-pole) 24 Vac/Vdc See Page V7-T1-196
4	RMQ-AFX Anti-Rotation Tab Included with C30 compact devices
5	Threaded Rings See Page V7-T1-116

Item	Description
6	SmartWire-DT I/O Module For connecting digital input/output signals to SmartWire-DT IP67
7	Cable with M12A Plug, 4-Pole
8	Cable with M8A Plug, 4-Pole
9	Cable End Open, 4-Pole

1













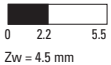



Product Selection

Pushbuttons

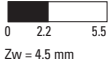
30 mm Flat Front—Metal Bezel

IP66, IP67, IP69K (at front), IP65 (at rear)

Flush

Cable Length (m)	Button Plate	Contact Configuration ①		Contact Sequence ②	Contact Diagram	Std. Pack	Momentary Catalog Number	Maintained Catalog Number
		NO = Normally Open Contact	NC = Normally Closed Contact					
1		—	1NC ⊖			1 Unit	C30C-FD-R-K01-P5	C30C-FDR-R-K01-P5
		—	1NC ⊖				C30C-FD-S-K01-P5	C30C-FDR-S-K01-P5
	Without button plate	—	1NC ⊖				C30C-FD-X-K01-P5	C30C-FDR-X-K01-P5
1		1NO	—			1 Unit	C30C-FD-G-K10-P5	C30C-FDR-G-K10-P5
		1NO	—				C30C-FD-W-K10-P5	C30C-FDR-W-K10-P5
	Without button plate	1NO	—				C30C-FD-X-K10-P5	C30C-FDR-X-K10-P5
1		—	1NC ⊖			1 Unit	C30C-FD-R-K01-P32	C30C-FDR-R-K01-P32
		—	1NC ⊖				C30C-FD-S-K01-P32	C30C-FDR-S-K01-P32
	Without button plate	—	1NC ⊖				C30C-FD-X-K01-P32	C30C-FDR-X-K01-P32
1		1NO	—			1 Unit	C30C-FD-G-K10-P32	C30C-FDR-G-K10-P32
		1NO	—				C30C-FD-W-K10-P32	C30C-FDR-W-K10-P32
	Without button plate	1NO	—				C30C-FD-X-K10-P32	C30C-FDR-X-K10-P32

Notes













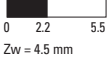

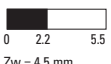

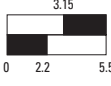

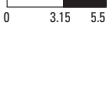





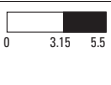

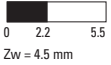

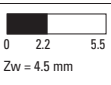



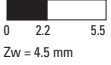

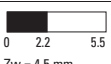

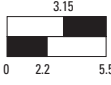

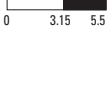
① ⊖ = Safety function implemented with positive opening as defined in IEC/EN 60947-5-1.

② Contact sequence: ■ = contact closed; □ = contact open.

30 mm Flat Front—Metal Bezel, continued

IP66, IP67, IP69K (at front), IP65 (at rear)
Flush

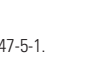

Cable Length (m)	Button Plate	Contact Configuration ①		Contact Sequence ②	Contact Diagram	Std. Pack	Momentary Catalog Number	Maintained Catalog Number		
		NO = Normally Open Contact	NC = Normally Closed Contact							
1	  Without button plate	—	1NC ⊕			1 Unit	C30C-FD-R-K01-P62	C30C-FDR-R-K01-P62		
			2NC ⊕				C30C-FD-S-K01-P62	C30C-FDR-S-K01-P62		
		1NO	1NC ⊕			C30C-FD-X-K01-P62	C30C-FDR-X-K01-P62			
			2NC ⊕			C30C-FD-X-K02-P62	C30C-FDR-X-K02-P62			
		  Without button plate	1NO	—			1 Unit	C30C-FD-G-K10-P62	C30C-FDR-G-K10-P62	
				2NO				C30C-FD-W-K10-P62	C30C-FDR-W-K10-P62	
	1NO		—			C30C-FD-X-K10-P62	C30C-FDR-X-K10-P62			
			2NO			C30C-FD-X-K20-P62	C30C-FDR-X-K20-P62			
	3.5		  Without button plate	—	1NC ⊕			1 Unit	C30C-FD-R-K01-P65	C30C-FDR-R-K01-P65
					2NC ⊕				C30C-FD-S-K01-P65	C30C-FDR-S-K01-P65
		1NO		1NC ⊕			C30C-FD-X-K01-P65	C30C-FDR-X-K01-P65		
				2NC ⊕			C30C-FD-X-K02-P65	C30C-FDR-X-K02-P65		
  Without button plate		1NO		—			1 Unit	C30C-FD-G-K10-P65	C30C-FDR-G-K10-P65	
				2NO				C30C-FD-W-K10-P65	C30C-FDR-W-K10-P65	
		1NO	—			C30C-FD-X-K10-P65	C30C-FDR-X-K10-P65			
			2NO			C30C-FD-X-K20-P65	C30C-FDR-X-K20-P65			

Notes















































- ① ⊕ = Safety function implemented with positive opening as defined in IEC/EN 60947-5-1.
- ② Contact sequence: ■ = contact closed; □ = contact open.

1

Indicating Lights

30 mm Flat Front—Metal Bezel





LED Rated Operating Voltage: 24 Vac/Vdc
IP66, IP67, IP69K (at Front), IP65 (at Rear)

	Connection Type	Cable Length (m)	Lens	LED	Contact Sequence	Std. Pack	Catalog Number	
	Cable (Black) with M12A Plug 4-Pole	1				1 Unit	C30C-FL-B-24-P5	
							C30C-FL-G-24-P5	
							C30C-FL-R-24-P5	
							C30C-FL-W-24-P5	
							C30C-FL-Y-24-P5	
	Cable (Black) with M8 Plug 4-Pole	1				1 Unit	C30C-FL-B-24-P32	
							C30C-FL-G-24-P32	
							C30C-FL-R-24-P32	
							C30C-FL-W-24-P32	
							C30C-FL-Y-24-P32	
	Cable (Black) with Untermated End 4-Pole	1				1 Unit	C30C-FL-B-24-P62	
							C30C-FL-G-24-P62	
							C30C-FL-R-24-P62	
							C30C-FL-W-24-P62	
							C30C-FL-Y-24-P62	
			3.5				1 Unit	C30C-FL-B-24-P65
								C30C-FL-G-24-P65
								C30C-FL-R-24-P65
								C30C-FL-W-24-P65
								C30C-FL-Y-24-P65

Illuminated Pushbutton Actuators

30 mm Flat Front—Metal Bezel

LED Rated Operating Voltage: 24 Vac/Vdc
 IP66, IP67, IP69K (at Front), IP65 (at Rear)
 Flush

Cable Length (m)	Button Plate	LED	Contact Configuration ①		Contact Sequence ②	Contact Diagram	Std. Pack	Momentary Catalog Number	Maintained Catalog Number
			NO = Normally Open Contact	NC = Normally Closed Contact					
1 	●	●	—	1NC ⊖			1	C30C-FDL-RK01-24P5	C30C-FDRL-RK01-24P5
	●	●	1NO	—				C30C-FDL-BK10-24P5	C30C-FDRL-BK10-24P5
	●	●						C30C-FDL-GK10-24P5	C30C-FDRL-GK10-24P5
	○	○						C30C-FDL-WK10-24P5	C30C-FDRL-WK10-24P5
1 	●	●	—	1NC ⊖			1	C30C-FDL-RK01-24P32	C30C-FDRL-RK01-24P32
	●	●	1NO	—				C30C-FDL-BK10-24P32	C30C-FDRL-BK10-24P32
	●	●						C30C-FDL-GK10-24P32	C30C-FDRL-GK10-24P32
	○	○						C30C-FDL-WK10-24P32	C30C-FDRL-WK10-24P32
1 	●	●	—	1NC ⊖			1	C30C-FDL-RK01-24P62	C30C-FDRL-RK01-24P62
	●	●	1NO	—				C30C-FDL-BK10-24P62	C30C-FDRL-BK10-24P62
	●	●						C30C-FDL-GK10-24P62	C30C-FDRL-GK10-24P62
	○	○						C30C-FDL-WK10-24P62	C30C-FDRL-WK10-24P62
1 	●	●	—	1NC ⊖			1	C30C-FDL-RK01-24P65	C30C-FDRL-RK01-24P65
	●	●	1NO	—				C30C-FDL-BK10-24P65	C30C-FDRL-BK10-24P65
	●	●						C30C-FDL-GK10-24P65	C30C-FDRL-GK10-24P65
	○	○						C30C-FDL-WK10-24P65	C30C-FDRL-WK10-24P65

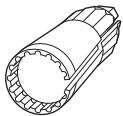

Mounting Ring Tool

Description	Std. Pack	Catalog Number
For threaded ring; can be used with cordless screwdriver.	1 Unit	C22-MS

Notes

- ① ⊖ = Safety function implemented with positive opening as defined in IEC/EN 60947-5-1.
- ② Contact sequence: ■ = contact closed; □ = contact open.

Technical Data

Global Compact 30 mm Pilot Devices—C30 Flat with Pigtail

Description	Unit	Controlled stop/ emergency switching off buttons	(Illuminated) pushbuttons Momentary/ maintained	Selector switches	Key-operated buttons	Indicator lights
General						
Standards		IEC/EN 60947-5-5 VDE 0660	IEC/EN 60947-5-1 VDE 0660	IEC/EN 60947-5-1 VDE 0660	IEC/EN 60947-5-1 VDE 0660	IEC/EN 60947-5-1 VDE 0660
Lifespan, mechanical	Operations x 10 ⁶	0.05	5/1	1	0.1	—
Operating frequency	Operations/h	300	3600	2000	100	—
Operating force	N	50	5	—	—	—
Operating torque	Nm	—	—	0.3	0.5	—
Plug tightening torque	Nm	M12 = 1, M8 = 0.6	M12 = 1, M8 = 0.6	M12 = 1, M8 = 0.6	M12 = 1, M8 = 0.6	M12 = 1, M8 = 0.6
Threaded ring tightening torque	Nm	2	2	2	2	2
Climatic proofing						
Damp heat, constant		As defined in IEC 60068-2-78	As defined in IEC 60068-2-78	As defined in IEC 60068-2-78	As defined in IEC 60068-2-78	As defined in IEC 60068-2-78
Damp heat, cyclic		As defined in IEC 60068-2-30	As defined in IEC 60068-2-30	As defined in IEC 60068-2-30	As defined in IEC 60068-2-30	As defined in IEC 60068-2-30
Degree of protection		IP66, IP67, IP69K (at front) IP65 (at rear)	IP66, IP67, IP69K (at front) IP65 (at rear)	IP66, IP67, IP69K (at front) IP65 (at rear)	IP66, IP67, IP69K (at front) IP65 (at rear)	IP66, IP67, IP69K (at front) IP65 (at rear)
Ambient air temperature						
Open	°C	–25 – +70	–25 – +70	–25 – +70	–25 – +70	–25 – +70
Storage	°C	–30 – +80	–30 – +80	–30 – +80	–30 – +80	–30 – +80
Mounting position		Any	Any	Any	Any	Any
Mechanical shock resistance for a shock duration of 11 ms	g	>30	>30	>30	>30	>30
Contacts						
Rated impulse withstand voltage	U _{imp}	Vac	M12A/unterminated: 4000 M8: 800	M12A/unterminated: 4000 M8: 800	M12A/unterminated: 4000 M8: 800	M12A/unterminated: 4000 M8: 800
Rated insulation voltage	U _i	V	M12A/unterminated: 250 M8: 30	M12A/unterminated: 250 M8: 30	M12A/unterminated: 250 M8: 30	M12A/unterminated: 250 M8: 30
Overvoltage category/degree of pollution		III/3	III/3	III/3	III/3	III/3
Control circuit reliability at 17 Vdc/7 mA	HF					
NO (statistically determined)		1 failure per 17 x 10 ⁶ operations	1 failure per 17 x 10 ⁶ operations	1 failure per 17 x 10 ⁶ operations	1 failure per 17 x 10 ⁶ operations	—
NC (statistically determined)		1 failure per 0.9 x 10 ⁶ operations	1 failure per 0.9 x 10 ⁶ operations	1 failure per 0.9 x 10 ⁶ operations	1 failure per 0.9 x 10 ⁶ operations	—
Fuse	gG/gL	A	4	4	4	4
Conditional short-circuit current	I _q	kA	1	1	1	1
Switching capacity						
Rated operational current	I _e	A				
AC-15: 24 V	I _e	A	4	4	4	—
DC-13: 24 V	I _e	A	3	3	3	—
Cable characteristics						
Versions			M12A/ unterminated	M12A/M8/ unterminated	M12A/M8/ unterminated	M12A/M8/ unterminated
Material			PUR	PUR	PUR	PUR
Diameter	∅	mm	4.7	4.7	4.7	4.7
Actuator travel and actuation force as per DIN EN 60947-5-1, K.5.4.1						
Positive opening sequence		mm	4.65	4.65	4.65	—
Maximum travel		mm	5.11	5.7	5.7	—
Minimum force for positive opening		N	K01 = 15/ K11 = 20/K02 = 34	K01 = 15/ K11 = 20/K02 = 30	K01 = 15/ K11 = 20/K02 = 35	K01 = 15/ K11 = 20/K02 = 36

Dimensions

Approximate Dimensions in mm [inches]

Pushbuttons, M12A

C30C-FD(R/L)-...-P5

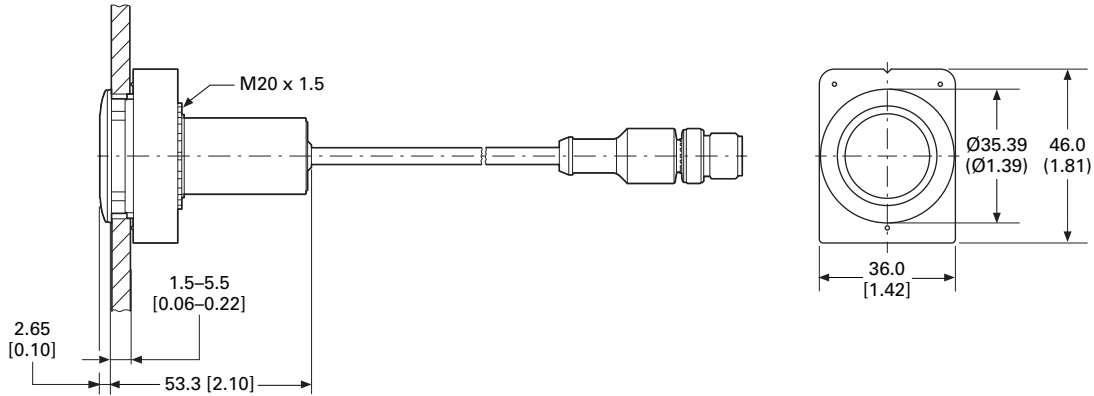

Pushbuttons, M8

C30C-FD(R/L)-...-P32

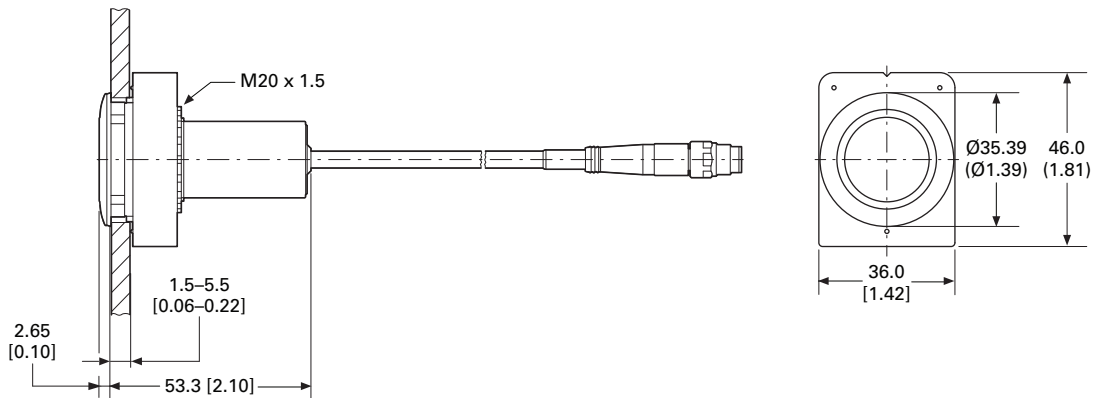

Pushbuttons, Unterminated Cable End

C30C-FD(R/L)-...-P62/-65

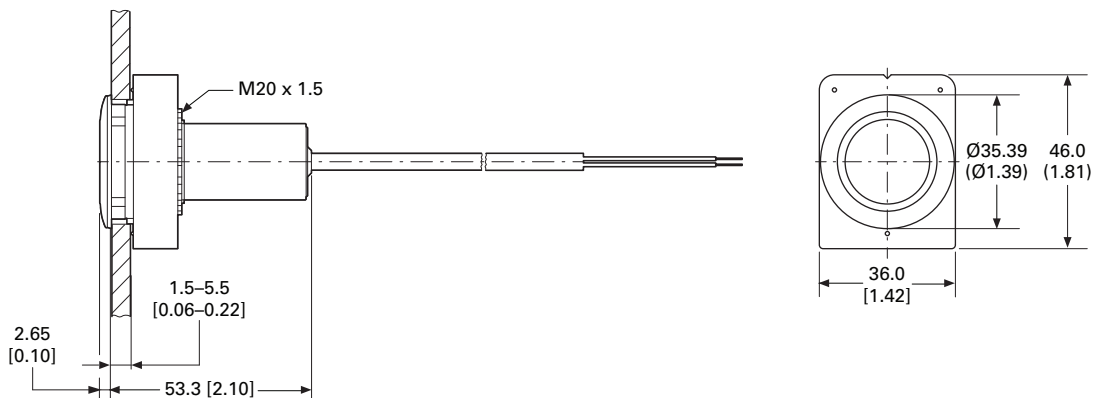

1.8

Pushbuttons and Indicating Lights

Global Compact 30 mm Pilot Devices—C30 Flat with Pigtail

1

Approximate Dimensions in mm [inches]

Indicator Lights, M12A

C30C-FL-...-P5

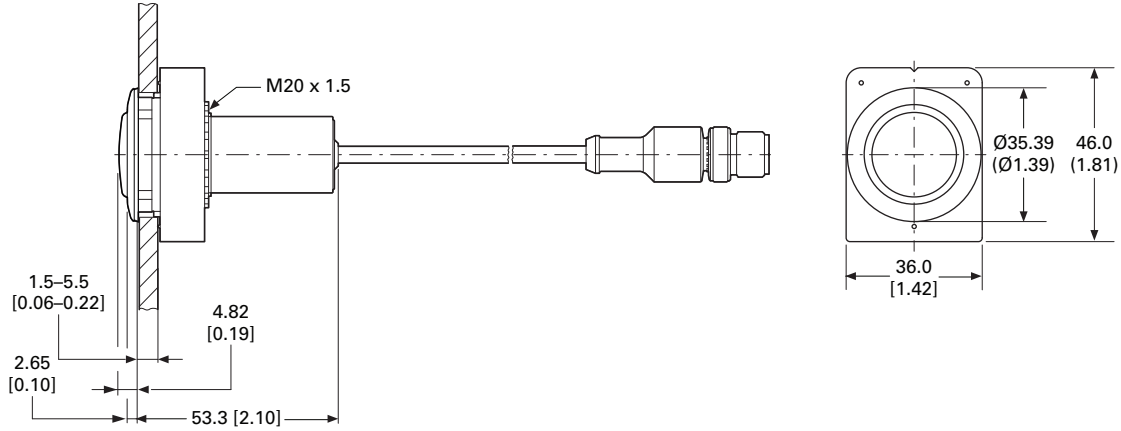

Indicator Lights, M8

C30C-FL-...-P32

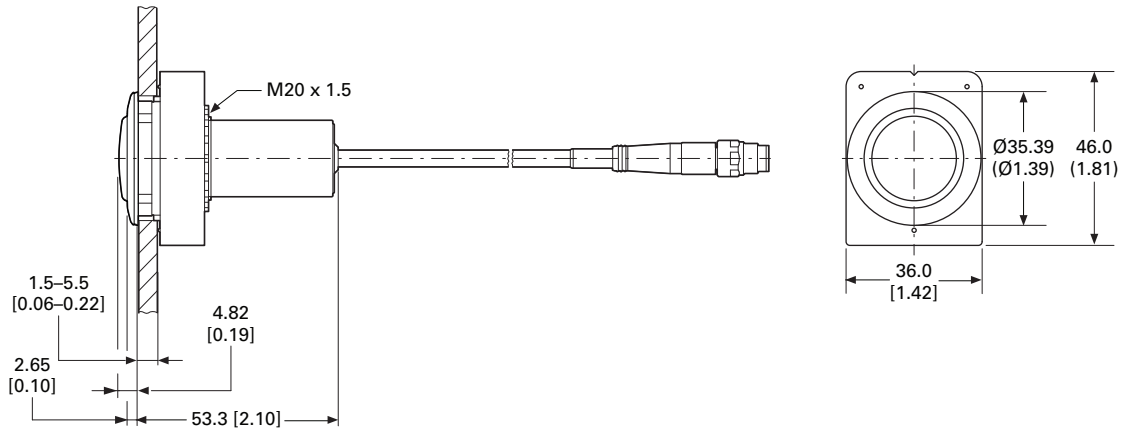

Indicator Lights, Underminated Cable End

C30C-FL-...-24-P62/-P65

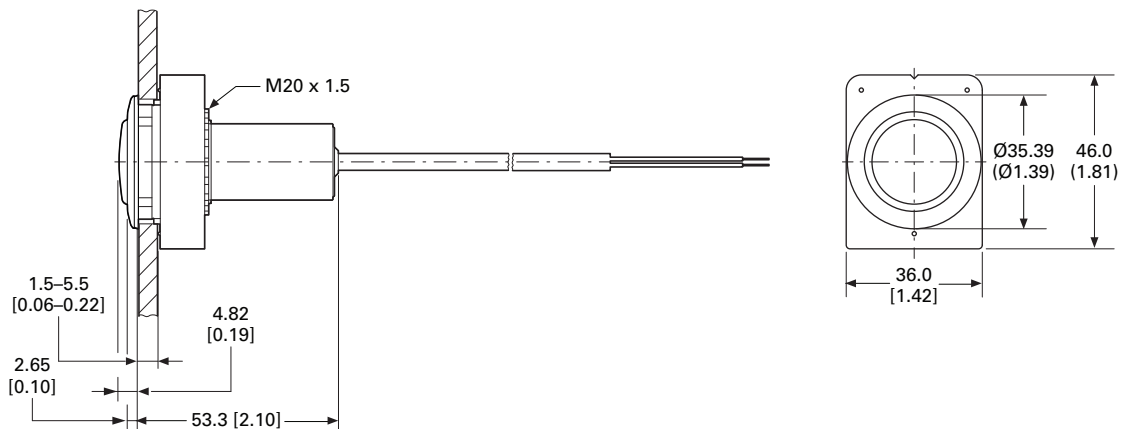

30.5 mm Square Multifunction Watertight/Oiltight—E30

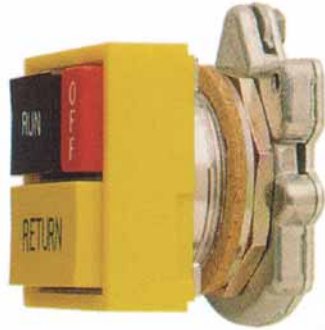

Contents

<i>Description</i>	<i>Page</i>
30.5 mm Square Multifunction Watertight/Oiltight—E30	
Product Identification	V7-T1-202
Product Selection	
Operators	V7-T1-203
Operator Components	V7-T1-206
Accessories	V7-T1-212
Options	V7-T1-213
Replacement Parts	V7-T1-216
Technical Data and Specifications	V7-T1-217
Dimensions	V7-T1-218

Product Description

The E30 industrial pushbutton and indicating light line from Eaton’s Electrical Sector features a wide selection of square, multifunction operators which conveniently mount in a standard 30.5 mm (1-13/64 in) diameter panel hole. Up to six input and indicating functions can be grouped into a single operating head, saving valuable panel space. Attractive square operator styling, coupled with custom legending of colored buttons and lenses and many special function accessories, makes E30 components ideally suited for use on control consoles and for a variety of industrial OEM applications.

Features

Type E30 control units consist of a basic operator with one or more buttons and lenses and contact block selection dependent on the specific operator configuration.

- **Pushbutton operators** will accommodate up to four single depth stackable contact blocks behind each operating button, up to eight circuits maximum.
- **Indicating lights** are supplied complete with either a transformer light unit up to 600 Vac supply line voltage or full voltage light unit up to 120 Vac/Vdc supply line voltage.
- **Combination pushbutton with indicating light** operators are supplied complete with a transformer or full voltage unit. Contact blocks must be ordered separately, up to four circuits maximum.

Die Cast Construction

Each operator has high pressure type seals to prevent the passage of oil and other contaminants through the operator into the contact structure or panel interior. Each operator uses a Buna N cork gasket between the mounting flange on the operator and the panel to maintain oiltightness.

Standards and Certifications

- UL Listed—File No. E131568
- CSA Certified—File No. LR68551



Ingress Protection

- Single and dual indicating lights
 - UL (NEMA) Type 1, 2, 3, 3R, 3S, 4, 4X, 12, 13
- All other operators
 - UL (NEMA) Type 3, 3R, 4, 4X, 12, 13

1

Product Identification

30.5 mm Square Multifunction Watertight/Oiltight

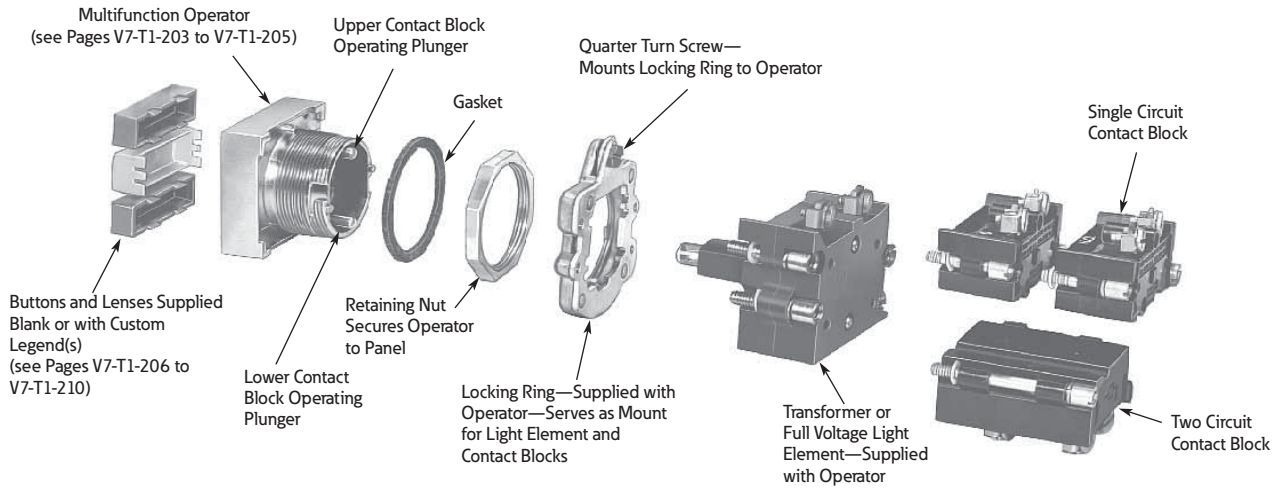

Product Selection

Operators

When Ordering a Complete E30 Control Unit Specify

Catalog Number of ...	Ordering Example (E30AB)	
Operator	E30KB130	“START”
Button(s)	E30KB231	“STOP”
Contact block(s)	E30KLA1	1NO
Accessories (if required)	E30KLA2	1NC

Square Multifunction Operators

UL (NEMA) Type 3, 3R, 4, 4X, 12, 13

Single Button Operator



Shown with Extended Button

Single Button Operator/without Button (Order Button Separately)





Button Type Required ①	Operation	Special Features	Catalog Number
	Momentary	—	E30AA

Two Button Operator

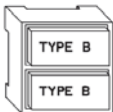

Shown with Extended Buttons

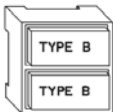
Two Button Operator/without Buttons (Order Buttons Separately)

Button Types Required ①	Operation		Special Features	Catalog Number
	Top Button	Bottom Button		
	Momentary	Momentary	—	E30AB
	Momentary	Momentary	With mechanical interlock	E30AC
	Maintained (all contacts)	Release (all contacts)	—	E30AD ②
	Maintained (all contacts)	Release (all contacts)	With mechanical interlock	E30AP ②③

Two Button Operator



Shown with Long Release Bar

Two Button Operator with Long (OFF) Release Bar—Includes OFF Bar/Button (Order Other Buttons Separately)

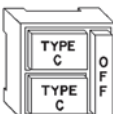
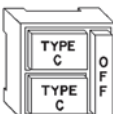
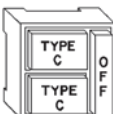
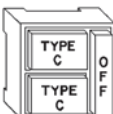
Button Types Required ④⑤	Operation		Special Features	Catalog Number
	Top Button	Bottom Button		
	Maintained	Maintained	—	E30AF
	Maintained	Maintained	With mechanical interlock	E30AG
	Maintained	Momentary	With mechanical interlock	E30AH
	Maintained (all contacts)	Maintained (bottom contacts only)	Top button operates both top and bottom contacts	E30AK ⑥



Notes

- ① Order from table on **Page V7-T1-206**.
- ② Limited to two single circuit, one double circuit 600V or two 120V (E30KLA9) contact blocks behind each button.
- ③ Buttons are interlocked so that one of the two is maintained at all times. Depressing the other button releases the maintained button and maintains the depressed button.
- ④ Operators are supplied as standard with red extended bar(s) marked “OFF” as shown in sketch. For other colors or markings, contact your nearest Eaton Distributor or call our Customer Service Center 1-800-356-1243. For replacement of standard red release bar, order **E30KR100**.
- ⑤ Order from table on **Page V7-T1-207**.
- ⑥ Limited to two single circuit, one double circuit 600V or two 120V (E30KLA9) contact blocks behind each button.

Square Multifunction Operators and Indicating Lights

UL (NEMA) Type 3, 3R, 4, 4X, 12, 13

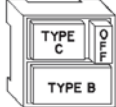
Two Button Operator with (OFF) Release—Includes OFF Bar/Button(s) (Order Other Buttons Separately)

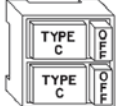
Two Button Operator	Button Types Required ^{①②}	Operation		Special Features	Catalog Number
		Top Button	Bottom Button		
 <p>Shown with Release Bar for Top Button</p>		Maintained	Momentary	Release bar for top button	E30AL
 <p>Shown with Release Bars for Each Button</p>		Maintained	Maintained	Individual release bars for each button	E30AN
		Maintained with interlock	Maintained with interlock	Individual release bars for each button	E30AM

Single Indicating Light Unit/without Lens (Order Lens Separately)

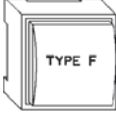
Single Indicating Light Unit	Type of Light Element			Full Voltage (60/50 Hertz AC or DC)			
	Lens Type Required ^③	Transformer (60/50 Hertz AC)		Voltage	Lamp Number ^④	Catalog Number	
		Voltage	Lamp Number ^④				Catalog Number
 <p>Shown with Lens</p>		120	#259	E30BA	24	24PSB	E30BJ
					120	120PSB	E30BM

Dual Indicating Light Unit/without Lenses (Order Lenses Separately)

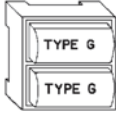
Dual Indicating Light Unit	Type of Light Element			Full Voltage (60/50 Hertz AC or DC)			
	Lens Types Required ^⑤	Transformer (60/50 Hertz AC)		Voltage	Lamp Number ^④	Catalog Number	
		Voltage	Lamp Number ^④				Catalog Number
 <p>Shown with Lens</p>		120	6PSB	E30CA	24	24PSB	E30CJ
					120	120PSB	E30CM

Notes

- ① Order from table on [Page V7-T1-207](#).
- ② Operators are supplied as standard with red extended release bar(s) marked "OFF" as shown in sketch. For other colors or markings, contact your nearest Eaton Distributor or call our Customer Service Center 1-800-356-1243. For replacement of standard red release bar, order **E30KR101**.
- ③ Order from table on [Page V7-T1-208](#).
- ④ Light units will also accept LED lamps. For LED part numbers, see table on [Page V7-T1-216](#).
- ⑤ Order from table on [Page V7-T1-209](#).

UL (NEMA) Type 3, 3R, 4, 4X, 12, 13

Single Button Operator and Indicating Light



Shown with Button and Lens

Single Button Operator with Indicating Light/without Button or Lens (Order Button and Lens Separately)

Button and Lens Types Required ①	Operation (Bottom Button)	Type of Light Element Transformer (60/50 Hertz AC)			Full Voltage (60/50 Hertz AC or DC)		
		Voltage	Lamp Number ②	Catalog Number	Voltage	Lamp Number ②	Catalog Number
TYPE G TYPE B	Momentary	120	6PSB	E30DA	24	24PSB	E30DX3
		120	120PSB	E30DF			

Single Button Operator with Release Bar and Indicating Light



Shown with Button and Lens

Single Button Operator with (OFF) Release Bar and Indicating Light—Includes OFF Bar/Button (Order Other Button and Lens Separately)

Button and Lens Types Required ①	Operation (Bottom Button)	Type of Light Element Transformer (60/50 Hertz AC)			Full Voltage (60/50 Hertz AC or DC)		
		Voltage	Lamp Number ②	Catalog Number	Voltage	Lamp Number ②	Catalog Number
TYPE G TYPE C	Maintained	120	6PSB	E30DG	24	24PSB	E30DX13
		120	120PSB	E30DM			

Two Button Operator with Indicating Light



Shown with Button and Lens

Two Button Operator with Indicating Light/without Buttons or Lens (Order Buttons and Lens Separately)

Button and Lens Types Required ④	Button Operation	Type of Light Element Transformer (60/50 Hertz AC)			Full Voltage (60/50 Hertz AC or DC)		
		Voltage	Lamp Number ②	Catalog Number	Voltage	Lamp Number ②	Catalog Number
TYPE E TYPE J TYPE E	Momentary	120	6PSB	E30EA	24	24PSB	E30EX3
		120	120PSB	E30EF			
TYPE E	Momentary with interlock	120	6PSB	E30EG	24	24PSB	E30EX13
		120	120PSB	E30EM			

Two Button Operator with Dual Indicating Lights



Shown with Button and Lens

Two Button Operator with Dual Indicating Lights/without Buttons and Lens

Button and Lens Types Required ①	Button Operation	Type of Light Element Transformer (60/50 Hertz AC)			Full Voltage (60/50 Hertz AC or DC)		
		Voltage	Lamp Number ②	Catalog Number	Voltage	Lamp Number ②	Catalog Number
TYPE E TYPE K TYPE E	Momentary	120	6PSB	E30JA	24	24PSB	E30JX3
		120	120PSB	E30JF			

Notes

- ① Order from tables on **Pages V7-T1-206 to V7-T1-210.**
- ② Light units will also accept LED lamps. For LED part numbers, see table on **Page V7-T1-216.**
- ③ Operators are supplied as standard with red extended release bar(s) marked "OFF" as shown in sketch. For other colors or markings, contact your nearest Eaton Distributor or call our Customer Service Center 1-800-356-1243. For replacement of standard red release bar, order **E30KR101.**
- ④ Order from tables on **Pages V7-T1-208 and V7-T1-209.**

Operator Components

Operating Buttons Only

Type A Extended Button



Type A Buttons with Standard Markings ^①

Button Application	Color	Marking	Extended Button Catalog Number	Short Button Catalog Number	Color	Marking	Extended Button Catalog Number	Short Button Catalog Number
TYPE A	Black	Blank	E30KA100	E30KA150	Green	START	E30KA330	E30KA380
		START	—	E30KA180	Yellow	Blank	E30KA400	E30KA450
TYPE A	Red	Blank	E30KA200	E30KA250	White	Blank	E30KA500	E30KA550
		EMERG. STOP	E30KA204	—	Gray	Blank	E30KA600	E30KA650
		OFF	E30KA218	E30KA268	Brown	Blank	E30KA700	E30KA750
		STOP	E30KA231	E30KA281	Orange	Blank	E30KA800	E30KA950
TYPE A	Green	Blank	E30KA300	E30KA350	Blue	Blank	E30KA900	E30KA950

Type B Extended Button



Type B Buttons with Standard Markings ^②

Button Application	Color	Marking	Extended Button Catalog Number	Short Button Catalog Number	Color	Marking	Extended Button Catalog Number	Short Button Catalog Number	
TYPE B	Black	Blank	E30KB100	E30KB150	Black	REVERSE	E30KB125	E30KB175	
		AUTO	E30KB101	E30KB151		RUN	E30KB126	E30KB176	
		CLOSE	E30KB102	E30KB152		SLOW	E30KB128	E30KB178	
		DOWN	E30KB103	E30KB153		START	E30KB130	E30KB180	
		FAST	E30KB105	E30KB155		TEST	E30KB132	E30KB182	
		FORWARD	E30KB107	E30KB157		UP	E30KB134	E30KB184	
		HIGH	E30KB109	E30KB159	Red	Blank	E30KB200	E30KB250	
		IN	E30KB110	E30KB160		EMERG. STOP	E30KB204	—	
		INCH	E30KB111	E30KB161		OFF	E30KB218	E30KB268	
		JOG	E30KB112	E30KB162		STOP	E30KB231	E30KB281	
		JOG FOR.	E30KB113	E30KB163		Green	Blank	E30KB300	E30KB350
		JOG REV.	E30KB114	E30KB164			START	E30KB330	E30KB380
		LOW	E30KB115	E30KB165		Yellow	Blank	E30KB400	E30KB450
		LOWER	E30KB116	E30KB166	White	Blank	E30KB500	E30KB550	
		MAN	E30KB117	E30KB167		AUTO	E30KB501	—	
		ON	E30KB119	E30KB169		HAND	E30KB508	—	
		OPEN	E30KB120	E30KB170	Gray	Blank	E30KB600	E30KB650	
OUT	E30KB121	E30KB171	Brown	Blank	E30KB700	E30KB750			
RAISE	E30KB122	E30KB172	Orange	Blank	E30KB800	E30KB850			
RESET	E30KB124	E30KB174	Blue	Blank	E30KB900	E30KB950			

Notes

^① Use with operator E30AA, legend characters 3/16 in (4.8 mm) high.

^② Use with operators E30AB thru AE, AL and DA thru DF, legend characters 3/16 in (4.8 mm) high.

Type C Extended Button



Type C Buttons with Standard Markings ①

Button Application	Color	Marking	Extended Button Catalog Number	Short Button Catalog Number	Color	Marking	Extended Button Catalog Number	Short Button Catalog Number	
	Black	Blank	E30KC100	E30KC150	Black	RESET	E30KC124	E30KC174	
		AUTO	E30KC101	E30KC151		REVERSE	E30KC125	E30KC175	
		CLOSE	E30KC102	E30KC152		RUN	E30KC126	E30KC176	
		DOWN	E30KC103	E30KC153		SLOW	E30KC128	E30KC178	
		FAST	E30KC105	E30KC155		START	E30KC130	E30KC180	
		FORWARD	E30KC107	E30KC157		TEST	E30KC132	E30KC182	
		HAND	E30KC108	E30KC158		UP	E30KC134	E30KC184	
		HIGH	E30KC109	E30KC159		Red	Blank	E30KC200	E30KC250
		IN	E30KC110	E30KC160			OFF	E30KC218	—
		INCH	E30KC111	E30KC161			STOP	E30KC231	E30KC281
		JOG	E30KC112	E30KC162		Green	Blank	E30KC300	E30KC350
		JOG FOR.	E30KC113	E30KC163			START	E30KC330	E30KC380
		JOG REV.	E30KC114	E30KC164		Yellow	Blank	E30KC400	E30KC450
		LOW	E30KC115	E30KC165			White	Blank	E30KC500
LOWER	E30KC116	E30KC166	Gray	Blank	E30KC600	E30KC650			
MAN	E30KC117	E30KC167		Brown	Blank	E30KC700	E30KC750		
ON	E30KC119	E30KC169	Orange	Blank	E30KC800	E30KC850			
OPEN	E30KC120	E30KC170		Blue	Blank	E30KC900	E30KC950		
OUT	E30KC121	E30KC171							
RAISE	E30KC122	E30KC172							

Note

① Use with operators E30AF thru AK, AL thru AM and DG thru DM, legend characters 1/8 in (3.2 mm) high.

1

Operating Buttons and Lens Only

Standard Color Buttons and Lens Marking ①

Black lettering on — White, Amber, Yellow and Clear.

White lettering on — Green, Red, Blue, Brown, Black, Orange and Gray.

Type E Button



Type E Buttons with Standard Markings ②

Button Application	Color	Marking	Extended Button Catalog Number	Color	Marking	Extended Button Catalog Number
	Black	Blank	E30KE100	Black	RESET	E30KE124
		CLOSE	E30KE102	REVERSE	E30KE125	
		DOWN	E30KE103	RUN	E30KE126	
		FAST	E30KE105	SLOW	E30KE128	
		FORWARD	E30KE107	START	E30KE130	
		HIGH	E30KE109	TEST	E30KE132	
		IN	E30KE110	UP	E30KE134	
		INCH	E30KE111	Red	Blank	E30KE200
		JOG	E30KE112		OFF	E30KE218
		JOG FOR.	E30KE113		STOP	E30KE231
		JOG REV.	E30KE114	Green	Blank	E30KE300
		LOW	E30KE115	START	E30KE330	
		LOWER	E30KE116	Yellow	Blank	E30KE400
		ON	E30KE119	White	Blank	E30KE500
		OPEN	E30KE120	Gray	Blank	E30KE600
OUT	E30KE121	Brown	Blank	E30KE700		
PHASE	E30KE122	Orange	Blank	E30KE800		
		Blue	Blank	E30KE900		

Type F Lens



Type F Lenses with Standard Markings ③

Button Application	Color	Marking	Catalog Number	Color	Marking	Catalog Number
	Red	Blank	E30KF10	Green	OFF	E30KF22
		MOTOR RUN	E30KF11	Amber	Blank	E30KF30
		ON	E30KF12	Blue	Blank	E30KF40
		POWER ON	E30KF13	Clear	Blank	E30KF50
Green	Blank	E30KF20	White	Blank	E30KF60	
	MOTOR STOP	E30KF21				
	MOTOR RUN	E30KF23				

Notes

① For lenses with special markings or with standard markings but in a different color, refer to instructions on **Pages V7-T1-213 to V7-T1-215**.

② Use with operators E30EA thru EM, FA thru FM and JA thru JM, legend characters 1/8 in (3.2 mm) high.

③ Use with operators E30BA thru BY, legend characters 3/16 in (4.8 mm) high.

Operating Lens Only

Standard Color Buttons and Lens Marking ①

Black lettering on — White, Amber, Yellow and Clear.

White lettering on — Green, Red, Blue, Brown, Black, Orange and Gray.

Type G Lens



Type G Lenses with Standard Markings ②

Lens Application	Color	Marking	Catalog Number	Color	Marking	Catalog Number
	Red	Blank	E30KG10	Green	OFF	E30KG22
		MOTOR RUN	E30KG11		READY	E30KG23
		ON	E30KG12	Amber	Blank	E30KG30
		POWER ON	E30KG13		Blue	Blank
Green	Blank	E30KG20	Clear	Blank	E30KG50	
	MOTOR RUN	E30KG24	White	Blank	E30KG60	
	MOTOR STOP	E30KG21				

Type J Lens



Type J Lenses with Standard Markings ③

Lens Application	Color	Marking	Catalog Number	Color	Marking	Catalog Number
	Red	Blank	E30KJ10	Green	OFF	E30KJ22
		MOTOR RUN	E30KJ11		ON	E30KJ24
		ON	E30KJ12	Amber	Blank	E30KJ30
		POWER ON	E30KJ13			
		MOTOR STOP	E30KJ14	Clear	Blank	E30KJ50
Green	Blank	E30KJ20	White	Blank	E30KJ60	
	MOTOR STOP	E30KJ21				
	MOTOR RUN	E30KJ23				

Type K Lenses



Type K Lenses with Standard Markings (Sold in Pairs Only) ④

Lens Application	Color	Left Hand Lens	Right Hand Lens	Marking		Catalog Number
				Left Hand Lens	Right Hand Lens	
	Red		Red	ON	ON	E30KK12
			Green	ON	OFF	E30KK13
	Green			OFF	OFF	E30KK22
			Red	OFF	ON	E30KK23

Notes

- ① For lenses with special markings or with standard markings but in a different color, refer to instructions on **Pages V7-T1-213 to V7-T1-215**.
- ② Use with operators E30CA thru CM and DA thru DM, legend characters 3/16 in (4.8 mm) high except MOTOR RUN, POWER ON and MOTOR STOP are 1/8 in (3.2 mm) high.
- ③ Use with operators E30EA thru EM, FA thru FM and GA thru GM, legend characters 1/8 in (3.2 mm) high.
- ④ Use with operators E30JA thru JW, legend characters 1/8 in (3.2 mm) high

1

Type K Lenses



Type K Lenses—Blank (Sold in Pairs Only)

Color			Color		
Left Hand Lens	Right Hand Lens	Catalog Number	Left Hand Lens	Right Hand Lens	Catalog Number
Red	Red	E30KK10	Blue	Red	E30KK41
	Green	E30KK11		Green	E30KK42
	Amber	E30KK17		Amber	E30KK43
	Blue	E30KK14		Blue	E30KK40
	Clear	E30KK15		Clear	E30KK45
	White	E30KK16		White	E30KK46
Green	Red	E30KK21	Clear	Red	E30KK51
	Green	E30KK20		Green	E30KK52
	Amber	E30KK27		Amber	E30KK53
	Blue	E30KK24		Blue	E30KK54
	Clear	E30KK25		Clear	E30KK50
	White	E30KK26		White	E30KK56
Amber	Red	E30KK31	White	Red	E30KK61
	Green	E30KK32		Green	E30KK62
	Amber	E30KK30		Amber	E30KK63
	Blue	E30KK34		Blue	E30KK64
	Clear	E30KK35		Clear	E30KK65
	White	E30KK36		White	E30KK60

Contact Blocks

Standard Contact Blocks—Molded, phenolic construction. Enclosed silver contacts with reliability “nibs” that improve the reliability of switching performance under dry circuit, corrosive atmosphere and fine dust conditions. For more extreme conditions, the logic level contact blocks described below are recommended.

Logic Level Contact Blocks—Feature palladium contacts. Palladium, which is more inert than gold, is well suited for voltages and currents approaching zero. When mounted in an enclosure rated for highly corrosive environments, logic level contact blocks can be used where exposure to chemicals may cause failure to other types of materials.

Mounting Limitations

See the contact block mounting limitations for Type E30 pushbutton and combination pushbutton and light operators on this page. Mounting positions 1 thru 8 indicate single depth contact blocks. Each of these positions can represent either a single circuit 600 volt block or a two-circuit 120 volt block. The two-circuit 600 volt block requires two of the numbered positions shown.

Mounting Positions

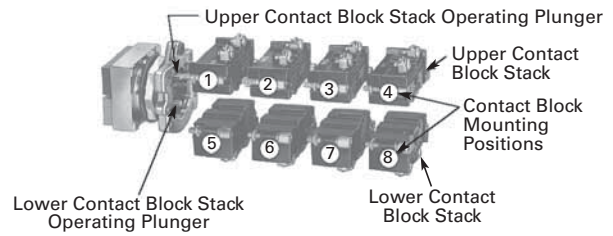

Catalog Number of Operator	Contact Blocks Can Be Mounted in Positions Listed Below	
	Upper Stack	Lower Stack
E30AA thru E30AM ^①	1-2-3-4	5-6-7-8
E30BA thru E30CM	None	None
E30DA thru E30DM	None	5-6-7-8
E30EA thru E30GM	2-3-4	6-7-8
E30JA thru E30JM	3-4	7-8

Contact Block Type ^② Contact Block Selection

Single Circuit, Screw Terminals



Two Circuit, Screw Terminals



Two Circuit, Quick Connect Terminals



120 Vac Only—Two Circuit













Circuit	Standard Catalog Number	Pressure Terminals	Logic Level	Quick Connect Terminals ^③
		Standard Catalog Number	Catalog Number	Standard Catalog Number
600 Vac, 250 Vdc—Single Circuit				
1NO	E30KLA1	E30KLAE1	E30KLB1	
1NC	E30KLA2	E30KLAE2	E30KLB2	
600 Vac, 250 Vdc—Two Circuit				
1NO-1NC	E30KLA3	E30KLAE3	E30KLB3	
2NO	E30KLA4	E30KLAE4	E30KLB4	
2NC	E30KLA5	E30KLAE5	E30KLB5	
Special Contact Operation				
1NO-1NC Overlapping	E30KLA6 ^④	—	E30KLB6 ^④	
2NO (One early closing)	E30KLA7 ^④	—	E30KLB7 ^④	
2NC (One late opening)	E30KLA8	—	E30KLB8	
120 Vac Only—Two Circuit				
1NO-1NC	E30KLA9 ^⑤	—	E30KLB9 ^⑤	

Notes

- ① Except operator E30AD, AJ or AK which will accommodate contact blocks 1, 2, 5 and 6 only. (See Mounting Positions above.)
- ② Individually boxed contact blocks master packed 10 per carton.
- ③ Supplied with non-stacking screws. Limited to 2 contact blocks mounted in positions 1 and 5.
- ④ Do not use with maintained operators.
- ⑤ Contacts must be same polarity.

Accessories

Accessories

	Description	Color/Type	Catalog Number
E30KR_ 	Collar —Snap on mounting for assembly in the field. Permits color coding of operator heads. Size: 1-19/32 x 1-19/32 x 9/16 in.	Black	E30KR1
		Red	E30KR2
		Green	E30KR3
		Yellow	E30KR4
		White	E30KR5
		Gray	E30KR6
		Orange	E30KR8
		Blue	E30KR9
		Brown	E30KR10
		E30KT_  Full Shroud  Half Shroud	Shroud —Similar to collar above except for extension above the face of button to prevent accidental actuation of button. Half shroud with an extension on only half the collar may be positioned to protect top or bottom button.
Half shroud (gray)	E30KT7		
E30KR3_ 	Guard —Two collars deep, removable slide prevents accidental operation. White slide can be marked with grease pencil.	Red with white slide	E30KR31
		Red with clear slide	E30KR32
E30KR30 	Terminal Block —2 terminals, each will accommodate 2-wire terminations.		E30KR30
E30KT_ 	Padlock Attachment for locking single button and bottom button of multi-function operators in the depressed position. Locks NC contacts open or early closing NO contacts closed. Cannot be used in conjunction with collar, shroud or boot.	Short button	E30KT1
		Extended button	E30KT2
E30KT3 	Transparent Boot —Guards against ingress of foreign material and freezing rain. Note: If this boot is used in conjunction with operator types AD or AE, an extended type button must be used in the top position and a short button in the lower position.		E30KT3 ①
E30KT_ 	Square Hole Plug —	Gray enameled	E30KT4
		Stainless steel	E30KT5
E30KV1 	Lamp and Lens Removal Tool —Will not fit Cat. No. E30B light units listed on Page V7-T1-204 .		E30KV1
E22CW 	Octagonal Wrench for mounting operators to panel.		E22CW
E30KV2 	Button and Lens Removal Tool		E30KV2

Note

① Color coordinating collars, padlock attachments or legend plates cannot be used with operators equipped with a transparent boot.

Options

Markings and Legend Plates

Buttons or Lenses with Non-Standard Horizontal Markings

Markings not listed as Standard Markings below are considered non-standard. If more than one marking is required on a button or lens, order non-standard markings.

Ordering Instructions

- Specify catalog number of blank button or lens of desired color, plus suffix "STAMP" for non-standard or "STD" for standard markings in order notes. See **Pages V7-T1-206 to V7-T1-210**.
- Specify size, legend desired and location in order notes by alphas as shown in example.
- Do not exceed maximum number of legend characters per line.

Ordering Example

Green Type B button to be marked with non-standard legend "ALL ELEVATORS DOWN."

Catalog No.: **E30KB300STAMP**
 Letter Size: 1/8 in
 Pos. A—ALL
 Pos. C—ELEVATORS
 Pos. F—DOWN

How to Use the Legend Location Figure

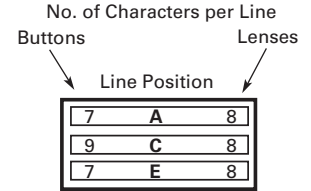

Legend Locations

Type A buttons and Type F lenses

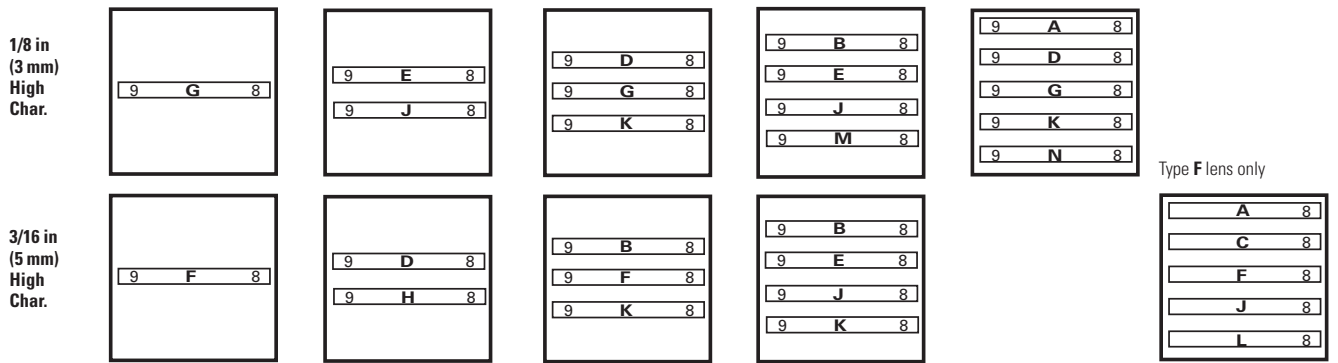

Type B buttons and Type G lenses



Type C buttons



Type D buttons

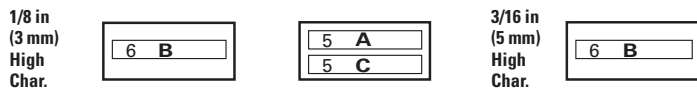

Type K buttons

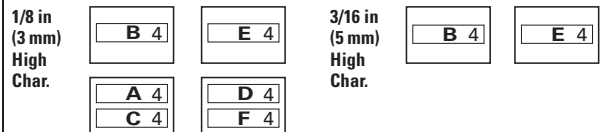

Type E buttons and Type J lenses

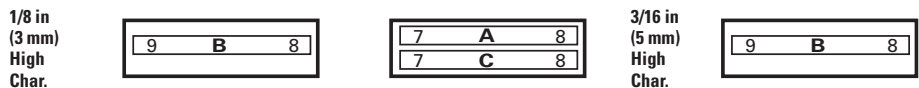

Standard Markings

AUTO	EMERG. STOP	HAND	INCH	JOG REV.	MAN.	OPEN	RESET	SLOW	TEST	MOTOR STOP
CLOSE	FAST	HIGH	JOG	LOW	OFF	OUT	REVERSE	START	UP	POWER ON
DOWN	FORWARD	IN	JOG FOR.	LOWER	ON	RAISE	RUN	STOP	MOTOR RUN	READY

1

Legend Arrangements and Legend Locations

Legend plates
E30KM1 or KM11

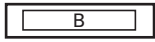

Legend plates
E30KM4 or KM14

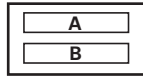

Legend plates
E30KM3 or KM13

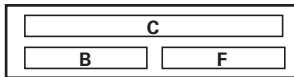
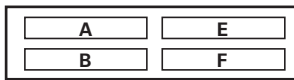
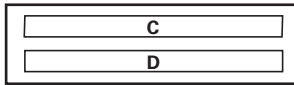

Legend plates
E30KM5 or KM15

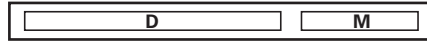
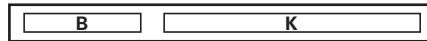
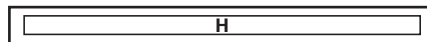

Legend plates
E30KM2 or KM12

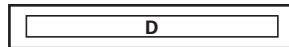

Legend plates
E30KM6 or KM16

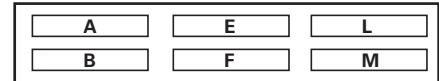
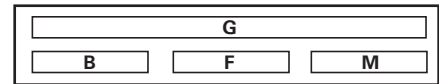
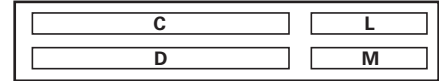
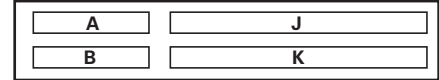
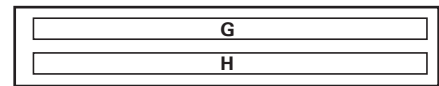

Legend Plates E30KN76 or KN76B

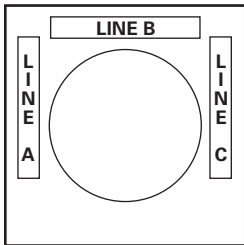

Legend plates
E30KN76 or KN76B
1/8 in character
size only with a maximum
of six characters.

Maximum Number and Size of Permissible Legend Characters of Custom Stamped Legend Plates

Type	No. of Lines	Size and Maximum Number of Characters Per Line								
		One Span			Two Span			Three Span		
		3/32 in (2.5 mm)	1/8 in (3 mm)	3/16 in (5 mm)	3/32 in (2.5 mm)	1/8 in (3 mm)	3/16 in (5 mm)	3/32 in (2.5 mm)	1/8 in (3 mm)	3/16 in (5 mm)
Standard	1	13	10	10	30	22	22	47	34	34
Large	1	13	10	10	30	23	23	47	36	36
	2	13	10	10	30	23	23	47	36	36

Characters available for non-standard markings
3/32 in (2.5 mm)—1/8 in (3 mm)—3/16 in (5 mm)

A B C D E F G H I J K L M N O P Q R S T U V W X Y Z

. / — ,

1 2 3 4 5 6 7 8 9 0

Buttons or Lenses with Non-Standard Vertical Markings

Ordering Instructions

- Specify catalog number of blank button or lens of desired color, selected from listings on **Pages V7-T1-206 to V7-T1-210**.
- Specify size, legend desired, location and state “vertically marked” in order notes.

Note: Specify either 1/8 or 3/16 in (3.2 or 4.8 mm) character height. Do not exceed maximum number of characters as outlined in table below.

Ordering Example:

Green Type K button to be marked with “RUN” “ON.”

Catalog No.: **E30KK20STAMP**
 Letter Size: 3/16 in (4.8 mm)
 Vertically Marked
 Pos. B—RUN
 Pos. E—ON

Legend Plates

Legend plates for Type E30 compact pushbutton and indicating light operators hook directly onto the operator and are clamped in place when the operator locking nut behind the panel is secured.

Two and three span plates are designed for use where two or more operators are mounted adjacent to each other **on minimum horizontal mounting centers**. These legend plates mount in the same manner as single span units.

When Ordering Legend Plates with Markings

- Catalog number of blank legend plate
- Insert the following in order notes:
 - Legends required
 - Size of characters—3/32, 1/8, 3/16 in (2.4, 3.2, 4.8 mm)
 - Positions of legends on one line standard and two line large legend plates by alphas as shown in sketches on following page.

Ordering Example:



Three span legend plate to be marked “MASTER CONTROL”, “STATION A” and “STATION B.”

Catalog No.: **E30KM3STAMP**
 Letter Size: 1/8 in (3.2 mm)
 Pos. C—MASTER CONTROL
 Pos. B—STATION A
 Pos. F—STATION B

Maximum Number of Characters

Description	Type	Maximum Number of Characters	
		1/8 in (3.2 mm)	3/16 in (4.8 mm)
Buttons	A	7	5
	B	7	5
	C	4	3
	D	5	3
	E	7	5
Lenses	F	7	5
	G	7	5
	J	7	5
	K	3	2

Blank Legend Plates and Legend Plates with Markings

Type		One Span Catalog Number
Black		
Standard—One Span	Standard	E30KM1
		
Large—One Span	Large	E30KM4
		

Replacement Parts

Replacement Light Units for E30 Components

Voltage AC and DC	Part Numbers—Receptacles without Lamps				
	Single Indicating Light	Dual Indicating Light	Single Light Single Pushbutton	Single Light Dual Pushbutton	Dual Light Dual Pushbutton
Full Voltage Type					
6V	57-2579-3A	57-2568A	57-2568A	57-2579-3A	57-2567
12V	57-2579-3A	57-2568A	57-2568A	57-2579-3A	57-2567
18/24V	57-2579-3A	57-2568A	57-2568A	57-2579-3A	57-2567
28V	57-2579-3A	57-2568A	57-2568A	57-2579-3A	57-2567
32V	57-2579-3A	57-2568-2A	57-2568-2A	—	57-2567
48V	57-2579-3A	57-2568A	57-2568A	57-2579-3A	57-2567
120V	57-2579-3A	57-2568A	57-2568A	57-2579-3A	57-2567
Transformer Type					
120V	42-2672A	42-2663A	42-2663A	42-2671A	42-2664A
208V	42-2672-2A	42-2663-2A	42-2663-2A	42-2671-2A	42-2664-2A
240V	42-2672-3A	42-2663-3A	42-2663-3A	42-2671-3A	42-2664-3A
380V	42-2672-4A	42-2663-4A	42-2663-4A	42-2671-4A	42-2664-4A
480V	42-2672-5A	42-2663-5A	42-2663-5A	42-2671-5A	42-2664-5A
600V	42-2672-6A	42-2663-6A	42-2663-6A	42-2671-6A	42-2664-6A
Description and Part Numbers—Related Parts					
Inner lens	28-1008	28-1010	28-1010	28-1010	28-1010
Retaining nut	15-1885	15-1885	15-1885	15-1885	15-1885
Gasket	16-2092	16-2092	16-2092	16-2092	16-2092
Locking ring	52-1116	52-1116	52-1116	52-1116	52-1116

Replacement Lamps for E30 Illuminated Operators

Mfg. Lamp Type	Voltage	Base Style	Application	Part Number
6PSB	6V	T2 slide	E30 transformer and full voltage	28-1022
12PSB	12V	T2 slide	E30 full voltage	28-1025
24PSB	24V	T2 slide	E30 full voltage	28-1026
28PSB	28V	T2 slide	E30 full voltage	28-1027
48PSB	48V	T2 slide	E30 full voltage	28-1028
60PSB	60V	T2 slide	E30 full voltage	28-1598
120PSB	120V	T2 slide	E30 full voltage	28-1029
#259	6.3V	T3-1/4 wedge	E30 single transformer	28-949

Replacement Lamps—Incandescent and LED

Lamp Voltage	Incandescent Lamps			LED Lamps			
	Manufacturer's Part Number	Base Style	Eaton's Part Number	Eaton's Part Number Red	Green	Yellow	Blue ①
6	6PSB	T2 slide	28-1022	35-1523	35-1523-2	35-1523-3	35-1523-17
12	12PSB	T2 slide	28-1025	35-1523-11	35-1523-12	35-1523-13	35-1523-18
24	24PSB	T2 slide	28-1026	35-1523-4	35-1523-5	35-1523-6	35-1523-19
28	28PSB	T2 slide	28-1027	35-1523-4	35-1523-5	35-1523-6	35-1523-19
48	48PSB	T2 slide	28-1028	35-1523-14	35-1523-15	35-1523-16	35-1523-20
120	120PSB	T2 slide	28-1029	35-1523-7	35-1523-8	35-1523-9	35-1523-21

Note

① E30 blue LED bulbs may not provide sufficient intensity for some applications.

Technical Data and Specifications

Operator Specifications

Description	Specification
Climate Conditions	
Operating	-20° to 150°F (-29° to 65°C)
Terminals	
Light units	Terminals are saddle clamp type for 2 stranded or solid wires up to 12 AWG (4.0 mm ²) Torque—7 lb-in (0.8 Nm)
Contact block	Terminals are saddle clamp type for 2 stranded or solid wires up to 12 AWG (4.0 mm ²) Torque—7 lb-in (0.8 Nm)
Materials	
Operator	Zinc base die casting with a copper-nickel-chrome plated finish Withstands the 200 hr. salt spray test in accordance with MIL Spec. QQ-M-151A and NEMA 4X testing.
Internal parts	Including shafts, washers and springs, are made of stainless steel
Buttons and lenses	Colorfast, wear resistant, molded acetal resin
Contact blocks	Made of molded, heat resistant, mineral filled phenolic Contact block plungers are molded of nylon filled phenolic Contacts are silver
Reliability nibs	These nibs combine a scrubbing action with high pressure density when the contacts are closed They push through particles and films found on contact surfaces in industrial environments Reliability nibs self-adjust to the application—dry circuit, normal or heavy-duty

Reliability Nibs



Electrical Ratings

Contact Blocks

Meet or Exceed NEMA Contact Rating Designation A600 and P300

Description	Vac A600				Vdc P300		
	120V	240V	480V	600V	24/28V	125V	250V
Make and emergency interrupting capacity (Amps)	60	30	15	12	5.73	1.1	0.55
Normal load break (Amps)	6	3	1.5	1.2	5.73	1.1	0.55
Continuous current (Amps)	10	10	10	10	5	5	5

- UL A600/P300 nominal connect 10A
- 1NO, 1NC, 2NO, 2NC, 1NO-1NC, early make, late break and overlapping configurations
- Mechanical positive drive operation on NC contacts
- Palladium alloy contact for logic level or highly corrosive environments

Maximum Ratings for Logic Level and Hostile Atmosphere Application

Description	Specification
Maximum amperes	0.5A ①
Maximum volts	120 Vac/Vdc

Note

① Logic level contact blocks are UL A600/P500 rated per table above.

Light Unit

Description	Specification
Bulbs—Average Life	
Transformer type	20,000 hrs.
Resistor/direct voltage type	2,500 hrs. min. at rated voltage
LED	60,000 to 100,000 hrs.

1.9

Pushbuttons and Indicating Lights

30.5 mm Square Multifunction Watertight/Oiltight—E30

1

Dimensions

Approximate Dimensions in Inches (mm)

Pushbutton Operators

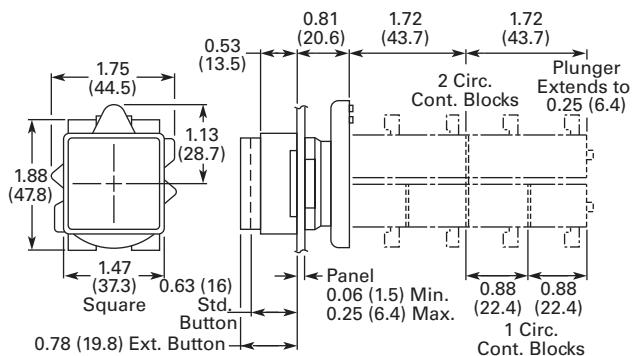

Combination Pushbutton and Indicating Light Operators

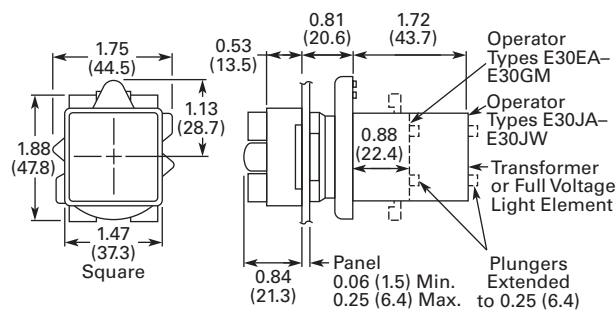

Combination Pushbutton and Indicating Light Operators

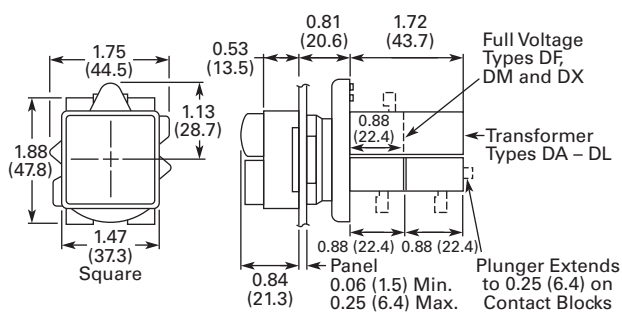

Indicating Light Operators

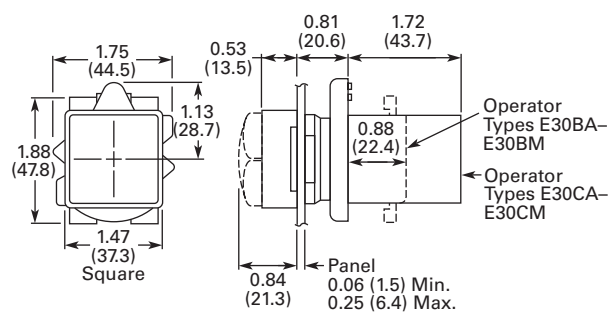

Padlocking Attachment and Half Shroud E30KT7

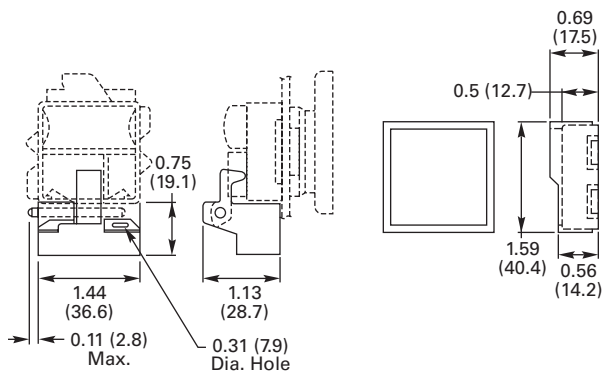

Drilling Dimensions—Minimum Spacing ^{①②}

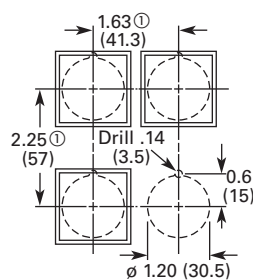

Notes

- ① Dimensions shown allow adequate space for the addition of one or two high legend plates and color coordinating collars.
- ② Locating nib hole or notch is 0.136 in (3.5 mm) drill. Alternate to drilling mounting holes use Greenlee Tool Co. punch (No. 730-S) to punch the hole and (No. 730-K) to punch the notch.

Legend Plates

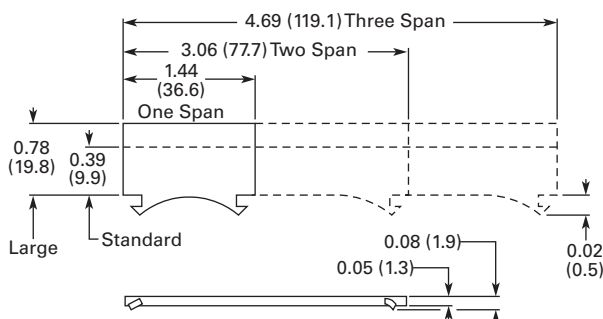

30.5 mm Heavy-Duty Watertight/Oiltight—10250T



Contents

<i>Description</i>	<i>Page</i>
30.5 mm Heavy-Duty Watertight/Oiltight—10250T	
Product Overview	V7-T1-220
Product Identification	V7-T1-220
Catalog Number Selection	V7-T1-221
Product Selection	
Point-of-Purchase Packaging	V7-T1-223
Non-Illuminated Momentary Pushbutton Units	V7-T1-224
Pushbuttons	V7-T1-225
Illuminated Momentary Pushbutton Units	V7-T1-228
Indicating Light Units	V7-T1-229
Illuminated Pushbuttons and Indicating Lights	V7-T1-230
Push-Pull Emergency Stop	V7-T1-232
Illuminated Push-Pull Units	V7-T1-235
Potentiometers	V7-T1-238
Push-Pull Operators	V7-T1-239
Selector Switch Units	V7-T1-243
Selector Switch Selection	V7-T1-244
Selector Switch Operators	V7-T1-247
Illuminated Selector Switch Operators	V7-T1-250
Joystick Units	V7-T1-251
Joysticks	V7-T1-252
Roto-Push Units	V7-T1-255
Roto-Push Operators	V7-T1-256
Accessories	V7-T1-261
Options	V7-T1-266
Replacement Parts	V7-T1-275
Technical Data and Specifications	V7-T1-277
Dimensions	V7-T1-280



Application Description

Contact Operation

Slow make and break. All normally closed contacts have positive opening operation, i.e., normally closed contacts are forced open in the event of contact weld or spring breakage.

Standards and Certifications

- CE EN 60947-5-1 and 60947-5-5
- UL 508—File No. 131568
- CSA C22.2 No. 14—File No. LR68551



Ingress Protection

When mounted in similarly rated enclosure—

- Standard indicating lights
 - UL (NEMA) Type 1, 2, 3, 3R, 3S, 4, 4X, 12, 13
 - IEC IP65
- Most other operators
 - UL (NEMA) Type 1, 2, 3, 3R, 4, 4X, 12, 13
 - IEC IP65

Product Description

The 30.5 mm pushbutton line features a zinc die cast construction with chrome-plated housing and mounting nut. The same durable construction is also available with the corrosive resistant E34 line of pushbuttons. See E34 section on **Pages V7-T1-290 to V7-T1-331**.

Features

- Heavy-duty zinc die cast construction
- Enclosed silver contacts with reliability nibs
- Diaphragm seals with drainage holes
- Grounding nibs on the operator casing

Benefits

- Reliability nibs improve contact reliability even under dry circuit and fine dust conditions
- Drainage holes prevent buildup of liquid inside the operator which can prevent operation in freezing environments
- Grounding nibs bit through paint and other coatings to provide secure ground

1

Product Overview

Reliability Nibs

Eaton's contact blocks feature enclosed silver contacts with pointed "reliability nibs" for reliable performance from logic level up to 600V. To ensure reliable switching, nibs bite through oxide which can form on silver contacts, eliminating the need for expensive logic level blocks for most applications.

Reliability Nibs

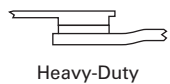
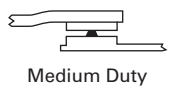
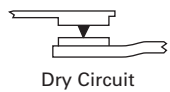

Reliability nibs improve performance in dry circuit, corrosive, fine dust and other contaminated atmospheres. Under normal environmental conditions, the minimum operational voltage is 5V and the minimum operational current is 1 mA, AC/DC. For operation under a wider range of environmental conditions, logic level contact blocks with inert palladium tipped contacts are recommended.

Grounding Nibs

10250T line operators have "grounding nibs"—four metal points on the operator casting designed to bite through most paints and other coatings on metal panels to enhance the ground connection when the operator is securely tightened.

Grounding Nibs

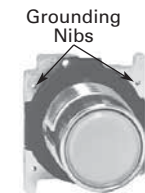

Diaphragm Seal with Drainage Holes

Liquid Drainage

Eaton's pushbutton operators offer front of panel drainage via holes in the operator bushing. Hidden from view by the mounting nut, these holes prevent buildup of liquid inside the operator, which can prevent operation in freezing environments. The holes also provide a route for escaping liquid in high pressure washdowns, effectively relieving pressure from the internal diaphragm seal, ensuring reliable sealing in applications even beyond NEMA 4.

Diaphragm Seal

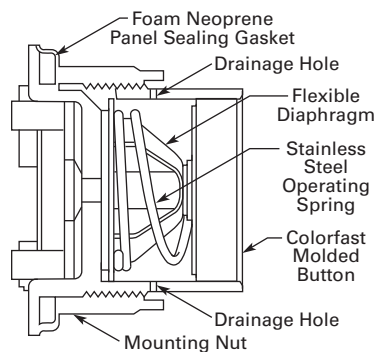

Product Identification

30.5 mm Heavy-Duty Watertight/Oiltight—10250T Series

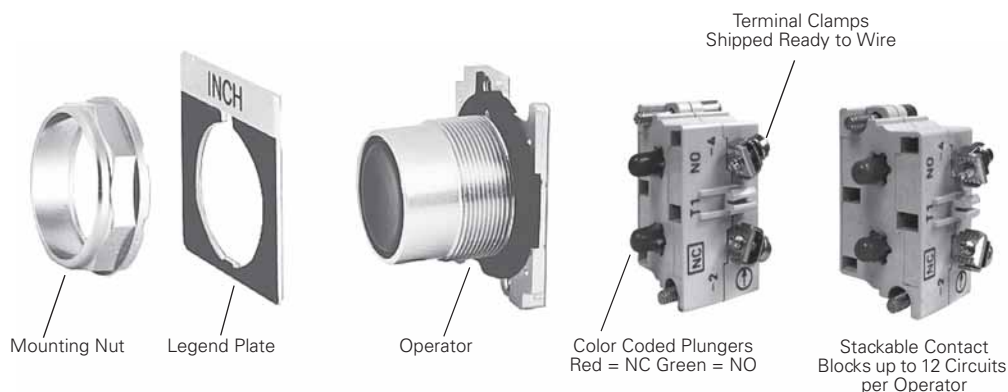

Catalog Number Selection

Catalog Number Selection is for illustrative purposes only and not to be used to create new catalog numbers.

Non-Illuminated Pushbuttons

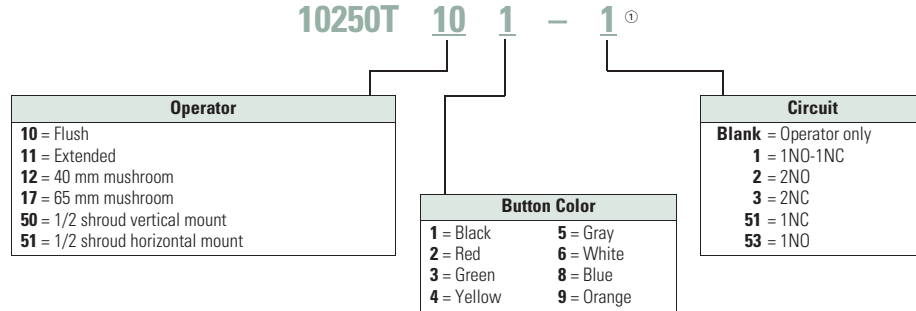

Illuminated and Non-Illuminated Push-Pulls

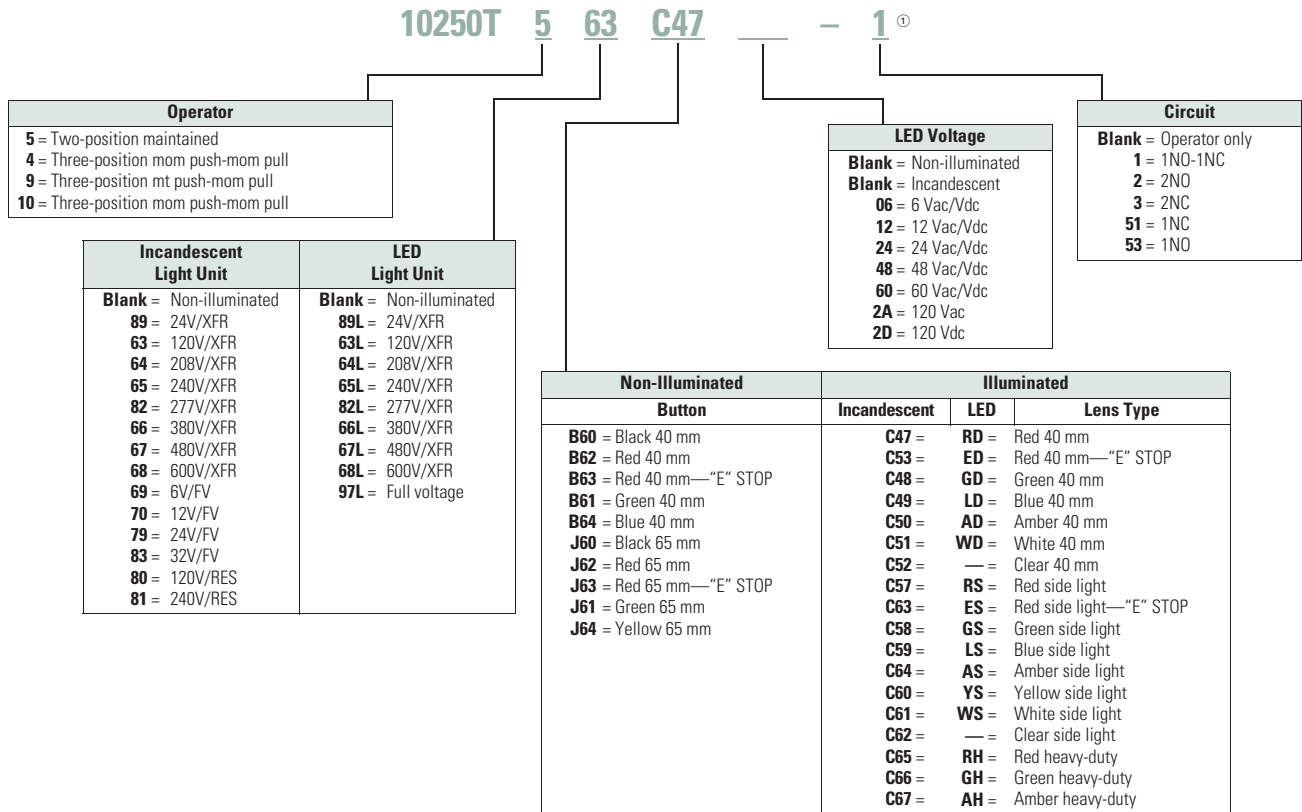

Note

① Add **X** at end of catalog number to receive parts assembled from factory.

1.10

Pushbuttons and Indicating Lights

30.5 mm Heavy-Duty Watertight/Oiltight—10250T

1

Catalog Number Selection is for illustrative purposes only and not to be used to create new catalog numbers.

Illuminated Pushbuttons

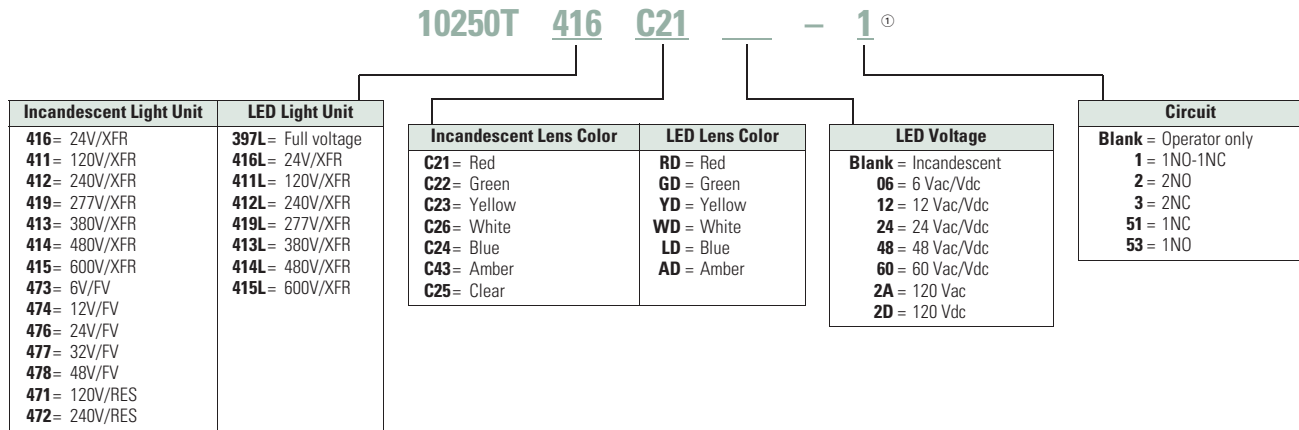

Standard Indicating Lights, PresTest and Master Test

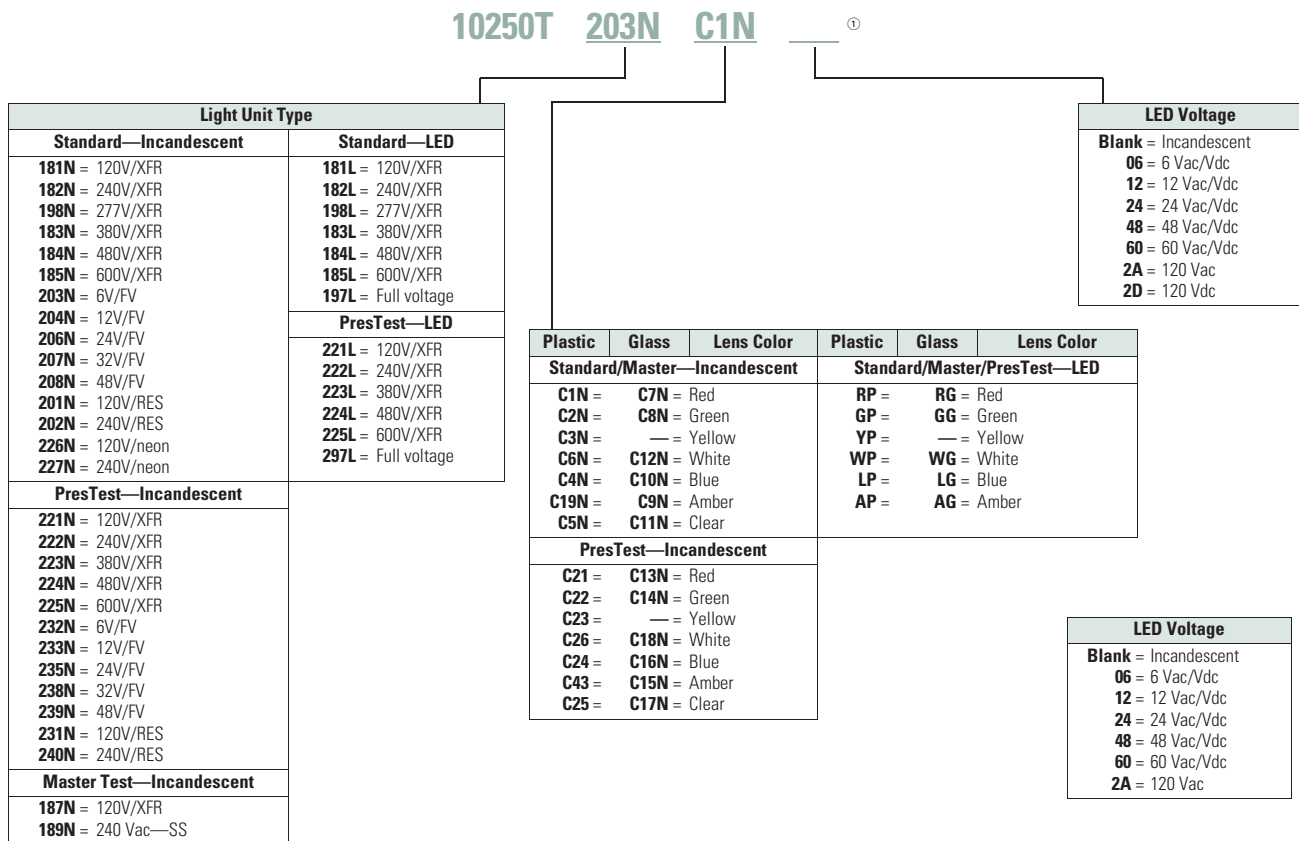

Note

① Add **X** at end of catalog number to receive parts assembled from factory.

Product Selection

Point-of-Purchase Packaging

Point-of-Purchase Packaged Pilot Device



10250T Point-of-Purchase Packaged Pilot Devices

Product	Description	Catalog Number
Emergency Stop Operators		
Red non-illuminated push-pull	1NO-1NC contact block. Also includes two square engraved legend plates: EMERG. STOP and STOP.	10250T5B62-1-POP
Red mushroom pushbutton	1NO-1NC contact block. Also includes two square engraved legend plates: EMERG. STOP and STOP.	10250T32R-POP
Red jumbo mushroom pushbutton	Engraved EMERG. STOP with 1NO-1NC contact block.	10250T33-POP
Momentary Pushbuttons		
Black flush pushbutton	1NO-1NC contact block. Also includes two square engraved legend plates: START and JOG.	10250T30B-POP
Green flush pushbutton		10250T30G-POP
Red extended pushbutton	1NO-1NC contact block. Also includes one square engraved legend plate: STOP.	10250T31R-POP
Indicating Lights		
Red indicating light	Full voltage 24 Vac/Vdc with two extra lenses: Green and amber. Also includes two square engraved legend plates: RUN and JOG.	10250T206NC1N-POP
Red indicating light	Resistor 120 Vac/Vdc with two extra lenses: Green and Amber. Also includes one square engraved legend plate: RUN and JOG.	10250T34R-POP
Illuminated Pushbuttons		
Red illuminating pushbutton	Full voltage 24 Vac/Vdc with 1NO-1NC contact block and two extra lenses: Green and amber. Also includes one square engraved legend plate: POWER ON.	10250T476C21-1-POP
Red illuminating pushbutton	Resistor 120 Vac/Vdc with 1NO-1NC contact block and two extra lenses: Green and amber. Also includes one square engraved legend plate: POWER ON.	10250T411C21-1-POP
Selector Switches		
Black knob two-position selector switch	1NO-1NC contact block. Also includes three square engraved legend plates: OFF/ON, HAND/AUTO and RUN/JOG.	10250T20KB-POP
Black knob three-position selector switch	2NO-2NC contact blocks. Also includes 1 square engraved legend plate: HAND/OFF/AUTO.	10250T22KB-POP
Black knob three-position selector switch	1NO-1NC contact block. Also includes legend plate: HAND/OFF/AUTO	10250T21KB-POP

Non-Illuminated Momentary Pushbutton Units

UL (NEMA) Type 3, 3R, 4, 4X, 12, 13

Flush Button**Extended Button****Mushroom Button****Jumbo Mushroom****Pushbutton Units—Flush, Extended, Mushroom Head or Jumbo Mushroom Head Operators**

Contact Type	Button Color	Flush Button Catalog Number	Extended Button Catalog Number	Mushroom Button Catalog Number	Jumbo Mushroom ^① Catalog Number
1NO	Black	10250T23B	10250T25B	10250T26B	10250T27B
	Red	10250T23R	10250T112-53	10250T122-53	10250T172-53
	Green	10250T23G	10250T25G	10250T26G	10250T27G
	Yellow	10250T23Y	10250T25Y	10250T26Y	10250T27Y
	Red—Engraved EMERG. STOP	—	—	—	10250T17213-53
1NC	Black	10250T101-51	10250T111-51	10250T121-51	10250T171-51
	Red	10250T102-51	10250T25R	10250T26R	10250T27R
	Green	10250T103-51	10250T113-51	10250T123-51	10250T173-51
	Yellow	10250T104-51	10250T120-51	10250T124-51	10250T174-51
	Red—Engraved EMERG. STOP	—	—	—	10250T29
1NO-1NC	Black	10250T30B	10250T31B	10250T32B	10250T33B
	Red	10250T30R	10250T31R	10250T32R	10250T33R
	Green	10250T30G	10250T31G	10250T32G	10250T33G
	Yellow	10250T30Y	10250T31Y	10250T32Y	10250T33Y
	Red—Engraved EMERG. STOP	—	—	—	10250T33
2NO	Black	10250T101-2	10250T111-2	10250T121-2	10250T171-2
	Red	10250T102-2	10250T112-2	10250T122-2	10250T172-2
	Green	10250T103-2	10250T113-2	10250T123-2	10250T173-2
	Yellow	10250T104-2	10250T120-2	10250T124-2	10250T174-2
	Red—Engraved EMERG. STOP	—	—	—	10250T17213-2
2NC	Black	10250T101-3	10250T111-3	10250T121-3	10250T171-3
	Red	10250T102-3	10250T112-3	10250T122-3	10250T172-3
	Green	10250T103-3	10250T113-3	10250T123-3	10250T173-3
	Yellow	10250T104-3	10250T120-3	10250T124-3	10250T174-3
	Red—Engraved EMERG. STOP	—	—	—	10250T17213-3







Note

① Anodized aluminum head is not suitable for use in ultraviolet light applications.

Pushbuttons

UL (NEMA) Type 3, 3R, 4, 4X, 12, 13

Momentary Pushbutton Operators, Non-illuminated

Part Number	Button	Color	Catalog Number			
			Vertical	Horizontal		
10250T10_ 	Flush button ①	Black	10250T101			
		Red	10250T102			
		Green	10250T103			
		Yellow	10250T104			
		Gray	10250T105			
		White	10250T106			
		Blue	10250T108			
		Orange	10250T109			
		10250T11_ 	Extended button	Black	10250T111	
Red	10250T112					
Green	10250T113					
Yellow	10250T120					
White	10250T116					
Blue	10250T118					
Orange	10250T119					
10250T5_ 	Half shrouded button			Black	10250T501	10250T511
				Red	10250T502	10250T512
		Green	10250T503	10250T513		
		Yellow	10250T504	10250T514		
		Gray	10250T505	10250T515		
		White	10250T506	10250T516		
		Blue	10250T508	10250T518		
		Orange	10250T509	10250T519		
		10250T12_ 	Mushroom button	Black	10250T121	
Red	10250T122					
Green	10250T123					
Yellow	10250T124					
Blue	10250T129					
10250T17_ 	Jumbo mushroom button ②	Black	10250T171			
		Red	10250T172			
		Red (EMERG. STOP)	10250T17213			
		Green	10250T173			
		Yellow	10250T174			
10250ED1164_ 	Low operating force—jumbo mushroom ②③	Black	10250ED1164-2			
		Red	10250ED1164-3			
		Green	10250ED1164-4			
		Yellow	10250ED1164-5			
		Clear	10250ED1164			

Note: To order complete assembled unit using one composite catalog number, add contact block and legend plate suffix to the end of operator catalog number. Example: 10250T101-1TS33



Operator
10250T101

+



Contact Block
10250T1

+



Legend Plate
10250TS33

Notes

- ① To order operator with factory assembled extended retaining nut, **10250TA12**, for thick panel applications, add suffix letter **E** to listed catalog number. Example: 10250T101**E**.
- ② Anodized aluminum head is not suitable for use in ultraviolet light applications.
- ③ Operating force—Standard = 2.4 lb; low force = 1.6 lb.

1

UL (NEMA) Type 3, 3R, 4, 4X, 12, 13

10250TA_

Mechanically Interlocked Pushbutton Operators



Description	Catalog Number
Black flush and green flush	10250TA66
Black flush and long red	10250TA67
Black flush and red mushroom head	10250TA68
Black flush and lock-down red mushroom head	10250TA69 ①
Black flush and red jumbo mushroom head	10250TA76
Green flush and long red	10250TA72
Black long and long red	10250TA73
Green flush and red mushroom head	10250TA77
Green flush and black flush	10250TA75

Lockout Pushbutton Operators with Padlock Attachments

UL (NEMA) Type 3, 3R, 4, 4X, 12, 13

The following pushbutton and mushroom operators include an integral padlock attachment for applications requiring lockout/tagout of specific machine functions. They are available in styles which allow locking of a button in the down position

(stopped position) or locking a button in the up position (to prevent starting). Select the “Hand” latch type which functions as a momentary pushbutton until the operator presses the button and moves the padlock attachment into position for

locking, or choose the “Spring Loaded” latch type where the padlock attachment springs into place when the button is pressed. Units accept a customer supplied 1/4 in padlock.

10250TA16

Padlockable in the Down Position ②



Operator Type	Color	Latch Type	Catalog Number
Flush head	Red	Hand	10250TA16
Mushroom head	Red	Hand	10250TA42
	Red	Spring loaded	10250TA45
Jumbo head ③	Red	Hand	10250TA52
	Red	Spring loaded	10250TA55
	Red (EMERG. STOP)	Spring loaded	10250ED952

Padlockable in the Up Position ②

10250TA4_



Operator Type	Color	Latch Type	Catalog Number
Mushroom head	Black	Hand	10250TA41
	Green	Hand	10250TA43

10250TA5_



Operator Type	Color	Latch Type	Catalog Number
Jumbo mushroom head ③	Black	Hand	10250TA51
	Green	Hand	10250TA53
	Yellow	Hand	10250TA54

Notes

Hand attachment must be manually moved into place for locking. Spring loaded: when operator is pressed—attachment springs into place. Must be moved manually to release button.

① NC contacts must be mounted behind lock-down mushroom head operator to ensure lockout.

② Operators can be latched down without a padlock. Padlock not included.

③ Jumbo mushroom heads are not recommended for use in applications where exposure to ultraviolet light exists.

Key Pushbutton Operator

UL (NEMA) Type 3, 3R, 4, 4X, 12, 13

These devices incorporate an integral locking mechanism which enables locking units in various positions (**Locked Down**), locking units to

prevent operation (**Locked Up**) or setting unit to lock when the button is pressed (**Push to Lock**), requiring the key to be inserted to return to

normal operation. With the key in the center position, these operators function as a normal momentary pushbutton (**Free**).

Replacement Keys or Dissimilar Locks for Key Operators Below

Listed operators have identical locks and keys (Key Code H661) Catalog Number 10250ED824. For dissimilar lock and key combinations, see listing on **Page V7-T1-248**.

Replacement Keys

Description	Catalog Number
Replacement keys (code H661)	10250ED824

10250T43



Key Pushbutton Operator

Key Position and Pushbutton Operations



Key Removal Positions

Vertical Mounting^① Catalog Number

Three-Position

Lock up	Free	Lock down	All	10250T430
Lock up	Free	Lock down	L and R	10250T431
Lock up	Free	Lock down	C and R	10250T432

Two-Position

Lock up	Free	—	L and C	10250T433
Lock up	Free	—	L	10250T434
—	Free	Lock down	C and R	10250T435
—	Free	Lock down	R	10250T436
—	Free	Push to lock	C and R	10250T437
—	Free	Push to lock	R	10250T438

Latch-In, Twist-to-Release Operator

UL (NEMA) Type 3, 3R, 4, 4X, 12, 13

10250ED1043-4



Operator Only with Button

Description	Catalog Number
Latch-in, twist-to-release operator with red mushroom head button	10250ED1043-4

Note

① Horizontal mounting available on request.

1

Illuminated Momentary Pushbutton Units

UL (NEMA) Type 3, 3R, 4, 4X, 12, 13

- LED or incandescent
- Full voltage, resistor or transformer type
- Plastic lenses

24V Full Voltage Illuminated Pushbutton



Illuminated Pushbutton Units

Type	Voltage	Color	LED/Lamp Number	Illuminated Pushbutton 1NO Catalog Number	1NO-1NC Catalog Number	1NC Catalog Number		
LED Lamp								
Full voltage	24 Vac/Vdc	Red	Bayonet base	10250T397LRD24-53	10250T397LRD24-1	10250T397LRD24-51		
		Green		10250T397LGD24-53	10250T397LGD24-1	10250T397LGD24-51		
		Amber		10250T397LAD24-53	10250T397LAD24-1	10250T397LAD24-51		
		Yellow		10250T397LYD24-53	10250T397LYD24-1	10250T397LYD24-51		
		Blue		10250T397LLD24-53	10250T397LLD24-1	10250T397LLD24-51		
		White		10250T397LWD24-53	10250T397LWD24-1	10250T397LWD24-51		
		120 Vac/Vdc		Red	10250T397LRD2A-53	10250T397LRD2A-1	10250T397LRD2A-51	
	Green	10250T397LGD2A-53	10250T397LGD2A-1	10250T397LGD2A-51				
	Amber	10250T397LAD2A-53	10250T397LAD2A-1	10250T397LAD2A-51				
	Yellow	10250T397LYD2A-53	10250T397LYD2A-2	10250T397LYD2A-51				
	Blue	10250T397LLD2A-53	10250T397LLD2A-1	10250T397LLD2A-51				
	White	10250T397LWD2A-53	10250T397LWD2A-1	10250T397LWD2A-51				
	Transformer	120 Vac	Red		10250T411LRD06-53	10250T411LRD06-1	10250T411LRD06-51	
			Green		10250T411LGD06-53	10250T411LGD06-1	10250T411LGD06-51	
Amber				10250T411LAD06-53	10250T411LAD06-1	10250T411LAD06-51		
Yellow				10250T411LYD06-53	10250T411LYD06-1	10250T411LYD06-51		
Blue				10250T411LLD06-53	10250T411LLD06-1	10250T411LLD06-51		
White				10250T411LWD06-53	10250T411LWD06-1	10250T411LWD06-51		
Incandescent Lamp								
Full voltage			24 Vac/Vdc	Red	#757	10250T476C21-53	10250T476C21-1	10250T476C21-51
				Green		10250T476C22-53	10250T476C22-1	10250T476C22-51
				Amber		10250T476C43-53	10250T476C43-1	10250T476C43-51
	Yellow	10250T476C23-53		10250T476C23-1		10250T476C23-51		
	Blue	10250T476C24-53		10250T476C24-1		10250T476C24-51		
	Clear	10250T476C25-53		10250T476C25-1		10250T476C25-51		
	White	10250T476C26-53		10250T476C26-1		10250T476C26-51		
Resistor	120 Vac/Vdc	Red	120MB	10250T471C21-53	10250T471C21-1	10250T471C21-51		
		Green		10250T471C22-53	10250T471C22-1	10250T471C22-51		
		Amber		10250T471C43-53	10250T471C43-1	10250T471C43-51		
		Yellow		10250T471C23-53	10250T471C23-1	10250T471C23-51		
		Blue		10250T471C24-53	10250T471C24-1	10250T471C24-51		
		Clear		10250T471C25-53	10250T471C25-1	10250T471C25-51		
		White		10250T471C26-53	10250T471C26-1	10250T471C26-51		
Transformer	120 Vac	Red	#755	10250T75R ①	10250T76R ①	10250T77R ①		
		Green		10250T75G ①	10250T76G ①	10250T77G ①		
		Amber		10250T75A ①	10250T76A ①	10250T77A ①		
		Yellow		10250T75Y ①	10250T76Y ①	10250T77Y ①		
		Blue		10250T75B ①	10250T76B ①	10250T77B ①		
		Clear		10250T75C ①	10250T76C ①	10250T77C ①		
		White		10250T75W ①	10250T76W ①	10250T77W ①		

Note

① For flashing module catalog number 10250TFL1, add suffix code **FM** to listed catalog number. Example: 10250T75RFM.

Indicating Light Units ①

UL (NEMA) Type 3, 3R, 4, 4X, 12, 13

- LED or incandescent
- Full voltage, resistor or transformer type
- Standard and PresTest types
- Plastic lenses

PresTest—This device incorporates a press-to-test feature whereby depressing the lens disconnects the light from the source being

monitored and connects the lamp to a continuously energized circuit for immediate detection of faulty lamps.

24V Full Voltage Illuminated Light



120 Vac Transformer PresTest



Indicating Light Units

Type	Voltage	Color	LED/Lamp Number	Indicating Light Catalog Number	PresTest Catalog Number		
LED Lamp							
Full voltage	24 Vac/Vdc	Red	Bayonet base	10250T197LRP24	10250T297LRP24		
		Green		10250T197LGP24	10250T297LGP24		
		Amber		10250T197LAP24	10250T297LAP24		
		Yellow		10250T197LYP24	10250T297LYP24		
		Blue		10250T197LLP24	10250T297LLP24		
		White		10250T197LWP24	10250T297LWP24		
		120 Vac		Red	10250T197LRP2A	10250T297LRP2A	
				Green	10250T197LGP2A	10250T297LGP2A	
	Amber		10250T197LAP2A	10250T297LAP2A			
	Yellow		10250T197LYP2A	10250T297LYP2A			
	Blue		10250T197LLP2A	10250T297LLP2A			
	White		10250T197LWP2A	10250T297LWP2A			
	Transformer		120 Vac	Red	10250T181LRP06	10250T221LRP06	
				Green	10250T181LGP06	10250T221LGP06	
		Amber		10250T181LAP06	10250T221LAP06		
		Yellow		10250T181LYP06	10250T221LYP06		
Blue		10250T181LLP06		10250T221LLP06			
White		10250T181LWP06		10250T221LWP06			
Incandescent Lamp							
Full voltage		24 Vac/Vdc		Red	#757	10250T206NC1N	10250T235NC21
	Green		10250T206NC2N	10250T235NC22			
	Amber		10250T206NC19N	10250T235NC43			
	Yellow		10250T206NC3N	10250T235NC23			
	Blue		10250T206NC4N	10250T235NC24			
	Clear		10250T206NC5N	10250T235NC25			
	White		10250T206NC6N	10250T235NC26			
	Resistor	120 Vac/Vdc	Red	120MB	10250T201NC1N	10250T231NC21	
			Green		10250T201NC2N	10250T231NC22	
			Amber		10250T201NC19N	10250T231NC43	
			Yellow		10250T201NC3N	10250T231NC23	
			Blue		10250T201NC4N	10250T231NC24	
			Clear		10250T201NC5N	10250T231NC25	
			White		10250T201NC6N	10250T231NC26	
Transformer ②	120 Vac	Red	#755	10250T34R	10250T74NR		
		Green		10250T34G	10250T74NG		
		Amber		10250T34A	10250T74NA		
		Yellow		10250T34Y	10250T74NY		
		Blue		10250T34B	10250T74NB		
		Clear		10250T34C	10250T74NC		
		White		10250T34W	10250T74NW		

Notes

- ① Standard indicating lights are rated UL (NEMA) 3S as well.
- ② For flashing lamp add letter **F** to listed catalog number. Example: 10250T34RF.

1

Illuminated Pushbuttons and Indicating Lights

- LED or incandescent
- Full voltage, resistor or transformer type

Illuminated Pushbutton



Indicating Light



PresTest



Master Test



Operators without Lens

Type	Voltage	LED/Lamp Number	Illuminated Pushbutton Catalog Number	Indicating Light Catalog Number	PresTest Catalog Number	Master Test Catalog Number
Incandescent Unit						
Full voltage AC/DC	6	#755	10250T473	10250T203N	10250T232N	—
	12	#756	10250T474	10250T204N	10250T233N	—
	24	#757	10250T476	10250T206N	10250T235N	—
	32	#1828	10250T477	10250T207N	10250T238N	—
	48	#1835	10250T478	10250T208N	10250T239N	—
Resistor AC/DC ^②	120	120MB	10250T471	10250T201N	10250T231N	—
	240	120MB	10250T472	10250T202N	10250T240N	—
Transformer AC only ^③	24	#755	10250T416	—	—	—
	120		10250T411	10250T181N	10250T221N	—
	240		10250T422	10250T182N	10250T222N	—
	277		10250T419	10250T198N	—	—
	380		10250T413	10250T183N	10250T223N	—
	480		10250T414	10250T184N	10250T224N	—
Neon AC/DC ^④	120	NE51H-R22	—	10250T226N	—	—
	240	NE51H-R68	—	10250T227N	—	—
Solid-state 50/60 Hz only	120	120MB	—	—	—	10250T189N
LED (LEDs not included) ^①						
Full voltage	—	Bayonet base	10250T397L	10250T197L	10250T297L	—
Transformer AC only	24		10250T416L	—	—	—
	120		10250T411L	10250T181L	10250T221L	—
	240		10250T412L	10250T182L	10250T222L	—
	277		10250T419L	10250T198L	—	—
	380		10250T413L	10250T183L	10250T223L	—
	480		10250T414L	10250T184L	10250T224L	—
	600		10250T415L	10250T185L	10250T225L	—

Notes

- ① These units do not include lamps. Order LED separately to match lens color. See **Page V7-T1-275** for LED Selection and **Page V7-T1-222** for Catalog Numbering System.
- ② Resistor units are not available for use with LEDs, choose either transformer or full voltage LED style.
- ③ For flashing lamp, add letter **F** to listed catalog number. Example: 10250T181NF.
- ④ Resistant to shock and vibration. For best illumination use amber, yellow or clear lens.

Plastic



Indicating and Master Test Lenses

Color	Plastic Catalog Number	Glass Catalog Number
Red	10250TC1N	10250TC7N
Green	10250TC2N	10250TC8N
Amber	10250TC19N	10250TC9N
Yellow	10250TC3N	—
Blue	10250TC4N	10250TC10N
Clear	10250TC5N	10250TC11N
White	10250TC6N	10250TC12N

Glass



10250TC2



Illuminated Pushbutton Lenses

Color	Catalog Number
Red	10250TC21
Green	10250TC22
Yellow	10250TC23
Amber	10250TC43
Blue	10250TC24
Clear	10250TC25
White	10250TC26

Plastic



PresTest Lenses

Color	Plastic Catalog Number	Glass Catalog Number
Red	10250TC21	10250TC13N
Green	10250TC22	10250TC14N
Amber	10250TC43	10250TC15N
Yellow	10250TC23	—
Blue	10250TC24	10250TC16N
Clear	10250TC25	10250TC17N
White	10250TC26	10250TC18N

Glass



1.10

Pushbuttons and Indicating Lights

30.5 mm Heavy-Duty Watertight/Oiltight—10250T

1 Push-Pull Emergency Stops (Compliant with IEC 60947-5-5)

UL (NEMA) Type 3, 3R, 4, 4X, 12, 13

- Two- and three-position
- Non-illuminated
- LONC contact block

10250T579C47-71X



Two-Position Push-Pull Units

Operator Position ①

Pull	Push	Button Type/Color	Lamp	Type	Voltage	Catalog Number
X	0	40 mm red—illuminated	Incandescent	Transformer	120 Vac/Vdc	10250T563C47-71X
X	0	40 mm red—illuminated EMERG. STOP	Incandescent	Transformer	120 Vac/Vdc	10250T563C53-71X
X	0	40 mm red—illuminated EMERG. STOP	LED	Transformer	120 Vac/Vdc	10250T563LED06-71X
X	0	40 mm red—illuminated	Incandescent	Full voltage	24 Vdc	10250T579C47-71X
X	0	40 mm red—illuminated EMERG. STOP	Incandescent	Full voltage	24 Vdc	10250T579C53-71X
X	0	40 mm red—illuminated	Incandescent	Resistor	120 Vac/Vdc	10250T580C47-71X
X	0	40 mm red—illuminated EMERG. STOP	Incandescent	Resistor	120 Vac/Vdc	10250T580C53-71X
X	0	40 mm red—illuminated	Incandescent	Transformer	24 Vac	10250T589C47-71X
X	0	40 mm red—illuminated EMERG. STOP	Incandescent	Transformer	24 Vac	10250T589C53-71X
X	0	40 mm red—illuminated EMERG. STOP	LED	Transformer	24 Vac	10250T589LED06-71X
X	0	40 mm red—illuminated	LED	Transformer	24 Vac	10250T589LRD06-71X
X	0	40 mm red—illuminated EMERG. STOP	LED	Full voltage	24 Vdc	10250T597LED24-71X
X	0	40 mm red—illuminated EMERG. STOP	LED	Full voltage	120 Vac/Vdc	10250T597LED2A-71X
X	0	40 mm red—illuminated	LED	Full voltage	24 Vdc	10250T597LRD24-71X
X	0	40 mm red—illuminated	LED	Full voltage	120 Vac/Vdc	10250T597LRD2A-71X
X	0	40 mm red	—	—	—	10250T5B62-71X
X	0	40 mm red—EMERG. STOP	—	—	—	10250T5B63-71X
X	0	65 mm red	—	—	—	10250T5J62-71X
X	0	65 mm red—EMERG. STOP	—	—	—	10250T5J63-71X

Note













① X = closed circuit, 0 = open circuit.

UL (NEMA) Type 3, 3R, 4, 4X, 12, 13



Two-Position Push-Pull Units

Operator Position ^①



	Operator Position ^①		Button Type/Color ^②	Contact Type	Mounting Location		Catalog Number ^②
	Pull	Push			A	B	
Two-Position Maintained Push, Maintained Pull							
 10250T5B62-1X	O	X	40 mm/red	1NO			10250T5B62-1X
	X	O		1NC			
 10250T5B63-1X	O	X	40 mm engraved EMERG. STOP/red	1NO			10250T5B63-1X
	X	O		1NC			
 10250T5J63-1X	O	X	65 mm aluminum engraved EMERG. STOP/red	1NO			10250T5J63-1X
	X	O		1NC			
 10250ED1080-2	O	X	65 mm aluminum engraved EMERG. STOP/red Special security jumbo mushroom head	1NO			10250ED1080-2
	X	O		1NC			

Button and Color Selection

	Color	Suffix Code	Catalog Number
Standard 	Standard—40 mm		
	Red	B62	10250TB62
	Red (EMERG. STOP)	B63	10250TB63
	Green	B61	10250TB61
	Black	B60	10250TB60
	Blue	B64	10250TB64
Jumbo Mushroom Head 	Jumbo Mushroom Head ^③ (Anodized) Aluminum—65 mm		
	Red	J62	10250TJ62
	Red (EMERG. STOP)	J63	10250TJ63
	Green	J61	10250TJ61
	Black	J60	10250TJ60
	Yellow	J64	10250TJ64

Notes

- ① X = closed circuit, O = open circuit.
- ② To order different type or color buttons, substitute the underlined characters with appropriate suffix code from the table.
Example: 10250T5B64-1X.
- ③ Anodized aluminum head is not suitable for use in ultraviolet light applications.

1.10

Pushbuttons and Indicating Lights

30.5 mm Heavy-Duty Watertight/Oiltight—10250T

1

UL (NEMA) Type 3, 3R, 4, 4X, 12, 13

10250T_

Three-Position Push-Pull Units

Operator Position ^①



Pull	Intermediate	Push	Button Type/Color ^②	Contact Type	Mounting Location		Catalog Number ^②
					A	B	
Maintained Push, Momentary Pull							
X	0	0	40 mm/black	1NC			10250T9B60-3X
X	X	0	40 mm/red	1NC			10250T9B62-3X
			40 mm engraved EMERG. STOP/red				10250T9B63-3X
Momentary Push, Momentary Pull							
X	0	0	40 mm/black	1NC			10250T4B60-3X
X	X	0	40 mm/red	1NC			10250T4B62-3X
0	0	X	40 mm/black	1NO			10250T10B60-1X
X	0	0	40 mm/red	1NC			10250T10B62-1X

Button and Color Selection

Color	Suffix Code	Catalog Number
Standard—40 mm		
Red	B62	10250TB62
Red (EMERG. STOP)	B63	10250TB63
Green	B61	10250TB61
Black	B60	10250TB60
Blue	B64	10250TB64
Jumbo Mushroom Head ^③ (Anodized) Aluminum—65 mm		
Red	J62	10250TJ62
Red (EMERG. STOP)	J63	10250TJ63
Green	J61	10250TJ61
Black	J60	10250TJ60
Yellow	J64	10250TJ64

Notes

- ① X = closed circuit, 0 = open circuit.
- ② To order different type or color buttons, substitute the underlined characters with appropriate suffix code from the table.
Example: 10250T5B64-1X.
- ③ Anodized aluminum head is not suitable for use in ultraviolet light applications.

Standard



Jumbo Mushroom Head



Illuminated Push-Pull Units

UL (NEMA) Type 3, 3R, 4, 4X, 12, 13

- LED or incandescent
- Full voltage, resistor or transformer type
- Two-position maintained

Two-Position Push-Pull Operator



Two-Position Illuminated Maintained Push, Maintained Pull

Operator Position ①

Maintained—Pull	Maintained—Push	Lamp	Type	Voltage	Contact Type	Mounting Location A	Mounting Location B	LED/Lamp Number	Red Standard Push-Pull Catalog Number ②
0	X	LED	Full Voltage	24 Vac/Vdc	1NO			Bayonet base	10250T597LRD24-1X
X	0			120 Vac/Vdc	1NC				10250T597LRD24A-1X
			Transformer	24 Vac		10250T589LRD06-1X			
				120 Vac		10250T563LRD06-1X			
0	X	Incandescent	Full voltage	24 Vac/Vdc	1NO			#757	10250T579C47-1X
X	0			120 Vac/Vdc	1NC			120MB	10250T580C47-1X
			Transformer	24 Vac			#755	10250T589C47-1X	
				120 Vac			10250T563C47-1X		

10250ED137_

Jumbo Lens Illuminated E-Stops



Lamp	Button Type/Color	Type	Voltage	Contact Type	Catalog Number
LED	Two-position illuminated maintained push/pull— 50 mm jumbo lens/red	Full voltage	24 Vac/Vdc	1NO 1NC	10250ED1375
LED	Three-position illuminated momentary push/pull— 50 mm jumbo lens/red	Full voltage	24 Vac/Vdc	1NC 1NC	10250ED1376
LED	Three-position illuminated momentary push/pull— 50 mm jumbo lens/red	Full voltage	24 Vac/Vdc	1NO 1NC	10250ED1377
LED	Three-position illuminated maintained push/momentary pull— 50 mm lens/red	Full voltage		1NO 1NC	10250ED1378

Notes

- ① X = closed circuit, 0 = open circuit.
- ② To order different type or color lens, substitute the underlined characters with appropriate suffix code from table on next page. Example: 10250T579C63-1X. For LEDs with different voltages see ordering example on **Page V7-T1-241**.

1.10





Pushbuttons and Indicating Lights

30.5 mm Heavy-Duty Watertight/Oiltight—10250T

1

UL (NEMA) Type 3, 3R, 4, 4X, 12, 13

Lens and Color Selection

	Color	Incandescent Suffix Code	LED Suffix Code	Catalog Number
Standard 	Standard—40 mm			
	Red	C47	RD	10250TC47
	Red (EMERG. STOP)	C53	ED	10250TC53
	Green	C48	GD	10250TC48
	Blue	C49	LD	10250TC49
	Amber	C50	AD	10250TC50
	White	C51	WD	10250TC51
	Clear	C52	CD	10250TC52
Side-Lighted Aluminum 	Side-Lighted Aluminum—40 mm ①			
	Red	C57	RS	10250TC57
	Red (EMERG. STOP)	C63	ES	10250TC63
	Green	C58	GS	10250TC58
	Blue	C59	LS	10250TC59
	Amber	C64	AS	10250TC64
	Yellow	C60	YS	10250TC60
	White	C61	WS	10250TC61
Clear	C62	CS	10250TC62	
Aluminum Transparent Center 	Aluminum Transparent Center—40 mm ①			
	Red	C65	RH	10250TC65
	Green	C66	GH	10250TC66
Jumbo Lens 	Jumbo Lens—50 mm			
Red	—	—	10250TC77	

Note

① Clear anodized aluminum and colored lens.

UL (NEMA) Type 3, 3R, 4, 4X, 12, 13

Three-Position Push-Pull Operator



Three-Position Illuminated Momentary Push, Momentary Pull

Operator Position ①

Momentary— Pull	Maintained— Intermediate	Momentary— Push	Lamp	Type	Voltage	Contact Type	Mounting Location		LED/ Lamp Number	Red Standard Push-Pull Catalog Number ③
							A	B		
0	0	X	LED	Full voltage	24 Vac/Vdc	1NO			Bayonet base	10250T1097LRD24-1X
X	0	0			120 Vac	1NC				10250T1097LRD2A-1X
				Transformer	24 Vac					10250T1089LRD06-1X
					120 Vac					10250T1063LRD06-1X
X	0	0	Incan- descent	Full voltage	24 Vac/Vdc	1NC			Bayonet base	10250T497LRD24-3X
X	X	0			120 Vac	1NC				10250T497LRD2A-3X
				Transformer	24 Vac					10250T489LRD06-3X
					120 Vac					10250T463LRD06-3X
0	0	X	Incan- descent	Full voltage	24 Vac/Vdc	1NO			#757	10250T1079C47-1X
X	0	0			Resistor	120 Vac				1NC
				Transformer	24 Vac				#755	10250T1089C47-1X
					120 Vac					10250T1063C47-1X
X	0	0	Incan- descent	Full voltage	24 Vac/Vdc	1NC			#757	10250T479C47-3X
X	X	0			Resistor	120 Vac				1NC
				Transformer	24 Vac				#755	10250T489C47-3X
					120 Vac					10250T463C47-3X

Three-Position Push-Pull Operator



Three-Position Illuminated Maintained Push, Momentary Pull

Operator Position ①

Momentary— Pull	Maintained— Intermediate	Momentary— Push	Lamp	Type	Voltage	Contact Type	Mounting Location		LED/ Lamp Number	Red Standard Push-Pull Catalog Number ②
							A	B		
X	0	0	LED	Full voltage	24 Vac/Vdc	1NC			Bayonet base	10250T997LRD24-3X
X	X	0			120 Vac	1NC				10250T997LRD2A-3X
				Transformer	24 Vac					10250T989LRD06-3X
					120 Vac					10250T963LRD06-3X
X	0	0	Incan- descent	Full voltage	24 Vac/Vdc	1NC			#757	10250T979C47-3X
X	X	0			Resistor	120 Vac				1NC
				Transformer	24 Vac				#755	10250T989C47-3X
					120 Vac					10250T963C47-3X

Notes

- ① X = closed circuit, 0 = open circuit.
- ② To order different type or color lens, substitute the underlined characters with appropriate suffix code from table on **Page V7-T1-236**. Example: 10250T1079C53-1X. For LEDs with different voltages see ordering example on **Page V7-T1-241**.
- ③ To order different type or color lens, substitute the underlined characters with appropriate suffix code from table on **Page V7-T1-236**. Example: 10250T979C53X. For LEDs with different voltages see ordering example on **Page V7-T1-241**.

Potentiometers

UL (NEMA) Type 3, 3R, 4, 4X, 12, 13

Vertical or Horizontal
One-Hole Mounting ①**Potentiometer with Knob and Standard Dial Plate—Linear Type $\pm 10\%$**

Potentiometer Ohms	Catalog Number
2 Watt (60V Max.) Single Potentiometer with Standard Aluminum Dial Plate ②③	
1000	10250T331
2500	10250T332
5000	10250T338
10000	10250T333
25000	10250T334
50000	10250T335
Operator only ④	10250T330
Alternative—black plastic large legend with standard markings	E34LP99

Notes

- ① Shown with standard aluminum dial plate.
- ② Large dial plate with space for legend is available at no charge. To order, add suffix **36** to catalog number. Example: 10250T331**36**. To order separately, see footnote ③ below.
- ③ Large dial plate has space at top for 15 letters. 3/32 in high. For custom stamped legend plates, order legend plate as separate item **10250TR30** and specify stamping.
- ④ For use with commercially purchased potentiometers having shaft dimensions per dimension drawing on **Page V7-T1-285**.

Push-Pull Operators

An illuminated push-pull pushbutton unit, arranged for one-hole mounting, can replace two pushbuttons and a pilot light or the non-illuminated form can replace two pushbuttons. These units are available in three basic types:

- **Maintained**—(Two-position). Maintains in the pulled or pushed position until manually actuated to the opposite mode.
- **Momentary**—(Three-position). Spring returns to an intermediate position when pulled or pushed and released.
- **Momentary Pull, Maintained Push**—(Three-position). Spring returns to intermediate position when pulled. Maintains in pushed position until manually returned to intermediate (ready to reset) position. Maintained stop holds circuit open and will prevent other series connected operators from starting the system.

The operators, buttons, contact blocks, etc., are offered as building block components that can be intermixed to satisfy many requirements. This minimizes the need for a varied and costly inventory.

Two-Position Maintained Push-Pull ①



Typical Applications

Control	Line—Diagram	Operator	Circuits	Operator Mode						
Three-wire three-position momentary		Momentary push and pull 10250T4	2NC contact block 10250T3	<table border="0"> <tr> <td>START (mom.)</td> <td>Normal pos. (maint.)</td> <td>STOP (mom.)</td> </tr> <tr> <td></td> <td></td> <td></td> </tr> </table>	START (mom.)	Normal pos. (maint.)	STOP (mom.)			
START (mom.)	Normal pos. (maint.)	STOP (mom.)								
Two-wire two-position maintained		Maintained push and pull 10250T5	1NC contact block 10250T1	<table border="0"> <tr> <td>START (maint.)</td> <td>No intermediate position</td> <td>STOP (maint.)</td> </tr> <tr> <td></td> <td></td> <td></td> </tr> </table>	START (maint.)	No intermediate position	STOP (maint.)			
START (maint.)	No intermediate position	STOP (maint.)								
Three-wire momentary pull maintained push		Maintained push and momentary pull 10250T9	2NC contact block 10250T3	<table border="0"> <tr> <td>START (mom.)</td> <td>Normal pos. (maint.)</td> <td>STOP (maint.)</td> </tr> <tr> <td></td> <td></td> <td></td> </tr> </table>	START (mom.)	Normal pos. (maint.)	STOP (maint.)			
START (mom.)	Normal pos. (maint.)	STOP (maint.)								

Notes

- A and B circuits shown in the application illustrations are defined in the "Application Guide" on the following page.
 ① Shown without button on lens.

1.10

Pushbuttons and Indicating Lights

30.5 mm Heavy-Duty Watertight/Oiltight—10250T

1

Application Guide

To assist in the selection of contact blocks, the sketch to the right shows pictorially by symbols **A** and **B** locations of contact circuits after assembly of contact blocks

and adapter to the operator. The table below shows the effect of the push and pull operations on either NO or NC contacts. (X = contact closed, O = contact open).

Contact Circuit Locations

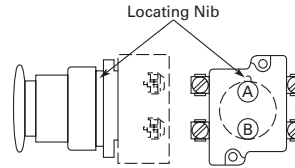

10250T579C47-71X

Push-Pull Operator Components



Operator Position and Circuit Arrangement



Contact Block Mounting Location

Type of Operator	Out—Pull		Intermediate		In—Push		Contact Block ①	Catalog Number
	A	B	A	B	A	B		
Two-Position Operator without Lens								
Maintained push-pull	O	O	No intermediate position		X	X	1NO	10250T5
	X or	X			O or	O	1NC	
Maintained push-pull with anti-theft jumbo mushroom	O	O	No intermediate position		X	X	1NO	10250ED1080
	X or	X			O or	O	1NC	
	O	O			X	X	2NO	
	X	X			O	O	2NC	
Three-Position Operator without Lens								
Momentary push-pull	O	O	O	O	X	O	1NO	10250T4 ①
	X or	X	O or	X	O or	O	1NC	
	O	O	O	O	X	O	2NO	
	X	X	O	X	O	O	2NC	
Maintained push-momentary pull	O	O	O	O	X	O	1NO	10250T9 ①
	X or	X	O or	X	O or	O	1NC	
	O	O	O	O	X	O	2NO	
	X	X	O	X	O	O	2NC	
Momentary push-pull	O	O	O	O	X	X	1NO	10250T10 ①
	X or	X	O or	O	O or	O	1NC	
	O	O	O	O	X	X	2NO	
	X	X	O	O	O	O	2ND	

Note

① Maximum of two blocks, four circuits. Special function contact blocks shown on **Page V7-T1-271** CANNOT be used with three-position push-pull operators 10250T4, 10250T9 or 10250T10.

Push-Pull Light Units, Lenses and Buttons

Ordering Example with One Composite Number

Non-illuminated:

10250T5 + 10250TB62 + 10250T1 = **10250T5B62-1X**

Incandescent:

10250T5 + 10250T79 + 10250TC47 + 10250T1 = **10250T579C47-1X**

LED:

10250T5 + 10250T97L + 10250TC47 + Voltage code + 10250T1 = **10250T597LRD24-1X**

06—6 Vac/Vdc	60—60 Vac/Vdc
12—12 Vac/Vdc	2A—120 Vac
24—24 Vac/Vdc	2D—120 Vdc
48—48 Vac/Vdc	





Light Units for Illuminated Push-Pull Devices

Light Unit Type	Type	Voltage	LED/Lamp Number	Catalog Number	
LED (LEDs not included) ^①	Full voltage	—	Bayonet base	10250T97L	
	Transformer	24		10250T89L	
	AC only	120		10250T63L	
	50/60 Hz	208		10250T64L	
		240		10250T65L	
		277		10250T82L	
		380		10250T66L	
		480		10250T67L	
		600		10250T68L	
		Incandescent		Full voltage	6
AC or DC			12	10250T70	
	24/28		10250T79		
	32		10250T83		
	Resistor		120	120MB	10250T80
AC or DC	240			10250T81	
	Transformer		24	#755	10250T89
	AC only		120	10250T63	
	50/60 Hz		208	10250T64	
			240	10250T65	
		277	10250T82		
		380	10250T66		
		480	10250T67		
600		10250T68			



Note

① These units do not include lamps. Order LED separately to match lens color, see **Page V7-T1-275**.

Alternate Lenses for Illuminated Push-Pull Devices

	Lens Color	Incandescent Suffix Code	LED Suffix Code ①	Catalog Number
Standard 	Standard			
	Red	C47	RD	10250TC47
	Red (EMERG. STOP)	C53	ED	10250TC53
	Green	C48	GD	10250TC48
	Blue	C49	LD	10250TC49
	Amber	C50	AD	10250TC50
	White	C51	WD	10250TC51
	Clear	C52	CD	10250TC52
Side-Lighted Anodized Aluminum Ring 	Side-Lighted Anodized Aluminum Ring			
	Red	C57	RS	10250TC57
	Red (EMERG. STOP)	C63	ES	10250TC63
	Green	C58	GS	10250TC58
	Blue	C59	LS	10250TC59
	Amber	C64	AS	10250TC64
	Yellow	C60	YS	10250TC60
	White	C61	WS	10250TC61
	Clear	C62	CS	10250TC62
Heavy-Duty Aluminum 	Heavy-Duty Aluminum with Transparent Center			
	Red	C65	RH	10250TC65
	Green	C66	GH	10250TC66
	Amber	C67	AH	10250TC67
	White	C68	—	10250TC68
Jumbo Lens 	Jumbo Lens—50 mm			
Red	—	—	10250TC77	

Buttons for Non-Illuminated Push-Pull Devices

	Color	Suffix Code	Catalog Number
Standard 	Standard		
	Red	B62	10250TB62
	Red (EMERG. STOP)	B63	10250TB63
	Green	B61	10250TB61
	Black	B60	10250TB60
	Blue	B64	10250TB64
Jumbo Mushroom Head (Anodized) Aluminum 	Jumbo Mushroom Head ② (Anodized) Aluminum		
	Red	J62	10250TJ62
	Red (EMERG. STOP)	J63	10250TJ63
	Green	J61	10250TJ61
	Black	J60	10250TJ60
	Yellow	J64	10250TJ64

Notes

- ① Suffix codes should only be used for assembling composite catalog numbers. To order lens above, order by catalog number.
- ② Anodized aluminum head is not suitable for use in ultraviolet light applications.

Legend Plates

For a complete listing of available legend plates see **Pages V7-T1-266 to V7-T1-268**.

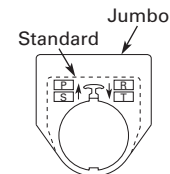

Selector Switch Units

UL (NEMA) Type 3, 3R, 4, 4X, 12, 13

- Two-, three- and four-position maintained
- Non-illuminated and illuminated

Two-Position Maintained Switch



Two-Position Selector Switch

Operator Position ^①		Operator Action ^②	Contact Type	Mounting Location		Non-Illuminated		Illuminated—120V Transformer	
				A	B	Black Knob Catalog Number ^③	Black Lever Catalog Number ^③	Red Knob Catalog Number ^③	Red Lever Catalog Number ^③
X	0		1NC			<u>10250T20KB</u>	<u>10250T20LB</u>	<u>10250ED1117-KR</u>	<u>10250ED1117-LR</u>
0	X		1NO						

Three-Position Maintained Switch



Three-Position Selector Switch

Operator Position ^①			Operator Action ^②	Contact Type	Mounting Location		Non-Illuminated		Illuminated—120V Transformer	
					A	B	Black Knob Catalog Number ^③	Black Lever Catalog Number ^③	Red Knob Catalog Number ^③	Red Lever Catalog Number ^③
X	0	0		1NO		<u>10250T21KB</u>	<u>10250T21LB</u>	<u>10250ED1117-2KR</u>	<u>10250ED1117-2LR</u>	
0	0	X		1NO						

Three-Position Maintained Switch



X	0	0		1NO		<u>10250T22KB</u>	<u>10250T22LB</u>	<u>10250ED1117-3KR</u>	<u>10250ED1117-3LR</u>
0	X	0		2NC (Series)					
0	0	X		1NO					

Three-Position Maintained Switch



Four-Position Selector Switch

Operator Position ^①				Operator Action ^②	Contact Type	Mounting Location		Non-Illuminated		Illuminated—120V Transformer	
						A	B	Black Knob Catalog Number ^③	Black Lever Catalog Number ^③	Red Knob Catalog Number ^③	Red Lever Catalog Number ^③
X	0	0	0		1NC		<u>10250T46KB</u>	<u>10250T46LB</u>	<u>10250ED1117-4KR</u>	<u>10250ED1117-4LR</u>	
0	X	0	0		1NO						
0	0	X	0		1NO						
0	0	0	X		1NC						

Color Selection

Illuminated						Non-Illuminated					
Color	Code Letter	Color	Code Letter	Color	Code Letter	Color	Code Letter	Color	Code Letter	Color	Code Letter
Red	R	White	W	Amber	A	Black	B	Green	G	Blue	L
Green	G	Blue	B	Clear	C	Red	R	White	W	Orange	O

Notes

- ① X = closed circuit, 0 = open circuit.
- ② M = Maintained.
- ③ To order different type or color selector switch, substitute the underlined character with appropriate suffix code from the Color Selection table. Example: 10250T20KG.

1

Selector Switch Selection



Cam and Contact Block Selection

Selector switches in their varied forms (two-position, three-position and four-position) are a big factor contributing to the great flexibility of control that a well rounded line of “pushbuttons” can achieve. Because of their flexibility, they tend to cause difficulty with product selection and application. The following systematic approach should simplify that task.

Cam and contact block selection is better understood if you:

- Work with each incoming and outgoing wire/circuit separately.
- Recognize the terms NO and NC only identify the type of contact by its mode before mounting to the operator. The “X-O” table (Page V7-T1-246) shows how that contact will act after assembly to the operator with the selected cam shape. X = closed circuit, O = open circuit.

- Up to six NO or NC contacts may be mounted behind each plunger location for a total of twelve contacts. Single circuit contact blocks have only one plunger with the other side of the block “open.” Therefore, single circuit contact blocks transmit motion to blocks behind them only for the position containing the circuit.
- Each cam has two separate lobes, each of which operates one of the two contact block plungers independently of each other. Those are identified as position A (locating nib side) and position B (opposite of locating nib). The position designations give direction in selecting and mounting of the contact blocks.

Contact Circuit Locations

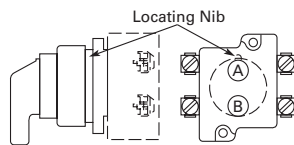

Systematic Approach

Application: **HAND-OFF-AUTO** selector switch. In this circuit, one incoming line is distributed to two other outgoing circuits by the switch. The two circuits can be looked at individually.

Step 1: Elementary Diagram.

Construct on paper, or in your mind, a simple elementary diagram of the switching scheme as follows:

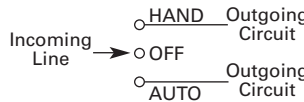

Step 2: “X-O” Pattern.

From the elementary diagram, you can construct an “X-O” diagram which describes when the contacts are to be closed (X) or open (O) in the various positions of the switch. The “X-O” for the **HAND** circuit looks like this:



In this circuit, you want a contact closed on the left (HAND) but open in the center and right.

For the **AUTO** circuit, the “X-O” diagram would look like this:

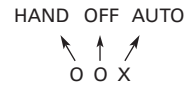

Putting them together, the complete “X-O” diagram is:



Once the “X-O” diagram has been generated the next step is to select the cam and contact block, or blocks, needed to perform the desired “X-O” functions. The selection tables on the following pages list the various types (shapes) of cams by number to choose from and the type of contact and position to achieve the function outlined in your “X-O” diagram.

Step 3: Cam Selection.

The cam you select determines the operation of all contact blocks mounted to the operator. It is selected on the basis that it provides the simplest circuitry for the desired “X-O” diagram. The selection tables show all the “X-O” combinations. For the purpose of this example, the applicable portion of those tables is shown on this page.

Now to make the cam selection, make a simple worksheet such as:

	Cam 2	Cam 3
X O O	(A)NO-(B)NC	(A)NO
O O X	(B)NO	(B)NO

It becomes immediately obvious that cam 3 is the better choice for two reasons, (1) the series combination can be avoided making it simpler to wire, (2) only two contacts are required, which is less expensive than the three contacts required by cam 2.

Step 4: Contact Block Selection.

Having selected the cam, contact block selection is simply a matter of gathering the A position and B position circuits into pairs which make up the most convenient contact block arrangement. If there is an imbalance in the number of circuits under A or B, then single circuit blocks must be selected for these leftover circuits.

Back to the worksheet, having selected cam 3 do this:



Step 5: Selector Switch Operator.

Lastly, you have to choose from the many types of operators—knob and lever in various colors or keyed. Also what combinations of maintained and spring return functions are required. Selection of these operators can be found on **Page V7-T1-248**. For the example in step 4 you may want a three-position maintained black knob, cam 3—Catalog Number 10250T1323.

The Complete Switch: 10250T1323 with one 10250T2 or, for one composite catalog number, 10250T21KB found on **Page V7-T1-243**.

Diagrams

Circuits shown illustrate connections to obtain a selector switch circuit combination and are shown with their appropriate line diagrams. Field wiring of jumper connections required as shown.

X = Closed circuit
O = Open circuit

Wiring of Jumper Connections

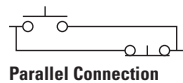

Four-position selector switches are limited to four contact blocks.

Contact Blocks

For selection and number of available contact blocks per operator, see **Pages V7-T1-271 to V7-T1-274**.

Example Selection Table

No.	“X-O” Pattern	Cam Code #2		Cam Code #3	
		Top A	Bottom B	Top A	Bottom B
1	X 0 0				—
4	0 0 X	—		—	

Two-Position Selector Switch Contact Block Selection

No.	Desired Circuit and Operator Position		Contact Blocks Required to Accomplish Circuit Function	
			Top Plunger A	Bottom Plunger B
1	X	0		or
2	0	X		or

Note
① Wired in series.

1.10

Pushbuttons and Indicating Lights

30.5 mm Heavy-Duty Watertight/Oiltight—10250T

1 Three-Position Switch—Cam and Contact Block Selection

No.	Desired Circuit and Operator Position			Contact Blocks Required to Accomplish Circuit Function (Jumpers must be installed where indicated)			
				Operator with Cam Code #2		Operator with Cam Code #3	
				Mounting Location		Mounting Location	
			Top Plunger A	Bottom Plunger B	Top Plunger A	Bottom Plunger B	
1	X	0	0				
2	X	X	0				
3	X	0	X				
4	0	0	X				
5	0	X	X				
6	0	X	0				

Four-Position Switch—Contact Block Selection

No.	Desired Circuit and Operator Position				Contact Blocks Required to Accomplish Circuit Function		No.	Desired Circuit and Operator Position				Contact Blocks Required to Accomplish Circuit Function	
					Top Plunger A	Bottom Plunger B						Top Plunger A	Bottom Plunger B
1	X	0	0	0			10	X	0	X	0		
2	0	X	0	0									
3	0	0	X	0			11	X	X	X	0		
4	0	0	0	X									
5	X	0	0	X			12	0	X	X	X		
6	0	X	X	0									
7	0	0	X	X			13	X	0	X	X		
8	X	X	0	0									
9	0	X	0	X			14	X	X	0	X		

Selector Switch Operators

Key Operators

UL (NEMA) Type 3, 3R, 4, 4X, 12, 13

Two-Position Maintained ^①



Key Operators with Cam

Positions	Operator Action ^②	Cam Code ^③	Optional Key Removal Positions ^④	Vertical Mounting Catalog Number	Horizontal Mounting Catalog Number
Two-position—60° throw		1	1, 2, 3	10250T1511_	10250T1611_
		1	2	10250T1571_	10250T1581_
Three-position—60° throw		2	1-7	10250T1522_	10250T1622_
		3		10250T1523_	10250T1623_
		2	1, 4, 5	10250T1532_	10250T1632_
		3		10250T1533_	10250T1633_
		2	4	10250T1542_	10250T1642_
		3		10250T1543_	10250T1643_
Four-position—40° throw		2	2, 4, 6	10250T1652_	10250T1662_
		3		10250T1653_	10250T1663_
		7	7	10250T1677_	10250T1687_

Notes

- ① Horizontal mount, key removal #1 keyed selector switch, cam 1 shown.
- ② M = Maintained. S = Spring return in direction of arrow (R).
- ③ For selection of the proper cam and contact block to obtain the proper circuit sequence, see selection instructions and tables on **Pages V7-T1-244, V7-T1-245 and V7-T1-246.**
- ④ Choose key removal position required for application from table on **Page V7-T1-248.** Add key removal code no. to listed catalog number. Example: 10250T15112.

Key Removal Positions

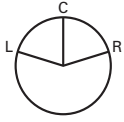

Code Suffix	Key Removal Position
1	Right only
2	Left only
3	Right and left
4	Center only
5	Right and center
6	Left and center
7	All positions

Note: Key removal in “spring return from” positions not recommended.

Replacement Keys or Dissimilar Locks for Key Operators

Operators listed on **Page V7-T1-248** have identical locks and keys (Key Code H661) Catalog Number 10250ED824. For dissimilar lock and key combinations, see listing on this page.

Replacement Key

Description	Catalog Number
Replacement keys (code H661)	10250ED824

Selector Switch Operators with Dissimilar Locks and Keys (UL [NEMA] 4, 4X and 13)

The locks in all key operators listed on **Pages V7-T1-227, V7-T1-248** and **V7-T1-385** are identical and use key code number H661. Two keys are supplied with every lock. For additional code number H661 keys, order **Catalog Number 10250ED824**. For others, order 10250ED1130 and designate lock number. When dissimilar locks for each operator or each group of operators are required, select from the lock and key combination listed below. **When Ordering Operator Only** or a complete control unit with a substitute lock, order from table below and add “except Lock and Key Code No. ...”

“H” Series Locks without Master Key—with Key Slot Cover

Lock and Key Code Numbers		
H501	H635	H663
H620	H639	H675
H621	H643	H683
H634	H654	H688

“M” Series Locks with Master Key—with Key Slot Cover

Lock and Key Code Numbers			
MD1	MD14	ME8	MJ6
MD2	MD15	ME11	MJ10
MD3	MD16	ME16	MJ11
MD4	MD19	ME17	MJ13
MD5	MD20	ME18	MJ15
MD7	ME2	ME19	MJ16
MD9	ME3	MJ1	MD17
MD10	ME5	MJ3	
MD11	ME6	MJ4	
MD13	ME7	MJ5	

Master Keys for Above Locks

Application	Catalog Number
For code:	
MD1–MD20	10250ED825-3
ME2–ME18	10250ED825-4
MJ1–MJ16	10250ED825-5

Selector Switch Operators with Caps

UL (NEMA) Type 3, 3R, 4, 4X, 12, 13

Selector Switch Operators with Caps

Positions	Operator Action ^②	Black Knob Selector Switch—Vertical Mounting ^③		Black Lever Selector Switch—Vertical Mounting ^③		
		Cam Code ^④	Catalog Number	Cam Code ^④	Catalog Number	
Two-Position Maintained ^①	Two-position—60° throw		1	10250T1311	1	10250T3011
			1	10250T1371	1	10250T3071
Three-Position Maintained ^⑤	Three-position—60° throw		2	10250T1322	2	10250T3022
			3	10250T1323	3	10250T3023
			2	10250T1332	2	10250T3032
			3	10250T1333	3	10250T3033
			2	10250T1342	2	10250T3042
			3	10250T1343	3	10250T3043
			2	10250T1352	2	10250T3052
			3	10250T1353	3	10250T3053
Four-position—40° throw		7	10250T1367	7	10250T3067	

Notes

- ① Black knob selector switch, cam 1 shown.
- ② M = Maintained. S = Spring return in direction of arrow.
- ③ Field convertible to horizontal mounting or order operator only and separate operator cap.
- ④ For selection of the proper cam and contact block to obtain the proper circuit sequence, see selection instructions and tables on **Pages V7-T1-244, V7-T1-245** and **V7-T1-246**.
- ⑤ Black lever selector switch, cam 3 shown.

Selector Switch Operators without Caps

Operators can be ordered with caps assembled to them by adding the code number from the table on this page to the end of catalog number below.
Example: 10250T4011**KB**

Two-Position Selector Switch Maintained



Selector Switch Operators without Caps

Positions	Operator Action ①	Cam Code ②	Catalog Number
Two-position—60° throw		1	10250T4011
		1	10250T4081
Three-position—60° throw		2	10250T4022
		3	10250T4023
		2	10250T4032
		3	10250T4033
		2	10250T4042
		3	10250T4043
Four-position—40° throw		2	10250T4052
		3	10250T4053
		7	10250T4067

Knob



Lever



Lever for Use with Maintained Operators



Coin Slot



Operating Caps

Color	Knob Catalog and Code Number	Lever Catalog and Code Number	Color	Lever ③ Catalog and Code Number	Coin Slot Catalog and Code Number
Black	10250TKB	10250TLB	Black	10250TSB	10250TCB
Red	10250TKR	10250TLR	Red	10250TSR	10250TCR
Green	10250TKG	10250TLG	Green	10250TSG	10250TCG
Yellow	10250TKY	10250TLY	Yellow	10250TSY	10250TCY
White	10250TKW	10250TLW	White	10250TSW	10250TCW
Gray	10250TKA	10250TLA	Gray	10250TSA	10250TCA
Blue	10250TKL	10250TLL	Blue	10250TSL	10250TCL
Orange	10250TKD	10250TLO	Orange	10250TSO	10250TCO

Notes

- ① M = Maintained. S = Spring return in direction of arrow (R).
- ② For selection of the proper cam and contact block to obtain the proper circuit sequence, see selection instructions and tables on **Pages V7-T1-244, V7-T1-245 and V7-T1-246**.
- ③ Designed for added ingress protection. For use in maintained operators only.

1

Illuminated Selector Switch Operators

Illuminated Selector Switches without Caps

Two-Position Selector Switch Maintained



Operator without Knob or Lever

Positions	Operator Action ①	Transformer Type—50/60 Hz 6 Volt #755 Lamp			Full Voltage Type—AC or DC ④ Lamps: 6V—#755, 12V—#756, 24V—#757, 48V—#1835, 120/240V—120MB		
		Cam Code ②	Voltage	Code Number and Catalog Number ③	Cam Code ②	Voltage	Code Number and Catalog Number ③
Two-position—60° throw		1	24	10250T5961	1	6	10250T6201
			120	10250T5971		12	10250T6211
			208	10250T6511		24	10250T6221
			240	10250T5981		48	10250T6231
			380	10250T5991		120	10250T6361
			480	10250T6001		240 ⑤	10250T6371
			600	10250T6011			
Three-position—60° throw		+ 2 or 3	24	10250T602_	+ 2 or 3	6	10250T624_
			120	10250T603_		12	10250T625_
			208	10250T652_		24	10250T626_
			240	10250T604_		48	10250T627_
			380	10250T605_		120	10250T638_
			480	10250T606_		240 ⑤	10250T639_
		600	10250T607_				
		+ 2 or 3	24	10250T654_	+ 2 or 3	6	10250T612_
			120	10250T620_		12	10250T632_
			208	10250T655_		24	10250T642_
			240	10250T656_		48	10250T672_
			380	10250T657_		120	10250T622_
			480	10250T658_		240	10250T682_
		600	10250T659_				
	+ 2 or 3	24	10250T660_	+ 2 or 3	6	10250T613_	
		120	10250T621_		12	10250T633_	
		208	10250T661_		24	10250T643_	
		240	10250T662_		48	10250T673_	
		380	10250T663_		120	10250T623_	
		480	10250T664_		240	10250T683_	
	600	10250T665_					
	+ 2 or 3	24	10250T614_	+ 2 or 3	6	10250T628_	
		120	10250T615_		12	10250T629_	
		208	10250T653_		24	10250T630_	
		240	10250T616_		48	10250T631_	
		380	10250T617_		120	10250T640_	
		480	10250T618_		240 ⑤	10250T641_	
	600	10250T619_					
Four-position—40° throw		7	24	10250T6087	7	6	10250T6327
			120	10250T6097		12	10250T6337
			208	10250T6547		24	10250T6347
			240	10250T6107		48	10250T6357
			380	10250T6117		120	10250T6427
			480	10250T6127		240 ⑤	10250T6437
			600	10250T6137			

Notes

- ① M = Maintained. S = Spring return in direction of arrow (R).
- ② For selection of the proper cam and contact block, to obtain the proper circuit sequence, see selection tables on **Pages V7-T1-244, V7-T1-245 and V7-T1-246.**
- ③ Operator includes lens gasket and lens attachment screws.
- ④ Full voltage light units can be used at other than listed voltages by changing lamp. Replacement lamps are listed on **Page V7-T1-275.**
- ⑤ Resistor type. May generate excess heat if used in high density.

Knob



Lever



Illuminated Knobs and Levers

Color ^①	Knob Code Number and Catalog Number	Lever Code Number and Catalog Number
Red	10250TER	10250FR
Green	10250TEG	10250FG
Yellow	10250TEA	10250FA
Blue	10250TEL	10250FL
Clear	10250TEC	10250FC
White	10250TEW	10250FW
Amber	10250TEM	10250FM

Joystick Units

Two-Position Joystick



Joystick Units—UL (NEMA) Type 3, 3R, 4, 4X, 12, 13

Operator Position ^②

	Operator Position ^②			Operator Action ^③	Contact Type	Mounting Location		Two-Position Assembled Unit Catalog Number ^④
	Up	Center	Down			A	B	
X					1NC			10250T452-3X
0			X		1NC			

Notes

- ① Amber, clear and white lenses have a black arrow (pointer), red, green and blue lenses have a white arrow (pointer).
- ② X = closed circuit, 0 = open circuit.
- ③ M = Maintained. S = Spring return in direction of arrow (R).
- ④ Field convertible momentary to maintained or vice versa.

1

Joysticks

Two-Position Joystick Operators

The device mounts in the standard 30.5 mm mounting hole. Allow sufficient panel space for lever movement.

The maximum travel of the knob operator (full up to full down) is 2.2 in (24°) momentary, 2.5 in (30°) maintained, but ample space for lever operation must be allowed. These operators are field convertible from momentary to maintained operation or vice versa.

The use of NC contacts is preferred because they provide positive drive contact opening and a direct relationship between lever movement and affected terminal, i.e., up movement affects the top terminals.

Application Caution

Joystick operators are not recommended on certain DC applications above 24 Vdc which may involve lightly engaging the contacts (teasing) to achieve speed control, positioning, jogging, etc. Excessive arcing and deterioration of the contacts will occur.

Two-Position Joystick Operator



Two-Position Joystick Operators—UL (NEMA) Type 3, 3R, 4, 4X, 12, 13

Contact Block Limitations	Two-Position Operator Only—AC Applications Only	
	Description ^①	Catalog Number
Momentary Mode 4NC contact blocks max. 3NO contact blocks max.	Momentary up and down	10250T452
	Maintained up—momentary down	10250T4521
	Maintained down—momentary up	10250T4522
Maintained Mode 2 contact blocks max.	Maintained up and down	10250T4525

Contact Block Operation and Selection

Handle Position ^②

Up	Center	Down	Contact Block Type ^④	Mounting Location ^{②③}		Catalog Number
				Top A	Bottom B	
			1NC			10250T51
			1NC			10250T51
			2LONC (Series)			10250T45
			1NC			10250T3
			1NC			
			1LONC			10250T45
			1LONC			
			1NC			10250T44 ^⑤
			1NO			
			1NC			
			1NO			

A and B Mounting Location

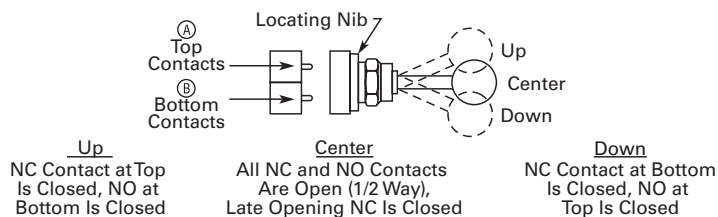

Notes

- ① Field convertible momentary to maintained or vice versa. To expedite shipment of maintained types, order momentary operator 10250T452 which is a stocked device.
- ② Bolded circuit corresponds to "X-O" circuit selection. X = closed circuit, O = open circuit.
- ③ See above for "A" and "B" mounting location.
- ④ NO = normally open, NC = normally closed, LONC = late opening normally closed.
- ⑤ Four circuits in single block depth—rated 300V max.

Four-Position Joystick Operators

The joystick operated control unit is intended for AC application only. For other use, see **Application Caution** on preceding page.

The panel area required for the four-position operator is equivalent to two standard pushbutton operators.

The latch holds the lever in the center position. The trigger latch must be released before lever can moved into any position.

Four-Position Joystick Operator



Four-Position Joystick Operator with Latch



Four-Position Joystick Operators—UL (NEMA) Type 3, 3R, 4, 4X, 12, 13

Contact Block Limitations	Description ①	Catalog Number
Operator Only—AC Application Only		
Four contact blocks max.—two in each position	Four-position—without latch	10250T451_
	Four-position—with latch	10250T461_
Hole Plug		
Four contact blocks max.—two in each position	To plug unused hole	10250TA7

Field Conversion—Gate

The factory assembled four-position operator is assembled with a gate arranged for four handle positions.

Handle Positions



Four-Position Gate

Three additional gates, supplied with every operator, allow on the job conversion to three- or eight-position operation as illustrated.

Two-, Three- or Eight-Position Operation

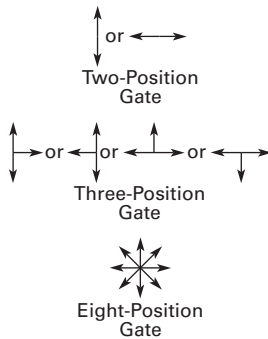

The eight-position gate controls the four functions shown as “Up,” “Down,” “Left” and “Right.” The remaining four diagonal positions each actuate two adjacent functions; for example, “Left Down” actuates both “Left” and “Down.” The operator may be arranged for spring return of handle to center position, or maintained in up to eight positions (see description of maintained position operator).

Adjacent Functions

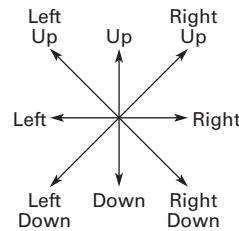

Maintained Position

For maintained position (non-spring return), locate required maintained position or positions of operating lever and add appropriate suffix number to the catalog number selected from the table above.

Maintained Positions

Maintained Positions				Suffix Number
Up	Down	Left	Right	
X	—	—	—	1
—	—	—	—	2
—	X	—	—	3
—	—	X	—	4
—	—	—	—	5
X	—	X	—	6
X	—	—	X	7
—	X	X	—	8
—	X	—	X	9
—	—	X	X	10
X	X	X	—	11
X	X	—	X	12
X	—	X	X	13
—	X	X	X	14
X	X	X	X	15

On an eight-position gate, when an adjacent vertical and horizontal position are both maintained, the included diagonal position is also maintained.

Note

① Momentary operators—spring return to center. For maintained operators add suffix code from table on this page. Example: 10250T451**10**. Operator without latch, maintained in left and right positions.

1.10

Pushbuttons and Indicating Lights

30.5 mm Heavy-Duty Watertight/Oiltight—10250T

1

Contact Block Operation

Contact blocks mount directly to the back of the operator. For reliable operation, the maximum number of contact blocks that should be installed behind each operator lever is two (four total).

The figure below identifies the circuits activated by each of the eight possible lever positions. Contact block plungers 1, 2, 3, 4 are depressed (change state) when handle is in the position indicated by arrows below.

Circuit Activation

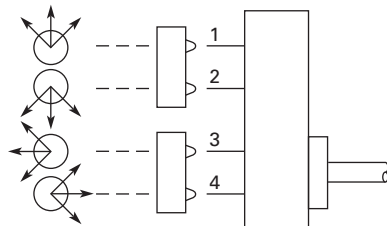

Note: Joystick in its resting state, center position, does not activate contact block plungers.

Ordering Example:

Suppose you are looking for a four-position momentary joystick without a latch and the following circuit arrangements. X = Closed Circuit, O = Open Circuit.

Example Circuit Arrangements

Circuit	Up	Down	Left	Right
1st	X	X	X	X
2nd	X	O	O	X

The contact blocks and their mounting locations would be as follows:

Example Contact Blocks and Locations

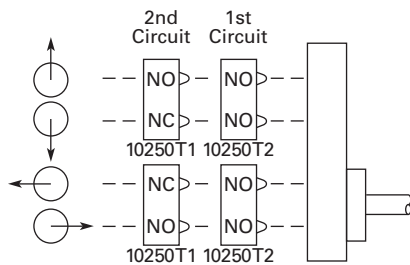

A complete bill of material for this example would include:

Example Order

Qty.	Catalog Number
1	10250T451
2	10250T2
2	10250T1

Blank Legend Plates for Joystick Operators

When ordering engraved legend plates, order by catalog number and insert the following into order notes:

- Legend required
- Size of characters: 3/16, 1/8, 3/32 in (4.8, 3.2, 2.4 mm)
- Location by letter (A–N)

Locations K and M can accommodate up to two lines horizontally; L and N up to two lines vertically.

Maximum number of characters:

- Horizontal
3/16 in—13, 1/8 in—14, 3/32 in—19
- Vertical
3/16 in—10, 1/8 in—13, 3/32 in—14

Ordering Example:

Two-position legend plate to be marked “UP” “DOWN.”

Catalog No. **10250TJ2S4STAMP**

Letter Size: 3/16 in (4.8 mm)

Pos. K—UP

Pos. M—DOWN

Two-Position

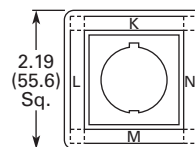

Catalog Number

Blank Plate

10250TJS3

Engraved Plate

10250TJS3STAMP

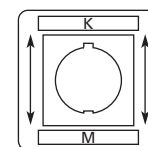

Catalog Number

Blank Plate

10250TJS4

Engraved Plate

10250TJS4STAMP

Four-Position

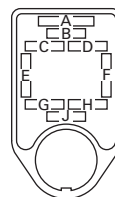

Catalog Number

Blank Plate

10250TJS1

Engraved Plate

10250TJS1STAMP

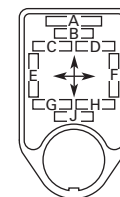

Catalog Number

Blank Plate

10250TJS2

Engraved Plate

10250TJS2STAMP

Roto-Push Units

Two-Position Momentary

Complete assembled two-position Roto-Push® Units are listed below. These operators have black flush buttons and are arranged for vertical mounting. Order legend plates separately.

Mounting Location

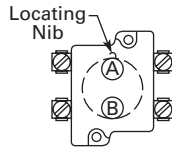

Roto-Push—Black Flush Button



Roto-Push Units—UL (NEMA) Type 3, 3R, 4, 4X, 12, 13

Typical Applications (Most Common Examples)	Operator Position ①		Collar Right		Contact Type	Mounting Location		Catalog Number ②
	Collar Left	Depressed	Normal	Depressed		A	B	
Two-Position FORWARD/REVERSE; HIGH/LOW; OPEN/CLOSE; UP/DOWN; etc.	Normal	Depressed	Normal	Depressed	1NO	⎓		10250T2411-2
	0	0	0	X	1NO		⎓	
JOG/RUN; MAN./AUTO; etc.	Normal	Depressed	Normal	Depressed	1NO	⎓		10250T24111-2
	0	X	0	X	1NO		⎓	
RUN/JOG; START/JOG; etc.	Normal	Depressed	Normal	Depressed	1NO	⎓		10250T24111-1
	X	X	0	0	1NC		⎓	
SAFE/RUN; etc.	Normal	Depressed	Normal	Depressed	1NO	⎓		10250T2415-2
	0	0	0	X	1NO		⎓	

Two-Position Latched

The two-position Roto-Push Latch Unit is fully assembled and only requires a legend plate for a great variety of applications. When the selector collar is in the extreme left position, the button is in the free or normal position and can be operated as a standard pushbutton. Rotating the collar to the

extreme right position automatically depresses and latches the button in the depressed position. The white filled groove in the button indicates the selector collar position. The selector collar has spring return to the left position except when in the extreme right latched position.

Red Long



Rotates to a Latch-Out Mode

Color and Type of Button	Contact Block	Vertical Mounting Catalog Number
Red long	1NC	10250T72
	2NC	10250T73

Notes

- ① X = closed circuit, 0 = open circuit.
- ② Roto-Push assembled with contact blocks.

1

Roto-Push Operators

Roto-Push Components

A Roto-Push control unit combines the function of a pushbutton and a selector switch. The contacts are operated by the combined action of rotating the outer collar and pushing a button contained in the collar.

In selecting the cam and contact blocks for the listed function, the analysis involves considering the function with the collar rotated to the given position with the button free (designated as “N”) and then in that same position with the button depressed (designated “D”). This is done for each rotational position of the collar.

When Ordering Specify

- Catalog number of operator with cam code suffix from tables below and on following pages, Example: 10250T2411.
- Catalog number(s) for contact blocks and legend plates if required.
- To select the cam and contact blocks needed for two-position and three-position switches, use the tables on following pages.

Operator and Cam



Operator and Cam

Color and Type of Button	Cam Code No. Select from Tables	Vertical Mounting Catalog and Code Number	Horizontal Mounting Catalog and Code Number
Black flush	+ 1 to 18	10250T241_	10250T251_
Red flush ①		10250T242_	10250T252_
Green flush		10250T243_	10250T253_
Black long		10250T261_	10250T271_
Red long ①		10250T262_	10250T272_
Green long		10250T263_	10250T273_

Two-Position Roto-Push Operator—Rotates to a Latch-Out Mode Special Rotor Latch

This differs from the other Roto-Push operators in that as the collar is rotated to the right it depresses the button and releases the button when rotated left. But the button in the released position can be momentarily pushed independent of the collar or

its position. As the button is depressed by rotating the collar, the button also rotates and indicates its mode by a white line on the button face. This button can be used as an emergency stop or latched stop.

Special Roto Latch— Red Long Button











































Special Roto Latch— UL (NEMA) Type 3, 3R, 4, 4X, 12, 13

Color and Type of Button	Vertical Mounting Catalog Number
Red long	10250T3213
Black long	10250T3214

Note

① Not to be used for emergency stop application.

Cam and Contact Block Selection for Two-Position Roto-Push

Combination Number	Collar Position		Circuit Sequence ^①		Cam Code 1	Cam Code 2	Cam Code 3	Cam Code 4	Cam Code 5	Cam Code 6
	N	D	N	D						
1	0	0	0	X	A  NO	A  NO	—	—	A  NO	—
2	0	0	X	0	—	—	—	A  NO B  NO	A  NO B  NO	—
3	0	0	X	X	—	—	—	—	B  NO	A  NO
4	0	X	0	0	B  NO	A  NO B  NO	—	—	—	A  NO B  NO
5	0	X	0	X	A  NO B  NO	B  NO	—	A  NO	—	—
6	0	X	X	0	—	—	—	—	—	—
7	0	X	X	X	—	—	A or B NO	B  NO	—	B  NO
8	X	0	0	0	—	—	A or B NC	B  NC	—	B  NC
9	X	0	0	X	—	—	—	—	—	—
10	X	0	X	0	A  NO B  NO	B  NO	—	A  NO	—	—
11	X	0	X	X	B  NO	A  NO B  NO	—	—	—	A  NO B  NO
12	X	X	0	0	—	—	—	—	B  NO	A  NO
13	X	X	0	0	—	—	—	A  NO B  NO	A  NO B  NO	—
14	X	X	X	0	A  NO	A  NO	—	—	A  NO	—

Series and Parallel Connections

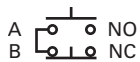

Series Connection



Parallel Connection

The connections are not made at the factory. They are illustrated in the selection table as requirements, but must be made on the job.

Circuit Location

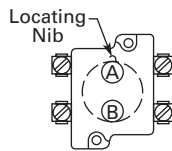

Letters "A" and "B" represent the locations which the two circuits of a contact block will occupy in relation to the locating nib of the operator.

Note

① N = Button in free or normal position. D = Button depressed.

Cam and Contact Block Selection for Two-Position Roto-Push, continued

Combination Number	Collar Position		Circuit Sequence ①		Cam Code 10	Cam Code 11	Cam Code 12	Cam Code 13	Cam Code 14	
	N	D	N	D						
15	0	0	0	X	—		—	—	—	
16	0	0	X	0	—		A	A or B NC	A	
17	0	0	X	X	B	B	—	—	—	
18	0	X	0	0	A		—	—	B	
19	0	X	0	X	—	A	B	—	—	
20	0	X	X	0	—	—	—	—	A	
21	0	X	X	X	A	A	A	—	—	
22	X	0	0	0	A	A	A	—	—	
23	X	0	0	X	—	—	—	—	A	
24	X	0	X	0	—	A	B	—	—	—
25	X	0	X	X	A	A	—	—	B	
26	X	X	0	0	B	B	—	—	—	—
27	X	X	0	0	—	A	A	A or B NO	A	
28	X	X	X	0	—	A	—	—	—	

Series and Parallel Connections

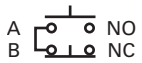

Series Connection



Parallel Connection

The connections are not made at the factory. They are illustrated in the selection table as requirements, but must be made on the job.

Note

① N = Button in free or normal position. D = Button depressed.

Circuit Location

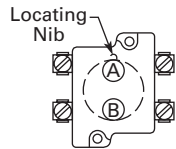

Letters “A” and “B” represent the locations which the two circuits of a contact block will occupy in relation to the locating nib of the operator.

Cam and Contact Block Selection for Three-Position Roto-Push

Combination Number	Collar Position						Cam Code 7	Cam Code 8	Cam Code 9	Cam Code 15 ^②	Cam Code 16	Cam Code 17	Cam Code 18
	Circuit Sequence ^①												
	N	D	N	D	N	D							
1	0	0	0	0	0	X			—			—	
2	0	0	0	0	X	X	—	—		—	—		—
3	0	0	0	X	0	0	—	—		—	—	—	
4	0	0	0	X	0	X	—	—	—	—	—	—	
5	0	0	0	X	X	X	—	—		—	—	—	—
6	0	0	X	X	0	0	—		—	—	—	—	—
7	0	0	X	X	0	X	—		—	—	—	—	—
8	0	0	X	X	X	0		—	—	—	—	—	—
9	0	0	X	X	X	X		—	—	—	—	—	—
10	0	X	0	0	0	0			—				
11	0	X	0	0	0	X		—	—			—	—
12	0	X	0	0	X	X	—	—	—	—	—		—
13	0	X	0	X	0	0	—	—	—	—	—	—	
14	0	X	0	X	0	X	—	—	—	—	—	—	
15	0	X	X	X	0	0	—		—	—	—	—	—
16	0	X	X	X	0	X	—		—	—	—	—	—
17	0	X	X	X	X	X		—	—	—	—	—	—

Series and Parallel Connections

Series Connection

Parallel Connection

The connections are not made at the factory. They are illustrated in the selection table as requirements, but must be made on the job.

Circuit Location

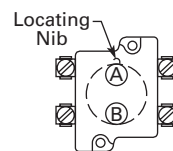

Letters “A” and “B” represent the locations which the two circuits of a contact block will occupy in relation to the locating nib of the operator.

Notes

- ① N = Button in free or normal position. D = Button depressed.
- ② Limited to 4 contact blocks. See Note on **Page V7-T1-272**.

Cam and Contact Block Selection for Three-Position Roto-Push, continued

Combination Number	Circuit Sequence ^①						Cam Code 7	Cam Code 8 ^②	Cam Code 9	Cam Code 15	Cam Code 16	Cam Code 17	Cam Code 18
	N	D	N	D	N	D							
18	X	0	0	0	0	0		—	—	—	—	—	—
19	X	0	0	0	X	X	—	A	—	—	—	—	—
20	X	0	0	0	X	0	—	A	—	—	—	—	—
21	X	0	X	X	0	0	—	—	—	—	—	A	—
22	X	0	X	X	X	X	A	A	—	—	A	B	A
23	X	0	X	X	X	0	A	—	—	—	A	—	—
24	X	0	X	0	X	0	—	—	—	A	—	—	A
25	X	0	X	0	X	X	—	—	—	A	—	—	A
26	X	X	0	0	0	0	B	—	A	—	—	—	—
27	X	X	0	0	0	X	A	—	—	—	—	—	—
28	X	X	0	0	X	0	—	B	—	—	—	—	—
29	X	X	0	0	X	X	—	A	B	—	—	—	—
30	X	X	X	X	0	0	—	—	B	—	—	A	—
31	X	X	X	X	X	0	A	A	—	—	B	—	A
32	X	X	X	0	X	0	—	—	—	B	—	—	B
33	X	X	X	0	X	X	—	—	—	A	—	—	A

Series and Parallel Connections



The connections are not made at the factory. They are illustrated in the selection table as requirements, but must be made on the job.

Circuit Location

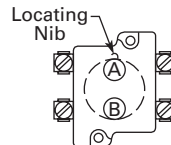

Letters "A" and "B" represent the locations which the two circuits of a contact block will occupy in relation to the locating nib of the operator.







Notes

- ① N = Button in free or normal position. D = Button depressed.
- ② Limited to 4 contact blocks. See Note on **Page V7-T1-272**.

Accessories

Padlocks not included with padlocking attachments. For operators with built-in padlock attachment, see **Page V7-T1-226**.

Accessories

	Description	Catalog Number
Padlock Attachments		
10250TA2 	Padlocking Attachment for Flush Pushbutton Operators Permits locking NC contacts in open position with 1/4 in padlock. Will not lock NO contact.	10250TA2
10250TA26 	Padlocking Attachment for Use with Extended Pushbutton Permits locking NC contacts in open position with 1/4 in padlock.	10250TA26
10250TA36 	Padlocking Cover Guard Cover locked over flush button makes it unaccessible or on extended button locks NC contacts open. Takes 1/4 in shank size padlock.	10250TA36
10250TA38 	Padlock Hasp or Flip-Up Guard When used with a 1/4 in padlock, makes flush and long button and knob selector switch unaccessible, but not locked down. Without the padlock, it is a flip-up guard. Padlock hasp can be removed before assembly.	10250TA38
10250TA63 	Padlocking Attachment for Use with Flexible Weather Resistant Boot Used on long button operators. Stainless steel. Use only for locking NC contacts open.	10250TA63
10250TA64 	Padlock Attachment For use with illuminated pushbuttons and maintained push-pull operators having standard button or lens only. Use 1/4 in padlock. Locks in down position only.	10250TA64
10250TA11 	Padlocking Attachment for Non-Illuminated Knob Selector Switches Provision for up to 5, 1/4 in padlocks.	10250TA11







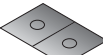

Accessories, continued

	Description	Catalog Number
Shrouds and Guards		
 10250TA6	Shroud for Mushroom Head Operator Prevents accidental operation. (Not for push-pull operators.)	10250TA6
 10250TA12	Extended Retaining Nut Replaces standard nut and provides guard for flush head pushbutton operators.	10250TA12
 10250TA15	Guard for Illuminated Pushbutton	10250TA15
 10250TA56_	Shroud For jumbo mushroom head operator.	
	Gray	10250TA56
	Yellow	10250TA56Y
 10250ED1241	Half Shroud —Yellow For jumbo mushroom head operator.	10250ED1241
 10250TA101	Fingerproof Shroud —10 per package Fits new style contact blocks and light units.	10250TA101
Boots		
 10250TA_	Flexible Weather Resistant Boot For use with button operators (extended buttons preferred). Temperature to –25°F (–32°C). (See Page V7-T1-265 for 10250TA96 Tightening Tool.)	
	Black	10250TA3
	Red	10250TA4 ①
	Green	10250TA10
 10250TA25	Transparent Boot For regular illuminated pushbutton operators and PresTest— Temperature to –38°F (–39°C). ②	10250TA25
 10250TA4_	Boot for Flush Pushbutton	
	Clear	10250TA46
	Black	10250TA47
	Red	10250TA48
	Green	10250TA49

Notes

- ① Should not be used on flush button for STOP function.
- ② Not suitable for single contact block depth cast enclosure. Cover is too thick.

Accessories, continued

	Description	Catalog Number
Hardware and Kits		
10250TK3 	Thrust Washers — To meet Ford Motor Co. mounting specifications.	10250TK3
10250TK5 	Contact Block Tape Seal — Seals plunger openings on last contact block. Order in multiples of 10 pieces.	10250TK5
56-9337 	Selector Switch Operator Gasket — Seals out dust from getting in-between the cam and contact block plungers. Supplied as standard with all selector switches.	56-9337
10250TA3 	Special Retaining Nut — To accommodate thick panel: Indicating lights	10250TA30
	PresTest, pushbuttons and selector switches	10250TA31
10250TA62 	Terminal Block — Two terminals, each will accommodate two wire terminations.	10250TA62
10250TA8 	Spacer Ring — Used when legend plate is not required.	10250TA8
10250TA79 	Stacking Screw — Replaces transformer mounting screws on indicating light so terminal block 10250TA62 can be mounted to light to support and connect a series resistor. This screw also fits all contact blocks. Order in multiples of 10.	10250TA79
10250TA2 	Base Mounting Spacers ①— Equivalent to contact block in depth (one block deep).	10250TA22
	Complete with screws, washers, etc. (two block deep).	10250TA23
10250TKG 	Grounding Kits — Kits consist of a ring connector and a #6 screw for mounting connector to rear of contact block mounting screw. All components except standard indicating lights and PresTest indicating lights.	10250TKG1
	Standard indicating lights	10250TKG2 ②
	PresTest indicating lights	10250TKG3 ②
10250TA7 	Contact Block Terminal Jumpers — Available in multiples of 100 only. Terminal to terminal—within block (short)	
	100 per pkg.	10250TA70
	1000 per pkg.	10250TA70-2
	Terminal to terminal—block to block (long)	
	100 per pkg.	10250TA71
	1000 per pkg.	10250TA71-2

Notes

- ① Component only. Not to be used for custom built (factory assembled) stations.
- ② Not suitable for single contact block depth cast enclosure. Cover is too thick.









Accessories, continued

	Description	Catalog Number
Special Operators and Attachments		
10250TA5 	Wobble Stick Complete with retaining nut—fits standard button.	10250TA5
10250TA14 	Lever Operator For use with two vertically mounted flush pushbuttons.	10250TA14
10250TA 	Maintained Contact Attachment Release Button Assembly ^① Mechanically interlocks with another pushbutton and contact block (not included). Provides mode indication. Minimum hole centers 1.62 in (41.1 mm), maximum 2.313 in (58.8 mm).	
	Black	10250TA17
	Red	10250TA18
	Green	10250TA19
	Yellow	10250TA20
	Same with Long Button—Black	10250TA39
10250TA1 	Maintained Contact Attachment ^① Mechanically interlocks two buttons and provides position indication for one. Use with two pushbutton operators and one or more contact blocks.	10250TA1
10250TA13 	Roto-Push Lever Operator — Used to provide lever operation for Roto-Push operators.	10250TA13
Special Light Modules		
10250TA79 	Master Test (Dual Input) Module — Internal Form C relay suitable for either AC or DC applications. Total electrical isolation between monitored and test circuit. Fits all illuminated 10250T, E22, E30 and E34 devices.	
	48 Vdc	10250TMT8
10250TFL 	Flasher Module — Changes any AC illuminated device to a controlled flashing light. Fits 10250T, E30 and E34 devices.	
	24V	10250TFL2
	120V	10250TFL1
10250ED986-4 	Flashing Incandescent Lamp — For use with 120V transformer type or 6V full voltage type indicating lights including PresTest and most E29 devices.	10250ED986-4

Note

^① Not suitable for single contact block depth cast enclosure. Cover is too thick.

Accessories, continued

Description	Catalog Number
Hole Plugs	
10250TA7 	Plug— For unused holes—steel, painted gray (stainless steel, use E30KT5 , see Page V7-T1-212)
Tools	
10250TA95 	Octagonal 10250T (notched to fit over selector switch lever), E29 and E30
E22CW 	E22, E30, E34 and octagonal 10250T (will not fit over selector switch levers)
10250TA96 	Tool for Tightening Boots— Used to install boot Catalog Numbers 10250TA3, A4, A10 and A25.
10250TA102 	10250T, E34 Allen Wrench— Used for removal of jumbo mushroom head.
10250TA74 	Lamp Removal Tools— For transformer type illuminated pushbuttons, push-pull and selector switches. Fits #12 lamp.
E30KV1 	For full voltage and resistor type illuminated pushbuttons, push-pull and selector switches and E30.
E29KLT 	Standard indicating lights. Fits #44, #755, #6S6 and #10S6.

1

Options

Legend Plates

Legend Plates with Standard Markings

The legend plates listed below are sized for all standard commercial enclosures and Eaton's cast enclosures. For vertical

spacing less than 1.75 in, replace the **S** in the catalog number with **MS**, or the **M** with **P** (except push-pull). No change in price. The smaller

size legend plates, "MS" or "P" size, have limited space for legend.

Square Legend Plate



1/2 Round Legend Plate



For Pushbutton Operators and Indicating Lights—Standard

Legend	Color of Field	Square ① Catalog Number	1/2 Round Catalog Number	Legend	Color of Field	Square ① Catalog Number	1/2 Round Catalog Number
Blank—see table on Page V7-T1-268.							
Letters on Legend Plates Below are 3/16 in High							
CLAMP	Black	10250TS90	10250TM90	OFF	Red	10250TS24	10250TM24
CLOSE		10250TS73	10250TM11	ON	Black	10250TS25	10250TM25
DOWN		10250TS74	10250TM12	OPEN		10250TS26	10250TM26
EMERG. STOP	Red	10250TS13	10250TM13	OUT		10250TS27	10250TM27
FAST	Black	10250TS75	10250TM14	POWER ON		10250TS80	10250TM80
FASTER		10250TS87	10250TM87	RAISE		10250TS28	10250TM28
FEEDER ON		10250TS94	10250TM94	READY		10250TS86	10250TM86
FEEDER OFF		10250TS95	10250TM95	RESET		10250TS29	10250TM29
FORWARD		10250TS15	10250TM15	REVERSE		10250TS30	10250TM30
HIGH		10250TS16	10250TM16	RUN		10250TS31	10250TM31
IN		10250TS17	10250TM17	SAFE		10250TS85	10250TM85
INCH		10250TS18	10250TM18	SLOW		10250TS32	10250TM32
JOG		10250TS19	10250TM19	SLOWER		10250TS88	10250TM88
JOG FOR.		10250TS20	10250TM20	START		10250TS33	10250TM33
JOG REV.		10250TS21	10250TM21	STOP	Red	10250TS34	10250TM34
LOW		10250TS22	10250TM22	TEST	Black	10250TS83	10250TM83
LOWER		10250TS23	10250TM23	TRANSFER		10250TS93	10250TM93
LUBE-FAIL		10250TS92	10250TM92	TRIP		10250TS84	10250TM84
MOTOR RUN		10250TS81	10250TM81	UNCLAMP		10250TS91	10250TM91
MOTOR STOP		10250TS82	10250TM82	UP		10250TS35	10250TM35

Blank Plastic Legend Plates—Square

Color Lettering	Field	Standard Catalog Number	Jumbo ② Catalog Number	Extra Large Catalog Number
Black	White or silver ③	10250TSP76	10250TLP76	10250TEP76
White	Red or black ③	10250TSP77	10250TLP77	10250TEP77

Notes

- ① Square legend plates have a satin aluminum field. Color is on lower portion.
- ② Cannot be used on cast enclosures except for top row. Suitable for most sheet metal enclosures.
- ③ If legend plate is to be engraved, specify field color required.

Square Legend Plate



1/2 Round Legend Plate



For Selector Switch and Roto-Push Operators—Standard Size

Legend	Color of Field	Square ^① Catalog Number	1/2 Round Catalog Number	Legend	Color of Field	Square ^① Catalog Number	1/2 Round Catalog Number
Blank—see table on Page V7-T1-268.							
2-Position—5/32 in High Lettering				3-Position—1/8 in High Lettering			
FOR. REV.	Black	10250TS38	10250TM38	AUTO OFF HAND	Black	10250TS49	10250TM49
HAND AUTO		10250TS39	10250TM39	FOR. OFF REV.		10250TS50	10250TM50
HIGH LOW		10250TS40	10250TM40	FOR. SAFE REV.		10250TS69	10250TM69
JOG RUN		10250TS41	10250TM41	HAND OFF AUTO		10250TS51	10250TM51
MAN. AUTO		10250TS67	10250TM67	MAN. OFF AUTO		10250TS68	10250TM68
OFF ON		10250TS42	10250TM42	OPEN OFF CLOSE		10250TS53	10250TM53
OPEN CLOSE		10250TS43	10250TM43	RUN SAFE JOG		10250TS70	10250TM70
RUN JOG		10250TS44	10250TM44	UP OFF DOWN		10250TS54	10250TM54
SAFE RUN		10250TS45	10250TM45	ON STOP SAFE	Red	10250TS71	10250TM71
START JOG		10250TS46	10250TM46				
START STOP		10250TS47	10250TM47				
UP DOWN		10250TS48	10250TM48				

70 mm Round—Plastic Legend Plate



45 mm and 70 mm Plastic—Round

Color	Lettering	Field	Catalog Number
45 mm			
Blank		Yellow or red ^②	10250TRP78
70 mm			
Blank		Yellow or red ^②	10250TRP76
Red	EMERG. STOP	Yellow	10250TRP79

For Push-Pull Units ^③

Legend	Color of Field	Square ^① Catalog Number	1/2 Round Catalog Number
Standard Size—Letters on Legend Plates Below are 3/32 in High			
PULL START/PUSH STOP	Green/red	10250TPP2	10250TR2
PUSH ON/PULL OFF	Black	10250TPP5	10250TR5
PULL OPEN/PUSH CLOSE	Black	10250TPP8	10250TR8
PULL UP/PUSH DOWN	Black	10250TPP11	10250TR11
Jumbo Size—Letters on Legend Plates Below are 1/8 in High			
PULL START/PUSH STOP	Green/red	10250TPP3	10250TR3
PULL ON/PUSH OFF	Black	10250TPP6	10250TR6
PULL OPEN/PUSH CLOSE	Black	10250TPP9	10250TR9
PULL UP/PUSH DOWN	Black	10250TPP12	10250TR12

Notes

- ① Square legend plates have a satin aluminum field. Color is on lower portion.
- ② If legend plate is to be engraved, specify field color required.
- ③ All push-pull legend plates include the symbols ≠ ∅ in the center of the plate.

1

Legend Plates with Non-Standard Markings

When Ordering Specify

- Catalog number of blank plate phase plus Suffix “STAMP”
- Insert the following into Order Notes: legend, letter size and locations (letters A–W)—combine letters for definitive locations as shown.

Ordering Example:

Catalog No.: **10250TS36STAMP**
 Letter Size: 3/32 in (2.4 mm)
 Pos. A—POWER HOUSE
 Pos. B—START PUMP 1

Legend Characters Available

A B C D E F G H I J K L M N O
 P Q R S T U V W X Y Z / - . , 1
 2 3 4 5 6 7 8 9 0

Legend characters on black and red plates are white—on satin aluminum plates, characters are black.

Blackening Kit

Solution blackens aluminum exposed by engraving process. Must be applied immediately after engraving. 0.3 oz. bottle—sufficient for approximately 1100 legend plates.

Catalog Number: **10250TBK**

Legend Positions

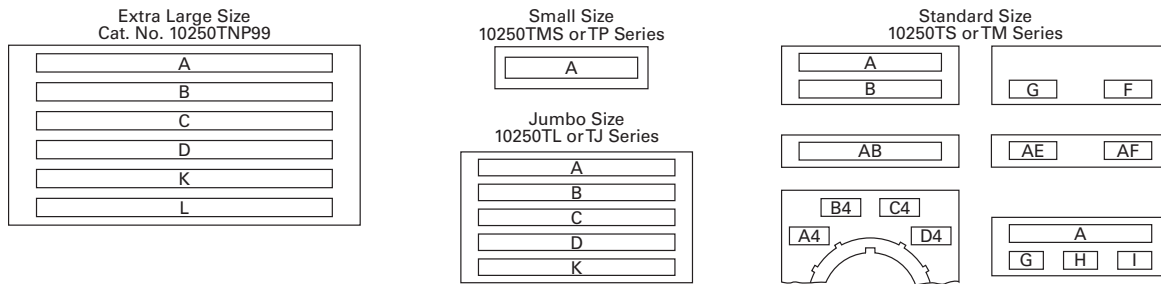

Blank and Custom Engraved Legend Plates

Style	Color	Small Catalog Number	Standard Catalog Number	Jumbo ^② Catalog Number	Extra Large ^③ Catalog Number	Four-Position Selector Switch		Push-Pull with Symbols ^①	
						Custom ^④ Catalog Number	Standard Catalog Number	Standard Catalog Number	Jumbo ^② Catalog Number
Square ^⑤	Black	10250TMS36	10250TS36	10250TL36	—	10250TS76	10250TS72	10250PPP17	10250PPP18
	Red	10250TMS37	10250TS37	10250TL37	—	—	—	—	—
	Green/red	—	—	—	—	—	—	10250PPP20	10250PPP21
	Satin alum.	—	—	—	10250TNP99	—	—	—	—
1/2 Round	Black	10250TP36	10250TM36	10250TJ36	—	—	10250TM72	10250TR17	10250TR18
	Red	10250TP37	10250TM37	10250TJ37	—	—	—	—	—
	Green/red	—	—	—	—	—	—	10250TR20	10250TR21
	Satin alum.	—	10250TM89	10250TJ89	—	—	—	—	—

Maximum Characters per Legend Plate and Approximate Dimensions

Top (Aluminum and Plastic)	Approximate Dimensions in Inches (mm)		Style	Character Size 3/32 in High		1/8 in High		3/16 in High	
	Width	Height		Number of Lines	Number of Characters	Number of Lines	Number of Characters	Number of Lines	Number of Characters
Small ^⑥	1.59 (40.4)	1.59 (40.4)	Square	1	17	—	—	—	—
			1/2 Round	1	15	1	12	1	9
Standard and custom	1.75 (44.5)	1.75 (44.5)	Square	2	18	2	13	1	9
			1/2 Round	2	15	2	12	1	9
Jumbo ^⑦	2.19 (55.6)	2.19 (55.6)	Square	5	23	3	18	2	12
			1/2 Round	5	19	4	15	2	11
Extra large ^⑧	2.44 (62.0)	2.44 (62.0)	Square	6	25	3	18	3	12



Notes

- ① All push-pull legend plates include the symbols ≠ ∅ in the center of the plate.
- ② Cannot be used on cast enclosures except for top row. Suitable for most sheet metal enclosures.
- ③ When used to meet Ford Motor Co. specifications, specify engraved legend. Cannot be used on standard cast or sheet metal enclosures.
- ④ Slightly larger than standard size for legends requiring more space—fits cast enclosures.
- ⑤ Square legend plates have a satin aluminum field. Color is on lower portion.
- ⑥ Recommended only when mounting on minimum centers (less than 1-3/4 in [44.5 mm] vertical centers).
- ⑦ Can be used on top row only of any enclosure.

Enclosures

Die Cast, Polyester and Stainless Steel Enclosures

Enclosures (Case and Cover)—Surface Mounting ^①

	Number of Elements	One Contact Block Depth Catalog Number	Two Contact Block Depth Catalog Number
Die Cast Enclosure	Die Cast Enclosure—In-Line ^{②③④} NEMA 4, 4X, 12, 13		
	1	10250TN1	10250TN11
	2	10250TN2	10250TN12
	3	10250TN3	10250TN13
	4	—	10250TN14
Polyester Enclosure	Polyester ^④—In-Line NEMA 3, 4X, 12		
	1	—	E34N51
	2	—	E34N52
	3	—	E34N53
	4	—	E34N54
Stainless Steel Enclosure	Stainless Steel ^{④⑤}—In-Line NEMA 4, 4X, 12		
	1	—	10250TN33
	2	—	10250TN34
	3	—	10250TN35
	4	—	10250TN36

Dimensions, see Page V7-T1-282.

Mounting Instructions

Two-position joystick must be used with two contact block deep enclosures (maximum number of contact blocks = 1). Four-position joysticks cannot be used within these enclosures.

One and Two Contact Block Depth Enclosures



One Contact Block Depth Enclosure

Two Contact Block Depth Enclosure

Enclosure Layouts

Top – For Vertical Mounting

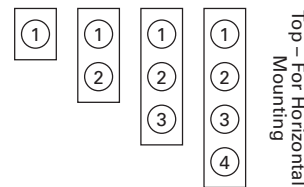

Notes

- ① For spacing increments, see Page V7-T1-270.
- ② All die cast enclosures can be converted to base mounting of contact blocks, with spacers 10250TA22 or 10250TA23. See listing on Page V7-T1-263.
- ③ When used with E30 pushbuttons, only the one element enclosure can be used.
- ④ When used with resistor light units, only the 2 contact block depth enclosure can be used.
- ⑤ 14 gauge, type 304.

1.10

Pushbuttons and Indicating Lights

30.5 mm Heavy-Duty Watertight/Oiltight—10250T

1

Die Cast and Stainless Steel—Flush Mount, Covers Only

Flush Mounting Covers



Covers Only—Flush Mounting

Number of Elements	Catalog Number	Catalog Number
Flush Die Cast Covers		
	In-Line Deep Cover	In-Line Flat Cover
1	10250TF11	10250TF1
2	10250TF12	10250TF2
3	10250TF13	10250TF3
4	10250TF14	10250TF4
In-Line Stainless Steel Flush Plates ^①		
	With Pullbox	Without Pullbox
1	10250TS10	10250TS1
2	10250TS11	10250TS2
3	10250TS12	10250TS3
4	10250TS14	10250TS4
Dimensions, see Page V7-T1-283.		

Spacing Increments

Approximate Dimensions in Inches (mm)

Type	F	G	H
Die cast	2.44 (62.0)	2.5 (63.5)	1.88 (47.8)
Polyester	1.88 (47.8)	Min. 2.13 (54.1)	2.25 (57.2)
Stainless steel	1.69 (42.9)	Min. 1.73 (43.9)	2.25 (57.2)

Spacing Increments for Enclosures

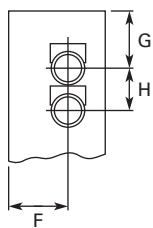

Enclosure Layouts

Top – For Vertical Mounting

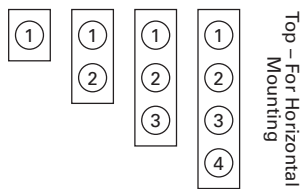

Note

^① Not oiltight. NEMA 1 applications only.

Contact Blocks

Standard Contact Blocks

- UL A600/P600 rated
- Color-coded plungers—red/green for NC/NO circuits
- Silver contact tips with “reliability nibs”
- Gray (opaque) or amber (translucent) housings
- Pressure plate or spade terminals
- Fingerproof shrouds (for pressure terminals only)

Logic Level Contact Blocks

- UL A600/P600 rated
- Color-coded plungers
- Inert palladium knife-blade contacts
- Gray (opaque) housings
- Pressure plate or spade terminals

Special Function Contact Blocks

- UL A600/P600 rated
- Color-coded plungers
- Silver contact tips with “reliability nibs”
- Gray (opaque) housings
- Pressure plate terminals only

Special Purpose Contact Block

- Maximum 300V rated
- Black plungers
- Silver contact tips with “reliability nibs”
- Black (opaque) housings
- Pressure plate terminals only
- Fingerproof shrouds not available

Reliability Nibs

Reliability nibs are the hallmark of Eaton’s contact blocks. A pointed silver nib on the contact tip ensures reliable switching from logic level (5V) up to 600V applications. Therefore standard contact blocks can be used for most logic level applications where the contacts are not exposed to any harsh environmental conditions.

Palladium Contacts

Palladium, which is more inert than gold, is well suited for voltages and currents approaching zero and is recommended for applications where environmental conditions are a factor.

Maximum Contact Block Mounting per Operator Type

Operator	Max. Stack
Pushbuttons	6
Push-pull operators	2
Roto-push operators	4
Two- or three-position selector switches	6
Four-position selector switches	4
Joysticks	4

10250T1



Contact Blocks

Symbol	Circuit	Description ^①	Standard	Spade Terminal ^②	Logic Level	Spade Terminal ^②
			Pressure Terminal Catalog Number	Catalog Number	Pressure Terminal Catalog Number	Catalog Number
	1NC	Stack up to six blocks (six circuits) unless otherwise noted.	10250T51	10250T59	10250T51E	10250T59E
	1NO	Stack up to six blocks (six circuits) unless otherwise noted.	10250T53	10250T60	10250T53E	10250T60E
	NO-NC	Stack up to six blocks (12 circuits) unless otherwise noted.	10250T1	10250T40	10250T1E	10250T40E
	2NC	Stack up to six blocks (12 circuits) unless otherwise noted.	10250T3	10250T42	10250T3E	10250T42E
	2NO	Stack up to six blocks (12 circuits) unless otherwise noted.	10250T2	10250T41	10250T2E	10250T41E
Special Function Blocks ^③						
	LONC	Late opening NC. Stack up to six blocks (six circuits) unless otherwise noted.	10250T71 ^③	—	10250T71E ^③	—
	ECNO-NC	Early closing NO and standard NC. Stack up to six blocks unless otherwise noted.	10250T47 ^{③④}	—	10250T47E ^③	—
	ECNO-NO	Early closing NO and standard NO. Stack up to four blocks unless otherwise noted.	10250T57 ^{③④}	—	10250T57E ^③	—
	2LONC	Two late opening NC contacts. Stack up to six blocks unless otherwise noted.	10250T45 ^③	—	10250T45E ^③	—
	LONC-ECNO	Overlapping contacts. Stack up to four blocks unless otherwise noted.	10250T55 ^{③④}	—	10250T55E ^③	—
Special Purpose Blocks ^⑤						
	2NO-2NC	Four circuits in single block depth. Rated 300V max. Stack up to four blocks unless otherwise noted.	10250T44 ^⑤	—		

Notes

- ^① All 10250T contact blocks shown are suitable for use on standard 10250T and E34 operators. These contact blocks are not suitable for Class I Division 2 type 10250T or E34 devices.
- ^② Contact blocks with spade terminals are limited to a maximum of one contact block per operator and minimum spacing between devices is 2.5 in (63.5 mm). Not suitable for use in 10250T or E34 enclosures. Also available in amber housing. Not available with fingerproof shrouds.
- ^③ Special function contact blocks are not suitable for use with roto-push operators, three-position push-pull operators, or four-position selector switches.
- ^④ ECNO contact blocks are not suitable for use with two-position joysticks or when operators are used with padlock attachments.
- ^⑤ Special purpose 10250T44 contact blocks are not suitable on selector switches or roto-push operators. Okay to use with three-position push-pull operators only on low voltage (30V or less) circuits. Fingerproof shrouds not available.

10250T1CP



Contact Blocks with Fingerproof Shrouds

Symbol	Circuit	Description ^①	Standard Pressure Terminal ^② Catalog Number	Logic Level Pressure Terminal ^② Catalog Number
Blank No Plunger	1NC	Stack up to six blocks (six circuits) unless otherwise noted.	10250T51P	10250T51EP
Blank No Plunger	1NO	Stack up to six blocks (six circuits) unless otherwise noted.	10250T53P	10250T53EP
	NO-NC	Stack up to six blocks (12 circuits) unless otherwise noted.	10250T1P	10250T1EP
	2NC	Stack up to six blocks (12 circuits) unless otherwise noted.	10250T3P	10250T3EP
	2NO	Stack up to six blocks (12 circuits) unless otherwise noted.	10250T2P	10250T2EP
Special Function Blocks ^③				
Blank No Plunger	LONC	Late opening NC. Stack up to six blocks (six circuits) unless otherwise noted.	10250T71P ^④	10250T71EP ^④
	ECNO-NC	Early closing NO and standard NC. Stack up to six blocks unless otherwise noted.	10250T47P ^{③④}	10250T47EP ^④
	ECNO-NO	Early closing NO and standard NO. Stack up to four blocks unless otherwise noted.	10250T57P ^{③④}	10250T57EP ^④
	2LONC	Two late opening NC contacts. Stack up to six blocks unless otherwise noted.	10250T45P ^④	10250T45EP ^④
Blank No Plunger	LONC-ECNO	Overlapping contacts. Stack up to four blocks unless otherwise noted.	10250T55P ^{③④}	10250T55EP ^④

Notes

- ① All 10250T contact blocks shown are suitable for use on standard 10250T and E34 operators. These contact blocks are not suitable for Class I Division 2 type 10250T or E34 devices.
- ② To order contact blocks with translucent amber housing, change suffix P to **CP** in catalog number e.g. 10250T51**CP**.
- ③ ECNO contact blocks are not suitable for use with two-position joysticks or when operators are used with padlock attachments.
- ④ Special function contact blocks are not suitable for use with roto-push operators, three-position push-pull operators, or four-position selector switches.

10250T1C



Amber Contact Blocks

Symbol	Circuit	Description ^①	Standard	Spade Terminal	Logic Level	Spade Terminal
			Pressure Terminal ^② Catalog Number	Catalog Number ^③	Pressure Terminal ^② Catalog Number	Catalog Number ^③
	Blank No Plunger 1NC	Stack up to six blocks (six circuits) unless otherwise noted.	10250T51C	10250T59C	10250T51EC	10250T59EC
	Blank No Plunger 1NO	Stack up to six blocks (six circuits) unless otherwise noted.	10250T53C	10250T60C	10250T53EC	10250T60EC
	NO-NC	Stack up to six blocks (12 circuits) unless otherwise noted.	10250T1C	10250T40C	10250T1EC	10250T40EC
	2NC	Stack up to six blocks (12 circuits) unless otherwise noted.	10250T3C	10250T42C	10250T3EC	10250T42EC
	2NO	Stack up to six blocks (12 circuits) unless otherwise noted.	10250T2C	10250T41C	10250T2EC	10250T41EC
Special Function Blocks ^③						
	Blank No Plunger LONC	Late opening NC. Stack up to six blocks (six circuits) unless otherwise noted.	10250T71C ^④	—	10250T71EC ^④	—
	ECNO-NC	Early closing NO and standard NC. Stack up to six blocks unless otherwise noted.	10250T47C ^{④⑤}	—	10250T47EC ^④	—
	ECNO-NO	Early closing NO and standard NO. Stack up to four blocks unless otherwise noted.	10250T57C ^{④⑤}	—	10250T57EC ^④	—
	2LONC	Two late opening NC contacts. Stack up to six blocks unless otherwise noted.	10250T45C ^④	—	10250T45EC ^④	—
	LONC-ECNO	Overlapping contacts. Stack up to four blocks unless otherwise noted.	10250T55C ^{④⑤}	—	10250T55EC ^④	—

Notes

- ① All 10250T contact blocks shown are suitable for use on standard 10250T and E34 operators. These contact blocks are not suitable for Class I Division 2 type 10250T or E34 devices.
- ② To order amber contact blocks with fingerproof shrouds, change suffix to **CP** in the catalog number e.g. 10250T51**CP**. Not available with spade terminals.
- ③ Contact blocks with spade terminals are limited to a maximum of one contact block per operator and minimum spacing between devices is 2.5 in (63.5 mm). Not suitable for use in 10250T or E34 enclosures. Also available in amber housing. Not available with fingerproof shrouds.
- ④ Special function contact blocks are not suitable for use with roto-push operators, three-position push-pull operators, or four-position selector switches.
- ⑤ ECNO contact blocks are not suitable for use with two-position joysticks or when operators are used with padlock attachments.

Replacement Parts

Replacement Lamps—For 10250T Illuminated Operators

Mfg. Lamp Type	Voltage	Base Style	Application	Part Number
120MB	120V	T 3-1/4 bayonet	10250T resistor indicating light	28-3044
#267	6.3V	T 3-1/4 bayonet	10250T flasher	10250ED986-4
#755	6.3V	T 3-1/4 bayonet	10250T transformer, PresTest and full voltage	28-2202
#756	12V	T 3-1/4 bayonet	10250T full voltage	28-5184
#757	24V	T 3-1/4 bayonet	10250T full voltage	28-5185
#1828	32V	T 3-1/4 bayonet	10250T full voltage	28-5186
#1835	55V	T 3-1/4 bayonet	10250T resistor	28-5187
NE48	120V	T 4-1/2 bayonet	10250T neon	28-494
NE51H-R22	120V	T 3-1/4 bayonet	10250T neon	28-3754
NE51H-R68	240V	T 3-1/4 bayonet	10250T neon	28-3755

Standard LED Lamp



Replacement LED Lamps—For 10250T, E34 and E22 Units

Voltage	Color	Continuous AC/DC Catalog Number	Flashing AC Catalog Number	DC Catalog Number
6–12V	Red	E22LED612RN	E22LED006RAF	E22LED006RDF
	Orange	E22LED612ON	E22LED006OAF	E22LED006ODF
	Yellow	E22LED612YN	E22LED006YAF	E22LED006YDF
	Green	E22LED612GN	E22LED006GAF	E22LED006GDF
	Blue	E22LED612BN	E22LED006BAF	E22LED006BDF
	White	E22LED612WN	E22LED006WAF	E22LED006WDF
24V	Red	E22LED024RN	E22LED024RAF	E22LED024RDF
	Orange	E22LED024ON	E22LED024OAF	E22LED024ODF
	Yellow	E22LED024YN	E22LED024YAF	E22LED024YDF
	Green	E22LED024GN	E22LED024GAF	E22LED024GDF
	Blue	E22LED024BN	E22LED024BAF	E22LED024BDF
	White	E22LED024WN	E22LED024WAF	E22LED024WDF
48V	Red	E22LED048RN	E22LED048RAF	E22LED048RDF
	Orange	E22LED048ON	E22LED048OAF	E22LED048ODF
	Yellow	E22LED048YN	E22LED048YAF	E22LED048YDF
	Green	E22LED048GN	E22LED048GAF	E22LED048GDF
	Blue	E22LED048BN	E22LED048BAF	E22LED048BDF
	White	E22LED048WN	E22LED048WAF	E22LED048WDF
60V	Red	E22LED060RN	E22LED060RAF	E22LED060RDF
	Orange	E22LED060ON	E22LED060OAF	E22LED060ODF
	Yellow	E22LED060YN	E22LED060YAF	E22LED060YDF
	Green	E22LED060GN	E22LED060GAF	E22LED060GDF
	Blue	E22LED060BN	E22LED060BAF	E22LED060BDF
	White	E22LED060WN	E22LED060WAF	E22LED060WDF
120V	Red	E22LED120RN	E22LED120RAF	E22LED120RDF
	Orange	E22LED120ON	E22LED120OAF	E22LED120ODF
	Yellow	E22LED120YN	E22LED120YAF	E22LED120YDF
	Green	E22LED120GN	E22LED120GAF	E22LED120GDF
	Blue	E22LED120BN	E22LED120BAF	E22LED120BDF
	White	E22LED120WN	E22LED120WAF	E22LED120WDF

1.10

Pushbuttons and Indicating Lights

30.5 mm Heavy-Duty Watertight/Oiltight—10250T

1



Two-Position Joystick Operator



Flush Head Pushbutton Operator



Mushroom Head Pushbutton Operator



Mushroom Head Operator with Padlock Attachment



Jumbo Mushroom Head Operator

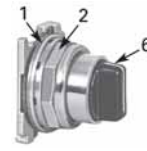

Knob-Operated Selector Switch Operator

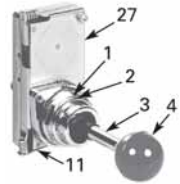

Four-Position Joystick Operator (without Latch)



Illuminated Pushbutton Operator



Full Voltage, Resistor and Transformer Type Illuminated Selector Switch



Transformer Type Indicating Light

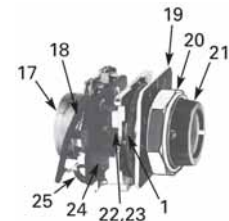

Potentiometers

10250T Style Operator Replacement Parts

Item No.	Description	No. Req.	Part Number
1	Gasket	1	16-1548
2	Mounting nut	1	15-1530
3	Handle	1	24-5045
4	Knob	1	53-3157
	Knob (not shown) for joystick operator with latch	1	53-3159
5	Common gate (supplied with operator)	2	16-3400
6	Set screw (#6-32 x 0.250 in long hollow hex)	2	11-2014
7	Mushroom head button (includes [2] Item 6)	1	As Req. Below
	Black	—	53-1317
	Red	—	53-1317-2
	Yellow	—	53-1317-3
	Green	—	53-1317-4
	Blue	—	53-1317-22
8	Set screw (#10-32 x 0.250 in long hollow hex)	2	11-544
9	Jumbo mushroom head button (aluminum—includes [2] Item 8)	1	As Req. Below
	Red	—	53-1317-9
	Black	—	53-1317-10
	Yellow	—	53-1317-11
	Green	—	53-1317-12
10	Jumbo mushroom head button (aluminum—red EMERG. STOP) does not include Item 8	1	53-1349-18
11	Position gate:		
	Two-position	1	54-7278
	Three-position	1	54-7173
	Four-position	1	54-12278
	Eight-position	1	54-12279
12	Mounting screw (#6-32 x 0.710 in long)	2	10250TA79
	Washer	2	16-2038
13	Terminal screw and lug (captives)	Req.	80-5502KIT

Item No.	Description	No. Req.	Part Number
14	Gasket (supplied with basic unit)	1	32-803
15	Round head screw (#4-40 x 0.344 in long) (supplied with basic unit)	2	11-4553
16	Mounting screw	2	11-1632
17	Simple potentiometer (does not include items 18, 28 or 29)	1	As Req. Below
	1,000 ohms	—	41-782-2
	2,500 ohms	—	41-782-3
	5,000 ohms	—	41-782-10
	10,000 ohms	—	41-782-4
	25,000 ohms	—	41-782-5
	50,000 ohms	—	41-782-6
18	Connector (includes screw and lug)	2	25-1851
19	Indicating plate	1	As Req. Above
	Standard size (without legend)	—	30-4460
	Large size (specify legend)	—	10250TR30
20	Retaining nut	1	15-1547
21	Knob	1	53-1314
	Socket set screw (#6-32 x 0.250 in long)	2	11-2014
22	Coupling	1	29-3749-2
23	Set screw (#6-32 x 0.188 in long)	1	11-1199
24	Spacer	2	56-1066-18
25	Connector (includes screw and lug)	1	25-1851-2
26	Mounting nut	1	15-1938
27	Four-position joystick operating mechanism (complete)	1	24-6565
28	Four-position joystick operating mechanism (not shown) (with latch) complete	1	24-6565-2
29	Spring loaded latch	1	52-1214-2
30	Hand operated latch	1	52-913-3

Technical Data and Specifications

Mechanical Ratings

Description	Specification
Frequency of Operation	
All pushbuttons	6000 operations/hr.
Key and lever selection switches	3000 operations/hr.
Auto-latch devices	1200 operations/hr.
Life	
Pushbuttons	10 x 10 ⁶ operations
Contact blocks	10 x 10 ⁶ operations
PresTest units	10 x 10 ⁶ operations
Lever and key selector switches	0.25 x 10 ⁶ operations
Twist to release pushbuttons	0.3 x 10 ⁶ operations
Shock Resistance	
Duration	20 ms ≥5g

General Specifications

Description	Specification
Climate Conditions	
Operating temperature	1° to 150°F (–17° to 66°C)
Storage temperature	–40° to 176°F (–40° to 80°C)
Altitude	6,562 ft (2,000m)
Humidity	Max. 95% RH at 60°C
Terminals	
Marking	NC-NO on the contact block to meet the NEMA requirements. Dual marking system 1–2 for normally closed, 3–4 for normally open to meet BS5472 (Cenelec EN50 005).
Clamps	Terminals are saddle clamp type for 1 x 22 AWG (0.34 mm ²) to 2 x 14 AWG (2.5 mm ²) conductors
Torque	7 lb-in (0.8 Nm)
Degree of protection against direct electrical contact	IP2X with fingerproof shroud
Light Units	
Transformers	Will withstand short-circuit for 1 hour per IEC 60997-5-1
Bulbs—average life:	
Transformer type	20,000 hrs.
Resistor/direct voltage type	2500 hrs. minimum at rated voltage
LED	60,000 to 100,000 hrs.

Electrical Ratings

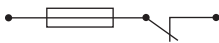
Description	Specification
Insulation	$U_i = 660 \text{ Vac or Vdc}$
Thermal	$I_{th} = 10\text{A}$
Short Circuit Coordination to IEC/EN 60947-5-1	
Rated conditional short circuit current	1 kA
Fuse type	GE power controls TIA 10, red spot type gG, 10A, 660 Vac, 460 Vdc, BS88-2, IEC 60269-2-1
	
UL rating	A600, P600
AC load life duty cycle 1200 operations/hour	
10A	110V pf 0.4— 1×10^6 operations
5A	250V pf 0.4— 1×10^6 operations
2A	600V pf 0.4— 1×10^6 operations
Switching capacity	
AC 15 rated make/break ($11 \times I_b$ at $1.1 \times U_e$)	
6A	120V pf 0.3
4A	240V pf 0.3
2A	660V pf 0.3
DC13 rated make/break ($1.1 \times I_b$ at $1.1 \times U_e$)	
1.0A	125V L/R ≥ 0.95 at 300 ms
0.55A	250V L/R ≥ 0.95 at 300 ms
0.1A	660V L/R ≥ 0.95 at 300 ms
10A	110V pure resistive
Maximum ratings for logic level and hostile atmosphere application	
Maximum amperes	0.5A
Maximum volts	120 Vac/Vdc

Electrical Ratings—Contact Block

Description	50 Vac or 60 Hz				Vdc		
	120	240	480	600	24/28	125	250
Meet or Exceed NEMA Rating Designations A600, A300 and B300 for AC and P600 for DC							
Make and emerg. interrupting capacity (amp)	60	30	15	12	5.7	1.1	0.55
Normal load break (amp)	6	3	1.5	1.2	5.7	1.1	0.55
Thermal current (amp)	10	10	10	10	5.0	5.0	5.0
Voltamperes:							
Make and emerg. interrupting capacity	7200	7200	7200	7200	138	138	138
Normal load break	720	720	720	720	138	138	138

Mounting Options

Panel Thickness

- Minimum: 0.06 in (1.6 mm)
- Maximum: 0.25 in (8 mm) including legend plate
- Maximum can be increased to 0.375 in (15.9 mm) using optional retaining nut
 - Indicating light: 10250TA30
 - Pushbutton/selector switch: 10250TA31

Mounting Matrix

Legend Plate	Dimensions in Inches (mm)			
	A	B	C	D
Small	1.63 (41.3)	2.25 (57.2)	2.25 (57.2)	1.63 (41.3)
Medium	1.75 (44.5)	2.25 (57.2)	2.25 (57.2)	1.75 (44.5)
Large	2.25 (57.2)	2.25 (57.2)	2.25 (57.2)	2.25 (57.2)

Mounting Options in Inches (mm)

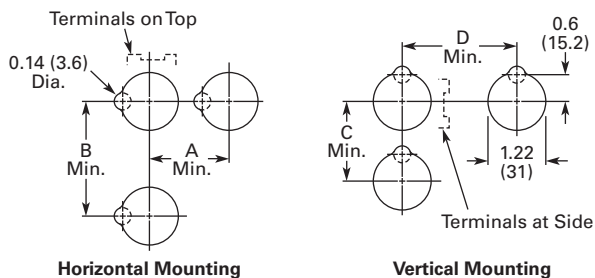

Horizontal mounting means terminals are located top and bottom of contact block. Vertical mounting means terminals are left and right of contact block. This allows close spacing of adjacent operators with easy access to terminals.

Locating nib hole or notch is 0.14 in (3.6 mm) #29 drill.

Drilling Dimensions in Inches (mm)

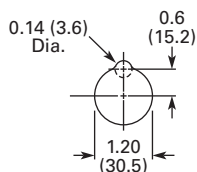

1.10

Pushbuttons and Indicating Lights

30.5 mm Heavy-Duty Watertight/Oiltight—10250T

1

Dimensions

Approximate Dimensions in Inches (mm)

Mechanically Interlocked Pushbutton Operators

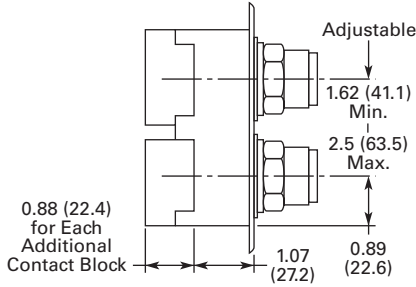

Lockout Pushbutton Operator Padlockable in the Down Position

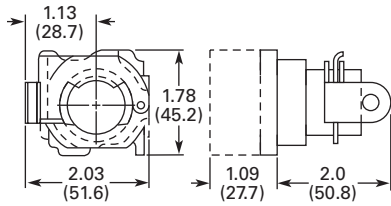

Lockout Pushbutton Operator Padlockable in the Up Position—Mushroom Head

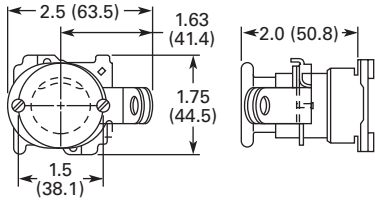

Lockout Pushbutton Operator Padlockable in the Up Position—Jumbo Mushroom Head

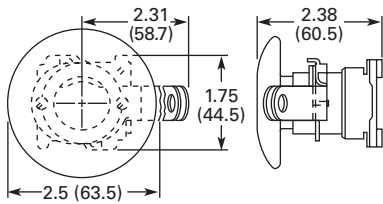

Potentiometer

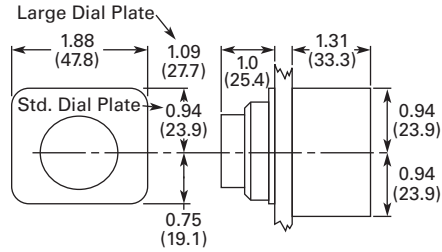

Potentiometer	A	B	C
2 watt single	1.31 (33.3)	0.94 (23.9)	0.94 (23.9)
25 watt—up to 25 mohms	2.38 (60.5)	1.19 (30.2)	0.81 (20.6)
50 mohms	2.56 (65.0)	1.69 (42.9)	1.25 (31.8)

Two-Position Joystick Operator

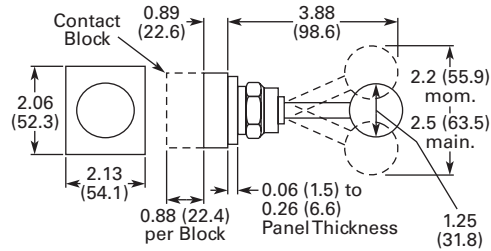

Four-Position Joystick Operator

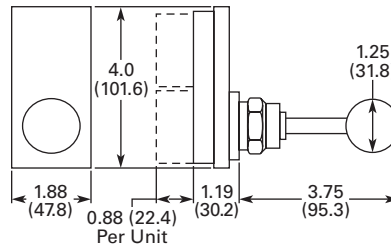

Approximate Dimensions in Inches (mm)

Key Operated Pushbutton Operator

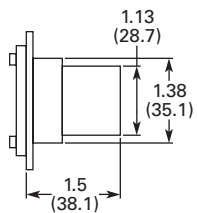

Operator and Cam

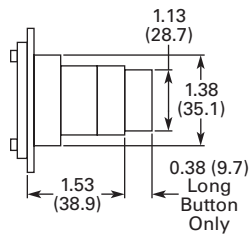

Latch-In, Twist-to-Release Operator Only with Button

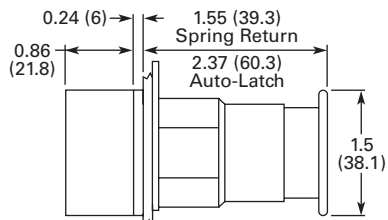

Special Rotor Latch

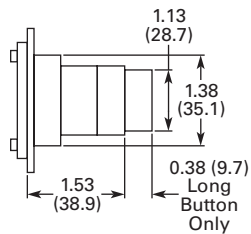

1.10

Pushbuttons and Indicating Lights

30.5 mm Heavy-Duty Watertight/Oiltight—10250T

1

Approximate Dimensions in Inches (mm)

Surface Mounting

Die Cast, Polyester and Stainless Steel Enclosures

4 Mtg. Holes — 10-32 Screw Size for
1 – 4 Element Die Cast/
Stainless Steel Enclosure
7/32 Screw Size for
Polyester

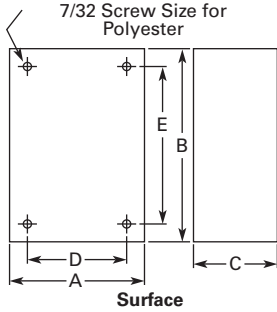

Number of Elements	Element Arrangement	Wide A	High B	Deep C	Mounting D	E	Conduit Entrance
Die Cast							
1	In-line	3.88 (98.6)	4.00 (101.6)	3.00 (76.3) ①	2.69 (68.3)	3.25 (82.6)	3/4
2		3.88 (98.6)	5.88 (149.4)	3.00 (76.3) ①	2.69 (68.3)	5.13 (130.3)	
3		3.88 (98.6)	7.75 (196.9)	3.00 (76.3) ①	2.69 (68.3)	7.00 (177.8)	1
4		3.88 (98.6)	9.63 (244.6)	3.00 (76.3) ①	2.69 (68.3)	8.88 (225.6)	
Polyester							
1	In-line	3.81 (96.8)	6.63 (168.4)	3.38 (85.9)	2.94 (74.7)	4.88 (124.0)	②
2		3.81 (96.8)	6.63 (168.4)	3.38 (85.9)	2.94 (74.7)	4.88 (124.0)	
3		3.81 (96.8)	8.88 (225.6)	3.38 (85.9)	2.94 (74.7)	7.13 (181.1)	
4		3.81 (96.8)	11.13 (282.7)	3.38 (85.9)	2.94 (74.7)	9.38 (238.3)	
Stainless Steel							
1	In-line	3.00 (76.2)	3.50 (88.9)	3.00 (76.2)	1.50 (38.1)	4.25 (108.0)	②
2		3.50 (88.9)	6.75 (171.5)	3.00 (76.2)	1.50 (38.1)	7.50 (190.5)	
3		3.50 (88.9)	9.00 (228.6)	3.00 (76.2)	1.50 (38.1)	9.00 (228.6)	
4		3.50 (88.9)	11.25 (285.8)	3.00 (76.2)	1.50 (38.1)	12.00 (304.8)	

Notes

- ① Depth given is for two contact block deep stations. One contact block deep stations subtract 3/4 in (19.1 mm).
- ② No conduit entrance holes provided. Drill as required.

Approximate Dimensions in Inches (mm)

Flush Mounting

Die Cast and Stainless Steel Covers Only

4 Mtg. Holes - 10-32 Screw Size
for 1-11 Element Encl, 1/4-20
Screw Size for 12 Element
and Larger

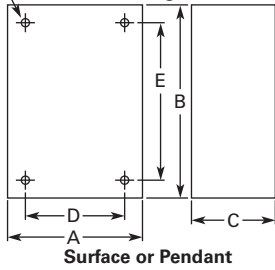

Number of Elements	Wide A	High B	Deep C	Mounting D	E
Die Cast					
1	3.88 (98.6)	4.00 (101.6)	0.25 (6.4) ①	3.50 (88.9)	3.63 (92.2)
2	3.88 (98.6)	5.88 (149.4)	0.25 (6.4) ①	3.50 (88.9)	5.50 (139.7)
3	3.88 (98.6)	7.75 (196.9)	0.25 (6.4) ①	3.50 (88.9)	6.00 (152.4)
4	3.88 (98.6)	9.63 (244.6)	0.25 (6.4) ①	3.50 (88.9)	9.25 (235.0)
Stainless Steel					
1	5.00 (127.0)	5.00 (127.0)	2.50 (63.5) ②	3.25 (82.6)	1.88 (47.8)
2	5.00 (127.0)	6.88 (174.8)	2.50 (63.5) ②	3.25 (82.6)	3.63 (92.2)
3	5.00 (127.0)	8.63 (219.2)	2.50 (63.5) ②	3.25 (82.6)	5.50 (139.7)
4	5.00 (127.0)	10.50 (266.7)	2.50 (63.5) ②	3.25 (82.6)	7.25 (184.2)

Notes

- ① Depth given is for flat cover. Deep cover is 3/4 in (19.1 mm) deeper.
- ② Depth given includes pull box.

1.10 Pushbuttons and Indicating Lights

30.5 mm Heavy-Duty Watertight/Oiltight—10250T

1

Approximate Dimensions in Inches (mm)

Flush and Long Pushbutton Half Shroud

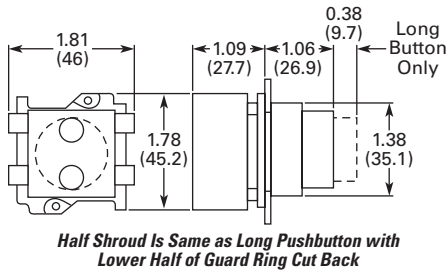

Push-Pull Switch

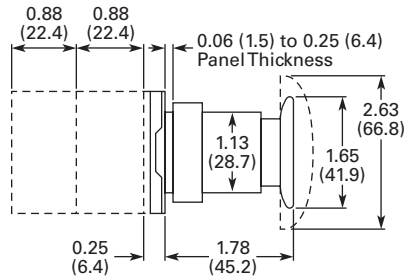

Mushroom and Jumbo Head Pushbutton

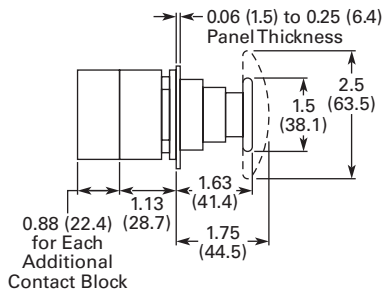

Flush Pushbutton Operator with Padlock Attachment

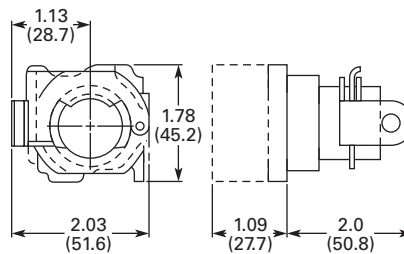

Pushbutton with Cylinder Lock

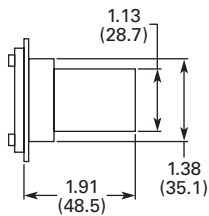

Mushroom Head Pushbutton Operator with Padlock Attachment

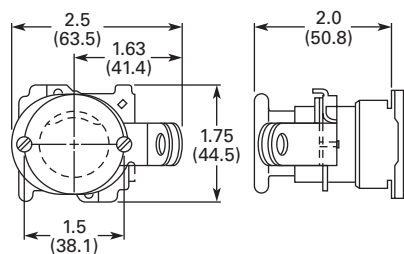

Illuminated Pushbutton

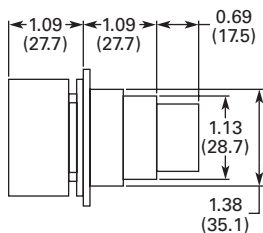

Indicating Light—Transformer Type

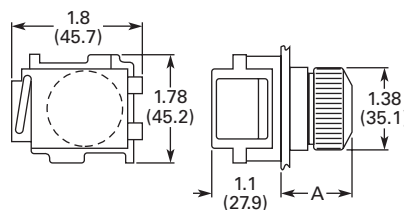

Approximate Dimensions in Inches (mm)

PresTest Indicating Light—Transformer Type

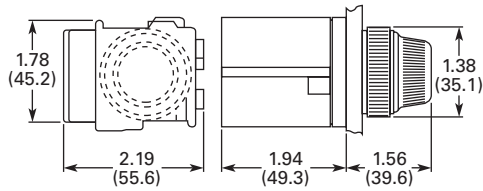

PresTest Indicating Light—Resistor Type

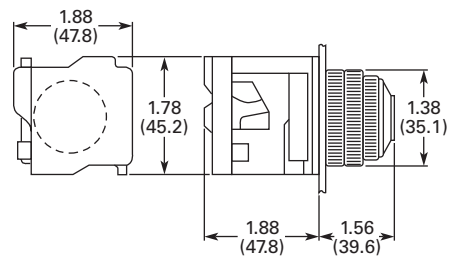

Jumbo Mushroom Head Pushbutton Operator with Padlock Attachment

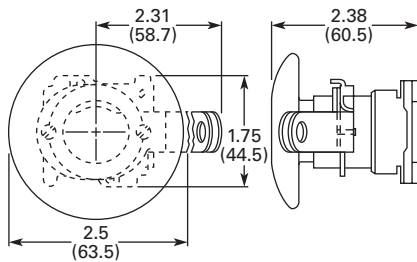

Master Test Indicating Light

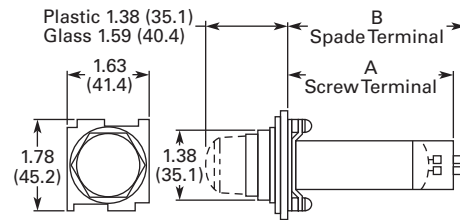

Description	B	C
Relay type	4.38 (111.2)	4.28 (108.7)
Solid-state type	2.94 (74.7)	2.88 (73.2)

Indicating Light—Resistor and Neon Type

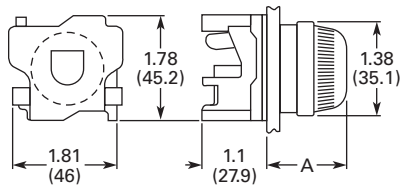

Lens	A
Plastic	1.38 (35.1)
Glass	1.56 (39.6)

Potentiometer Shaft

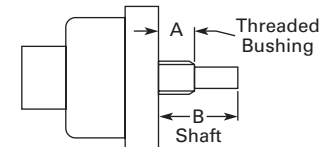

Shaft Dimensions of Potentiometer That C-H Operator Will Accept

Operator Catalog Number	A	B
10250T330	0.38 (9.7) dia. x 0.38 (9.7) long	0.25 (6.4) dia. x 0.63 (16) long

1.10

Pushbuttons and Indicating Lights

30.5 mm Heavy-Duty Watertight/Oiltight—10250T

1

Approximate Dimensions in Inches (mm)

Coin Operated Selector Switch

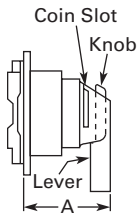

Operator	Dim. A
Knob	1.38 (35.1)
Lever	1.50 (38.1)
Coin slot	1.38 (35.1)

Key Operated Selector Switch

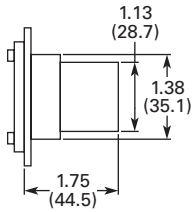

Illuminated Selector Switch

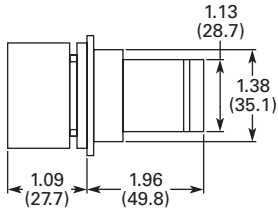

Roto-Push

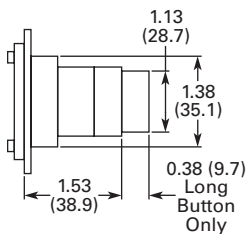

Wobble Stick Catalog No. 10250TA5

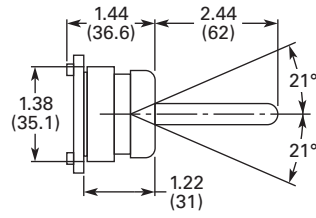

Lever Operator—For Use with Two Vertically Mounted Flush Pushbuttons Catalog No. 10250TA14

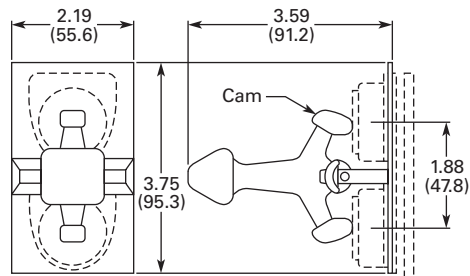

Flexible Boot—For Protecting Flush or Long Pushbutton Catalog No. 10250TA3 Typical

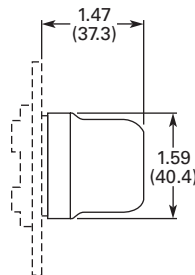

Transparent Flexible Boot—For Illuminated Pushbutton Catalog No. 10250TA25

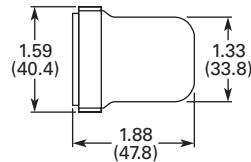

Approximate Dimensions in Inches (mm)

**Padlock Attachment—For Knob Selector Switch
Catalog No. 10250TA11**

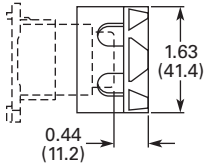

**Padlock Attachment—For Flush Pushbutton
Catalog No. 10250TA2**

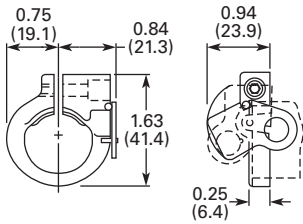

**Padlock Attachment—For Extended Pushbutton
Catalog No. 10250TA26**

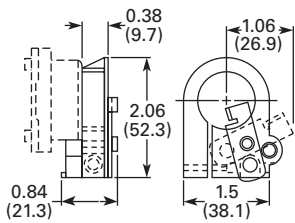

**Maintained Pushbutton
Catalog No. 10250TA66 Typical**

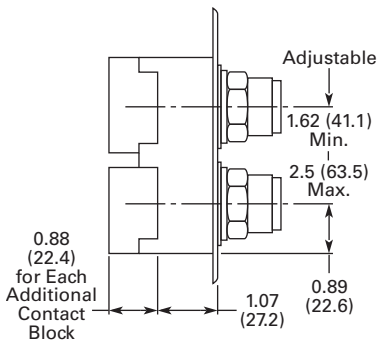

**Maintained Contact Attachment
Catalog No. 10250TA17 Typical**

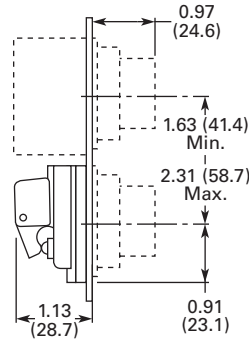

**Padlock Cover Guard for Flush Pushbutton
Catalog No. 10250TA36**

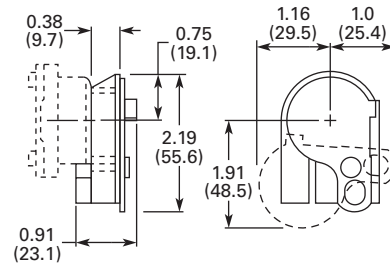

**Padlock Attachment for Maintained Push-Pull Operator
Catalog No. 10250TA64**

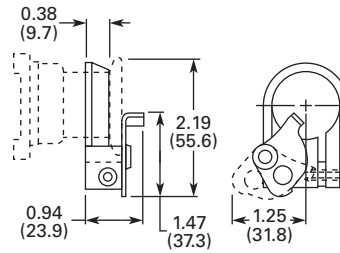

**Protecting Shroud for Jumbo Mushroom Head Button
Catalog No. 10250TA56**

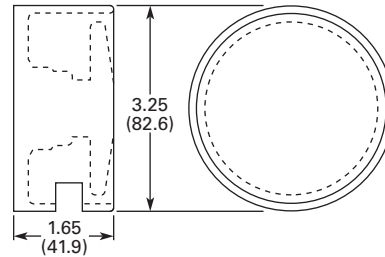

1.10

Pushbuttons and Indicating Lights

30.5 mm Heavy-Duty Watertight/Oiltight—10250T

1

Approximate Dimensions in Inches (mm)

Protecting Shroud for Mushroom Head Button Catalog No. 10250TA6

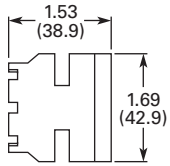

Extended Retaining Nut Catalog No. 10250TA12

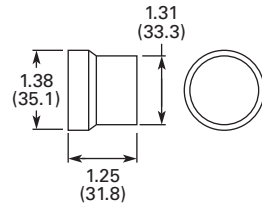

Panel Drilling and Minimum Spacing

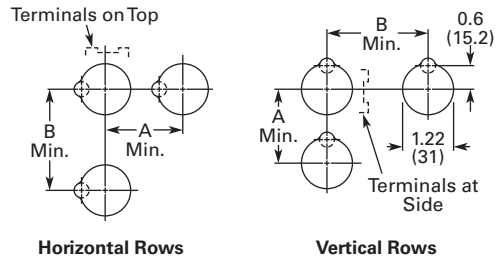

Protecting Shroud for Illuminated Pushbutton Catalog No. 10250TA15

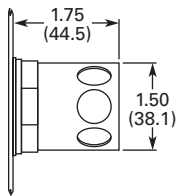

Lever for Roto-Push Operator Catalog No. 10250TA13

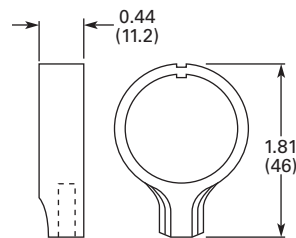

Padlock Hasp or Flip-Up Guard Catalog No. 10250TA38

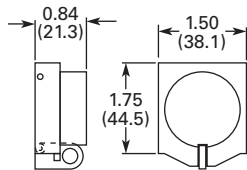

Legend Plate	A Min.	B Min.
1 or 2 Circuit Contact Blocks		
Small or none	1.63 (41.4)	2.25 (57.2)
Standard	1.75 (44.5)	2.25 (57.2)
Jumbo ^①	2.25 (57.2)	2.25 (57.2)
Extra large	2.50 (63.5)	2.60 (66.0)
4 Circuit Contact Block 10250T44		
Small or none	1.88 (47.8)	2.25 (57.2)
Standard	1.88 (47.8)	2.25 (57.2)
Jumbo ^①	2.25 (57.2)	2.25 (57.2)
Extra large	2.50 (63.5)	2.60 (66.0)

Notes

Locating nib hole or notch is 1.36–1.4 in (34.5–35.6 mm) #29 drill.

^① If jumbo plates are to be placed one above the other vertically, add 0.13 (3.3) to minimum dimensions listed.

Approximate Dimensions in Inches (mm)

Multiple Button Guard

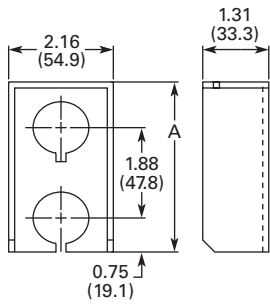

Number of Elements	A
2	4.0 (101.6)
3	5.88 (149.4)
4	7.88 (200.2)
7	13.38 (339.9)

Chain Hook Bracket

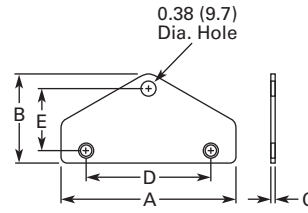

Enclosure Size (No. of Elements)	Wide A	High B	Deep C	Mounting	
				D	E
2, 3 and 4	3.75 (95.3)	1.94 (49.3)	0.13 (3.3)	2.69 (68.3)	1.38 (35.1)
6 and 7	4.0 (101.6)	2.19 (55.6)	0.13 (3.3)	2.88 (73.2)	1.63 (41.4)

Master Test Module, Flasher Module and Legend Plate

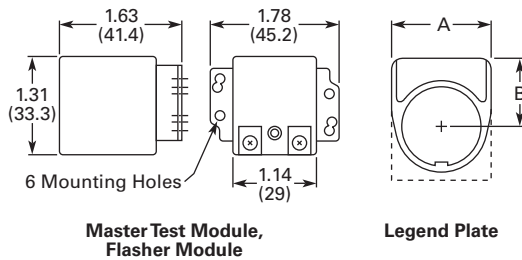

Legend Plate	A	B
1/2 Round Legend Plates		
Small	1.56 (39.6)	0.91 (23.1)
Standard	1.59 (40.4)	1.07 (27.2)
Jumbo	2.06 (52.3)	1.53 (38.9)
Square Legend Plates		
Small	1.59 (40.4) sq.	0.90 (22.9)
Standard	1.75 (44.5) sq.	1.06 (26.9) ①
Jumbo	2.19 (55.6) sq.	1.50 (38.1)
Extra large	2.44 (62.0) sq.	1.63 (41.4)

Notes

Locating nib hole or notch is 1.36–1.4 in (34.5–35.6 mm) #29 drill.

① For plastic legend plate, Dimension B is 1.12 (28.4).

30.5 mm Corrosion Resistant Watertight/Oiltight—E34



Product Description

Eaton's E34 Series 30.5 mm pushbutton line features the same rugged die cast construction of our 10250T line with an additional two-layer 100% solid thermosetting cathodic epoxy coating. This coating provides a flat black smooth, consistent, corrosion resistant surface that has passed a demanding 600 hour salt spray test. (The industry standard for this 4X test requires only 200 hours.)

Features

- Epoxy-coated metal operators
- Corrosion resistant
- Integral ground screw terminal on operators
- FDA approved for sanitary chemical resistance requirements

Contents

<i>Description</i>	<i>Page</i>
30.5 mm Corrosion Resistant Watertight/Oiltight—E34	
Product Overview	V7-T1-291
Product Identification	V7-T1-292
Catalog Number Selection	V7-T1-293
Ordering Complete Devices	V7-T1-295
Product Selection	
Non-Illuminated Momentary	
Pushbutton Units	V7-T1-296
Plastic Lens Indicating Light Units	V7-T1-296
Pushbuttons	V7-T1-297
Illuminated Pushbuttons and	
Indicating Lights	V7-T1-298
Push-Pull Units	V7-T1-300
Illuminated Push-Pull Units	V7-T1-301
Potentiometers	V7-T1-303
Push-Pull Operators	V7-T1-304
Selector Switch Units	V7-T1-308
Selector Switch Selection	V7-T1-309
Selector Switch Operators	V7-T1-312
Key Operators	V7-T1-312
Illuminated Selector Switch Operators	V7-T1-314
Accessories	V7-T1-315
Options	V7-T1-317
Replacement Parts	V7-T1-323
Technical Data and Specifications	V7-T1-325
Dimensions	V7-T1-328

Standards and Certifications

- CE EN60947-5-1 and 60947-5-5
- UL 508—File No. E131568
- CSA C22.2 No. 14—File No. LR68551
- FDA 3-A Sanitary Standards



Ingress Protection

When mounted in similarly rated enclosure—

- Standard indicating lights
 - UL (NEMA) Type 1, 2, 3, 3R, 3S, 4, 4X, 12, 13
 - IEC IP65
- All other operators
 - UL (NEMA) Type 1, 2, 3, 3R, 4, 4X, 12, 13
 - IEC IP65

Product Overview

Ultraviolet Light

E34 cathodic coating is not recommended for use in applications where exposure to ultraviolet light exists—use NEMA 4X 10250T operators.

Reliability Nibs

Eaton’s contact blocks feature enclosed silver contacts with pointed “reliability nibs” for reliable performance from logic level up to 600V. To ensure reliable switching, nibs bite through oxide which can form on silver contacts, eliminating the need for expensive logic level blocks for most applications.

Reliability Nibs

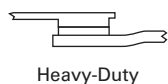
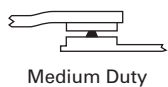
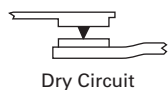

Diaphragm Seal with Drainage Holes

Liquid Drainage

Eaton’s pushbutton operators offer front of panel drainage via holes in the operator bushing. Hidden from view by the mounting nut, these holes prevent buildup of liquid inside the operator, which can prevent operation in freezing environments. The holes also provide a route for escaping liquid in high pressure washdowns, effectively relieving pressure from the internal diaphragm seal, ensuring reliable sealing in applications even beyond NEMA 4.

Diaphragm Seal

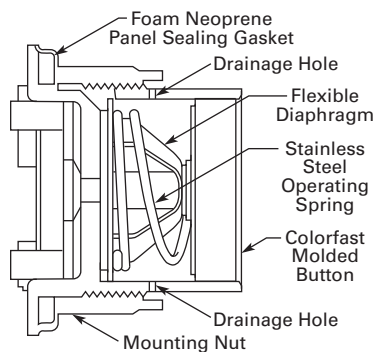

1

Product Identification

30.5 mm Corrosion Resistant Watertight/Oiltight—E34 Series

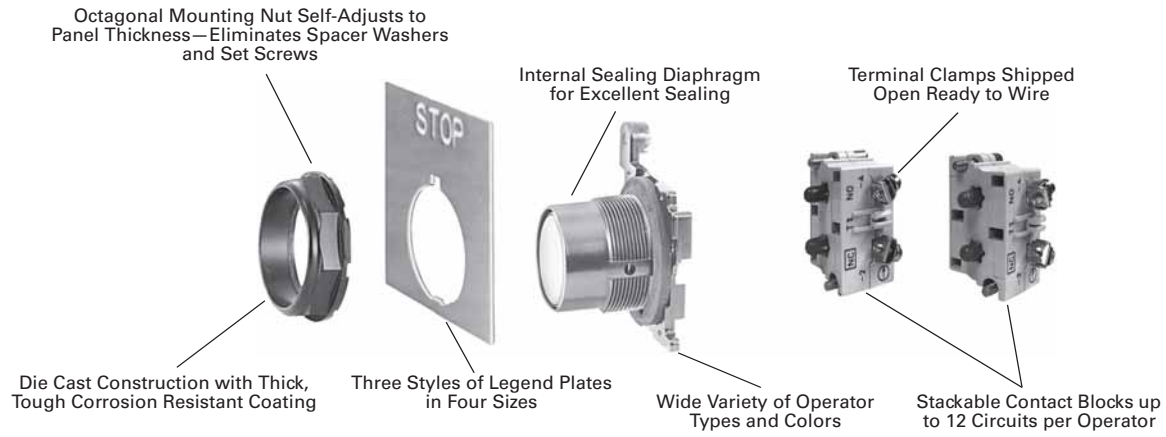

Catalog Number Selection

Catalog Number Selection is for illustrative purposes only and not to be used to create new catalog numbers.

Non-Illuminated Pushbuttons

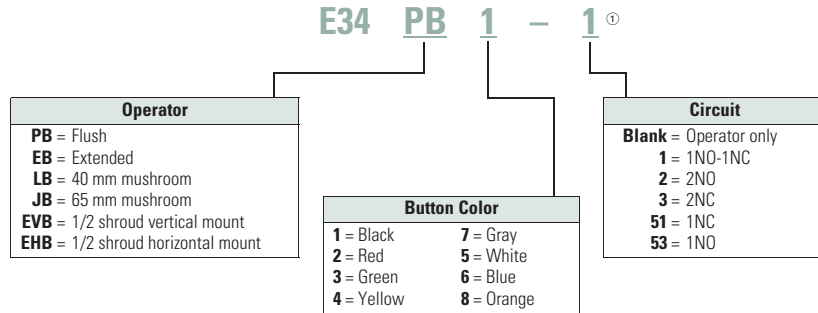

Illuminated and Non-Illuminated Push-Pulls

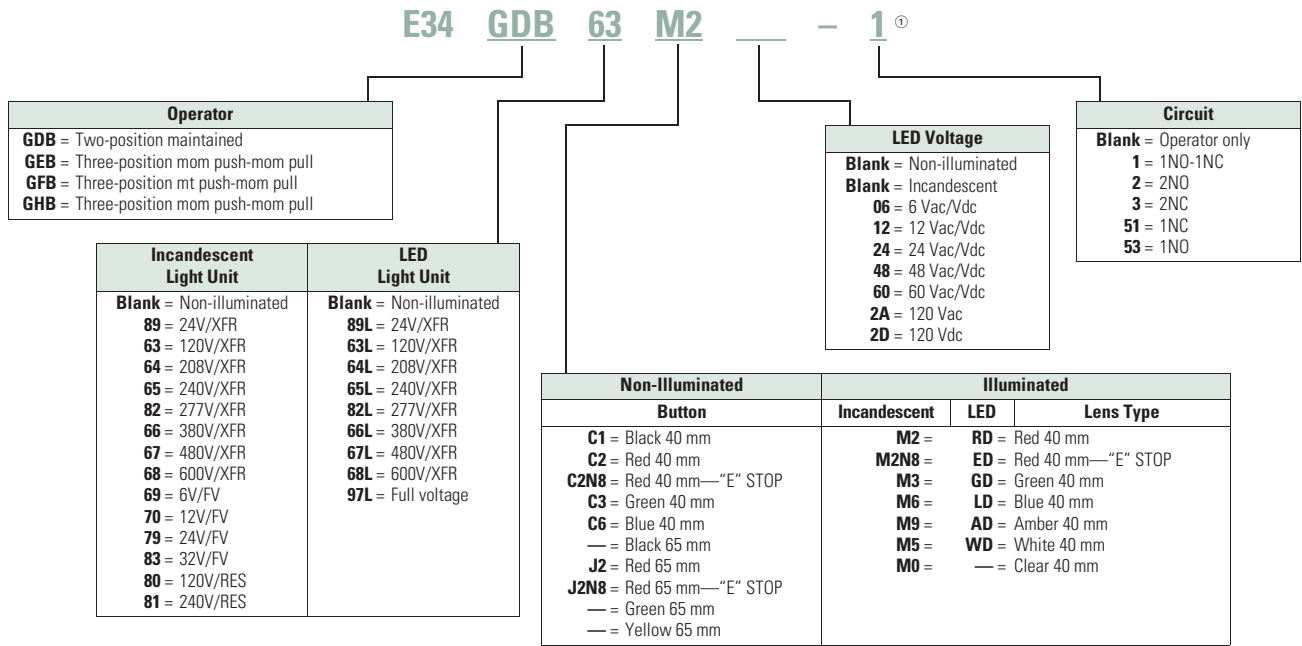

Note

① Add **X** at end of catalog number to receive parts assembled from factory.

1.11

Pushbuttons and Indicating Lights

30.5 mm Corrosion Resistant Watertight/Oiltight—E34

1

Catalog Number Selection is for illustrative purposes only and not to be used to create new catalog numbers.

Illuminated Pushbuttons

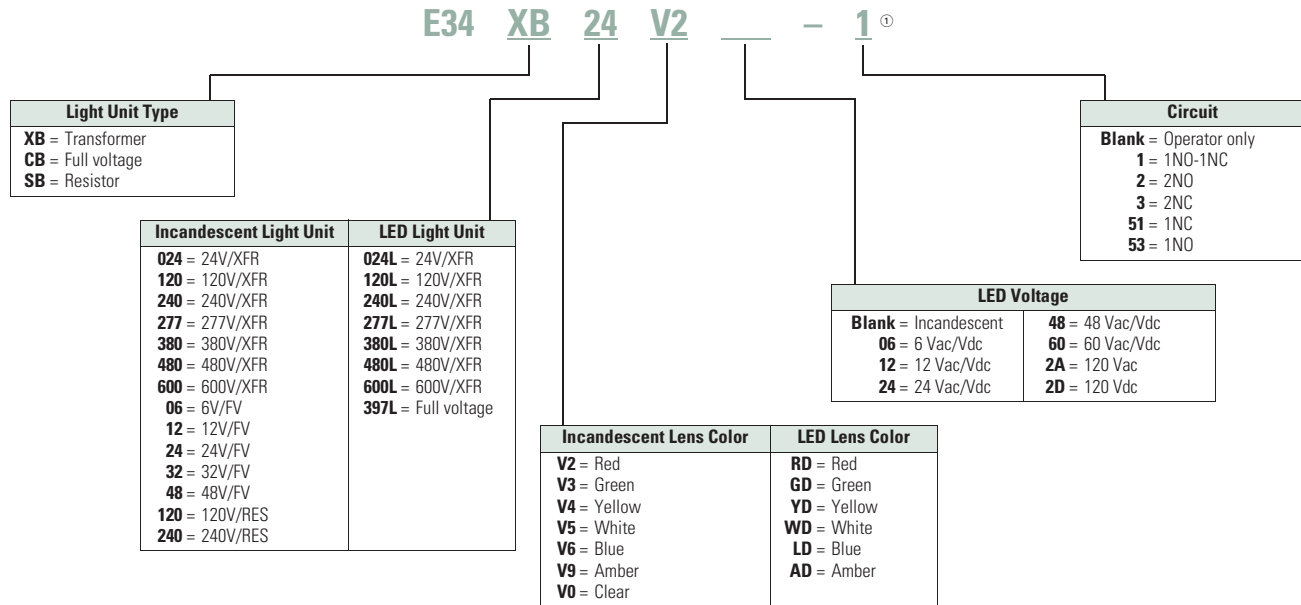

Standard Indicating Lights, PresTest and Master Test

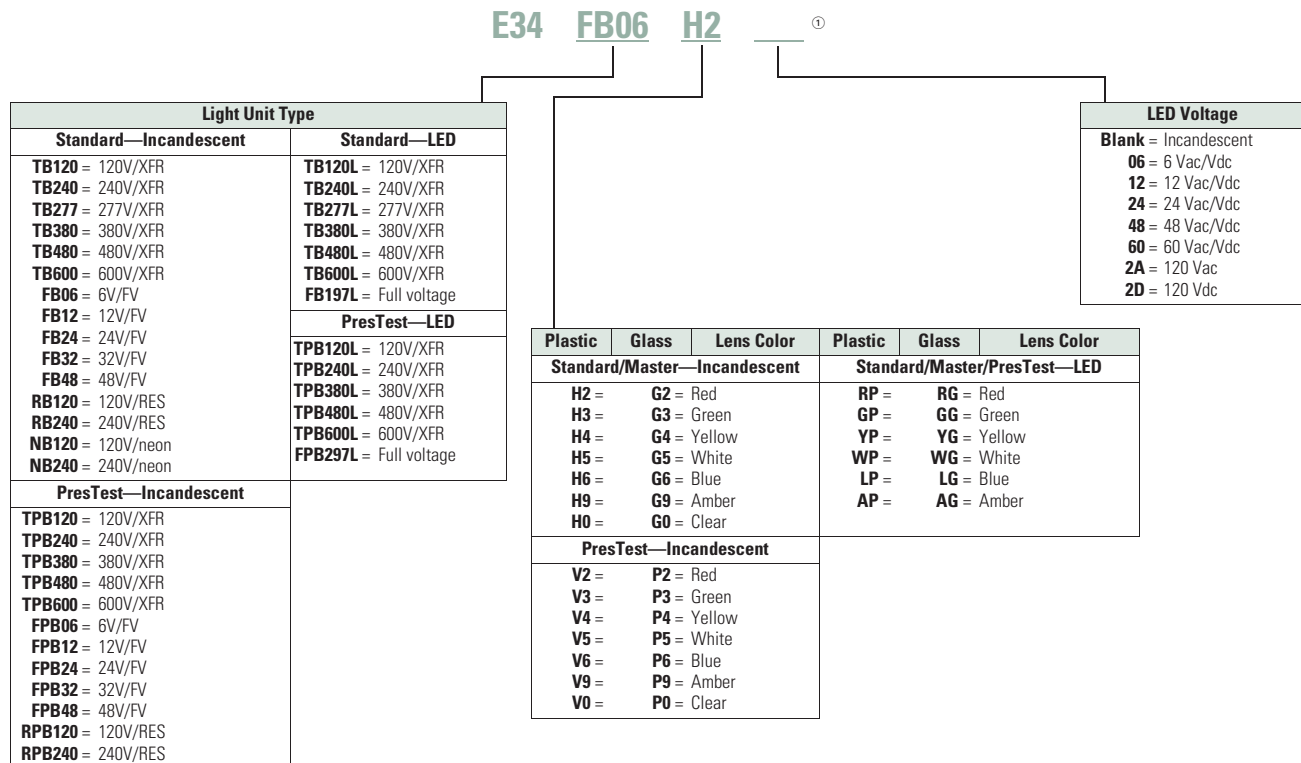

Note

① Add **X** at end of catalog number to receive parts assembled from factory.

Catalog Number Selection is for illustrative purposes only and not to be used to create new catalog numbers.

Ordering Complete Devices

Complete E34 pushbuttons, indicating lights and/or selector switch operators including contact block(s) and legend plate can be ordered using a single composite catalog number. The

individually packaged components will be shipped unassembled in a single overpack carton marked with the composite catalog number.

Ordering Example

Illuminated Pushbutton Device—Catalog Number E34XB120V2-153SP90

For a complete Catalog Number breakdown, see **Pages V7-T1-293 to V7-T1-294.**

For Complete E34 Device Ordering

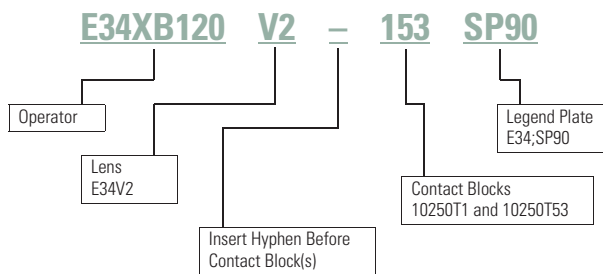

1

Product Selection

Non-Illuminated Momentary Pushbutton Units

UL (NEMA) Type 3, 3R, 4, 4X, 12, 13

Flush Button



Extended Button



Mushroom Button



Jumbo Mushroom



Pushbutton Units

Contact Type	Button Color	Flush Button Catalog Number	Extended Button Catalog Number	Mushroom Button Catalog Number	Jumbo Mushroom ^① Catalog Number
1NO	Black	E34PB1-53X	E34EB1-53X	E34LB1-53X	E34JB1-53X
	Red	E34PB2-53X	E34EB2-53X	E34LB2-53X	E34JB2-53X
	Green	E34PB3-53X	E34EB3-53X	E34LB3-53X	E34JB3-53X
	Red—Engraved EMERG. STOP	—	—	—	E34JB2N8-53X
1NC	Black	E34PB1-51X	E34EB1-51X	E34LB1-51X	E34JB1-51X
	Red	E34PB2-51X	E34EB2-51X	E34LB2-51X	E34JB2-51X
	Green	E34PB3-51X	E34EB3-51X	E34LB3-51X	E34JB3-51X
	Red—Engraved EMERG. STOP	—	—	—	E34JB2N8-51X
1NO-1NC	Black	E34PB1-1X	E34EB1-1X	E34LB1-1X	E34JB1-1X
	Red	E34PB2-1X	E34EB2-1X	E34LB2-1X	E34JB2-1X
	Green	E34PB3-1X	E34EB3-1X	E34LB3-1X	E34JB3-1X
	Red—Engraved EMERG. STOP	—	—	—	E34JB2N8-1X

Plastic Lens Indicating Light Units

UL (NEMA) Type 3, 3R, 4, 4X, 12, 13

24V Full Voltage Indicating Light



Indicating Light Units

Type	Voltage	Color	LED/Lamp Number	Indicating Light ^① Catalog Number
LED Lamp				
Full voltage	24 Vac/Vdc	Red	Bayonet base	E34FB197LRP24
		Green		E34FB197LGP24
		Amber		E34FB197LAP24
	120 Vac	Red		E34FB197LRP2A
		Green		E34FB197LGP2A
		Amber		E34FB197LAP2A
Incandescent Lamp				
Full voltage	24 Vac/Vdc	Red	#757	E34FB24H2X
		Green		E34FB24H3X
		Amber		E34FB24H9X
Resistor	120 Vac/Vdc	Red	120MB	E34RB120H2X
		Green		E34RB120H3X
		Amber		E34RB120H9X
Transformer	120 Vac 50/60 Hz	Red	#755	E34TB120H2X
		Green		E34TB120H3X
		Amber		E34TB120H9X

Notes





Use NEMA 4X 10250T operators where exposed to ultraviolet light, see **Pages V7-T1-219 to V7-T1-289**.

① Anodized aluminum head—may not be suitable for some corrosive environments.

Pushbuttons

UL (NEMA) Type 3, 3R, 4, 4X, 12, 13

Momentary Pushbutton Operators, Non-Illuminated

Button	Color	Catalog Number		
E34PB_ 	Flush button	Black	E34PB1	
	Red		E34PB2	
	Green		E34PB3	
	Yellow		E34PB4	
	White		E34PB5	
	Blue		E34PB6	
	Gray		E34PB7	
	Orange		E34PB8	
E34EB_ 	Extended button	Black	E34EB1	
	Red		E34EB2	
	Green		E34EB3	
	Yellow		E34EB4	
	White		E34EB5	
	Blue		E34EB6	
	Gray		E34EB7	
	Orange		E34EB8	
E34EHB_ 	Half shrouded button		Vertical	Horizontal
		Black	E34EVB1	E34EHB1
	Red	E34EVB2	E34EHB2	
	Green	E34EVB3	E34EHB3	
	Yellow	E34EVB4	E34EHB4	
	White	E34EVB5	E34EHB5	
	Blue	E34EVB6	E34EHB6	
	Gray	E34EVB7	E34EHB7	
	Orange	E34EVB8	E34EHB8	
	E34LB_ 	Mushroom button	Black	E34LB1
Red			E34LB2	
Green			E34LB3	
Yellow			E34LB4	
Blue			E34LB6	
E34JB_ 	Anodized aluminum jumbo mushroom button ^①	Black	E34JB1	
		Red	E34JB2	
		Red (Engraved EMERG. STOP)	E34JB2N8	
		Green	E34JB3	
		Yellow	E34JB4	

Notes

Use NEMA 4X 10250T operators where exposed to ultraviolet light, see **Pages V7-T1-219 to V7-T1-289**.

① Anodized aluminum head—may not be suitable for some corrosive environments.

Illuminated Pushbuttons and Indicating Lights

Illuminated Pushbutton



Indicating Light



PresTest



Operators without Lens

Type	Voltage	Lamp Number	Illuminated Pushbutton Catalog Number	Indicating Light Catalog Number	PresTest Catalog Number
LED Lamp (LEDs not included) ①					
Full voltage	—	Bayonet base	E34CB497L	E34FB197L	E34FPB297L
Transformer AC only	24		E34XB024L	—	—
	120		E34XB120L	E34TB120L	E34TPB120L
	240		E34XB240L	E34TB240L	E34TPB240L
	277		E34XB277L	E34TB277L	—
	380		E34XB380L	E34TB380L	E34TPB380L
	480		E34XB480L	E34TB480L	E34TPB480L
	600		E34XB600L	E34TB600L	E34TPB600L
Incandescent Lamp					
Full voltage AC/DC	6	#755	E34CB06	E34FB06	E34FPB06
	12	#756	E34CB12	E34FB12	E34FPB12
	24	#757	E34CB24	E34FB24	E34FPB24
	32	#1828	E34CB32	E34FB32	E34FPB32
	48	#1835	E34CB48	E34FB48	E34FPB48
Resistor AC/DC ②	120	120MB	E34SB120	E34RB120	E34RPB120
	240		E34SB240	E34RB240	E34RPB240
Transformer AC only	24	#755	E34XB024	—	—
	120		E34XB120	E34TB120	E34TPB120
	240		E34XB240	E34TB240	E34TPB240
	277		E34XB277	E34TB277	—
	380		E34XB380	E34TB380	E34TPB380
	480		E34XB480	E34TB480	E34TPB480
	600		E34XB600	E34TB600	E34TPB600
Neon AC/DC	120	NE51H-R-22	—	E34NB120	—
	240	NE51H-4-68	—	E34NB240	—

Notes

Use NEMA 4X 10250T operators where exposed to ultraviolet light, see **Pages V7-T1-219 to V7-T1-289**.

① These units do not include lamps. Order LED separately to match lens color, see **Page V7-T1-275** for LED Selection and **Pages V7-T1-293 to V7-T1-294** for Catalog Numbering Selection.

② Resistor units are not available for use with LEDs, choose either transformer or full voltage LED style.

Plastic



Indicating Light Lens

Color	Plastic Catalog Number	Glass ① Catalog Number
Red	E34H2	E34G2
Green	E34H3	E34G3
Yellow	E34H4	E34G4
White	E34H5	E34G5
Blue	E34H6	E34G6
Ambler	E34H9	E34G9
Clear	E34H0	E34G0

Glass



E34V_



Illuminated Pushbutton Lens

Color	Catalog Number
Red	E34V2
Green	E34V3
Yellow	E34V4
White	E34V5
Blue	E34V6
Ambler	E34V9
Clear	E34V0

Plastic



PresTest Lens

Color	Plastic Catalog Number	Glass ① Catalog Number
Red	E34V2	E34P2
Green	E34V3	E34P3
Yellow	E34V4	E34P4
White	E34V5	E34P5
Blue	E34V6	E34P6
Ambler	E34V9	E34P9
Clear	E34V0	E34P0

Glass



Note

① Glass lens has black anodized aluminum bezel.

1

Push-Pull Units

UL (NEMA) Type 3, 3R, 4, 4X, 12, 13

- Two- and three-position
- Non-illuminated

Two-Position Push-Pull Unit



Two-Position Push-Pull Units, Non-Illuminated

Operator Position ^①

Pull	Push	Button Type/Color ^②	Contact Type	Mounting Location		Catalog Number
				A	B	
Maintained Push, Maintained Pull						
0	X	40 mm/red	1NO			<u>E34GDBC2</u> -1X
X	0	40 mm engraved EMERG. STOP/red	1NC			<u>E34GDBC2N8</u> -1X
		65 mm aluminum engraved EMERG. STOP/red				<u>E34GDBJ2N8</u> -1X

Three-Position Push-Pull Unit



Three-Position Push-Pull Units, Non-Illuminated

Operator Position ^①

Pull	Intermediate	Push	Button Type/Color ^②	Contact Type	Mounting Location		Catalog Number
					A	B	
Maintained Push, Momentary Pull							
X	0	0	40 mm/black	1NC			<u>E34GFBC1</u> -3X
X	X	0	40 mm/red	1NC			<u>E34GFBC2</u> -3X
			40 mm engraved EMERG. STOP/red				<u>E34GFBC2N8</u> -3X
Momentary Push, Momentary Pull							
X	0	0	40 mm/black	1NC			<u>E34GEBc1</u> -3X
X	X	0	40 mm/red	1NC			<u>E34GEBc2</u> -3X
0	0	X	40 mm/black	1NO			<u>E34GHBC1</u> -1X
X	0	0	40 mm/red	1NC			<u>E34GHBC2</u> -1X

Button and Color Selection

Color	Suffix Code	Catalog Number
Standard—40 mm		
Black	C1	E34C1
Red	C2	E34C2
Red (EMERG. STOP)	C2N8	E34C2N8
Green	C3	E34C3
Blue	C6	E34C6
Jumbo Mushroom Head ^③ (Anodized) Aluminum—65 mm		
Red	J2	E34J2
Red (EMERG. STOP)	J2N8	E34J2N8

Notes

Use NEMA 4X 10250T operators where exposed to ultraviolet light, see **Pages V7-T1-219 to V7-T1-289**.

^① X = closed circuit, 0 = open circuit.

^② To order different type or color buttons, substitute the underlined characters with appropriate suffix code from the table. Example: E34GDBCC6-1X.

^③ Anodized aluminum may not be suitable for use on some corrosive applications.

Illuminated Push-Pull Units

UL (NEMA) Type 3, 3R, 4, 4X, 12, 13

- Two-position maintained
- Illuminated

Illuminated Push-Pull Unit



Two-Position Illuminated Maintained Push, Maintained Pull

Operator Position ①



		Lamp	Type	Voltage	Contact Type	Mounting Location A B	LED/Lamp Number	Red Standard Push-Pull Catalog Number ②	
0	X	LED	Full voltage	24 Vac/Vdc	1NO		Bayonet base	E34GDB97LRD24-1X	
X	0			120 Vac/Vdc	1NC				E34GDB97LRD24A-1X
				Transformer	24 Vac				
				120 Vac				E34GDB63LRD06-1X	
0	X	Incandescent	Full voltage	24 Vac/Vdc	1NO		#757	E34GDB79M2-1X	
X	0			Resistor	120 Vac/Vdc		1NC	120MB	E34GDB80M2-1X
				Transformer	24 Vac			#755	E34GDB89M2-1X
					120 Vac				E34GDB63M2-1X

Standard



Lens and Color Selection

Color	Incandescent Suffix Code	LED Suffix Code	Catalog Number
Standard			
Red	M2	RD	E34M2
Red (EMER. STOP)	M2N8	ED	E34M2N8
Green	M3	GD	E34M3
Blue	M6	LD	E34M6
Amber	M9	AD	E34M9
White	M5	WD	E34M5
Clear	M0	CD	E34M0

Notes

Use NEMA 4X 10250T operators where exposed to ultraviolet light, see **Pages V7-T1-219 to V7-T1-289**.

① X = closed circuit, 0 = open circuit.

② To order different type or color lens, substitute the underlined characters with appropriate suffix code from Lens and Color Selection table above. Example: E34GDB79M3-1X. For LEDs with different voltages see ordering example on **Page V7-T1-307**.

1

UL (NEMA) Type 3, 3R, 4, 4X, 12, 13

- Three-position maintained
- Illuminated

Illuminated Push-Pull Unit



Three-Position Illuminated Momentary Push, Momentary Pull

Operator Position ①



Operator Position ①			Lamp	Type	Voltage	Contact Type	Mounting Location		LED/Lamp Number	Red Standard Push-Pull Catalog Number ②			
Momentary—Pull	Maintained—Intermediate	Momentary—Push					A	B					
0	0	X	LED	Full voltage	24 Vac/Vdc	1NO		Bayonet base	E34GHB97LRD24-1X				
X	0	0			120 Vac	1NC					E34GHB97LRD2A-1X		
					Trans-former	24 Vac					E34GHB89LRD06-1X		
					120 Vac				E34GHB63LRD06-1X				
X	0	0	LED	Full voltage	24 Vac/Vdc	1NC		Bayonet base	E34GEB97LRD24-3X				
X	X	0			120 Vac	1NC					E34GEB97LRD2A-3X		
					Trans-former	24 Vac					E34GEB89LRD06-3X		
					120 Vac				E34GEB63LRD06-3X				
0	0	X	Incandescent	Full voltage	24 Vac/Vdc	1NO		#757	E34GHB79M2-1X				
X	0	0			Resistor	120 Vac				1NC		120MB	E34GHB80M2-1X
					Trans-former	24 Vac						#755	E34GHB89M2-1X
					120 Vac				E34GHB63M2-1X				
X	0	0	LED	Full voltage	24 Vac/Vdc	1NC		#757	E34GEB79M2-3X				
X	X	0			Resistor	120 Vac				1NC		120MB	E34GEB80M2-3X
					Trans-former	24 Vac						#755	E34GEB89M2-3X
					120 Vac				E34GEB63M2-3X				

Notes

Use NEMA 4X 10250T operators where exposed to ultraviolet light, see **Pages V7-T1-219 to V7-T1-289**.

① X = closed circuit, 0 = open circuit.

② To order different type or color lens, substitute the underlined characters with appropriate suffix code from Lens and Color Selection table on the bottom of **Page V7-T1-301**. Example: E34GEB79M3-3X. For LEDs with different voltages see ordering example on **Page V7-T1-307**.

UL (NEMA) Type 3, 3R, 4, 4X, 12, 13

- Three-position—maintained push, momentary pull
- Illuminated

Illuminated Push-Pull Unit



Three-Position Illuminated Maintained Push, Momentary Pull

Operator Position ①



Momentary Pull	Maintained Intermediate	Maintained Push	Lamp	Type	Voltage	Contact Type	Mounting Location		LED/Lamp Number	Red Standard Push-Pull Catalog Number ②
							A	B		
X	0	0	LED	Full voltage	24 Vac/Vdc	1NC	o o	Bayonet base		E34GFB97LRD24-3X
X	X	0			120 Vac	1NC				
					24 Vac					
				Trans-former	120 Vac					E34GFB63LRD06-3X
X	0	0	Incandescent	Full voltage	24 Vac/Vdc	1NC	o o	#757		E34GFB79M2-3X
X	X	0			120 Vac	1NC				
				24 Vac			#755	E34GFB89M2-3X		
				120 Vac				E34GFB63M2-3X		

Vertical or Horizontal One-Hole Mounting ③



Potentiometers

UL (NEMA) Type 3, 3R, 4, 4X, 12, 13

Potentiometer with Knob and Standard Dial Plate—Linear Type ±10%

Potentiometer Ohms	Catalog Number
2 Watt (60V Max.) Single Potentiometer with Standard Aluminum Dial Plate ④⑤	
1000	E34PDB1F1
2500	E34PDB1F2
5000	E34PDB1F5
10000	E34PDB1F10
25000	E34PDB1F25
50000	E34PDB1F50
Operator only ⑥	E34PDB1A0
Alternative—black plastic large legend with standard markings	E34LP99

Dimensions, see Page V7-T1-328.

Notes

Use NEMA 4X 10250T operators where exposed to ultraviolet light, see **Pages V7-T1-219 to V7-T1-289.**

① X = closed circuit, 0 = open circuit.

② To order different type or color lens, substitute the underlined characters with appropriate suffix code from table on the bottom of **Page V7-T1-301.**

Example: E34GFB79M3-3X. For LEDs with different voltages see ordering example on **Page V7-T1-307.**

③ Shown with standard aluminum dial plate.

④ Large dial plate with space for legend is available at no charge. To order, add suffix **36** to catalog number.

Example: E34PDB1F136. To order separately, see footnote ⑥ below.

⑤ Large dial plate has space at top for 15 letters. 3/32 in high. For custom stamped legend plates, order legend plate as separate item **10250TR30** and specify stamping.

⑥ For use with commercially purchased potentiometers having shaft dimensions per dimension drawing on **Page V7-T1-280.**

1

Push-Pull Operators

An illuminated push-pull pushbutton unit, arranged for one-hole mounting, can replace two pushbuttons and a pilot light or the non-illuminated form can replace two pushbuttons. These units are available in three basic types:

- **Maintained**—(Two-position). Maintains in the pulled or pushed position until manually actuated to the opposite mode.
- **Momentary**—(Three-position). Spring returns to an intermediate position when pulled or pushed and released.

- **Momentary Pull, Maintained Push**—(Three-position). Spring returns to intermediate position when pulled. Maintains in pushed position until manually returned to intermediate (ready to reset) position. Maintained stop holds circuit open and will prevent other series connected operators from starting the system.

The operators, buttons, contact blocks, etc., are offered as building block components that can be intermixed to satisfy many requirements. This minimizes the need for a varied and costly inventory.

Application Guide

To assist in the selection of contact blocks, the sketch below shows pictorially by symbols **A** and **B** locations of contact circuits after assembly of contact blocks and adapter to the operator. The table below shows the effect of the push and pull operations on either NO or NC contacts. (X = contact closed, O = contact open).

Contact Circuit Locations

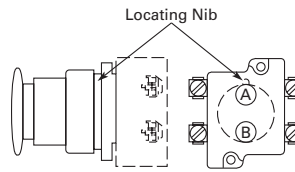

Two-Position Maint. Push-Pull ①



Push-Pull Operator Components

Operator Position and Circuit Arrangement



Contact Block Mounting Location

Type of Operator	Out—Pull		Intermediate		In—Push		Contact Block ②	Catalog Number
	A	B	A	B	A	B		
Two-Position Operator without Lens								
Maintained push-pull	O	O	No intermediate position		X	X	1NO	E34GDB
	X or	X			O or	O	1NC	
	O	O			X	X	2NO	
	X	X			O	O	2NC	
Three-Position Operator without Lens								
Momentary push-pull	O	O	O	O	X	O	1NO	E34GEB ②
	X or	X	O	X	O or	O	1NC	
	O	O	O	O	X	O	2NO	
	X	X	O	X	O	O	2NC	
Maintained push-momentary pull	O	O	O	O	X	O	1NO	E34GFB ②
	X or	X	O	X	O or	O	1NC	
	O	O	O	O	X	O	2NO	
	X	X	O	X	O	O	2NC	
Momentary push-pull	O	O	O	O	X	X	1NO	E34GHB ②
	X or	X	O	O	O or	O	1NC	
	O	O	O	O	X	X	2NO	
	X	X	O	O	O	O	2NC	

Notes

Use NEMA 4X 10250T operators where exposed to ultraviolet light, see **Pages V7-T1-219 to V7-T1-289**.

See Typical Applications on **Page V7-T1-239**.

① Shown without button on lens.

② Maximum of two blocks, four circuits. Special function contact blocks shown on **Page V7-T1-322** CANNOT be used with three-position push-pull operators E34GEB, E34GFB or E34GHB.

Push-Pull Light Units, Lenses and Buttons

Ordering Example with One Composite Number

Non-illuminated:

E34GDB + E34C2 + 10250T1 = **E34GDBC2-1X**

Incandescent:

E34GDB + 10250T79 + E34M2 + 10250T1 = **E34GDB79M2-1X**

LED:

E34GDB + 10250T97L + E34M2 + Voltage Code + 10250T1 = **E34GDB97LRD24-1X**

06—6 Vac/Vdc
12—12 Vac/Vdc
24—24 Vac/Vdc
48—48 Vac/Vdc

60—60 Vac/Vdc
2A—120 Vac
2D—120 Vdc

Light Units for Illuminated Push-Pull Devices

Light Unit Type	Type	Voltage	LED/Lamp Number	Catalog Number
LED (LEDs not included) ①	Full voltage Transformer AC only 50/60 Hz	—	Bayonet base	10250T97L
		24		10250T89L
		120		10250T63L
		208		10250T64L
		240		10250T65L
		277		10250T82L
		380		10250T66L
		480		10250T67L
		600		10250T68L
		Incandescent		Full voltage AC or DC
12	#756		10250T70	
24/28	#757		10250T79	
	#1828		10250T79	
32			10250T83	
Resistor AC or DC	120		120MB	10250T80
	240			10250T81
Transformer AC only 50/60 Hz	24		#755	10250T89
	120			10250T63
	208			10250T64
	240			10250T65
	277			10250T82
	380			10250T66
	480			10250T67
	600			10250T68

Notes

Use NEMA 4X 10250T operators where exposed to ultraviolet light, see **Pages V7-T1-219 to V7-T1-289**.

① These units do not include lamps. Order LED separately to match lens color from chart on **Page V7-T1-307**

Buttons for Non-Illuminated Push-Pull Devices

Color	Incandescent Suffix Code	Catalog Number
Standard Button		
Black	C1	E34C1
Red	C2	E34C2
Red (EMERG. STOP)	C2N8	E34C2N8
Green	C3	E34C3
Blue	C6	E34C6
Jumbo Mushroom Head		
Red ①	J2	E34J2
Red (EMERG. STOP)	J2N8	E34J2N8

E34M_ Alternate Lenses for Illuminated Push-Pull Devices

Color	Incandescent Suffix Code	LED Suffix Code ②	Catalog Number
Red	M2	RD	E34M2
Red (EMERG. STOP)	M2N8	ED	E34M2N8
Green	M3	GD	E34M3
Blue	M6	LD	E34M6
Amber	M9	AD	E34M9
White	M5	WD	E34M5
Clear	M0	—	E34M0

Notes

Use NEMA 4X 10250T operators where exposed to ultraviolet light, see **Pages V7-T1-219 to V7-T1-289**.

① Anodized aluminum may not be suitable for use on some corrosive applications.

② Suffix codes should only be used for assembling composite catalog numbers. To order lens, order by catalog number.

Standard LED Lamp



LED Selection

Voltage	Color	Catalog Number
6 Vac/Vdc suitable for use with transformers	Red	E22LED006RN
	Orange	E22LED006ON
	Yellow	E22LED006YN
	Green	E22LED006GN
	Blue	E22LED006BN
	White	E22LED006WN
12 Vac/Vdc	Red	E22LED012RN
	Orange	E22LED012ON
	Yellow	E22LED012YN
	Green	E22LED012GN
	Blue	E22LED012BN
	White	E22LED012WN
24 Vac/Vdc	Red	E22LED024RN
	Orange	E22LED024ON
	Yellow	E22LED024YN
	Green	E22LED024GN
	Blue	E22LED024BN
	White	E22LED024WN
48 Vac/Vdc	Red	E22LED048RN
	Orange	E22LED048ON
	Yellow	E22LED048YN
	Green	E22LED048GN
	Blue	E22LED048BN
	White	E22LED048WN

Voltage	Color	Catalog Number
60 Vac/Vdc	Red	E22LED060RN
	Orange	E22LED060ON
	Yellow	E22LED060YN
	Green	E22LED060GN
	Blue	E22LED060BN
	White	E22LED060WN
120 Vac	Red	E22LED120RA
	Orange	E22LED120OA
	Yellow	E22LED120YA
	Green	E22LED120GA
	Blue	E22LED120BA
	White	E22LED120WA
120 Vdc	Red	E22LED120RD
	Orange	E22LED120OD
	Yellow	E22LED120YD
	Green	E22LED120GD
	Blue	E22LED120BD
	White	E22LED120WD

1

Selector Switch Units

UL (NEMA) Type 3, 3R, 4, 4X, 12, 13

- Two-, three- and four-position—maintained
- Non-illuminated and illuminated

Two-Position Maint. Switch Knob



Two-Position Selector Switch

Operator Position ^①		Operator Action ^②	Contact Type	Mounting Location		Cam Code	Non-Illuminated		Illuminated—120V Transformer	
X	O			A	B		Black Knob Catalog Number ^③	Black Lever Catalog Number ^③	Red Knob Catalog Number ^③	Red Lever Catalog Number ^③
X	O	M M	1NC	A	B	1	E34VFBK1-1X	E34VFB1-1X	E34VFB120ER-1X	E34VFB120FR-1X
O	X		1NO							

Three-Position Maint. Switch Knob



Three-Position Selector Switch

Operator Position ^①			Operator Action ^②	Contact Type	Mounting Location		Cam Code	Non-Illuminated		Illuminated—120V Transformer	
X	O	O			A	B		Black Knob Catalog Number ^③	Black Lever Catalog Number ^③	Red Knob Catalog Number ^③	Red Lever Catalog Number ^③
X	O	O	M M M	1NO	A	B	3	E34VHBK1-2X	E34VHBL1-2X	E34VHB120TER-2X	E34VHB120TFR-2X
O	O	X		1NO							
X	O	O	M M M	1NO	A	B	3	E34VHBK1-23X	E34VHBL1-23X	E34VHB120TER-23X	E34VHB120TFR-23X
O	X	O		2NC (Series)							
O	O	X		1NO							

Four-Position Maint. Switch Lever



Four-Position Selector Switch

Operator Position ^①				Operator Action ^②	Contact Type	Mounting Location		Cam Code	Non-Illuminated		Illuminated—120V Transformer	
X	O	O	O			A	B		Black Knob Catalog Number ^③	Black Lever Catalog Number ^③	Red Knob Catalog Number ^③	Red Lever Catalog Number ^③
X	O	O	O	M M M M	1NC	A	B	7	E34VTBK1-23X	E34VTBL1-23X	E34VRB120TER-23X	E34VRB120TFR-23X
O	X	O	O		1NO							
O	O	X	O		1NO							
O	O	O	X		1NC							

Color Selection, Non-Illuminated

Color	Code Letter	Color	Code Letter
Black	1	White	5
Red	2	Blue	6
Green	3	Gray	7
Yellow	4	Orange	8

Notes

For Light Unit Voltage Suffix and Knobs, Levers tables, see **Page V7-T1-314**.

Use NEMA 4X 10250T operators where exposed to ultraviolet light, see **Pages V7-T1-219 to V7-T1-289**.

^① X = closed circuit, O = open circuit.

^② M = Maintained.

^③ To order different type or color selector switch, substitute the underlined character with appropriate suffix code from the Color Selection table. Example: E34VFBK2-X1.

Selector Switch Selection



Cam and Contact Block Selection

Selector switches in their varied forms (two-position, three-position and four-position) are a big factor contributing to the great flexibility of control that a well rounded line of “pushbuttons” can achieve. Because of their flexibility, they tend to cause difficulty with product selection and application. The following systematic approach should simplify that task.

Cam and contact block selection is better understood if you:

- Work with each incoming and outgoing wire/circuit separately.
- Recognize the terms NO and NC only identify the type of contact by its mode before mounting to the operator. The “X-O” chart (Page V7-T1-311) shows how that contact will act after assembly to the operator with the selected cam shape. X = closed circuit, O = open circuit.

- Up to six NO or NC contacts may be mounted behind each plunger location for a total of twelve contacts. Single circuit contact blocks have only one plunger with the other side of the block “open.” Therefore, single circuit contact blocks transmit motion to blocks behind them only for the position containing the circuit.
- Each cam has two separate lobes, each of which operates one of the two contact block plungers independently of each other. Those are identified as position A (locating nib side) and position B (opposite of locating nib). The position designations give direction in selecting and mounting of the contact blocks.

Contact Circuit Locations

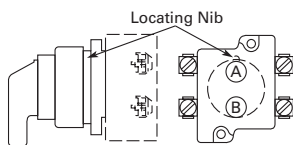

Systematic Approach

Application: **HAND-OFF-AUTO** selector switch. In this circuit, one incoming line is distributed to two other outgoing circuits by the switch. The two circuits can be looked at individually.

Step 1: Elementary Diagram.

Construct on paper, or in your mind, a simple elementary diagram of the switching scheme as follows:



Step 2: “X-O” Pattern.

From the elementary diagram, you can construct an “X-O” diagram which describes when the contacts are to be closed (X) or open (O) in the various positions of the switch. The “X-O” for the **HAND** circuit looks like this:



In this circuit, you want a contact closed on the left (HAND) but open in the center and right.

For the **AUTO** circuit, the “X-O” diagram would look like this:



Putting them together, the complete “X-O” diagram is:



Once the “X-O” diagram has been generated, the next step is to select the cam and contact block, or blocks, needed to perform the desired “X-O” functions. The selection tables on the following pages list the various types (shapes) of cams by number to choose from and the type of contact and position to achieve the function outlined in your “X-O” diagram.

1

Step 3: Cam Selection.

The cam you select determines the operation of all contact blocks mounted to the operator. It is selected on the basis that it provides the simplest circuitry for the desired "X-O" diagram. The selection tables show all the "X-O" combinations. For the purpose of this example, the applicable portion of those tables is shown on this page.

Now to make the cam selection, make a simple worksheet such as:

	Cam 2	Cam 3
X O O	(A)NO-(B)NC	(A)NO
O O X	(B)NO	(B)NO

It becomes immediately obvious that cam 3 is the better choice for two reasons, (1) the series combination can be avoided making it simpler to wire, (2) only two contacts are required, which is less expensive than the three contacts required by cam 2.

Step 4: Contact Block Selection.

Having selected the cam, contact block selection is simply a matter of gathering the A position and B position circuits into pairs which make up the most convenient contact block arrangement. If there is an imbalance in the number of circuits under A or B, then single circuit blocks must be selected for these leftover circuits.

Back to the worksheet, having selected cam 3 do this:



Step 5: Selector Switch Operator.

Lastly, you have to choose from the many types of operators—knob and lever in various colors or keyed. Also what combinations of maintained and spring return functions are required. Selection of these operators can be found on **Page V7-T1-312**. For the example in step 4, you may want a three-position maintained black knob, cam 3—Catalog Number E34VHBK1.

The Complete Switch: E34VHBK1 with one 10250T2 or, for one composite catalog number, E34VHBK1-Y1 found on **Page V7-T1-309**.

Diagrams

Circuits shown illustrate connections to obtain a selector switch circuit combination and are shown with their appropriate line diagrams. Field wiring of jumper connections required as shown.

X = Closed circuit
O = Open circuit

Wiring of Jumper Connections



Series Connection

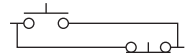

Parallel Connection

Four-position selector switches are limited to four contact blocks.

Contact Blocks

For selection and number of available contact blocks per operator, see **Page V7-T1-321**.

Example Selection Table

No.	"X-O" Pattern	Cam Code #2		Cam Code #3	
		Top A	Bottom B	Top A	Bottom B
1	X 0 0				—
4	0 0 X	—		—	

Two-Position Selector Switch Contact Block Selection

No.	Desired Circuit and Operator Position		Contact Blocks Required to Accomplish Circuit Function	
			Top Plunger A	Bottom Plunger B
1	X	0		or
2	0	X		or

Note

① Wired in series.

Three-Position Switch—Cam and Contact Block Selection

No.	Desired Circuit and Operator Position			Contact Blocks Required to Accomplish Circuit Function (Jumpers must be installed where indicated)			
				Operator with Cam Code #2		Operator with Cam Code #3	
				Mounting Location		Mounting Location	
				Top Plunger A	Bottom Plunger B	Top Plunger A	Bottom Plunger B
1	X	0	0				
2	X	X	0				
3	X	0	X				
4	0	0	X				
5	0	X	X				
6	0	X	0				

Four-Position Switch—Contact Block Selection

No.	Desired Circuit and Operator Position				Contact Blocks Required to Accomplish Circuit Function		No.	Desired Circuit and Operator Position				Contact Blocks Required to Accomplish Circuit Function	
					Top Plunger A	Bottom Plunger B						Top Plunger A	Bottom Plunger B
1	X	0	0	0			10	X	0	X	0		
2	0	X	0	0									
3	0	0	X	0			11	X	X	X	0		
4	0	0	0	X									
5	X	0	0	X			12	0	X	X	X		
6	0	X	X	0									
7	0	0	X	X			13	X	0	X	X		
8	X	X	0	0									
9	0	X	0	X			14	X	X	0	X		

1

Selector Switch Operators

UL (NEMA) Type 3, 3R, 4, 4X, 12, 13

Two-Position Knob Selector Switch



Operators with Knob Assembled

Positions	Operator Action ^①	Black Knob Selector Switch— Vertical Mounting ^②	Cam Code ^③	Catalog Number ^④
Two-position—60° throw			1	<u>E34VFBK1</u>
			1	<u>E34VEBK1</u>
Three-position—60° throw			2	<u>E34VGBK1</u>
			3	<u>E34VHBK1</u>
			2	<u>E34VJBK1</u>
			3	<u>E34VKBK1</u>
			2	<u>E34VLBK1</u>
			3	<u>E34VMBK1</u>
Four-position—40° throw			2	<u>E34VNBK1</u>
			3	<u>E34VPBK1</u>
Four-position—40° throw			7	<u>E34VTBK1</u>

Key Operators

Three-Position Keyed Selector Switch



Key Operators with Cam and Cap

Positions	Operator Action ^①	Cam Code ^③	Key Removal Positions ^⑤	Vertical Mounting Catalog Number	Horiz. Mounting Catalog Number
Two-position—60° throw		1	1, 2, 3	<u>E34KFB_</u>	<u>E34KFHB_</u>
		1	2	<u>E34KEB_</u>	<u>E34KEHB_</u>
Three-position—60° throw		2	1–7	<u>E34KGB_</u>	<u>E34KGHB_</u>
		3		<u>E34KHB_</u>	<u>E34KHGB_</u>
		2	1, 4, 5	<u>E34KJB_</u>	<u>E34KJHB_</u>
		3		<u>E34KKB_</u>	<u>E34KKHB_</u>
		2	4	<u>E34KLB_</u>	<u>E34KLHB_</u>
		3		<u>E34KMB_</u>	<u>E34KMHB_</u>
Four-position—40° throw		2	2, 4, 6	<u>E34KNB_</u>	<u>E34KNHB_</u>
		3		<u>E34KPB_</u>	<u>E34KPHB_</u>
Four-position—40° throw		7	7	<u>E34KTB_</u>	<u>E34KTHB_</u>

Notes

Use NEMA 4X 10250T operators where exposed to ultraviolet light, see **Pages V7-T1-219 to V7-T1-289**.

① M = Maintained. S = Spring return in direction of arrow (R).

② Field convertible to horizontal mounting.

③ For selection of the proper cam and contact block to obtain the proper circuit sequence, see selection instructions and tables on **Pages V7-T1-309 to V7-T1-311**.

④ For other colors of either the knob or lever, replace the underlined characters of the catalog number with the appropriate suffix code from Alternate Knob and Lever table on **Page V7-T1-313**. Example: E34VFBL2.

⑤ Choose key removal position required for application from table on **Page V7-T1-313**. Add key removal code number to listed catalog number. Example: E34KFB2.

Key Removal Positions ①

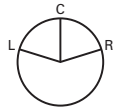

Code Suffix	Key Removal Position
1	Right only
2	Left only
3	Right and left
4	Center only
6	Left and center
7	All positions

Dissimilar Locks and Keys

Listed operators have identical locks and keys (Key Code H661), Catalog Number **10250ED824**. For dissimilar lock and key combinations, see **Page V7-T1-248**.

Alternate Knobs and Levers for Operators ②

E34K_



E34L_



E34A_



Color	Knob		Lever		Lever Designed for Added Ingress Protection ③	
	Suffix Code	Catalog Number	Suffix Code	Catalog Number	Suffix Code	Catalog Number
Black	K1	E34K1	L1	E34L1	A1	E34A1
Red	K2	E34K2	L2	E34L2	A2	E34A2
Green	K3	E34K3	L3	E34L3	A3	E34A3
Yellow	K4	E34K4	L4	E34L4	A4	E34A4
White	K5	E34K5	L5	E34L5	A5	E34A5
Blue	K6	E34K6	L6	E34L6	A6	E34A6
Gray	K7	E34K7	L7	E34L7	A7	E34A7
Orange	K8	E34K8	L8	E34L8	A8	E34A8

Notes

- ① Key removal in “spring return from” positions not recommended.
- ② See operators on **Page V7-T1-312**.
- ③ For use on maintained operators only.

1

Illuminated Selector Switch Operators

120 Vac Transformer
Selector Switch, Cam 1



Operator without Knob or Lever

Positions	Operator Action	Transformer Type—50/60 Hz 6V #755 Lamp Catalog Number ^{③④}	Full Voltage Type—AC or DC ^① Lamps—#755, #757, #1835, 120MB ^② Catalog Number ^④	
Two-position—60° throw		Cam Code 1 ^⑤ E34VFB_	Cam Code 1 ^⑤ E34SFB_	
Three-position—60° throw		Cam Code 2 ^⑤ E34VGB_	Cam Code 3 ^⑤ E34VHB_	Cam Code 2 ^⑤ E34SGB_
		E34VNB_ ^⑥	E34VPB_ ^⑥	E34SNB_ ^⑦
		E34VJB_ ^⑥	E34VKB_ ^⑥	E34SJB_ ^⑦
		E34VLB_	E34VMB_	E34SLB_
		E34VSB_	E34VMB_	E34SMB_
Four-position—40° throw		E34VRB_	—	E34SRB_

Knob



Lever



Knobs and Levers

Color ^②	Knob Catalog Number and Code Number	Lever Catalog Number and Code Number
Red	10250TER	10250TFR
Green	10250TEG	10250TFG
Yellow	10250TEA	10250TFA
Blue	10250TEL	10250TFL
Clear	10250TEC	10250TFC
White	10250TEW	10250TFW
Amber	10250TEM	10250TFM

Light Unit Voltage Suffix

Add to operator Catalog Number listed in table above.

Type of Light Unit

Transformer Type 50/60 Hz		Full Voltage Type AC or DC ^①	
Voltage	Suffix Code	Voltage	Suffix Code
24	024	6	06
120	120	12	12
208	208	24	24
240	240	48	48
380	380	120	120
480	480	240 ^⑥	240
600	600		

Notes

Use NEMA 4X 10250T operators where exposed to ultraviolet light, see **Pages V7-T1-219 to V7-T1-289**.

^① Full voltage light units can be used at other than listed voltages by changing lamp. Replacement lamps are listed on **Page V7-T1-275**.

^② 120MB lamps are used on both 120V and 240V operators.

^③ Operator includes lens gasket and lens attachment screws.

^④ Add suffix code for light unit voltage to listed catalog number from Light Unit Voltage Suffix table above.

Example: For 24V transformer type light unit, order E34VFB024.

^⑤ For selection of the proper cam and contact block required to obtain a specific circuit sequence, see selection tables on **Pages V7-T1-309 to V7-T1-311**.

^⑥ 120 and 240V transformer only.

^⑦ 120 full voltage only.

^⑧ Resistor type. May generate excess heat if used in high density.

^⑨ Amber, clear and white lenses have a black arrow (R). Red, green and blue lenses have a white arrow (R).

Accessories





Accessories

	Description	Catalog Number
E34TA2 	Padlocking Attachment for Flush Pushbutton Operators. Permits locking NC contacts in open position with 1/4 in padlock. Will not lock NO contact.	E34TA2
10250TA_ 	Flexible Weather Resistant Boot for use with flush pushbutton operators.	
	Clear	10250TA46
	Black	10250TA47
	Red	10250TA48
	Green	10250TA49
	Flexible Weather Resistant Boot for use with button operators (extended buttons preferred).	
	Black	10250TA3
	Red	10250TA4 ①
	Green	10250TA10
	Clear	10250TA85
	Transparent Boot for regular, illuminated pushbutton operators and PresTest.	10250TA25 ②
E34TA3_ 	Special Retaining Nut —to accommodate thick panel.	
	Indicating light	E34TA30
	PresTest, pushbuttons and selector switches	E34TA31
E34TA6 	Shroud for Mushroom Head Operator —prevents accidental operation. (Not for push-pull operators.)	E34TA6
E34TA12 	Extended Retaining Nut —replaces standard nut and provides guard for flush type pushbutton operators.	E34TA12
E34TA15 	Guard for illuminated pushbutton	E34TA15
E34TA11 	Padlocking Attachment for non-illuminated knob selector switches— accommodates up to five, 1/4 in padlocks.	E34TA11

Notes

- ① Should not be used on flush button for STOP function.
- ② Not suitable for single contact block depth cast enclosure. Cover is too thick.

Accessories, continued

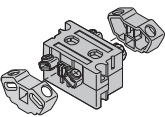
	Description	Catalog Number
<p>E34TK3</p> 	<p>Thrust Washer—To meet Ford Motor Company mounting specifications.</p>	<p>E34TK3</p>
<p>10250TA7_</p> 	<p>Contact Block Terminal Jumps—Available in multiples of 100 only.</p> <p>Terminal to terminal—within block (short):</p> <p>100 per package 10250TA70</p> <p>1000 per package 10250TA70-2</p> <p>Terminal to terminal—block to block (long):</p> <p>100 per package 10250TA71</p> <p>1000 per package 10250TA71-2</p>	
<p>10250TMT8</p> 	<p>Master Test (Dual Input) Module—Internal Form C relay suitable for either AC or DC applications. Total electrical isolation between monitored and test circuit. Fits all illuminated 10250T, E22, E30 and E34 devices.</p> <p>48 Vdc 10250TMT8</p>	
<p>10250TFL_</p> 	<p>Flasher Module—Internal Form C relay suitable for AC applications. One unit required for each operator in master test circuit.</p> <p>24 Vac 10250TFL2</p> <p>120 Vac 10250TFL1</p>	
<p>E22CW</p> 	<p>Panel Mounting Nut Wrench—E22, E30, E34 and octagonal 10250T.</p>	<p>E22CW</p>
<p>10250TA101</p> 	<p>Fingerproof Shroud—10 per package. Fits new style contact blocks and light units.</p>	<p>10250TA101</p>

Options

Legend Plates ①

Field Color

Legend plates can be supplied printed on black, red, silver or white field. To order legend printed on a color other than indicated—add

suffix code to the end of the catalog number as follows:

“R” for Red field;
“W” for White field; or
“S” for Silver field.

Example: E34SP26**R**—
Standard plate with red field marked OPEN.

Standard



Jumbo



For Pushbutton Operators and Indicating Lights

Legend	Color of Field	Standard ② Catalog Number	Jumbo Catalog Number	Legend	Color of Field	Standard ② Catalog Number	Jumbo Catalog Number
Letters on Legend Plates Below are 3/16 in High							
CLAMP	Black	E34SP90	E34LP90	OFF	Red	E34SP24	E34LP24
CLOSE		E34SP73	E34LP73	ON	Black	E34SP25	E34LP25
DOWN		E34SP74	E34LP74	OPEN		E34SP26	E34LP26
EMERG. STOP	Red	E34SP13	E34LP13	OUT		E34SP27	E34LP27
FAST	Black	E34SP75	E34LP75	POWER ON		E34SP80	E34LP80
FASTER		E34SP87	E34LP87	RAISE		E34SP28	E34LP28
FEEDER ON		E34SP94	E34LP94	READY		E34SP86	E34LP86
FEEDER OFF		E34SP95	E34LP95	RESET		E34SP29	E34LP29
FORWARD		E34SP15	E34LP15	REVERSE		E34SP30	E34LP30
HIGH		E34SP16	E34LP16	RUN		E34SP31	E34LP31
IN		E34SP17	E34LP17	SAFE		E34SP85	E34LP85
INCH		E34SP18	E34LP18	SLOW		E34SP32	E34LP32
JOG		E34SP19	E34LP19	SLOWER		E34SP88	E34LP88
JOG FOR.		E34SP20	E34LP20	START		E34SP33	E34LP33
JOG REV.		E34SP21	E34LP21	STOP	Red	E34SP34	E34LP34
LOW		E34SP22	E34LP22	TEST	Black	E34SP83	E34LP83
LOWER		E34SP23	E34LP23	TRANSFER		E34SP93	E34LP93
LUBE-FAIL		E34SP92	E34LP92	TRIP		E34SP84	E34LP84
MOTOR RUN		E34SP81	E34LP81	UNCLAMP		E34SP91	E34LP91
MOTOR STOP		E34SP82	E34LP82	UP		E34SP35	E34LP35

Blank Plastic Legend Plates—Square ③

Color Lettering	Field Side 1	Side 2	Standard Catalog Number	Jumbo Catalog Number	Extra Large Catalog Number
Black	White	Silver	10250TSP76	10250TLP76	10250TEP76
White	Red	Black	10250TSP77	10250TLP77	10250TEP77

Notes

- ① For dimensions, see **Page V7-T1-294**.
- ② 3/32 in high lettering.
- ③ Legend plates with non-standard markings or aluminum legend plates see 10250T listing on **Page V7-T1-268**.

1

Standard



Jumbo



For Selector Switch Operators

Legend	Color of Field	Standard Catalog Number	Jumbo Catalog Number	Legend	Color of Field	Standard Catalog Number	Jumbo Catalog Number
Two-Position—3/16 in High Lettering				Three-Position—3/16 in High Lettering			
FOR. REV.	Black	E34SP38	E34LP38	AUTO OFF HAND	Black	E34SP49	E34LP49
HAND AUTO		E34SP39	E34LP39	FOR. OFF REV.		E34SP50	E34LP50
HIGH LOW		E34SP40	E34LP40	FOR. SAFE REV.		E34SP69	E34LP69
JOG RUN		E34SP41	E34LP41	HAND OFF AUTO		E34SP51	E34LP51
MAN. AUTO		E34SP67	E34LP67	MAN. OFF AUTO		E34SP68	E34LP68
OFF ON		E34SP42	E34LP42	OPEN OFF CLOSE		E34SP53	E34LP53
OPEN CLOSE		E34SP43	E34LP43	RUN SAFE JOG		E34SP70	E34LP70
RUN JOG		E34SP44	E34LP44	UP OFF DOWN		E34SP54	E34LP54
SAFE RUN		E34SP45	E34LP45	ON STOP SAFE		E34SP71	E34LP71
START JOG		E34SP46	E34LP46				
START STOP		E34SP47	E34LP47				
UP DOWN		E34SP48	E34LP48				

For Push-Pull Units

Legend	Color of Field	Standard ^① Catalog Number	Jumbo ^② Catalog Number
PULL ON/PUSH OFF	Black	E34PP5	E34R5
PULL OPEN/PUSH CLOSE	Black	E34PP8	E34R8
PULL UP/PUSH DOWN	Black	E34PP11	E34R11



Notes

- ① 3/32 in (2.4 mm) high lettering.
- ② 1/8 in (3.2 mm) high lettering.

Enclosures

Die Cast, Polyester and Stainless Steel Enclosures

Enclosures (Case and Cover)—Surface Mounting ^①

	Number of Elements	One Contact Block Depth Catalog Number	Two Contact Block Depth Catalog Number
Die Cast Enclosure 	Die Cast Enclosure—In-Line ^{②③} NEMA 4, 4X, 12, 13		
	1	E34N1	E34N11
	2	E34N2	E34N12
	3	E34N3	E34N13
	4	—	E34N14
Polyester Enclosure 	Polyester—In-Line NEMA 3, 4X, 12		
	1	—	E34N51
	2	—	E34N52
	3	—	E34N53
	4	—	E34N54
Stainless Steel Enclosure 	Stainless Steel ^④—In-Line NEMA 4, 4X, 12		
	1	—	10250TN33
	2	—	10250TN34
	3	—	10250TN35
	4	—	10250TN36

Dimensions, see Page V7-T1-328.

Mounting Instructions

These E34 Die Cast Enclosures feature a corrosion resistant coating identical to finish on the E34 operators except gray in color. Not for use in ultraviolet light applications.

One and Two Contact Block Depth Enclosures



Enclosure Layouts

Top – For Vertical Mounting

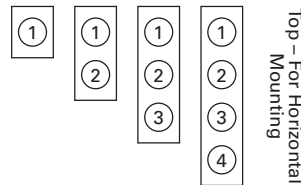

Notes

- ① For spacing increments, see **Page V7-T1-320**.
- ② All die cast enclosures can be converted to base mounting of contact blocks with spacers 10250TA22 or 10250TA23. See listing on **Page V7-T1-263**.
- ③ When used with E30 pushbuttons, only the one element enclosure can be used.
- ④ 14 gauge, type 304.

1 Die Cast and Stainless Steel—Flush Mount, Covers Only^①

Flush Mounting Covers



Covers Only—Flush Mounting

Number of Elements	Catalog Number	Catalog Number
Flush Die Cast Covers		
	In-Line Deep Cover	In-Line Flat Cover
1	E34F11	E34F1
2	E34F12	E34F2
3	E34F13	E34F3
4	E34F14	E34F4
In-Line Stainless Steel Flush Plates^②		
	With Pullbox	Without Pullbox
1	10250TS10	10250TS1
2	10250TS11	10250TS2
3	10250TS12	10250TS3
4	10250TS14	10250TS4
Dimensions, see Page V7-T1-329.		

Spacing Increments

Approximate Dimensions in Inches (mm)

Type	F	G	H
Die cast	2.44 (62.0)	2.5 (63.5)	1.88 (47.8)
Polyester	1.88 (47.8)	Min. 2.13 (54.1)	2.25 (57.2)
Stainless steel	1.69 (42.9)	Min. 1.73 (43.9)	2.25 (57.2)

Spacing Increments for Enclosures

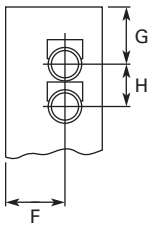

Enclosure Layouts

Top – For Vertical Mounting

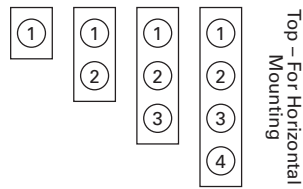

Notes

- ^① These E34 die cast covers feature a corrosion resistant coating identical to the finish on the E34 operators except gray in color.
- ^② Not oiltight. NEMA 1 applications only.

Contact Blocks

Standard Contact Blocks

- UL A600/P600 rated
- Color-coded plungers—red/green for NC/NO circuits
- Silver contact tips with “reliability nibs”
- Black (opaque) or amber (translucent) housings
- Pressure plate or spade terminals
- Fingerproof shrouds (for pressure terminals only)

Logic Level Contact Blocks

- UL A600/P600 rated
- Black plungers
- Inert palladium knife-blade contacts
- Black (opaque) housings
- Pressure plate or spade terminals
- Fingerproof shrouds not available

Special Function Contact Blocks

- UL A600/P600 rated
- Black plungers
- Silver contact tips with “reliability nibs”
- Black (opaque) housings
- Pressure plate terminals only
- Fingerproof shrouds not available

Special Purpose Contact Block

- Maximum 300V rated
- Black plungers
- Silver contact tips with “reliability nibs”
- Black (opaque) housings
- Pressure plate terminals only
- Fingerproof shrouds not available

Reliability Nibs

Reliability nibs are the hallmark of Eaton’s contact blocks. A pointed silver nib on the contact tip ensures reliable switching from logic level (5V) up to 600V applications. Therefore standard contact blocks can be used for most logic level applications where the contacts are not exposed to any harsh environmental conditions.

Palladium Contacts

Palladium, which is more inert than gold, is well suited for voltages and currents approaching zero and is recommended for applications where environmental conditions are a factor.

Maximum Contact Block Mounting per Operator Type

Operator	Max. Stack
Pushbuttons	6
Push-pull operators	2
Roto-push operators	4
Two- or three-position selector switches	6
Four-position selector switches	4
Joysticks	4

10250T1



Contact Blocks

Symbol	Circuit	Description ^①	Standard	Spade Terminal ^②	Logic Level	Spade Terminal ^②
			Pressure Terminal Catalog Number	Catalog Number	Pressure Terminal Catalog Number	Catalog Number
	1NC	Stack up to six blocks (six circuits) unless otherwise noted.	10250T51	10250T59	10250T51E	10250T59E
	1NO	Stack up to six blocks (six circuits) unless otherwise noted.	10250T53	10250T60	10250T53E	10250T60E
	NO-NC	Stack up to six blocks (12 circuits) unless otherwise noted.	10250T1	10250T40	10250T1E	10250T40E
	2NC	Stack up to six blocks (12 circuits) unless otherwise noted.	10250T3	10250T42	10250T3E	10250T42E
	2NO	Stack up to six blocks (12 circuits) unless otherwise noted.	10250T2	10250T41	10250T2E	10250T41E
Special Function Blocks ^③						
	LONC	Late opening NC. Stack up to six blocks (six circuits) unless otherwise noted.	10250T71 ^③	—	10250T71E ^③	—
	ECNO-NC	Early closing NO and standard NC. Stack up to six blocks unless otherwise noted.	10250T47 ^{③④}	—	10250T47E ^③	—
	ECNO-NO	Early closing NO and standard NO. Stack up to four blocks unless otherwise noted.	10250T57 ^{③④}	—	10250T57E ^③	—
	2LONC	Two late opening NC contacts. Stack up to six blocks unless otherwise noted.	10250T45 ^③	—	10250T45E ^③	—
	LONC-ECNO	Overlapping contacts. Stack up to four blocks unless otherwise noted.	10250T55 ^{③④}	—	10250T55E ^③	—
Special Purpose Blocks ^⑤						
	2NO-2NC	Four circuits in single block depth. Rated 300V max. Stack up to four blocks unless otherwise noted.	10250T44 ^⑤	—		

Notes

- ① All 10250T contact blocks shown are suitable for use on standard 10250T and E34 operators. These contact blocks are not suitable for Class I Division 2 type 10250T or E34 devices.
- ② Contact blocks with spade terminals are limited to a maximum of one contact block per operator and minimum spacing between devices is 2.5 in (63.5 mm). Not suitable for use in 10250T or E34 enclosures. Also available in amber housing. Not available with fingerproof shrouds.
- ③ Special function contact blocks are not suitable for use with roto-push operators, three-position push-pull operators, or four-position selector switches.
- ④ ECNO contact blocks are not suitable for use with two-position joysticks or when operators are used with padlock attachments.
- ⑤ Special purpose 10250T44 contact blocks are not suitable on selector switches or roto-push operators. Okay to use with three-position push-pull operators only on low voltage (30V or less) circuits.

10250T1CP



Contact Blocks with Fingerproof Shrouds

Symbol	Circuit	Description ^①	Standard Pressure Terminal ^② Catalog Number	Logic Level Pressure Terminal ^② Catalog Number
Blank No Plunger	1NC	Stack up to six blocks (six circuits) unless otherwise noted.	10250T51P	10250T51EP
Blank No Plunger	1NO	Stack up to six blocks (six circuits) unless otherwise noted.	10250T53P	10250T53EP
Blank No Plunger	NO-NC	Stack up to six blocks (12 circuits) unless otherwise noted.	10250T1P	10250T1EP
Blank No Plunger	2NC	Stack up to six blocks (12 circuits) unless otherwise noted.	10250T3P	10250T3EP
Blank No Plunger	2NO	Stack up to six blocks (12 circuits) unless otherwise noted.	10250T2P	10250T2EP
Special Function Blocks ^③				
Blank No Plunger	LONC	Late opening NC. Stack up to six blocks (six circuits) unless otherwise noted.	10250T71P ^④	10250T71EP ^④
Blank No Plunger	ECNO-NC	Early closing NO and standard NC. Stack up to six blocks unless otherwise noted.	10250T47P ^{③④}	10250T47EP ^④
Blank No Plunger	ECNO-NO	Early closing NO and standard NO. Stack up to four blocks unless otherwise noted.	10250T57P ^{③④}	10250T57EP ^④
Blank No Plunger	2LONC	Two late opening NC contacts. Stack up to six blocks unless otherwise noted.	10250T45P ^④	10250T45EP ^④
Blank No Plunger	LONC-ECNO	Overlapping contacts. Stack up to four blocks unless otherwise noted.	10250T55P ^{③④}	10250T55EP ^④

Replacement Parts

Replacement Lamps—For E34 Illuminated Operators

Mfg. Lamp Type	Voltage	Base Style	Application	Part Number
120MB	120V	T 3-1/4 bayonet	10250T resistor indicating light	28-3044
#267	6.3V	T 3-1/4 bayonet	10250T flasher	10250ED986-4
#755	6.3V	T 3-1/4 bayonet	10250T transformer, PresTest and full voltage	28-2202
#756	12V	T 3-1/4 bayonet	10250T full voltage	28-5184
#757	24V	T 3-1/4 bayonet	10250T full voltage	28-5185
#1828	32V	T 3-1/4 bayonet	10250T full voltage	28-5186
#1835	55V	T 3-1/4 bayonet	10250T resistor	28-5187
NE48	120V	T 4-1/2 bayonet	10250T neon	28-494
NE51H-R22	120V	T 3-1/4 bayonet	10250T neon	28-3754
NE51H-R68	240V	T 3-1/4 bayonet	10250T neon	28-3755

Notes

- ① All 10250T contact blocks shown are suitable for use on standard 10250T and E34 operators. These contact blocks are not suitable for Class I Division 2 type 10250T or E34 devices.
- ② To order contact blocks with translucent amber housing, change suffix P to **CP** in catalog number, e.g., 10250T51**CP**.
- ③ ECNO contact blocks are not suitable for use with two-position joysticks or when operators are used with padlock attachments.
- ④ Special function contact blocks are not suitable for use with roto-push operators, three-position push-pull operators, or four-position selector switches.



Flush Head Pushbutton Operator



Mushroom Head Pushbutton Operator



Jumbo Mushroom Head Operator

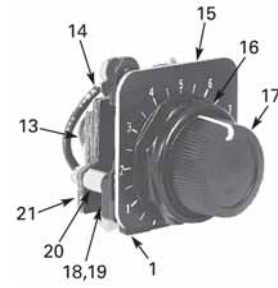

Potentiometers



Illuminated Pushbutton Operator



Transformer Type Indicating Light



Knob-Operated Selector Switch Operator



Full Voltage, Resistor and Transformer Type Illuminated Selector Switch

E34 Style Operator Replacement Parts

Item No.	Description	No. Req.	Part Number
1	Gasket	1	16-1548
2	Mounting nut	1	15-1530-4
3	Set screw (#6-32 x 0.250 in long hollow hex)	2	11-2014
4	Mushroom head button (includes [2] item 5)	1	As Req. Below
	Black	—	53-1317
	Red	—	53-1317-2
	Yellow	—	53-1317-3
	Green	—	53-1317-4
	Blue	—	53-1317-22
5	Set screw (#10-32 x 0.250 in long hollow hex)	2	11-544
6	Jumbo mushroom head button (aluminum—includes [2] item 5)	1	As Req. Below
	Red	—	53-1317-9
	Black	—	53-1317-10
	Yellow	—	53-1317-11
	Green	—	53-1317-12
7	Jumbo mushroom head button (aluminum—red EMERG. STOP) does not include item 5	1	53-1349-18
8	Mounting screw (#6-32 x 0.710 in long)	2	10250TA79
	Washer	2	16-2038
9	Terminal screw and lug (captive)	Req.	80-5502
10	Gasket (supplied with basic unit)	1	32-803
11	Round head screw (#4-40 x 0.344 in long) (supplied with basic unit)	2	11-4553

Item No.	Description	No. Req.	Part Number
12	Mounting screw	2	11-1632
13	Simple potentiometer (does not include items 18, 28 or 29)	1	As Req. Below
	1,000 ohms	—	41-782-2
	2,500 ohms	—	41-782-3
	5,000 ohms	—	41-782-10
	10,000 ohms	—	41-782-4
	25,000 ohms	—	41-782-5
	50,000 ohms	—	41-782-6
14	Connector (includes screw and lug)	2	25-1851
15	Indicating plate	1	As Req. Above
	Standard size (without legend)	—	30-4460
	Large size (specify legend)	—	10250TR30
16	Retaining nut	1	15-1547-3
17	Knob	1	53-1314
	Socket set screw (#6-32 x 0.250 in long)	1	11-2014
18	Coupling	1	11-2014 29-3749-2
19	Set screw (#6-32 x 0.188 in long)	1	11-1199
20	Spacer	2	56-1066-18
21	Connector (includes screw and lug)	1	25-1851-2
22	Mounting nut	1	15-1938-2

Technical Data and Specifications

Mechanical Ratings

Description	Specification
Frequency of Operation	
All pushbuttons	6000 operations/hr.
Key and lever selector switches	3000 operations/hr.
Auto-latch devices	1200 operations/hr.
Life	
Pushbuttons	10 x 10 ⁶ operations
Contact blocks	10 x 10 ⁶ operations
PresTest units	10 x 10 ⁶ operations
Lever and key selector switches	0.25 x 10 ⁶ operations
Twist to release pushbuttons	0.3 x 10 ⁶ operations
Shock Resistance	
Duration	210 ms ≥5g

General Specifications

Description	Specification
Climate Conditions	
Operating temperature	1° to 150°F (–17° to 66°C)
Storage temperature	–40° to 176°F (–40° to 80°C)
Altitude	6,562 ft (2,000m)
Humidity	Max. 95% RH at 60°C
Terminals	
Marking	NC-NO on the contact block to meet the NEMA requirements. Dual marking system 1–2 for normally closed, 3–4 for normally open to meet BS5472 (Cenelec EN50 005).
Clamps	Terminals are saddle clamp type for 1 x 22 AWG (0.34 mm ²) to 2 x 14 AWG (2.5 mm ²) conductors
Torque	7 lb-in (0.8 Nm)
Degree of protection against direct electrical contact	IP2X with fingerproof shroud
Light Units	
Transformers	Will withstand short-circuit for 1 hour per IEC 60947-5-1
Bulbs—average life:	
Transformer type	20,000 hrs.
Resistor/direct voltage type	2500 hrs. minimum at rated V
LED	60,000 to 100,000 hrs.

Electrical Ratings

Description	Specification
Insulation	$U_i = 660 \text{ Vac or Vdc}$
Thermal	$I_{th} = 10\text{A}$
Short Circuit Coordination to IEC/EN 60947-5-1	
Rated conditional short circuit current	1 kA
Fuse type	GE power controls TIA 10, red spot type gG, 10A, 660 Vac, 460 Vdc, BS88-2, IEC 60269-2-1
	
UL rating	A600, P600
AC load life duty cycle 1200 operations/hour	
10A	110V pf 0.4— 1×10^6 operations
5A	250V pf 0.4— 1×10^6 operations
2A	600V pf 0.4— 1×10^6 operations
Switching capacity	
AC 15 rated make/break ($11 \times I_b$ at $1.1 \times U_b$)	
6A	120V pf 0.3
4A	240V pf 0.3
2A	660V pf 0.3
DC13 rated make/break ($1.1 \times I_b$ at $1.1 \times U_b$)	
1.0A	125V L/R ≥ 0.95 at 300 ms
0.55A	250V L/R ≥ 0.95 at 300 ms
0.1A	660V L/R ≥ 0.95 at 300 ms
10A	110V pure resistive
Maximum ratings for logic level and hostile atmosphere application	
Maximum amperes	0.5A
Maximum volts	120 Vac/Vdc
Low voltage switching	Conical shaped points or “reliability nibs” improve performance in dry circuit, corrosive, fine dust and other contaminated atmospheres. Under normal environmental conditions, the minimum operational voltage is 5V and the minimum operational current is 1 mA, Vac/Vdc.
Contact operation	Slow make and break. All normally closed contacts have positive opening operation, i.e., normally closed contacts are forced open in the event of contact weld or spring breakage.

Electrical Ratings—Contact Block

Meet or Exceed NEMA Rating Designations A600, A300 and B300 for AC and P600 for DC

Description	50 Vac or 60 H				Vdc		
	120	240	480	600	24/28	125	250
Meet or Exceed NEMA Rating Designations A600, A300 and B300 for AC and P600 for DC							
Make and emerg. interrupting capacity (amp)	60	30	15	12	5.7	1.1	0.55
Normal load break (amp)	6	3	1.5	1.2	5.7	1.1	0.55
Thermal current (amp)	10	10	10	10	5.0	5.0	5.0
Voltamperes:							
Make and emerg. interrupting capacity	7200	7200	7200	7200	138	138	138
Normal load break	720	720	720	720	138	138	138

Mounting Options

Panel Thickness

- Minimum: 0.06 in (1.6 mm)
- Maximum: 0.25 in (8 mm) including legend plate
- Maximum can be increased to 0.375 in (15.9 mm) using optional retaining nut
 - Indicating light: 10250TA30
 - Pushbutton/selector switch: 10250TA31

Mounting Matrix

Legend Plate	Dimensions in Inches (mm)			
	A	B	C	D
Small	1.63 (41.3)	2.25 (57.2)	2.25 (57.2)	1.63 (41.3)
Medium	1.75 (44.5)	2.25 (57.2)	2.25 (57.2)	1.75 (44.5)
Large	2.25 (57.2)	2.25 (57.2)	2.25 (57.2)	2.25 (57.2)

Mounting Options in Inches (mm)

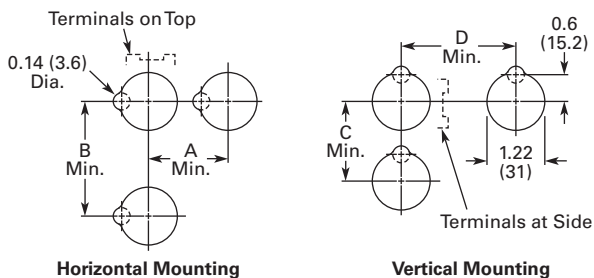

Horizontal mounting means terminals are located top and bottom of contact block. Vertical mounting means terminals are left and right of contact block. This allows close spacing of adjacent operators with easy access to terminals.

Locating nib hole or notch is 0.14 in (3.6 mm) #29 drill.

Drilling Dimensions in Inches (mm)

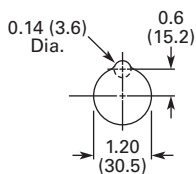

1

Dimensions

Approximate Dimensions in Inches (mm)

Potentiometer

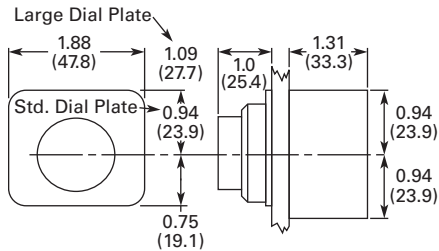

Legend Plates

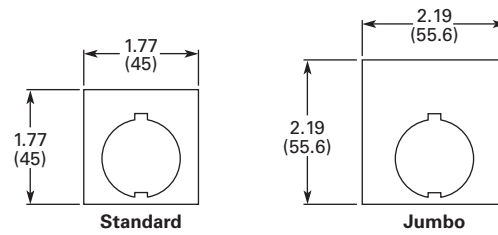

Surface Mounting

Die Cast, Polyester and Stainless Steel Enclosures

4 Mtg. Holes — 10-32 Screw Size for
1 – 4 Element Die Cast/
Stainless Steel Enclosure
7/32 Screw Size for
Polyester

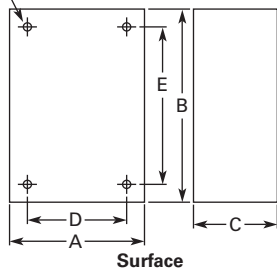

Number of Elements	Element Arrangement	Wide A	High B	Deep C	Mounting D	E	Conduit Entrance
Die Cast							
1	In-line	3.88 (98.6)	4.00 (101.6)	3.00 (76.3) ①	2.69 (68.3)	3.25 (82.6)	3/4
2		3.88 (98.6)	5.88 (149.4)	3.00 (76.3) ①	2.69 (68.3)	5.13 (130.3)	
3		3.88 (98.6)	7.75 (196.9)	3.00 (76.3) ①	2.69 (68.3)	7.00 (177.8)	1
4		3.88 (98.6)	9.63 (244.6)	3.00 (76.3) ①	2.69 (68.3)	8.88 (225.6)	
Polyester							
1	In-line	3.81 (96.8)	6.63 (168.4)	3.38 (85.9)	2.94 (74.7)	4.88 (124.0)	②
2		3.81 (96.8)	6.63 (168.4)	3.38 (85.9)	2.94 (74.7)	4.88 (124.0)	
3		3.81 (96.8)	8.88 (225.6)	3.38 (85.9)	2.94 (74.7)	7.13 (181.1)	
4		3.81 (96.8)	11.13 (282.7)	3.38 (85.9)	2.94 (74.7)	9.38 (238.3)	
Stainless Steel							
1	In-line	3.00 (76.2)	3.50 (88.9)	3.00 (76.2)	1.50 (38.1)	4.25 (108.0)	②
2		3.50 (88.9)	6.75 (171.5)	3.00 (76.2)	1.50 (38.1)	7.50 (190.5)	
3		3.50 (88.9)	9.00 (228.6)	3.00 (76.2)	1.50 (38.1)	9.00 (228.6)	
4		3.50 (88.9)	11.25 (285.8)	3.00 (76.2)	1.50 (38.1)	12.00 (304.8)	

Notes

- ① Depth given is for two contact block deep stations. One contact block deep stations subtract 3/4 in (19.1 mm).
- ② No conduit entrance holes provided. Drill as required.

Approximate Dimensions in Inches (mm)

Flush Mounting

Die Cast and Stainless Steel Covers Only

4 Mtg. Holes - 10-32 Screw Size
for 1-11 Element Encl, 1/4-20
Screw Size for 12 Element
and Larger

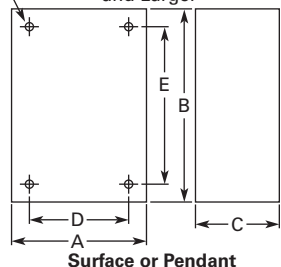

Number of Elements	Wide A	High B	Deep C	Mounting D	E
Die Cast					
1	3.88 (98.6)	4.00 (101.6)	0.25 (6.4) ①	3.50 (88.9)	3.63 (92.2)
2	3.88 (98.6)	5.88 (149.4)	0.25 (6.4) ①	3.50 (88.9)	5.50 (139.7)
3	3.88 (98.6)	7.75 (196.9)	0.25 (6.4) ①	3.50 (88.9)	6.00 (152.4)
4	3.88 (98.6)	9.63 (244.6)	0.25 (6.4) ①	3.50 (88.9)	9.25 (235.0)
Stainless Steel					
1	5.00 (127.0)	5.00 (127.0)	2.50 (63.5) ②	3.25 (82.6)	1.88 (47.8)
2	5.00 (127.0)	6.88 (174.8)	2.50 (63.5) ②	3.25 (82.6)	3.63 (92.2)
3	5.00 (127.0)	8.63 (219.2)	2.50 (63.5) ②	3.25 (82.6)	5.50 (139.7)
4	5.00 (127.0)	10.50 (266.7)	2.50 (63.5) ②	3.25 (82.6)	7.25 (184.2)

Notes

- ① Depth given is for flat cover. Deep cover is 3/4 in (19.1 mm) deeper.
- ② Depth given includes pull box.

1.11

Pushbuttons and Indicating Lights

30.5 mm Corrosion Resistant Watertight/Oiltight—E34

1

Approximate Dimensions in Inches (mm)

Padlocking Attachment for Flush Pushbutton Operators

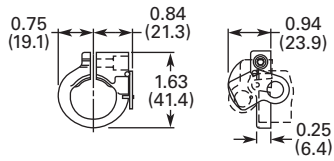

Flexible Weather Resistant Boot

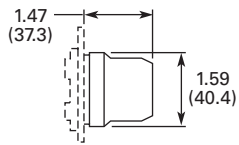

Transparent Boot

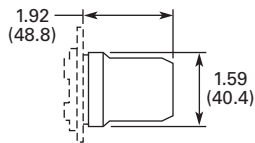

Shroud for Mushroom Head Operator

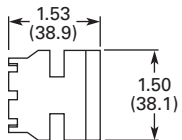

Extended Retaining Nut

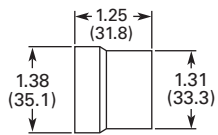

Guard for Illuminated Pushbutton

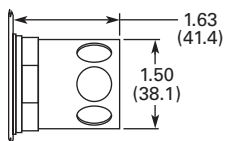

Contact Block Terminal Jumps

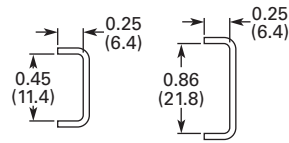

Master Test Module and Flasher Module

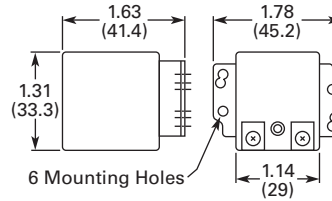

Flush Pushbutton

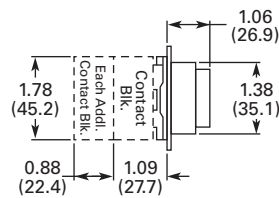

Extended Pushbutton

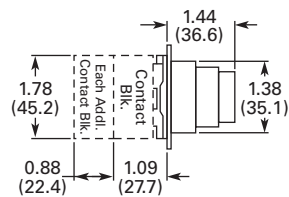

Half Shroud Pushbutton

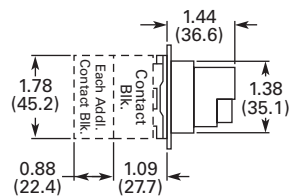

Approximate Dimensions in Inches (mm)

Mushroom Pushbutton

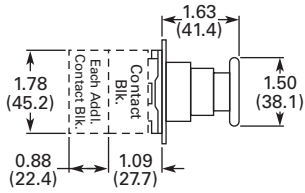

Illuminated Pushbutton

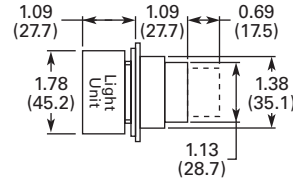

Jumbo Mushroom Pushbutton

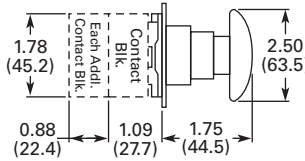

Selector Switch

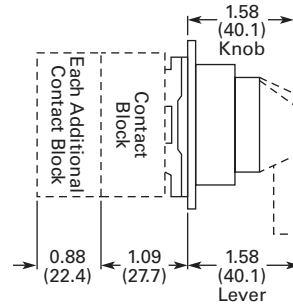

Push-Pull Switch

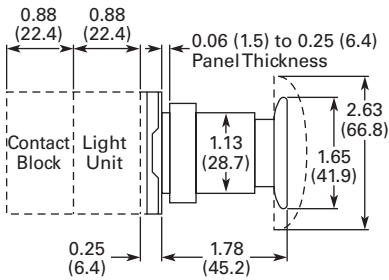

Key Selector Switch

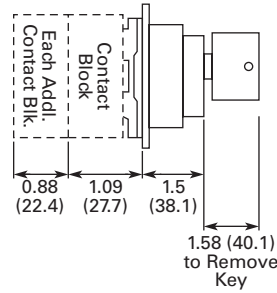

Indicating Light

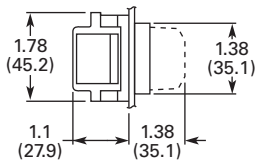

Illuminated Selector Switch

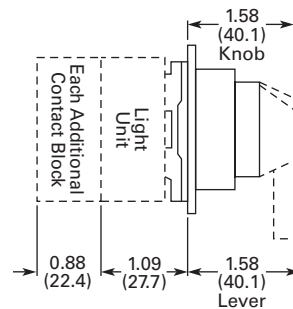

PresTest Indicating Light

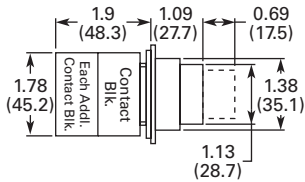

1.12

Pushbuttons and Indicating Lights

30.5 mm Watertight/Oiltight—HT800

1

30.5 mm Watertight/Oiltight—HT800



Contents

Description	Page
30.5 mm Watertight/Oiltight—HT800	
Catalog Number Selection	V7-T1-333
Product Selection	
Momentary Pushbutton Units, Non-Illuminated	V7-T1-334
Illuminated Pushbutton Units	V7-T1-336
Guarded Illuminated Pushbutton Units	V7-T1-338
Indicating Light Units	V7-T1-340
Push-Pull Units	V7-T1-342
Illuminated Push-Pull Units	V7-T1-343
Selector Switch Units	V7-T1-344
Selector Switch Contact Block Selection	V7-T1-346
Accessories	V7-T1-347
Options	V7-T1-348
Replacement Parts	V7-T1-351
Technical Data and Specifications	V7-T1-352
Dimensions	V7-T1-353

Product Description

The HT800 Series from Eaton's Electrical Sector is a family of 30.5 mm pushbutton devices which includes momentary, illuminated and mushroom head pushbuttons, selector switches, indicating lights and push-pull switches. The HT800 devices have a familiar appearance found in most industrial applications and are suitable for replacement of several other manufacturers' 30.5 mm pushbutton devices.

Features

- Anodized aluminum mounting rings
- Watertight double V-gasket seals
- Extended height bulbs
- Transparent housing contact blocks
- Color-coded contact blocks
- Gold-plated contacts (on low voltage contact block)
- Reliability ridge on movable contact
- Stackable screw-mounted contact blocks
- Contact blocks can be mounted in left/right or top/bottom positions
- Standard NC contact opens before NO contact closes (break before make operation)
- Bright and long lasting LED indicating lights in six colors
- Field convertible maintained selector switches—from two- to three-position and vice versa
- Field selectable knob/lever mounting positions—at any 22.5° increment

Benefits

- Corrosion resistant NEMA 4X finish
- Watertight and oiltight NEMA 4, 13 ingress protection
- Increased side illumination of indicating lights and illuminated pushbuttons
- Easy visual inspection of contact conditions
- Easily identifiable NO (white) or NC (black) contact blocks
- Gold-plated contacts suitable for logic level circuits
- Reliability ridge penetrates contamination buildup on stationary contacts
- Left/right or top/bottom mounted contact blocks allow correct positioning in retrofit applications
- All-purpose selector switches are convertible and can rotate in 22.5° increments to suit panel layouts

Standards and Certifications

- UL508 per File No. E131568
- CSA C22.2 No. 14 per File No. LR68551



Ingress Protection

- UL (NEMA) Type 1, 2, 3, 3R, 4, 4X, 12 and 13 when mounted in similarly rated enclosures

Catalog Number Selection

Catalog Number Selection is for illustrative purposes only and not to be used to create new catalog numbers.

HT800 Pushbuttons, Push-Pulls and Indicating Lights

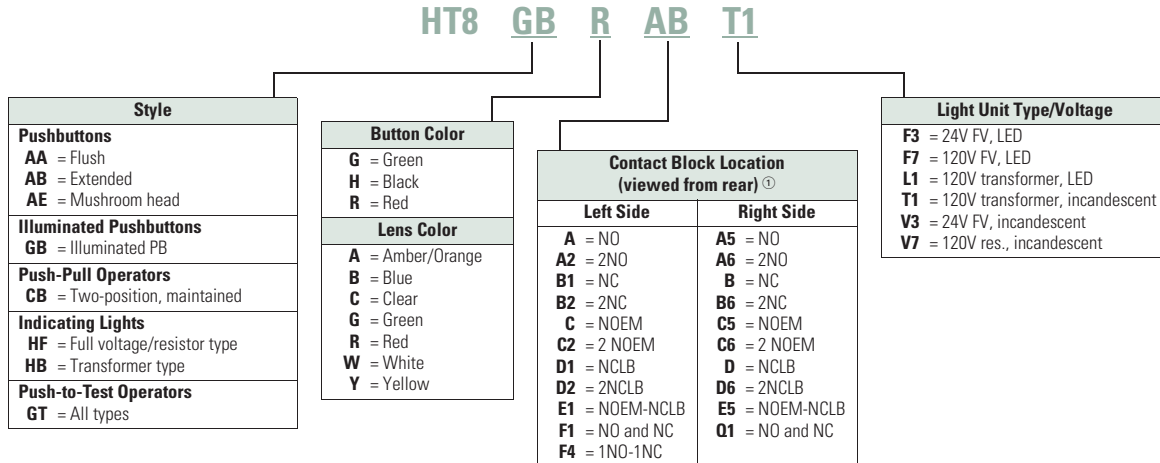

HT800 Selector Switch

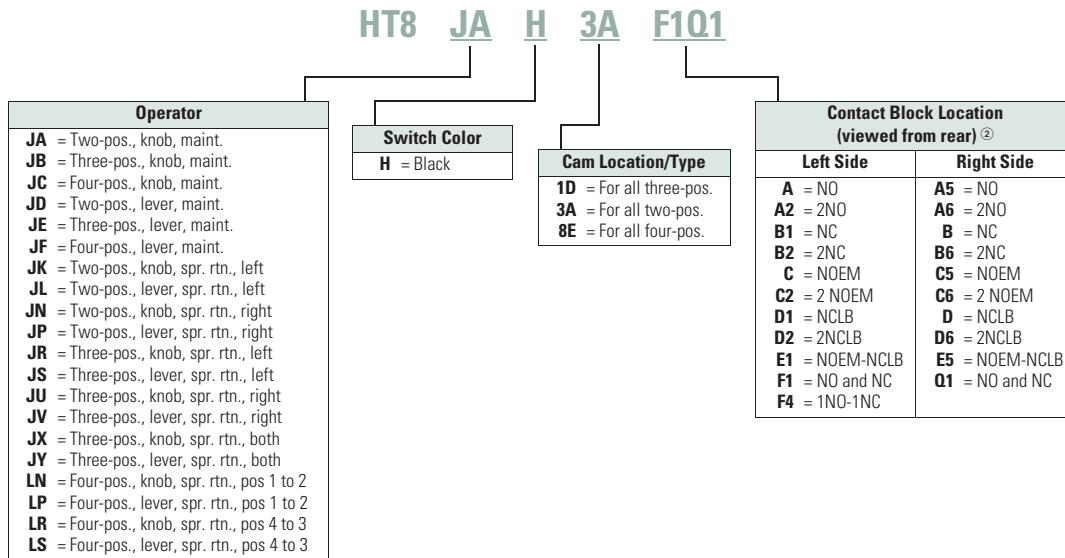

Notes

- ① Maximum of four contact blocks per side or a total of eight contact blocks recommended.
- ② Maximum of two contact blocks per side or a total of four contact blocks recommended.

Product Selection**Momentary Pushbutton Units, Non-Illuminated**

UL (NEMA) Type 3, 3R, 4, 4X, 12 and 13

- Flush, extended or 40 mm mushroom head operators

HT800 Pushbuttons**HT800 Pushbuttons—Point-of-Purchase Units**

Description	Catalog Number
Two-position maintained selector switch 1NO/1NC contact block, three square legend plates: OFF ON, MAN. AUTO, UP DOWN	HT8JAH3AAB-POP
Three-position maintained selector switch, black knob, 1NO/1NC contact block, three square legend plates: HAND OFF AUTO, FOR. OFF REV., OPEN OFF CLOSE	HT8JBH1DAB-POP
Three-position selector switch, spring return from left and right, black knob, 1NO/1NC contact block, three square legend plates: UP OFF DOWN, FOR OFF REV., OPEN OFF CLOSE	HT8JXH1DAB-POP
Red push-pull emergency stop, 1NO/1NC contact block, three square legend plates: STOP, EMERG. STOP, OFF	HT8CBRAB-POP
Illuminated push-pull maintained red pushbutton, 120V full voltage low profile LED, three square legend plates: STOP, EMERG. STOP, OFF	HT8FBRABFL7-POP
Illuminated push-pull maintained red pushbutton, 24V full voltage low profile LED, three square legend plates: STOP, EMERG. STOP, OFF	HT8FBRABFL3-POP
Green flush pushbutton, 1NO/1NC contact block, three square legend plates: START, ON, RUN	HT8AAGAB-POP
Black flush pushbutton, 1NO/1NC contact block, three square legend plates: RESET, JOG, OPEN	HT8AAHAB-POP
Red flush pushbutton, 1NO/1NC contact block, three square legend plates: STOP, CLOSE, OFF	HT8AARAB-POP
Red extended pushbutton, 1NO/1NC contact block, three square legend plates: STOP, CLOSE, OFF	HT8ABRAB-POP
Black extended pushbutton, 1NO/1NC contact block, three square legend plates: RESET, JOG, OPEN	HT8ABHAB-POP
Illuminated green pushbutton, 120V full voltage incandescent, 1NO/1NC contact block, three square legend plates: START, ON, RUN	HT8GBGABV7-POP
Illuminated green pushbutton, 24V full voltage incandescent, 1NO/1NC contact block, three square legend plates: START, ON, RUN	HT8GBGABV3-POP

Flush Head Operator



Extended Head Operator



40 mm Mushroom Head Operator



Momentary Contact Pushbutton Units, Non-Illuminated

Contact Type	Button Color	Flush Head Catalog Number	Extended Head Catalog Number	Mushroom Head (40 mm) Catalog Number
No contact	Black	HT8AAH	HT8ABH	HT8AEH
	Red	HT8AAR	HT8ABR	HT8AER
	Green	HT8AAG	HT8ABG	HT8AEG
1NO	Black	HT8AAHA	HT8ABHA	HT8AEHA
	Red	HT8AARA	HT8ABRA	HT8AERA
	Green	HT8AAGA	HT8ABGA	HT8AEGA
1NC	Black	HT8AAHB	HT8ABHB	HT8AEHB
	Red	HT8AARB	HT8ABRB	HT8AERB
	Green	HT8AAGB	HT8ABGB	HT8AEGB
1NO-1NC	Black	HT8AAHAB	HT8ABHAB	HT8AEHAB
	Red	HT8AARAB	HT8ABRAB	HT8AERAB
	Green	HT8AAGAB	HT8ABGAB	HT8AEGAB
2NO-2NC	Black	HT8AAHF1Q1	HT8ABHF1Q1	HT8AEHF1Q1
	Red	HT8AARF1Q1	HT8ABRF1Q1	HT8AERF1Q1
	Green	HT8AAGF1Q1	HT8ABGF1Q1	HT8AEGF1Q1

1.12

Pushbuttons and Indicating Lights

30.5 mm Watertight/Oiltight—HT800

1

Illuminated Pushbutton Units

UL (NEMA) Type 3, 3R, 4, 4X, 12 and 13

- Incandescent or LED
- Full voltage or transformer type
- 24V and 120V

Illuminated Pushbutton Operator



Illuminated Pushbuttons

Type	Volts	Lens Color	Operator Only Catalog Number	1NO Catalog Number	1NC Catalog Number	1NO-1NC Catalog Number	2NO-2NC Catalog Number
Incandescent Lamp							
Full voltage	120 Vac/Vdc	No lens ①	HT8GBFV	—	—	—	—
		Red	HT8GBRV7	HT8GBRAV7	HT8GBRBV7	HT8GBRABV7	HT8GBRF1Q1V7
		Green	HT8GBGV7	HT8GBGAV7	HT8GBGBV7	HT8GBGABV7	HT8GBGF1Q1V7
		Amber	HT8GBAV7	HT8GBAAV7	HT8GBABV7	HT8GBAAV7	HT8GBAF1Q1V7
		Clear	HT8GBCV7	HT8GBCAV7	HT8GBCBV7	HT8GBCABV7	HT8GBCF1Q1V7
		White	HT8GBWV7	HT8GBWAV7	HT8GBWBV7	HT8GBWABV7	HT8GBWF1Q1V7
		Yellow	HT8GBYV7	HT8GBYAV7	HT8GBYBV7	HT8GBYABV7	HT8GBYF1Q1V7
		Blue	HT8GBBV7	HT8GBBAV7	HT8GBBBV7	HT8GBBABV7	HT8GBBF1Q1V7
	24 Vac/Vdc	No lens ①	HT8GBFV	—	—	—	—
		Red	HT8GBRV3	HT8GBRAV3	HT8GBRBV3	HT8GBRABV3	HT8GBRF1Q1V3
		Green	HT8GBGV3	HT8GBGAV3	HT8GBGBV3	HT8GBGABV3	HT8GBGF1Q1V3
		Amber	HT8GBAV3	HT8GBAAV3	HT8GBABV3	HT8GBAAV3	HT8GBAF1Q1V3
		Clear	HT8GBCV3	HT8GBCAV3	HT8GBCBV3	HT8GBCABV3	HT8GBCF1Q1V3
		White	HT8GBWV3	HT8GBWAV3	HT8GBWBV3	HT8GBWABV3	HT8GBWF1Q1V3
Transformer	120 Vac	No lens ①	HT8GBT1	—	—	—	—
		Red	HT8GBRT1	HT8GBRAT1	HT8GBRBT1	HT8GBRABT1	HT8GBRF1Q1T1
		Green	HT8GBGT1	HT8GBGAT1	HT8GBGBT1	HT8GBGABT1	HT8GBGF1Q1T1
		Amber	HT8GBAT1	HT8GBAAT1	HT8GBABT1	HT8GBAABT1	HT8GBAF1Q1T1
		Clear	HT8GBCT1	HT8GBCAT1	HT8GBCBT1	HT8GBCABT1	HT8GBCF1Q1T1
		White	HT8GBWT1	HT8GBWAT1	HT8GBWBT1	HT8GBWABT1	HT8GBWF1Q1T1
		Yellow	HT8GBYT1	HT8GBYAT1	HT8GBYBT1	HT8GBYABT1	HT8GBYF1Q1T1
		Blue	HT8GBBT1	HT8GBBAT1	HT8GBBBT1	HT8GBBABT1	HT8GBBF1Q1T1

Note

① Light unit base operator without lens or bulb.

UL (NEMA) Type 3, 3R, 4, 4X, 12 and 13

Illuminated Pushbutton Operator



Illuminated Pushbuttons, continued

Type	Volts	Lens Color	Operator Only Catalog Number	1NO Catalog Number	1NC Catalog Number	1NO-1NC Catalog Number	2NO-2NC Catalog Number
LED							
Full voltage	120 Vac/Vdc	No lens ①	HT8GBFV	—	—	—	—
		Red	HT8GBRF7	HT8GBRAF7	HT8GBRBF7	HT8GBRABF7	HT8GBRF1Q1F7
		Green	HT8GBGF7	HT8GBGAF7	HT8GBGBF7	HT8GBGABF7	HT8GBGF1Q1F7
		Amber	HT8GBAF7	HT8GBAAF7	HT8GBABF7	HT8GBAABF7	HT8GBAF1Q1F7
		Clear	HT8GBCF7	HT8GBCAF7	HT8GBCBF7	HT8GBCABF7	HT8GBCF1Q1F7
		White	HT8GBWF7	HT8GBWAF7	HT8GBWBF7	HT8GBWABF7	HT8GBWF1Q1F7
		Yellow	HT8GBYF7	HT8GBYAF7	HT8GBYBF7	HT8GBYABF7	HT8GBYF1Q1F7
		Blue	HT8GBBF7	HT8GBBAF7	HT8GBBBF7	HT8GBBABF7	HT8GBBF1Q1F7
	24 Vac/Vdc	No lens ①	HT8GBFV	—	—	—	—
		Red	HT8GBRF3	HT8GBRAF3	HT8GBRBF3	HT8GBRABF3	HT8GBRF1Q1F3
		Green	HT8GBGF3	HT8GBGAF3	HT8GBGBF3	HT8GBGABF3	HT8GBGF1Q1F3
		Amber	HT8GBAF3	HT8GBAAF3	HT8GBABF3	HT8GBAABF3	HT8GBAF1Q1F3
		Clear	HT8GBCF3	HT8GBCAF3	HT8GBCBF3	HT8GBCABF3	HT8GBCF1Q1F3
		White	HT8GBWF3	HT8GBWAF3	HT8GBWBF3	HT8GBWABF3	HT8GBWF1Q1F3
		Yellow	HT8GBYF3	HT8GBYAF3	HT8GBYBF3	HT8GBYABF3	HT8GBYF1Q1F3
Blue		HT8GBBF3	HT8GBBAF3	HT8GBBBF3	HT8GBBABF3	HT8GBBF1Q1F3	
Transformer	120 Vac	No lens ①	HT8GBT1	—	—	—	—
		Red	HT8GBRL1	HT8GBRAL1	HT8GBRBL1	HT8GBRABL1	HT8GBRF1Q1L1
		Green	HT8GBGL1	HT8GBGAL1	HT8GBGBL1	HT8GBGABL1	HT8GBGF1Q1L1
		Amber	HT8GBAL1	HT8GBAAL1	HT8GBABL1	HT8GBAABL1	HT8GBAF1Q1L1
		Clear	HT8GBCL1	HT8GBCAL1	HT8GBCBL1	HT8GBCABL1	HT8GBCF1Q1L1
		White	HT8GBWL1	HT8GBWAL1	HT8GBWBL1	HT8GBWABL1	HT8GBWF1Q1L1
		Yellow	HT8GBYL1	HT8GBYAL1	HT8GBYBL1	HT8GBYABL1	HT8GBYF1Q1L1
		Blue	HT8GBBL1	HT8GBBAL1	HT8GBBBL1	HT8GBBABL1	HT8GBBF1Q1L1

Note

① Light unit base operator without lens or bulb.

1.12

Pushbuttons and Indicating Lights

30.5 mm Watertight/Oiltight—HT800

1

Guarded Illuminated Pushbutton Units

UL (NEMA) Type 3, 3R, 4, 4X, 12 and 13

- Incandescent or LED
- Full voltage or transformer type
- 24V and 120V

Guarded Illuminated Pushbutton Operator



Guarded Illuminated Pushbuttons

Type	Volts	Lens Color	Operator Only Catalog Number	1NO Catalog Number	1NC Catalog Number	1NO-1NC Catalog Number	2NO-2NC Catalog Number
Incandescent Lamp							
Full voltage	120 Vac/Vdc	No lens ①	HT8GDFV	—	—	—	—
		Red	HT8GDRV7	HT8GDRAV7	HT8GDRBV7	HT8GDRABV7	HT8GDRF1Q1V7
		Green	HT8GDGV7	HT8GDGAV7	HT8GDGBV7	HT8GDGABV7	HT8GDGF1Q1V7
		Amber	HT8GDAV7	HT8GDAAV7	HT8GDABV7	HT8GDAABV7	HT8GDAF1Q1V7
		Clear	HT8GDCV7	HT8GDVAV7	HT8GDCBV7	HT8GDCABV7	HT8GDCF1Q1V7
		White	HT8GDWV7	HT8GDWAV7	HT8GDWBV7	HT8GDWABV7	HT8GDWF1Q1V7
		Yellow	HT8GDYV7	HT8GDYAV7	HT8GDYBV7	HT8GDYABV7	HT8GDYF1Q1V7
	Blue	HT8GDBV7	HT8GDBAV7	HT8GDBBV7	HT8GDBABV7	HT8GDBF1Q1V7	
	24 Vac/Vdc	No lens ①	HT8GDFV	—	—	—	—
		Red	HT8GDRV3	HT8GDRAV3	HT8GDRBV3	HT8GDRABV3	HT8GDRF1Q1V3
		Green	HT8GDGV3	HT8GDGAV3	HT8GDGBV3	HT8GDGABV3	HT8GDGF1Q1V3
		Amber	HT8GDAV3	HT8GDAAV3	HT8GDABV3	HT8GDAABV3	HT8GDAF1Q1V3
		Clear	HT8GDCV3	HT8GDVAV3	HT8GDCBV3	HT8GDCABV3	HT8GDCF1Q1V3
		White	HT8GDWV3	HT8GDWAV3	HT8GDWBV3	HT8GDWABV3	HT8GDWF1Q1V3
Yellow		HT8GDYV3	HT8GDYAV3	HT8GDYBV3	HT8GDYABV3	HT8GDYF1Q1V3	
Transformer	120 Vac	No lens ①	HT8GDT1	—	—	—	—
		Red	HT8GDR1	HT8GDRAT1	HT8GDRBT1	HT8GDRABT1	HT8GDRF1Q1T1
		Green	HT8GDG1	HT8GDGAT1	HT8GDGBT1	HT8GDGABT1	HT8GDGF1Q1T1
		Amber	HT8GDAT1	HT8GDAAT1	HT8GDABT1	HT8GDAABT1	HT8GDAF1Q1T1
		Clear	HT8GDC1	HT8GDCA1	HT8GDGBT1	HT8GDCABT1	HT8GDCF1Q1T1
		White	HT8GDWT1	HT8GDWAT1	HT8GDWBT1	HT8GDWABT1	HT8GDWF1Q1T1
		Yellow	HT8GDY1	HT8GDYAT1	HT8GDYBT1	HT8GDYABT1	HT8GDYF1Q1T1
Blue	HT8GDB1	HT8GDBAT1	HT8GDBBT1	HT8GDBABT1	HT8GDBF1Q1T1		

Note

① Light unit base operator without lens or bulb.

UL (NEMA) Type 3, 3R, 4, 4X, 12 and 13

Guarded Illuminated Pushbutton Operator



Guarded Illuminated Pushbuttons, continued

Type	Volts	Lens Color	Operator Only Catalog Number	1NO Catalog Number	1NC Catalog Number	1NO-1NC Catalog Number	2NO-2NC Catalog Number
LED							
Full voltage	120 Vac/Vdc	No lens ①	HT8GDFV	—	—	—	—
		Red	HT8GDRF7	HT8GDRAF7	HT8GDRBF7	HT8GDRABF7	HT8GDRF1Q1F7
		Green	HT8GDGF7	HT8GDGAF7	HT8GDGBF7	HT8GDGABF7	HT8GDGF1Q1F7
		Amber	HT8GDAF7	HT8GDAAF7	HT8GDABF7	HT8GDAABF7	HT8GDAF1Q1F7
		Clear	HT8GDCF7	HT8GDCAF7	HT8GDCBF7	HT8GDCABF7	HT8GDCF1Q1F7
		White	HT8GDWF7	HT8GDWAF7	HT8GDWBF7	HT8GDWABF7	HT8GDWF1Q1F7
		Yellow	HT8GDYF7	HT8GDYAF7	HT8GDYBF7	HT8GDYABF7	HT8GDYF1Q1F7
	Blue	HT8GDBF7	HT8GDBAF7	HT8GDBBF7	HT8GDBABF7	HT8GDBF1Q1F7	
	24 Vac/Vdc	No lens ①	HT8GDFV	—	—	—	—
		Red	HT8GDRF3	HT8GDRAF3	HT8GDRBF3	HT8GDRABF3	HT8GDRF1Q1F3
		Green	HT8GDGF3	HT8GDGAF3	HT8GDGBF3	HT8GDGABF3	HT8GDGF1Q1F3
		Amber	HT8GDAF3	HT8GDAAF3	HT8GDABF3	HT8GDAABF3	HT8GDAF1Q1F3
		Clear	HT8GDCF3	HT8GDCAF3	HT8GDCBF3	HT8GDCABF3	HT8GDCF1Q1F3
		White	HT8GDWF3	HT8GDWAF3	HT8GDWBF3	HT8GDWABF3	HT8GDWF1Q1F3
Yellow		HT8GDYF3	HT8GDYAF3	HT8GDYBF3	HT8GDYABF3	HT8GDYF1Q1F3	
Blue	HT8GDBF3	HT8GDBAF3	HT8GDBBF3	HT8GDBABF3	HT8GDBF1Q1F3		
Transformer	120 Vac	No lens ①	HT8GDT1	—	—	—	—
		Red	HT8GDRL1	HT8GDRAL1	HT8GDRBL1	HT8GDRABL1	HT8GDRF1Q1L1
		Green	HT8GDGL1	HT8GDGAL1	HT8GDGBL1	HT8GDGABL1	HT8GDGF1Q1L1
		Amber	HT8GDAL1	HT8GDAAL1	HT8GDABL1	HT8GDAABL1	HT8GDAF1Q1L1
		Clear	HT8GDCL1	HT8GDCAL1	HT8GDCBL1	HT8GDCABL1	HT8GDCF1Q1L1
		White	HT8GDWL1	HT8GDWAL1	HT8GDWBL1	HT8GDWABL1	HT8GDWF1Q1L1
		Yellow	HT8GDYL1	HT8GDYAL1	HT8GDYBL1	HT8GDYABL1	HT8GDYF1Q1L1
		Blue	HT8GDBL1	HT8GDBAL1	HT8GDBBL1	HT8GDBABL1	HT8GDBF1Q1L1

Note

① Light unit base operator without lens or bulb.

1.12

Pushbuttons and Indicating Lights

30.5 mm Watertight/Oiltight—HT800

1

Indicating Light Units

UL (NEMA) Type 3, 3R, 4, 4X, 12 and 13

- Incandescent or LED
- Full voltage or transformer type
- Standard and PresTest types
- 24V and 120V

PresTest—This device incorporates a press-to-test feature whereby depressing the lens disconnects the light from the source

being monitored and connects the lamp to a continuously energized circuit for immediate detection of faulty lamps.

Indicating Light Unit



PresTest Light Unit



Indicating Light Units

Type	Volts	Lens Color	Indicating Light Catalog Number	PresTest Catalog Number
Incandescent				
Full voltage	120 Vac/Vdc	No lens ①	HT8HFFV	HT8GTFV
		Red	HT8HFRV7	HT8GTRV7
		Green	HT8HFGV7	HT8GTGV7
		Amber	HT8HFAV7	HT8GTAV7
		Clear	HT8HFCV7	HT8GTCV7
		White	HT8HFVV7	HT8GTWV7
		Yellow	HT8HFYV7	HT8GTYV7
		Blue	HT8HFBV7	HT8GTBV7
		24 Vac/Vdc	No lens ①	HT8HFFV
	Red		HT8HFRV3	HT8GTRV3
	Green		HT8HFGV3	HT8GTGV3
	Amber		HT8HFAV3	HT8GTAV3
	Clear		HT8HFCV3	HT8GTCV3
	White		HT8HFVV3	HT8GTWV3
	Transformer	120 Vac 50/60 Hz	No lens ①	HT8HBT1
Red			HT8HBRT1	HT8GTRT1
Green			HT8HBGT1	HT8GTGT1
Amber			HT8HBAT1	HT8GTAT1
Clear			HT8HBCT1	HT8GTCT1
White			HT8HBWT1	HT8GTWT1
Yellow			HT8HBYT1	HT8GTYT1
Blue			HT8HBBT1	HT8GTBT1

Note

① Light unit base operator without lens or bulb.

UL (NEMA) Type 3, 3R, 4, 4X, 12 and 13

Indicating Light Unit



Indicating Light Units, continued

PresTest Light Unit



Type	Volts	Lens Color	Indicating Light Catalog Number	PresTest Catalog Number
LED				
Full voltage	120 Vac/Vdc	No lens ①	HT8HFFV	HT8GTFV
		Red	HT8HFRF7	HT8GTRF7
		Green	HT8HFGF7	HT8GTGF7
		Amber	HT8HFAF7	HT8GTAF7
		Clear	HT8HFCF7	HT8GTCF7
		White	HT8HFWF7	HT8GTWF7
		Yellow	HT8HFYF7	HT8GTYF7
		Blue	HT8HBF7	HT8GTBF7
	24 Vac/Vdc	No lens ①	HT8HFFV	HT8GTFV
		Red	HT8HFRF3	HT8GTRF3
		Green	HT8HFGF3	HT8GTGF3
		Amber	HT8HFAF3	HT8GTAF3
		Clear	HT8HFCF3	HT8GTCF3
		White	HT8HFWF3	HT8GTWF3
		Yellow	HT8HFYF3	HT8GTYF3
		Blue	HT8HBF3	HT8GTBF3
Transformer	120 Vac 50/60 Hz	No lens ①	HT8HBT1	HT8GTT1
		Red	HT8HBRL1	HT8GTRL1
		Green	HT8HBGL1	HT8GTGL1
		Amber	HT8HBAL1	HT8GTAL1
		Clear	HT8HBCL1	HT8GTCL1
		White	HT8HBWL1	HT8GTWL1
		Yellow	HT8HBYL1	HT8GTYL1
		Blue	HT8HBBL1	HT8GTBL1

Note

① Light unit base operator without lens or bulb.

1.12

Pushbuttons and Indicating Lights

30.5 mm Watertight/Oiltight—HT800

1

Push-Pull Units

UL (NEMA) Type 3, 3R, 4, 4X, 12 and 13

- 40 mm mushroom head
- Two-position maintained
- Non-illuminated

Round Head Two-Position Push-Pull Unit



Flat Head Two-Position Push-Pull Unit



Two-Position Push-Pull, Maintained, Non-Illuminated

Contact Type	Operator Position—Maintained		Button Color	Round Head Mushroom Head Button Catalog Number	Flat Head Mushroom Head Button Catalog Number
	Out	In			
No contact	—	—	Black	HT8CBH	HT8DBH
			Red	HT8CBR	HT8DBR
			Green	HT8CBG	HT8DBG
NO	0	X	Black	HT8CBHA	HT8DBHA
			Red	HT8CBRA	HT8DBRA
			Green	HT8CBGA	HT8DBGA
NC	X	0	Black	HT8CBHB	HT8DBHB
			Red	HT8CBRB	HT8DBRB
			Green	HT8CBGB	HT8DBGB
NO-NC	0	X	Black	HT8CBHAB	HT8DBHAB
	X	0	Red	HT8CBRAB	HT8DBRAB
			Green	HT8CBGAB	HT8DBGAB
NCLB [Ⓢ]	X	0	Black	HT8CBHD1B	HT8DBHD1B
NC	X	0	Red	HT8CBRD1B	HT8DBRD1B
			Green	HT8CBGD1B	HT8DBGD1B
NCLB [Ⓢ]	X	0	Black	HT8CBHD1D	HT8DBHD1D
NCLB [Ⓢ]	X	0	Red	HT8CBRD1D	HT8DBRD1D
			Green	HT8CBGD1D	HT8DBGD1D

Note

Ⓢ NCLB = normally closed late break.

Illuminated Push-Pull Units

UL (NEMA) Type 3, 3R, 4, 4X, 12 and 13

- Incandescent or LED
- Full voltage or transformer type
- 24V and 120V

Illuminated Push-Pull Unit



Illuminated Push-Pull Units

Type	Volts	Lens Color	Operator Only Catalog Number	1NO Catalog Number	1NC Catalog Number	1NO-1NC Catalog Number	2NCLB Catalog Number
Incandescent Lamp							
Full voltage	120 Vac/Vdc	Red	HT8FBRV7	HT8FBRAV7	HT8FBRBV7	HT8FBRAV7	HT8FBRD1DV7
		Green	HT8FBGV7	HT8FBGAV7	HT8FBGBV7	HT8FBGAV7	HT8FBGD1DV7
	24 Vac/Vdc	Red	HT8FBRV3	HT8FBRAV3	HT8FBRBV3	HT8FBRAV3	HT8FBRD1DV3
		Green	HT8FBGV3	HT8FBGAV3	HT8FBGBV3	HT8FBGAV3	HT8FBGD1DV3
Transformer	120 Vac	Red	HT8FBRT1	HT8FBRA1	HT8FBRBT1	HT8FBRA1	HT8FBRD1DT1
		Green	HT8FBGT1	HT8FBGA1	HT8FBGBT1	HT8FBGA1	HT8FBGD1DT1
LED Lamp							
Full voltage	120 Vac/Vdc	Red	HT8FBRF7	HT8FBRAF7	HT8FBRBF7	HT8FBRAF7	HT8FBRD1DF7
		Green	HT8FBGF7	HT8FBGAF7	HT8FBGBF7	HT8FBGAF7	HT8FBGD1DF7
	24 Vac/Vdc	Red	HT8FBRF3	HT8FBRAF3	HT8FBRBF3	HT8FBRAF3	HT8FBRD1DF3
		Green	HT8FBGF3	HT8FBGAF3	HT8FBGBF3	HT8FBGAF3	HT8FBGD1DF3
Transformer	120 Vac	Red	HT8FBRL1	HT8FBRAL1	HT8FBRBL1	HT8FBRAL1	HT8FBRD1DL1
		Green	HT8FBGL1	HT8FBGAL1	HT8FBGBL1	HT8FBGAL1	HT8FBGD1DL1

Note: Complete illuminated push-pull switches will not fit in a standard 3 in deep enclosure.

Illuminated Push-Pull Units with Low Profile Light Units

Type	Voltage	Color	Fingersafe	Operator Only Catalog Number	1NO Catalog Number	1NC Catalog Number	1NO-1NC Catalog Number	2NCLB Catalog Number	1NO-1NCLB Catalog Number
LED Lamp									
Full voltage	120 Vac/Vdc	Red	Yes	HT8FBRFL7P	HT8FBRAFL7P	HT8FBRBFL7P	HT8FBRAFL7P	HT8FBRD1DFL7P	HT8FBRD1BFL7P
		Red	No	HT8FBRFL7	HT8FBRAFL7	HT8FBRBFL7	HT8FBRAFL7	HT8FBRD1DFL7	HT8FBRD1BFL7
	24 Vac/Vdc	Red	Yes	HT8FBRFL3P	HT8FBRAFL3P	HT8FBRBFL3P	HT8FBRAFL3P	HT8FBRD1DFL3P	HT8FBRD1BFL3P
		Red	No	HT8FBRFL3	HT8FBRAFL3	HT8FBRBFL3	HT8FBRAFL3	HT8FBRD1DFL3	HT8FBRD1BFL3
Incandescent									
Full voltage	120 Vac/Vdc	Red	Yes	HT8FBRVL7P	HT8FBRAVL7P	HT8FBRBVL7P	HT8FBRAVL7P	HT8FBRD1DVL7P	HT8FBRD1BVL7P
		Red	No	HT8FBRVL7	HT8FBRAVL7	HT8FBRBVL7	HT8FBRAVL7	HT8FBRD1DVL7	HT8FBRD1BVL7
	24 Vac/Vdc	Red	Yes	HT8FBRVL3P	HT8FBRAVL3P	HT8FBRBVL3P	HT8FBRAVL3P	HT8FBRD1DVL3P	HT8FBRD1BVL3P
		Red	No	HT8FBRVL3	HT8FBRAVL3	HT8FBRBVL3	HT8FBRAVL3	HT8FBRD1DVL3	HT8FBRD1BVL3

1

Selector Switch Units

UL (NEMA) Type 3, 3R, 4, 4X, 12 and 13

- Two-, three- and four-position
- Non-illuminated

Standard Knob Operator



Standard Lever Operator



Two-Position Selector Switch Units, Non-Illuminated

Contact Type	Operator Position ^①		Operating Mode ^②		Standard Black Knob Catalog Number	Standard Black Lever Catalog Number
No contacts	—	—	M	M	HT8JAH3A	HT8JDH3A
			S	M	HT8JKH3A	HT8JLH3A
			M	S	HT8JNH3A	HT8JPH3A
1NO	0	X	M	M	HT8JAH3AA5	HT8JDH3AA5
			S	M	HT8JKH3AA5	HT8JLH3AA5
			M	S	HT8JNH3AA5	HT8JPH3AA5
2NO	X 0	0 X	M	M	HT8JAH3AAA5	HT8JDH3AAA5
			S	M	HT8JKH3AAA5	HT8JLH3AAA5
			M	S	HT8JNH3AAA5	HT8JPH3AAA5
2NO-2NC	X 0 0 X	0 X X 0	M	M	HT8JAH3AF1Q1	HT8JDH3AF1Q1
			S	M	HT8JKH3AF1Q1	HT8JLH3AF1Q1
			M	S	HT8JNH3AF1Q1	HT8JPH3AF1Q1

Standard Knob Operator



Standard Lever Operator



Three-Position Selector Switch Units, Non-Illuminated

Contact Type	Operator Position ^①			Operating Mode ^②			Standard Black Knob Catalog Number	Standard Black Lever Catalog Number
No contacts	—	—	—	M	M	M	HT8JBH1D	HT8JEH1D
				S	M	M	HT8JRH1D	HT8JSH1D
				M	M	S	HT8JUH1D	HT8JVH1D
				S	M	S	HT8JXH1D	HT8JYH1D
2NO	X 0	0 0	0 X	M	M	M	HT8JBH1DAA5	HT8JEH1DAA5
				S	M	M	HT8JRH1DAA5	HT8JSH1DAA5
				M	M	S	HT8JUH1DAA5	HT8JVH1DAA5
				S	M	S	HT8JXH1DAA5	HT8JYH1DAA5
2NO-2NC ^③	X 0 0	0 X 0	0 0 X	M	M	M	HT8JBH1DF1Q1	HT8JEH1DF1Q1
				S	M	M	HT8JRH1DF1Q1	HT8JSH1DF1Q1
				M	M	S	HT8JUH1DF1Q1	HT8JVH1DF1Q1
				S	M	S	HT8JXH1DF1Q1	HT8JYH1DF1Q1
2NO-2NC	X 0 0 X	0 X 0 X	X X X 0	M	M	M	HT8JBH1DF1Q1	HT8JEH1DF1Q1
				S	M	M	HT8JRH1DF1Q1	HT8JSH1DF1Q1
				M	M	S	HT8JUH1DF1Q1	HT8JVH1DF1Q1
				S	M	S	HT8JXH1DF1Q1	HT8JYH1DF1Q1

Notes

^① X = closed circuit, 0 = open circuit.

^② M = Maintained, S = Momentary.

^③ For OX0, NC contacts must be wired in series—see Three-Position Selector Switch table on Page V7-T1-346.

UL (NEMA) Type 3, 3R, 4, 4X, 12 and 13

Four-Position Selector Switch Units, Non-Illuminated

Standard Knob Operator



Standard Lever Operator



Contact Type	Operator Position ^①				Operating Mode ^②				Standard Black Knob Catalog Number	Standard Black Lever Catalog Number
No contacts	—	—	—	—	M	M	M	M	HT8JCH8E	HT8JFH8E
					S	M	M	M	HT8LNH8E	HT8LPH8E
					M	M	M	S	HT8LRH8E	HT8LSH8E
2NO-2NC	X	0	0	0	M	M	M	M	HT8JCH8EF1Q1	HT8JFH8EF1Q1
	0	X	0	0	S	M	M	M	HT8LNH8EF1Q1	HT8LPH8EF1Q1
	0	0	X	0	M	M	M	S	HT8LRH8EF1Q1	HT8LSH8EF1Q1
	0	0	0	X	M	M	M	S	HT8LRH8EF1Q1	HT8LSH8EF1Q1

Notes

- ① X = closed circuit, 0 = open circuit.
- ② M = Maintained, S = Momentary.

1.12

Pushbuttons and Indicating Lights

30.5 mm Watertight/Oiltight—HT800







1

Selector Switch Contact Block Selection

For Two-, Three- and Four-Position Selector Switches









Two-Position Selector Switch (Cam Code 3A)

Operator Position

			Left	or	Right
X	0		 NO		 NC
0		X	 NC		 NO









Three-Position Selector Switch (Cam Code 1D)

Operator Position

				Left	Right
X	0	0		 NO	—
0		X	0	 NC	 NC
0	0	0	X	—	 NO
0		X	X	 NC	—
X		X	0	—	 NC

Four-Position Selector Switch (Cam Code 8E)

Operator Position

					Left	Right
X	0	0	0		 NO	—
0		X	0	0	 NC	—
0	0	0	X	0	—	 NO
0	0	0	0	X	—	 NC

Accessories

HT800 Accessories

	Description	Catalog Number
 <p>HT8A15</p>	Illuminated Pushbutton Guard	HT8A15
 <p>HT8WRENCH</p>	Wrench Tool	HT8WRENCH
 <p>HT8LAMPTOOL</p>	Lamp/Bulb Removal Tool	HT8LAMPTOOL
 <p>HT8X1</p>	Thrust Washer (Anti-rotation) (Included with every operator)	HT8X1
 <p>HT8X2</p>	Trim Ring (Included with every operator)	HT8X2
 <p>HT8X3</p>	Sealing/Spacer Washer (Five included with every operator)	HT8X3
 <p>HT8GR1</p>	Grounding Kit for Pushbuttons and Selector Switches (Included with every operator)	HT8GR1
 <p>HT8GR2</p>	Grounding Kit for Indicating Lights (Included with indicating lights)	HT8GR2

Light Units

Light Unit



Type	Voltage	Catalog Number
Full voltage	24 Vac/Vdc	HT8F3V3
	120 Vac/Vdc	HT8F7V8
Transformer	120 Vac	HT8L1T1

1

Options

Legend Plates ①

Standard



Jumbo



For Pushbutton Operators and Indicating Lights

Legend	Color of Field	Standard Catalog Number	Jumbo Catalog Number	Legend	Color of Field	Standard Catalog Number	Jumbo Catalog Number
Letters on Legend Plates Below are 3/16 in High							
CLAMP	Black	HT8SP90	HT8LP90	OFF	Red	HT8SP24	HT8LP24
CLOSE		HT8SP73	HT8LP73	ON	Black	HT8SP25	HT8LP25
DOWN		HT8SP74	HT8LP74	OPEN		HT8SP26	HT8LP26
EMERG. STOP		HT8SP13	HT8LP13	OUT		HT8SP27	HT8LP27
FAST		HT8SP75	HT8LP75	POWER ON		HT8SP80	HT8LP80
FASTER		HT8SP87	HT8LP87	RAISE		HT8SP28	HT8LP28
FEEDER ON		HT8SP94	HT8LP94	READY		HT8SP86	HT8LP86
FEEDER OFF		HT8SP95	HT8LP95	RESET		HT8SP29	HT8LP29
FORWARD		HT8SP15	HT8LP15	REVERSE		HT8SP30	HT8LP30
HIGH		HT8SP16	HT8LP16	RUN		HT8SP31	HT8LP31
IN		HT8SP17	HT8LP17	SAFE		HT8SP85	HT8LP85
INCH		HT8SP18	HT8LP18	SLOW		HT8SP32	HT8LP32
JOG		HT8SP19	HT8LP19	SLOWER		HT8SP88	HT8LP88
JOG FOR.		HT8SP20	HT8LP20	START		HT8SP33	HT8LP33
JOG REV.		HT8SP21	HT8LP21	STOP	Red	HT8SP34	HT8LP34
LOW		HT8SP22	HT8LP22	TEST	Black	HT8SP83	HT8LP83
LOWER		HT8SP23	HT8LP23	TRANSFER		HT8SP93	HT8LP93
LUBE-FAIL		HT8SP92	HT8LP92	TRIP		HT8SP84	HT8LP84
MOTOR RUN		HT8SP81	HT8LP81	UNCLAMP		HT8SP91	HT8LP91
MOTOR STOP		HT8SP82	HT8LP82	UP		HT8SP35	HT8LP35

Standard



Jumbo



For Selector Switch Operators

Legend	Color of Field	Standard Catalog Number	Jumbo Catalog Number	Legend	Color of Field	Standard Catalog Number	Jumbo Catalog Number
Two-Position—3/16 in High Lettering							
FOR. REV.	Black	HT8SP38	HT8LP38	Three-Position—3/16 in High Lettering			
HAND AUTO		HT8SP39	HT8LP39	AUTO OFF HAND	Black	HT8SP49	HT8LP49
HIGH LOW		HT8SP40	HT8LP40	FOR. OFF REV.		HT8SP50	HT8LP50
JOG RUN		HT8SP41	HT8LP41	FOR. SAFE REV.		HT8SP69	HT8LP69
MAN. AUTO		HT8SP67	HT8LP67	HAND OFF AUTO		HT8SP51	HT8LP51
OFF ON		HT8SP42	HT8LP42	MAN. OFF AUTO		HT8SP68	HT8LP68
OPEN CLOSE		HT8SP43	HT8LP43	OPEN OFF CLOSE		HT8SP53	HT8LP53
RUN JOG		HT8SP44	HT8LP44	RUN SAFE JOG		HT8SP70	HT8LP70
SAFE RUN		HT8SP45	HT8LP45	UP OFF DOWN		HT8SP54	HT8LP54
START JOG		HT8SP46	HT8LP46	ON STOP SAFE		HT8SP71	HT8LP71
START STOP		HT8SP47	HT8LP47				
UP DOWN		HT8SP48	HT8LP48				

For Push-Pull Units

Legend	Color of Field	Standard ② Catalog Number	Jumbo ③ Catalog Number
ON/OFF	Black	HT8PP5	HT8R5
OPEN/CLOSE		HT8PP8	HT8R8
UP/DOWN		HT8PP11	HT8R11

Blank Plastic Legend Plates—Square

Legend	Color of Field	Standard Catalog Number	Jumbo Catalog Number
Black	White/Silver	HT8SP76	HT8LP76
White	Red/Black	HT8SP77	HT8LP77

Notes

① For dimensions, see Page V7-T1-356.

② 3/32 in high lettering.

③ 1/8 in high lettering.

Legend Plates with Non-Standard Markings

When Ordering Specify

- Catalog number of blank plate.
- Insert the following into Order Notes: legend, letter size and locations. See information below.

Ordering Example:

Catalog no.: **HT85P76STAMP**
 Letter size: 3/32 in (2.4 mm)
 Pos. A—POWER HOUSE
 Pos. B—START PUMP 1

Legend Characters Available

A B C D E F G H I J K L M N O
 P Q R S T U V W X Y Z / - . , 1
 2 3 4 5 6 7 8 9 0

Legend Positions

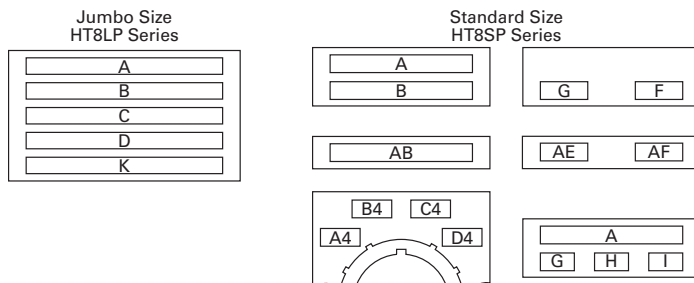

Blank Plastic Legend Plates for Non-Standard Markings—Plastic

Legend	Color of Field	Standard Catalog Number	Jumbo Catalog Number
Black	White/Silver	HT8SP76STAMP	HT8LP76STAMP
White	Red/Black	HT8SP77STAMP	HT8LP77STAMP

Maximum Characters per Legend Plate and Approximate Dimensions

Top (Aluminum and Plastic)	Style	Character Size		1/8 in High		3/16 in High	
		3/32 in High	Number of Characters	Number of Lines	Number of Characters	Number of Lines	Number of Characters
Standard	Square	2	18	2	13	1	9
Jumbo ①	Square	5	23	3	18	2	12

Note

① Can be used on top row only of any enclosure.

1.12

Pushbuttons and Indicating Lights

30.5 mm Watertight/Oiltight—HT800

1

Contact Blocks

NO Contact Block



NC Contact Block



Contact Blocks ^{①②}

Description/Function	Contact Type	Without Guard Catalog Number	Fingerproof Catalog Number
Standard normally open contact	NO	HT8A	HT8AP
Standard normally closed contact	NC	HT8B	HT8BP
Normally open early make contact will make circuit before standard NO contact. DC ratings do not apply.	NOEM	HT8C	HT8CP
Normally closed late break contact will open after standard NC contact. DC ratings do not apply.	NCLB	HT8D	HT8DP
Logic level, low voltage NO contact. Gold plated contacts.	NO	HT8E	HT8EP

Contact Block Location (Viewed from Rear)

Suffix Codes ^{③④}

Left Side	Right Side
A = NO	A5 = NO
A2 = 2NO	A6 = 2NO
B1 = NC	B = NC
B2 = 2NC	B6 = 2NC
C = NOEM	C5 = NOEM
C2 = 2 NOEM	C6 = 2 NOEM
D1 = NCLB	D = NCLB
D2 = 2 NCLB	D6 = 2 NCLB
E1 = NOEM-NCLB	E5 = NOEM-NCLB
F1 = NO and NC	Q1 = NO and NC
F4 = 1NO-1NC	

Notes

- ① See **Page V7-T1-352** for contact block electrical ratings.
- ② Maximum of four contact blocks per side or a total of eight contact blocks recommended.
- ③ Maximum of two contact blocks per side or a total of four contact blocks recommended.
- ④ Standard contact blocks without fingerproof protection.

Replacement Parts

Replacement Bulbs and LEDs

Incandescent Bulb



Voltage	Color	Catalog Number
Incandescent		
6V	—	HT8BULBV1
24V	—	HT8BULBV3
120V	—	HT8BULBV7

LED Bulb



Voltage	Color	Catalog Number
LED		
6–12V (For use with transformers with 6V secondary winding)	Red	HT8LEDRF1
	Green	HT8LEDGF1
	Amber/orange	HT8LEDAF1
	White/clear	HT8LEDWF1
	Yellow	HT8LEDYF1
	Blue	HT8LEDBF1
24V	Red	HT8LEDRF3
	Green	HT8LEDGF3
	Amber/orange	HT8LEDAF3
	White/clear	HT8LEDWF3
	Yellow	HT8LEDYF3
	Blue	HT8LEDBF3
120V	Red	HT8LEDRF7
	Green	HT8LEDGF7
	Amber/orange	HT8LEDAF7
	White/clear	HT8LEDWF7
	Yellow	HT8LEDYF7
	Blue	HT8LEDBF7

Replacement Lenses

Color	Indicating Lights Catalog Number	PresTest Lights Illuminated Pushbuttons Catalog Number
Amber	HT8LA	HT8BA
Blue	HT8LB	HT8BB
Clear	HT8LC	HT8BC
Green	HT8LG	HT8BG
Red	HT8LR	HT8BR
White	HT8LW	HT8BW
Yellow	HT8LY	HT8BY

Technical Data and Specifications

HT800—Specifications

Description	Specification
Mechanical Ratings	
Frequency of operation	
Pushbuttons	6,000 operations per hour
Selector switches	3,000 operations per hour
Push-pull operators	3,000 operations per hour
Mechanical endurance/life	
Pushbuttons	10 x 10 ⁶ operations 6K ops/hr with 6 NO on left and 6 NC on right
Selector switches	250 x 10 ³ operations 3K ops/hr with 2 NO on left and 2 NC on right
Push-pull operators	250 x 10 ³ operations 3K ops/hr with 6 NO on left and 6 NC on right
Climatic Conditions	
Operating temperature	10° to 140°F (–12° to 60°C)
Storage temperature	–40° to 176°F (–40° to 80°C)
Altitude	6,562 ft (2,000m)
Humidity	95% RH at 60°C
Terminals	
Contact blocks	#6-32 posidrive saddle clamp type, 1 x 16 AWG to 2 x 14 AWG, 12 in-lbs max.
Light units	#6-32 posidrive saddle clamp type, 1 x 22 AWG to 2 x 14 AWG, 7 in-lbs max.
Electrical Ratings	
Standard contact blocks UL (NEMA) rating	See table below.
Logic level contact block power rating	5V 1 mA (minimum) 28V 500 mA (maximum)

Electrical Ratings—HT800 Standard Contact Blocks, UL Rating

Description/Function	Contact Type	AC	DC	Catalog Number
Standard normally open contact	NO	A600 ①	P600 ②	HT8A
Standard normally closed contact	NC	A600 ①	P600 ②	HT8B
Normally open early make contact will make circuit before standard NO contact. DC ratings do not apply.	NOEM	A600 ①	—	HT8C
Normally closed late break contact will open after standard NC contact. DC ratings do not apply.	NCLB	A600 ①	—	HT8D
Logic level, low voltage NO contact. Gold plated contacts.	NO	5V 1 mA (minimum) 28V 500 mA (maximum)		HT8E

UL A600 and P600 Ratings

Description	50 Vac or 60 Hz				Vdc ③		
	120	240	480	600	125	250	600
Make and emerg. interrupting capacity (amp)	60	30	15	12	1.1	0.55	0.2
Normal load break (amp)	6	3	1.5	1.2	1.1	0.55	0.2
Thermal current (amp)	10	10	10	10	5	5	5
Voltamperes:							
Make and emerg. interrupting capacity	7200	7200	7200	7200	138 ④	138 ④	138 ④
Normal load break	720	720	720	720	138	138	138

Notes

- ① Heavy-duty.
- ② Standard-duty.
- ③ DC ratings do not apply to NOEM (Normally Open Early Make) and NCLB (Normal Closed Late Break) contact blocks HT8C and HT8D.
- ④ Maximum make or break volt-amperes at 300V or less.

Dimensions

Approximate Dimensions in Inches (mm)

Momentary Pushbuttons—Non-Illuminated

Back, side and bottom views of pushbutton operator with attached contact blocks.

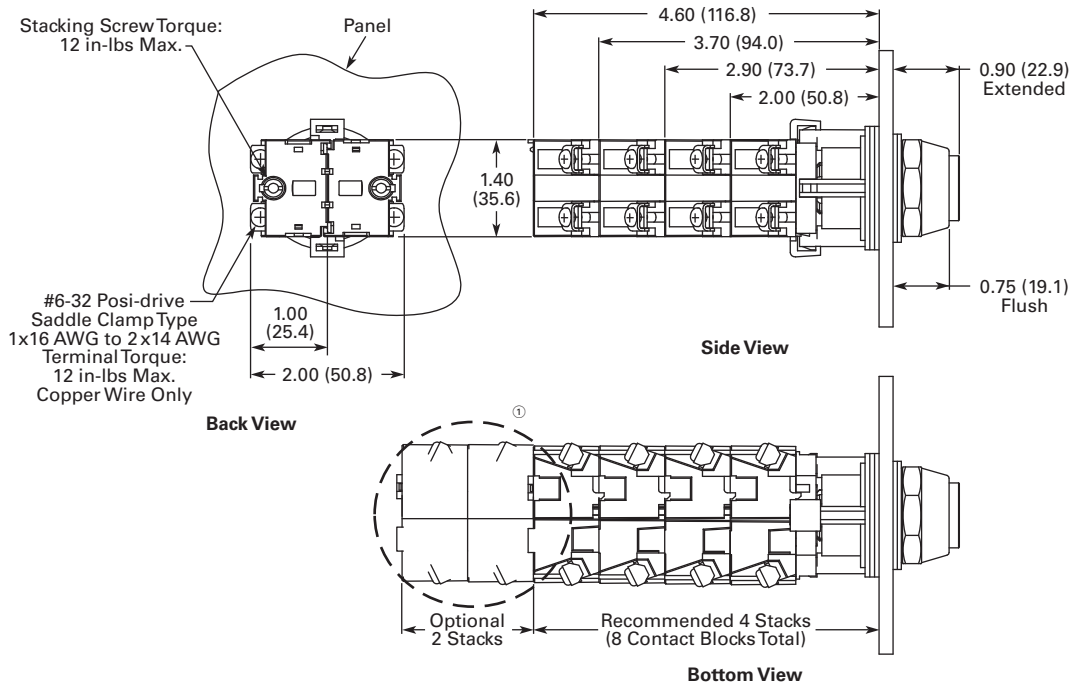

Illuminated Pushbuttons

Back, side and bottom views of pushbutton operator with attached contact blocks.

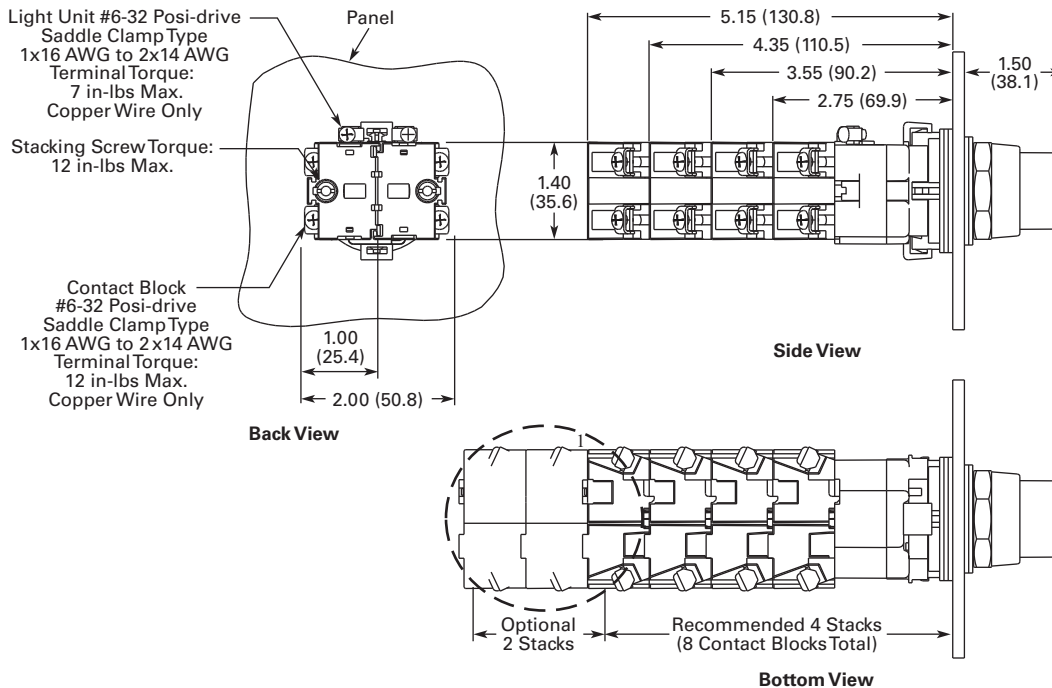

Note

① Recommended maximum of four tandem stacks of contact blocks behind operator. At users' discretion, two additional tandem stacks may be added.

1.12 Pushbuttons and Indicating Lights

30.5 mm Watertight/Oiltight—HT800

1

Approximate Dimensions in Inches (mm)

Mushroom Head Pushbuttons and Round Head MRH Push-Pull Operators

Back, side and bottom views of mushroom head operator with attached contact blocks.

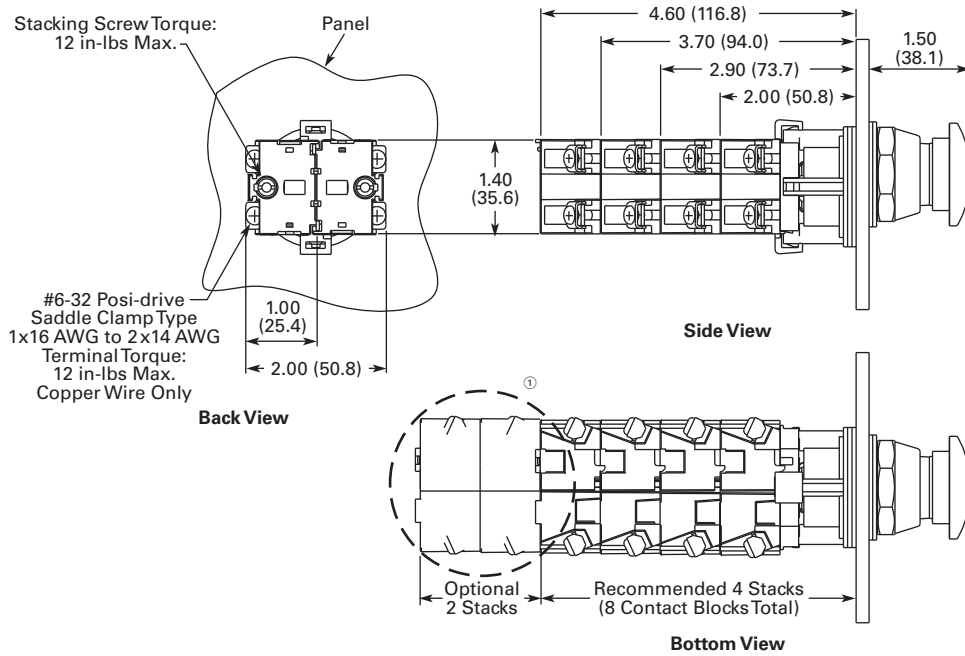

Illuminated and Non-Illuminated Flat Head MRH Push-Pull Operators

Back, side and bottom views of push-pull operator with attached contact blocks.

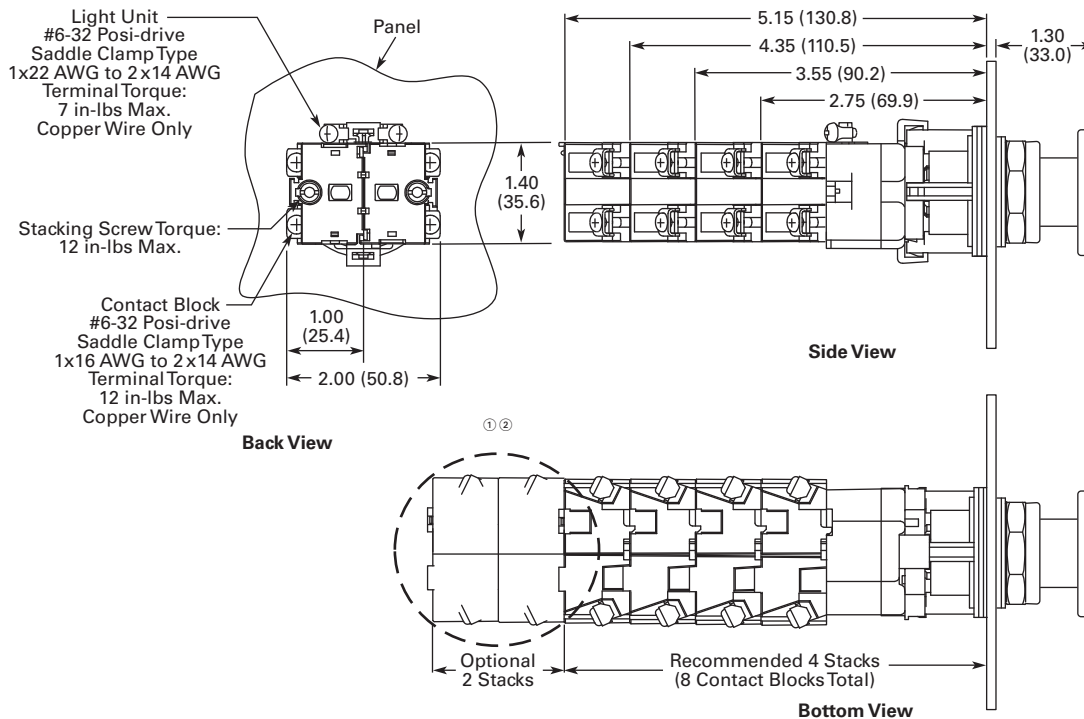

Notes

- ① Recommended maximum of four tandem stacks of contact blocks behind operator. At users' discretion, two additional tandem stacks may be added.
- ② Contact blocks mount directly to operator adaptor in non-illuminated version.

Approximate Dimensions in Inches (mm)

Indicating Lights

Back, side and bottom views of indicating light operator with attached contact blocks.

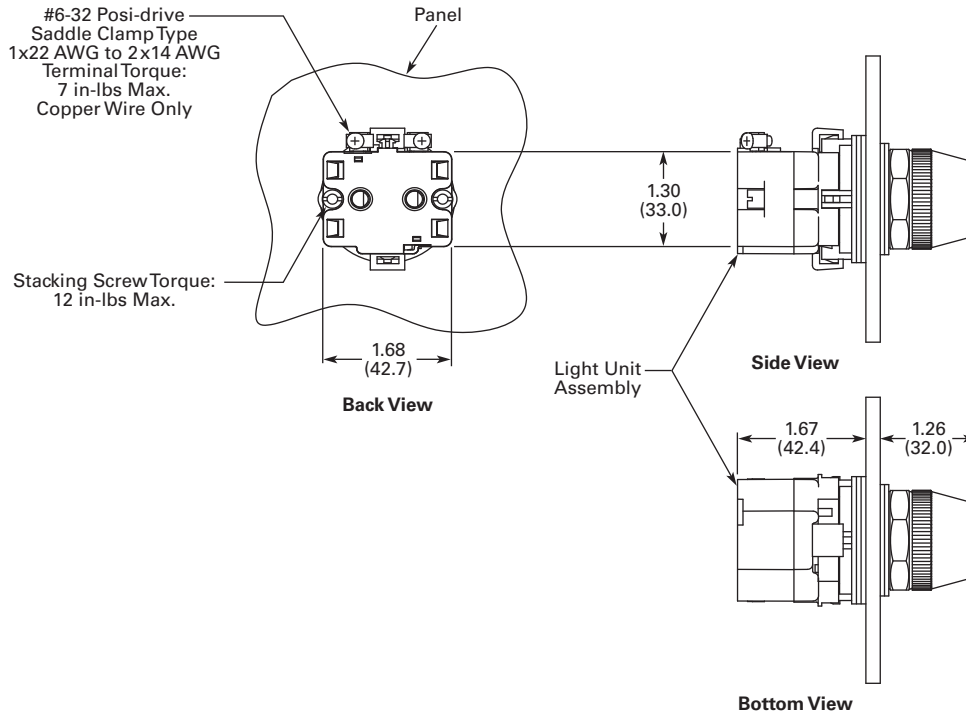

Selector Switches

Back, side and bottom views of selector switch operator with attached contact blocks.

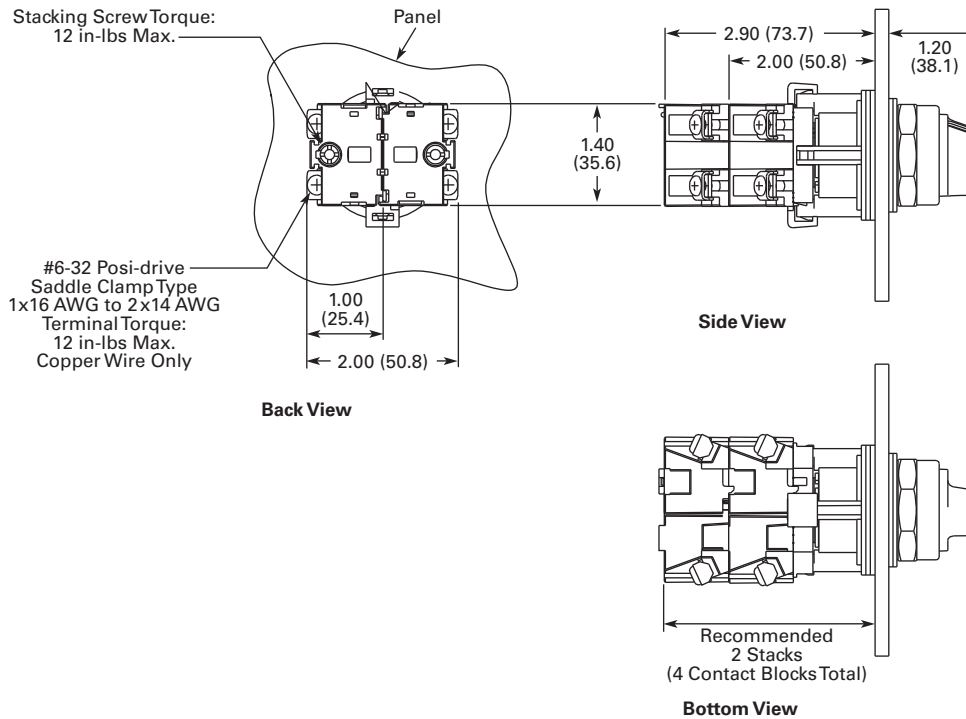

1.12

Pushbuttons and Indicating Lights

30.5 mm Watertight/Oiltight—HT800

1

Approximate Dimensions in Inches (mm)

Mounting Matrix and Minimum Panel Spacing Requirements

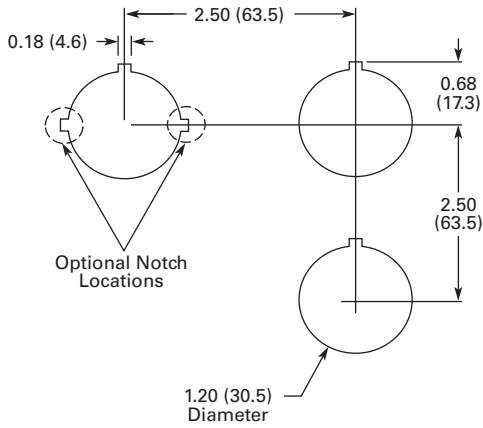

Legend Plates

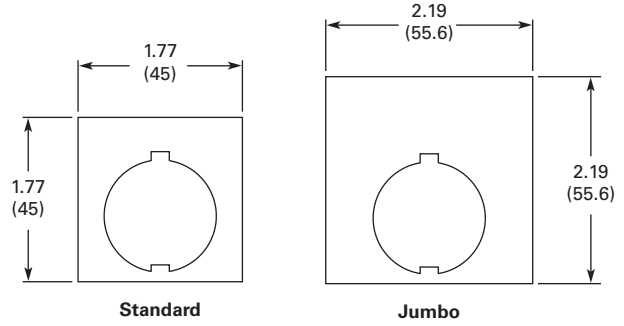

30.5 mm Class I Division 2 Hazardous Locations—10250T/E34



Contents

<i>Description</i>	<i>Page</i>
30.5 mm Class I Division 2 Hazardous Locations—10250T/E34	
Product Overview	V7-T1-358
Product Identification	V7-T1-359
Catalog Number Selection	V7-T1-359
Product Selection	
Momentary Pushbutton Units	V7-T1-360
Non-Illuminated Pushbutton Units	V7-T1-364
Illuminated Pushbutton Units	V7-T1-366
Guarded Illuminated Pushbutton Units	V7-T1-367
Indicating Light Units	V7-T1-368
Illuminated Pushbuttons and Indicating Lights	V7-T1-369
Push-Pull Units	V7-T1-371
Illuminated Push-Pull Units	V7-T1-373
Push-Pull Operators	V7-T1-376
Selector Switch Units	V7-T1-380
Selector Switch Selection	V7-T1-382
Selector Switch Operators	V7-T1-385
Illuminated Selector Switch Operators	V7-T1-388
Options	V7-T1-390
Technical Data and Specifications	V7-T1-393
Dimensions	V7-T1-395
Ratings	V7-T1-396

Product Description

All the Industry-Proven Quality of Eaton's 10250T and E34 Series of Logic Devices, plus Class I Division 2 Certification

The **10250T1H** consists of a normally open-normally closed factory sealed contact block that is UL Listed for use in Class I, Division 2, Groups B, C and D (NEC 500–503)—Class I, Zone 2, IIB + H2 (NEC 505) hazardous locations and is rated for both NEMA A600 and NEMA Q300. 10250T and E34 illuminated components have also been UL Listed for use in Class I, Division 2, Groups B, C and D (NEC 500–503)—Class I, Zone 2, IIB + H2 (NEC 505).

This, combined with the industry-proven Eaton 10250T 30.5 mm pushbutton line, offers a complete solution to Division 2 hazardous location requirements.

Single composite catalog numbers for complete assembled stations and operators for use in Division 2 hazardous locations are featured throughout this section.

Features

- Factory sealed contact blocks
- Heavy-duty zinc die cast construction
- NEMA rated 1, 2, 3, 3R, 4, 4X, 12, 13
- Front-of-panel drainage holes
- Grounding nibs on the operator casing
- Solid thermosetting cathodic epoxy coating on E34
- Corrosion resistance in E34

Benefits

- Pushbutton for hazardous locations
- Drainage holes prevent buildup of liquid inside the operator which can prevent operation in freezing environments
- Grounding nibs bite through paint and other coatings to provide secure ground
- Suitable for corrosive environments (E34 only)
- Earth terminal provides additional grounding point and allows for daisy chain grounding (E34 line)

Standards and Certifications

- UL 508—File No. E131568
- UL 1604—File No. E10323
- CSA Certified C22.2 No.14—File No. LR 68551
- CSA Certified C22.2 No. 213-M1987—File No. LR 20713



Ingress Protection

- Standard indicating lights
 - UL (NEMA) Type 3, 3R, 3S, 4, 4X, 12, 13
 - IEC IP65
- All other operators
 - UL (NEMA) Type 3, 3R, 4, 4X, 12, 13
 - IEC IP65

1.13

Pushbuttons and Indicating Lights

30.5 mm Class I Division 2 Hazardous Locations—10250T/E34

1

Product Overview

Operator

The 30.5 mm 10250T pushbutton line features a zinc die cast construction with chrome-plated housing and mounting nut.

Eaton's E34 Series 30.5 mm pushbutton line features the same rugged die cast construction of our 10250T line with an additional two-layer 100% solid thermosetting cathodic epoxy coating. This coating provides a flat black smooth, consistent, corrosion resistant surface that has passed a demanding 600 hour salt spray test. (The industry standard for this 4X test requires only 200 hours.)

Ultraviolet Light

E34 epoxy coating is not recommended for use in applications where exposure to ultraviolet light exists—use NEMA 4X 10250T operators.

Ratings

Our Class I Division 2 line of pushbuttons are UL Listed (NEMA type) 1, 2, 3, 3R, 4, 4X, 12 and 13. Our Class I Division 2 E34 line meets IEC 947-1 IP66 standards and the cathodic coating meets FDA 3A sanitary chemical resistance requirements. For a complete listing of all applicable ratings see **Pages V7-T1-393 to V7-T1-394.**

10250T Grounding Nibs

10250T line operators have "grounding nibs"—four metal points on the operator casting designed to bite through most paints and other coatings on metal panels to enhance the grounding connection when the operator is securely tightened.

10250T Grounding Nibs



E34 Grounding Nibs

E34 line of operators is equipped with a ground screw terminal as part of its die cast construction. This earthing terminal provides an easily accessible point for grounding operators when used in a painted or nonmetallic enclosure and eliminates the need for extra kits when daisy chain grounding is required.

E34 Grounding Nibs

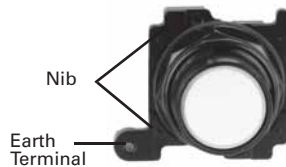

Diaphragm Seal with Drainage Holes

Liquid Drainage

Eaton's pushbutton operators offer front of panel drainage via holes in the operator bushing. Hidden from view by the mounting nut, these holes prevent buildup of liquid inside the operator, which can prevent operation in freezing environments. The holes also provide a route for escaping liquid in high pressure washdowns, effectively relieving pressure from the internal diaphragm seal, ensuring reliable sealing in applications even beyond NEMA 4.

Diaphragm Seal

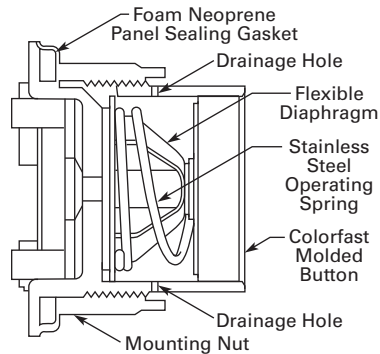

Product Identification

30.5 mm Class I Division 2 Hazardous Locations

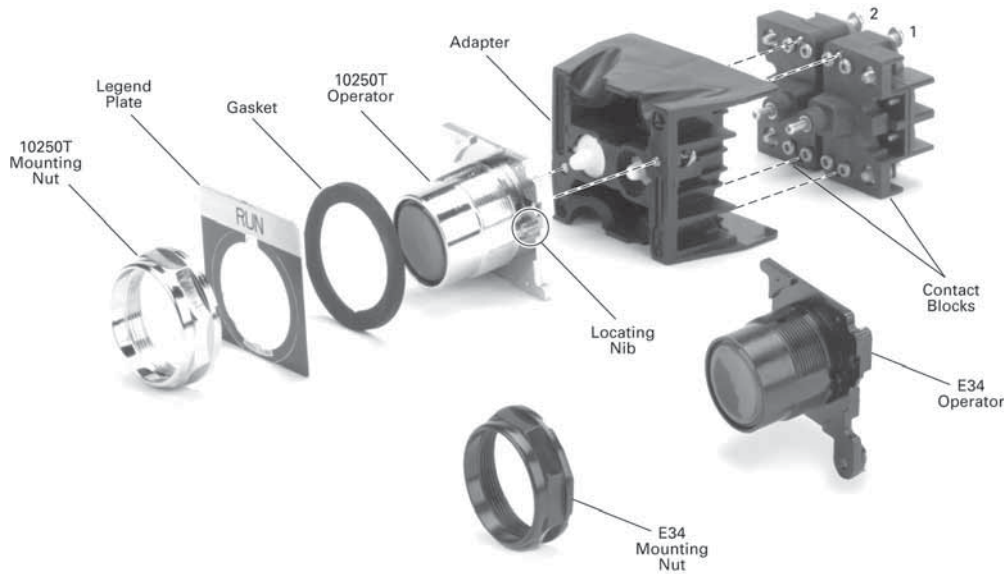

Catalog Number Selection

Catalog Number Selection is for illustrative purposes only and not to be used to create new catalog numbers.

Non-Illuminated Assembled Operators

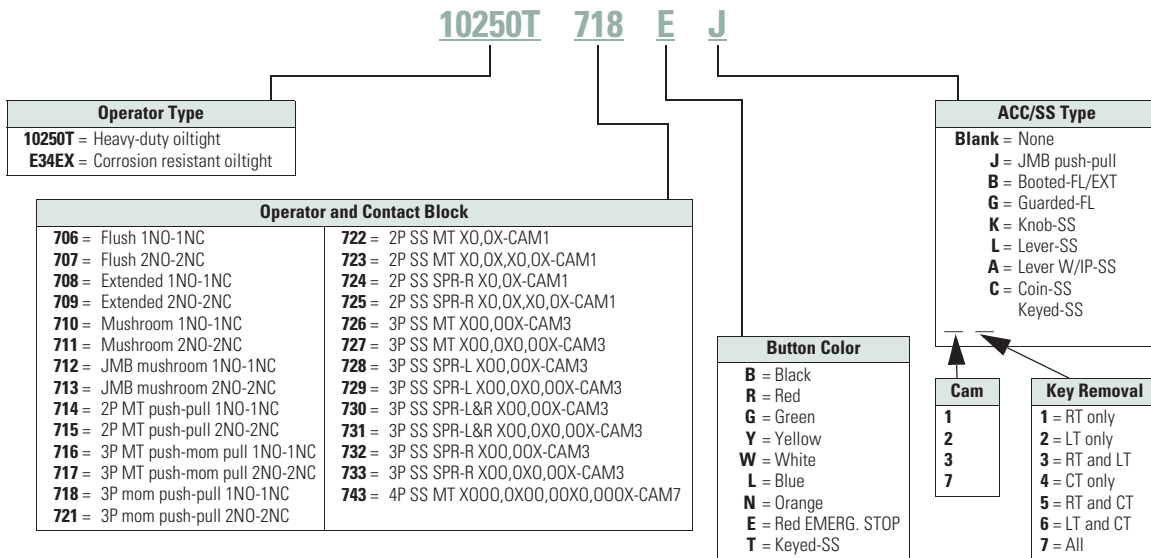

1

Product Selection

Momentary Pushbutton Units

UL (NEMA) Type 3, 3R, 4, 4X, 12, 13, NEC Class I Division 2, Groups B, C and D

10250T Flush Button



E34 Flush Button



10250T Extended Button



E34 Extended Button



Non-Illuminated Flush and Extended Pushbuttons

Contact Type	Button Color ①	Flush Button		Extended Button	
		10250T Catalog Number	E34 Catalog Number	10250T Catalog Number	E34 Catalog Number
1NO-1NC	Black	<u>10250T706B</u>	<u>E34EX706B</u>	<u>10250T708B</u>	<u>E34EX708B</u>
	Red	<u>10250T706R</u>	<u>E34EX706R</u>	<u>10250T708R</u>	<u>E34EX708R</u>
	Green	<u>10250T706G</u>	<u>E34EX706G</u>	<u>10250T708G</u>	<u>E34EX708G</u>
2NO-2NC	Black	<u>10250T707B</u>	<u>E34EX707B</u>	<u>10250T709B</u>	<u>E34EX709B</u>
	Red	<u>10250T707R</u>	<u>E34EX707R</u>	<u>10250T709R</u>	<u>E34EX709R</u>
	Green	<u>10250T707G</u>	<u>E34EX707G</u>	<u>10250T709G</u>	<u>E34EX709G</u>

Color Selection

Color	Suffix Code	Color	Suffix Code
Black	B	White	W
Red	R	Blue	L ②
Green	G	Orange ③	N
Yellow	Y	Red (EMERG. STOP) ④	E

Notes

Use NEMA 4X 10250T operators where exposed to ultraviolet light.

① To order different color guarded button, simply substitute the underlined character in catalog number with appropriate suffix code from Color Selection table above. Example: 10250T71Y.

② Blue not available on jumbo mushroom pushbutton.

③ Orange is only available on flush or extended pushbuttons.

④ Red with EMERG. STOP engraved on button head for jumbo mushroom pushbutton only.

UL (NEMA) Type 3, 3R, 4, 4X, 12, 13, NEC Class I Division 2, Groups B, C and D

10250T Mushroom Button



E34 Mushroom Button



10250T Jumbo Mushroom Button



E34 Jumbo Mushroom Button



Non-Illuminated Mushroom and Jumbo Mushroom Pushbuttons

Contact Type	Button Color ^①	Mushroom Button	E34 Catalog Number	Jumbo Mushroom Button	E34 ^② Catalog Number
		10250T Catalog Number		10250T ^② Catalog Number	
1NO-1NC	Black	10250T710B	E34EX710B	10250T712B	E34EX712B
	Red	10250T710R	E34EX710R	10250T712R	E34EX712R
	Green	10250T710G	E34EX710G	10250T712G	E34EX712G
2NO-2NC	Black	10250T711B	E34EX711B	10250T713B	E34EX713B
	Red	10250T711R	E34EX711R	10250T713R	E34EX713R
	Green	10250T711G	E34EX711G	10250T713G	E34EX713G

Color Selection

Color	Suffix Code	Color	Suffix Code
Black	B	White	W
Red	R	Blue	L ^③
Green	G	Orange ^④	N
Yellow	Y	Red (EMERG. STOP) ^⑤	E

Notes

- Use NEMA 4X 10250T operators where exposed to ultraviolet light.
- ^① To order different color guarded button, simply substitute the underlined character in catalog number with appropriate suffix code from Color Selection table above. Example: 10250T710Y.
- ^② Anodized aluminum head is not suitable for use in ultraviolet applications.
- ^③ Blue not available on jumbo mushroom pushbutton.
- ^④ Orange is only available on flush or extended pushbuttons.
- ^⑤ Red with EMERG. STOP engraved on button head for jumbo mushroom pushbutton only.

1.13

Pushbuttons and Indicating Lights

30.5 mm Class I Division 2 Hazardous Locations—10250T/E34

1

UL (NEMA) Type 3, 3R, 4, 4X, 12, 13, NEC Class I Division 2, Groups B, C and D

- Momentary contact
- Non-illuminated
- Booted or guarded

Booted Flush Button



Booted Extended Button



Guarded Extended Button



10250T Pushbuttons Booted and Guarded

Contact Type	Button Color	Booted Flush Button Catalog Number	Booted Extended Button Catalog Number	Guarded Extended Button ^① Catalog Number
1NO-1NC	Black	10250T706BB	10250T708BB	10250T706BG
	Red	10250T706RB ^②	10250T708RB	10250T706RG
	Green	10250T706GB	10250T708GB	10250T706GG
2NO-2NC	Black	10250T707BB	10250T709BB	10250T707BG
	Red	10250T707RB ^②	10250T709RB	10250T707RG
	Green	10250T707GB	10250T709GB	10250T707GG

Color Selection

Color	Suffix Code	Color	Suffix Code
Black	B	White	W
Red	R	Blue	L
Green	G	Orange	N
Yellow	Y		

Notes



Use NEMA 4X 10250T operators where exposed to ultraviolet light.

^① To order different color guarded button, simply substitute the underlined character in catalog number with appropriate suffix code from Color Selection table above. Example: 10250T706YG.

^② Red booted flush pushbutton is not recommended for STOP function.

UL (NEMA) Type 3, 3R, 4, 4X, 12, 13, NEC Class I Division 2, Groups B, C and D

- Momentary contact
- Non-illuminated
- Booted or guarded

		E34 Pushbuttons Booted and Guarded		
Contact Type	Button Color	Booted Flush Button Catalog Number	Booted Extended Button Catalog Number	Guarded Extended Button ^① Catalog Number
 Booted Flush Button	Black	E34EX706BB	E34EX708BB	E34EX706BG
	Red	E34EX706RB ^②	E34EX708RB	E34EX706RG
	Green	E34EX706GB	E34EX708GB	E34EX706GG
 Booted Extended Button	Black	E34EX707BB	E34EX709BB	E34EX707BG
	Red	E34EX707RB ^②	E34EX709RB	E34EX707RG
	Green	E34EX707GB	E34EX709GB	E34EX707GG
 Guarded Extended Button	Black	E34EX707BB	E34EX709BB	E34EX707BG
	Red	E34EX707RB ^②	E34EX709RB	E34EX707RG
	Green	E34EX707GB	E34EX709GB	E34EX707GG

Color Selection

Color	Suffix Code	Color	Suffix Code
Black	B	White	W
Red	R	Blue	L
Green	G	Orange	N
Yellow	Y		

Notes

Use NEMA 4X 10250T operators where exposed to ultraviolet light.

^① To order different color guarded button, simply substitute the underlined character in catalog number with appropriate suffix code from Color Selection table above. Example: 10250T706YG.

^② Red booted flush pushbutton is not recommended for STOP function.

1

Non-Illuminated Pushbutton Units

UL (NEMA) Type 3, 3R, 4, 4X, 12, and 13

10250T Flush Button



E34 Flush Button



10250T Extended Button



E34 Extended Button



10250T Half Shrouded Button



E34 Half Shrouded Button



Non-Illuminated Pushbuttons, Momentary Contact

Color	Flush Button		Extended Button		Half Shrouded Button		E34	
	10250T ^① Catalog Number	E34 Catalog Number	10250T Catalog Number	E34 Catalog Number	10250T Vertical Catalog Number	Horizontal Catalog Number	Vertical Catalog Number	Horizontal Catalog Number
Black	10250T101	E34PB1	10250T111	E34EB1	10250T501	10250T511	E34EVB1	E34EHB1
Red	10250T102	E34PB2	10250T112	E34EB2	10250T502	10250T512	E34EVB2	E34EHB2
Green	10250T103	E34PB3	10250T113	E34EB3	10250T503	10250T513	E34EVB3	E34EHB3
Yellow	10250T104	E34PB4	10250T120	E34EB4	10250T504	10250T514	E34EVB4	E34EHB4
Gray	10250T105	E34PB5	—	E34EB5	10250T505	10250T515	E34EVB5	E34EHB5
White	10250T106	E34PB6	10250T116	E34EB6	10250T506	10250T516	E34EVB6	E34EHB6
Blue	10250T108	E34PB7	10250T118	E34EB7	10250T508	10250T518	E34EVB7	E34EHB7
Orange	10250T109	E34PB8	10250T119	E34EB8	10250T509	10250T519	E34EVB8	E34EHB8

Notes

Use NEMA 4X 10250T operators where exposed to ultraviolet light.

^① To order operator with factory assembled extended retaining nut, 10250TA12, for thick panel applications, add suffix letter **E** to listed catalog number.

UL (NEMA) Type 3, 3R, 4, 4X, 12, and 13

10250T Mushroom Button



Mushroom Head Non-Illuminated Pushbuttons, Momentary Contact

Color	Mushroom Button		Anodized Aluminum Jumbo Mushroom Button	
	10250T Catalog Number	E34 Catalog Number	10250T ^① Catalog Number	E34 ^② Catalog Number
Black	10250T121	E34LB1	10250T171	E34JB1
Red	10250T122	E34LB2	10250T172	E34JB2
Red (EMERG. STOP)	—	—	10250T17213	E34JB2N8
Green	10250T123	E34LB3	10250T173	E34JB3
Yellow	10250T124	E34LB4	10250T174	E34JB4
Blue	10250T129	E34LB6	—	—

E34 Mushroom Button



10250T Jumbo Mushroom Button



E34 Jumbo Mushroom Button



Notes

- Use NEMA 4X 10250T operators where exposed to ultraviolet light.
- ① Anodized aluminum head is not suitable for use in ultraviolet light applications.
- ② Anodized aluminum head may not be suitable for some corrosive environments.

1

Illuminated Pushbutton Units

UL (NEMA) Type 3, 3R, 4, 4X, 12, 13, NEC Class I Division 2, Groups B, C and D

- Momentary contact
- Illuminated
- Plastic lenses

10250T₈



E34EX₈



Illuminated Pushbuttons

Type	Voltage	Color	Contact	10250T LED/Lamp Number	Catalog Number ①	E34 LED/Lamp Number	Catalog Number ①
LED Lamp							
Full voltage	24 Vac/Vdc	Red	1NO-1NC	Bayonet base	10250T828RD24	Bayonet base	E34EX828RD24
		Green			10250T828GD24		E34EX828GD24
		Amber			10250T828AD24		E34EX828AD24
Transformer	120 Vac	Red	1NO-1NC	10250T828RD2A	E34EX828RD2A		E34EX828RD2A
		Green		10250T828GD2A	E34EX828GD2A		E34EX828GD2A
		Amber		10250T828AD2A	E34EX828AD2A		E34EX828AD2A
Transformer	120 Vac	Red	1NO-1NC	10250T802RD06	10250T802GD06	Bayonet base 6 Vac	E34EX802RD06
		Green		10250T802GD06			E34EX802GD06
		Amber		10250T802AD06			E34EX802AD06
Incandescent Lamp							
Full voltage	24 Vac/Vdc	Red	1NO-1NC	#757	10250T818RD	#757	E34EX818RD
		Green			10250T818GD		E34EX818GD
		Amber			10250T818AD		E34EX818AD
Resistor	120 Vac/Vdc	Red	1NO-1NC	120MB	10250T824RD	120MB	E34EX824RD
		Green			10250T824GD		E34EX824GD
		Amber			10250T824AD		E34EX824AD
Transformer	120 Vac	Red	1NO-1NC	#755	10250T802RD	#755 6 Vac	E34EX802RD
		Green			10250T802GD		E34EX802GD
		Amber			10250T802AD		E34EX802AD

10250TC₂



E34V₂



Lens Selection

Color	Suffix Code	Catalog Number	Color	Suffix Code	Catalog Number
10250T			E34		
Red	R	10250TC21	Red	R	E34V2
Green	G	10250TC22	Green	G	E34V3
Yellow	Y	10250TC23	Yellow	Y	E34V4
Amber	A	10250TC43	Amber	A	E34V9
Blue	L	10250TC24	Blue	L	E34V6
Clear	C	10250TC25	Clear	C	E34V0
White	W	10250TC26	White	W	E34V5

Note

① To order different color lens, simply substitute the underlined character in the catalog number with appropriate suffix code from Lens Selection table above. Example: 10250T828YD24.

Guarded Illuminated Pushbutton Units

UL (NEMA) Type 3, 3R, 4, 4X, 12, 13, NEC Class I Division 2, Groups B, C and D

- Momentary contact
- Guarded illuminated
- Plastic lenses

Guarded Illuminated Pushbuttons

10250T8_



E34EX8_



Type	Voltage	Color	Contact	10250T LED/Lamp Number	Catalog Number ①	E34 LED/Lamp Number	Catalog Number ①
LED Lamp							
Full voltage	24 Vac/Vdc	Red	1NO-1NC	Bayonet base	<u>10250T828RG24</u>	Bayonet base	<u>E34EX828RG24</u>
		Green			10250T828GG24		E34EX828GG24
		Amber			10250T828AG24		E34EX828AG24
Transformer	120 Vac	Red	1NO-1NC		<u>10250T828RG2A</u>		<u>E34EX828RG2A</u>
		Green			10250T828GG2A	E34EX828GG2A	
		Amber			10250T828AG2A	E34EX828AG2A	
Transformer	120 Vac	Red	1NO-1NC		<u>10250T802RG06</u>		<u>E34EX802RG06</u>
		Green			10250T802GG06	E34EX802GG06	
		Amber			10250T802AG06	E34EX802AG06	
Incandescent Lamp							
Full voltage	24 Vac/Vdc	Red	1NO-1NC	#757	<u>10250T818RG</u>	#757	<u>E34EX818RG</u>
		Green			10250T818GG		E34EX818GG
		Amber			10250T818AG		E34EX818AG
Resistor	120 Vac/Vdc	Red	1NO-1NC	120MB	<u>10250T824RG</u>	120MB	<u>E34EX824RG</u>
		Green			10250T824GG		E34EX824GG
		Amber			10250T824AG		E34EX824AG
Transformer	120 Vac	Red	1NO-1NC	#755	<u>10250T802RG</u>	#755 6 Vac	<u>E34EX802RG</u>
		Green			10250T802GG		E34EX802GG
		Amber			10250T802AG		E34EX802AG

10250TC2_



E34V_



Lens Selection

Color	Suffix Code	Catalog Number	Color	Suffix Code	Catalog Number
10250T			E34		
Red	R	<u>10250TC21</u>	Red	R	<u>E34V2</u>
Green	G	<u>10250TC22</u>	Green	G	<u>E34V3</u>
Yellow	Y	<u>10250TC23</u>	Yellow	Y	<u>E34V4</u>
Amber	A	<u>10250TC43</u>	Amber	A	<u>E34V9</u>
Blue	L	<u>10250TC24</u>	Blue	L	<u>E34V6</u>
Clear	C	<u>10250TC25</u>	Clear	C	<u>E34V0</u>
White	W	<u>10250TC26</u>	White	W	<u>E34V5</u>

Note

① To order different color lens, simply substitute the underlined character in the catalog number with appropriate suffix code from Lens Selection table above. Example: 10250T828YD24.

1

Indicating Light Units

UL (NEMA) Type 3, 3R, 3S, 4, 4X, 12, 13, NEC Class I Division 2, Groups B, C and D

- Standard
- Plastic lenses

10250T_



E34_



Indicating Lights

Type	Voltage	Color	LED/Lamp Number	10250T Catalog Number ①	E34 Catalog Number ①	
LED Lamp						
Full voltage	24 Vac/Vdc	Red	Bayonet base	<u>10250T197HLRP24</u>	<u>E34FB197HLRP24</u>	
		Green		<u>10250T197HLGP24</u>	<u>E34FB197HLGP24</u>	
		Amber		<u>10250T197HLAP24</u>	<u>E34FB197HLAP24</u>	
	120 Vac	Red	<u>10250T197HLRP2A</u>	<u>E34FB197HLRP2A</u>		
		Green	<u>10250T197HLGP2A</u>	<u>E34FB197HLGP2A</u>		
		Amber	<u>10250T197HLAP2A</u>	<u>E34FB197HLAP2A</u>		
Transformer	120 Vac	Red		<u>10250T181HLRP06</u>	<u>E34TB120HLRP06</u>	
		Green		<u>10250T181HLGP06</u>	<u>E34TB120HLGP06</u>	
		Amber		<u>10250T181HLAP06</u>	<u>E34TB120HLAP06</u>	
	Incandescent Lamp					
	Full voltage	24 Vac/Vdc	Red	#757	<u>10250T206HRP</u>	<u>E34FB24HRP</u>
			Green		<u>10250T206HGP</u>	<u>E34FB24HGP</u>
Amber				<u>10250T206HAP</u>	<u>E34FB24HAP</u>	
Resistor	120 Vac/Vdc	Red	120MB	<u>10250T201HRP</u>	<u>E34RB120HRP</u>	
		Green		<u>10250T201HGP</u>	<u>E34RB120HGP</u>	
		Amber		<u>10250T201HAP</u>	<u>E34RB120HAP</u>	
Transformer	120 Vac	Red	#755	<u>10250T181HRP</u>	<u>E34TB120HRP</u>	
		Green		<u>10250T181HGP</u>	<u>E34TB120HGP</u>	
		Amber		<u>10250T181HAP</u>	<u>E34TB120HAP</u>	

Plastic



Glass



Lens Selection

Color	Plastic Suffix Code	Catalog Number	Color	Glass Suffix Code	Catalog Number	Color	Plastic Suffix Code	Catalog Number	Color	Glass Suffix Code	Catalog Number
10250T						E34					
Red	RP	10250TC1N	Red	RG	10250TC7N	Red	RP	E34H2	Red	RG	E34G2
Green	GP	10250TC2N	Green	GG	10250TC8N	Green	GP	E34H3	Green	GG	E34G3
Amber	AP	10250TC19N	Amber	AG	10250TC9N	Amber	AP	E34H9	Amber	AG	E34G9
Yellow	YP	10250TC3N	Yellow	—	—	Yellow	YP	E34H4	Yellow	YG	E34G4
Blue	LP	10250TC4N	Blue	LG	10250TC10N	Blue	LP	E34H6	Blue	LG	E34G6
Clear	CP	10250TC5N	Clear	CG	10250TC11N	Clear	CP	E34H0	Clear	CG	E34G0
White	WP	10250TC6N	White	WG	10250TC12N	White	WP	E34H5	White	WG	E34G5

Notes

Use NEMA 4X 10250T operators where exposed to ultraviolet light.

① To order different color lens, simply substitute the underlined characters in the catalog number with appropriate suffix code from the Lens Selection table above.
Example: 10250T201HYP.

Illuminated Pushbuttons and Indicating Lights

NEC Class I Division 2, Groups B, C and D

Operators without Lenses

10250T Illuminated Pushbutton



E34 Illuminated Pushbutton



10250T Indicating Light



E34 Indicating Light



Type	Voltage	LED/Lamp Number	Illuminated Pushbutton		Indicating Light	
			10250T Catalog Number	E34 Catalog Number	10250T Catalog Number	E34 Catalog Number
LED Light Unit Type (LEDs not included) ①						
Full voltage	—	Bayonet base	10250T397HL	E34CB497HL	10250T197HL	E34FB197HL
Transformer AC only	24		10250T416HL	E34XB024HL	—	—
	120		10250T411HL	E34XB120HL	10250T181HL	E34TB120HL
	240		10250T412HL	E34XB240HL	10250T182HL	E34TB240HL
	277		10250T419HL	E34XB277HL	10250T198HL	E34TB277HL
	380		10250T413HL	E34XB380HL	10250T183HL	E34TB380HL
	480		10250T414HL	E34XB480HL	10250T184HL	E34TB480HL
	600		10250T415HL	E34XB600HL	10250T185HL	E34TB600HL
Incandescent Light Unit Type						
Full voltage AC/DC	6	#755	10250T473H	E34CB06H	10250T203H	E34FB06H
	12	#756	10250T474H	E34CB12H	10250T204H	E34FB12H
	24	#757	10250T476H	E34CB24H	10250T206H	E34FB24H
	32	#1828	10250T477H	E34CB32H	10250T207H	E34FB32H
	48	#1835	10250T478H	E34CB48H	10250T208H	E34FB48H
Resistor ② AC/DC	120	120MB	10250T471H	E34SB120H	10250T201H	E34RB120H
	240	120MB	10250T472H	E34SB240H	10250T202H	E34RB240H
Transformer AC only	24	#755	10250T416H	E34XB024H	—	—
	120		10250T411H	E34XB120H	10250T181H	E34TB120H
	240		10250T412H	E34XB240H	10250T182H	E34TB240H
	277		10250T419H	E34XB277H	10250T198H	E34TB277H
	380		10250T413H	E34XB380H	10250T183H	E34TB380H
	480		10250T414H	E34XB480H	10250T184H	E34TB480H
	600		10250T415H	E34XB600H	10250T185H	E34TB600H
Neon AC/DC	120	NE51H-R-22	—	—	10250T226H	E34NB120H
	240	NE51H-4-68	—	—	10250T227H	E34NB240H





Notes

Use NEMA 4X 10250T operators where exposed to ultraviolet light.



① These units do not include lamps. Order LED separately to match lens color from the LED Selection table on **Page V7-T1-379**.

② Resistor units are not available for use with LEDs, choose either transformer or full voltage LED style.

Indicating Light Lenses

	Color	10250T Catalog Number	E34 Catalog Number
Plastic			
 10250TC_	Red	10250TC1N	E34H2
	Green	10250TC2N	E34H3
	Amber	10250TC19N	E34H9
	Yellow	10250TC3N	E34H4
	Blue	10250TC4N	E34H6
	Clear	10250TC5N	E34H0
 E34H_	White	10250TC6N	E34H5
	Glass		
 10250TC_	Red	10250TC7N	E34G2
	Green	10250TC8N	E34G3
	Amber	10250TC9N	E34G9
	Yellow	—	E34G4
	Blue	10250TC10N	E34G6
	Clear	10250TC11N	E34G0
 E34G_	White	10250TC12N	E34G5

Illuminated Pushbutton Lenses

	Color	10250T Catalog Number	E34 Catalog Number
 10250TC_	Red	10250TC21	E34V2
	Green	10250TC22	E34V3
	Yellow	10250TC23	E34V4
	Amber	10250TC43	E34V9
	Blue	10250TC24	E34V6
	Clear	10250TC25	E34V0
 E34V_	White	10250TC26	E34V5

Push-Pull Units

UL (NEMA) Type 3, 3R, 4, 4X, 12, 13, NEC Class I Division 2, Groups B, C and D

- Two- and three-position
- Non-illuminated

10250T71_

Two-Position Maintained Push, Maintained Pull



Operator Function (Position) ①

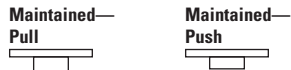

	Maintained— Pull	Maintained— Push	Contact Type	Mounting Location ①		Red Standard Push-Pull ②	
				1	2	10250T Catalog Number	E34 Catalog Number
0		X	1NO			<u>10250T714R</u>	<u>E34EX714R</u>
X	X	0	1NC				

E34EX71_



0		X	2NO			<u>10250T715R</u>	<u>E34EX715R</u>
X	X	0	2NC				
0		X					
X	X	0					

10250T71_

Three-Position Maintained Push, Momentary Pull



Operator Function (Position) ①



	Momentary— Pull	Maintained— Intermediate	Maintained— Push	Contact Type	Mounting Location ①		Red Standard Push-Pull ③	
					1	2	10250T Catalog Number	E34 Catalog Number
0		0	X	1NO			<u>10250T716R</u>	<u>E34EX716R</u>
X	X	0	0	1NC				

E34EX71_



X		0	0	1NC			<u>10250T717R</u>	<u>E34EX717R</u>
X	X	X	0	1NC				

Notes

- ① Bolded circuit corresponds to "X-0" circuit selection. X = closed circuit, 0 = open circuit.
- ② To order different type or color buttons, simply substitute underlined character with appropriate suffix code from the Button and Color Selection table on **Page V7-T1-372**. Example: 10250T714G.
- ③ To order different type or color buttons, simply substitute underlined character with appropriate suffix code from the Button and Color Selection table on **Page V7-T1-372**. Example: 10250T716G.

1.13

Pushbuttons and Indicating Lights

30.5 mm Class I Division 2 Hazardous Locations—10250T/E34

1

UL (NEMA) Type 3, 3R, 4, 4X, 12, 13, NEC Class I Division 2, Groups B, C and D

- Two- and three-position
- Non-illuminated

10250T7_



E34EX7_



Three-Position Momentary Push, Momentary Pull

Operator Function (Position) ①

Momentary— Pull	Maintained— Intermediate	Momentary— Push	Contact Type	Mounting Location ①		Red Standard Push-Pull ②	
				1	2	10250T Catalog Number	E34 Catalog Number
0 X	0 0	X 0	1NO 1NC			<u>10250T718R</u>	<u>E34EX718R</u>
X X	0 X	0 0	1NC 1NC			<u>10250T721R</u>	<u>E34EX721R</u>

Button and Color Selection

Standard



Jumbo Mushroom
Head



Color	Suffix Code	10250T Catalog Number	E34 Catalog Number
Standard			
Red	R	10250TB62	E34C2
Red (EMERG. STOP)	E	10250TB63	E34C2N8
Green	G	10250TB61	E34C3
Black	B	10250TB60	E34C1
Blue	L	10250TB64	E34C6
Jumbo Mushroom Head (Anodized) Aluminum			
Red	RJ	10250TJ62	E34J2
Red (EMERG. STOP)	EJ	10250TJ63	E34J2N8
Green	GJ	10250TJ61	—
Black	BJ	10250TJ60	—
Yellow	YJ	10250TJ64	—

Notes

- ① Bolded circuit corresponds to “X-0” circuit selection. X = closed circuit, 0 = open circuit.
 ② To order different type or color buttons, simply substitute underlined character with appropriate suffix code from the Button and Color Selection table above. Example: 10250T718G.

Illuminated Push-Pull Units

UL (NEMA) Type 3, 3R, 4, 4X, 12, 13, NEC Class I Division 2, Groups B, C and D

- Two-position maintained
- Illuminated

10250T8



E34EX8



Two-Position Illuminated Maintained Push, Maintained Pull

Operator Function (Position) ①

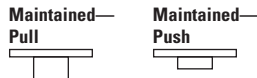

Operator Function (Position) ①		Type	Voltage	Contact Type	Mounting Location ①	Red Standard Push-Pull ②	
Maintained Pull	Maintained Push					10250T Catalog Number	E34 Catalog Number
LED Lamp							
0	X	Full voltage	24 Vac/Vdc	1NO		10250T853RD24	E34EX853RD24
X	0		120 Vac	1NC		10250T853RD2A	E34EX853RD2A
		Transformer	24 Vac			10250T843RD06	E34EX843RD06
			120 Vac			10250T844RD06	E34EX844RD06
Incandescent Lamp							
0	X	Full voltage	24 Vac/Vdc	1NO		10250T849RD	E34EX849RD
X	0		120 Vac/Vdc	1NC		10250T851RD	E34EX851RD
		Transformer	24 Vac			10250T843RD	E34EX843RD
			120 Vac			10250T844RD	E34EX844RD

Lens and Color Selection

Color	10250T		E34	
	Suffix Code	Catalog Number	Suffix Code	Catalog Number
Standard				
Red	RD	10250TC47	RD	E34M2
Red (EMERG. STOP)	ED	10250TC53	ED	E34M2N8
Green	GD	10250TC48	GD	E34M3
Blue	LD	10250TC49	LD	E34M6
Amber	AD	10250TC50	AD	E34M9
White	WD	10250TC51	WD	E34M5
Clear	CD	10250TC52	CD	E34M0
Side-Lighted (Anodized) Aluminum				
Red	RS	10250TC57	—	—
Red (EMERG. STOP)	ES	10250TC63	—	—
Green	GS	10250TC58	—	—
Blue	LS	10250TC59	—	—
Amber	AS	10250TC64	—	—
Yellow	YS	10250TC60	—	—
White	WS	10250TC61	—	—
Clear	CS	10250TC62	—	—
HD Aluminum with Transparent Center				
Red	RH	10250TC65	—	—
Green	GH	10250TC66	—	—
Amber	AH	10250TC67	—	—

Notes

- ① Bolded circuit corresponds to “X-0” circuit selection. X = closed circuit, 0 = open circuit.
- ② To order different type or color lens, simply substitute the underlined characters with appropriate suffix code from the Lens and Color Selection table above. Example: 10250T851GS.

1.13

Pushbuttons and Indicating Lights

30.5 mm Class I Division 2 Hazardous Locations—10250T/E34

1

UL (NEMA) Type 3, 3R, 4, 4X, 12, 13, NEC Class I Division 2, Groups B, C and D

- Three-position—maintained push, momentary pull
- Illuminated

10250T₈



E34EX₈



Three-Position Illuminated Maintained Push, Momentary Pull

Operator Function (Position) ①

Momentary— Pull	Maintained— Intermediate	Maintained— Push	Type	Voltage	Contact Type	Mounting Location ①		Red Standard Push-Pull ②		
						1	2	10250T Catalog Number	E34 Catalog Number	
LED Lamp										
0	0	X	Full voltage	24 Vac/Vdc	1NO			10250T864RD24	E34EX864RD24	
X	0	0		120 Vac	1NC			10250T864RD2A	E34EX864RD2A	
				Transformer	24 Vac				10250T854RD06	E34EX854RD06
				120 Vac				10250T855RD06	E34EX855RD06	
X	0	0	Full voltage	24 Vac/Vdc	1NC			10250T875RD24	E34EX875RD24	
X	X	0		120 Vac	1NC			10250T875RD2A	E34EX875RD2A	
				Transformer	24 Vac				10250T865RD06	E34EX865RD06
				120 Vac				10250T866RD06	E34EX866RD06	
Incandescent Lamp										
0	0	X	Full voltage	24 Vac/Vdc	1NO			10250T860RD	E34EX860RD	
X	0	0		Resistor	120 Vac			1NC	10250T862RD	E34EX862RD
				Transformer	24 Vac				10250T854RD	E34EX854RD
				120 Vac				10250T855RD	E34EX855RD	
X	0	0	Full voltage	24 Vac/Vdc	1NC			10250T871RD	E34EX871RD	
X	X	0		Resistor	120 Vac			1NC	10250T873RD	E34EX873RD
				Transformer	24 Vac				10250T865RD	E34EX865RD
				120 Vac				10250T866RD	E34EX866RD	

Notes

① Bolded circuit corresponds to “X-0” circuit selection. X = closed circuit, 0 = open circuit.

② To order different type or color lens, simply substitute the underlined characters with appropriate suffix code from the Lens and Color Selection table on the bottom of **Page V7-T1-373**. Example: 10250T862AS.

UL (NEMA) Type 3, 3R, 4, 4X, 12, 13, NEC Class I Division 2, Groups B, C and D

- Three-position—momentary
- Illuminated

10250T₈



E34EX₈



Three-Position Illuminated Momentary Push, Momentary Pull

Operator Function (Position) ①

Momentary— Pull	Maintained— Intermediate	Maintained— Push	Type	Voltage	Contact Type	Mounting Location ①		Red Standard Push-Pull ②		
						1	2	10250T Catalog Number	E34 Catalog Number	
LED Lamp										
0	0	X	Full voltage	24 Vac/Vdc	1NO			10250T886RD24	E34EX886RD24	
X	0	0		120 Vac	1NC			10250T886RD2A	E34EX886RD2A	
				Transformer	24 Vac				10250T876RD06	E34EX876RD06
				120 Vac				10250T877RD06	E34EX877RD06	
X	0	0	Full voltage	24 Vac/Vdc	1NC			10250T897RD24	E34EX897RD24	
X	X	0		120 Vac	1NC			10250T897RD2A	E34EX897RD2A	
				Transformer	24 Vac				10250T887RD06	E34EX887RD06
				120 Vac				10250T888RD06	E34EX888RD06	
Incandescent Lamp										
0	0	X	Full voltage	24 Vac/Vdc	1NO			10250T882RD	E34EX882RD	
X	0	0		Resistor	120 Vac			1NC	10250T884RD	E34EX884RD
				Transformer	24 Vac				10250T876RD	E34EX876RD
				120 Vac				10250T877RD	E34EX877RD	
X	0	0	Full voltage	24 Vac/Vdc	1NC			10250T893RD	E34EX893RD	
X	X	0		Resistor	120 Vac			1NC	10250T895RD	E34EX895RD
				Transformer	24 Vac				10250T887RD	E34EX887RD
				120 Vac				10250T888RD	E34EX888RD	

Notes

- ① Bolded circuit corresponds to “X-0” circuit selection. X = closed circuit, 0 = open circuit.
- ② To order different type or color lens, simply substitute the underlined characters with appropriate suffix code from the Lens and Color Selection table on the bottom of **Page V7-T1-373**. Example: 10250T862**AS**.

1.13

Pushbuttons and Indicating Lights

30.5 mm Class I Division 2 Hazardous Locations—10250T/E34

1

Push-Pull Operators

An illuminated push-pull pushbutton unit, arranged for one-hole mounting, can replace two pushbuttons and a pilot light or the non-illuminated form can replace two pushbuttons. These units are available in three basic types:

- **Maintained**—(Two-position). Maintains in the pulled or pushed position until manually actuated to the opposite mode.
- **Momentary**—(Three-position). Spring returns to an intermediate position when pulled or pushed and released.

- **Momentary Pull, Maintained Push**—(Three-position). Spring returns to intermediate position when pulled. Maintains in pushed position until manually returned to intermediate (ready to reset) position. Maintained stop holds circuit open and will prevent other series connected operators from starting the system.

The operators, buttons, contact blocks, etc., are offered as building block components that can be intermixed to satisfy many requirements. This minimizes the need for a varied and costly inventory.

Application Guide

To assist in the selection of contact blocks, the sketch below shows pictorially by symbols **1** and **2** locations of contact circuits after assembly of contact blocks and adapter to the operator. The table below shows the effect of the push and pull operations on either NO or NC contacts. (X = contact closed, O = contact open).

Locating Nibs

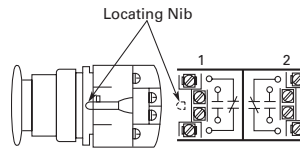

10250T_ Push-Pull Operator Components



E34G_



Operator Position and Circuit Arrangement



Type of Operator	Contact Block	Contact Block Mounting Location				10250T Catalog Number	E34 Catalog Number
		1		2			
Two-Position Operator without Lens							
Maintained push-pull	1NO	O	O	No intermediate position		10250T5	E34GDB
	1NC	X or X	X or X				
	2NO	O	O	X	X		
	2NC	X	X	O	O		
Three-Position Operator without Lens							
Momentary push-pull	1NO	O	O	O	O	10250T4	E34GEB
	1NC	X or X	X or X	O or X	O or O		
Maintained push-momentary pull	2NO	O	O	O	O	10250T9	E34GFB
	2NC	X	X	O	X		
Momentary push-pull	1NO	O	O	O	O	10250T10	E34GHB
	1NC	X or X	X or X	O or O	O or O		
	2NO	O	O	O	O	X	X
	2NC	X	X	O	O	O	O

Note

Use NEMA 4X 10250T operators where exposed to ultraviolet light.

Push-Pull Light Units, Lenses and Buttons

NEC Class I Division 2 Groups B, C and D



Light Units for Illuminated Push-Pull Devices

Light Unit Type	Type	Voltage	LED/Lamp Number	Catalog Number
LED (LEDs not included) ①	Full voltage	—	Bayonet base	10250T97HL
	Transformer AC only 50/60 Hz	24		10250T89HL
		120		10250T63HL
		208		10250T64HL
		240		10250T65HL
		277		10250T82HL
		380		10250T66HL
		480		10250T67HL
		600		10250T68HL
		Incandescent		Full voltage AC or DC
12	#756		10250T70H	
24/28	#757		10250T79H	
32	#1828		10250T83H	
Resistor AC or DC	120		120MB	10250T80H
	240			10250T81H
Transformer AC only 50/60 Hz	24		#755	10250T89H
	120			10250T63H
	208			10250T64H
	240			10250T65H
	277			10250T82H
	380			10250T66H
	480			10250T67H
600			10250T68H	



Note

① These units do not include lamps. Order LED separately to match lens color from table on [Page V7-T1-379](#).

Alternate Lenses for Illuminated Push-Pull Devices

	Color	10250T Catalog Number	E34 Catalog Number
Standard 	Standard		
	Red	10250TC47	E34M2
	Red (EMERG. STOP)	10250TC53	E34M2N8
	Green	10250TC48	E34M3
	Blue	10250TC49	E34M6
	Amber	10250TC50	E34M9
	White	10250TC51	E34M5
	Clear	10250TC52	E34M0
Side-Lighted (Anodized) Aluminum 	Side-Lighted Anodized Aluminum Ring		
	Red	10250TC57	—
	Red (EMERG. STOP)	10250TC63	—
	Green	10250TC58	—
	Blue	10250TC59	—
	Amber	10250TC64	—
	Yellow	10250TC60	—
	White	10250TC61	—
	Clear	10250TC62	—
	HD Aluminum with Transparent Center 	Heavy-Duty Aluminum with Transparent Center	
Red		10250TC65	—
Green		10250TC66	—
Amber		10250TC67	—

Buttons for Non-Illuminated Push-Pull Devices

	Color	10250T Catalog Number	E34 Catalog Number
Standard 	Standard		
	Red	10250TB62	E34C2
	Red (EMERG. STOP)	10250TB63	E34C2N8
	Green	10250TB61	E34C3
	Black	10250TB60	E34C1
Jumbo Mushroom Head 	Blue	10250TB64	E34C6
	Jumbo Mushroom Head (Anodized) Aluminum [Ⓢ]		
	Red	10250TJ62	E34J2
	Red (EMERG. STOP)	10250TJ63	E34J2N8
	Green	10250TJ61	—
	Black	10250TJ60	—
Yellow	10250TJ64	—	

Notes

Use NEMA 4X 10250T operators where exposed to ultraviolet light.

[Ⓢ] Anodized aluminum head is not suitable for use with ultraviolet light applications.

Standard LED Lamp



LED Selection

Voltage	Color	Catalog Number
6 Vac/Vdc suitable for use with transformers	Red	E22LED006RN
	Orange	E22LED006ON
	Yellow	E22LED006YN
	Green	E22LED006GN
	Blue	E22LED006BN
	White	E22LED006WN
12 Vac/Vdc	Red	E22LED012RN
	Orange	E22LED012ON
	Yellow	E22LED012YN
	Green	E22LED012GN
	Blue	E22LED012BN
	White	E22LED012WN
24 Vac/Vdc	Red	E22LED024RN
	Orange	E22LED024ON
	Yellow	E22LED024YN
	Green	E22LED024GN
	Blue	E22LED024BN
	White	E22LED024WN
48 Vac/Vdc	Red	E22LED048RN
	Orange	E22LED048ON
	Yellow	E22LED048YN
	Green	E22LED048GN
	Blue	E22LED048BN
	White	E22LED048WN

Voltage	Color	Catalog Number
60 Vac/Vdc	Red	E22LED060RN
	Orange	E22LED060ON
	Yellow	E22LED060YN
	Green	E22LED060GN
	Blue	E22LED060BN
	White	E22LED060WN
120 Vac	Red	E22LED120RA
	Orange	E22LED120OA
	Yellow	E22LED120YA
	Green	E22LED120GA
	Blue	E22LED120BA
	White	E22LED120WA
120 Vdc	Red	E22LED120RD
	Orange	E22LED120OD
	Yellow	E22LED120YD
	Green	E22LED120GD
	Blue	E22LED120BD
	White	E22LED120WD

Note

For a complete listing of all LEDs available, see **Page V7-T1-275**.

1.13

Pushbuttons and Indicating Lights

30.5 mm Class I Division 2 Hazardous Locations—10250T/E34

1

Selector Switch Units

UL (NEMA) Type 3, 3R, 4, 4X, 12, 13, NEC Class I Division 2, Groups B, C and D

- Two- and three-position
- Non-illuminated

10250T72_



E34EX72_



Two-Position Selector Switch—Non-Illuminated

Operator Position ^①		Operator Action ^②	Contact Type	Mounting Location ^①		Cam Code	Black Knob—Selector Switch ^③	
				1	2		10250T Catalog Number	E34 Catalog Number
X	O		1NC 1NO			1	<u>10250T722BK</u>	<u>E34EX722BK</u>
O	X							
							<u>10250T724BK</u>	<u>E34EX724BK</u>
X	O			1NC 1NO 1NC 1NO		1	<u>10250T723BK</u>	<u>E34EX723BK</u>
O	X							
X	O							
O	X							<u>10250T725BK</u>

10250T_



Three-Position Selector Switch—Non-Illuminated

Operator Position ^①			Operator Action ^②	Contact Type	Mounting Location ^①		Cam Code	Black Knob—Selector Switch ^④	
					1	2		10250T Catalog Number	E34 Catalog Number
X	O	O		1NO 1NO			3	<u>10250T726BK</u>	<u>E34EX726BK</u>
O	O	X							
								<u>10250T728BK</u>	<u>E34EX728BK</u>
									<u>10250T730BK</u>
									<u>10250T732BK</u>
X	O	O			1NO 1NC-1NC (Series) 1NO			3	<u>10250T727BK</u>
O	X	O							
O	O	X							
									<u>10250T731BK</u>
									<u>10250T733BK</u>

Notes

- ^① Bolded circuit corresponds to "X-O" circuit selection. X = closed circuit, O = open circuit.
- ^② M = Maintained. S = Spring return in direction of arrow (→).
- ^③ To order different type or color selector switch, simply substitute the underlined characters with appropriate suffix code from the table on **Page V7-T1-381**.
Example: 10250T722LL. For keyed selector switch, substitute the underlined characters with **T_ (cam)+_ (key removal position)**. Example: 10250T722T13.
- ^④ To order different type or color selector switch, simply substitute the underlined characters with appropriate suffix code from the Switch and Color Selection table on **Page V7-T1-381**.
Example: 10250T726LL. For keyed selector switch, substitute the underlined characters with **T_ (cam)+_ (key removal position)**. Example: 10250T726T13.

UL (NEMA) Type 3, 3R, 4, 4X, 12, 13, NEC Class I Division 2, Groups B, C and D

- Four-position maintained
- Non-illuminated

10250T743

Four-Position Selector Switch—Non-Illuminated



E34EX743



Operator Position ①

Operator Position ①	Operator Position ①	Operator Position ①	Operator Position ①
X	0	0	0
0	X	0	0
0	0	X	0
0	0	0	X

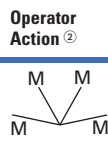

Operator Action ②	Contact Type
M	1NC
M	1NO
M	1NO
M	1NC

Mounting Location ①

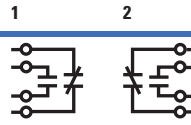

Cam Code

7

Black Knob—Selector Switch ③

10250T Catalog Number	E34 Catalog Number
10250T743BK	E34EX743BK

Knob



Lever



Coin Slot ⑤



Switch and Color Selection

Color	Knob Suffix Code	Lever Suffix Code	Lever ④ Suffix Code	Coin Slot ⑤ Suffix Code
Black	BK	BL	BA	BC
Red	RK	RL	RA	RC
Green	GK	GL	GA	GC
Yellow	YK	YL	YA	YC
White	WK	WL	WA	WC
Gray	AK	AL	AA	AC
Blue	LK	LL	LA	LC
Orange	NK	NL	NA	NC

Key Operated Selection

Number of Position	Operator Action ⑥	Suffix and Removal Position
2	M M	T1 + 1, 2, 3
	M ← S	T1 + 2
3	M M M	T3 + 1–7
	S → M M	T3 + 1, 4, 5
	S → M ← S	T3 + 4
	M M ← S	T3 + 2, 4, 6
4	MMMM	T7 + 7

Key Removal Positions ⑦

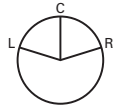

Code Suffix	Key Removal Position
1	Right only
2	Left only
3	Right and left
4	Center only
6	Left and center
7	All positions

Notes

- ① Bolded circuit corresponds to “X-0” circuit selection. X = closed circuit, 0 = open circuit.
- ② M = Maintained.
- ③ To order different type or color selector switch, simply substitute the underlined characters with appropriate suffix code from the Switch and Color Selection table above. Example: 10250T743LL. For keyed selector switch, substitute the underlined characters with **T_ (cam) + _ (key removal position)**. Example: 10250T7431Z.
- ④ Designed for added ingress protection. For use in maintained operators only.
- ⑤ 10250T only.
- ⑥ M = Maintained. S = Spring return in direction of arrow (→).
- ⑦ Key removal in “spring return from” positions not recommended.

1.13

Pushbuttons and Indicating Lights

30.5 mm Class I Division 2 Hazardous Locations—10250T/E34

1

Selector Switch Selection



10250T



E34

Cam and Contact Block Selection

Selector switches in their varied forms (two-position, three-position, and four-position) are a big factor contributing to the great flexibility of control that a well rounded line of “pushbuttons” can achieve. Because of their flexibility, they tend to cause difficulty with product selection and application. The following systematic approach should simplify that task.

Cam and contact block selection is better understood if you:

- Work with each incoming and outgoing wire/circuit separately.
- Recognize the terms NO and NC only identify the type of contact by its mode before mounting to the operator. The “X-O” table (Page V7-T1-384) shows how that contact will act after assembly to the operator with the selected cam shape. X = closed circuit, O = open circuit.

- One NO-NC contact block may be mounted behind each plunger of the mounting adapter for a total of four circuits.
- Each cam has two separate lobes, each of which operates one of the two contact block plungers independently of each other. Those are identified as position 1 (locating nib side) and position 2 (opposite of locating nib). The position designations give direction in selecting and mounting of the contact blocks.

Contact Circuit Locations

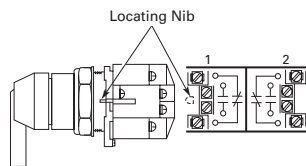

Systematic Approach

Application: **HAND-OFF-AUTO** selector switch. In this circuit, one incoming line is distributed to two other outgoing circuits by the switch. The two circuits can be looked at individually.

Step 1: Elementary Diagram.

Construct on paper, or in your mind, a simple elementary diagram of the switching scheme as follows:

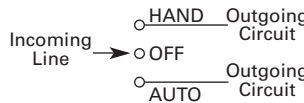

In this circuit, you want a contact closed on the left (HAND) but open in the center and right.

For the **AUTO** circuit, the “X-O” diagram would look like this:

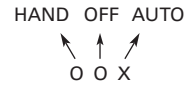

Putting them together, the complete “X-O” diagram is:



Step 2: “X-O” Pattern.

From the elementary diagram, you can construct an “X-O” diagram which describes when the contacts are to be closed (X) or open (O) in the various positions of the switch. The “X-O” for the **HAND** circuit looks like this:

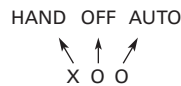

Once the “X-O” diagram has been generated, the next step is to select the cam and contact block, or blocks, needed to perform the desired “X-O” functions. The selection tables on the following pages list the various types (shapes) of cams by number to choose from and the type of contact and position to achieve the function outlined in your “X-O” diagram.

Step 3: Cam Selection.

The cam you select determines the operation of all contact blocks mounted to the operator. It is selected on the basis that it provides the simplest circuitry for the desired "X-O" diagram. The selection tables show all the "X-O" combinations. For the purpose of this example, the applicable portion of those tables is shown on this page.

Now to make the cam selection, make a simple worksheet such as below. (1) or (2) = mounting location from chart above:

	Cam 2	Cam 3
X O O	(1)NO-(2)NC ①	(1)NO
O O X	(2)NO	(2)NO

It becomes obvious that cam 3 is the better choice because the series connection can be avoided, making it simpler to wire.

Step 4: Contact Block Selection.

Having selected the cam, contact block selection is simply a matter of determining if you require one NO-NC contact block (Cat. No 10250T1H) or two. Given the limitations of the factory sealed contact block and the desired "X-O" application, you may have circuits that will not be needed—as seen here with the two additional NC circuits. (1) or (2) = mounting location from chart above.

Qty	Catalog No.	Cam 3
2	10250TIH	(1)NO (2)NC (1)NC (2)NO

Step 5: Selector Switch Operator.

Lastly, you have to choose from the many types of operators—knob and lever in various colors or keyed. Also what combinations of maintained and spring return functions are required. Selection of these operators can be found on **Page V7-T1-385**. For the example in step 4, you may want a three-position maintained black knob, cam 3—Catalog Number 10250T1323 (or 34VHBK1).

The Complete Switch: 10250T1323 (or 34VHBK1) with two 10250T1H or for one composite catalog number—10250T726BK (or E34EX726BK) found on **Page V7-T1-380**.

Diagrams

Circuits shown illustrate connections to obtain a selector circuit combination and are shown with their appropriate line diagrams in **BOLD**. Field wiring of jumper connections required as shown.

X = Closed circuit
O = Open circuit

Example Selection Table

No.	Desired Circuit and Operator Position			Cam Code #2 Contact Blocks and Mounting Location		Cam Code #3 Contact Blocks and Mounting Location	
				1	2	1	2
1	X	O	O				—
4	O	O	X	—		—	

Note

① Wired in series.

1.13

Pushbuttons and Indicating Lights

30.5 mm Class I Division 2 Hazardous Locations—10250T/E34

1

Two-Position Selector Switch

Number	Desired Circuit and Operator Position		Cam Code #1 Contact Blocks and Mounting Location	
			1	2
1	X	0		
2	0	X		

Three-Position Selector Switch

No.	Desired Circuit and Operator Position			Cam Code #2 Contact Blocks and Mounting Location		Cam Code #3 Contact Blocks and Mounting Location	
				1	2	1	2
1	X	0	0			—	—
2	X	X	0	—		—	
3	X	0	X		—		—
4	0	0	X	—		—	
5	0	X	X			—	—
6	0	X	0		—		—

Four-Position Selector Switch

Number	Desired Circuit and Operator Position				Cam Code #7 Contact Blocks and Mounting Location	
					1	2
1	X	0	0	0		—
2	0	X	0	0	—	
3	0	0	X	0		—
4	0	0	0	X	—	
5	X	0	0	X		—
6	0	X	X	0		—
7	0	0	X	X		—
8	X	X	0	0		—
9	0	X	0	X	—	
10	X	0	X	0		—

Selector Switch Operators

10250T Selector Switch Operators with Caps

UL (NEMA) Type 3, 3R, 4, 4X, 12, 13

Black Knob Selector Switch



Black Lever Selector Switch



10250T Selector Switch Operators with Caps

Positions	Operator Action ^①	Black Knob Selector Switch— Vertical Mounting ^②		Black Lever Selector Switch— Vertical Mounting ^②	
		Cam Code ^③	Catalog Number	Cam Code ^③	Catalog Number
Two-position—60° throw	M ↘ M	1	10250T1311	1	10250T3011
	M ↘ S	1	10250T1371	1	10250T3071
Three-position—60° throw	M ↘ M	2	10250T1322	2	10250T3022
	M ↘ M	3	10250T1323	3	10250T3023
	S ↘ M	2	10250T1332	2	10250T3032
	S ↘ M	3	10250T1333	3	10250T3033
	S ↘ S	2	10250T1342	2	10250T3042
	S ↘ S	3	10250T1343	3	10250T3043
Four-position—40° throw	M ↘ M	2	10250T1352	2	10250T3052
	M ↘ M	3	10250T1353	3	10250T3053
Four-position—40° throw	M ↘ M	7	10250T1367	7	10250T3067
	M ↘ M				

Horizontal Mounting



10250T Key Operators with Cam

Positions	Operator Action ^①	Cam Code ^③	Optional Key Removal Positions ^④	Vertical Mounting Catalog Number ^④	Horizontal Mounting Catalog Number ^④
Two-position—60° throw	M ↘ M	1	1, 2, 3	10250T1511_	10250T1611_
	M ↘ S	1	2	10250T1571_	10250T1581_
Three-position—60° throw	M ↘ M	2	1–7	10250T1522_	10250T1622_
	M ↘ M	3		10250T1523_	10250T1623_
	S ↘ M	2	1, 4, 5	10250T1532_	10250T1632_
	S ↘ M	3		10250T1533_	10250T1633_
	S ↘ S	2	4	10250T1542_	10250T1642_
	S ↘ S	3		10250T1543_	10250T1643_
Four-position—40° throw	M ↘ S	2	2, 4, 6	10250T1652_	10250T1662_
	M ↘ S	3		10250T1653_	10250T1663_
Four-position—40° throw	M ↘ M	7	7	10250T1677_	10250T1687_
	M ↘ M				

Key Removal Positions

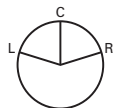

Key Removal Positions ^⑤

Code Suffix	Key Removal Position	Code Suffix	Key Removal Position
1	Right only	5	Right and center
2	Left only	6	Left and center
3	Right and left	7	All positions
4	Center only		

Notes

① M = Maintained. S = Spring return in direction of arrow (→).

② Field convertible to horizontal mounting or order operator only and separate operator cap.

③ For selection of the proper cam and contact block to obtain the proper circuit sequence, see selection instructions and table on **Pages V7-T1-382 to V7-T1-384**.

④ Choose key removal position required for application from table above. Add key removal code no. to listed catalog number. Example: 10250T15112.

⑤ Key removal in “spring return from” positions not recommended.

Replacement Keys or Dissimilar Locks for Above Key Operators

Listed operators have identical locks and keys (Key Code H661) Catalog Number 10250ED824.

Replacement Keys

Description	Catalog Number
Replacement keys (code H661)	10250ED824

1

UL (NEMA) Type 3, 3R, 4, 4X, 12, 13

Black Knob Selector Switch



E34 Selector Switch Operators with Knob Assembled

Positions	Operator Action ①	Black Knob Selector Switch— Vertical Mounting ②	
		Cam Code ③	Catalog Number ④
Two-position—60° throw		1	E34VFBK1
		1	E34VEBK1
Three-position—60° throw		2	E34VGBK1
		3	E34VHBK1
		2	E34VJBK1
		3	E34VKBK1
		2	E34VLBK1
		3	E34VMBK1
Four-position—40° throw		2	E34VNBK1
		3	E34VPBK1
Four-position—40° throw		7	E34VTBK1

E34KFB_



E34 Key Operators with Cam and Cap

Positions	Operator Action ①	Cam Code ③	Key Removal Positions ⑤	Vertical Mounting Catalog Number	Horizontal Mounting Catalog Number
Two-position—60° throw		1	1, 2, 3	E34KFB_	E34KFHB_
		1	2	E34KEB_	E34KEHB_
Three-position—60° throw		2	1–7	E34KGB_	E34KGHB_
		3		E34KHB_	E34KHGB_
		2	1, 4, 5	E34KJB_	E34KJHB_
		3		E34KKB_	E34KKHB_
		2	4	E34KLB_	E34KLHB_
		3		E34KMB_	E34KMHB_
Four-position—40° throw		2	2, 4, 6	E34KNB_	E34KNHB_
		3		E34KPB_	E34KPHB_
Four-position—40° throw		7	7	E34KTB_	E34KTHB_

Notes

Use NEMA 4X 10250T operators where exposed to ultraviolet light, see **Page V7-T1-385**.

① M = Maintained. S = Spring return in direction of arrow (→).

② Field convertible to horizontal mounting.

③ For selection of the proper cam and contact block to obtain the proper circuit sequence, see selection instructions and table on **Pages V7-T1-382 to V7-T1-384**.

④ For other colors of either knob or lever, replace the underlined characters of the catalog number with the appropriate suffix code from Alternate Knobs and Levers table on **Page V7-T1-387**. Example: E34VFBL2.

⑤ Choose key removal position required for application from table on **Page V7-T1-387**. Add key removal code no. to listed catalog number. Example: E34KFB2.

Key Removal Positions

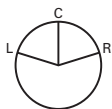

Key Removal Positions

Code Suffix	Key Removal Position	Code Suffix	Key Removal Position
1	Right only	5	Right and center
2	Left only	6	Left and center
3	Right and left	7	All positions
4	Center only		

Knob



Lever



Lever for Added Ingress Protection



Alternate Knobs and Levers for Operators ①

Color	Knob		Lever		Lever Designed for Added Ingress Protection ②	
	Suffix Code	Catalog Number	Suffix Code	Catalog Number	Suffix Code	Catalog Number
Black	K1	E34K1	L1	E34L1	A1	E34A1
Red	K2	E34K2	L2	E34L2	A2	E34A2
Green	K3	E34K3	L3	E34L3	A3	E34A3
Yellow	K4	E34K4	L4	E34L4	A4	E34A4
White	K5	E34K5	L5	E34L5	A5	E34A5
Blue	K6	E34K6	L6	E34L6	A6	E34A6
Gray	K7	E34K7	L7	E34L7	A7	E34A7
Orange	K8	E34K8	L8	E34L8	A8	E34A8

Notes

- ① Key removal in “spring return from” positions not recommended.
- ② For use on maintained operators only.

1

Illuminated Selector Switch Operators

Two-Position Maint. Selector Switch



10250T Illuminated Selector Switch Operator Only without Knob or Lever

Position	Operator Action ①	Transformer Type—50/60 Hz 6V #755 Lamp			Full Voltage Type—AC or DC ④		
		Cam Code ③	Voltage	Catalog and Code Number ②	Cam Code ③	Voltage	Catalog and Code Number ②
Two-position—60° throw		1	24	10250T5961H	1	6	10250T6201H
			120	10250T5971H		12	10250T6211H
			208	10250T6511H		24	10250T6221H
			240	10250T5981H		48	10250T6231H
			380	10250T5991H		120	10250T6361H
			480	10250T6001H		240 ⑤	10250T6371H
			600	10250T6011H			
Three-position—60° throw		+ 2 or 3	24	10250T602_H	+ 2 or 3	6	10250T624_H
			120	10250T603_H		12	10250T625_H
			208	10250T652_H		24	10250T626_H
			240	10250T604_H		48	10250T627_H
			380	10250T605_H		120	10250T638_H
			480	10250T607_H		240 ⑤	10250T639_H
		+ 2 or 3	120	10250T620_H	+ 2 or 3	120	10250T622_H
			240	10250T656_H			
		+ 2 or 3	120	10250T621_H	+ 2 or 3	120	10250T623_H
			240	10250T662_H			
		+ 2 or 3	24	10250T614_H	+ 2 or 3	6	10250T628_H
			120	10250T615_H		12	10250T629_H
			208	10250T653_H		24	10250T630_H
			240	10250T616_H		48	10250T631_H
380			10250T617_H	120		10250T640_H	
480			10250T618_H	240 ⑤		10250T641_H	
600			10250T619_H				
Four-position—40° throw		7	24	10250T6087H	7	6	10250T6327H
			120	10250T6097H		12	10250T6337H
			208	10250T6547H		24	10250T6347H
			240	10250T6107H		48	10250T6357H
			380	10250T6117H		120	10250T6427H
			480	10250T6127H		240 ⑤	10250T6437H
			600	10250T6137H			

Knob



Lever



Knobs and Levers

Color ⑥	Knob Catalog and Code Number	Lever Catalog and Code Number	Color ⑥	Knob Catalog and Code Number	Lever Catalog and Code Number
Red	10250TER	10250TFR	Clear	10250TEC	10250TFC
Green	10250TEG	10250TFG	White	10250TEW	10250TFW
Yellow	10250TEA	10250TFA	Amber	10250TEM	10250TFM
Blue	10250TEL	10250TFL			

Notes

- ① M = Maintained. S = Spring return in direction of arrow (→).
- ② For selection of the proper cam and contact block, to obtain the proper circuit sequence, see selection table on [Page V7-T1-384](#).
- ③ Operator includes lens gasket and lens attachment screws.
- ④ Full voltage light units can be used at other than listed voltages by changing lamp. Replacement lamps are listed on [Page V7-T1-275](#).
- ⑤ Resistor type. May generate excess heat if used in high density.
- ⑥ Amber, clear and white lenses have a black arrow (pointer), red, green and blue lenses have a white arrow (pointer).

120 Vac Transformer Selector Switch, Cam 1



Illuminated Selector Switch Operator Only without Knob or Lever

Positions	Operator Action	Transformer Type—50/60 Hz 6V #755 Lamp Catalog Number ^{①②}	Full Voltage Type—AC or DC ^③ Lamps—#755, #757, #1835, 120MB ^④ Catalog Number ^②			
Two-position—60° throw		Cam Code 1 ^⑤ E34VFB_H	Cam Code 1 ^⑤ E34SFB_H			
Three-position—60° throw		Cam Code 2 ^⑤ E34VGB_H	Cam Code 3 ^⑤ E34VHB_H	Cam Code 2 ^⑤ E34SGB_H	Cam Code 3 ^⑤ E34SHB_H	
		E34VNB_H ^⑥	E34VPB_H ^⑥	E34SNB_H ^⑦	E34SPB_H ^⑦	
		E34VJB_H ^⑥	E34VKB_H ^⑥	E34SJB_H ^⑦	E34SKB_H ^⑦	
		E34VLB_H	E34VMB_H	E34SLB_H	E34SMB_H	
Four-position—40° throw		E34VRB_H	—	E34SRB_H	—	

Knob



Lever



Knobs and Levers

Color ^④	Knob Catalog Number and Code Number	Lever Catalog Number and Code Number
Red	10250TER	10250TFR
Green	10250TEG	10250TFG
Yellow	10250TEA	10250TFA
Blue	10250TEL	10250TFL
Clear	10250TEC	10250TFC
White	10250TEW	10250TFW
Amber	10250TEM	10250TFM

Light Unit Voltage Suffix

Add to operator catalog number listed in table above.

Type of Light Unit		Full Voltage Type AC or DC ^③	
Transformer Type 50/60 Hz	Suffix Code	Voltage	Suffix Code
24	024	6	06
120	120	12	12
208	208	24	24
240	240	48	48
380	380	120	120
480	480	240 ^⑥	240
600	600		

Notes

Use NEMA 4X 10250T operators where exposed to ultraviolet light, see **Page V7-T1-388**.

- ① Operator includes lens gasket and lens attachment screws.
- ② Replace underscore with proper voltage suffix code from Light Unit Voltage Suffix table above. Example: three-position maintained with 120V transformer type light unit: E34VGB120H.
- ③ Full voltage light units can be used at other than listed voltages by changing lamp. Replacement lamps are listed on **Page V7-T1-275**.
- ④ 120MB lamps are used on both 120V and 240V operators.
- ⑤ For selection of the proper cam and contact block required to obtain a specific circuit sequence, see selection table on **Page V7-T1-384**.
- ⑥ 120 and 240V transformer only.
- ⑦ 120 full voltage only.
- ⑧ Resistor type. May generate excess heat if used in high density.
- ⑨ Amber, clear and white lenses have a black arrow (pointer). Red, green and blue lenses have a white arrow (pointer).

Options**Contact Blocks and Mounting Adapters**

NEC Class I Division 2, Groups B, C and D

Contact Block**Contact Block**

Description	Catalog Number
Class I Division 2 factory sealed contact block with 1NO-1NC	10250T1H

Dimensions, see **Page V7-T1-395**.

Mounting Adapter**Mounting Adapter**

Description	Catalog Number
Mounting adapter for pushbuttons	10250TD2
Mounting adapter for selector switches	10250TD3

Dimensions, see **Page V7-T1-395**.

Mounting Adapters with Contact Block(s)—Overpacked

Description	Catalog Number
Pushbutton adapter with 1NO-1NC	10250TD21H
Pushbutton adapter with 2 (1NO-1NC)	10250TD21H1H
Selector switch adapter with 1NO-1NC	10250TD31H
Selector switch adapter with 2 (1NO-1NC)	10250TD31H1H

Mounting and Assembly

Panel Thickness

- Minimum: 0.06 in (1.6 mm)
- Maximum: 0.25 in (8 mm) including legend plate
- Maximum can be increased to 0.375 in (15.9 mm) using optional retaining nut
 - Indicating light: 10250TA30/E34TA30
 - Pushbutton/selector switch: 10250TA31/E34TA31

Mounting Matrix

Legend Plate	Dimensions in Inches (mm)			
	A	B	C	D
Small	2.87 (72.6)	2.25 (57.2)	2.25 (57.2)	2.87 (72.6)
Jumbo	2.87 (72.6)	2.32 (58.6)	2.32 (58.6)	2.87 (72.6)
Extra large	2.87 (72.6)	2.56 (65.2)	2.52 (64.1)	2.87 (72.6)

Panel Spacing and Drilling

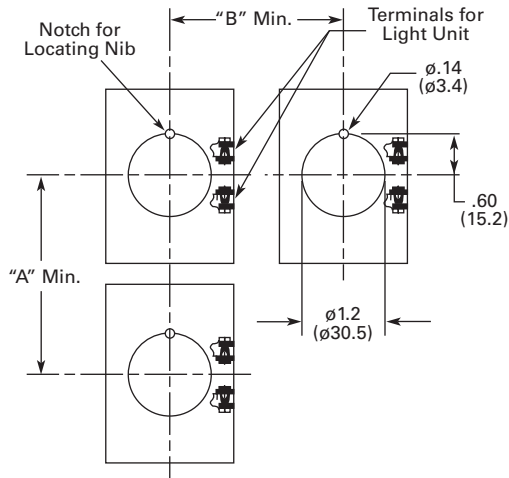

Drilling for One Hole Mounting and Dimensions for Minimum Spacing in Vertical Rows.

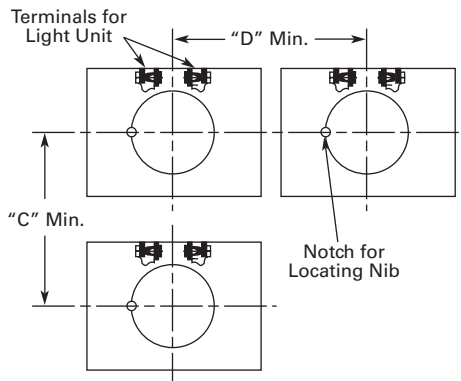

Drilling for One Hole Mounting and Dimensions for Minimum Spacing in Horizontal Rows.

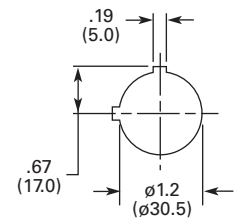

NOTE: Suitable for Use in This Alternate Mounting Hole.

Operator Assembly

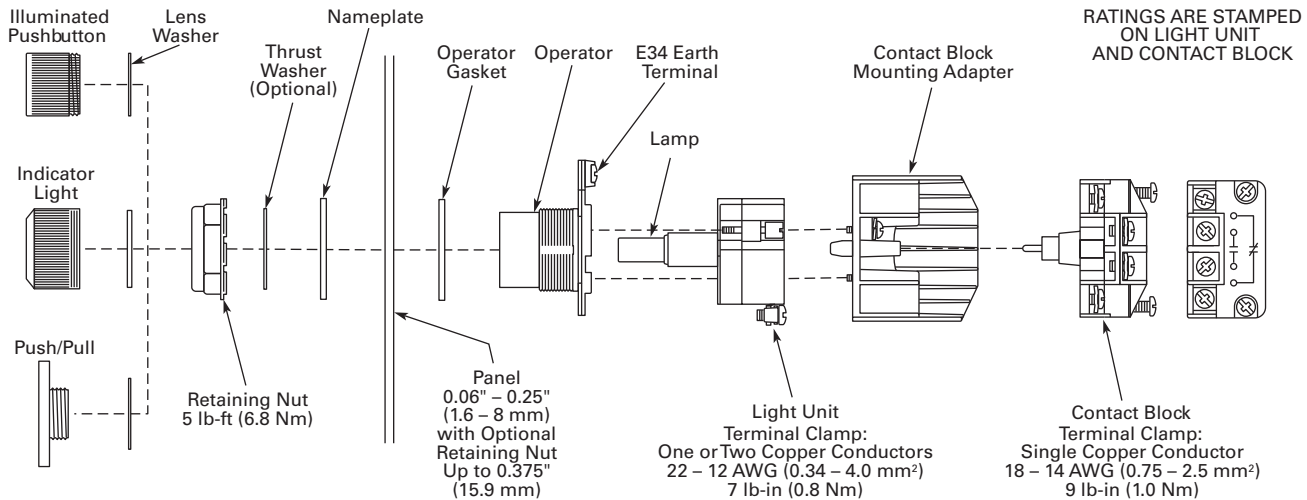



RATINGS ARE STAMPED ON LIGHT UNIT AND CONTACT BLOCK

1

Enclosures

Die Cast, Polyester and Stainless Steel Enclosures

Enclosures (Case and Cover)—Surface Mounting ^①

	Number of Elements	10250T Catalog Number	E34 Catalog Number
Die Cast Enclosure	Die Cast Enclosure—Deep Cover—In-Line NEMA 4, 4X, 12, 13		
	1	10250TN11	E34N11
	2	10250TN12	E34N12
	3	10250TN13	E34N13
	4	10250TN14	E34N14
Polyester Enclosure	Polyester—In-Line NEMA 3, 4X, 12		
	1	—	E34N51
	2	—	E34N52
	3	—	E34N53
	4	—	E34N54
Stainless Steel Enclosure	Stainless Steel ^②—In-Line NEMA 4, 4X, 12		
	1	—	10250TN33
	2	—	10250TN34
	3	—	10250TN35
	4	—	10250TN36

Dimensions, see Page V7-T1-395.

Notes

- ① For spacing increments, see Page V7-T1-270.
- ② 14 gauge, type 304.

Application Notes:

1. Operators need to be mounted in their horizontal orientation for all enclosures. For die cast enclosures remove locating nib on operators and use thrust washer (Catalog Number 10250TK3).
2. Polyester enclosures must be used when mounting illuminated operators.

Enclosure Layouts

Top – For Vertical Mounting

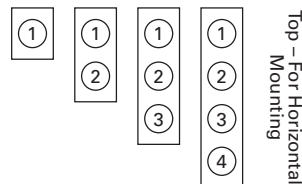

Top – For Horizontal Mounting

Technical Data and Specifications

Mechanical Ratings

Description	Specification
Frequency of Operation	
All pushbuttons	6000 operations/hr.
Key and lever selector switches	3000 operations/hr.
Life	
Pushbuttons	10 x 10 ⁶ operations
Contact block	10 x 10 ⁶ operations
Key and lever selector switches	0.25 x 10 ⁶ operations
Shock Resistance	
Duration/force	20 ms ≥5g

Climatic Conditions

Description	Specification
Operating temperature	32° to 140°F (0° to 66°C)
Storage temperature	-40° to 176°F (-40° to 80°C)
Altitude	6,562 ft (2,000m)
Humidity	Max. 95% RH at 60°C

Terminals

Description	Specification
Light Units	
Clamps	Terminals are saddle clamp type for 1 x 22 AWG (0.34 mm ²) to 2 x 14 AWG (4.0 mm ²) conductors
Torque	7 lb-in (0.8 Nm)
Degree of protection against direct electrical contact	IP2X with fingerproof shroud
Contact Blocks	
Clamps	Terminals are stainless steel saddle clamp type for 1 x 18–14 AWG (0.75–2.5 mm ²) solid or stranded copper conductor
Torque	9 lb-in (1.0 Nm) with size 2 Phillips screwdriver
Degree of protection against direct electrical contact	IP2X with fingerproof shroud

Electrical Ratings

Description	Specification
Light Units	
Bulbs—average life:	
Transformer type	20,000 hrs.
Resistor/direct voltage type	2500 hrs. minimum at rated voltage
LED	60,000 to 100,000 hrs.

1.13

Pushbuttons and Indicating Lights

30.5 mm Class I Division 2 Hazardous Locations—10250T/E34

1

Electrical Ratings—Contact Block

Meet or Exceed NEMA Contact Rating Designations A600 and Q300

Description	A600 (AC)				Q300 (DC)	
	120V	240V	480V	600V	125V	250V
Make and emerg. interrupting capacity (amps)	60	30	15	12	0.55	0.27
Normal load break (amps)	6	3	1.5	1.2	0.55	0.27
Thermal current (amps)	10	10	10	10	2.5	2.5
Voltamperes:						
Maximum make	7200	7200	7200	7200	69	69
Maximum break	720	720	720	720	69	69

Temperature Codes

All illuminated devices have operating temperatures below 100°C except for the following catalog numbers with temperature codes per NEC table 500.5(d) and UL 1604:

10250T	E34	Temp. Code
10250T201H	E34RB120H	T3C
10250T202H	E34RB240H	T3A
10250T471H	E34SB120H	TC3
10250T472H	E34SB240H	T3B
10250T80H	—	T3C
10250T81H	—	T3B
All selector switches w/120 MB lamp		T3C
All illuminated devices with lamp 1835		T4A

Note: For additional technical information, see Publication Number **TD.74.T.E.04**.

Dimensions

Approximate Dimensions in Inches (mm)

Surface Mounting

Die Cast, Polyester and Stainless Steel Enclosures

4 Mtg. Holes — 10-32 Screw Size for
1 – 4 Element Die Cast/
Stainless Steel Enclosure
7/32 Screw Size for
Polyester

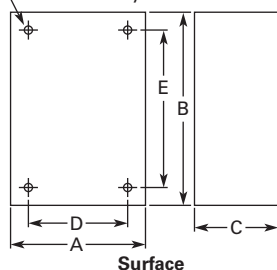

Number of Elements	Element Arrangement	Wide A	High B	Deep C	Mounting D	E	Conduit Entrance
Die Cast							
1	In-line	3.88 (98.6)	4.00 (101.6)	3.00 (76.3)	2.69 (68.3)	3.25 (82.6)	3/4
2		3.88 (98.6)	5.88 (149.4)	3.00 (76.3)	2.69 (68.3)	5.13 (130.3)	
3		3.88 (98.6)	7.75 (196.9)	3.00 (76.3)	2.69 (68.3)	7.00 (177.8)	1
4		3.88 (98.6)	9.63 (244.6)	3.00 (76.3)	2.69 (68.3)	8.88 (225.6)	
Polyester							
1	In-line	3.81 (96.8)	6.63 (168.4)	3.38 (85.9)	2.94 (74.7)	4.88 (124.0)	①
2		3.81 (96.8)	6.63 (168.4)	3.38 (85.9)	2.94 (74.7)	4.88 (124.0)	
3		3.81 (96.8)	8.88 (225.6)	3.38 (85.9)	2.94 (74.7)	7.13 (181.1)	
4		3.81 (96.8)	11.13 (282.7)	3.38 (85.9)	2.94 (74.7)	9.38 (238.3)	
Stainless Steel							
1	In-line	3.00 (76.2)	3.50 (88.9)	3.00 (76.2)	1.50 (38.1)	4.25 (108.0)	①
2		3.50 (88.9)	6.75 (171.5)	3.00 (76.2)	1.50 (38.1)	7.50 (190.5)	
3		3.50 (88.9)	9.00 (228.6)	3.00 (76.2)	1.50 (38.1)	9.00 (228.6)	
4		3.50 (88.9)	11.25 (285.8)	3.00 (76.2)	1.50 (38.1)	12.00 (304.8)	

Contact Block

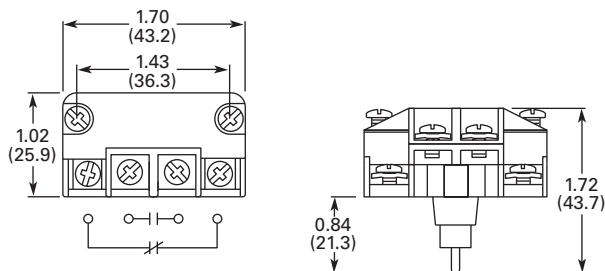

Mounting Adapter

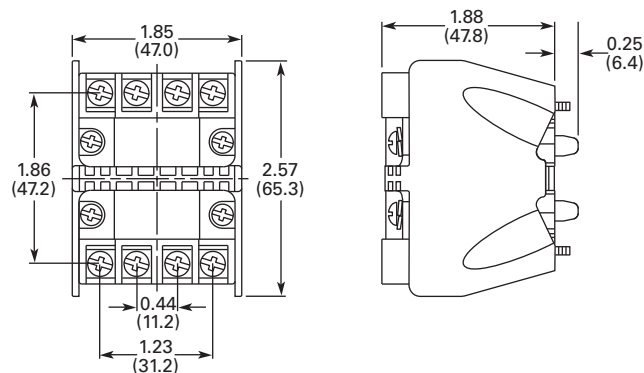

Note

① No conduit entrance holes provided. Drill as required.

Ratings

Summary of NEC Article 500

The NEC Article 500 explains in great detail the requirements for the installation of wiring and electrical equipment in hazardous locations. The purpose of this summary is for general reference only, the National Electrical Code along with other applicable authorities having jurisdiction over the site should be the installer's guidelines when wiring or installing electrical equipment in any hazardous or potentially hazardous location.

Class I, Division 2 Definition

Class I, Division 2 covers hazardous locations where flammable gases, vapors or volatile liquids are handled either in a closed system, or confined within suitable enclosures, or where hazardous concentrations are normally prevented by positive mechanical ventilation. Areas adjacent to Division 1 locations, into which gases might occasionally flow, would also belong to Division 2 (NEC (500.5(b))).

Hazardous Location

Any area where there is the possibility of explosion and fire resulting from the presence of flammable vapors, liquids or gas, or combustible dust or fibers.

Summary of NEC Article 505

The NEC also classifies hazardous locations for flammable gases and vapors into zones under NEC 505. This system is more in line with the European Standards, CENELEC and IEC, with the major difference being that NEC 505 only classifies gases and vapors while CENELEC and IEC also include dusts.

Summary of Classifications

NEC 500-503

Class	Division	Group
I. Gas	1. Hazard may exist—May exist in atmosphere under normal operating conditions	A. Acetylene
		B. Hydrogen and manufactured gases containing 30% hydrogen by volume (e.g. butadiene, ethylene oxide, propylene oxide)
	2. Potential hazard—May be present in atmosphere only under abnormal circumstances OR location adjacent to Class I, Division 1 location	C. Petrochemicals (e.g. carbon monoxide, ether, ethylene, hydrogen sulfide, morpholine, cyclopropane)
		D. Petrochemicals (e.g. gasoline, benzene, butane, propane, acetone, ammonia, vinyl chloride)
II. Dust	1. Hazard may exist—May exist in atmosphere under normal operating conditions	A. Acetylene
		B. Hydrogen and manufactured gases containing 30% hydrogen by volume (e.g. butadiene, ethylene oxide, propylene oxide)
		C. Petrochemicals (e.g. carbon monoxide, ether, ethylene, hydrogen sulfide, morpholine, cyclopropane)
	2. Potential hazard—May be present in atmosphere only under abnormal circumstances	D. Petrochemicals (e.g. gasoline, benzene, butane, propane, acetone, ammonia, vinyl chloride)
		E. Conductive and combustible dust (resistivity <math><10^9</math> ohm/cm) (metal dusts)
		F. Carbonaceous dusts (resistivity >math>10^2</math> ohms/cm but $\leq 10^8$ ohms/cm) (e.g. carbon black, coke dust, coal)
III. Fibers	1. Production areas	G. Non-conductive combustible dust (resistivity >math>10^5</math> ohms/cm) (e.g. grain dust, flour, starch, sugar, plastics)
		F. Carbonaceous dusts (resistivity >math>10^2</math> ohms/cm but $\leq 10^8$ ohms/cm) (e.g. carbon black, coke dust, coal)
	2. Handling and storage areas	G. Non-conductive combustible dust (resistivity >math>10^5</math> ohms/cm) (e.g. grain dust, flour, starch, sugar, plastics)
		Easily ignitable fibers or flyings

NEC 505

Class	Zone	Group
I. Gas	0. Continuously present or present for long periods of time	IIC. Acetylene, hydrogen or equivalent hazard
		IIB. Acetaldehyde, ethylene or equivalent hazard
		IIA. Acetone, ammonia, ethyl alcohol, gasoline, methane, propane or equivalent hazard
	1. Likely to exist under normal operating or maintenance conditions or adjacent to Zone 0	IIC. Acetylene, hydrogen or equivalent hazard
		IIB. Acetaldehyde, ethylene or equivalent hazard
		IIA. Acetone, ammonia, ethyl alcohol, gasoline, methane, propane or equivalent hazard
	2. Not likely to occur in normal operation and if they do occur will only exist for short period or adjacent to Zone 1	IIC. Acetylene, hydrogen or equivalent hazard
		IIB. Acetaldehyde, ethylene or equivalent hazard
		IIA. Acetone, ammonia, ethyl alcohol, gasoline, methane, propane or equivalent hazard

Note

For additional information on grouping of compounds, see NFPA 497M-1991 and NFPA 325-1994.

Summary of Basic Methods Available for Class I, Division 2 Locations

Method	Features Configuration	Advantages	Disadvantages
Factory sealed contact block	Closed-ended labyrinth contact block with an incendive circuit incapable of external ignition	Higher continuous carrying amperages—up to 10A Direct drive contacts—contacts can be forced open Suitable for use in all enclosures Best suited for motor control applications	May not be suitable for logic level circuits
Hermetically sealed block	Reed switch sealed against an external atmosphere	Suitable for low energy level circuits Suitable for use in all enclosures	Lower continuous carrying amperages are not suitable for motor control applications (typically 3A to 5A rated) Contacts cannot be forced open Permanent magnet attracts metallic dust and filings that can reduce the electrical creepage distance between live terminals
Explosion proof enclosures (Class I, Division 1 and 2)	Enclosures capable of withstanding an internal explosion while preventing external ignition. Enclosures designed for Class I, Division 1 can safely be used in Class I, Division 2	Higher level of protection than required for Class I Division 2	Higher material and installation costs Conduit sealing is still required Time consuming maintenance

Factory Sealed Contact Blocks

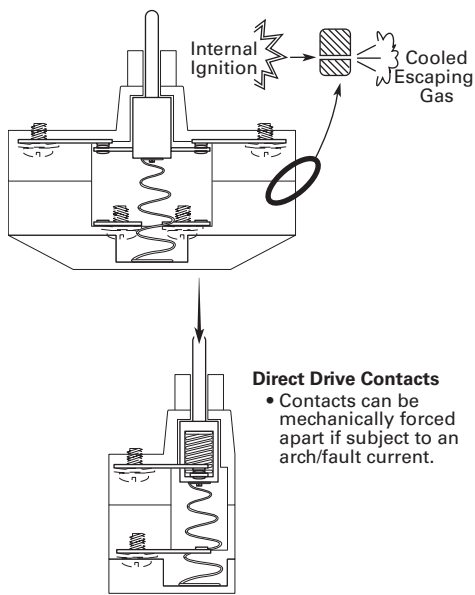

Hermetically Sealed Reed Contact Block

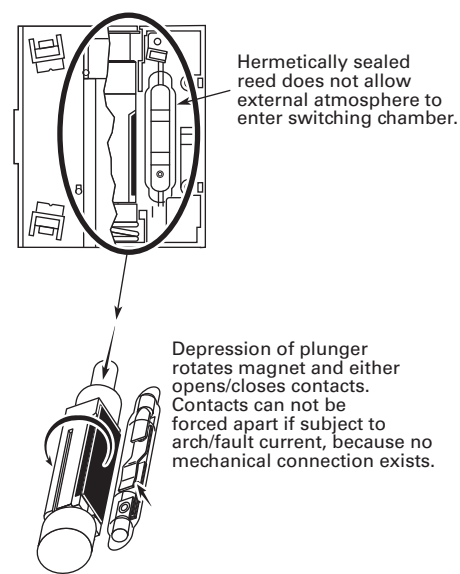

Explosion Proof Enclosure

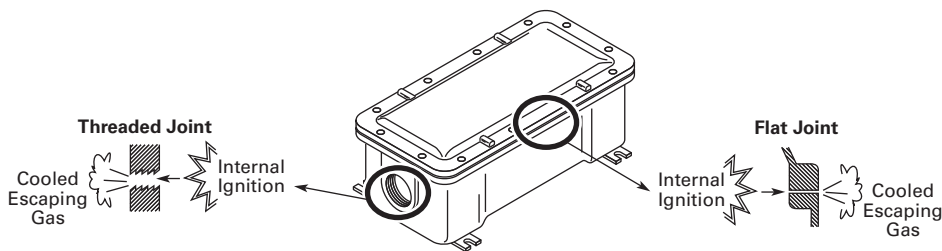

SL Series Stacklights



E26 Series Stacklights



2.1 SL Series

Product Description	V7-T2-2
Features	V7-T2-2
Benefits	V7-T2-2
Standards and Certifications	V7-T2-2
Product Overview	V7-T2-3
Component Identification—SL7	V7-T2-4
Product Selection—SL7	V7-T2-6
Component Identification—SL4	V7-T2-12
Product Selection—SL4	V7-T2-14
Accessories	V7-T2-19
Technical Data and Specifications	V7-T2-20
Dimensions	V7-T2-25

2.2 E26 Series

Product Description	V7-T2-32
Features	V7-T2-32
Benefits	V7-T2-32
Standards and Certifications	V7-T2-32
Product Identification	V7-T2-33
Catalog Number Selection	V7-T2-34
Product Selection	V7-T2-35
Replacement Parts	V7-T2-40
Technical Data and Specifications	V7-T2-41
Ratings	V7-T2-42
Mounting Instructions	V7-T2-43
Dimensions	V7-T2-44

2.1

Stacklights

SL Series

Stacklights—SL Series

2



Product Description

The new Eaton SL7 and SL4 stacklights provide reliable control over all key processes and machine availability. Now available in two sizes, 70 mm (SL7) and 40 mm (SL4), the new stacklights are engineered to keep you informed about potential material requirements, downtime and hazards. Modules are available in a wide selection of audible, illuminating and mounting options that are well suited to adapt to any industrial application.

Highly Modular and Versatile Line

- Easily configurable components
- Simple bayonet mounting mechanism for quick assembly
- Flexible mounting and lighting options
- Volume-adjustable alarms

Optimal Performance in Rugged Applications

- All elements have IP66 and UL Type 4/4X/13 ratings for protection against strong jets of water
- Bright and efficient LEDs with a lifespan of up to 100,000 hours
- High-performance LEDs for maximum illumination in direct sunlight
- Acoustic modules with up to 100 dB sound levels
- Operating temperatures: -22° to +140°F (-30° to +60°C)

Contents

Description

	<i>Page</i>
SL Series	
Product Overview	V7-T2-3
Component Identification—SL7	V7-T2-4
Product Selection—SL7	V7-T2-6
Component Identification—SL4	V7-T2-12
Product Selection—SL4	V7-T2-14
Accessories	V7-T2-19
Technical Data and Specifications	V7-T2-20
Dimensions	V7-T2-25

Features

- Six lens colors: red, amber, yellow, green, blue, white
- Continuous, flashing, strobe and multi-strobe lighting functions
- Mono-tone, dual-tone and multi-tone audible alarms
- LED or incandescent lighting options
- Control up to five modules on a single stack, 10 with dual-arm base
- 24V, 120 Vac and 230 Vac operating voltages

Benefits

- Simplified twist-and-lock assembly, no tools required
- Compact components reduce inventory requirements and increase flexibility
- Versatile hardware for quick installation and minimized downtime
- New slim 40 mm size is ideal for applications with constrained space
- Lean automation with SmartWire-DT connectivity
- Ideal for indoor and outdoor usage

Standards and Certifications

- UL 508—File No. E29184
- IEC/EN 60947-5-1
- CSA C22.2 No. 14-10
- CSA C22.2 No. 94-91
- CSA Class No. NKCR7



Product Overview

	SL7	SL4
Diameter	70 mm	40 mm
		
Acoustic Modules	Page V7-T2-9	Page V7-T2-16
		
Light Modules	Continuous light, LED: Page V7-T2-6 Flashing light, LED: Page V7-T2-7 Strobe light, LED: Page V7-T2-7 Continuous light, high-performance LED: Page V7-T2-8 Strobe light, high-performance LED: Page V7-T2-8 Multi-strobe light, high-performance LED: Page V7-T2-8 Continuous light, Incandescent: Page V7-T2-8	Continuous light, LED: Page V7-T2-16 Flashing light, LED: Page V7-T2-15 Strobe light, LED: Page V7-T2-15 Multi-strobe light, LED: Page V7-T2-17 Continuous light, Incandescent: Page V7-T2-17
		
		
Base Modules	Page V7-T2-10, V7-T2-11	Page V7-T2-17
Accessories	Page V7-T2-19	Page V7-T2-19

2.1

Stacklights

SL Series

Component Identification—SL7

2

Component Identification

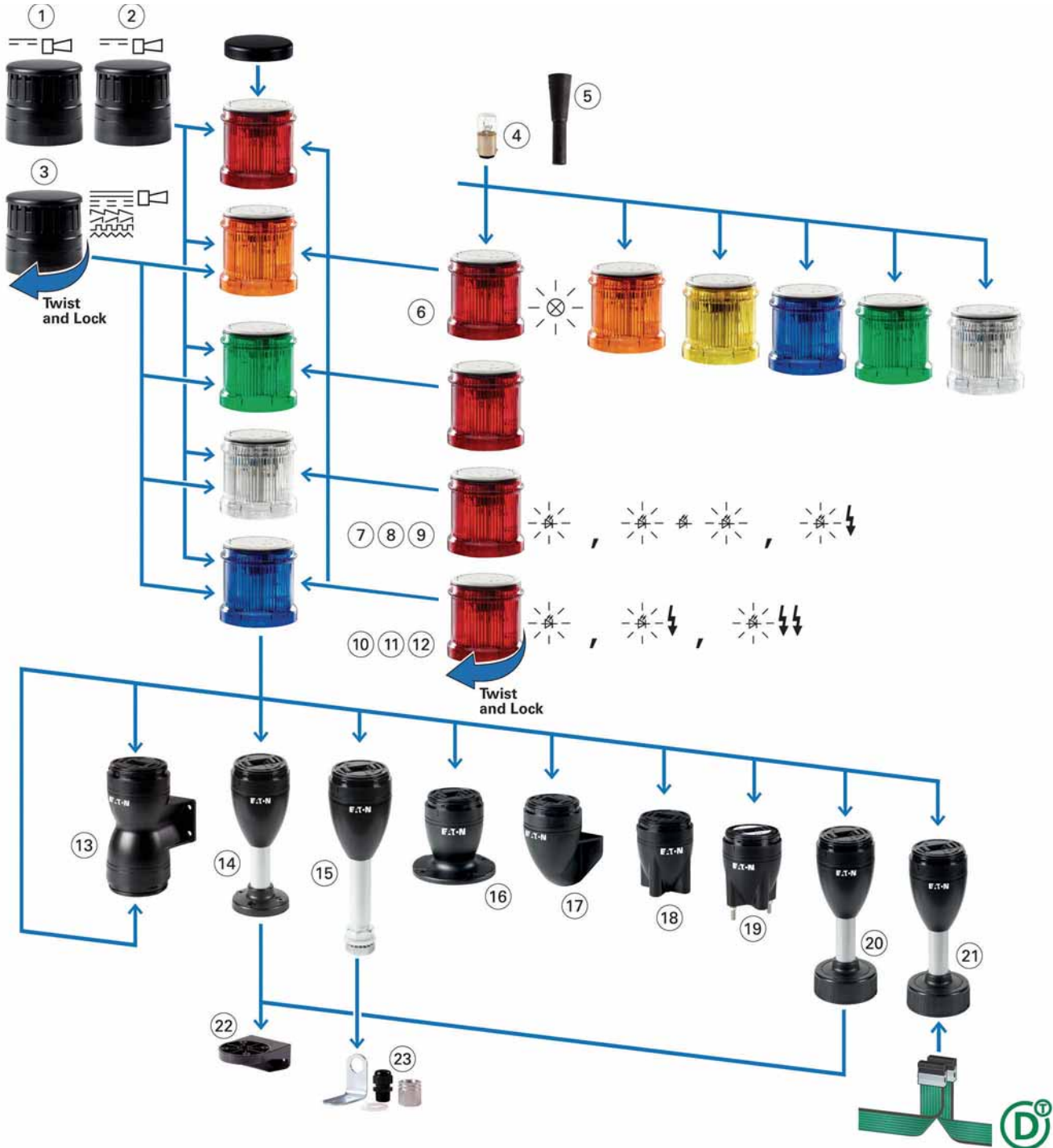

Light Modes

	Continuous	Flashing	Strobe	Multi-Strobe
Incandescent		—	—	—
LED				

SL7—Component Identification Descriptions

Item	Item Number	Description	Page Reference
Acoustic Modules			
Easy mounting with bayonet mount, place at highest position Sound pressure up to 100 dB, adjustable with internal potentiometer Operating mode: 100% DF (duty factor) Degree of protection: UL Type 4/4X/13, IP66 Operational voltages: 24 Vac/Vdc, 110/120 Vac, 230/240 Vac	1	Continuous tone or pulsed tone, adjustable with internal DIP switches Frequency: 2800 Hz	V7-T2-9
	2	Continuous tone or pulsed tone; can be actuated externally; takes up to two inputs (two modules) Frequency: 2800 Hz	V7-T2-9
	3	Multi-tone (eight tones) adjustable with internal DIP switch Frequency 500–2700 Hz	V7-T2-9
Incandescent Bulb	4	Accessory	V7-T2-19
Tool for Replacing Incandescent Bulb	5	Accessory	V7-T2-19
Light Modules			
Easy mounting with bayonet mount, modules can be arranged in any order Operating mode: 100% DF (duty factor) Degree of protection: UL Type 4/4X/13, IP66 Max. 5 modules per stack or up to 10 via dual-arm base option			
Light Module for Incandescent Bulb			
Continuous light	6	BA15d socket, without incandescent bulb	V7-T2-7
Light Modules with LED			
Continuous light	7		V7-T2-6
Flashing light	8	Flashing frequency: 2 Hz	V7-T2-7
Strobe light	9	Flashing frequency: 1.4 Hz	V7-T2-7
Light Modules with High-Output LED			
Continuous light	10		V7-T2-8
Strobe light	11	High-performance LED, flashing frequency: 1.4 Hz	V7-T2-8
Strobe light, multi-strobe light	12	High-performance LED, with various strobe sequences Flashing frequency: 1–2.6 Hz	V7-T2-8
Base Modules			
Easy mounting with bayonet mount, includes cover plate, with spring-cage terminals Degree of protection: UL Type 4/4X/13, IP66			
Base for mounting on both sides	13	Max. 2 x 5 modules that can be actuated individually	V7-T2-11
Base with aluminum tube and plastic foot	14	Aluminum tube 100 mm, 250 mm or 400 mm	V7-T2-10
Base with aluminum tube and M20 thread	15	Aluminum tube 100 mm, 250 mm or 400 mm	V7-T2-10
Base with external fixing holes	16	—	V7-T2-10
Vertical base with bracket	17	—	V7-T2-11
Base with internal (on the inside) fixing holes	18	—	V7-T2-10
Base with built-in fixing screws (pre-assembled)	19	—	V7-T2-10
Base with base adapter for slipping onto place (rapid mounting and wiring system)	20	Aluminum tube 100 mm, 250 mm or 400 mm	V7-T2-10
Base with base adapter for slipping onto place (rapid mounting and wiring system) and SmartWire-DT™ connection	21	Aluminum tube 100 mm	V7-T2-10
Mounting Bracket			
Bracket	22	Accessory	V7-T2-19
Bracket	23	Accessory, includes M20 cable gland	V7-T2-19

2.1

Stacklights

SL Series

Product Selection—SL7

Complete Devices

2

SL7-100-L-R_



Continuous Light, LED, UL Type 4/4X/13, IP66

Rated Operational Voltage (U _e V)	Number of Modules	Color	Function	Standard Pack	Catalog Number
Base Module with Foot and 100 mm Tube					
24 Vac/Vdc	2	Red/Green		1	SL7-100-L-RG-24LED
	3	Red/Amber/Green			SL7-100-L-RAG-24LED

Light Module with LED

SL7-L_



Continuous Light, UL Type 4/4X/13, IP66

Rated Operational Voltage (U _e V)	Color	Function	Standard Pack	Catalog Number
24 Vac/Vdc	Blue		1	SL7-L24-B
	Green			SL7-L24-G
	Red			SL7-L24-R
	White			SL7-L24-W
	Yellow			SL7-L24-Y
	Amber			SL7-L24-A
110/120 Vac	Blue		1	SL7-L120-B
	Green			SL7-L120-G
	Red			SL7-L120-R
	White			SL7-L120-W
	Yellow			SL7-L120-Y
	Amber			SL7-L120-A
230/240 Vac	Blue		1	SL7-L230-B
	Green			SL7-L230-G
	Red			SL7-L230-R
	White			SL7-L230-W
	Yellow			SL7-L230-Y
	Amber			SL7-L230-A

Light Module with LED, continued

SL7-BL_

Flashing Light, UL Type 4/4X/13, IP66, 2 Hz



Rated Operational Voltage (U _e V)	Color	Function	Standard Pack	Catalog Number
24 Vac/Vdc	Blue		1	SL7-BL24-B
	Green			SL7-BL24-G
	Red			SL7-BL24-R
	White			SL7-BL24-W
	Yellow			SL7-BL24-Y
	Amber			SL7-BL24-A
	110/120 Vac	Blue		
Green			SL7-BL120-G	
Red			SL7-BL120-R	
White			SL7-BL120-W	
Yellow			SL7-BL120-Y	
Amber			SL7-BL120-A	
230/240 Vac		Blue		1
	Green		SL7-BL230-G	
	Red		SL7-BL230-R	
	White		SL7-BL230-W	
	Yellow		SL7-BL230-Y	
	Amber		SL7-BL230-A	

SL7-FL_

Strobe Light, UL Type 4/4X/13, IP66, 1.4 Hz



Rated Operational Voltage (U _e V)	Color	Function	Standard Pack	Catalog Number
24 Vac/Vdc	Blue		1	SL7-FL24-B
	Green			SL7-FL24-G
	Red			SL7-FL24-R
	White			SL7-FL24-W
	Yellow			SL7-FL24-Y
	Amber			SL7-FL24-A
	110/120 Vac	Blue		
Green			SL7-FL120-G	
Red			SL7-FL120-R	
White			SL7-FL120-W	
Yellow			SL7-FL120-Y	
Amber			SL7-FL120-A	
230/240 Vac		Blue		1
	Green		SL7-FL230-G	
	Red		SL7-FL230-R	
	White		SL7-FL230-W	
	Yellow		SL7-FL230-Y	
	Amber		SL7-FL230-A	

2.1

Stacklights

SL Series

SL7 Light Module with High-Output LED

2

SL7-L24-

Continuous Light, UL Type 4/4X/13, IP66



Rated Operational Voltage (U _e V)	Color	Function	Standard Pack	Catalog Number
High-Performance LED for Maximum Signaling Effect				
24 Vac/Vdc	Blue		1	SL7-L24-B-HP
	Green			SL7-L24-G-HP
	Red			SL7-L24-R-HP
	White			SL7-L24-W-HP
	Yellow			SL7-L24-Y-HP
	Amber			SL7-L24-A-HP

SL7-FL24- -HP

Strobe Light, UL Type 4/4X/13, IP66



Rated Operational Voltage (U _e V)	Color	Function	Standard Pack	Catalog Number
High-Performance LED for Maximum Signaling Effect, 1.4 Hz				
24 Vac/Vdc	Blue		1	SL7-FL24-B-HP
	Green			SL7-FL24-G-HP
	Red			SL7-FL24-R-HP
	White			SL7-FL24-W-HP
	Yellow			SL7-FL24-Y-HP
	Amber			SL7-FL24-A-HP

SL7-FL24- -HPM

Multi-Strobe Light, UL Type 4/4X/13, IP66



Rated Operational Voltage (U _e V)	Color	Function	Standard Pack	Catalog Number
High-Performance LED for Maximum Signaling Effect, 1–2.6 Hz				
24 Vac/Vdc	Blue		1	SL7-FL24-B-HPM
	Green			SL7-FL24-G-HPM
	Red			SL7-FL24-R-HPM
	White			SL7-FL24-W-HPM
	Yellow			SL7-FL24-Y-HPM
	Amber			SL7-FL24-A-HPM

SL7 Light Module for Incandescent Bulb

SL7-L-

Continuous Light, UL Type 4/4X/13, IP66

For incandescent bulb selection, see **Page V7-T2-19**.





Rated Operational Voltage (U _e V)	Color	Function	Standard Pack	Catalog Number
Without Light Elements, Incandescent Bulb, Maximum 7W				
<250 Vac/Vdc	Blue		1	SL7-L-B
	Green			SL7-L-G
	Red			SL7-L-R
	White			SL7-L-W
	Yellow			SL7-L-Y
	Amber			SL7-L-A

SL7 Acoustic Modules

SL7-AP_

**Continuous Tone or Pulsed Tone, UL Type 4/4X/13, IP66** ①



Adjustable with internal DIP switches.
Sound pressure 100 dB, adjustable with internal potentiometer.
 $f = 2800$ Hz.

Rated Operational Voltage (U_e V)	Rated Operational Current (I_e mA)	Color	Function	Sound Type	Standard Pack	Catalog Number
24 Vac/Vdc	Maximum 92	Black			1	SL7-AP24
110/120 Vac	Maximum 41	Black				SL7-AP120
230/240 Vac	Maximum 43	Black				SL7-AP230

SL7-AP_-E

**Continuous Tone or Pulsed Tone, External Actuation, UL Type 4/4X/13, IP66** ①



Assigned two inputs (two modules).
Sound pressure 100 dB, adjustable with internal potentiometer.
 $f = 2800$ Hz.

Rated Operational Voltage (U_e V)	Rated Operational Current (I_e mA)	Color	Function	Sound Type	Standard Pack	Catalog Number
24 Vac/Vdc	Maximum 92	Black			1	SL7-AP24-E
110/120 Vac	Maximum 41	Black				SL7-AP120-E
230/240 Vac	Maximum 43	Black				SL7-AP230-E

SL7-AP_-M

**Multi-Tone; Eight Tones, UL Type 4/4X/13, IP66** ①

Adjustable with internal DIP switch.
Sound pressure 100 dB, adjustable with internal potentiometer.
 $f = 500$ – 2700 Hz.

Rated Operational Voltage (U_e V)	Rated Operational Current (I_e mA)	Color	Function	Sound Type	Standard Pack	Catalog Number
24 Vac/Vdc	Maximum 115	Black			1	SL7-AP24-M
110/120 Vac	Maximum 45	Black				SL7-AP120-M
230/240 Vac	Maximum 43	Black				SL7-AP230-M

Note

① Place only at the highest position on a pole.

2.1





Stacklights

SL Series

SL7 Base Modules



2

For Horizontal Mounting—Includes Cover, Maximum 5 Modules

	Description	Tube Length	Color	Standard Pack	For use with ...	Catalog Number
SL7-CB-__ 	Base with aluminum tube and plastic foot Spring-loaded terminals	100 mm	Black	1	SL7-L-...	SL7-CB-100
		250 mm	aluminum color tube		SL7-BL-...	SL7-CB-250
		400 mm			SL7-FL-...	SL7-CB-400
SL7-CB-T-__ 	Base with aluminum tube and M20 threaded base Spring-loaded terminals	100 mm	Black	1	SL7-L-...	SL7-CB-T-100
		250 mm	aluminum color tube		SL7-BL-...	SL7-CB-T-250
		400 mm			SL7-FL-...	SL7-CB-T-400
SL7-CB-IMH 	Base with internal (on the inside) fixing holes Spring-loaded terminals	—	Black	1	SL7-L-... SL7-BL-... SL7-FL-... SL7-AP-...	SL7-CB-IMH
SL7-CB-IMS 	Base with built-in (pre-assembled) fixing screws Spring-loaded terminals	—	Black	1	SL7-L-... SL7-BL-... SL7-FL-... SL7-AP-...	SL7-CB-IMS
SL7-CB-EMH 	Base with external fixing holes Spring-loaded terminals	—	Black	1	SL7-L-... SL7-BL-... SL7-FL-... SL7-AP-...	SL7-CB-EMH

SL7 Base Modules, continued

For Horizontal Mounting—Includes Cover, Maximum 5 Modules, continued

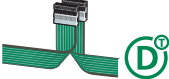
	Description	Tube Length	Color	Standard Pack	For use with ...	Catalog Number
SL7-FMS_ 	Base with base adapter for slipping onto place (rapid mounting and wiring system) Screw terminals	100 mm	Black	1	SL7-L-...	SL7-FMS-100
		250 mm	aluminum		SL7-BL-...	SL7-FMS-250
		400 mm	color tube		SL7-FL-... SL7-AP-...	SL7-FMS-400
SL7-SWD  	Base with base adapter for slipping onto place (rapid mounting and wiring system) Blade terminal SWD4-8MF2 Maximum 0.3A per module External power supply connectable (24 Vdc) Configurable with SWD-Assist (planning and ordering help)	100 mm	—	1	SL7-L-... SL7-BL-... SL7-FL-... SL7-AP-...	SL7-SWD

SL7-CB-FW For Vertical Mounting—Includes Cover, Maximum 5 Modules

	Description	Color	Standard Pack	For use with ...	Catalog Number
	Vertical base with bracket Spring-loaded terminals	Black	1	SL7-L-... SL7-BL-... SL7-FL-... SL7-AP-...	SL7-CB-FW

SL7-CB-D For Mounting on Both Sides—Includes Cover, Maximum 2 x 5 Modules

	Description	Color	Standard Pack	For use with ...	Catalog Number
	Base with external fixing holes Spring-loaded terminals	Black	1	SL7-L-... SL7-BL-... SL7-FL-... SL7-AP-...	SL7-CB-D

2.1

Stacklights

SL Series

Component Identification—SL4

Component Identification

2

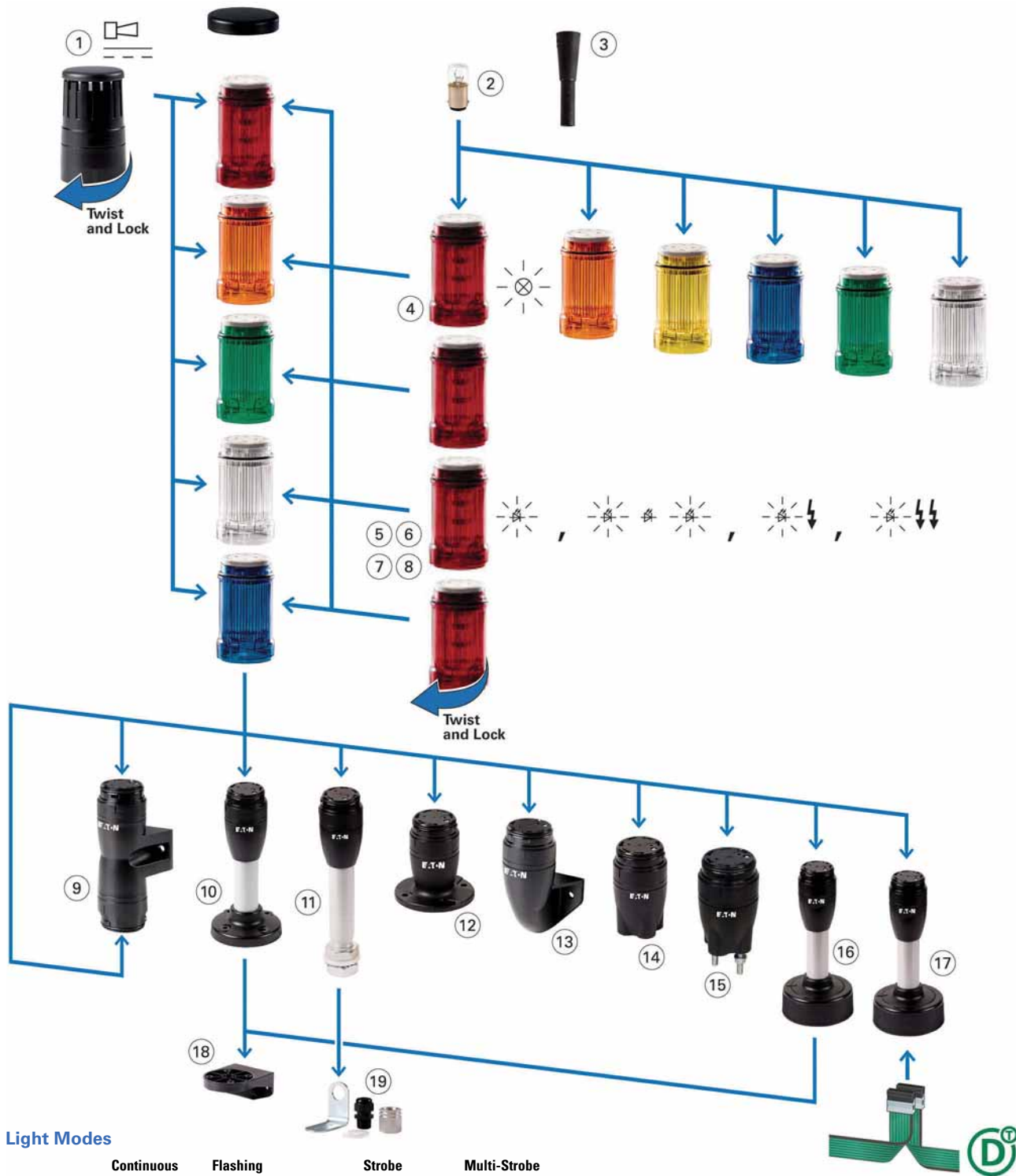

Light Modes

	Continuous	Flashing	Strobe	Multi-Strobe
Incandescent		—	—	—
LED				

SL4—Component Identification Descriptions

Item	Item Number	Description	Page Reference
Acoustic Modules			
Sound pressure 80 dB, adjustable with internal potentiometer, frequency 4000 Hz Easy mounting with bayonet mount, set up as highest module Permanently integrated cover plate Operating mode: 100% DF (duty factor) Degree of protection: UL Type 4/4X/13, IP66	1	Continuous tone or pulsed tone, adjustable with internal DIP switches Frequency: 2800 Hz	V7-T2-16
Incandescent Bulb	2	Accessory	V7-T2-19
Tool for Replacing Incandescent Bulb	3	Accessory	V7-T2-19
Light Modules			
Easy mounting with bayonet mount, modules can be arranged in any order Without light element (incandescent bulb with BA15d socket), easy mounting with bayonet mount. Operating mode: 100% DF (duty factor) Flashing frequency 2 Hz Degree of protection: UL Type 4/4X/13, IP66			
Light Module for Incandescent Bulb			
Continuous light	4	BA15d socket, without incandescent bulb	V7-T2-16
Light Modules with LED			
Continuous light	5		V7-T2-14
Flashing light	6	Flashing frequency: 2 Hz	V7-T2-15
Strobe light	7	Flashing frequency: 1.4 Hz	V7-T2-15
Strobe light, multi-strobe light	8	High-performance LED, with various strobe sequences Flashing frequency: 1–2.6 Hz	V7-T2-16
Base Modules			
Easy mounting with bayonet mount, includes cover plate, with spring-cage terminals Degree of protection: UL Type 4/4X/13, IP66			
Base for mounting on both sides	9	Max. 2 x 5 modules that can be actuated individually	V7-T2-17
Base with aluminum tube and plastic foot	10	Aluminum tube 100 mm, 250 mm or 400 mm	V7-T2-17
Base with aluminum tube and M20 thread	11	Aluminum tube 100 mm, 250 mm or 400 mm	V7-T2-17
Base with external fixing holes	12	—	V7-T2-17
Vertical base with bracket	13	—	V7-T2-17
Base with internal (on the inside) fixing holes	14	—	V7-T2-17
Base with built-in fixing screws (pre-assembled)	15	—	V7-T2-17
Base with base adapter for slipping onto place (rapid mounting and wiring system)	16	Aluminum tube 100 mm, 250 mm or 400 mm	V7-T2-17
Base with base adapter for slipping onto place (rapid mounting and wiring system) and SmartWire-DT™ connection	17	Aluminum tube 100 mm	V7-T2-17
Mounting Bracket			
Bracket	18	Accessory	V7-T2-19
Bracket	19	Accessory, includes M20 cable gland	V7-T2-19

2.1

Stacklights

SL Series

Product Selection—SL4

2

Complete Devices

SL4-100-L-R_



Continuous Light, LED, UL Type 4/4X/13, IP66

Rated Operational Voltage (U _e V)	Number of Modules	Color	Function	Standard Pack	Catalog Number
Base Module with Foot and 100 mm Tube					
24 Vac/Vdc	2	Red/Green		1	SL4-100-L-RG-24LED
	3	Red/Amber/Green		SL4-100-L-RAG-24LED	

Light Module with LED

SL4-L_



Continuous Light, UL Type 4/4X/13, IP66

Rated Operational Voltage (U _e V)	Color	Function	Standard Pack	Catalog Number
24 Vac/Vdc	Blue		1	SL4-L24-B
	Green			SL4-L24-G
	Red			SL4-L24-R
	White			SL4-L24-W
	Yellow			SL4-L24-Y
	Amber			SL4-L24-A
110/120 Vac	Blue		1	SL4-L120-B
	Green			SL4-L120-G
	Red			SL4-L120-R
	White			SL4-L120-W
	Yellow			SL4-L120-Y
	Amber			SL4-L120-A
230/240 Vac	Blue		1	SL4-L230-B
	Green			SL4-L230-G
	Red			SL4-L230-R
	White			SL4-L230-W
	Yellow			SL4-L230-Y
	Amber			SL4-L230-A

Light Module with LED, continued

SL4-BL_

Flashing Light, UL Type 4/4X/13, IP66, 2 Hz



Rated Operational Voltage (U _e V)	Color	Function	Standard Pack	Catalog Number
24 Vac/Vdc	Blue		1	SL4-BL24-B
	Green			SL4-BL24-G
	Red			SL4-BL24-R
	White			SL4-BL24-W
	Yellow			SL4-BL24-Y
	Amber			SL4-BL24-A
	110/120 Vac	Blue		
Green			SL4-BL120-G	
Red			SL4-BL120-R	
White			SL4-BL120-W	
Yellow			SL4-BL120-Y	
Amber			SL4-BL120-A	
230/240 Vac		Blue		1
	Green		SL4-BL230-G	
	Red		SL4-BL230-R	
	White		SL4-BL230-W	
	Yellow		SL4-BL230-Y	
	Amber		SL4-BL230-A	

SL4-FL_

Strobe Light, UL Type 4/4X/13, IP66, 1.4 Hz



Rated Operational Voltage (U _e V)	Color	Function	Standard Pack	Catalog Number
24 Vac/Vdc	Blue		1	SL4-FL24-B
	Green			SL4-FL24-G
	Red			SL4-FL24-R
	White			SL4-FL24-W
	Yellow			SL4-FL24-Y
	Amber			SL4-FL24-A
	110/120 Vac	Blue		
Green			SL4-FL120-G	
Red			SL4-FL120-R	
White			SL4-FL120-W	
Yellow			SL4-FL120-Y	
Amber			SL4-FL120-A	
230/240 Vac		Blue		1
	Green		SL4-FL230-G	
	Red		SL4-FL230-R	
	White		SL4-FL230-W	
	Yellow		SL4-FL230-Y	
	Amber		SL4-FL230-A	

2.1

Stacklights

SL Series

Light Module with LED, continued

2

SL4-FL24-_-M



Multi-Strobe Light, UL Type 4/4X/13, IP66

Rated Operational Voltage (U _e V)	Color	Function	Standard Pack	Catalog Number
LED for Effective Signaling Effect With Various Strobe Sequences, 1–2.6 Hz				
24 Vac/Vdc	Blue		1	SL4-FL24-B-M
	Green			SL4-FL24-G-M
	Red			SL4-FL24-R-M
	White			SL4-FL24-W-M
	Yellow			SL4-FL24-Y-M
	Amber			SL4-FL24-A-M

SL4 Light Module for Incandescent Bulb

SL4-L-_-



Continuous Light, UL Type 4/4X/13, IP66

For incandescent bulb selection, see **Page V7-T2-19**.

Rated Operational Voltage (U _e V)	Color	Function	Standard Pack	Catalog Number
Without Light Elements, Incandescent Bulb, Maximum 4W				
<250 Vac/Vdc	Blue		1	SL4-L-B
	Green			SL4-L-G
	Red			SL4-L-R
	White			SL4-L-W
	Yellow			SL4-L-Y
	Amber			SL4-L-A

SL4 Acoustic Modules

SL4-AP-_-



Continuous Tone or Pulsed Tone, UL Type 4/4X/13, IP66

Adjustable with internal DIP switches.





Sound pressure 80 dB, adjustable with internal potentiometer.

f = 4000 Hz.

Rated Operational Voltage (U _e V)	Rated Operational Current (I _e mA)	Color	Function	Sound Type	Standard Pack	Catalog Number
Place only at the highest position on a pole.						
24 Vac/Vdc	Maximum 39	Black			1	SL4-AP24
110/120 Vac	Maximum 21	Black				SL4-AP120
230/240 Vac	Maximum 21	Black				SL4-AP230

SL4 Base Modules

For Horizontal Mounting—Includes Cover, Maximum 5 Modules

	Description	Tube Length	Color	Standard Pack	For use with ...	Catalog Number
	Base with aluminum tube and plastic foot Spring-loaded terminals	100 mm	Black	1	SL4-L-...	SL4-PIB-100
		250 mm	aluminum		SL4-BL-...	SL4-PIB-250
			color tube		SL4-FL-...	SL4-PIB-400
		400 mm			SL4-AP-...	
	Base with aluminum tube and M20 threaded base Spring-loaded terminals	100 mm	Black	1	SL4-L-...	SL4-PIB-T-100
		250 mm	aluminum		SL4-BL-...	SL4-PIB-T-250
			color tube		SL4-FL-...	SL4-PIB-T-400
		400 mm			SL4-AP-...	
	Base with internal (on the inside) fixing holes Spring-loaded terminals	—	Black	1	SL4-L-... SL4-BL-... SL4-FL-... SL4-AP-...	SL4-PIB-IMH
	Base with built-in (pre-assembled) fixing screws Spring-loaded terminals	—	Black	1	SL4-L-... SL4-BL-... SL4-FL-... SL4-AP-...	SL4-PIB-IMS
	Base with external fixing holes Spring-loaded terminals	—	Black	1	SL4-L-... SL4-BL-... SL4-FL-... SL4-AP-...	SL4-PIB-EMH

2.1



Stacklights

SL Series

SL4 Base Modules, continued

2

For Horizontal Mounting—Includes Cover, Maximum 5 Modules, continued

Description	Tube Length	Color	Standard Pack	For use with ...	Catalog Number
SL4-FMS_  Base with base adapter for slipping onto place (rapid mounting and wiring system) Screw terminals	100 mm	Black	1	SL4-L-...	SL4-FMS-100
	250 mm	aluminum color tube		SL4-BL-... SL4-FL-...	SL4-FMS-250
	400 mm			SL4-AP-...	SL4-FMS-400
SL4-SWD   Base with base adapter for slipping onto place (rapid mounting and wiring system) Blade terminal SWD4-BMF2 Maximum 0.3A per module External power supply connectable (24 Vdc) Configurable with SWD-Assist (planning and ordering help)	100 mm	—	1	SL4-L-... SL4-BL-... SL4-FL-... SL4-AP-...	SL4-SWD

SL4-PIB-FW For Vertical Mounting—Includes Cover, Maximum 5 Modules

Description	Color	Standard Pack	For use with ...	Catalog Number
SL4-PIB-FW  One-sided base with bracket Spring-loaded terminals	Black	1	SL4-L-... SL4-BL-... SL4-FL-... SL4-AP-...	SL4-PIB-FW

SL4-PIB-D For Mounting on Both Sides—Includes Cover, Maximum 2 x 5 Modules

Description	Color	Standard Pack	For use with ...	Catalog Number
SL4-PIB-D  Base with external fixing holes Spring-loaded terminals	Black	1	SL4-L-... SL4-BL-... SL4-FL-... SL4-AP-...	SL4-PIB-D

Accessories

SL7 and SL4 Series

Mounting Brackets

SL7/4-FW



Mounting Brackets for Vertical Mounting, Plastic

Standard Pack	For Use With ...	Catalog Number
1	SL4-PIB-... SL7-CB-...	SL7/4-FW

SL7/4-FW-T



M20 Cable Gland for Vertical Mounting, Metal (Includes Mounting Bracket)

Standard Pack	For Use With ...	Catalog Number
1	SL4-PIB-T-... SL7-CB-T-...	SL7/4-FW-T

Incandescent Bulb Tool

SL7/4-BET



Tool for Replacing Incandescent Bulb

Standard Pack	For Use With ...	Catalog Number
1	SL7-L-... SL4-L-...	SL7/4-BET

Incandescent Bulbs

SL7 Series

SL7-L12



Incandescent Bulbs, Mounting: Ba15d

Lifespan (h)	Rated Operational Voltage (U _e V)	Power (Watts)	Standard Pack	For Use With ...	Catalog Number
3000	12	5	1	SL7-L-...	SL7-L12
	24	6.5			SL7-L24
	120	7			SL7-L120
	230	6.5			SL7-L230

SL4 Series

SL4-L12



Incandescent Bulbs, Mounting: Ba15d

Lifespan (h)	Rated Operational Voltage (U _e V)	Power (Watts)	Standard Pack	For Use With ...	Catalog Number
3000	12	4	1	SL4-L-...	SL4-L12
	24				SL4-L24
	120				SL4-L120
	230				SL4-L230

Technical Data and Specifications

2

SL7 Series

SL7 General Specifications

Description	Specification
Standards	IEC/EN 60947-5-1
Lens color	Blue, green, red, clear, yellow, amber
Number of signal elements	Max. 5 with standard base Max. 10 with base for mounting on both sides
Mechanical Ratings	
Shock (IEC 68-2-27)	11 ms, 15g
Vibration (IEC 68-2-6)	20 sweeps 10–150 Hz, 1g
Climate Conditions	
Climatic proofing	Damp heat, constant, to IEC 60068-2-78 Damp heat, cyclic, to IEC 60069-2-30
Operating temperature	–22° to +140°F (–30° to +60°C)
Storage temperature	–22° to +185°F (–30° to +85°C)
Environmental Ratings	
IEC degree of protection	UL Type 4/4X/13, IP66 IEC/EN 60529
Protection type UL	Type 4/4X/13
Materials	
Cover	Polycarbonate
Lenses	Polycarbonate
Stacklight base	Polycarbonate
Tubes	Aluminum
Terminal Capacity	
Solid or flexible conductor	0.13–2.5 mm ²
Flexible with ferrule with plastic collar	0.25–1.5 mm ² AWG 24–AWG 14
Contacts	
Rated impulse withstand voltage (U _{imp})	4000 Vac
Rated insulation voltage (U _i)	250V
Overvoltage category/pollution degree	III/3

SL7 Light Module Specifications

	Unit	SL7-L-...-...	SL7-BL-...-...	SL7-FL-...-...	SL7-L24-...-HP	SL7-FL24-...-HP	SL7-FL24-...-HPM	SL7-L-...
Type of light		Continuous light	Flashing light	Strobe light	Continuous light	Strobe light	Multi-strobe light	Continuous light
Light elements		LED	LED	LED	High-performance LED	High-performance LED	High-performance LED	Incandescent bulb (max. 7W)
Mounting		—	—	—	—	—	—	Ba15d
Flashing/strobe frequency		—	2 Hz	1.4 Hz	—	1.4 Hz	1–2.6 Hz	—
Transmission angle		360°	360°	360°	360°	360°	360°	360°
Leakage current	A	< 0.003	< 0.003	< 0.003	< 0.003	< 0.003	< 0.003	< 0.003
Current-/power consumption								
24 Vac/Vdc	A	0.049–0.054	0.058	0.130–0.135	0.170–0.200	0.260–0.265	0.260–0.265	—
110/120 Vac	A	0.028–0.031	0.028–0.030	0.010	—	—	—	—
230/240 Vac	A	0.027–0.028	0.030–0.031	0.010	—	—	—	—
Power consumption		—	—	—	—	—	—	Max. 7W with the specified voltages
Voltage levels		24 Vac/Vdc ± 10% 110/120 Vac ± 10% 230/240 Vac ± 10%	24 Vac/Vdc ± 10% 110/120 Vac ± 10% 230/240 Vac ± 10%	24 Vac/Vdc ± 10% 110/120 Vac ± 10% 230/240 Vac ± 10%	18–30 Vdc/ 18–26 Vac	18–30 Vdc/ 18–26 Vac	18–30 Vdc/ 18–26 Vac	Up to 250 Vac/Vdc
Lifespan	h	100,000	100,000	100,000	50,000	50,000	50,000	3000
Weight	g	80	80	80	80	80	80	80

SL7 Acoustic Module Specifications

	Unit	SL7-AP...	SL7-AP...-E	SL7-AP...-M
Type of tone		Continuous or pulsed tone	Continuous or pulsed tone	Continuous or pulsed tone Eight types of sound
Types of sound		Two versions, table of sound types	Two versions, table of sound types	Eight versions, table of sound types
Sound setting		Internal; single-pole DIP	Can be externally actuated	Internal; three-pole DIP
Sound pressure	dB	Max.: 100 Min.: 88	Max.: 100 Min.: 88	Max.: 100 Min.: 88
Sound pressure level adjustment		Built-in, potentiometer	Built-in, potentiometer	Built-in, potentiometer
Transmission angle		360°	360°	360°
Current-/power consumption				
24 Vac/Vdc	A	0.092	0.092	0.115
110/120 Vac	A	0.041	0.041	0.045
230/240 Vac	A	0.043	0.043	0.043
Voltage levels				
		24 Vac/Vdc ± 10% 110/120 Vac ± 10% 230/240 Vac ± 10%	24 Vac/Vdc ± 10% 110/120 Vac ± 10% 230/240 Vac ± 10%	24 Vac/Vdc ± 10% 110/120 Vac ± 10% 230/240 Vac ± 10%
Weight	g	102	102	102

SL7 Table of Sound Types

	Sound Type	Frequency (Hz)	Diagram	Repeat Rate	DIP Switch Position	Maximum Volume at 1M (dB)
SL7-AP...	Continuous tone	Approx. 2800		—	—	100
	Pulsed tone	Approx. 2800		Approx. 2 Hz	—	100
SL7-AP...-E	Continuous tone	Approx. 2800		—	—	100
	Pulsed tone	Approx. 2800		Approx. 2 Hz	—	100
SL7-AP...-M	Continuous tone	2700		—	ON	Tone 01 100
	Continuous tone	1350		—	ON	Tone 02 100
	Pulsed tone	2700		250 ms on, 250 ms off	ON	Tone 03 100
	Pulsed tone	1350		250 ms on, 250 ms off	ON	Tone 04 100
	Falling	1200–500		1 Hz	ON	Tone 05 98
	Rising	500–1200		Rising 3s, 0.5s off	ON	Tone 06 98
	Alternating	800–1000		2 Hz	ON	Tone 07 94
	rising/falling	500–1500		10 Hz	ON	Tone 08 94

SL4 Series**SL4 General Specifications**

Description	Specification
Standards	IEC/EN 60947-5-1
Lens color	Blue, green, red, clear, yellow, orange
Number of signal elements	Max. 5 with standard base Max. 10 with base for mounting on both sides
Mounting position	As required
Mechanical Ratings	
Mechanical shock resistance	>15g according to IEC 60068-2-27 Shock duration 11 ms Sinusoidal
Climate Conditions	
Climatic proofing	Damp heat, constant, to IEC 60068-2-78 Damp heat, cyclic, to IEC 60069-2-30
Ambient temperature	-22°F to +140°F (-30°C to +60°C)
Environmental Ratings	
IEC degree of protection	UL Type 4/4X/13, IP66 IEC/EN 60529
Protection type UL	Type 4/4X/13
Materials	
Enclosure	Polycarbonate (PC), black
Cap	Polycarbonate (PC)
Terminal Capacity	
Solid or flexible conductor	0.2–1.5 mm ²
Solid or flexible conductor, with ferrule	0.25–1.5 mm ²
Flexible with ferrule with plastic collar	0.25–0.75 mm ² AWG 24–AWG 16
Contacts	
Rated impulse withstand voltage (U _{imp})	4000 Vac
Rated insulation voltage (U _i)	250V
Overvoltage category/pollution degree	III/3

SL4 Light Module Specifications

	Unit	SL4-L...-...	SL4-BL...-...	SL4-FL...-...	SL4-FL24...-M	SL4-L...
Type of light		Continuous light	Flashing light	Strobe light	Multi-strobe light	Continuous light
Light elements		LED	LED	LED	LED	Incandescent bulb (max. 4W)
Mounting		—	—	—	—	Ba15d
Flashing/strobe frequency		—	2 Hz	1.4 Hz	1–2.6 Hz	—
Transmission angle		360°	360°	360°	360°	360°
Leakage current	A	< 0.003	< 0.003	< 0.003	< 0.003	< 0.003
Current/power consumption						
24 Vac/Vdc	A	0.022–0.033	0.028–0.036	0.035–0.065	0.048–0.068	—
110/120 Vac	A	0.030	0.030	0.10	—	—
230/240 Vac	A	0.030	0.030	0.10	—	—
Power consumption		—	—	—	—	Maximum 4W with the specified voltages
Voltage levels		24 Vac/Vdc ± 10% 110/120 Vac ± 10% 230/240 Vac ± 10%	24 Vac/Vdc ± 10% 110/120 Vac ± 10% 230/240 Vac ± 10%	24 Vac/Vdc ± 10% 110/120 Vac ± 10% 230/240 Vac ± 10%	24 Vac/Vdc ± 10%	Up to 250 Vac/Vdc
Lifespan	h	100,000	100,000	100,000	100,000	100,000
Weight	g	45	45	45	45	45

SL4 Acoustic Module Specifications

	Unit	SL4-AP...
Type of tone		Continuous or pulsed tone
Types of sound		Two versions, table of sound types
Sound setting		Internal; single-pole DIP
Sound pressure	dB	80
Sound pressure level adjustment		—
Sound pressure can be lowered to a minimum of		—
Transmission angle		360°
Current/power consumption		
24 Vac/Vdc	A	0.039
110/120 Vac	A	0.021
230/240 Vac	A	0.021
Voltage levels		24 Vac/Vdc ± 10% 110/120 Vac ± 10% 230/240 Vac ± 10%
Weight	g	43

SL4 Table of Sound Types

	Sound Type	Frequency (Hz)	Diagram	Repeat Rate	Maximum Volume at 1M (dB)
SL4-AP...	Continuous tone	Approx. 4000	—————	—	80
	Pulsed tone	Approx. 4000	— — —	Approx. 2 Hz	80

Dimensions

Approximate Dimensions in Inches (mm)

SL7 Series

Complete Devices

SL7-100-L-RG-24LED

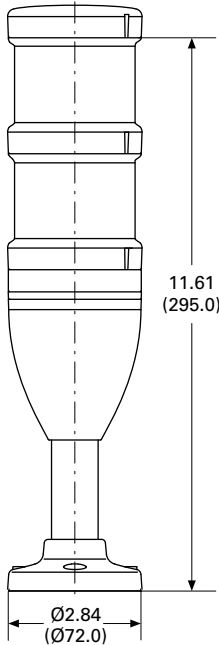

SL7-100-L-RYG-24LED

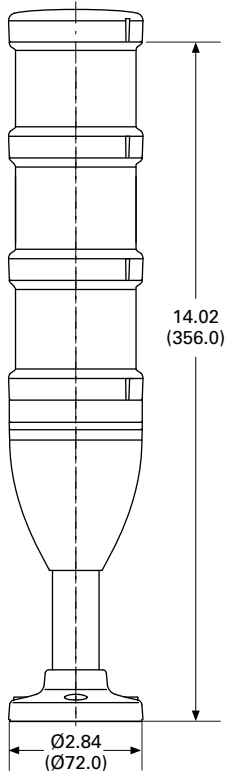

Light Modules

SL7-(B)(F)L...

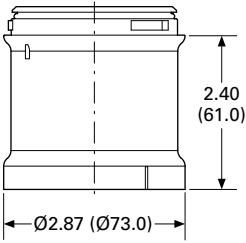

Acoustic Modules

SL7-AP...

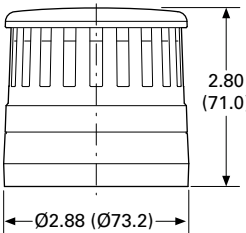

2.1

Stacklights

SL Series

Approximate Dimensions in Inches (mm)

2

Basic Modules

SL7-CB-...

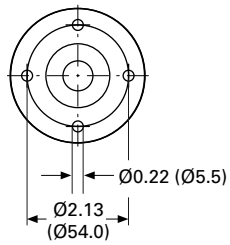
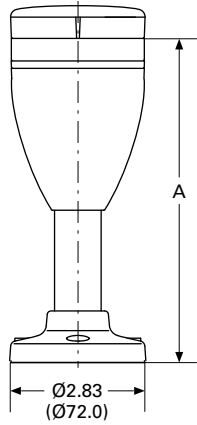

Catalog Number	A
SL7-CB-100	6.73 (171.0)
SL7-CB-250	12.64 (321.0)
SL7-CB-400	18.54 (471.0)

SL7-CB-T...

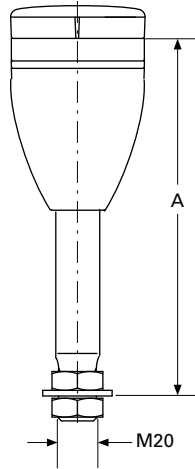

Catalog Number	A
SL7-CB-T-100	7.48 (190.0)
SL7-CB-T-250	13.38 (340.0)
SL7-CB-T-400	19.29 (490.0)

SL7-CB-D

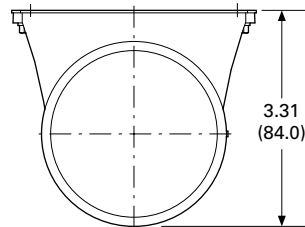
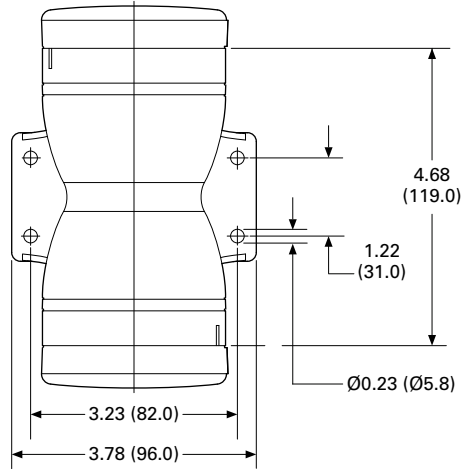

SL7-CB-EMH

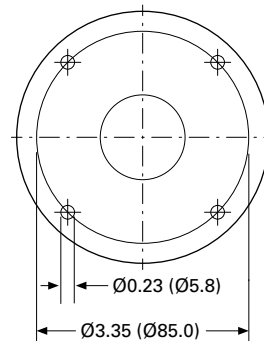
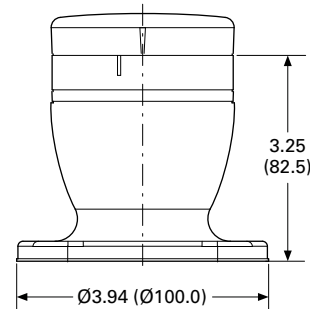

Approximate Dimensions in Inches (mm)

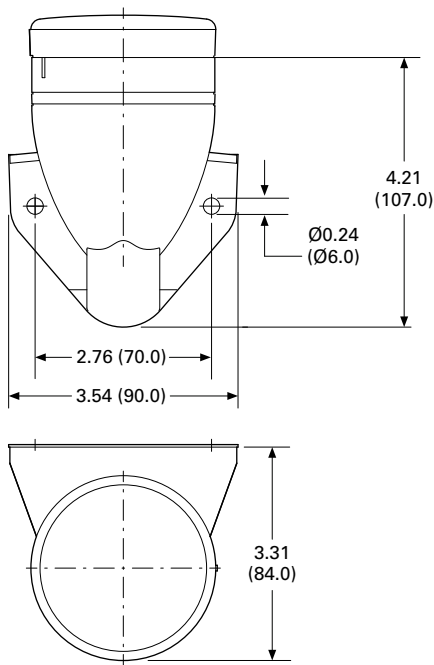
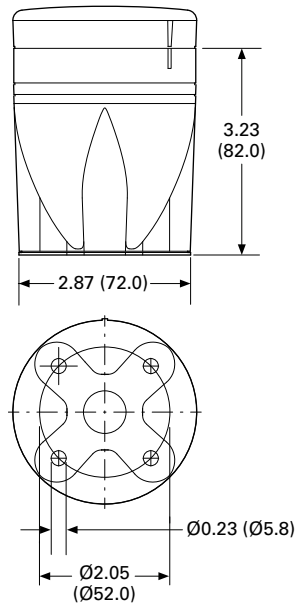
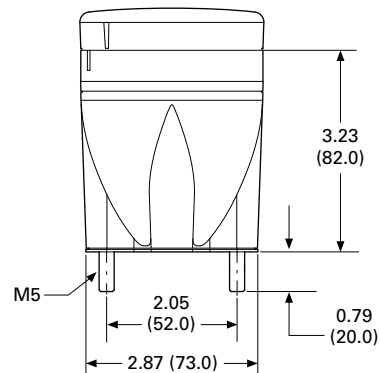
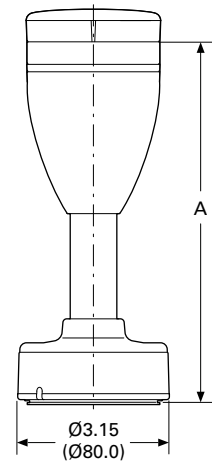
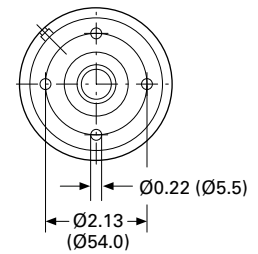
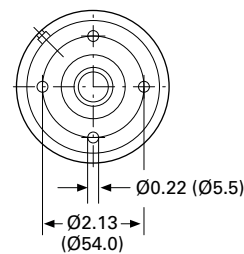
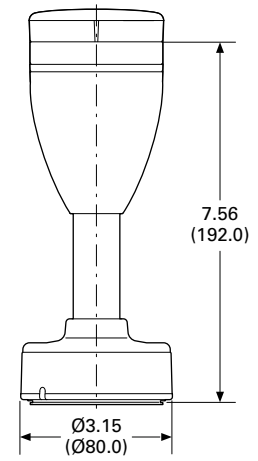
SL7-CB-FW**SL7-CB-IMH****SL7-CB-IMS****SL7-FMS-...****SL7-SWD ①**

Catalog Number	A
SL7-FMS-100	7.55 (192.0)
SL7-FMS-250	13.46 (342.0)
SL7-FMS-400	19.37 (192.0)

Note

① For connecting to SmartWire-DT.

2.1

Stacklights

SL Series

Approximate Dimensions in Inches (mm)

2

SL4 Series

Complete Devices

SL4-100-L-RG-24LED

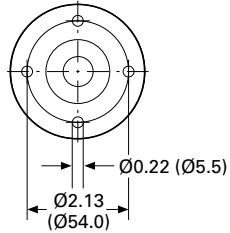
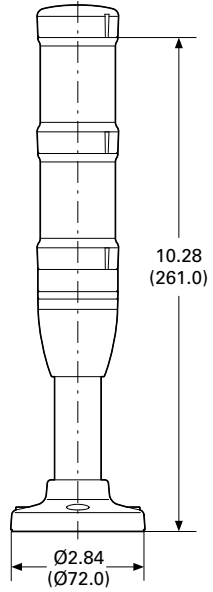

SL4-100-L-RYG-24LED

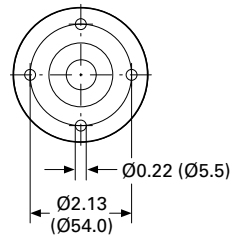
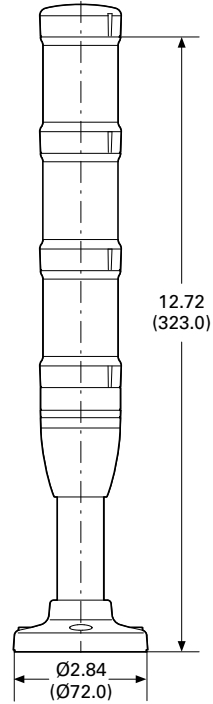

Light Modules

SL4-(B)(F)L...

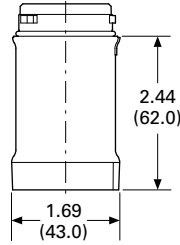

Acoustic Modules

SL4-AP...

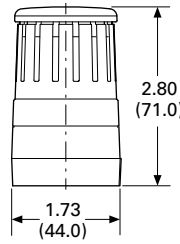

Approximate Dimensions in Inches (mm)

Basic Modules

SL4-PIB-...

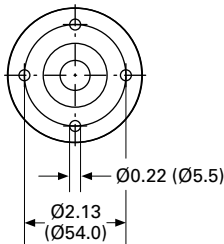
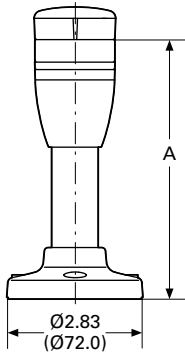

Catalog Number	A
SL4-PIB-100	3.53 (136.0)
SL4-PIB-250	11.26 (286.0)
SL4-PIB-400	17.16 (436.0)

SL4-PIB-T...

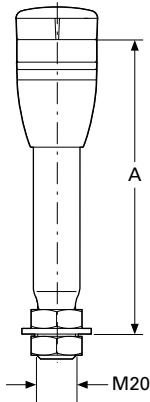

Catalog Number	A
SL4-PIB-T-100	5.90 (150.0)
SL4-PIB-T-250	11.81 (300.0)
SL4-PIB-T-400	17.72 (450.0)

SL4-PIB-D

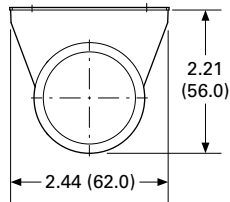
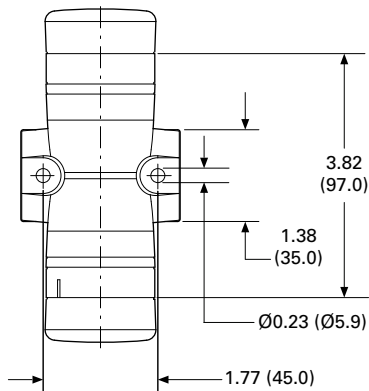

SL4-PIB-EMH

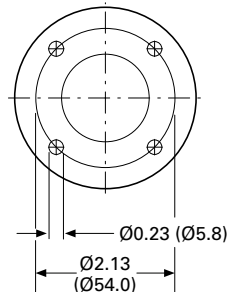
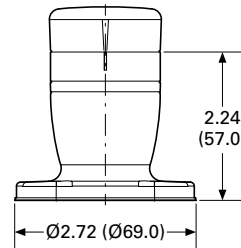

2.1

Stacklights

SL Series

Approximate Dimensions in Inches (mm)

2

SL4-PIB-FW

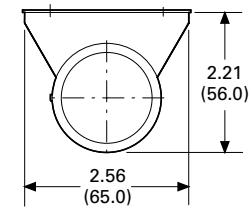
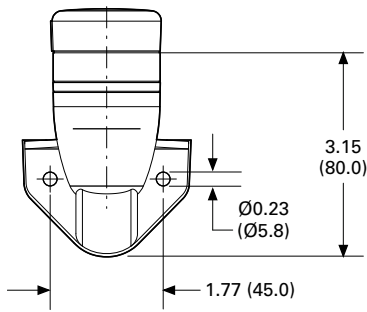

SL4-PIB-IMH

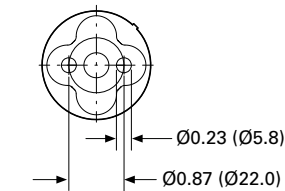
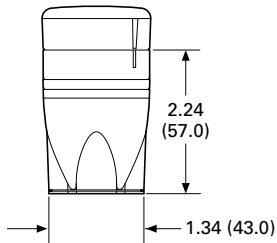

SL4-PIB-IMS

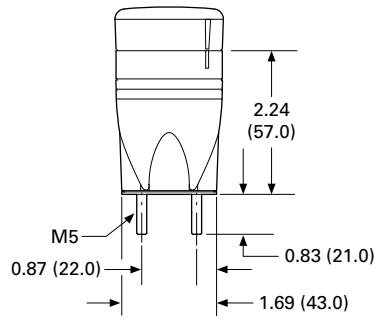

SL4-FMS-...

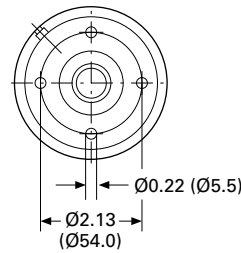
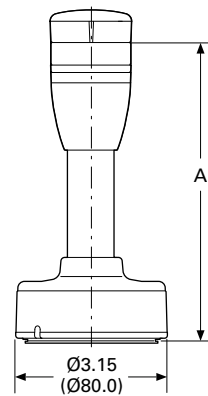

SL4-SWD^①

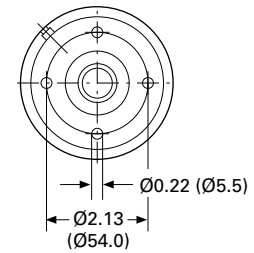
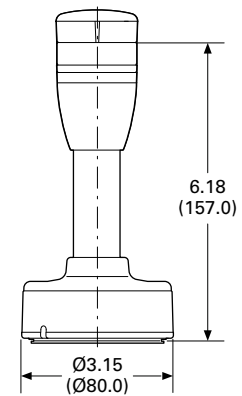

Catalog Number	A
SL4-FMS-100	6.18 (157.0)
SL4-FMS-250	12.09 (307.0)
SL4-FMS-400	17.99 (457.0)

Note

① For connecting to SmartWire-DT.

Approximate Dimensions in Inches (mm)

Mounting Brackets

SL7/4-FW

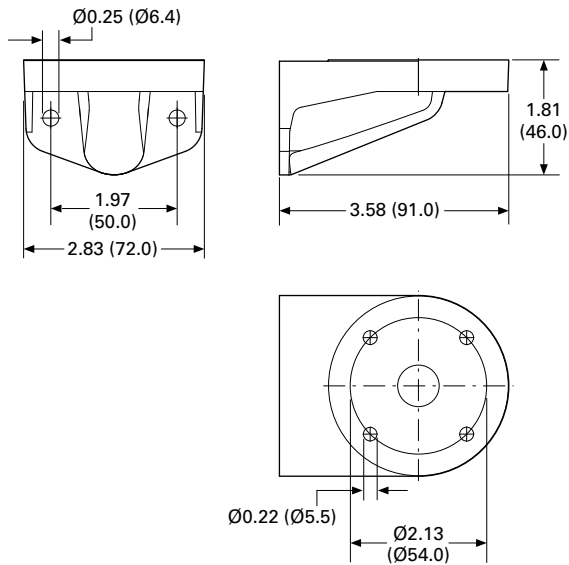

SL7/4-FW-T

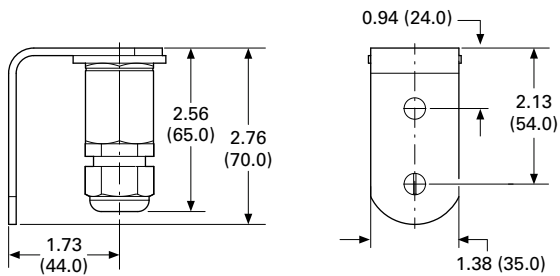

Incandescent Bulbs

SL7-L12 and SL4-L12

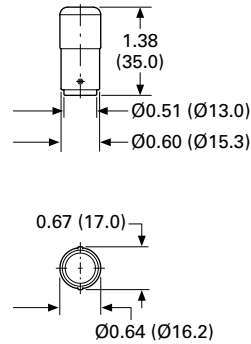

Tool for Replacing Incandescent Bulb

SL7/4-BET

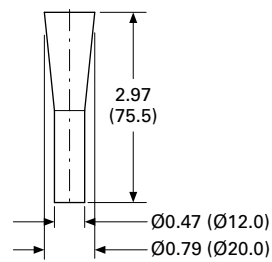

Stacklights—E26 Series

2



Product Description

The E26 stacklight unit is a modular system that provides illuminated and audible status indication in all directions. Easily assembled plug-in modular units include constant, flashing and strobe light units, as well as mono-tonal, bi-tonal, intermittent audible alarms. Stacklights may be assembled in a variety of configurations, which are identified in the Maximum Configurations table on **Page V7-T2-33**. Several lamp, color and mounting options further enhance the stacklight's versatility.

Features

- Modular construction
- Six lens colors
- Variety of lamp types and voltages
- Mono-tonal, bi-tonal and intermittent audible alarms

Benefits

- Combination of visible and audible alarms
- Modular components reduce inventory requirements, increase flexibility
- Steady and flashing modes allow one light to signal multiple conditions
- No-tools assembly permits easy lamp replacement

Standards and Certifications

- CE 60947-5-1
- UL 508—File No. E131568
- cUL C22.2 No. 14—File No. E131568



Ingress Protection

- Stacklight base and light units: IP65, NEMA 4, 4X and 13
- Alarm units: IP20, NEMA 1

Electrical Shock Protection

- Stacklight base and light unit: IP2X
- Alarm units: IPOX

Contents

Description	Page
E26 Series	
Product Identification	V7-T2-33
Catalog Number Selection	V7-T2-34
Product Selection	V7-T2-35
Replacement Parts	V7-T2-40
Technical Data and Specifications	V7-T2-41
Ratings	V7-T2-42
Mounting Instructions	V7-T2-43
Dimensions	V7-T2-44

Product Identification



Standard Stacklight Base

For use with incandescent or standard LEDs for steady, non-flashing illumination or with flashing LEDs for flashing illumination. Bases include terminal block for wiring, stacklight cover and gasket. See **Page V7-T2-38**.



Flashing Stacklight Base

Allows configuration of each light in the stack for either steady or 60 times per minute flashing illumination. Flashing circuit for use with incandescent lamps only. (Maximum allowable number of light modules is 2 at 12V, 4 at 24V and 6 at 48V and above.) See **Page V7-T2-38**.

For flashing LEDs use standard base with flashing LED light module.



Light Modules

Available in a variety of colors for both incandescent lamps and LED lamps. To maximize illumination and light dispersion, incandescent units include an opal white diffuser while LED diffusers are clear. See **Page V7-T2-36**.



Xenon Strobe

Sets are similar to standard lens/diffuser units, except each set consists of two lens units. The lower unit includes the electronics and is permanently fused to the upper unit which contains the Xenon lamp. Xenon units may be placed in any position in a complete stacklight unit. They will flash 60 times per minute when used with a standard or flashing base. See **Page V7-T2-36**.



Alarms

May be fitted to the top of a complete stacklight unit or directly to the stacklight bases, if desired. Available in three versions, each with adjustable sound levels. See **Page V7-T2-39**.

Complete Stacklight Modules



- Stacklights accept a maximum of six incandescent or LED light modules or two Xenon Flasher modules and can be mounted in any position on the stack.
- Alarm units are mounted in the top most position only.

Maximum Configurations

Incandescent or LED Modules	Xenon Modules	Alarm Modules	Max. Number of Modules
6	—	—	6
5	—	1	6
4	1	—	5
3	1	1	5
2	2	—	4
1	2	1	4

Catalog Number Selection

Stacklight Catalog Numbering System

2

E26X 9 KM L 39R W - V 4

Mounting Base ^①		
Code	Description	Component Catalog No.
W	None (base mount)	—
4	3/4 in NPT hub, chrome	E26S104
8	Standard three-hole	E26S108
9	Standard four-hole	E26S109

Extension Tube ^⑤		
Code	Description	Component Catalog No.
W	None (base mount)	—
Gray Aluminum		
HM	20 mm 3/4 in NPT	E26BHM
JM	160 mm 3/4 in NPT	E26BJM
KM	360 mm 3/4 in NPT	E26BKM
MM	760 mm 3/4 in NPT	E26BMM
Black Aluminum		
HU	20 mm 3/4 in NPT	E26BHU
JU	160 mm 3/4 in NPT	E26BJU
KU	360 mm 3/4 in NPT	E26BKU
MU	760 mm 3/4 in NPT	E26BMU
RU	Right angle 3/4 in NPT	E26BRU

Stacklight Base		
Code	Description	Component Catalog No. ^②
L	Standard	E26BL
F	Flashing ^⑥	E26BF_

Alarm		
Code	Description	Component Catalog No. ^②
W	None	—
Q	Mono-tonal	E26BQ_
N	Bi-tonal	E26BN_
P	Intermittent	E26BP_

Voltage ^③	
Code	Description
V1	12V
V2	24V
V3	48V
V4	120V
V5 ^④	240V

Light Module		
Code	Description	Component Catalog No. ^②
0	Clear incandescent	E26B0_
2	Red incandescent	E26B2_
3	Green incandescent	E26B3_
4	Yellow incandescent	E26B4_
6	Blue incandescent	E26B6_
9	Amber incandescent	E26B9_
W	White cluster LED with clear lens	E26BW_
R	Red cluster LED with red lens	E26BR_
G	Green cluster LED with green lens	E26BG_
Y	Yellow cluster LED with yellow lens	E26BY_
B	Blue cluster LED with blue lens	E26BB_
A	Amber cluster LED with amber lens	E26BA_
W1	White cylindrical LED with clear lens ^④	E26BW1_
R1	Red cylindrical LED with red lens ^④	E26BR1_
G1	Green cylindrical LED with green lens ^④	E26BG1_
Y1	Yellow cylindrical LED with yellow lens ^④	E26BY1_
B1	Blue cylindrical LED with blue lens ^④	E26BB1_
A1	Amber cylindrical LED with amber lens ^④	E26BA1_
M	Flashing white cluster LED with clear lens	E26BM_
E	Flashing red cluster LED with red lens	E26BE_
U	Flashing green cluster LED with green lens	E26BU_
V	Flashing yellow cluster LED with yellow lens	E26BV_
K	Flashing blue cluster LED with blue lens	E26BK_
Z	Flashing amber cluster LED with amber lens	E26BZ_
X0	Xenon flasher with clear lens	E26BX0_
X2	Xenon flasher with red lens	E26BX2_
X3	Xenon flasher with green lens	E26BX3_
X4	Xenon flasher with yellow lens	E26BX4_
X6	Xenon flasher with blue lens	E26BX6_
X9	Xenon flasher with amber lens	E26BX9_

Voltage Codes

Voltage Code	Incandescent Lamp	Cluster LED	Cylindrical LED	Xenon Flasher	Flasher Base/Alarm
(Blank)	No lamp supplied	No LED supplied	No LED supplied	—	—
V1	12 Vac/Vdc	12 Vac/Vdc	12 Vac/Vdc	12 Vac/Vdc	12 Vac/Vdc
V2	24 Vac/Vdc	24 Vac/Vdc	24 Vac/Vdc	24 Vac/Vdc	24 Vac/Vdc
V3	48 Vac/Vdc	48 Vac/Vdc	48 Vac/Vdc	48 Vac/Vdc	48 Vac/Vdc
V4	120 Vac/Vdc	120 Vac	120 Vac	120 Vac	120 Vac/Vdc
V5	240 Vac/Vdc	240 Vac	—	240 Vac	240 Vac/Vdc

Notes

- ① Unless base mount is specified, an extension tube must be selected for a complete unit.
- ② Component catalog numbers for flashing bases, alarm units and light modules are incomplete and require the addition of a suffix code to specify the required voltage rating. See table above.
- ③ If no voltage is specified, assembled stacklight will be supplied without lamps or LEDs.
- ④ 240V not available for cylindrical LEDs.
- ⑤ For complete length (extension tube and base), see **Page V7-T2-39**.
- ⑥ Flashing base is for use with incandescent lamps.

Product Selection

Assembled Units

One-, Two- and Three-Light Assembled Stacklights

- Base mountable
- Incandescent or LED versions
- 24V and 120V versions

One-Light Unit Stacklight

Volts AC/DC	Alarm	First Level Color	Illumination Type	Catalog Number
24V	None	Red	Incandescent—steady	E26XWWL2W-V2
24V	None	Red	Cylindrical LED—steady	E26XWWLR1W-V2
24V	None	Green	Incandescent—steady	E26XWWL3W-V2
24V	None	Green	Cylindrical LED—steady	E26XWWLG1W-V2
24V	None	Amber	Incandescent—steady	E26XWWL9W-V2
24V	None	Amber	Cylindrical LED—steady	E26XWWLA1W-V2
120V	None	Red	Incandescent—steady	E26XWWL2W-V4
120V ^①	None	Red	Cylindrical LED—steady	E26XWWLR1W-V4
120V	None	Green	Incandescent—steady	E26XWWL3W-V4
120V ^①	None	Green	Cylindrical LED—steady	E26XWWLG1W-V4
120V	None	Amber	Incandescent—steady	E26XWWL9W-V4
120V ^①	None	Amber	Cylindrical LED—steady	E26XWWLA1W-V4

Two-Light Unit Stacklight

Volts AC/DC	Alarm	First Level Color	Illumination Type	Second Level Color	Illumination Type	Catalog Number
24V	None	Green	Incandescent—steady	Red	Incandescent—steady	E26XWWL32W-V2
24V	None	Green	Cylindrical LED—steady	Red	Cylindrical LED—steady	E26XWWLG1R1W-V2
120V	None	Green	Incandescent—steady	Red	Incandescent—steady	E26XWWL32W-V4
120V ^①	None	Green	Cylindrical LED—steady	Red	Cylindrical LED—steady	E26XWWLG1R1W-V4

Three-Light Unit Stacklight

Volts AC/DC	Alarm	First Level Color	Illumination Type	Second Level Color	Illumination Type	Third Level Color	Illumination Type	Catalog Number
24V	None	Green	Incandescent—steady	Amber	Incandescent—steady	Red	Incandescent—steady	E26XWWL392W-V2
24V	None	Green	Cylindrical LED—steady	Amber	Cylindrical LED—steady	Red	Cylindrical LED—steady	E26XWWLG1A1R1W-V2
120V	None	Green	Incandescent—steady	Amber	Incandescent—steady	Red	Incandescent—steady	E26XWWL392W-V4
120V ^①	None	Green	Cylindrical LED—steady	Amber	Cylindrical LED—steady	Red	Cylindrical LED—steady	E26XWWLG1A1R1W-V4

Note

- ^① LED modules have very low current draw and should not be used with triac output devices like PLC triac output modules. It is recommended that dry contact outputs be used to switch 120 Vac modules.

Light and Xenon Strobe Modules

2

- Light modules include lens diffusers which provide even illumination and eliminate hot spots.
- Xenon strobes emit a bright attention-getting white flashing light. Flash rate = 60/min.
- Xenon strobe modules occupy two positions in the stacklight assembly.

Light/LED Module



Xenon Strobe Module



Light and Xenon Strobe Modules ^①

LED/Lamp Voltage	Lens Color	Incandescent Steady or Flashing Catalog Number	Cylindrical LED Steady Only Catalog Number	Cluster LED Steady Catalog Number	Cluster LED Flashing Catalog Number	Xenon Flashing Catalog Number
Without bulb or LED	Red	E26B2	E26B	E26BR	E26BR	—
	Green	E26B3	E26BG	E26BG	E26BG	—
	Yellow	E26B4	E26BY	E26BY	E26BY	—
	Blue	E26B6	E26BB	E26BB	E26BB	—
	Amber	E26B9	E26BA	E26BA	E26BA	—
	Clear	E26B0	E26BW	E26BW	E26BW	—
12 Vac/Vdc	Red	E26B2V1	E26BR1V1	E26BRV1	E26BEV1	E26BX2V1
	Green	E26B3V1	E26BG1V1	E26BGV1	E26BUV1	E26BX3V1
	Yellow	E26B4V1	E26BY1V1	E26BYV1	E26BVV1	E26BX4V1
	Blue	E26B6V1	E26BB1V1	E26BBV1	E26BKV1	E26BX6V1
	Amber	E26B9V1	E26BA1V1	E26BAV1	E26BZV1	E26BX9V1
	Clear	E26B0V1	E26BW1V1	E26BWW1	E26BMV1	E26BX0V1
24 Vac/Vdc	Red	E26B2V2	E26BR1V2	E26BRV2	E26BEV2	E26BX2V2
	Green	E26B3V2	E26BG1V2	E26BGV2	E26BUV2	E26BX3V2
	Yellow	E26B4V2	E26BY1V2	E26BYV2	E26BVV2	E26BX4V2
	Blue	E26B6V2	E26BB1V2	E26BBV2	E26BKV2	E26BX6V2
	Amber	E26B9V2	E26BA1V2	E26BAV2	E26BZV2	E26BX9V2
	Clear	E26B0V2	E26BW1V2	E26BWW2	E26BMV2	E26BX0V2
48 Vac/Vdc	Red	E26B2V3	E26BR1V3	E26BRV3	E26BEV3	E26BX2V3
	Green	E26B3V3	E26BG1V3	E26BGV3	E26BUV3	E26BX3V3
	Yellow	E26B4V3	E26BY1V3	E26BYV3	E26BVV3	E26BX4V3
	Blue	E26B6V3	E26BB1V3	E26BBV3	E26BKV3	E26BX6V3
	Amber	E26B9V3	E26BA1V3	E26BAV3	E26BZV3	E26BX9V3
	Clear	E26B0V3	E26BW1V3	E26BWW3	E26BMV3	E26BX0V3
120 Vac ^②	Red	E26B2V4	E26BR1V4	E26BRV4	E26BEV4	E26BX2V4
	Green	E26B3V4	E26BG1V4	E26BGV4	E26BUV4	E26BX3V4
	Yellow	E26B4V4	E26BY1V4	E26BYV4	E26BVV4	E26BX4V4
	Blue	E26B6V4	E26BB1V4	E26BBV4	E26BKV4	E26BX6V4
	Amber	E26B9V4	E26BA1V4	E26BAV4	E26BZV4	E26BX9V4
	Clear	E26B0V4	E26BW1V4	E26BWW4	E26BMV4	E26BX0V4
240 Vac ^②	Red	E26B2V5	—	E26BRV5	E26BEV5	E26BX2V5
	Green	E26B3V5	—	E26BGV5	E26BUV5	E26BX3V5
	Yellow	E26B4V5	—	E26BYV5	E26BVV5	E26BX4V5
	Blue	E26B6V5	—	E26BBV5	E26BKV5	E26BX6V5
	Amber	E26B9V5	—	E26BAV5	E26BZV5	E26BX9V5
	Clear	E26B0V5	—	E26BWW5	E26BMV5	E26BX0V5

Notes

- ① Include lens, diffusers and lamps unless otherwise noted.
- ② Incandescent bulbs are AC/DC rated, LEDs are AC rated only.

LEDs—Cylindrical or Cluster

Cylindrical
Stacklight LED

Cylindrical or Cluster LEDs

Cluster LED



Voltage	Color	Cylindrical LED Steady Only Catalog Number	Cluster LED Steady Catalog Number	Cluster LED Flashing Catalog Number
12 Vac/Vdc	Red	E26S110	E26S15	E26S48
	Green	E26S114	E26S19	E26S53
	Yellow	E26S112	E26S23	E26S58
	Blue	E26S115	E26S27	E26S63
	White	E26S116	E26S71	E26S75
	Amber	E26S111	E26S79	E26S84
	24 Vac/Vdc	Red	E26S117	E26S16
Green		E26S121	E26S20	E26S54
Yellow		E26S119	E26S24	E26S59
Blue		E26S122	E26S28	E26S64
White		E26S123	E26S72	E26S76
Amber		E26S118	E26S80	E26S85
48 Vac/Vdc		Red	E26S124	E26S17
	Green	E26S128	E26S21	E26S55
	Yellow	E26S126	E26S25	E26S60
	Blue	E26S129	E26S29	E26S65
	White	E26S130	E26S73	E26S77
	Amber	E26S125	E26S81	E26S86
	120 Vac/Vdc	Red	E26S138	E26S18
Green		E26S142	E26S22	E26S56
Yellow		E26S140	E26S26	E26S61
Blue		E26S143	E26S30	E26S66
White		—	E26S74	E26S78
Amber		E26S139	E26S82	E26S87
240 Vac/Vdc	Red	—	E26S44	E26S52
	Green	—	E26S45	E26S57
	Yellow	—	E26S46	E26S62
	Blue	—	E26S47	E26S67
	White	—	E26S101	E26S102
	Amber	—	E26S83	E26S88

Mounting Bases Components

Standard Base

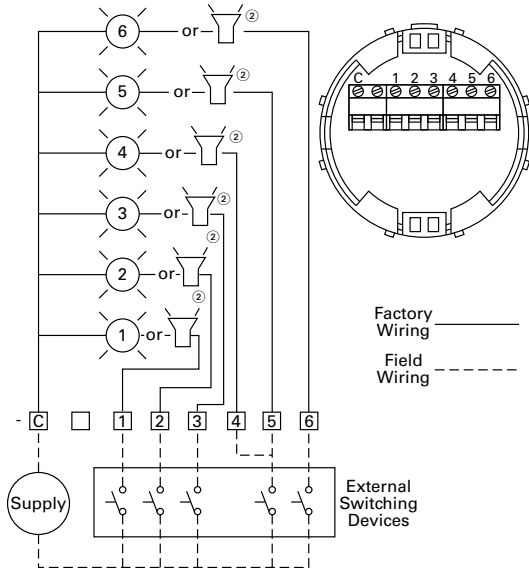

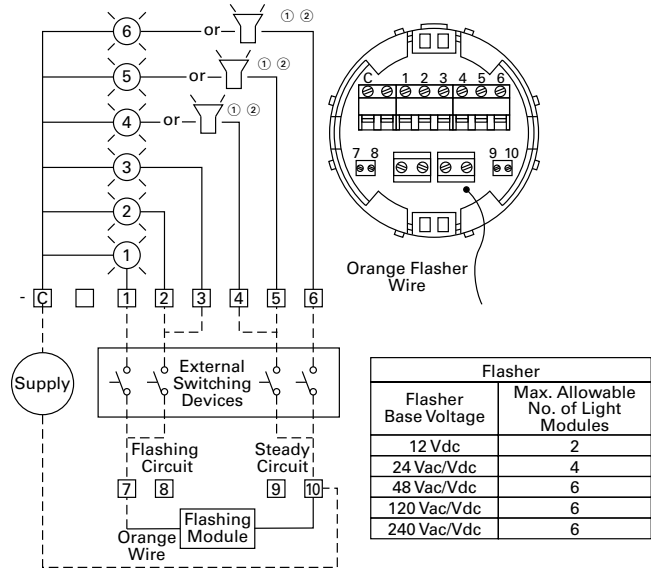

Flashing Base



Description	Voltage	Catalog Number
Standard Base		
For use with steady incandescent or steady/flashing LED	12 Vac/Vdc to 240 Vac/Vdc	E26BL
Flashing Base		
Enables configuration of incandescent light modules for steady or flashing operation	12 Vdc	E26BFV1
	24 Vac/Vdc	E26BFV2
	48 Vac/Vdc	E26BFV3
	120 Vac/Vdc	E26BFV4
	240 Vac/Vdc	E26BFV5

Mounting Bases and Hubs

Description	Voltage	Catalog Number
Standard Three-Hole Mounting Base		
 Standard three-hole mounting base	—	E26S108
Standard Four-Hole Mounting Base		
 Standard four-hole mounting base	—	E26S109
Myers Type Hub		
 3/4 in NPT threaded hub	—	E26S104

Notes

- ① Audible alarm units must be wired via the steady circuit on flashing base units.
- ② Audible alarm units can be wired in positions as shown but only one unit is permitted on each stack and unit must occupy the last or top mounting position.

Alarm Units and Extension Tubes Components

E26B_



Audible Alarm Units-NEMA Type 1 (IP20) ①

Description	Voltage	Catalog Number
Mono-Tonal		
4.5 mA	12 Vac/Vdc	E26BQV1
12.6 mA	24 Vac/Vdc	E26BQV2
9.4 mA	48 Vac/Vdc	E26BQV3
11.5 mA	120 Vac/Vdc	E26BQV4
5.1 mA	240 Vac/Vdc	E26BQV5
Bi-Tonal		
4.5 mA	12 Vac/Vdc	E26BNV1
12.6 mA	24 Vac/Vdc	E26BNV2
9.4 mA	48 Vac/Vdc	E26BNV3
11.5 mA	120 Vac/Vdc	E26BNV4
5.1 mA	240 Vac/Vdc	E26BNV5
Intermittent		
4.5 mA	12 Vac/Vdc	E26BPV1
12.6 mA	24 Vac/Vdc	E26BPV2
9.4 mA	48 Vac/Vdc	E26BPV3
11.5 mA	120 Vac/Vdc	E26BPV4
5.1 mA	240 Vac/Vdc	E26BPV5

Extension Tubes

Extension Tube

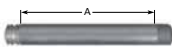

Description	Voltage	Catalog Number
Extension "A" ②		
0.79 in (20 mm) extension	—	E26BHM
6.30 in (160 mm) extension	—	E26BJM
14.17 in (360 mm) extension	—	E26BKM
29.92 in (760 mm) extension	—	E26BMM

Extension Tube

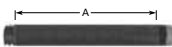

Extension "A" ③		
0.79 in (20 mm) extension	—	E26BHU
6.30 in (160 mm) extension	—	E26BJU
14.17 in (360 mm) extension	—	E26BKU
29.92 in (760 mm) extension	—	E26BMU

E26BRU



Right angle extension tube	—	E26BRU
----------------------------	---	--------

Notes

- ① Volume adjustment range: 64 dB to 90 dB typical current draw (mA).
- ② For use with standard mounting base or 3/4 in NPT threaded hub—gray aluminum.
- ③ For use with standard mounting base or 3/4 in NPT threaded hub—black aluminum.

Replacement Parts

2

Stacklight Replacement Parts

Description	Notes	Number in Diagram	Catalog Number
Replacement cover	Normally included with stacklight base	1	E26S68
Replacement lens O-ring	Normally included with light modules	2	E26S106 ^①
Replacement lenses	Clear	3	E26S38
	Red		E26S39
	Green		E26S40
	Yellow		E26S41
	Blue		E26S42
	Amber		E26S43
Replacement Xenon strobe dual high (does not include lenses)	12 Vac/Vdc	4	E26S33
	24 Vac/Vdc		E26S34
	48 Vac/Vdc		E26S35
	120 Vac		E26S36
	240 Vac		E26S37
Replacement diffusers	White — normally supplied with incandescent light modules	4	E26S31
	Clear — normally supplied with LED light modules		E26S32
Replacement lamps ^②	12V	5	E26S8
	24V		E26S9
	48V		E26S10
	120V		E26S11
	240V		E26S12
Replacement extension tube O-rings	Normally included with extension tubes	6	E26S107 ^③
Replacement mounting gasket ^④	Normally included with stacklight base	7	E26S105
Lamp removal tool	For E26 and E22 incandescent lamps		E22BA3

Typical Stacklight Assemblies

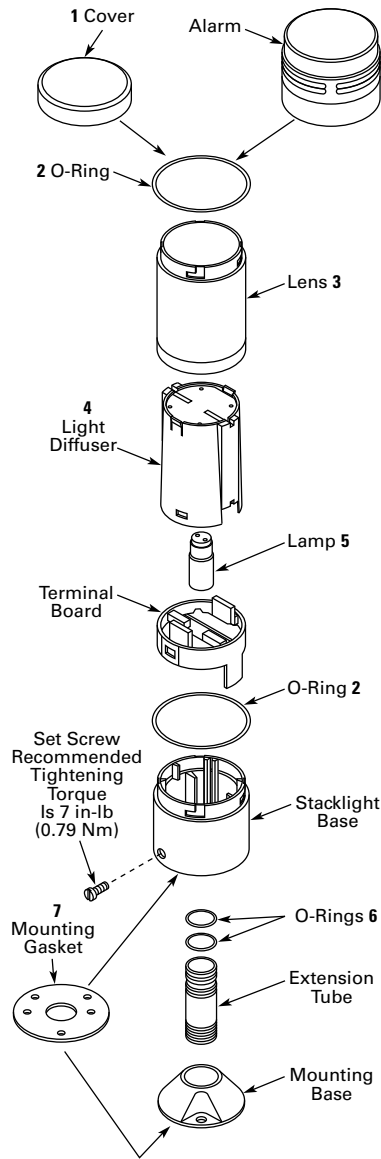

Typical Stacklight Assembly (Exploded View)

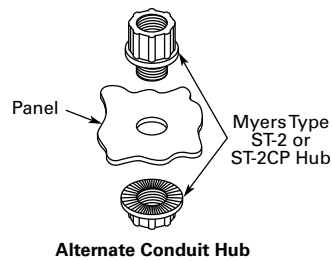

Notes

- ① Sold in packages of 5 pieces.
- ② For replacement LEDs, see table on **Page V7-T2-37**.
- ③ Sold in packages of 10 pieces.
- ④ Mounting gaskets have two sets of mounting holes—one set with center-to-center spacing of 1.75 in (44.5 mm) and another set with center-to-center spacing of 1.65 in (42 mm).

Technical Data and Specifications

General Specifications

Description	Specification
Mechanical Ratings	
Shock (IEC 68-2-27)	11 ms, 15g
Vibration (IEC 68-2-6)	10 sweeps 10–150 Hz, 2g
Bump (IEC 68-2-29)	1000 pulses, 6 ms, 15g
Climate Conditions	
Operating	Maximum 104°F (40°C) at 95% RH, Temperature –4° to 140°F (–20° to 60°C)
Storage	Temperature –40° to 176°F (–40° to 80°C)
Materials	
Cover	Polycarbonate
Lenses	Polycarbonate
Stacklight base	Nylon
Extension tubes	Aluminum
Mounting base	Zinc die cast
Terminals	
Single conductor	14–30 AWG (2.5–0.05 mm ²)
Two conductors (same size)	18–26 AWG (0.75–0.14 mm ²) Do not mix solid and stranded wire in the same terminal
Recommended tightening torque	4.4–5.3 lb-in (0.5–0.6 Nm)
Electrical Ratings	
Insulation voltage (U _i)	690V
Operational voltage (U _o)	250V
Impulse withstand voltage (U _{imp})	1.5 kV
Bulb Specifications	
Incandescent lamp type	BA15d
Maximum lamp wattage	6W
Bulbs—average life	
Incandescent	7,000 to 12,000 hrs. (based on voltage)
Xenon flasher	20,000 hrs.
LED	60,000 to 100,000 hrs. (based on colors)
LED/Incandescent Comparison	
Incandescent lamps	Average operating life of 7,000 hours Each lamp can be used with any color lens Low cost results in short term savings
LED lamps	Average operating life of 60,000 to 100,000 hours Low power consumption Extended life results in long-term savings

Ratings

Published theoretical lamp lives are based on ideal laboratory conditions and should be used for comparison only. Actual life may be shorter due to various application conditions.

2

Stacklight Incandescent Application Data

Type of Light	Lamp Used	Approximate Current, mA per Light	Theoretical Lamp Life, Hours as Applied
12V	BA15d	417	7,000
24V	BA15d	208	7,000
48V	BA15d	104	7,000
110–140V	BA15d	36–50	7,000
220–260V	BA15d	23–27	12,000

Xenon Flasher Application Data

Type of Light	Lamp Used	Approximate Current, mA per Light	Theoretical Lamp Life, Hours as Applied
12V	DC	460 mA	20,000
	AC	780 mA	20,000
24V	DC	190 mA	20,000
	AC	320 mA	20,000
48V	DC	100 mA	20,000
	AC	150 mA	20,000
120V	AC	60 mA ^①	20,000
240V	AC	30 mA ^①	20,000

LED Application Data

Type of Light	Color	Cluster LED Approximate Current, mA at Rated Volts	Cylindrical LED Approximate Current, mA at Rated Volts	Theoretical Lamp Life, Hours as Applied
Continuous/Flashing Stacklight LED				
12 Vac/Vdc	Red	92	92	100,000
	Amber	92	92	100,000
	Yellow	92	92	100,000
	Green	60	60	80,000
	Blue	60	60	60,000
	White	60	60	60,000
24 Vac/Vdc	Red	47	47	100,000
	Amber	47	47	100,000
	Yellow	47	47	100,000
	Green	59	59	80,000
	Blue	59	59	60,000
	White	59	59	60,000
48 Vac/Vdc	Red	25	25	100,000
	Amber	25	25	100,000
	Yellow	25	25	100,000
	Green	18	18	80,000
	Blue	31	31	60,000
	White	31	31	60,000
60 Vac/Vdc	Red	25	25	100,000
	Amber	25	25	100,000
	Yellow	25	25	100,000
	Green	18	18	80,000
	Blue	17	17	60,000
	White	17	17	60,000
120 Vac/Vdc	Red	24	24	100,000
	Amber	24	24	100,000
	Yellow	24	24	100,000
	Green	17	17	80,000
	Blue	16	16	60,000
	White	16	16	60,000

Note

^① Represents average current draw, 1.6A peak for 120V and 0.8A peak at 240V.

Mounting Instructions

Stacklight bases may be mounted without the use of an extension tube or mounting base. If additional height is required, choose

0.8–30 in (20–760 mm) extension tubes that fit between the mounting base and stacklight base. The extension tubes are threaded

with 3/4 in NPT threads, allowing for direct connection to conduit fittings or threaded holes without the use of a mounting base.

Base Mounting

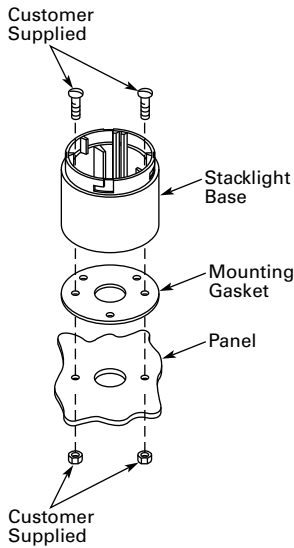

Utilizing Extension Tube and Mounting Base

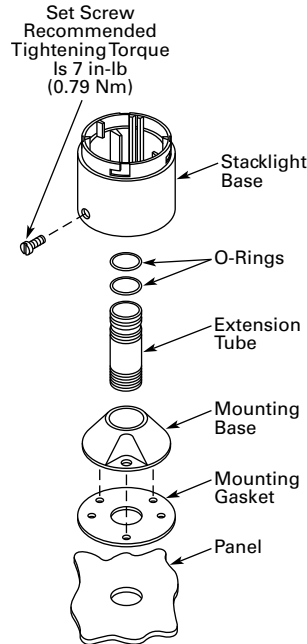

Utilizing Extension Tube and 3/4 In (19.1 mm) Conduit Hub

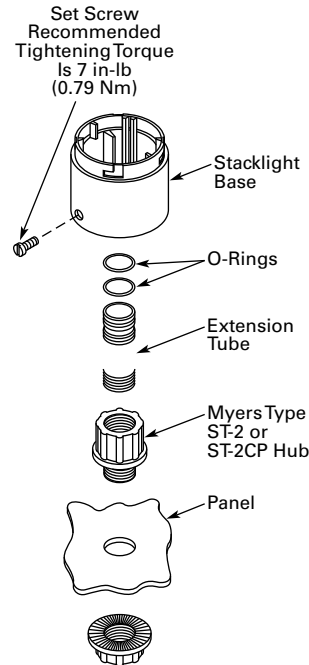

(Use Rubber-Jawed Pliers for Installation to Avoid Scratching the Black Anodized Coating)

Mounting Dimensions

Approximate Dimensions in Inches (mm)

Base Mounting

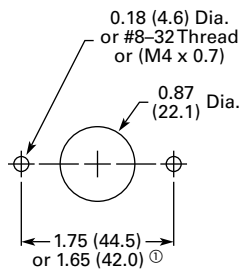

Three-Hole Mounting for E26S108

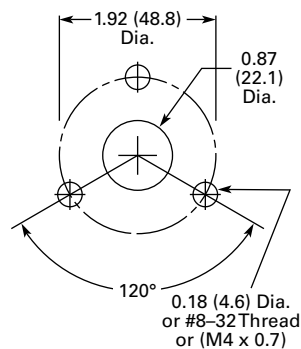

Four-Hole Mounting for E26S109

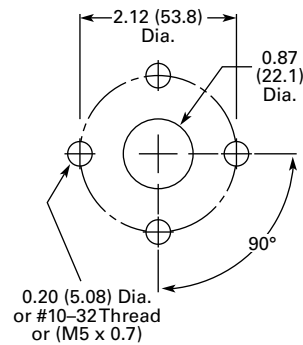

Conduit Hub for E26S104–3/4 In (19.1 mm)

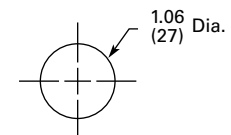

Note

① Stacklight base and gasket are supplied as standard with two sets of base mount holes. One set with center-to-center spacing of 1.75 in (44.5 mm) and another set with center-to-center spacing of 1.65 in (42 mm).

Dimensions

Approximate Dimensions in Inches (mm)

Standard and Flashing Bases ①

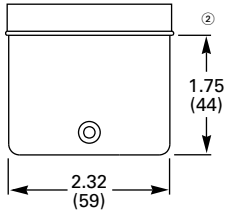

Alarm Units

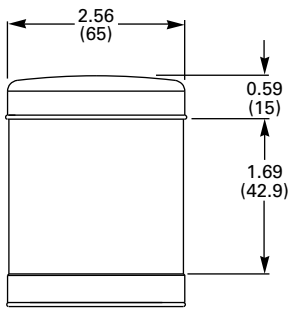

Assembled Extension Tubes

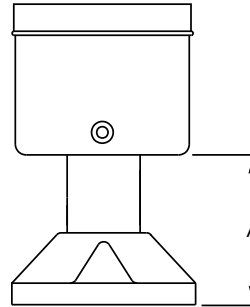

Tube Extension	Height A
0.79 (20)	1.77 (45)
6.30 (160)	7.28 (185)
14.17 (360)	15.16 (385)
29.92 (760)	30.91 (785)

Right Angle Extension Tubes

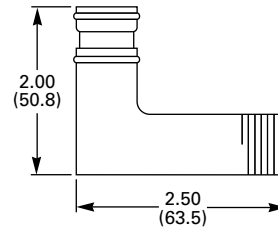

Notes

- ① Bases also suitable for mounting with extension tubes listed on [Page V7-T2-39](#).
- ② Mounting gasket and cover are supplied as standard with stacklight bases.

Approximate Dimensions in Inches (mm)

One-Light Unit Stacklight

Standard

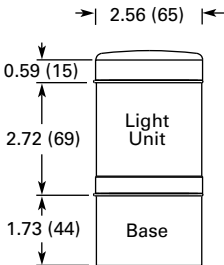

With Alarm

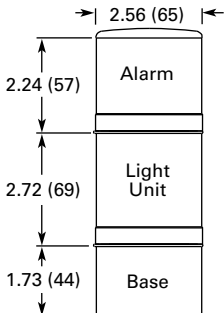

With Xenon Flasher

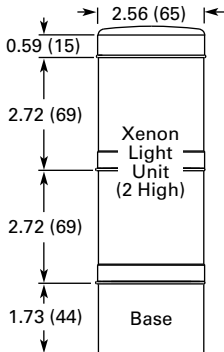

Two-Light Unit Stacklight

Standard

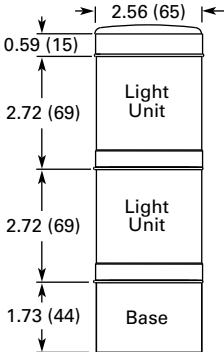

With Alarm

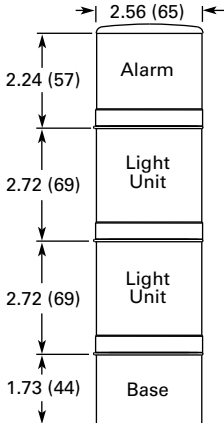

With Xenon Flasher

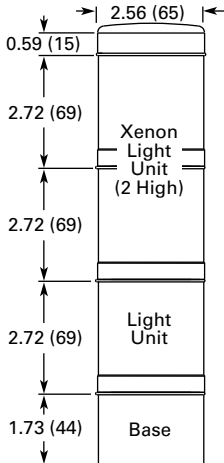

2.2

Stacklights

E26 Series

Approximate Dimensions in Inches (mm)

2

Three-Light Unit Stacklight

Standard

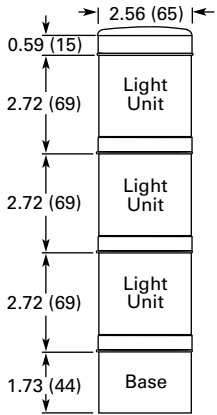

With Alarm

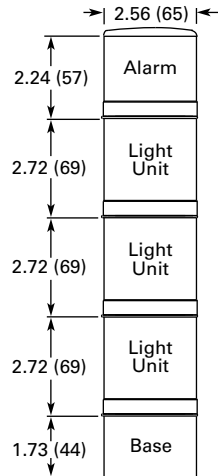

With Xenon Flasher

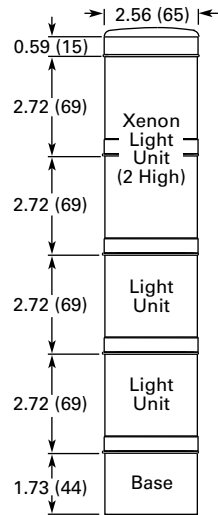

Light Modules

Standard

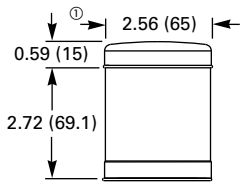

Xenon

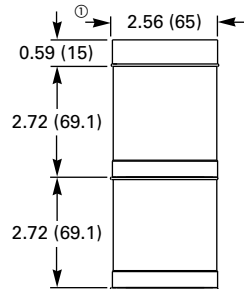

Note

① Cover included with stacklight base.

easyRelay Programmable Relays



D1 Series General Purpose Relay



D96 Series Solid-State Relay



Universal TR Series Timing Relay



Safety Relay



3.1 Relay Products

Control Relays and Timers Comparison **V7-T3-2**

3.2 XR Series Terminal Block Relays

Standard, OptoCoupler and High Current
 Catalog Number Selection **V7-T3-3**

3.3 Programmable Relays

easy500, easy700, easy800, easy802/806 Relays and MFD-Titan Multi-Function Displays
 Product Overview **V7-T3-19**

3.4 General Purpose Plug-In Relays

General Purpose Relays—D1, D2, D3, D4, D5, D7, D8 and D9 Series
 Product Selection Guide **V7-T3-49**

3.5 General Purpose Open Style Relays

9575H Series 3000 Relay
 9575H Series 3000—Type AA, AC and DC **V7-T3-118**

3.6 Solid-State Relays

D93, D96 and D99 Series
 Product Overview **V7-T3-122**

3.7 Machine Tool Relays

D15, BF/BFD, AR/ARD and D26 Series
 Product Overview **V7-T3-141**

3.8 Timing Relays

Universal TR, TR and TMR Series
 Product Selection Guide **V7-T3-167**

3.9 Alternating Relays

D85 Series
 Product Description **V7-T3-188**

3.10 Safety Relays

ESR5 Series
 Product Description **V7-T3-193**

3.11 easySafety

ES4P Series
 Product Description **V7-T3-199**

3.1

Control Relays and Timers

Relay Product Overview

Relay Products

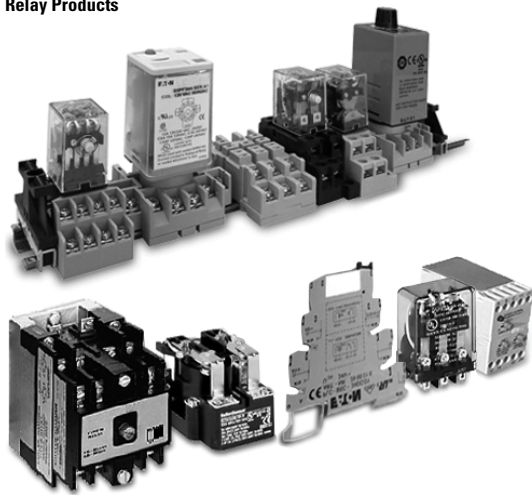

3

Contents

<i>Description</i>	<i>Page</i>
Terminal Block Relays	V7-T3-3
Programmable Relays	V7-T3-19
General Purpose Plug-In Relays	V7-T3-49
General Purpose Type AA Relays	V7-T3-118
Solid-State Relays	V7-T3-122
Machine Tool Relays	V7-T3-141
Timing Relays	V7-T3-167
Alternating Relays	V7-T3-188
Safety Relays	V7-T3-193

Control Relays and Timers Comparison

Selection Guide by Catalog Number Prefix

Relays	Type	Mounting	Contacts	Maximum Amperage (AC)	RU	UL	CSA	CE	Page Number
9575H3	General purpose	Panel mount	Fixed	40 A	—	■	■	■	V7-T3-119
AR/ARD	Machine tool	Panel mount	Convertible	10 A	—	■	■	—	V7-T3-154
BF/BFD	Machine tool	Panel mount	Fixed	10 A	■	—	■	—	V7-T3-148
D2RF	Full featured plug-in	DIN rail / panel mount	Fixed	10 A	■	—	■	■	V7-T3-59
D2RR	Standard plug-in	DIN rail / panel mount / flange	Fixed	10 A	■	—	■	■	V7-T3-59
D3RF	Full featured plug-in	DIN rail / panel mount	Fixed	16 A	■	—	■	■	V7-T3-69
D3RR	Standard plug-in	DIN rail / panel mount	Fixed	16 A	■	—	■	■	V7-T3-69
D4PR	Standard plug-in	DIN rail / panel mount	Fixed	10 A	■	—	■	■	V7-T3-77
D5RF	Full featured plug-in	DIN rail / panel mount	Fixed	16 A	■	—	■	■	V7-T3-82
D5RR	Standard plug-in	DIN rail / panel mount / PC board	Fixed	16 A	■	—	■	■	V7-T3-82
D7PF	Full featured plug-in	DIN rail / panel mount	Fixed	20 A	■	—	■	■	V7-T3-91
D7PR	Standard plug-in	DIN rail / panel mount / flange	Fixed	20 A	■	—	■	■	V7-T3-91
D8PR	Standard plug-in	DIN rail / panel mount / flange	Fixed	30 A	■	—	■	■	V7-T3-104
D9PR	Standard plug-in	Panel mounting	Fixed	25 A	■	—	■	—	V7-T3-109
D15	Machine tool	DIN rail / panel mount	Fixed	10 A	—	■	■	■	V7-T3-143
D26	Machine tool	Panel or channel mount	Convertible	10 A	—	■	■	—	V7-T3-159
D85	Alternating relays	DIN rail / panel mount	Fixed	10 A	■	■	—	■	V7-T3-189
D1RF	Full featured plug-in	DIN rail / panel mount	Fixed	20 A	■	—	■	■	V7-T3-54
D1RR	Standard plug-in	DIN rail / panel mount	Fixed	20 A	■	—	■	■	V7-T3-54
easyRelay	Programmable relay	DIN rail	Fixed	8 A	—	■	■	■	V7-T3-23
TMR5	Timing relay (non-programmable)	DIN rail / panel mount	Fixed	10 A	■	■	—	■	V7-T3-180
TMR6	Timing relay (non-programmable)	DIN rail / panel mount	Fixed	10 A	■	■	—	■	V7-T3-184
TR	Timing relay (programmable)	DIN rail / panel mount	Fixed	10 A	—	■	■	—	V7-T3-177
Universal TR	Timing relay (programmable)	DIN rail	Fixed	8 A	—	■	■	■	V7-T3-173
XR	Terminal block relay	DIN rail	Fixed	6 A, 10 A	■	—	—	■	V7-T3-5

Terminal Block Relays



Contents

Description

Terminal Block Relays

Standard Terminal Block Relays	V7-T3-4
OptoCoupler Terminal Block Relays	V7-T3-12
High Current Terminal Block Relays	V7-T3-15
XR Series Accessories	V7-T3-18

Page

Catalog Number Selection

XR Series—Overview

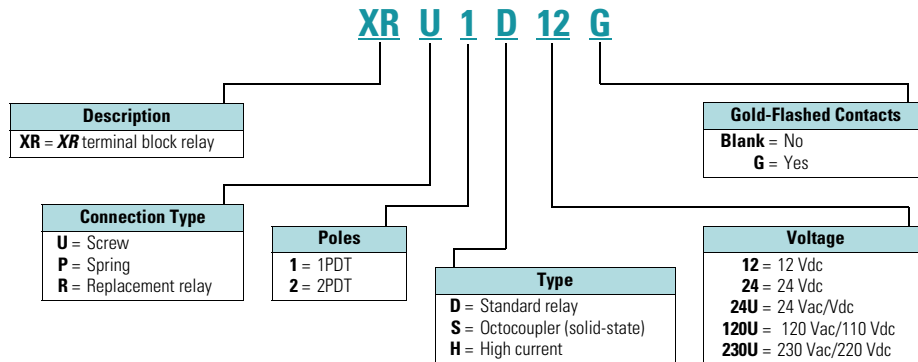

Standard Terminal Block Relay

3



Contents

<i>Description</i>	<i>Page</i>
Standard Terminal Block Relays	
Product Selection	V7-T3-5
Technical Data and Specifications	V7-T3-6
Electrical Schematics	V7-T3-11
Dimensions	V7-T3-11
OptoCoupler Terminal Block Relays	V7-T3-12
High Current Terminal Block Relays	V7-T3-15
XR Series Accessories	V7-T3-18

Standard Terminal Block Relays

Product Description

The **XR** Series Terminal Block Relays are ideal for applications that require a high switching capacity and long electrical service life. The relays are plug-in interfaces that connect to basic terminal blocks. The **XR** Series uses screw or spring-cage technology, as well as offers quick system wiring, superior safety features, clear labeling and a high level of modularity.

Application Description

Used in automation systems, electromechanical relays guarantee a safe connection between process I/O and electronic controls. The following functions are covered by relay coupling elements:

- Electrical isolation between the input and output circuits
- Independence of the type of switching current (AC and DC)
- High short-term overload resistance in the event of short circuits or voltage peaks
- Low switching losses
- Ease of operation

Features

- Pluggable relay allows for field replacement
- Functional plug-in bridges
- Choice of screw connections or spring-cage connection
- LED status indication
- DIN rail mount
- Only 6.2 mm wide for single-pole versions, 14 mm wide for double-pole
- All common input voltages between 12 Vdc to 120 Vac
- Gold-plated contacts available
- Equipped with a robust, miniature relay:
 - IP67 protection
 - Environmentally friendly, cadmium-free contact material
 - Easy, cost-effective installation and replacement using the engagement lever

Standards and Certifications

- cULus listed
- CE



Product Selection

XRU1D 24U



Standard Terminal Block Relays

Gold-Plated Contacts	Rated Current	Supply Voltage	Standard Pack	Catalog Number
1PDT Screw Connection				
No	6 A	12 Vdc	10	XRU1D12
No	6 A	120 Vac/110 Vdc	10	XRU1D120U
Yes	6 A	120 Vac/110 Vdc	10	XRU1D120UG
No	6 A	24 Vdc	10	XRU1D24
No	6 A	24 Vac/Vdc	10	XRU1D24U
Yes	6 A	24 Vac/Vdc	10	XRU1D24UG
No	6 A	230 Vac/220 Vdc	10	XRU1D230U
1PDT Spring Cage Connection				
No	6 A	12 Vdc	10	XRP1D12
No	6 A	120 Vac/110 Vdc	10	XRP1D120U
No	6 A	24 Vdc	10	XRP1D24
No	6 A	24 Vac/Vdc	10	XRP1D24U
No	6 A	230 Vac/220 Vdc	10	XRP1D230U
DPDT Screw Connection				
No	6 A	12 Vdc	10	XRU2D12
No	6 A	120 Vac/110 Vdc	10	XRU2D120U
No	6 A	24 Vdc	10	XRU2D24
No	6 A	24 Vac/Vdc	10	XRU2D24U
No	6 A	230 Vac/220 Vdc	10	XRU2D230U

Standard Replacement Relays

Gold-Plated Contacts	Rated Current	Supply Voltage ^①	Standard Pack	Catalog Number
1PDT				
No	6 A	12 Vdc	10	XRR1D12
No	6 A	120 Vac/110 Vdc	10	XRR1D120U
Yes	6 A	120 Vac/110 Vdc	10	XRR1D120UG
No	6 A	24 Vdc	10	XRR1D24
Yes	6 A	24 Vdc	10	XRR1D24G
DPDT				
No	6 A	12 Vdc	10	XRR2D12
No	6 A	120 Vac/110 Vdc	10	XRR2D120U
No	6 A	24 Vdc	10	XRR2D24
No	6 A	230 Vac/220 Vdc	10	XRR2D230U

Note

^① Voltage is the rating at the base. It may not match the voltage on the specific replacement relay.

Technical Data and Specifications

Standard 1PDT Screw Connection Terminal Block Relays

Catalog Number	XRU1D12	XRU1D24	XRU1D24U	XRU1D120U
Replacement Relay	XRR1D12	XRR1D24	XRR1D24	XRR1D120U
Input voltage	12 Vdc	24 Vdc	24 Vac/Vdc	120 Vac/110 Vdc
Connection Data				
Rigid solid AWG (mm ²)	26–14 (0.14–2.5)	26–14 (0.14–2.5)	26–14 (0.14–2.5)	26–14 (0.14–2.5)
Flexible stranded AWG (mm ²)	26–14 (0.14–2.5)	26–14 (0.14–2.5)	26–14 (0.14–2.5)	26–14 (0.14–2.5)
Input Data for 1PDT Screw Connection Versions				
Input voltage	12 Vdc	24 Vdc	24 Vac/Vdc	120 Vac/110 Vdc
Permissible range	See Page V7-T3-10	See Page V7-T3-10	See Page V7-T3-10	See Page V7-T3-10
Typical input current	15.3 mA	9 mA	11 mA (24 Vac)/8.5 mA (24 Vdc)	3.5 mA (120 Vac)/3 mA (110 Vdc)
Typical response time	5 ms	5 ms	6 ms	6 ms
Typical release time	8 ms	8 ms	15 ms	15 ms
Input protection	Polarity protection diode, free-wheeling diode	Polarity protection diode, free-wheeling diode	Bridge rectifier	Bridge rectifier
Output Data				
Contact type	1PDT	1PDT	1PDT	1PDT
Contact material	AgSnO	AgSnO	AgSnO	AgSnO
Max. switching voltage	250 Vac/Vdc ^①	250 Vac/Vdc ^①	250 Vac/Vdc ^①	250 Vac/Vdc ^①
Min. switching voltage	12 Vac/Vdc	12 Vac/Vdc	12 Vac/Vdc	12 Vac/Vdc
Limiting continuous current	6 A	6 A	6 A	6 A
Min. switching current	10 mA	10 mA	10 mA	10 mA
Min. switching power	120 mW	120 mW	120 mW	120 mW
Miscellaneous Data				
Ambient temp range	–4 °F to +140 °F (–20 °C to +60 °C)	–4 °F to +140 °F (–20 °C to +60 °C)	–4 °F to +140 °F (–20 °C to +60 °C)	–4 °F to +140 °F (–20 °C to +60 °C)
Rated operating mode	100% operating factor	100% operating factor	100% operating factor	100% operating factor
Inflammability class	V0, in accordance with UL 94	V0, in accordance with UL 94	V0, in accordance with UL 94	V0, in accordance with UL 94
Mechanical service life	2 x 10 ⁷ cycles	2 x 10 ⁷ cycles	2 x 10 ⁷ cycles	2 x 10 ⁷ cycles

Note

^① The separating plate, XRAPLCEsk, should be installed for voltages greater than 250 V (L1, L2, L3) between identical terminal points of adjacent modules. Potential bridging is then possible with the XRAFBST bridge system.

Standard 1PDT Screw Connection Terminal Block Relays with Gold Contacts

Catalog Number	XRU1D24UG	XRU1D120UG
Replacement Relay	XRR1D24G	XRR1D120UG
Input voltage	24 Vac/Vdc	120 Vac/110 Vdc
Connection Data		
Rigid solid AWG (mm ²)	26–14 (0.14–2.5)	26–14 (0.14–2.5)
Flexible stranded AWG (mm ²)	26–14 (0.14–2.5)	26–14 (0.14–2.5)
Input Data for 1PDT Screw Connection Versions with Gold Contacts		
Input voltage	24 Vac/Vdc	120 Vac/110 Vdc
Permissible range	See Page V7-T3-10	See Page V7-T3-10
Typical input current	11 mA (24 Vac)/8.5 mA (24 Vdc)	3.5 mA (120 Vac)/3 mA (110 Vdc)
Typical response time	6 ms	6 ms
Typical release time	15 ms	15 ms
Input protection	Bridge rectifier	Bridge rectifier
Output Data		
Contact type	1PDT	1PDT
Contact material	AgSnO, gold plated ^①	AgSnO, gold plated ^①
Max. switching voltage	30 Vac/36 Vdc (250 Vac/Vdc) ^②	30 Vac/36 Vdc (250 Vac/Vdc) ^②
Min. switching voltage	100 mV (12 Vac/Vdc) ^②	100 mV (12 Vac/Vdc) ^②
Limiting continuous current	50 mA (6 A) ^②	50 mA (6 A) ^②
Min. switching current	1 mA (10 mA) ^②	1 mA (10 mA) ^②
Min. switching power	100 mW (120 mW) ^②	100 mW (120 mW) ^②
Miscellaneous Data		
Ambient temp range	–4 °F to +140 °F (–20 °C to +60 °C)	–40 °F to +131 °F (–20 °C to +55 °C)
Rated operating mode	100% operating factor	100% operating factor
Inflammability class	V0, in accordance with UL 94	V0, in accordance with UL 94
Mechanical service life	2 x 10 ⁷ cycles	2 x 10 ⁷ cycles

Notes

- ^① The separating plate, XRAPLCEsk, should be installed for voltages greater than 250 V (L1, L2, L3) between identical terminal points of adjacent modules. Potential bridging is then possible with the XRAFBST bridge system.
- ^② If the maximum values are exceeded, the gold layer is destroyed and the values in parentheses apply.

Standard 1PDT Spring Cage Terminal Block Relays

Catalog Number	XRP1D12	XRP1D24	XRP1D24U	XRP1D120U
Replacement Relay	XRR1D12	XRR1D24	XRR1D24	XRR1D120U
Input voltage	12 Vdc	24 Vdc	24 Vac/Vdc	120 Vac/110 Vdc
Connection Data				
Rigid solid AWG (mm ²)	26–14 (0.14–2.5)	26–14 (0.14–2.5)	26–14 (0.14–2.5)	26–14 (0.14–2.5)
Flexible stranded AWG (mm ²)	26–14 (0.14–2.5)	26–14 (0.14–2.5)	26–14 (0.14–2.5)	26–14 (0.14–2.5)
Input Data for 1PDT Spring Cage Versions				
Input voltage	12 Vdc	24 Vdc	24 Vac/Vdc	120 Vac/110 Vdc
Permissible range	See Page V7-T3-10	See Page V7-T3-10	See Page V7-T3-10	See Page V7-T3-10
Typical input current	15.3 mA	9 mA	11 mA (24 Vac)/8.5 mA (24 Vdc)	3.5 mA (120 Vac)/3 mA (110 Vdc)
Typical response time	5 ms	5 ms	6 ms	6 ms
Typical release time	8 ms	8 ms	15 ms	15 ms
Input protection	Polarity protection diode, free-wheeling diode	Polarity protection diode, free-wheeling diode	Bridge rectifier	Bridge rectifier
Output Data				
Contact type	1PDT	1PDT	1PDT	1PDT
Contact material	AgSnO	AgSnO	AgSnO	AgSnO
Max. switching voltage	250 Vac/Vdc ^①	250 Vac/Vdc ^①	250 Vac/Vdc ^①	250 Vac/Vdc ^①
Min. switching voltage	12 Vac/Vdc	12 Vac/Vdc	12 Vac/Vdc	12 Vac/Vdc
Limiting continuous current	6 A	6 A	6 A	6 A
Min. switching current	10 mA	10 mA	10 mA	10 mA
Min. switching power	120 mW	120 mW	120 mW	120 mW
Miscellaneous Data				
Ambient temp range	–4 °F to +140 °F (–20 °C to +60 °C)	–4 °F to +140 °F (–20 °C to +60 °C)	–4 °F to +140 °F (–20 °C to +60 °C)	–4 °F to +131 °F (–20 °C to +55 °C)
Rated operating mode	100% operating factor	100% operating factor	100% operating factor	100% operating factor
Inflammability class	V0, in accordance with UL 94	V0, in accordance with UL 94	V0, in accordance with UL 94	V0, in accordance with UL 94
Mechanical service life	2 x 10 ⁷ cycles	2 x 10 ⁷ cycles	2 x 10 ⁷ cycles	2 x 10 ⁷ cycles

Note

^① The separating plate, XRAPLCEsk, should be installed for voltages greater than 250 V (L1, L2, L3) between identical terminal points of adjacent modules. Potential bridging is then possible with the XRAFBST bridge system.

Standard DPDT Screw Connection Terminal Block Relays

Catalog Number Replacement Relay	XRU2D12 XRR2D12	XRU2D24 XRR2D24	XRU2D24U XRR2D24	XRU2D120U XRR2D120U
Input voltage	12 Vdc	24 Vdc	24 Vac/Vdc	120 Vac/110 Vdc
Connection Data				
Rigid solid AWG (mm ²)	26–14 (0.14–2.5)	26–14 (0.14–2.5)	26–14 (0.14–2.5)	26–14 (0.14–2.5)
Flexible stranded AWG (mm ²)	26–14 (0.14–2.5)	26–14 (0.14–2.5)	26–14 (0.14–2.5)	26–14 (0.14–2.5)
Input Data for 1PDT Spring Cage Versions				
Input voltage	12 Vdc	24 Vdc	24 Vac/Vdc	120 Vac/110 Vdc
Permissible range	See Page V7-T3-10	See Page V7-T3-10	See Page V7-T3-10	See Page V7-T3-10
Typical input current	33 mA	18 mA	17.5 mA	4.5 mA (120 Vac)/4.2 mA (110 Vdc)
Typical response time	8 ms	8 ms	8 ms	7 ms
Typical release time	10 ms	10 ms	10 ms	10 ms
Input protection	Polarity protection diode, free-wheeling diode	Polarity protection diode, free-wheeling diode	Bridge rectifier	Bridge rectifier
Output Data				
Contact type	2PDT	Single contact, 2PDT	Single contact, 2PDT	Single contact, 2PDT
Contact material	AgNi	AgNi	AgNi	AgNi
Max. switching voltage	250 Vac/Vdc ^①	250 Vac/Vdc ^①	250 Vac/Vdc ^①	250 Vac/Vdc ^①
Min. switching voltage	5 V	5 V	5 V	5 V
Limiting continuous current	6 A	6 A	6 A	6 A
Max. inrush current	15 A (300 ms)	15 A (300 ms)	15 A (300 ms)	15 A (300 ms)
Min. switching current	10 mA	10 mA	10 mA	10 mA
Min. switching power	50 mW	50 mW	50 mW	50 mW
General Data				
Ambient temp range	–4 °F to +140 °F (–20 °C to +60 °C)	–4 °F to +140 °F (–20 °C to +60 °C)	–4 °F to +140 °F (–20 °C to +60 °C)	–4 °F to +140 °F (–20 °C to +60 °C)
Rated operating mode	100% operating factor	100% operating factor	100% operating factor	100% operating factor
Inflammability class	V0, in accordance with UL 94	V0, in accordance with UL 94	V0, in accordance with UL 94	V0, in accordance with UL 94
Mechanical service life	3 x 10 ⁷ cycles	3 x 10 ⁷ cycles	3 x 10 ⁷ cycles	3 x 10 ⁷ cycles

Note

^① The separating plate, XRAPLCEsk, should be installed for voltages greater than 250 V (L1, L2, L3) between identical terminal points of adjacent modules. Potential bridging is then possible with the XRFBST bridge system.

3.2

Control Relays and Timers

Terminal Block Relays

Permissible Range Diagrams

1PDT Relay Modules

Operating Range Voltage for 12 Vdc

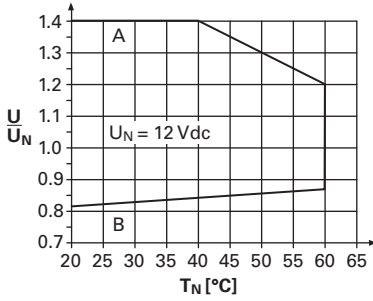

DPDT Relay Modules

Operating Range Voltage for 12 Vdc

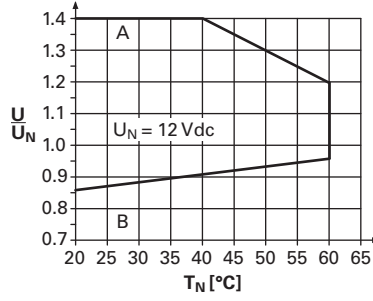

Operating Range Voltage for 120 Vac/110 Vdc

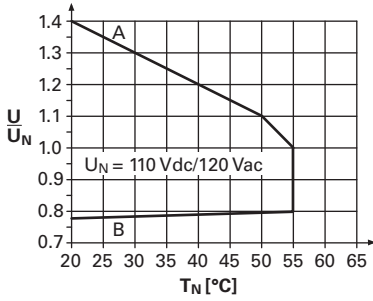

Operating Range Voltage for 120 Vac/110 Vdc

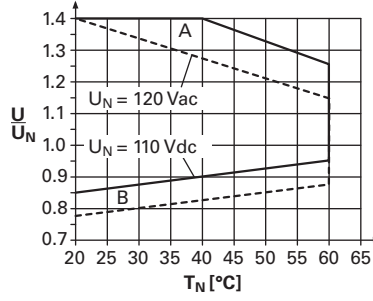

Operating Range Voltage for 24 Vdc

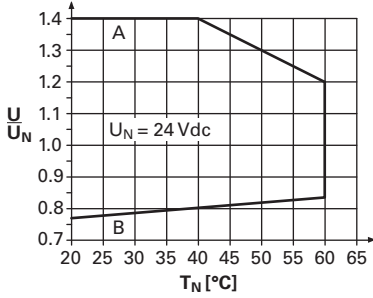

Operating Range Voltage for 24 Vdc

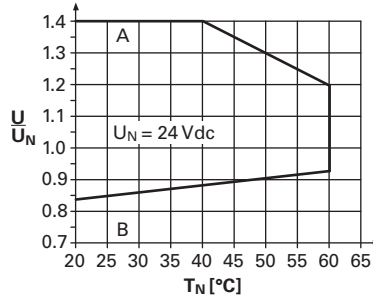

Operating Range Voltage for 24 Vac/Vdc

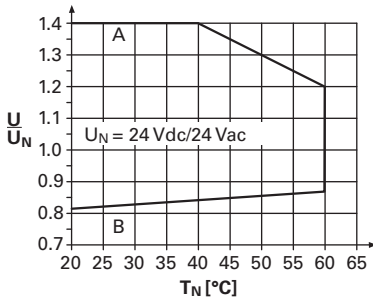

Operating Range Voltage for 24 Vac/Vdc

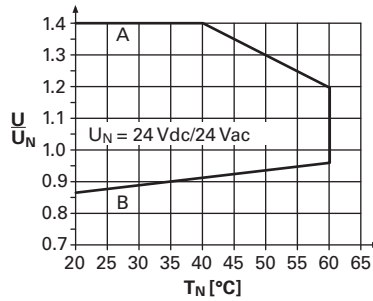

Notes

General Conditions — Direct alignment in the block, all devices 100% operating factor, horizontal or vertical mounting.

Curve A — Maximum permissible continuous operating voltage U_{max} with limiting continuous current on the contact side (see respective technical data).

Curve B — Minimum permissible relay operate voltage U_{op} after pre-excitation ^① (see respective technical data).

^① Pre-excitation: Relay has been operated in a thermally steady state at the ambient temperature T_U with nominal voltage U_N and limiting continuous current on the contact side (see respective technical data) (warm coil). After being switched off for a short time, the relay must reliably pick up again at U_{op} .

Electrical Schematics

1PDT Terminal Block Relays

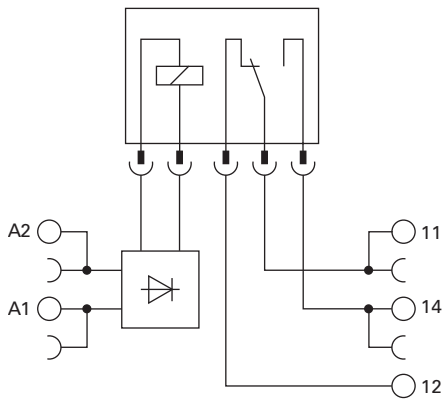

DPDT Terminal Block Relays

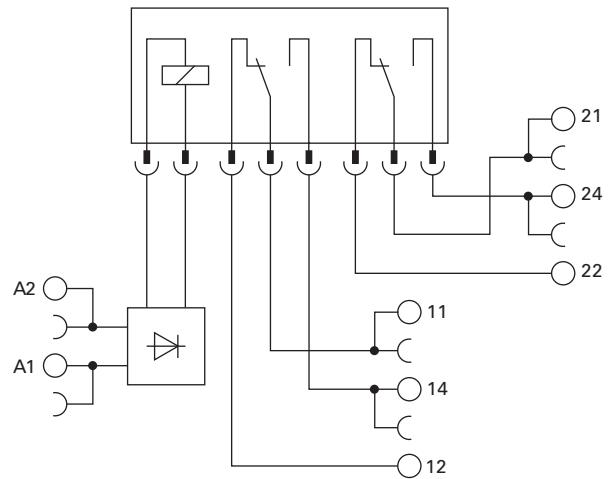

Dimensions

Approximate Dimensions in Inches (mm)

Standard 1PDT Terminal Block Relays

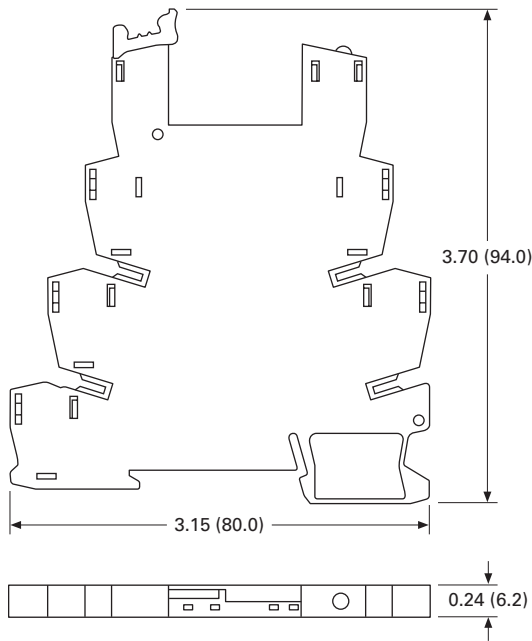

Standard DPDT Terminal Block Relays

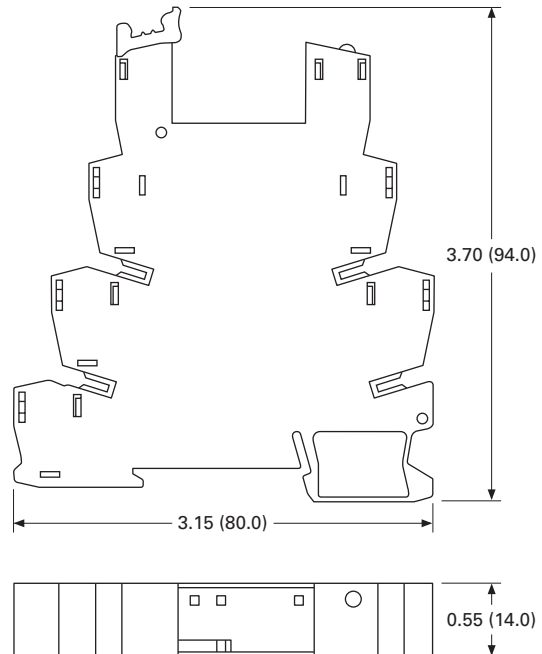

OptoCoupler Terminal Block Relay



Contents

Description	Page
Standard Terminal Block Relays	V7-T3-4
OptoCoupler Terminal Block Relays	
Product Selection	V7-T3-13
Technical Data and Specifications	V7-T3-13
Electrical Schematic	V7-T3-14
Dimensions	V7-T3-14
High Current Terminal Block Relays	V7-T3-15
XR Series Accessories	V7-T3-18

OptoCoupler Terminal Block Relays

Product Description

The **XR** Series OptoCoupler Terminal Block Relays can be used in all applications and consist of a pluggable miniature OptoCoupler and a basic terminal block. The **XR** Series uses screw or spring-cage technology, as well as offers quick system wiring, superior safety features, clear labeling and a high level of modularity.

Application Description

The **XR** Series OptoCoupler relays can be used as an input or output interface. They provide the typical reliability of OptoCouplers and are especially suited for high operating frequencies.

Features

- Pluggable relay allows for field replacement
- Functional plug-in bridges
- LED status indication
- DIN rail mount
- Only 6.2 mm wide
- Switching capacity up to 24 Vdc/3 A
- IP67-protected optical electronics
- Wear-resistant and bounce-free switching
- Insensitive to shock and vibration
- Integrated protection circuit
- Zero voltage switch at AC output

Standards and Certifications

- cULus listed
- CE



Product Selection

XRU1S24



OptoCoupler Terminal Block Relays

Rated Current	Supply Voltage	Standard Pack	Catalog Number
2 A	120 Vac/110 Vdc	10	XRU1S120U
2 A	24 Vdc	10	XRU1S24

OptoCoupler Replacement Relays

Rated Current	Supply Voltage ^①	Standard Pack	Catalog Number
2 A	24 Vdc	18	XRR1S24
2 A	120 Vac/110 Vdc	10	XRR1S120U

Technical Data and Specifications

Pluggable Power OptoCoupler (Solid-State) Terminal Block Relays

Catalog Number	XRU1S24	XRU1S120U
Replacement Relay	XRR1S24	XRR1S120U
Input voltage	24 Vdc	120 Vac/110 Vdc
Connection Data		
Rigid solid AWG (mm ²)	26–14 (0.14–2.5)	26–14 (0.14–2.5)
Flexible stranded AWG (mm ²)	26–14 (0.14–2.5)	26–14 (0.14–2.5)
Input Data		
Input voltage	24 Vdc	120 Vac/110 Vdc
Permissible range	0.8–1.2	0.8–1.1
Typical input current	9 mA	4 mA
Switching level 1 signal ("H")	≥0.8	≥0.8
Switching level 0 signal ("L")	≤0.4	≤0.25
Typical switch-on time	20 μS	6 ms
Typical turn-off time	500 μS	10 ms
Input protection	Polarity protection diode, free-wheeling diode	Bridge rectifier
Output Data		
Max. switching voltage	33 Vdc	33 Vdc
Min. switching voltage	3 Vdc	3 Vdc
Limiting continuous current	3 A (See derating curve)	3 A (See derating curve)
Max. inrush current	15 A (10 ms)	15 A (10 ms)
Output circuit	2-conductor floating	2-conductor floating
Output protection	Polarity protection, surge protection	Polarity protection, surge protection
Voltage drop at maximum limiting continuous current	≤ 200 mV	≤ 200 mV
General Data		
Ambient temp range	–4 °F to +140 °F (–20 °C to +60 °C)	–4 °F to +140 °F (–20 °C to +60 °C)
Rated operating mode	100% operating factor	100% operating factor
Inflammability class	V0, in accordance with UL 94	V0, in accordance with UL 94
Mechanical service life	2 x 10 ⁷ cycles	2 x 10 ⁷ cycles

Note

^① Voltage is the rating at the base. It may not match the voltage on the specific replacement relay.

3.2

Control Relays and Timers

Terminal Block Relays

3

Derating Curve OptoCoupler

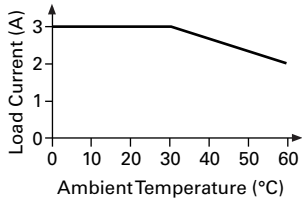

Electrical Schematic

Pluggable Power OptoCoupler (Solid-State) Terminal Block Relays

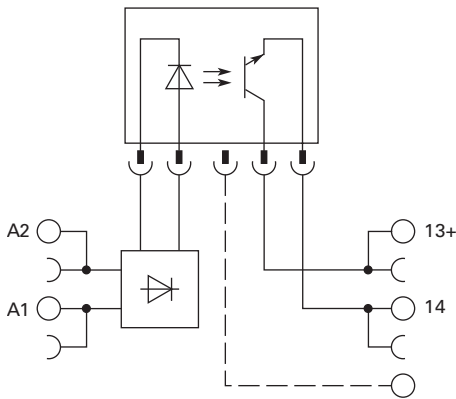

Dimensions

Approximate Dimensions in Inches (mm)

Pluggable Power OptoCoupler (Solid-State) Terminal Block Relays

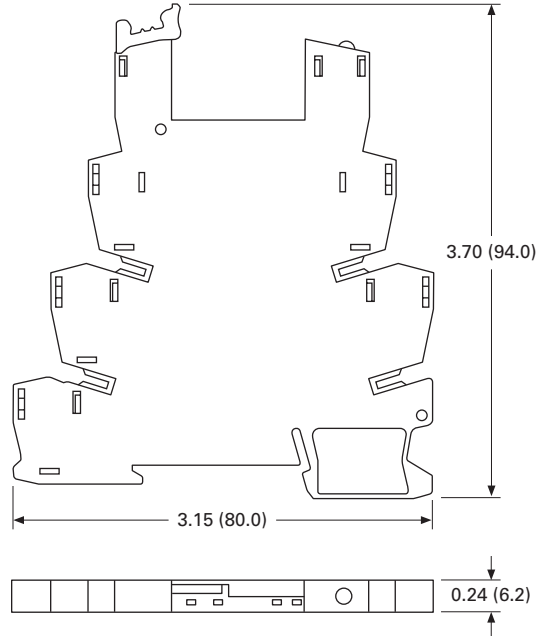

High Current Terminal Block Relay



Contents

Description	Page
Standard Terminal Block Relays	V7-T3-4
OptoCoupler Terminal Block Relays	V7-T3-12
High Current Terminal Block Relays	
Product Selection	V7-T3-16
Technical Data and Specifications	V7-T3-16
Electrical Schematic	V7-T3-17
Dimensions	V7-T3-17
XR Series Accessories	V7-T3-18

High Current Terminal Block Relays

Product Description

The **XR** Series Relays include products designed to meet high continuous current and/or long electrical service life applications. The **XR** Series Relays are plug-in interfaces that connect to basic terminal blocks that use screw connection technology. Overall width is 14 mm.

Application Description

These relays are best suited for applications that require higher continuous load currents than miniature relays can carry and switch. They can withstand inrush currents or brief overloads without damage, and allow for continuous load currents of up to 10 A. The **XR** Series Relay boasts an average service life of the contacts that is two or three times the normal life of a less powerful relay, resulting in service cost savings.

Features

- 14 mm wide
- Pluggable relay allows for field replacement
- Convenient plug-in bridge system
- LED status indication
- DIN Rail Mount
- IP67-protected optical electronics
- Wear-resistant and bounce-free switching
- Insensitive to shock and vibration
- Integrated protection circuit
- Zero voltage switch at AC output
- Environmentally friendly, cadmium-free contact material
- Electrical isolation between input and output

Standards and Certifications

- cULus listed
- CE



Product Selection

XRU1H24



High Current Terminal Block Relays

Rated Current	Supply Voltage	Standard Pack	Catalog Number
10 A	12 Vdc	10	XRU1H12
10 A	120 Vac/110 Vdc	10	XRU1H120U
10 A	24 Vdc	10	XRU1H24
10 A	24 Vac/Vdc	10	XRU1H24U

High Current Replacement Relays

Rated Current	Supply Voltage ^①	Standard Pack	Catalog Number
10 A	24 Vdc	10	XRR1H24
10 A	24 Vac/Vdc	10	XRR1H24U
10 A	12 Vdc	10	XRR1H12
10 A	120 Vac/110 Vdc	10	XRR1H120U

Technical Data and Specifications

High Current Terminal Block Relays (1PDT)

Catalog Number Replacement Relay	XRU1H12 XRR1H12	XRU1H24 XRR1H24	XRU1H24U XRR1H24U	XRU1H120U XRR1H120U
Input voltage	12 Vdc	24 Vdc	24 Vac/Vdc	120 Vac/110 Vdc
Connection Data				
Rigid solid AWG (mm ²)	26–14 (0.14–2.5)	26–14 (0.14–2.5)	26–14 (0.14–2.5)	26–14 (0.14–2.5)
Flexible stranded AWG (mm ²)	26–14 (0.14–2.5)	26–14 (0.14–2.5)	26–14 (0.14–2.5)	26–14 (0.14–2.5)
Input Data for 1PDT Spring Cage Versions				
Input voltage	12 Vdc	24 Vdc	24 Vac/Vdc	120 Vac/110 Vdc
Permissible range	See Page V7-T3-10	See Page V7-T3-10	See Page V7-T3-10	See Page V7-T3-10
Typical input current	33 mA	18 mA	17.5 mA	4.5 mA (120 Vac)/4.2 mA (110 Vdc)
Typical response time	8 ms	8 ms	8 ms	7 ms
Typical release time	10 ms	10 ms	10 ms	10 ms
Input protection	Polarity protection diode, free-wheeling diode	Polarity protection diode, free-wheeling diode	Bridge rectifier	Bridge rectifier
Output Data				
Contact type	Single contact, 1PDT	Single contact, 1PDT	Single contact, 1PDT	Single contact, 1PDT
Contact material	AgNi	AgNi	AgNi	AgNi
Max. switching voltage	250 Vac/Vdc ^②	250 Vac/Vdc ^②	250 Vac/Vdc ^②	250 Vac/Vdc ^②
Min. switching voltage	12 Vac/Vdc	12 Vac/Vdc	12 Vac/Vdc	12 Vac/Vdc
Limiting continuous current	10 A ^③	10 A ^③	10 A ^③	10 A ^③
Max. inrush current	30 A (300 ms)	30 A (300 ms)	30 A (300 ms)	30 A (300 ms)
Min. switching current	100 mA	100 mA	100 mA	100 mA
Min. switching power	1.2 W	1.2 W	1.2 W	1.2 W
Miscellaneous Data				
Ambient temp range	–4 °C to +140 °F (–20 °C to +60 °C)	–4 °C to +140 °F (–20 °C to +60 °C)	–4 °C to +140 °F (–20 °C to +60 °C)	–4 °C to +140 °F (–20 °C to +60 °C)
Rated operating mode	100% operating factor	100% operating factor	100% operating factor	100% operating factor
Inflammability class	V0, in accordance with UL 94	V0, in accordance with UL 94	V0, in accordance with UL 94	V0, in accordance with UL 94
Mechanical service life	3 x 10 ⁷ cycles	3 x 10 ⁷ cycles	3 x 10 ⁷ cycles	3 x 10 ⁷ cycles

Notes

- ^① Voltage is the rating at the base. It may not match the voltage on the specific replacement relay.
- ^② The separating plate, XRAPLCEsk, should be installed for voltages greater than 250 V (L1, L2, L3) between identical terminal points of adjacent modules. Potential bridging is then possible with the XRAFBST bridge system.
- ^③ The current rating for the normally open contact (#14) is 10 A. The current rating for the normally closed contact (#12) is 6 A and can be increased to 10 A by bridging the two #12 contact connections.

Electrical Schematic

High Current Terminal Block Relays

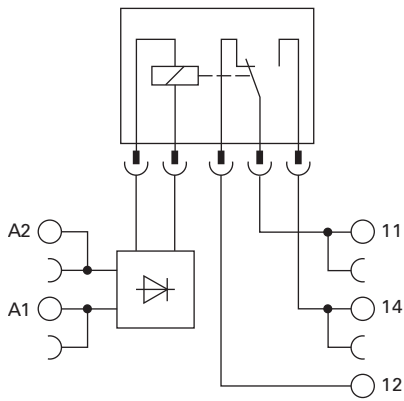

Dimensions

Approximate Dimensions in Inches (mm)

High Current Terminal Block Relays

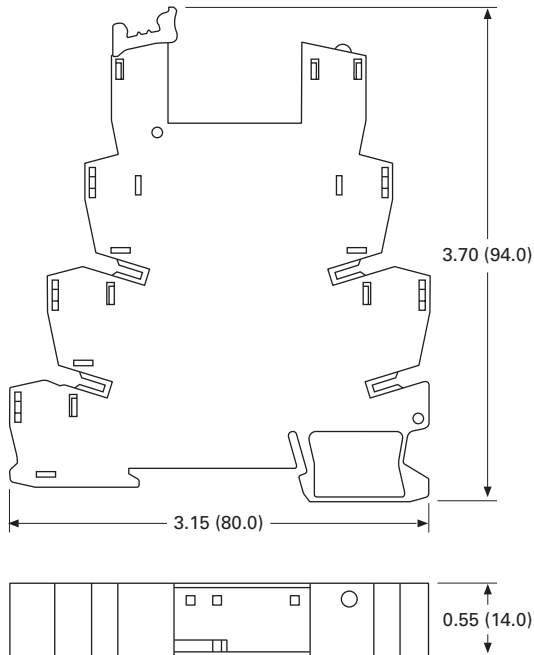

XR Series Accessories

Product Description

Power Terminal Block

Bridges



The XRAPLCEK power terminal block has the same shape as the relay modules and is used to feed in the bridging potentials. The nominal current is 32 A. When the total current is less than or equal to 6 A, supply can take place directly at the connecting terminal blocks of one of the connected relays.

End Cover

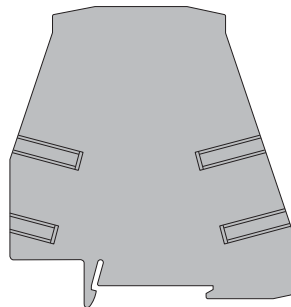

The XRAATPBK end cover is required at the start and stop of a relay strip. It can also be used for visual separation of groups of relays as well as separating relays with voltages greater than 250 V and separating neighboring bridges with different potentials. It is equipped with pre-scored break out points at the bridging positions so that individual bridges can be passed through as needed. It may also be necessary to use the end cover between adjacent relays when three phases (L1, L2, L3) are used on the contact side of the relay.

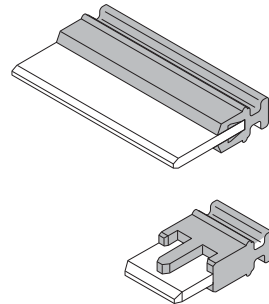

The XRAFBST colored, insulated plug-in bridge system reduces wiring time by up to 70% compared to conventionally wired relays. The XRAFBST2, 2-position bridges, are suited for bridging a smaller number of relays and total currents ≤ 6 A. When a circuit is supplied from both sides, the circuit can be opened at any point, allowing all other modules to continue being supplied at the same time. The XRAFBST500 allow up to 80 modules to be bridged at one time. If bridges with different potentials meet in neighboring modules, the end cover XRAATPBK should be used. All bridges are equipped with a groove for removal with a standard screwdriver.

Product Selection

XR Series Accessories

Color	Standard Pack	Catalog Number
2-Position Snap-In Jumper		
Red	10	XRAFBST2RD
Blue	10	XRAFBST2BU
Gray	10	XRAFBST2GY
80-Position Snap-In Jumper		
Red	5	XRAFBST500RD
Blue	5	XRAFBST500BU
Gray	5	XRAFBST500GY
Power Terminal Block		
Gray	5	XRAPLCEK
End Cover		
Black	5	XRAATPBK

Technical Data and Specifications

Power Terminal Block

Description	Specification
Connection Data	
Rigid solid AWG (mm ²)	24–10 (0.2–4)
Flexible stranded AWG (mm ²)	24–10 (0.2–4)
Miscellaneous Data	
Max. current	32 A
Max. voltage	250 Vac ^①

Note

- ^① The separating plate, XRAPLCEK, should be installed for voltages greater than 250 V (L1, L2, L3) between identical terminal points of adjacent modules. Potential bridging is then possible with the XRAFBST bridge system.

Programmable Relays



Product Overview

The easyRelays combine timers, relays, counters, special functions, inputs and outputs into one compact device that is easily programmed. The easyRelay family of products provides an exceptional level of flexibility together with a substantial savings of commissioning time and effort.

The easyRelays are available in more than 35 styles that support from 12 I/O up to a network of up to 320 I/O points, providing the ideal solution for lighting, energy management, industrial control, irrigation, pump control, HVAC and home automation.

Once easyRelays are installed, changes are easily accomplished through front panel programming, eliminating the need to change wiring and minimizing downtime.

The easy802/806 relays are even more powerful than the easy800 series and include an integrated SmartWire-DT gateway. Conventional hardwiring to pushbuttons, selector switches, pilot devices and contactors can now be eliminated, allowing for a dramatic increase in panel wiring productivity. For more information on SmartWire-DT and how it can increase productivity, go to www.eaton.com/smartwiredt.

Contents

Description

Page

Programmable Relays	
easy500/700/800 Programmable Relays	V7-T3-20
easy802/806 Programmable Relays with SmartWire-DT	V7-T3-26
easyRelay and MFD Expansion Modules	V7-T3-30
MFD-Titan Multi-Function Displays	V7-T3-33
easyRelay Communication Modules	V7-T3-40
easyRelay Power Supplies, Accessories and Software	V7-T3-43

Application Description

The easyRelays excel in traditional applications where multiple relays, timers and pushbuttons are used. Applications span residential, commercial and industrial installations.

Typical control applications are:

- Lighting controls
- Duplex pump controls
- Water fountain controls
- Parking garage access controls
- Refrigeration control system
- Greenhouse temperature and ventilation controls
- Booster pump controls

See publication no. **AP05013001E** for the easyRelay application guide. Download from www.eaton.com/easyrelays.

easy500/700/800 Programmable Relays



3

easy500/700/800 Programmable Relays

Product Description

Three families make up the easyRelay programmable relay product line. All models are available with and without displays. DIN rail mounted.

easy500—for controlling small applications with up to 12 input/output signals. Connectable to Ethernet.

easy700—for controlling medium-sized applications with 20 I/O points (expandable to 40 I/O points). Connectable to Ethernet and bus systems.

easy800—for controlling large-scale applications with 20 points, expandable to 40 points locally, and expandable using the easyNet network up to 320 I/O points. Connectable to Ethernet and bus systems.

The easyNet integrated network provides easy and inexpensive linking of up to eight easy800 devices over a distance of up to 1000 meters. Each easy800 device can run its own program, or be used as a distributed input/output module. Connect up to eight controllers with up to 40 I/O to obtain 320 I/O.

Standards

- CSA C22.2 No. 142-M1987
- CSA C22.2 No. 213-M1987
- EN 55011
- EN 50178
- EN 61131-2
- IEC EN 61000-4
- IEC 60068-2-6
- IEC 60068-2-27
- UL 508

Certifications

- UL
- CSA
- CE
- CSA Class I, Div. 2, Groups A, B, C, D; Temp. Code T3C
- C-Tick
- GOST-R
- Ukrain-GOST



Shipping Approvals

- Bureau Veritas
- Det Norske Veritas
- Germanischer Lloyd
- Lloyd's Register of Shipping

Contents

Description

	<i>Page</i>
easy500/700/800 Programmable Relays	
System Overview	V7-T3-21
Product Selection	V7-T3-23
Technical Data and Specifications	V7-T3-24
Dimensions	V7-T3-25
easy802/806 Programmable Relays with SmartWire-DT	V7-T3-26
easyRelay and MFD Expansion Modules	V7-T3-30
MFD-Titan Multi-Function Displays	V7-T3-33
easyRelay Communication Modules	V7-T3-40
easyRelay Power Supplies, Accessories and Software	V7-T3-43

Catalog Number Selection

easy500/700/800

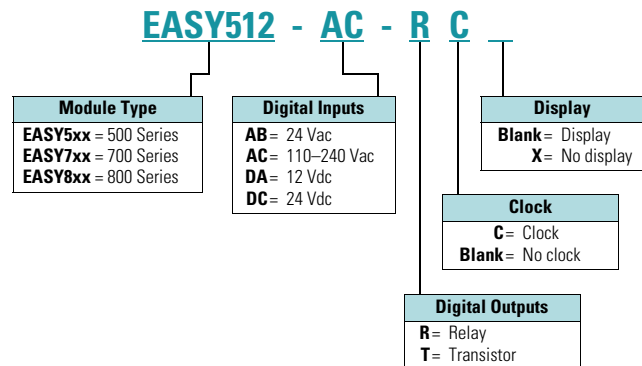

Note: Not all combinations are possible. See selection tables.

System Overview

easy500/700 Programmable Relays

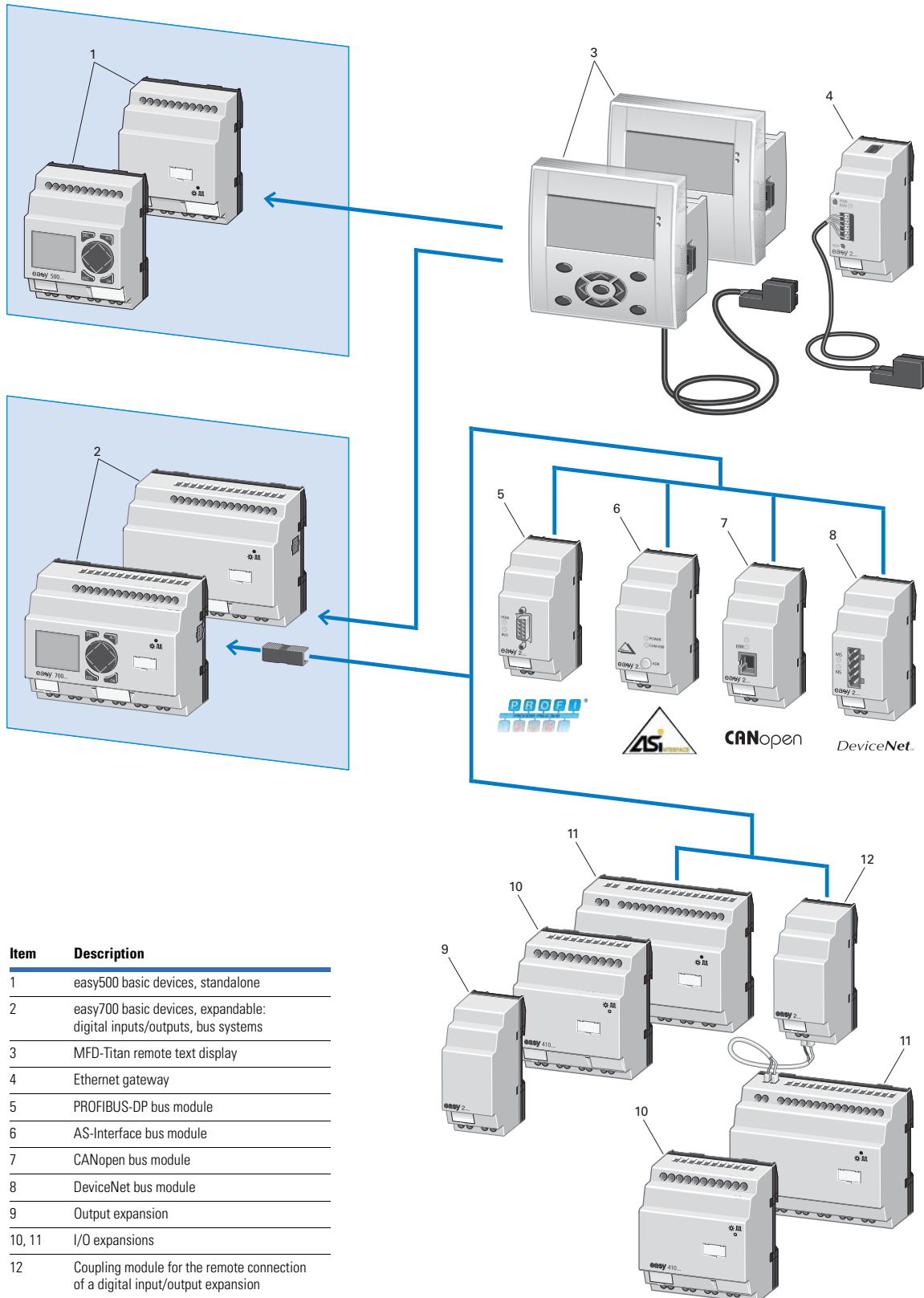

3.3

Control Relays and Timers

Programmable Relays

easy800 Programmable Relay

3

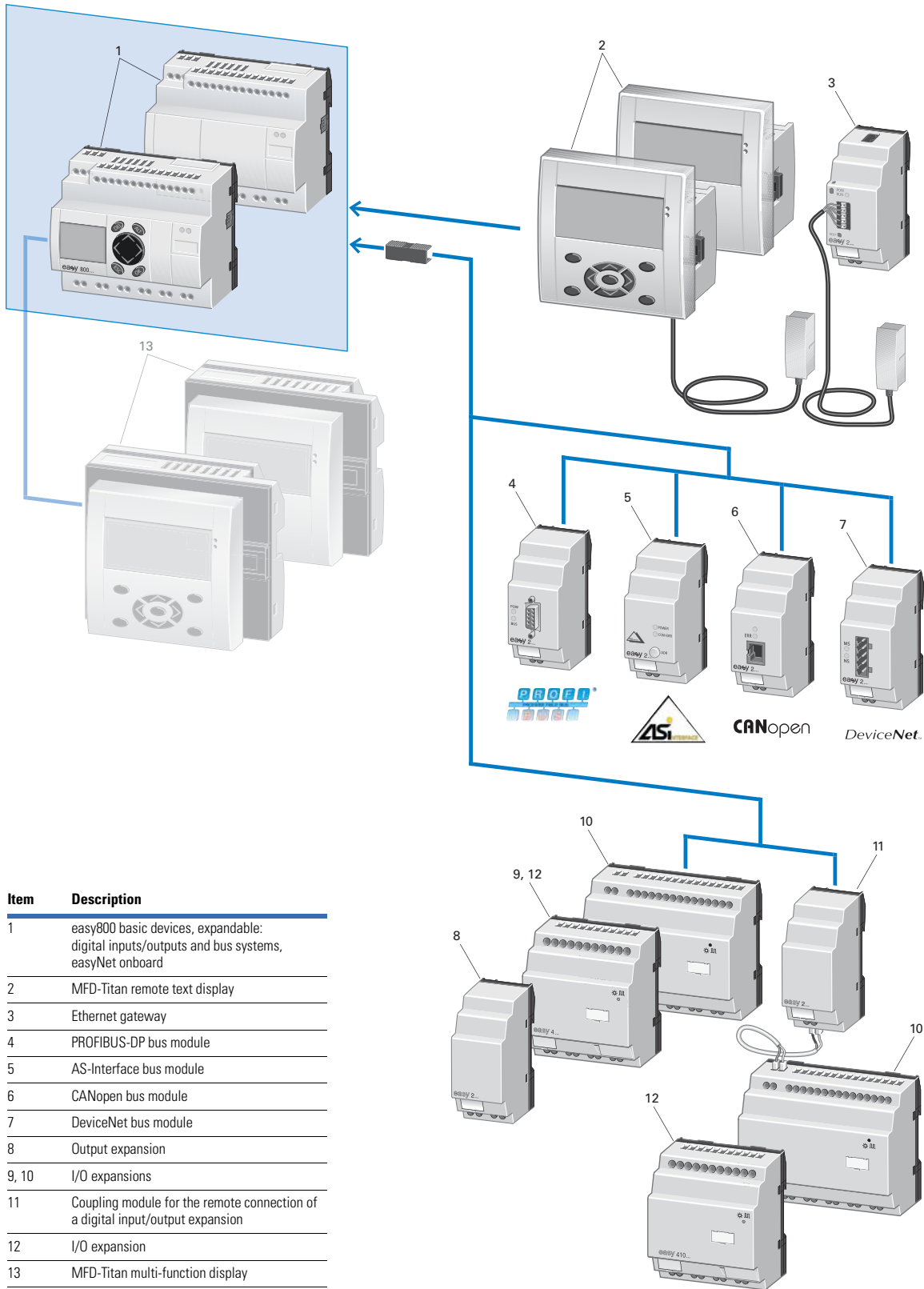

Product Selection

easy500—Display



easy500 Programmable Relays (Standalone)

Description	Inputs					Outputs		Catalog Number
	24 Vac	110–240 Vac	12 Vdc	24 Vdc	Analog ^①	Relay	Transistor	
Display								
12 I/O, no clock	—	8	—	—	—	4	—	EASY512-AC-R
	—	—	—	8	2	4	—	EASY512-DC-R
12 I/O, clock	8	—	—	—	2	4	—	EASY512-AB-RC
	—	8	—	—	—	4	—	EASY512-AC-RC
	—	—	8	—	2	4	—	EASY512-DA-RC
	—	—	—	8	2	4	—	EASY512-DC-RC
	—	—	—	8	2	—	4	EASY512-DC-TC
No Display								
12 I/O, clock	8	—	—	—	2	4	—	EASY512-AB-RCX
	—	8	—	—	—	4	—	EASY512-AC-RCX
	—	—	8	—	2	4	—	EASY512-DA-RCX
	—	—	—	8	2	4	—	EASY512-DC-RCX
	—	—	—	8	2	—	4	EASY512-DC-TCX

easy500—No Display



easy700—Display



easy700 Programmable Relays (Expandable and Networkable)

Description	Inputs					Outputs		Catalog Number
	24 Vac	110–240 Vac	12 Vdc	24 Vdc	Analog ^①	Relay	Transistor	
Display								
18 I/O, clock	12	—	—	—	4	6	—	EASY719-AB-RC
	—	12	—	—	—	6	—	EASY719-AC-RC
	—	—	12	—	4	6	—	EASY719-DA-RC
	—	—	—	12	4	6	—	EASY719-DC-RC
20 I/O, clock	—	—	—	12	4	—	8	EASY721-DC-TC
No Display								
18 I/O, clock	12	—	—	—	4	6	—	EASY719-AB-RCX
	—	12	—	—	—	6	—	EASY719-AC-RCX
	—	—	12	—	4	6	—	EASY719-DA-RCX
	—	—	—	12	4	6	—	EASY719-DC-RCX
20 I/O, clock	—	—	—	12	4	—	8	EASY721-DC-TCX

easy700—No Display



easy800—Display



easy800 Programmable Relays (Expandable and Networkable)

Description	Inputs			Outputs			Catalog Number
	110–240 Vac	24 Vdc	Analog ^①	Relay	Transistor	Analog	
Display							
18 I/O, clock	12	—	—	6	—	—	EASY819-AC-RC
	—	12	4	6	—	—	EASY819-DC-RC
19 I/O, clock	—	12	4	6	—	1	EASY820-DC-RC
20 I/O, clock	—	12	4	—	8	—	EASY821-DC-TC
21 I/O, clock	—	12	4	—	8	1	EASY822-DC-TC
No Display							
18 I/O, clock	12	—	—	6	—	—	EASY819-AC-RCX
	—	12	4	6	—	—	EASY819-DC-RCX
19 I/O, clock	—	12	4	6	—	1	EASY820-DC-RCX
20 I/O, clock	—	12	4	—	8	—	EASY821-DC-TCX
21 I/O, clock	—	12	4	—	8	1	EASY822-DC-TCX

easy800—No Display



Note

① Analog inputs optional. Use of analog inputs will result in a decrease in the same number of available digital inputs.

Technical Data and Specifications

easy500 Series

Type	EASY512-AB...	EASY512-AC...	EASY512-DA...	EASY512-DC-R...	EASY512-DC-TC.
Supply voltage	24 Vac	100–240 Vac	12 Vdc	24 Vdc	24 Vdc
Heat dissipation	5 VA	5 VA	2 W	2 W	2 W
Continuous current outputs ^①	8 A	8 A	8 A	8 A	0.5 A
Short-circuit proof with power factor 1	Line protection B16, 600 A				—
Short-circuit proof with power factor 0.7...0.7	Line protection B16, 900 A				—
Mounting	On 35 mm DIN rail or screw mounting with ZB4-101-GF1 mounting feet				
Connection cables					
Solid	0.2–4.0 mm ² (AWG 22–12)	0.2–4.0 mm ² (AWG 22–12)	0.2–4.0 mm ² (AWG 22–12)	0.2–4.0 mm ² (AWG 22–12)	0.2–4.0 mm ² (AWG 22–12)
Flexible	0.2–2.5 mm ² (AWG 22–12)	0.2–2.5 mm ² (AWG 22–12)	0.2–2.5 mm ² (AWG 22–12)	0.2–2.5 mm ² (AWG 22–12)	0.2–2.5 mm ² (AWG 22–12)
Degree of protection	IP20	IP20	IP20	IP20	IP20
RFI suppression	EN 55011, EN 55022 Class B, IEC 61000-6-1, 2, 3, 4				
Ambient operating temperature	–25 °C to +55 °C	–25 °C to +55 °C	–25 °C to +55 °C	–25 °C to +55 °C	–25 °C to +55 °C
Transport and storage temperature	–40 °C to +70 °C	–40 °C to +70 °C	–40 °C to +70 °C	–40 °C to +70 °C	–40 °C to +70 °C
Hazardous location	CSA Class I, Div. 2, Groups A, B, C, D; Temp. Code T3C				

easy700 Series

Type	EASY719-AB...	EASY719-AC...	EASY719-DA...	EASY719-DC-RC...	EASY721-DC-TC.
Supply voltage	24 Vac	100–240 Vac	12 Vdc	24 Vdc	24 Vdc
Heat dissipation	7 VA	10 VA	3.5 W	3.5 W	3.5 W
Continuous current outputs ^①	8 A	8 A	8 A	8 A	0.5 A
Short-circuit proof with power factor 1	Line protection B16, 600 A	Line protection B16, 600 A	Line protection B16, 600 A	Line protection B16, 600 A	—
Short-circuit proof with power factor 0.7...0.7	Line protection B16, 900 A	Line protection B16, 900 A	Line protection B16, 900 A	Line protection B16, 900 A	—
Mounting	On 35 mm DIN rail or screw mounting with ZB4-101-GF1 mounting feet				
Connection cables					
Solid	0.2–4.0 mm ² (AWG 22–12)	0.2–4.0 mm ² (AWG 22–12)	0.2–4.0 mm ² (AWG 22–12)	0.2–4.0 mm ² (AWG 22–12)	0.2–4.0 mm ² (AWG 22–12)
Flexible	0.2–2.5 mm ² (AWG 22–12)	0.2–2.5 mm ² (AWG 22–12)	0.2–2.5 mm ² (AWG 22–12)	0.2–2.5 mm ² (AWG 22–12)	0.2–2.5 mm ² (AWG 22–12)
Degree of protection	IP20	IP20	IP20	IP20	IP20
RFI suppression	EN 55011, EN 55022 Class B, IEC 61000-6-1, 2, 3, 4				
Ambient operating temperature	–25 °C to +55 °C	–25 °C to +55 °C	–25 °C to +55 °C	–25 °C to +55 °C	–25 °C to +55 °C
Transport and storage temperature	–40 °C to +70 °C	–40 °C to +70 °C	–40 °C to +70 °C	–40 °C to +70 °C	–40 °C to +70 °C
Hazardous location	CSA Class I, Div. 2, Groups A, B, C, D; Temp. Code T3C				

easy800 Series

Type	EASY819-AC...	EASY819-DC-RC...	EASY820-DC-RC...	EASY821-DC-TC...	EASY822-DC-TC.
Supply voltage	100–240 Vac	24 Vdc	24 Vdc	24 Vdc	24 Vdc
Heat dissipation	10 VA	3.4 W	3.4 W	3.4 W	3.4 W
Continuous current outputs ^①	8 A	8 A	8 A	8 A	0.5 A
Short-circuit proof with power factor 1	Line protection B16, 600 A	Line protection B16, 600 A	Line protection B16, 600 A	Line protection B16, 600 A	—
Short-circuit proof with power factor 0.7...0.7	Line protection B16, 900 A	Line protection B16, 900 A	Line protection B16, 900 A	Line protection B16, 900 A	—
Mounting	On 35 mm DIN rail or screw mounting with ZB4-101-GF1 mounting feet				
Connection cables					
Solid	0.2–4.0 mm ² (AWG 22–12)	0.2–4.0 mm ² (AWG 22–12)	0.2–4.0 mm ² (AWG 22–12)	0.2–4.0 mm ² (AWG 22–12)	0.2–4.0 mm ² (AWG 22–12)
Flexible	0.2–2.5 mm ² (AWG 22–12)	0.2–2.5 mm ² (AWG 22–12)	0.2–2.5 mm ² (AWG 22–12)	0.2–2.5 mm ² (AWG 22–12)	0.2–2.5 mm ² (AWG 22–12)
Degree of protection	IP20	IP20	IP20	IP20	IP20
RFI suppression	EN 55011, EN 55022 Class B, IEC 61000-6-1, 2, 3, 4				
Ambient operating temperature	–25 °C to +55 °C	–25 °C to +55 °C	–25 °C to +55 °C	–25 °C to +55 °C	–25 °C to +55 °C
Transport and storage temperature	–40 °C to +70 °C	–40 °C to +70 °C	–40 °C to +70 °C	–40 °C to +70 °C	–40 °C to +70 °C
Hazardous location	CSA Class I, Div. 2, Groups A, B, C, D; Temp. Code T3C				

Note

^① Relay = 8 A (10 A to UL) with resistive load, 3 A with inductive load. Transistor outputs = 0.5 A/24 Vdc, maximum four outputs switchable in parallel.

Dimensions

Approximate Dimensions in Inches (mm)

easy500 Series, Drawing Number MD05013001E

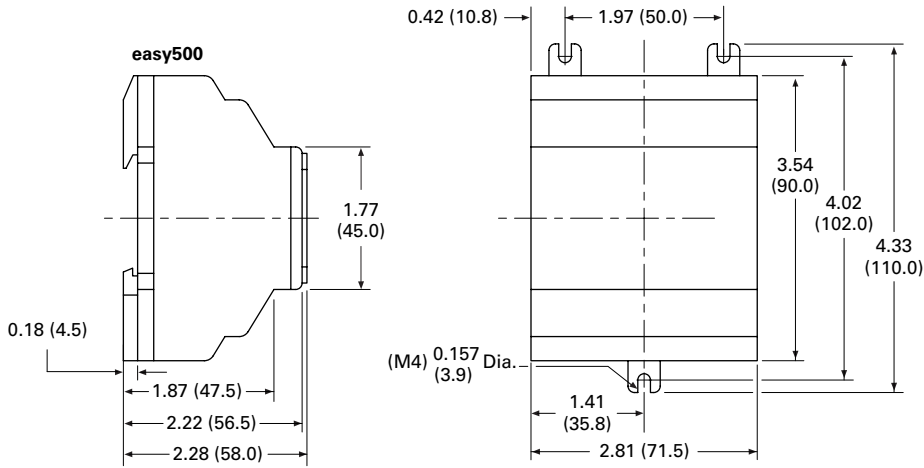

easy700 Series, Drawing Number MD05013002E

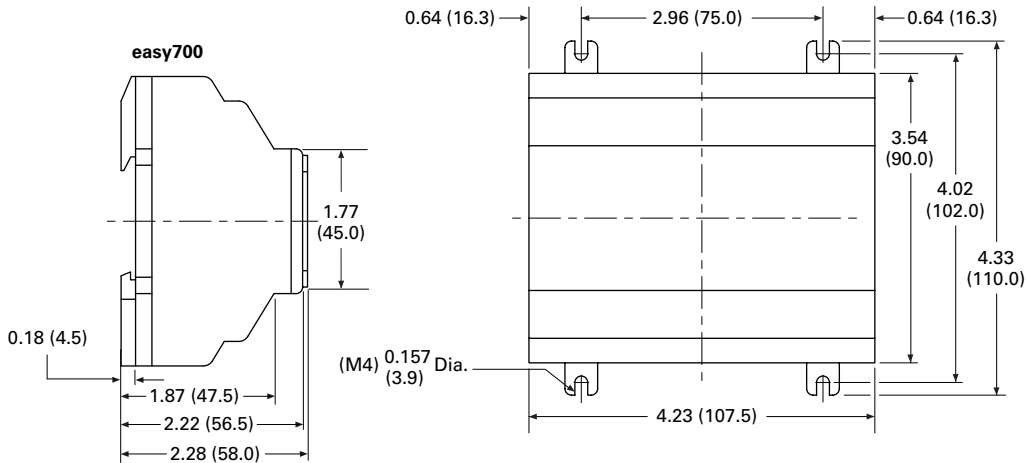

easy800 Series, Drawing Number MD05013003E

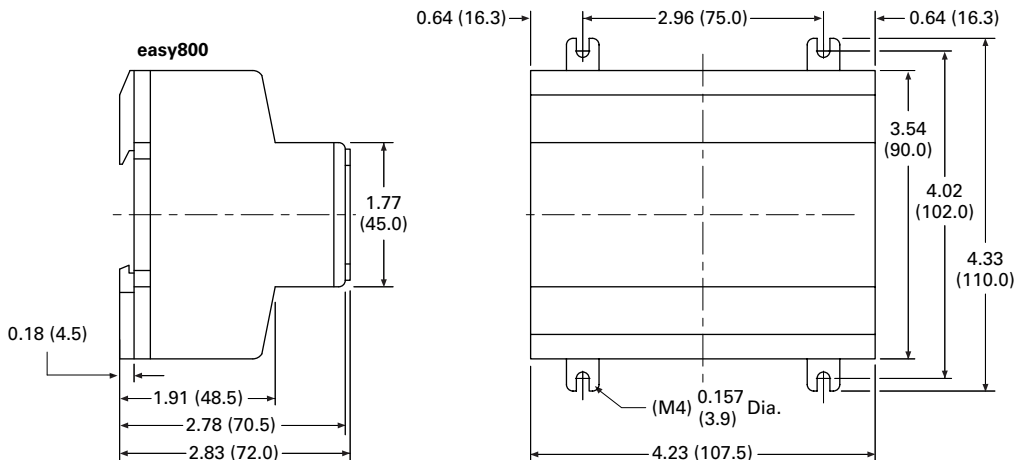

easy802/806 Programmable Relays with SmartWire-DT



easy802/806 Programmable Relays with SmartWire-DT

Product Description

SmartWire-DT is a high-performance system that can be used to quickly and easily connect motor control components such as relays, contactors, pilot devices, manual motor protectors, soft starters ① and variable frequency drives ② as well as digital and analog input/output modules. On the new easy800 with integrated SmartWire-DT master, up to 99 SmartWire-DT devices in total with up to 166 inputs/outputs can be connected via the SmartWire-DT line. All required supply voltages, including those for bus devices as well as 24 Vdc for the contactors, are provided directly with the flat eight-pole SmartWire-DT bus line. This reduces wiring effort and troubleshooting and saves time and costs.

The easy802 features a POW power feeder for regulating power to the device as well as the SmartWire-DT devices. A second AUX power feeder provides the connected contactors with 24 Vdc. A separate 24 Vdc power supply is required to provide 24 Vdc power to the easy802 or easy806 controllers. The configuration of the SmartWire-DT devices is undertaken at a touch of the provided Configuration button. LEDs provide feedback on the connecting states on the device and the SmartWire-DT line. The serial interface serves for programming as well as for connection of a remote text display, touch panel or for connection to the Ethernet.

Contents

Description

<i>Description</i>	<i>Page</i>
easy500/700/800 Programmable Relays	V7-T3-20
easy802/806 Programmable Relays with SmartWire-DT	
Product Selection	V7-T3-27
Accessories.	V7-T3-27
Technical Data and Specifications.	V7-T3-28
Dimensions.	V7-T3-29
easyRelay and MFD Expansion Modules	V7-T3-30
MFD-Titan Multi-Function Displays	V7-T3-33
easyRelay Communication Modules	V7-T3-40
easyRelay Power Supplies, Accessories and Software	V7-T3-43

Standards

- EN 50178
- IEC/EN 60947
- UL 508

Certifications

- cULus
- CE
- C-Tick



In addition to the functionality of the easy802, the easy806 also features four fast inputs (5 kHz). Two of the four inputs can also be configured as fast outputs (5 kHz) (transistor 24 Vdc, 0.1 A). In addition to the additional inputs/outputs on easy806, there is a connection option to the easyNet. Up to eight EASY806-DC-SWD controllers can be connected via easyNet, allowing up to 1360 inputs/outputs.

For more information on SmartWire-DT and related components, see **Tab 9** of this volume or go to www.eaton.com/smawiredt.

Note

① Soft starters and variable frequency drives will be available with direct SmartWire-DT connectivity in late 2013.

Product Selection

Control relay for connection of SmartWire-DT and simultaneously for supply of power to the SmartWire-DT devices, such as switchgear and contactors.

EASY802-DC-SWD



easy800 with SmartWire-DT

Supply Voltage	Description	Catalog Number
24 Vdc	Control relay with SmartWire-DT	EASY802-DC-SWD

EASY806-DC-SWD



24 Vdc	Control relay with SmartWire-DT, four inputs, two of which can be used as outputs (transistor 24 Vdc, 0.1 A), easyNet onboard	EASY806-DC-SWD
--------	---	-----------------------

Remote Displays

Both the easy802 and easy806 controllers can be connected to a MFD remote display or a XV touch panel display with Galileo.

Accessories

MFD-80



Accessories—easy800

Description	Catalog Number
MFD display, NEMA 4X indoor rated	MFD-80

MFD-CP4



24 Vdc power / communication module	MFD-CP4
easy802/806 to MFD-CP4 communication cable, 1.5m	EU4A-RJ45-CAB2
easy802/806 to XV HMI communication cable, 2m	EU4A-RJ45-CAB1

Technical Data and Specifications

easy802/806 Programmable Relays with SmartWire-DT

Description	Unit	Specification
Ambient Climatic Conditions		
Cold to IEC 60068-2-1, heat to IEC 60068-2-2, damp heat, constant, to IEC 60068-2-78; cyclical to IEC 60068-2-30; temperature change to IEC 68000-2-14		
Operating ambient temperature	°C (°F)	–25 ° to +55 ° (–13 ° to +131 °)
Condensation		Prevent condensation by means of suitable measures
LCD display (reliable legible)	°C (°F)	0 ° to +55 ° (32 ° to +131 °)
Storage	°C (°F)	–40 ° to +70 ° (–40 ° to +158 °)
Relative humidity, noncondensing (IEC EN 60068-2-30)	%	5 to 95
Air pressure (in operation)	hPa	795 up to 1080
Ambient Mechanical Conditions		
Protection type EN 50178, IEC 60529, VBG4		IP20
Vibrations (IEC EN 60068-2-6)		
Constant amplitude: easy800-SWD; 3.5 mm	Hz	5–8.4
Constant acceleration: easy800-SWD; 1g	Hz	8.4–150
Mechanical shock resistance (IEC EN 60068-2-27) semi-sinusoidal 15g / 11 ms	Shocks	18
Drop (IEC EN 60068-2-31)	Drop height	mm 50
Free fall, packaged (IEC EN 60068-2-32)	m	0.3
Electromagnetic Compatibility (EMC)		
Electrostatic discharge (ESD), to IEC EN 61000-4-2		
Air discharge	kV	8
Contact discharge	kV	6
Electromagnetic fields (RFI), to IEC EN 61000-4-3		
0.8–1.0 GHz	V/m	10
1.4–2.0 GHz	V/m	3
2.0–2.7 GHz	V/m	1
Radio interference suppression		EN 55011 Class B
Burst, to IEC EN 61000-4-4		
Supply cables	kV	2
Signal cables	kV	2
easyNet	kV	2
SWD-line	kV	2
Power pulses (surge), to IEC EN 61000-4-5 (supply cables, symmetrical)	kV	1
Radiated RFI, to IEC EN 61000-4-6	V	10
Insulation Resistance		
Overvoltage category		III
Pollution degree		2
Clearance in air and creepage distances		EN 50178, UL 508, CSA C22.2, No. 142
Insulation resistance		EN 50178
Terminal Capacity		
Solid, minimum to maximum	mm ²	0.2 to 1.5 (AWG 24–16)
Flexible with ferrule, minimum to maximum	mm ²	0.2 to 1.5 (AWG 24–16)
DC POW Rated Operational Voltage		
Rated value U _e	Vdc, (%)	24 DC (–15/+20)
Permissible range ①	Vdc	20.4–28.8
Residual ripple	%	≤ 5
Protection against polarity reversal		Yes
Input current		
At rated operating voltage	mA	easy802: 500 / easy806: 900
Inrush current and duty factor		12.5 A for 6 ms
Voltage dips (IEC EN 61131-2)	ms	10

Note

① Use power-feed modules if the cable length of the SWD line causes excessive voltage drop.

easy802/806 Programmable Relays with SmartWire-DT, continued

Description	Unit	Specification
Heat dissipation		
At 24 Vdc	W	easy802: max. 5 / easy806: max. 6
Fuse	A	≥ 3
Potential isolation (easy800-SWD)		
To auxiliary ^①		Yes
To easyNet ^①		Yes
To serial interface		Yes
To easyLink ^①		No
To inputs ^①		No
To outputs ^①		No
To SWD ^①		No
DC AUX Rated Operational Voltage (easy800-SWD)		
Rated value U_e	Vdc, (%)	24 (-15/+20)
Permissible range U_{AUX}	Vdc	20.4–28.8
Residual ripple	%	≤ 5
Input current ^② (max.)	A	2 (UL) / 3 (CE)
Rated operational voltage of the 24 Vdc stations	V	$U_{AUX} - 0.3$ V
Protection against polarity reversal		Yes
Short-circuit strength		No
Fuse	A	≤ 2 (UL) external fuse with FAZ B2
Heat dissipation		
At 24 Vdc	W	Normally 1
Potential isolation (easy800-SWD)		
To POW power supply, inputs and outputs		Yes
To PC interface (COM), easyNet		Yes
To SWD		Yes

Notes

- ① If present.
 ② If contactors with a higher total power consumption are connected, an EU5C-SWD-PF1 or EU5C-SWD-PF2 power-feed module must be used.

Dimensions

Approximate Dimensions in Inches (mm)

easy802 and easy806 Controllers

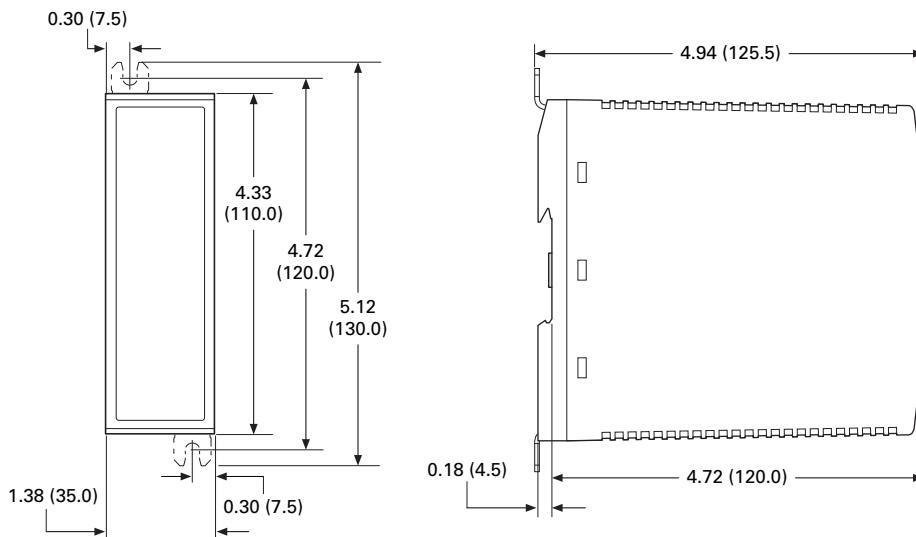

easyRelay Expansion Modules



3

Contents

<i>Description</i>	<i>Page</i>
easy500/700/800 Programmable Relays	V7-T3-20
easy802/806 Programmable Relays with SmartWire-DT	V7-T3-26
easyRelay and MFD Expansion Modules	
Product Selection	V7-T3-31
Technical Data and Specifications	V7-T3-31
Dimensions	V7-T3-32
MFD-Titan Multi-Function Displays	V7-T3-33
easyRelay Communication Modules	V7-T3-40
easyRelay Power Supplies, Accessories and Software	V7-T3-43

easyRelay and MFD Expansion Modules

Product Description

Expansion modules are available for increasing the input/output of the easy700/800 and MFD-Titan multi-function displays to 24 inputs and up to 16 outputs. Expansion modules can be mounted directly to the easy700 or easy800 relays or up to 98 ft (30m) away using coupling module EASY200-EASY.

Standards

- CSA C22.2 No. 142-M1987
- CSA C22.2 No. 213-M1987
- EN 55011
- EN 50178
- EN 61131-2
- IEC EN 61000-4
- IEC 60068-2-6
- IEC 60068-2-27
- UL 508

Certifications

- UL
- CSA
- CE
- CSA Class I, Div. 2, Groups A, B, C, D; Temp. Code T3C
- C-Tick
- GOST-R
- Ukrain-GOST



Shipping Approvals

- Bureau Veritas
- Det Norske Veritas
- Germanischer Lloyd
- Lloyd's Register of Shipping

Product Selection

EASY618_



Digital I/O Expansion Modules

Can be used via easyLink.

Supply Voltage	Digital Inputs	Outputs		Catalog Number
		Relay 10 A (UL)	Transistor	
100–240 Vac	12	6	—	EASY618-AC-RE
24 Vdc	12	6	—	EASY618-DC-RE
24 Vdc	12	—	8	EASY620-DC-TE
24 Vdc	6	4	—	EASY410-DC-RE
24 Vdc	6	—	4	EASY410-DC-TE
24 Vdc	—	2	—	EASY202-RE
For distributed connection of a digital input/output expansion at up to 98 ft (30m) distance				EASY200-EASY

EASY406_



Analog I/O Expansion Modules

Can be used via easyLink.

Supply Voltage	Inputs		Digital Outputs		Analog Outputs	Catalog Number
	Digital/ Analog	Can Be Used for Digital	Relay 10 A (UL)	Transistor		
24 Vdc	1/2	2	—	2	1	EASY406-DC-ME
24 Vdc	1/6	2	—	2	2	EASY411-DC-ME

Technical Data and Specifications

easyRelay I/O Expansion Modules

Type	EASY202-RE	EASY618-AC-RE	EASY618-DC-RE	EASY620-DC-TE	EASY200-EASY
Supply voltage	—	100 – 240 Vac	24 Vac	24 Vac	—
Heat dissipation	1 W	10 VA	4 W	4 W	1 W
Continuous current outputs ^①	8 A	8 A	8 A	0.5 A	—
Short-circuit proof with power factor 1	Line protection B16, 600 A	Line protection B16, 600 A	Line protection B16, 600 A	Line protection B16, 600 A	—
Short-circuit proof with power factor 0.7...0.7	Line protection B16, 900 A	Line protection B16, 900 A	Line protection B16, 900 A	Line protection B16, 900 A	—
Connection cables					
Solid	0.2–4.0 mm ² (AWG 22–12)	0.2–4.0 mm ² (AWG 22–12)	0.2–4.0 mm ² (AWG 22–12)	0.2–4.0 mm ² (AWG 22–12)	0.2–4.0 mm ² (AWG 22–12)
Flexible	0.2–2.5 mm ² (AWG 22–12)	0.2–2.5 mm ² (AWG 22–12)	0.2–2.5 mm ² (AWG 22–12)	0.2–2.5 mm ² (AWG 22–12)	0.2–2.5 mm ² (AWG 22–12)
Degree of protection	IP20	IP20	IP20	IP20	IP20
RFI suppression	EN 55011, EN 55022 Class B, IEC 61000-6-1,2,3,4				
Ambient operating temperature	–25 °C to +55 °C	–25 °C to +55 °C	–25 °C to +55 °C	–25 °C to +55 °C	–25 °C to +55 °C
Transport and storage temperature	–40 °C to +70 °C	–40 °C to +70 °C	–40 °C to +70 °C	–40 °C to +70 °C	–40 °C to +70 °C
Certification, standards	EN 50178, IEC/EN 60947, UL, CSA				
Mounting	On 35 mm DIN rail or screw mounting with ZB4-101-GF1 mounting feet				

3.3

Control Relays and Timers

Programmable Relays

Dimensions

Approximate Dimensions in Inches (mm)

easy600 Series, Drawing Number MD05013002E

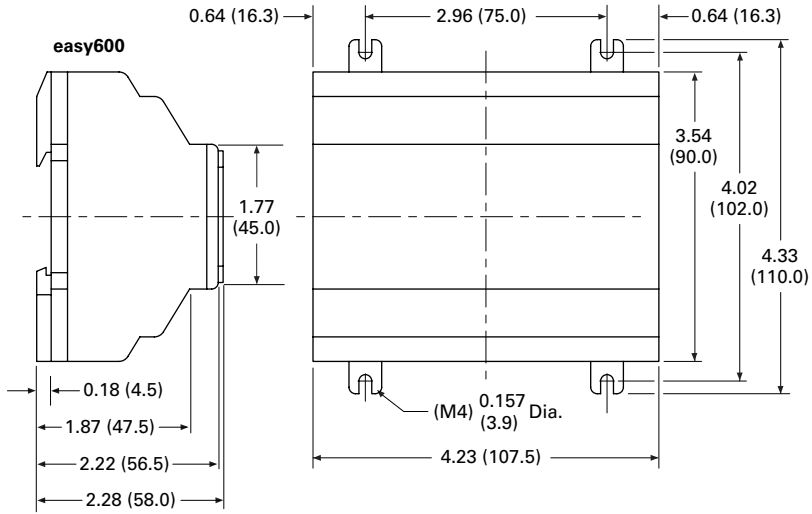

EASY202-RE/EASY200-EASY/EASY205-ASI Series, Drawing Number MD05013012E

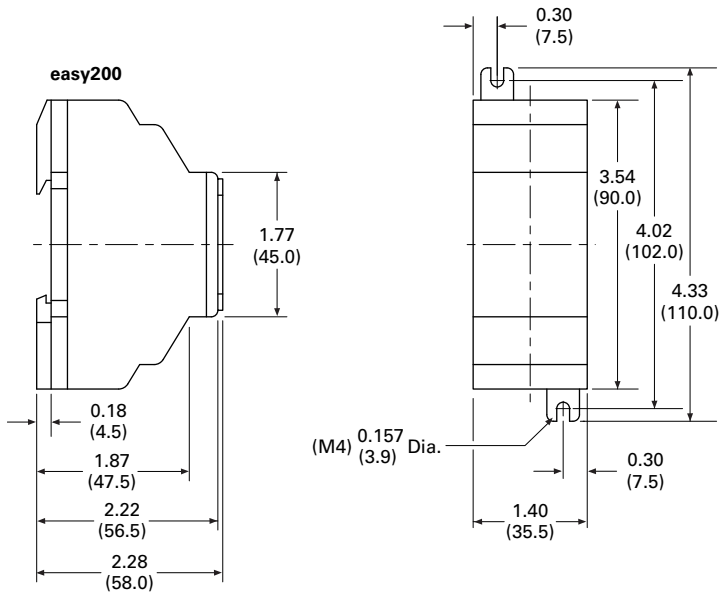

MFD-Titan Multi-Function Displays**Contents**

Description	Page
easy500/700/800 Programmable Relays	V7-T3-20
easy802/806 Programmable Relays with SmartWire-DT	V7-T3-26
easyRelay and MFD Expansion Modules	V7-T3-33
MFD-Titan Multi-Function Displays	
System Overview	V7-T3-34
Product Selection	V7-T3-35
Accessories	V7-T3-36
Technical Data and Specifications	V7-T3-37
Dimensions	V7-T3-38
easyRelay Communication Modules	V7-T3-40
easyRelay Power Supplies, Accessories and Software	V7-T3-43

MFD-Titan Multi-Function Displays**Product Description**

The MFD-Titan multi-function displays can be used as remote text displays for easy500, easy700, easy800 and easy802/806 relays or can be configured as standalone or networked multi-function displays. As a multi-function display, the MFD-Titan combines the control functions of an easy800 with a door-mounted graphics display.

MFD-Titan multi-function display is comprised of three parts: display, controller and I/O modules. Match each piece to the needs of your application. If you need to both monitor and modify parameters within your application, choose the MFD-80-B display. The preprogrammed and user programmable buttons give you the capability to make small changes to the way your application is running, start or stop a process, or change your program completely. Select a controller with or without easyNet support, and with AC or DC power. Finally, add the MFD I/O module that best suits your application.

MFD-Titan—for controlling small applications that require graphic visualization and for large-scale applications with 20 points, expandable to 40 points locally, and expandable using the easyNet network up to 320 I/O points.

The MFD-Titan display can be linked to the easy500/700/800 models to provide an enhanced text based operator interface.

The easyNet integrated network provides easy and inexpensive linking of up to eight MFD-Titan devices over a distance of up to 1000 meters. Each MFD-Titan device can run its program, or be used as a distributed input/output module. Connect up to eight controllers with up to 40 I/O to obtain 320 I/O.

Standards

- CSA C22.2 No. 142-M1987
- CSA C22.2 No. 213-M1987
- EN 55011
- EN 50178
- EN 61131-2
- IEC EN 61000-4
- IEC 60068-2-6
- IEC 60068-2-27
- UL 508

Certifications

- UL
- CSA
- CE
- CSA Class I, Div. 2, Groups A, B, C, D; Temp. Code T3C
- C-Tick
- GOST-R
- Ukrain-GOST

**Shipping Approvals**

- Bureau Veritas
- Det Norske Veritas
- Germanischer Lloyd
- Lloyd's Register of Shipping

3.3

Control Relays and Timers

Programmable Relays

System Overview

MFD-Titan Multi-Function Display

3

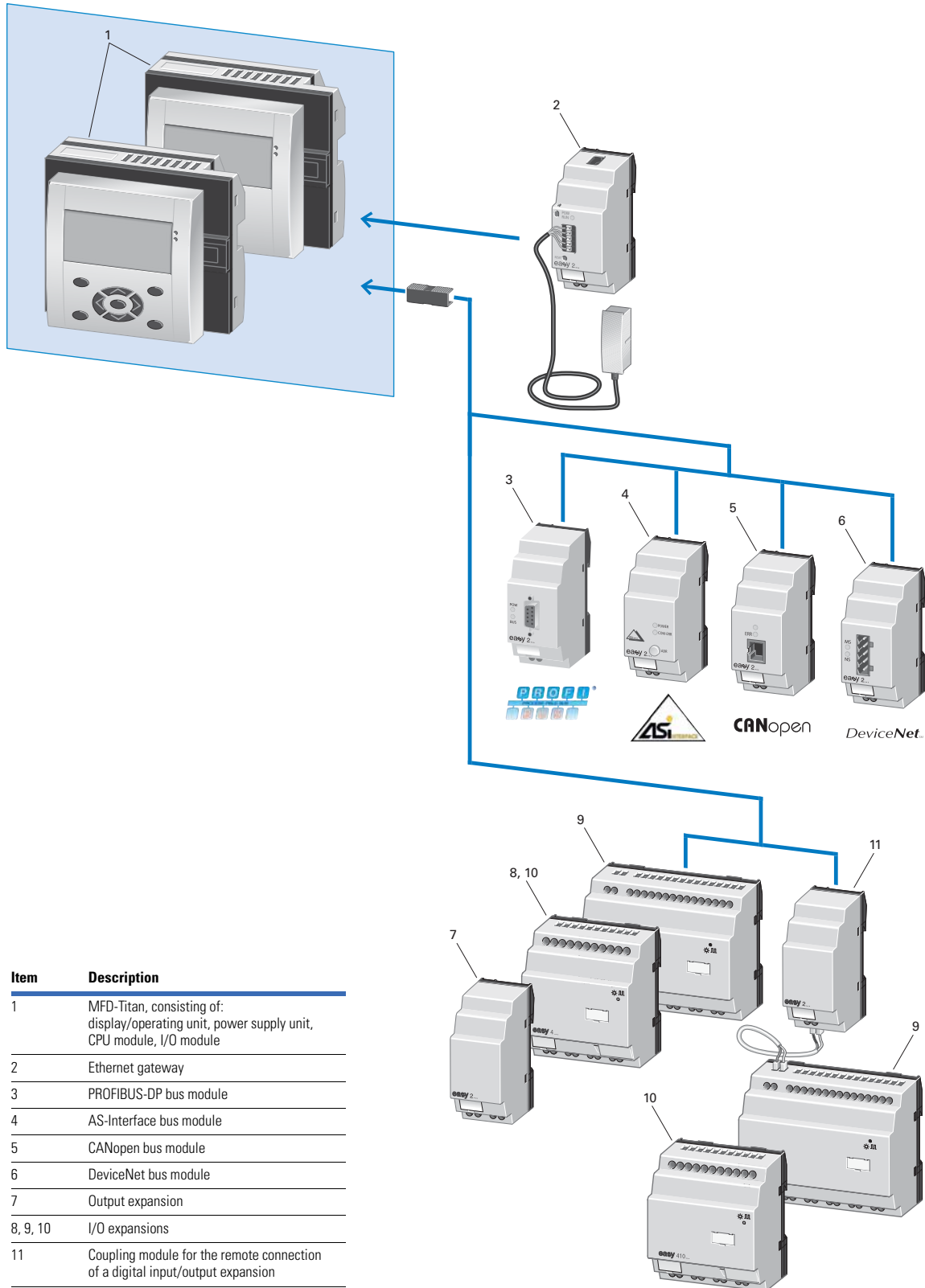

Product Selection

MFD-80-B



MFD-Titan Display/Operator Units

Monochrome display 132 x 64 pixels with switchable backlight and removable front frame.

Description	Keypad	Eaton Logo	Custom Engraving	Catalog Number
MFD display, NEMA 4X indoor rated	—	—	—	MFD-80-X
MFD display, NEMA 4X indoor rated	—	■	—	MFD-80
MFD display, NEMA 4X indoor rated	—	—	■	MFD-80-ETCH ①
MFD display with keypad ②	■	—	—	MFD-80-B-X
MFD display with keypad ②	■	■	—	MFD-80-B
MFD display with keypad ②	—	—	■	MFD-80-B-ETCH ①

MFD-CP4



MFD-Titan Text/Graphics Display Power Module

For use with MFD-Titan displays for use as remote text/graphics display.

Supply Voltage	Description	Catalog Number
100–240 Vac	AC power supply / communication module (no cable)	MFD-AC-CP4
	AC module for easy500/700 relays and cable MFD-CP4-500-CAB5	MFD-AC-CP4-500
	AC module for easy800 relays and cable MFD-CP4-800-CAB5	MFD-AC-CP4-800
24 Vdc	DC power supply / communication module (no cable)	MFD-CP4
	DC module for easy500/700 relays and cable MFD-CP4-500-CAB5	MFD-CP4-500
	DC module for easy800 relays and cable MFD-CP4-800-CAB5	MFD-CP4-800

MFD-CP



MFD-Titan Controller Modules

For use with MFD-Titan display/operator units. Add MFD-Titan I/O modules as needed.

Supply Voltage	Description	Catalog Number
100–240 Vac	Program and screen memory	MFD-AC-CP8-ME
	Program and screen memory, with easyNet	MFD-AC-CP8-NT
24 Vdc	Program and screen memory	MFD-CP8-ME
	Program and screen memory, with easyNet	MFD-CP8-NT
	Double program and screen memory (as MFD-CP8)	MFD-CP10-ME
	Double program and screen memory (as MFD-CP8), with easyNet	MFD-CP10-NT

Notes

- ① To order an MFD display with custom engraving, a marking file with the required text and/or graphics must be created as a Labeleditor ZIP file. The ZIP file has to be sent to the Eaton factory, and the name of the file must be referenced in the order notes section. To download the Labeleditor configuration software, please visit www.eaton.com/software.
- ② To obtain a NEMA 4X indoor rating on MFD displays with keypads, use with a protective membrane cover MFD-XM-80.

MFD-R16



MFD-Titan I/O Modules

For use with MFD-Titan controller modules.

Supply Voltage	Description	Inputs		Outputs			Catalog Number
		Digital	Analog ^①	Relay	Transistor	Analog	
100–240 Vac	16 I/O	12	—	4	—	—	MFD-AC-R16
		12	4	4	—	—	MFD-R16
24 Vdc	17 I/O	12	4	—	4	—	MFD-T16
		12	4	4	—	1	MFD-RA17
		12	4	—	4	1	MFD-TA17

MFD-TP_



MFD-Titan I/O Modules with Temperature Detection

For use with MFD-CP8_ ^② and MFD-CP10_ MFD-Titan controller modules.

Supply Voltage	Inputs			Outputs			Temperature Ranges	Catalog Number
	Digital	Can Be Used For Analog	Pt100	Relay 10 A (UL)	Transistor	Analog		
24 Vdc	6	2	2	—	4	—	–40 ° to +90 °C/0 ° to +250 °C/0 ° to +400 °C	MFD-TP12-PT-A
	6	2	2	—	4	—	–200 ° to +200 °C/0 ° to +850 °C	MFD-TP12-PT-B
	6	2	—	—	4	—	–40 ° to +90 °C/0 ° to +250 °C	MFD-TP12-NI-A
	6	2	2	—	4	1	–40 ° to +90 °C/0 ° to +250 °C/0 ° to +400 °C	MFD-TAP13-PT-A
	6	2	2	—	4	1	–200 ° to +200 °C/0 ° to +850 °C	MFD-TAP13-PT-B
	6	2	—	—	4	1	–40 ° to +90 °C/0 ° to +250 °C	MFD-TAP13-NI-A

Accessories

Miscellaneous Parts

Description	Catalog Number
MFD-Titan display protective membrane cover	MFD-XM-80
MFD-Titan display protective plastic cover	MFD-XS-80
MFD-Titan display DIN rail mount kit	MFD-TS-144

Notes

- ① Analog inputs optional. Use of analog inputs will result in a decrease in the same number of available digital inputs
- ② Version 8 and higher MFD-CP8_ controllers are compatible with the temperature detection modules.

Technical Data and Specifications

MFD-80, MFD-CP4, MFD-CP8

Type	MFD-80...	MFD-CP4/CP8
Connection cables		
Solid	—	0.2–4.0 mm ² (AWG 22–12)
Flexible	—	0.2–2.5 mm ² (AWG 22–12)
Degree of protection	IP65	IP20
RFI suppression	EN 55011, EN 55022 Class B, IEC 61000-6-1, 2, 3, 4	EN 55011, EN 55022 Class B, IEC 61000-6-1, 2, 3, 4
Ambient operating temperature	Clearly legible at –5 °C to +50 °C	–25 °C to +55 °C
Transport and storage temperature	–40 °C to +70 °C	–40 °C to +70 °C
Hazardous location	CSA Class I, Div. 2, Groups A, B, C, D; Temp. Code T3C	CSA Class I, Div. 2, Groups A, B, C, D; Temp. Code T3C

MFD-Titan I/O Modules

Type	MFD-AC-R16	MFD-R16	MFD-RA17	MFD-T16	MFD-TA17
Supply voltage	Supply via MFD-CP8 module	Supply via MFD-CP8 module	Supply via MFD-CP8 module	Supply via MFD-CP8 module	Supply via MFD-CP8 module
Heat dissipation	0.5 W	0.5 W	0.5 W	0.5 W	0.5 W
Continuous current outputs ^①	8 A	8 A	8 A	0.5 A	0.5 A
Short-circuit proof with power factor 1	Line protection B16, 600 A	Line protection B16, 600 A	Line protection B16, 600 A	—	—
Short-circuit proof with power factor 0.7...0.7	Line protection B16, 600 A	Line protection B16, 600 A	Line protection B16, 600 A	—	—
Connection cables					
Solid	0.2–4.0 mm ² (AWG 22–12)	0.2–4.0 mm ² (AWG 22–12)	0.2–4.0 mm ² (AWG 22–12)	0.2–4.0 mm ² (AWG 22–12)	0.2–4.0 mm ² (AWG 22–12)
Flexible	0.2–2.5 mm ² (AWG 22–12)	0.2–2.5 mm ² (AWG 22–12)	0.2–2.5 mm ² (AWG 22–12)	0.2–2.5 mm ² (AWG 22–12)	0.2–2.5 mm ² (AWG 22–12)
Degree of protection	IP20	IP20	IP20	IP20	IP20
RFI suppression	EN 55011, EN 55022 Class B, IEC 61000-6-1,2,3,4				
Ambient operating temperature	–25 °C to +55 °C	–25 °C to +55 °C	–25 °C to +55 °C	–25 °C to +55 °C	–25 °C to +55 °C
Transport and storage temperature	–40 °C to +70 °C	–40 °C to +70 °C	–40 °C to +70 °C	–40 °C to +70 °C	–40 °C to +70 °C
Mounting	Snap fitted to MFD-CP8 module	Snap fitted to MFD-CP8 module	Snap fitted to MFD-CP8 module	Snap fitted to MFD-CP8 module	Snap fitted to MFD-CP8 module

MFD-CP4 and CP8 Communication Modules

Type	MFD-80...	MFD-CP4-...	MFD-CP8...	MFD-AC-CP8...
Supply voltage	Supply from -CP	24 Vdc	24 Vdc	100–240 Vac
Heat dissipation	3 W	1.5 W	3 W	8 VA
Mounting	Front mounting in 2 x 22.5 mm Standard drill holes	Snap fitted to MFD-80	Snap fitted to MFD-80 or on 35 mm DIN rail or screw mounting with ZB4-101-GF1 mounting feet	

Note

- ^① Relay = 8 A with resistive load, 3 A with inductive load.
Transistor outputs = 0.5 A/24 Vdc, maximum four outputs switchable in parallel.

3.3

Control Relays and Timers

Programmable Relays

Dimensions

Approximate Dimensions in Inches (mm)

MFD-80 Series, Drawing Number MD05013005E

3

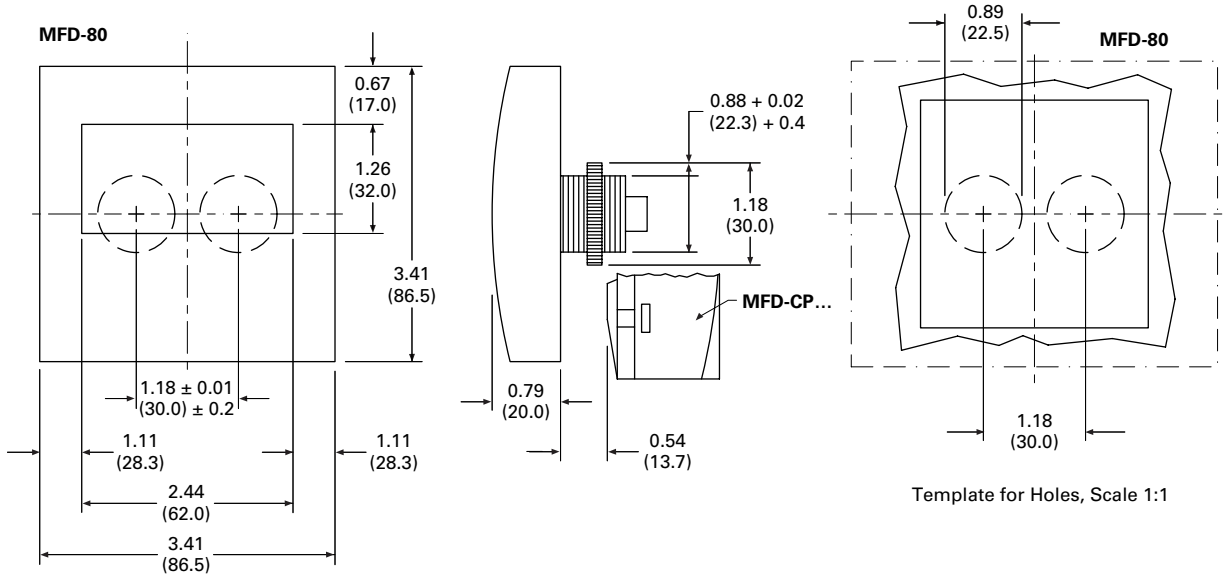

MFD-CP4, MFD-80 and MFD-CP4 Series Combined, Drawing Number MD013013E

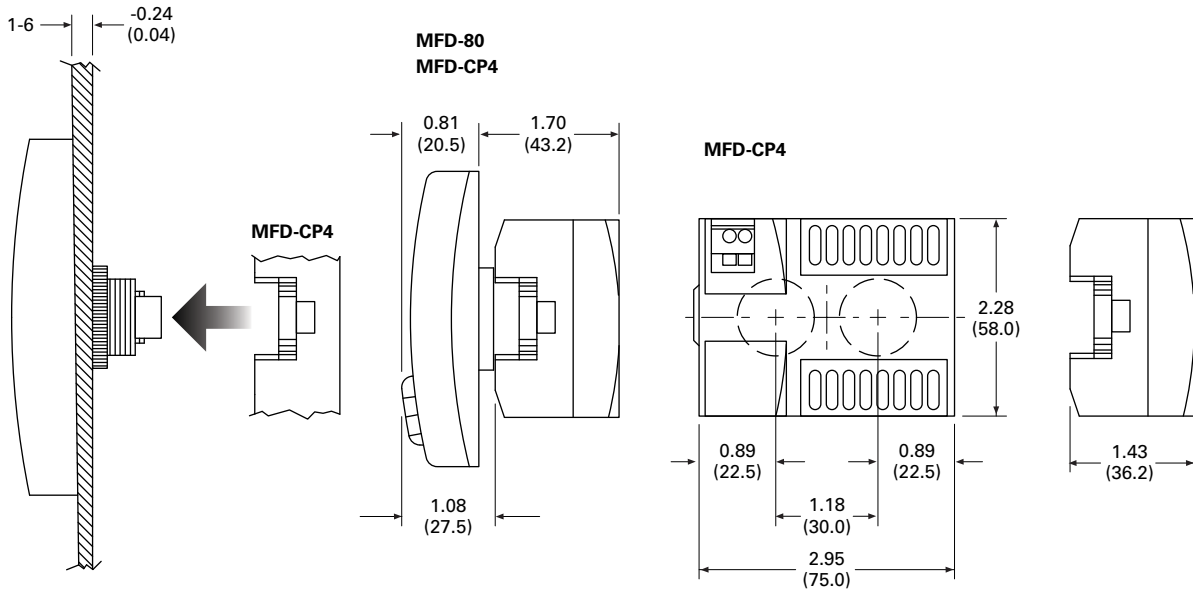

Approximate Dimensions in Inches (mm)

MFD-CP8 Series, Drawing Number MD05013006E

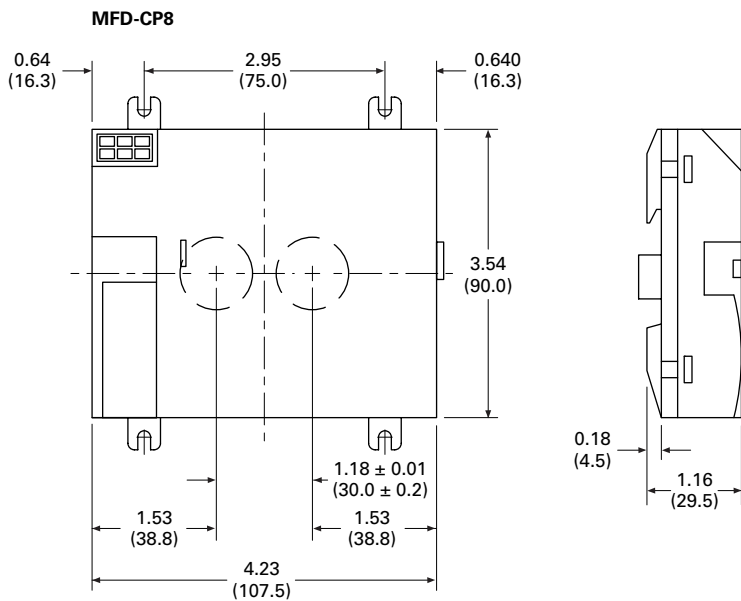

MFD-R/MFD-T I/O Module, Drawing Number MD05013007E

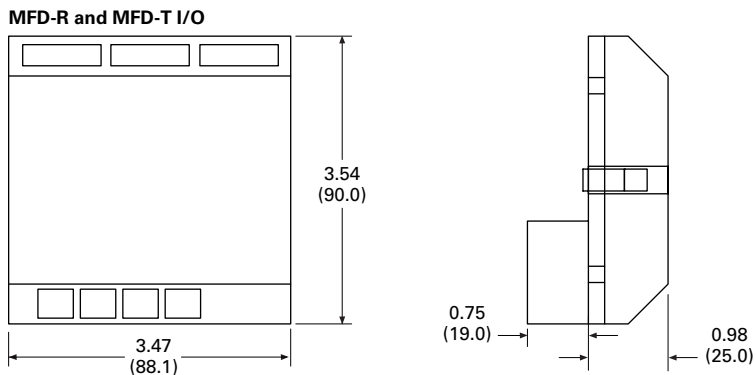

easyRelay Communication Modules



Contents

<i>Description</i>	<i>Page</i>
easy500/700/800 Programmable Relays	V7-T3-20
easy802/806 Programmable Relays with SmartWire-DT	V7-T3-26
easyRelay and MFD Expansion Modules	V7-T3-33
MFD-Titan Multi-Function Displays	V7-T3-33
easyRelay Communication Modules	
Technical Data and Specifications	V7-T3-41
Dimensions	V7-T3-41
easyRelay Power Supplies, Accessories and Software	V7-T3-43

easyRelay Communication Modules

Product Description

Four network modules are available for easily connecting to world-standard networks. The network modules can be used with the easy700/800 programmable relays and MFD-Titan multi-function displays.

Available communication modules support:

- DeviceNet
- PROFIBUS-DP
- AS-Interface
- CANopen

All modules operate exclusively as nodes on the given network.

Product Selection

The Ethernet gateway connects devices provided with an RS-232 serial interface with the Ethernet network. This gateway can be used with easy500 as well as easy700/800 relays and MFD-Titan displays.

EASY209-SE



Ethernet Gateway Module

Description		Catalog Number
Ethernet gateway	Serial interface easyRelay or MFD-...CP8/CP10_ to Ethernet, for connecting to easyOPC server, easySoft or easyCom	EASY209-SE ①

EASY204-DP



Network Interface Modules

Description		Catalog Number
DeviceNet interface module	Addresses available 0 to 63	EASY222-DN
PROFIBUS-DP interface module	Device addresses available 1 to 126	EASY204-DP
AS-Interface interface module with 4 in and 4 out	Device: 4 inputs, 4 outputs, 4 parameter bits Addresses available 0 to 31	EASY205-ASI
CANopen interface module	Addresses available 1 to 127	EASY221-CO

Note

① To set up the Ethernet gateway, download the EASY209-SE configuration software at www.eaton.com/easyrelays.

Technical Data and Specifications

easy700/800/MFD Communication Interface Modules

EASY204-DP, EASY205-ASI, EASY221-CO, EASY222-DN, EASY209-SE ①

Description	Specification
Supply voltage	24 Vdc
Heat dissipation ②	1 W
Connection cables	
Solid	0.2–4.0 mm ² (AWG 22–12)
Flexible	0.2–2.5 mm ² (AWG 22–12)
Degree of protection	IP20
RFI suppression	EN 55011, EN 55022 Class B, IEC 61000-6-1,2,3,4
Ambient operating temperature	–25 °C to +55 °C
Transport and storage temperature	–40 °C to +70 °C
Certification, standards	EN 50178, IEC/EN 60947, UL, CSA
Mounting	On 35 mm DIN rail or screw mounting with ZB4-101-GF1 mounting feet

Notes

- ① EASY209-SE is also compatible with easy500 programmable relays.
 ② EASY204-DP dissipates 2 W.

Dimensions

Approximate Dimensions in Inches (mm)

EASY202-RE/EASY200-EASY/EASY205-ASI/ EASY209-SE Series, Drawing Number MD05013012E

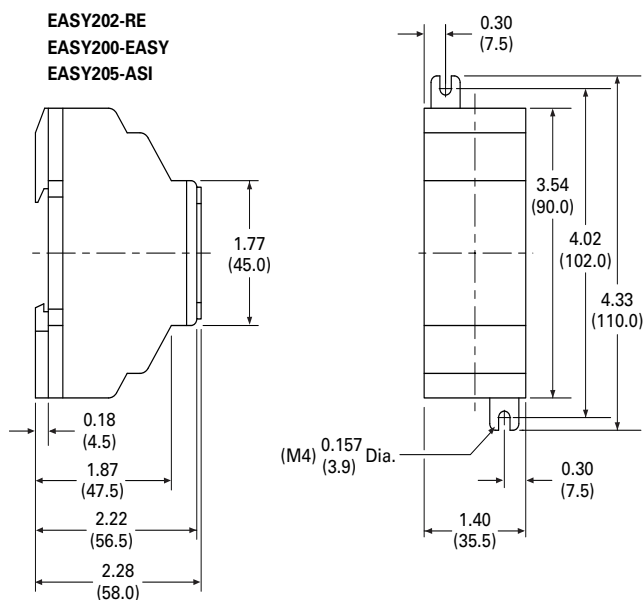

EASY221-CO/EASY222-DN Series, Drawing Number MD05013010E

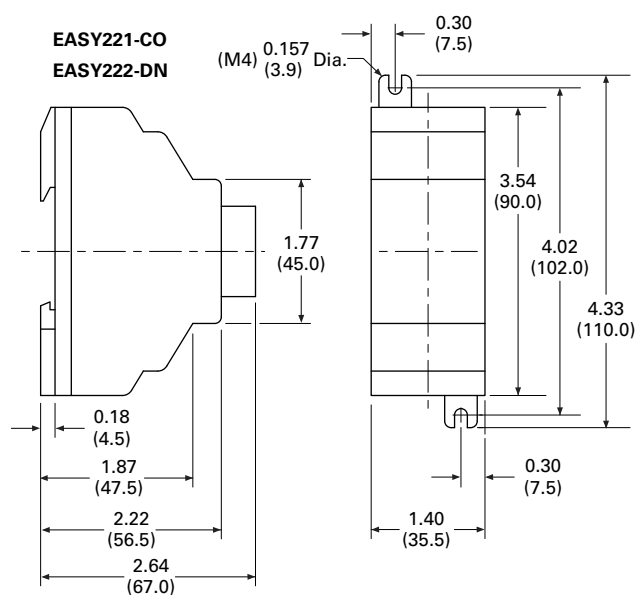

3.3

Control Relays and Timers

Programmable Relays

EASY204-DP Series,
Drawing Number MD05013011E

3

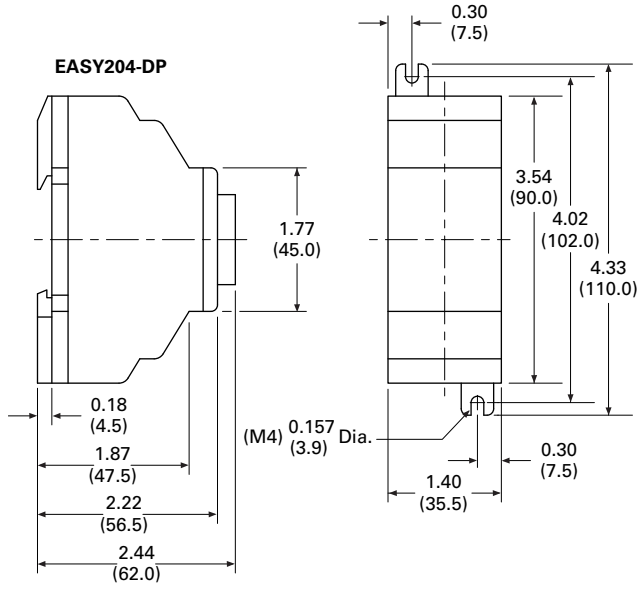

easyRelay Power Supplies, Accessories and Software



Contents

<i>Description</i>	<i>Page</i>
easy500/700/800 Programmable Relays	V7-T3-20
easy802/806 Programmable Relays with SmartWire-DT	V7-T3-26
easyRelay and MFD Expansion Modules	V7-T3-30
MFD-Titan Multi-Function Displays	V7-T3-33
easyRelay Communication Modules	V7-T3-40
easyRelay Power Supplies, Accessories and Software	
Accessories	V7-T3-44
Technical Data and Specifications	V7-T3-46
Wiring Diagram	V7-T3-46
Dimensions	V7-T3-47

easyRelay Power Supplies, Accessories and Software

Product Description

Power Supplies—12 Vdc and 24 Vdc power supplies for applications where only 100–240 Vac is available.

Accessories—Memory modules, cables and other components to complete your automation solutions.

Software—The easySoft software is used to program all of the easyRelays and MFD-Titan displays. The Windows®-based software provides straightforward circuit diagram input and editing and the diagrams can be displayed in the format desired. When easy800 and MFD-Titan controllers are connected using easyNet, all connected devices can be accessed and their programs loaded from a single controller.

easySoft includes an integrated offline simulation tool that allows users to test a circuit diagram before commissioning.

Product Selection

Power supply units are primary switched-mode power supplies that are optimally suited for the easyRelay and easySafety product series in terms of functions and design. The new and high-performance power supply units support safe operation in plants and machines. They are simple and flexible in handling.

Fast diagnosis of the voltage output: continuous light on the LED—fault-free operation; flashing on the LED—short circuit or overload on voltage output.

- Suitable for worldwide use due to wide range input from 85 V to 264 Vac, 50/60 Hz
- Output voltages can be connected in parallel to increase power output or for redundant operation to achieve greater system availability
- Compliance with international standards and approvals

The primary switched-mode power supply units can be used everywhere:

- Safety extra low voltage (SELV to EN 60 950)
- Radio interference Class B to EN 55 011 and EN 55 022 for use in industrial and public networks

EASY...-POW



Power Supply Units

Rated input voltage 100–240 Vac, single-phase.

Input Voltage Range	Rated Output Voltage	Output Voltage Setting Range	Rated Output Power	Rated Output Current	Catalog Number
100–240 Vac	24 Vdc/12 Vdc	—	8 W	0.35 A/20 mA	EASY200-POW
	24 Vdc	—	30 W	1.25 A	EASY400-POW
	24 Vdc	—	60 W	2.5 A	EASY500-POW
	24 Vdc	—	100 W	4.2 A	EASY600-POW

Bluetooth Adapter

Conveniently commission and service machines and other equipment remotely.

- Simple communication with easy800 or MFD-Titan from outside loud and/or dangerous areas
- An 8-digit PIN security code prevents unauthorized remote access
- Simple recognition in Windows 7
- Full online functionality with easySoft-Pro V6.91 or higher
- Has all necessary radio type approvals for USA, Canada and Europe

EASY800-BLT-ADP



Bluetooth Adapter

Description	Catalog Number
easy800/MFD Bluetooth adapter	EASY800-BLT-ADP
The Bluetooth adapter provides wireless connectivity to easySoft-Pro for easy programming download and upload. Use it with the easyRemote Display Android App for simple and fast access to your easy800 relays up to a distance of 10 meters.	

Accessories

easySoft



Programming Software

Description	Catalog Number
Programming software for easy500/700	EASY-SOFT-BASIC
Programming software for easy800, easy 802/806 and MFD-Titan includes SWD-Assist for configuration of the SmartWire-DT network	EASY-SOFT-PRO

EASY-USB-CAB



Programming Cables

Description	Catalog Number
easy500/700 to PC programming cable—USB	EASY-USB-CAB
easy500/700 to PC programming cable—RS-232	EASY-PC-CAB
easy800/MFD to PC programming cable—RS-232	EASY800-PC-CAB
easy800/MFD to PC programming cable—USB	EASY800-USB-CAB
easy802/806 to PC programming cable—USB, 2m	EU4A-RJ45-USB-CAB1

MFD-CP4-800-CAB5



Cables and Connectors

Description	Catalog Number
easy500/700 to MFD-CP4 communication cable, 5m	MFD-CP4-500-CAB5
easy800 to MFD-CP4 communication cable, 5m	MFD-CP4-800-CAB5
easy800 to MFD-CP8 communication cable, 2m	MFD-800-CAB
easy800 to MFD-CP8 communication cable, 5m	MFD-800-CAB5
easy800 modem, printer, programming cable	EASY800-MO-CAB
easy802/806 to MFD-CP4 communication cable, 1.5m	EU4A-RJ45-CAB2
easy802/806 to XV HMI communication cable, 2m	EU4A-RJ45-CAB1
easy800/MFD easyNet cable, 0.3m networking cable	EASY-NT-30
easy800/MFD easyNet cable, 0.8m networking cable	EASY-NT-80
easy800/MFD easyNet cable, 1.5m networking cable	EASY-NT-150
easy800/MFD easyNet cable (cable only, no connectors, see EASY-NT-RJ45), 100m	EASY-NT-CAB
RJ45 network connectors for easyNet cable (EASY-NT-CAB), 10/pack	EASY-NT-RJ45
easy800/MFD network termination resistor, 2/pack	EASY-NT-R

EASY800-MO-CAB



EASY-M-32K**EASY-M-256K****Memory Storage Modules**

Description	Catalog Number
easy500/700 32K memory storage module	EASY-M-32K
easy800/MFD 256K memory storage module	EASY-M-256K
easy800/MFD 512K memory storage module	EASY-M-512K

Panel Window**Mounting Kit****Simulator****Miscellaneous Parts**

Description	Catalog Number
easy500 panel window	SKF-FF4
easy700/800 panel window	SKF-FF6
easy500/700/800 panel window mounting kit to front mount units	SKF-HA
High current input adapter, six-channel	EASY256-HCI
Base to expander, interface connector	EASY-LINK-DS
easy500 relay simulator	EASY412-DC-SIM-NA
Mounting feet, 9/pack	ZB4-101-GF1
Grounding kit	ZB4-102-KS1

Technical Data and Specifications

easyRelay Power Supplies

Type	EASY200-POW	EASY400-POW
Supply voltage	100–240 Vac	100–240 Vac
Maximum range	85–264 Vac	85–264 Vac
Output voltage	24 Vdc (±3%)	24 Vdc (±3%)
Output current (rated value)	0.25 A	1.25 A
Overcurrent limitation form	0.3 A	1.4 A
Short-circuit proof (secondary)	Yes	Yes
Overload proof	Yes	Yes
Potential isolation (prim./sec.)	Yes, SELV, (to EN 600950, VDE 805)	Yes, SELV, (to EN 600950, VDE 805)
Others	Additional output voltage 12 DC, 20 mA	Additional output voltage 12 DC, 20 mA
Connection cables		
Solid	0.2–4.0 mm ² (AWG 22–12)	0.2–4.0 mm ² (AWG 22–12)
Flexible	0.2–2.5 mm ² (AWG 22–12)	0.2–2.5 mm ² (AWG 22–12)
Degree of protection	IP20	IP20
RFI suppression	EN 55011, EN 55022 Class B, IEC 61000-6-1, 2, 3, 4	EN 55011, EN 55022 Class B, IEC 61000-6-1, 2, 3, 4
Ambient operating temperature	–25 °C to +55 °C	–25 °C to +55 °C
Transport and storage temperature	–40 °C to +70 °C	–40 °C to +70 °C
Mounting	On 35 mm DIN rail or screw mounting with ZB4-101-GF1 mounting feet	

Wiring Diagram

EASY256-HCI

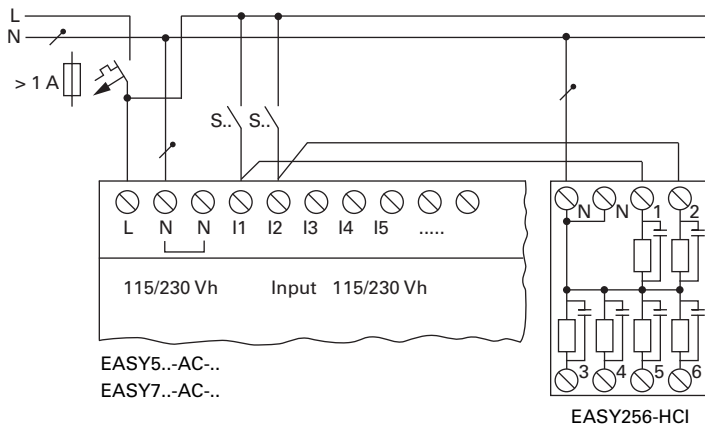

Dimensions

Approximate Dimensions in Inches (mm)

EASY200-POW/EASY256-HCI and EASY400-POW Series, Drawing Number MD05013004E

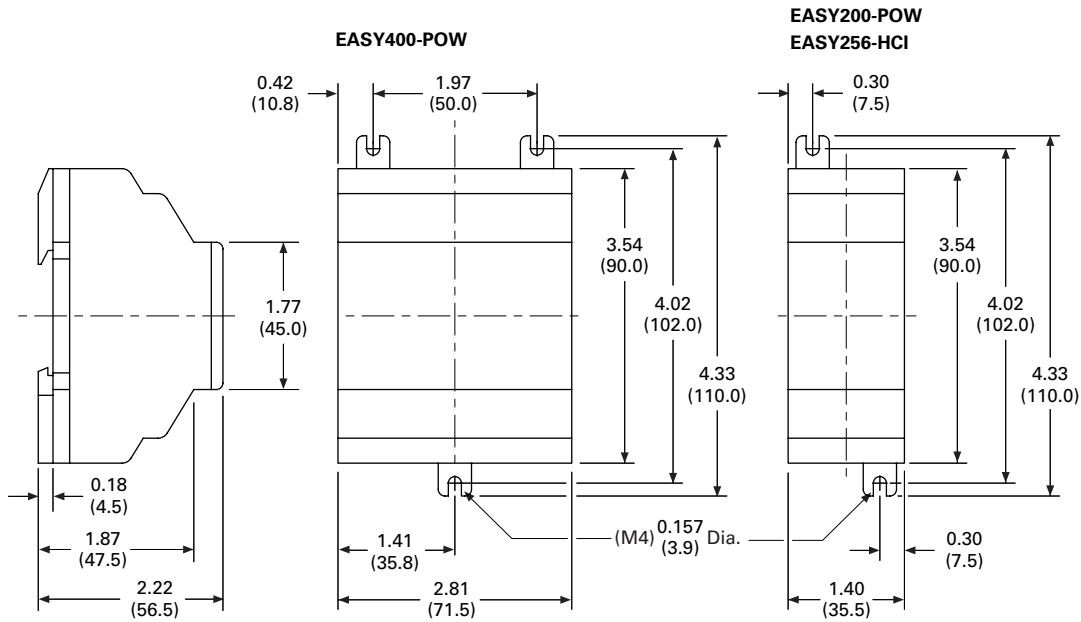

MFD-XS-80 and MFD-XM-80 Series, Drawing Number MD05013009E

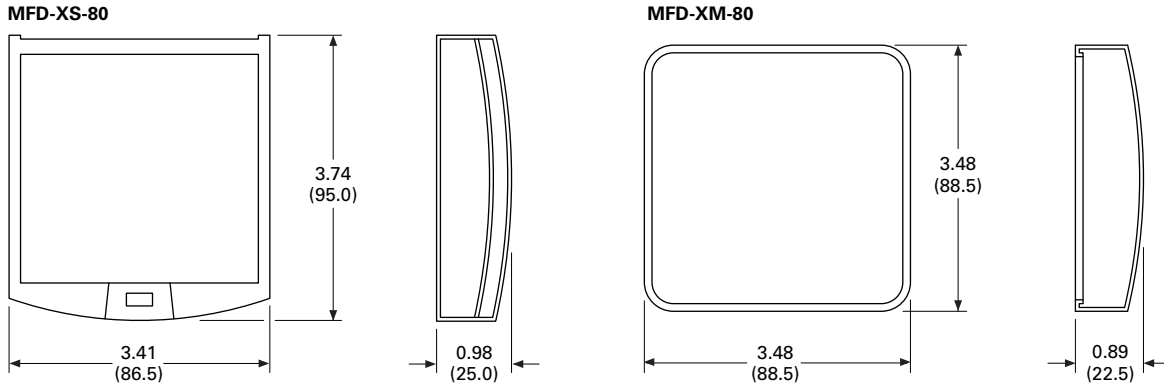

SKF-FF4 and SKF-FF6 Series, Drawing Number MD05013014E

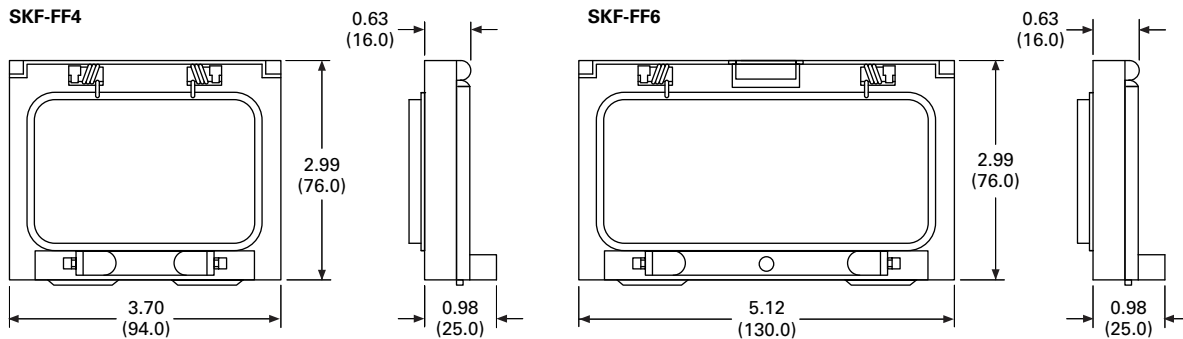

3.3

Control Relays and Timers

Programmable Relays

Approximate Dimensions in Inches (mm)

SKF-HA Series, Drawing Number MD05013015E

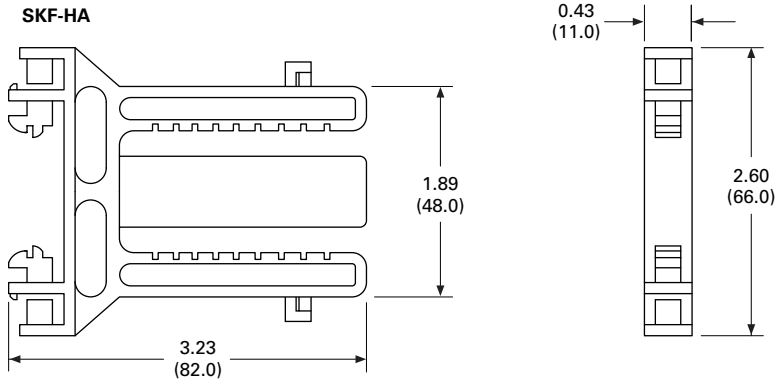

ZB4-101-GF1 Mounting Feet

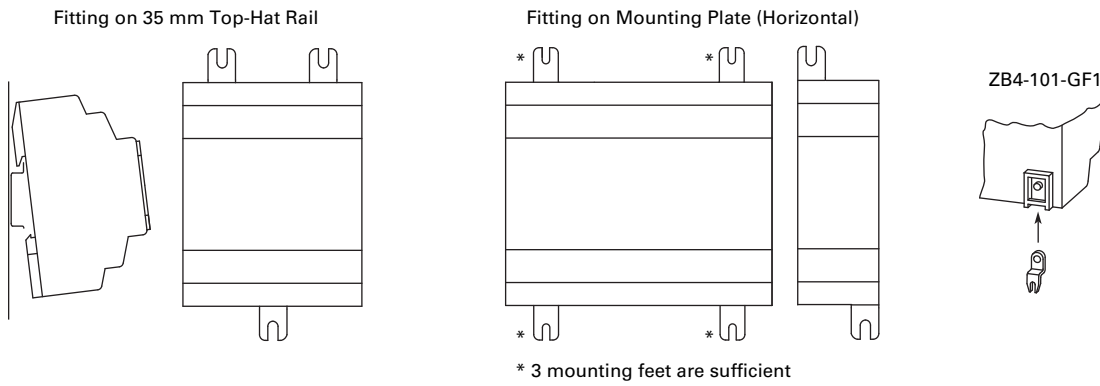

ZB4-102-KS1 Series— Grounding the Screen for Top-Hat Rail

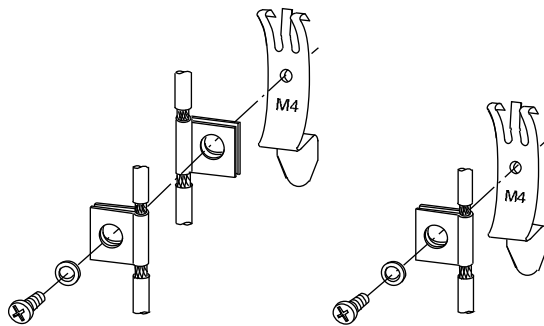

ZB4-102-KS1 Series— Grounding the Screen for Mounting Plate

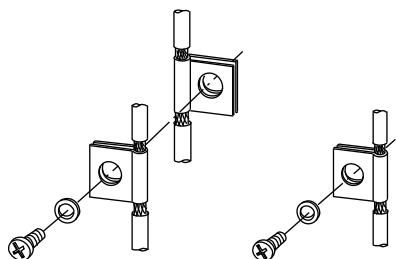

EASY412-DC-SIM-NA Series

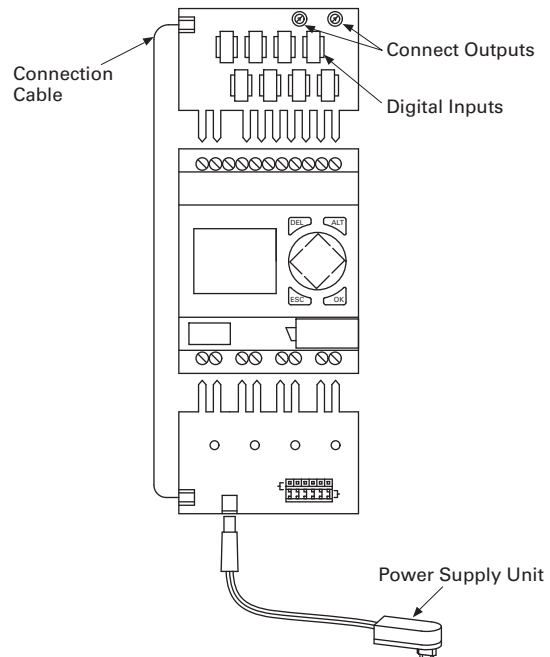

General Purpose Plug-In Relay



Contents

Description	Page
D1RR/D1RF Series	V7-T3-53
D2RR/D2RF Series	V7-T3-57
D3RR/D3RF Series	V7-T3-67
D4 Series	V7-T3-76
D5RR/D5RF Series	V7-T3-80
D7PR/D7PF Series	V7-T3-89
D8 Series	V7-T3-103
D9 Series	V7-T3-108
Accessories	V7-T3-112

Product Selection Guide

General Purpose Relay Selection Characteristics

- Current rating: 1 A–30 A
- Contact arrangement: SPDT, DPDT, 3PDT, 4PDT, etc.
- Coil voltage: 6 V–240 Vac/ 6 V–110 Vdc
- Mounting options: socket, flange, DIN rail, panel
- Specifications: CSA, CE, IEC, NEMA, UL, etc.
- Other: physical dimensions, maximum voltage, mechanical/ electrical life, etc.

3.4

Control Relays and Timers

General Purpose Plug-In Relays

3

General Purpose Plug-In Relays

Relay Series

D1RR/D1RF



D2RR/D2RF



D3RR/D3RF



Approvals



Note: UL when used with the appropriate socket.



Note: UL when used with the appropriate socket.



Note: UL when used with the appropriate socket.

Features

Polycarbonate cover	Polycarbonate cover	Polycarbonate cover
Indicator lamp and pushbutton available	Indicator lamp and pushbutton available	Indicator lamp and pushbutton available
Panel and DIN mounting	Panel, DIN and flange mounting	Panel and DIN mounting
	Latching	

Contact Data

Configuration	SPDT	DPDT	4PDT	DPDT	3PDT
Max. allowable load	15 A	12 A	6 A	10 A	10 A
Material	Silver alloy	Silver alloy		Silver alloy	
Dielectric strength between poles	1500 V	1500 V		1500 V	

Coil Data

AC	6 to 240 Vac	6 to 240 Vac	6 to 240 Vac
DC	6 to 110 Vdc	6 to 110 Vdc	6 to 110 Vdc
Power			
VA (Vac)	0.9 VA	1.2 VA	3 VA 1.4 W (D3RR and D3RF)
Watts (Vdc)	0.7 W	0.9 W	—

General Data

Ambient temperature			
Storage	−40 °F to +185 °F (−40 °C to +85 °C)	−40 °F to +185 °F (−40 °C to +85 °C)	−40 °F to +185 °F (−40 °C to +85 °C)
Operational	−40 °F to +131 °F (−40 °C to +55 °C)	−40 °F to +131 °F (−40 °C to +55 °C)	−40 °F to +131 °F (−40 °C to +55 °C)
Response time	20 milliseconds	20 milliseconds	20 milliseconds
Life			
Mechanical operations	10 million	10 million	5 million (D3RR and D3RF)
Electrical operations	100,000	200,000	100,000
Page Numbers	V7-T3-53 to V7-T3-56	V7-T3-57 to V7-T3-66	V7-T3-67 to V7-T3-75

General Purpose Plug-In Relays, continued

Relay Series

D4



D5RR/D5RF



D7PR/D7PF



Approvals



Note: UL when used with the appropriate socket.

Note: UL when used with the appropriate socket.

Features

Polycarbonate cover

Polycarbonate cover

Polycarbonate cover

Indicator lamp available

Indicator lamp and pushbutton available

Indicator lamp and pushbutton available

Panel and DIN mounting

Panel, DIN and flange mounting

Panel and DIN mounting

Socket has built-in hold-down spring

Contact Data

Configuration	SPDT	DPDT	DPDT	3PDT	DPDT	3PDT	4PDT
Max. allowable load	10 A at 250 Vac	5 A at 240 Vac	10 A	10 A	15 A	15 A	15 A
Material	AgCdO		Silver alloy		Silver alloy		
Dielectric strength	5000 V		1500 V		1500 V	2500 V	2500 V

Coil Data

AC	6 to 240 Vac		6 to 240 Vac		6 to 240 Vac		
DC	6 to 110 Vdc		6 to 110 Vdc		6 to 110 Vdc		
Power							
VA (Vac)	0.9 VA		3 VA		1.2 VA	1.5 VA	1.5 VA
Watts (Vdc)	0.5 W		1.4 W		0.9 W	1.4 W	1.5 W

General Data

Ambient temperature							
Storage	−40 °F to +158 °F (−40 °C to +70 °C)		−40 °F to +185 °F (−40 °C to +85 °C)		−40 °F to +185 °F (−40 °C to +85 °C)		
Operational	−40 °F to +158 °F (−40 °C to +70 °C)		−40 °F to +131 °F (−40 °C to +55 °C)		−40 °F to +131 °F (−40 °C to +55 °C)		
Response time	15 milliseconds		20 milliseconds		20 milliseconds (30 milliseconds for latching)		
Life							
Mechanical operations	10 million		5 million		10 million		
Electrical operations	100,000		100,000		100,000	200,000	200,000

Page Numbers

V7-T3-76 to V7-T3-79

V7-T3-80 to V7-T3-88

V7-T3-89 to V7-T3-102

3.4

Control Relays and Timers

General Purpose Plug-In Relays

3

General Purpose Plug-In Relays, continued

Relay Series

D8

D9



Approvals



Features

Dust cover

Dust cover

Panel, DIN and flange mounting

Pushbutton available

Quick-connect and screw terminals

Panel mounting

Screw terminals

Contact Data

Configuration

4PST

SPST-NO

DPST-NO

NO

NC

Max. allowable load

30 A at
220 Vac

25 A at
220 Vac

25 A at
220 Vac

8 A at
220 Vac

Material

AgCdO

AgCdO

Dielectric strength

4000 V

4000 V

Coil Data

AC

6 to 240 Vac

24 to 240 Vac

DC

12 to 24 Vdc

12 to 110 Vdc

Power

VA (Vac)

2.5 VA

2.6 VA

Watts (Vdc)

1.9 W

2.0 W

General Data

Ambient temperature

Storage

-4 °F to +185 °F (-20 °C to +85 °C)

-13 °F to +140 °F (-25 °C to +60 °C)

Operational

-4 °F to +131 °F (-20 °C to +55 °C)

-13 °F to +140 °F (-25 °C to +60 °C)

Response time

30 milliseconds

50 milliseconds

Life

Mechanical operations

5 million

1 million

Electrical operations

100,000

100,000

Page Numbers

V7-T3-103 to V7-T3-107

V7-T3-108 to V7-T3-111

D1 Series Relay



D1RR/D1RF Series

Product Description

The D1 Series of relay provides a compact single-pole relay capable of handling 15 A. Multiple feature and voltage options allow for the perfect fit for any application.

Features

D1RR

- Compact relay capable of breaking relatively large load currents
- Panel and DIN rail mounting

D1RF

- The contact operation can be easily checked by Push-to-Test button
- Flag indicator shows relay status in manual or powered condition
- LED status lamp shows coil ON or OFF status—ideal for use in low light applications
- Push-to-Test button allows for manual operation of relay without the need for coil power
- Lock-down door holds pushbutton and contacts in the operate position when activated
- Finger-grip cover allows operator to remove relays from sockets easily
- ID tag/write label to identify relays in multiple-relay circuits
- Bipolar LED allows for reverse polarity applications

Contents

Description

	<i>Page</i>
D1RR/D1RF Series	
Product Selection	V7-T3-54
Accessories	V7-T3-54
Technical Data and Specifications	V7-T3-55
Wiring Diagram	V7-T3-56
Dimensions	V7-T3-56
D2RR/D2RF Series	V7-T3-57
D3RR/D3RF Series	V7-T3-67
D4 Series	V7-T3-76
D5RR/D5RF Series	V7-T3-80
D7PR/D7PF Series	V7-T3-89
D8 Series	V7-T3-103
D9 Series	V7-T3-108
Accessories	V7-T3-112

Standards and Certifications



When used with accompanying Eaton screw terminal socket.

Catalog Number Selection

D1RF/D1RR Series

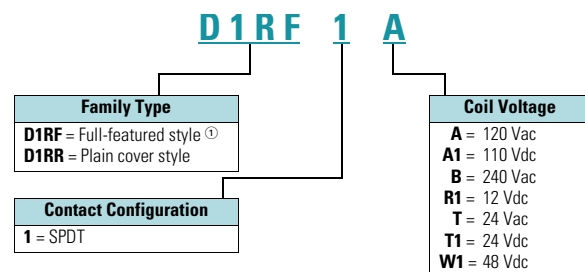

Note

① Full-featured, LED test button, flag indicator, lock-down door, finger-grip cover, ID tag.

3.4

Control Relays and Timers

General Purpose Plug-In Relays

3

Product Selection

D1RR/D1RF Relay/Socket Quick Reference

Relay Type	Socket	Clip	Module Type	ID Tag	Jumper
D1RR1	D1RAA	PMC-1781	B	—	—
D1RF1	D1RAA	PMC-1781	B	—	—

D1RF Series Relay



D1RR/D1RF Series

Coil Voltage	Contact Configuration	Coil Resistance (Ohms)	Catalog Number
Full Featured			
12 Vdc	SPDT	188	D1RF1R1
24 Vac 50/60 Hz	SPDT	180	D1RF1T
24 Vdc	SPDT	750	D1RF1T1
110 Vdc	SPDT	13,800	D1RF1A1
120 Vac 50/60 Hz	SPDT	4430	D1RF1A
240 Vac 50/60 Hz	SPDT	15,720	D1RF1B
Plain Cover			
12 Vdc	SPDT	188	D1RR1R1
24 Vdc	SPDT	750	D1RR1T1
48 Vdc	SPDT	2600	D1RR1W1
110 Vdc	SPDT	13,800	D1RR1A1
120 Vac 50/60 Hz	SPDT	4430	D1RR1A
240 Vac	SPDT	15,270	D1RR1B

Accessories

D1RR/D1RF Sockets and Accessories

Type	Module Size	Nominal Voltage (Max. for Sockets)	Nominal Current	Mounting Style	Wire Size	Wire Connection	Standard Pack	Catalog Number
Socket	B	300	20	Panel/DIN rail	12 /14 (2) AWG, 4 /2.5 (2) mm ²	Screw clamping	10	D1RAA ①
Flange mount adapter	—	—	—	Flange	—	—	25	PFC-D11
Metal spring clip	—	—	—	—	—	—	25	PMC-1781
Protection diode	B	6 to 250 Vdc	—	—	—	—	20	MOD-BD250
LED indicator	B	24 Vac/Vdc	—	—	—	—	20	MOD-BLG24
	B	120/240 Vac/Vdc	—	—	—	—	20	MOD-BLG240
MOV suppressor	B	120 Vac/Vdc	—	—	—	—	20	MOD-BMV120
	B	24 Vac/Vdc	—	—	—	—	20	MOD-BMV24
	B	240 Vac/Vdc	—	—	—	—	20	MOD-BMV240
Plastic DIN rail end stop	—	—	—	—	—	—	25	PPF-P

Note

① Protection Category (Finger Safe), EN 60529: IP20.

Technical Data and Specifications**D1RF/D1RR Relay Specifications**

Description	D1RR	D1RF
Contact Characteristics		
Contact rating	15 A	15 A
Terminal style	Plug-in	Plug-in
Contact materials	Silver alloy	Silver alloy
Maximum switching voltage	300 V	300 V
Switching current at voltage—resistive	20 A at 120 Vac 50/60 Hz	20 A at 120 Vac 50/60 Hz
	20 A at 277 Vac 50/60 Hz	20 A at 277 Vac 50/60 Hz
	20 A at 28 Vdc	20 A at 28 Vdc
Switching current at voltage	1/2 hp at 120 Vac	1/2 hp at 120 Vac
	1 hp at 277 Vac	1 hp at 277 Vac
Pilot duty	B300	B300
Minimum switching requirement	100 mA at 5 Vdc (0.5 W)	100 mA at 5 Vdc (0.5 W)
Coil Characteristics		
Operating range		
% of nominal (AC)	85 to 110%	85 to 110%
% of nominal (DC)	80 to 110%	80 to 110%
Average consumption	0.9 VA	0.9 VA
	0.7 W	0.7 W
Dropout voltage threshold	15% (AC)	15% (AC)
	10% (DC)	10% (DC)
Performance		
Electrical life (UL 508) operations at rated current	100,000 operations	100,000 operations
Mechanical life operations unpowered	10,000,000 operations	10,000,000 operations
Response time	20 ms	20 ms
Dielectric strength		
Between coil and contact Vac (rms)	2500 V (rms)	2500 V (rms)
Between poles Vac (rms)	1500 V (rms)	1500 V (rms)
Environment		
Ambient air temperature around the device		
Storage	−40 °F to +131 °F (−40 °C to +55°C)	−40 °F to +131 °F (−40 °C to +55 °C)
Operation	−40 °F to +185 °F (−40 °C to +85°C)	−40 °F to +185 °F (−40 °C to +85 °C)
Vibration resistance—operational	3 g-n at 10–55 Hz	3 g-n at 10–55 Hz
Shock resistance	10 g-n	10 g-n
Degree of protection	IP40	IP40
Features		
Cover options	Plain cover	Full featured
Features	Mechanical flag indicator (optional LED)	Locking pushbutton/ Bipolar LED/ Removable ID tag/ Mechanical flag indicator
Product certifications	RoHS/UL/CE/CSA	RoHS/UL/CE/CSA

3.4

Control Relays and Timers

General Purpose Plug-In Relays

Wiring Diagram

D1RF/D1RR

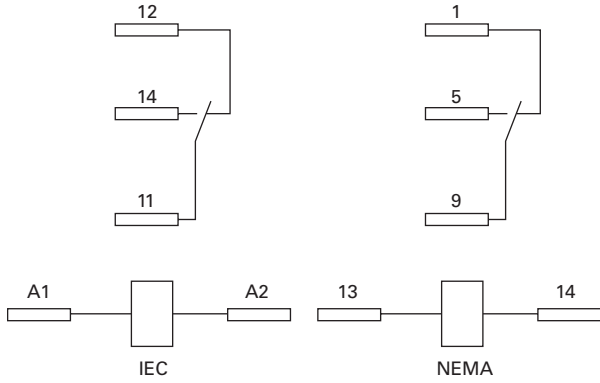

Dimensions

Approximate Dimensions in Inches (mm)

D1RF/D1RR

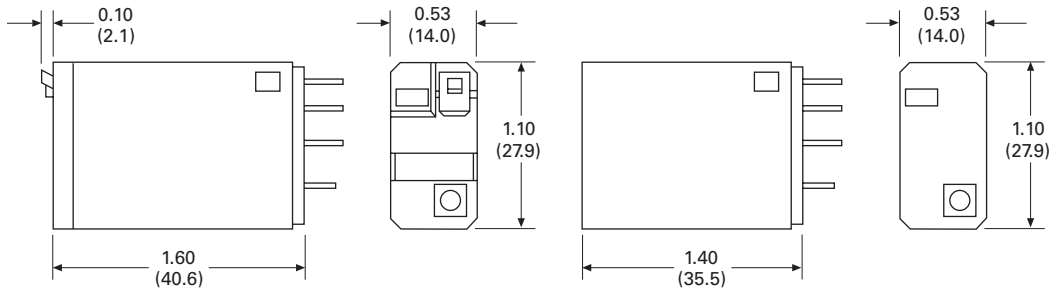

D1RAA

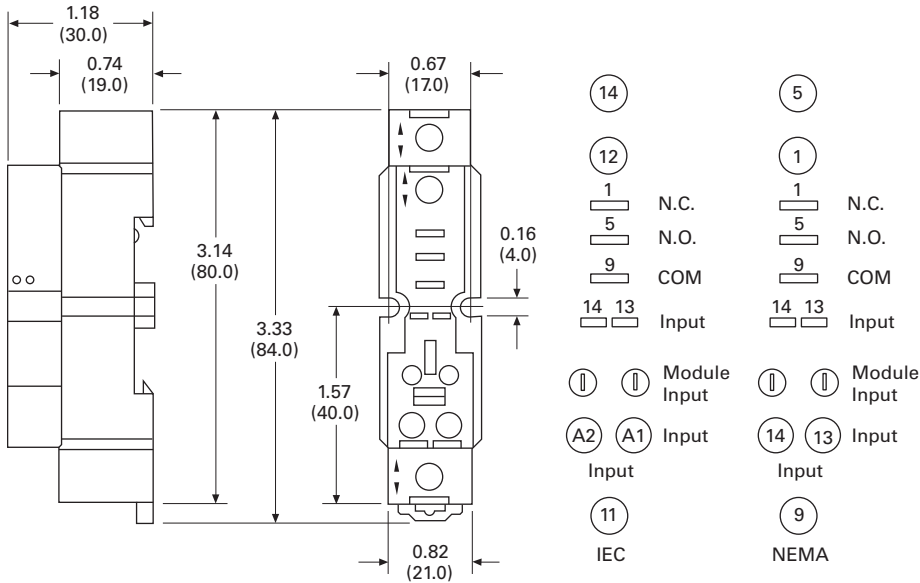

D2 Series Relay



D2RR/D2RF Series

Product Description

The D2 Series is a compact line of relays with quick response time and long life. Available in DPDT and 4PDT configurations.

Features

D2RR

- Ultra-high sensitivity relay with quick response
- High reliability, long life
- Panel, DIN rail and flange mounting
- Small size

Contents

Description	Page
D1RR/D1RF Series	V7-T3-53
D2RR/D2RF Series	
Catalog Number Selection	V7-T3-58
Product Selection	V7-T3-58
Accessories	V7-T3-60
Technical Data and Specifications	V7-T3-61
Wiring Diagrams	V7-T3-62
Dimensions	V7-T3-63
D3RR/D3RF Series	V7-T3-67
D4 Series	V7-T3-76
D5RR/D5RF Series	V7-T3-80
D7PR/D7PF Series	V7-T3-89
D8 Series	V7-T3-103
D9 Series	V7-T3-108
Accessories	V7-T3-112

Standards and Certifications



 When used with accompanying Eaton screw terminal socket.

D2RF

- Flag indicator shows relay status in manual or powered condition
- Bipolar LED status lamp allows for reverse polarity applications
 - Shows coil ON or OFF status
 - Ideal in low light conditions
- Color-coded pushbutton identifies AC coils with red or DC coils with blue pushbuttons
 - Allows for manual operation of relay without the need for coil power
 - Ideal for field service personnel to test control circuits
- Lock-down door, when activated, holds pushbutton and contacts in the operate position
 - Excellent for analyzing circuit problems
- Finger-grip cover allows operator to remove relays from sockets more easily than conventional relays
- White plastic ID tag/write label used for identification of relays in multi-relay circuits

3.4

Control Relays and Timers

General Purpose Plug-In Relays

Catalog Number Selection

D2RF/D2RR ①

3

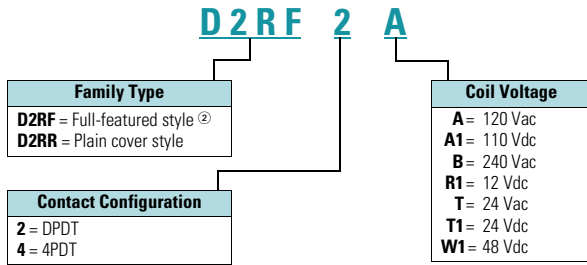

Product Selection

D2RF/D2RR Relay/Socket Quick Reference

Relay Type	Socket	Clip	Module Type	ID Tag	Jumper
D2RR2, D2RF2	D2PAL	PWC-D24	B	PWF-D2P	D2PJ1
		PQC-1782	—	—	—
	D2PA6	PQC-1342	None	—	—
D2RR4, D2RF4	D2PAP	PWC-D24	B	PWF-D2P	D2PJ1
		PQC-1782	—	—	—
	D2PA7	PWC-D24	B	—	—
		PQC-1782	B	—	—
	D2PA6	PQC-1342	None	—	—

Notes

- ① For deciphering catalog numbers. Do not use for ordering as not all combinations are readily available.
- ② Full-featured, LED test button, flag indicator, lock-down door, finger-grip cover, ID tag.

D2RF Series Relay



D2RF/D2RR Series

Coil Voltage	Contact Configuration	Coil Resistance (Ohms)	Catalog Number
Full Featured Style			
12 Vdc	DPDT	160	D2RF2R1
24 Vac	DPDT	180	D2RF2T
24 Vdc	DPDT	650	D2RF2T1
48 Vdc	DPDT	2600	D2RF2W1
110/125 Vdc	DPDT	11,000	D2RF2A1
120 Vac	DPDT	4430	D2RF2A
220/240 Vac	DPDT	15,720	D2RF2B
12 Vdc	4PDT	160	D2RF4R1
24 Vac	4PDT	180	D2RF4T
24 Vdc	4PDT	650	D2RF4T1
48 Vdc	4PDT	2600	D2RF4W1
110/125 Vdc	4PDT	11,000	D2RF4A1
120 Vac	4PDT	4430	D2RF4A
220/240 Vac	4PDT	15,720	D2RF4B
Plain Cover Style			
12 Vdc	DPDT	160	D2RR2R1
24 Vac	DPDT	180	D2RR2T
24 Vdc	DPDT	650	D2RR2T1
120 Vac	DPDT	4430	D2RR2A
220/240 Vac	DPDT	15,720	D2RR2B
12 Vdc	4PDT	160	D2RR4R1
24 Vac	4PDT	180	D2RR4T
24 Vdc	4PDT	650	D2RR4T1
110/125 Vdc	4PDT	11,000	D2RR4A1
120 Vac	4PDT	4430	D2RR4A
220/240 Vac	4PDT	15,720	D2RR4B

Accessories

D2RF/D2RR Sockets and Accessories

Type	Module Size	Nominal Voltage (Max. for Sockets)	Nominal Current	Mounting Style	Wire Size	Wire Connection	Standard Pack	Catalog Number
Socket	B	300	12	DIN rail/panel	14/16 (2) AWG, 2.5/1.5 (2) mm ²	Elevator	1	D2PAL ①
	None	300	10	DIN rail/panel	12/14 (2) AWG, 4/2.5 (2) mm ²	Screw clamping	10	D2PA6
	B	300	10	DIN rail/panel	14/16 (2) AWG, 2.5/1.5 (2) mm ²	Elevator	1	D2PAP ①
	B	300	10	DIN rail/panel	12/14 (2) AWG, 4/2.5 (2) mm ²	Screw clamping	10	D2PA7 ①
	None	300	10	DIN rail/panel	12/14 (2) AWG, 4/2.5 (2) mm ²	Screw clamping	5	D2PA4
Flange mount adapter	—	—	—	Flange	—	—	25	PFC-D2D72
Plastic ejector clip	—	—	—	—	—	—	10	PWC-D24
Metal spring clip	—	—	—	—	—	—	25	PQC-1782
	—	—	—	—	—	—	25	PQC-1342
Hold-down spring	—	—	—	—	—	—	100	PYC-A1
Protection diode	B	6 to 250 Vdc	—	—	—	—	20	MOD-BD250
LED indicator	B	24 Vac/Vdc	—	—	—	—	20	MOD-BLG24
	B	120/240 Vac/Vdc	—	—	—	—	20	MOD-BLG240
MOV suppressor	B	120 Vac/Vdc	—	—	—	—	20	MOD-BMV120
	B	24 Vac/Vdc	—	—	—	—	20	MOD-BMV24
	B	240 Vac/Vdc	—	—	—	—	20	MOD-BMV240
Coil bus jumpers	—	—	—	—	—	—	10	D2PJ1
Plastic DIN rail end stop	—	—	—	—	—	—	25	PPF-P

Note

① Protection category (finger safe), EN 60529: IP20.

Technical Data and Specifications

D2RF/D2RR Relay Specifications

Description	D2RR2/D2RR4	D2RF
Contact Characteristics		
Contact rating	12 A / 6 A	6 A
Terminal style	Plug-in	Plug-in
Contact materials	Silver alloy	Silver alloy
Maximum switching voltage	300 V	300 V
Switching current at voltage—resistive	10 A at 120 Vac 50/60 Hz	10 A at 277 Vac 50/60 Hz
	8 A at 277 Vac 50/60 Hz	8 A at 120 Vac 50/60 Hz
	8 A at 28 Vdc	8 A at 28 Vdc
Switching current at voltage	1/3 hp at 120 Vac 1 hp at 277 Vac	1/3 hp at 120 Vac 1 hp at 277 Vac
Pilot duty	B300	B300
Minimum switching requirement	100 mA at 5 Vdc (0.5 W)	100 mA at 5 Vdc (0.5 W)
Coil Characteristics		
Operating range		
% of nominal (AC)	85 to 110%	85 to 110%
% of nominal (DC)	80 to 110%	80 to 110%
Average consumption	1.2 VA	1.2 VA
	0.9 W	0.9 W
Dropout voltage threshold	15% (AC)	15% (AC)
	10% (DC)	10% (DC)
Performance		
Electrical life (UL 508) operations at rated current	200,000	200,000
Mechanical life operations unpowered	10,000,000	10,000,000
Response time	20 ms	20 ms
Dielectric strength		
Between coil and contact Vac (rms)	1500 rms	1500 rms
Between poles Vac (rms)	1500 rms	1500 rms
Environment		
Ambient air temperature around the device		
Operation	−40 °F to +131 °F (−40 °C to +55 °C)	−40 °F to +131 °F (−40 °C to +55 °C)
Storage	−40 °F to +185 °F (−40 °C to +85 °C)	−40 °F to +185 °F (−40 °C to +85 °C)
Vibration resistance—operational	3 g-n at 10–55 Hz	3 g-n at 10–55 Hz
Shock resistance	10 g-n	10 g-n
Degree of protection	IP40	IP40
Features		
Cover options	Plain cover	Full featured
Features	Mechanical flag indicator	Locking pushbutton/ Bipolar LED/ Removable ID tag/ Mechanical flag indicator
Product certifications	RoHS/UL/CE/CSA	RoHS/UL/CE/CSA

3.4

Control Relays and Timers

General Purpose Plug-In Relays

Wiring Diagrams

D2RF2/D2RR2

3

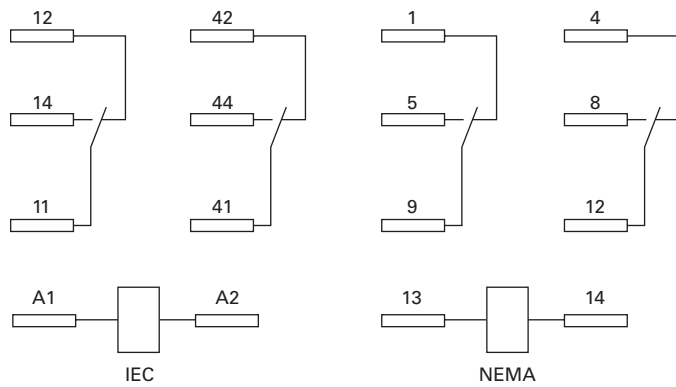

D2RF4/D2RR4

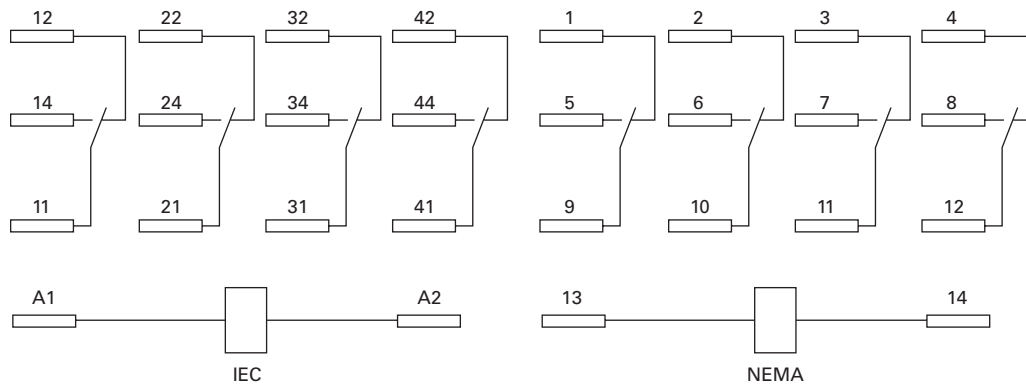

Dimensions

Approximate Dimensions in Inches (mm)

D2RF2/D2RR2

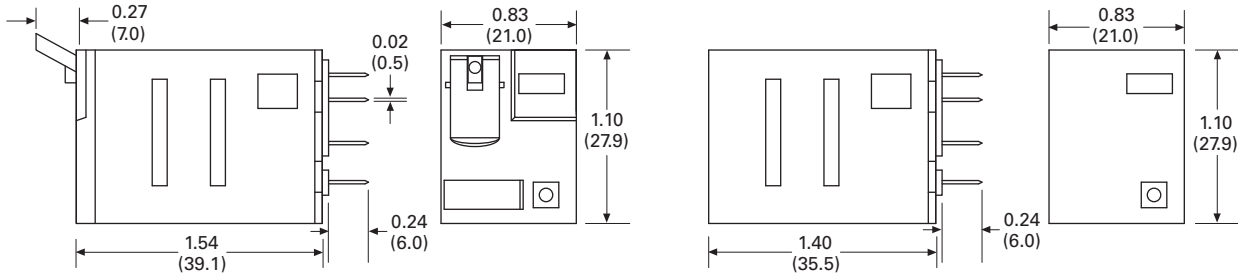

D2RF4/D2RR4

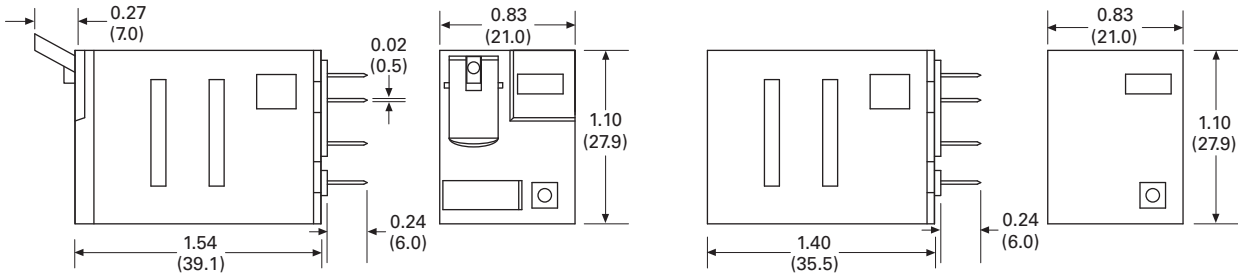

D2PA6

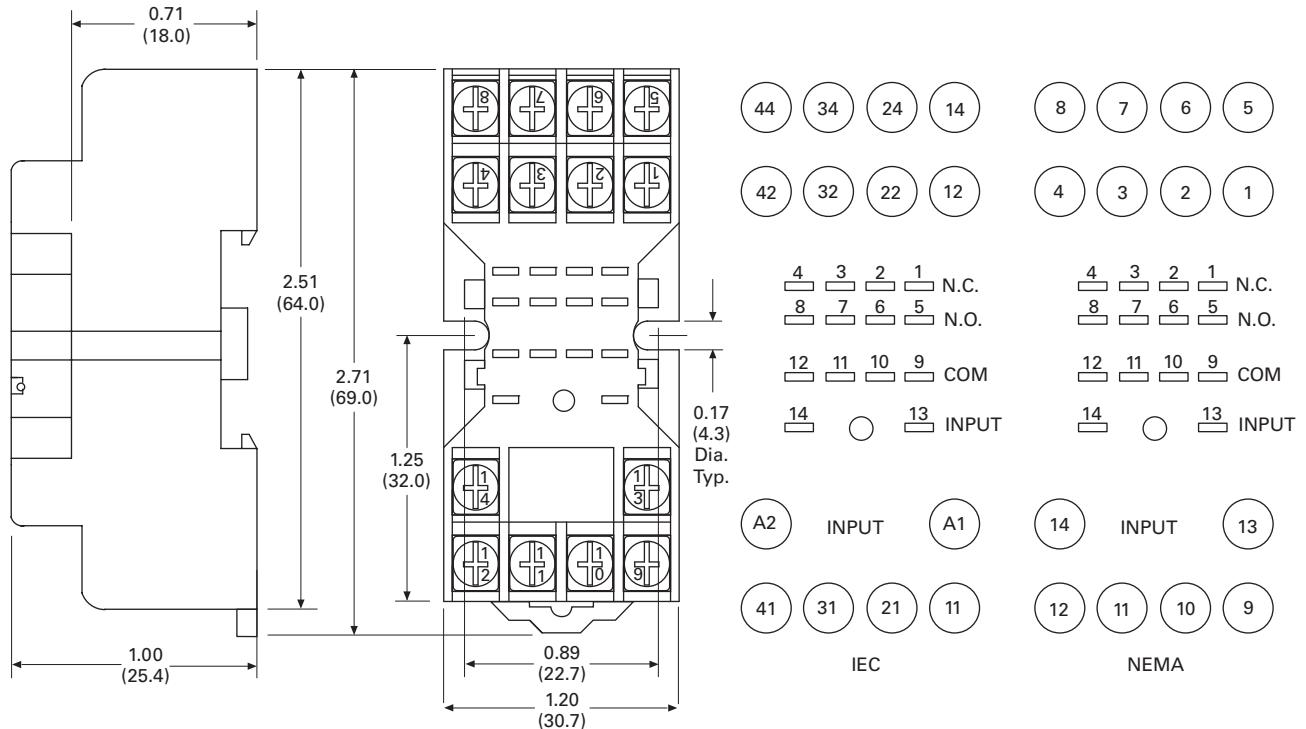

3.4

Control Relays and Timers

General Purpose Plug-In Relays

Approximate Dimensions in Inches (mm)

D2PA7

3

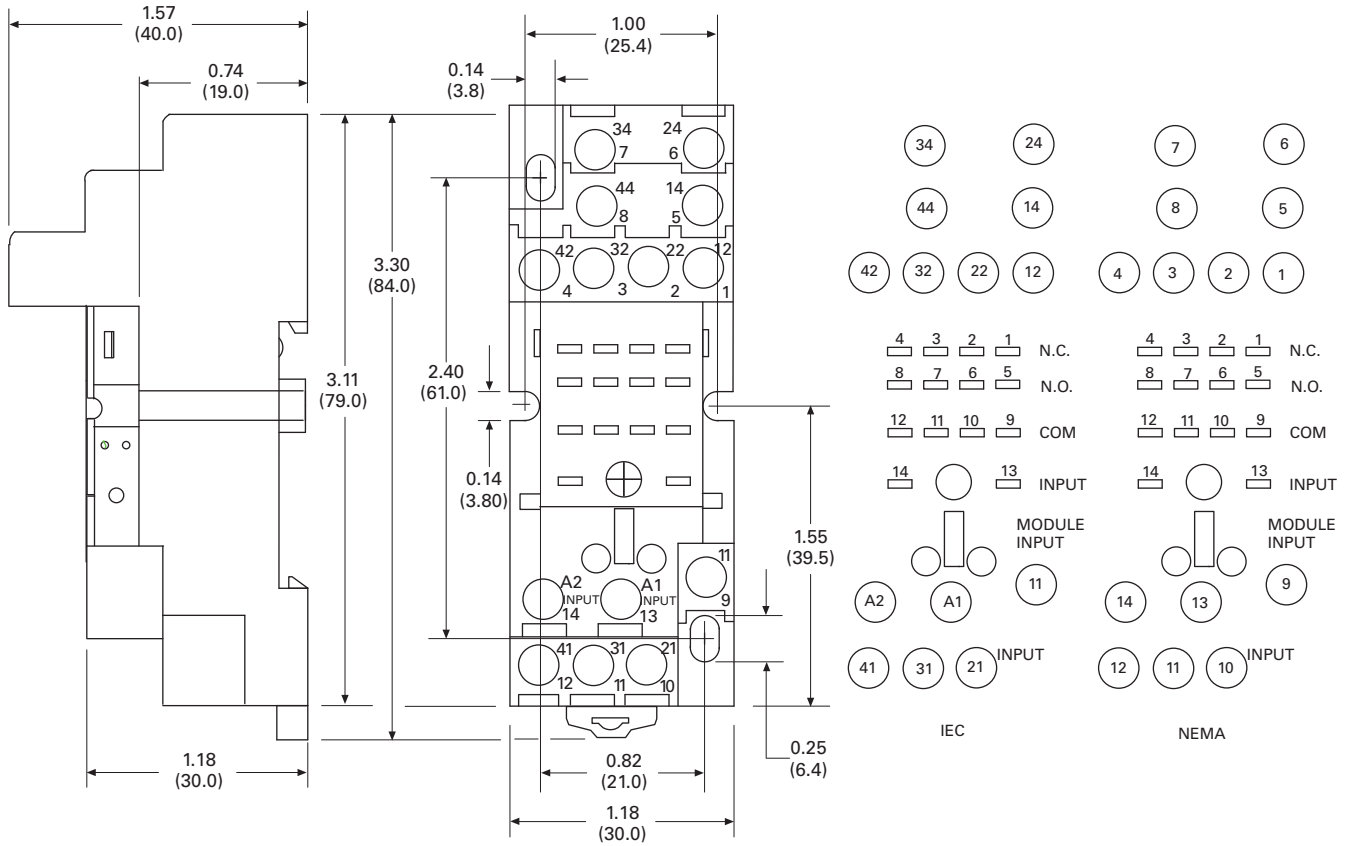

Approximate Dimensions in Inches (mm)

D2PAP

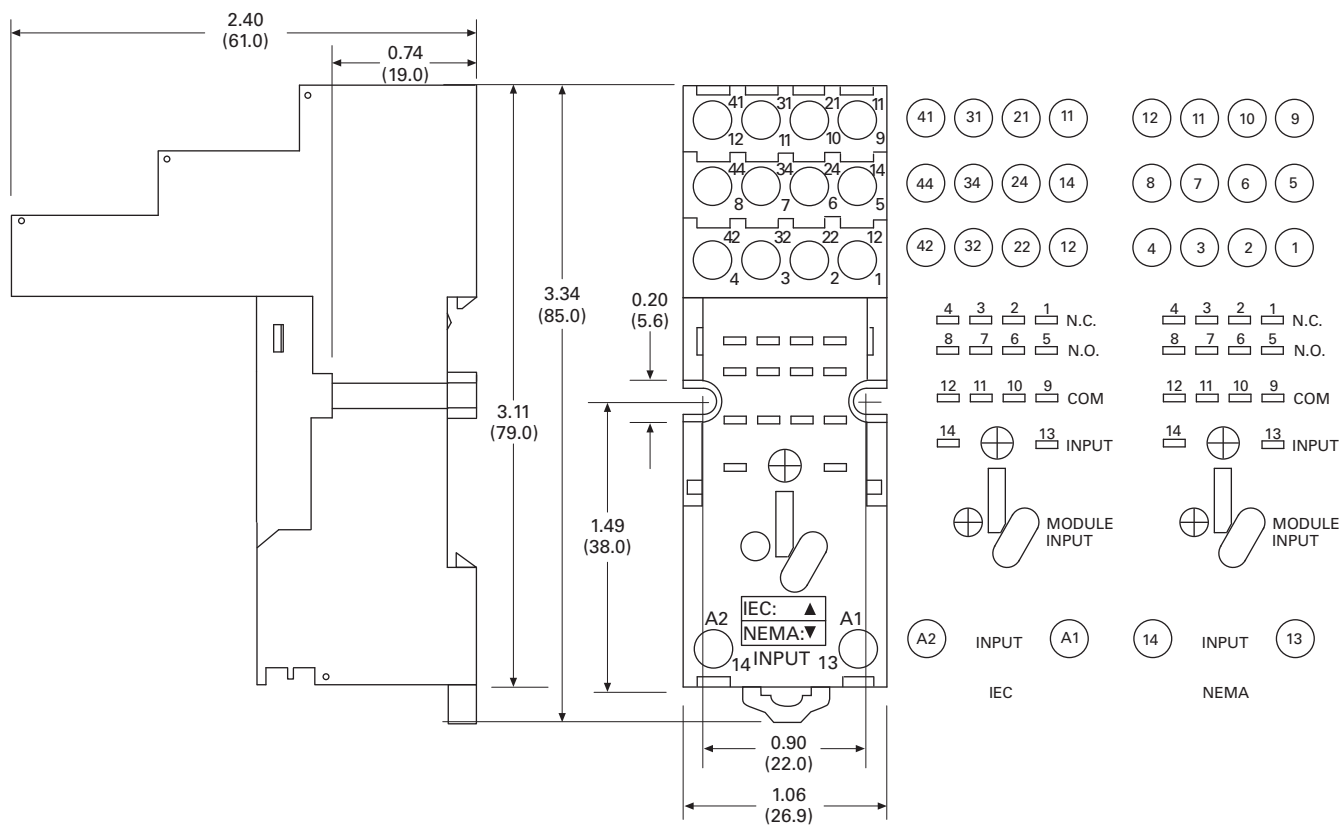

3.4

Control Relays and Timers

General Purpose Plug-In Relays

Approximate Dimensions in Inches (mm)

D2PAL

3

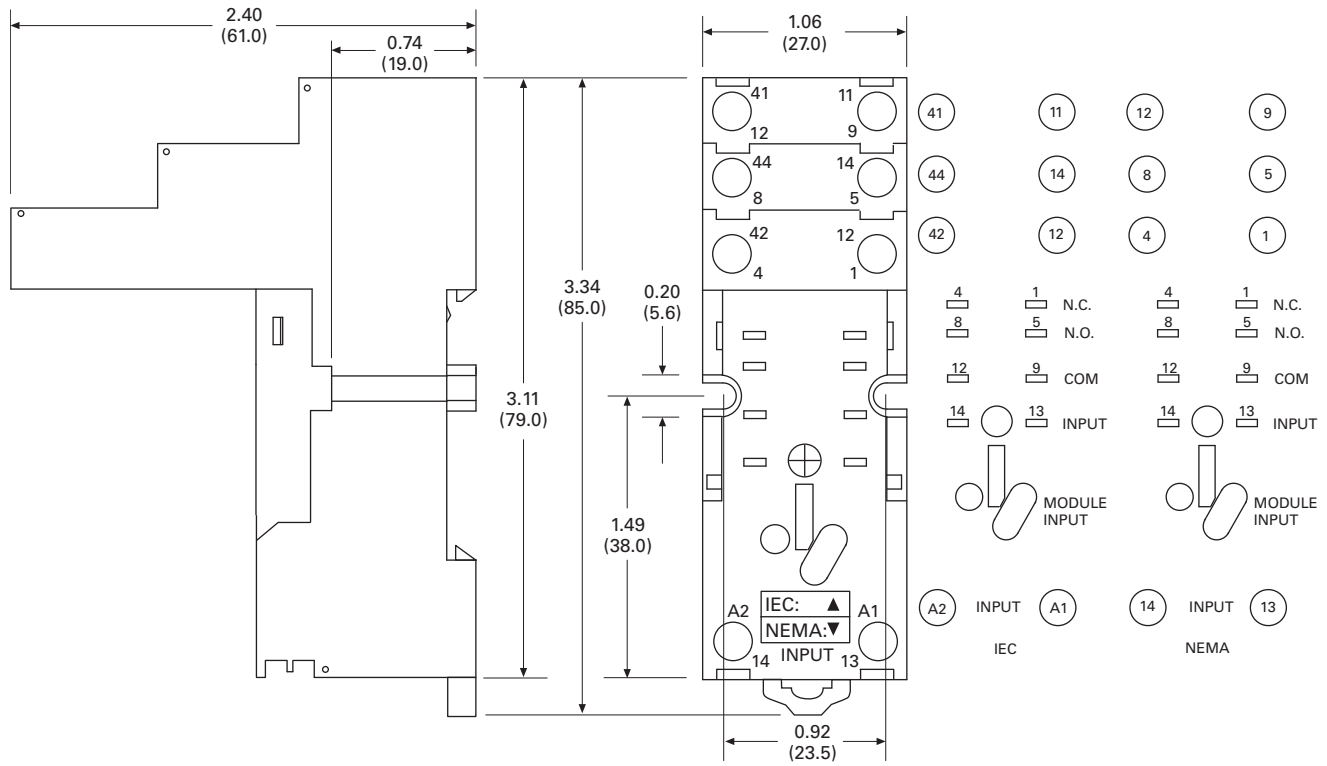

D3 Series Relay



D3RR/D3RF Series

Product Description

The D3 Series of relays provides excellent functionality in a popular octal base design. Rigid pins and guide allow for quick and easy installation with little risk of damage.

Features

D3RR

- Compact relay capable of breaking relatively large load currents
- Panel and DIN rail mounting
- 8- or 11-pin octal plug-in

Contents

Description

	Page
D1RR/D1RF Series	V7-T3-53
D2RR/D2RF Series	V7-T3-57
D3RR/D3RF Series	
Catalog Number Selection	V7-T3-68
Product Selection	V7-T3-68
Accessories	V7-T3-70
Technical Data and Specifications	V7-T3-71
Dimensions	V7-T3-72
D4 Series	V7-T3-76
D5RR/D5RF Series	V7-T3-80
D7PR/D7PF Series	V7-T3-89
D8 Series	V7-T3-103
D9 Series	V7-T3-108
Accessories	V7-T3-112

Standards and Certifications



When used with accompanying Eaton screw terminal socket (for D3RF only)

D3RF

- The contact operation can be easily checked by Push-to-Test button
- Flag indicator shows relay status in manual or powered condition
- LED status lamp shows coil ON or OFF status—ideal for use in low light applications
- Push-to-Test button allows for manual operation of relay without the need for coil power
- Lock-down door holds pushbutton and contacts in the operate position when activated
- Finger-grip cover allows operator to remove relays from sockets easily
- ID tag/write label to identify relays in multiple-relay circuits
- Bipolar LED allows for reverse polarity applications

3.4

Control Relays and Timers

General Purpose Plug-In Relays

Catalog Number Selection

D3RR/D3RF Series ①

3

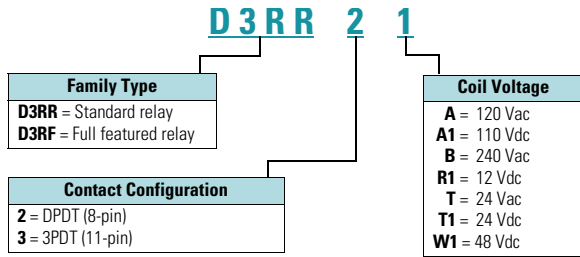

Product Selection

D3 Relay/Socket Quick Reference

Relay Type	Socket	Clip	Module Type	ID Tag	Jumper
D3RR2, D3RF2	D3PA6	PQC-1332	A	—	D3PJ1
	D3PAL8	PQC-1351	A	PWF-D3D5	—
	D3PA2	PQC-1351	None	—	—
D3RR3, D3RF3	D3PA7	PQC-1332	A	—	D3PJ1
	D3PAL11	PQC-1351	A	PWF-D3D5	—
	D3PA3	PQC-1351	None	—	—

Notes

① For deciphering catalog numbers. Do not use for ordering as not all combinations are readily available.

D3 Series Relay



D3RR/D3RF Series

Coil Voltage	Contact Configuration	Coil Resistance (Ohms)	Catalog Number
Full Featured Style			
120 Vac	DPDT	1700	D3RF2A
240 Vac	DPDT	7200	D3RF2B
12 Vdc	DPDT	120	D3RF2R1
24 Vdc	DPDT	470	D3RF2T1
120 Vac	3PDT	1700	D3RF3A
220/240 Vac	3PDT	7200	D3RF3B
24 Vac	3PDT	72	D3RF3T
24 Vdc	3PDT	470	D3RF3T1
Plain Cover Style			
120 Vac	DPDT	1700	D3RR2A
110/125 Vdc	DPDT	10,000	D3RR2A1
220/240 Vac	DPDT	7200	D3RR2B
12 Vdc	DPDT	120	D3RR2R1
24 Vac	DPDT	72	D3RR2T
24 Vdc	DPDT	470	D3RR2T1
48 Vdc	DPDT	1800	D3RR2W1
120 Vac	3PDT	1700	D3RR3A
110/125 Vdc	3PDT	10,000	D3RR3A1
220/240 Vac	3PDT	7200	D3RR3B
12 Vdc	3PDT	120	D3RR3R1
24 Vac	3PDT	72	D3RR3T
24 Vdc	3PDT	470	D3RR3T1

3.4

Control Relays and Timers

General Purpose Plug-In Relays

Accessories

D3RR/D3RF Series Sockets and Accessories

3

Type	Module Size	Nominal Voltage (Max. for Sockets)	Nominal Current	Mounting Style	Wire Size	Wire Connection	Standard Pack	Catalog Number
Socket	A	300	16	DIN rail/panel	12/14 (2) AWG, 4/2.5 (2) mm ²	Screw clamping	1	D3PA6 ^①
	A	300	12	DIN rail/panel	12/14 (2) AWG, 4/2.5 (2) mm ²	Elevator	10	D3PAL8 ^①
	None	300/600	15/10	DIN rail/panel	12/14 (2) AWG, 4/2.5 (2) mm ²	Screw clamping	10	D3PA2
	A	600	5	DIN rail/panel	12/14 (2) AWG, 4/2.5 (2) mm ²	Screw clamping	1	D3PA7 ^①
	A	300	12	DIN rail/panel	12/14 (2) AWG, 4/2.5 (2) mm ²	Elevator	10	D3PAL11 ^①
	None	300/600	15/5	DIN rail/panel	12/14 (2) AWG, 4/2.5 (2) mm ²	Screw clamping	10	D3PA3
Metal spring clip	—	—	—	—	—	—	25	PQC-1332
	—	—	—	—	—	—	10	PQC-1351
Protection diode	A	6 to 250 Vdc	—	—	—	—	20	MOD-AD250
LED indicator	A	24 Vac/Vdc	—	—	—	—	20	MOD-ALG24
	A	120/240 Vac/Vdc	—	—	—	—	20	MOD-ALG240
MOV suppressor	A	120 Vac/Vdc	—	—	—	—	20	MOD-AMV120
	A	24 Vac/Vdc	—	—	—	—	20	MOD-AMV24
	A	240 Vac/Vdc	—	—	—	—	20	MOD-AMV240
R/C suppressor	A	6 to 24 Vac/Vdc	—	—	—	—	20	MOD-RC24
	A	110 to 240 Vac/Vdc	—	—	—	—	20	MOD-RC240
Write-on plastic labels	—	—	—	—	—	—	10	PWF-D3D5
Coil bus jumpers	—	—	—	—	—	—	10	D3PJ1
Plastic DIN rail end stop	—	—	—	—	—	—	25	PPF-P

Note

^① Protection category (finger safe), EN 60529: IP20.

Technical Data and Specifications

D3RR/D3RF Series Relay Specifications

Description	D3RR	D3RF
Contact Characteristics		
Contact rating	10 A	10 A
Terminal style	Octal	Octal
Contact materials	Silver alloy	Silver alloy
Maximum switching voltage	300 V	300 V
Switching current at voltage—resistive	16 A at 277 Vac 50/60 Hz	16 A at 277 Vac 50/60 Hz
	16 A at 120 Vac 50/60 Hz	16 A at 120 Vac 50/60 Hz
	16 A at 28 Vdc	16 A at 28 Vdc
Switching current at voltage	1/2 hp at 240 Vac	1/2 hp at 240 Vac
	1/3 hp at 120 Vac	1/3 hp at 120 Vac
Pilot duty	B300	B300
Minimum switching requirement	100 mA at 5 Vdc (0.5 W)	100 mA at 5 Vdc (0.5 W)
Coil Characteristics		
Operating range		
% of nominal (AC)	85 to 110%	85 to 110%
% of nominal (DC)	80 to 110%	80 to 110%
Average consumption	3 VA	3 VA
	1.4 W	1.4 W
Dropout voltage threshold	15% (AC)	15% (AC)
	10% (DC)	10% (DC)
Performance		
Electrical life (UL 508) operations at rated current	100,000 operations	100,000 operations
Mechanical life operations unpowered	5,000,000 operations	5,000,000 operations
Response time	20 ms	20 ms
Dielectric strength		
Between coil and contact Vac (rms)	1500 V (rms)	1500 V (rms)
Between poles Vac (rms)	1500 V (rms)	1500 V (rms)
Environment		
Ambient air temperature around the device		
Storage	−40 °F to +185 °F (−40 °C to +85 °C)	−40 °F to +185 °F (−40 °C to +85 °C)
Operation	−40 °F to +131 °F (−40 °C to +55 °C)	−40 °F to +131 °F (−40 °C to +55 °C)
Vibration resistance—operational	3 g-n at 10–55 Hz	3 g-n at 10–55 Hz
Shock resistance	10 g-n	10 g-n
Degree of protection	IP40	IP40
Features		
Cover options	Plain cover	Full Featured
Features	Mechanical flag indicator	Bipolar LED/ Locking pushbutton/ Removable ID tag/ Mechanical flag indicator
Product certifications	RoHS/UL/CE/CSA	RoHS/UL/CE/CSA

3.4

Control Relays and Timers

General Purpose Plug-In Relays

Dimensions

Approximate Dimensions in Inches (mm)

3

D3RR2/D3RF2

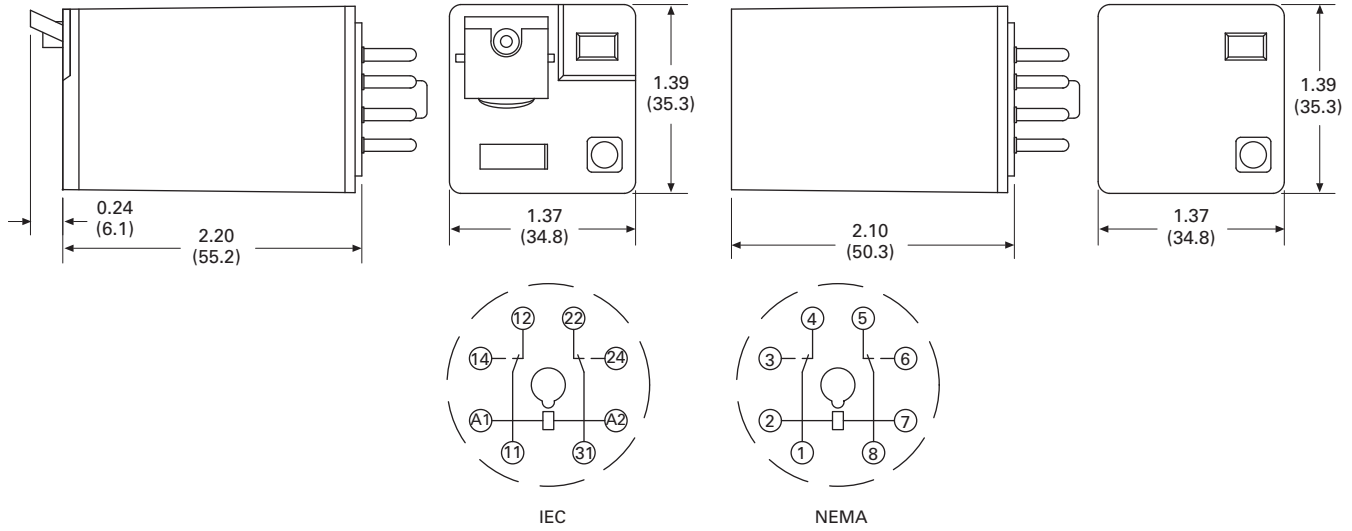

D3RR3/D3RF3

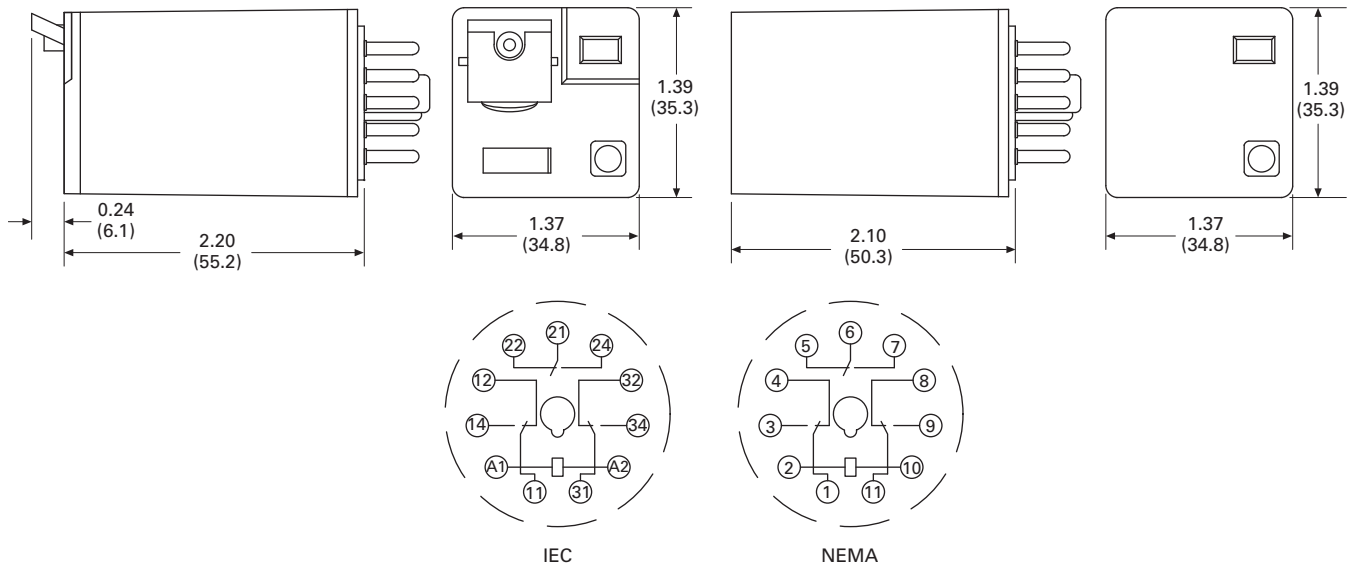

Approximate Dimensions in Inches (mm)

D3PA2

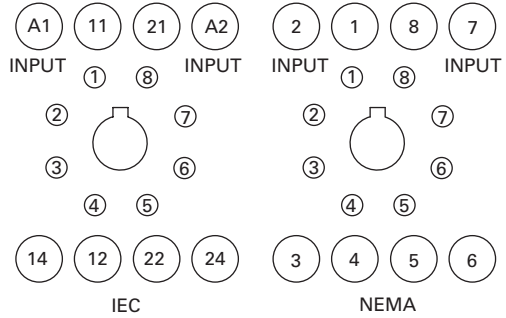
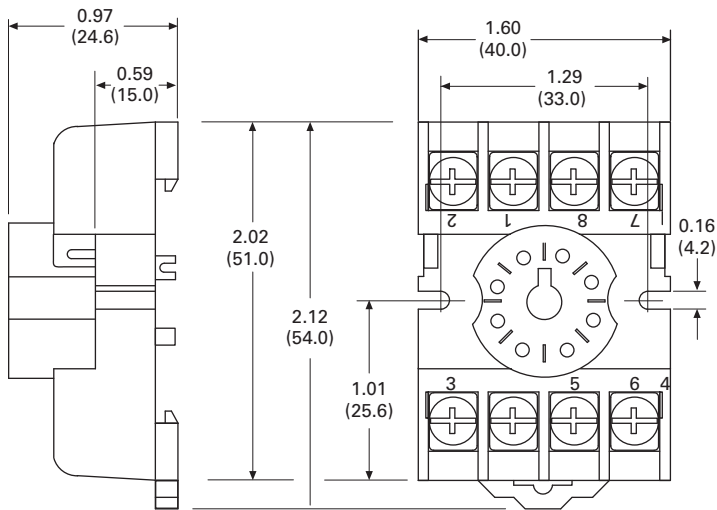

D3PA3

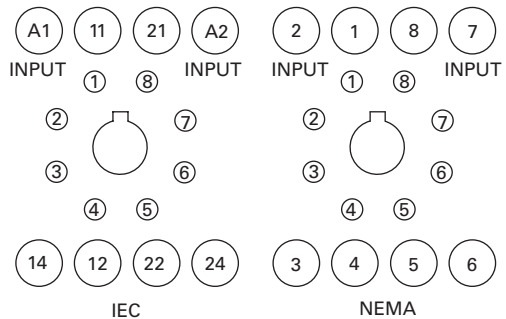
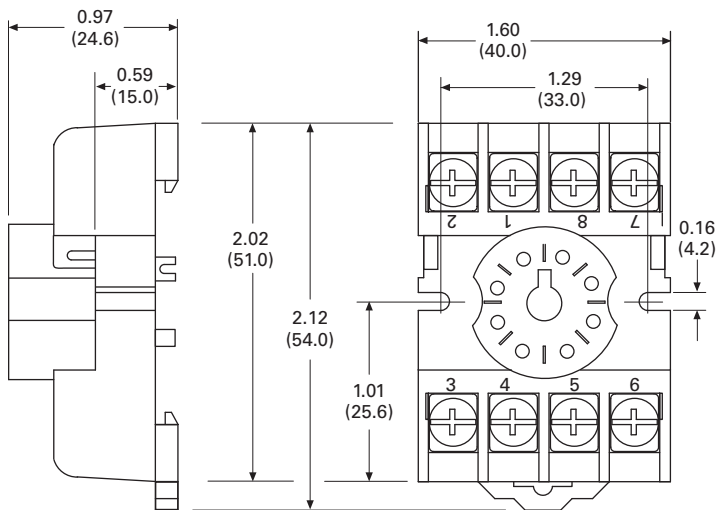
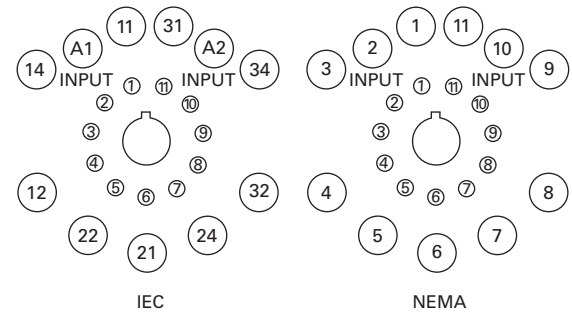
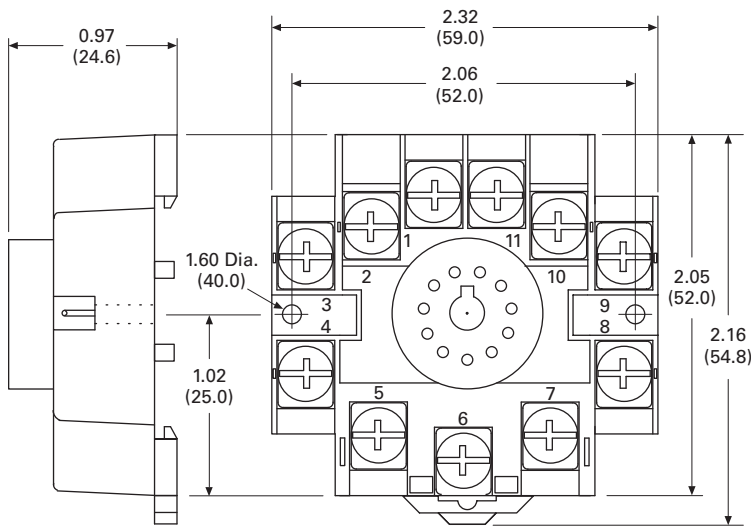

3.4

Control Relays and Timers

General Purpose Plug-In Relays

Approximate Dimensions in Inches (mm)

D3PA6

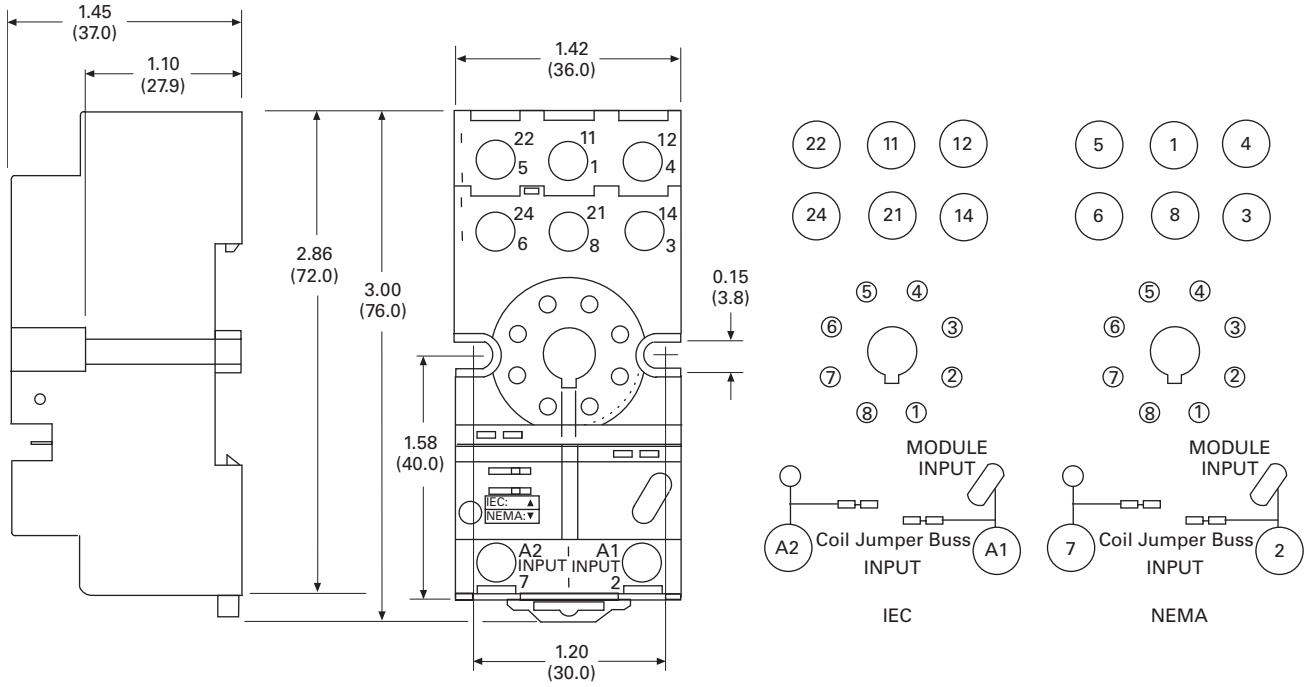

D3PA7

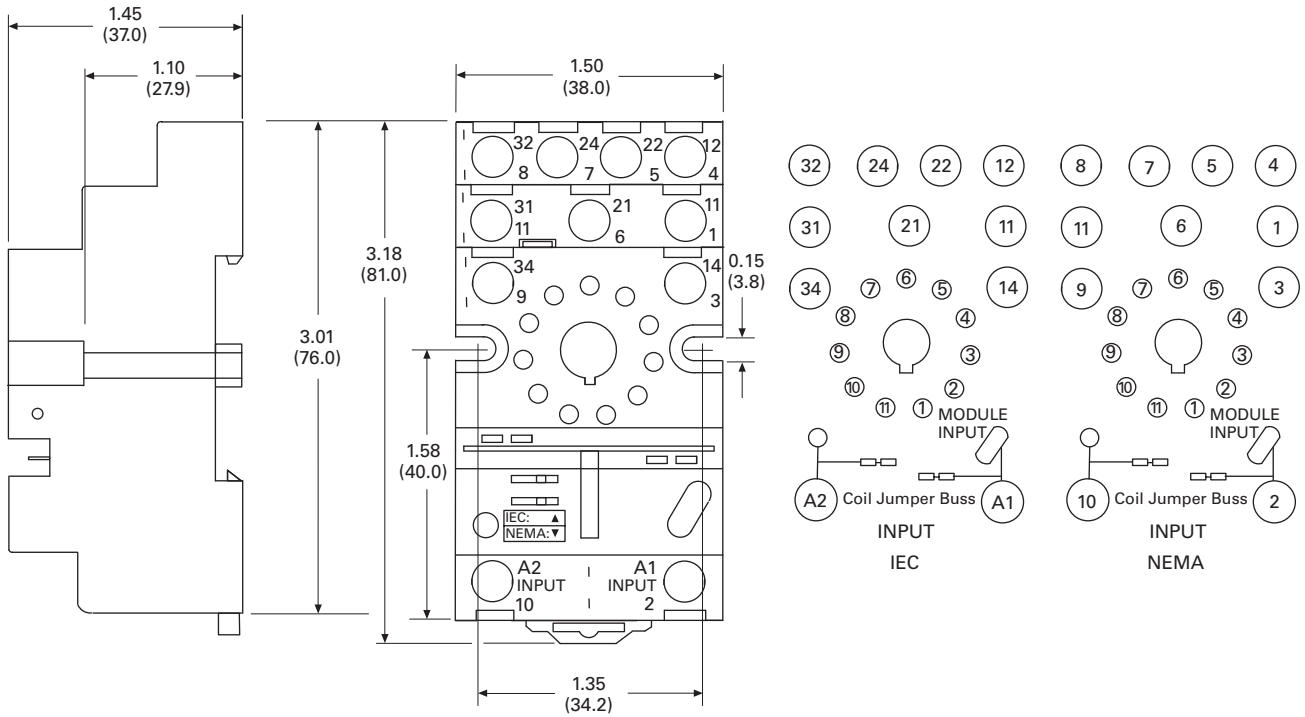

Approximate Dimensions in Inches (mm)

D3PAL8

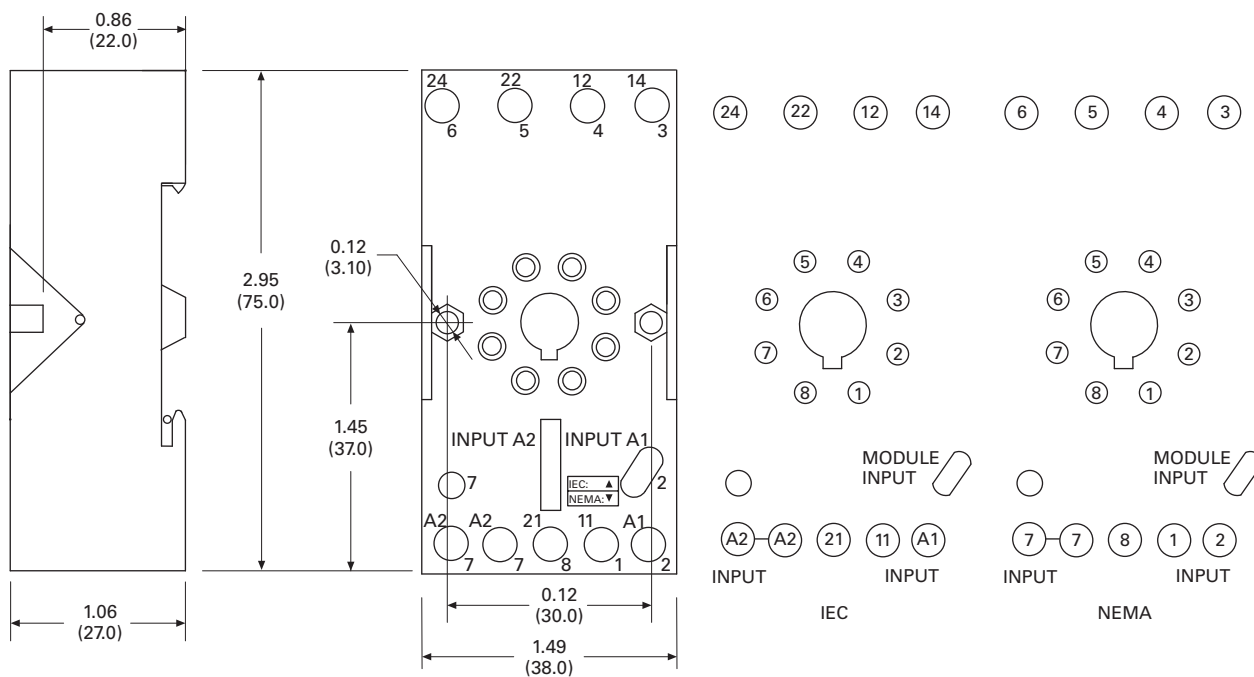

D3PAL11

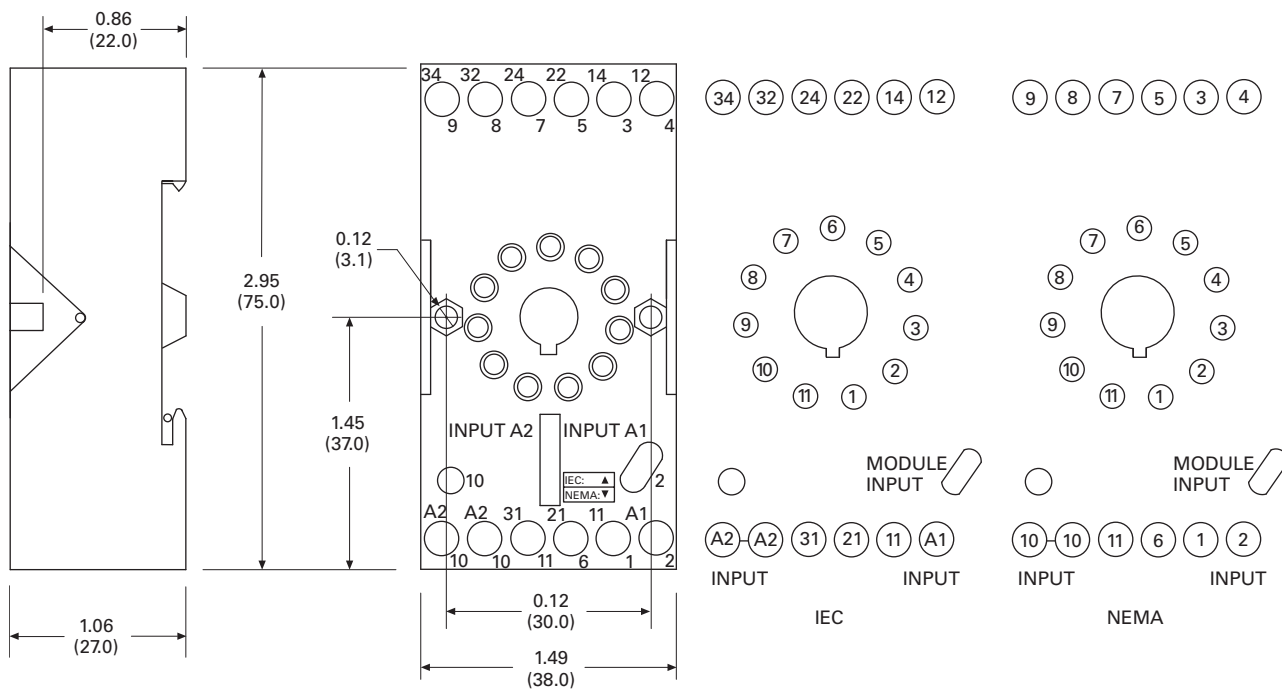

D4 Series Relay



D4 Series

Product Description

The D4 Series is a slim-form relay designed to fit into tight spaces. The retaining clip is built in to the socket to provide easy and secure assembly.

Features

- Slim-styled power relay
- Socket has built-in hold-down clip
- Panel or DIN rail mounting

Standards and Certifications

File # E1491, E65657

File # LR701519



Contents

Description	Page
D1RR/D1RF Series	V7-T3-53
D2RR/D2RF Series	V7-T3-57
D3RR/D3RF Series	V7-T3-67
D4 Series	
Technical Data and Specifications	V7-T3-78
Dimensions	V7-T3-79
D5RR/D5RF Series	V7-T3-80
D7PR/D7PF Series	V7-T3-89
D8 Series	V7-T3-103
D9 Series	V7-T3-108
Accessories	V7-T3-112

Catalog Number Selection

D4 Series ^①

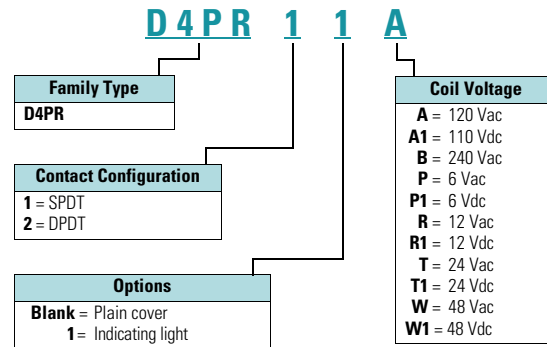

Product Selection

D4 Relay/Socket Quick Reference

Relay Type	Socket	Hold-Down Clip
D4PR1	D4PA1	②
D4PR2	D4PA2	②

Notes

- ① For deciphering catalog numbers. Do not use for ordering as not all combinations are readily available.
- ② Socket has built-in hold-down spring.

D4 Series Relay



D4 Series

Voltage/Poles	Standard Pack	Catalog Number
DIN Rail Sockets		
Single-pole	10	D4PA1
Two-pole	10	D4PA2
SPDT with Indicating Light		
120 Vac	1	D4PR11A
110 Vdc	1	D4PR11A1
240 Vac	1	D4PR11B
6 Vac	50	D4PR11P
6 Vdc	50	D4PR11P1
12 Vac	50	D4PR11R
12 Vdc	1	D4PR11R1
24 Vac	1	D4PR11T
24 Vdc	1	D4PR11T1
48 Vdc	50	D4PR11W1
Standard SPDT		
120 Vac	1	D4PR1A
110 Vdc	50	D4PR1A1
240 Vac	50	D4PR1P
6 Vac	1	D4PR1P1
6 Vdc	50	D4PR1R
12 Vac	1	D4PR1R1
12 Vdc	1	D4PR1R1-A2
24 Vac	1	D4PR1T
24 Vdc	1	D4PR1T1
48 Vdc	1	D4PR1W1

Voltage/Poles	Standard Pack	Catalog Number
DPDT with Indicating Light		
120 Vac	1	D4PR21A
110 Vdc	1	D4PR21A1
240 Vac	1	D4PR21B
6 Vac	50	D4PR21P
6 Vdc	1	D4PR21P1
12 Vac	50	D4PR21R
12 Vdc	1	D4PR21R1
24 Vac	1	D4PR21T
24 Vdc	1	D4PR21T1
48 Vdc	50	D4PR21W1
Standard DPDT		
120 Vac	1	D4PR2A
110 Vdc	50	D4PR2A1
240 Vac	50	D4PR2B
6 Vac	50	D4PR2P
6 Vdc	1	D4PR2P1
12 Vac	50	D4PR2R
12 Vdc	1	D4PR2R1
24 Vac	1	D4PR2T
24 Vdc	1	D4PR2T1
48 Vdc	1	D4PR2W1

Technical Data and Specifications

D4 Series

3

Description	Resistive Load (p.f. = 1)	Inductive Load (p.f. = 0.4, L/R = 7 ms)
D4PR1		
Rated load	250 Vac 10 A	250 Vac 7.5 A
	30 Vdc 10 A	30 Vdc 5 A
Carry current	10 A	10 A
Max. operating voltage	380 Vac/125 Vdc	380 Vac/125 Vdc
Max. operating current	10 A	10 A
Contact material	AgCdO	AgCdO
Max. switching capacity	2500 VA	1875 VA
	300 W	150 W
Min. permissible load	100 mA, 5 Vdc	100 mA, 5 Vdc
Pickup voltage (max.)	80% AC/70% DC	80% AC/70% DC
Dropout voltage (min.)	30% AC/15% DC	30% AC/15% DC
Voltage (max.)	110%	110%
Mechanical life (min.)	10,000,000 AC/20,000,000 DC	10,000,000 AC/20,000,000 DC
Electrical life at all contact ratings (min.)	100,000	100,000
Maximum hp ratings	1/3 hp (125 Vac)	1/3 hp (125 Vac)
	1/2 hp (250 Vac)	1/2 hp (250 Vac)
	1/2 hp (277 Vac)	1/2 hp (277 Vac)
D4PR2		
Rated load	240 Vac 5 A	250 Vac 2 A
	30 Vdc 5 A	30 Vdc 3 A
Carry current	5 A	5 A
Max. operating voltage	380 Vac/125 Vdc	380 Vac/125 Vdc
Max. operating current	5 A	5 A
Contact material	AgCdO	AgCdO
Max. switching capacity	1250 VA	500 VA
	150 W	90 W
Min. permissible load	10 mA, 5 Vdc	10 mA, 5 Vdc
Pickup voltage (max.)	80% AC/70% DC	80% AC/70% DC
Dropout voltage (min.)	30% AC/15% DC	30% AC/15% DC
Voltage (max.)	110%	110%
Mechanical life (min.)	10,000,000 AC/20,000,000 DC	10,000,000 AC/20,000,000 DC
Electrical life at all contact ratings (min.)	100,000	100,000
Maximum hp ratings	1/6 hp (120 Vac)	1/6 hp (120 Vac)
	1/3 hp (240 Vac)	1/3 hp (240 Vac)
	1/3 hp (265 Vac)	1/3 hp (265 Vac)

Dimensions

Approximate Dimensions in Inches (mm)

D4PR1

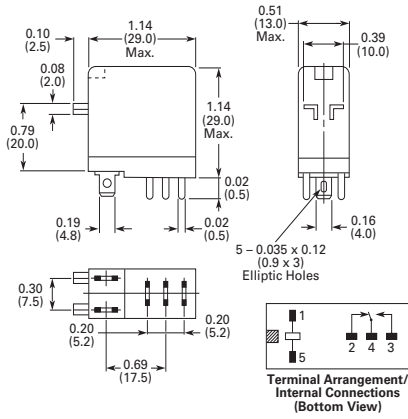

D4PR2

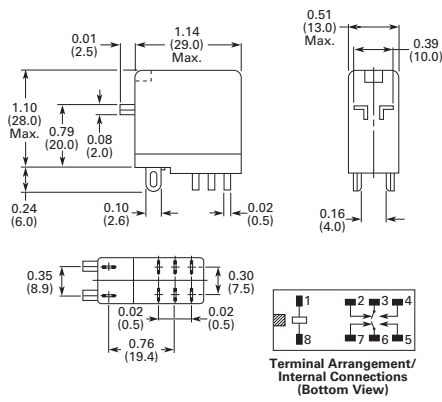

D4PA1

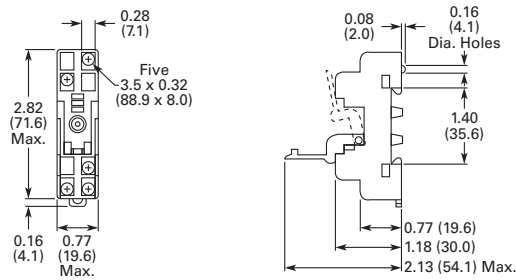

Terminal Arrangement

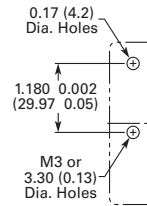

Mounting Holes

D4PA2

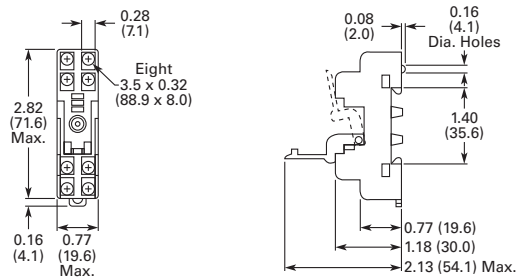

Terminal Arrangement

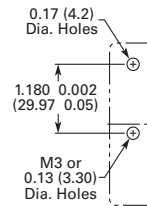

Mounting Holes

D5 Series Relay



Contents

<i>Description</i>	<i>Page</i>
D1RR/D1RF Series.....	V7-T3-53
D2RR/D2RF Series.....	V7-T3-57
D3RR/D3RF Series.....	V7-T3-67
D4 Series.....	V7-T3-76
D5RR/D5RF Series	
Catalog Number Selection.....	V7-T3-81
Product Selection.....	V7-T3-81
Accessories.....	V7-T3-83
Technical Data and Specifications.....	V7-T3-84
Wiring Diagrams.....	V7-T3-85
Dimensions.....	V7-T3-86
D7PR/D7PF Series.....	V7-T3-89
D8 Series.....	V7-T3-103
D9 Series.....	V7-T3-108
Accessories.....	V7-T3-112

D5RR/D5RF Series

Product Description

The D5 Series is rated at 10 A and is available in full-featured and plain cover styles.

Features

D5RR

- Industrial rated 300 V, 10 A relay in two-pole and three-pole configurations
- Compact design can be panel or DIN rail mounted

D5RF

- Flag indicator shows relay status in manual or powered condition
- LED status lamp shows coil ON or OFF status—ideal for use in low light applications
- Push-to-Test button allows for manual operation of relay without the need for coil power
- Lock-down door holds pushbutton and contacts in the operate position when activated
- Finger-grip cover allows operator to remove relays from sockets easily
- ID tag/write label to identify relays in multiple-relay circuits
- Bipolar LED allows for reverse polarity applications

Standards and Certifications



 When used with accompanying Eaton screw terminal socket (D5RF only)

Catalog Number Selection

D5 Series

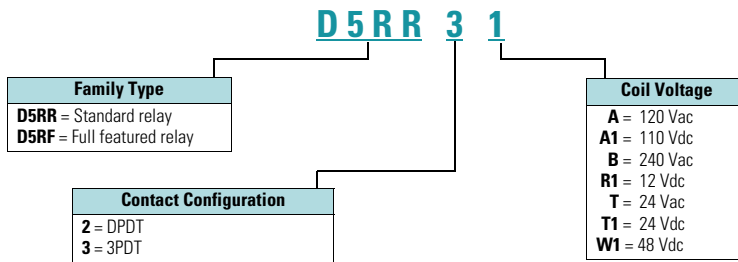

Product Selection

D5 Relay/Socket Quick Reference

Relay Type	Socket	Clip	Module Type	ID Tag	Jumper
D5RR2, D5RF2, D5RR3, D5RF3	D5PAL	PQC-1351	A	PWF-D3D5	D3PJ1
	D5PA2	PQC-1351	None	—	—
	D5PA3L	PQC-1351	None	—	—
	D5PA3S	PQC-1351	None	—	—

3.4

Control Relays and Timers

General Purpose Plug-In Relays

D5 Series Relay



D5 Series

Coil Voltage	Contact Configuration	Coil Resistance (Ohms)	Catalog Number
Full Featured			
120 Vac	DPDT	1700	D5RF2A
110/125 Vdc	DPDT	10,000	D5RF2A1
220/240 Vac	DPDT	7200	D5RF2B
12 Vdc	DPDT	120	D5RF2R1
24 Vac	DPDT	72	D5RF2T
24 Vdc	DPDT	470	D5RF2T1
120 Vac	3PDT	1700	D5RF3A
110/125 Vdc	3PDT	10,000	D5RF3A1
220/240 Vac	3PDT	7200	D5RF3B
12 Vdc	3PDT	120	D5RF3R1
24 Vac	3PDT	72	D5RF3T
24 Vdc	3PDT	470	D5RF3T1
Side Flange Cover			
220/240 Vac	DPDT	7200	D5RB2B
12 Vdc	DPDT	120	D5RB2R1
24 Vac	DPDT	72	D5RB2T
24 Vdc	DPDT	470	D5RB2T1
Plain Cover			
120 Vac	DPDT	1700	D5RR2A
110/125 Vdc	DPDT	10,000	D5RR2A1
220/240 Vac	DPDT	7200	D5RR2B
24 Vac	DPDT	72	D5RR2T
24 Vdc	DPDT	470	D5RR2T1
120 Vac	3PDT	1700	D5RR3A
110/125 Vdc	3PDT	10,000	D5RR3A1
220/240 Vac	3PDT	7200	D5RR3B
12 Vdc	3PDT	120	D5RR3R1
24 Vac	3PDT	72	D5RR3T
24 Vdc	3PDT	470	D5RR3T1

Accessories

D5 Sockets and Accessories

Type	Module Size	Nominal Voltage (Max. for Sockets)	Nominal Current	Mounting Style	Wire Size	Wire Connection	Standard Pack	Catalog Number
Socket	A	300	25	DIN rail	10 /14 (2) AWG, 6/2.5 (2) mm ²	Elevator	10	D5PAL ①
	None	300	15	DIN rail/panel	12/14 (2) AWG, 4/2.5 (2) mm ²	Screw clamping	10	D5PA2
	None	300	15	Chassis	(Output): 16 AWG, 1 mm ²	Solder	10	D5PA3L
	None	300	15	Chassis	(Output): 16 AWG, 1 mm ²	Solder	10	D5PA3S
Metal spring clip	—	—	—	—	—	—	10	PQC-1351
Protection diode	A	6 to 250 Vdc	—	—	—	—	20	MOD-AD250
LED indicator	A	24 Vac/Vdc	—	—	—	—	20	MOD-ALG24
	A	120/240 Vac/Vdc	—	—	—	—	20	MOD-ALG240
MOV suppressor	A	120 Vac/Vdc	—	—	—	—	20	MOD-AMV120
	A	24 Vac/Vdc	—	—	—	—	20	MOD-AMV24
	A	240 Vac/Vdc	—	—	—	—	20	MOD-AMV240
R/C suppressor	A	6 to 24 Vac/Vdc	—	—	—	—	20	MOD-RC24
	A	110 to 240 Vac/Vdc	—	—	—	—	20	MOD-RC240
Write-on plastic labels	—	—	—	—	—	—	10	PWF-D3D5
Coil bus jumpers	—	—	—	—	—	—	10	D3PJ1
Plastic DIN rail end stop	—	—	—	—	—	—	25	PFP-P

Note

① Protection category (finger safe), EN 60529: IP20.

Technical Data and Specifications

D5 Series

Description	D5RR	D5RF
Contact Characteristics		
Contact rating	10 A	10 A
Terminal style	Plug-in	Plug-in
Contact materials	Silver alloy	Silver alloy
Maximum switching voltage	300 V	300 V
Switching current at voltage—resistive		
	16 A at 277 Vac 50/60 Hz	16 A at 277 Vac 50/60 Hz
	16 A at 120 Vac 50/60 Hz	16 A at 120 Vac 50/60 Hz
	16 A at 28 Vdc	16 A at 28 Vdc
Switching current at voltage	1/2 hp at 240 Vac	1/2 hp at 240 Vac
	1/3 hp at 120 Vac	1/3 hp at 120 Vac
Pilot duty	B300	B300
Minimum switching requirement	100 mA at 5 Vdc (0.5 W)	100 mA at 5 Vdc (0.5 W)
Coil Characteristics		
Operating range		
% of nominal (AC)	85 to 110%	85 to 110%
% of nominal (DC)	80 to 110%	80 to 110%
Average consumption	3 VA 1.4 W	3 VA 1.4 W
Drop-out voltage threshold	10%/15% (AC) 10% (DC)	10%/15% (AC) 10% (DC)
Performance		
Electrical life (UL 508) operations at rated current	100,000 operations	100,000 operations
Mechanical life operations unpowered	5,000,000 operations	5,000,000 operations
Response time	20 ms	20 ms
Dielectric strength		
Between coil and contact Vac (rms)	1500 V (rms)	1500 V (rms)
Between poles Vac (rms)	1500 V (rms)	1500 V (rms)
Environment		
Ambient air temperature around the device		
Storage	−40 °F to +185 °F (−40 °C to +85 °C)	−40 °F to +185 °F (−40 °C to +85 °C)
Operation	−40 °F to +131 °F (−40 °C to +55 °C)	−40 °F to +131 °F (−40 °C to +55 °C)
Vibration resistance—operational	3 g-n at 10–55 Hz	3 g-n at 10–55 Hz
Shock resistance	10 g-n	10 g-n
Degree of protection	IP40	IP40
Features		
Cover options	Flange/plain cover with LED	Full featured
Features	Mechanical flag indicator (LED optional)	Bipolar LED/ Mechanical flag indicator/ Locking pushbutton/ Removable ID tag
Product certifications	RoHS/UL/CE/CSA	RoHS/UL/CE/CSA

Wiring Diagrams

D5PA3L and D5PA3S

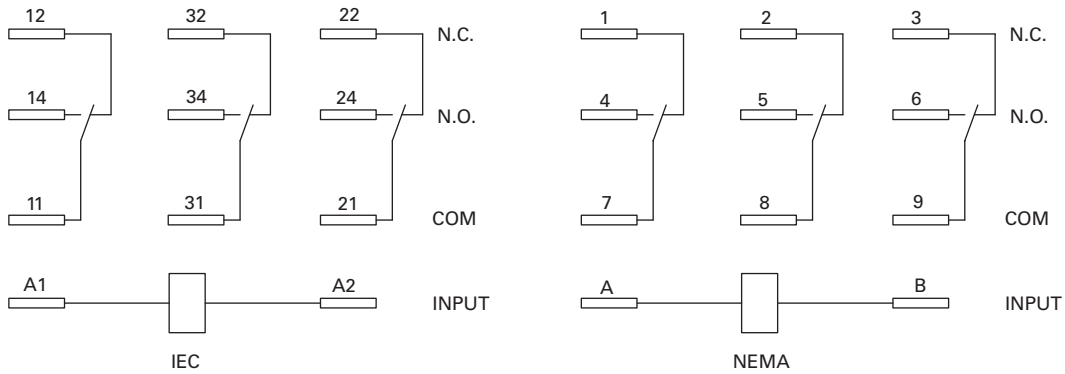

D5RR2/D5RF2 DPDT

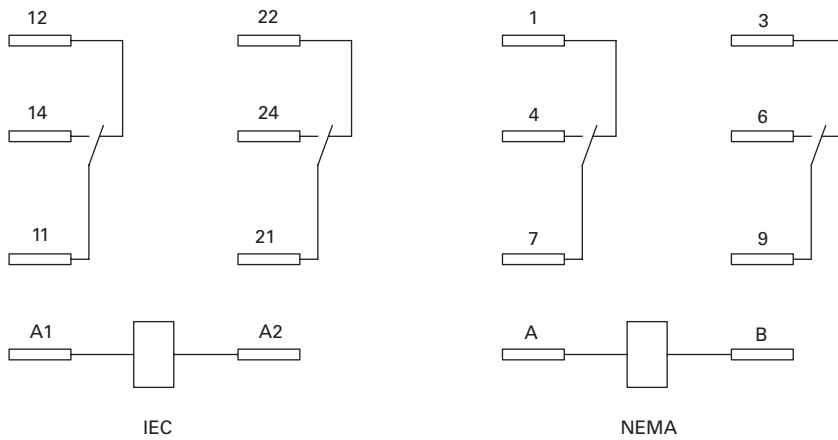

D5RR3/D5RF3 3PDT

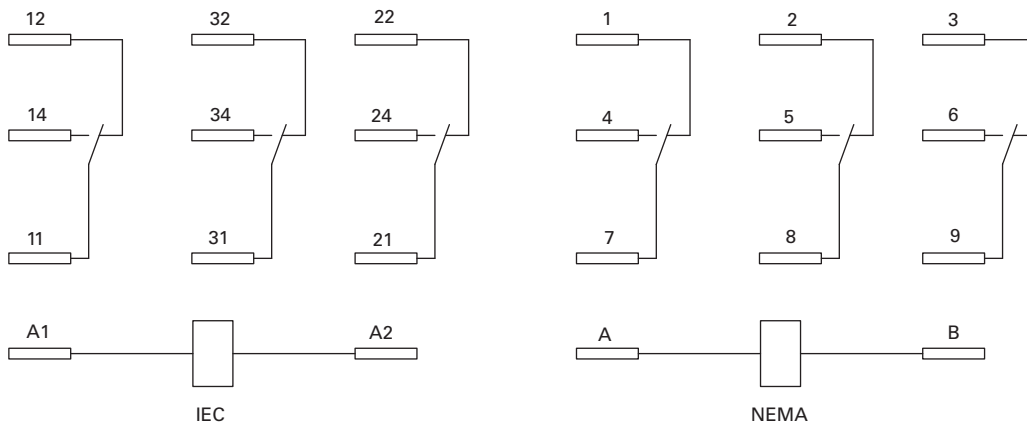

3.4

Control Relays and Timers

General Purpose Plug-In Relays

Dimensions

Approximate Dimensions in Inches (mm)

D5RR and D5RF

3

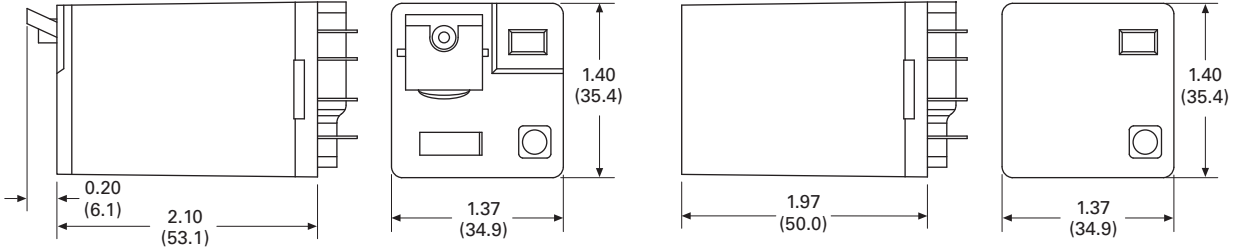

D5PA2

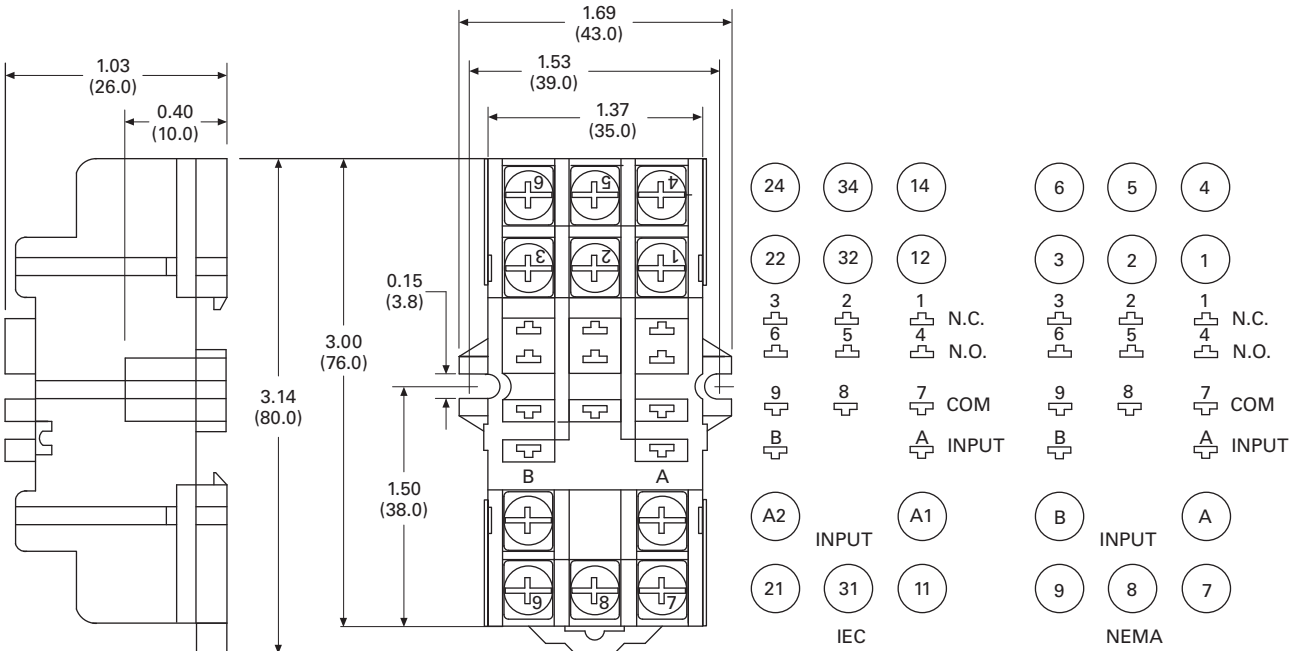

Approximate Dimensions in Inches (mm)

D5PA3L and D5PA3S

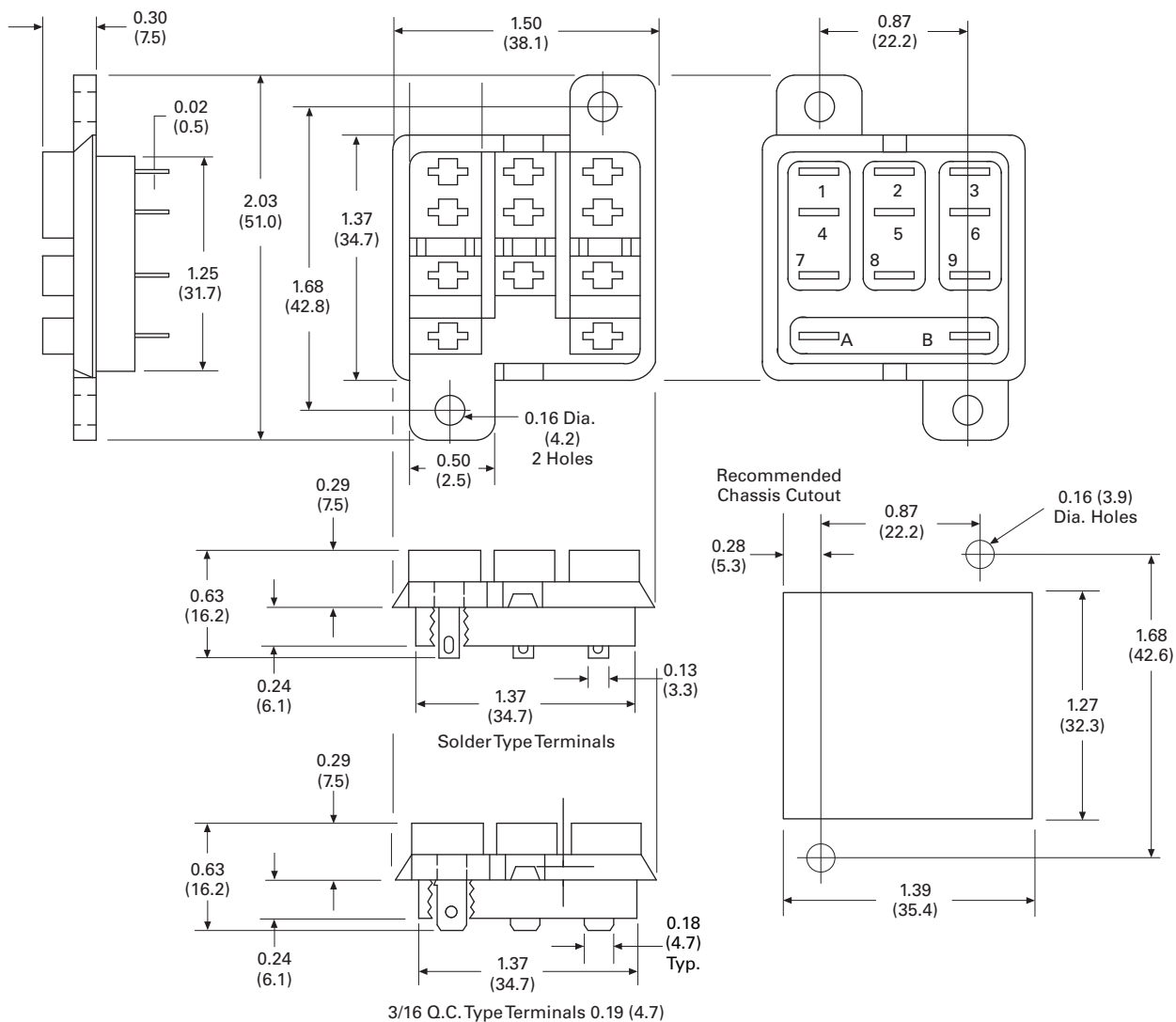

3.4

Control Relays and Timers

General Purpose Plug-In Relays

Approximate Dimensions in Inches (mm)

D5PAL

3

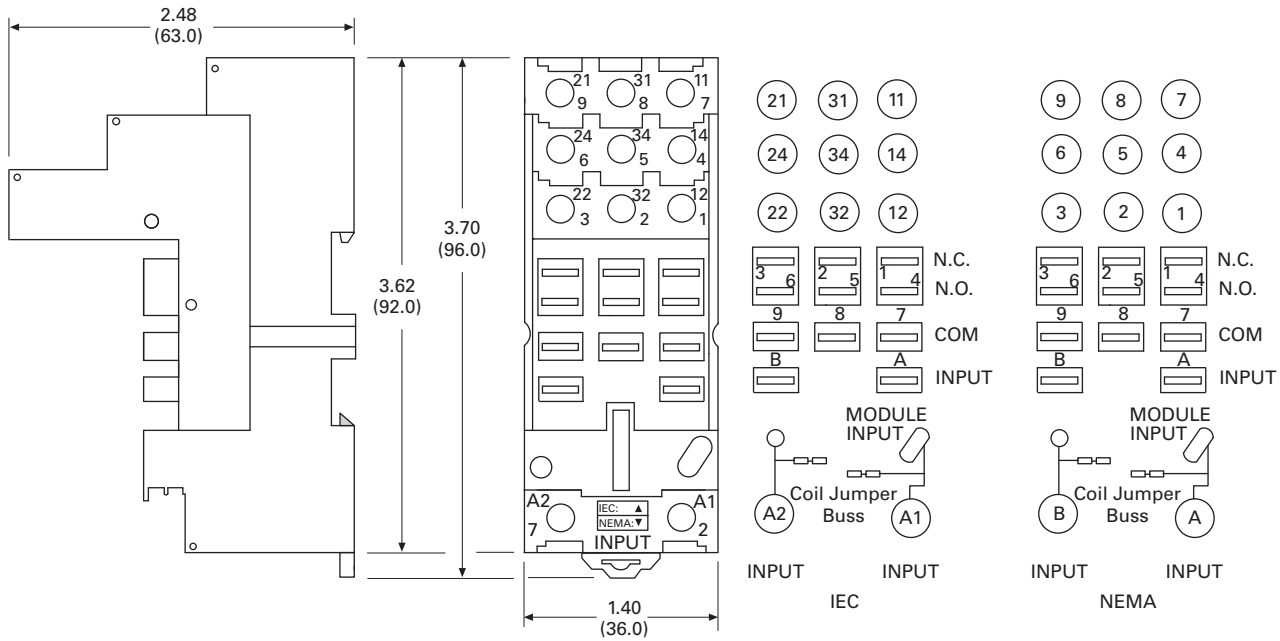

D7 Series Relay



D7PR/D7PF Series

Product Description

The D7 Series is a cost-effective control relay with high dielectric strength and high current-carrying capacity.

Features

D7PR

- Arc barrier equipped relay with high dielectric strength
- Panel and DIN rail mounting

Contents

Description	Page
D1RR/D1RF Series	V7-T3-53
D2RR/D2RF Series	V7-T3-57
D3RR/D3RF Series	V7-T3-67
D4 Series	V7-T3-76
D5RR/D5RF Series	V7-T3-80
D7PR/D7PF Series	
Catalog Number Selection	V7-T3-90
Product Selection	V7-T3-90
Accessories	V7-T3-92
Technical Data and Specifications	V7-T3-93
Wiring Diagrams	V7-T3-95
Dimensions	V7-T3-96
D8 Series	V7-T3-103
D9 Series	V7-T3-108
Accessories	V7-T3-112

Standards and Certifications

 File # E37317, E65657

 File # LR217017, LR217069



 RoHS COMPLIANT

D7PF

- Flag indicator shows relay status in manual or powered condition
- Bipolar LED status lamp allows for reverse polarity applications
 - Shows coil ON or OFF status
 - Ideal in low light conditions
- Color-coded pushbutton identifies AC coils with red or DC coils with blue pushbuttons
 - Allows for manual operation of relay without the need for coil power
 - Ideal for field service personnel to test control circuits
- Lock-down door, when activated, holds pushbutton and contacts in the operate position
 - Excellent for analyzing circuit problems
- Finger-grip cover allows operator to remove relays from sockets more easily than conventional relays
- White plastic ID tag/write label used for identification of relays in multi-relay circuits

3.4

Control Relays and Timers

General Purpose Plug-In Relays

Catalog Number Selection

D7 Series

3

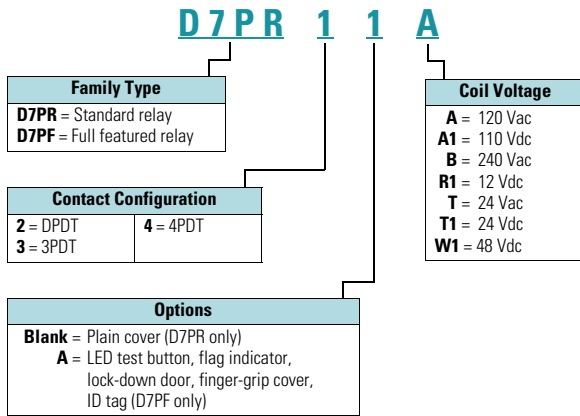

Product Selection

D7 Relay/Socket Quick Reference

Relay Type	Socket/Adapter	Clip	Module Type	ID Tag	Jumper
D7PR2, D7PF2	D7PAA	PQC-1342	B	—	—
		PQC-1349	B	—	—
	D7PA9	PQC-1342	None	—	—
		PFC-D2D72	—	None	—
D7PR3, D7PF3	D7PAB	PQC-1783	A	—	—
		PMC-1783	A	—	—
	PFC-D73	—	None	—	—
D7PR4, D7PF4	D7PAD	PQC-1784	A	—	—
		PMC-1784	A	—	—
	PFC-D74	—	None	—	—

D7 Series Relay



D7 Series

Coil Voltage	Contact Configuration	Coil Resistance (Ohms)	Catalog Number
Full Featured			
120 Vac	DPDT	4430	D7PF2AA
110/125 Vdc	DPDT	11,000	D7PF2AA1
220/240 Vac	DPDT	15,720	D7PF2AB
12 Vdc	DPDT	160	D7PF2AR1
24 Vac	DPDT	180	D7PF2AT
24 Vdc	DPDT	650	D7PF2AT1
24 Vac	3PDT	103	D7PF3AT
24 Vdc	3PDT	400	D7PF3AT1
120 Vac	4PDT	2220	D7PF4AA
110/125 Vdc	4PDT	7340	D7PF4AA1
240 Vac	4PDT	9120	D7PF4AB
12 Vdc	4PDT	96	D7PF4AR1
24 Vac	4PDT	84.5	D7PF4AT
24 Vdc	4PDT	388	D7PF4AT1
48 Vac	4PDT	410	D7PF4AW1
Plain Cover			
120 Vac	DPDT	4430	D7PR2A
110/125 Vdc	DPDT	11,000	D7PR2A1
12 Vdc	DPDT	160	D7PR2R1
24 Vac	DPDT	180	D7PR2T
24 Vdc	DPDT	650	D7PR2T1
120 Vac	3PDT	2770	D7PR3A
240 Vac	3PDT	12,100	D7PR3B
12 Vdc	3PDT	100	D7PR3R1
24 Vac	3PDT	103	D7PR3T
24 Vdc	3PDT	400	D7PR3T1
120 Vac	4PDT	2220	D7PR4A
110/125 Vdc	4PDT	7340	D7PR4A1
240 Vac	4PDT	9120	D7PR4B
24 Vac	4PDT	84.5	D7PR4T
24 Vdc	4PDT	388	D7PR4T1

Accessories

D7 Sockets and Accessories

Type	Module Size	Nominal Voltage (Max. for Sockets)	Nominal Current	Mounting Style	Wire Size	Wire Connection	Standard Pack	Catalog Number
Socket	B	300	16	DIN rail/panel	12/14 (2) AWG, 4/2.5 (2) mm ²	Screw clamping	—	D7PAA ①
	None	300	10	DIN rail/panel	12/14 (2) AWG, 4/2.5 (2) mm ²	Screw clamping	1	D7PA9
	A	300	16	DIN rail/panel	12/14 (2) AWG, 4/2.5 (2) mm ²	Screw clamping	—	D7PAD ①
	A	300	16	DIN rail/panel	12/14 (2) AWG, 4/2.5 (2) mm ²	Screw clamping	—	D7PAB ①
Flange mount adapter	—	—	—	Flange	—	—	25	PFC-D2D72
	—	—	—	Flange	—	—	25	PFC-D73
	—	—	—	Flange	—	—	25	PFC-D74
Metal spring clip	—	—	—	—	—	25	PQC-1342	
Plastic ID clip	—	—	—	—	—	10	PQC-1349	
Metal spring clip	—	—	—	—	—	25	PQC-1784	
Plastic ID clip	—	—	—	—	—	10	PMC-1784	
Hold-down spring	—	—	—	—	—	25	PYC-B2	
Metal spring clip	—	—	—	—	—	10	PQC-1783	
Plastic ID clip	—	—	—	—	—	10	PMC-1783	
Protection diode	A	6 to 250 Vdc	—	—	—	—	20	MOD-AD250
LED indicator	A	24 Vac/Vdc	—	—	—	—	20	MOD-ALG24
	A	120/240 Vac/Vdc	—	—	—	—	20	MOD-ALG240
MOV suppressor	A	120 Vac/Vdc	—	—	—	—	20	MOD-AMV120
	A	24 Vac/Vdc	—	—	—	—	20	MOD-AMV24
	A	240 Vac/Vdc	—	—	—	—	20	MOD-AMV240
R/C suppressor	A	6 to 24 Vac/Vdc	—	—	—	—	20	MOD-RC24
	A	110 to 240 Vac/Vdc	—	—	—	—	20	MOD-RC240
Protection diode	B	6 to 250 Vdc	—	—	—	—	20	MOD-BD250
LED indicator	B	24 Vac/Vdc	—	—	—	—	20	MOD-BLG24
	B	120/240 Vac/Vdc	—	—	—	—	20	MOD-BLG240
MOV suppressor	B	120 Vac/Vdc	—	—	—	—	20	MOD-BMV120
	B	24 Vac/Vdc	—	—	—	—	20	MOD-BMV24
	B	240 Vac/Vdc	—	—	—	—	20	MOD-BMV240
Plastic DIN rail end stop	—	—	—	—	—	25	PPF-P	

Note

① Protection category (finger safe), EN 60529: IP20.

Technical Data and Specifications

D7PR Relay

Description	D7PR (DPDT)	D7PR (3PDT)	D7PR (4PDT)
Contact Characteristics			
Contact rating	15 A	15 A	15 A
Terminal style	Plug-in	Plug-in	Plug-in
Contact materials	Silver alloy	Silver alloy	Silver alloy
Maximum switching voltage	300 V	300 V	300 V
Switching current at voltage—resistive	15 A at 120 Vac 50/60 Hz	15 A at 120 Vac 50/60 Hz	15 A at 120 Vac 50/60 Hz
	12 A at 277 Vac 50/60 Hz	12 A at 277 Vac 50/60 Hz	12 A at 277 Vac 50/60 Hz
	10 A at 277 Vac 50/60 Hz	—	—
	12 A at 28 Vdc	12 A at 28 Vdc	12 A at 28 Vdc
Switching current at voltage	1/2 hp at 120 Vac	1/2 hp at 120 Vac	1/2 hp at 120 Vac
	1 hp at 250 Vac	3/4 hp at 250 Vac	3/4 hp at 250 Vac
Pilot duty	B300	B300	B300
Minimum switching requirement	100 mA at 5 Vdc (0.5 W)	100 mA at 5 Vdc (0.5 W)	100 mA at 5 Vdc (0.5 W)
Coil Characteristics			
Operating range			
% of nominal (AC)	85 to 110%	85 to 110%	85 to 110%
% of nominal (DC)	80 to 110%	80 to 110%	80 to 110%
Average consumption	1.2 VA	1.5 VA	1.5 VA
	0.9 W	1.4 W	1.5 W
Dropout voltage threshold	15% (AC)	15% (AC)	15% (AC)
	10% (DC)	10% (DC)	10% (DC)
Performance			
Electrical life (UL 508) operations at rated current	100,000 operations	200,000 operations	200,000 operations
Mechanical life operations unpowered	10,000,000 operations	10,000,000 operations	10,000,000 operations
Response time	20 ms	20 ms	20 ms
Dielectric strength			
Between coil and contact Vac (rms)	2500 V (rms)	2500 V (rms)	2500 V (rms)
Between poles Vac (rms)	1500 V (rms)	2500 V (rms)	2500 V (rms)
Environment			
Ambient air temperature around the device			
Operation	−40 °F to +131 °F (−40 °C to +55 °C)	−40 °F to +131 °F (−40 °C to +55 °C)	−40 °F to +131 °F (−40 °C to +55 °C)
Storage	−40 °F to +185 °F (−40 °C to +85 °C)	−40 °F to +185 °F (−40 °C to +85 °C)	−40 °F to +185 °F (−40 °C to +85 °C)
Vibration resistance—operational	3 g-n at 10–55 Hz	3 g-n at 10–55 Hz	3 g-n at 10–55 Hz
Shock resistance	10 g-n	10 g-n	10 g-n
Degree of protection	IP40	IP40	IP40
Features			
Cover options	Plain cover	Plain cover	Plain cover
Features	Mechanical flag indicator (optional LED)	Mechanical flag indicator (optional LED)	Mechanical flag indicator (optional LED)
Product certifications	RoHS/UL/CE/CSA	RoHS/UL/CE/CSA	RoHS/UL/CE/CSA

3.4

Control Relays and Timers

General Purpose Plug-In Relays

3

D7PF Relay

Description	D7PF (DPDT)	D7PF (3PDT)	D7PF (4PDT)
Contact Characteristics			
Contact rating	15 A	15 A	15 A
Terminal style	Plug-in	Plug-in	Plug-in
Contact materials	Silver alloy	Silver alloy	Silver alloy
Maximum switching voltage	300 V	300 V	300 V
Switching current at voltage—resistive	15 A at 120 Vac 50/60 Hz	15 A at 120 Vac 50/60 Hz	15 A at 120 Vac 50/60 Hz
	12 A at 277 Vac 50/60 Hz	12 A at 277 Vac 50/60 Hz	12 A at 277 Vac 50/60 Hz
	10 A at 277 Vac 50/60 Hz	—	—
	12 A at 28 VDC	12 A at 28 Vdc	12 A at 28 Vdc
Switching current at voltage	1/2 hp at 120 Vac	3/4 hp at 250 Vac	1/2 hp at 120 Vac
	1 hp at 250 Vac	1/2 hp at 120 Vac	3/4 hp at 250 Vac
Pilot duty	B300	B300	B300
Minimum switching requirement	100 mA at 5 Vdc (0.5 W)	100 mA at 5 Vdc (0.5 W)	100 mA at 5 Vdc (0.5 W)
Coil Characteristics			
Operating range			
% of nominal (AC)	85 to 110%	85 to 110%	85 to 110%
% of nominal (DC)	80 to 110%	80 to 110%	80 to 110%
Average consumption	1.2 VA	1.5 VA	1.5 VA
	0.9 W	1.4 W	1.5 W
Dropout voltage threshold	15% (AC)	15% (AC)	15% (AC)
	10% (DC)	10% (DC)	10% (DC)
Performance			
Electrical life (UL 508) operations at rated current	100,000 operations	200,000 operations	200,000 operations
Mechanical life operations unpowered	10,000,000 operations	10,000,000 operations	10,000,000 operations
Response time	20 ms	20 ms	20 ms
Dielectric strength			
Between coil and contact Vac (rms)	2500 V (rms)	2500 V (rms)	2500 V (rms)
Between poles Vac (rms)	1500 V (rms)	2500 V (rms)	2500 V (rms)
Environment			
Ambient air temperature around the device			
Operation	−40 °F to +131 °F (−40 ° to 55 °C)	−40 °F to +131 °F (−40 ° to 55 °C)	−40 °F to +131 °F (−40 ° to 55 °C)
Storage	−40 °F to +185 °F (−40 ° to 85 °C)	−40 °F to +185 °F (−40 ° to 85 °C)	−40 °F to +185 °F (−40 ° to 85 °C)
Vibration resistance—operational	3 g-n at 10–55 Hz	3 g-n at 10–55 Hz	3 g-n at 10–55 Hz
Shock resistance	10 g-n	10 g-n	10 g-n
Degree of protection	IP40	IP40	IP40
Features			
Cover options	Full featured	Full featured	Full featured
Features	Locking pushbutton/ Bipolar LED/ Removable ID tag/ Mechanical flag indicator	Locking pushbutton/ Bipolar LED/ Removable ID tag/ Mechanical flag indicator	Locking pushbutton/ Bipolar LED/ Removable ID tag/ Mechanical flag indicator
Product certifications	RoHS/UL/CE/CSA	RoHS/UL/CE/CSA	RoHS/UL/CE/CSA

Wiring Diagrams

D7PR2/D7PF2

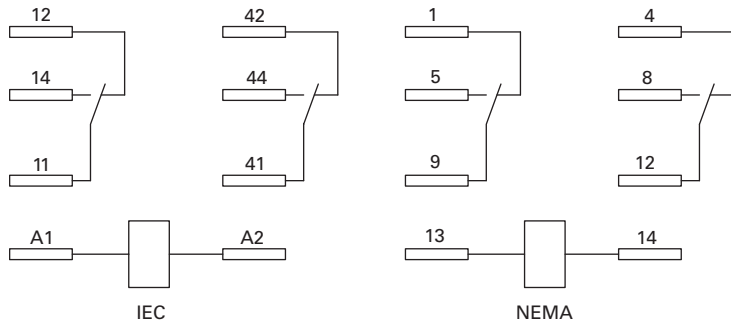

D7PR3/D7PF3

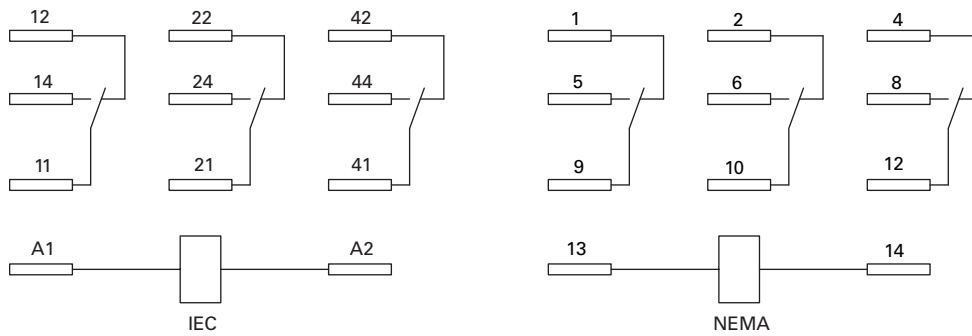

D7PR4/D7PF4

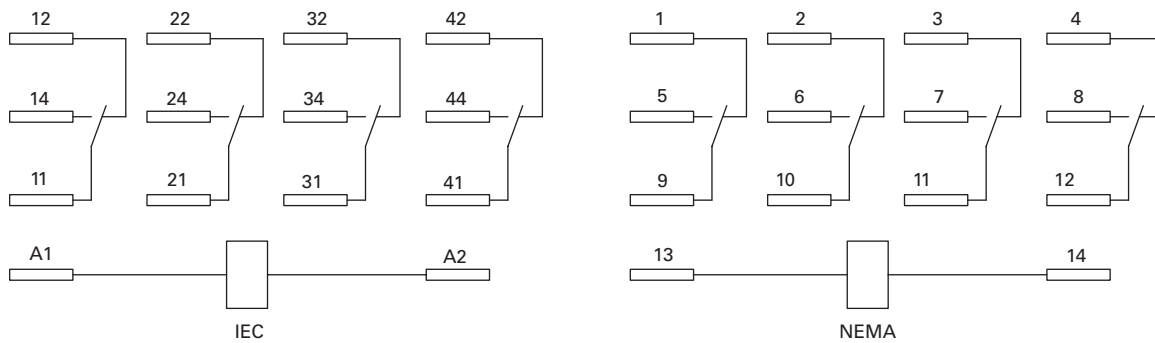

3.4

Control Relays and Timers

General Purpose Plug-In Relays

Dimensions

Approximate Dimensions in Inches (mm)

D7PR1/D7PF1

3

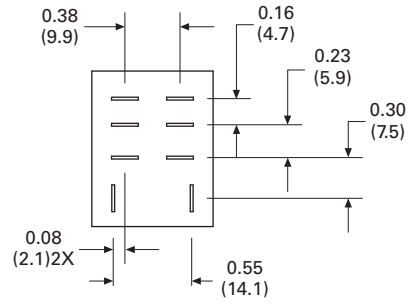
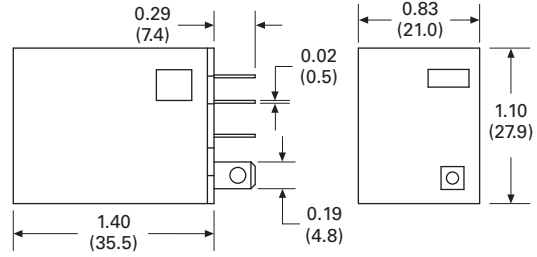
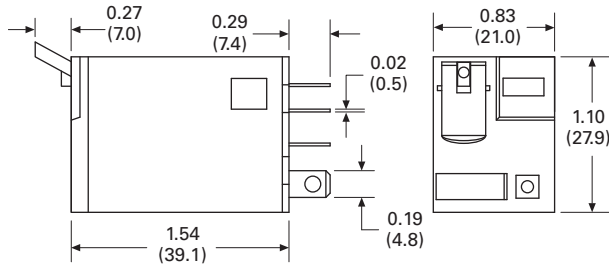

D7PR2/D7PF2

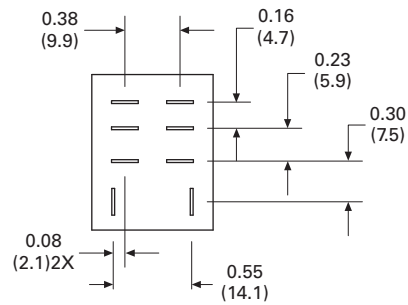
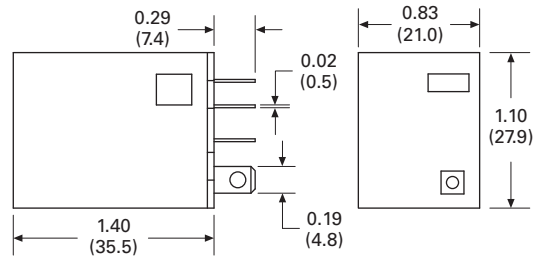
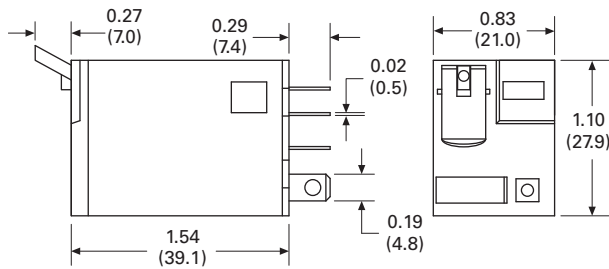

Approximate Dimensions in Inches (mm)

D7PR3/D7PF3

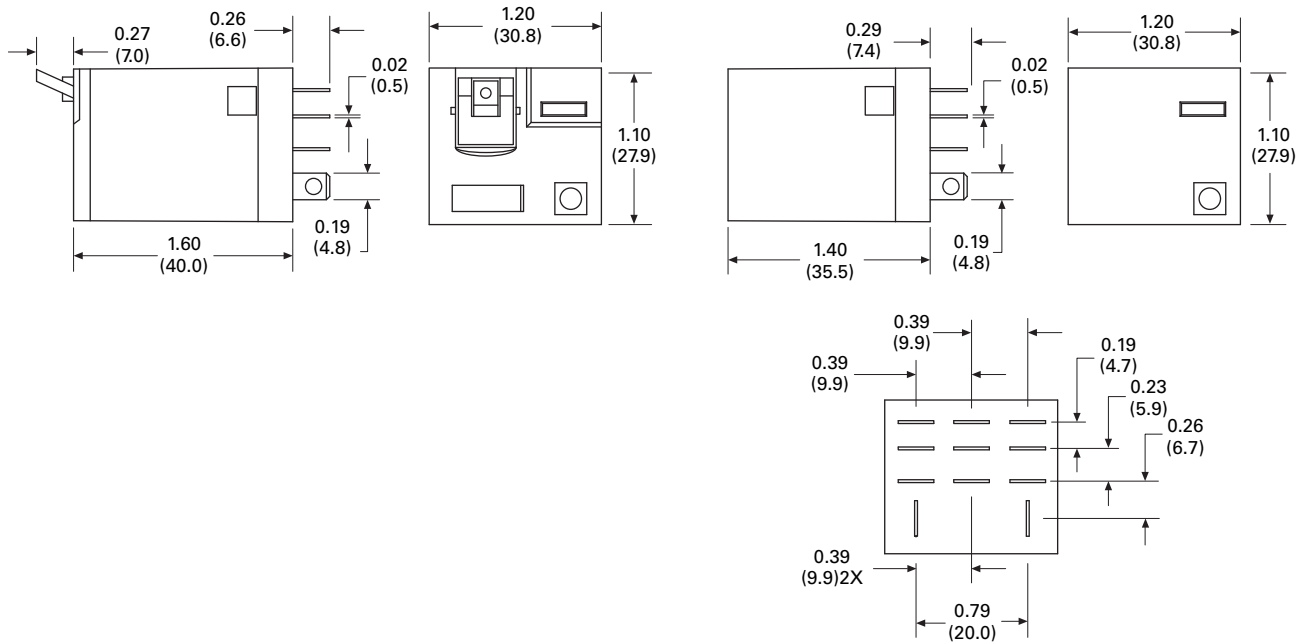

D7PR4/D7PF4

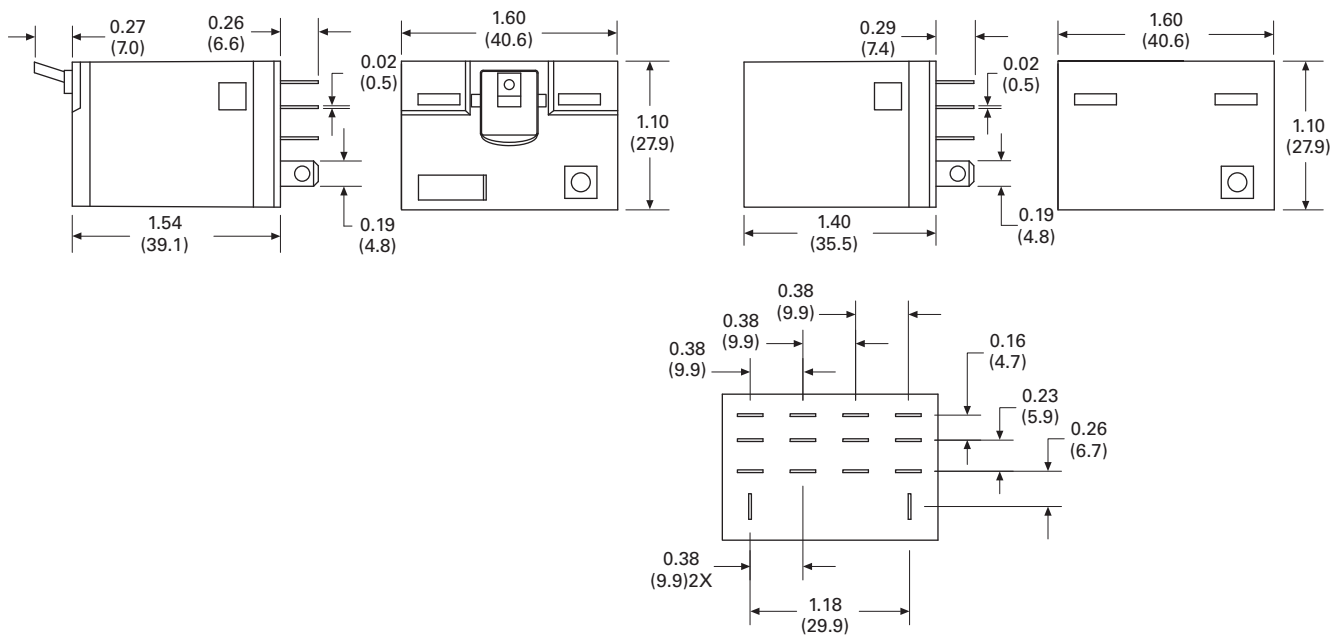

3.4

Control Relays and Timers

General Purpose Plug-In Relays

Approximate Dimensions in Inches (mm)

D7PA3

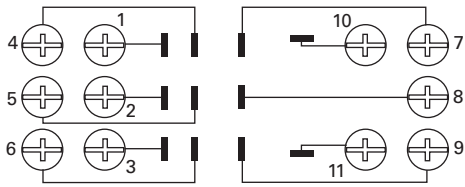

Wiring Diagram (Top View)

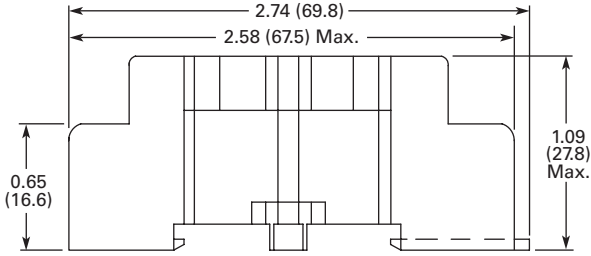

Combination Slotted/Phillips
Head Screws 6-32 x 5/16"

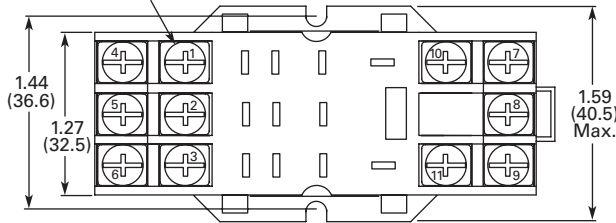

D7PA4

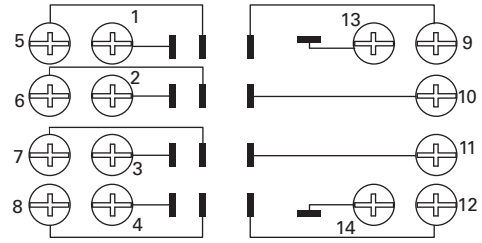

Wiring Diagram (Top View)

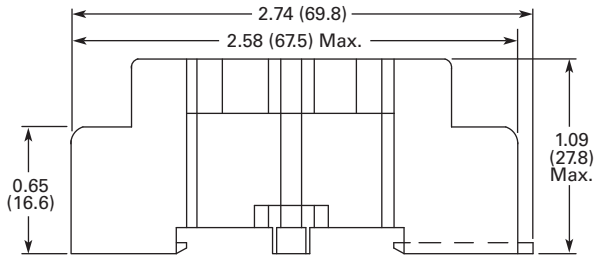

Combination Slotted/Phillips
Head Screws 6-32 x 5/16"

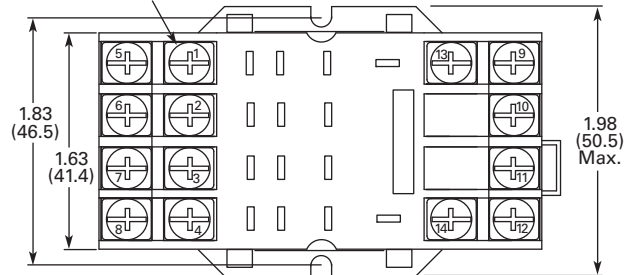

Approximate Dimensions in Inches (mm)

D7PA9 Standard Mount

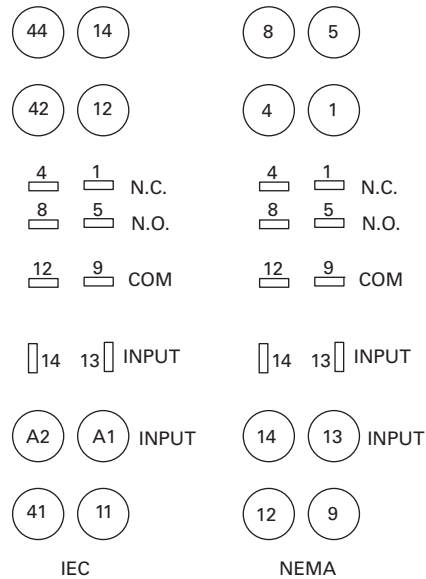
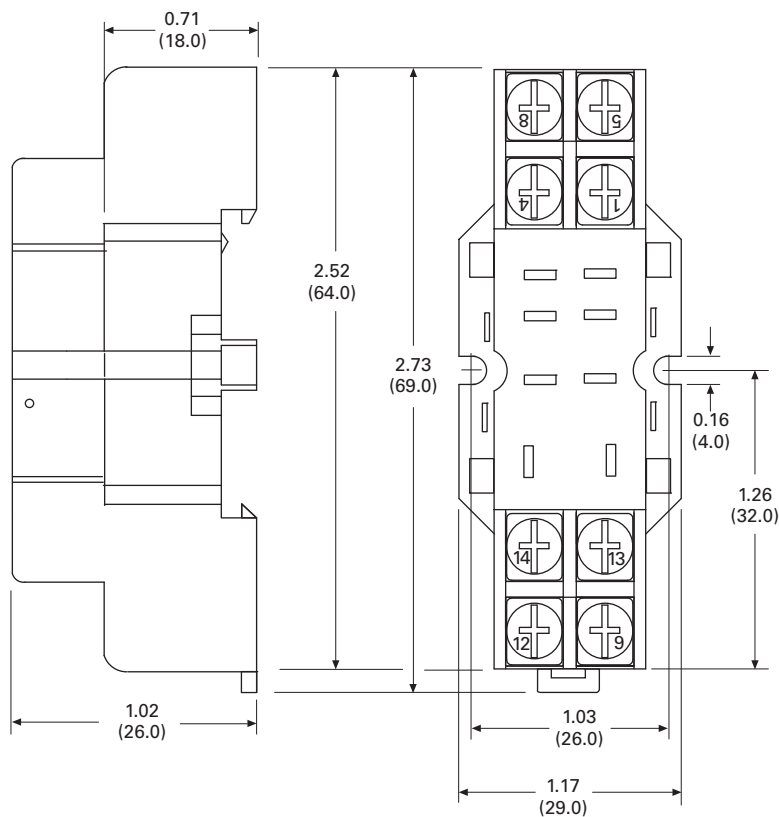

3.4

Control Relays and Timers

General Purpose Plug-In Relays

Approximate Dimensions in Inches (mm)

D7PAA

3

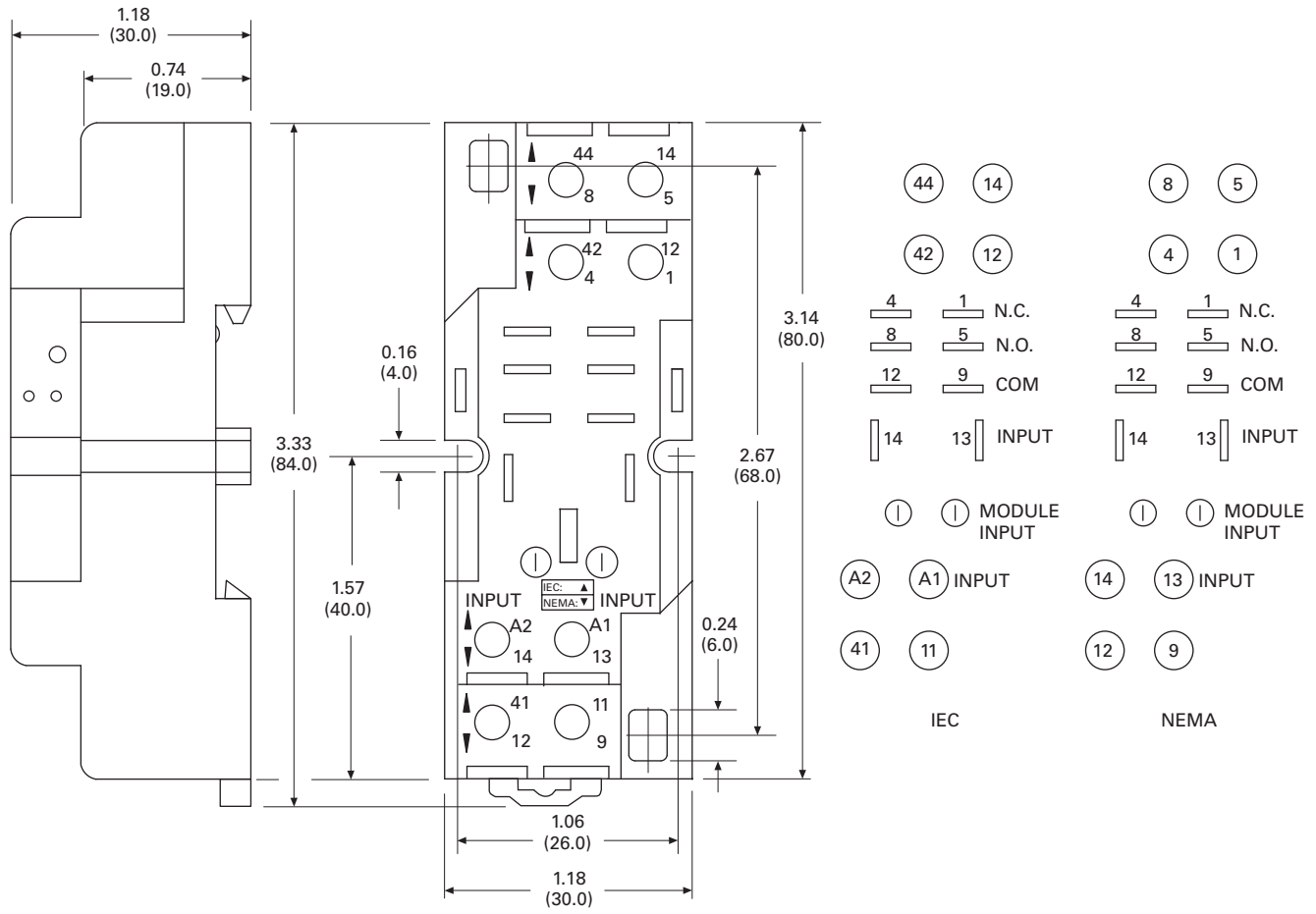

Approximate Dimensions in Inches (mm)

D7PAB

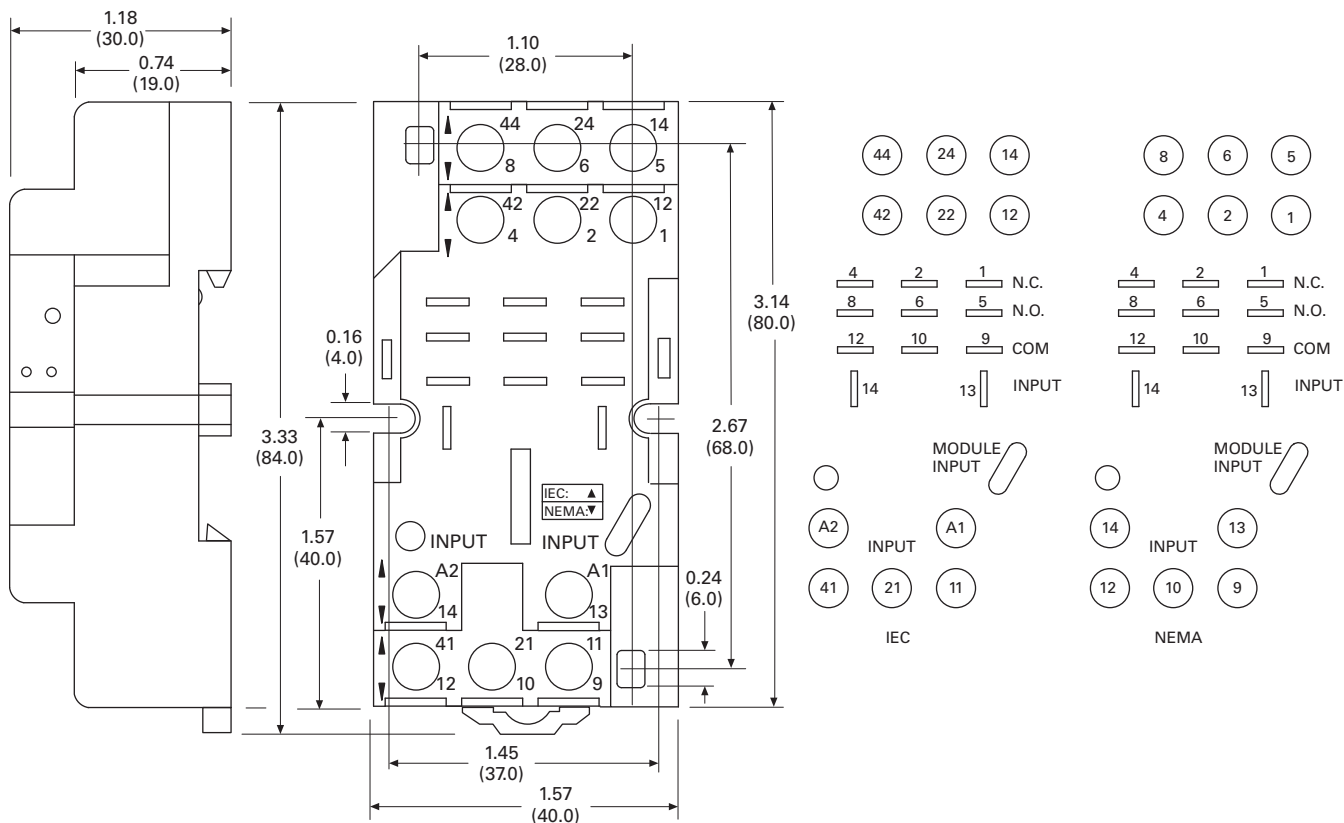

3.4

Control Relays and Timers

General Purpose Plug-In Relays

Approximate Dimensions in Inches (mm)

D7PAD

3

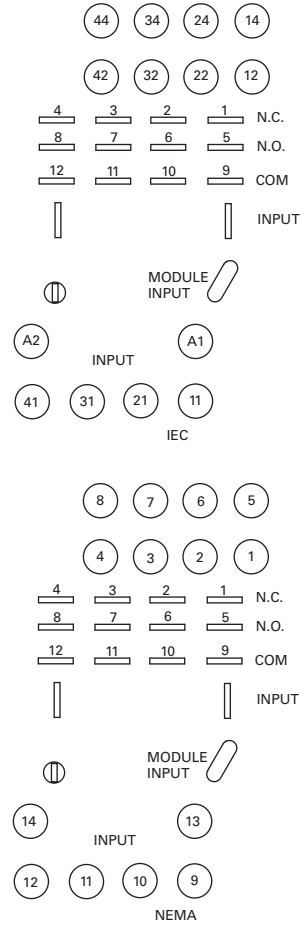
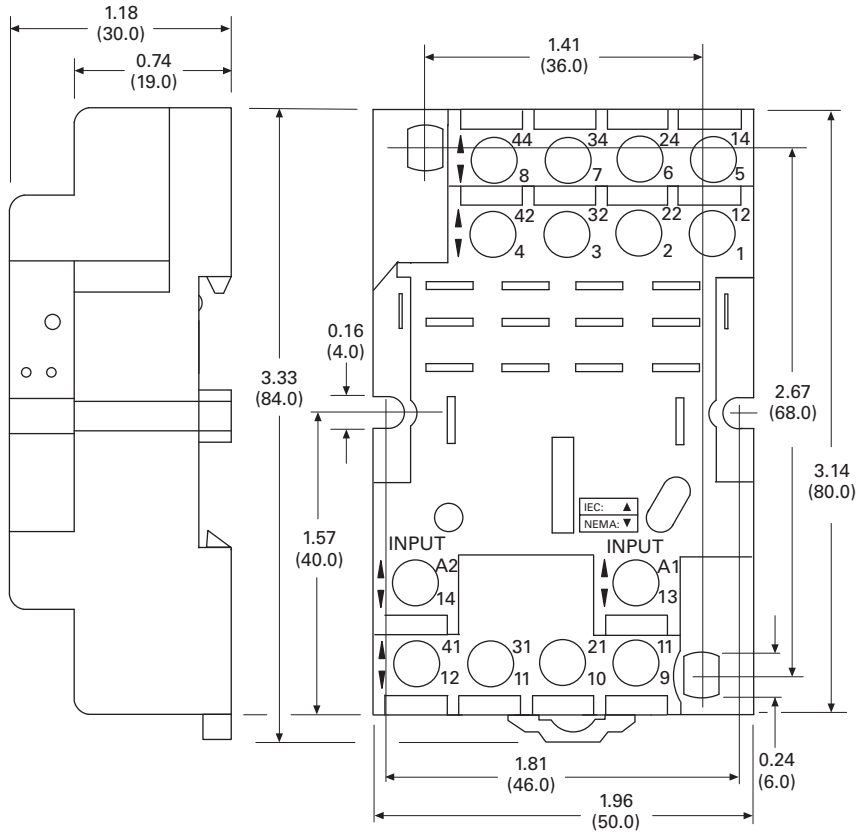

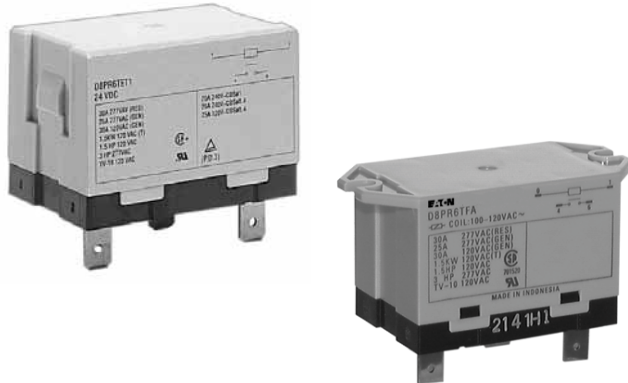
D8 Series Relay**D8 Series****Product Description**

The D8 Series power relays are perfect for loads up to 30 A, with versions for flange mounting and e-clip mounting available.

Features

- Allows switching of 25 A and 30 A loads
- A high-capacity, high-withstand voltage relay compatible with momentary voltage drops
- No contact chattering for momentary voltage drops up to 50% of rated voltage
- UL Class B construction standard
- Wide-range AC-activated coil that handles 100 to 120 Vac at either 50 or 60 Hz
- Panel, DIN rail and flange mounting

Contents**Description**

	Page
D1RR/D1RF Series	V7-T3-53
D2RR/D2RF Series	V7-T3-57
D3RR/D3RF Series	V7-T3-67
D4 Series	V7-T3-76
D5RR/D5RF Series	V7-T3-80
D7PR/D7PF Series	V7-T3-89
D8 Series	
Catalog Number Selection	V7-T3-104
Product Selection	V7-T3-104
Technical Data and Specifications	V7-T3-105
Dimensions	V7-T3-105
D9 Series	V7-T3-108
Accessories	V7-T3-112

Standards and Certifications

 File # E1491

 File # LR701520



3.4

Control Relays and Timers

General Purpose Plug-In Relays

3

Catalog Number Selection

D8 Series ①

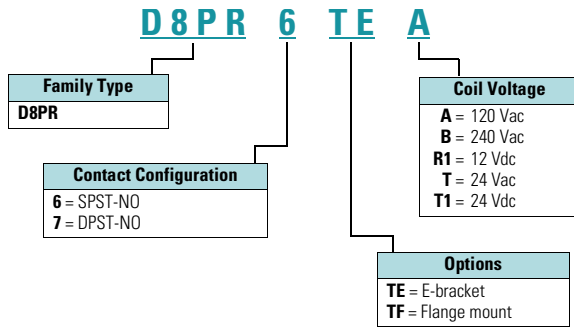

Product Selection

D8 Relay/Socket Quick Reference

Relay Type	Mounting Bracket	Adapter Track/ Panel Mount	Front Connecting Sockets Track/ Panel Mount
D8PR6TE	D8PA5	D8PA1	D8PA2
D8PR7TE	D8PA5	D8PA1	D8PA2

D8 Series Relay



D8 Series ②

Type	Standard Pack	Catalog Number
SPST E-Bracket		
Coil voltage		
24 Vac	1	D8PR6TET
24 Vdc	1	D8PR6TET1
SPST Flange Mount		
120 Vac	1	D8PR6TFA
24 Vdc	1	D8PR6TFT1
DPST E-Bracket		
Coil voltage		
120 Vac	1	D8PR7TEA
DPST Flange Mount		
120 Vac	1	D8PR7TFA
24 Vdc	1	D8PR7TFT1
Sockets		
DIN rail adapter	10	D8PA1
Screw terminal adapter	10	D8PA2
Bracket adapter	10	D8PA5
Accessory		
DIN rail end stop	100	PFP-M

Notes

- ① For deciphering catalog numbers. Do not use for ordering as not all combinations are readily available.
- ② Additional coil voltages available—consult Sales Office or Customer Support Center.

Technical Data and Specifications

Coil Resistance

Coil Voltage	Ohms	mA
24 Vac	303	71
110/120 Vac	5260	20.4
220/240 Vac	21,000	10.2
12 Vdc	75	158
24 Vdc	303	79

D8 Relays

Description	D8PR6	D8PR7
Rated load	220 Vac 30 A	220 Vac 25 A
Carry current	30 A	25 A
Max. operating voltage	250 Vac	250 Vac
Max. switching current	30 A	25 A
Contact material	AgCdO	AgCdO
Max. switching capacity	6600 VA	5500 VA
Min. permissible load	100 mA at 5 Vdc	100 mA at 5 Vdc
Mechanical life (min.)	5,000,000 operations	5,000,000 operations
Electrical life at all contact ratings (min.)	100,000 operations	100,000 operations
Maximum hp ratings	1-1/2 hp (120 Vac) 3 hp (240/265/277 Vac)	1-1/2 hp (120 Vac) 3 hp (240/265/277 Vac)

Coil Data

Coil Voltage	Must Operate	Must Release	Maximum Voltage
24 Vdc/Vac, 12 Vdc	75% maximum	15% minimum	110%
120 Vac	75 V	18 V	132 V
240 Vac	150 V	36 V	264 V

Dimensions

Approximate Dimensions in Inches (mm)

D8PR6TF

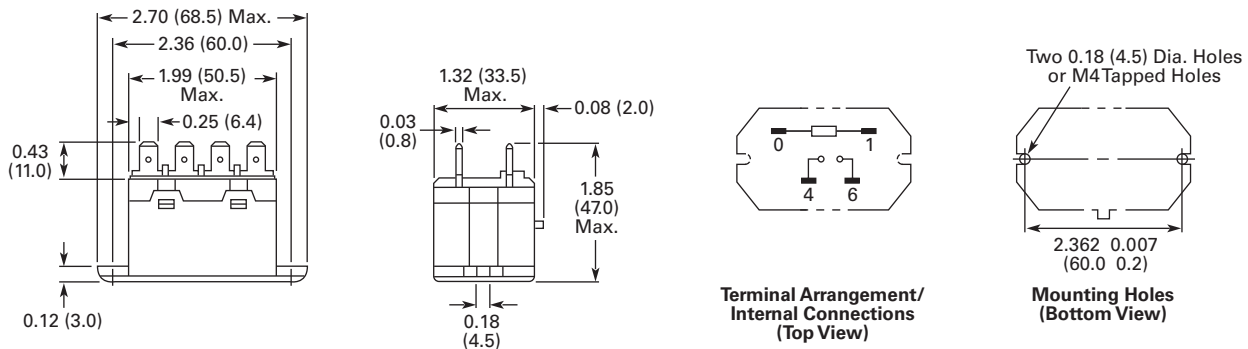

3.4

Control Relays and Timers

General Purpose Plug-In Relays

Approximate Dimensions in Inches (mm)

D8PR7TF

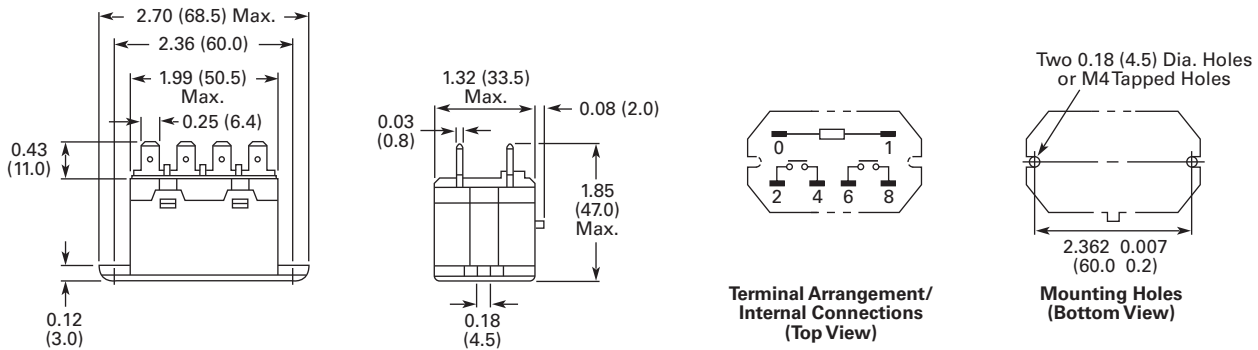

D8PR6TE with D8PA5 Bracket Attached

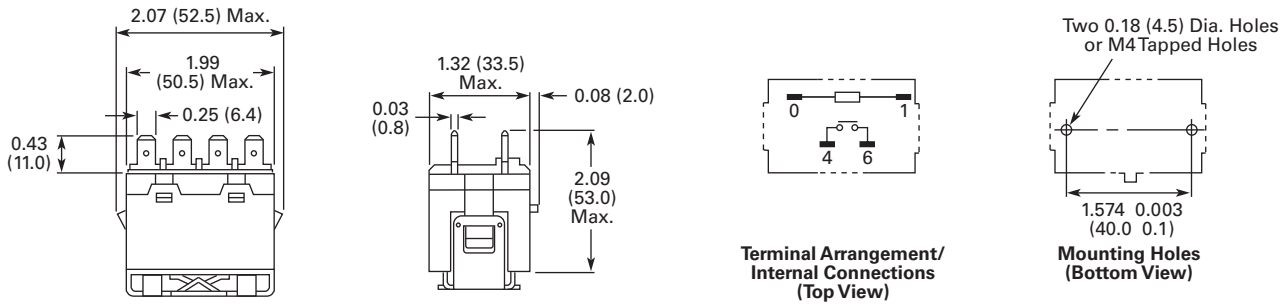

D8PR7TE with D8PA5 Bracket Attached

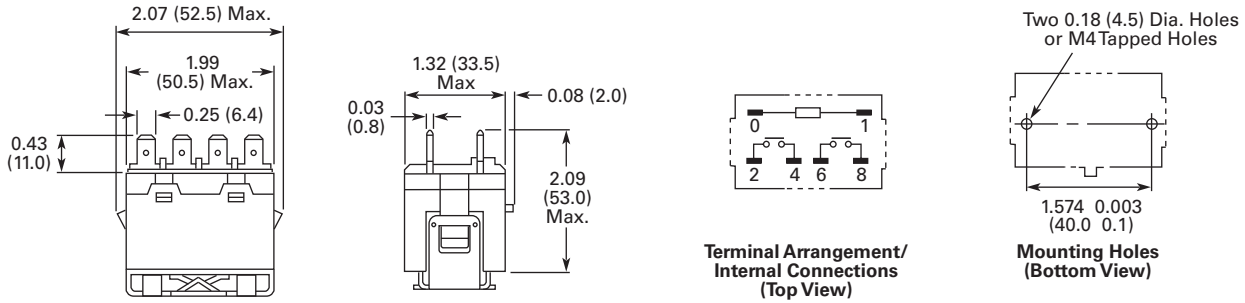

D8PA1

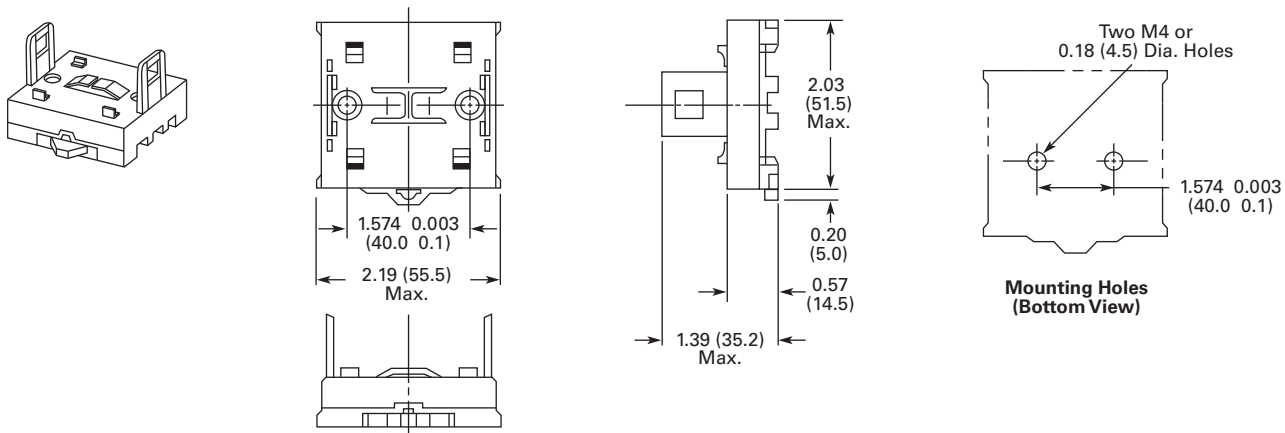

Note: Minimum spacing around relay = 0.20 inches (5 mm).

Approximate Dimensions in Inches (mm)

D8PA2

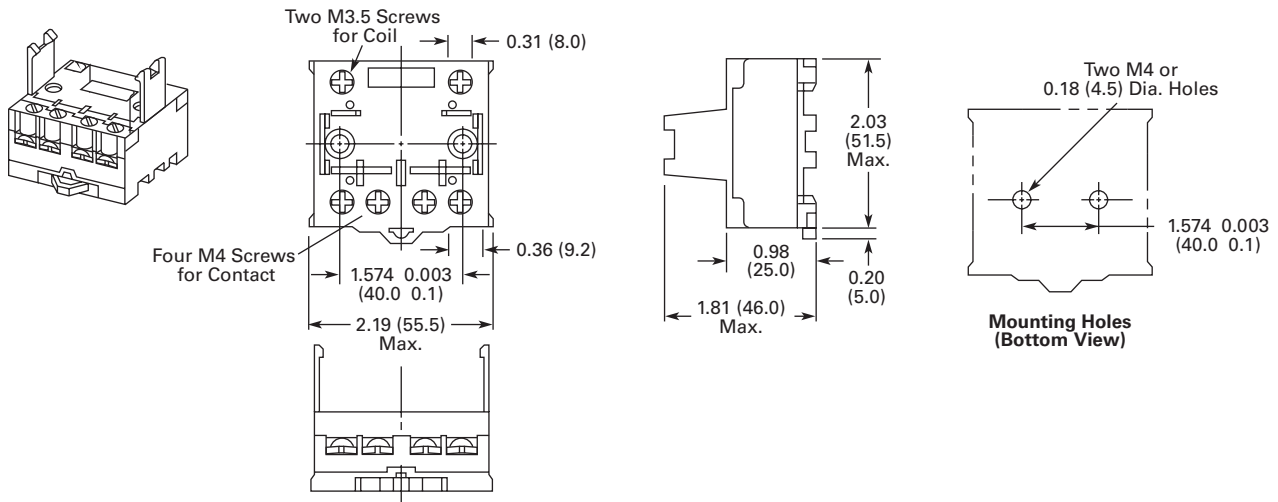

D8PA5

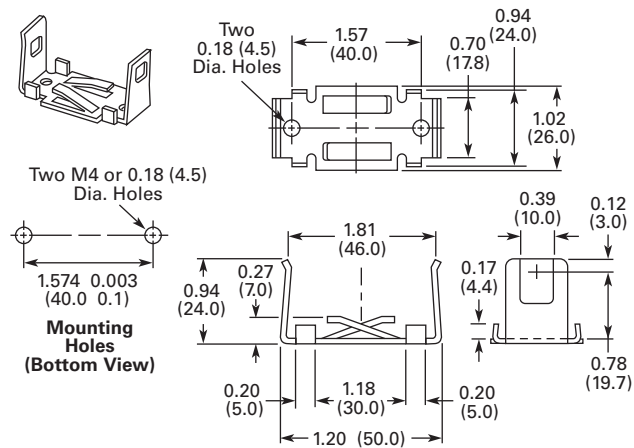

PFP-M DIN Rail End Stop

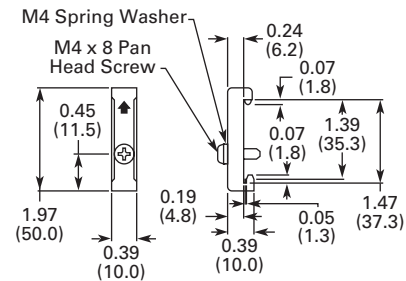

D9 Series Relay

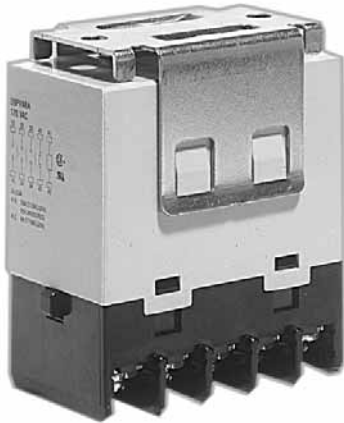

Contents

Description	Page
D1RR/D1RF Series.....	V7-T3-53
D2RR/D2RF Series.....	V7-T3-57
D3RR/D3RF Series.....	V7-T3-67
D4 Series.....	V7-T3-76
D5RR/D5RF Series.....	V7-T3-80
D7PR/D7PF Series.....	V7-T3-89
D8 Series.....	V7-T3-103
D9 Series	
Product Selection.....	V7-T3-109
Technical Data and Specifications.....	V7-T3-109
Dimensions.....	V7-T3-110
Accessories.....	V7-T3-112

D9 Series

Product Description

The four-pole D9 Series is ideal for three-phase motor applications. Various contact configurations are available.

Features

- Ideal for three-phase motor control applications
- No contact chattering for momentary voltage drops up to 50% of rated voltage
- Push-to-Test button is a standard feature to check contact operation
- Mounting bracket is supplied with relay

Catalog Number Selection

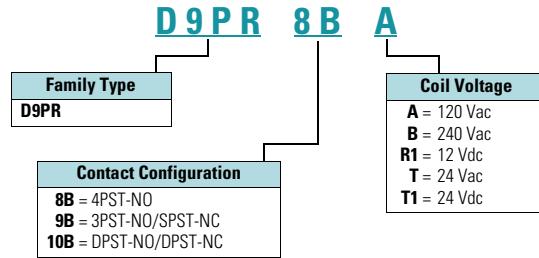

Standards and Certifications



File # E1491



File # LR701520

Product Selection

D9 Series

	Catalog Number		Catalog Number
4PST-NO Power Relay		DPST-NO/DPST-NC Power Relay	
Coil voltage		Coil voltage	
24 Vac	D9PR8BT	24 Vac	D9PR10BT
120 Vac	D9PR8BA	120 Vac	D9PR10BA
240 Vac	D9PR8BB	24 Vac	D9PR10BT1
24 Vdc	D9PR8BT1		
3PST-NO/SPST-NC Power Relay			
120 Vac	D9PR9BA		

Technical Data and Specifications

Coil Resistance

Coil Voltage	Ohms	mA	Coil Voltage	Ohms	mA
24 Vac	—	75	12 Vdc	72	167
120 Vac	—	21.6	24 Vdc	288	83
240 Vac	—	10.8	110 Vdc	6050	18

D9PR Specifications

Description	NO Contacts Resistive Load (p.f. = 1)	NC Contacts Resistive Load (p.f. = 1)
Rated load	220 Vac 25 A 30 Vdc 25 A	220 Vac 8 A 30 Vdc 8 A
Carry current	25 A	8 A
Max. operating voltage	250 Vac/125 Vdc	250 Vac/125 Vdc
Max. switching current	25 A	8 A
Max. switching capacity	5500 VA 750 W	1760 VA 240 W
Min. permissible load	100 mA at 24 Vdc	100 mA at 24 Vdc
Mechanical life (min.)	1,000,000 operations	1,000,000 operations
Electrical life at all contact ratings (min.)	100,000 operations	100,000 operations
Maximum hp ratings	1-1/2 hp (120 Vac) 3 hp (240/265/277 Vac) Three-phase 3 hp (240/265/277 Vac) 30,000 cycles Three-phase 5 hp (240/265/277 Vac) 30,000 cycles	1-1/2 hp (120 Vac) 3 hp (240/265/277 Vac) Three-phase 3 hp (240/265/277 Vac) 30,000 cycles Three-phase 5 hp (240/265/277 Vac) 30,000 cycles

3.4

Control Relays and Timers

General Purpose Plug-In Relays

3

Coil Data

Coil Voltage	Must Operate	Must Release	Maximum Voltage
24 Vdc/Vac, 12 Vdc, 110 Vdc	75% maximum	10% minimum	110%
120 Vac	75 V	18 V	132 V
240 Vac	150 V	36 V	264 V

Terminal Arrangements

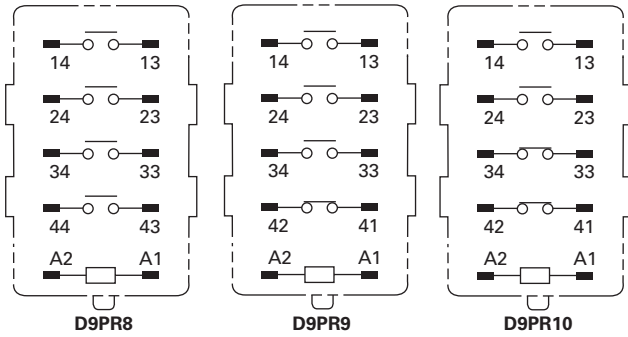

Dimensions

Approximate Dimensions in Inches (mm)

D9PR

Screw Terminal Brackets

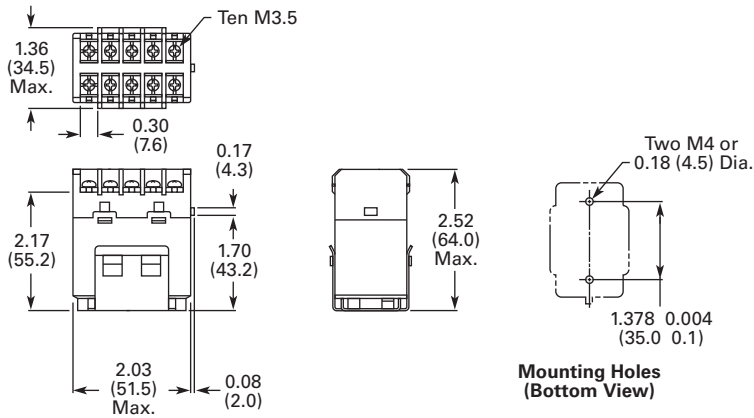

Mounting Holes
(Bottom View)

Approximate Dimensions in Inches (mm)

Mounting Bracket

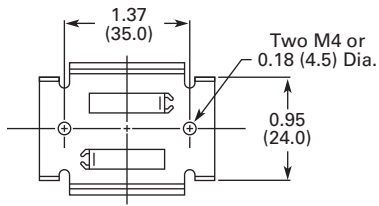

Mounting Holes

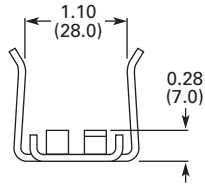
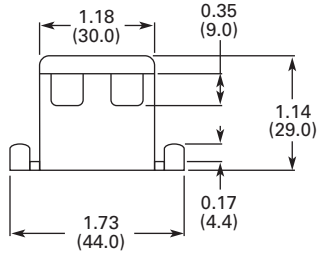
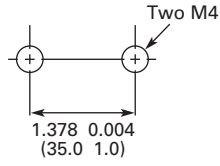

3.4

Control Relays and Timers

General Purpose Plug-In Relays

Accessories



3

Contents

Description	Page
D1RR/D1RF Series	V7-T3-53
D2RR/D2RF Series	V7-T3-57
D3RR/D3RF Series	V7-T3-67
D4 Series	V7-T3-76
D5RR/D5RF Series	V7-T3-80
D7PR/D7PF Series	V7-T3-89
D8 Series	V7-T3-103
D9 Series	V7-T3-108
Accessories	
MOD Modules	V7-T3-113
Relay Clips	V7-T3-114
Coil Bus Jumpers	V7-T3-116
Write-On Plastic Labels/ID Tags	V7-T3-116
Flange Mount Adapters	V7-T3-117

Accessories

Accessories Selection Guide

Eaton offers a variety of simple-to-install relay accessories that allow you to customize the features of a relay system to meet your exact needs.

The MOD Module System

Eaton's plug-in modules are a simple way to add functionality to your relay without the hassle of messy wiring and additional mounting of external electronics. They are available in a variety of configurations to meet the needs of almost any application.

Circuit Diagrams

Diode Circuit

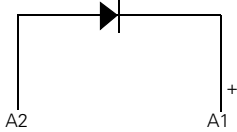

The diode module protects external drive circuitry from inductive voltages generated when removing coil voltages.

LED Circuit

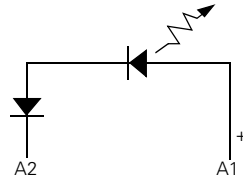

The LED status lamp verifies that power is being supplied to the coil. Ideal for both AC and DC applications. Polarity sensitive for DC applications.

RC Circuit

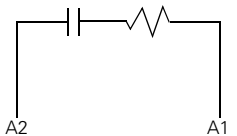

Snubs back EMF of relay coil.

Metal Oxide Varistor (MOV) Circuit

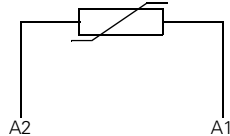

The MOV circuit protects by shunting potentially damaging electrical spikes away from the relay coil. Ideal for AC and DC applications.

System Diagrams



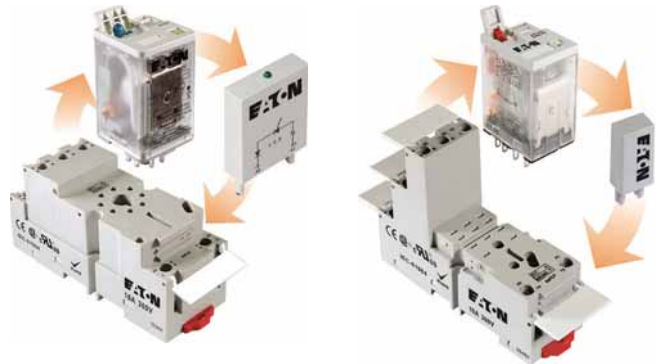



The MOD Module System



MOD Modules

Eaton's relay accessories provide a complete solution for add-on modules and identification tags.

MOD Modules

	Module Size	Description	Nominal Voltage	Catalog Number	Mating Sockets	
	MOD-AD250	A	Protection diode	6–250 Vdc	MOD-AD250	D3PA6, D3PAL8, D3PA7, D3PAL11, D5PAL, D7PAB, D7PAD
	MOD-RC_		R/C suppressor	6–24 Vac 110–240 Vac	MOD-RC24 MOD-RC240	
	MOD-ALG_		LED indicator	24 Vac 120/240 Vac	MOD-ALG24 MOD-ALG240	
	MOD-AMV_		MOV suppressor	24 Vac 120 Vac 240 Vac	MOD-AMV24 MOD-AMV120 MOD-AMV240	
	MOD-BD250	B	Protection diode	6–250 Vdc	MOD-BD250	D1RAA, D2PAL, D2PAP, D2PA7, D7PAA
	MOD-BLG_		LED indicator	24 Vac 120/240 Vac	MOD-BLG24 MOD-BLG240	
	MOD-BMV_		MOV suppressor	24 Vac 120 Vac 240 Vac	MOD-BMV24 MOD-BMV120 MOD-BMV240	

3.4

Control Relays and Timers

General Purpose Plug-In Relays

3







Relay Clips

Eaton offers a variety of relay clips designed to improve the performance and functionality within an electrical panel.

Metal Hold-Down Clips

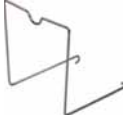
Metal hold-down clips, or spring clips, are ideal for use where high heat or humid conditions are a factor. These clips hold their shape and tension and are designed to withstand harsh environments. All clips are made of corrosion-resistant stainless steel.

Metal Hold-Down Clips

	Catalog Number	Mating Sockets	Mating Relays
	PMC-1781	D1RAA	D1RR, D1RF
	PQC-1782	D2PAL, D2PAP, D2PA7	D2RR2, D2RF2, D2RR3, D2RF4
	PQC-1342	D2PA6, D7PAA, D7PA9	D2RR4, D2RF4
	PQC-1332	D3PA6, D3PA7	D3RR2, D3RF2, D3RR3, D3RF3
	PQC-1351	D3PAL8, D3PA2, D3PAL11, D3PA3, D5PAL, D5PA2, D5PA3L, D5PA3S	D3RR2, D3RF2, D3RR3, D3RF4, D5RR, D5RF
	PQC-1783	D7PAB	D7PR1, D7PF1, D7PR2, D7PF3
	PQC-1784	D7PAD	D7PR4, D7PF4
	PYC-B2	D7PA3, D7PA4	D7PR1, D7PR2, D7PR4

Plastic Ejector/ Hold-Down Clips

These clips are great for applications where sockets are located in dense or tight areas. They allow for quick, safe and firm securing of relays in the sockets with the added benefit that the relay can be ejected with one finger. Plastic clips also aid in keeping operators' fingers away from live circuits. The optional snap-in identification tag allows for custom marking of sockets when used in multi-socket applications.

PWC-D24



Plastic Ejector/Hold-Down Clips

Catalog Number	Mating Sockets	Mating Relays
PWC-D24	D2PAL, D2PAP, D2PA7	D2RF2, D2RF4

Plastic ID Clips

Plastic ID clips allow for easy circuit identification in multi-relay applications. They are designed for labeling and are not ideal for securing the relay in the socket.

PQC-1349



Plastic ID Clips

Catalog Number	Mating Sockets	Mating Relays
PQC-1349	D7PAA	D7PF1, D7PF2

PMC-1783



PMC-1783	D7PAB	D7PF1, D7PF2
----------	-------	--------------

PMC-1784



PMC-1784	D7PAD	D7PF4
----------	-------	-------

3.4

Control Relays and Timers

General Purpose Plug-In Relays

3

Coil Bus Jumpers

Eaton's coil bus jumpers allow inputs to be bridged to adjacent sockets without additional wiring, making multi-relay connections quick and easy. The easy-to-install design requires no tools and can be complete in a matter of seconds.



System Diagrams

Coil Bus Jumpers ①



Write-On Plastic Labels/ID Tags

These convenient plastic labels snap easily onto the relay socket for clear identification in multi-relay panels. The hinged design makes wiring simple and allows for angular adjustment of the tag to improve readability in the panel. Marking with a standard permanent marker creates a smudge-free surface.

Coil Bus Jumpers

Catalog Number	Mating Sockets
D2PJ1	D2PAL, D2PAP
D3PJ1	D3PA6, D3PA7, D5PAL

Write-On Plastic Labels/ID Tags

Catalog Number	Mating Sockets
PWF-D2P	D2PAL, D2PAP
PWF-D3D5	D3PAL8, D3PAL11, D5PAL

Note

① Jumpers in photo are colored green to improve visibility, actual jumpers are black.

Flange Mount Adapters

Eaton's relay flange mount adapters create a modular approach to flexible mounting options. Each low-cost adapter allows for panel mounting of a standard control relay and can eliminate the need for a socket.

Unit with Flange Mount Adapter



Flange Mount Adapters

	Catalog Number	Mating Relay
	PFC-D11	D1RF1, D1RR1
	PFC-D2D72	D2P, D7PF2, D7PR2
	PFC-D73	D7PF3, D7PR3
	PFC-D74	D7PF4, D7PR4

9575H Series 3000 Relay



9575H Series 3000—Type AA, AC and DC

Product Description

Type AA panel-mounted relays are rated (each pole) 40 A up to 300 Vac, 50/60 Hz; 5 A at 480/600 Vac, 50/60 Hz and 40 A at 28 Vdc.

Application Description

9575H Series 3000 relays are ideal for applications when controlling smaller loads, such as single-phase motors.

Contents

Description

9575H Series 3000—Type AA, AC and DC	
Product Selection	V7-T3-119
Accessories	V7-T3-119
Technical Data and Specifications	V7-T3-120
Dimensions	V7-T3-121

Page

Standards and Certifications

- UL listed, E1491
- CSA 41729
- CE: EN60947-4-1, EN60947-5-1



Product Selection

When Ordering, Specify

Catalog number and magnet coil code letter. Example: for DPDT relay with auxiliary

switch and a 120 V 50/60 Hz coil, order Catalog Number 9575H3A010.

9575H Series 3000 Relay



Type AA Relays ^①

Relay Style	Catalog Number ^②
Relay (DPDT)	9575H3_000
Relay with auxiliary switch	9575H3_010
Relay with blowout magnets	9575H3_100
Relay with auxiliary switch and blowout magnets	9575H3_110

Coil Voltage Selection

Coil Voltage	Hz	Suffix Code
Volts AC		
120	50/60	A
240	50/60	B
480/440	60/50	C
600/550	60/50	D
208	50/60	E
277	50/60	H
6	50/60	J
12	50/60	K
24	50/60	L
48	50/60	M
Volts DC		
110	—	P
220	—	Q
6	—	R
12	—	S
24	—	T
48	—	W

Accessories

Enclosure ^③

Description	Catalog Number
NEMA 1 Enclosure	9575H2449

Notes

- ① There are no "repair parts" available for these relays.
- ② Underscore indicates missing code suffix for magnet coil—see Selection table above.
- ③ Only 9575H3 relays without an auxiliary switch should be mounted in the 9575H2449 enclosure.

Technical Data and Specifications

Relay Specifications

3

Coil

- Pull-in voltage: 80% DC coils, 85% AC coils of nominal voltage or less at 25°C
- Dropout voltage: 10% of nominal voltage or more at 25°C
- Coil resistance: $\pm 10\%$ measured at 25°C
- Max. DC coil dissipation capability: 4 watts DC continuous at 25°C

Contacts

- Contact combination: DPDT
- Contact rating each pole (main contacts): Each pole rated 40 amps up to 300 Vac, 50/60 Hz, 5 amps at 480/600 Vac 50/60 Hz, 0.75 PF load. 1-1/2 hp motor load (each pole) at 120–600 Vac, 50/60 Hz. 2 hp motor load at 200–600 Vac, 50/60 Hz only when using both poles to switch both sides of load, 40 amps at 28 Vdc resistive load each pole. NEMA A 600 pilot duty 50/60 Hz
- Additional contact ratings for relays with blowout magnets: 10 A at 110 Vdc resistive, 4 A at 225 Vdc resistive, 2 A at 325 Vdc resistive. For inductive loads, contacts must be derated accordingly.
- Contact material: Silver cadmium oxide, gold flashed. 5/16 in (7.9 mm) diameter standard

Dielectric Withstanding Voltage

- Between open contacts: 1500 V_{rms}
- All other mutually insulated conductive elements: 2200 V_{rms}

Miscellaneous

- Coil terminals: 6–32 screws
- Contact terminals: 8–32 screws
- Main base material: Molded phenolic, UL recognized (QMFZ2)
- Weight (DPDT Relay): 11 oz (311 grams) approximately
- Weight (DPDT Relay with auxiliary switch) 14.5 oz (411 grams) approximately

Auxiliary Switch Specifications

- Contact combination: SPDT
- Contact rating: Auxiliary switch rated 10 amps at 125 or 250 Vac, resistive load; 1/4 hp at 125 or 250 Vac, motor load; 0.4 amps at 125 Vdc or 0.20 amps at 250 Vdc, resistive load; 3 amps at 125 Vac lamp load. All AC ratings are 50/60 Hz
- Dielectric withstanding voltage: 500 Vac rms between open contacts, 1500 Vac rms between all other mutually insulated conductive elements
- Terminals: 4–40 round head screws for auxiliary contacts standard

Average Operating Times (Milliseconds)

Operation	DPDT Relay	DPDT Relay with Auxiliary Switch
Pickup	40	50
Dropout	35	35

Temperature Ranges

Temperature	AC	DC
Operating range	-30 °C to +55 °C	-30 °C to +55 °C
Non-operating range	-30 °C to +100 °C	-30 °C to +100 °C

Dimensions

Approximate Dimensions in Inches (mm)

9575H3 DPDT Relay

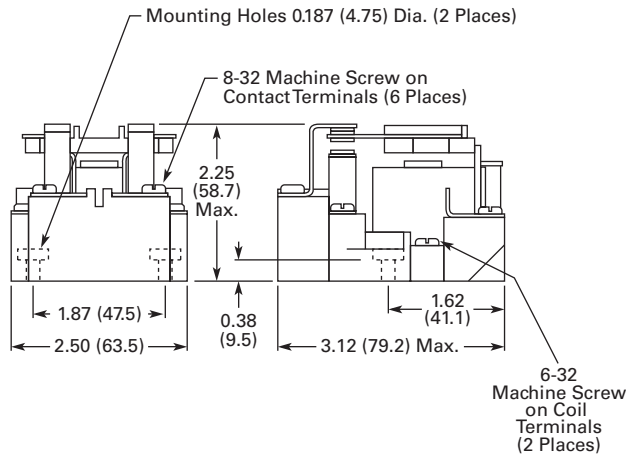

9575H2449

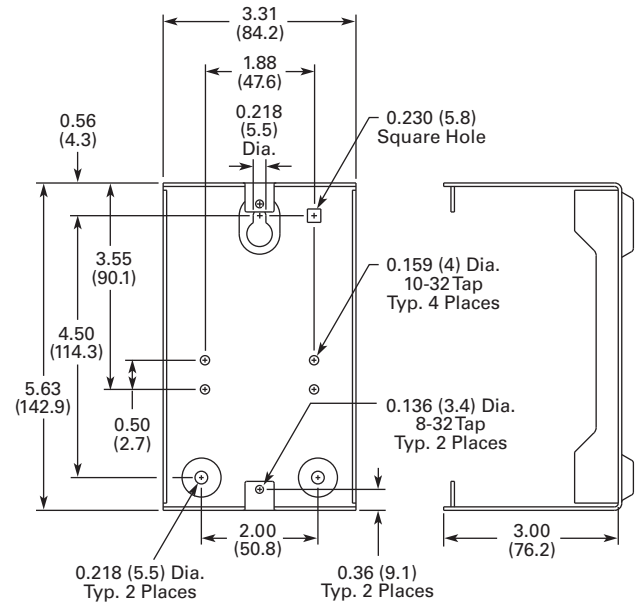

9575H3 DPDT Relay with Auxiliary SPDT Switch

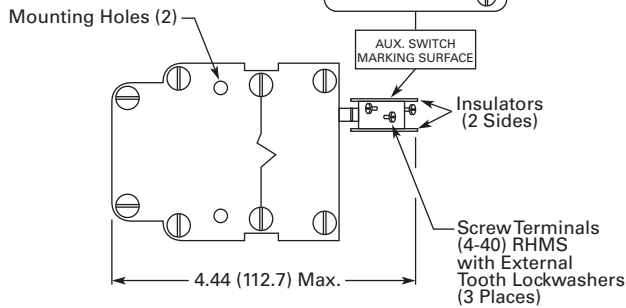
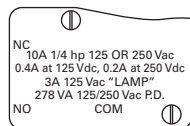
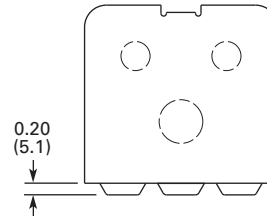
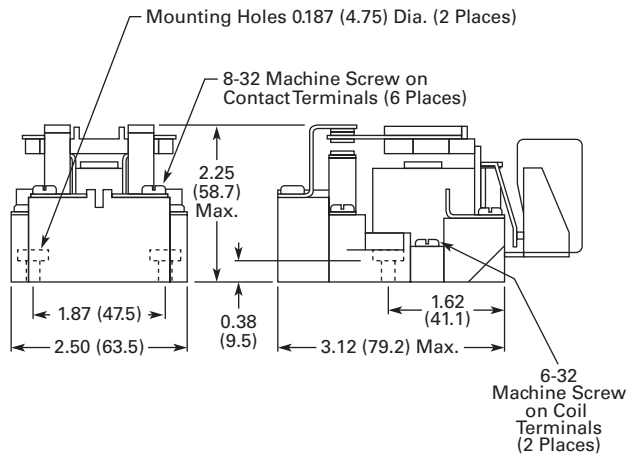

RELAY TOP VIEW

3.6

Control Relays and Timers

Solid-State Relays

3

Solid-State Relays



Contents

Description

Solid-State Relays

Description	Page
D93 Series	V7-T3-123
D96 Series	V7-T3-130
D99 Series	V7-T3-135

Product Overview

Catalog Number Selection

Solid-State Relays—D93, D96 and D99 Series

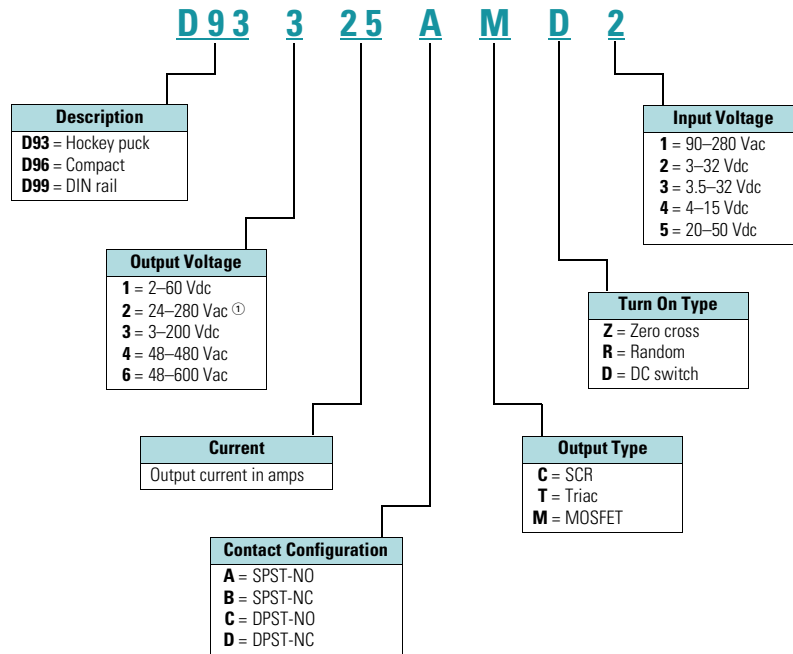

Note

① For D96208ACZ3, output voltage is 3–150 Vdc.

D93 Series—Solid-State Relays



D93 Series

Product Description

Eaton's D93 series of solid-state relays is a line of heavy-duty industrial relays in the common "hockey puck" package. The removable, finger-safe cover and optional accessories make the D93 safe and easy to install in a variety of applications.

Models are available in a variety of input voltages and switch types up to 75 A.

Application Description

A solid-state relay (SSR) can perform many applications that an electromechanical relay can perform. The SSR differs in that it has no moving mechanical parts within it and has some distinct advantages over an electromechanical relay.

When used correctly in the intended application, the SSR provides a high degree of reliability, a long service life, significantly reduced electromagnetic interference, fast response and high vibration resistance.

Applications for the SSR typically include equipment that requires high cycling rates, low acoustical or electrical noise, or high vibration resistance. Some examples are medical equipment, heating/cooling equipment, lighting control and pumps/compressors, among others.

Contents

Description

Description	Page
D93 Series	
Product Selection	V7-T3-124
Accessories	V7-T3-124
Technical Data and Specifications	V7-T3-125
Dimensions	V7-T3-129
D96 Series	V7-T3-130
D99 Series	V7-T3-135

Features and Benefits

- All solid-state circuitry with no moving parts to wear
- Compact, panel mounting for flexible installation
- Isolated input and output terminals to protect the system from electrical noise
- Internal snubber circuitry to protect the SSR from transients

Standards and Certifications

- UL/cUL recognized—UL 508
- CSA certified
- CE marked
- RoHS compliant



3.6

Control Relays and Timers

Solid-State Relays

Product Selection

3

D93210ACZ1

D93 Series



Input Voltage	Output Voltage	Contact Configuration	Switching Type	Rated Current Load (Amps)	Catalog Number
90–280 Vac	24–280 Vac	SPST-NO	Zero cross	10	D93210ACZ1
3–32 Vdc	24–280 Vac	SPST-NO	Zero cross	10	D93210ACZ2
3–32 Vdc	24–280 Vac	SPST-NO	Triac	10	D93210ATZ2
90–280 Vac	24–280 Vac	SPST-NO	Zero cross	25	D93225ACZ1
3–32 Vdc	24–280 Vac	SPST-NO	Zero cross	25	D93225ACZ2
3–32 Vdc	24–280 Vac	SPST-NO	Triac	25	D93225ATZ2
90–280 Vac	24–280 Vac	SPST-NO	Zero cross	40	D93240ACZ1
3–32 Vdc	24–280 Vac	SPST-NO	Zero cross	40	D93240ACZ2
3–32 Vdc	24–280 Vac	SPST-NO	Triac	40	D93240ATZ2
90–280 Vac	24–280 Vac	SPST-NO	Zero cross	50	D93250ACZ1
3–32 Vdc	24–280 Vac	SPST-NO	Zero cross	50	D93250ACZ2
90–280 Vac	24–280 Vac	SPST-NO	Zero cross	75	D93275ACZ1
3–32 Vdc	24–280 Vac	SPST-NO	Zero cross	75	D93275ACZ2
3–32 Vdc	3–200 Vdc	SPST-NO	MOSFET	12	D93312AMD2
3–32 Vdc	3–200 Vdc	SPST-NO	MOSFET	25	D93325AMD2
3–32 Vdc	3–200 Vdc	SPST-NO	MOSFET	40	D93340AMD2

Accessories

D93HS1



D93 Series—Heat Sink

Eaton's D93HS1 heat sink is specifically designed to be used with D93 solid-state relays. It is pre-drilled and tapped, and matches the heat dissipation requirements for relays up to 50 A.

Heat Sink Accessory

Description	Catalog Number
Heat sink	D93HS1

Note: Always ensure that all details of the application are considered when determining heat dissipation requirements, including ambient temperature. The D93 relays must be firmly mounted to the heat sink using a suitable thermally conductive grease or thermal transfer pad.

D93TP1



D93 Series—Thermal Transfer Pad

The D93TP1 is a self-adhesive transfer pad designed for use with Eaton's D93 solid-state relays. When used properly, it will adequately conduct the heat to a heat sink without the use of grease.

Technical Data and Specifications

D93 Series

Description	Units	D93210ACZ1	D93210ACZ2	D93210ATZ2	D93225ACZ1	D93225ACZ2	D93225ATZ2
Output Characteristics							
Contact configuration		SPST-NO	SPST-NO	SPST-NO	SPST-NO	SPST-NO	SPST-NO
Switching device		SCR	SCR	Triac	SCR	SCR	Triac
Current rating	A	10	10	10	25	25	25
Switching type		Zero cross	Zero cross	Zero cross	Zero cross	Zero cross	Zero cross
Maximum rate of rise off state voltage (DV/DT)	V/us	200	250	700	500	500	250
Incandescent lamp ampere rating (rms)	A	8	16	16	16	16	16
Motor load rating (rms)	A	4.5	8	8	8	8	8
Min. load current to maintain on	mA	50	120	250	120	120	120
Non-repetitive surge current (1 cycle)	A	83	250	1000	250	250	250
Max. rms overload current (1 second)	A	24	80	50	40	40	80
Max. off state leakage current (rms)	mA	8	10	10	8	10	10
Peak blocking voltage	Vpk	600	300	—	600	600	—
Typical on state voltage drop (rms)	Vac	1.6	1.6	1.35	1.6	1.6	1.6
Max. on state voltage drop (rms)	Vac	1.6	1.6	1.6	1.6	1.6	1.6
Max. I ² t for fusing (A ²)		72	300	1700	312	250	300
Input Characteristics							
Must release voltage	V	10 AC	1 DC	10 AC	10 AC	1 DC	1 DC
Typical input impedance	ohms	13k	Current regulator	16–25k	13k	Current regulator	1.5k
Nominal input current at 5 Vdc or 240 Vac	mA	20	2	12	20	16	2
Reverse polarity protection		NA	Yes	NA	NA	Yes	Yes
Performance Characteristics							
Operating time (response time)							
ON	ms	8.3	8.3	8.3	8.3	8.3	8.3
OFF	ms	8.3	8.3	8.3	8.3	8.3	8.3
Rated insulation voltage—input to input	Vac	4000	4000	4000	4000	4000	4000
Dielectric strength—terminal to chassis	Vac	4000	4000	4000	4000	4000	4000
Environment							
Product certifications		UR, CSA, CE	UR, CSA, CE	UR, CSA, CE	UR, CSA, CE	UR, CSA, CE	UR, CSA, CE
Ambient air temperature							
Storage	°C	–40 to 100	–40 to 100	–40 to 100	–40 to 100	–40 to 100	–40 to 100
Operating	°C	–40 to 80	–40 to 80	–40 to 80	–40 to 80	–40 to 80	–40 to 80
Degree of protection		IP20	IP20	IP20	IP20	IP20	IP20
Miscellaneous Characteristics							
Thermal resistance (junction to case)	°C/W	3.5	3.5	1.45	1.02	1.02	1.45
Weight	g (oz)	100 (3.5)	100 (3.5)	100 (3.5)	100 (3.5)	100 (3.5)	100 (3.5)
LED—input		Green	Green	Green	Green	Green	Green
Input terminals		M3.5	M3.5	M3.5	M3.5	M3.5	M3.5
Output terminals		M4	M4	M4	M4	M4	M4
Terminal torque (max.)	Nm	1.0	1.0	1.0	1.0	1.0	1.0

3.6

Control Relays and Timers

Solid-State Relays

3

D93 Series, continued

Description	Units	D93240ACZ1	D93240ACZ2	D93240ATZ2	D93250ACZ1	D93250ACZ2
Output Characteristics						
Contact configuration		SPST-NO	SPST-NO	SPST-NO	SPST-NO	SPST-NO
Switching device		SCR	SCR	Triac	SCR	SCR
Current rating	A	40	40	40	50	50
Switching type		Zero cross	Zero cross	Zero cross	Zero cross	Zero cross
Maximum rate of rise off state voltage (DV/DT)	V/us	500	500	250	500	500
Incandescent lamp ampere rating (rms)	A	30	30	20	39	39
Motor load rating (rms)	A	14	14	14	14	14
Min. load current to maintain on	mA	250	250	50	250	250
Non-repetitive surge current (1 cycle)	A	625	625	250	520	520
Max. rms overload current (1 second)	A	80	80	80	100	100
Max. off state leakage current (rms)	mA	10	10	10	10	8
Peak blocking voltage	Vpk	600	600	600	600	600
Typical on state voltage drop (rms)	Vac	1.6	1.6	1.6	1.1	1.8
Max. on state voltage drop (rms)	Vac	1.6	1.6	1.6	1.8	1.8
Max. I ² t for fusing (A ²)		1250	1250	438	1250	1250
Input Characteristics						
Must release voltage	V	10 AC	1 DC	1 DC	10 AC	1 DC
Typical input impedance	ohms	13k	ACL	1.5k	13k	Current regulator
Nominal input current at 5 Vdc or 240 Vac	mA	20	16	2	20	16
Reverse polarity protection		N/A	Yes	Yes	NA	Yes
Performance Characteristics						
Operating time (response time)						
ON	ms	8.3	8.3	8.3	8.3	8.3
OFF	ms	8.3	8.3	8.3	8.3	8.3
Rated insulation voltage—input to input	Vac	4000	4000	4000	4000	4000
Dielectric strength—terminal to chassis	Vac	4000	4000	4000	4000	4000
Environment						
Product certifications		UR, CSA, CE	UR, CSA, CE	UR, CSA, CE	UR, CSA, CE	UR, CSA, CE
Ambient air temperature						
Storage	°C	−40 to 100	−40 to 100	−40 to 100	−40 to 100	−40 to 100
Operating	°C	−40 to 80	−40 to 80	−40 to 80	−40 to 80	−40 to 80
Degree of protection		IP20	IP20	IP20	IP20	IP20
Miscellaneous Characteristics						
Thermal resistance (junction to case)	°C/W	0.9	0.9	0.95	0.63	0.63
Weight	g (oz)	100	100	100	135 (4.8)	135 (4.8)
LED—input		Green	Green	Green	Green	Green
Input terminals		M3.5	M3.5	M3.5	M3.5	M3.5
Output terminals		M6	M6	M6	M6	M6
Terminal torque (max.)	Nm	1.0	1.0	1.0	1.0	1.0

D93 Series, continued

Description	Units	D93275ACZ1	D93275ACZ2	D93312AMD2	D93325AMD2	D93340AMD2
Output Characteristics						
Contact configuration		SPST-NO	SPST-NO	SPST-NO	SPST-NO	SPST-NO
Switching device		SCR	SCR	MOSFET	MOSFET	MOSFET
Current rating	A	75	75	12	25	40
Switching type		Zero cross	Zero cross	DC switching	DC switching	DC switching
Maximum rate of rise off state voltage (DV/DT)	V/us	500	500	NA	NA	NA
Incandescent lamp ampere rating (rms)	A	39	39	NA	NA	NA
Motor load rating (rms)	A	25	25	NA	NA	NA
Min. load current to maintain on	mA	250	250	20	20	20
Non-repetitive surge current (1 cycle)	A	1150	1150	27	50	90
Max. rms overload current (1 second)	A	150	150	NA	NA	NA
Max. off state leakage current (rms)	mA	10	10	8	8	8
Peak blocking voltage	Vpk	600	600	—	—	—
Typical on state voltage drop (rms)	Vac	1.8	1.8	1.6	1.6	1.6
Max. on state voltage drop (rms)	Vac	1.8	1.8	2.83	2.83	2.83
Max. I ² t for fusing (A ²)		5000	5000	NA	NA	NA
Input Characteristics						
Must release voltage	V	10 AC	1 DC	1 DC	1 DC	1 DC
Typical input impedance	ohms	13k	Current regulator	1k	1k	1k
Nominal input current at 5 Vdc or 240 Vac	mA	20	16	10	10	10
Reverse polarity protection		NA	Yes	No	No	No
Performance Characteristics						
Operating time (response time)						
ON	ms	8.3	8.3	300 μs	600 μs	600 μs
OFF	ms	8.3	8.3	1	2.6	2.6
Rated insulation voltage—input to input	Vac	4000	4000	4000	4000	4000
Dielectric strength—terminal to chassis	Vac	4000	4000	2500	2500	2500
Environment						
Product certifications		UR, CSA, CE	UR, CSA, CE	UR, CSA, CE	UR, CSA, CE	UR, CSA, CE
Ambient air temperature						
Storage	°C	–40 to 100	–40 to 100	–40 to 100	–40 to 100	–40 to 100
Operating	°C	–40 to 80	–40 to 80	–40 to 80	–40 to 80	–40 to 80
Degree of protection		IP20	IP20	IP20	IP20	IP20
Miscellaneous Characteristics						
Thermal resistance (junction to case)	°C/W	0.6	0.63	1.06	1.06	0.63
Weight	g (oz)	200	135 (4.8)	110 (3.9)	110 (3.9)	135 (4.8)
LED—input		Green	Green	Green	Green	Green
Input terminals		M3.5	M3.5	M3.5	M3.5	M3.5
Output terminals		M6	M6	M4	M4	M6
Terminal torque (max.)	Nm	1.0	1.0	1.0	1.0	1.0

3.6

Control Relays and Timers

Solid-State Relays

3

Temperature Derating Curves

10 Amp Styles

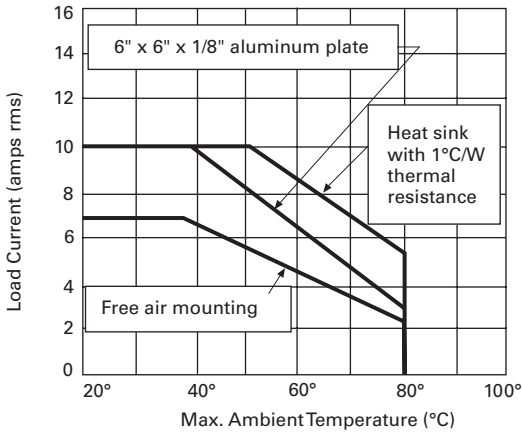

40 and 50 Amp Styles

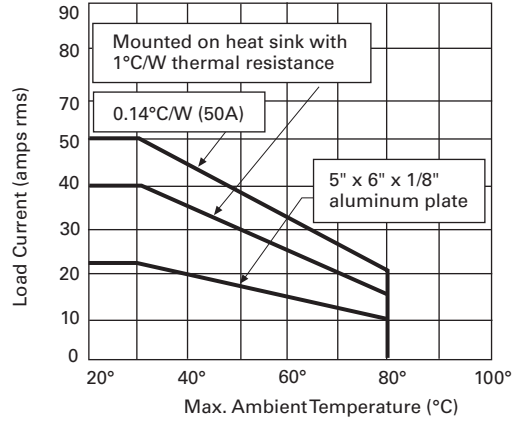

25 Amp Styles

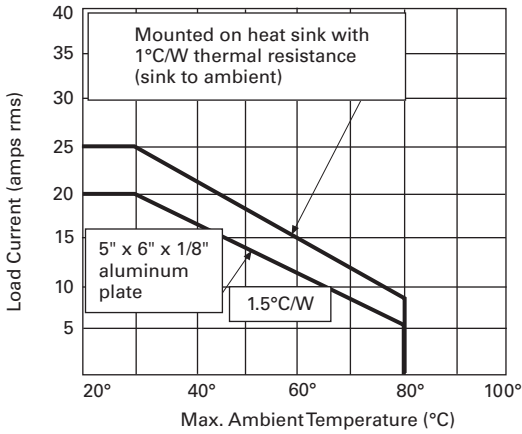

75 Amp Styles

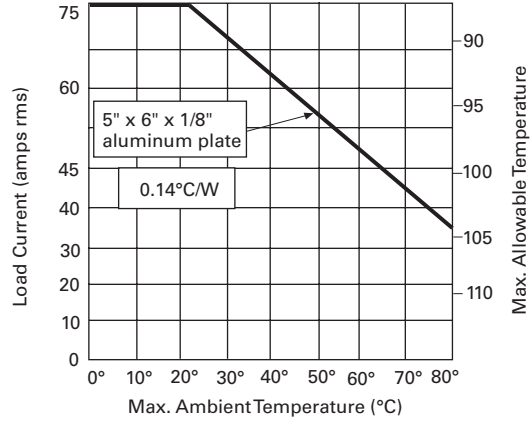

Dimensions

Approximate Dimensions in Inches (mm)

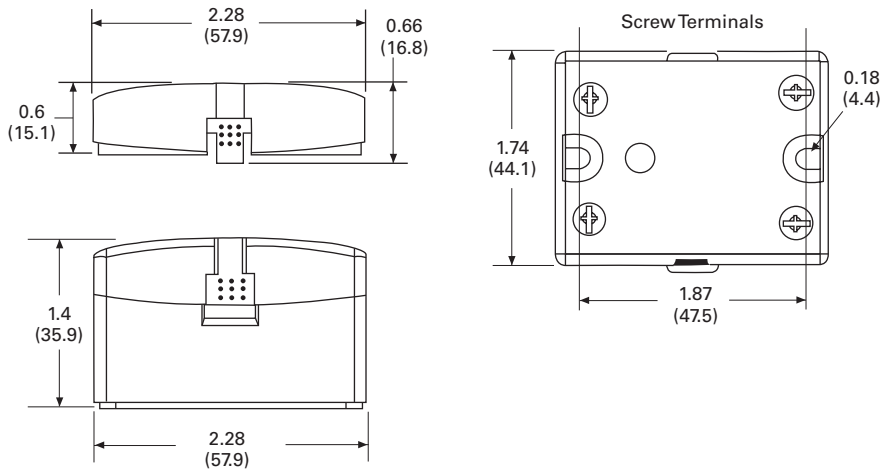
D93 Series

D96 Series—Solid-State Relays



Contents

Description	Page
D93 Series	V7-T3-123
D96 Series	
Product Selection	V7-T3-131
Technical Data and Specifications	V7-T3-132
Dimensions	V7-T3-134
D99 Series	V7-T3-135

D96 Series

Product Description

Eaton’s D96 series of solid-state relays is a technologically advanced set of electronic relays for tough applications and harsh environments. The compact 17.5 mm wide package with an integrated heat sink provides easy mounting in tight spaces.

Application Description

A solid-state relay (SSR) can perform many applications that an electromechanical relay can perform. The SSR differs in that it has no moving mechanical parts within it and has some distinct advantages over an electromechanical relay.

When used correctly in the intended application, the SSR provides a high degree of reliability, a long service life, significantly reduced electromagnetic interference, fast response and high vibration resistance.

Applications for the SSR typically include equipment that requires high cycling rates, low acoustical or electrical noise, or high vibration resistance. Some examples are medical equipment, heating/cooling equipment, lighting control and pumps/compressors, among others.

Features and Benefits

- All solid-state circuitry has no moving parts to wear
- Integral heat sink eliminates the need for added accessories and installation
- Flexible mounting allows DIN rail or panel mounting without additional hardware or tools
- Isolated input and output terminals protect the system from electrical noise
- Internal snubber circuitry protects the SSR from transients

Standards and Certifications

- UL/cUL listed—UL 508
- CSA certified
- CE marked
- RoHS compliant



Product Selection

D96115ACZ3

D96 Series



Input Voltage	Output Voltage	Contact Configuration	Switching Type	Rated Current Load (Amps)	Catalog Number
3.5–32 Vdc	3–50 Vdc	SPST-NO	DC switch	15	D96115ACZ3
3.5–32 Vdc	3–150 Vdc	SPST-NO	DC switch	8	D96208ACZ3
90–280 Vac	24–280 Vac	SPST-NO	Random	10	D96210ACR1
3–32 Vdc	24–280 Vac	SPST-NO	Random	10	D96210ACR2
90–280 Vac	24–280 Vac	SPST-NO	Zero cross	10	D96210ACZ1
3–32 Vdc	24–280 Vac	SPST-NO	Zero cross	10	D96210ACZ2
3–32 Vdc	24–280 Vac	SPST-NC	Random	10	D96210BCR2
90–280 Vac	48–480 Vac	SPST-NO	Random	10	D96410ACR1
3–32 Vdc	48–480 Vac	SPST-NO	Random	10	D96410ACR2
90–280 Vac	48–480 Vac	SPST-NO	Zero cross	10	D96410ACZ1
3–32 Vdc	48–480 Vac	SPST-NO	Zero cross	10	D96410ACZ2
90–280 Vac	48–600 Vac	SPST-NO	Random	10	D96610ACR1
90–280 Vac	48–600 Vac	SPST-NO	Zero cross	10	D96610ACZ1
3–32 Vdc	48–600 Vac	SPST-NO	Zero cross	10	D96610ACZ2

Technical Data and Specifications

D96 Series

3

Description	Units	D96210ACZ1	D96210ACZ2	D96210ACR1	D96210ACR2	D96115ACZ3	D96208ACZ3	D96210BCR2
Output Characteristics								
Contact configuration		SPST-NO	SPST-NO	SPST-NO	SPST-NO	SPST-NO	SPST-NO	SPST-NC
Switching device		SCR	SCR	SCR	SCR	MOSFET	MOSFET	SCR
Current rating	A	10	10	10	10	15	8	10
Switching type		Zero cross	Zero cross	Random turn on	Random turn on	DC switching	DC switching	Random turn on
Maximum zero turn-on voltage (Vpk)	V	35	35	35	35	NA	NA	35
Maximum rate of rise off state voltage (DV/DT)	V/us	500	500	500	500	NA	NA	500
Incandescent lamp ampere rating (rms)	A	8	8	8	8	NA	NA	8
Motor load rating (rms)	A	4.5	4.5	4.5	4.5	NA	NA	4.5
Min. load current to maintain on	mA	50	50	50	50	20	20	50
Non-repetitive surge current (1 cycle)	A	500	500	500	500	50	35	500
Max. rms overload current (1 second)	A	24	24	24	24	24	17	24
Max. off state leakage current (rms)	mA	10	10	10	10	10	10	10
Typical on state voltage drop (rms)	V	1.25 AC	1.25 AC	1.25 AC	1.25 AC	1.25 DC	1.25 DC	1.25 AC
Max. on state voltage drop (rms)	V	1.6 AC	1.6 AC	1.6 AC	1.6 AC	1.6 DC	1.6 DC	1.6 AC
Max. I ² t for fusing (A ²)		1250	1250	1250	1250	NA	NA	1250
Input Characteristics								
Must release voltage	V	10 AC	1 DC	10 AC	1 DC	1 DC	1 DC	1 DC
Typical input impedance	ohms	16–25k	Current regulator	16–25k	ACL	Current regulator	Current regulator	ACL
Nominal input current at 5 Vdc or 240 Vac	mA	12	16	12	16	12	12	12
Reverse polarity protection		NA	Yes	NA	Yes	Yes	Yes	Yes
Performance Characteristics								
Operating time (response time)								
ON	ms	40	8.3	8.3	8.3	5	5	8.3
OFF	ms	80	8.3	8.3	8.3	5	5	8.3
Rated insulation voltage—input to input	Vac	2500	2500	4000	4000	2500	2500	4000
Dielectric strength—terminal to chassis	Vac	2500	2500	2500	2500	2500	2500	2500
Environment								
Product certifications		UL, CSA, CE	UL, CSA, CE	UL, CSA, CE	UL, CSA, CE	UL, CSA, CE	UL, CSA, CE	UL, CSA, CE
Ambient air temperature								
Storage	°C	–40 to 100	–40 to 100	–40 to 100	–40 to 100	–40 to 100	–40 to 100	–40 to 100
Operating	°C	–30 to 80	–30 to 80	–30 to 80	–30 to 80	–30 to 80	–30 to 80	–30 to 80
Degree of protection		IP20	IP20	IP20	IP20	IP20	IP20	IP20
Miscellaneous Characteristics								
Thermal resistance (junction to case)	°C/W	0.66	0.66	0.66	0.66	0.66	0.66	0.66
Integral heat sink	°C/W	4.0	4.0	4.0	4.0	4.0	4.0	4.0
Weight	g (oz)	127 (4.1)	127 (4.1)	127 (4.1)	127 (4.1)	127 (4.1)	127 (4.1)	127 (4.1)
LED—input		Green	Green	Green	Green	Green	Green	Green
Terminal wire capacity	AWG (mm ²)	14 (2.1)	14 (2.1)	14 (2.1)	14 (2.1)	14 (2.1)	14 (2.1)	14 (2.1)
Terminal torque (max.)	in-lb (Nm)	7.1 (0.8)	7.1 (0.8)	7.1 (0.8)	7.1 (0.8)	7.1 (0.8)	7.1 (0.8)	7.1 (0.8)

Temperature Derating Curves

8 Amp Style

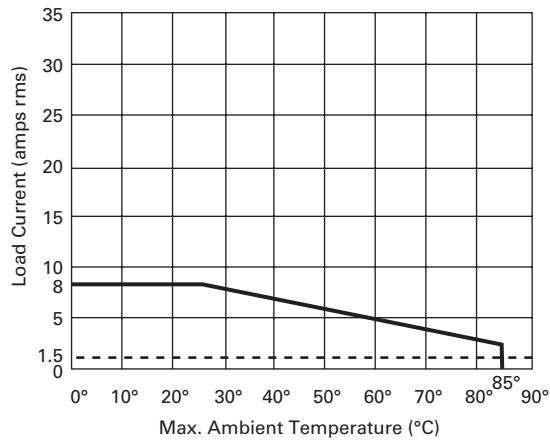

15 Amp Style

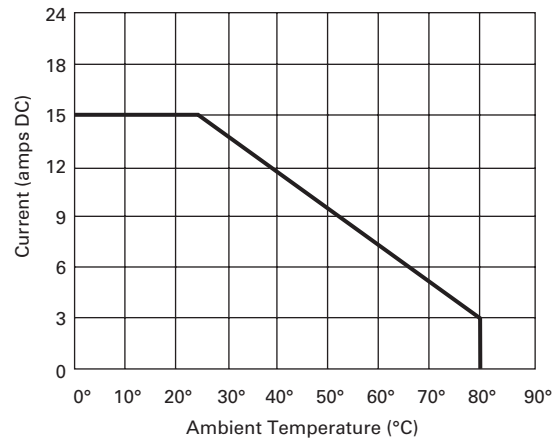

10 Amp Style

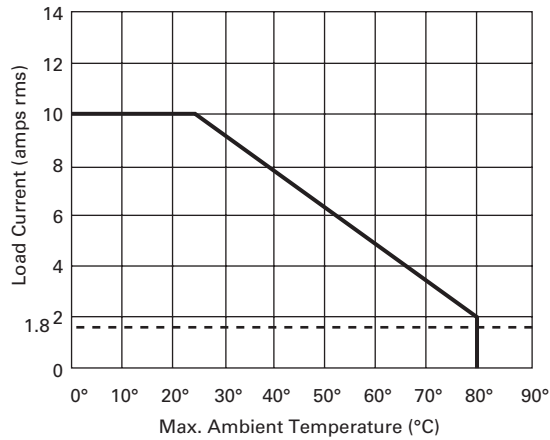

3.6

Control Relays and Timers

Solid-State Relays

Dimensions

Approximate Dimensions in Inches (mm)

D96 Series

3

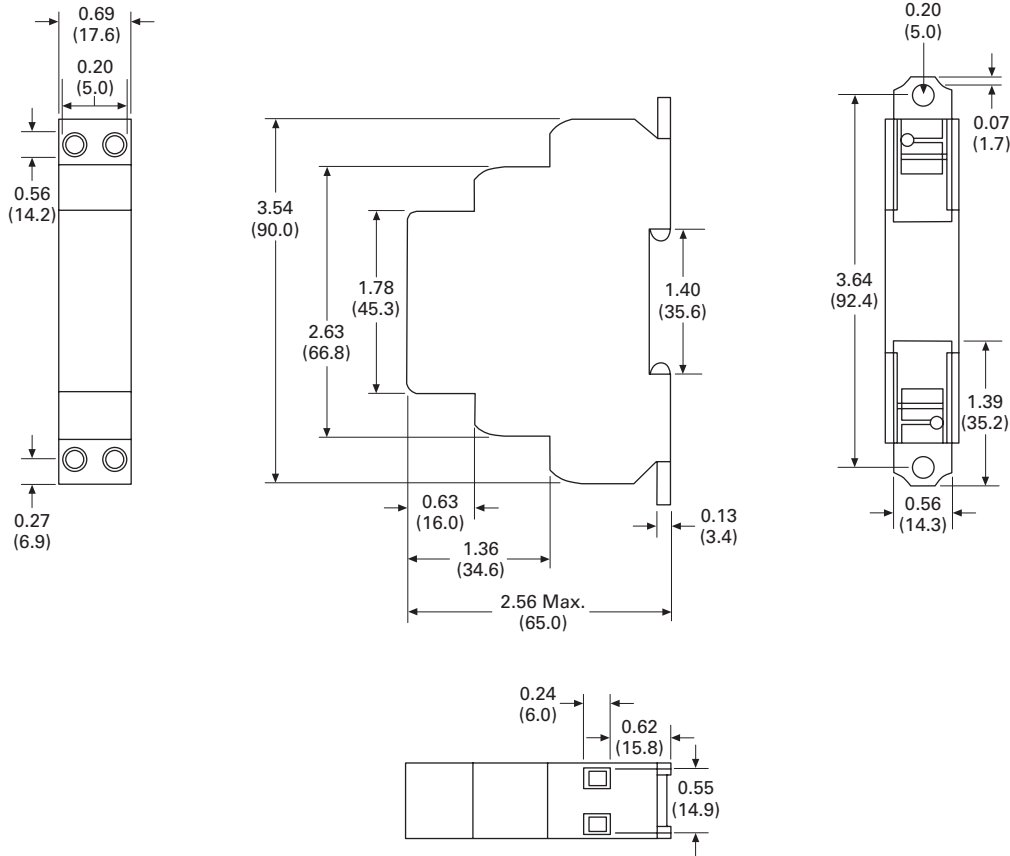

D99 Series—Solid-State Relays



D99 Series

Product Description

Eaton's D99 series of solid-state relays is a line of heavy-duty industrial relays with an integrated heat sink. The attached metal hardware can be used for DIN rail or panel mounting.

Models are available in a variety of input voltages in 10 A, 25 A and 40 A sizes.

Application Description

A solid-state relay (SSR) can perform many applications that an electromechanical relay can perform. The SSR differs in that it has no moving mechanical parts within it and has some distinct advantages over an electromechanical relay.

When used correctly in the intended application, the SSR provides a high degree of reliability, a long service life, significantly reduced electromagnetic interference, fast response and high vibration resistance.

Applications for the SSR typically include equipment that requires high cycling rates, low acoustical or electrical noise, or high vibration resistance. Some examples are medical equipment, heating/cooling equipment, lighting control and pumps/compressors, among others.

Contents

Description	Page
D93 Series	V7-T3-123
D96 Series	V7-T3-130
D99 Series	
Product Selection	V7-T3-136
Technical Data and Specifications	V7-T3-137
Dimensions	V7-T3-140

Features and Benefits

- All solid-state circuitry has no moving parts to wear
- Integral heat sink eliminates the need for added accessories and installation
- Flexible mounting allows DIN rail or panel mounting without additional hardware or tools
- Isolated input and output terminals protect the system from electrical noise
- Internal snubber circuitry protects the SSR from transients

Standards and Certifications

- UL/cUL listed—UL 508
- CSA certified
- CE marked
- RoHS compliant



3.6

Control Relays and Timers

Solid-State Relays

Product Selection

D99210ACZ1

D99 Series

3



Input Voltage	Output Voltage	Contact Configuration	Switching Type	Rated Current Load (Amps)	Catalog Number
90–280 Vac	24–280 Vac	SPST-NO	Zero cross	10	D99210ACZ1
3–32 Vdc	24–280 Vac	SPST-NO	Zero cross	10	D99210ACZ2
90–280 Vac	24–280 Vac	SPST-NO	Zero cross	25	D99225ACZ1
3–32 Vdc	24–280 Vac	SPST-NO	Zero cross	25	D99225ACZ2
90–280 Vac	24–280 Vac	SPST-NO	Zero cross	40	D99240ACZ1
3–32 Vdc	24–280 Vac	SPST-NO	Zero cross	40	D99240ACZ2
90–280 Vac	48–600 Vac	SPST-NO	Zero cross	10	D99610ACZ1
3–32 Vdc	48–600 Vac	SPST-NO	Zero cross	10	D99610ACZ2
90–280 Vac	48–600 Vac	SPST-NO	Zero cross	25	D99625ACZ1
3–32 Vdc	48–600 Vac	SPST-NO	Zero cross	25	D99625ACZ2
90–280 Vac	48–600 Vac	SPST-NO	Zero cross	40	D99640ACZ1
3–32 Vdc	48–600 Vac	SPST-NO	Zero cross	40	D99640ACZ2

Technical Data and Specifications

D99 Series

Description	Units	D99210ACZ1	D99210ACZ2	D99225ACZ1	D99225ACZ2	D99240ACZ1	D99240ACZ2
Output Characteristics							
Contact configuration		SPST-NO	SPST-NO	SPST-NO	SPST-NO	SPST-NO	SPST-NO
Switching device		SCR	SCR	SCR	SCR	SCR	SCR
Current rating	A	10	10	25	25	40	40
Switching type		Zero cross	Zero cross	Zero cross	Zero cross	Zero cross	Zero cross
Maximum zero turn-on voltage (Vpk)	V	35	35	35	35	35	35
Maximum rate of rise off state voltage (DV/DT)	V/us	500	200	500	500	500	500
Incandescent lamp ampere rating (rms)	A	8	8	16	16	20	20
Motor load rating (rms)	A	4.5	4.5	8	8	14	14
Min. load current to maintain on	mA	50	50	120	120	250	250
Non-repetitive surge current (1 cycle)	A	83	83	800	800	800	800
Max. rms overload current (1 second)	A	24	24	40	40	100	100
Max. off state leakage current (rms)	mA	10	10	10	10	10	10
Typical on state voltage drop (rms)	Vac	1.25	1.25	1.35	1.35	1.6	1.6
Max. on state voltage drop (rms)	Vac	1.6	1.6	1.8	1.8	1.6	1.6
Max. I ² t for fusing (A ²)		83	83	3700	3700	3700	83
Input Characteristics							
Must release voltage	V	10 AC	1 DC	10 AC	1 DC	10 AC	1 DC
Typical input impedance	ohms	16–25k	Current regulator	16–25k	Current regulator	13k	Current regulator
Nominal input current at 5 Vdc or 240 Vac	mA	12	12	12	12	16	16
Reverse polarity protection		NA	Yes	NA	Yes	NA	Yes
Performance Characteristics							
Operating time (response time)							
ON	ms	8.3	8.3	8.3	8.3	8.3	10
OFF	ms	8.3	8.3	8.3	8.3	8.3	10
Rated insulation voltage—input to input	Vac	4000	4000	4000	4000	4000	4000
Dielectric strength—terminal to chassis	Vac	4000	4000	4000	4000	4000	4000
Environment							
Product certifications		UL, CSA, CE	UL, CSA, CE	UL, CSA, CE	UL, CSA, CE	UL, CSA, CE	UL, CSA, CE
Ambient air temperature							
Storage	°C	–40 to 100	–40 to 100	–40 to 100	–40 to 100	–40 to 100	–40 to 100
Operating	°C	–30 to 80	–30 to 80	–30 to 80	–30 to 80	–30 to 80	–30 to 80
Degree of protection		IP20	IP20	IP20	IP20	IP20	IP20
Miscellaneous Characteristics							
Thermal resistance (junction to case)	°C/W	1.5	1.5	1.5	0.43	1.5	0.43
Integral heat sink	°C/W	2.2	2.2	2.2	2.2	2.2	2.2
Weight	g (oz)	320 (11.3)	320 (11.3)	320 (11.3)	326 (11.5)	320 (11.3)	332 (11.7)
LED—input		Green	Green	Green	Green	Green	Green
Terminal wire capacity	AWG (mm ²)	8 (10)	8 (10)	8 (10)	8 (10)	8 (10)	8 (10)
Terminal torque (max.)	in-lb (Nm)	12.5 (1.4)	12.5 (1.4)	12.5 (1.4)	12.5 (1.4)	12.5 (1.4)	12.5 (1.4)

3.6

Control Relays and Timers

Solid-State Relays

3

D99 Series, continued

Description	Units	D99610ACZ1	D99610ACZ2	D99625ACZ1	D99625ACZ2	D99640ACZ1	D99640ACZ2
Output Characteristics							
Contact configuration		SPST-NO	SPST-NO	SPST-NO	SPST-NO	SPST-NO	SPST-NO
Switching device		SCR	SCR	SCR	SCR	SCR	SCR
Current rating	A	10	10	25	10	40	40
Switching type		Zero cross	Zero cross	Zero cross	Zero cross	Zero cross	Zero cross
Maximum zero turn-on voltage (V _{pk})	V	35	35	35	35	35	35
Maximum rate of rise off state voltage (DV/DT)	V/us	200	200	700	700	500	500
Incandescent lamp ampere rating (rms)	A	8	8	16	16	20	20
Motor load rating (rms)	A	4.5	4.5	8	8	14	14
Min. load current to maintain on	mA	80	80	250	250	250	250
Non-repetitive surge current (1 cycle)	A	83	83	1000	1000	800	800
Max. rms overload current (1 second)	A	24	24	50	50	100	100
Max. off state leakage current (rms)	mA	10	10	10	10	10	10
Typical on state voltage drop (rms)	Vac	1.25	1.25	1.35	1.35	1.6	1.6
Max. on state voltage drop (rms)	Vac	1.6	1.6	1.6	1.6	1.6	1.6
Max. I ² t for fusing (A ²)		83	83	1700	1700	3700	3700
Input Characteristics							
Must release voltage	V	10 AC	1 DC	10 AC	1 DC	10 AC	1 DC
Typical input impedance	ohms	16–25k	Current regulator	16–25k	Current regulator	13k	Current regulator
Nominal input current at 5 Vdc or 240 Vac	mA	12	16	12	16	16	16
Reverse polarity protection		NA	Yes	NA	Yes	NA	Yes
Performance Characteristics							
Operating time (response time)							
ON	ms	8.33	8.3	8.33	8.3	10	10
OFF	ms	8.33	8.3	8.33	8.3	10	10
Rated insulation voltage—input to input	Vac	4000	4000	4000	4000	4000	4000
Dielectric strength—terminal to chassis	Vac	4000	4000	4000	4000	4000	4000
Environment							
Product certifications		UL, CSA, CE	UL, CSA, CE	UL, CSA, CE	UL, CSA, CE	UL, CSA, CE	UL, CSA, CE
Ambient air temperature							
Storage	°C	–40 to 100	–40 to 100	–40 to 100	–40 to 100	–40 to 100	–40 to 100
Operating	°C	–30 to 80	–30 to 80	–30 to 80	–30 to 80	–30 to 80	–30 to 80
Degree of protection		IP20	IP20	IP20	IP20	IP20	IP20
Miscellaneous Characteristics							
Thermal resistance (junction to case)	°C/W	1.8	1.8	0.43	0.43	0.43	0.43
Integral heat sink	°C/W	2.2	2.2	2.2	2.2	2.2	2.2
Weight	g (oz)	320 (11.3)	321 (11.3)	326 (11.5)	326 (11.5)	332 (11.7)	332 (11.7)
LED—input		Green	Green	Green	Green	Green	Green
Terminal wire capacity	AWG (mm ²)	8 (10)	9 (10)	8 (10)	8 (10)	8 (10)	8 (10)
Terminal torque (max.)	in-lb (Nm)	12.5 (1.4)	12.5 (1.4)	12.5 (1.4)	12.5 (1.4)	12.5 (1.4)	12.5 (1.4)

Temperature Derating Curves

10 Amp Styles

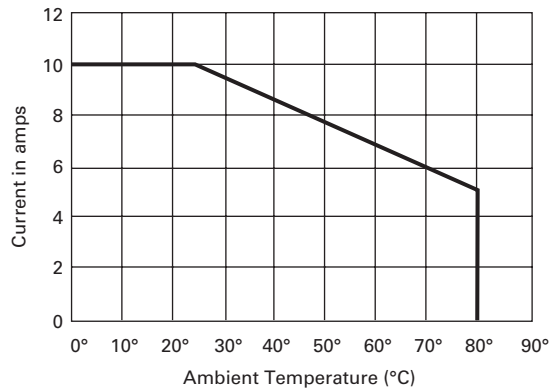

40 Amp Styles

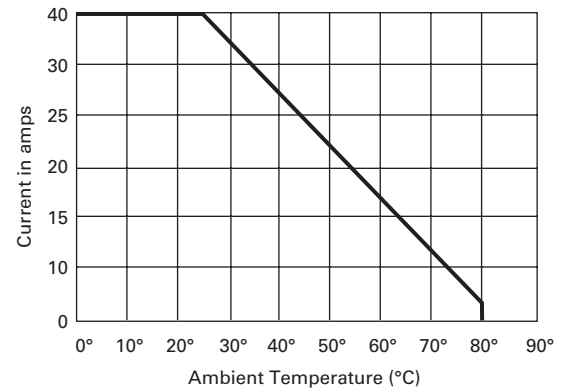

25 Amp Styles

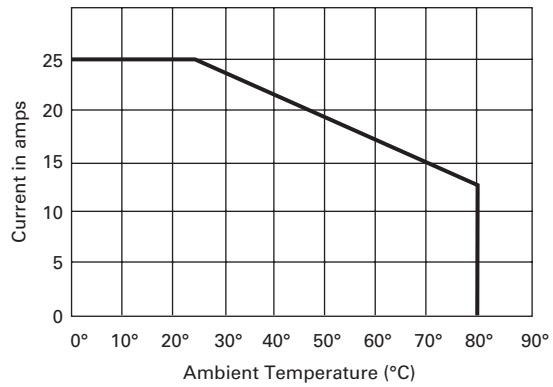

3.6

Control Relays and Timers

Solid-State Relays

Dimensions

Approximate Dimensions in Inches (mm)

D99 Series

3

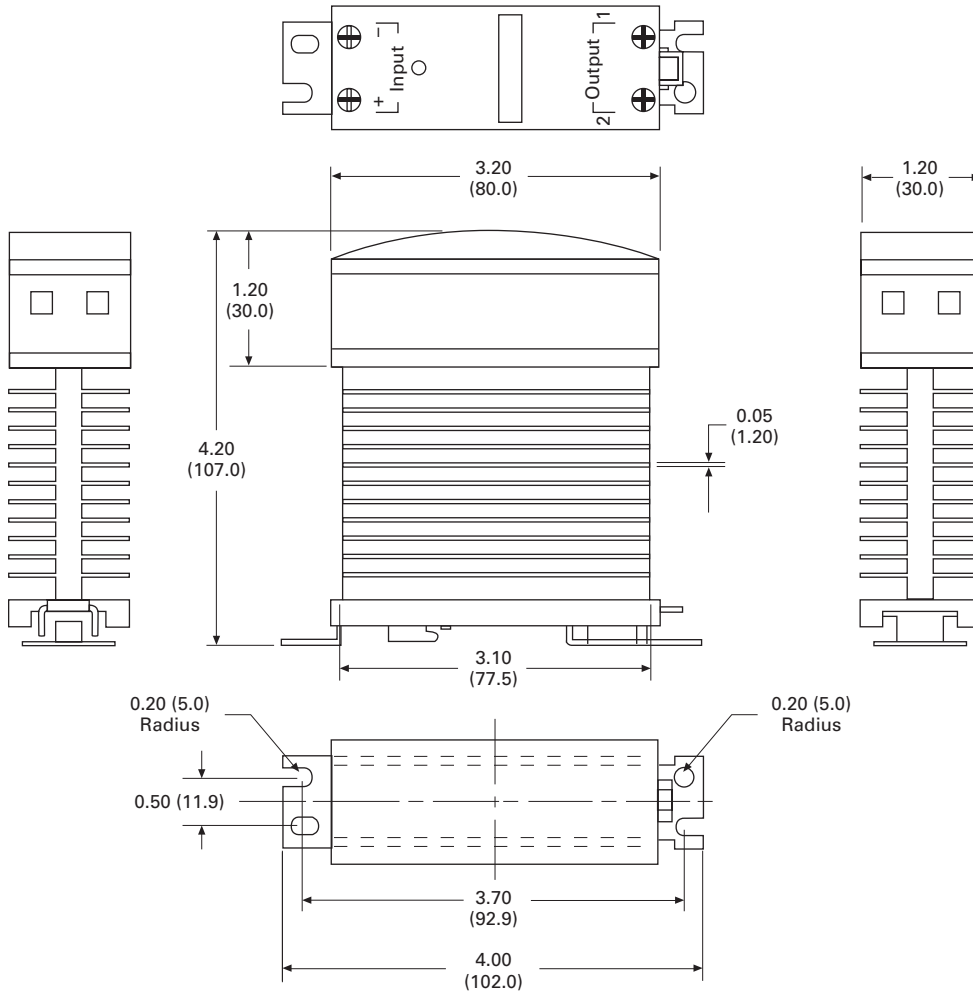

Machine Tool Relays



Product Overview

Eaton's machine tool relay offering includes a variety of NEMA type relays. Included in this are open style relays and relays with convertible or side-mount contacts. Also included in this family are a variety of accessories to match the application, including suppressors, timing contacts and enclosures. The relay coils are available in a variety of line and control level voltages.

Contents

Description	Page
Machine Tool Relays	
D15 Series—Freedom 600 V Multipole	V7-T3-142
BF/BFD Series—Fixed Contact Industrial Control	V7-T3-147
AR/ARD Series—Convertible Contact Industrial Control	V7-T3-153
D26 Series—Type M, 600 Vac Multipole with Convertible Contacts	V7-T3-158
D26 Series—Type M, DC Multipole with Convertible Contacts	V7-T3-163

D15 Series—Freedom 600 V Multipole



Contents

<i>Description</i>	<i>Page</i>
D15 Series—Freedom 600 V Multipole	
Product Selection	V7-T3-143
Accessories	V7-T3-144
Technical Data and Specifications	V7-T3-145
Dimensions	V7-T3-146
BF/BFD Series—Fixed Contact	
Industrial Control	V7-T3-147
AR/ARD Series—Convertible Contact	
Industrial Control	V7-T3-153
D26 Series—Type M, 600 Vac Multipole	
with Convertible Contacts	V7-T3-158
D26 Series—Type M, DC Multipole	
with Convertible Contacts	V7-T3-163

D15 Series—Freedom 600 V Multipole

Product Description

Contact poles on the D15 relay are of the fixed design and are not convertible. The basic four-pole relay will accept a front-mounted contact pole deck and/or side-mounted contact blocks (one per side). In addition, a side-mounted solid-state timer or a front-mounted pneumatic timer can be added to the relay. Only one front-mounted attachment can be added to the basic relay.

Application Description

Side-mounted contact blocks can be used to provide additional poles in applications where a pneumatic timer is installed on the front of the relay. They can also be used where panel depth is restricted.

The maximum number of contacts recommended per relay is eight, six of which can be NC. When a pneumatic timer is used, the maximum recommended number of NC contacts is three.

Relays with DC coils are supplied with a coil clearing NC contact mounted on the side of the relay.

Features and Benefits

- 600 V, 10 A continuous thermal current
- State indicator visually shows relay ON or OFF status
- Relay base has mounting holes on 35 x 60 mm centers, permitting direct replacement of competitive relays
- Relay also mounts on 35 mm DIN rail as standard
- Magnet coil has three terminals, permitting either top or diagonal wiring—easy to replace European or U.S. relays without changing wiring layout
- Contact pole terminals have captive, backed-out, self-lifting pressure plates with ± screws—reduced wiring time
- All terminals are shrouded or “finger-proofed” to reduce possibility of electrical shock

Standards and Certifications

- UL
- CSA certified

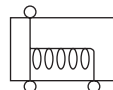



Product Selection

When Ordering, Specify

Catalog number and magnet coil code letter. Example: For a four-pole relay having 4NO contacts with a 120 V 60 Hz coil, order Catalog Number D15CR40**AB**.

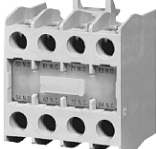
Factory-Assembled Multipole Relays

	Number of Poles	Type of Contacts		Open Type Catalog Number ^①
		NO	NC	
 D15CR40_B	4	4	0	D15CR40_B
		3	1	D15CR31_B
		2	2	D15CR22_B
		1	3	D15CR13_B
		0	4	D15CR04_B
 D15CR60_B (four-pole relay with two-pole front-mounted deck)	6	6	0	D15CR60_B
		5	1	D15CR51_B
		4	2	D15CR42_B
		3	3	D15CR33_B
		2	4	D15CR24_B
		1	5	D15CR15_B ^②
		0	6	D15CR06_B ^②
 D15CR80_B (four-pole relay with four-pole front-mounted deck)	8	8	0	D15CR80_B
		7	1	D15CR71_B
		6	2	D15CR62_B
		5	3	D15CR53_B
		4	4	D15CR44_B
		3	5	D15CR35_B ^②
		2	6	D15CR26_B ^②

Additional Contact Poles

Description	Catalog Number
Front Contact Pole Deck	
1NO-1NC	C320KGT3
2NO	C320KGT4
2NC	C320KGT5
1NO (early closing)–1NC (late opening)	C320KGT7
4NO	C320KGT13
3NO-1NC	C320KGT14
2NO-2NC	C320KGT15
1NO-3NC	C320KGT16
4NC	C320KGT17
Side-Mounted Contact Blocks	
1NO-1NC	C320KGS3
2NO	C320KGS4
2NC	C320KGS5
1NO (early closing)–1NC (late opening)	C320KGS7

Notes

- ① Underscore indicates missing code suffix for magnet coil—see Magnet Coil Selection table above.
 ② Not all suffix codes available: consult Customer Support Center.

Magnet Coil Selection

AC Coils Volts and Hertz	Code Suffix	DC Coils Volts	Code Suffix
120/60 or 110/50	A	12	R1
240/60 or 220/50	B	24	T1
480/60 or 440/50	C	48	W1
600/60 or 550/50	D	120	A1
208/60	E		
277/60	H		
208–240/60	J		
24/60	T		

Accessories

C320 Pneumatic Timer Attachment



Pneumatic Timer Attachment

Timing Range	Catalog Number
0.1 to 30 seconds	C320TP1
10 to 180 seconds	C320TP2

Description	Maximum Ampere Ratings			
	Volts AC			
	120	240	480	600
Make	30	15	7.5	6
Break	3	1.5	0.75	0.6

Attachment mounts on top of any Freedom Series relay (top-mounted auxiliary contacts can not be installed on device when timer is used). Timer unit has DPST

timed contacts—circuits in each pole must be the same polarity. Units are convertible from OFF to ON delay or vice-versa.

Finger Protection Shields

Application	Catalog Number
D15	C320LS1

Snap-on shields for both contactors and starters provide IEC Type IP20

Finger Protection. Prevents accidental contact with line/load terminals.

Adhesive Dust Cover

Description	Catalog Number
25 to a package	C320DSTCVR

These adhesive stickers come 25 to a package and provide extra protection from contaminants when applied to the sides of Freedom D15. Adhesive covers are easily

applied to side opening where auxiliaries are not installed and provide extra protection from metal filings and other debris.

Solid-State Timer



Solid-State ON DELAY Timer ①

Timing Range	Catalog Number ②③④
0.1 to 1.0 seconds	C320TDN1_
1 to 30 seconds	C320TDN30_
30 to 300 seconds	C320TDN300_
5 to 30 minutes	C320TDN3000_

This timer is designed to be **wired in series with the load** (typically a coil). When the START button is pushed (power applied to timer), the ON delay timing function starts. At the completion of the set timing period, timer and series wired load will both be energized.

C321MP1



Metal Mounting Plate

Description	Catalog Number
Metal mounting plate	C321MP1

Fits all D15 multipole relays.

DIN Rail



Mounting Channel (DIN Rail)

Description	Catalog Number
1 meter length	XBANS3575P

Designed for DIN rail mounting of Freedom Series relays.

C320TS2



Transient Suppressor Kits

Description	Coil Voltage 50/60 Hz ⑤	Catalog Number
Transient	24/120 V	C320TS1
Suppressor	208/240 V	C320TS2
	277/480 V	C320TS3

These kits limit high voltage transients produced in the control circuit when power is removed from the contactor or starter coil. There are three separate suppressors for use on 24–120 V, 208–240 V or 27–480 V coils respectively.

These devices mount directly to the coil terminals.

Notes

- ① Side mounted on Freedom Series NEMA 00–2, D15, IECA-K and C25D, C25E and C25F frame.
- ② Add operating voltage suffix to catalog number; **A** = 120 V, **B** = 240 V, **E** = 208 V.
- ③ Rated 0.5 ampere pilot duty—not to be used on larger contactors.
- ④ Terminal connections are quick connects only. Two per side.
- ⑤ Suppressor is compatible with coil voltages/ranges as shown, both 50 and 60 Hz.

C320DC



AC/DC Interface Module— Controller Coil Voltage Ranges

Controller Catalog Number Prefix	Controller Size or Rating	Coil Range Volts AC
AE16, AE17, AE56, AE57, CE15, CE55	A–F	24–240
	G–K	48–240
	L–N	110–240
AN16, AN56, CN15, CN55	00–0	24–240
	1–2	48–240
	3	110–240
CN35	10–30 A	24–240
	60 A	48–240
	100 A	110–240

The Catalog Number C320DC Interface Module is an optically isolated solid-state switch that provides a means of operating AC coils with a 24 Vdc control signal. It acts as a space-saving interposing relay that can switch a specified 50/60 Hz AC source to the contactor or starter coil.

The module may be directly attached to the coil terminals of any Freedom Series contactor or starter—NEMA Sizes 00–3, D15, IEC Sizes A–N and lighting contactors 10–100 A. It also has

provisions for DIN rail mounting.

The module will operate coils within the voltage ranges shown in the table to the left.

Design Characteristics

- DC input: 24 V \pm 10% at mA nominal
- AC operating voltage: 24–240 Vac \pm 10% 50/60 Hz
- AC current rating: 10 A make (inrush), 1 A break (sealed)

Typical Application—Solid-State Switch

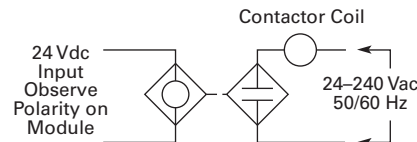

Technical Data and Specifications

Contact Ratings—NEMA A600

Continuous Thermal Rating: 10 A

AC Volts	Make	Break
120	60	6.0
240	30	3.0
480	15	1.5
600	12	1.2

Contact Ratings—NEMA P300

Continuous Thermal Rating: 5 A

DC Volts	Make/Break Amperes
125	1.1
250	0.55

Magnet Coil Data

AC Voltage	Pickup VA	Watts	Sealed VA	Watts
12–600 V	80	49	7.5	2.4

DC Voltage	Pickup Amps	Watts	Sealed VA	Watts
12	6.4	76.8	0.28	3.36
24	3.2	76.8	0.14	3.36
48	1.6	76.8	0.07	3.36
120	0.64	76.8	0.028	3.36

Example of Terminal Marking with 2NO and 2NC Contacts

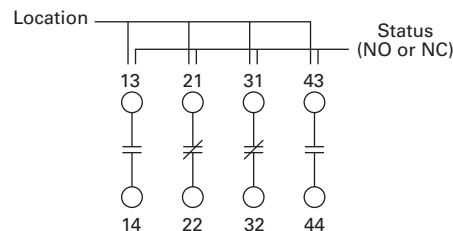

Relay terminals are identified by a two-digit number in accordance with International Standards approved by CENELEC (European Committee for Electrotechnical Standardization). The number is marked on the relay and is used to identify location and status of the contacts.

The first digit indicates the location of the contact on the relay. The numbering begins with 1 and continues without a break from left to right.

The second digit indicates the status of the contacts (NO or NC). Terminal marking 1 and 2 mean NC and 3 and 4 mean NO.

3.7

Control Relays and Timers

Machine Tool Relays

Dimensions

Approximate Dimensions in Inches (mm)

D15 Four-Pole Relay

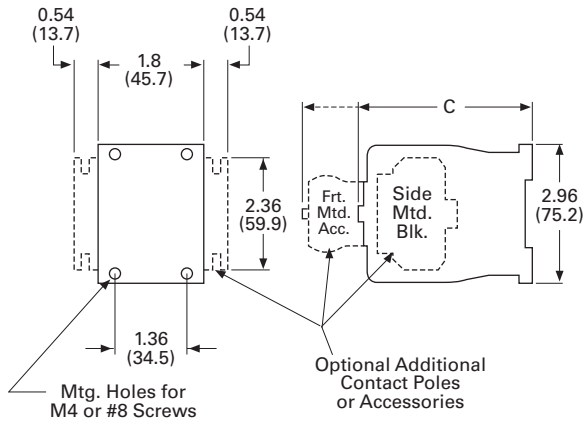

D15 Six- and Eight-Pole Relays

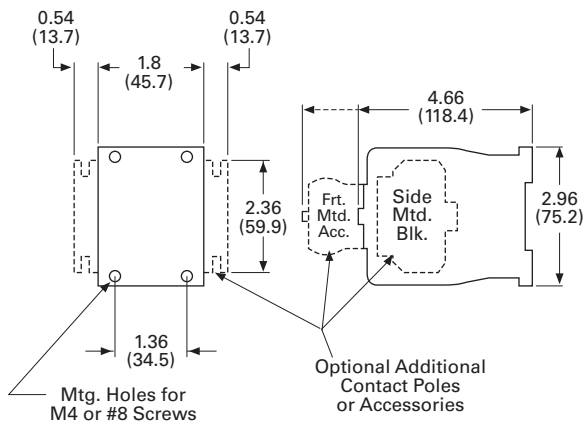

Dimensions and Shipping Weights

Description	Dimension C	Shipping Weights Lbs (kg)
Relay only	3.30 (83.8)	1.3 (0.6)
Relay with timer attachment	5.55 (141.0)	1.5 (0.7)
Relay with front contact pole deck	4.66 (118.4)	1.7 (0.8)

BF/BFD Series—Fixed Contact Industrial Control**BF/BFD Series—Fixed Contact Industrial Control****Product Description**

Type BF is AC operated, 300 V maximum, and the BFD is DC operated, 250 V. Fixed contact relays are available in any combination of NO and NC from two to 12 poles. BF and BFD relays have captive clamp terminals fully accessible from the front, a molded coil with low operating temperature and silver alloy contacts suitable for low voltage circuits.

Features and Benefits**Wiring to Relay**

- In parallel with coil—one timed and up to 12 instantaneous contacts, or
- In series with coil—up to 12 timed contacts in one relay

Permanent Magnet Latch

- Field mountable on Catalog Number BF; factory installed on BFD
- Latch coil continuously rated
- Latch plunger adjustable for optimum performance

Contents

Description	Page
D15 Series—Freedom 600 V Multipole	V7-T3-142
BF/BFD Series—Fixed Contact Industrial Control	
Product Selection	V7-T3-148
Options	V7-T3-150
Technical Data and Specifications	V7-T3-151
Dimensions	V7-T3-152
AR/ARD Series—Convertible Contact Industrial Control	V7-T3-153
D26 Series—Type M, 600 Vac Multipole with Convertible Contacts	V7-T3-158
D26 Series—Type M, DC Multipole with Convertible Contacts	V7-T3-163

Standards and Certifications

- UL recognized, UL File No. E19223 (AC relays only)
- CSA certified, File No. LR39402-6, LR28548-10, 11 (AC and DC relays)



Product Selection

When Ordering, Specify

- Catalog number of basic relay
- If a coil voltage other than listed is required, select the suffix code from the Coil Voltage table and substitute it for the last letter in the catalog number. Example: BF80**V** for a 110/60 AC coil

3

Type BF



Type BFD

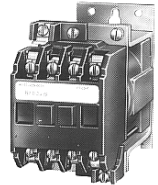

Complete Relay—Type BF and BFD, Two-, Three-, Four- and Six-Pole ^①

Number of Poles	Type of Contact		BF 300 Vac Basic Relays 120/60, 110/50 AC Coil	BFD 250 Vdc Basic Relays 120 DC Coil
	NO (Form A)	NC (Form B)	Catalog Number	Catalog Number
2	2	0	BF20F	BFD20S
	1	1	BF11F	BFD11S
	0	2	BF02F	BFD02S
3	3	0	BF30F	BFD30S
	2	1	BF21F	BFD21S ^②
	1	2	BF12F	BFD12S
	0	3	BF03F	BFD03S
4	4	0	BF40F	BFD40S
	3	1	BF31F	BFD31S
	2	2	BF22F	BFD22S
	1	3	BF13F	BFD13S
	0	4	BF04F	BFD04S
6	6	0	BF60F	BFD60S
	5	1	BF51F	BFD51S
	4	2	BF42F	BFD42S
	3	3	BF33F	BFD33S
	2	4	BF24F	BFD24S
	0	6	BF06F	BFD06S

Coil Voltage

BF Coils		
Volts AC	Hz	Suffix Code
12	60	H
24	60	I
48	60	J
110	60	V
110/120	50/60	F
208	60	K
220/240	50/60	G
440	60	C

BFD Coils	
Volts DC	Suffix Code
6	C
12	D
24	L
38	N
48	M
72	E
95	B
120	S
130	U
240	T

Notes

- ^① Relays listed above with equal number of NO and NC contact poles are specially priced—1NO and 1NC pole are supplied at no additional charge.
- ^② Consult Customer Support Center for availability.

When Ordering, Specify

- Catalog number of basic relay
- If a coil voltage other than listed is required, select the suffix code from the Coil Voltage table and substitute it for the last letter in the catalog number. Example: BF80**V** for a 110/60 AC coil

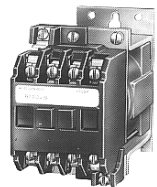
Type BF**Type BFD****Complete Relay—Type BF and BFD, Eight-, 10- and 12-Pole** ^①

Number of Poles	Type of Contact		BF 300 Vac Basic Relays 120/60, 110/50 AC Coil	BFD 250 Vdc Basic Relays 120 DC Coil
	NO (Form A)	NC (Form B)	Catalog Number	Catalog Number
8	8	0	BF80F	BFD80S
	7	1	BF71F	BFD71S
	6	2	BF62F	BFD62S
	5	3	BF53F	BFD53S
	4	4	BF44F	BFD44S
	0	8	BF08F	BFD08S
10	10	0	BF100F	BFD100S
	8	2	BF82F	BFD82S ^②
	7	3	BF73F ^②	BFD73S
	6	4	BF64F	BFD64S
	5	5	BF55F	BFD55S ^②
	4	6	BF46F	BFD46S
	2	8	BF28F	BFD28S
12	12	0	BF120F	BFD120S
	8	4	BF84F	BFD84S
	7	5	BF75F	BFD75S
	6	6	BF66F	BFD66S
	5	7	BF57F	BFD57S
	4	8	BF48F	BFD48S

Coil Voltage

BF Coils		
Volts AC	Hz	Suffix Code
12	60	H
24	60	I
48	60	J
110	60	V
110/120	50/60	F
208	60	K
220/240	50/60	G
440	60	C

BFD Coils	
Volts DC	Suffix Code
6	C
12	D
24	L
38	N
48	M
72	E
95	B
120	S
130	U
240	T

Notes

- ^① Relays listed above with equal number of NO and NC contact poles are specially priced—1NO and 1NC pole are supplied at no additional charge.
- ^② Consult Customer Support Center for availability.

Permanent Magnet Latch, Relay Mounted



Permanent Magnet Latch

Coil Volts	Coil Hz	Catalog Number
AC Relays		
24	60	BFMLI ②
48	60	BFMLJ ②
110/120	50/60	BFMLF
220/240	50/60	BFMLG
DC Relays		
24	—	BFMLL
48	—	BFMLM
120	—	BFMLS
240	—	BFMLT

3

Options

FASTON Push-On Terminals

Description	Code Letter	Catalog Number
Insert letter F after relay type designation in listed catalog number. Example: BFF20F or BFDF20S	F	—

Overlapping Contacts

Description	Code Letter	Catalog Number
NO contact closes before corresponding NC contact opens—supplied as NO/NC set(s). Insert letter A after relay type designation in listed catalog number. Example: BFA22F or BFDAF22S	A	—

NEMA 1 Enclosure for Relay Types

Description	Code Letter	Catalog Number
BF, AR—all poles	—	4977D40G04
BFD—4–8 poles	—	4977D40G04
ARD—4–8 poles	—	4977D40G04

Notes

- ① For panel mount, add Suffix **F**.
- ② Consult Customer Support Center for availability.

Technical Data and Specifications

General Specifications

BF Relay Electrical Ratings—NEMA A300

Volts	Maximum Current			Maximum VA	
	Cont.	Make	Break	Make	Break
120	10	60	6	7200	720
240	10	30	3	7200	720

Horsepower Ratings (UL Recognized)

Phase	AC Volts		Volts	DC Rating—NEMA P300			Max. Make or Break (VA)
	115	230		Maximum Current	Break	Max. Make or Break (VA)	
1	1/6	1/2	125	5.0	1.1	1.1	138
3	—	1	250	5.0	0.55	0.55	138

Resistive Rating

125 Vdc	3 A
250 Vdc	1.5 A

Coil Power Requirements

AC	72 VA open, 22 VA closed
DC	12 watts (nominal), 250 V max.

Permanent Magnet Latch Specifications

Item	Specification
Unlatching power requirements	Open gap: 24 VA AC Closed gap: 7 VA Burden: 4 watts (AC)

3.7

Control Relays and Timers

Machine Tool Relays

3

Contact Arrangements—BF and BFD Relays

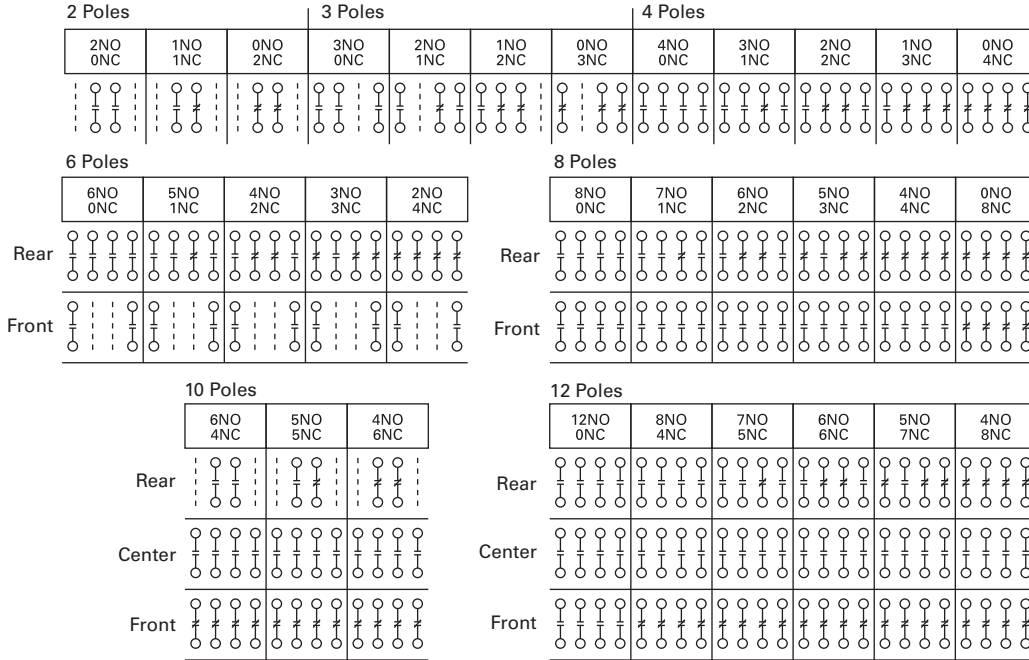

Note: NO = Normally Open NC = Normally Closed

Dimensions

Approximate Dimensions in Inches (mm)

BF Relay with Permanent Magnet Latch and Solid-State Timer

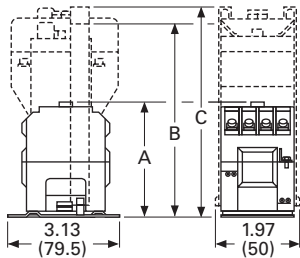

BFD Relay with Solid-State Timer

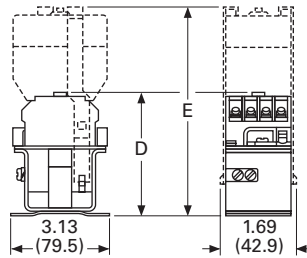

Enclosures—NEMA 1 for BF, BFD, AR and ARD

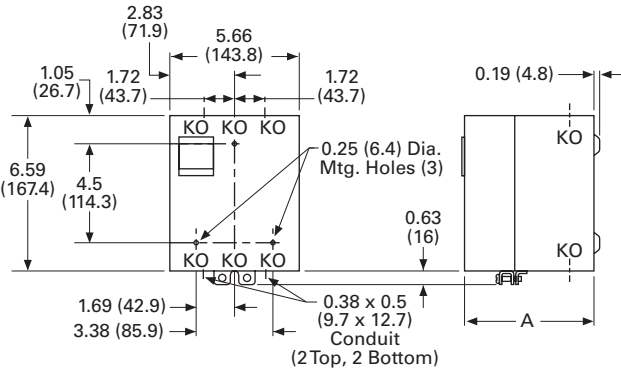

BF and BFD Relay Dimensions

Number of Poles	A BF Only	B BF w/Latch	C BF w/Timer	D BFD Only	E BFD w/Timer
4	3.22 (81.8)	6.22 (158.0)	5.88 (149.4)	4.03 (102.4)	7.06 (179.3)
8	4.19 (106.4)	7.19 (182.6)	6.88 (174.8)	4.97 (126.2)	8.00 (203.2)
12	4.81 (122.2)	7.81 (198.4)	7.50 (190.5)	5.63 (143.0)	8.66 (220.0)

NEMA 1 for BF, BFD, AR and ARD Dimensions

Poles	Catalog Number	A NEMA 1
Relays without Attachments		
All	BF, AR, ARD	5.34 (135.6)
4 – 8	BFD	5.34 (135.6)
10, 12	BFD	7.97 (202.4)
Relays with Attachments		
All	BF, AR, ARD	7.97 (202.4)

AR/ARD Series—Convertible Contact Industrial Control**AR/ARD Series—Convertible Contact Industrial Control****Product Description**

The AR/ARD relays are electromechanical convertible contact relays. AR relays are AC devices and the ARD is for DC applications.

Application Description

Type AR and ARD relays are designed for use on machine tools, process lines, conveyors and similar automatic and semi-automatic equipment.

Features and Benefits**Permanent Magnet Latch**

By energizing the relay coil, the latch attachment “sets” (when the base relay’s armature/crossbar assembly has closed) holding the relay ON, even after the relay coil has been de-energized. The clearing coil on the latch is energized to release the armature/crossbar assembly.

- Field mountable to four- and six-pole
- Latch plunger is adjustable
- Latch coil continuously rated
- Unlatching power requirements
 - Open gap: 24 VA
 - Closed gap: 7 VA
 - Burden: 4 watts AC, 6 watts DC

Contents

Description	Page
D15 Series—Freedom 600 V Multipole	V7-T3-142
BF/BFD Series—Fixed Contact Industrial Control	V7-T3-147
AR/ARD Series—Convertible Contact Industrial Control	
Product Selection	V7-T3-154
Accessories	V7-T3-155
Options	V7-T3-155
Technical Data and Specifications	V7-T3-156
Dimensions	V7-T3-157
D26 Series—Type M, 600 Vac Multipole with Convertible Contacts	V7-T3-158
D26 Series—Type M, DC Multipole with Convertible Contacts	V7-T3-163

Operation

AR relays are available in either four- or six-pole configurations. AR relays are easily converted to eight- or 10-poles simply by adding a four-pole deck. In addition, mechanical latch attachments are available with four- and six-pole relays.

Contacts are convertible from NO to NC, to provide any combination desired up to a maximum of 10. For the ARD, the number of poles cannot exceed **four** NC in any pole configuration. Wide spacing of contacts simplifies installation, contact testing and maintenance. Contacts are electrically and mechanically isolated from each other. Overlap contacts are also available in one or two sets. These contacts should be mounted in the center pole positions. AC and DC contact cartridges should not be used in the same relay.

Standards and Certifications

- UL File No. E19223
- CSA File No. LR39402-6, LR54517 and LR54520

**Reference Information**

- ART, ARTD: IL 14510, IL 14485

Product Selection

When Ordering, Specify

- Catalog number of basic relay with 120/60, 110/50 AC coil from AR/ARD Relays table.
- If a coil voltage other than listed is required, select the suffix code from the Coil Voltage table below and substitute it for the last letter in the catalog number. Example: AR64**V** for a 110/60 AC coil.

3

AR/ARD Relays



AR/ARD Relays

Number of Poles	Contact			AR 600 Vac Relays 120/60, 110/50 AC Coil	ARD 600 Vdc Relays 120 DC Coil
	NO	NC	Blank Cavities	Catalog Number	Catalog Number
4	0	0	4	AR4A	ARD4S
	2	0	2	AR420A	ARD420S
	4	0	0	AR440A	ARD440S
6	0	0	6	AR6A	ARD6S
	4	0	2	AR640A	—
	6	0	0	AR660A	ARD660S
8 ^①	6	0	2	AR860A	ARD860S ^②
	8	0	0	AR880A	ARD880S
10 ^①	10	0	0	AR10100A	ARD10100S

Coil Voltage

AR Coils			ARD Coils	
Volts AC	Hz	Suffix Code	Volts DC	Suffix Code
12	60	F	12	D
24	60	I	24	L
48	60	G	48	M
110	60	V	95	B
110/120	50/60	A	120	S
208	60	B	130	U
220/240	50/60	W	240	T
277	60	C		
380/440	50/60	H		
440/480	50/60	X		
550	60	D		
550/600	50/60	E		

Contact Cartridges—600 V

Terminal Type	Standard Contact Cartridge Catalog Number ^③	Overlap Contact Cartridge Catalog Number ^④
AC Cartridges		
With clamp terminals	ARC	AROC
With screw terminals	ARCR	AROCR
DC Cartridges		
With clamp terminals	ARDC	ARDOC
With screw terminals	ARDCR	ARDOCR

Notes

- ① Will not accept top-mounted latch or timers.
- ② Contact Customer Support Center for availability.
- ③ Standard cartridges are sold in cartons of four cartridges. Catalog number is for single cartridge.
- ④ Overlap contact cartridges are sold in sets of two cartridges. Catalog number is for sets of two.

ARML Permanent Magnet Latch for AR/ARD Relays



Permanent Magnet Latch

Operating Volts	Coil Hz	Catalog Number
For AC Control Circuits		
24	60	ARMLI
48	60	ARMLG
120	60/50	ARMLA
240	60/50	ARMLW
For DC Control Circuits		
24	—	ARMLL
48	—	ARMLM
120	—	ARMLS
240	—	ARMLT

Accessories

Four-Pole Top Deck Adder

- Increases contact capacity from four/six-poles to eight/10-poles
- Mounts on top of basic relay using three screws
- Will not interfere with wiring, testing or convertible cartridges
- Screw terminals for ring connectors available; to order, add Suffix **R** to catalog number listed below

Four-Pole Top Deck Adder



Four-Pole Top Deck Adder

No. of Poles	Contacts			Catalog Number
	NO	NC	Blank Cavities	
With 600 Vac Cartridges				
4	2	0	2	ARA20
	4	0	0	ARA40
With 600 Vdc Cartridges				
4	2	0	2	ARDA20
	4	0	0	ARDA40

Options

Convertible Contacts

Description	Code Letter	Catalog Number
AR and ARD relays listed are supplied with NO contacts that are easily converted to NC. If both NO and NC poles are required, order by catalog number. Example: four-pole relay with 1NO and 3NC contacts, order AR413A.	①	—

Screw Terminals

Description	Code Letter	Catalog Number
For ring-type connectors, add suffix R to the catalog number. Example: AR420 AR .	R	—

Surge Suppressor

ARSS Surge Suppressor for AR Relays



	Catalog Number
Surge Suppressor	ARSS

Overlapping Contacts

Description	Code Letter	Catalog Number
NO contact closes before corresponding NC contact opens — supplied as NO/NC sets of two cartridges. Insert letter S after relay type designation in listed catalog number. Example: AR402 AS . Specify the number of sets required: S for one set and S2 for two sets.	S or S2 ①	—

Note

① Consult Customer Support Center for availability.

Technical Data and Specifications

General

Contact Ratings—600 Vac Cartridge NEMA A600

Volts	Maximum Current			Maximum VA	
	Cont.	Make	Break	Make	Break
120	10	60	6	7200	720
240	10	30	3	7200	720
480	10	15	1.5	7200	720
600	10	12	1.2	7200	720

DC Cartridges—NEMA P600

Volts	Maximum Current		Maximum VA
	Continuous	Make or Break	Make or Break
125	5	1.10	138
250	5	0.55	138
600	5	0.20	138

Resistive Rating

125 Vdc	3 A
250 Vdc	1.5 A

Coil Power Requirements

AC	96 VA open, 14 VA closed
DC	14 watts open, 250 V max.

Voltage	AR Relays	ARD Relays
Pickup voltage (max.)	85%	65%
Dropout voltage (min.)	60%	15%
Voltage (max.)	110%	110%

Dimensions

Approximate Dimensions in Inches (mm)

Four- and Six-Pole with Four-Pole Adder, Solid-State Timer and Mechanical Latch

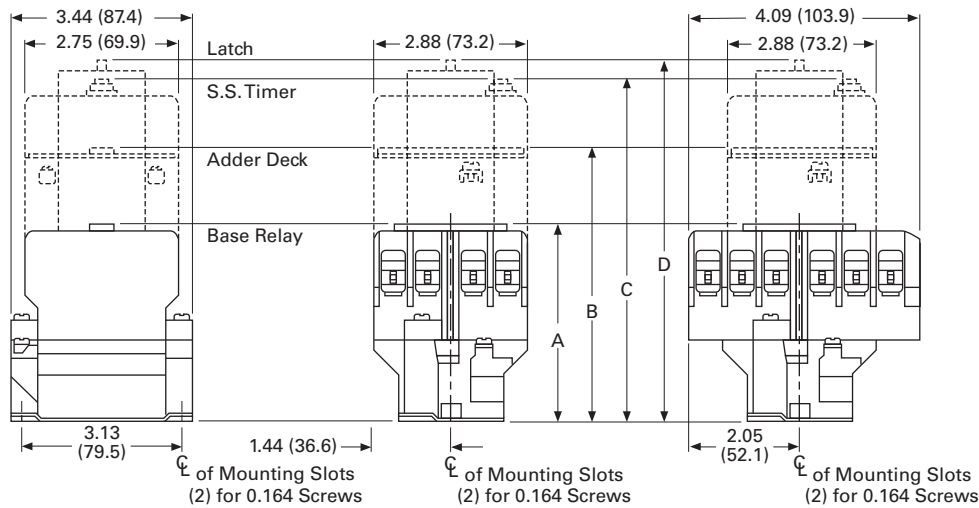

End View, 4- and 6-Pole

Side View, 4-Pole

Side View, 6-Pole

Four- and Six-Pole with Four-Pole Adder, Solid-State Timer and Mechanical Latch

Relay Catalog Number	A Four-, Six-Pole Relays	B Relay Adder	C Relay with Timer	D Relay with Latch
AR	3.56 (90.4)	4.94 (125.5)	6.00 (152.4)	6.39 (162.3)
ARD	4.63 (117.6)	6.00 (152.4)	7.06 (179.3)	7.45 (189.2)

Enclosures—NEMA 1 for BF, BFD, AR and ARD

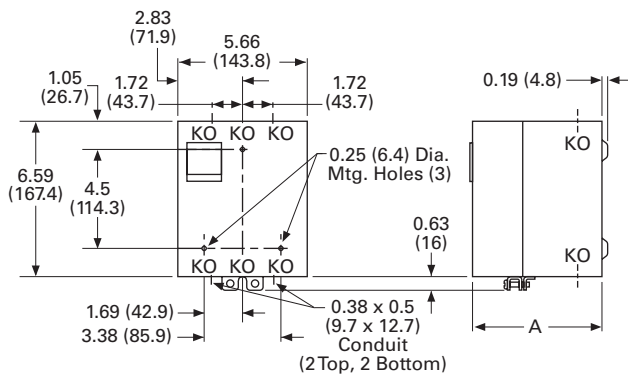

Enclosures—NEMA 1 for BF, BFD, AR and ARD

Poles	Catalog Number	Dimension A NEMA 1
Relays without Attachments		
All	BF, AR, ARD	5.34 (135.6)
4-8	BFD	5.34 (135.6)
10, 12	BFD	7.97 (202.4)
Relays with Attachments		
All	BF, AR, ARD	7.97 (202.4)

D26 Series—Type M, 600 Vac Multipole with Convertible Contacts



Contents

<i>Description</i>	<i>Page</i>
D15 Series—Freedom 600 V Multipole	V7-T3-142
BF/BFD Series—Fixed Contact Industrial Control	V7-T3-147
AR/ARD Series—Convertible Contact Industrial Control	V7-T3-153
D26 Series—Type M, 600 Vac Multipole with Convertible Contacts	
Product Selection	V7-T3-159
Technical Data and Specifications	V7-T3-161
Dimensions	V7-T3-162
D26 Series—Type M, DC Multipole with Convertible Contacts	V7-T3-163

D26 Series—Type M, 600 Vac Multipole with Convertible Contacts

Product Description

Relays can be ordered as complete devices in any pole combination up to a maximum of 12NO or 8NC and 4NO poles, or can be assembled from components shown on **Page V7-T3-160**.

Relay base assembly (**D26MB**) will accept from 1 to 4 rear poles (**D26MPR**, **D26MPS** and/or **D26MPL**).

Features

Contact poles D26MPR and D26MPF in 2- through 8-pole relays are convertible NO to NC or vice versa. Simply reverse the terminal screws and rotate the unit pole 180° (in either direction).

Options

Adding a front deck, the total number of poles can be increased to 8, all convertible NO to NC.

Adding a **D26MF**, 4-pole fixed NO attachment, builds a 12-pole relay with 8 convertible poles and 4 fixed NO poles.

Relays with mechanical latch are available in any convertible pole combination up to eight poles maximum.

Standards and Certifications

- UL listed—Class No. NKCR2, File E1230(N)
- CSA certified—File LR353



Normally Closed Contact

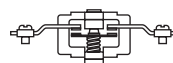

Normally Open Contact

To obtain overlapping contacts, use **D26MPS** (NO early closing) and **D26MPL** (NC late opening) rear poles, in related circuits.

Product Selection

Complete AC Relays

When Ordering, Specify

- Catalog number and magnet coil suffix letter.
- Example: For a 4-pole relay having 4NO contacts, order Catalog Number **D26MR40**, with a 120 V, 60 Hz coil, order **D26MR40A**.
- For fast delivery and minimum inventory, it is recommended that component parts or complete relays with NO poles be ordered.

4-Pole Complete AC Relays—Open Type

Number of Contacts	Type of Contact		Relay Only Catalog Number	Relay with Mechanical Latch Catalog Number
	NO (Form A)	NC (Form B)		
2	2	0	D26MR20	D26MR202
	1	1	D26MR11	D26MR112
	0	2	D26MR02	D26MR022
3	3	0	D26MR30	D26MR302
	2	1	D26MR21	D26MR212
	1	2	D26MR12	D26MR122
	0	3	D26MR03	D26MR032
4	4	0	D26MR40	D26MR402
	3	1	D26MR31	D26MR312
	2	2	D26MR22	D26MR222
	1	3	D26MR13	D26MR132
	0	4	D26MR04	D26MR042
6 ^①	6	0	D26MR60	D26MR602
	5	1	D26MR51	D26MR512
	4	2	D26MR42	D26MR422
	3	3	D26MR33	D26MR332
	2	4	D26MR24	D26MR242
	1	5	D26MR15	D26MR152
	0	6	D26MR06	D26MR062
	0	6	D26MR06	D26MR062
8 ^①	8	0	D26MR80	D26MR802
	7	1	D26MR71	D26MR712
	6	2	D26MR62	D26MR622
	5	3	D26MR53	D26MR532
	4	4	D26MR44	D26MR442
	3	5	D26MR35	D26MR352
	2	6	D26MR26	D26MR262
	1	7	D26MR17	D26MR172
	0	8	D26MR08	D26MR082



4-Pole with Latch



4-Pole with Pneumatic Timer Attachment



Magnet Coil Selection

Volts/Hertz	Suffix Code	Volts/Hertz	Suffix Code
120/60–110/50	A	32/60 ^②	V
240/60–220/50	B	12/60 ^②	R
208/60 ^②	E	6/60	P
24/60	T	380/50 ^②	L
277/60	H	480/60 or 440/50	C
		600/60 or 550/50 ^②	D

Notes

^① **10- and 12-Poles:** The 6 and 8 contact relays (without mechanical latch only) listed above can be provided with four additional NO non-convertible contacts. Add suffix number **4** to above listed catalog number plus magnet coil suffix. Example: For a 12 contact relay, order **D26MR804A**.

^② Consult Customer Support Center for availability.

Relay Component Parts Location

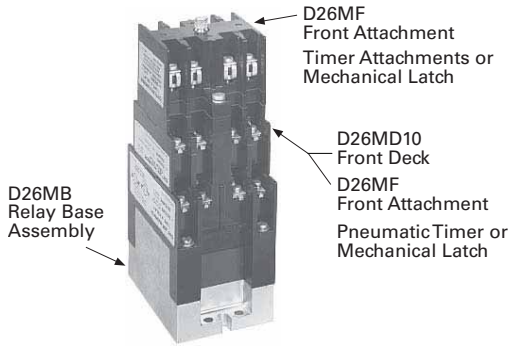

Relay with Pneumatic Timer Attachment Factory Installed (without Relay Contacts)

Contact Positions ^①	Timer Operation	Catalog Number ^②
4	ON delay	D26MR005
4	OFF delay	D26MR006

The relays listed above will accept up to four catalog number D26MPR contacts (convertible—NO or NC) for instantaneous operation. Order contacts separately.

For additional information on timer attachment, see **Page V7-T3-161**.

For assembly of relays from component parts and relay accessories, see components tables below.

Rear Pole



Front Pole



Separate Contacts

Description	Catalog Number
Convertible Contacts	
Rear pole—NO	D26MPR
Rear pole—NC	D26MPR02
Front pole—NO	D26MPF
Front pole—NC	D26MPF02
Gold plated (for low power circuits)	
Rear pole—NO	D26MPR03
Front pole—NO	D26MPF03
Non-Convertible Contacts	
Rear pole NO early closing ^③	D26MPS
Rear pole NC late opening ^③	D26MPL

Relay Base Assembly



Relay Base Assembly (without Poles)

Description	Catalog Number
Relay base assembly	D26MB ^④

Basic four-pole D26 relay without contacts. Provision for adding one to four poles

as needed, **D26MPR**, **D26MPL** and/or **D26MPS** rear pole type.

Rear Pole



Front Deck (Convertible Contact Poles)

Description	Catalog Number
Front Deck with ...	
1NO contact pole	D26MD10
2NO contact poles	D26MD20
4NO contact poles	D26MD40

Provides up to four additional front pole type D26MPF contacts. Convertible, NO to NC.

Four-Pole Front Attachment



Four-Pole Front Attachment (4NO Fixed Circuit)

Description	Catalog Number
Front attachment	D26MF

Can be added to any two- to eight-pole Type M, D26 relay to provide up to a 12-pole

relay. Four NO, non-convertible contacts are included in this assembly.

Notes

- ① Number of available instantaneous contact positions (order contacts separately—Catalog Number D26MPR).
- ② Consult Customer Support Center for availability.
- ③ To obtain overlapping contacts, these two special poles must be used in related circuits.
- ④ Add magnet coil suffix letter, see **Page V7-T3-159**. Example: D26MBA.

Relay State Indicating Light



Relay State Indicating Light

Description	Catalog Number
120 Vac, 50/60 Hz	D26MAP120
240 Vac, 50/60 Hz	D26MAP240

Light provided with leads and bracket for mounting on two-to 12-pole relays. May be

used to monitor state of magnet coil or relay contact operation.

Pneumatic Timer Attachment



Pneumatic Timer Attachment

Description	Catalog Number
ON delay	D26MTE
OFF delay	D26MTD

Attachment mounts on any 0-to four-pole D26 relay without latch. Timer unit has DPDT timed contacts (circuits in each pole must be the same polarity). Adjustable timing

range—0.1 to 180 seconds, repeat accuracy $\pm 10\%$. Units are convertible from OFF delay to ON delay or vice versa.

Mounting Channel



Mounting Channel

Description	Catalog Number
10 in length for 4 relays	D26MC4
20 in length for 8 relays	D26MC8
30 in length for 12 relays	D26MC12
40 in length for 16 relays	D26MC16

Pre-spaced mounting for adjacent relay installation. Indexed for cutting to desired

length. Captive mounting screws provided in channel for easier installation.

Manual Test Accessory



Manual Test Accessory

Description	Catalog Number
Manual test accessory	D26MTA

Tool to manually hold relays in the energized position for circuitry testing on completed

panel. (10 per box, order in multiples of 10.)

Transient Suppressor



Transient Suppressor

Description	Catalog Number
Magnet coil transient suppressor	D26MAS1
Latch coil transient suppressor	D26MAS2

May be mounted on any 120 Vac relay magnet coil or latch coil or 120 Vdc latch coil—connects directly across coil terminals. All DC magnet coils have a built-in varistor for transient suppression.

Limits high voltage transients produced in the circuit when power is removed from the coil.

Technical Data and Specifications

General

Contact Ratings (Amperes) A600

AC Volts ^①	Make and Emergency Interrupting Capacity	Break	Continuous Thermal Rating
120	60	6	10
240	30	3	10
480	15	1.5	10
600	12	1.2	10

Coil Power

Relay	Watts		VA		Operating Time
	Inrush	Sealed	Inrush	Sealed	Range in Milliseconds
Two- to 12-pole	95.0	9	155	22	Pickup: 6–13
Latch coil	18.5	11	41	17	Dropout: 8–26

Note

^① For DC contact ratings, see **Page V7-T3-165**.

3.7

Control Relays and Timers

Machine Tool Relays

Dimensions

Approximate Dimensions in Inches (mm)

AC and DC D26 Relays

3

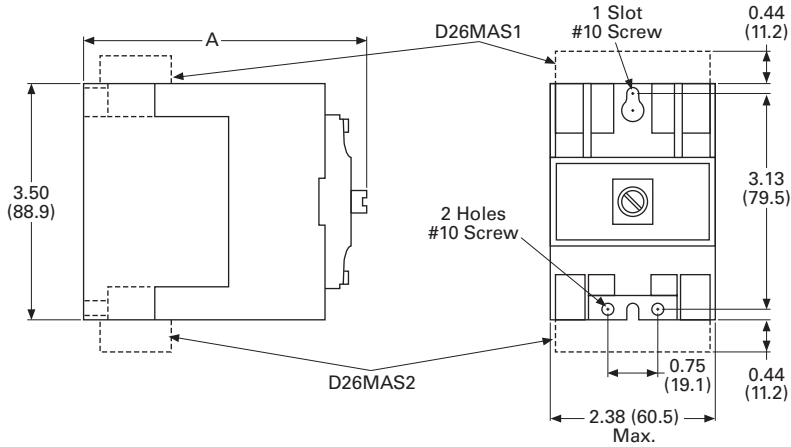

AC Relay D26	DC Relay D26	Dimension A	Ship. Wt. Lbs (kg)
1-4 poles	1-3 poles	4.00 (101.6)	2.5 (1.1)
1-4 poles with timer D26 or D87	1-3 poles with timer D26 or D87	6.00 (152.4)	3.3 (1.5)
1-4 poles with latch	1-2 poles with latch	6.13 (155.7)	3.5 (1.6)
1-4 poles with D26MF	1-3 poles with D26MF	5.81 (147.6)	2.8 (1.3)
5-8 poles	4-7 poles	5.25 (133.4)	2.8 (1.3)
5-8 poles with timer D87	4-7 poles with timer D87	7.25 (184.2)	3.5 (1.6)
5-8 poles with latch	3-6 poles with latch	7.31 (185.7)	3.8 (1.7)
9-12 poles	8-11 poles	7.00 (177.8)	3.0 (1.4)

Mounting Channel

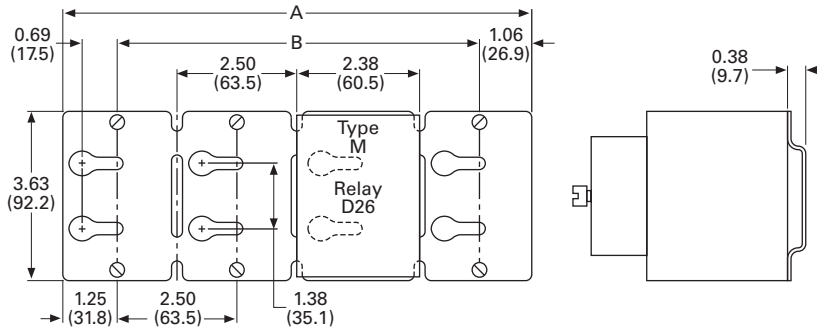

Catalog Number	Dimension A	Dimension B
D26MC16	40 (1016)	37.5 (952.5)
D26MC12	30 (762)	27.5 (698.5)
D26MC8	20 (508)	17.5 (444.5)
D26MC4	10 (254)	7.5 (190.5)

Note: Channel mounts through keyholes with #10 screws (two each end and one every fourth relay). Relays mount with screws captive in channel. All screws must be tightened firmly.

D26 Series—Type M, DC Multipole with Convertible Contacts



Contents

Description	Page
D15 Series—Freedom 600 V Multipole	V7-T3-142
BF/BFD Series—Fixed Contact Industrial Control	V7-T3-147
AR/ARD Series—Convertible Contact Industrial Control	V7-T3-153
D26 Series—Type M, 600 Vac Multipole with Convertible Contacts	V7-T3-158
D26 Series—Type M, DC Multipole with Convertible Contacts	
Product Selection	V7-T3-164
Technical Data and Specifications	V7-T3-165
Dimensions	V7-T3-166

D26 Series—Type M, DC Multipole with Convertible Contacts

Product Description

Type M, DC multipole relays are physically and mechanically similar to the (D26) Type M AC relays described on **Page V7-T3-159**. They differ only in the electrical ratings and available pole combinations due to the use of a normally closed late opening, coil clearing contact, factory wired to the pickup winding of the magnet coil. (Contact is shown as L in figure to the right.) Magnet coil has built-in varistor for transient suppression.

The mechanically latched relay has one extra contact, normally open early closing, factory wired in series with the winding of the intermittent rated latch coil. (Contact is shown as S in figure to the right.)

Component parts for these relays are the same as those listed for the (D26) Type M AC relays on **Page V7-T3-159**, except for the Indicating Light, which is not applicable to a DC relay.

Contact poles D26MPR and D26MPF in 2- to 7-pole relays are convertible NO to NC or vice versa. Simply reverse the terminal screws and rotate the unit pole 180° (in either direction).

Latch Operation

With the latch coil de-energized, energizing the relay coil will pick up the relay and mechanically latch it in the pickup position. With the relay coil de-energized, energizing the latch coil will allow the relay to drop out.

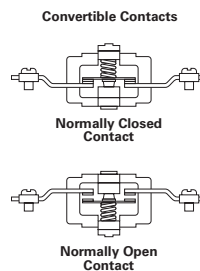

DC Type M Relay

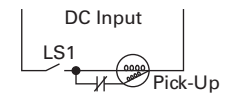

L = NC Late Opening

DC Type M Relay with Latch

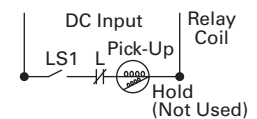

L = NC Late Opening

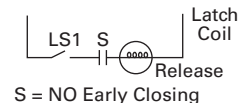

S = NO Early Closing

Product Selection

Complete DC Relays

When Ordering, Specify

- Catalog number and magnet coil suffix letter.
- Example: For a 4-pole relay having 4NO contacts, order Catalog Number **D26MRD40**, with a 120 Vdc coil, order **D26MRD40A1**.

3

3-Pole



3-Pole with Latch



Complete DC Relays—Open Type

Number of Contacts	Type of Contact ^①		Relay Only Catalog Number	Relay with Mechanical Latch Catalog Number
	NO (Form A)	NC (Form B)		
2	2	0	D26MRD20	D26MRD202
	1	1	D26MRD11	D26MRD112
	0	2	D26MRD02	D26MRD022
3	3	0	D26MRD30	D26MRD302
	2	1	D26MRD21	D26MRD212
	1	2	D26MRD12	D26MRD122
4	0	3	D26MRD03	D26MRD032
	4	0	D26MRD40	D26MRD402
	3	1	D26MRD31	D26MRD312
6 ^②	2	2	D26MRD22	D26MRD222
	1	3	D26MRD13	D26MRD132
	0	4	D26MRD04	D26MRD042
	6	0	D26MRD60	D26MRD602
7 ^②	5	1	D26MRD51	D26MRD512
	4	2	D26MRD42	D26MRD422
	3	3	D26MRD33	D26MRD332
	2	4	D26MRD24	D26MRD242
	1	5	D26MRD15	D26MRD152
	0	6	D26MRD06	D26MRD062
	7	0	D26MRD70	—
6	1	D26MRD61	—	
5	2	D26MRD52	—	
4	3	D26MRD43	—	
3	4	D26MRD34	—	
2	5	D26MRD25	—	
1	6	D26MRD16	—	
0	7	D26MRD07	—	

Magnet Coil Selection

Volts/Hertz	Suffix Code	Volts/Hertz	Suffix Code
12	R1	120	A1
24	T1	240	B1
48	W1		

Notes

- ^① Relay has additional factory wired normally closed coil clearing contact (see diagram).
- ^② **10- and 11-Poles:** The 6 and 7 contact relays (without mechanical latch only) listed above can be provided with four additional NO non-convertible contacts. Add suffix number **4** to above listed catalog number plus magnet coil suffix. Example: For an 11 contact relay, order D26MRD70**4A1**.

3-Pole with Timer Attachment**Relay with Pneumatic Timer Attachment (without Relay Contacts)**

Contact Positions ^①	Timer Operation	Catalog Number
3	ON delay	D26MRD005
3	OFF delay	D26MRD006

The relays listed above will accept up to three catalog number D26MPR contacts (convertible—NO or NC) for instantaneous operation.

Order contacts separately. For additional information on timer attachment, see **Page V7-T3-161**.

Technical Data and Specifications**General****Contact Ratings (Amperes) ^②**

DC Volts	Inductive Make/Break	Resistive Make/Break
28	7.0	10.0
48	2.5	10.0
120	1.1	2.0
240	0.2	0.4

Relay	Coil Power		Operating Time
	Watts Inrush	Sealed	Average Milliseconds
Two- to 11-pole	168	13.2	Pickup: 10
Latch coil	21.6 intermittent	21.6 intermittent	Dropout: 16

Notes

- ^① Number of available instantaneous contact positions (order contacts separately—Catalog Number D26MPR).
- ^② Contact ratings do not apply to contacts D26MPL and D26MPS. For AC contact ratings, see **Page V7-T3-161**.

3.7

Control Relays and Timers

Machine Tool Relays

Dimensions

Approximate Dimensions in Inches (mm)

AC and DC D26 Relays

3

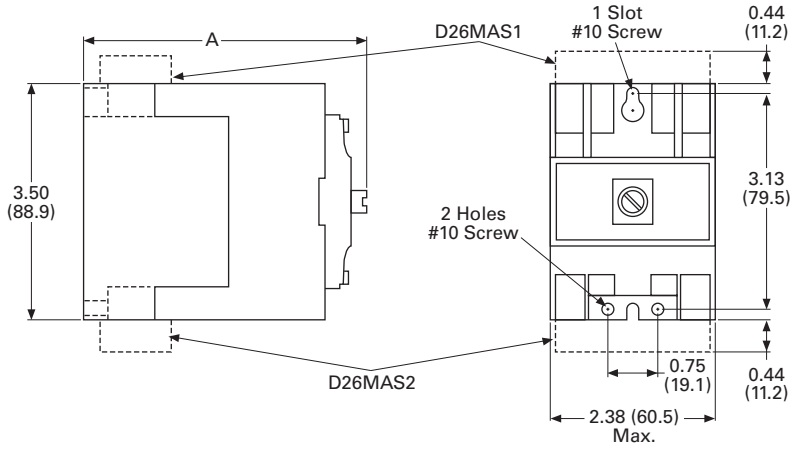

AC Relay D26	DC Relay D26	Dimension A	Ship. Wt. Lbs (kg)
1-4 poles	1-3 poles	4.00 (101.6)	2.5 (1.1)
1-4 poles with timer D26 or D87	1-3 poles with timer D26 or D87	6.00 (152.4)	3.3 (1.5)
1-4 poles with latch	1-2 poles with latch	6.13 (155.7)	3.5 (1.6)
1-4 poles with D26MF	1-3 poles with D26MF	5.81 (147.6)	2.8 (1.3)
5-8 poles	4-7 poles	5.25 (133.4)	2.8 (1.3)
5-8 poles with timer D87	4-7 poles with timer D87	7.25 (184.2)	3.5 (1.6)
5-8 poles with latch	3-6 poles with latch	7.31 (185.7)	3.8 (1.7)
9-12 poles	8-11 poles	7.00 (177.8)	3.0 (1.4)

Mounting Channel

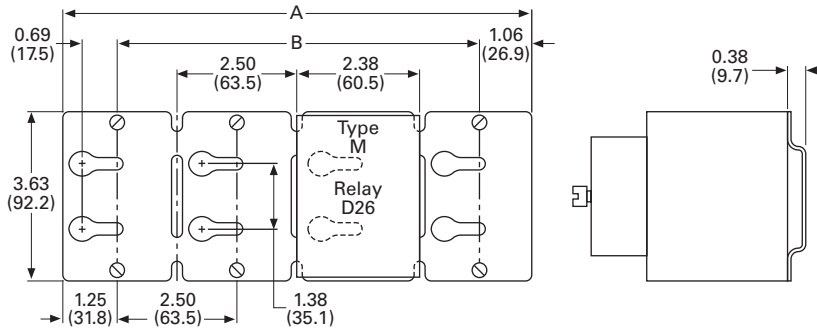

Catalog Number	Dimension A	Dimension B
D26MC16	40 (1016)	37.5 (952.5)
D26MC12	30 (762)	27.5 (698.5)
D26MC8	20 (508)	17.5 (444.5)
D26MC4	10 (254)	7.5 (190.5)

Note: Channel mounts through keyholes with #10 screws (two each end and one every fourth relay). Relays mount with screws captive in channel. All screws must be tightened firmly.

Timing Relays



Contents

Description	Page
Timing Relays	
Universal TR Series	V7-T3-172
TR Series	V7-T3-176
TMR5 Series	V7-T3-179
TMR6 Series	V7-T3-183
TMRP Series	V7-T3-185

Product Selection Guide

Function Code Cross-Reference Guide

Function	Description	Timer Series					
		Universal TR	TR	TMR5	TMR6	TMRP	E5-248 ^③
1	Asymmetrical flasher, pause first	lp	—	R/P	—	—	RC DLY
2	Asymmetrical flasher, pulse first	li	—	Y	—	—	RC
3	ON delay and OFF delay with control contact	ER	—	—	—	—	—
4	ON delay and single shot leading edge voltage controlled	EWu	—	—	—	—	—
5	ON delay and single shot leading edge control contact	EWs	—	—	—	—	—
6	Single shot leading and single shot trailing edge with control contact	WsWa	—	—	—	—	—
7	Pulse sequence monitoring	Wt	—	—	—	—	—
8	ON delay, power triggered	E	A ^①	N	—	A	—
9	Single shot leading edge voltage controlled	Wu	B ^①	T	—	C	—
10	OFF delay/signal OFF delay	R	E ^②	F	—	D	OFF DLY
11	Single shot leading edge with control input	Ws	F ^②	C/G	—	H	SS
12	Single shot trailing edge with control input	Wa	—	—	—	—	—
13	ON delay control signal start, trailing edge OFF	Es	—	—	—	—	—
14	Flasher, pause first	Bp	C ^①	L	—	B	—
15	Retriggerable single shot	—	—	W/D	—	E	SS
16	Flasher, ON first	—	D ^①	—	—	F	—
17	ON delay control signal start, leading edge OFF	—	A ^②	—	—	—	ON DLY
18	Flasher—control signal start, pause first	—	B ^②	—	—	—	RC DLY
19	Flasher—control signal start, ON first	—	C ^②	—	—	—	RC
20	Signal ON/OFF delay	—	D ^②	—	—	—	—
21	ON/OFF delay	—	—	—	—	I	—
22	Single pulse generator	—	—	—	—	G	OS
23	Memory latch	—	—	—	—	J	—
24	True OFF delay	—	—	—	X	—	—

Notes

^① Applies to TRN model only.

^② Applies to TRF model only.

^③ The E5-248 is battery powered and has three programmable trigger functions. This product may perform somewhat differently from the standard timing relays. Refer to the operator instructions for details.

Product Overview

Timer Function Descriptions

Function #1—Universal TR, TMR5, E5-248

Asymmetrical Flasher, Pause First Repeat Cycle, OFF/ON Delay

When the supply voltage U is applied, the set interval t1 begins. After the interval t1 has expired, the output relay R switches into ON position and the set interval t2 begins.

After the interval t2 has expired, the output relay switches into OFF position. The output relay is triggered at the ratio of t1:t2 until the supply voltage is interrupted.

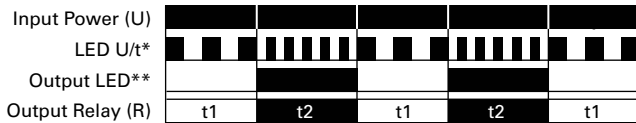

Function #2—Universal TR, TMR5, E5-248

Asymmetrical Flasher, Pulse First Repeat Cycle, ON/OFF Delay

When the supply voltage U is applied, the output relay R switches into the ON position and the set interval t1 begins. After the interval t1 has expired, the output relay R switches into OFF position

and the set interval t2 begins. After the interval t2 has expired, the output relay switches into ON position. The output relay is triggered at the ratio of t1:t2 until the supply voltage is interrupted.

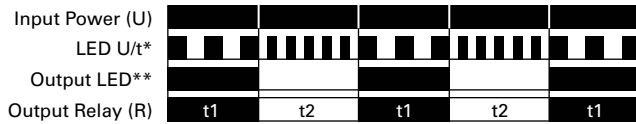

Function #3—Universal TR

ON Delay and OFF Delay with Control Contact

The supply voltage U must be constantly applied to the device. When the control contact S is closed, the set interval t1 begins. After the interval t1 has expired, the output relay R switches into ON position. If the control contact is opened, the set

interval t2 begins. After the interval t2 has expired, the output relay R switches into OFF position. If the control contact is opened before the interval t1 has expired, the interval already expired is erased and is restarted with the next cycle.

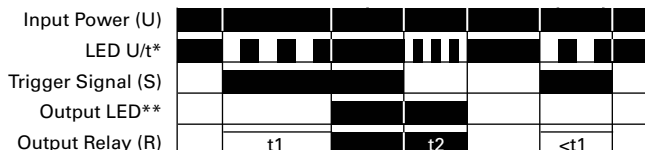

Function #4—Universal TR

ON Delay and Single Shot Leading Edge Voltage Controlled

When the supply voltage U is applied, the set interval t1 begins. After the interval t1 has expired, the output relay R switches into ON position. After the interval t2 has expired, the output relay

switches into OFF position. If the supply voltage is interrupted before the interval t1 + t2 has expired, the interval already expired is erased and is restarted when the supply voltage is next applied.



Function #5—Universal TR

ON Delay and Single Shot Leading Edge Control Contact

The supply voltage U must be constantly applied to the device. When the control contact S is closed, the set interval t1 begins. After the interval t1 has expired, the output relay R switches into ON position and the set

interval t2 begins. After the interval t2 has expired, the output relay R switches into OFF position. During the interval, the control contact is ignored. A new cycle can only be initiated when the control has been completed.

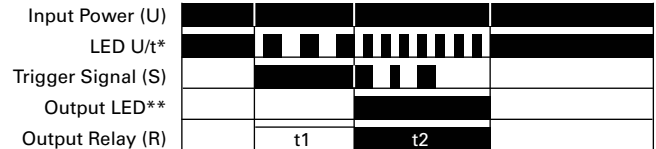

Function #6—Universal TR

Single Shot Leading and Single Shot Trailing Edge with Control Contact Asymmetrical Signal ON/OFF Delay

The supply voltage U must be constantly applied to the device. When the control contact S is closed, the output relay R switches to the ON position and the set interval t1 begins. After the interval t1 has expired, the output relay R switches into OFF position. If the control contact S is opened, the

output relay again switches to the ON position and the set interval t2 begins. After the interval t2 has expired, the output relay R switches into OFF position. During the interval, the control contact is ignored. During the interval, the control contact can be operated any number of times.

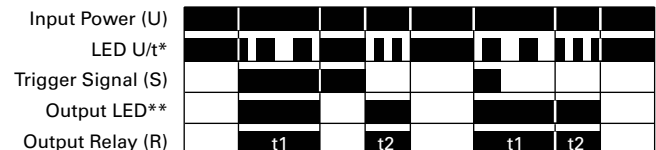

Function #7—Universal TR Pulse Sequence Monitoring

When the supply voltage U is applied, the set interval t1 begins and the output relay R switches to the ON position. After the interval t1 has expired, the interval t2 begins. As long as the control switch S is closed and opened within the

interval t2, the relay will remain in the ON position. If the control switch is not closed and opened within the interval t2, the relay will change to the OFF position until supply voltage U is interrupted and reapplied.

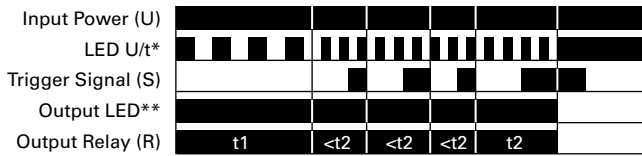

Function #10—Universal TR, TRF, TMR5, TMRP, E5-248 OFF Delay/Signal OFF Delay Delay ON Release

The supply voltage U must be constantly applied to the device. When the control contact S is closed, the output relay R switches to the ON position. When the control contact is opened, interval t begins. After the interval t has expired, the

output relay R switches to the OFF position. If the control contact S is closed before interval t expires, the output relay will remain in the ON position until the control switch opens, at which time the interval t will begin again.

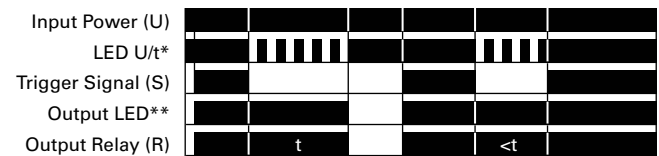

Function #8—Universal TR, TRN, TMR5, TMRP ON Delay, Power Triggerged Delay ON Make

When the supply voltage U is applied, the set interval t begins. After the interval t has expired, the output relay

R switches to the ON position. The relay will remain in that position until supply voltage U is interrupted.

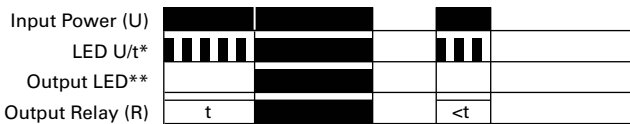

Function #11—Universal TR, TRF, TMR5, TMRP, E5-248 Single Shot Leading Edge with Control Input Single Shot/One Shot (Signal Start)/Momentary Interval

The supply voltage U must be constantly applied to the device. When the control contact S is closed, the output relay R switches to the ON position and the set interval t begins. After the

interval t has expired, the output relay R switches to the OFF position. The control contact is ignored during the interval t, and a new cycle cannot be started until the set interval t has timed out.

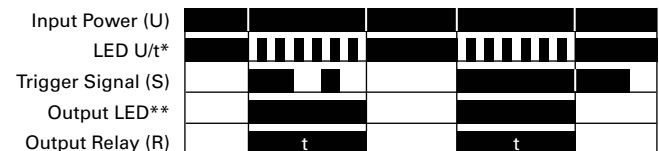

Function #9—Universal TR, TRN, TMR5, TMRP Single Shot Leading Edge Voltage Controlled Interval ON/Interval (Power Start)

When the supply voltage U is applied, the output relay R switches to the ON position and set interval t begins. After the interval t has expired, the output relay R switches to the OFF position.

The relay will remain in that position until supply voltage U is interrupted. If the supply voltage is interrupted prior to interval t timing out, the relay will immediately switch to the OFF position.



Function #12—Universal TR Single Shot Trailing Edge with Control Input

The supply voltage U must be constantly applied to the device. When the control contact S is closed and reopened, the output relay R switches to the ON position and the set interval t begins. After the interval t

has expired, the output relay R switches to the OFF position. The control contact is ignored during the interval t, and a new cycle must be started after the set interval t has timed out.

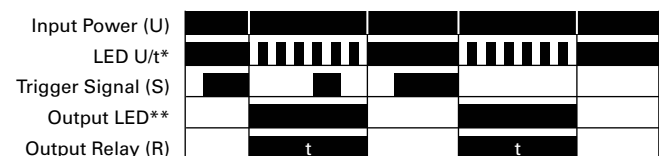

3.8

Control Relays and Timers

Timing Relays

3

Function #13—Universal TR ON Delay Control Signal Start, Trailing Edge OFF

The supply voltage U must be constantly applied to the device. When the control switch S is applied, the set interval t begins. After the interval t has expired, the output relay R switches to the ON position. The relay

will remain in that position until the control switch opens. If the control switch is opened prior to interval t timing out, the relay will remain in the OFF position and any elapsed time will be erased.

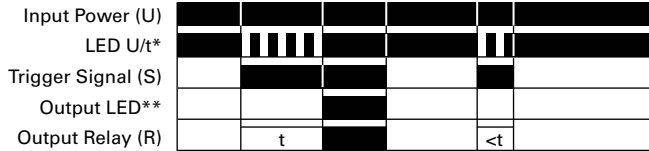

Function #14—Universal TR, TRN, TMR5, TMRP Flasher, Pause First Cycle 1 (Power Start, OFF First)

When the supply voltage U is applied, the set interval t begins. After the interval t has expired, the output relay R switches to the ON position and set interval t will begin again. After interval t

has expired, the relay will switch to the OFF position for the set interval t. This cycle will repeat at a 1:1 ratio until supply voltage U is interrupted.

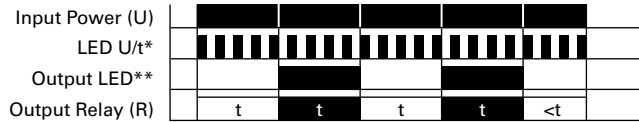

Function #15—TMR5, TMRP, E5-248 Watchdog Retriggerable Single Shot

The supply voltage U must be constantly applied to the device. When the control switch S is applied, the relay switches to the ON position and the set interval t begins. After the interval t has expired, the output relay R

switches to the OFF position. Closing the control switch during interval t will reset the time. Continuous cycling of the trigger signal at a rate faster than the preset time will cause the relay to remain in the ON position.



Function #16—TRN, TMRP Flasher, ON First Cycle 3 (Power Start, ON First)

When the supply voltage U is applied, the relay switches to the ON position and set interval t begins. After the interval t has expired, the output relay R switches to the OFF position and set interval t will begin again.

After interval t has expired, the relay will again switch to the ON position for the set interval t. This cycle will repeat at a 1:1 ratio until supply voltage U is interrupted.



Function #17—TRF, E5-248 ON Delay Control Signal Start, Leading Edge OFF

The supply voltage U must be constantly applied to the device. When the control switch S is applied, the set interval t begins. After the interval t has expired, the output relay R switches to the ON position. The relay will remain in that position

until the control switch has opened and closed. If the control switch is opened and closed prior to interval t timing out, the relay will remain in the OFF position and any elapsed time will be erased.

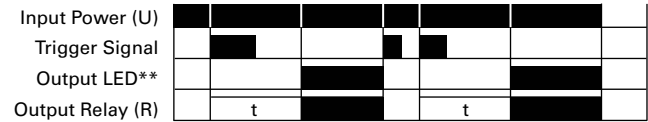

Function #18—TRF, E5-248 Flasher—Control Signal Start, Pause First

The supply voltage U must be constantly applied to the device. When the control switch S is closed, the set interval t begins. After the interval t has expired, the output relay R switches to the ON position and set interval t will begin again.

After interval t has expired, the relay will switch to the OFF position for the set interval t. This cycle will repeat at a 1:1 ratio until supply voltage U is interrupted. The control switch is ignored during the cycle.

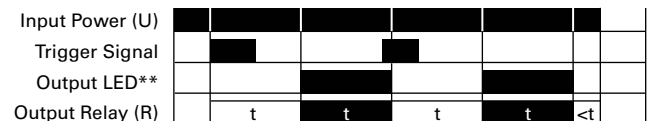

Function #19—TRF, E5-248

Flasher—Control Signal Start, ON First

The supply voltage U must be constantly applied to the device. When the control switch S is closed, the relay switches to the ON position and set interval t begins. After the interval t has expired, the output relay R switches to the OFF position and set interval t will begin

again. After interval t has expired, the relay will again switch to the ON position for the set interval t. This cycle will repeat at a 1:1 ratio until supply voltage U is interrupted. The control switch is ignored during the cycle.

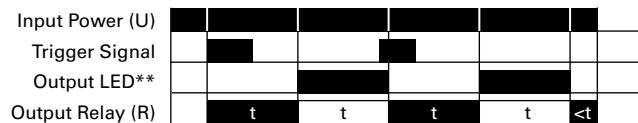

Function #20—TRF Signal ON/OFF Delay

The supply voltage U must be constantly applied to the device. When the control switch S is closed, the relay switches to the ON position and set interval t begins. After the interval t has expired with the control switch still closed, the output relay R switches to the OFF

position. When the control switch is opened, the relay will switch to the ON position again and the interval t will begin. If the control switch is closed and opened within the interval t, the relay will remain in the ON position until interval t has timed out after the control switch is opened.

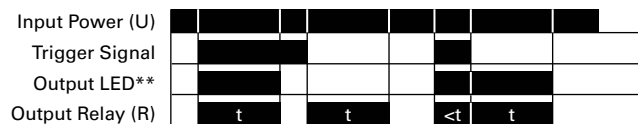

Function #21—TMRP

ON/OFF Delay Make/Break with Control Switch Trigger

The supply voltage U must be constantly applied to the device. When the control switch S is closed, the set interval t begins. After the interval t has expired, the output relay R switches to the ON position. When the

control switch is opened, interval t will begin again. After interval t has timed out, the relay will switch to the OFF position. If supply voltage U is removed at any time, the relay will return to the OFF position.

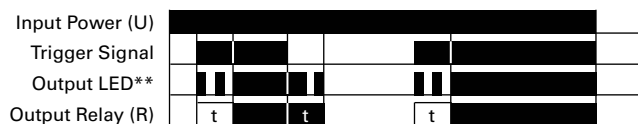

Function #22—TMRP, E5-248

Single Pulse Generator, Voltage Controlled

When the supply voltage U is applied, the set interval t begins. After the interval t has expired, the relay will switch to the ON position for

0.5 seconds before returning to the OFF position. Supply voltage U must be removed and reapplied to repeat the pulse.

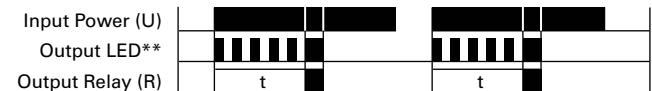

Function #23—N/A

Memory Latch Control Switch Make

The supply voltage U must be constantly applied to the device. Output changes state

with every closure of the control switch S (leading edge).

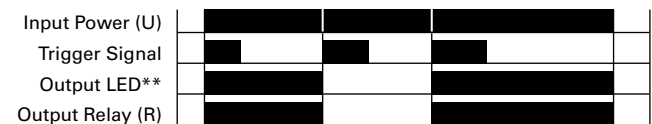

Function #24—TMR6

True OFF Delay

When the supply voltage U is applied, the relay switches to the ON position. When supply power is removed, set time interval t begins. After

interval t has expired, the relay switches to the OFF position and will remain there until supply power U is applied again.



Universal TR Series



3

Universal TR Series

Product Description

Eaton's Universal TR Series timers are our most flexible and cost-effective timing relays available. Products are available with up to seven user-selectable functions and seven user-selectable time ranges. Each unit is DIN rail mountable with a direct connection, eliminating the need for additional sockets. The Universal TR Series timers are available in SPDT and DPDT contact configurations, and have a compact IEC-style footprint and a universal input voltage range for AC and DC applications.

Application Description

A timing relay is a simple form of time-based control, allowing the user to open or close the contacts based on a specified timing function. The Universal TR Series timers are equipped with a set of selector switches, which can easily be set to a specific function and time, thereby reducing the number of product variations required. The universal input voltage (either 12–240 Vac/Vdc or 24–240 Vac/Vdc, depending on the model) further reduces the number of product variations.

The Universal TR Series timers are ideal for high-variability operations, such as systems integrators, distributors, and small equipment manufacturers. The compact design saves panel space, and the low cost and high flexibility of the units reduce inventory requirements.

Contents

Description

	<i>Page</i>
Universal TR Series	
Product Selection	V7-T3-173
Technical Data and Specifications	V7-T3-173
Wiring Diagrams	V7-T3-174
Dimensions	V7-T3-175
TR Series	V7-T3-176
TMR5 Series	V7-T3-179
TMR6 Series	V7-T3-183
TMRP Series	V7-T3-185

Features

- Multiple user-selectable timing functions and timing ranges in a single unit reduce product variations and stock keeping units (SKUs)
- Universal input voltages from 12 or 24 to 240 Vac or Vdc eliminate the need to order and stock separate coil voltages
- Compact, DIN rail mountable case reduces panel size
- Advanced LED indication makes troubleshooting easy
- Staggered terminal locations allow access to lower-level terminals after wiring
- SPDT or DPDT contacts with 8 A ratings

Standards and Certifications

- cULus listed
- CE marked
- RoHS compliant
- IEC/EN 61812



Product Selection

Single-Pole Model

Universal TR Timing Relays



Supply Voltage	Description	Catalog Number
4-Function		
24–240 Vac/Vdc	Compact DIN rail mount, SPDT	TRL04
7-Function		
24–240 Vac/Vdc	Compact DIN rail mount, SPDT	TRL07
12–240 Vac/Vdc	Compact DIN rail mount, DPDT	TRL27
	Asymmetrical pulse generator, DPDT	TRW27

Technical Data and Specifications

Universal TR Timing Relays

Description	TRL04	TRL07	TRL27	TRW27
Functions ^①	E, R, Wu, Bp	E, R, Wu, Bp, Ws, Wa, Es	E, R, Wu, Bp, Ws, Wa, Es	li, lp, ER, Ewu, Ews, WsWa, Wt
Time range	0.05 sec to 100 hours	0.05 sec to 100 hours	0.05 sec to 100 hours	0.05 sec to 100 hours
Input				
Supply voltage	24–240 Vac/Vdc	24–240 Vac/Vdc	12–240 Vac/Vdc	12–240 Vac/Vdc
Rated supply frequency	+10% /–15%	+10% /–15%	±10%	±10%
Rated consumption	4 VA (1.5 W)	4 VA (1.5 W)	6 VA (2 W)	6 VA (2 W)
Duty cycle	100%	100%	100%	100%
Reset time	100 ms	100 ms	100 ms	100 ms
Residual ripple for DC	10%	10%	10%	10%
dropout voltage	>30% of rated supply voltage	>30% of rated supply voltage	>30% of rated supply voltage	>30% of rated supply voltage
Overvoltage category	III (in accordance with IEC 60664-1)	III (in accordance with IEC 60664-1)	III (in accordance with IEC 60664-1)	III (in accordance with IEC 60664-1)
Rated surge voltage	4 kV	4 kV	4 kV	4 kV
Output				
Contact configuration	SPDT (one changeover contact)	SPDT (one changeover contact)	DPDT (two changeover contacts)	DPDT (two changeover contacts)
Rated voltage	250 Vac	250 Vac	250 Vac	250 Vac
Switching capacity	2000 VA (8 A/250 V)	2000 VA (8 A/250 V)	2000 VA (8 A/250 V)	2000 VA (8 A/250 V)
Fusing	8 A fast acting	8 A fast acting	8 A fast acting	8 A fast acting
Mechanical life	20 x 10 ⁶ operations	20 x 10 ⁶ operations	20 x 10 ⁶ operations	20 x 10 ⁶ operations
Electrical life	2 x 10 ⁵ operations at 1000 VA load, resistive	2 x 10 ⁵ operations at 1000 VA load, resistive	2 x 10 ⁵ operations at 1000 VA load, resistive	2 x 10 ⁵ operations at 1000 VA load, resistive
Switching frequency	Max. 6/min. at 1000 VA resistive load (in accordance with IEC 60947-5-1)	Max. 6/min. at 1000 VA resistive load (in accordance with IEC 60947-5-1)	Max. 6/min. at 1000 VA resistive load (in accordance with IEC 60947-5-1)	Max. 6/min. at 1000 VA resistive load (in accordance with IEC 60947-5-1)
Overvoltage category	III (in accordance with IEC 60664-1)	III (in accordance with IEC 60664-1)	III (in accordance with IEC 60664-1)	III (in accordance with IEC 60664-1)
Rated surge voltage	4 kV	4 kV	4 kV	4 kV
Control Signal				
Loadable	Yes	Yes	Yes	Yes
Maximum cable length	10m	10m	10m	10m
Trigger level (sensitivity)	Automatic adaption to supply voltage	Automatic adaption to supply voltage	Automatic adaption to supply voltage	Automatic adaption to supply voltage
Minimum control pulse length	DC 50 ms/AC 100 ms	DC 50 ms/AC 100 ms	DC 50 ms/AC 100 ms	DC 50 ms/AC 100 ms

Note

^① Refer to Function Code Cross-Reference Guide on **Page V7-T3-167** for function details.

Universal TR Timing Relays, continued

Description	TRL04	TRL07	TRL27	TRW27
Accuracy				
Base accuracy	±1% of maximum scale value	±1% of maximum scale value	±1% of maximum scale value	±1% of maximum scale value
Adjustment accuracy	<5% of maximum scale value	<5% of maximum scale value	<5% of maximum scale value	<5% of maximum scale value
Repetition accuracy	<0.5% or ±5 ms	<0.5% or ±5 ms	<0.5% or ±5 ms	<0.5% or ±5 ms
Temperature influence	≤0.01% / °C	≤0.01% / °C	≤0.01% / °C	≤0.01% / °C
Physical				
Ambient temperature	-25 to 55 °C	-25 to 55 °C	-25 to 55 °C	-25 to 55 °C
Storage temperature	-25 to 70 °C	-25 to 70 °C	-25 to 70 °C	-25 to 70 °C
Relative humidity	15% to 85% (in accordance with IEC 60721-3-3 Class 3K3)	15% to 85% (in accordance with IEC 60721-3-3 Class 3K3)	15% to 85% (in accordance with IEC 60721-3-3 Class 3K3)	15% to 85% (in accordance with IEC 60721-3-3 Class 3K3)
Pollution degree	2, if built in 3 (in accordance with IEC 60664-1)	2, if built in 3 (in accordance with IEC 60664-1)	2, if built in 3 (in accordance with IEC 60664-1)	2, if built in 3 (in accordance with IEC 60664-1)
Housing material	Self-extinguishing plastic housing, IP40 rating	Self-extinguishing plastic housing, IP40 rating	Self-extinguishing plastic housing, IP40 rating	Self-extinguishing plastic housing, IP40 rating
Mounting	Mounted on DIN rail TS 35 according to EN 60715, any position	Mounted on DIN rail TS 35 according to EN 60715, any position	Mounted on DIN rail TS 35 according to EN 60715, any position	Mounted on DIN rail TS 35 according to EN 60715, any position
Terminal rating	Shockproof terminal connection according to VBG 4 (PZ1 required), IP20 rating	Shockproof terminal connection according to VBG 4 (PZ1 required), IP20 rating	Shockproof terminal connection according to VBG 4 (PZ1 required), IP20 rating	Shockproof terminal connection according to VBG 4 (PZ1 required), IP20 rating
Tightening torque	Max. 1 Nm	Max. 1 Nm	Max. 1 Nm	Max. 1 Nm

Terminal Capacity

Description

- 1 x 0.5 to 2.5 mm² with/without multicore cable end
- 1 x 4 mm² without multicore cable end
- 2 x 0.5 to 1.5 mm² with/without multicore cable end
- 2 x 2.5 mm² flexible without multicore cable end

Wiring Diagrams

Single-Pole, Double-Throw Units (SPDT)—TRL04 and TRL07

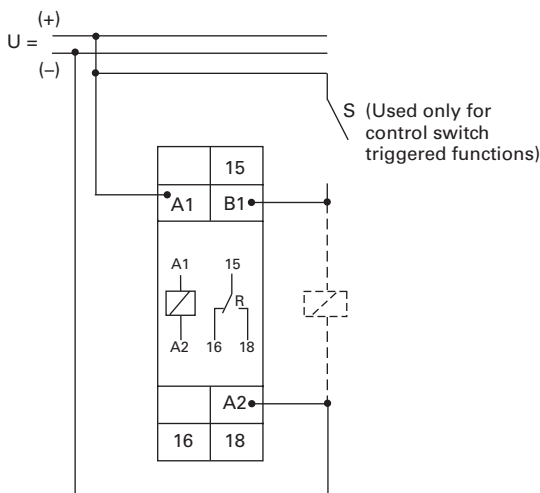

Double-Pole, Double-Throw Units (DPDT)—TRL27 and TRW27

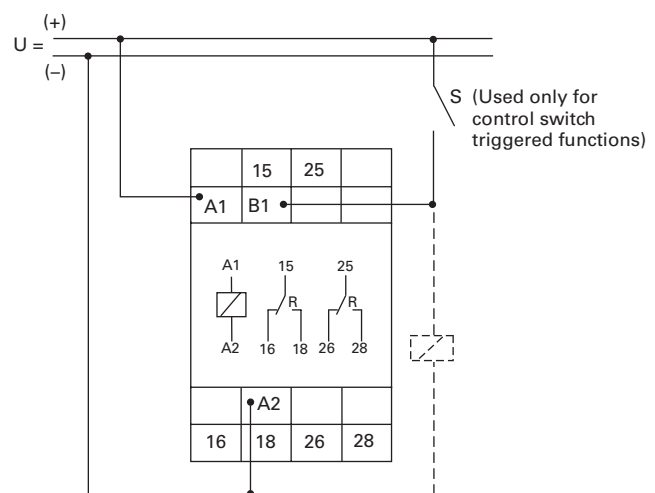

Dimensions

Approximate Dimensions in Inches (mm)

17.5 mm (TRL04 and TRL07)

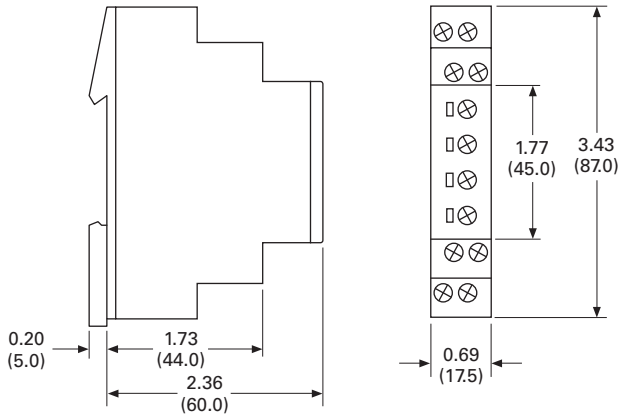

35 mm (TRL27 and TRW27)

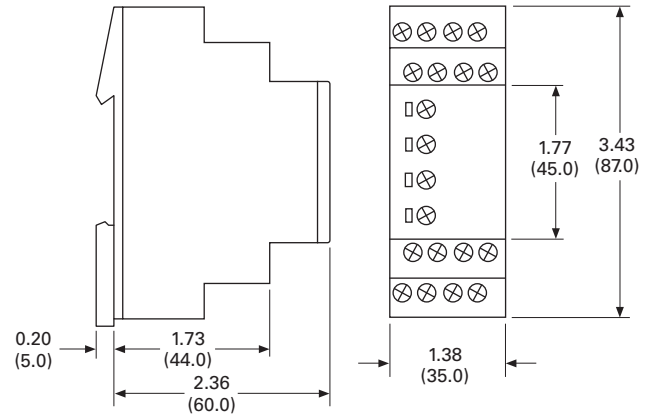

TR Series

3



TR Series

Product Description

The upgraded TR Series Timing Relays are designed to meet most timing requirements by offering more flexibility in range of input voltage, timing range and functionality. Use a rotary switch to choose from 20 selectable time ranges from 0.1 second to 600 hours. We offer both a power triggered and signal triggered model—each with expanded operation modes. There is a green LED to indicate when power is ON and an orange LED when output is ON.

Features

- 20 time ranges and 10 timing functions
- Time delays from 0.1 sec to 600 hrs
- Space-saving, compact package
- High repeat accuracy of $\pm 0.2\%$
- LED indication
- Standard 8- or 11-pin and 11-blade termination
- 2 Form C DPDT delayed output contacts
- 10 A contact rating

Contents

Description

	<i>Page</i>
Universal TR Series	V7-T3-172
TR Series	
Catalog Number Selection	V7-T3-177
Product Selection	V7-T3-177
Accessories	V7-T3-177
Technical Data and Specifications	V7-T3-178
Dimensions	V7-T3-178
TMR5 Series	V7-T3-179
TMR6 Series	V7-T3-183
TMRP Series	V7-T3-185

Operation

TRNP and TRNB

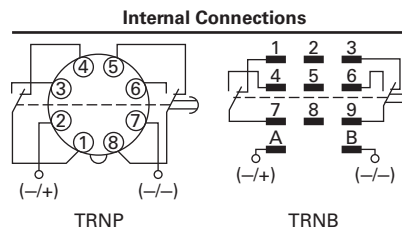

TRFP and TRFB

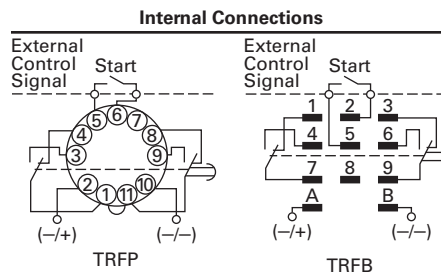

Standards and Certifications

- cULus listed
- CSA
- CE marked
- TUV



Catalog Number Selection

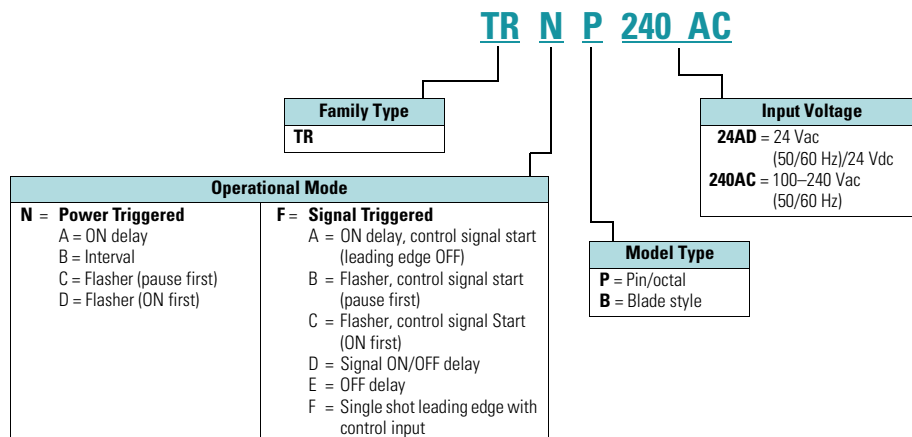

Product Selection

TR Plug-In Timing Relays—Power Triggered

Coil Voltage	Octal Catalog Number	Blade Catalog Number
24 Vac/Vdc	TRNP24AD	TRNB24AD
100–240 Vac	TRNP240AC	TRNB240AC

TR Plug-In Timing Relays—Signal Triggered

Coil Voltage	Octal Catalog Number	Blade Catalog Number
24 Vac/Vdc	TRFP24AD	TRFB24AD
100–240 Vac	TRFP240AC	TRFB240AC

Accessories

Sockets for Use with TR Timers—Standard Pack of 10

Timing Relay	Terminal Style	Catalog Number
TRNP	8-pin octal	D3PA2
TRFP	11-pin octal	D3PA3
TRNB, TRFB	0.187 in solder/QC terminals (blade style)	D5PA2

Technical Data and Specifications

General

Description	Specification
Operation system	Solid-state CMOS circuit
Time range	0.1 sec to 600 hours
Pollution degree	2 (IE60664-1)
Overvoltage category	III (IE60664-1)
Rated operational voltage	
240 AC	100–240 Vac (50/60 Hz)
24 AC	24 Vac (50/60 Hz)/24 Vdc
12 DC	12 Vdc
Voltage tolerance	
240 AC	85–264 Vac (50/60 Hz)
24 AC	20.4–26.4 Vac (50/60 Hz)/21.6–26.4 Vdc
12 DC	10.8–13.2 Vdc
Input OFF voltage	Rated voltage x 10% minimum
Ambient operating temperature	–4 to 149 °F (–20 to 65 °C)
Reset time	100 ms maximum
Repeat error	± 0.2%, ± 20 ms ^①
Voltage error	± 0.2%, ± 20 ms ^①
Temperature error	± 0.5%, ± 20 ms ^①
Setting error	± 10% maximum
Insulation resistance	100M ohm minimum (500 Vdc)
Dielectric strength	
Between power and output terminals	2000 Vac, 1 minute
Between contacts of different poles	2000 Vac, 1 minute
Between contacts of same pole	1000 Vac, 1 minute
Vibration resistance	10–55 Hz amplitude 0.5 mm; 2 hrs in each of 3 axes
Shock resistance	
Operating extremes	10G
Damage limits —	
TRNP, TRFP	40G (3x in each of 3 axes)
TRNB, TRFB	10G (3x in each of 3 axes)
Power consumption (approx.)	
240 AC	6.5 VA TRNP, TRNB/6.6 VA TRFP, TRFB
240 Vac/60 Hz	11.6 VA TRNP, TRNB/12.1 VA TRFP, TRFB
24 AC (AC/DC)	3.4 VA–1.7 W TRNP, TRNB/3.5 VA–1.7 W TRFP, TRFB
12 DC	1.6 W

TR Series Contact Ratings

Description	Specification
Contact configuration	2 Form C, DPDT (delayed output)
Allowable voltage/current	240 Vac, 30 Vdc/10 A
Max. permissible operating frequency	1800 cycles per hour
Rated load	
Resistive	10 A, 240 Vac/30 Vdc
Inductive	7 A, 240 Vac/30 Vdc
Horsepower rating	1/6 hp 120 Vac, 1/3 hp 240 Vac
Life	
Electrical	500,000 operations minimum (resistive)
Mechanical	50,000,000 operations minimum

Dimensions

Approximate Dimensions in Inches (mm)

TR Series Dimensions and Weights

Description	Specification
Dimensions	
TRNP, TRFP	1.58H x 1.42W x 3.07D in. (40H x 36W x 77.9D mm)
TRNB, TRFB	1.58H x 1.42W x 2.95D in. (40H x 36W x 74.9D mm)
Weights	
TRNP	87g
TRFP	89g
TRNB, TRFB	85g

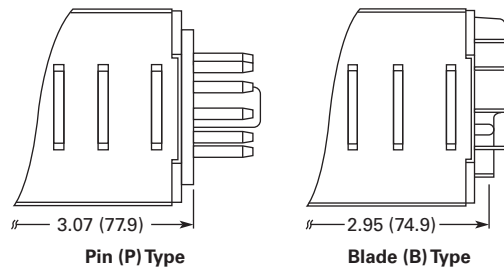

Note

^① For the value of the error against a preset time, whichever value is larger should apply.

TMR5 Series



TMR5 Series

Product Description

The TMR5 Series Time Delay Relays are designed for a broad range of OEM applications. The TMR5 Series offers non-programmable plug-in style timers with a variety of functions available. Each unit offers a single function and single input voltage, and operates over a defined time delay range. Units with fixed time delays are also available. Eaton also offers customization capabilities for these timers—remote adjustments, special pin configurations, and more. Contact us to discuss your specific application and design of a custom timer.

Features

- Single timing range for each unit
- Ranges available from 0.02 sec to 24 hours
- Wide variety of functions available
- Plugs into standard 8- or 11-pin socket
- 10 A DPDT output contacts
- Can be easily customized to meet your needs

Contents

Description

Description	Page
Universal TR Series	V7-T3-172
TR Series	V7-T3-176
TMR5 Series	
Catalog Number Selection	V7-T3-180
Product Selection	V7-T3-180
Accessories	V7-T3-180
Technical Data and Specifications	V7-T3-181
Wiring Diagrams	V7-T3-181
Dimensions	V7-T3-182
TMR6 Series	V7-T3-183
TMRP Series	V7-T3-185

Standards and Certifications

- cRUus
- UL listed (with Eaton socket)
- RoHS compliant
- CE marked

cRUUS

ROHS
COMPLIANT

Catalog Number Selection

All configurations from Catalog Number Selection are available.

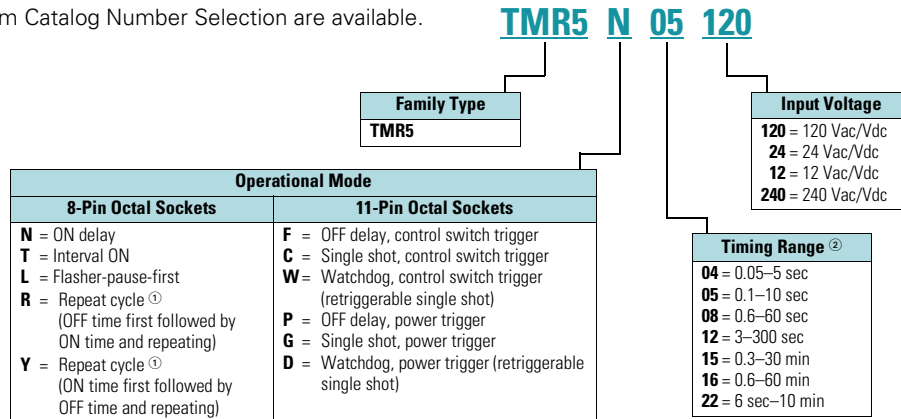

Product Selection

TMR5 Time Delay Relays

Input Voltage	Socket	Timing Range	Catalog Number
ON Delay			
120 Vac/Vdc	8-pin	0.1–10 sec	TMR5N05120
		0.6–60 sec	TMR5N08120
24 Vac/Vdc		0.1–10 sec	TMR5N0524
		0.6–60 sec	TMR5N0824
OFF Delay, Control Switch Trigger			
120 Vac/Vdc	11-pin	0.1–10 sec	TMR5F05120
		0.6–60 sec	TMR5F08120
24 Vac/Vdc		0.1–10 sec	TMR5F0524
		0.6–60 sec	TMR5F0824
Interval ON			
120 Vac/Vdc	8-pin	0.1–10 sec	TMR5T05120
		0.6–60 sec	TMR5T08120
24 Vac/Vdc		0.1–10 sec	TMR5T0524
		0.6–60 sec	TMR5T0824
Single Shot, Control Switch Trigger			
120 Vac/Vdc	11-pin	0.1–10 sec	TMR5C05120
		0.6–60 sec	TMR5C08120
24 Vac/Vdc		0.1–10 sec	TMR5C0524
		0.6–60 sec	TMR5C0824
Repeat Cycle (OFF Time First Followed by ON Time and Repeating)			
120 Vac/Vdc	8-pin	0.1–10 sec	TMR5R05120
		0.6–60 sec	TMR5R08120
24 Vac/Vdc		0.1–10 sec	TMR5R0524
		0.6–60 sec	TMR5R0824
Repeat Cycle (ON Time First Followed by OFF Time and Repeating)			
120 Vac/Vdc	8-pin	0.1–10 sec	TMR5Y05120
		0.6–60 sec	TMR5Y08120
24 Vac/Vdc		0.1–10 sec	TMR5Y0524
		0.6–60 sec	TMR5Y0824

Accessories

Accessories for Use with TMR5 Time Delay Relays

Description	Standard Pack	Catalog Number
8-pin socket	10	D3PA2
11-pin socket	10	D3PA3-A2
Hold-down spring	10	D65CHDS

Notes

- Indicates DUAL knob unit. All dual knob units can have independently selectable and adjustable ON and OFF times. If different ON and OFF times are desired, add two codes for time ranges in the part number. The first code listed indicates the first timing range of the unit (OFF time for R, ON time for Y) and the second code indicates the second timing range (ON time for R, OFF Time for Y).
- Fixed time delay settings are available for orders of 50 pieces or more. Contact EatonCare for additional information at 877-ETN-CARE (386-2273).

Technical Data and Specifications

TMR5 Time Delay Relays

Description	Specification
Voltage tolerance	
AC operation	+10/−15% of nominal at 50/60 Hz
DC operation	+10/−15% of nominal
Load burden	2 VA
Setting accuracy	
Maximum setting (adjustable)	+5%, −0%
Minimum setting (adjustable)	+0%, −50%
Fixed time delay	
< 2 seconds	+1%
0.1–2 seconds	±5%
Repeat accuracy (constant voltage and temperature)	
> 2 seconds delay	±0.1%
0.1–2 seconds delay	±2%
Reset time	
ON Delay/interval/repeat cycle	0.1 second
OFF Delay/single shot/watchdog	0.04 second
Startup time (time from when power is applied until unit is timing)	
120 and 240 V units	0.05 second
12, 24 and 48 V units	0.08 second
Maintain function time (time unit continues to time after power is removed)	0.01 second
Temperature	
12–120 V input voltage	−18 to 150 °F (−28 to 65 °C)
240 V input voltage	−18 to 122 °F (−28 to 50 °C)
Insulation voltage	2000 V
Output contacts	DPDT 10 A @ 240 Vac/30 Vdc, 1/2 hp @ 120/240 Vac (NO contacts) 1/3 hp @ 120/240 Vac (NC contacts) B300 and R300; AC-15 and DC-13
Life	
Mechanical	10,000,000 operations
Full load	100,000 operations

Wiring Diagrams

Wiring for 8-Pin Units

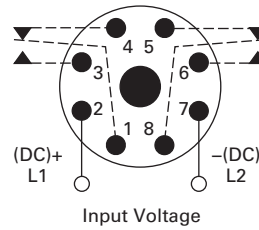

Wiring for 11-Pin Control Switch Trigger Units

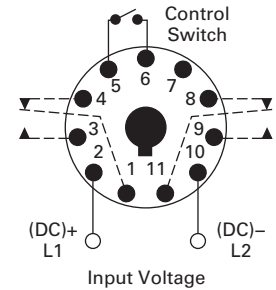

Wiring for 11-Pin Power Trigger Units

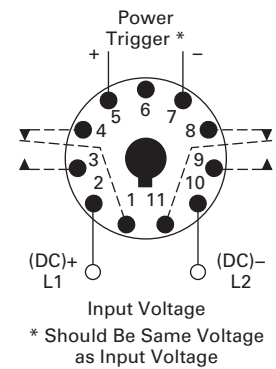

3.8

Control Relays and Timers

Timing Relays

Dimensions

Approximate Dimensions in Inches (mm)

TMR5

3

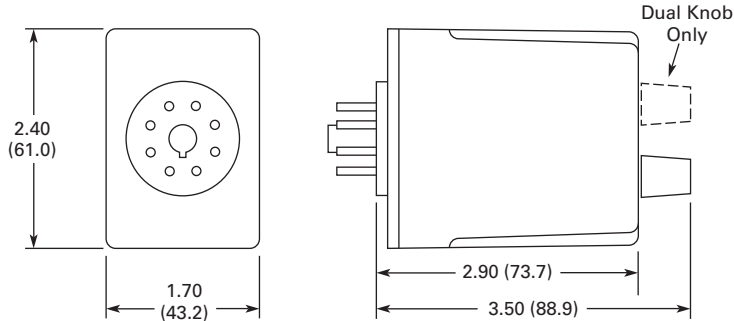

D3PA2 Socket

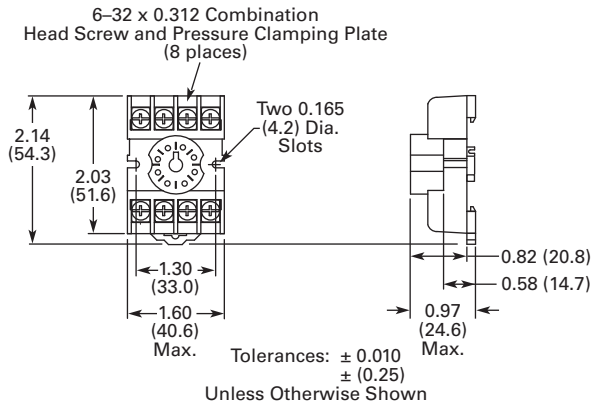

D3PA3 Socket

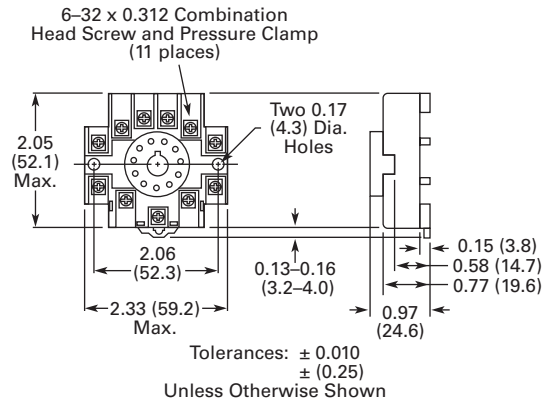

TMR6 Series



TMR6 Series

Product Description

Most electronic time delay relays with an OFF delay function require input voltage to be applied continuously in order to operate correctly. However, there are many applications where this is not possible—keeping a relay energized for some amount of time after input voltage has been removed. Eaton's TMR6 true OFF delay product provides this function even when input voltage is removed. It duplicates the operation of the older OFF delay pneumatic time delay relays.

Features

- Provides OFF delay function without requiring input voltage during OFF time delay
- Duplicates operation of pneumatic OFF delay timers
- Each unit has eight timing ranges built in, covering 0.05 seconds to 30 minutes
- Selecting a range is easy using a rotary switch (no math is required or DIP switches to set)
- Uses industry-standard 8-pin octal socket
- 10 A DPDT output contacts

Timing Ranges

Select one of the eight timing ranges using the selector knob, and then adjust the time within that range for an accurate delay setting.

Timing Ranges

Dial Setting	Timing Range
A	0.05–5 sec.
B	0.1–10 sec.
C	0.3–30 sec.
D	0.6–60 sec.
E	1.8–180 sec.
F	3–300 sec.
G	0.1–10 min.
H	0.3–30 min.

Contents

Description

Description	Page
Universal TR Series	V7-T3-172
TR Series	V7-T3-176
TMR5 Series	V7-T3-179
TMR6 Series	
Catalog Number Selection	V7-T3-184
Product Selection	V7-T3-184
Accessories	V7-T3-184
Technical Data and Specifications	V7-T3-184
Wiring Diagram	V7-T3-184
Dimensions	V7-T3-184
TMRP Series	V7-T3-185

Operation

True OFF Delay

Upon application of input voltage, the relay is energized. When the input voltage is removed, the preset time begins. At the end of the preset time, the relay is de-energized.

Voltage must be applied for a minimum of 0.1 second to assure proper operation.

Any application of the input voltage during the preset time will keep the relay energized and reset the time delay. No external trigger switch is required.

True OFF Delay

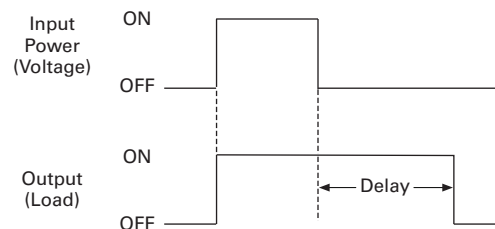

Standards and Certifications

- cRUus
- UL listed (with Eaton socket)
- RoHS compliant
- CE marked



3.8

Control Relays and Timers

Timing Relays

3

Catalog Number Selection

All configurations from Catalog Number Selection are available.

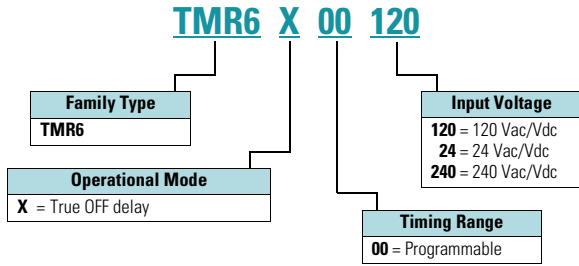

Wiring Diagram

Wiring for 8-Pin Units

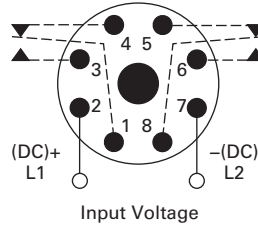

Product Selection

TMR6 True OFF Delay Relays

Input Voltage	Timing Range	Catalog Number
True OFF Delay		
120 Vac/Vdc	0.05 sec–30 min (user selectable, 8 ranges)	TMR6X00120
24 Vac/Vdc		TMR6X0024
240 Vac/Vdc		TMR6X00240

Accessories

Accessories for Use with TMR6 Time Delay Relays

Description	Standard Pack	Catalog Number
8-pin socket	10	D3PA2
Hold-down spring	10	D65CHDS

Technical Data and Specifications

TMR6 Time Delay Relays

Description	Specification
Voltage tolerance	
AC operation	+10/–15% of nominal at 50/60 Hz
DC operation	+10/–15% of nominal
Load burden	2 VA
Setting accuracy	
Maximum setting (adjustable)	+5%, –0%
Minimum setting (adjustable)	+0%, –50%
Repeat accuracy (constant voltage and temperature)	±0.1% or 50 ms, whichever is greater
Temperature	–18 to 150 °F (–28 to 65 °C)
Insulation voltage	2,000 V
Output contacts	DPDT 10 A @ 240 Vac/30 Vdc, 1/2 hp @ 120/240 Vac (NO contacts) 1/3 hp @ 120/240 Vac (NC contacts) B300 and R300; AC-15 and DC-13
Life	
Mechanical	2,000,000 operations
Full load	100,000 operations

Dimensions

Approximate Dimensions in Inches (mm)

TMR6

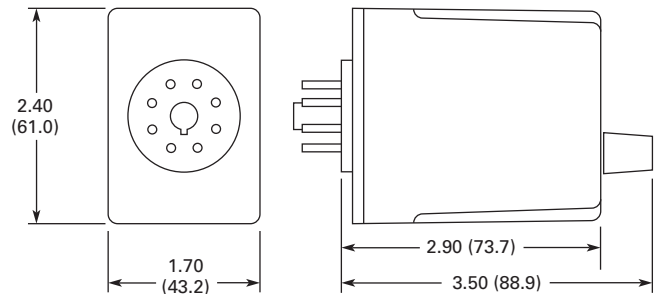

D3PA2 Socket

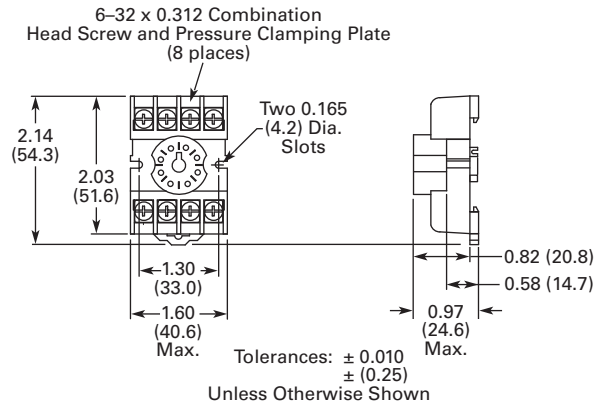

TMRP Series



TMRP Series

Product Description

Eaton's TMRP Series timers combine flexibility with ease of use and installation to make the most versatile timer in our offering. The thumb-wheel setting design allows for quick selection and review of up to 10 timing functions and seven timing ranges. The TMRP units can be mounted in a 1/16 DIN cutout or on a DIN rail with our D3 series sockets. Input voltage is 12–240 Vac/Vdc to work with all popular control voltages.

Application Description

A timing relay is a simple form of time-based control, allowing the user to open or close the contacts based on a specified timing function. The TMRP series is equipped with a set of thumb-wheel style selector switches, which can easily be set to a specific function and time, thereby reducing the number of product variations required. The universal input voltage of 12–240 Vac/Vdc further reduces the number of product variations.

The TMRP timers are ideal for high-variability operations, such as systems integrators, distributors, and small equipment manufacturers. The flexible enclosure design allows for back-panel mounting, through-panel mounting, or DIN rail mounting.

Contents

Description	Page
Universal TR Series	V7-T3-172
TR Series	V7-T3-176
TMR5 Series	V7-T3-179
TMR6 Series	V7-T3-183
TMRP Series	
Product Selection	V7-T3-186
Technical Data and Specifications	V7-T3-186
Wiring Diagrams	V7-T3-187
Dimensions	V7-T3-187

Features

- Multiple user-selectable timing functions and timing ranges in a single unit reduce product variations and stock keeping units (SKUs)
- Universal input voltages from 12–240 Vac/Vdc eliminate the need to order and stock separate coil voltages
- Timing ranges up to 9990 hours
- Dual LED indication makes troubleshooting easy
- Flexible design for back-panel, through-panel (45 mm x 45 mm cutout), or DIN rail mounting
- SPDT or DPDT contacts with 12 A ratings
- Plastic dust cover keeps out contaminants and eliminates accidental set point changes
- Use with standard Eaton D3 sockets—see Technical Data and Specifications

LED Indicator

LED Description	Function
Solid green "Input"	Supply voltage present
Solid red "Output"	Relay energized
Slowly flashing red "Output"	Timing cycle activated, relay not energized
Rapidly flashing red "Output"	Timing cycle activated, relay energized

Standards and Certifications

- UL recognized
- CE marked
- RoHS compliant



Product Selection

TMRP5100

TMRP Timing Relays



Supply Voltage	Description	Catalog Number
10-Function		
12–240 Vac/Vdc	Control switch trigger, DPDT	TMRP5100
	Control switch trigger, SPDT	TMRP5101
	Power trigger, DPDT	TMRP5102

Technical Data and Specifications

TMRP Timing Relays

Description	TMRP5100	TMRP5101	TMRP5102
Functions ^①	A, B, C, D, E, F, G, H, I, J	A, B, C, D, E, F, G, H, I, J	A, B, C
Time range	0.1 sec to 9,990 hours	0.1 sec to 9,990 hours	0.1 sec to 9,990 hours
Input			
Supply voltage	12–240 Vac/Vdc	12–240 Vac/Vdc	12–240 Vac/Vdc
Supply voltage tolerance	±15%	±15%	±15%
Rated consumption	2.5 VA (2 W) maximum	2.5 VA (2 W) maximum	2.5 VA (2 W) maximum
Reset time	150 ms	150 ms	150 ms
Reverse polarity protection	Yes	Yes	Yes
Operate time	25 ms maximum	25 ms maximum	25 ms maximum
Release time	25 ms maximum	25 ms maximum	25 ms maximum
Rated surge voltage	4 kV	4 kV	4 kV
Output			
Contact configuration	DPDT	SPDT	DPDT
Contact rating (AC)	12 A resistive at 120, 240 UL 508	12 A resistive at 120, 240 UL 508	12 A resistive at 120, 240 UL 508
Contact rating (DC)	12 A resistive at 30 UL 508	12 A resistive at 30 UL 508	12 A resistive at 30 UL 508
Contact rating horsepower	1/2 at 120 Vac, 1 at 240 Vac	1/2 at 120 Vac, 1 at 240 Vac	1/2 at 120 Vac, 1 at 240 Vac
Contact rating pilot duty	A300, 720 VA at 240 Vac	A300, 720 VA at 240 Vac	A300, 720 VA at 240 Vac
Minimum load	12 V/100 mA	12 V/100 mA	12 V/100 mA
Contact material	Silver-nickel 90/10	Silver-nickel 90/10	Silver-nickel 90/10
Contact resistance	100 milliohms max. at 1 A 12 Vdc	100 milliohms max. at 1 A 12 Vdc	100 milliohms max. at 1 A 12 Vdc
Mechanical life—full load	10 million operations	10 million operations	10 million operations
Electrical life—full load	100,000 operations	100,000 operations	100,000 operations
Control Signal			
Minimum control pulse length	50 ms minimum	50 ms minimum	50 ms minimum
Accuracy			
Repetition accuracy	0.10% at constant voltage and temperature	0.10% at constant voltage and temperature	0.10% at constant voltage and temperature
Physical			
Ambient temperature	–10 to 55 °C	–10 to 55 °C	–10 to 55 °C
Storage temperature	–40 to 85 °C	–40 to 85 °C	–40 to 85 °C
Mounting	Use with D3PA3 socket	Use with D3PA2 socket	Use with D3PA2 socket

Note

^① Refer to Function Code Cross-Reference Guide on **Page V7-T3-167** for function details.

Wiring Diagrams

TMRP5100

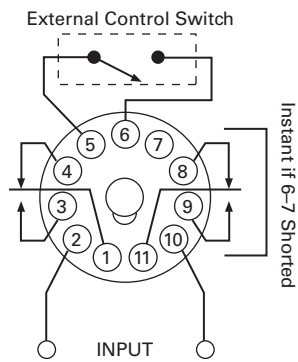

TMRP5101

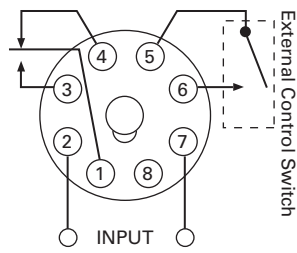

TMRP5102

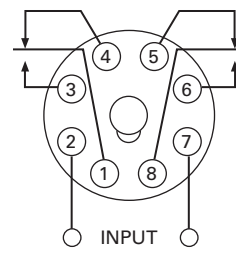

Dimensions

Approximate Dimensions in Inches (mm)

TMRP Series

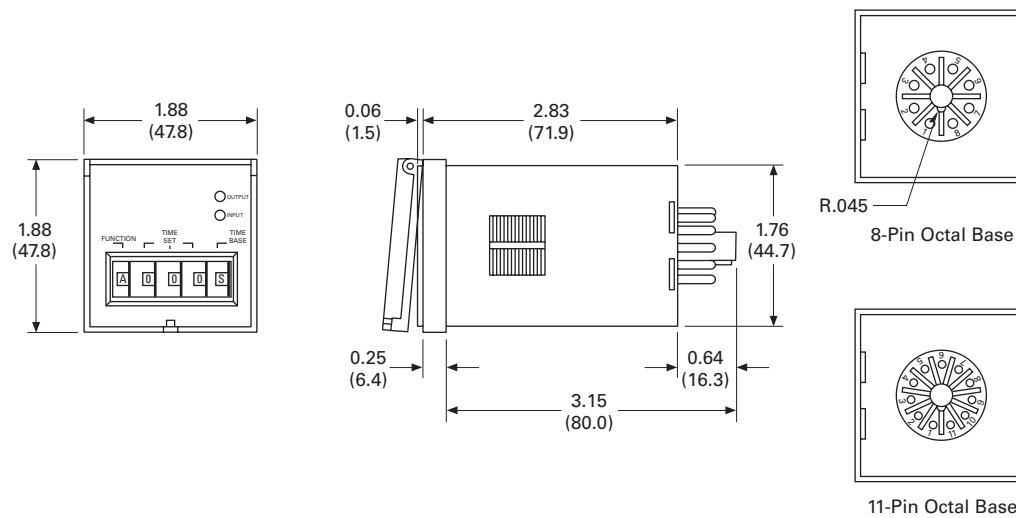

D85 Series—Alternating Relays



Product Description

Alternating relays are used in applications where the optimization of load usage is required by equalizing the run time of two loads. They are also used where additional capacity is required in case of excess load requirements. This alternating action is initiated by a control switch—such as a float switch, manual switch, timing relay, pressure switch or other isolated contact. Each time the initiating switch is opened, the output relay contacts will change state, thus alternating the two loads. Two LED indicators show the status of the output relay.

The D851 and D852 Series Relays are used with one control switch and are available in either SPDT or DPDT output configurations with or without a selector switch to lock in one sequence. The D852X Series Relays are available in DPDT cross-wired output configurations for use with one or two control switches (LEAD and LAG).

The D853 Series is designed for use with three-switch applications (LEAD, LAG and STOP). The D853 Series combines a standard DPDT Cross-Wired alternating relay, contactor auxiliary contacts, and a control relay into one compact and economical product. This saves space and labor, while reducing the number of components needed. The D853 Series uses Sequence On—Simultaneous Off (S.O.S.O.) operation, where the two loads are energized sequentially, but remain on together until the STOP switch is opened. This device also protects against failure of the STOP and LEAD switches. If both switches fail, the two pump motors will be energized simultaneously when the LAG switch is closed.

Contents

Description

	<i>Page</i>
D85 Series—Alternating Relays	
Product Selection	V7-T3-189
Accessories	V7-T3-189
Technical Data and Specifications	V7-T3-190
Wiring Diagrams	V7-T3-190
Dimensions	V7-T3-192

Each of the D85 Series alternating relays is available with an optional three-position selector switch, which allows the unit to alternate the two loads as normal, or lock the relay to one load or the other. By locking the alternating relay to one load, the other load can be removed for service without rewiring the first load for continuous operation. The selector switch has a low profile to prevent any accidental actuation.

Features

- For duplex loads
- Works with one-, two-, or three-switch applications
- Compact plug-in design using industry standard sockets
- 10 A SPDT or DPDT output configurations
- Optional low profile selector switch to lock in one sequence
- Two LEDs indicate relay status
- D853 Series replaces separate components in duplex panel—saving space and reducing labor

Standards and Certifications

- CE
- cRUus
- UL listed ①
- RoHS compliant



Note

① When used with appropriate Eaton socket.

Product Selection

D85 Series—Alternating Relays ^①

Output Contacts	Control Voltage	Socket	Catalog Number
SPDT	12 Vac	8-pin	D851NR
SPDT	24 Vac	8-pin	D851NT
SPDT	120 Vac	8-pin	D851NA
SPDT	240 Vac	8-pin	D851NB
SPDT w/selector switch	12 Vac	8-pin	D851LR
SPDT w/selector switch	24 Vac	8-pin	D851LT
SPDT w/selector switch	120 Vac	8-pin	D851LA
SPDT w/selector switch	240 Vac	8-pin	D851LB
DPDT	12 Vac	11-pin	D852NR
DPDT	24 Vac	11-pin	D852NT
DPDT	120 Vac	11-pin	D852NA
DPDT	240 Vac	11-pin	D852NB
DPDT w/selector switch	12 Vac	11-pin	D852LR
DPDT w/selector switch	24 Vac	11-pin	D852LT
DPDT w/selector switch	120 Vac	11-pin	D852LA
DPDT w/selector switch	240 Vac	11-pin	D852LB
DPDT cross-wired	12 Vac	8-pin	D852XNR
DPDT cross-wired	24 Vac	8-pin	D852XNT
DPDT cross-wired	120 Vac	8-pin	D852XNA
DPDT cross-wired	240 Vac	8-pin	D852XNB
DPDT cross-wired w/selector switch	12 Vac	8-pin	D852XLR
DPDT cross-wired w/selector switch	24 Vac	8-pin	D852XLT
DPDT cross-wired w/selector switch	120 Vac	8-pin	D852XLA
DPDT cross-wired w/selector switch	240 Vac	8-pin	D852XLB

Accessories

D85 Series—Alternating Relays

Description	Standard Pack	Catalog Number
8-pin socket	10	D3PA2
11-pin socket	10	D3PA3-A2
Hold-down spring	10	D65CHDS

Note

^① Contact Eaton for relays for 3-switch applications (Lead-Lag-Stop).

Technical Data and Specifications

D85 Series—Alternating Relays

Description	Specification
Voltage tolerance	+10%/-15% of control voltage at 50/60 Hz
Load (burden)	Less than 3 VA
Output contacts	10 A resistive at 240 Vac / 30 Vdc, 1/2 hp at 120/240 Vac (NO), 1/3 hp at 120/240 Vac (NC)
Mechanical life	10,000,000 operations
Electrical life	100,000 operations
Temperature	-20 °F to +150 °F (-28 ° to 65 °C)
Transient protection	10,000 volts for 20 microseconds
Indicator LEDs	2 LEDs marked LOAD A and LOAD B
Optional selector switch settings	ALTERNATE, LOCK LOAD A, LOCK LOAD B

Wiring Diagrams

D851 Series Relays, SPDT

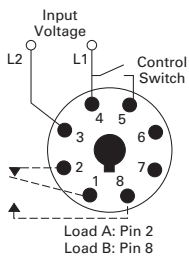

D852 Series Relays, DPDT

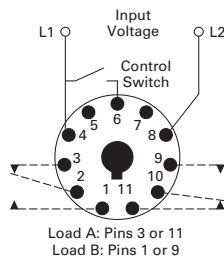

D852X Series Relays, DPDT Cross-Wired

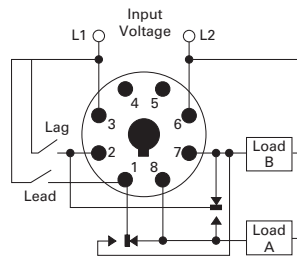

D853 Series Relays, Three-Switch Applications

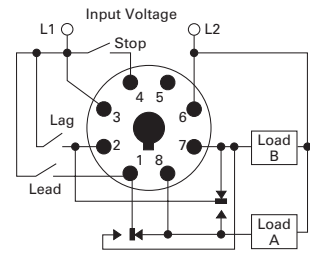

Typical Installations for SPDT and DPDT Alternating Relays, Standard Installation

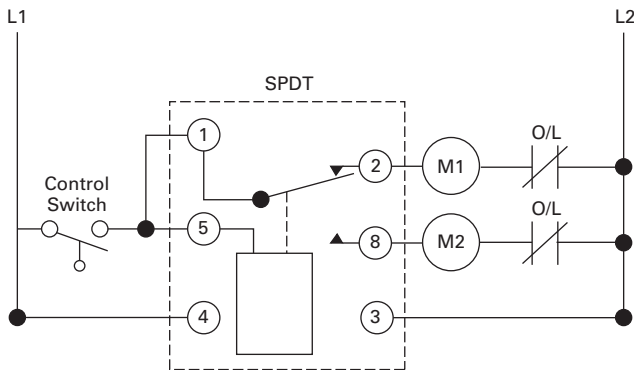

In the OFF state (standard installation), the control switch is open, the alternating relay is in the LOAD A position, and both loads (M1 and M2) are off. When the control switch closes, it energizes the first load (M1). The red LED marked "LOAD A" glows. As long as the control switch remains closed, M1 remains energized.

When the control switch opens, the first load (M1) is turned off and the alternating relay toggles to the LOAD B position. When the control switch closes again, it energizes the second load (M2). The red LED marked "LOAD B" glows.

Typical Installations for SPDT and DPDT Alternating Relays, Anti-Bounce Installation

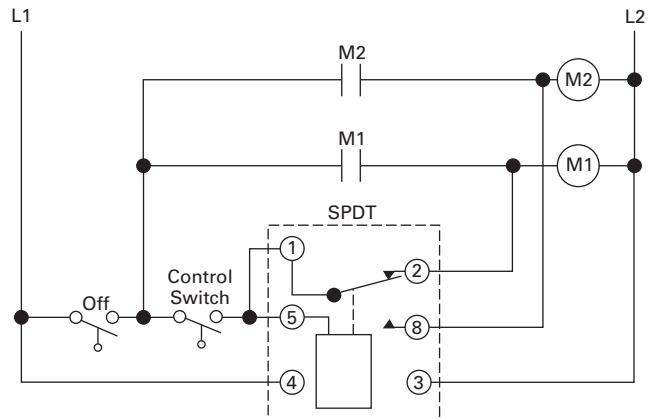

When the control switch opens, the second load (M2) is turned off, the alternating relay toggles back to the LOAD A position, and the process can be repeated again. On relays with DPDT contacts, two pilot lights can be used for remote indication of LOAD A or LOAD B status.

To eliminate any bounce condition of the control switch, the addition of a second switch (OFF) along with two auxiliary contacts is recommended as shown in the Anti-Bounce Installation.

Typical Installations for DPDT Cross-Wired Alternating Relays, Standard Installation

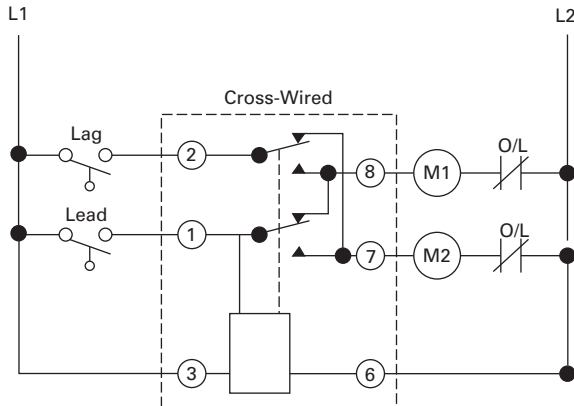

In the OFF state, both the LEAD control switch and the LAG control switch are open, the alternating relay is in the LOAD A position, and both loads are off. When the LEAD control switch closes, it energizes the first load (M1). The red LED marked "LOAD A" glows. As long as the LEAD control switch remains closed, M1 remains energized. If the LAG control switch closes, it energizes the second load (M2).

When the LAG control switch opens, the second load (M2) is turned off. When the LEAD control switch opens, the first load (M1) is turned off and the alternating relay toggles to the LOAD B position.

Typical Installations for DPDT Cross-Wired Alternating Relays, Anti-Bounce Installation

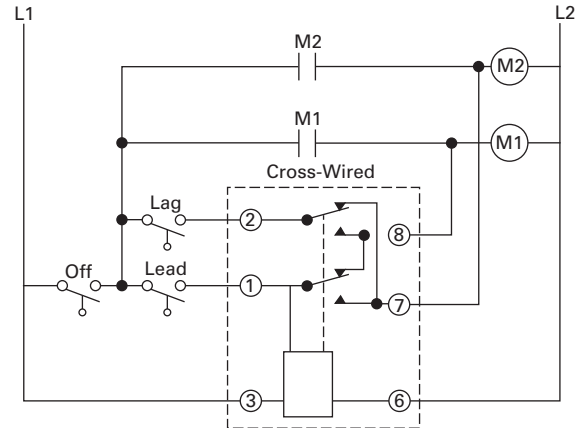

When the LEAD control switch closes, it turns on the second load (M2). The red LED marked "LOAD B" glows. If the LAG control switch closes, it will energize the first load (M1). When the LAG control switch opens, the first load (M1) is turned off. When the LEAD control switch opens, the second load (M2) is turned off, the alternating relay toggles back to the LOAD A position, and the process can be repeated again.

To eliminate any bounce condition of the control switch, the addition of a second switch (OFF) along with two auxiliary contacts is recommended as shown in the Anti-Bounce Installation.

Typical Installations for DPDT Cross-Wired Relays for Three-Switch Applications

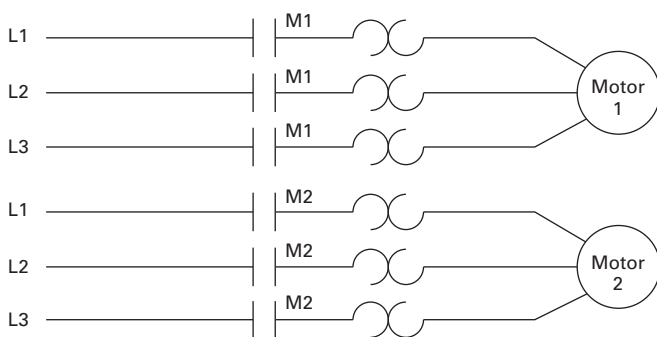

In the OFF state, all three switches are open, the alternating relay is in the LOAD A position, and both loads are off. No action happens with the alternating relay or either load when the STOP switch closes. When the LEAD switch closes, Load #1 (M1) turns on. When the LAG switch closes, Load #2 (M2) turns on. Both loads remain on as long as all three switches are closed.

When the LAG switch opens, Load #2 (M2) remains on because the STOP switch is still closed. When the LEAD switch opens, Load #1 (M1) remains on because the STOP switch is still closed. When the STOP switch opens, both Load #1 (M1) and Load #2 (M2) are turned off simultaneously.

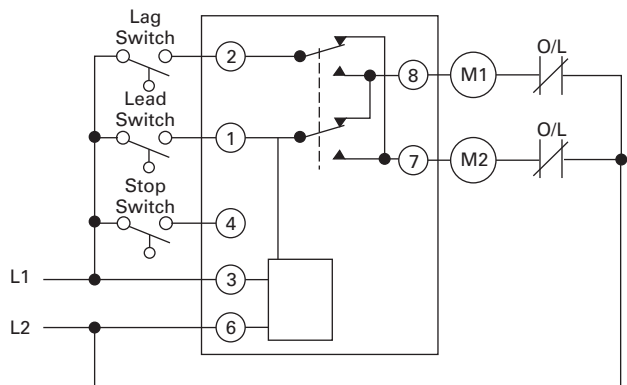

The alternating relay toggles to the LOAD B position. The entire cycle is then repeated, but with Load #2 (M2) energized first followed by Load #1 (M1). This type of operation is known as "Sequence On-Simultaneously Off (S.O.S.O.)"—the two loads are energized sequentially, but remain on together until the STOP switch is opened.

If both the STOP switch and LEAD switch fail to close and turn on the first load, both loads will be turned on simultaneously when the LAG switch is closed.

3.9

Control Relays and Timers

Alternating Relays

Dimensions

Approximate Dimensions in Inches (mm)

D85 Series—Alternating Relays

3

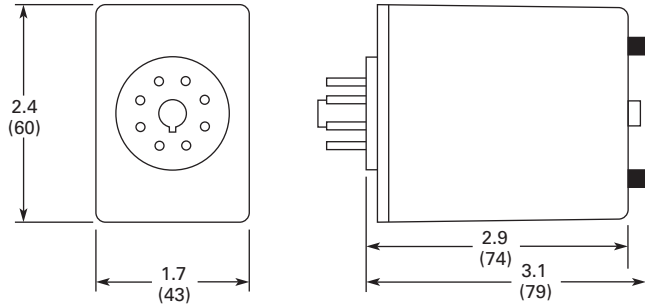

Safety Relays



Product Description

Safety relays are intended to reliably monitor the signals from safety devices at all times and switch off quickly and reliably in an emergency. Single-channel and dual channel versions are available for the construction of safety applications. The internal logic of the safety relays monitors the safety circuits (emergency stop, guard door, and so on) and activates the enable paths in a fault-free condition. Upon actuation of the safety device or in the event of a fault, the enable paths are switched off. Any faults that occur in the control circuit, such as ground fault, cross connection fault or wire breakage are also detected.

Application Description

Eaton's ESR5 safety relays provide optimal safety and a high degree of reliability on plant machinery. Applications that meet the highest safety requirements in accordance with EN 954-1, EN ISO 13849-1 up to PL e and accordance with IEC 62061 up to SILCL 3 can be realized with the ESR5 safety relay.

Compatible with a wide variety of safety devices:

- Emergency stops
- Rope pulls
- Two-hand control stations
- Light curtain (OSSD)
- Gate enable device
- Safety switches

Contents

Description

	<i>Page</i>
Safety Relays	
Product Selection	V7-T3-194
Technical Data and Specifications	V7-T3-195
Dimensions	V7-T3-198

Features

- Use for the highest safety requirements in accordance with EN 954-1, EN ISO 13849-1, IEC 62061 and EC 61508
- Suitable for the world market with UL, cUL certifications and TÜV Rhineland functional safety certifications
- Applicable for EN 60204 stop categories 0 or 1
- Plug-in screw terminals for fast and fault-free replacement
- Multi-voltage versions (24–230 Vac/Vdc) for a flexible range of application
- Delayed and non-delayed contact expansions accommodate a wide variety of applications

Standards and Certifications

- UL 508; CSA C22.2 No 14-95; CE Marked
- UL/cUL file number: E29184
- Degree of protection: IP20
- TÜV Rhineland certified
- UL/cULus listed



Product Selection

Safety Relays

Technical Overview

3



Single Channel	Dual Channel	Safety Output (NO)	Safety Output (NO) (Delayed)	Output Delay	Signal Output (NC)	Feedback Output	Control Voltage	Removable Terminal Blocks	Type of Unit	Catalog Number
■	—	4	—	—	1	—	24 Vac/Vdc	■	Main	ESR5-NO-41-24VAC-DC
■	■	2	—	—	1	—	24 Vac/Vdc	■	Main	ESR5-NO-21-24VAC-DC
■	■	3	—	—	1	—	24 Vac/Vdc	■	Main	ESR5-NO-31-24VAC-DC
■	■	3	—	—	1	—	230 Vac	■	Main	ESR5-NO-31-230VAC
■	■	3	—	—	1	—	24–230 Vac/Vdc	■	Main	ESR5-NO-31-AC-DC
■	■	2	2	0.1–30s	—	—	24 Vdc	■	Main	ESR5-NV3-30
—	■	2	—	—	1	—	24 Vac/Vdc	■	Main	ESR5-NZ-21-24VAC-DC
■	—	5	—	—	1	1	24 Vac/Vdc	■	Expansion	ESR5-NE-51-24VAC-DC
■	—	—	4	0.3–3s	1	1	24 Vdc	■	Expansion	ESR5-VE3-42

Application Overview

Emergency Stop	Safety Switches	Light Curtain/OSSD ①	Two-Hand Control (EN 574 Type III C)	Contact Expansion	Off-Delayed	Cross Circuit Recognition	Monitored Manual Reset ②	Catalog Number
■	■	—	—	—	—	—	—	ESR5-NO-41-24VAC-DC
■	■	—	—	—	—	■	—	ESR5-NO-21-24VAC-DC
■	■	—	—	—	—	■	—	ESR5-NO-31-24VAC-DC
■	■	—	—	—	—	■	■	ESR5-NO-31-230VAC
■	■	—	—	—	—	■	■	ESR5-NO-31-AC-DC
■	■	■	—	—	■	■	■	ESR5-NV3-30
—	■	—	■	—	—	■	—	ESR5-NZ-21-24VAC-DC
—	—	—	—	■	—	—	—	ESR5-NE-51-24VAC-DC
—	—	—	—	■	■	—	—	ESR5-VE3-42

Application Overview, continued

Single Channel	Dual Channel	Stop Category EN 60204	Control Category to EN 954-1	Achievable PL per ISO 13849-1	Achievable SIL per EN IEC 62061	Catalog Number
■	—	0	2	PL d	SIL 3	ESR5-NO-41-24VAC-DC
■	■	0	4	PL e	SIL 3	ESR5-NO-21-24VAC-DC
■	■	0	4	PL e	SIL 3	ESR5-NO-31-24VAC-DC
■	■	0	4	PL e	SIL 3	ESR5-NO-31-230VAC
■	■	0	4	PL e	SIL 3	ESR5-NO-31-AC-DC
■	■	0/1	4	PL e	SIL 3	ESR5-NV3-30
—	■	0	4	PL e	SIL 3	ESR5-NZ-21-24VAC-DC
■	—	0	4	PL e	SIL 3	ESR5-NE-51-24VAC-DC
■	—	1	3	PL d	SIL 2	ESR5-VE3-42

Notes

- ① Laser scanners or light curtains with OSSD outputs.
- ② All main units can also be reset automatically or manually.

Technical Data and Specifications

Safety Relay

Description	Unit	ESR5-NO-21_	ESR5-NO-41_	ESR5-NO-31-24VAC-DC	ESR5-NZ-21_
General					
Standards		EN ISO 13849-1, IEC 62061, IEC 61508, DIN EN 50178, UL/CUL listed	EN ISO 13849-1, IEC 62061, IEC 61508, DIN EN 50178, UL/CUL listed	EN ISO 13849-1, IEC 62061, IEC 61508, DIN EN 50178, UL/CUL listed	EN ISO 13849-1, IEC 62061, IEC 61508, DIN EN 50178, UL/CUL listed
Type-dependent standards		—	—	—	EN 574 Part no. IIIC
Lifespan, mechanical—c (contacts)	x 10 ⁶	10	10	10	10
Maximum operating frequency	Ops/h	3600	3600	3600	3600
Climatic proofing		Cold according to EN 60068-2-1, dry heat according to EN60068-2-2, damp heat according to EN 60068-2-3	Dry heat according to EN60068-2-2, damp heat according to EN 60068-2-3	Cold according to EN 60068-2-1, dry heat according to EN60068-2-2, damp heat according to EN 60068-2-3	Dry heat according to EN60068-2-2, damp heat according to EN 60068-2-3
Ambient temperature	°F (°C)	−4 ° to 131 ° (−20 ° to 55 °)	−4 ° to 131 ° (−20 ° to 55 °)	−4 ° to 131 ° (−20 ° to 55 °)	−4 ° to 131 ° (−20 ° to 55 °)
Ambient temperature storage	°F (°C)	−13 ° to 167 ° (−25 ° to 75 °)	−13 ° to 167 ° (−25 ° to 75 °)	−13 ° to 167 ° (−25 ° to 75 °)	−13 ° to 167 ° (−25 ° to 75 °)
Mounting position		Any	Any	Any	Any
Vibration resistance (IEC/EN 60068-2-6)		2g, frequency: 10–150 Hz, amplitude: 0.15 mm	2g, frequency: 10–150 Hz, amplitude: 0.15 mm	2g, frequency: 10–150 Hz, amplitude: 0.15 mm	2g, frequency: 10–150 Hz, amplitude: 0.15 mm
Shock resistance (IEC 60068-2-27)		—	—	—	—
Protection type					
Housing		IP20	IP20	IP20	IP20
Terminals		IP20	IP20	IP20	IP20
Protection against direct contact when actuated from front (IEC 0106 Part 100)		Finger- and back-of-hand proof	Finger- and back-of-hand proof	Finger- and back-of-hand proof	Finger- and back-of-hand proof
Weight	kg	0.17	0.22	0.17	0.22
Terminal capacity					
Solid or flexible	mm ²	1 x (0.2–2.5) 2 x (0.2–1)	1 x (0.2–2.5) 2 x (0.2–1)	1 x (0.2–2.5) 2 x (0.2–1)	1 x (0.2–2.5) 2 x (0.2–1)
Flexible with ferrule	mm ²	1 x (0.25–2.5) 2 x (0.25–1)	1 x (0.25–2.5) 2 x (0.25–1)	1 x (0.25–2.5) 2 x (0.25–1)	1 x (0.25–2.5) 2 x (0.25–1)
Solid or stranded	AWG	24–12	24–12	24–12	24–12
Terminal screw					
Pozidriv screwdriver	Size	2	2	2	2
Flat-blade screwdriver	mm	0.6 x 3.5	0.6 x 3.5	0.6 x 3.5	0.6 x 3.5
Max. tightening torque	Nm	0.6	0.6	0.6	0.6
Main Contacts					
Rated impulse withstand voltage—U _{imp}	Vac	6000	4000	4000	6000
Overvoltage category/pollution degree					
Outside		III/2	III/2	III/2	III/2
Inside		—	—	—	—
Rated insulation voltage—U _i	Vac	250	250	250	250
Rated operating voltage—U _e	Vac	230	230	230	230
Rated operation current					
AC-15					
230 V (360 ops./h)—I _e	A	5	4	5	4
230 V (3600 ops./h)—I _e	A	3	3	3	3
DC-13					
24 V (360 ops./h)—I _e	A	6	4	6	4
24 V (3600 ops./h)—I _e	A	3	2.5	3	2.5
Max. summation current of all poles					
24 Vac/Vdc devices	A	72	72	72	72
230 Vac devices	A	—	—	—	—
Square of the total current (and total current) of all current paths		72 A ² (6 + 6)	72 A ² (4.2 + 4.2 + 4.2 + 4.2)	72 A ² (4.9 + 4.9 + 4.9)	72 A ² (6 + 6)
Short-circuit protection					
Max. fuse	A gG/gL	10	6	10	6

3.10

Control Relays and Timers

Safety Relays

3

Safety Relay, continued

Description	Unit	ESR5-N0-21_	ESR5-N0-41_	ESR5-N0-31-24VAC-DC	ESR5-NZ-21_
Power Supply Circuit					
Actuating voltage 50/60 Hz	Vac	24	24	24	24
Actuating voltage— U_s	Vdc	24	24	24	24
Voltage tolerance pick-up voltage	x_e	0.85–1.1	0.85–1.1	0.85–1.1	0.85–1.1
Power consumption					
AC operated 50/60 Hz	VA	—	—	—	—
AC operated 50/60 Hz	W	3.4	3.4	3.4	3
DC operated	W	1.6	1.6	1.6	1.5
Fuse for control circuit supply					
24 V		Short-circuit proof	Short-circuit proof	Short-circuit proof	Short-circuit proof
115/230 V		—	—	—	—
Control Circuit					
Rated output voltage	Vdc	24	24	24	24
Rated operational current	mA	S12, S22: 30, S34: 45	S12: 65, S34: 40	S12, S22: 30, S34: 45	S11, S21: 60, Y2: 45
Resistance—R		50	22	50	22
Short-circuit current	A	2.3	2.3	2.3	2.3
Response time	ms	100	65	100	50
Recovery time	ms	—	—	—	—
Response time with reset monitoring— t_{A1}	ms	—	—	—	—
Response time without reset monitoring— t_{A2}	ms	100	65	100	50
Reset time— t_R/t_{R1}	ms	Single-channel 45; dual-channel 10	45	Single-channel 45; dual-channel 10	20
Minimum on duration— t_M	ms	—	—	—	—
Recovery time— t_W	ms	Approx. 1000	Approx. 1000	Approx. 1000	Approx. 1000
Synchronous monitoring time— t_S	ms	—	—	—	500
Electromagnetic Compatibility (EMC)					
Emitted interference		EN 61000-6-4	EN 61000-6-4	EN 61000-6-4	EN 61000-6-4
Interference immunity		According to EN 61000-6-2, EN 62061	According to EN 61000-6-2	According to EN 61000-6-2, EN 62061	According to EN 61000-6-2

Safety Relay, continued

Description	Unit	ESR5-NO-31-230VAC	ESR5-NO-31-24V-230VAC-DC	ESR5-NV3_	ESR5-VE3_	ESR5-NE51_
General						
Standards		EN ISO 13849-1, IEC 62061, IEC 61508, DIN EN 50178, UL/CUL listed	EN ISO 13849-1, IEC 62061, IEC 61508, DIN EN 50178, UL/CUL listed	EN ISO 13849-1, IEC 62061, IEC 61508, DIN EN 50178, UL/CUL listed	EN ISO 13849-1, IEC 62061, IEC 61508, DIN EN 50178, UL/CUL listed	EN ISO 13849-1, IEC 62061, IEC 61508, DIN EN 50178, UL/CUL listed
Type-dependent standards		EN 60204 (if applicable)	EN 60204 (if applicable)	EN 60204 (if applicable)	—	—
Lifespan, mechanical—c (contacts)	x 10 ⁶	10	10	10	10	10
Maximum operating frequency	Ops/h	3600	3600	3600	900	3600
Climatic proofing		Dry heat according to EN60068-2-2, damp heat according to EN 60068-2-3	Dry heat according to EN60068-2-2, damp heat according to EN 60068-2-3	Cold in accordance with: EN 60068-2-1, dry heat in accordance with EN 60068-2-2, humidity storage test in accordance with 60068-2-78	Dry heat according to EN60068-2-2, damp heat according to EN 60068-2-3	Dry heat according to EN60068-2-2, damp heat according to EN 60068-2-3
Ambient temperature	°F (°C)	−4 ° to 131 ° (−20 ° to 55 °)	−4 ° to 131 ° (−20 ° to 55 °)	−4 ° to 131 ° (−20 ° to 55 °)	−4 ° to 131 ° (−20 ° to 55 °)	−4 ° to 131 ° (−20 ° to 55 °)
Ambient temperature storage	°F (°C)	−13 ° to 167 ° (−25 ° to 75 °)	−13 ° to 167 ° (−25 ° to 75 °)	−13 ° to 167 ° (−25 ° to 75 °)	−13 ° to 167 ° (−25 ° to 75 °)	−13 ° to 167 ° (−25 ° to 75 °)
Mounting position		Any	Any	Any	Any	Any
Vibration resistance (IEC/EN 60068-2-6)		2g, frequency: 10–150 Hz, amplitude: 0.15 mm	2g, frequency: 10–150 Hz, amplitude: 0.15 mm	2g, frequency: 10–150 Hz, amplitude: 0.15 mm	2g, frequency: 10–150 Hz, amplitude: 0.15 mm	2g, frequency: 10–150 Hz, amplitude: 0.15 mm
Shock resistance (IEC 60068-2-27)		—	—	—	—	—
Protection type						
Housing		IP40	IP40	IP20	IP20	IP20
Terminals		IP20	IP20	IP20	IP20	IP20
Protection against direct contact when actuated from front (IEC 0106 Part 100)		Finger- and back-of-hand proof	Finger- and back-of-hand proof	Finger- and back-of-hand proof	Finger- and back-of-hand proof	Finger- and back-of-hand proof
Weight	kg	0.3	0.3	0.17	0.17	0.22
Terminal capacity						
Solid or flexible	mm ²	1 x (0.2–2.5) 2 x (0.2–1)	1 x (0.2–2.5) 2 x (0.2–1)	1 x (0.2–2.5) 2 x (0.2–1)	1 x (0.2–2.5) 2 x (0.2–1)	1 x (0.2–2.5) 2 x (0.2–1)
Flexible with ferrule	mm ²	1 x (0.25–2.5) 2 x (0.25–1)	1 x (0.25–2.5) 2 x (0.25–1)	1 x (0.25–2.5) 2 x (0.25–1)	1 x (0.25–2.5) 2 x (0.25–1)	1 x (0.25–2.5) 2 x (0.25–1)
Solid or stranded	AWG	24–12	24–12	24–12	24–12	24–12
Terminal screw						
Pozidriv screwdriver	Size	2	2	2	2	2
Flat-blade screwdriver	mm	0.6 x 3.5	0.6 x 3.5	0.6 x 3.5	0.6 x 3.5	0.6 x 3.5
Max. tightening torque	Nm	0.6	0.6	0.6	0.6	0.6
Main Contacts						
Rated impulse withstand voltage—U _{imp}	Vac	6000	6000	4000	4000	4000
Overvoltage category/pollution degree						
Outside		III/2	III/2	III/2	III/2	III/2
Inside		—	—	—	—	—
Rated insulation voltage—U _i	Vac	250	250	250	250	250
Rated operating voltage—U _e	Vac	230	230	230	230	230
Rated operation current						
AC-15						
230 V (360 ops./h)—I _e	A	4	4	—	5	4
230 V (3600 ops./h)—I _e	A	3	3	3	3	3
DC-13						
24 V (360 ops./h)—I _e	A	4	4	—	6	4
24 V (3600 ops./h)—I _e	A	2.5	2.5	3	3	2.5
Max. summation current of all poles						
24 Vac/Vdc devices	A	50	50	49	50	50
230 Vac devices	A	50	50	—	—	—
Square of the total current (and total current) of all current paths		50 A ² (4 + 4 + 4)	50 A ² (4 + 4 + 4)	50 A ² (4 + 4 + 4)	49 A ² (3.5 + 3.5 + 3.5 + 3.5)	50 A ² (3.7 + 3.7 + 3.7 + 3.7)
Short-circuit protection						
Max. fuse	A gG/gL	6	6	10	10	6

3.10

Control Relays and Timers

Safety Relays

Safety Relay, continued

Description	Unit	ESR5-NO-31-230VAC	ESR5-NO-31-24V-230 VAC-DC	ESR5-NV3_	ESR5-VE3_	ESR5-NE-51_
Power Supply Circuit						
Actuating voltage 50/60 Hz	Vac	230	24–230	—	—	24
Actuating voltage— U_s	Vdc	—	230	24	24	24
Voltage tolerance pick-up voltage	x_e	0.85–1.1	0.85–1.1	0.85–1.1	0.85–1.1	0.8–1.1
Power consumption						
AC operated 50/60 Hz	VA	—	—	—	—	—
AC operated 50/60 Hz	W	5.8	5.8	—	—	2.2
DC operated	W	2.9	2.9	1.8	2	2.2
Fuse for control circuit supply						
24 V		—	Short-circuit proof	—	—	—
115/230 V		Short-circuit proof	Short-circuit proof	—	—	—
Control Circuit						
Rated output voltage	Vdc	24	24	24	24	24
Rated operational current	mA	S10, S12, S22: 35, S34, S35: 45	S10, S12, S22: 35, S34, S35: 45	S12, S22: 3.5, S34, S35: 7	A1, A2: 84, K1/K2: 5	A1, A2: 92
Resistance—R		11	11	500	—	—
Short-circuit current	A	0.7	0.7	0.1	—	—
Response time	ms	250	250	150	20	20
Recovery time	ms	—	—	—	—	—
Response time with reset monitoring— t_{A1}	ms	60	60	150	20	20
Response time without reset monitoring— t_{A2}	ms	250	250	150	20	20
Reset time— t_R/t_{R1}	ms	20	20	20 (non-delayed enable paths); 100 (min. delayed enable paths)	0.3–3 s (+50%) adjustable	20
Minimum on duration— t_M	ms	—	—	—	—	—
Recovery time— t_W	ms	Approx. 1000	Approx. 1000	Approx. 330	Approx. 1000	—
Synchronous monitoring time— t_S	ms	—	—	—	—	—
Electromagnetic Compatibility (EMC)						
Emitted interference		EN 61000-6-4	EN 61000-6-4	EN 61000-6-4	EN 61000-6-4	EN 61000-6-4
Interference immunity		According to EN 61000-6-2	According to EN 61000-6-2	According to EN 61000-6-2, EN 62061	According to EN 61000-6-2	According to EN 61000-6-2

Dimensions

Approximate Dimensions in Inches (mm)

Safety Relays, Contact Expansion Modules

ESR5_ 24 Vac/Vdc

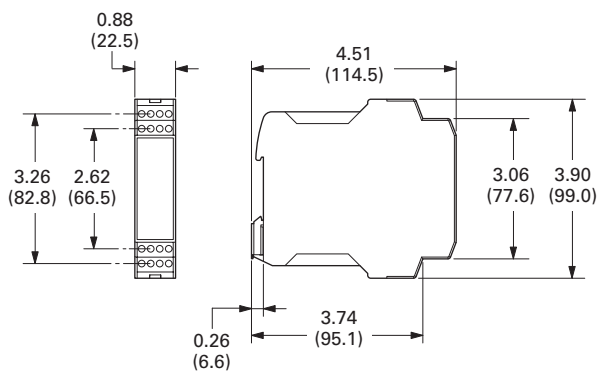

ESR5_ 230 Vac

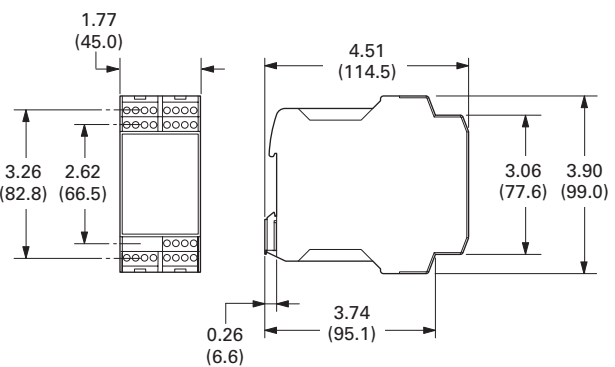

easySafety



Product Description

The easySafety control relay for safety-related applications monitors all commonly used safety devices and also takes over the required control tasks for the machine. Packed with a host of conventional safety relays in the form of safety function blocks, easySafety not only features integrated safety functions but also standard functions in a single device—all in one.

In addition to the safety circuit diagram containing the safety configuration, the safety control relay also contains a standard circuit diagram. This circuit diagram can be used for standard tasks, such as the processing of diagnostics signals or general control tasks of a machine.

Application Description

Because of the large number of safety function blocks, the user can tackle a large number of application options with only one device. The user can also respond directly to future and changing application requirements. This saves financial resources and offers future investment security. Last but not least, it reduces the stock-keeping required for special safety relays. The easySafety meets the requirements of Category 4 to EN 954-1, PL e to EN ISO 13849-1, SILCL 3 to EN IEC 62061 and SIL 3 to EN IEC 61508. With easySafety, it is possible to implement applications meeting the most stringent safety requirements.

Contents

Description

Description	Page
easySafety	
Product Selection	V7-T3-200
Accessories	V7-T3-200
Technical Data and Specifications	V7-T3-201
Dimensions	V7-T3-204

Safety function blocks:

- Emergency stop
- Guard door monitoring with and without interlock/guard locking
- Two-hand control (EN 574)
- Electro-sensitive protective devices (light curtains)
- Light curtain muting
- Enable switch
- Start device
- Operating mode selector
- Safety timing relay
- Overspeed monitoring
- Feedback loop monitoring (EDM)
- Zero speed monitoring

Features

- All-in-one: Safety and control functions combined in one device
- Simple configuration through prefabricated and tested safety components
- Direct state display and increased machine availability due to fast error diagnosis through integrated display
- Multistep password concept prevents unwanted manipulation

Standards and Certifications

- Product standards: CE marked; UL 508; CSA C22.20.4-04; CSA 22.2 No. 142-M11987
- UL CCN: NRAQ
- CSA File No. 012528
- CSA Class No. 2252-81 and 2252-01
- TÜV Rhineland certified
- Degree of Protection IEC: IP20



Product Selection

easySafety

easySafety Relays ^①



Inputs (Safety) Digital	Outputs (Safety) 6 A Relay	Outputs (Safety) Transistor	Outputs (Safety) Test Signal	Display + Keypad	Catalog Number
14	1 (redundant)	4	4	—	ES4P-221-DMXX1
14	1 (redundant)	4	4	Yes	ES4P-221-DMXD1
14	4	—	4	—	ES4P-221-DRXX1
14	4	—	4	Yes	ES4P-221-DRXD1

Accessories

easySoft



Programming Software

Description	Catalog Number
easySoft-Safety (including easySoftPro) ^②	ESP-SOFT

Memory Card



Memory Card

Description	Catalog Number
256 kB module	ES4A-MEM-CARD1

Programming Cables

Description	Catalog Number
SUB-D, nine-pole, serial, 2m	EASY800-PC-CAB

SUB-D Cable



Description	Catalog Number
USB, 2m	EASY800-USB-CAB

USB Cable



Input/Output Simulator

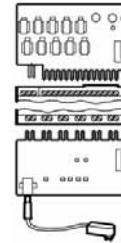

Input/Output Simulator

Description	Catalog Number
With plug-in power supply unit 100–240 Vac/24 Vdc	ES4A-221-DMX-SIM

Notes

- ① EN 954-1: 1996, Category 4.
EN ISO 13849-1: 2006, PL e (Performance Level).
IEC 61508: 1998, SIL 3 (Safety Integrity Level).
IEC 62061: 2005, SILCL 3 (Safety Integrity Level Claim Limit).
Expandable: standard inputs/outputs and standard bus systems.
24 Vdc supply voltage.
- ② Operating systems:
Windows® 2000 SP4, Windows XP SP1, Windows Vista (32 bit).

Technical Data and Specifications

easySafety Relay

Description	Unit	ES4P_
General		
Standards		EN 55011, EN 55022, IEC/EN 61000-4, IEC 60068-2-6, IEC 60068-2-27, EN 954-1: Category 4, EN ISO 13849-1: PL e, EN IEC 62061: SILCL 3, EN IEC 61508: SIL 3
Dimensions (W x H x D)	mm	107.5 (6 space units) x 90 x 72
Mounting		Top-hat rail IEC/EN 60715, 35 mm or screw fixing using fixing brackets ZB4-101-GF1 (accessories)
Times		
Inputs		
Maximum duration of external test pulse	ms	1
Semi-conductor output		
Off test pulse	ms	<1
Switch-off delay	ms	<0.15
Terminal Capacity		
Solid	mm ²	0.2–4 (AWG 22–12)
Flexible with ferrule	mm ²	0.2–2.5 (AWG 22–12)
Standard screwdriver	mm	3.5 x 0.8
Maximum tightening torque	Nm	0.6
Ambient Climatic Conditions		
Operating ambient temperature	°C	–25 to +55, low temperatures to IEC 60068-2-1, high temperatures to IEC 60068-2-2
Condensation		Prevent condensation by means of suitable measures
LCD display (clearly legible)	°C	0 to +55
Storage	°C	–40 to +70
Relative humidity, noncondensing (IEC/EN 60068-2-30)	%	5 to 95
Air pressure (in operation)	hPa	795 to 1080
Ambient Mechanical Conditions		
Protection type, IEC/EN 60529		IP20
Vibrations (IEC/EN 60068-2-6)		
Constant amplitude 0.15 mm	Hz	10 to 57
Constant acceleration, 2g	Hz	57 to 150
Mechanical shock resistance (IEC/EN 60068-2-27) semi-sinusoidal 15g/11 ms	Shocks	18
Drop to IEC/EN 60068-2-31	Drop	mm
Mounting position		Horizontal/vertical
Electromagnetic Compatibility (EMC) According to IEC/EN 61000-6-2		
Electrostatic discharge (IEC/EN 61000-4-2, Level 3, ESD)		
Air discharge	kV	8
Contact discharge	kV	6
Radio interference suppression (EN 55011)		EN 55011 Class B, EN 55022 Class B
Power pulses (surge) (IEC/EN 61000-4-5, Level 2)	kV	1 (supply cables, symmetrical)
Insulation Resistance		
Overvoltage category/pollution degree		III/2
Clearance in air and creepage distances		EN 50178, UL 508, CSA C22.2, No. 142, EN 60664-1:2003
Insulation resistance		EN 50178
Backup/Accuracy of the Real-Time Clock		
Accuracy of the real-time clock	s/day	Normally ±5 (±0.5 h/year)
Repetition Accuracy of Timing Relays in Standard Circuit		
Accuracy of timing relay (of value)	%	±0.02
Resolution		
Range "S"	ms	5
Range "M:S"	s	1
Retentive Memory		
Write cycles of the retentive memory (minimum)		10,000,000,000 (1010) (read/write cycles)

easySafety Relay, continued

Description	Unit	ES4P_	
Power Supply			
Rated operational voltage	U_e	V	24 Vdc (–15/+20%)
Permissible range		Vdc	20.4 to 28.8
Ripple		%	≤ 5
Interfaces			
EASYN _e t (CAN-based)			
Bus termination (first and last station)			Yes
Control operating mode EASYN _e t			
Number of users			Maximum 8
NET Network			
Stations	Number		Maximum 8
Data transfer rate/distance			1000 Kbit/s, 6m 500 Kbit/s, 25m 250 Kbit/s, 60m 125 Kbit/s, 125m 50 Kbit/s, 300m 20 Kbit/s, 700m 10 Kbit/s, 1000m Bus lengths greater than 40m can only be achieved with enhanced cross-section conductors and terminal adapters
Potential isolation			
From power supply			Yes
From the inputs			Yes
From the outputs			Yes
From the PC interface, memory card, NET network, EASYLink			Yes
Bus termination (first and last station)			Yes
Terminal type			RJ45
Digital Inputs 24 Vdc			
Number			14
Inputs can be used as analog inputs			—
Status display			LCD display (if provided)
Potential isolation			
From power supply			No
Between digital inputs			No
From the outputs			Yes
From PC interface, memory card, EASYLink			No
From network EASYN _e t			Yes
Rated operational voltage	U_e	Vdc	24
At signal "0"	U_e	Vdc	<5
At signal "1"	U_e	Vdc	>15
Clock Outputs			
Number			4
Voltage		Vdc	24
Electrical isolation			No

easySafety Relay, continued

Description	Unit	ES4P_
Relay Outputs		
Number		4 for ES4P-...-DR_, 1 redundant for ES4P-...-DM_
Outputs in groups of		1
Parallel switching of outputs to increase power		Not permissible
Protection of an output relay		Fuse: 6 A gG, circuit breaker with characteristic C: 24 Vdc 4 A, Short-circuit current <250 A
Potential isolation		
From power supply		Yes
From the inputs		Yes
From PC interface, memory card, EASYNet, EASYLink		Yes
Safe isolation according to EN 50178	Vac	300
Basic insulation	Vac	600
Lifespan, mechanical	Operations	$\times 10^6$ 10
Contacts		
Conventional thermal current	A	6
Rated impulse withstand voltage U_{imp} contact coil	kV	6
Rated operational voltage	U_e	Vac 250
Rated insulation voltage	U_i	Vac 250
Safe isolation to EN 50178 between coil and contact	Vac	300
Making capacity		
AC-15, 230 Vac, 3 A	Operations	80,000
DC-13, 24 Vdc, 5 A, 0.1 Hz	Operations	40,000
Switching frequency		
Mechanical operations	$\times 10^6$	10
Switching frequency	Hz	10
UL/CSA		
UL 508		B300/R300
Transistor Outputs		
Number		4
Rated operational voltage	U_e	Vdc 24
Permissible range	U_e	Vdc 20.4–28.8
Ripple	%	≤ 5
Protection against polarity reversal		Yes (Caution: A short-circuit will result if 0 V or GND is applied to the outputs in the event that the supply voltage is connected to the wrong poles.)
Potential isolation		
From power supply		Yes
From the inputs		Yes
From PC interface, memory card, network, EASYNet, EASYLink		Yes
Rated operational current at signal "1" DC	I_e	A Maximum 0.5
At signal "1" with $I_e = 0.5$ A		V $U = U_e - 1$ V
Short-circuit protection		Yes, thermal
Short-circuit tripping current for $R_A \leq 10$ m ohms	A	$0.7 \leq I_e \leq 2$ per output
Total short-circuit current	A	8
Peak short-circuit current	A	16
Thermal cutout		Yes
Maximum operating frequency at constant resistive load $R_L < 100$ k Ω (dependant on program and load)	Ops/h	40,000
Parallel connection of outputs		No
Status indication of the outputs		LCD display (if provided)
Inductive load		
Without external suppressor circuit		
Duty factor		$T_{0.95} = 3 \times T_{0.65} = 3 \times L/R$ $T_{0.95}$ = Time in ms, until 95% of the steady-state current has been reached
With external suppressor circuit		
Utilization factor	g	1
Duty factor	% DF	100
Maximum switching frequency, maximum duty factor	Operations	Depending on the suppressor circuit

3.11

Control Relays and Timers

easySafety

Dimensions

Approximate Dimensions in Inches (mm)

ESR5_

3

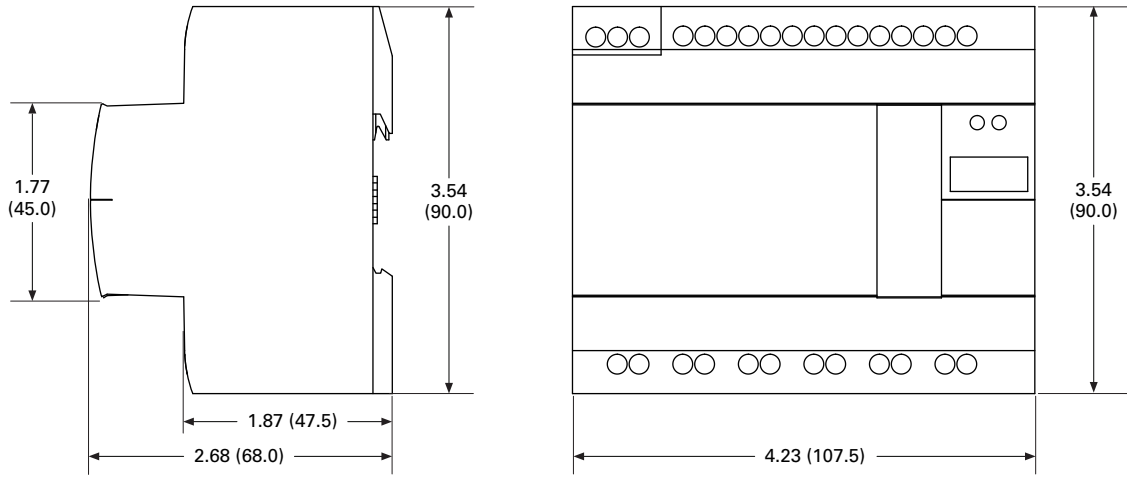

XC Series PLCs



XC152 Series PLCs



XN300 Series Remote I/O



4.1	XC Series Programmable Logic Controllers	
	Product Overview	V7-T4-2
	Product Selection Guide	V7-T4-3
	System Overview	V7-T4-4
	Product Selection	V7-T4-6
	Technical Data and Specifications	V7-T4-12
	Dimensions	V7-T4-28
4.2	XC152 Series Programmable Logic Controllers	
	Product Description	V7-T4-30
	Product Selection	V7-T4-31
	Technical Data and Specifications	V7-T4-32
	Dimensions	V7-T4-33
4.3	XN300 Series Remote I/O	
	Product Description	V7-T4-34
	Features	V7-T4-34
	Standards and Certifications	V7-T4-34
	Product Selection	V7-T4-35

Note: For EASY Programmable Relays, see Tab 3 in this volume.

XC Series Programmable Logic Controllers



4

Contents

Description

Page

XC Series Programmable Logic Controllers	
Product Selection Guide	V7-T4-3
Catalog Number Selection	V7-T4-4
System Overview	V7-T4-4
Product Selection	V7-T4-6
Accessories	V7-T4-9
Technical Data and Specifications	V7-T4-12
Dimensions	V7-T4-28

Product Overview

The XC100 and XC200 series modular PLCs stand out on account of their highly scalable design. Different CPU performance classes and a wide range of expansion modules are available. An important feature is their ability to be integrated in modern communication systems. Innovative solutions can be created thanks to the possibility of exchanging data with OPC clients via the Ethernet interface and the integrated web server.

Features and Benefits

Flexible Range

- Compact and modular CPU versions to suit the needs of the application
- With or without on-board Ethernet and/or built-in web server
- Range of CPU performance
- Integrated CANopen interface for easy integration with XI/ON remote I/O

High Performance

- Parallel backplane bus for faster processing speed
- Fiber optic CANopen interface for environments with severe electromagnetic interference
- High performance XC202 CPU with
 - 10/100 Mbit Ethernet
 - XSoft-CoDeSys programming software

Standards and Certifications

- IEC—UL508; CSA C22.2 No. 0-M; CSA C22.2 No. 142-M; CE marking
- UL File No.—E135462
- UL CCN—NRAQ
- CSA File No. 012528
- CSA Class No. 2252-01
- NA Certification—
 - UL Listed
 - CSA certified/cUL
- RoHS



Product Selection Guide

XC Series Programmable Logic Controllers



XC121 Compact PLC

Page V7-T4-6

This PLC is particularly suitable for applications where space is at premium and with high communication requirements.

- Two serial and two CAN interfaces enable:
 - the coupling of two CAN networks
 - Modbus master/slave coupling (RS-232 or RS-485)—CAN
 - RS-232—CAN coupling
- I/O expansion with 18 digital and 8 analog inputs/outputs
- 6 interrupt inputs
- Expandable with standard XIOC modules



XC101 Modular PLCs

Page V7-T4-6

The modular PLCs of the XC101 series are universal automation devices for small and medium-sized applications.

- Locally expandable with up to 15 XIOC modules
- Data storage on SD card
- CAN interface



XC201 Modular PLCs

Page V7-T4-7

The modular PLCs of the XC201 series offer a high CPU performance, a high speed and a wide range of communication options.

- Locally expandable with up to 15 XIOC modules
- Ethernet interface for communication and programming
- CAN interface
- Data storage on SD card or USB stick
- Web server enables visualization via CoDeSys
- Operating system update SD card or USB



XC202 Modular PLCs

Page V7-T4-7

The modular PLCs of the XC202 series offer higher CPU performance and memory than the XC201 PLCs.

- Locally expandable with up to 15 XIOC modules
- Ethernet interface for communication and programming
- CAN interface
- Data storage on SD card or USB stick
- Operating system update via Ethernet, SD card or USB
- Up to three IP addresses can be configured
- 29-bit CAN identifier

Features	XC121	XC101	XC201	XC202
Input voltage	24 Vdc	24 Vdc	24 Vdc	24 Vdc
Memory size	256 kB	64, 128 or 256 kB	256 kB or 2 MB	4 MB
Microprocessor	Infineon CC161	Infineon C164	MIPS RISC	ARM11
Processor speed	36 MHz	24 MHz	131 MHz	532 MHz
Cycle time per 1k instructions	<0.3 ms	<0.5 ms	<0.15 ms	<0.025 ms
SD card slot	Yes	Yes	Yes	Yes
USB interface	No	No	Yes	Yes
Real time clock	Yes	Yes	Yes	Yes
On-board digital inputs	—	8	8	8
On-board digital outputs	—	6	6	6
Interrupt inputs	6	4	2	2
Expandability	XIO-EXT base module + Up to 15 XIOC modules	Up to 15 XIOC modules	Up to 15 XIOC modules	Up to 15 XIOC modules
Removable terminal blocks	Yes	Yes	Yes	Yes
Screw terminal option	No	Yes	Yes	Yes
Spring-cage terminal option	Yes	Yes	Yes	Yes
Serial interface	1, RS-232 1, RS-232/RS-485	1, RS-232	1, RS-232	1, RS-232
Ethernet port	No	No	Yes	Yes
CANopen interface	2	1	1	1
On-board high speed counters	No	No	Yes	Yes
On-board encoder inputs	No	No	Yes	Yes
OPC server	Yes	Yes	Yes	Yes
Integrated web server	No	No	On suffix “-XV” models	Yes
FTP server	No	No	On suffix “-XV” models	Yes
Networks master	CANopen/easyNet	CANopen/PROFIBUS-DP/easyNet	Ethernet/CANopen/PROFIBUS-DP/easyNet	Ethernet/CANopen/PROFIBUS-DP/easyNet
Networks node/device	CANopen/PROFIBUS-DP®/ easyNet	CANopen/PROFIBUS-DP/ easyNet	Ethernet/CANopen/PROFIBUS-DP/ easyNet	Ethernet/CANopen/PROFIBUS-DP/ easyNet
Operating system	Proprietary	Proprietary	Windows CE	Windows CE
X-Soft-CoDeSys version	V2.3	V2.3	V2.3	V2.3 and 3.0

Catalog Number Selection

Controllers

4

XC - CPU 201 - EC 512K - XV

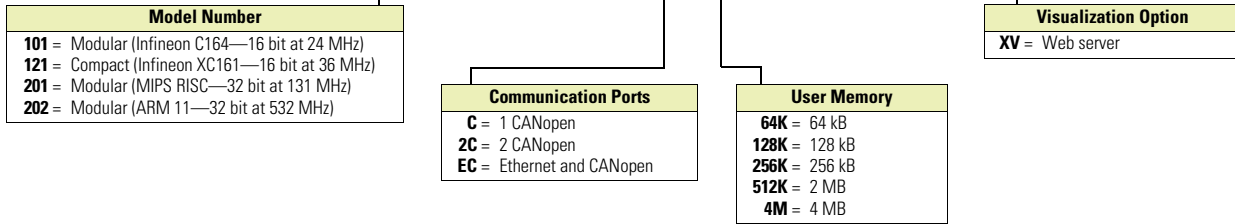

System Overview

System Configuration

①

CPU	1	2	3	4	5	6	7
XIOC-BP-XC	XIOC-BP-2	XIOC-BP-2	XIOC-BP-2	XIOC-BP-2	XIOC-BP-2	XIOC-BP-3	XIOC-BP-3
XIOC-BP-XC1	XIOC-BP-2	XIOC-BP-2	XIOC-BP-2	XIOC-BP-2	XIOC-BP-2	XIOC-BP-3	XIOC-BP-3

②

CPU	1	2	3	4	5	6	7	8	9	10	11	12	13	14	15
XIOC-BP-XC	XIOC-BP-2	XIOC-BP-2	XIOC-BP-3	XIOC-BP-3	XIOC-BP-3	XIOC-BP-EXT	XIOC-BP-EXT	XIOC-BP-EXT	XIOC-BP-3	XIOC-BP-3	XIOC-BP-2	XIOC-BP-2	XIOC-BP-2	XIOC-BP-2	XIOC-BP-2
XIOC-BP-XC1	XIOC-BP-2	XIOC-BP-2	XIOC-BP-2	XIOC-BP-2	XIOC-BP-2	XIOC-BP-EXT	XIOC-BP-EXT	XIOC-BP-EXT	XIOC-BP-3	XIOC-BP-3	XIOC-BP-2	XIOC-BP-2	XIOC-BP-2	XIOC-BP-2	XIOC-BP-2

Notes

- ① Maximum basic version, ≤7 signal modules.
- ② Maximum total version, ≤15 signal modules.

Product Identification

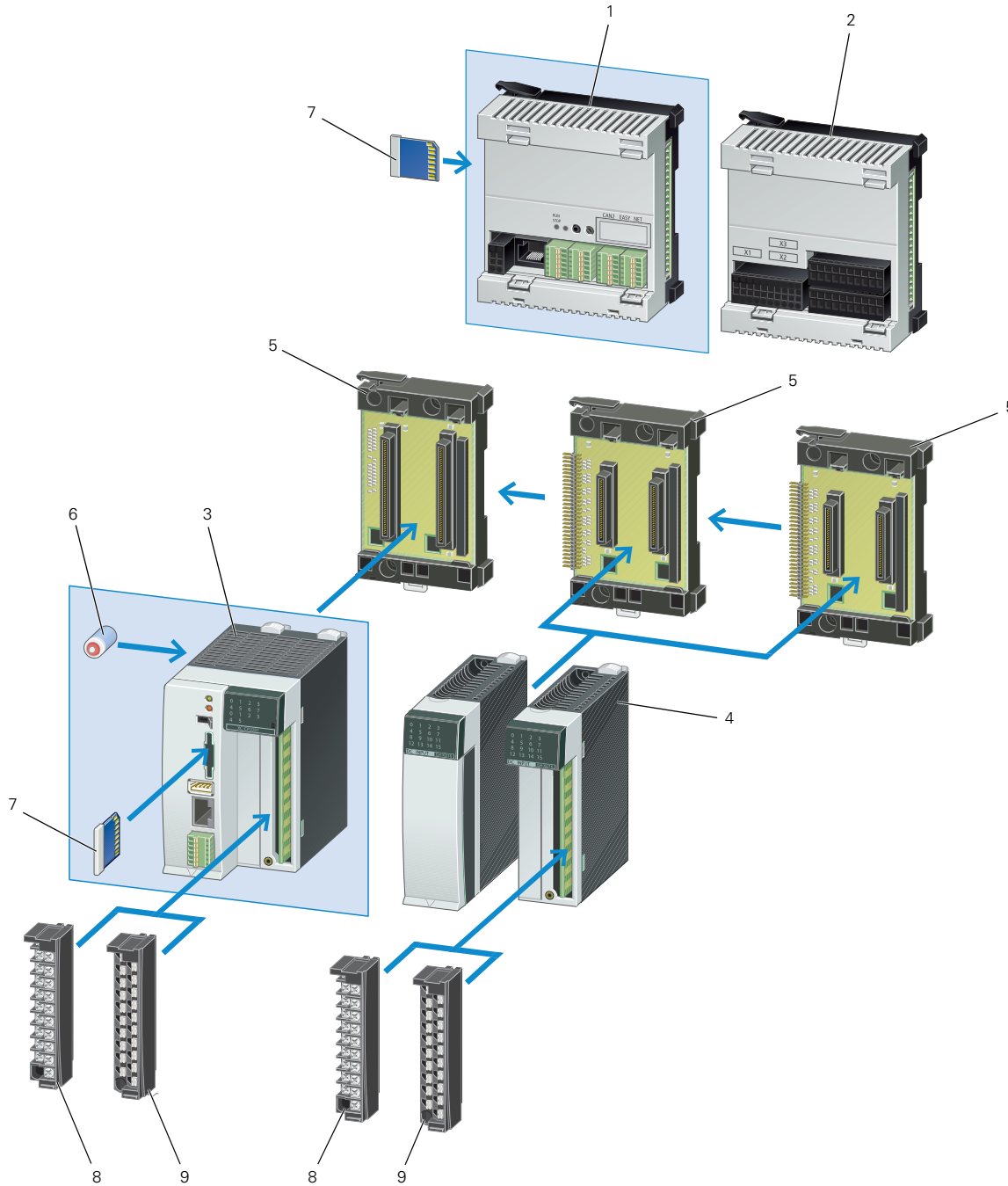

Item Number	Description
1	XC121 Compact PLC CPU
2	XC121 I/O Expansion module
3	XC100/XC200 Modular PLC
4	XIOC I/O modules
5	XIOC Module backplane

Item Number	Description
6	Battery
7	SD Memory card
8	XIOC Terminal block, screw terminals
9	XIOC Terminal block, spring-cage terminals

Product Selection

XC121 Compact PLC CPU

Can be locally expanded with I/O module XIO-EXT-121-1.

- 24 Vdc input supply
- Real time clock
- 2 CANopen interfaces (500 kB)
- RS-232 interface for programming and communication
- Second RS-232/RS-485 interface
- Slot for SD memory card
- Spring-cage terminal blocks
- OPC server
- RUN/STOP switch

XC121



XC121 Compact PLC

Program Memory Size	Cycle Time ①	Ethernet	CAN	Serial Interface	Web Server	Pkg. Qty.	Style Number	Catalog Number
256 kB	<0.3 ms	—	2	1, RS-232 1, RS-232/RS-485	—	1	290446	XC-CPU121-2C256K

XC121 I/O Expansion Module

Base I/O module for the XC121.

- 10 digital inputs 24 Vdc
- 6 interrupt inputs
- 8 digital inputs/outputs 24 Vdc 0.5A
- 2 analog inputs 0–10V
- 2 analog inputs 0–20 mA
- 2 analog inputs PT100 RTD
- 2 analog outputs 0–10V
- Removable spring-cage terminals
- Expandable with 15 XIOC modules ②

XC121 I/O Module



XC121 I/O Expansion Module

Digital Inputs	Digital Inputs/Outputs	Analog Inputs	Analog Outputs	Pkg. Qty.	Style Number	Catalog Number
10, 24 Vdc	8, 24 Vdc 0.5A	2, 0–10V 2, 0–20 mA 2, PT100 RTD	2, 0–10V	1	290450	XIO-EXT121-1

XC101 Modular PLCs

Order backplane, terminals and battery separately.

- 24 Vdc input supply
- Real time clock
- Expandable with 15 XIOC modules
- 8 digital inputs
- 4 interrupt inputs
- 6 digital outputs
- RS-232 interface for programming and communication
- CANopen interface (500 kB)
- Slot for SD memory card
- RUN/STOP switch and LED indicators

XC101



XC101 Modular PLCs

Program Memory Size	Cycle Time ①	Ethernet	CANopen	Serial Interface	Web Server	Pkg. Qty.	Style Number	Catalog Number
64 kB	<0.5 ms	—	1	1, RS-232 typ.	—	1	262152	XC-CPU101-C64K
128 kB	<0.5 ms	—	1	1, RS-232 typ.	—	1	262146	XC-CPU101-C128K
256 kB	<0.5 ms	—	1	1, RS-232 typ.	—	1	274399	XC-CPU101-C256K

Notes

- ① Cycle time per 1k of instructions.
- ② Except the XIOC-NET-DP-M module.

XC201 Modular PLCs

Order backplane, terminals and battery accessories separately.

- 24 Vdc input supply
- Real time clock
- Expandable with 15 XIOC modules
- 8 digital inputs
- 2 interrupt inputs
- Incremental encoder inputs
- High speed counter (50 kHz) inputs
- 6 digital outputs
- Ethernet and RS-232 interface for programming and communication
- CANopen interface (1 MB)
- Slot for SD memory card
- USB interface
- RUN/STOP switch and LED indicators
- Built-in Web server on XV models

XC201



XC201 Modular PLCs

Program Memory Size	Cycle Time ①	Ethernet	CANopen	Serial Interface	Web Server	Pkg. Qty.	Style Number	Catalog Number
256 kB	<0.15 ms	✓	1	1, RS-232	—	1	262155	XC-CPU201-EC256K
2 MB	<0.15 ms	✓	1	1, RS-232	—	1	262157	XC-CPU201-EC512K
256 kB Integrated web server	<0.15 ms	✓	1	1, RS-232	✓	1	262156	XC-CPU201-EC256K-XV
2 MB Integrated web server	<0.15 ms	✓	1	1, RS-232	✓	1	262158	XC-CPU201-EC512K-XV

XC202 Modular PLCs

Order backplane, terminals and battery accessories separately.

- 24 Vdc input supply
- Real time clock
- Expandable with 15 XIOC modules
- 8 digital inputs
- 2 interrupt inputs
- Incremental encoder inputs
- High speed counter (50 kHz) inputs
- 6 digital outputs
- Ethernet and RS-232 interface for programming and communication
- CANopen interface (1 MB)
- Slot for SD memory card
- USB interface
- RUN/STOP switch and LED indicators
- Built-in Web server

XC202



XC202 Modular PLCs

Program Memory Size	Cycle Time ①	Ethernet	CANopen	Serial Interface	Web Server	Pkg. Qty.	Style Number	Catalog Number
4 MB Integrated web server	<0.025 ms	✓	1	1, RS-232	✓	1	134238	XC-CPU202-EC4M-XV

XIOC Expansion Modules

Order screw, spring-cage terminals or 40-pin connector cable for 32 I/O modules separately.

- 8, 16 and 32 input modules
- 8, 16 and 32 output modules
- User configurable input/output module
- Isolated relay output module

XIOC—Digital



XIOC Digital Expansion Modules

Description	Pkg. Qty.	Style Number	Catalog Number
8 inputs, 24 Vdc	1	257891	XIOC-8DI
16 inputs, 24 Vdc	1	257892	XIOC-16DI
32 inputs, 24 Vdc	1	267411	XIOC-32DI
8 outputs, 24 Vdc, 0.3A	1	257894	XIOC-8DO
16 outputs, 24 Vdc, 0.3A	1	257896	XIOC-16DO
16 outputs, 24 Vdc, 0.8A, short-circuit protected	1	257895	XIOC-16DO-S
16 terminals, 4 inputs, 12 configurable as inputs/outputs, 24 Vdc—outputs 0.5A	1	262322	XIOC-16DX
32 outputs, 24 Vdc, 0.2A	1	267413	XIOC-32DO
12 relay outputs, isolated	1	257897	XIOC-12DO-R

Note

① Cycle time per 1k of instructions.

XIOC—Analog



XIOC Analog Modules

Description	Pkg. Qty.	Style Number	Catalog Number
Inputs: 8 inputs 4–20 mA	1	262549	XIOC-8AI-I2
Inputs: 8 voltage inputs 0–10V	1	257899	XIOC-8AI-U1
Inputs: 8 voltage inputs, ±10V	1	257900	XIOC-8AI-U2
Inputs: 4 inputs for temperature monitoring, PT100/1000	1	257901	XIOC-4T-PT
Inputs: 4 inputs for thermocouples Type K, J, L, B, N, E, R, S, T	1	289933	XIOC-4AI-T
Outputs: 2 outputs, ±10V	1	257904	XIOC-2AO-U2
Outputs: 2 outputs 0–10V, 2 outputs 4–20 mA	1	257902	XIOC-2AO-U1-2AO-I2
Outputs: 4 outputs 0–10 V	1	257903	XIOC-4AO-U1
Combination modules: 2 inputs and 1 output 0–10V/1 ms conversion time	1	262409	XIOC-2AI-1AO-U1
Combination modules: 2 inputs and 1 output 0–10V, 0–20 mA/1 ms conversion time, individual changeover	1	281545	XIOC-2AI-1AO-U1-I1
Combination modules: 4 inputs and 2 outputs 0–10V/1 ms conversion time	1	262405	XIOC-4AI-2AO-U1
Combination modules: 4 inputs and 2 outputs 0–10V, 0–20 mA/1 ms conversion time, individual changeover	1	281544	XIOC-4AI-2AO-U1-I1

XIOC—Counter



Counter Modules

Description	Pkg. Qty.	Style Number	Catalog Number
1 input up to 100 kHz, 24 Vdc, 5 Vdc, 2 digital transistor outputs, opto-isolated, 24 Vdc 30-pin connector required for counter module	1	257906	XIOC-1CNT-100KHZ
2 inputs up to 100 kHz, (24 Vdc or 5V diff), 4 digital transistor outputs, opto-isolated, 24 Vdc 30-pin connector required for counter module	1	257907	XIOC-2CNT-100KHZ
2 incremental encoders up to 400 kHz, 5 Vdc, 2 analog outputs ±10V	1	262417	XIOC-2CNT-2AO-INC

XIOC—Communication Card



Communication Modules

Description	Pkg. Qty.	Style Number	Catalog Number
PROFIBUS-DP master module	1	257908	XIOC-NET-DP-M
PROFIBUS-DP node module	1	286419	XIOC-NET-DP-S
Serial interfaces: RS-232C, RS-485, RS-422 (for XC101, XC201 and XC202) Modes of operation: Transparent mode, Modbus master/node	1	267191	XIOC-SER
Serial interfaces: RS-232C, RS-485, RS-422 (for XC201 and XC202 only) Modes of operation: Transparent mode, Modbus master/node	1	135265	XIOC-TC1

Accessories

Terminals



Terminals

One 18 pole terminal plug is required for each digital and analog module.

Description	Pkg. Qty.	Style Number	Catalog Number
18-pin connector with screw terminals for digital or analog I/O	10	258102	XIOC-TERM-18S
18-pin connector with spring-cage terminal for digital or analog I/O	10	258104	XIOC-TERM-18T
40-pin connector for digital module, with 4 m cable XIOC-32DI XIOC-32DO	1	267414	XIOC-TERM32
30-pin connector for counter module, with 4 m cable XIOC-1CNT-100KHZ XIOC-2CNT-100KHZ	1	262248	XIOC-TERM30-CNT4

Module Backplane

Backplane



Description	Pkg. Qty.	Style Number	Catalog Number
Basic backplane for mounting XC100/200 on top-hat rail, can be expanded Width: 2 slots for controller	1	260792	XIOC-BP-XC
Expansion backplane for mounting XIOC modules on top-hat rail, can be expanded Width: 2 slots for XIOC modules	1	260794	XIOC-BP-2

Backplane



Basic backplane for mounting XC100/200 on DIN rail, can be expanded Width: 3 slots for controller and one XIOC module	1	260793	XIOC-BP-XC1
Expansion backplane for mounting XIOC modules on DIN rail, can be expanded Width: 3 slots for XIOC modules	1	260795	XIOC-BP-3
Expansion backplane for mounting XIOC modules on DIN rail, can be expanded Width: 3 slots for XIOC modules ①	1	274291	XIOC-BP-EXT

Memory Card



Memory Card

For storage of programs, data, recipes for XC100, XC121, XC200.

Description	Pkg. Qty.	Style Number	Catalog Number
512 MB	1	138257	XT-MEM-MM512M
32 MB	1	262731	XT-MEM-MM32M

Note

① Module backplane for expansion with up to 15 modules, must be plugged into the 6th slot.

Battery



Battery

Description	Pkg. Qty.	Style Number	Catalog Number
Lithium 1/2 AA 3.6V battery for backup of real-time clock	1	256209	XT-CPU-BAT1

Programming Cables

D-Sub 9-Pin



Description	Pkg. Qty.	Style Number	Catalog Number
2m, D-sub 9-pin, serial	1	262186	XT-SUB-D/RJ45

Ethernet Cross



2m, Ethernet cross	1	256487	XT-CAT5-X-2
5m, Ethernet cross	1	256488	XT-CAT5-X-5

Programming



Programming cable for XC through USB interface	1	115735	EU4A-RJ45-USB-CAB1
--	---	--------	---------------------------

Connection Cable



Connection Cables

Description	Pkg. Qty.	Style Number	Catalog Number
0.3m: Connection cable for XC200 to interface switch	1	256283	EASY-NT-30
0.8m: Connection cable for XC200 to interface switch	1	256284	EASY-NT-80
1.5m: Connection cable for XC200 to interface switch	1	256285	EASY-NT-150

Empty Module



Empty Module

Description	Pkg. Qty.	Style Number	Catalog Number
Empty module to cover open XIOC slots	1	288894	XIOC-NOP

Interface Switch



Interface Switch

Description	Pkg. Qty.	Style Number	Catalog Number
Interface adapter to split the combined RS-232/Ethernet interface of the XC200 into RJ45 sockets. Connection cable EASY-NT-30/80/150 usable for connection to XC200	1	289170	XT-RJ45-ETH-RS232

Filter



Filter

Description	Pkg. Qty.	Style Number	Catalog Number
Interference suppression of the external 24 Vdc supply of the XC100/200. Maximum current consumption: 2.2A	1	285316	XT-FIL-1
Power supply interference suppression of I/O modules of XC100/200. Maximum current consumption: 12A	1	118980	XT-FIL-2

XSoft-CoDeSys-2 Software

Combined Logic and Visualization Development for XC Series PLCs

IEC 61131-3 Programming Languages

- Ladder Diagram
- Structured Text
- Sequential function chart
- Function block diagram
- Freely definable function block chart/continuous function chart
- Instruction List

Project Development

- Automatic variable declaration
- On-line editing
- Pop-up variable and function search/pick tools
- Automatic formatting and color coding of logic/declaration text
- Re-usable Visual-Logic Function Blocks

Debugging and commissioning

XSoft-CoDeSys-2 offers you a number of important functions for debugging, testing and commissioning your applications quickly and efficiently.

All these features are available as soon as you log on to the XV HMI-PLC or XC200 PLC (online mode) over an Ethernet connection.

Target Visualization

Integrated design of Operator Interface screens for the XV HMI-PLC series. Visualization and logic developed as part of the same project. Simplifies screen design and always keeps the Logic and visualization in synch.

Web Visualization

Optionally XSoft-CoDeSys-2 can automatically generate XML-based runtime screens to make the screens from the XV HMI-PLC accessible remotely using a web browser with a JavaScript plug-in such as Internet Explorer®, Firefox® and others.

Simulation

Users can also test the application when the XV HMI-PLC is not connected to the process. This is possible thanks to the integrated online simulation feature. Simulation supports both the screens and logic that have been designed using XSoft-CoDeSys.

Advanced Features

- Up to 16 time and/or event driven tasks per project
- Each task can include multiple logic programs or subroutines
- Programs and screen designs can be exported and imported to support reuse
- Powerful, built-in function block libraries
- Ability to create user-defined function blocks

- Fieldbus Configurator for CANopen, PROFIBUS-DP and SmartWire-DT® device I/O
- Ethernet and serial communication function blocks (OPC server, UDP, TCP/IP, FTP client/ server, Modbus Master/Node, email, SMS, and more)
- 8 level password protection
- Web access selectable per screen
- System function libraries (OS Storage Card, and more)
- On-line and historical alarms
- On-line and historical trends

System Requirements

Windows XP and Windows 7 32-bit systems

XSoft-CoDeSys-2



XSoft-CoDeSys-2 Software

Description	Catalog Number
Single Seat License	SW-XSOFT-CODESYS-2-S
Multiple Seat License (3)	SW-XSOFT-CODESYS-2-M

Technical Data and Specifications

XC121 Compact PLC

Description	Unit	XC-CPU121-2C256K
General		
Standards		IEC/EN 61131-2; EN 50178
Ambient temperature	°F (°C)	32° to 131° (0° to 55°)
Storage	°F (°C)	−13° to 158° (−25° to 70°)
Mounting position		Horizontal
Relative humidity, noncondensing (IEC/EN 60068-2-30)	%	10–95
Air pressure (in operation)	hPa	795–1080
Vibration resistance		Frequency 5–9 Hz; 3.5 mm amplitude 9–150 Hz; 1.0g constant acceleration
Mechanical shock resistance		15g/11 ms
Overvoltage category		II
Pollution degree		2
Degree of protection		IP20
Rated insulation voltage (U _i)	V	500
Emitted interference		EN 61000-6-4
Interference immunity		EN 61000-6-2
Backup time		At least 72 hours
Weight	kg	0.15
Electromagnetic Compatibility (EMC)		Refer to Page V7-T4-27
Connections		
Supply voltage		—
Connection type		—
Terminal capacity	mm ²	0.14–1 (AWG28-18)
COM1 interface		
Connection type		RJ45
COM2, CAN1, CAN2 interfaces		
Connection type		Spring-loaded terminal block, 6-pole
Terminal capacity	mm ²	0.14–0.5 (AWG28-20)
Power Supply		
Input voltage	Vdc	24
Permissible range	Vdc	20.4–28.8
Input power	W	Max. 1.44
Input current	mA	60
Ripple	%	≤5
Maximum heat dissipation (without local I/O) (P _v)	W	6
Overvoltage protection		Yes
Protection against polarity reversal		Yes
Inrush current	x I _n	No limitation (limited only by upstream 24 Vdc power supply unit)
Supply failure bridging		
Duration of power failure	ms	10
Repetition rate	s	1
External supply filter		Part No.: XT-FIL-1, Refer to Page V7-T4-10
Memory		
Program code/program data	kByte	256/244
Marker/input/output/retain data	kByte	16/4/4/8
Cycle time for 1k of instructions (bits, bytes)	ms	<0.3

XC121 Compact PLC, continued

Description	Unit	XC-CPU121-2C256K
Interfaces		
Serial interface (RS-232) without handshake lines		
Baud rate	kbit/s	Programming (character format: 8 data bits, No parity, 1 stop bit) 19.2, 38.4 (default), 57.6
Connector type		RJ45
Potential isolation		No
In transparent mode		
Baud rate	kbit/s	0.3, 0.6, 1.2, 2.4, 4.8, 9.6, 19.2, 38.4, 57.6, 115.2
Character formats		8E1, 8O1, 8N1, 8N2, 7E2, 7O2, 7N2, 7E1
Number of send bytes for block		190
Number of receive bytes for block		190
COM2 (RS-232/RS-485) without handshake lines		
Baud rate	kbit/s	Transparent mode (setting through function blocks) 0.3, 0.6, 1.2, 2.4, 4.8, 9.6, 19.2, 38.4, 57.6
Character formats		8E1, 8O1, 8N1, 8N2, 7E2, 7O2, 7N2, 7E1 (setting through function blocks)
Potential isolation		No
Bus termination		External, for RS-485
CAN1/CAN2 interface		
Baud rate	kbit/s	10 – 500
Potential isolation		No
Stations		126
Bus termination		Adjustable for each interface (CAN1/CAN2)
PDO type		Asyn., cyc., acyc.
Power Supply of Local Inputs/Outputs (24 V_Q/0 V_Q)		
Input voltage	Vdc	24
Voltage range	Vdc	19.2–30, observe polarity
Potential isolation		
Between power supply and CPU voltage		Yes
Overvoltage protection		Yes

XC121 Expansion Module

Description	Unit	X10-EXT121-1
General		
Standards		IEC/EN 61131-2; EN 50178
Ambient temperature	°F (°C)	32° to 131° (0° to 55°)
Storage	°F (°C)	−13° to 158° (−25° to 70°)
Mounting position		Horizontal
Relative humidity, noncondensing (IEC/EN 60068-2-30)	%	10–95
Air pressure (in operation)	hPa	795–1080
Vibration resistance		Frequency 5–9 Hz; 3.5 mm amplitude 9–150 Hz; 1.0g constant acceleration
Mechanical shock resistance		15g/11 ms
Overvoltage category		II
Pollution degree		2
Degree of protection		IP20
Rated insulation voltage (U _i)	V	500
Emitted interference		EN 61000-6-4
Interference immunity		EN 61000-6-2
Backup time		At least 72 hours
Weight	kg	0.15
Electromagnetic Compatibility (EMC)		
Refer to Page V7-T4-27		
Connections		
X1 connector		
Connector type		Spring-loaded terminal block, 20 pole, B2L 3.5
Terminal capacity (solid)	mm ²	0.5–1
X2/X3 connector		
Connector type		Spring-loaded terminal block, 10-pole, BLZF 3.5/180 or BLI/O 3.5/10F with LEDs
Terminal capacity (solid)	mm ²	0.5–1
Power Supply		
Supply failure bridging		
Duration of power failure	ms	10
Repetition rate	s	1
Input voltage	Vdc	24
Permissible range	Vdc	20.4 – 28.8
Input power	W	Max.1.68
Input current	mA	70
Ripple	%	≤5
Overvoltage protection		Yes
Protection against polarity reversal		Yes
Inrush current	x I _n	Max. 1A
Output voltage for signal modules		
Max. field current (I _f)	A	2
Digital Inputs		
Number		X2: 9 with plug BLI/O 3.5/10F or 10 with plug BLZF 3.5/180 X3: 8 (can also be used as outputs)
Rated voltage (U _o)	Vdc	24
At state "0" (U _o)	Vdc	<5
At state "1" (U _o)	Vdc	>15
Rated operational current		
At state "1" (I _o)	mA	3.3
Delay time		
X2: DI0–DI3	μs	20
X2: DI4–DI9	μs	250
X2: DX0–DX7	ms	20
Potential isolation		No

XC121 Expansion Module, continued

Description	Unit	X10-EXT121-1
Digital Outputs		
Number		At X3: 8 (can also be used as inputs)
Rated voltage		
Rated voltage (U_o)	Vdc	24
Permissible range		20.4–28.8 Vdc
Ripple	%	≤5
Rated operational current		
At state "1" (I_o)	A	0.5 at 24 Vac
Utilization factor (%)	g	1
Maximum duty factor	ms	100%
Lamp load without (R_v)	W	5
Potential isolation		No
Residual current at state "0" per channel	mA	<0.1
Max. output voltage		
At state "0" with external load <10M ohms	V	2.5
At state "1" at $I_o = 0.5A$	V	$U = U_o - 1V$
Short-circuit tripping current		
Short-circuit tripping current for $R_a < 10M$ ohms	A	$0.7 \leq I_o \leq 2$ for output
Total short-circuit current	A	16
Peak short-circuit current	A	32
Max. operating frequency	ops/h	40,000
Parallel connection capability		Yes
Analog Inputs 0–10V		
Number of channels		2
Primary voltage range	V	0–10
Resolution	bit	10
Conversion time	ms	≤5
Overall accuracy		≤ ± 1% (of full-scale value)
Input resistance	kohm	200
Analog Inputs 0–20 mA		
Number of channels		2
Primary voltage range	mA	0–20
Resolution	bit	10
Conversion time	ms	≤5
Overall accuracy		≤ ± 1% (of full-scale value)
Input resistance	ohm	50
PT100 RTD		
Number of channels		2
Temperature range	°F (°C)	–348° to 392° (–200° to 200°)
Resistance range	ohm	18.5–175.8
Resolution	bit	10
Overall accuracy		≤ ± 2%
Analog Outputs		
Number of channels		2
Secondary voltage range	V	0–10
Resolution	bit	12
Conversion time	ms	≤5
Overall accuracy		≤ ± 1% (of full-scale value)
External load resistance (R)	kohm	10

XC101 Modular PLCs

Description	Unit	XC-CPU101-C64K-8DI-6DO	XC-CPU101-C128K-8DI-6DO	XC-CPU101-FC128K-8DI-6DO	XC-CPU101-C256K-8DI-6DO
General					
Standards		IEC/EN 61131-2; EN 50178	IEC/EN 61131-2; EN 50178	IEC/EN 61131-2; EN 50178	IEC/EN 61131-2; EN 50178
Ambient temperature	°F (°C)	32° to 131° (0° to 55°)	32° to 131° (0° to 55°)	32° to 131° (0° to 55°)	32° to 131° (0° to 55°)
Storage	°F (°C)	-13° to 158° (-25° to 70°)	-13° to 158° (-25° to 70°)	-13° to 158° (-25° to 70°)	-13° to 158° (-25° to 70°)
Mounting position		Horizontal	Horizontal	Horizontal	Horizontal
Relative humidity, noncondensing (IEC/EN 60068-2-30)	%	10–95	10–95	10–95	10–95
Air pressure (in operation)	hPa	795–1080	795–1080	795–1080	795–1080
Vibration resistance		10–57 Hz ±0.075 mm/57–150 Hz ±1.0g			
Mechanical shock resistance		15g/11 ms	15g/11 ms	15g/11 ms	15g/11 ms
Overvoltage category		II	II	II	II
Pollution degree		2	2	2	2
Degree of protection		IP20	IP20	IP20	IP20
Rated insulation voltage (U _i)	V	500	500	500	500
Emitted interference	U _i	EN 61000-6-4, Class A	EN 61000-6-4, Class A	EN 61000-6-4, Class A	EN 61000-6-4, Class A
Interference immunity		EN 61000-6-2	EN 61000-6-2	EN 61000-6-2	EN 61000-6-2
Battery (lifespan)		Normally 5 years	Normally 5 years	Normally 5 years	Normally 5 years
Weight	kg	0.23	0.23	0.23	0.23
Terminals		Plug-in terminal block	Plug-in terminal block	Plug-in terminal block	Plug-in terminal block
Terminal capacity					
Screw terminals					
Flexible with ferrule	mm ²	0.5–1.5	0.5–1.5	0.5–1.5	0.5–1.5
Solid	mm ²	0.5–2.5	0.5–2.5	0.5–2.5	0.5–2.5
Spring-cage terminal					
Flexible	mm ²	0.34–1.0	0.34–1.0	0.34–1.0	0.34–1.0
Solid	mm ²	0.14–1.0	0.14–1.0	0.14–1.0	0.14–1.0
Electromagnetic Compatibility (EMC)		Refer to Page V7-T4-27			
Power Supply					
Mains failure duration	ms	10	10	10	10
Repetition rate	s	1	1	1	1
Input voltage	Vdc	24	24	24	24
Permissible range	Vdc	20.4–28.8	20.4–28.8	20.4–28.8	20.4–28.8
Input power	W	Max. 26	Max. 26	Max. 26	Max. 26
Ripple	%	≤5	≤5	≤5	≤5
Maximum heat dissipation (without local I/O) (P _v)	W	6	6	6	6
Overvoltage protection		Yes	Yes	Yes	Yes
Protection against polarity reversal		Yes	Yes	Yes	Yes
Mains filter (external)		Yes	Yes	Yes	Yes
Inrush current	x I _n	Not limited, (limiting only by a supply-side 24 Vdc PSU)			
Output voltage for signal modules					
Rated value	Vdc	5	5	5	5
Output current	A	3.2	3.2	3.2	3.2
Short-circuit rating		Yes	Yes	Yes	Yes
Isolated from supply voltage		No	No	No	No
CPU					
Microprocessor		Infineon C164	Infineon C164	Infineon C164	Infineon C164
Memory					
Program code/program data	kByte	64/64	128/128	128/128	256/256
Marker/retain data	kByte	4/4	8/8	8/8	8/8
Cycle time for 1k of instructions (bits, bytes)	ms	<0.5	<0.5	<0.5	<0.5

XC101 Modular PLCs, continued

Description	Unit	XC-CPU101-C64K-8DI-6DO	XC-CPU101-C128K-8DI-6DO	XC-CPU101-FC128K-8DI-6DO	XC-CPU101- C256K-8DI-6DO
Interfaces					
Serial interface (RS-232) without handshake lines					
Baud rate	kbit/s	Max. 57.6	Max. 57.6	Max. 57.6	Max. 57.6
Connections		RJ45	RJ45	RJ45	RJ45
Potential isolation		No	No	No	No
CANopen					
Maximum data transfer rate	bit/s	500,000	500,000	500,000	500,000
Potential isolation		Yes	Yes	Yes	Yes
Device profile		To DS 301 V4	To DS 301 V4	To DS 301 V4	To DS 301 V4
PDO type		Asyn., cyc., acyc.	Asyn., cyc., acyc.	Asyn., cyc., acyc.	Asyn., cyc., acyc.
Connection		Plug-in terminal block	Plug-in terminal block	Optical fiber interface, wavelength 660 nm, plug for example HFBR-4516 Agilent Technologies	Plug-in terminal block
Bus terminating resistors					
Stations	Number	Max. 126	Max. 126	Max. 126	Max. 126
Watchdog		Yes	Yes	Yes	Yes
RTC (real-time clock)		Yes	Yes	Yes	Yes
Power Supply of Local Inputs/Outputs (24 V_Q/0 V_Q)					
Input voltage	Vdc	24	24	24	24
Voltage range	Vdc	19.2–30, observe polarity	19.2–30, observe polarity	19.2–30, observe polarity	19.2–30, observe polarity
Potential isolation					
Between power supply and CPU voltage		Yes	Yes	Yes	Yes
Overvoltage protection		Yes	Yes	Yes	Yes
Protection against polarity reversal		Yes	Yes	Yes	Yes
Digital Inputs					
Input current for channel at rated voltage	mA	Normally 3.5	Normally 3.5	Normally 3.5	Normally 3.5
Heat dissipation for channel	mW	Normally 85	Normally 85	Normally 85	Normally 85
Voltage level to IEC/EN 61131-2					
Limit value type 1		Low <5 Vdc/High >15 Vdc	Low <5 Vdc/High >15 Vdc	Low <5 Vdc/High >15 Vdc	Low <5 Vdc/High >15 Vdc
Input delay					
OFF → ON	ms	Normally 0.1	Normally 0.1	Normally 0.1	Normally 0.1
ON → OFF	ms	Normally 0.1	Normally 0.1	Normally 0.1	Normally 0.1
Inputs	Number	8 (of which 4 interrupt inputs)	8 (of which 4 interrupt inputs)	8 (of which 4 interrupt inputs)	8 (of which 4 interrupt inputs)
Channels with the same reference potential	Number	8	8	8	8
Status indication		LED	LED	LED	LED
Digital Outputs					
Channels	Number	6	6	6	6
Heat dissipation for channel	W	0.08	0.08	0.08	0.08
Load circuits	A	0.5	0.5	0.5	0.5
Output delay					
OFF → ON		Normally 0.1 ms	Normally 0.1 ms	Normally 0.1 ms	Normally 0.1 ms
ON → OFF		Normally 0.1 ms	Normally 0.1 ms	Normally 0.1 ms	Normally 0.1 ms
Channels with the same reference potential	Number	6	6	6	6
Status indication		LED	LED	LED	LED
Switching capacity		IEC/EN 60947-5-1, utilization category DC-13	IEC/EN 60947-5-1, utilization category DC-13	IEC/EN 60947-5-1, utilization category DC-13	IEC/EN 60947-5-1, utilization category DC-13
Duty factor	% DF	100	100	100	100
Utilization factor	g	1	1	1	1

XC200 Series Modular PLCs

Description	Unit	XC-CPU201-EC256K-8DI-6DO(-XV)	XC-CPU201-EC512K-8DI-6DO(-XV)	XC-CPU202-EC4M-8DI-6DO-XV
General				
Standards		IEC/EN 61131-2; EN 50178	IEC/EN 61131-2; EN 50178	IEC/EN 61131-2; EN 50178
Ambient temperature	°F (°C)	32° to 131° (0° to 55°)	32° to 131° (0° to 55°)	32° to 131° (0° to 55°)
Storage	°F (°C)	-13° to 158° (-25° to 70°)	-13° to 158° (-25° to 70°)	-13° to 158° (-25° to 70°)
Mounting position		Horizontal	Horizontal	Horizontal
Relative humidity, noncondensing (IEC/EN 60068-2-30)	%	10–95	10–95	10–95
Air pressure (in operation)	hPa	795–1080	795–1080	795–1080
Vibration resistance		10–57 Hz ±0.075 mm 57–150 Hz ±1.0g	10–57 Hz ±0.075 mm 57–150 Hz ±1.0g	10–57 Hz ±0.075 mm 57–150 Hz ±1.0g
Mechanical shock resistance		15g/11 ms	15g/11 ms	15g/11 ms
Overvoltage category		II	II	II
Pollution degree		2	2	2
Degree of protection		IP20	IP20	IP20
Rated impulse withstand voltage (U _{imp})	V	850	850	850
Emitted interference		EN 61000-6-4, Class A	EN 61000-6-4, Class A	EN 61000-6-4, Class A
Interference immunity		EN 61000-6-2	EN 61000-6-2	EN 61000-6-2
Battery (lifespan)		Normally 5 years	Normally 5 years	Normally 5 years
Weight	kg	0.23	0.23	0.23
Terminals		Plug-in terminal block	Plug-in terminal block	Plug-in terminal block
Terminal capacity				
Screw terminals				
Flexible with ferrule	mm ²	0.5–1.5	0.5–1.5	0.5–1.5
Solid	mm ²	0.5–2.5	0.5–2.5	0.5–2.5
Spring-cage terminal				
Flexible	mm ²	0.34–1.0	0.34–1.0	0.34–1.0
Solid	mm ²	0.14–1.0	0.14–1.0	0.14–1.0
Electromagnetic Compatibility (EMC)			Refer to Page V7-T4-27	
Power Supply				
Duration of mains failure	ms	10	10	10
Repetition rate	s	1	1	1
Input voltage	Vdc	24	24	24
Permissible range	Vdc	20.4–28.8	20.4–28.8	20.4–28.8
Input power	W	Max. 33	Max. 33	Max. 33
Ripple	%	≤5	≤5	≤5
Maximum heat dissipation (P _v)	W	6	6	6
Overvoltage protection		Yes	Yes	Yes
Protection against polarity reversal		Yes	Yes	Yes
Line filter		Yes	Yes	Yes
Inrush current	x I _n	Not limited (limiting only by a supply-side 24 Vdc PSU)		
Output voltage for signal modules				
Rated value	Vdc	5	5	5
Output current	A	3.2	3.2	3.2
Short-circuit rating		Yes	Yes	Yes
Isolated from supply voltage		No	No	No
CPU				
Microprocessor		NEC VR4181 A MIPS	NEC VR4181 A MIPS	ARM 532 MHz
Memory				
Program code/program data		256 kByte/256 kByte	2 Mbyte/512 kByte	4 Mbyte/512 kByte
Marker/retain data	kByte	16/32	16/32	16/64
Cycle time for 1k of instructions (bits, bytes)	ms	<0.15	<0.15	<0.025

XC200 Series Modular PLCs, continued

Description	Unit	XC-CPU201-EC256K-8DI-6DO(-XV)	XC-CPU201-EC512K-8DI-6DO(-XV)	XC-CPU202-EC4M-8DI-6DO-XV
Interfaces				
Ethernet				
Baud rate	Mbit/s	10/100–Autodetect	10/100–Autodetect	10/100–Autodetect
Connector type		RJ45	RJ45	RJ45
Potential isolation		No	No	No
Serial interface (RS-232) without handshake lines				
Baud rate	kbit/s	Max. 115.2	Max. 115.2	Max. 115.2
Connector type		RJ45	RJ45	RJ45
Potential isolation		No	No	No
USB interface		1.0	1.0	2.0
CANopen				
Maximum data transfer rate	Mbit/s	1	1	1
Potential isolation		Yes	Yes	Yes
Device profile		To DS 301 V4	To DS 301 V4	To DS 301 V4
PDO type		Asyn., cyc., acyc.	Asyn., cyc., acyc.	Asyn., cyc., acyc.
Connection		Plug-in terminal block	Plug-in terminal block	Plug-in terminal block
Bus terminating resistors		External	External	Internal
Stations	Number	Max. 126	Max. 126	Max. 126
Watchdog		Yes	Yes	Yes
RTC (real-time clock)		Yes	Yes	Yes
Power Supply of Local Inputs/Outputs (24 V_Q/0 V_Q)				
Input voltage	Vdc	24	24	24
Voltage range	Vdc	19.2–30, observe polarity	19.2–30, observe polarity	19.2–30, observe polarity
Potential isolation				
Between power supply and CPU voltage		Yes	Yes	Yes
Between power supply and inputs/outputs		No	No	No
Status indication		LED	LED	LED
Terminals		Plug-in terminal block	Plug-in terminal block	Plug-in terminal block
Overvoltage protection		Yes	Yes	Yes
Protection against polarity reversal		Yes	Yes	Yes
Digital Inputs				
Input current per channel at rated voltage	mA	Normally 3.5	Normally 3.5	Normally 3.5
Heat dissipation per channel		Normally 85m W	Normally 85m W	Normally 85m W
Voltage level to IEC/EN 61131-2				
Limit value type 1		Low <5 Vdc/High >15 Vdc	Low <5 Vdc/High >15 Vdc	Low <5 Vdc/High >15 Vdc
Input delay				
OFF → ON	ms	Type 0.1	Type 0.1	Type 0.1
ON → OFF	ms	Type 0.1	Type 0.1	Type 0.1
Inputs	Number	8, of which parameterizable: 2 counters, 50 kHz, 2 interrupt inputs, 1 incremental input		
Channels with the same reference potential	Number	8	8	8
Status indication		LED	LED	LED
Digital Outputs				
Channels	Number	6	6	6
Heat dissipation per channel	W	0.08	0.08	0.08
Load circuits	A	0.5	0.5	0.5
Output delay				
OFF → ON		Normally 0.1 ms	Normally 0.1 ms	Normally 0.1 ms
ON → OFF		Normally 0.1 ms	Normally 0.1 ms	Normally 0.1 ms
Channels with the same reference potential	Number	6	6	6
Status indication		LED	LED	LED
Switching capacity		IEC/EN 60947-5-1, utilization category DC-13		
Duty factor	% DF	100	100	100
Utilization factor	g	1	1	1

XIOC Digital Input Modules

Description	Unit	XIOC-8DI	XIOC-16DI	XIOC-32DI
Modules				
Input type		DC input	DC input	DC input
Input voltage	Vdc	24	24	24
Permissible range	Vdc	20.4–28.8	20.4–28.8	20.4–28.8
Input voltage	Vac	—	—	—
Permissible range	Vac	—	—	—
Input resistance		Normally 3.5 kohm	Normally 5.9 kohm	Normally 5.6 kohm
Input current	mA	Normally 6.9	Normally 4.0	Normally 4.3
Voltage level to IEC 61131-2, limit value type 1				
ON	Vdc	≥15	≥15	≥15
OFF	Vdc	≤5	≤5	≤5
Input delay				
OFF → ON	ms	5 (normally 4)	5 (normally 4)	5 (normally 4)
OFF → ON	ms	5 (normally 4)	5 (normally 4)	5 (normally 4)
Input channels	Number	8	16	32
Channels with the same reference potential	Number	8	16	32
Potential isolation		With optocouplers	With optocouplers	With optocouplers
Indication		LED (green)	LED (green)	16 LEDs (green), switchable: 0–15, 16–31
Terminals		Plug-in terminal block	Plug-in terminal block	XIOC-TERM32 (connector and cable)
Internal current consumption (5 Vdc)	mA	Normally 26	Normally 51	Normally 100
Weight	kg	0.16	0.16	0.16

XIOC Digital Output Modules

Description	Unit	XIOC-8DO	XIOC-16DO	XIOC-16DO-S	XIOC-32DO
Modules					
Output type		Transistor (source type)	Transistor (source type)	Transistor (source type)	Transistor (source type)
Output voltage	Vdc	24 (–15 to +20%)	24 (–15 to +20%)	24 (–15 to +20%)	24 (–15 to +20%)
Switching current, minimum	mA	1	1	1	1
Leakage current	mA	0.1	0.1	0.1	0.1
Maximum load current					
Per circuit	A	0.3	0.3	0.8	0.2
Per common potential terminal	A	2.4	4	5	3.2
Output delay					
OFF → ON	ms	≤0.3	≤0.3	≤0.3	≤0.3
OFF → ON	ms	≤1	≤1	≤1	≤1
Output channels	Number	8	16	16	32
Channels with the same reference potential	Number	8	16	16	32
Overvoltage protection		Diode	Diode	Integrated	Diode
Fuse rating	A	4	8	None	8
Potential isolation		With optocouplers	With optocouplers	With optocouplers	With optocouplers
Indication		LED (green)	LED (green)	LED (green)	16 LEDs (green) switchable: 0–15, 16–31
Terminals		Plug-in terminal block	Plug-in terminal block	Plug-in terminal block	XIOC-TERM32 (connector and cable)
Internal current consumption (5 Vdc)	mA	Normally 30	Normally 50	Normally 50	Normally 250
External voltage for outputs/module (30 mA for module supply) (U _s)	Vdc	24 (–15 to +20%)	24 (–15 to +20%)	24 (–15 to +20%)	24 (–15 to +20%)
Short-circuit protection		—	—	Yes	—
Weight	kg	0.16	0.16	0.16	0.16

XIOC Relay Output Module

Description	Unit	XIOC-12D0-R
Modules		
Output type		Relays
Output voltage	Vdc	24
Output voltage	Vac	100/240
Switching current, minimum	mA	1
Maximum load current		
Per circuit	A	2
Per common potential terminal	A	5
Output delay		
OFF → ON	ms	≤10
OFF → ON	ms	≤10
Output channels	Number	12
Channels with the same reference potential	Number	12
Overvoltage protection		External
Fuse rating	A	External
Potential isolation		With optocouplers
Indication		LED (green)
Terminals		Plug-in terminal block
Internal current consumption (5 Vdc)	mA	Normally 40
External voltage for operating the relay		24 Vdc (-15 to +20%, max. 70 mA)
Weight	kg	0.2

XIOC Digital Input/Output Module

Description	Unit	XIOC-16DX
Power Supply		
Supply voltage		24 Vdc (-15 to +20%)
Ripple	%	≤5
Overtoltage protection		Yes
Protection against polarity reversal		Yes
Potential isolation		
Between power supply and I/O bus		Yes
Between power supply and I/O		No
Internal current consumption (5 Vdc)	mA	Normally 80
Channels	Number	16
Terminals		Plug-in terminal block
Status indication		LED
Inputs		
Input type		DC input
Input voltage	Vdc	24
Inputs	Number	4, 12, configurable
Input current	mA	Normally 4
Voltage level to IEC 61131-2, limit value type 1		
ON	Vdc	≥15
OFF	Vdc	≤5
Input delay		
OFF → ON	ms	Normally 0.1
OFF → ON	ms	Normally 0.1
Outputs		
Output type		Transistor (source type)
Output voltage	Vdc	12/24 -15 to +20%
Output current	A	Normally 0.5
Outputs	Number	Max. 12, configurable
Short-circuit tripping current	A	Max. 1.2 over 3 ms for output
Lamp load	W	Max. 3
Drop-out delay (High → Low)	μs	Normally 100
Switching capacity		IEC/EN 60947-5-1, utilization category DC-13
Short-circuit rating		Yes
Parallel connection of outputs		In groups 0 – 3, 4 – 7, 8 – 11; Actuation of the outputs within a group only in the same program cycle
Number of outputs that can be switched in parallel		Max. 3
Total maximum current	A	2 for group
Weight	kg	0.16

XIOC Analog Modules

Description	Unit	XIOC-8AI-I2	XIOC-8AI-U1	XIOC-8AI-U2	XIOC-4T-PT
Modules					
Input voltage	Vdc	—	0 to 10	-10 to +10	—
Input current	mA	4-20	—	—	—
Resolution, digital	bit	12	12	12	15 bit with sign
Conversion time		≤5 ms	≤5 ms	≤5 ms	—
Total errors	%	≤ ± 1 (of full-scale value)	≤ ± 1 (of full-scale value)	≤ ± 1 (of full-scale value)	≤ ± 1 (of full-scale value)
Input resistance	kohm	—	100	100	—
Potential isolation					
Circuit within each channel		With optocouplers	With optocouplers	With optocouplers	With optocouplers
Between the input channels		No	No	No	No
Input channels	Number	8	8	8	4
Terminals		Plug-in terminal block	Plug-in terminal block	Plug-in terminal block	Plug-in terminal block
External power supply		24 Vdc (-15 to +20%), approx. 150 mA	24 Vdc (-15 to +20%), approx. 150 mA	24 Vdc (-15 to +20%), approx. 150 mA	24 Vdc (-15 to +20%), 100 mA
External resistance (R)	kohm	—	—	—	Max. 0.4, 4 channels
Connection type		2-core shielded cable (≤20m)	2-core shielded cable (≤20m)	2-core shielded cable (≤20m)	Shielded cable
Platinum RTD		—	—	—	PT100 (IEC 751), PT1000
Accuracy					
-20° to 40°C (PT100)	°C	—	—	—	±0.5
-50° to 400°C (PT100)	°C	—	—	—	±3
-50° to 400°C (PT1000)	°C	—	—	—	±6
Temperature measuring range		—	—	—	-20 to 40°/-50 to 400° (uninterrupted current: 2 mA)
Internal current consumption (5 Vdc)	mA	Normally 100	Normally 100	Normally 100	Max. 200
Additional function		—	—	—	Linearization
Fault detection					
-20° to 40°C		—	—	—	≤ -25°C or ≥ +45°C = resistance value 7FFFhex
-50° to 400°C		—	—	—	≤ -60°C or ≥ +410°C = resistance value 7FFFhex
Response to cable break or unused inputs		—	—	—	In these cases, the resistance value is 7FFFhex
Weight	kg	0.18	0.18	0.18	0.18

XIOC Thermocouple Module

Description	Unit	XIOC-4AI-T
Channels		
Number		4
Temperature measuring range	°C	Type K: -270 to 1370 Type J: -210 to 1200 Type B: 100 to 1800 Type N: -270 to 1300 Type E: -270 to 1000 Type R: -50 to 1760 Type T: -200 to 400
Voltage measurement	mV	-50 to 50 -100 to 100 -500 to 500 -1000 to 1000
Cold-junction compensation		Yes, built-in
Interference suppression		50 Hz, 60 Hz
Unit		0.1°C, 0.1 F
Resolution	bit	16
Total errors	%	±0.5 of measurement range
Conversion time		<1s
Temperature coefficient		<200 ppm/°C of measurement range

XIOC Analog Modules

Description	Unit	XIOC-2A0-U1-2A0-I2	XIOC-4A0-U1	XIOC-2A0-U2
Modules				
Output voltage	Vdc	0–10	0–10	–10 to 10
Output current	mA	4–20	—	—
Resolution	bit	12	12	12
Conversion time		≤5 ms	≤5 ms	≤5 ms
Total errors	%	≤±1 (of full-scale value)	≤±1 (of full-scale value)	≤±1 (of full-scale value)
External load resistance				
Voltage output		≥10 kohm	≥10 kohm	≥10 kohm
Current output	ohm	0 to 500 ohm	—	—
Potential isolation				
Circuit within each channel		With optocouplers		
Between channels		No	No	No
Number of outputs				
Output voltage		2 (channels 0 and 1)	4	2
Output current		2 (channels 2 and 3)	—	—
Terminals		Plug-in terminal block	Plug-in terminal block	Plug-in terminal block
Internal current consumption (5 Vdc)	mA	Normally 100	Normally 100	Normally 100
External power supply		24 Vdc (–15/+20%), approx. 150 mA	24 Vdc (–15/+20%), approx. 150 mA	24 Vdc (–15/+20%), approx. 150 mA
Connection type		2-core shielded cable (≤20m)	2-core shielded cable (≤20m)	2-core shielded cable (≤20m)

XIOC Analog Modules

Description	Unit	XIOC-2AI-1A0-U1	XIOC-2AI-1A0-U1-I1	XIOC-4AI-2A0-U1	XIOC-4AI-2A0-U1-I1
Inputs					
Input voltage	Vdc	0–10	0–10	0–10	0–10
Input current	mA	—	0–20	—	0–20
Resolution	bit	14	14	14	14
Conversion time		<1 ms	<1 ms	<1 ms	<1 ms
Total errors	%	Normally 0.4	Normally 0.4	Normally 0.4	Normally 0.4
Potential isolation					
Circuit within each channel		No	No	No	No
Between the input channels		No	No	No	No
Between input/output channels		No	No	No	No
Channels	Number	2	2	4	4
Input resistance	kohm	40	40	40	40
Outputs					
Output voltage	Vdc	0–10	0–10	0–10	0–10
Output current	mA	—	0–20	—	0–20
Resolution	bit	12	12	12	12
Errors		Normally 0.4%	Normally 0.4%	Normally 0.4%	Normally 0.4%
Potential isolation					
Circuit within each channel		No	No	No	No
Between the output channels		No	No	No	No
Number of channels		1	1	2	2
External load resistance		≥2 kohm	≥2 kohm	≥2 kohm	≥2 kohm
Short-circuit rating		Yes	Yes	Yes	Yes
Terminal Connection					
Terminals		Plug-in terminal block	Plug-in terminal block	Plug-in terminal block	Plug-in terminal block
Internal current consumption (5 Vdc)	mA	Normally 200	Normally 200	Normally 200	Normally 200
Weight	kg	0.16	0.16	0.16	0.16

XIOC Communication Modules

Description	Unit	XIOC-NET-DP-M	XIOC-NET-DP-S	XIOC-SER	XIOC-TC1
Interfaces					
Interfaces		PROFIBUS-DP, RS-485, EN 50170	PROFIBUS-DP, RS-485, EN 50170	RS-232(C), RS-422, RS-485	RS-232(C), RS-422, RS-485
Protocol		PROFIBUS-DP master (class 1)	PROFIBUS-DP slave	Transparent mode, Modbus master/slave	Transparent mode, Modbus master/slave, DNP3 protocol
Character formats		—	—	8E1, 8O1, 8N1, 8N2, 7E2, 7O2, 7N2, 7E1	8E1, 8O1, 8N1, 8N2, 7E2, 7O2, 7N2, 7E1
Control and signal cables		—	—	RTS, CTS, DTR, DSR, DCD	RTS, CTS, DTR, DSR, DCD
Transfer rate	kbit/s	9.6 to 12,000	9.6 to 12,000	0.3–57.6	0.3–57.6
Potential isolation		Yes	Yes	Yes (RS-485, RS-422)	Yes (RS-485, RS-422)
Number of slaves		124	—	—	—
Send/receive data		3500 Byte each	Max. 244 Byte	250 Byte per slave 120 Byte per slave	250/500
Bus terminating resistors		Switchable	Switchable	Switchable for RS-485, RS-422	Switchable for RS-485, RS-422
Connector type		D-sub 9-pin socket	D-sub 9-pin socket	RS-232: D-sub 9-pin RS-485, 422: plug-in terminal block	RS-232: D-sub 9-pin RS-485, 422: plug-in terminal block
Current consumption	mA	<300	<300	<275	<275
Weight	kg	Approx. 0.2	Approx. 0.2	Approx. 0.2	Approx. 0.2
Number of modules		XC100: 1/XC200: 3	XC100: 1/XC200: 3	XC100: 2/XC200: 4	XC200: 4
Slots		1, 2, 3	1, 2, 3	Any	Any

XIOC Counter Modules

Description	Unit	XIOC-1CNT-100KHZ	XIOC-2CNT-100KHZ	XIOC-2CNT-2A0-INC
Inputs				
Counter limits		0–4294967295 (32 bit)	0–4294967295 (32 bit)	0–4294967295 (32 bit)
Internal current consumption	mA	200	200	450
Frequency	kHz	100 (25 with four times resolution)	100 (25 with four times resolution)	400 (100 with four times resolution)
Number of channels		1	2	2
Input voltage	Vdc	12–24	12–24	—
Voltage for ON	Vdc	>10	>10	—
Voltage for OFF	VA/W	<4	<4	—
Input current	mA	≥4	≥4	—
Differential input voltage	Vdc	±5	±5	±5
Voltage for ON	Vdc	2–5	2–5	0.2–5
Voltage for OFF	Vdc	–5 to 8	–5 to 8	–5 to –0.2
Differential input current	mA	35	35	5
Minimum pulse width	µs	ON ≥4/OFF ≥4	ON ≥4/OFF ≥4	—
Potential isolation		With optocouplers	With optocouplers	—
Connection for external cabling		30-pin plug: XIOC-TERM30-CNT4	30-pin plug: XIOC-TERM30-CNT4	Plug-in terminal block
External cabling		Shielded, twisted pair cable	Shielded, twisted pair cable	Shielded, twisted pair cable
Outputs				
Output type		Transistor (open collector)	Transistor (open collector)	Analog
External power supply		12/24 Vdc (30 max.)	12/24 Vdc (30 max.)	—
Minimum load current	mA	1	1	—
Maximum load current (I _o)	mA	20	20	—
Max. leakage current	mA	0.5	0.5	—
Max. voltage drop at ON	V	1.5	1.5	—
Debounce OFF				
OFF → ON	ms	≤1	≤1	—
OFF → ON	ms	≤1	≤1	—
Output channels	Number	2	4	2
Potential isolation		With optocouplers	With optocouplers	—
Output voltage	Vdc	—	—	–10 to 10
Resolution	bit	—	—	12
Conversion time		—	—	≤1 ms
Total errors	%	—	—	Normally 0.4
Load resistance		—	—	≥1 kohm
Connection for external cabling		30-pin plug: XIOC-TERM30-CNT4	30-pin plug: XIOC-TERM30-CNT4	Plug-in terminal block
External cabling		Shielded, twisted pair cable	Shielded, twisted pair cable	Shielded 2-core cable
Current per channel	mA	—	—	≤300
Power supply of encoders		—	—	5 Vdc
Current consumption	mA	200	200	Max. 450
Weight	kg	0.16	0.16	0.18

Power Supply Suppression Filters

Description	Unit	XT-FIL-1	XT-FIL-2
General			
Standards		IEC/EN 61131-2; EN 50178	IEC/EN 61131-2; EN 50178
Ambient temperature	°F (°C)	32° to 131° (0° to 55°)	32° to 131° (0° to 55°)
Storage	°F (°C)	-13° to 158° (-25° to 70°)	-13° to 158° (-25° to 70°)
Mounting position		Vertical or horizontal	Vertical or horizontal
Vibration resistance		10–57 Hz ± 0.075 mm 57–150 Hz ± 1.0g	10–57 Hz ± 0.075 mm 57–150 Hz ± 1.0g
Mechanical shock resistance		15g/11 ms	15g/11 ms
Impact strength		500g/50 mm ±25g	500g/50 mm ±25g
Overvoltage category		II	II
Pollution degree		2	2
Protection type		IP20	IP20
Rated impulse withstand voltage (U _{imp})	V	850	850
Interference immunity		EN 61000-6-2	EN 61000-6-2
Weight	kg	0.1	0.1
Dimensions (W x H x D)	mm	35 x 90 x 30	35 x 90 x 57
Terminals		Screw terminals	Screw terminals
Terminal capacity			
Screw terminals			
Flexible with ferrule	mm ²	0.2–2.5 (AWG22–12)	0.2–2.5 (AWG22–12)
Solid	mm ²	0.2–2.5 (AWG22–12)	0.2–2.5 (AWG22–12)
Power Supply			
Input voltage	Vdc	24	24
Permissible range	Vdc	20.4–28.8	20.4–28.8
Ripple	%	≤5	≤5
Mains overvoltage protection		Yes	Yes
Potential isolation			
Between input voltage and PE		Yes	Yes
Between input voltage and output voltage		No	No
Between output voltage and PE		Yes	Yes
Rated value	Vdc	24	24
Output current	A	2.2	12

General Information on Electromagnetic Compatibility (EMC) of Automation Systems

Description	Specification
Emitted interference	EN 55011/22 Class A (VDE 0875, Part 11)
Interference immunity	
ESD	IEC/EN 61000-4-2 Contact discharge: 4 kV Air discharge 8 kV
RFI	IEC/EN 61000-4-3 AM (80%) 80–1000 MHz 10V/m
Mobile phones/cellphones	IEC/EN 61000-4-3 PM 800–960 MHz 10V/m
Burst	IEC/EN 61000-4-4 Mains/digital I/O (direct): 2 kV Analog I/O, fieldbus (capacitive coupling): 1 kV
Surge	IEC/EN 61000-4-5 Digital I/O, asymmetric, analog I/O, asymmetric, connection to shielding: 0.5 kV Mains DC, asymmetric: 1 kV Mains DC, symmetric: 1 kV Mains AC, asymmetric: 0.5 kV Mains AC, symmetric: 2 kV
Conducted interference, induced by high-frequency fields	IEC/EN 61000-4-6; 2003 AM (80%) 150 kHz–80 MHz 3V

4.1

PLC, I/O and Communications Products

XC Series Programmable Logic Controllers

4

Dimensions

Approximate Dimensions in Inches (mm)

XC-CPU101, XC-CPU201, XC-CPU202

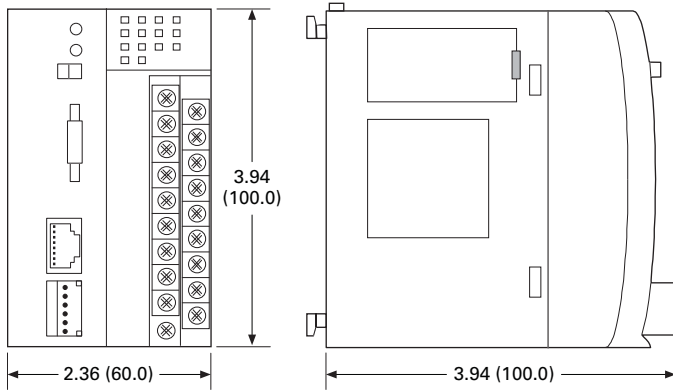

XIOC

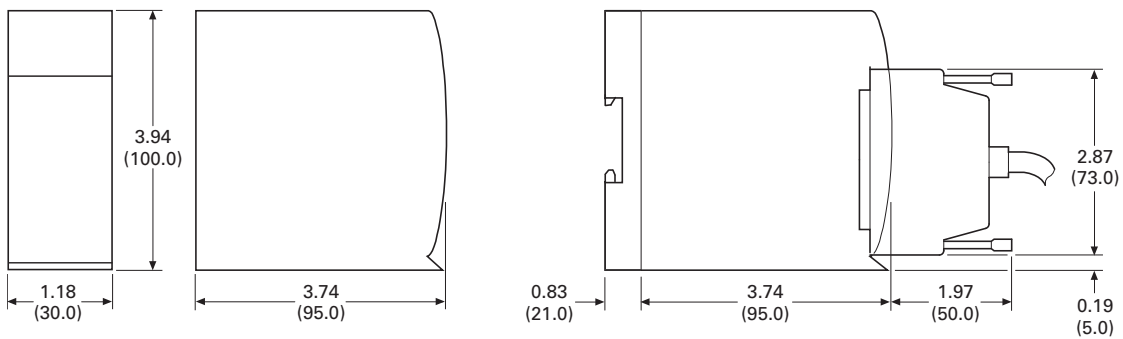

Backplates

**XIOC-BP-2
XIOC-BP-XC**

**XIOC-BP-3
XIOC-BP-EXT**

XIOC-BP-XC1

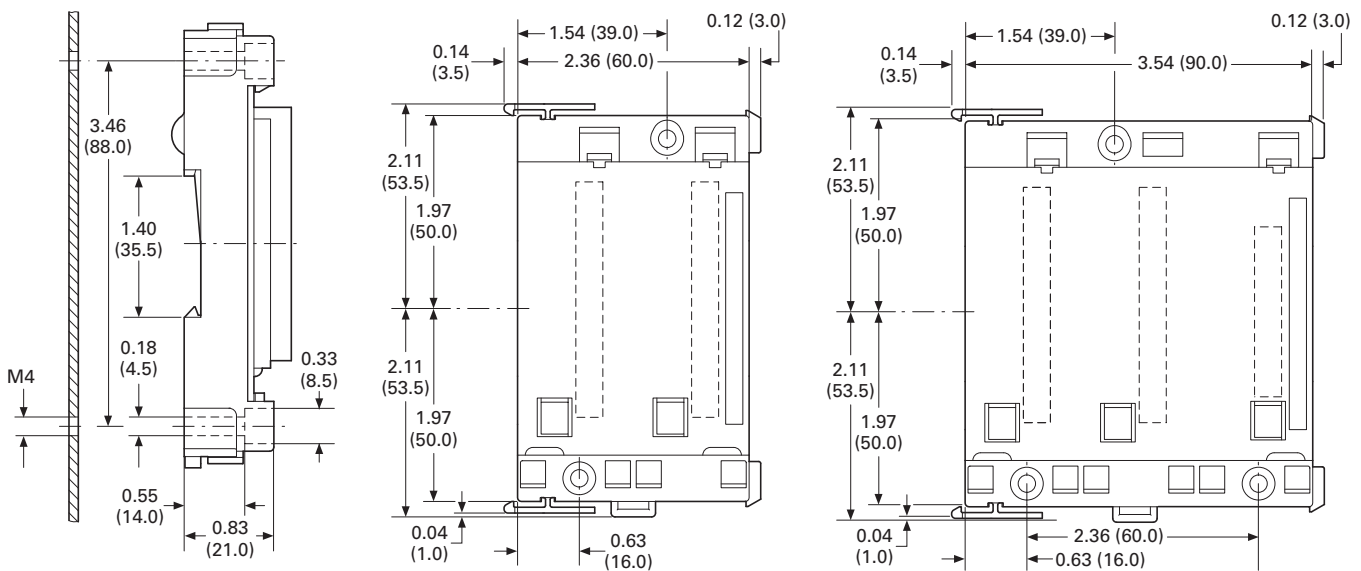

Approximate Dimensions in Inches (mm)

XC-CPU-121_, XIO-EXT121-1

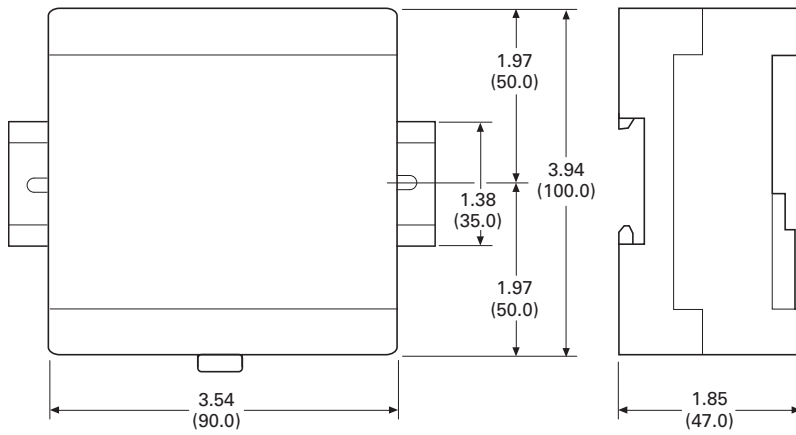

XT-RJ45-ETH-RS232

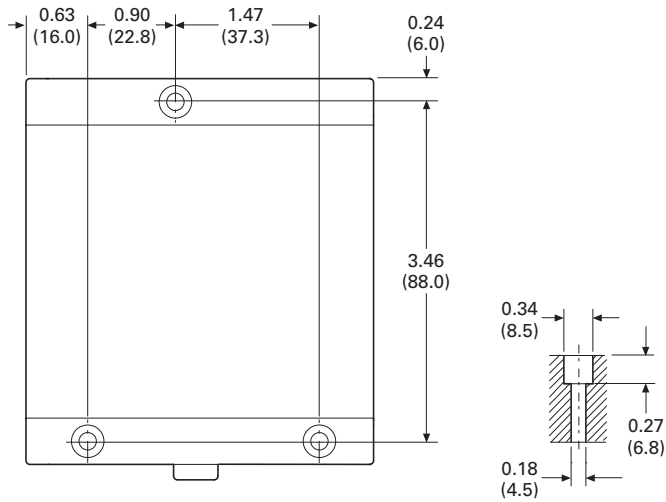
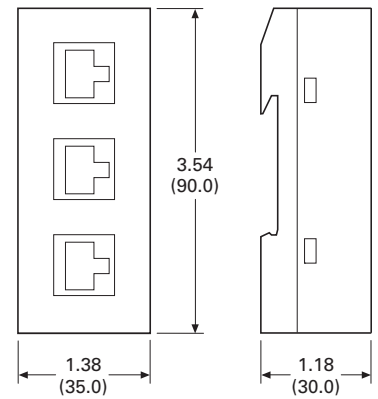

XC152 Series Programmable Logic Controllers



Product Description

The XC152 compact PLC combines plenty of processing power with a large number of communication interfaces. This makes the device particularly well-suited to standardized automation solutions in modular machine building applications.

The XC152 not only provides machine segment control functions that can be programmed with CoDeSys, but it can store module-specific visualizations. These visualizations can be retrieved and displayed on a central HMI or a computer as needed.

In addition, the XC152 connects SmartWire-DT systems to standard fieldbus systems via its interfaces. This enables the XC152 PLC to support Eaton's Lean Automation strategy while enabling users to design automation systems in a flexible manner and run them cost-effectively.

Application Description

Flexible Solutions for Modular Machine Units

In the field of automation, complex processes are subdivided into easily manageable functional units to make programming, production and installation easier. For example, a packaging machine can be subdivided into infeed, positioning (erector), filling and sealing (gluing) modules. Other systems and machines can also be effectively subdivided to create a wide variety of different models or to delimit various expansion stages.

With the XC152, a powerful PLC controls individual system modules while making it possible to directly connect SmartWire-DT system devices and standard fieldbus components. Data transfers via the Ethernet interface to OPC clients, together with the available remote visualization system, support a connection to a central control and visualization system.

Contents

Description

	<i>Page</i>
XC152 Series Programmable Logic Controllers	
Catalog Number Selection	V7-T4-31
Product Selection	V7-T4-31
Accessories	V7-T4-31
Technical Data and Specifications	V7-T4-32
Dimensions	V7-T4-33

SmartWire-DT

The XC152 relies on Eaton's tried-and-true SmartWire-DT connection system, eliminating the need for control current wiring in every single machine module and simplifying the commissioning process by means of better diagnostic options. This results in significant design, commissioning and maintenance cost reductions.

Standard CAN and PROFIBUS Fieldbus Systems

Servo drives, frequency inverters and hydraulic components can all be easily connected using the large number of fieldbus interfaces available on the XC152.

Visualization

The integrated Web visualization function offers a key advantage, as machine module diagnostic and visualization information can be displayed on a central HMI or a terminal.

Features and Benefits

- CoDeSys PLC and Web visualization
- Galileo/CoDeSys remote visualization
- Ethernet port on all models
- Windows® CE 5 operating system
- 32-bit RISC CPU at 400 MHz
- 64 MB internal memory
- SD card slot for external memory
- Run/Stop switch
- Optional: Integrated SmartWire-DT master for 99 nodes
- Optional: RS-232, RS-485, PROFIBUS-DP/MPI, CANopen/easyNet

Standards and Certifications

- IEC/EN 61131-2, EN 50178
- EN 61000-6-2, EN 61000-6-4
- cULus
- CE



Catalog Number Selection

XC152 PLCs with and without SmartWire-DT

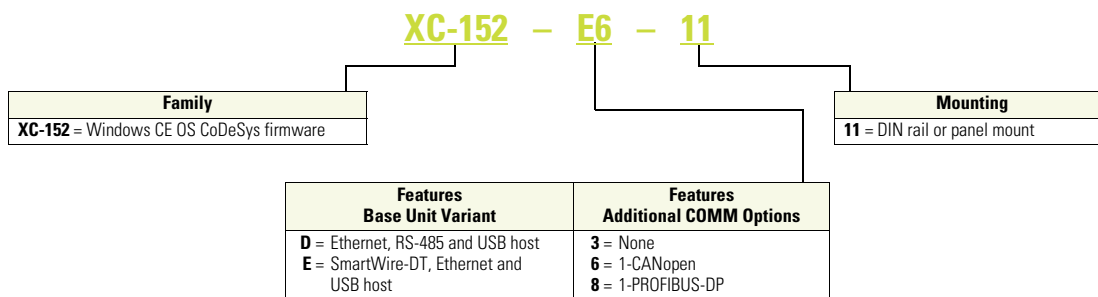

Product Selection

XC152 PLC



XC152 PLC

CoDeSys Firmware	Fieldbus Type	RS-232	RS-485	Ethernet	Catalog Number
Yes	CANopen	Yes	Yes	Yes	XC-152-D6-11
Yes	PROFIBUS-DP	Yes	Yes	Yes	XC-152-D8-11

XC152 PLC SmartWire-DT



XC152 PLC SmartWire-DT

CoDeSys Firmware	Fieldbus Type	RS-232	RS-485	Ethernet	SmartWire-DT	Catalog Number
Yes	None	Y	None	Yes	Yes	XC-152-E3-11
Yes	CANopen	None	Yes	Yes	Yes	XC-152-E6-11
Yes	PROFIBUS-DP	None	Yes	Yes	Yes	XC-152-E8-11

Accessories

XC PLC Accessories

Description	Catalog Number
PLC programming software, single seat license	SW-XSOFT-CODESYS-2-S
PLC programming software, multiple seat license	SW-XSOFT-CODESYS-2-M
SD memory card	MEMORY-SD-A1-S

Technical Data and Specifications

XC152 Series Programmable Logic Controllers

Description	Unit	XC-152-D6-11	XC-152-D8-11	XC-152-E3-11	XC-152-E6-11	XC-152-E8-11
System						
Processor		RISC, 32 bit at 400 MHz	RISC, 32 bit at 400 MHz	RISC, 32 bit at 400 MHz	RISC, 32 bit at 400 MHz	RISC, 32 bit at 400 MHz
Internal memory						
DRAM (OS-, program and data memory)	Mbyte	64	64	64	64	64
NAND FLASH (can be used for data security)	Mbyte	Approx. 128 available	Approx. 128 available	Approx. 128 available	Approx. 128 available	Approx. 128 available
NVRAM (retain)	kByte	Approx. 32 available	Approx. 32 available	Approx. 32 available	Approx. 32 available	Approx. 32 available
External memory						
SD memory card slot		SDA Specification 1.00	SDA Specification 1.00	SDA Specification 1.00	SDA Specification 1.00	SDA Specification 1.00
Real-time clock (battery backup)						
Battery (not rechargeable)		Zero maintenance	Zero maintenance	Zero maintenance	Zero maintenance	Zero maintenance
Backup time at zero voltage		Normally 10 years	Normally 10 years	Normally 10 years	Normally 10 years	Normally 10 years
Operating system		Windows CE 5	Windows CE 5	Windows CE 5	Windows CE 5	Windows CE 5
Engineering						
PLC-Programming software		CoDeSys 2/3	CoDeSys 2/3	CoDeSys 2/3	CoDeSys 2/3	CoDeSys 2/3
Visualization						
WEB-VISU		CoDeSys	CoDeSys	CoDeSys	CoDeSys	CoDeSys
Remote Client		Galileo/CoDeSys	Galileo/CoDeSys	Galileo/CoDeSys	Galileo/CoDeSys	Galileo/CoDeSys
Communication Interfaces						
Ethernet		100Base-TX/10Base-T	100Base-TX/10Base-T	100Base-TX/10Base-T	100Base-TX/10Base-T	100Base-TX/10Base-T
USB host ^①		—	—	—	—	—
USB device ^①		USB 2.0	USB 2.0	USB 2.0	USB 2.0	USB 2.0
System port (RS-232) ^①		■	■	■	—	—
SmartWire-DT ^①		—	—	■	■	■
CAN ^①		■	—	—	■	—
PROFIBUS/MP ^①		—	■	—	—	■
RS-485 ^①		■	■	—	■	■
General						
Rated operating voltage		24 Vdc SELV	24 Vdc SELV	24 Vdc SELV	24 Vdc SELV	24 Vdc SELV
Power consumption	W	Max. 5	Max. 5	Max. 5	Max. 5	Max. 5
Protect against polarity reversal		Yes	Yes	Yes	Yes	Yes
Approvals		CE, cULus	CE, cULus	CE, cULus	CE, cULus	CE, cULus
Ambient air temperature	°C	0 to 55	0 to 55	0 to 55	0 to 55	0 to 55
Storage temperature	°C	–40 to +70	–40 to +70	–40 to +70	–40 to +70	–40 to +70
Protection type		IP20	IP20	IP20	IP20	IP20
Flush mounting		DIN rail EN 60715, 35 mm	DIN rail EN 60715, 35 mm	DIN rail EN 60715, 35 mm	DIN rail EN 60715, 35 mm	DIN rail EN 60715, 35 mm
Dimensions (H x W x D)	mm	105 x 155 x 40	105 x 155 x 40	105 x 155 x 40	105 x 155 x 40	105 x 155 x 40
Weight (approximate)	kg	0.3	0.3	0.3	0.3	0.3
Applied standards and directives						
Product standard		IEC/EN 61131-2, EN50178	IEC/EN 61131-2, EN50178	IEC/EN 61131-2, EN50178	IEC/EN 61131-2, EN50178	IEC/EN 61131-2, EN50178
EMC		EN 61000-6-2, EN 61000-6-4	EN 61000-6-2, EN 61000-6-4	EN 61000-6-2, EN 61000-6-4	EN 61000-6-2, EN 61000-6-4	EN 61000-6-2, EN 61000-6-4

Note

^① Interface not galvanically isolated.

Dimensions

Approximate Dimensions in Inches (mm)

XC152 Series Programmable Logic Controllers

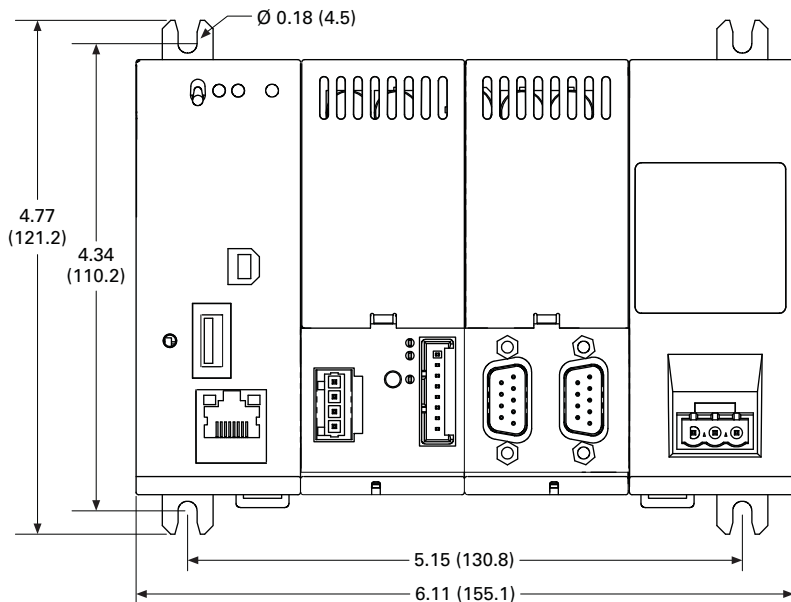

With Fixing Brackets

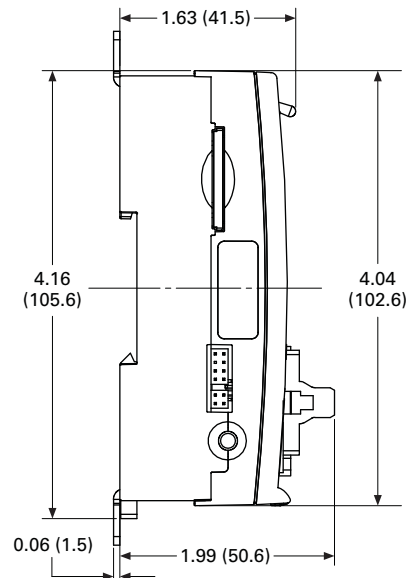

Without Fixing Brackets

XN300 Series Remote I/O

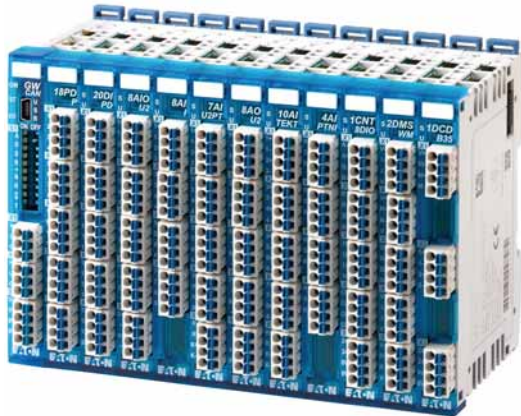

4

Contents

Description

XN300 Series Remote I/O

Product Selection **V7-T4-35**

Page

Product Description

The XN300 family of slice I/O modules offers the highest density I/O available on the market today. With a very cost-effective price per I/O point, it meets the needs of machinery OEMs for high-speed, low-cost and compact I/O systems. The CANopen Gateway provides a remote I/O connection that can connect to all Eaton XC PLCs and XV HMI-PLCs as well as many third-party PLCs. The tool-less assembly saves time in connecting modules on a DIN rail and the PUSH-IN technology makes wiring up the I/O a breeze. Status LEDs on all I/O points make it easy to quickly identify any wiring errors and to determine current signal conditions. The free XN300 Assist programming tool helps you to generate and check the I/O configuration and produce both electronic documentation and EDS files to simplify PLC configuration of XN300 I/O.

Coupled with the new XV300 HMI-PLC, the XN300 I/O products provide a high-powered low-cost system solution for MOEMs. Bundled with Visual Designer and CoDeSys 3 on an XV300 HMI-PLC, you get the smallest, most cost-effective and powerful HMI-PLC and SCADA system available on the market. This industry-leading combination of compact I/O solutions and HMI-PLCs can significantly reduce the overall control panel size, helping MOEMs in the never-ending quest to reduce the size and cost of their machinery.

Features

- Efficient—a wide range of discrete and analog input and output modules along with specialty modules focused on solving application needs
- Compact—up to 20 channels per slice (12.5 x 102 mm) helps reduce installation space and cost
- Simple—tool-free assembly with PUSH-IN & plug connection, with simple dismantling of plug connectors
- Fast identification of errors and signal conditions via LED status displays for all points
- Application specific, free, programmable module status LED
- CANopen Gateway connects up to 32 slices per block to connect I/O to both Eaton PLCs and HMI-PLCs and many third-party PLCs. Mini USB port to connect to XN300 Assist
- XN300 Assist software tool to generate electronic documentation and EDS files for PLC configuration

Standards and Certifications

- CE Mark
- UL/cUL
- RoHS



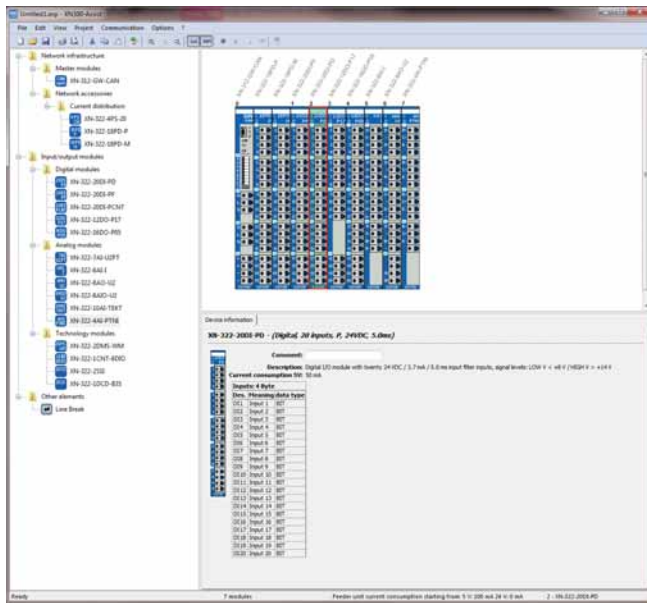

Product Selection

XN-322 XN300 Series Remote I/O



Description	Style Number	Catalog Number
Digital Inputs		
Digital, 20 input, P, 24 Vdc, 5.0 ms	178786	XN-322-20DI-PD
Digital, 20 input, P, 24 Vdc, 0.5 ms	178768	XN-322-20DI-PF
Digital, 20 input, P, 24 Vdc, 2/4 cnt, 25 kHz	178767	XN-322-20DI-PCNT
Counters		
Counter, 1 cnt, 125 kHz, 16 bit, 4 DO, 4 DI	178795	XN-322-1CNT-8DIO
Digital Outputs		
Digital, 16 output, P, 24 Vdc, 0.5 A, sp	178787	XN-322-16DO-P05
Digital, 12 output, P, 24 Vdc, 1.7 A, sp	178788	XN-322-12DO-P17
Analog		
Analog, 6 input, ±10 V, 1 PT/KTY, U _{ref}	178789	XN-322-7AI-U2PT
Analog, 8 input, 0/4–20 mA	179288	XN-322-8AI-I
Analog, 8 input, thermo element, 2 KTY	178792	XN-322-10AI-TEKT
Analog, 4 input, PT/Ni/KTY/R, 2/3 wire	178772	XN-322-4AI-PTNI
Analog, 8 output, ±10 V	178790	XN-322-8AO-U2
Analog, 4 In-/4 output, ±10 V, U _{ref}	178791	XN-322-8AIO-U2
Specialty		
Weigh module, 2 DMS, 24 bit	178793	XN-322-2DMS-WM
DC-motor driver, 12–30 V, brush, 3.5 A	178794	XN-322-1DCD-B35
Power		
Power supply, 4 x 24 Vdc / 2 A, sp	178796	XN-322-4PS-20
Power distribution, 18 channel, GND	178769	XN-322-18PD-M
Power distribution, 18 channel, VCC	178770	XN-322-18PD-P
Serial and SSI		
Serial, 2 SSI, RS-422, 32 bit	178773	XN-322-2SSI
Gateways		
CANopen Gateway module (supports 32 slices)	178782	XN-312-GW-CAN

XV-100 Operator Interface



XV-300 Operator Interface



XP-500 Operator Interface



5.1	Product Overview	
	Product and Software Selection Guides	V7-T5-2
5.2	XV-100 Operator Interface	
	Product Description	V7-T5-8
	Features	V7-T5-8
	Standards and Certifications	V7-T5-8
	Catalog Number Selection	V7-T5-9
	Product Selection	V7-T5-9
	Accessories	V7-T5-10
	Technical Data and Specifications	V7-T5-11
5.3	XV-300 Operator Interface	
	Product Description	V7-T5-12
	Features	V7-T5-12
	Standards and Certifications	V7-T5-12
	Catalog Number Selection	V7-T5-13
	Product Selection	V7-T5-14
	Accessories	V7-T5-15
	Technical Data and Specifications	V7-T5-16
5.4	XP-500 Operator Interface	
	Product Description	V7-T5-17
	Features	V7-T5-17
	Standards and Certifications	V7-T5-17
	Catalog Number Selection	V7-T5-18
	Product Selection	V7-T5-18
	Accessories	V7-T5-18
	Technical Data and Specifications	V7-T5-19
5.5	Operator Interface Software	
	Galileo Software	V7-T5-20
	XSoft-CoDeSys-3 Software	V7-T5-21
	Visual Designer Software	V7-T5-22



Product and Software Selection Guides

Operator Interfaces and Programming Software Selection Guide



5

Description	XV-100 Operator Interface	XV-300 Operator Interface	XP-500 Series Operator Interface
	Page V7-T5-8	Page V7-T5-12	Page V7-T5-17
Screen size	3.5-inch, 5.7-inch, 7.0-inch, 8.4-inch and 10.4-inch	7.0-inch, 10.1-inch, 15-inch	10.1-inch, 15.6-inch, 21.5-inch
Screen options	Color TFT, 64 k colors; resolutions from QVGA (320 x 240) to WVGA (800 x 480)	LED backlit Projected Capacitive Touch (PCT), resolutions from (1024 x 600) to (1366 x 768)	LED backlit Projected Capacitive Touchscreen (PCT), resolutions from (1024 x 600) to (1920 x 1080)
Interface	Resistive touchscreen	Non-reflective tempered scratch-resistant glass	Non-reflective tempered scratch-resistant glass
Communication ports	Ethernet, RS-232 and/or RS-485, USB; CANopen or PROFIBUS [®] -DP, SmartWire-DT [®] , USB and RS-485 on CoDeSys models	Ethernet, RS-232 and/or RS-485, USB; CANopen or PROFIBUS-DP, SmartWire-DT, USB and RS-485 on CoDeSys models	2 Ethernet, 1 RS-232, 1 RS-485, 2 USB 3.0, 1 DVI-I
Simultaneous protocols	Varies	3 on Visual Designer, varies for Galileo and XSoft-CoDeSys-3	5 (8 optional)
Ethernet drivers	Yes	Yes	Yes
Upload/download	Serial, Ethernet, USB	Serial, Ethernet, USB	Serial, Ethernet, USB
Operating system	Windows CE 5.0 Professional	Windows CE 7	Windows [®] Embedded Standard 7 (protected)
Third-party software support	—	—	Yes
Screen saver	Yes	Yes	Yes

Product Selection Guide

XV Series with Galileo

Series Model Screen Size	XV Model XV-102-H 3.5, 5.7, 7.0	XV Model XV-303
Housing material	Plastic	Plastic
Operating system	WinCE 5.0 Standard	WinCE 7.0 Professional
Touchscreen	Resistive	Projected Capacitive Touchscreen (PCT)
Communications ports	1 Ethernet, 1 RS-232, or 1 RS-485, 1 USB	1 Ethernet, 1 RS-232, or 1 RS-485, 1 USB
Optional field buses	N/A	N/A
Development software	Galileo	Galileo
Alarm online/historical	Yes	Yes
Trend online/historical	Yes	Yes
Scripting	Structured text	Structured text
Scheduler	No	No
Recipe	Yes	Yes
Reports	No	No
Full remote access	Yes	Yes
Ability to run third-party software	No	No
Vision system interfaces	Yes	Yes
Multi-language support	Yes	Yes
PLC variable import	Yes	Yes

XV Series with CoDeSys Runtime (Not Available on XP Series)

Series Model Screen Size	XV-102 3.5, 5.7, 7.0	XV XV-152 5.7, 8.4, 10.4	XV-303 7.0, 10.1
Housing material	Plastic	Metal	Plastic
Operating system	WinCE 5.0 Standard	WinCE 5.0 Standard	WinCE 7.0 Professional
Touchscreen	Resistive	Resistive	PCT, ruggedized glass
Communications ports	1 Ethernet, 1 or 2 serial, 0 or 1 USB	1 Ethernet, 1 or 2 serial, 0 or 1 USB	1 Ethernet, 2 serial, 1 USB, CAN
Optional field buses	PROFIBUS, CANopen, SmartWire-DT	PROFIBUS, CANopen, SmartWire-DT	Optional Field Buses—2nd Ethernet, SmartWire-DT, PROFIBUS
Development software	XSoft-CoDeSys-3	XSoft-CoDeSys-3	XSoft-CoDeSys-3
IEC-61131-3 logic programming	(LD, ST, SFC, IL, FBD, CFC) Yes	(LD, ST, SFC, IL, FBD, CFC) Yes	(LD, ST, SFC, IL, FBD, CFC) Yes
Integrated screen design	Yes	Yes	Yes
Integrated field bus configuration	Yes	Yes	Yes
Alarm online/historical	Yes	Yes	Yes
Trend online/historical	Yes	Yes	Yes
Scripting	Structured Text	Structured Text	Structured Text (ST)
Scheduler	Yes	Yes	Yes
Recipe	Yes	Yes	No
Reports	No	No	Yes
OPC, TCP/IP and communication driver	Yes (OPC Server for PC)	Yes (OPC Server for PC)	Yes (OPC Server for PC)
Web Server and Web Thin Client support	Yes	Yes	Yes
Full remote access	Yes	Yes	Yes
Local/remote data base access	Limited (DDE)	Limited (DDE)	Yes (with Visual Designer software bundle)
Ability to run third-party software	No	No	No
ActiveX and .NET controls	No	No	No
Full document viewing	No	No	Yes (PDF and HTML)
Windows media player	No	No	No
Vision system interfaces	No	No	No
Network camera monitoring	No	No	No

XV Operator Interface with Visual Designer**Series****Model****XV-300****Screen Size****7.0, 10.1**

Housing material	Plastic
Operating system	WinCE 7.0 Professional
Touchscreen technology	PCT, ruggedized glass
Communication ports	1 Ethernet, 2 serial, 1 USB, CAN
Optional field buses	Optional Communication Ports—2nd Ethernet, SmartWire-DT, PROFIBUS-DP
Development software	Visual Designer
Pre-licensed tags, driver and Web session and field upgrade options	1500 tags, 3 drivers, 1 Web session Optional upgrade to 4000 tags, 3 drivers, 1, 2, 4 or 8 simultaneous Web sessions
Alarm online/history	Yes
Trend online/history	Yes
Scripting	Yes (VB Script)
Scheduler	Yes
Recipe	Yes
Reports	Yes
OPC, TCP/IP, and communication drivers	Yes
Web Server and Web Thin Client support	Yes
Full remote access	Yes
Local/remote database interface	Yes
Ability to run third-party software	No
ActiveX and .NET controls	No
Full document viewing	Yes (PDF and HTML)
Windows media player	No
Vision system interfaces	No
Network camera monitoring	No

XP Operator Interface with Galileo**Series****XP****Model****XP-503****Screen Size****10.1, 15.6, 21.5**

Housing material	Powder-coated aluminum
Operating system	Windows Embedded Standard 7
Touchscreen technology	Projected Capacitive Touchscreen (PCT), non-reflective tempered glass
Communication ports	2 Ethernet, 2 serial, 4 USB 2 Ethernet; 1 RS-232; 1 RS-485; 2 USB 3.0
Optional field buses	N/A
Development software	Galileo
Alarm online/historical	Yes
Trend online/historical	Yes
Scripting	Structured text
Scheduler	No
Recipe	Yes
Reports	No
Full remote access	Yes
Ability to run third-party software	No
Vision system interfaces	Yes
Multi-language support	Yes
PLC variable import	Yes

XP Operator Interface with Visual Designer

Series	XP
Model	XP-503
Screen Size	10.1, 15.6, 21.5
Housing material	Powder-coated aluminum
Operating system	Windows Embedded Standard 7
Touchscreen technology	Projected Capacitive Touchscreen (PCT), non-reflective tempered glass
Communication ports	2 Ethernet, 2 serial, 4 USB 2 Ethernet; 1 RS-232; 1 RS-485; 2 USB 3.0
Optional field buses	N/A
Development software	Visual Designer (VISUALDXP) (Runtime pre-installed)
Pre-licensed tags, driver and Web session and field upgrade options	Standard 4000 tags, 5 drivers, 1 Web session Optional upgrades to 64,000 tags, 8 drivers, 1, 2, 4, 8, 16, 32, 64 or 128 simultaneous Web sessions
Alarm online/history	Yes
Trend online/history	Yes
Scripting	Yes (VB Script)
Scheduler	Yes
Recipe	Yes
Reports	Yes
OPC, TCP/IP, and communication drivers	Yes
Web Server and Web Thin Client support	Yes
Full remote access	Yes
Local/remote database interface	Yes
Ability to run third-party software	Yes
ActiveX and .NET controls	Yes
Full document viewing	Yes
Windows media player	Yes
Vision system interfaces	Yes
Network camera monitoring	Yes

Software Product Selection Guide



Galileo



XSoft-CoDeSys-3 ^①



Visual Designer

Description

Overview

Intuitive visualization tool. Use Galileo on XV-102-H_ units or on XV units running CoDeSys when a stronger visualization package is needed

Feature-rich software package with integrated logic and visualization that can be run on specific XV operator interface models

Feature-rich software package with SCADA functionality and Web serving capabilities that can be run on XV, XP, ePro PS operator interfaces or personal computers

Catalog ID

Development software seat license	SW-GALILEO-S SW-GALILEO-M	SW-XSOFT-CODESYS-3-S ^② SW-XSOFT-CODESYS-3-M ^③	VISUALDCE (CE hardware) VISUALDXP5 (5-pack of VISUALDXP) VISUALDCE5 (5-pack of VISUALDCE) VISUALDXP (PCs, XPe, and CE hardware)
-----------------------------------	------------------------------	--	--

Runtime software for a PC	■	N/A	VISUALRTPC
---------------------------	---	-----	------------

Time-Saving Editor Features

Online and offline simulation	■	■	■
Macro capability	■	■	■
VB scripting	—	—	■
Multi-language	■	■	■
System/internal variables	■	■	■
Auto-scale application to different resolution/screen size	■	■	■
Scripting (IF, THEN, ELSE, GOTO)	■	■	■
Graphics library	■	—	■
Master pages	■ Screen groups	■ One	■ Screen groups
User-created controls	■	■	■
Customizable application symbols	■	■	■
Full math evaluation	■ With macros	■	■
Reusable controls, images and pages	■	■	■ Via indirect tag and/or PLC assignments
Advanced search and replace	■	■	■
Advanced context sensitive help	■	■	■
Conversion of legacy PanelMate [®] configurations	—	—	■
Optional PanelBuilder [™] conversion utility	—	—	■
Online configuration/editing	—	■	■

Notes

- ① See the logic section of the catalog for details on the logic features in the XSoft-CoDeSys-3 software package.
- ② Includes XSoft-CoDeSys-3 software for developing applications, runtime software for the XV Series. Single User License.
- ③ Includes XSoft-CoDeSys-3 software for developing applications, runtime software for the XV Series. Multi User License.

Software Product Selection Guide, continued



Galileo



XSoft-CoDeSys-3 [Ⓢ]



Visual Designer

Description	Galileo	XSoft-CoDeSys-3 [Ⓢ]	Visual Designer
Runtime Features			
Clock synchronization with controller	■	■ Configured via visualization screens	■
Sound actions or control	■	—	■
Security	■	■	■ Advanced multi-level
Pop-up screens	■	—	■ And group screens
Animated graphics	■	■	■
Multi-touch and gesture support	■	—	■
Real-time trending	■	■	■
Recipes	■	■	■
Report generation	■	—	■
Timer scheduling	■	■	■
Calendar scheduling	—	■	■
Notification of data and events via email/text messaging	—	■	■
Data archiving	■	■	■
Archive to shared network drive	■	■	■
Alarm and event archiving	■	■	■
Historical trending	■	■	■
Import/export from XML or CSV	■	■	■
Database interface	—	■ DDE	■ ADO.net compliant
Vision system interfaces	■	—	■
Secure document and Web network browser	—	■ With user created passwords	■
Web server—viewing and control	—	■	■
Automatic scaling of Web clients	—	—	■
Remote desktop	■ VNC and RemoteClient	■ VNC and RemoteClient	■ VNC and RemoteClient
Launch/control third-party applications	—	—	■
Embedded PLC logic	—	■	—

Note

[Ⓢ] See the logic section of the catalog for details on the logic features in the XSoft-CoDeSys-3 software package.

XV-100 Series Operator Interface



5

Contents

<i>Description</i>	<i>Page</i>
XV-100 Series Operator Interface	
Catalog Number Selection	V7-T5-9
Product Selection	V7-T5-9
Accessories	V7-T5-10
Technical Data and Specifications	V7-T5-11

XV-100 with Galileo and XSoft-CoDeSys-3

Product Description

XV with Galileo

The XV Series with Galileo offers a global visualization software package for all applications in system and machine building. It is designed to optimize performance on the XV platform. Galileo can also run as the visualization package on XV CoDeSys units when a stronger visualization tool is required.

XV with XSoft-CoDeSys

The XV series with XSoft-CoDeSys combines powerful logic and visualization capabilities into a single device. It is ideal for OEM applications where low component count and ease of program development and remote administration is critical.

The XV Models with XSoft-CoDeSys offer multiple field bus options built directly on-board the unit to provide an overall solution optimized both for size and cost.

Features

XV-102 with Galileo only units

- 3.5-, 5.7- and 7.0-inch (widescreen)
- Plastic housing
- Resistive touch with flush bezel
- Ethernet on all models
- RS-232 or RS-485 serial ports available
- Prelicensed for Galileo Runtime (GRS)

XV-100 with XSoft-CoDeSys

XV Series operator interface with Windows CE operating system

- 3.5-, 5.7-, 7.0- (widescreen), 8.4- and 10.4-inch screen sizes
- Cost-effective plastic or metal housing
- Resistive touch with flush bezel
- Ethernet and serial ports on all models
- PROFIBUS, CANopen and SmartWire-DT optional
- XSoft-CoDeSys-3 programming software
- Pre-licensed for CoDeSys runtime

Standards and Certifications

- CE
- UL
- cUL
- RoHS



Selecting the right model for your application

The XV product offered with Visual Designer, Galileo or XSoft-CoDeSys offers the highest level of flexibility for one operator interface product.

Galileo provides a visualization environment designed around the needs of machine building OEMs. Use Galileo when designing high-performance machines in the OEM space.

XSoft-CoDeSys turns the XV into a fully integrated Logic and OI platform (HMI-PLC). Use XSoft-CoDeSys to unleash the PLC functionality on an XV. With optional communication interfaces like SmartWire-DT, CANopen and PROFIBUS, Eaton welcomes you into the Lean Automation space.

On XV-300 models on **Page V7-T5-12**, you can take advantage of the best of both worlds with Visual Designer and XSoft-CoDeSys together. Combining the power of these two software platforms provides limitless possibilities on an HMI-PLC and SCADA platform.

Visual Designer provides a fully integrated SCADA and HMI platform. Use Visual Designer when Web enabling, remote access, database and connectivity, and when one operator software package is required across XV and XP platforms.

Catalog Number Selection

XV Operator Interface—XV-102, XV-152

XV-102, XV-152

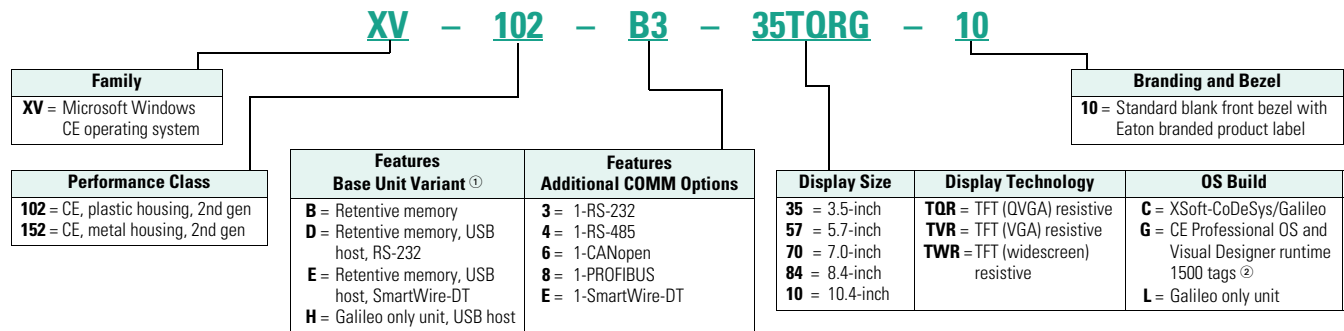

Product Selection

XV Operator Interface with Galileo Only^③



Description	Catalog Number
XV 3.5-inch TFT plastic housing, resistive touch, Ethernet RS-232	XV-102-H3-35TQRL-10
XV 3.5-inch TFT plastic housing, resistive touch, Ethernet RS-485	XV-102-H4-35TQRL-10
XV 5.7-inch TFT plastic housing, resistive touch, Ethernet RS-232	XV-102-H3-57TVRL-10
XV 5.7-inch TFT plastic housing, resistive touch, Ethernet RS-485	XV-102-H4-57TVRL-10
XV 7.0-inch TFT plastic housing, resistive touch, Ethernet RS-232	XV-102-H3-70TWRL-10
XV 7.0-inch TFT plastic housing, resistive touch, Ethernet RS-485	XV-102-H4-70TWRL-10

Notes

- ① All 1xx performance class units have 400 MHz processor, 64 MB DRAM, 1 x 10/100 Ethernet, and 1 x USB device.
- ② Standard software on embedded hardware. These XV models have a Microsoft Windows CE 5.0 Professional operating system and are pre-licensed with Visual Designer runtime for up to 1500 tags, 3 simultaneous communication drivers, and 1 Web session. Field upgrades are available for up to 4000 tags, 3 drivers, and 2, 4 or 8 simultaneous Web sessions.
- ③ For more information on Galileo software, see **Page V7-T5-20**.



XV Operator Interface with XSoft-CoDeSys, HMI-PLC ^①

Description	Catalog Number
XV 3.5-inch TFT plastic housing, resistive touch, CANopen, RS-485	XV-102-B6-35TQRC-10
XV 3.5-inch TFT plastic housing, resistive touch, PROFIBUS, RS-485	XV-102-B8-35TQRC-10
XV 3.5-inch TFT plastic housing, resistive touch, SmartWire-DT	XV-102-BE-35TQRC-10
XV 5.7-inch TFT plastic housing, resistive touch, CANopen, RS-232, RS-485	XV-102-D6-57TVRC-10
XV 5.7-inch TFT plastic housing, resistive touch, PROFIBUS, RS-232, RS-485	XV-102-D8-57TVRC-10
XV 5.7-inch TFT plastic housing, resistive touch, CANopen, SmartWire-DT, RS-485	XV-102-E6-57TVRC-10
XV 5.7-inch TFT plastic housing, resistive touch, PROFIBUS, SmartWire-DT, RS-485	XV-102-E8-57TVRC-10
XV 7.0-inch TFT plastic housing, resistive touch, CANopen, RS-232, RS-485	XV-102-D6-70TWRC-10
XV 7.0-inch TFT plastic housing, resistive touch, PROFIBUS, RS-232, RS-485	XV-102-D8-70TWRC-10
XV 7.0-inch TFT plastic housing, resistive touch, CANopen, SmartWire-DT, RS-485	XV-102-E6-70TWRC-10
XV 7.0-inch TFT plastic housing, resistive touch, PROFIBUS, SmartWire-DT, RS-485	XV-102-E8-70TWRC-10
XV 5.7-inch TFT metal housing, resistive touch, CANopen, RS-232, RS-485	XV-152-D6-57TVRC-10
XV 5.7-inch TFT metal housing, resistive touch, PROFIBUS, RS-232, RS-485	XV-152-D8-57TVRC-10
XV 5.7-inch TFT metal housing, resistive touch, CANopen, SmartWire-DT, RS-485	XV-152-E6-57TVRC-10
XV 5.7-inch TFT metal housing, resistive touch, PROFIBUS, SmartWire-DT, RS-485	XV-152-E8-57TVRC-10
XV 8.4-inch TFT metal housing, resistive touch, CANopen, RS-232, RS-485	XV-152-D6-84TVRC-10
XV 8.4-inch TFT metal housing, resistive touch, PROFIBUS, RS-232, RS-485	XV-152-D8-84TVRC-10
XV 8.4-inch TFT metal housing, resistive touch, CANopen, SmartWire-DT, RS-485	XV-152-E6-84TVRC-10
XV 8.4-inch TFT metal housing, resistive touch, PROFIBUS, SmartWire-DT, RS-485	XV-152-E8-84TVRC-10
XV 10.4-inch TFT metal housing, resistive touch, CANopen, RS-232, RS-485	XV-152-D6-10TVRC-10
XV 10.4-inch TFT metal housing, resistive touch, PROFIBUS, RS-232, RS-485	XV-152-D8-10TVRC-10
XV 10.4-inch TFT metal housing, resistive touch, CANopen, SmartWire-DT, RS-485	XV-152-E6-10TVRC-10
XV 10.4-inch TFT metal housing, resistive touch, PROFIBUS, SmartWire-DT, RS-485	XV-152-E8-10TVRC-10

Accessories

XV Family Accessories

Description	Catalog Number
SD memory card for all XV-102 and XV-152 models	MEMORY-SD-A1-S
Spare part kit for XV-102 models—1 power connector, 8 mounting brackets, 1 sealing strip, 1 touch pen	ACC-TP-57-KG-1
Spare part kit for XV-152 models—1 power connector, 8 mounting brackets, 1 sealing strip, 1 touch pen	ACC-TP-10-12-RES-1
SD memory card with 1 GB storage for all XV-100 and XV-300 models	MEMORY-SD-A2-S
Accessory set for XV-303 (10 mounting brackets and 1 power plug)	ACCESSORIES-TP-10-KG

XV Family Software Options

Description	Catalog Number
Product license for 40 points for use with Galileo or XSoft-CoDeSys units	LIC-OPT-1ST-LEVEL
Product license for 80 points for use with Galileo or XSoft-CoDeSys units	LIC-OPT-2ND-LEVEL
License product Paper PLC with license sticker for XSoft-CoDeSys-2/-3 for XV-300	LIC-PLC-A
License product Paper Visual Designer with license sticker for XV-300	LIC-VISD-A

Note

^① For more information on XSoft-CoDeSys software, see **Page V7-T5-21**.

Technical Data and Specifications

XV Operator Interface

Series Model	XV Midrange Operator Interface			XV-152 5.7-Inch	8.4-Inch	10.4-Inch
	3.5-Inch	5.7-Inch	7.0-Inch			
Operating system	WinCE 5.0 Professional/Standard			WinCE 5.0 Professional/Standard		
Touchscreen technology	Resistive	Resistive	Resistive	Resistive	Resistive	Resistive
Display, colors	Color TFT, 64 k colors	Color TFT, 64 k colors	Color TFT, 64 k colors	Color TFT, 64 k colors	Color TFT, 64 k colors	Color TFT, 64 k colors
Pixel resolution (landscape) portrait mode also available	QVGA 320 x 240	VGA 640 x 480	WVGA 800 x 480	VGA 640 x 480	VGA 640 x 480	VGA 640 x 480
Brightness (cd/m ²)	250	250	250	350	350	350
Backlight	LED, selectable dimming	LED, selectable dimming	LED, selectable dimming	LED, selectable dimming	LED, selectable dimming	LED, selectable dimming
Lifespan of backlight (half-life)	40,000 hrs	40,000 hrs	40,000 hrs	40,000 hrs	40,000 hrs	40,000 hrs
Processor	32 bit RISC, 400 MHz	32 bit RISC, 400 MHz	32 bit RISC, 400 MHz	32 bit RISC, 400 MHz	32 bit RISC, 400 MHz	32 bit RISC, 400 MHz
Volatile memory	64 MB DRAM	64 MB DRAM	64 MB DRAM	64 MB DRAM	64 MB DRAM	64 MB DRAM
Non-volatile memory	125 KB NVRAM/64 MB NAND, 1 SD card slot	125 KB NVRAM/64 MB NAND/ 2 MB NOR, 1 SD card slot		125 KB NVRAM/64 MB NAND/ 2 MB NOR, 1 SD card slot		
Real time clock	Yes	Yes	Yes	Yes	Yes	Yes
Communication ports	Ethernet 10/100, RS-485 or RS-232 USB Device	Ethernet 10/100, RS-485, RS-232 USB Host, USB Device		Ethernet 10/100, RS-485, RS-232 USB Host, USB Device		
Slots for COMMM modules	None	None	None	None	None	None
Power supply rated voltage	24 Vdc nominal (–20%/+25%) with polarity protection			24 Vdc nominal (–20%/+25%) with polarity protection		
Continuous current consumption (max. amps)	0.2	0.4	0.4	0.4	0.6	0.6
Starting current inrush (A ² s)	1.5	1.5	1.5	1.5	1.5	1.5
Ambient conditions						
Operation—relative humidity, noncondensing	0 to 50 °C, 10 to 95%	0 to 50 °C, 10 to 95%	0 to 50 °C, 10 to 95%	0 to 50 °C, 10 to 95%	0 to 50 °C, 10 to 95%	0 to 50 °C, 10 to 95%
Storage/transport—relative humidity, noncondensing	–20 to 60 °C, 10 to 95%	–20 to 60 °C, 10 to 95%	–20 to 60 °C, 10 to 95%	–20 to 60 °C, 10 to 95%	–20 to 60 °C, 10 to 95%	–20 to 60 °C, 10 to 95%
Shock	IEC 60068-2-27 15 g for 11 ms duration			IEC 60068-2-27 15 g for 11 ms duration		
Vibration	IEC 60068-2-6 5–9 Hz: 3.5 mm displacement 9–60 Hz: 0.15 mm displacement 60–150 Hz: 2 g acceleration			IEC 60068-2-6 5–9 Hz: 3.5 mm displacement 9–60 Hz: 0.15 mm displacement 60–150 Hz: 2 g acceleration		
Agency certifications and standards	CE, UL/cUL, CSA (pending), RoHS			CE, UL/cUL, CSA (pending), RoHS		
Protection type						
Front	IP65, NEMA 4X (indoor)	IP65, NEMA 4X (indoor)	IP65, NEMA 4X (indoor)	IP65, NEMA 4X (indoor)	IP65, NEMA 4X (indoor)	IP65, NEMA 4X (indoor)
Rear	IP20, NEMA 1	IP20, NEMA 1	IP20, NEMA 1	IP20, NEMA 1	IP20, NEMA 1	IP20, NEMA 1
Housing material	Plastic	Plastic	Plastic	Metal	Metal	Metal
Dimensions W x H x D (mm)	136 x 100 x 30	170 x 130 x 39	210 x 135 x 38	212 x 156 x 53	275 x 208 x 53	345 x 260 x 54
Mounting cutout W x H (mm)	123 x 87	157 x 117	197 x 122	198 x 142	261 x 194	329 x 238
Approximate weight lbs (kg)	0.7 (0.3)	1.3 (0.6)	1.3 (0.6)	2.9 (1.3)	4.3 (2.1)	6.1 (3.0)
Ability to run third-party software	No	No	No	No	No	No
XSoft-CoDeSys-3 development software	SW-XSOFT-CODESYS-3-S (seat) SW-XSOFT-CODESYS-3-M (multi-seat)			SW-XSOFT-CODESYS-3-S (seat) SW-XSOFT-CODESYS-3-M (multi-seat)		
Galileo development software	SW-GALILEO-S (seat) SW-GALILEO-M (multi-seat)			SW-GALILEO-S (seat) SW-GALILEO-M (multi-seat)		

XV-300 Series Operator Interface



Contents

<i>Description</i>	<i>Page</i>
XV-300 Series Operator Interface	
Catalog Number Selection	V7-T5-13
Product Selection	V7-T5-14
Accessories	V7-T5-15
Technical Data and Specifications	V7-T5-16

XV-300 with Galileo, XSoft-CoDeSys-3 or Visual Designer

Product Description

XV with Galileo

The XV Series with Galileo offers a global visualization software package for all applications in system and machine building. It is designed to optimize performance on the XV platform. Galileo can also run as the visualization package on XV CoDeSys units when a stronger visualization tool is required.

XV with XSoft-CoDeSys

The XV series with XSoft-CoDeSys combines powerful logic and visualization capabilities into a single device. It is ideal for OEM applications where low component count and ease of program development and remote administration is critical.

The XV Models with XSoft-CoDeSys offer multiple field bus options built directly on-board the unit to provide an overall solution optimized both for size and cost.

XV with Visual Designer

Positioned between the **HMi** and the XP series of operator interface, the XV series is ideal for applications requiring extensive connectivity and the advanced features available in Visual Designer without the expense associated with more powerful open platforms.

The XV models were designed with OEMs in mind featuring an attractive bezel and slim and light weight housing. The clip mount design simplifies installation.

Features

XV-300 Software Bundles

The XV-300 series is the latest and most powerful in the XV product line. Its powerful CPU and graphics co-processor provide the high-performance engine required by demanding HMI and HMI-PLC applications. Coupled with an attractive, sleek design and multi-touch touchscreen, it supports the modern gesture based user interface that redefines ease of use.

The XV-300 series can run Visual Designer, XSoft-CoDeSys and Galileo and unlike the XV-100 series, there are bundles that include Visual Designer and XSoft-CoDeSys runtime licenses on a single unit. Because of the higher capacity and performance of the XV-300 over the XV-100, these appeal to OEMs who have demanding HMI-PLC applications in which case they will choose a model bundled with XSoft-CoDeSys software.

All XSoft-CoDeSys models include XSoft-CoDeSys logic and visualization tools, but also include a Galileo runtime license at no additional charge so the user can choose which visualization tool is appropriate for their needs. Users who have large or demanding HMI applications that also require some SCADA software features such as web serving, document (PDF) viewing, SQL database interfaces, FDA 21 CFR Part 11 compliance or other advanced functionality could choose the XV-300 models bundled with Visual Designer software. For users who need PLC applications and advanced Visualization and SCADA features, they can choose XV-300 models with both XSoft-CoDeSys and Visual Designer runtime licenses bundled in a single package.

Standards and Certifications

- CE
- UL
- cUL
- RoHS



Selecting the right model for your application

The XV product offered with Visual Designer, Galileo or XSoft-CoDeSys offers the highest level of flexibility for one operator interface product.

Galileo provides a visualization environment designed around the needs of machine building OEMs. Use Galileo when designing high-performance machines in the OEM space.

XSoft-CoDeSys turns the XV into a fully integrated Logic and OI platform (HMI-PLC). Use XSoft-CoDeSys to unleash the PLC functionality on an XV. With optional communication interfaces like SmartWire-DT, CANopen and PROFIBUS, Eaton welcomes you into the Lean Automation space.

On XV-300 models, you can take advantage of the best of both worlds with Visual Designer and XSoft-CoDeSys together. Combining the power of these two software platforms provides limitless possibilities on an HMI-PLC and SCADA platform.

Visual Designer provides a fully integrated SCADA and HMI platform. Use Visual Designer when Web enabling, remote access, database and connectivity, and when one operator software package is required across XV and XP platforms.

Software Suite

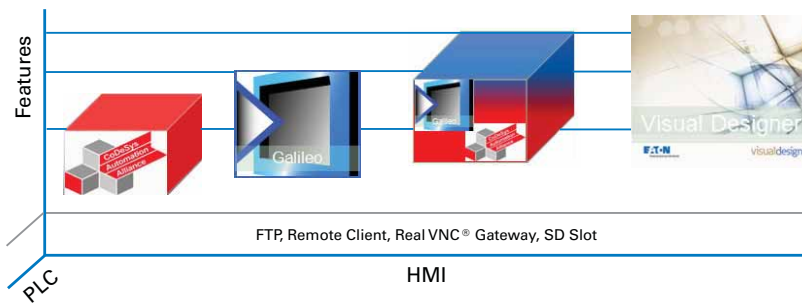

Catalog Number Selection

XV Operator Interface—XV-303, XV-313

XV-303, XV-313

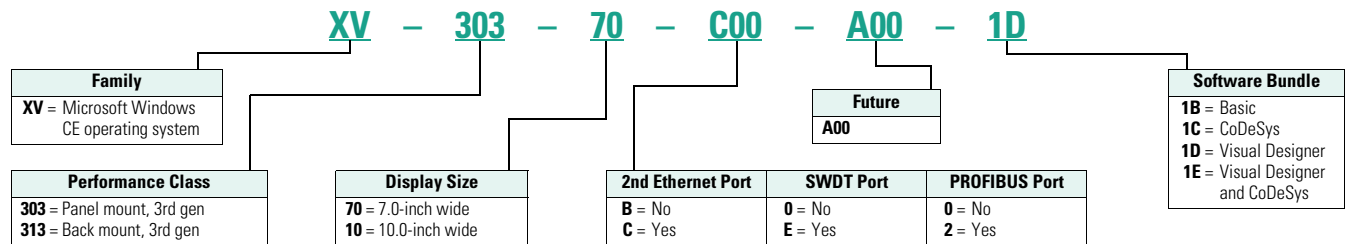

Product Selection

XV Operator Interface with Galileo ^①

Description	Catalog Number
XV with 7.0-inch TFT, plastic housing, PCT multi-touch, single Ethernet	XV-303-70-B00-A00-1B
XV with 7.0-inch TFT, plastic housing, PCT multi-touch, dual Ethernet	XV-303-70-C00-A00-1B
XV with 10.1-inch TFT, plastic housing, PCT multi-touch, single Ethernet	XV-303-10-B00-A00-1B
XV with 10.1-inch TFT, plastic housing, PCT multi-touch, dual Ethernet	XV-303-10-C00-A00-1B
XV with 15.4-inch TFT, plastic housing, PCT multi-touch, single Ethernet	XV-303-15-C00-A00-1B
XV with 15.4-inch TFT, plastic housing, PCT multi-touch, dual Ethernet, Profibus	XV-303-15-C02-A00-1B

XV Operator Interface with XSoft-CoDeSys, HMI-PLC ^②

Description	Catalog Number
XV with 7.0-inch TFT, plastic housing, PCT multi-touch, single Ethernet, CAN, RS-232, RS-485, USB host	XV-303-70-B00-A00-1C
XV with 7.0-inch TFT, plastic housing, PCT multi-touch, dual Ethernet, CAN, RS-232, RS-485, USB host	XV-303-70-C00-A00-1C
XV with 7.0-inch TFT, plastic housing, PCT multi-touch, single Ethernet, CAN, PROFIBUS, RS-232, RS-485, USB host	XV-303-70-B02-A00-1C
XV with 7.0-inch TFT, plastic housing, PCT multi-touch, dual Ethernet, CAN, PROFIBUS, RS-232, RS-485, USB host	XV-303-70-C02-A00-1C
XV with 7.0-inch TFT, plastic housing, PCT multi-touch, single Ethernet, CAN, SmartWire-DT, RS-232, RS-485, USB host	XV-303-70-BE0-A00-1C
XV with 7.0-inch TFT, plastic housing, PCT multi-touch, dual Ethernet, CAN, SmartWire-DT, RS-232, RS-485, USB host	XV-303-70-CE0-A00-1C
XV with 10.0-inch TFT, plastic housing, PCT multi-touch, single Ethernet, CAN, RS-232, RS-485, USB host	XV-303-10-B00-A00-1C
XV with 10.0-inch TFT, plastic housing, PCT multi-touch, dual Ethernet, CAN, RS-232, RS-485, USB host	XV-303-10-C00-A00-1C
XV with 10.0-inch TFT, plastic housing, PCT multi-touch, single Ethernet, CAN, PROFIBUS, RS-232, RS-485, USB host	XV-303-10-B02-A00-1C
XV with 10.0-inch TFT, plastic housing, PCT multi-touch, dual Ethernet, CAN, PROFIBUS, RS-232, RS-485, USB host	XV-303-70-C02-A00-1C
XV with 10.0-inch TFT, plastic housing, PCT multi-touch, single Ethernet, CAN, SmartWire-DT, RS-232, RS-485, USB host	XV-303-10-BE0-A00-1C
XV with 10.0-inch TFT, plastic housing, PCT multi-touch, dual Ethernet, CAN, SmartWire-DT, RS-232, RS-485, USB host	XV-303-10-CE0-A00-1C
XV with 15.4-inch TFT, plastic housing, PCT multi-touch, dual Ethernet	XV-303-15-C00-A00-1C
XV with 15.4-inch TFT, plastic housing, PCT multi-touch, dual Ethernet, Profibus	XV-303-15-C02-A00-1C
XV with 15.4-inch TFT, plastic housing, PCT multi-touch, dual Ethernet, SWDT	XV-303-15-CE0-A00-1C
XV with 15.4-inch TFT, plastic housing, PCT multi-touch, dual Ethernet, Profibus and SWDT	XV-303-15-CE2-A00-1C

XV Rear Mounted Operator Interface with XSoft-CoDeSys, HMI-PLC

Description	Catalog Number
XV rear mount with 7.0-inch TFT, plastic housing, PCT multi-touch, single Ethernet	XV-313-70-B00-A00-1C
XV rear mount with 7.0-inch TFT, plastic housing, PCT multi-touch, dual Ethernet	XV-313-70-C00-A00-1C
XV rear mount with 7.0-inch TFT, plastic housing, PCT multi-touch, dual Ethernet, SWDT	XV-313-70-CE0-A00-1C
XV rear mount with 10.1-inch TFT, plastic housing, PCT multi-touch, single Ethernet	XV-313-10-B00-A00-1C
XV rear mount with 10.1-inch TFT, plastic housing, PCT multi-touch, dual Ethernet	XV-313-10-C00-A00-1C
XV rear mount with 10.1-inch TFT, plastic housing, PCT multi-touch, dual Ethernet, SWDT	XV-313-10-CE0-A00-1C

Notes

- ① For more information on Galileo software, see **Page V7-T5-20**.
- ② For more information on XSoft-CoDeSys software, see **Page V7-T5-21**.

XV Operator Interface

XV Operator Interface with Visual Designer ^①

Description	Catalog Number
XV with 7.0-inch TFT, plastic housing, PCT multi-touch, dual Ethernet, CAN, RS-232, RS-485, USB host	XV-303-70-C00-A00-1D
XV with 10.0-inch TFT, plastic housing, PCT multi-touch, dual Ethernet, CAN, RS-232, RS-485, USB host	XV-303-10-C00-A00-1D
XV with 15.4-inch TFT, plastic housing, PCT multi-touch, dual Ethernet	XV-303-15-C00-A00-1D

XV Operator Interface with Visual Designer and XSoft-CoDeSys ^②

Description	Catalog Number
XV with 7.0-inch TFT, plastic housing, PCT multi-touch, dual Ethernet, CAN, RS-232, RS-485, USB host	XV-303-70-C00-A00-1E
XV with 7.0-inch TFT, plastic housing, PCT multi-touch, dual Ethernet, CAN, SmartWire-DT, RS-232, RS-485, USB host	XV-303-70-CE0-A00-1E
XV with 10.0-inch TFT, plastic housing, PCT multi-touch, dual Ethernet, CAN, RS-232, RS-485, USB host	XV-303-10-C00-A00-1E
XV with 10.0-inch TFT, plastic housing, PCT multi-touch, dual Ethernet, CAN, SmartWire-DT, RS-232, RS-485, USB host	XV-303-10-CE0-A00-1E

Accessories

XV Family Accessories

Description	Catalog Number
SD memory card for all XV-102 and XV-152 models	MEMORY-SD-A1-S
Spare part kit for XV-102 models—1 power connector, 8 mounting brackets, 1 sealing strip, 1 touch pen	ACC-TP-57-KG-1
Spare part kit for XV-152 models—1 power connector, 8 mounting brackets, 1 sealing strip, 1 touch pen	ACC-TP-10-12-RES-1
SD memory card with 1 GB storage for all XV-100 and XV-300 models	MEMORY-SD-A2-S
Accessory set for XV-303 (10 mounting brackets and 1 power plug)	ACCESSORIES-TP-10-KG

XV Family Software Options

Description	Catalog Number
Product license for 40 points for use with Galileo or XSoft-CoDeSys units	LIC-OPT-1ST-LEVEL
Product license for 80 points for use with Galileo or XSoft-CoDeSys units	LIC-OPT-2ND-LEVEL
License product Paper PLC with license sticker for XSoft-CoDeSys-2/-3 for XV-300	LIC-PLC-A
License product Paper Visual Designer with license sticker for XV-300	LIC-VISD-A

Notes

- ① For more information on Galileo software, see **Page V7-T5-20**.
- ② For more information on Visual Designer software, see **Page V7-T5-22**.

Technical Data and Specifications

XV Operator Interface

Series

Model

Screen Size

	XV-303		
	7.0-Inch	10.0-Inch	15.0-Inch
Operating system	WinCE7.0 Professional	WinCE7.0 Professional	WinCE7.0 Professional
Touchscreen technology	Projected Capacitive Multi-touch	Projected Capacitive Multi-touch	Projected Capacitive Multi-touch
Display colors	16 million	16 million	16 million
Pixel resolution (landscape) portrait mode also available	WSVGA 1024 x 600	WSVGA 1024 x 600	1366 x 768
Brightness (cd/m ²)	400	400	400
Backlight	LED, selectable dimming	LED, selectable dimming	LED, selectable dimming
Lifespan of backlight (half-life)	50,000 hrs	50,000 hrs	50,000 hrs
Processor	800 MHz Cortex A8 CPU with graphics co-processor	800 MHz Cortex A8 CPU with graphics co-processor	800 MHz Cortex A8 CPU with graphics co-processor
Volatile memory	512 MB DRAM	512 MB DRAM	512 MB DRAM
Non-volatile memory	128 KB NVRAM (PLC), 1 GB SLC, 1 SD card slot	128 KB NVRAM (PLC), 1 GB SLC, 1 SD card slot	128 KB NVRAM (PLC), 1 GB SLC, 1 SD card slot
Real time clock	Yes	Yes	Yes
Communication ports	Ethernet 10/100, RS-232, RS-485, CAN, USB Host, USB Device	Ethernet 10/100, RS-232, RS-485, CAN, USB Host, USB Device	Ethernet 10/100, RS-232, RS-485, CAN, USB Host, USB Device
Optional communication ports	Second Ethernet 10/100, PROFIBUS DP, SmartWire-DT	Second Ethernet 10/100, PROFIBUS DP, SmartWire-DT	Second Ethernet 10/100, PROFIBUS DP, SmartWire-DT
Power supply rated voltage	24 Vdc nominal (–20%/+25%) with polarity protection	24 Vdc nominal (–20%/+25%) with polarity protection	24 Vdc nominal (–20%/+25%) with polarity protection
Continuous current consumption (max. amps)	0.6 (7.0-inch)	0.75 (10.1-inch)	0.9 (15.4-inch)
Starting current inrush (A2s)	1.0 (7.0-inch)	1.0 (10.1-inch)	1.0 (15.4-inch)
Ambient conditions			
Operation-relative humidity, noncondensing	0 to 50 °C, 10 to 95%	0 to 50 °C, 10 to 95%	0 to 50 °C, 10 to 95%
Storage/transport-relative humidity, noncondensing	–20 to +60 °C, 10 to 95%	–20 to +60 °C, 10 to 95%	–20 to +60 °C, 10 to 95%
Shock	IEC 60068-2-27 15 g for 11 ms duration	IEC 60068-2-27 15 g for 11 ms duration	IEC 60068-2-27 15 g for 11 ms duration
Vibration	IEC 60068-2-6 5–9 Hz: 3.5 mm displacement 9–60 Hz: 0.15 mm displacement 60–150 Hz: 2 g acceleration	IEC 60068-2-6 5–9 Hz: 3.5 mm displacement 9–60 Hz: 0.15 mm displacement 60–150 Hz: 2 g acceleration	IEC 60068-2-6 5–9 Hz: 3.5 mm displacement 9–60 Hz: 0.15 mm displacement 60–150 Hz: 2 g acceleration
Agency certifications and standards	CE, UL/cUL, RoHS2, UL/cUL Class I Div 2 groups A, B, C, D (pending) ATEX Zone 22 (pending)	CE, UL/cUL, RoHS2, UL/cUL Class I Div 2 groups A, B, C, D (pending) ATEX Zone 22 (pending)	CE, UL/cUL, RoHS2, UL/cUL Class I Div 2 groups A, B, C, D (pending) ATEX Zone 22 (pending)
Protection type			
Front	IP65, NEMA 4X (indoor)	IP65, NEMA 4X (indoor)	IP65, NEMA 4X (indoor)
Rear	IP20, NEMA 1	IP20, NEMA 1	IP20, NEMA 1
Housing material	Plastic	Plastic	Plastic
Dimensions W x H x D (mm)	196 x 135 x 51	269 x 174 x 58	404 x 255 x 53
Mounting cutout W x H (mm)	182 x 121	254 x 160	388 x 239
Approximate weight lbs (kg)	1.6 (0.74)	2.5 (1.13)	8.6 (3.9)
Ability to run third-party software	No	No	No
Visual Designer development software	VISUALDCE or VISUALDXP	VISUALDCE or VISUALDXP	VISUALDCE or VISUALDXP
Pre-licensed tags, drivers, Web	1500 tags, 3 drivers, 1 Web session	1500 tags, 3 drivers, 1 Web session	1500 tags, 3 drivers, 1 Web session
Field upgradeable max. tags, drivers, Web sessions (VisD)	4000 tags, 5 drivers, 1, 2, 4 or 8 simultaneous Web sessions	4000 tags, 5 drivers, 1, 2, 4 or 8 simultaneous Web sessions	4000 tags, 5 drivers, 1, 2, 4 or 8 simultaneous Web sessions
XSoft-CoDeSys-3 development software	SW-XSOFT-CODESYS-3-S (seat)	SW-XSOFT-CODESYS-3-M (multi-seat)	SW-XSOFT-CODESYS-3-M (multi-seat)

XP Operator Interface



Contents

Description	Page
XP-503 with Visual Designer	
Catalog Number Selection	V7-T5-18
Product Selection	V7-T5-18
Accessories	V7-T5-18
Technical Data and Specifications	V7-T5-19

XP-503 with Visual Designer

Product Description

The XP-500 series sets a new standard for HMI and SCADA controls. Capacitive multi-touch displays allow familiar intuitive gestures for zoom, scroll and swipe, and offer increased safety to your system with two hand or multiple button activation control for critical functions.

XP-500 Panel PCs run on an open Windows Embedded Standard 7 Operating System to support all Windows standard PC applications and feature Protect Mode™ for preventing unauthorized changes to the operating system.

XP-500 units come with advanced yet easy-to-use Visual Designer software pre-installed and licensed.

All these features come standard in a package that is slim and modern in design yet also rugged. With no fan or moving parts, a scratch-resistant glass screen, and powder-coated aluminum body, XP-500 is fit for any industrial application.

Features

XP-500 series operator interface with Windows Embedded Standard 7 operating system

- 10.1, 15.6 and 21.5 inch high resolution widescreen displays
- Projected capacitive touchscreen supports gestures and recognizes up to 4 simultaneous touch inputs
- Remote access to mobile devices or tablets using HTML5 interface
- 1.65 GHz Dual Core CPU with fast Radeon™ HD graphics for best-in-class speed and graphics performance

- 4 GB DDR3-RAM large memory for parallel processing and increased system performance
- 32 GB internal solid-state drive high volume internal memory
- 2 independent Ethernet ports standard for separation of IT and process level communications
- All solid-state media and no moving parts or fan increases reliability
- Non-corruptible OS with Protect Mode increases security and reliability

Standards and Certifications

- UL/cUL (UL 508)
- CE Mark
- UL Class 1 Div 2 (Groups A, B, C, D)
- ATEX Zone 22, Category 3D
- Front
 - IP65, NEMA 4X (indoor), NEMA 12
- Rear
 - IP20



Catalog Number Selection

XP Operator Interface

XP

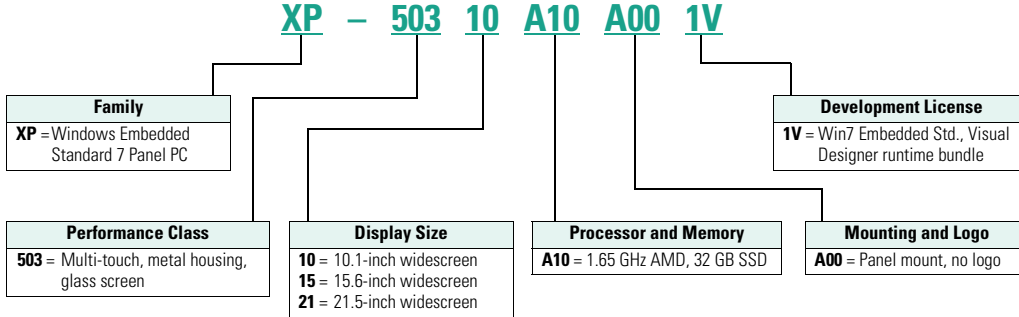

Product Selection

XP Operator Interface with Galileo

Description	Catalog Number
10.1-inch widescreen with multi-touch, 1.65 GHz dual core CPU, 4 GB DDR3-RAM, 4 GB CFast memory	XP-503-10-A10-A00-1B
15.4-inch widescreen with multi-touch, 1.65 GHz dual core CPU, 4 GB DDR3-RAM, 4 GB CFast memory	XP-503-15-A10-A00-1B
21.5-inch widescreen with multi-touch, 1.65 GHz dual core CPU, 4 GB DDR3-RAM, 4 GB CFast memory	XP-503-21-A10-A00-1B

XP Operator Interface



XP Operator Interface with Visual Designer

Description	Catalog Number
XP 10.1-inch widescreen with multi-touch, 1.65 GHz dual core CPU, 4 GB DDR3-RAM, 4 GB CFast memory, 4000 tags, 5 drivers, 1 Web session	XP-503-10-A10-A00-1V
XP 15.6-inch widescreen with multi-touch, 1.65 GHz dual core CPU, 4 GB DDR3-RAM, 4 GB CFast memory, 4000 tags, 5 drivers, 1 Web session	XP-503-15-A10-A00-1V
XP 21.5-inch widescreen with multi-touch, 1.65 GHz dual core CPU, 4 GB DDR3-RAM, 4 GB CFast memory, 4000 tags, 5 drivers, 1 Web session	XP-503-21-A10-A00-1V

Accessories

XP Operator Interface

Description	Catalog Number
XP-500 spare part kit for all XP models—1 power connector, 8 mounting brackets, 1 sealing strip	ACC-TP-57-RES-1

Notes

- ① All 5XX units have 2 x 10/100/1000 Ethernet, 2 x USB 3.0, 1 x RS-232, 1 x RS-485, 1 x DVI-I.
- ② Standard software on embedded hardware.

Technical Data and Specifications

XP Operator Interface



10.1-inch XP-503-10-A10-A00-1V



15.6-inch XP-503-15-A10-A00-1V



21.5-inch XP-503-21-A10-A00-1V

Model	10.1-inch XP-503-10-A10-A00-1V	15.6-inch XP-503-15-A10-A00-1V	21.5-inch XP-503-21-A10-A00-1V
Display			
Screen diagonal	10.1-inch widescreen	15.6-inch widescreen	21.5-inch widescreen
Resolution	1024 x 600 pixels	1366 x 768 pixels	1920 x 1080 pixels
Backlight	LED, dimmable via software	LED, dimmable via software	LED, dimmable via software
Display brightness (typical)	500 cd/m ²	300 cd/m ²	250 cd/m ²
Contrast ratio (typical)	500:1	500:1	1000:1
Operation			
Touch sensor	Multi-touch touchscreen (4 simultaneous touches)	Multi-touch touchscreen (4 simultaneous touches)	Multi-touch touchscreen (4 simultaneous touches)
Technology	Projected Capacitive Touch (PCT)	Projected Capacitive Touch (PCT)	Projected Capacitive Touch (PCT)
Enclosures			
Front glass	Non-reflective tempered glass	Non-reflective tempered glass	Non-reflective tempered glass
Bezel	Powder-coated aluminum	Powder-coated aluminum	Powder-coated aluminum
Device dimensions (w x h x d)	275 x 179 x 80 mm	404 x 255 x 80 mm	536 x 328 x 83 mm
Installation cutout (w x h)	261 x 164 mm	387 x 238 mm	519 x 313 mm
Weight	2.6 kg	4.8 kg	7.8 kg
System			
Processor	AMD GX217GA 1.65 GHz DualCore	AMD GX217GA 1.65 GHz DualCore	AMD GX217GA 1.65 GHz DualCore
Graphic	AMD Radeon HD8280E 450 MHz	AMD Radeon HD8280E 450 MHz	AMD Radeon HD8280E 450 MHz
Memory	4 GB DDR3-RAM	4 GB DDR3-RAM	4 GB DDR3-RAM
Internal mass memory	32 GB SSD mSATA	32 GB SSD mSATA	32 GB SSD mSATA
Removable memory	1 x CFast slot, pre-populated with 4 GB CFast memory card	1 x CFast slot, pre-populated with 4 GB CFast memory card	1 x CFast slot, pre-populated with 4 GB CFast memory card
Interfaces	2 x Ethernet 10/100/1000 Mbps; 2 x USB 3.0; 1 x RS-232; 1 x RS-485; 1 x DVI-I	2 x Ethernet 10/100/1000 Mbps; 2 x USB 3.0; 1 x RS-232; 1 x RS-485; 1 x DVI-I	2 x Ethernet 10/100/1000 Mbps; 2 x USB 3.0; 1 x RS-232; 1 x RS-485; 1 x DVI-I
Power supply	24 Vdc	24 Vdc	24 Vdc
Maximum current	1.2 A	1.5 A	1.7 A
Operating system	Windows Embedded Standard 7	Windows Embedded Standard 7	Windows Embedded Standard 7
Environment			
Agency certifications	UL/cUL Class I Div 2, Groups A, B, C, D, ATEX Zone 22	UL/cUL Class I Div 2, Groups A, B, C, D, ATEX Zone 22	UL/cUL Class I Div 2, Groups A, B, C, D, ATEX Zone 22
Degree of protection	Front: IP65, NEMA 4X (indoor), NEMA 12; Rear: IP20	Front: IP65, NEMA 4X (indoor), NEMA 12; Rear: IP20	Front: IP65, NEMA 4X (indoor), NEMA 12; Rear: IP20
Operating temperature	0 to +50 °C	0 to +50 °C	0 to +50 °C
Storage temperature	-20 to +60 °C	-20 to +60 °C	-20 to +60 °C
Relative air humidity	10 to 20% noncondensing	10 to 20% noncondensing	10 to 20% noncondensing
Shock	IEC 60068-2-27 15 g for 11 ms duration	IEC 60068-2-27 15 g for 11 ms duration	IEC 60068-2-27 15 g for 11 ms duration
Vibration	IEC 60068-2-6 5-9 Hz: 3.5 mm displacement 9-60 Hz: 0.15 mm displacement 60-150 Hz: 2 g acceleration	IEC 60068-2-6 5-9 Hz: 3.5 mm displacement 9-60 Hz: 0.15 mm displacement 60-150 Hz: 2 g acceleration	IEC 60068-2-6 5-9 Hz: 3.5 mm displacement 9-60 Hz: 0.15 mm displacement 60-150 Hz: 2 g acceleration
Software			
Development software	Visual Designer	Visual Designer	Visual Designer
Ability to run third-party software	Yes	Yes	Yes
Pre-licensed tags, drivers, Web sessions			
Standard models	4000 tags, 5 drivers, 1 Web session	4000 tags, 5 drivers, 1 Web session	4000 tags, 5 drivers, 1 Web session
Field upgradable max. tags, drivers, Web sessions	64,000 tags, 8 drivers, 1, 2, 4, 8, 16, 32, 64 or 128 Web sessions simultaneously	64,000 tags, 8 drivers, 1, 2, 4, 8, 16, 32, 64 or 128 Web sessions simultaneously	64,000 tags, 8 drivers, 1, 2, 4, 8, 16, 32, 64 or 128 Web sessions simultaneously

Galileo Software

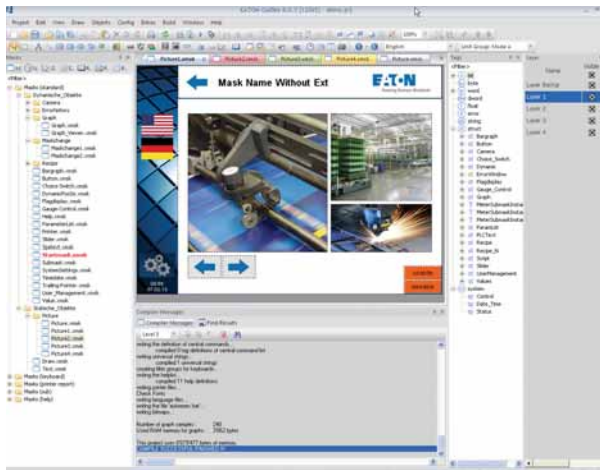

Contents

Description

Description	Page
Operator Interface Software	
Galileo Software	
XSoft-CoDeSys-3 Software	V7-T5-21
Visual Designer Software	V7-T5-22

Galileo Software

Product Description

The Intuitive Visualization Tool

Galileo is an easy to learn yet powerful and extensive project design environment that can be used ideally in all system and machine building applications close to the machine and process.

Galileo is designed for use in all sectors and offers comprehensive project design tools. Galileo provides a full range of functions without any graduated restrictions on tags or screens, and is optimized for our XV operator interface panels.

Features

- Easy to learn and intuitive graphical user interface with a project overview window
- User-friendly project design with project simulation on development PC
- Different user interface styles
- Drag and drop positioning of objects, WYSIWYG (what you see is what you get)
- Simple, clear user guidance
- Tabular object properties, easy and fast assignment of attributes—copy and paste
- Convenient series assignment of texts and images to tags
- Many graphical objects such as bar graph, slide adjuster, graph plotter, curve chart, camera
- Anti-aliased gauge display
- Enhanced password handling with complex password and aging
- Extensive recipe handling
- Alarm handling with time stamp, history and diagnostics support with image display
- Multi-line display of alarm entries
- Online language selection
- Unicode support (also Asian character sets)
- Text import/export in XML format (example, Excel®)
- Brilliant image display, up to 65536 colors
- Import of 15 different image formats
- Dynamic objects
- Object parameter list, any number of data objects in a screen
- Dynamic unit of measure selection (example, °C–°F, inch–mm)
- Direct printing on panel (reports, forms)
- Many specific objects and system functions
- Simple import of PLC variables
- Full functionality always available, no graduated performance level

System Requirements

Windows XP and Windows 7

Product Selection

Galileo Development Software

Description	Catalog Number
Single-seat license	SW-GALILEO-S
Multiple-seat license	SW-GALILEO-M

XSoft-CoDeSys-3 Software

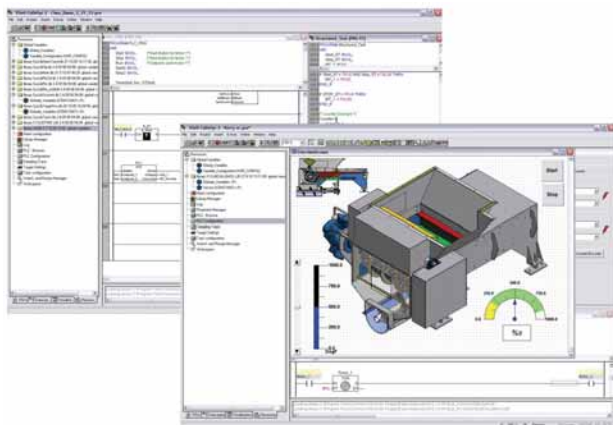

Contents

Description	Page
Operator Interface Software	
Galileo Software	V7-T5-20
XSoft-CoDeSys-3 Software	
Visual Designer Software	V7-T5-22

XSoft-CoDeSys-3 Software

Product Description

Combined Logic and Visualization Development

IEC 61131-3 Logic Programming

- Ladder Diagram (LD)
- Structured Text (ST)
- Sequential function chart (SFC)
- Function block diagram (FBD)
- Freely definable function block chart/continuous function chart (CFC)
- Instruction List (IL)

Target Visualization

Integrated design of Operator Interface screens for the XV series. Visualization and logic developed as part of the same project. Simplifies screen design and always keeps the Logic and visualization in synch.

Web Visualization

Optionally XSoft-CoDeSys-3 can automatically generate XML-based runtime screens to make the screens from the XV accessible remotely using a Web browser with a JavaScript plug-in such as Internet Explorer®, Firefox® and others.

Features

Project Development

- Automatic variable declaration
- On line editing
- Pop-up variable and function search/pick tools
- Automatic formatting and color coding of logic/declaration text
- Re-usable Visual-Logic Function Blocks

Debugging and commissioning

XSoft-CoDeSys-3 offers you a number of important functions for debugging, testing and commissioning your XV applications quickly and efficiently.

All these features are available as soon as you log on to the XV (online mode) over an Ethernet connection.

Simulation

Users can also test the application when the XV is not connected to the process. This is possible thanks to the integrated online simulation feature. Simulation supports both the screens and logic that have been designed using XSoft-CoDeSys.

Advanced Features

- Up to 16 time and/or event driven tasks per project
- Each task can include multiple logic programs or subroutines
- Programs and screen designs can be exported and imported to support reuse
- Powerful, built-in function block libraries
- Ability to create user-defined function blocks
- Fieldbus Configurator for CANopen, PROFIBUS-DP and SmartWire-DT device I/O
- Ethernet and serial communication function blocks (OPC server, UDP, TCP/IP, FTP client/ server, Modbus Master/Slave, email, SMS, and more)
- 8-level password protection
- Web access selectable per screen
- System function libraries (OS Storage Card, and more)
- Online and historical alarms
- Online and historical trends

System Requirements

Windows XP and Windows 7 32-bit systems

Product Selection

XSoft-CoDeSys-3



XSoft-CoDeSys-3 Software

Description	Catalog Number
Single Seat License	SW-XSOFT-CODESYS-3-S
Multiple Seat License (3)	SW-XSOFT-CODESYS-3-M

Visual Designer Software

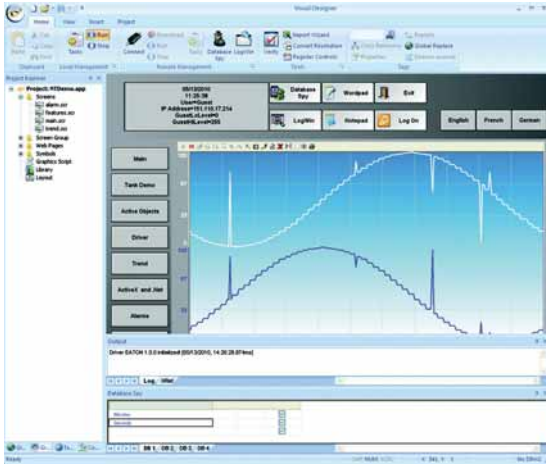

Contents

<i>Description</i>	<i>Page</i>
Operator Interface Software	
Galileo Software	V7-T5-20
XSoft-CoDeSys-3 Software	V7-T5-21
Visual Designer Software	
Product Selection	V7-T5-23

Visual Designer Software

Product Description

Advanced GUI Development, Made Easy

Time-saving solutions, lower costs.

With application development expense often outweighing the hardware expense, the demand to quickly design and implement advanced GUI solutions is greater than ever. Even advanced features such as data archiving, recipe management, multi-language, SQL database access, and Web serving are made easy through an elegant and modern user interface. Visual Designer's ease-of-use and time-saving features lower your total installed cost.

Features

Visual Designer is a software development package optimized for OEMs. New tools streamline the application development process, and the creation of Web-based applications has never been easier. In addition to basic monitor and control functionality, Visual Designer is packed with advanced features streamlining the design of sophisticated applications.

Advanced Features

- Pop-ups and group screens
- Full mathematical and logical evaluation
- Web browsing and document viewing
- Remote access and control without having to install software to the remote PC
- Database interfacing
- Historical alarms and events
- Historical data archiving and trending
- Recipe management
- Multi-language
- VB scripting
- Report generation
- Scheduling
- Resolution conversion
- Emailing and text messaging
- Launch and control of third-party applications

Advanced Development Features

- Conversion of legacy PanelMate configurations
- Optional PanelBuilder conversion utility
- Online configuration/editing
- Advanced search and replace
- Automatic scaling of Web clients
- Customizable application symbols
- Reusable controls, images, and screens via indirect tag and/or PLC assignments

System Requirements

Windows XP and Windows 7 32-bit and 64-bit systems

Fully connected, Web-enabled

Today's operator interface applications range from basic monitor and control to high-end, feature-rich HMI software with Supervisory Control and Data Acquisition (SCADA). Customers demand communications capability with any network, PLC, Web client, and database. The answer: Eaton's Web-enabled Visual Designer operator interface software.

Web-based thin client

- Zero admin client—no need to install software on the remote PC
- Supports multiple simultaneous and independent Web clients
- Simplified security—the same local user accounts and passwords for viewing and control also apply remotely

Connectivity

- Extensive list of over 240 native communication drivers for PLCs, drives, and many other industrial and commercial devices
- Visual Designer software can interface to any relational database—access both local and enterprise functions such as MRP/ERP through databases such as Microsoft® Access, FoxPro, SQL Server, Oracle®, PI System® and many others
- Other connectivity tools provide redundancy capabilities, Real-Time Data Exchange, Centralized Alarm Management, and more

Open platform

- Visual Designer Software can host third-party ActiveX® and .NET controls and Visual Basic® programs
- In addition to Eaton's Operator Interface families, Visual Designer's runtime may be licensed on any 32 or 64-bit Windows PC

Interoperability

- Software is designed to open standards such as XML, OPC, ActiveX, .NET, ODBC, ADO, SOAP, DDE and more

Peace of mind

All of these capabilities—combined with Eaton's commitment to provide free technical support for both OI hardware and software—make it quick and easy to purchase, develop and deploy XP and XV operator interface solutions.

Product Selection

Visual Designer Software

Visual Designer

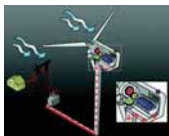

Visual Designer Development Software License Key

Description	Development Software Catalog Number	Runtime Software Catalog Number
Development license for CE hardware	VISUALDCE	—
Development license for PCs, XP-503 and CE hardware	VISUALDXP	—
Multiple development licenses for CE hardware (5-pack of VISUALDCE)	VISUALDCE5	—
Multiple development licenses for PCs, XP-503 and CE hardware (5-pack of VISUALDXP)	VISUALDXP5	—
Development license for all hardware platforms (for use with VISUALD-LIC-SERVER)	VISUALDXPLS	—
Multiple development licenses for use with VISUALD-LIC-SERVER (5-pack for use with VISUALDXPLS)	VISUALDXP5LS	—
License server key to serve development licenses over a LAN	VISUALD-LIC-SERVER	—
Visual Designer development software license and PC Runtime software licenses for a maximum of 64 k tags, 8 drivers, 1 Web session	VISUALRTDEVPC	VISUALRTDEVPC
For a PC Runtime license with a maximum of 64 k tags, 8 drivers, 1 Web session	—	VISUALRTPC64K
For a PC Runtime license with a maximum of 4 k tags, 5 drivers, 1 Web session	—	VISUALRTPC4k
For a PC Runtime license with a maximum of 1500 tags, 3 drivers, 1 Web session	—	VISUALRTPC1500
For a PC Runtime license with a maximum of 300 tags, 3 drivers, 1 Web session	—	VISUALRTPC300
For an XP-503 PC Runtime license with a maximum of 4 k tags, 5 drivers, 1 Web session	—	N/A: Unit pre-licensed
For an XP-503 PC Runtime license with up to 64 k tags, 8 drivers, and 128 Web sessions	—	See upgrade list on next page

Visual Designer

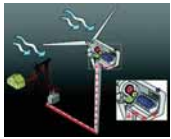

5

Software Updates and Upgrades

Description	Catalog Number
Update to current version Visual Designer development software for CE hardware	VISUALDUPCE
Update to current version Visual Designer development software PCs/XPe/CE	VISUALDUPXP
Update to current version of Visual Designer runtime license for PCs	VISUALRTUPPC
Upgrade from Visual Designer CE 1500 tag to 4000 tag runtime	VISUALRT4KCE
Upgrade from Visual Designer XP-500 4000 tag, 5 driver to 64 k tag, 8 driver runtime license	VISUALRT64KXP
Upgrade from Visual Designer development software CE to CE plus PC and XPe (64 k tag, 8 drivers)	VISUALDCE2XP
Visual Designer PanelBuilder conversion utility optional plug-in (requires Visual Designer software)	VISUALDPBCU
Visual Designer 1 additional Web thin client license for Internet Explorer: Total of 2	VISUALWEB1
Visual Designer 3 additional Web thin client licenses for Internet Explorer: Total of 4	VISUALWEB3
Visual Designer 7 additional Web thin client licenses for Internet Explorer: Total of 8	VISUALWEB7
Visual Designer 15 additional Web thin client licenses for Internet Explorer: Total of 16	VISUALWEB16
Visual Designer 31 additional Web thin client licenses for Internet Explorer: Total of 32	VISUALWEB32
Visual Designer 63 additional Web thin client licenses for Internet Explorer: Total of 64	VISUALWEB64
Visual Designer 127 additional Web thin client licenses for Internet Explorer: Total of 128	VISUALWEB128
Visual Designer 1 additional Secure Viewer Thin Client license: Total of 2	VISUALSVT2
Visual Designer 3 additional Secure Viewer Thin Client license: Total of 4	VISUALSVT4
Visual Designer 7 additional Secure Viewer Thin Client license: Total of 8	VISUALSVT8
Visual Designer 15 additional Secure Viewer Thin Client license: Total of 16	VISUALSVT16
Visual Designer 31 additional Secure Viewer Thin Client license: Total of 32	VISUALSVT32
Visual Designer 63 additional Secure Viewer Thin Client license: Total of 64	VISUALSVT64
Visual Designer 127 additional Secure Viewer Thin Client license: Total of 128	VISUALSVT128
Visual Designer 1 additional SMA Thin Client license: Total of 2	VISUALSMA2
Visual Designer 3 additional SMA Thin Client license: Total of 4	VISUALSMA4
Visual Designer 7 additional SMA Thin Client license: Total of 8	VISUALSMA8
Visual Designer 15 additional SMA Thin Client license: Total of 16	VISUALSMA16
Visual Designer 31 additional SMA Thin Client license: Total of 32	VISUALSMA32
Visual Designer 63 additional SMA Thin Client license: Total of 64	VISUALSMA64
Visual Designer 127 additional SMA Thin Client license: Total of 128	VISUALSMA128
Visual Designer collaborative server	VISUALCBSERVER
Visual Designer business dashboard tool	VISUALDASHBOARD
Visual Designer communication package for electrical products	VISUALDELECDRVS

Power Supply



6.1 General Purpose and Sensor Power Supplies

Product Selection Guide	V7-T6-2
PSG Series	V7-T6-3
ELC Series	V7-T6-23
easyRelay Power Supply	V7-T6-26
Sensor Power Supply	V7-T6-30
PSS Series	V7-T6-33

6.1

Power Supplies

General-Purpose and Sensor Power Supplies

Power Supplies



6

Contents

Description

Page

General-Purpose and Sensor Power Supplies	
PSG Series	V7-T6-3
ELC Series	V7-T6-23
easyRelay Power Supply	V7-T6-26
Sensor Power Supply	V7-T6-30
PSS Series	V7-T6-33

Product Selection Guide

Power Supply Series and Features



PSG Series

ELC Series

easyRelay Power Series

Sensor Power Supplies

PSS Series

Features	PSG Series	ELC Series	easyRelay Power Series	Sensor Power Supplies	PSS Series
	General-purpose 12 Vdc and 24 Vdc output for 1.25 A to 40 A loads Single-phase and three-phase inputs up to 500 Vac 150% power surge output Redundancy modules Buffer module DIN rail mount Rugged metal and plastic housing options Heavy-duty screw and finger-safe terminals Hazardous Location Class I, Division 2 rated models NEC® Class 2 rated model Protection from overvoltage, overcurrent and overtemperature conditions	Compact, low cost 24 Vdc control for loads up to 2 A Plastic enclosure can be DIN rail or panel mounted Single-phase (100–240 Vac) input	Low profile power supplies for 12 Vdc or 24 Vdc applications 8 W, 30 W, 60 W or 100 W output power easyRelay styling provides optimal panel aesthetics Plastic enclosure can be DIN rail or panel mounted (with optional kit) CSA Class 1, Division 2 qualified Single-phase (100–240 Vac) input	27 Vdc supplies for tough sensor applications Rugged housings with integrated junction box for mounting outside of electrical enclosures Advanced diagnostic features	24 Vdc control for high startup loads Peak current surge (boost/outrush) up to 6 times nominal current Semi 47 approved Long ride-through capability Pluggable terminal connections Single-phase and three-phase inputs up to 600 Vac

Product Selection	Page V7-T6-4	Page V7-T6-24	Page V7-T6-27	Page V7-T6-31	Page V7-T6-34
Technical Data and Specifications	Page V7-T6-6	Page V7-T6-24	Page V7-T6-28	Page V7-T6-31	Page V7-T6-35
Dimensions	Page V7-T6-17	Page V7-T6-25	Page V7-T6-29	Page V7-T6-32	—

PSG Series



Contents

Description	Page
PSG Series	
Catalog Number Selection	V7-T6-4
Product Selection	V7-T6-5
Technical Data and Specifications	V7-T6-6
Power Derating Curves	V7-T6-14
Dimensions	V7-T6-17
ELC Series	V7-T6-23
easyRelay Power Supply	V7-T6-26
Sensor Power Supply	V7-T6-30
PSS Series	V7-T6-33

PSG Series

Product Description

Eaton’s PSG Series of power supplies is designed to be a high-performance, high-quality line of products covering a majority of 12 Vdc and 24 Vdc control applications. With global certifications, a compact size and an impressive operating temperature range, the PSG Series fits a wide variety of applications at a competitive price.

Our expansive 22 model offering is able to provide solutions for most applications with PSG outputs ranging from 12 Vdc at 1.25 A up to 24 Vdc at 40 A, plus redundancy and buffer modules to ensure uptime.

Application Description

The PSG Series is a line of general-purpose power supplies for use in a wide variety of industrial control applications. Applications include communication networks, sensors, PLCs and many other electrical systems. Each model is equipped with the options of a rugged metal or plastic housing, heavy-duty screw or finger-safe terminals and a variety of protection features, making the PSG one of the most versatile industrial power supply lines on the market.

Features, Benefits and Functions

- Universal input voltages: 100–240 Vac for single-phase units, 400–500 Vac for three-phase units
- General-purpose 12 Vdc and 24 Vdc adjustable output
- 150% power surge output
- Wide operating temperature range: –25 °C to +80 °C
- MTBF up to 1,000,000 hours ensures uptime and reliability
- Protection from overvoltage, overcurrent and over-temperature conditions
- Rugged aluminum and plastic housings provide the durability required to stand up to harsh environments
- All-metal DIN rail mounting hardware
- Heavy-duty screw and finger-safe terminals
- LED indicating light for DC OK simplifies troubleshooting
- Conformal coated electronics
- Hazardous Location Class I, Division 2 rated models
- NEC® Class 2 rated model
- Redundancy modules keep loads up and running in the event of a device failure
- Buffer module has the stored power needed to keep loads running through a short duration power failure
- Three-year standard warranty

Standards and Certifications

- cULus listed—UL 508
- CSA listed—CSA 22.2 No. 107.1-01
- Hazardous Location, Class I, Div. 2, Groups A, B, C, D
- IEC
- EN
- NEC Class 2

- CE marked
- RoHS compliant



Note: Some models may not carry all certifications listed.

6.1

Power Supplies

General-Purpose and Sensor Power Supplies

Catalog Number Selection

Note: Catalog number selection breakdown shown below is for illustrative purposes only and not to be used to create new catalog number configurations.

PSG Series

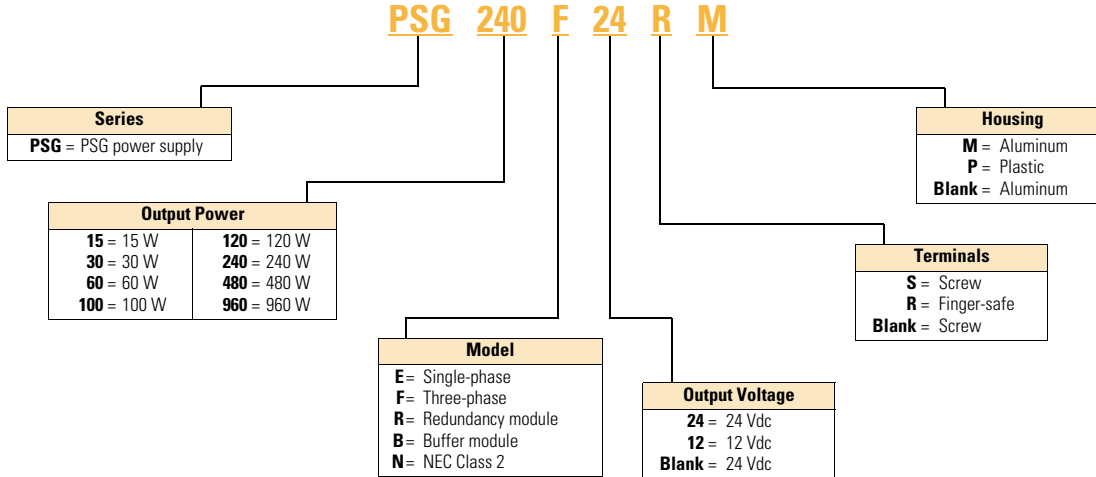



Note: Not all combinations are available. See Pages **V7-T6-6–V7-T6-13** for all available combinations.



Product Selection

PSG Series

Screw Type Terminals—Connections for those that require multiple types of terminations and lug connections.

Power	Description	Catalog Number
Screw Type Terminals		
PSG100E12SM 	12 Vdc output single-phase power supplies (100–240 Vac nominal input)	15 W 1.25 A output, plastic housing PSG15E12SP
		30 W 2.5 A output, plastic housings PSG30E12SP
		60 W 5 A output, aluminum housing PSG60E12SM
		100 W 8.33 A output, aluminum housing PSG100E12SM
PSG60E 	24 Vdc output single-phase power supplies (100–240 Vac nominal input)	60 W 2.5 A output, aluminum housing PSG60E
		60 W 2.5 A output, plastic housing PSG60E24SP
		120 W 5 A, aluminum housing PSG120E
		240 W 10 A, aluminum housing PSG240E
		480 W 20 A, aluminum housing PSG480E

Finger-Safe Terminals—Connections for those that require IP20 terminals for all your safety solutions

Power	Description	Catalog Number
Finger-Safe Terminals		
PSG60E24RM 	24 Vdc output single-phase power supplies (100–240 Vac nominal input)	60 W 2.5 A output, aluminum housing PSG60E24RM
		120 W 5 A, aluminum housing PSG120E24RM
		240 W 10 A, aluminum housing PSG240E24RM
		480 W 20 A, aluminum housing PSG480E24RM
		60 W 2.5 A output, plastic housing, NEC Class 2 PSG60N24RP
PSG480F24RM 	24 Vdc output, three-phase power supplies (400–500 Vac nominal input)	60 W 2.5 A, aluminum housing PSG60F24RM
		120 W 5 A, aluminum housing PSG120F24RM
		240 W 10 A, aluminum housing PSG240F24RM
		480 W 20 A, aluminum housing PSG480F24RM
		960 W 40 A, aluminum housing PSG960F24RM
PSG480B24RM 	Module power supplies (24 Vdc input)	Buffer module, 480 W 20 A output, aluminum housing PSG480B24RM
		Redundancy module, 480 W <20 A output, aluminum housing PSG480R24RM
		Redundancy module, 960 W <40 A output, aluminum housing PSG960R24RM

Technical Data and Specifications

PSG Series

	Single-Phase PSG15E12SP	PSG30E12SP	PSG60E12SM	PSG100E12SM	PSG60E	PSG60E24SP	PSG60E24RM
Input							
Nominal voltage	100–240 Vac	100–240 Vac	100–240 Vac	100–240 Vac	100–240 Vac	100–240 Vac	100–240 Vac
AC input range	85–264 Vac	85–264 Vac	85–264 Vac	85–264 Vac	85–264 Vac	85–264 Vac	85–264 Vac
DC input range	120–375 Vdc	120–375 Vdc	120–375 Vdc	120–375 Vdc	120–375 Vdc	120–375 Vdc	120–375 Vdc
Frequency	47–63 Hz	47–63 Hz	47–63 Hz	47–63 Hz	47–63 Hz	47–63 Hz	47–63 Hz
Nominal current ^①	<0.37 A	<0.7 A	<1.35 A	<2.5 A	1.1 A	<1.10 A	<1.4 A
Inrush current limitation ^①	<30 A	<30 A	<50 A	<100 A	30 A	<40 A	<20 A
Internal fuse	T3.15 AH / 250 V	T3.15 AH / 250 V	T3.15 AH / 250 V	T3.15 AH / 250 V	T3.15 AH / 250 V	T3.15 AH / 250 V	T3.15 AH / 250 V
External fusing	4 A or 6 A	4 A or 6 A	6 A, 10 A or 16 A	6 A, 10 A or 16 A	6 A, 10 A or 16 A	6 A, 10 A or 16 A	6 A, 10 A or 16 A
Leakage current	<1 mA	<1 mA	<1 mA	<1 mA	<1 mA	<1 mA	<1 mA
Output							
Power	15 W	30 W	60 W	100 W	60 W	60 W	60 W
Nominal output voltage	12 Vdc ±2%	12 Vdc ±2%	12 Vdc ±2%	12 Vdc ±2%	24 Vdc ±2%	24 Vdc ±2%	24 Vdc ±2%
Adjustment range	11–14 Vdc	11–14 Vdc	11–14 Vdc	11–14 Vdc	22–28 Vdc	22–28 Vdc	24–28 Vdc
Nominal current	1.25 A	2.5 A	5 A	8.33 A	2.5 A	2.5 A	2.5 A
Startup with capacitive loads	Max. 5000 µF	Max. 6600 µF	Max. 8000 µF	Max. 10,000 µF	Max. 8000 µF	Max. 8000 µF	Max. 8000 µF
Efficiency	>84% at 115 Vac, >83% at 230 Vac	>85% at 115 Vac and 230 Vac	>85% at 115 Vac and 230 Vac	>85.5% at 115 Vac, >87.5% at 230 Vac	>85% typ	>86% at 115 Vac, >87% at 230 Vac	>90% at 115 Vac and 230 Vac
Current surge	1.875 A	3.75 A	7.5 A	12.495 A	3.75 A	3.75 A	3.75 A
Current surge time	3 s	3 s	3 s	3 s	1 s (at 10 s intervals)	3 s	5 s
Residual ripple/peak switching (20 MHz)	<100 mVpp	<100 mVpp	<100 mVpp	<100 mVpp	<50 mV / <240 mVpp	<50 mV / <240 mVpp	<50 mVpp / <150 mVpp
Turn-on time	<2.5 s	<2.5 s	<2.5 s	<0.6s	<2.5 s	<3 s	<2s
Mains buffering at nominal load (typ.) ^①	>22 ms	>22 ms	>22 ms	>22 ms	>20 ms	>20 ms	>20 ms
Parallel operation	With o-ring diode	With o-ring diode	With o-ring diode	With o-ring diode	PSG480R24RM / PSG960R24RM / With o-ring diode	PSG480R24RM / PSG960R24RM / With o-ring diode	PSG480R24RM / PSG960R24RM / With o-ring diode
Galvanic Isolation							
Input/output	4 k Vac	4 k Vac	4 k Vac	4 k Vac	4 k Vac (type test) / 3 k Vac (routine test)	4 k Vac	4 k Vac
Input/ground	1.5 k Vac	1.5 k Vac	1.5 k Vac	1.5 k Vac	1.5 k Vac (type test) / 1.5 k Vac (routine test)	1.5 k Vac	1.5 k Vac
Output/ground	1.5 k Vac	1.5 k Vac	1.5 k Vac	1.5 k Vac	1.5 k Vac (type test) / 500 Vac (routine test)	1.5 k Vac	1.5 k Vac
General/Physical Data							
Housing material	Plastic	Plastic	Aluminum	Aluminum	Aluminum	Plastic	Aluminum
Signals	Green LED for DC OK	Green LED for DC OK	Green LED for DC OK	Green LED for DC OK	Green LED for DC OK	Green LED for DC OK	Green LED for DC OK
MTBF	>1,000,000 hr	>1,000,000 hr	>800,000 hr	>800,000 hr	>800,000 hr	>800,000 hr	>1,000,000 hr
Dimensions (L)	100 mm	100 mm	121 mm	121 mm	121 mm	120.6 mm	121 mm
Dimensions (W)	32 mm	32 mm	32 mm	50 mm	32 mm	32 mm	32 mm
Dimensions (H)	100.6 mm	100.6 mm	120 mm	118.7 mm	120 mm	113 mm	125 mm
Weight (kg)	0.18	0.2	0.33	0.64	0.37	0.33	0.37
Terminals	Screw	Screw	Screw	Screw	Screw	Screw	Finger-safe, removable
Wire size	AWG 22–14	AWG 22–14	AWG 22–14	AWG 18–24	AWG 22–14	AWG 22–14	AWG 22–12
Operating temperature	–20 °C to +75 °C	–20 °C to +75 °C	–20 °C to +75 °C	–20 °C to +75 °C	–20 °C to +75 °C	–20 °C to +75 °C	–20 °C to +80 °C
Storage temperature	–25 °C to +85 °C	–25 °C to +85 °C	–25 °C to +85 °C	–25 °C to +85 °C	–25 °C to +85 °C	–25 °C to +85 °C	–25 °C to +85 °C

Note

^① Ratings for single-phase models are at 115 Vac; three-phase models are at 400 Vac.

PSG Series, continued

	Single-Phase PSG15E12SP	PSG30E12SP	PSG60E12SM	PSG100E12SM	PSG60E	PSG60E24SP	PSG60E24RM
General/Physical Data, continued							
Power derating— vertical mounting	>50 °C derate power by 2.5% / °C, >70 °C derate power by 4% / °C	>50 °C derate power by 2.5% / °C, >70 °C derate power by 4% / °C	>50 °C derate power by 2.5% / °C, >70 °C derate power by 4% / °C	>50 °C derate power by 2.5% / °C	>50 °C derate power by 2.5% / °C	<0 °C to –20 °C derate power by 1% / °C, >50 °C derate power by 2.5% / °C, >70 °C derate power by 4% / °C	>50 °C derate power by 2.5% / °C
Power derating— horizontal mounting	N/A	N/A	N/A	>50 °C derate power by 2.5% / °C, >70 °C derate power by 4% / °C	N/A	N/A	>50 °C derate power by 2.5% / °C
Operating humidity	<95% RH, noncondensing	<95% RH, noncondensing	<95% RH, noncondensing	<95% RH, noncondensing	<95% RH, noncondensing	<95% RH, noncondensing	<95% RH, noncondensing
Vibration	10 to 150 Hz, 0.35 mm acc. 50 m/s ² , single amplitude (5G max.) for 90 min. in each X, Y and Z directions, in accordance with IEC 60068-2-6						
Pollution degree	2	2	2	2	2	2	2
Climatic class	3K3 according to EN 60721	3K3 according to EN 60721	3K3 according to EN 60721	3K3 according to EN 60721	3K3 according to EN 60721	3K3 according to EN 60721	3K3 according to EN 60721
Safety and Protection							
Transient surge voltage	Varistor	Varistor	Varistor	Varistor	Varistor	Varistor	Varistor
Surge voltage protection against internal surge	Yes	Yes	Yes	Yes	Yes	Yes	Yes
Safety class	Class I with ground connection	Class I with ground connection	Class I with ground connection	Class I with ground connection	Class I with ground connection	Class I with ground connection	Class I with ground connection
Shock	30 G (300 m/s ²) in all directions according to IEC 60068-2-27	30 G (300 m/s ²) in all directions according to IEC 60068-2-27	30 G (300 m/s ²) in all directions according to IEC 60068-2-27	30 G (300 m/s ²) in all directions according to IEC 60068-2-27	30 G (300 m/s ²) in all directions according to IEC 60068-2-27	30 G (300 m/s ²) in all directions according to IEC 60068-2-27	30 G (300 m/s ²) in all directions according to IEC 60068-2-27

PSG Series, continued

	Single-Phase, continued						
	PSG60N24RP	PSG120E	PSG120E24RM	PSG240E	PSG240E24RM	PSG480E	PSG480E24RM
Input							
Nominal voltage	100–240 Vac	100–240 Vac	100–240 Vac	100–240 Vac	100–240 Vac	100–240 Vac	100–240 Vac
AC input range	85–264 Vac	85–264 Vac	85–264 Vac	85–264 Vac	85–264 Vac	85–264 Vac	85–264 Vac
DC input range	N/A	120–375 Vdc	120–375 Vdc	120–375 Vdc	120–375 Vdc	120–375 Vdc	120–375 Vdc
Frequency	47–63 Hz	47–63 Hz	47–63 Hz	47–63 Hz	47–63 Hz	47–63 Hz	47–63 Hz
Nominal current ^①	<1.5 A at 100 Vac	1.4 A	<2.2 A	2.9 A	<2.5 A	5.7 A	<5 A
Inrush current limitation ^①	<40 A	<80 A	<35 A	N/A	<35 A	N/A	<35 A
Internal fuse	T3.15 AH / 250 V	T3.15 AH / 250 V	T4 AH / 250 V	T6.3 AH / 250 V	T6.3 AH / 250 V	F10H / 250 A	T8 AH / 250 V
External fusing	6 A, 10 A or 16 A	6 A, 10 A or 16 A	6 A, 10 A or 16 A	10 A or 16 A	10 A or 16 A	10 A or 16 A	10 A or 16 A
Leakage current	<1 mA	<1 mA	<1 mA	<3.5 mA	<1 mA	<1 mA	<3 mA
Output							
Power	60 W	120 W	120 W	240 W	240 W	480 W	480 W
Nominal output voltage	24 Vdc ±2%	24 Vdc ±2%	24 Vdc ±2%	24 Vdc ±2%	24 Vdc ±2%	24 Vdc ±2%	24 Vdc ±2%
Adjustment range	22–28 Vdc	22–28 Vdc	24–28 Vdc	22–28 Vdc	24–28 Vdc	22–28 Vdc	22–28 Vdc
Nominal current	2.5 A	5 A	5 A	10 A	10 A	20 A	20 A
Startup with capacitive loads	Max. 8000 µF	Max. 10,000 µF	Max. 10,000 µF	Max. 10,000 µF	Max. 10,000 µF	Max. 10,000 µF	Max. 10,000 µF
Efficiency	>86% at 115 Vac, >87% at 230 Vac	>84% typ	>89% at 115 Vac, >90% at 230 Vac	>84% typ	>90% at 115 Vac and 230 Vac	>86% typ	>90% at 115 Vac and 230 Vac
Current surge	N/A	7.5 A	7.5 A	15 A	15 A	30 A	30 A
Current surge time	N/A	1 s (at 10 s intervals)	5 s	1 s (at 10 s intervals)	5 s	1 s (at 10 s intervals)	5 s
Residual ripple/peak switching (20 MHz)	<50 mVpp / <240 mVpp	<50 mV / <240 mVpp	<50 mVpp / <150 mVpp	<50 mV / <240 mVpp	<50 mVpp / <150 mVpp	<50 mV / <240 mVpp	<50 mVpp
Turn-on time	<3 s	<1 s	<1 s	<1 s	<1 s	<1 s	<1 s
Mains buffering at nominal load (typ.) ^①	>20 ms	>35ms	>20 ms	>20 ms	>20 ms	>20 ms	>20 ms
Parallel operation	PSG480R24RM / PSG960R24RM / With o-ring diode	PSG480R24RM / PSG960R24RM / With o-ring diode	PSG480R24RM / PSG960R24RM / With o-ring diode	PSG480R24RM / PSG960R24RM / With o-ring diode	PSG480R24RM / PSG960R24RM / With o-ring diode	PSG480R24RM / PSG960R24RM / With o-ring diode	PSG480R24RM / PSG960R24RM / With o-ring diode
Galvanic Isolation							
Input/output	4 k Vac	4 k Vac (type test) / 3 k Vac (routine test)	4 k Vac	4 k Vac (type test) / 3 k Vac (routine test)	4 k Vac	4 k Vac (type test) / 3 k Vac (routine test)	4 k Vac
Input/ground	1.5 k Vac	1.5 k Vac (type test) / 1.5 k Vac (routine test)	1.5 k Vac	1.5 k Vac (type test) / 1.5 k Vac (routine test)	1.5 k Vac	1.5 k Vac (type test) / 1.5 k Vac (routine test)	1.5 k Vac
Output/ground	1.5 k Vac	1.5 k Vac (type test) / 500 Vac (routine test)	1.5 k Vac	1.5 k Vac (type test) / 500 Vac (routine test)	1.5 k Vac	1.5 k Vac (type test) / 500 Vac (routine test)	1.5 k Vac
General/Physical Data							
Housing material	Aluminum	Aluminum	Aluminum	Aluminum	Aluminum	Aluminum	Aluminum
Signals	Green LED for DC OK	Green LED for DC OK	Green LED for DC OK	Green LED for DC OK	Green LED for DC OK	Green LED for DC OK	Green LED for DC OK
MTBF	>800,000 hr	>800,000 hr	>800,000 hr	>300,000 hr	>500,000 hr	>300,000 hr	>500,000 hr
Dimensions (L)	120.6 mm	121 mm	121 mm	121 mm	121 mm	121 mm	121 mm
Dimensions (W)	32 mm	32 mm	50 mm	85 mm	85 mm	160 mm	144 mm
Dimensions (H)	119.3 mm	120 mm	123.1 mm	118.5 mm	124.1 mm	115 mm	118.6 mm
Weight (kg)	0.33	0.54	0.72	1.04	1.1	1.8	1.37
Terminals	Finger-safe, fixed	Screw	Finger-safe, removable	Screw	Finger-safe, removable	Screw	Finger-safe, fixed
Wire size	AWG 22–10	AWG 22–14	AWG 20–12	AWG 22–14	AWG 16–12	AWG 16–14 (input) AWG 12–10 (output)	AWG 18–10
Operating temperature	–20 °C to +80 °C	–20 °C to +75 °C	–20 °C to +80 °C	–20 °C to +75 °C	–20 °C to +80 °C	–20 °C to +75 °C	–25 °C to +75 °C
Storage temperature	–25 °C to +85 °C	–25 °C to +85 °C	–25 °C to +85 °C	–25 °C to +85 °C	–25 °C to +85 °C	–25 °C to +85 °C	–25 °C to +85 °C

Note

^① Ratings for single-phase models are at 115 Vac; three-phase models are at 400 Vac.

PSG Series, continued

		Single-Phase, continued						
		PSG60N24RP	PSG120E	PSG120E24RM	PSG240E	PSG240E24RM	PSG480E	PSG480E24RM
General/Physical Data, continued								
Power derating— vertical mounting	>50 °C derate power by 2.5% / °C, >70 °C derate power by 4% / °C	>50 °C derate power by 2.5% / °C	>50 °C derate power by 2.5% / °C	>50 °C derate power by 2.5% / °C	>50 °C derate power by 2.5% / °C, >70 °C derate power by 4% / °C	>50 °C derate power by 2.5% / °C	>50 °C derate power by 2.5% / °C	>50 °C derate power by 2.5% / °C, >70 °C to 75 °C derate power by 5% / °C
Power derating— horizontal mounting	>50 °C derate power by 2.5% / °C, >70 °C derate power by 4% / °C	N/A	>50 °C derate power by 2.5% / °C	N/A	N/A	N/A	N/A	N/A
Operating humidity	<95% RH, noncondensing	<95% RH, noncondensing	<95% RH, noncondensing	<95% RH, noncondensing	<95% RH, noncondensing	<95% RH, noncondensing	<95% RH, noncondensing	<95% RH, noncondensing
Vibration	10 to 500 Hz, 0.35 mm acc. 30 m/s ² , single amplitude (3 G max.) for 60 min. in each X, Y and Z directions, in accordance with IEC 60068-2-6	10 to 150 Hz, 0.35 mm acc. 50 m/s ² , single amplitude (5G max.) for 90 min. in each X, Y and Z directions, in accordance with IEC 60068-2-6	10 to 150 Hz, 0.35 mm acc. 50 m/s ² , single amplitude (5G max.) for 90 min. in each X, Y and Z directions, in accordance with IEC 60068-2-6	10 to 150 Hz, 0.35 mm acc. 50 m/s ² , single amplitude (5G max.) for 90 min. in each X, Y and Z directions, in accordance with IEC 60068-2-6	10 to 150 Hz, 0.35 mm acc. 50 m/s ² , single amplitude (5G max.) for 90 min. in each X, Y and Z directions, in accordance with IEC 60068-2-6	10 to 150 Hz, 0.35 mm acc. 50 m/s ² , single amplitude (5G max.) for 90 min. in each X, Y and Z directions, in accordance with IEC 60068-2-6	10 to 150 Hz, 0.35 mm acc. 50 m/s ² , single amplitude (5G max.) for 90 min. in each X, Y and Z directions, in accordance with IEC 60068-2-6	10 to 150 Hz, 0.35 mm acc. 50 m/s ² , single amplitude (5G max.) for 90 min. in each X, Y and Z directions, in accordance with IEC 60068-2-6
Pollution degree	2	2	2	2	2	2	2	2
Climatic class	3K3 according to EN 60721	3K3 according to EN 60721	3K3 according to EN 60721	3K3 according to EN 60721	3K3 according to EN 60721	3K3 according to EN 60721	3K3 according to EN 60721	3K3 according to EN 60721
Safety and Protection								
Transient surge voltage	Varistor	Varistor	Varistor	Varistor	Varistor	Varistor	Varistor	Varistor
Surge voltage protection against internal surge	Yes	Yes	Yes	Yes	Yes	Yes	Yes	Yes
Safety class	Class I with ground connection	Class I with ground connection	Class I with ground connection	Class I with ground connection	Class I with ground connection	Class I with ground connection	Class I with ground connection	Class I with ground connection
Shock	30 G (300 m/s ²) in all directions according to IEC 60068-2-27	30 G (300 m/s ²) in all directions according to IEC 60068-2-27	30 G (300 m/s ²) in all directions according to IEC 60068-2-27	30 G (300 m/s ²) in all directions according to IEC 60068-2-27	30 G (300 m/s ²) in all directions according to IEC 60068-2-27	30 G (300 m/s ²) in all directions according to IEC 60068-2-27	30 G (300 m/s ²) in all directions according to IEC 60068-2-27	30 G (300 m/s ²) in all directions according to IEC 60068-2-27

PSG Series, continued

	Three-Phase PSG60F24RM	PSG120F24RM	PSG240F24RM	PSG480F24RM	PSG960F24RM
Input					
Nominal voltage	3 x 400–500 Vac	3 x 400–500 Vac	3 x 400–500 Vac	3 x 400–500 Vac	3 x 400–500 Vac
AC input range	3 x 320–600 Vac	3 x 320–600 Vac	3 x 320–600 Vac	3 x 320–600 Vac	3 x 320–600 Vac
DC input range	450–800 Vdc	450–800 Vdc	450–800 Vdc	450–800 Vdc	450–800 Vdc
Frequency	47–63 Hz	47–63 Hz	47–63 Hz	47–63 Hz	47–63 Hz
Nominal current ^①	<0.3 A	<0.5 A	<0.75 A	<1 A	<1.7 A
Inrush current limitation ^①	<30 A	<30 A	<40 A	<50 A	<40 A
Internal fuse	T 3.15 AH / 500 V, 600 V	T 3.15 AH / 500 V, 600 V	T 3.15 AH / 500 V, 600 V	T 3.15 AH / 500 V	T 4 AH / 500 V
External fusing	3 x circuit breakers 6 A, 10 A or 16 A	3 x circuit breakers 6 A, 10 A or 16 A	3 x circuit breakers 6 A, 10 A or 16 A	3 x circuit breakers 6 A, 10 A or 16 A	3 x circuit breakers 10 A or 16 A
Leakage current	<3.5 mA	<3.5 mA	<3.5 mA	<3.5 mA	<3.5 mA
Output					
Power	60 W	120 W	240 W	480 W	960 W
Nominal output voltage	24 Vdc ±2%	24 Vdc ±2%	24 Vdc ±2%	24 Vdc ±2%	24 Vdc ±2%
Adjustment range	24–28 Vdc	24–28 Vdc	24–28 Vdc	24–28 Vdc	24–28 Vdc
Nominal current	2.5 A	5 A	10 A	20 A	40 A
Startup with capacitive loads	Max. 10,000 µF	Max. 10,000 µF	Max. 10,000 µF	Max. 10,000 µF	Max. 10,000 µF
Efficiency	>86% at 3 x 400 Vac and 3 x 500 Vac	>88% at 3 x 400 Vac and 3 x 500 Vac	>92% at 3 x 400 Vac and 3 x 500 Vac	>91% at 3 x 400 Vac and 3 x 500 Vac	>92% at 3 x 400 Vac and 3 x 500 Vac
Current surge	3.75 A	7.5 A	15 A	30 A	60 A
Current surge time	5 s	5 s	5 s	5 s	5 s
Residual ripple/peak switching (20 MHz)	<50 mVpp	<50 mVpp	<150 mVpp	<150 mVpp	<240 mVpp
Turn-on time	<1 s	<1 s	<1 s	<1 s	<1.5 s
Mains buffering at nominal load (typ.) ^①	>20 ms	>20 ms	>20 ms	>20 ms	>20 ms
Parallel operation	PSG480R24RM / PSG960R24RM / With o-ring diode	PSG480R24RM / PSG960R24RM / With o-ring diode	PSG480R24RM / PSG960R24RM / With o-ring diode	PSG480R24RM / PSG960R24RM / With o-ring diode	PSG960R24RM / With o-ring diode
Galvanic Isolation					
Input/output	4 k Vac	4 k Vac	4 k Vac	4 k Vac	4 k Vac
Input/ground	2 k Vac	2 k Vac	2 k Vac	2 k Vac	2 k Vac
Output/ground	1.5 k Vac	1.5 k Vac	1.5 k Vac	1.5 k Vac	1.5 k Vac
General/Physical Data					
Housing material	Aluminum	Aluminum	Aluminum	Aluminum	Aluminum
Signals	Green LED for DC OK	Green LED for DC OK	Green LED for DC OK	Green LED for DC OK	Green LED for DC OK
MTBF	>500,000 hr	>500,000 hr	>300,000 hr	>500,000 hr	>300,000 hr
Dimensions (L)	121 mm	121 mm	121 mm	121 mm	121 mm
Dimensions (W)	50 mm	50 mm	70 mm	140 mm	255 mm
Dimensions (H)	117.3 mm	117.3 mm	117.3 mm	117.3 mm	117.3 mm
Weight (kg)	0.66	0.66	0.89	1.35	2.6
Terminals	Finger-safe, fixed	Finger-safe, fixed	Finger-safe, fixed	Finger-safe, fixed	Finger-safe, fixed
Wire size	AWG 18–12	AWG 18–12	AWG 18–12 (input) AWG 16–12 (output)	AWG 18–8 (input) AWG 12–10 (output)	AWG 18–8 (input) AWG 12–10 (output)
Operating temperature	–25 °C to +75 °C	–25 °C to +75 °C	–25 °C to +75 °C	–25 °C to +80 °C	–25 °C to +65 °C
Storage temperature	–25 °C to +85 °C	–25 °C to +85 °C	–25 °C to +85 °C	–25 °C to +85 °C	–25 °C to +85 °C

Note

^① Ratings for single-phase models are at 115 Vac; three-phase models are at 400 Vac.

PSG Series, continued

	Three-Phase, continued				
	PSG60F24RM	PSG120F24RM	PSG240F24RM	PSG480F24RM	PSG960F24RM
General/Physical Data, continued					
Power derating— vertical mounting	>50 °C derate power by 2.5% / °C, >70 °C derate power by 5% / °C	>50 °C derate power by 2.5% / °C, >70 °C derate power by 5% / °C	>50 °C derate power by 2.5% / °C, >70 °C derate power by 5% / °C	>50 °C derate power by 2.5% / °C, >70 °C derate power by 5% / °C	>50 °C derate power by 2.5% / °C
Power derating— horizontal mounting	>45 °C derate power by 2.5% / °C, >55 °C derate power by 1.66% / °C, >70 °C derate power by 5% / °C	>40 °C derate power by 2.5% / °C, >60 °C derate power by 5% / °C	>40 °C derate power by 2.5% / °C, >60 °C derate power by 5% / °C	N/A	N/A
Operating humidity	<95% RH, noncondensing	<95% RH, noncondensing	<95% RH, noncondensing	5 to 95% RH, noncondensing	5 to 95% RH, noncondensing
Vibration	10 to 500 Hz, 0.35 mm acc. 30 m/s ² , single amplitude (3 G max.) for 60 min. in each X, Y and Z directions, in accordance with IEC 60068-2-6				
Pollution degree	2	2	2	2	2
Climatic class	3K3 according to EN 60721	3K3 according to EN 60721	3K3 according to EN 60721	3K3 according to EN 60721	3K3 according to EN 60721
Safety and Protection					
Transient surge voltage	Varistor	Varistor	Varistor	Varistor	Varistor
Surge voltage protection against internal surge	Yes	Yes	Yes	Yes	Yes
Safety class	Class I with ground connection				
Shock	30 G (300 m/s ²) in all directions according to IEC 60068-2-27	30 G (300 m/s ²) in all directions according to IEC 60068-2-27	30 G (300 m/s ²) in all directions according to IEC 60068-2-27	30 G (300 m/s ²) in all directions according to IEC 60068-2-27	30 G (300 m/s ²) in all directions according to IEC 60068-2-27

PSG Series, continued

	Redundancy Modules	
	PSG480R24RM	PSG960R24RM
Input		
Nominal voltage	24–48 Vdc	24–48 Vdc
DC input range	22–60 Vdc	22–60 Vdc
Nominal current	<20 A	<40 A
Inrush current limitation	<25 A	<50 A
Output		
Nominal output voltage	Vin–0.65 V (typ.)	Vin–0.65 V (typ.)
Nominal current	<20 A	<40 A
Efficiency	>97% typ.	>97% typ.
Galvanic Isolation		
Input/ground	1.5 k Vac	1.5 k Vac
Output/ground	1.5 k Vac	1.5 k Vac
General/Physical Data		
Housing material	Aluminum	Aluminum
Signals ^①	Green LED for DC Vin1 OK and DC Vin2 OK	Green LED for DC Vin1 OK and DC Vin2 OK
MTBF	>800,000 hr	>800,000 hr
Dimensions (L)	121 mm	121 mm
Dimensions (W)	50 mm	50 mm
Dimensions (H)	122.1 mm	122.1 mm
Weight (kg)	0.375	0.515
Terminals	Finger safe—fixed	Finger safe—fixed
Wire size	AWG 12–10	AWG 12–10
Operating temperature	–40 °C to +80 °C	–40 °C to +80 °C
Storage temperature	–40 °C to +85 °C	–40 °C to +85 °C
Power de-rating—vertical mounting	> 50 °C de-rate power by 2.5% / °C	> 50 °C de-rate power by 2.5% / °C
Power de-rating—horizontal mounting	N/A	N/A
Operating humidity	< 95% RH, noncondensing	< 95% RH, noncondensing
Vibration	10 to 500 Hz, 0.35 mm acc. 30m/s ² , single amplitude (3 G max.) for 60 min. in each X, Y and Z directions, in accordance with IEC 60068-2-6	10 to 500 Hz, 0.35 mm acc. 30m/s ² , single amplitude (3 G max.) for 60 min. in each X, Y and Z directions, in accordance with IEC 60068-2-6
Pollution degree	2	2
Climatic class	3K3 according to EN 60721	3K3 according to EN 60721
Safety and Protection		
Safety class	Class 2 with ground connection	Class III with ground connection
Shock	30 G (300 m/S ²) in all directions according to IEC 60068-2-27	30 G (300 m/S ²) in all directions according to IEC 60068-2-27

Note

^① The LED will turn on when the Vin1 and Vin2 > 18 V ±5% (for 24 V system) or > 36 V ±5% (for 48 V system) and not more than 30 V (for 24 V system) or not more than 60 V (for 48 V system), the relay contacts will be closed. If Vin1 and Vin2 is under or over this range, the LED will be turned off.

PSG Series, continued

**Buffer Module
PSG480B24RM**

Input	
Nominal voltage	24 Vdc
DC input range	22.8–28.8 Vdc
Maximum voltage	35 Vdc
Current	Charging mode: <0.6 A Discharging mode: 20 A max.
Power (standby mode)	2.5 W average
Maximum signal (inhibit)	35 V / 10 mA
Max inrush current	< 20 A
Charging time	< 30s
Output	
Nominal voltage	24 Vdc typ.
DC adjustment range	Switch = "Fix 22V": Buffering starts if terminal voltage falls below 22 V Switch = "Vin-1V" (Factory Setting): Buffering starts if terminal voltage is decreased by >1 V
Maximum voltage	35 Vdc
Current	20 A max.
buffering time	250 ms min. at 24 V/20 A load, 5 s min. at 24 V/1 A load
Maximum signal	35 V / 10 mA
PARD (20MHz)	<200 mVpp
Galvanic isolation	
Input/ground	1.5 k Vac
Output/ground	1.5 k Vac
Signal/ground	1.5 k Vac
General/Physical Data	
Housing material	Aluminum
Signals	Green LED off: unit is discharged or Vin < 22 Vdc Green LED on: unit is fully charged Green LED blinking slowly: unit is charging Green LED blinking quickly: unit is discharging
MTBF	>800,000 hr
Parallel connection	Yes
Series connection	No
Dimensions (L)	121 mm
Dimensions (W)	70 mm
Dimensions (H)	120.1 mm
Weight (kg)	0.76
Terminals	Finger safe-fixed
Wire Size	Input / Output: AWG 12–10 Signal: AWG 24–10
Operating temperature	–25 °C to +75 °C
Storage temperature	–25 °C to +85 °C
Power de-rating—vertical mounting	>70 °C de-rate power by 5% / °C
Operating humidity	< 95% RH, noncondensing
Vibration	10 to 500 Hz, 0.35 mm acc. 30 m/s ² , single amplitude (3 G max.) for 60 min. in each X, Y and Z directions, in accordance with IEC 60068-2-6
Pollution degree	2
Safety and Protection	
Shock	30 G (300 m/S ²) in all directions according to IEC60068-2-27
Safety class	Class I with ground connection

6.1

Power Supplies

General-Purpose and Sensor Power Supplies

6

Power Derating Curves

Vertical Mounting Position PSG15E12SP

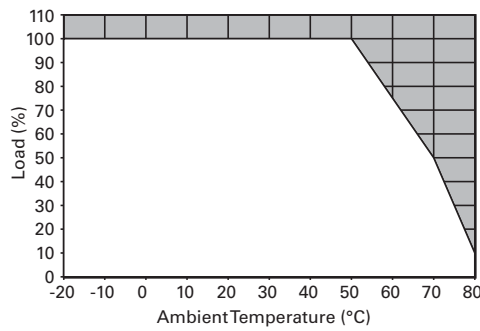

Vertical Mounting Position PSG60E

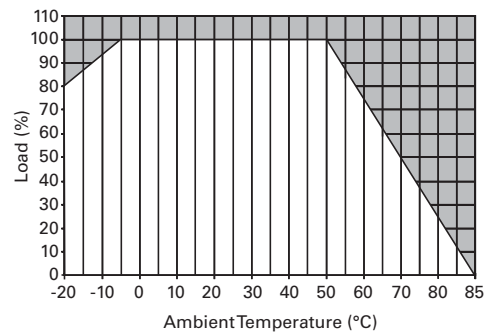

Vertical Mounting Position PSG30E12SP

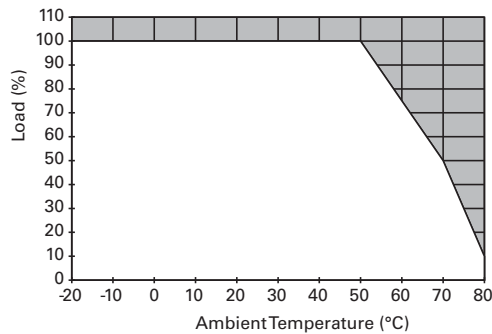

Vertical Mounting Position PSG60E24SP

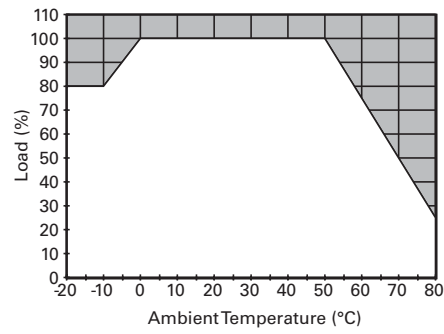

Vertical Mounting Position PSG60E12SM

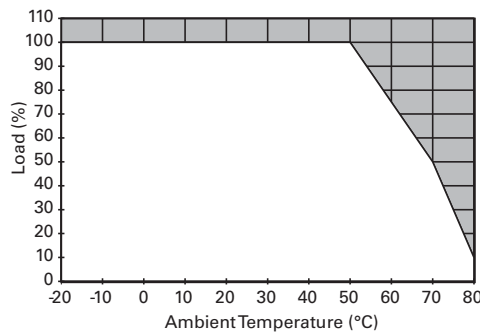

Vertical and Horizontal Mounting Position PSG60E24RM

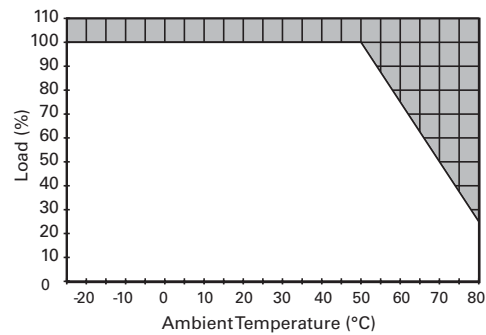

Vertical and Horizontal Mounting Position PSG100E12SM

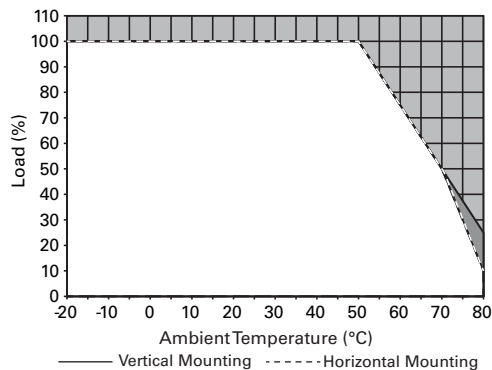

Vertical and Horizontal Mounting Position PSG60N24RP

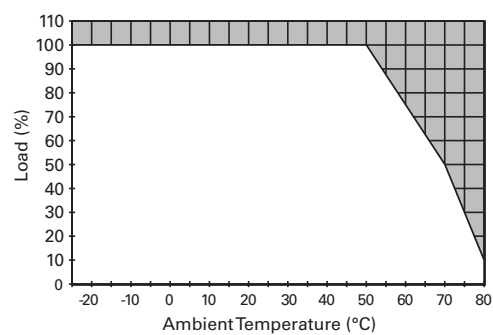

Vertical Mounting Position PSG120E

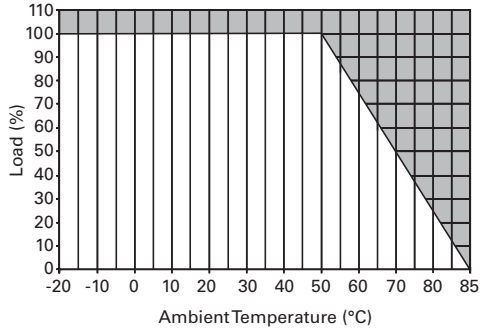

Vertical Mounting Position PSG480E

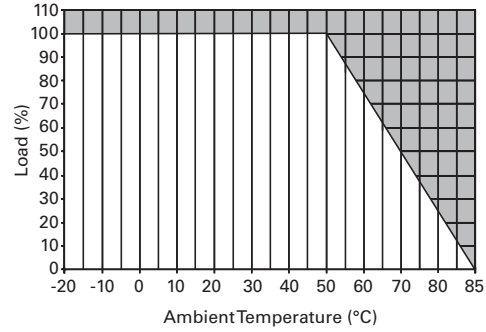

Vertical and Horizontal Mounting Position PSG120E24RM

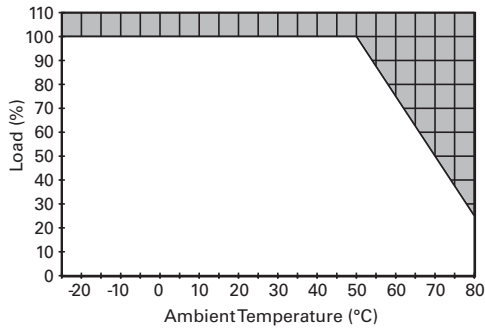

Vertical Mounting Position PSG480E24RM

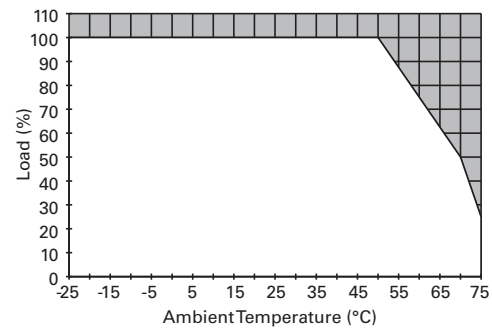

Vertical Mounting Position PSG240E

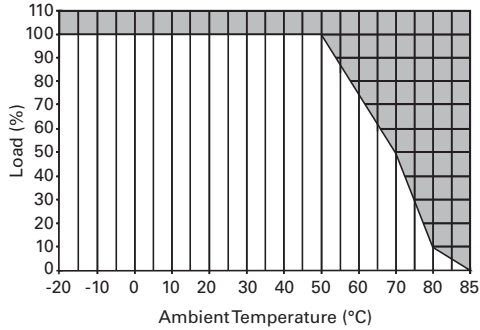

Vertical and Horizontal Mounting Position PSG60F24RM

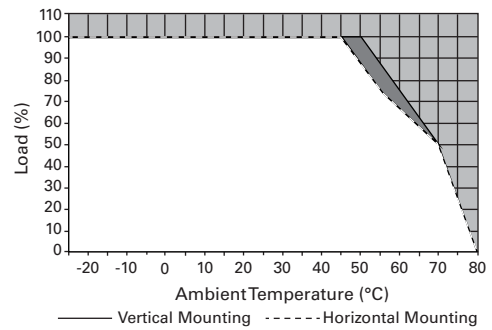

Vertical and Horizontal Mounting Position PSG240E24RM

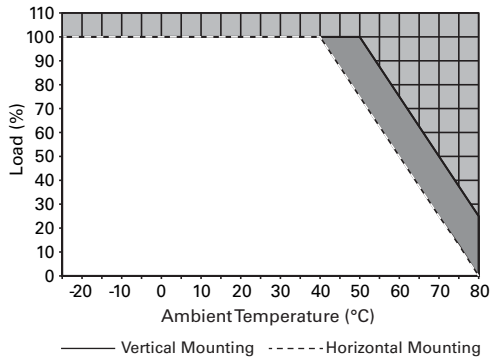

Vertical and Horizontal Mounting Position PSG120F24RM

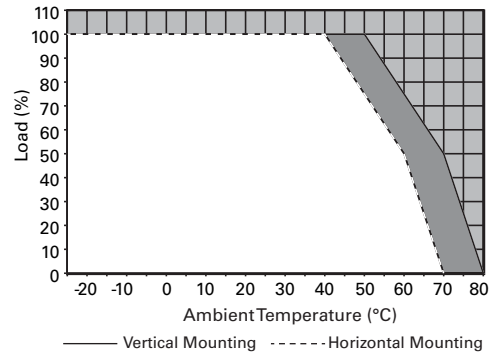

6.1

Power Supplies

General-Purpose and Sensor Power Supplies

6

Vertical and Horizontal Mounting Position PSG240F24RM

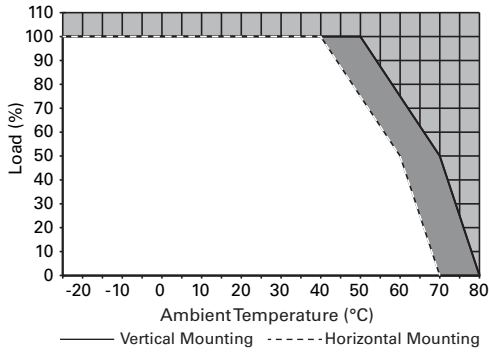

Vertical Mounting Position PSG480R24RM

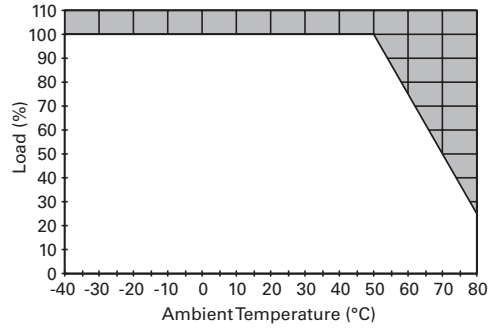

Vertical Mounting Position PSG480F24RM

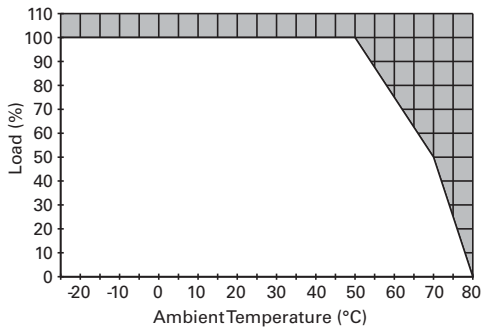

Vertical Mounting Position PSG960R24RM

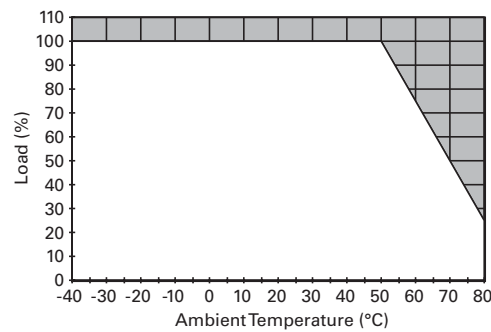

Vertical Mounting Position PSG960F24RM

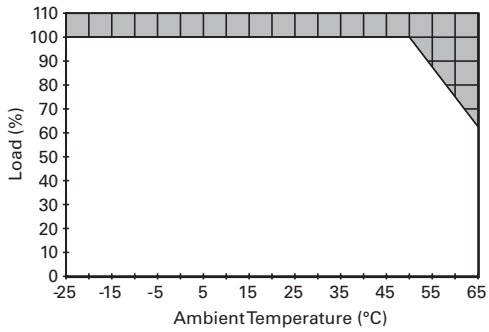

Vertical Mounting Position PSG480B24RM

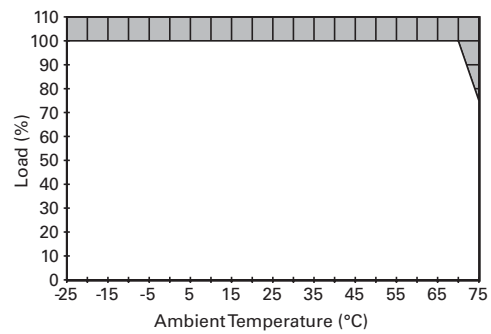

Dimensions

Approximate Dimensions in mm

Note: Dimensions are for reference only.

PSG15E12SP

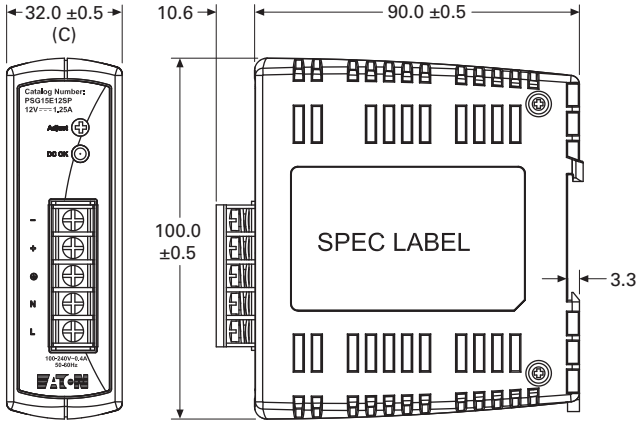

PSG60E12SM

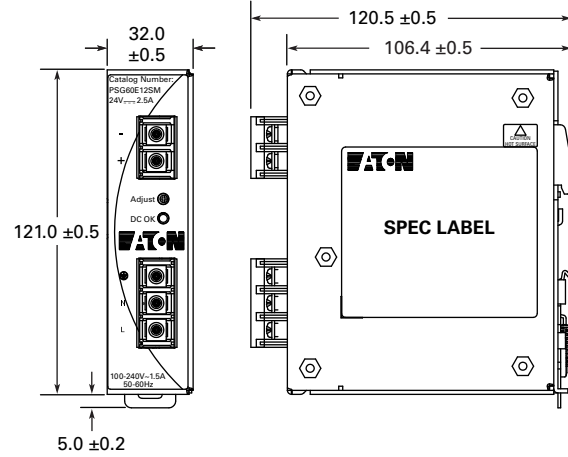

PSG30E12SP

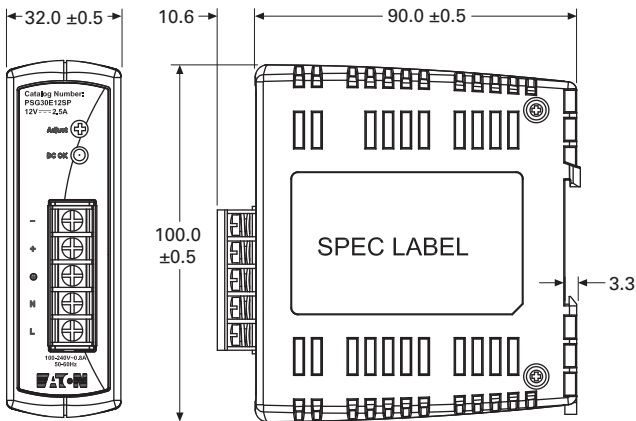

PSG100E12SM

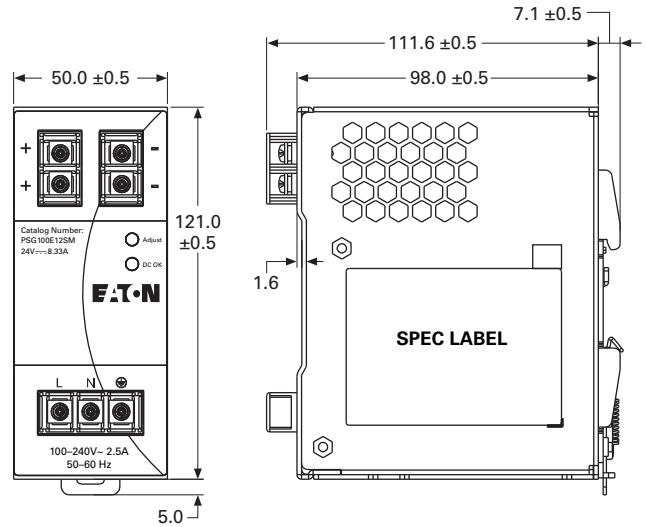

6.1

Power Supplies

General-Purpose and Sensor Power Supplies

Approximate Dimensions in mm

Note: Dimensions are for reference only.

PSG60E

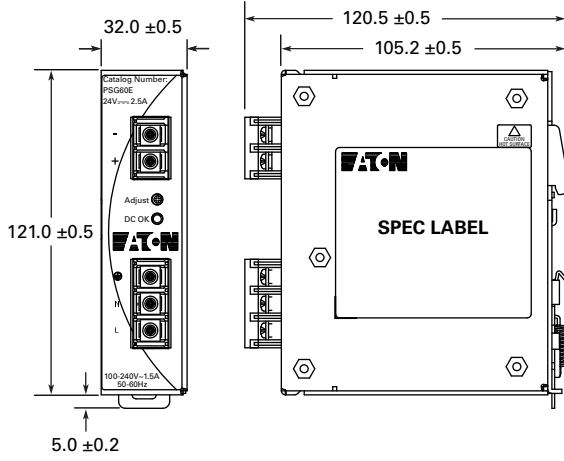

PSG60E24RM

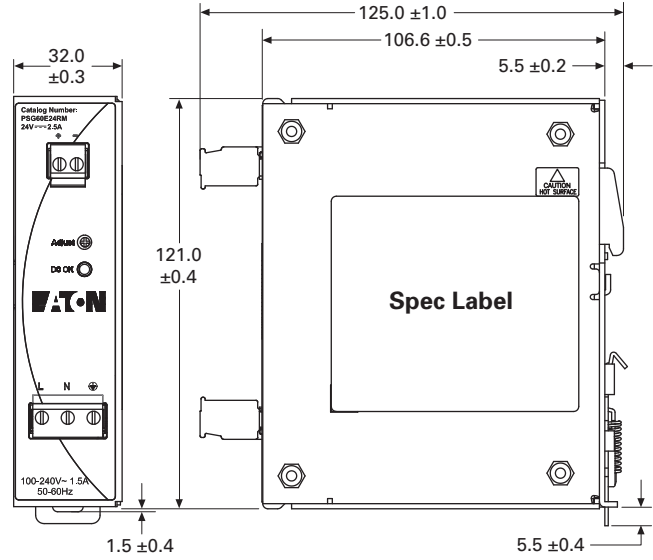

PSG60E24SP

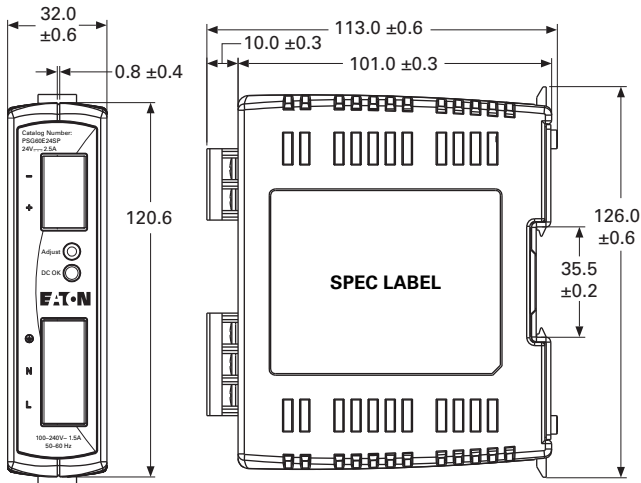

PSG60N24RP

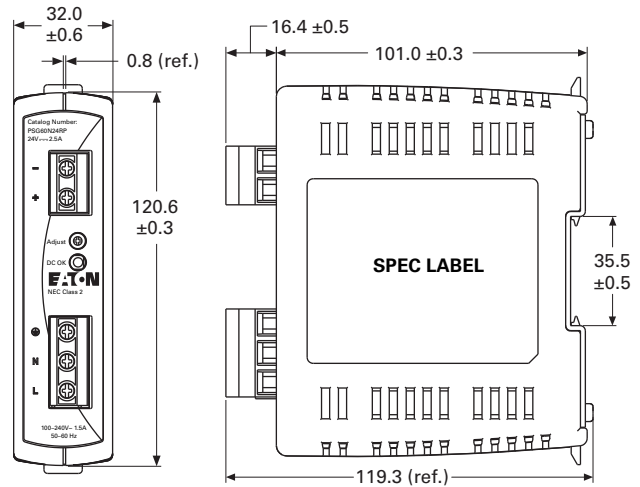

Approximate Dimensions in mm

Note: Dimensions are for reference only.

PSG120E

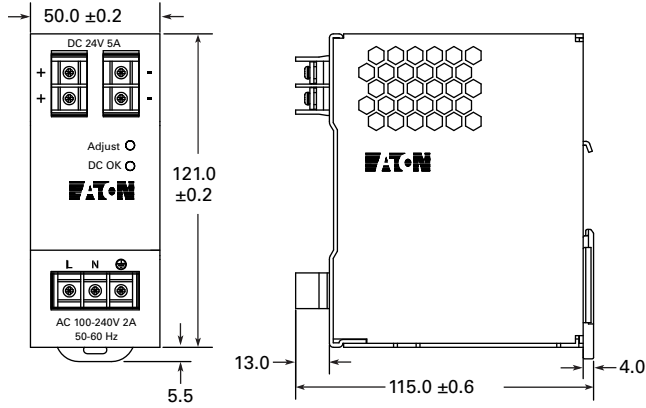

PSG240E

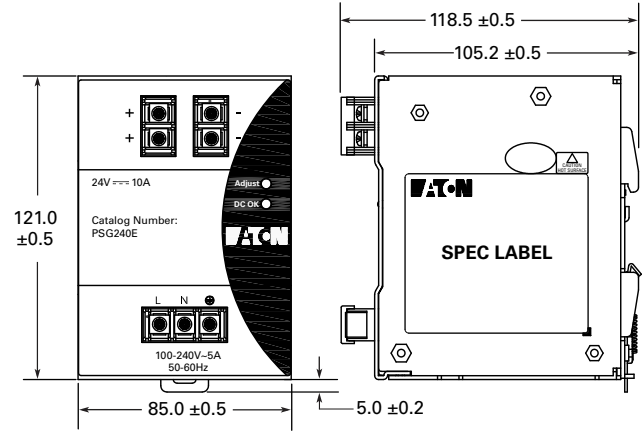

PSG120E24RM

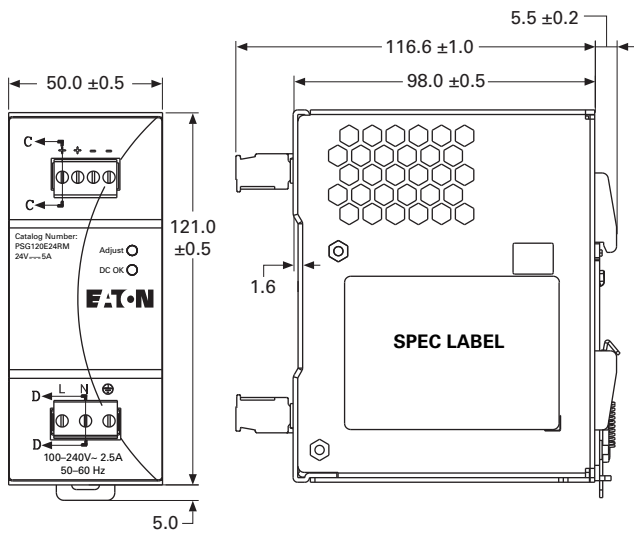

PSG240E24RM

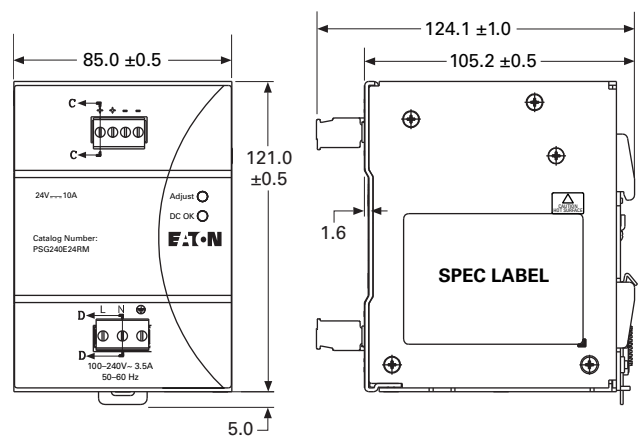

6.1

Power Supplies

General-Purpose and Sensor Power Supplies

Approximate Dimensions in mm

Note: Dimensions are for reference only.

6

PSG480E

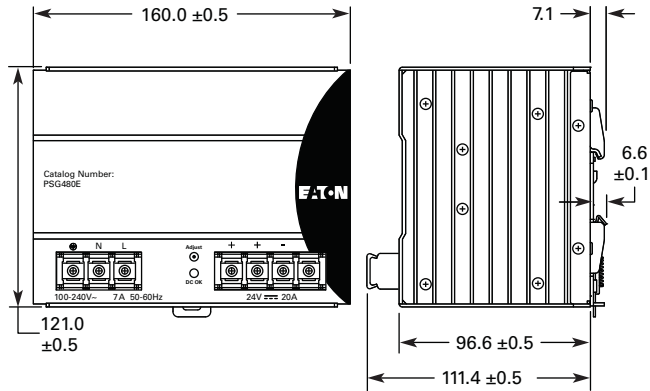

PSG60F24RM

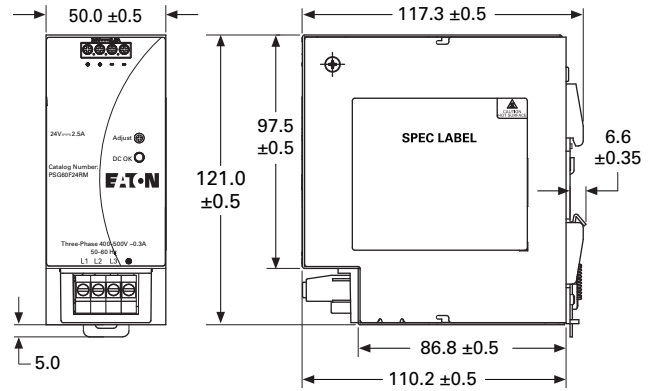

PSG480E24RM

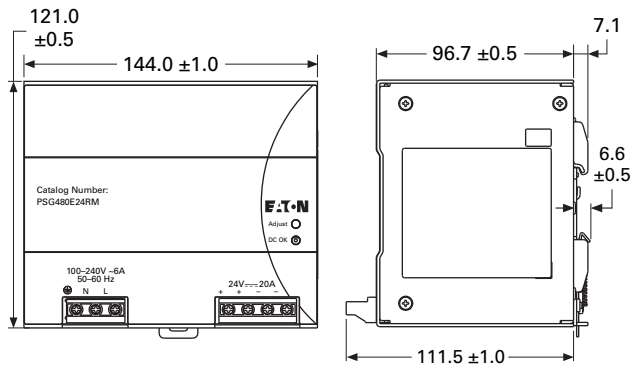

PSG120F24RM

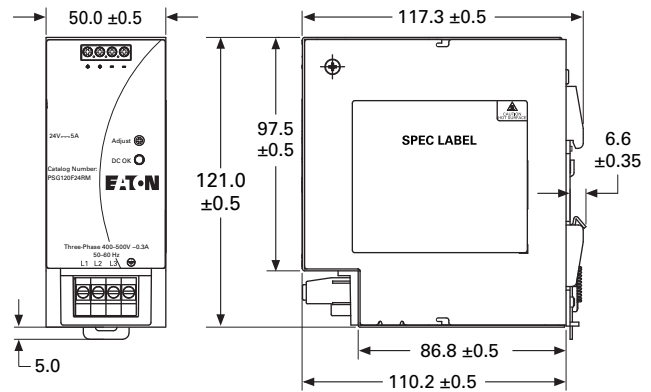

Approximate Dimensions in mm

Note: Dimensions are for reference only.

PSG240F24RM

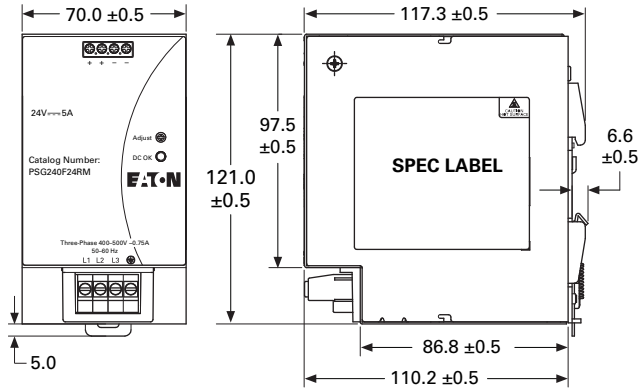

PSG960F24RM

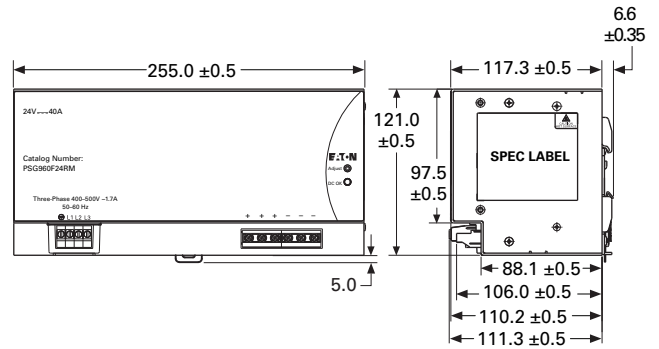

PSG480F24RM

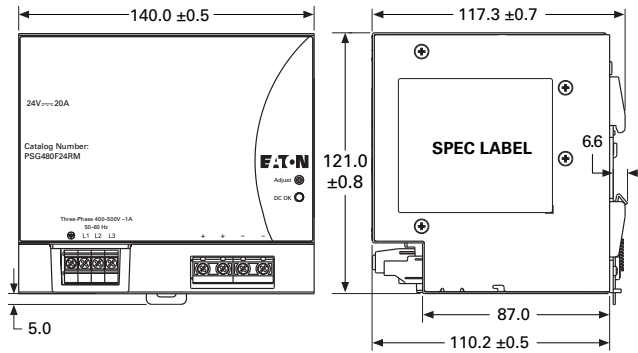

PSG480R24RM

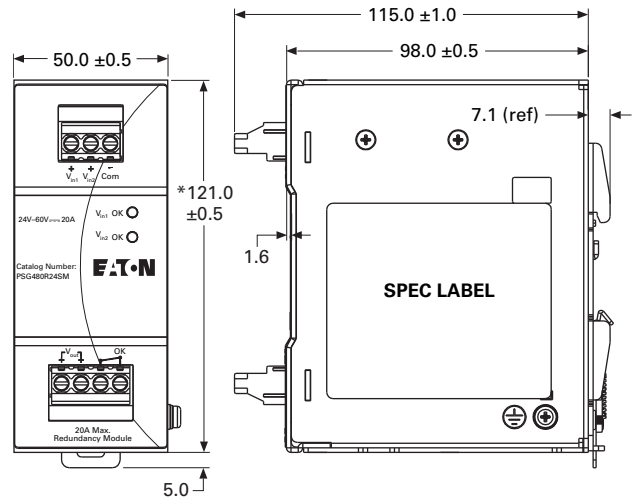

6.1

Power Supplies

General-Purpose and Sensor Power Supplies

Approximate Dimensions in mm

Note: Dimensions are for reference only.

PSG960R24RM

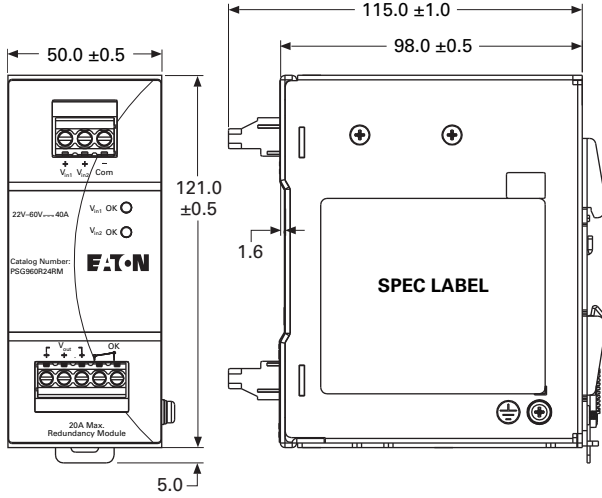

PSG480B24RM

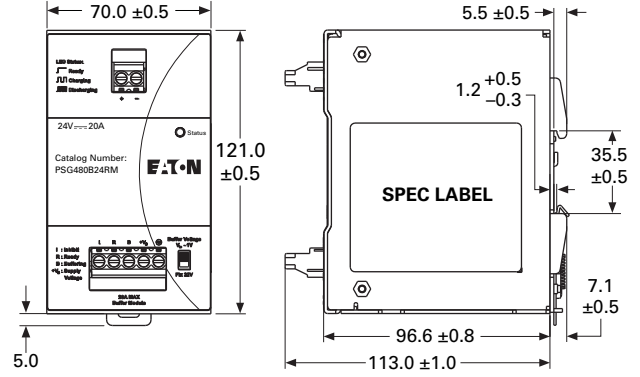

ELC Series



Contents

Description	Page
PSG Series	V7-T6-3
ELC Series	
Product Selection	V7-T6-24
Technical Data and Specifications	V7-T6-24
Dimensions	V7-T6-25
easyRelay Power Supply	V7-T6-26
Sensor Power Supply	V7-T6-30
PSS Series	V7-T6-33

ELC Series

Product Description

Eaton’s ELC power supplies are the perfect products for those applications requiring a very compact and low-cost source for 24 Vdc power. While these products were developed to be a perfect match for our Eaton Logic Controllers, they can be used in a variety of applications.

The lightweight, DIN rail mounted enclosures, wide input voltage range and robust screw terminals make these power supplies easy to install and use. They are available in 1 A and 2 A models.

Features, Benefits and Functions

- Universal input voltage: 85–264 Vac
- Compact size, with common depth and height across models allows for common panel depths and family consistency
- ELC styling provides maximum aesthetic appeal when used with Eaton Logic Controllers
- Front-mounted pressure plate screw terminals for a robust connection
- Removable finger-safe protective cover for terminals
- Power ON indication LED
- Integrated mounting hardware for panel mounting or DIN rail mounting

Standards and Certifications

- cULus listed
- CE marked
- RoHS compliant



Product Selection

ELC-PS01

ELC Series



Description	Catalog Number
24 watt, 1 amp power supply	ELC-PS01
48 watt, 2 amp power supply	ELC-PS02

6

Technical Data and Specifications

ELC Series

Capacity	ELC-PS01 24 W	ELC-PS02 48 W
Input		
Nominal voltage	100–240 Vac	100–240 Vac
Voltage range	85–264 Vac	85–264 Vac
Frequency	47–63 Hz	47–63 Hz
Output		
Nominal output voltage	24 Vdc ± 3%	24 Vdc ± 3%
Nominal current	1 A	2 A
Efficiency	78% to 87% typical at full load	78% to 87% typical at full load
Residual ripple/peak switching (20 MHz)	< 100 mV typical at full load	< 240 mV typical at full load
General/Physical Data		
Housing material	Plastic	Plastic
Dimensions (D)	60 mm	60 mm
Dimensions (W)	36.5 mm	55 mm
Dimensions (H)	90 mm	90 mm
Weight (g)	158	250
Operating temperature	0 °C to +55 °C	0 °C to +55 °C
Storage temperature	–25 °C to +70 °C	–25 °C to +70 °C
Operating humidity	50% to 95% RH, noncondensing	50% to 95% RH, noncondensing
Pollution degree	2	2
Approvals/Certifications		
	UL 508, CE, RoHS, EMC directive 89/336/EEC, low voltage directive 73/23/EEC	UL 508, CE, RoHS, EMC directive 89/336/EEC, low voltage directive 73/23/EEC
Safety and Protection		
Overload/short circuit protection	Auto recovery	Auto recovery

Dimensions

Approximate Dimensions in Inches (mm)

ELC-PS01 Power Supply

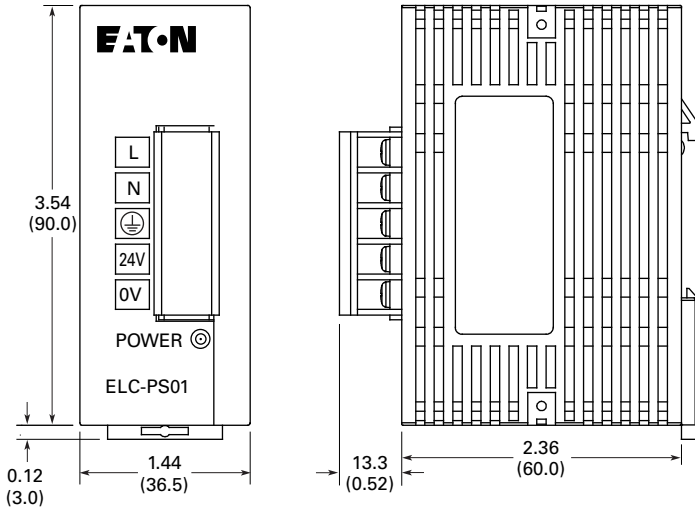

ELC-PS02 Power Supply

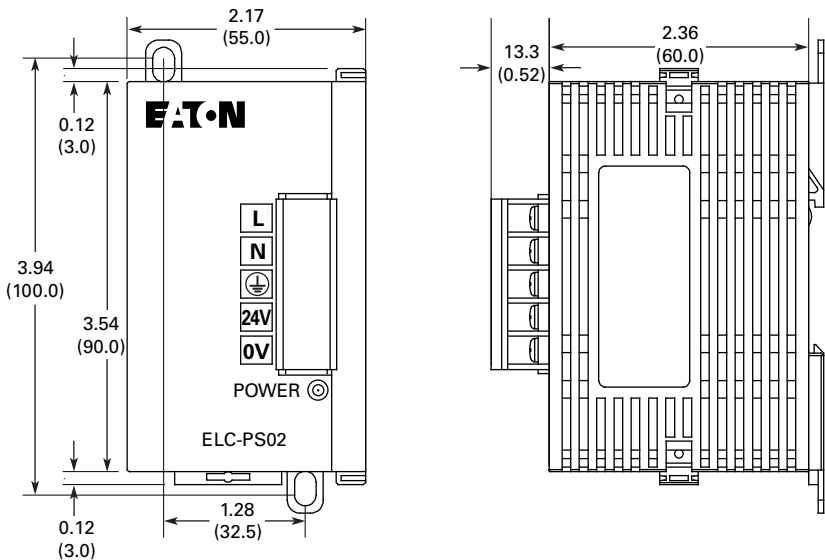

easyRelay Power Supply



Contents

Description	Page
PSG Series	V7-T6-3
ELC Series	V7-T6-23
easyRelay Power Supply	
Product Selection	V7-T6-27
Technical Data and Specifications	V7-T6-28
Dimensions	V7-T6-29
Sensor Power Supply	V7-T6-30
PSS Series	V7-T6-33

easyRelay Power Supply

Product Description

Eaton’s easyRelay power supplies are the perfect products for those applications requiring a low amperage 24 Vdc power source. While these products were developed to be a perfect match for our easyRelay products, they can be used in a variety of applications.

Features, Benefits and Functions

- Universal input voltage: 85–264 Vac, 50/60 Hz
- Wide operating temperature range (–25 °C to +55 °C)
- Power ON / diagnostics LED: continuous light on—fault-free operation; flashing LED—short circuit overload on voltage output
- Optional mounting hardware for panel mounting (EZB4-101-GF1) or standard DIN rail mounting
- Finger-safe, side-entry screw clamp terminals for clean wiring
- Primary switched-mode power supplies
- Output voltages can be connected in parallel to increase power output or for redundant operation to achieve greater system availability
- Safety extra low voltage (SELV to EN 55 022)
- Radio interference Class B to EN 55 011 and EN 55 022 for use in industrial and public networks

Standards and Certifications



- UL listed
- CSA certified
- CE marked
- RoHS compliant
- CSA Class I, Division 2 rated for groups A, B, C, D



Product Selection

easyRelay Power Supply Units

Rated input voltage 100–240 Vac, single-phase.

	Input Voltage Range	Rated Output Voltage	Output Voltage Setting Range	Rated Output Power	Rated Output Current	Catalog Number
EASY200-POW 	100–240 Vac	24 Vdc/12 Vdc	—	8 W	0.35 A / 20 mA	EASY200-POW
EASY400-POW 	100–240 Vac	24 Vdc	—	30 W	1.25 A	EASY400-POW
EASY500-POW 	100–240 Vac	24 Vdc	—	60 W	2.5 A	EASY500-POW
EASY600-POW 	100–240 Vac	24 Vdc	—	100 W	4.2 A	EASY600-POW

Technical Data and Specifications

easyRelay Series

Capacity	EASY200-POW 8 W	EASY400-POW 30 W	EASY500-POW 60 W	EASY600-POW 100 W
Input				
Nominal voltage	100–240 Vac	100–240 Vac	100–240 Vac	100–240 Vac
Voltage range	85–264 Vac	85–264 Vac	85–264 Vac	85–264 Vac
Frequency	47–63 Hz	47–63 Hz	47–63 Hz	47–63 Hz
Output				
24 Vdc				
Nominal output voltage	24 Vdc ± 3%	24 Vdc ± 3%	24 Vdc ± 3%	24 Vdc ± 3%
Nominal current	0.35 A	1.25 A	2.5 A	4.2 A
12 Vdc				
Nominal output voltage	12 Vdc	—	—	—
Nominal current	20 mA	—	—	—
General/Physical Data				
Housing material	Plastic	Plastic	Plastic	Plastic
Dimensions (D)	2.22 in (56.5 mm)	2.22 in (56.5 mm)	2.22 in (56.5 mm)	2.22 in (56.5 mm)
Dimensions (W)	1.40 in (35.5 mm)	2.81 in (71.5 mm)	2.81 in (71.5 mm)	4.23 in (107.5 mm)
Dimensions (H)	3.54 in (90 mm)	3.54 in (90 mm)	3.54 in (90 mm)	3.54 in (90 mm)
Operating temperature	–25 °C to +55 °C	–25 °C to +55 °C	–25 °C to +55 °C	–25 °C to +55 °C
Storage temperature	–40 °C to +70 °C	–40 °C to +70 °C	–40 °C to +70 °C	–40 °C to +70 °C
Pollution degree	2	2	2	2
Connection cables				
Solid	0.2–4.0 mm ² (AWG 22–12)	0.2–4.0 mm ² (AWG 22–12)	0.2–4.0 mm ² (AWG 22–12)	0.2–4.0 mm ² (AWG 22–12)
Flexible	0.2–2.5 mm ² (AWG 22–12)	0.2–2.5 mm ² (AWG 22–12)	0.2–2.5 mm ² (AWG 22–12)	0.2–2.5 mm ² (AWG 22–12)
Approvals/Certifications				
	UL, CE, RoHS, CSA, EN 50178m IEC/EN 60947	UL, CE, RoHS, CSA, EN 50178m IEC/EN 60947	UL, CE, RoHS, CSA, EN 50178m IEC/EN 60947	UL, CE, RoHS, CSA, EN 50178m IEC/EN 60947
Safety and Protection				
Overload/short circuit protection	Yes	Yes	Yes	Yes
Overcurrent limitation form	0.3 A	1.4 A	2.8 A	4.6 A
Degree of protection	IP20	IP20	IP20	IP20
RFI suppression	EN 55011, EN 55022 Class B, IEC 61000-6-1, 2, 3, 4	EN 55011, EN 55022 Class B, IEC 61000-6-1, 2, 3, 4	EN 55011, EN 55022 Class B, IEC 61000-6-1, 2, 3, 4	EN 55011, EN 55022 Class B, IEC 61000-6-1, 2, 3, 4
Potential isolation (prim./sec.)	Yes, SELV, (to EN 600950, VDE 805)	Yes, SELV, (to EN 600950, VDE 805)	Yes, SELV, (to EN 600950, VDE 805)	Yes, SELV, (to EN 600950, VDE 805)

Dimensions

Approximate Dimensions in Inches (mm)

EASY200-PO W, EASY400-POW and EASY500-POW Series

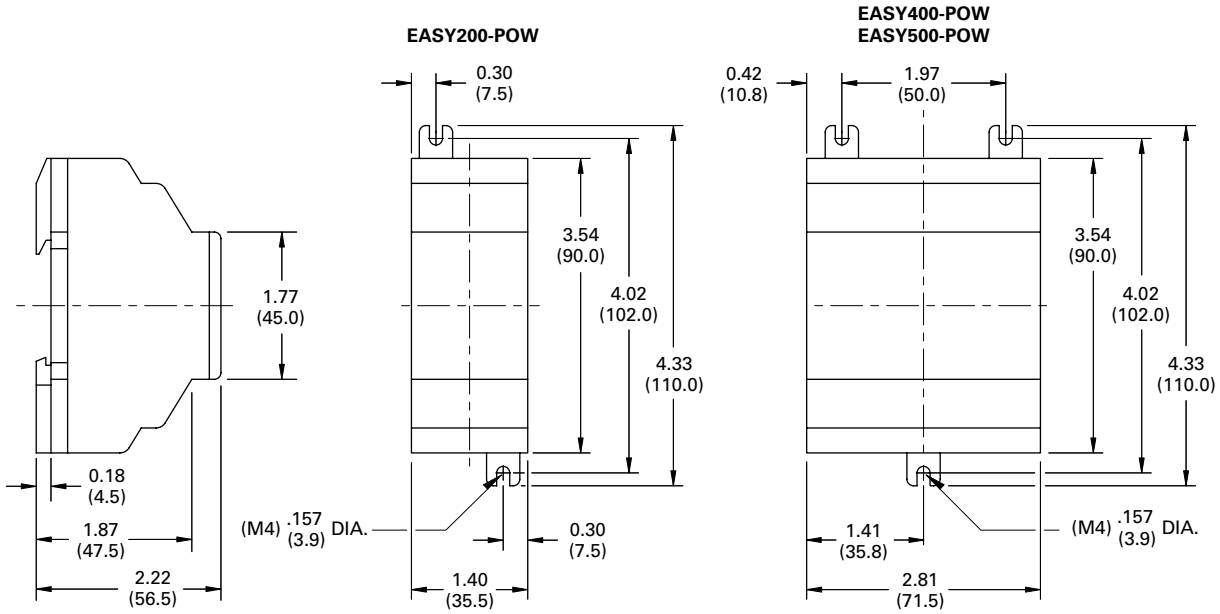

EASY600-POW Series

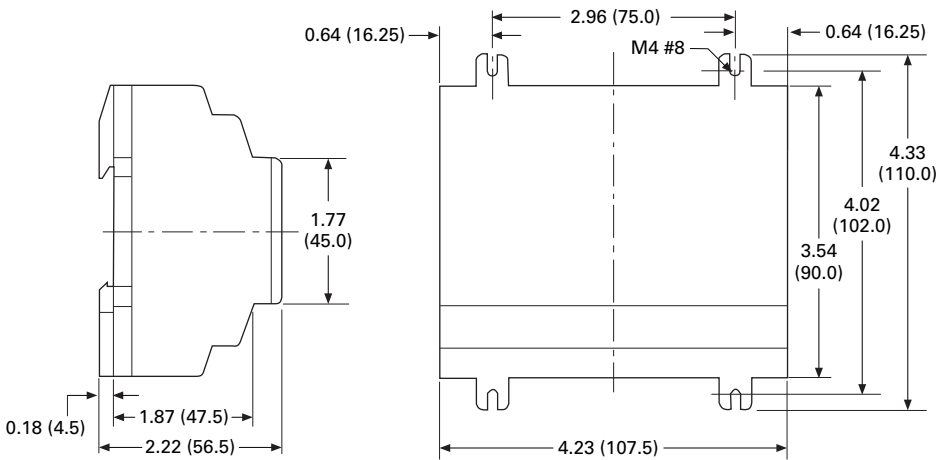

Sensor Power Supply



6

Sensor Power Supply

Product Description

Eaton’s sensor power supply was specially designed to be used with the 200 Series and E68 Series zero pressure accumulation systems, but is also suitable for use in a wide variety of applications. The unit delivers 100 W output at 27 Vdc and supports easy, Class II wiring. The power supply is a tamper-proof, rugged component easily mounted to a conveyor side-channel or support. Internal components are fully encapsulated in a strong die-cast housing to stand up to rugged handling, ensuring flawless performance in any material handling environment.

Features, Benefits and Functions

- Integrated AC junction box for one-step mounting and wiring without the need for additional accessories
- Built-in DC power health contact allows easy monitoring of power supply status
- Unitized design features a tamper-proof encapsulated construction to reduce the risk of damage associated with conventional open control-panel type construction
- Built-in slug-release input converts an AC or DC input to the appropriate DC signal for integration with the 200 Series and E68 Series zero pressure accumulation systems
- Dual output connection terminals to make it easy and convenient to locate the power supply at the center of the cable run
- Power switch protected against accidental operation
- Power in and out indicators show status at a glance
- Conduit entry box for NEC compliance
- Simple mounting with two 1/4-inch bolts
- Rugged die-cast housing
- Fully encapsulated electronics

Standards and Certifications

- UL listed
- CSA approved



Contents

Description

	<i>Page</i>
PSG Series	V7-T6-3
ELC Series	V7-T6-23
easyRelay Power Supply	V7-T6-26
Sensor Power Supply	
Product Selection	V7-T6-31
Technical Data and Specifications	V7-T6-31
Wiring Diagram	V7-T6-32
Dimensions	V7-T6-32
PSS Series	V7-T6-33

Product Selection

PS256 A

Sensor Power Supply



Output	Slug Input	Type	Slug Output	Catalog Number
Operating Voltage 105–132 Vac				
27 Vdc, 100 W; short circuit, overload and overvoltage protection (cycle power to reset)	15–132 Vac/Vdc 3 mA minimum	Standard For use with 200 Series and E68 systems	Sinking or sourcing, switch selectable; 80 mA maximum; short circuit protection for loads less than 32 Vac or Vdc (auto reset)	PS256 A-01B1 ②
	15–132 Vac/Vdc 3 mA minimum	High current slug For use with solenoid valve systems requiring full current slug signals	Sinking only; 100 W output; short circuit, overload and overvoltage protection (cycle power to reset) ①	PS256 A-04B1 ②

Technical Data and Specifications

Sensor Power Supply

Description	PS256 A-01B1	PS256 A-04B1
Input power	144 W, maximum inrush 30 A from cold start	144 W, maximum inrush 30 A from cold start
Input voltage	105–132 Vac	105–132 Vac
Input current (full load)	105 Vac–1.92 A, 115 Vac–1.65 A, 132 Vac–1.5 A	105 Vac–1.92 A, 115 Vac–1.65 A, 132 Vac–1.5 A
Output power	100 W	100 W
Output voltage	27 Vdc	27 Vdc
Output protection	Short circuit, overload and overvoltage protection (cycle power to reset), diode protected	Short circuit, overload and overvoltage protection (cycle power to reset), diode protected
Regulation	± 3%	± 3%
Slug input	15–132 Vac/Vdc	15–132 Vac/Vdc
Slug output	Sinking or sourcing, switch selectable; 80 mA maximum; short circuit protection for loads less than 32 Vac or Vdc (auto reset)	Sinking only; 100 W output; short circuit, overload and overvoltage protection (cycle power to reset) ①
Indicators	Red LED: AC In; Green LED: DC Out	Red LED: AC In; Green LED: DC Out
DC fail indication output	NO contact, solid-state relay, 80 mA maximum	NO contact, solid-state relay, 80 mA maximum
Temperature range	–13 ° to 131 °F (–25 ° to 55 °C)	–13 ° to 131 °F (–25 ° to 55 °C)
Vibration	20 g	20 g
Enclosure material	Die-cast aluminum	Die-cast aluminum
Enclosure rating	NEMA 1	NEMA 1
Connections	Main output/slug output: Two three-position finger protected barrier strips; AC line input, DC fail indication and slug input: 8-position screw terminal strip inside conduit entry box	Main output/slug output: Two three-position finger protected barrier strips; AC line input, DC fail indication and slug input: 8-position screw terminal strip inside conduit entry box

Notes

- ① Total output power of supply is 100 W. Total supply output power (100 W) = main output power + slug output power.
 ② Stocked product, typical order quantities guaranteed in stock.

6.1

Power Supplies

General-Purpose and Sensor Power Supplies

Wiring Diagram

Sensor Power Supply

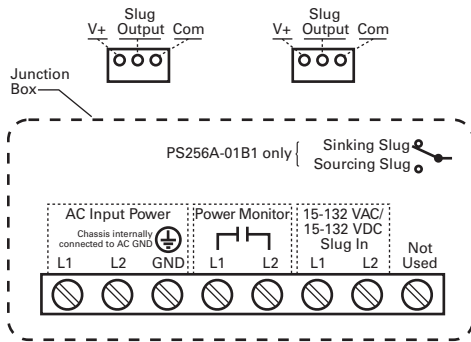

Dimensions

Approximate Dimensions in Inches (mm)

Sensor Power Supply

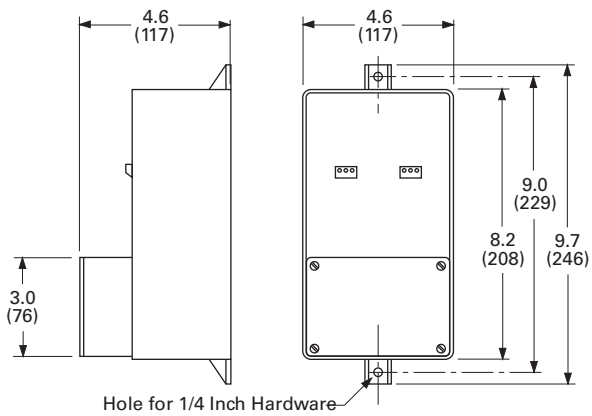

PSS Series



Contents

<i>Description</i>	<i>Page</i>
PSG Series	V7-T6-3
ELC Series	V7-T6-23
easyRelay Power Supply	V7-T6-26
Sensor Power Supply	V7-T6-30
PSS Series	
Catalog Number Selection	V7-T6-34
Product Selection	V7-T6-34
Technical Data and Specifications	V7-T6-35

PSS Series

Product Description

Eaton’s PSS Series of power supplies is designed to work in a variety of applications. They also work in most control applications that require 24 Vdc. All of the PSS power supplies are designed to provide the highest “outrush” current in the industry for units of their size.

Application Description

The PSS line of power supplies is specifically designed to work with the S801 and S811 solid-state reduced voltage starters. They can also serve in a variety of other applications, including support of sensors, operator interfaces, PLCs, communication networks, heaters and lights, and in many other industrial applications where 24 Vdc power supplies are required.

Features

- High current outrush capability in all units
- Semiconductor F47 approved
- Long ride-through capability designed in
- Wide operating temperature range
- Multiple 24 Vdc terminals for easy wiring
- Removable terminal connections
- IP20 fingerproof design

Benefits

- 24 Vdc control enhances personnel and equipment safety
- IP20 design improves personnel safety
- Removable terminal connectors make installation and repair quick and easy
- High current outrush capability allows use of smaller power supplies in many applications and ensures stable output during high power demand cycles
- Due to long ride-through time, the power supply can maintain the control power system during brownout and blackout conditions

Standards and Certifications

- cCSAus
- 

6.1

Power Supplies

General-Purpose and Sensor Power Supplies

Catalog Number Selection

PSS Series Power Supply

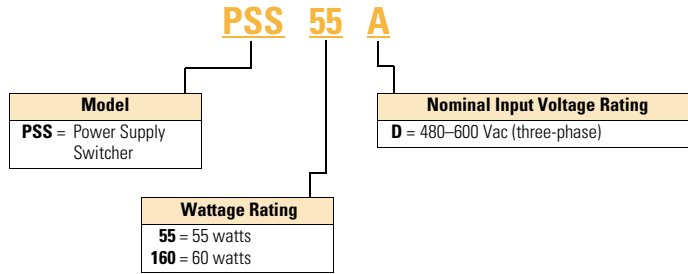

6

Product Selection

PSS55D



PSS Series Power Supply

Steady-State Current (Amps)	Steady-State Wattage	Input Voltage	Catalog Number
2.3	55 W	480-600	PSS55D
6.7	160 W	480-600	PSS160D

Technical Data and Specifications**PSS Series, PSS10E–PSS55D**

Capacity	PSS55D 55 W	PSS160D 160 W
Input		
Voltage	480–600 Vac three-phase	480–600 Vac three-phase
Input current (rms)	0.07 A/phase	0.66 A/phase
Frequency	47–63 Hz	47–63 Hz
Voltage range	± 10%	± 10%
Inrush current	15 A	5.9 A
Overvoltage	Varistor	Varistor
Internal input fuse	(3)KTK-R-3/4, 600 V	(3)KTK-R-3/4, 600 V
External fusing	Not required	Not required
Output		
Voltage nominal	24 Vdc	24 Vdc
Voltage regulation	± 3.5%	± 0.5%
Current nominal	2.3 A	6.7 A
Voltage adj. range	None	None
Current surge	10 A	20 A
Current surge time	180 ms	1 sec
Hold up time	30 ms	30 ms
Max. load capacitance	10,000 µF	10,000 µF
Switching frequency	61 kHz	61 kHz
Efficiency at max. load	85%	88%
Output ripple	± 1%	± 1%
Protection		
Short circuit	Auto restart	Auto restart
Overvoltage	No	No
Undervoltage	No	No
Overtemperature	None. Software in micro controller	None. Software in micro controller
Overcurrent	10 A typical 24 V for >300 ms	13 A typical 24 V for >1 s
Galvanic Isolation		
Input to output	4 kV	4 kV
Input/output to rail	4 kV	4 kV
Input to ground	2.0 kV	2.0 kV
Output to ground	250 V	250 V
Special Features		
Cooling	Convection	Convection
Load sharing	Maximum 5 units	Maximum 5 units
Redundancy	Maximum 2 units	Maximum 2 units
Analog outputs	None	None
Fault relay	Form C, 12 A at 125 Vac / 24 Vdc	Form C, 12 A at 125 Vac / 24 Vdc

6.1

Power Supplies

General-Purpose and Sensor Power Supplies

PSS Series, PSS10E–PSS55D, continued

Capacity	PSS55D 55 W	PSS160D 160 W
Wire Size		
Input	20–14 AWG	20–14 AWG
Output	20–14 AWG	20–14 AWG
I/O	None	None
Indications		
Indicators	Green LED (DC on)	Green LED (DC on)
Physical Data		
Dimensions		
Length x Width x Depth in Inches (mm)	2.32 x 6.19 x 6.00 (59 x 157 x 154)	5.44 x 2.5 x 6.68 (138 x 63 x 170)
Weight (kg)	2.45 (1.1)	2.6 (1.18)
Mounting and recommended clearance	TS35 rail with optional PSSDIN Kit or chassis; leave 4 in. (10 cm) free space on venting sides.	TS35 rail with optional PSSDIN Kit or chassis; leave 4 in. (10 cm) free space on venting sides.
Environmental Performance		
Storage temperature	–40 to +85 °C	–40 to +85 °C
Operating temperature	–25 to +50 °C	–25 to +50 °C
Storage humidity	5 to 95%	5 to 95%
Operating humidity	20 to 85% noncondensing	20 to 85% noncondensing
Approvals/Certifications		
	cCSAus	cCSAus

Types MTE and MTK



7.1 Transformers

Standards and Certifications	V7-T7-2
Catalog Number Selection	V7-T7-3
Type MTE	V7-T7-4
Type MTK	V7-T7-13
CE Marked	V7-T7-18
Type AP.	V7-T7-25



CE Marked



Type AP



Industrial Control Transformers



Contents

Description	Page
Transformers	
Type MTE	V7-T7-4
Type MTK	V7-T7-13
CE Marked	V7-T7-18
Type AP	V7-T7-25

Standards and Certifications

Eaton dry-type distribution transformers are approved, listed, recognized or may comply with the following standards.

Engineering Standards

Catalog Product Name	UL Standard ①	UL/cUL File Number	UL Listed Control Number	cUL Energy Efficiency File Number	CSA File Number	Insulation System Temp/°C	kVA Single-Phase	kVA Three-Phase	Applicable IEC Standard
Industrial Control Transformer									
MTE	5085	E46323	702X	—	—	105	0.025–1.5	N/A	61558
MTK	5085	E46323	702X	—	—	180	0.05–5	N/A	61558
Encapsulated Transformer									
AP	5085	E10156	591H	—	—	180	3–10	N/A	61558
AP	1561	E78389	591H	—	—	180	15	N/A	61558
EP	5085	E10156	591H	—	LR60545	180	0.05–10	N/A	61558
EP	1561	E78389	591H	EV157 ②	LR60545 ③	180	15–50	N/A	61558 ④ / 726 ⑤
EPT	5085	E10156	591H	—	LR60545	180	N/A	3–9	61558 ⑥ / 726 ⑦
EPT	1561	E78389	591H	EV157 ⑧	LR60545 ⑨	180	N/A	15–75	726
MPC	1062	E53449	591H	—	LR60546	180	3–25	15–30	—
Ventilated Transformer									
DS-3	1561	E78389	591H	—	—	220	15–167	N/A	60726
DT-3	1561	E78389	591H	—	—	220	N/A	15–750	60726
KT	1561	E78389	591H	—	—	220	N/A	9–500	N/A

Notes

- ① UL 5085 replaces UL 506.
- ② Applies to 25–50 kVA.
- ③ Applies to 25 kVA.
- ④ Applies to 15–25 kVA.
- ⑤ Applies to 37.5 kVA.
- ⑥ Applies to 3 kVA.
- ⑦ Applies to 5–9 kVA.
- ⑧ Applies to 30–75 kVA.
- ⑨ Applies to 30 kVA.

In addition to the above standards, Eaton dry-type distribution transformers are also manufactured in compliance with the applicable standards listed below.

Not all of the following standards apply to every transformer.

- NEC:** National Electrical Code®
- NEMA ST-1:** Specialty Transformers (C89.1) (control transformers).
- NEMA ST-20:** General-Purpose Transformers.
- NEMA 250:** Enclosures for Electrical Equipment (1000 volts maximum).
- IEEE C57.12.01:** General Requirements for Dry-Type Distribution and Power Transformers (including those with solid-cast and/or resin-encapsulated windings).

ANSI C57.12.70: Terminal Markings and Connections for Distribution and Power Transformers.

ANSI C57.12.91: Standard Test Code for Dry-Type Distribution and Power Transformers.

CSA C22 No. 47-M90: Air-Cooled Transformers (Dry-Type).

CSA C9-M1981: Dry-Type Transformers.

CSA C22.2 No. 66: Specialty Transformers.

CSA 802-94: Maximum Losses for Distribution, Power and Dry-Type Transformers.

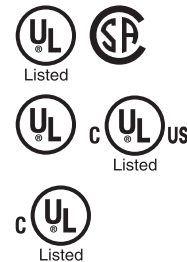

Catalog Number Selection

Industrial Control Transformers, CE Marked Control Transformers—Example: CE0250E2FCE ①

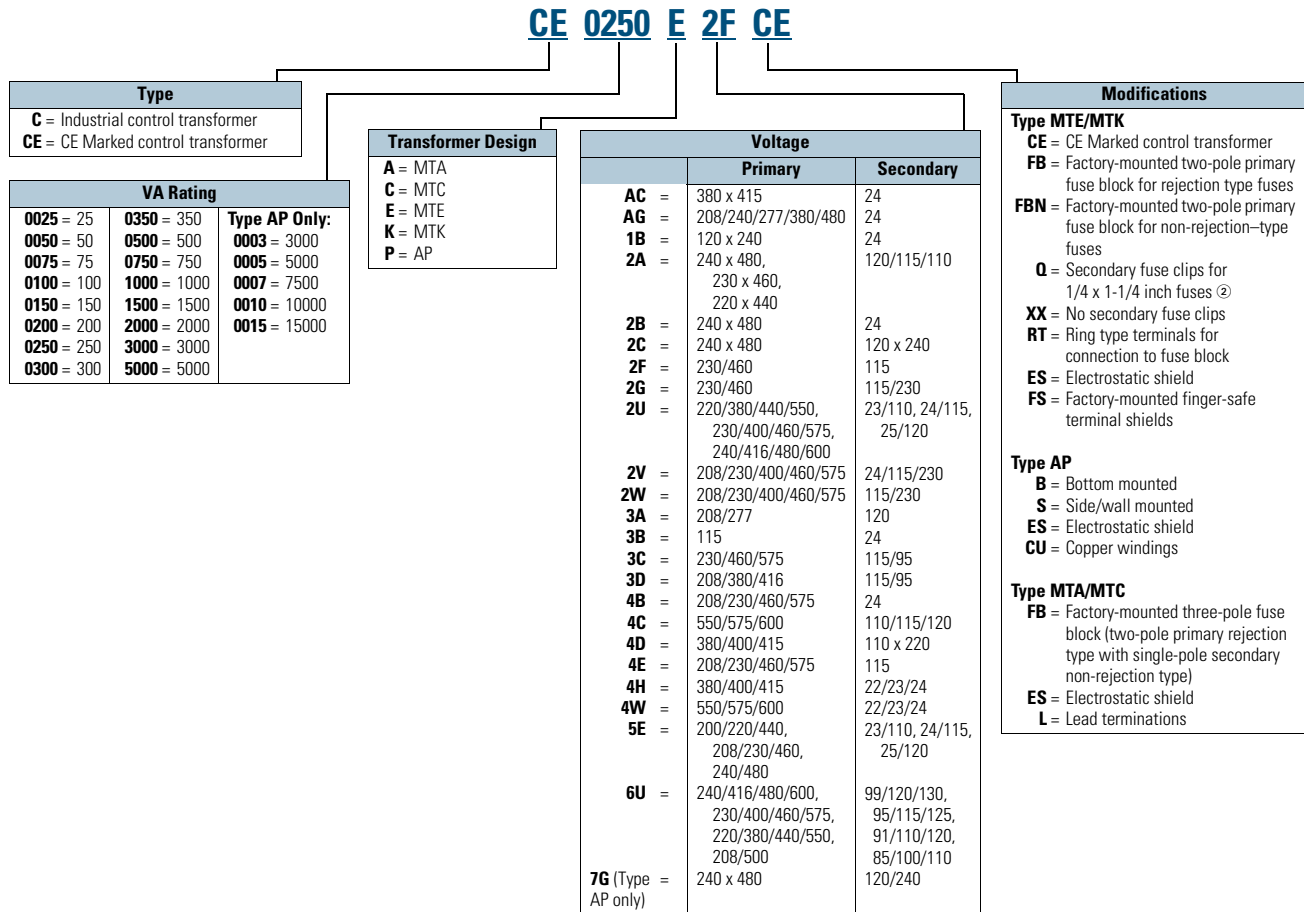

Notes

① For Eaton's dry-type transformers catalog number selection, see Volume 2, CA08100003E.

② Fuse clip covers not available with this option.

Contact your local Eaton sales office for voltage combinations not shown. Use table for catalog number breakdown only. Do not use to create catalog numbers because all combinations may not be valid.

Type MTE Transformer



Contents

Description	Page
Type MTE	
Product Selection	V7-T7-5
Accessories	V7-T7-10
Technical Data and Specifications	V7-T7-10
Wiring Diagrams	V7-T7-11
Type MTK	V7-T7-13
CE Marked	V7-T7-18
Type AP	V7-T7-25

Type MTE

Product Description

Note: The following pages provide listings for most standard transformer ratings and styles. For other ratings or styles not shown, or for special enclosure types (including stainless steel), refer to Eaton.

- Epoxy-encapsulated coils

Application Description

Transformers provide stepped-down voltages to machine tool control devices, enabling control circuits to be isolated from all power and lighting circuits. This allows the use of grounded or ungrounded circuits that are independent of the power or lighting grounds; thus, greater safety is afforded the operator. The control transformer line is particularly adaptable on applications where compact construction is demanded.

Note: The MTG “open core-coil design” has been superseded by the epoxy-encapsulated core-coil design MTE with no change to dimensions or functionality.

Features, Benefits and Functions

- Epoxy encapsulated
- Laminations of high-quality silicon steel to minimize core losses and optimize performance
- Copper magnet wire for high-quality, efficient operation
- Secondary fuse clips where applicable
- Optional primary fusing
- Molded in terminals
- 50/60 Hz operation
- 130°C insulation system standard
- Performance meets/exceeds requirements of ANSI/NEMA ST-1
- Regulation exceeds ANSI/NEMA requirements for all ratings
- 25–1500 VA ratings
- Molded-in terminals for maximum durability

Standards and Certifications

- UL listed
- cUL listed
- RoHS compliant



Industry Standards

All Eaton dry-type distribution and control transformers are built and tested in accordance with applicable NEMA, ANSI and IEEE Standards. All 600 volt class transformers are UL listed unless otherwise noted.

Catalog Number Selection

Please refer to **Page V7-T7-3**.

Product Selection

Additional Product Selection information is available in Volume 2, **CA08100003E**.

Type MTE

Primary: 240 x 480, 230 x 460, 220 x 440 with Jumpers
Secondary: 120/115/110 with Fuse Clips for
13/32 x 1-1/2 Fuses

VA	Wiring Diagram ①	Weight Lbs (kg)	Style Number
25	1	1.7 (0.8)	C0025E2A ②
50	1	2.6 (1.2)	C0050E2A ②
75	1	3.5 (1.6)	C0075E2A ②
100	1	4.2 (1.9)	C0100E2A ②
150	1	6.7 (3.0)	C0150E2A
200	1	8.5 (3.9)	C0200E2A
250	1	10.0 (4.5)	C0250E2A
300	1	11.3 (5.1)	C0300E2A
350	1	13.6 (6.2)	C0350E2A
500	1	19.2 (8.7)	C0500E2A
750	1	28.1 (12.8)	C0750E2A
1000	1	29.5 (13.4)	C1000E2A
1500	1	40.0 (18.1)	C1500E2A

Primary: 240 x 480 with Jumpers
Secondary: 24 with Fuse Clips for 13/32 x 1-1/2 Fuses
(through 500 VA)

VA	Wiring Diagram ①	Weight Lbs (kg)	Style Number
50	2	2.7 (1.2)	C0050E2B ②
75	2	3.5 (1.6)	C0075E2B ②
100	2	4.2 (1.9)	C0100E2B ②
150	2	6.7 (3.0)	C0150E2B
200	2	8.5 (3.9)	C0200E2B
250	2	10.1 (4.6)	C0250E2B
300	2	11.4 (5.2)	C0300E2B
350	2	13.4 (6.1)	C0350E2B
500	2	17.5 (7.9)	C0500E2B
750	2	28.1 (12.8)	C0750E2B

Primary: 120 X 240 with Jumpers
Secondary: 24 with Fuse Clips for 13/32 x 1-1/2 Fuses

VA	Wiring Diagram ①	Weight Lbs (kg)	Style Number
50	3	2.6 (1.2)	C0050E1B ②
75	3	3.6 (1.6)	C0075E1B ②
100	3	4.4 (2.0)	C0100E1B ②
150	3	6.7 (3.0)	C0150E1B
200	3	8.3 (3.8)	C0200E1B
250	3	10.1 (4.6)	C0250E1B
300	3	11.2 (5.1)	C0300E1B
350	3	13.2 (6.0)	C0350E1B
500	3	17.5 (7.9)	C0500E1B

Primary: 208/277
Secondary: 120 with Fuse Clips for 13/32 x 1-1/2 Fuses

VA	Wiring Diagram ①	Weight Lbs (kg)	Style Number
50	4	2.9 (1.3)	C0050E3A ②
75	4	3.8 (1.7)	C0075E3A ②
100	4	4.5 (2.0)	C0100E3A ②
150	4	6.9 (3.1)	C0150E3A
200	4	8.7 (3.9)	C0200E3A
250	4	10.2 (4.6)	C0250E3A
300	4	11.4 (5.2)	C0300E3A
350	4	13.7 (6.2)	C0350E3A
500	4	17.2 (7.8)	C0500E3A
750	4	25.7 (11.7)	C0750E3A

Notes

- ① See Page V7-T7-11 for wiring diagrams.
 ② 105°C insulation system.

7.1

Industrial Control Transformers

Transformers

7

Primary: 240 x 480 with Jumpers
Secondary: 120 x 240 with Jumpers,
Secondary Fuse Clips Not Applicable

VA	Wiring Diagram ①	Weight Lbs (kg)	Style Number
50	11	2.6 (1.2)	C0050E2CXX ②
75	11	3.5 (1.6)	C0075E2CXX ②
100	11	4.2 (1.9)	C0100E2CXX ②
150	11	6.7 (3.1)	C0150E2CXX
200	11	8.5 (3.9)	C0200E2CXX
250	11	10.0 (4.6)	C0250E2CXX
300	11	11.8 (5.4)	C0300E2CXX
350	11	13.6 (6.2)	C0350E2CXX
500	11	17.5 (8.0)	C0500E2CXX
750	11	26.4 (12.0)	C0750E2CXX

Primary: 550/575/600
Secondary: 110/115/120 with for 13/32 x 1-1/2 Fuses

VA	Wiring Diagram ①	Weight Lbs (kg)	Style Number
50	10	2.7 (1.2)	C0050E4C ②
75	10	3.6 (1.6)	C0075E4C ②
100	10	4.2 (1.9)	C0100E4C ②
150	10	6.8 (3.1)	C0150E4C
200	10	8.4 (3.8)	C0200E4C
250	10	10.0 (4.6)	C0250E4C
300	10	11.3 (5.1)	C0300E4C
350	10	13.6 (6.2)	C0350E4C
500	10	16.8 (7.6)	C0500E4C
750	10	25.7 (11.7)	C0750E4C

Primary: 380/400/415
Secondary: 22/23/24 with Fuse Clips for 13/32 x 1-1/2 Fuses

VA	Wiring Diagram ①	Weight Lbs (kg)	Style Number
50	13	2.5 (1.1)	C0050E4H ②
75	13	3.5 (1.6)	C0075E4H ②
100	13	4.0 (1.8)	C0100E4H ②
150	13	6.5 (3.0)	C0150E4H
200	13	8.2 (3.7)	C0200E4H
250	13	10.0 (4.5)	C0250E4H
300	13	11.0 (5.0)	C0300E4H
350	13	13.6 (6.2)	C0350E4H
500	13	17.7 (8.0)	C0500E4H

Primary: 550/575/600
Secondary: 22/23/24 with Fuse Clips for 13/32 x 1-1/2 Fuses

VA	Wiring Diagram ①	Weight Lbs (kg)	Style Number
50	12	2.5 (1.1)	C0050E4W ②
75	12	3.5 (1.6)	C0075E4W ②
100	12	4.0 (1.8)	C0100E4W ②
150	12	6.5 (3.0)	C0150E4W
200	12	8.2 (3.7)	C0200E4W
250	12	10.0 (4.5)	C0250E4W
300	12	11.0 (5.0)	C0300E4W
350	12	13.6 (6.2)	C0350E4W
500	12	17.7 (8.0)	C0500E4W
750	12	28.0 (12.7)	C0750E4WXX ③

Primary: 230/460/575
Secondary: 115/95 with Fuse Clips for 13/32 x 1-1/2 Fuses

VA	Wiring Diagram ①	Weight Lbs (kg)	Style Number
50	5	3.5 (1.6)	C0050E3C ②
75	5	4.5 (2.0)	C0075E3C ②
100	5	6.0 (2.7)	C0100E3C ②
150	5	7.7 (3.5)	C0150E3C
200	5	9.0 (4.1)	C0200E3C
250	5	9.7 (4.4)	C0250E3C
300	5	11.7 (5.3)	C0300E3C
350	5	16.5 (7.5)	C0350E3C
500	5	21.5 (9.8)	C0500E3C
750	5	28.0 (12.7)	C0750E3C

Primary: 380/400/415
Secondary: 110 x 220 with Jumpers;
Fuse Clips Not Applicable

VA	Wiring Diagram ①	Weight Lbs (kg)	Style Number
50	6	3.0 (1.4)	C0050E4D ②
75	6	4.0 (1.8)	C0075E4D ②
100	6	5.2 (2.4)	C0100E4D ②
150	6	7.0 (3.2)	C0150E4D
200	6	8.7 (3.9)	C0200E4D
250	6	10.2 (4.6)	C0250E4D
300	6	11.0 (5.0)	C0300E4D
350	6	13.0 (5.9)	C0350E4D
500	6	20.0 (9.1)	C0500E4D
750	6	28.0 (12.7)	C0750E4D

Notes

- ① See Page V7-T7-11 for wiring diagrams.
- ② 105°C insulation system.
- ③ Secondary fuse clips are not available on this catalog number.

Primary: 200/220/440, 208/230/460, 240/480
Secondary: 23/110, 24/115, 25/120 with Fuse Clips for 13/32 x 1-1/2 Fuses

VA	Wiring Diagram ①	Weight Lbs (kg)	Style Number
50	7	3.4 (1.5)	C0050E5E ②
75	7	4.8 (2.2)	C0075E5E ②
100	7	5.9 (2.7)	C0100E5E ②
150	7	7.9 (3.6)	C0150E5E
200	7	10.6 (4.8)	C0200E5E
250	7	13.9 (6.3)	C0250E5E
300	7	15.5 (7.0)	C0300E5E
350	7	16.8 (7.6)	C0350E5E
500	7	23.4 (10.6)	C0500E5E

Universal Design (MTE Epoxy Encapsulated)

Primary: 240/416/480/600, 230/400/460/575, 220/380/440/550, 208/500
Secondary: 99/120/130, 95/115/125, 91/110/120, 85/100/110 with Fuse Clips for 13/32 x 1-1/2 Fuses

VA	Wiring Diagram ①	Weight Lbs (kg)	Style Number
50	8	4.0 (1.8)	C0050E6U ②③
100	8	6.6 (3.0)	C0100E6U ②③
150	8	8.8 (4.0)	C0150E6U ②④
250	8	14.7 (6.7)	C0250E6U ②④
350	8	18.6 (8.4)	C0350E6U ②④
500	8	25.6 (11.6)	C0500E6U ②④
750	8	30.5 (13.8)	C0750E6U ②④

Transformers with Primary Fuse Blocks

Primary: 240 x 480, 230 x 460, 220 x 440 with Jumpers and Two-Pole Primary Fuse Block for Rejection-Type Fuses
Secondary: 120/115/110 with Fuse Clips for 13/32 x 1-1/2 Fuses

VA	Wiring Diagram ①	Weight Lbs (kg)	Style Number
50	1	2.8 (1.3)	C0050E2AFB ②
75	1	3.7 (1.7)	C0075E2AFB ②
100	1	4.4 (2.0)	C0100E2AFB ②
150	1	6.9 (3.1)	C0150E2AFB
200	1	8.7 (3.9)	C0200E2AFB
250	1	10.2 (4.6)	C0250E2AFB
300	1	11.5 (5.2)	C0300E2AFB
350	1	13.8 (6.3)	C0350E2AFB
500	1	19.4 (8.8)	C0500E2AFB
750	1	28.3 (12.8)	C0750E2AFB
1000	1	29.7 (13.4)	C1000E2AFB
1500	1	40.2 (18.1)	C1500E2AFB

Primary: 240 x 480 with Jumpers and Two-Pole Primary Fuse Block for Rejection-Type Fuses
Secondary: 24 with Fuse Clips for 13/32 x 1-1/2 Fuses

VA	Wiring Diagram ①	Weight Lbs (kg)	Style Number
50	2	2.8 (1.3)	C0050E2BFB ②
75	2	3.8 (1.7)	C0075E2BFB ②
100	2	4.4 (2.1)	C0100E2BFB ②
150	2	6.9 (3.1)	C0150E2BFB
200	2	8.7 (3.9)	C0200E2BFB
250	2	10.3 (4.7)	C0250E2BFB
300	2	11.6 (5.3)	C0300E2BFB
350	2	13.6 (6.2)	C0350E2BFB
500	2	17.7 (8.0)	C0500E2BFB

Notes

- ① See Page V7-T7-11 for wiring diagrams.
- ② 105°C insulation system.
- ③ Type MTG open core-coil universal design has been superseded by Type MTE epoxy encapsulated universal design with no changes to form, fit or function.
- ④ Type MTE epoxy encapsulated universal design.

7.1

Industrial Control Transformers

Transformers

7

Primary: 120 x 240 with Jumpers and Two-Pole Primary Fuse Block for Rejection-Type Fuses
Secondary: 24 with Fuse Clips for 13/32 x 1-1/2 Fuses

VA	Wiring Diagram ①	Weight Lbs (kg)	Style Number
50	3	2.8 (1.3)	C0050E1BFB ②
75	3	3.8 (1.7)	C0075E1BFB ②
100	3	4.6 (2.1)	C0100E1BFB ②
150	3	6.9 (3.1)	C0150E1BFB
200	3	8.5 (3.9)	C0200E1BFB
250	3	10.3 (4.7)	C0250E1BFB
300	3	11.4 (5.2)	C0300E1BFB
350	3	13.4 (6.1)	C0350E1BFB
500	3	17.7 (8.0)	C0500E1BFB

Primary: 208/277 with Two-Pole Primary Fuse Block for Rejection-Type Fuses
Secondary: 120 with Fuse Clips for 13/32 x 1-1/2 Fuses

VA	Wiring Diagram ①	Weight Lbs (kg)	Style Number
50	4	3.1 (1.4)	C0050E3AFB ②
75	4	4.0 (1.8)	C0075E3AFB ②
100	4	4.7 (2.1)	C0100E3AFB ②
150	4	7.1 (3.2)	C0150E3AFB
200	4	8.9 (4.0)	C0200E3AFB
250	4	10.4 (4.7)	C0250E3AFB
300	4	11.6 (5.3)	C0300E3AFB
350	4	13.9 (6.3)	C0350E3AFB
500	4	17.4 (7.9)	C0500E3AFB

Primary: 550/575/600 with Two-Pole Primary Fuse Block for Rejection-Type Fuses
Secondary: 110/115/120 with Fuse Clips for 13/32 x 1-1/2 Fuses

VA	Wiring Diagram ①	Weight Lbs (kg)	Style Number
50	10	2.9 (1.3)	C0050E4CFB ②
75	10	3.8 (1.7)	C0075E4CFB ②
100	10	4.4 (2.0)	C0100E4CFB ②
150	10	7.0 (3.2)	C0150E4CFB
200	10	8.6 (3.9)	C0200E4CFB
250	10	10.2 (4.6)	C0250E4CFB
300	10	11.5 (5.2)	C0300E4CFB
350	10	13.8 (6.3)	C0350E4CFB
500	10	17.0 (7.7)	C0500E4CFB
750	10	25.9 (11.8)	C0750E4CFB

Primary: 380/400/415 with Two-Pole Primary Fuse Block for Rejection-Type Fuses
Secondary: 22/23/24 with Fuse Clips for 13/32 x 1-1/2 Fuses

VA	Wiring Diagram ①	Weight Lbs (kg)	Style Number
50	13	2.6 (1.2)	C0050E4HFB ②
75	13	3.7 (1.7)	C0075E4HFB ②
100	13	4.2 (1.9)	C0100E4HFB ②
150	13	6.7 (3.0)	C0150E4HFB
200	13	8.4 (3.8)	C0200E4HFB
250	13	10.2 (4.6)	C0250E4HFB

Primary: 550/575/600 with Two-Pole Primary Fuse Block for Rejection-Type Fuses
Secondary: 22/23/24 with Fuse Clips for 13/32 x 11/2 Fuses

VA	Wiring Diagram ①	Weight Lbs (kg)	Style Number
50	12	2.7 (1.2)	C0050E4WFB ②
75	12	3.7 (1.7)	C0075E4WFB ②
100	12	4.2 (1.9)	C0100E4WFB ②
150	12	6.7 (3.0)	C0150E4WFB
200	12	8.4 (3.8)	C0200E4WFB
250	12	10.2 (4.6)	C0250E4WFB

Primary: 230/460/575 with Two-Pole Primary Fuse Block for Rejection-Type Fuses
Secondary: 115/95 with Fuse Clips for 13/32 x 1-1/2 Fuses

VA	Wiring Diagram ①	Weight Lbs (kg)	Style Number
50	5	3.7 (1.7)	C0050E3CFB ②
75	5	4.7 (2.1)	C0075E3CFB ②
100	5	6.2 (2.8)	C0100E3CFB ②
150	5	7.9 (3.6)	C0150E3CFB
200	5	9.2 (4.2)	C0200E3CFB
250	5	9.9 (4.5)	C0250E3CFB
300	5	11.9 (5.4)	C0300E3CFB
350	5	16.7 (7.6)	C0350E3CFB
500	5	21.7 (9.9)	C0500E3CFB

Notes

- ① See Page V7-T7-11 for wiring diagrams.
- ② 105°C insulation system.

**Primary: 380/400/415 with Two-Pole
Primary Fuse Block for Rejection-Type Fuses
Secondary: 110 x 220 with Jumpers;
Fuse Clips Not Available**

VA	Wiring Diagram ①	Weight Lbs (kg)	Style Number
50	6	3.2 (1.5)	C0050E4DFB ②
75	6	4.2 (1.9)	C0075E4DFB ②
100	6	5.4 (2.5)	C0100E4DFB ②
150	6	7.2 (3.3)	C0150E4DFB
200	6	8.9 (4.0)	C0200E4DFB
250	6	10.4 (4.7)	C0250E4DFB
300	6	11.2 (5.1)	C0300E4DFB
350	6	13.2 (6.0)	C0350E4DFB
500	6	20.2 (9.2)	C0500E4DFB

**Primary: 200/220/440, 208/230/460, 240/480 with
Two-Pole Primary Fuse Block for Rejection-Type Fuses
Secondary: 23/110, 24/115, 25/120 with Fuse Clips
for 13/32 x 1-1/2 Fuses**

VA	Wiring Diagram ①	Weight Lbs (kg)	Style Number
50	7	3.6 (1.6)	C0050E5EFB ②
75	7	5.0 (2.3)	C0075E5EFB ②
100	7	6.1 (2.8)	C0100E5EFB ②
150	7	8.1 (3.7)	C0150E5EFB
200	7	10.8 (4.9)	C0200E5EFB
250	7	14.1 (6.4)	C0250E5EFB
300	7	15.7 (7.1)	C0300E5EFB
350	7	17.0 (7.7)	C0350E5EFB
500	7	23.6 (10.7)	C0500E5EFB

**Universal Design (MTE Epoxy Encapsulated)
Primary: 240/416/480/600, 230/400/460/575,
220/380/440/550, 208/500 with Two-Pole
Primary Fuse Block for Rejection-Type Fuses
Secondary: 99/120/130, 95/115/125, 91/110/120,
85/100/110 with Fuse Clips for 13/32 x 1-1/2 Fuses**

VA	Wiring Diagram ①	Weight Lbs (kg)	Style Number
50	8	4.2 (1.9)	C0050E6UFB ②③
100	8	6.8 (3.1)	C0100E6UFB ②③
150	8	9.0 (4.1)	C0150E6UFB ②④
250	8	14.9 (6.8)	C0250E6UFB ②④
350	8	18.8 (8.5)	C0350E6UFB ②④
500	8	25.8 (11.7)	C0500E6UFB ②④

Notes

- ① See Page V7-T7-11 for wiring diagrams.
- ② 105°C insulation system.
- ③ Type MTG open core-coil universal design has been superseded by Type MTE epoxy encapsulated universal design with no changes to form, fit or function.
- ④ Type MTE epoxy encapsulated universal design.

Accessories

Primary Fuse Kit

The primary fuse kit includes a two-pole class CC fuse block, instructions, and all associated mounting and wiring hardware. Fuses are not included. When installed, the primary fuse kit will add a maximum of 11/16 inch to the transformer depth and 1-15/16 inches to the transformer height.



Primary Fuse Kit

Description	Catalog Number
Primary fuse kit	PFK1

Finger-Safe Terminal Covers (Optional)

- Fits CE Marked designs 50–750 VA
- Fits MTE designs 0.25–750 VA

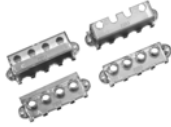
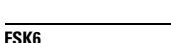
Finger-Safe Terminal Covers

Description	Catalog Number
 <p>Four terminal transformers</p>	FSK4
 <p>Four terminal Series 2 transformers only</p>	FSK4S2
 <p>Six terminal transformers</p>	FSK6

Finger-Safe Primary Fuse Block Covers

- Fits two-pole primary fuse blocks on MTE designs
- No fuse block covers are available for transformers with suffix "FBQ"

Finger-Safe Primary Fuse Block Covers

Description	Catalog Number
 <p>Primary fuse block covers</p>	FSKFB

Secondary Fuse Clip

Secondary Fuse Clip

Description	Catalog Number
Fits 500 VA and smaller models	SFCS
Fits models greater than 500 VA	SFCL

Technical Data and Specifications

Insulation System and Temperature Rise

Industry standards classify insulation systems and rise as shown below:

Insulation System Classification

Ambient	+ Winding Rise	+ Hot Spot	= Temp. Class
40°C	55°C	10°C	105°C
40°C	80°C	30°C	150°C
25°C	135°C	20°C	180°C
40°C	115°C	30°C	185°C
40°C	150°C	30°C	220°C

The design life of transformers having different insulation systems is the same—the lower-temperature systems are designed for the same life as the higher-temperature systems.

Series-Multiple Windings

Series-multiple windings consist of two similar coils in each winding that can be connected in series or parallel (multiple). Transformers with series-multiple windings are designated with an "x" or "/" between the voltage ratings, such as voltages of "120/240" or "240 x 480." If the series-multiple winding is designated by an "x," the winding can be connected only for a series or parallel. With the "/" designation, a mid-point also becomes available in addition to the series or parallel connection. As an example, a 120 x 240 winding can be connected for either 120 (parallel) or 240 (series), but a 120/240 winding can be connected for 120 (parallel), 240 (series) or 240 with a 120 mid-point.

For additional information, please refer to Volume 2, CA08100003E.

Wiring Diagrams

Diagram 1

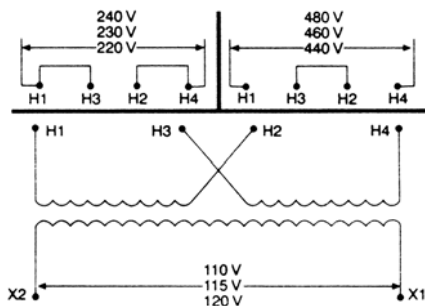

Diagram 5

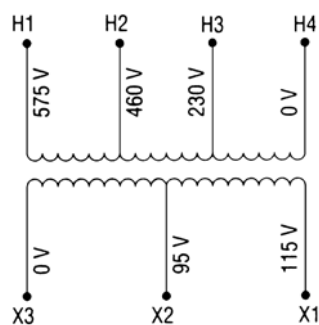

Diagram 2

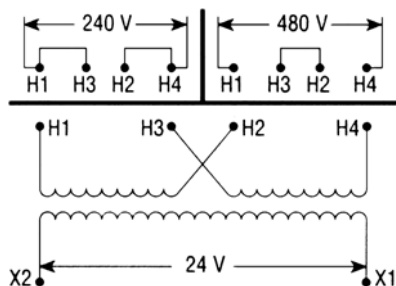

Diagram 6

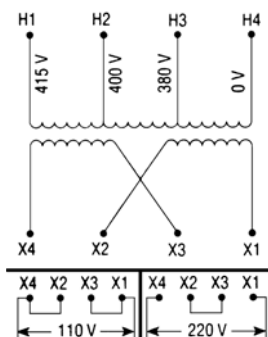

Diagram 3

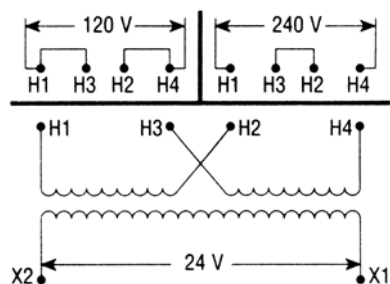

Diagram 7

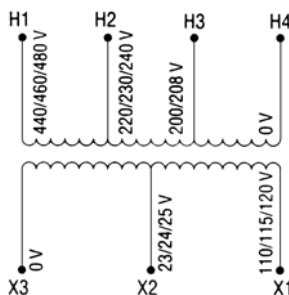

Diagram 4

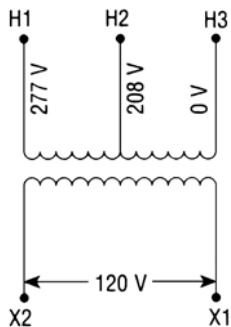
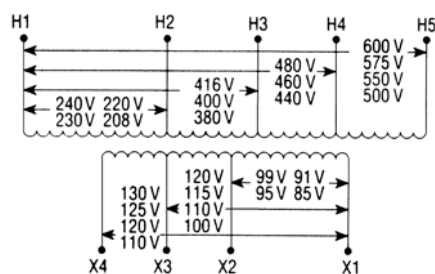

Diagram 8



7.1

Industrial Control Transformers

Transformers

7

Diagram 9

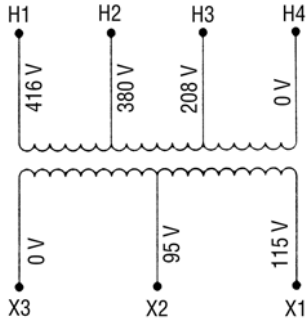

Diagram 13

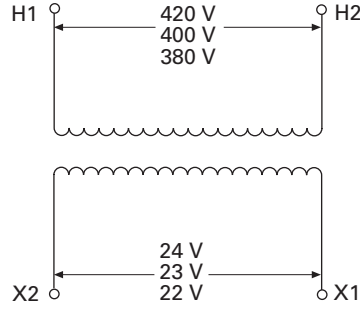

Diagram 10

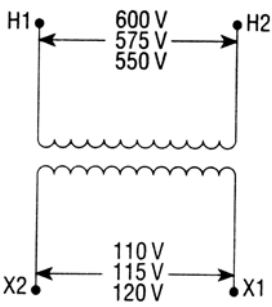

Diagram 14

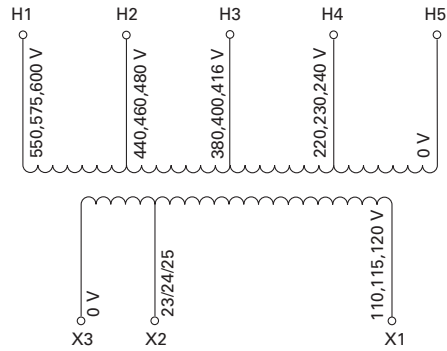

Diagram 11

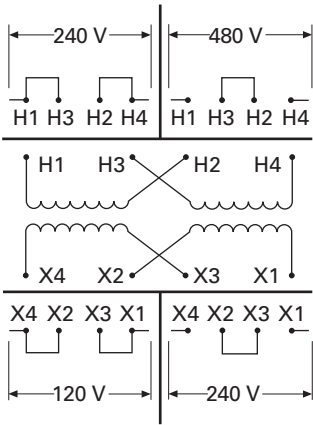

Diagram 15

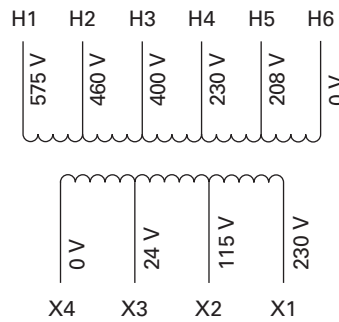

Diagram 12

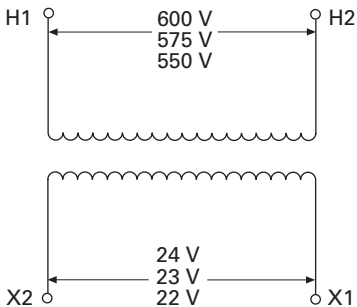
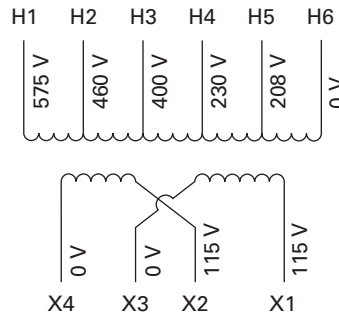

Diagram 16



Type MTK Transformer



Contents

Description	Page
Type MTE	V7-T7-4
Type MTK	
Product Selection	V7-T7-14
Technical Data and Specifications	V7-T7-15
Wiring Diagrams	V7-T7-15
CE Marked	V7-T7-18
Type AP	V7-T7-25

Type MTK

Product Description

Note: The following pages provide listings for most standard transformer ratings and styles. For other ratings or styles not shown, or for special enclosure types (including stainless steel), refer to Eaton.

- Epoxy resin-impregnated coil
- Economical solution for high inrush applications

Application Description

Transformers provide stepped-down voltages to machine tool control devices, enabling control circuits to be isolated from all power and lighting circuits. This allows the use of grounded or ungrounded circuits that are independent of the power or lighting grounds; thus, greater safety is afforded the operator. The control transformer line is particularly adaptable on applications where compact construction is demanded.

Features, Benefits and Functions

- Epoxy resin impregnated coil design
- Copper magnet wire for high-quality, efficient operation
- 50/60 Hz operation
- 180°C insulation system
- Performance meets/exceeds requirements of ANSI/NEMA ST-1
- Regulation exceeds ANSI/NEMA requirements for all ratings
- 500–5000 VA ratings

Standards and Certifications

- UL listed
- cUL listed
- RoHS compliant



Industry Standards

All Eaton dry-type distribution and control transformers are built and tested in accordance with applicable NEMA, ANSI and IEEE Standards. All 600 volt class transformers are UL listed unless otherwise noted.

Catalog Number Selection

Please refer to **Page V7-T7-3**.

7.1

Industrial Control Transformers

Transformers

Product Selection

Additional Product Selection information is available in Volume 2, **CA08100003E**.

Type MTK

Primary: 240 x 480, 230 x 460, 220 x 440
Secondary: 120/115/110

VA	Wiring Diagram ①	Weight Lbs (kg)	Style Number
500	1	13.0 (5.9)	C0500K2A
750	1	19.5 (8.9)	C0750K2A
1000	1	29.8 (13.6)	C1000K2A
1500	1	30.0 (13.6)	C1500K2A
2000	1	38.0 (17.3)	C2000K2A
3000	1	53.0 (24.1)	C3000K2A
5000	1	89.0 (40.5)	C5000K2A

Primary: 208/277 Secondary: 120

VA	Wiring Diagram ①	Weight Lbs (kg)	Style Number
1000	4	29.0 (13.1)	C1000K3A
1500	4	33.0 (15.0)	C1500K3A
2000	4	43.0 (19.5)	C2000K3A
3000	4	64.0 (29.0)	C3000K3A
5000	4	102.0 (46.3)	C5000K3A

Primary: 230/460/575 Secondary: 115/95

VA	Wiring Diagram ①	Weight Lbs (kg)	Style Number
1000	5	29.2 (13.3)	C1000K3C
1500	5	33.5 (15.2)	C1500K3C
2000	5	42.5 (19.3)	C2000K3C
3000	5	63.7 (29.0)	C3000K3C
5000	5	102.0 (46.4)	C5000K3C

Primary: 208/380/416 Secondary: 115/95

VA	Wiring Diagram ①	Weight Lbs (kg)	Style Number
1000	9	29.0 (13.1)	C1000K3D
1500	9	43.0 (19.5)	C1500K3D
2000	9	55.0 (25.0)	C2000K3D
3000	9	74.0 (33.5)	C3000K3D
5000	9	108.0 (49.0)	C5000K3D

Primary: 550/575/600 Secondary: 110/115/120

VA	Wiring Diagram ①	Weight Lbs (kg)	Style Number
1000	10	29.0 (13.1)	C1000K4C
1500	10	33.0 (15.0)	C1500K4C
2000	10	43.0 (19.5)	C2000K4C
3000	10	64.0 (29.0)	C3000K4C
5000	10	102.0 (46.3)	C5000K4C

Primary: 380/400/415 Secondary: 110 x 220

VA	Wiring Diagram ①	Weight Lbs (kg)	Style Number
1000	6	28.0 (12.7)	C1000K4D
1500	6	33.0 (15.0)	C1500K4D
2000	6	43.0 (19.5)	C2000K4D
3000	6	64.0 (29.0)	C3000K4D
5000	6	102.0 (46.3)	C5000K4D

Primary: 240 x 480 with Jumpers
Secondary: 120 x 240 with Jumpers,
Secondary Fuse Clips Not Applicable

VA	Wiring Diagram ①	Weight Lbs (kg)	Style Number
1000	11	26.4 (12.0)	C1000K2CXX
1500	11	31.0 (14.1)	C1500K2CXX
2000	11	40.0 (18.2)	C2000K2CXX
3000	11	56.0 (25.5)	C3000K2CXX
5000	11	85.5 (28.9)	C5000K2CXX

Primary: 120 x 240 with Jumpers Secondary: 24

VA	Wiring Diagram ①	Weight Lbs (kg)	Style Number
750	3	19.0 (8.6)	C0750K1B
1000	3	26.4 (12.0)	C1000K1B

Primary: 240/416/480/600, 230/400/460/575,
220/380/440/550, 208/500
Secondary: 99/120/130, 95/115/125, 91/110/120, 85/100/110

VA	Wiring Diagram ①	Weight Lbs (kg)	Style Number
1000	8	26.5 (12.0)	C1000K6U
1500	8	38.5 (17.5)	C1500K6U
2000	8	52.0 (23.6)	C2000K6U
3000	8	68.0 (30.9)	C3000K6U
5000	8	105.0 (47.7)	C5000K6U

Note

① See **Page V7-T7-15** for wiring diagrams.

Technical Data and Specifications

Insulation System and Temperature Rise

Industry standards classify insulation systems and rise as shown below:

Insulation System Classification

Ambient	+ Winding Rise	+ Hot Spot	= Temp. Class
40°C	55°C	10°C	105°C
40°C	80°C	30°C	150°C
25°C	135°C	20°C	180°C
40°C	115°C	30°C	185°C
40°C	150°C	30°C	220°C

The design life of transformers having different insulation systems is the same—the lower-temperature systems are designed for the same life as the higher-temperature systems.

Series-Multiple Windings

Series-multiple windings consist of two similar coils in each winding that can be connected in series or parallel (multiple). Transformers with series-multiple windings are designated with an “x” or “/” between the voltage ratings, such as voltages of “120/240” or “240 x 480.” If the series-multiple winding is designated by an “x,” the winding can be connected only for a series or parallel. With the “/” designation, a mid-point also becomes available in addition to the series or parallel connection. As an example, a 120 x 240 winding can be connected for either 120 (parallel) or 240 (series), but a 120/240 winding can be connected for 120 (parallel), 240 (series) or 240 with a 120 mid-point.

For additional information, please refer to Volume 2, CA08100003E.

Wiring Diagrams

Diagram 1

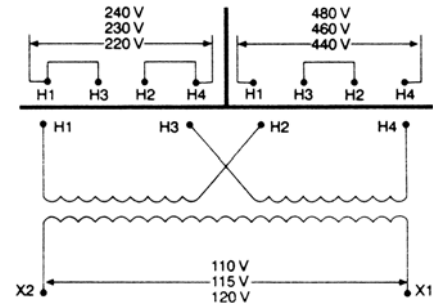

Diagram 2

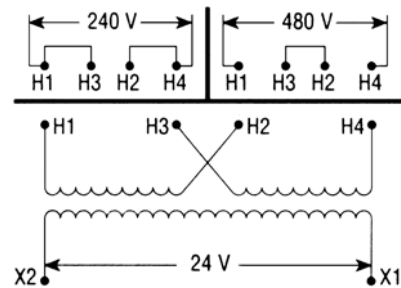

Diagram 3

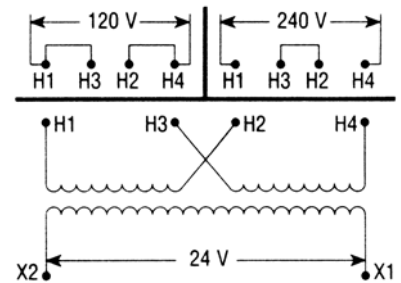
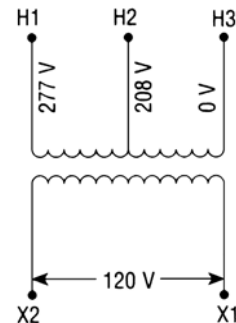

Diagram 4



7.1

Industrial Control Transformers

Transformers

7

Diagram 5

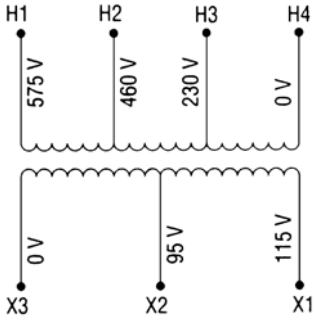

Diagram 9

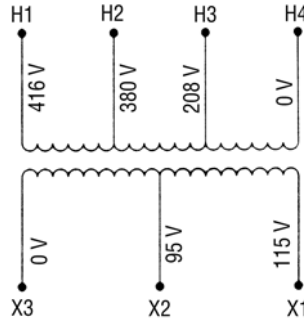

Diagram 6

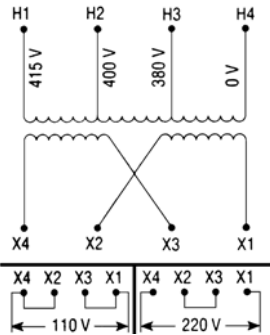

Diagram 10

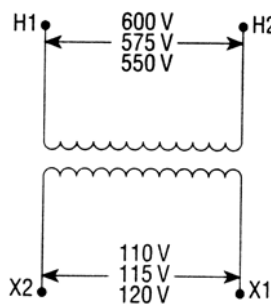

Diagram 7

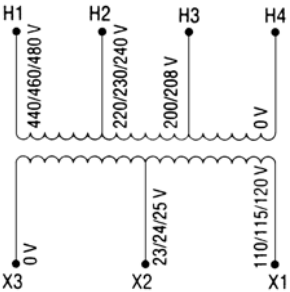

Diagram 11

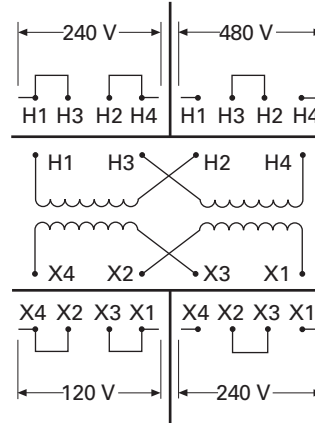

Diagram 8

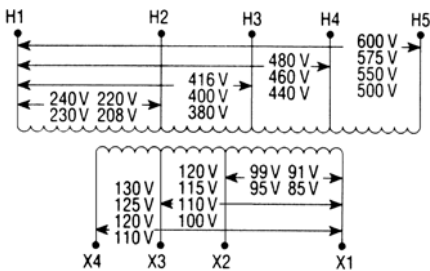

Diagram 12

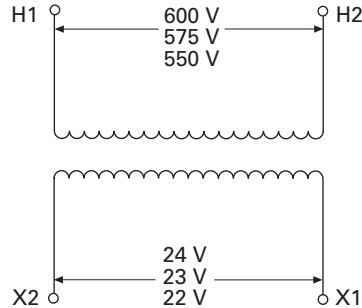

Diagram 13

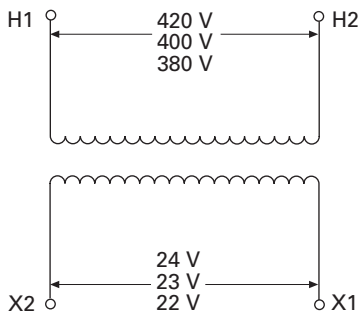

Diagram 14

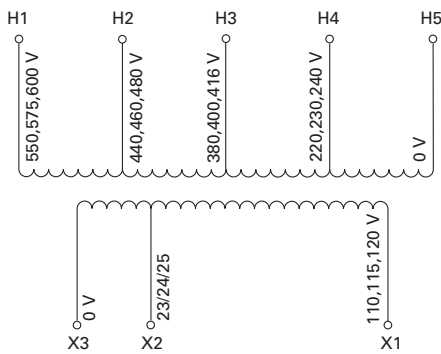

Diagram 15

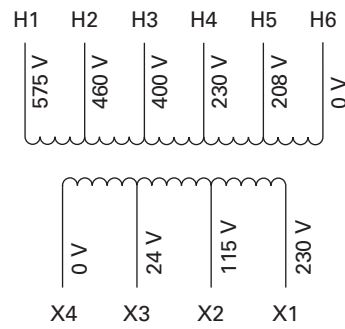
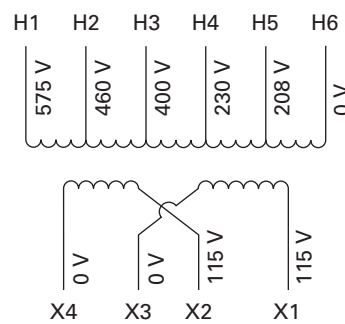

Diagram 16



Type MTE CE-Marked CPT



7

Contents

<i>Description</i>	<i>Page</i>
Type MTE	V7-T7-4
Type MTK	V7-T7-13
CE Marked	
Product Selection	V7-T7-19
Accessories	V7-T7-21
Technical Data and Specifications	V7-T7-21
Wiring Diagrams	V7-T7-22
Type AP	V7-T7-25

CE Marked

Product Description

Note: The following pages provide listings for most standard transformer ratings and styles. For other ratings or styles not shown, or for special enclosure types (including stainless steel), refer to Eaton.

Application Description

Transformers provide stepped-down voltages to machine tool control devices, enabling control circuits to be isolated from all power and lighting circuits. This allows the use of grounded or ungrounded circuits that are independent of the power or lighting grounds; thus, greater safety is afforded the operator. The control transformer line is particularly adaptable on applications where compact construction is demanded.

Features, Benefits and Functions

Type MTE

- Epoxy encapsulated coil design
- Copper magnet wire for high-quality, efficient operation
- Laminations of high-quality silicon steel to minimize core losses and optimize performance
- Molded-in terminals
- 50/60 Hz operation
- 130°C insulation system standard
- Performance meets/exceeds requirements of ANSI/NEMA ST-1
- Regulation exceeds ANSI/NEMA requirements for all ratings
- Non-short circuit-proof transformer, isolation type

Type MTK

- Epoxy resin-impregnated coil design
- Copper magnet wire for high-quality, efficient operation
- 50/60 Hz operation
- 180°C insulation system
- Performance meets/exceeds requirements of ANSI/NEMA ST-1
- Regulation exceeds ANSI/NEMA requirements for all ratings
- 500–5000 VA ratings

Standards and Certifications

- UL listed
- cUL listed
- CE Marked units comply with IEC EN-61558-2
- RoHS compliant



Industry Standards

All Eaton dry-type distribution and control transformers are built and tested in accordance with applicable NEMA, ANSI and IEEE Standards. All 600 volt class transformers are UL listed unless otherwise noted.

Catalog Number Selection

Please refer to **Page V7-T7-3**.

Product Selection

Additional Product Selection information is available in Volume 2, **CA08100003E**.

Type MTE CE Marked IP00

Primary: 240 x 480, 230 x 460, 220 x 440 with Jumpers
Secondary: 120/115/110

VA	Wiring Diagram ①	Weight Lbs (kg)	Style Number
50	1	3.5 (1.6)	CE0050E2ACE ②
75	1	4.8 (2.2)	CE0075E2ACE ②
100	1	5.9 (2.7)	CE0100E2ACE ②
150	1	8.5 (3.9)	CE0150E2ACE
200	1	10.6 (4.8)	CE0200E2ACE
250	1	11.3 (5.1)	CE0250E2ACE
300	1	13.2 (6.0)	CE0300E2ACE
350	1	14.9 (6.8)	CE0350E2ACE
500	1	21.0 (9.5)	CE0500E2ACE
750	1	29.8 (13.5)	CE0750E2ACE

Primary: 550/575/600
Secondary: 110/115/1204

VA	Wiring Diagram ①	Weight Lbs (kg)	Style Number
50	10	3.5 (1.6)	CE0050E4CCE ②
75	10	4.8 (2.2)	CE0075E4CCE ②
100	10	5.9 (2.7)	CE0100E4CCE ②
150	10	8.5 (3.9)	CE0150E4CCE
200	10	10.6 (4.8)	CE0200E4CCE
250	10	11.3 (5.1)	CE0250E4CCE
300	10	13.2 (6.0)	CE0300E4CCE
350	10	14.9 (6.8)	CE0350E4CCE
500	10	21.0 (9.5)	CE0500E4CCE
750	10	29.8 (13.5)	CE0750E4CCE

Primary: 240 x 480 with Jumpers
Secondary: 24

VA	Wiring Diagram ①	Weight Lbs (kg)	Style Number
50	2	3.4 (1.5)	CE0050E2BCE ②
75	2	4.2 (1.9)	CE0075E2BCE ②
100	2	5.9 (2.7)	CE0100E2BCE ②
150	2	8.5 (3.9)	CE0150E2BCE
200	2	10.6 (4.5)	CE0200E2BCE
250	2	11.3 (5.1)	CE0250E2BCE
300	2	13.2 (6.0)	CE0300E2BCE
350	2	14.9 (6.8)	CE0350E2BCE
500	2	19.2 (8.7)	CE0500E2BCE
750	2	28.1 (12.8)	CE0750E2BCE

Primary: 380/400/415
Secondary: 110 x 220 with Jumpers

VA	Wiring Diagram ①	Weight Lbs (kg)	Style Number
50	6	3.5 (1.6)	CE0050E4DCE ②
75	6	4.8 (2.2)	CE0075E4DCE ②
100	6	5.9 (2.7)	CE0100E4DCE ②
150	6	8.5 (3.9)	CE0150E4DCE
200	6	10.6 (4.8)	CE0200E4DCE
250	6	11.3 (5.1)	CE0250E4DCE
300	6	13.2 (6.0)	CE0300E4DCE
350	6	15.2 (6.9)	CE0350E4DCE
500	6	21.0 (9.5)	CE0500E4DCE
750	6	29.8 (13.5)	CE0750E4DCE

Primary: 120 x 240 with Jumpers
Secondary: 24

VA	Wiring Diagram ①	Weight Lbs (kg)	Style Number
50	3	3.4 (1.5)	CE0050E1BCE ②
75	3	4.2 (1.9)	CE0075E1BCE ②
100	3	5.9 (2.7)	CE0100E1BCE ②
150	3	8.5 (3.9)	CE0150E1BCE
200	3	10.6 (4.5)	CE0200E1BCE
250	3	11.3 (5.1)	CE0250E1BCE
300	3	13.2 (6.0)	CE0300E1BCE
350	3	14.9 (6.8)	CE0350E1BCE
500	3	19.2 (8.7)	CE0500E1BCE
750	3	29.8 (13.5)	CE0750E1BCE

Primary: 200/220/440, 208/230/460, 240/480
Secondary: 23/110, 24/115, 25/120

VA	Wiring Diagram ①	Weight Lbs (kg)	Style Number
50	7	4.2 (1.9)	CE0050E5ECE ②
75	7	5.9 (2.7)	CE0075E5ECE ②
100	7	7.9 (3.6)	CE0100E5ECE ②
150	7	10.0 (4.5)	CE0150E5ECE
200	7	12.8 (5.8)	CE0200E5ECE
250	7	15.2 (6.9)	CE0250E5ECE
300	7	16.8 (7.6)	CE0300E5ECE
350	7	19.2 (8.7)	CE0350E5ECE
500	7	27.0 (12.3)	CE0500E5ECE

Notes

① See **Page V7-T7-22** for wiring diagrams.

② 105°C insulation system.

Transformers are designed to operate in a maximum ambient of 40°C. Contact your local Eaton sales office for availability on additional CE Marked control transformers. For other ratings or styles not shown, refer to Eaton.

7.1

Industrial Control Transformers

Transformers

Type MTK CE Marked with Factory Mounted Finger-Safe Terminal Covers IP20

Primary: 240 x 480, 230 x 460, 220 x 440 with Jumpers
Secondary: 120/115/110

VA	Terminal Type	Wiring Diagram ①	Weight Lbs (kg)	Style Number
250	A	1	8.8 (4.0)	CE0250K2ACEFS
300	A	1	11.0 (5.0)	CE0300K2ACEFS
350	A	1	11.2 (5.1)	CE0350K2ACEFS
500	A	1	14.8 (6.7)	CE0500K2ACEFS
750	A	1	18.0 (8.2)	CE0750K2ACEFS
1000	A	1	26.3 (11.9)	CE1000K2ACEFS
1500	C	1	40.0 (18.1)	CE1500K2ACEFS
2000	C	1	45.1 (20.5)	CE2000K2ACEFS
3000	C	1	65.2 (29.6)	CE3000K2ACEFS
5000	C	1	104.8 (47.5)	CE5000K2ACEFS

Primary: 240 x 480 with Jumpers
Secondary: 24

VA	Terminal Type	Wiring Diagram ①	Weight Lbs (kg)	Style Number
250	C	2	8.2 (3.7)	CE0250K2BCEFS
300	C	2	9.5 (4.3)	CE0300K2BCEFS
350	C	2	12.2 (5.5)	CE0350K2BCEFS
500	C	2	14.4 (6.5)	CE0500K2BCEFS
750	C	2	19.5 (8.9)	CE0750K2BCEFS
1000	C	2	26.2 (11.9)	CE1000K2BCEFS

Primary: 120 x 240 with Jumpers
Secondary: 24

VA	Terminal Type	Wiring Diagram ①	Weight Lbs (kg)	Style Number
250	C	3	8.3 (3.8)	CE0250K1BCEFS
300	C	3	9.3 (4.2)	CE0300K1BCEFS
350	C	3	12.0 (5.4)	CE0350K1BCEFS
500	C	3	14.4 (6.5)	CE0500K1BCEFS
750	C	3	19.5 (8.9)	CE0750K1BCEFS
1000	C	3	25.2 (11.4)	CE1000K1BCEFS

Primary: 200/220/440, 208/230/460, 240/480
Secondary: 23/110, 24/115, 25/120

VA	Terminal Type	Wiring Diagram ①	Weight Lbs (kg)	Style Number
250	B	7	12.5 (5.7)	CE0250K5ECEFS
300	B	7	14.0 (6.3)	CE0300K5ECEFS
350	B	7	15.3 (6.9)	CE0350K5ECEFS
500	B	7	20.8 (9.4)	CE0500K5ECEFS
750	C	7	29.8 (13.5)	CE0750K5ECEFS
1000	C	7	30.2 (13.7)	CE1000K5ECEFS

Primary: 220/380/440/550, 230/400/460/575,
240/416/480/600
Secondary: 23/110, 24/115, 25/120

VA	Terminal Type	Wiring Diagram ①	Weight Lbs (kg)	Style Number
250	B	14	14.3 (6.5)	CE0250K2UCEFS
300	B	14	15.8 (7.2)	CE0300K2UCEFS
350	B	14	16.5 (7.5)	CE0350K2UCEFS
500	B	14	20.5 (9.3)	CE0500K2UCEFS
750	C	14	28.8 (13.1)	CE0750K2UCEFS
1000	C	14	39.4 (17.9)	CE1000K2UCEFS

Primary: 208/230/400/460/575
Secondary: 24 ②/115/230

VA	Terminal Type	Wiring Diagram ①	Weight Lbs (kg)	Style Number
250	B	15	14.9 (6.8)	CE0250K2VCEFS
300	B	15	17.4 (7.9)	CE0300K2VCEFS
350	B	15	17.8 (8.1)	CE0350K2VCEFS
500	B	15	26.6 (12.1)	CE0500K2VCEFS
750	B	15	32.5 (14.7)	CE0750K2VCEFS
1000	C	15	44.0 (20.0)	CE1000K2VCEFS
1500	C	15	45.4 (20.6)	CE1500K2WCEFS
2000	C	16	58.6 (26.6)	CE2000K2WCEFS
3000	C	16	92.9 (42.1)	CE3000K2WCEFS
5000	C	16	127.4 (57.8)	CE5000K2WCEFS

Primary: 240/416/480/600, 230/400/460/575,
220/380/440/550, 208/500
Secondary: 99/120/130, 95/115/125, 91/110/120, 85/100/110

VA	Terminal Type	Wiring Diagram ①	Weight Lbs (kg)	Style Number
250	A	8	11.4 (5.2)	CE0250K6UCEFS
300	A	8	13.6 (6.2)	CE0300K6UCEFS
350	A	8	14.2 (6.4)	CE0350K6UCEFS
500	A	8	17.4 (7.9)	CE0500K6UCEFS
750	A	8	27.5 (12.5)	CE0750K6UCEFS
1000	A	8	27.9 (12.6)	CE1000K6UCEFS
1500	A	8	43.1 (19.5)	CE1500K6UCEFS
2000	B	8	56.0 (25.4)	CE2000K6UCEFS
3000	B	8	76.2 (34.6)	CE3000K6UCEFS

Notes

① See Page V7-T7-22 for wiring diagrams.

② 24 volt secondary only available through 1000 VA.

Accessories



Protection Index IP00

When terminal covers are installed on primary and secondary, and fuse block covers are used, the protection index is IP20.

Finger-Safe Terminal Covers (Optional)

- Fits CE Marked designs 50–750 VA
- Fits MTE designs 0.25–750 VA

Finger-Safe Terminal Covers

	Description	Catalog Number
	Four terminal transformers	FSK4
	Four terminal Series 2 transformers only	FSK4S2
	Six terminal transformers	FSK6

Finger-Safe Primary Fuse Block Covers

- Fits two-pole primary fuse blocks on MTE designs

Finger-Safe Primary Fuse Block Covers

	Description	Catalog Number
	Primary fuse block covers	FSKFB

Secondary Fuse Clip

Secondary Fuse Clip

Description	Catalog Number
Fits 500 VA and smaller models	SFCS
Fits models greater than 500 VA	SFCL

Technical Data and Specifications

Overload Capability

Short-term overload is designed into transformers as required by ANSI. Basically, dry-type distribution transformers will deliver 200% nameplate load for one-half hour, 150% load for one hour and 125% load for four hours without being damaged, provided that a constant 50% load precedes and follows the overload. See ANSI C57.96-01.250 for additional limitations.

Continuous overload capacity is not deliberately designed into a transformer because the design objective is to be within the allowed winding temperature rise with nameplate loading.

Insulation System and Temperature Rise

Industry standards classify insulation systems and rise as shown below:

Insulation System Classification

Ambient	+ Winding Rise	+ Hot Spot	= Temp. Class
40°C	55°C	10°C	105°C
40°C	80°C	30°C	150°C
25°C	135°C	20°C	180°C
40°C	115°C	30°C	185°C
40°C	150°C	30°C	220°C

The design life of transformers having different insulation systems is the same—the lower-temperature systems are designed for the same life as the higher-temperature systems.

Series-Multiple Windings

Series-multiple windings consist of two similar coils in each winding that can be connected in series or parallel (multiple). Transformers with series-multiple windings are designated with an “x” or “/” between the voltage ratings, such as voltages of “120/240” or “240 x 480.” If the series-multiple winding is designated by an “x,” the winding can be connected only for a series or parallel. With the “/” designation, a mid-point also becomes available in addition to the series or parallel connection. As an example, a 120 x 240 winding can be connected for either 120 (parallel) or 240 (series), but a 120/240 winding can be connected for 120 (parallel), 240 (series) or 240 with a 120 mid-point.

For additional information, please refer to Volume 2, **CA08100003E**.

7.1

Industrial Control Transformers

Transformers

Wiring Diagrams

Diagram 1

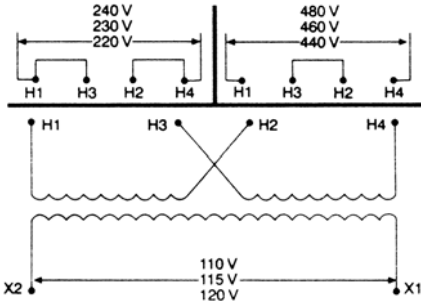

Diagram 5

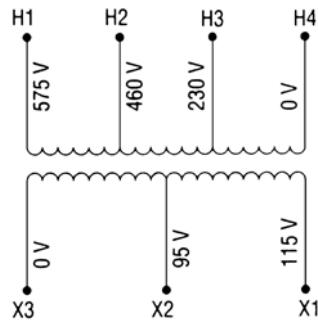

Diagram 2

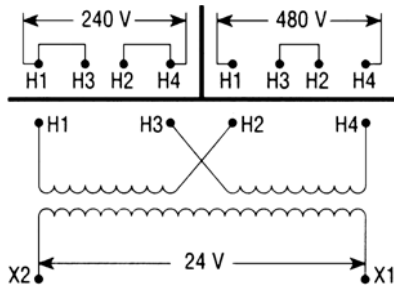

Diagram 6

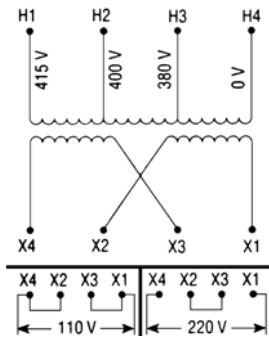

Diagram 3

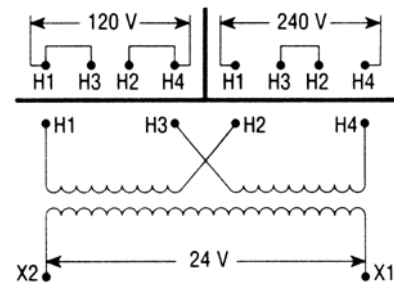

Diagram 7

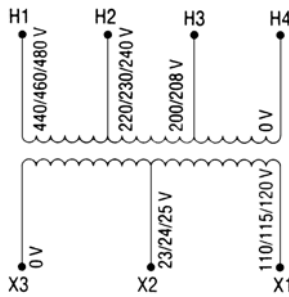

Diagram 4

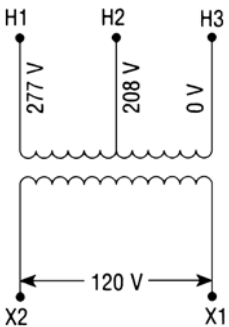

Diagram 8

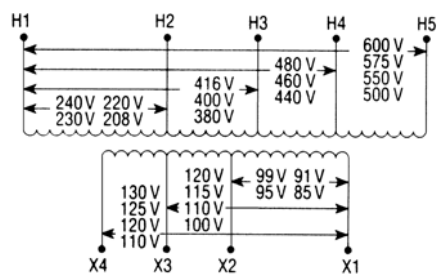

Diagram 9

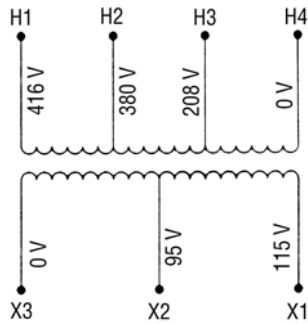

Diagram 13

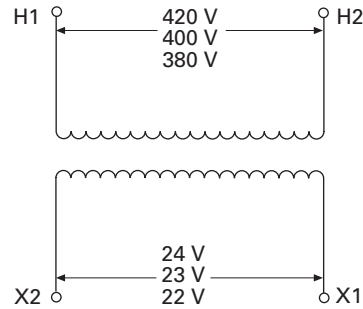

Diagram 10

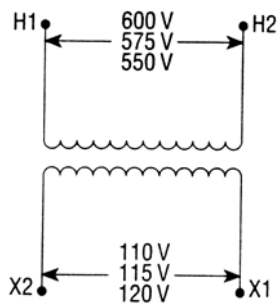

Diagram 14

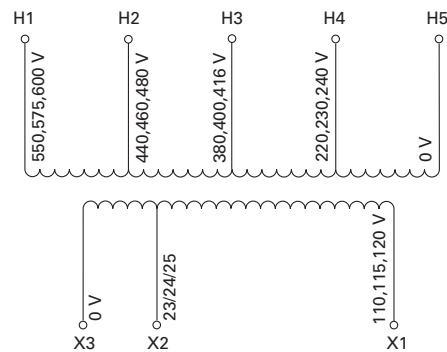

Diagram 11

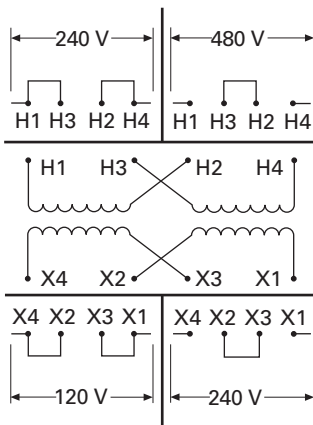

Diagram 15

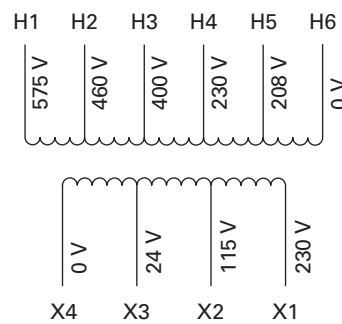

Diagram 12

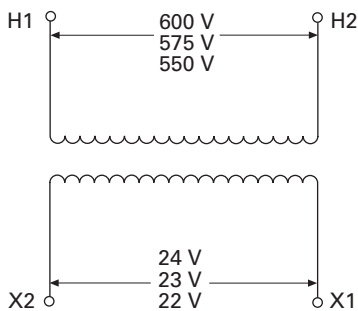
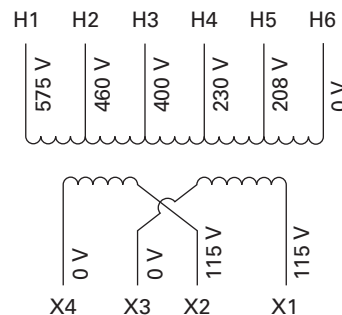

Diagram 16



Acceptable Rating of Primary Overcurrent Protection for CE Marked Control Transformers ^①

Fuses 13/32 x 1-1/2 Inches (10 x 38 mm) Timelag (IEC 269)

Sec. Voltage	50	75	100	150	200	250	300	350	500	750
115	2.0	2.0	4.0	4.0	6.0	6.0	8.0	10.0	12.0	20.0
120	2.0	2.0	4.0	4.0	6.0	6.0	8.0	10.0	12.0	20.0
200	1.0	2.0	2.0	4.0	4.0	4.0	4.0	6.0	8.0	12.0
208	1.0	2.0	2.0	4.0	4.0	4.0	4.0	6.0	8.0	12.0
220	1.0	1.0	2.0	4.0	4.0	4.0	4.0	6.0	6.0	10.0
230	1.0	1.0	2.0	4.0	4.0	4.0	4.0	6.0	6.0	10.0
240	1.0	1.0	2.0	4.0	4.0	4.0	4.0	4.0	6.0	10.0
277	0.5	1.0	1.0	2.0	4.0	4.0	4.0	4.0	6.0	8.0
380	0.5	1.0	1.0	2.0	2.0	4.0	4.0	4.0	6.0	6.0
400	0.5	0.5	1.0	2.0	2.0	4.0	4.0	4.0	4.0	6.0
415	0.5	0.5	1.0	1.0	2.0	4.0	4.0	4.0	4.0	6.0
440	0.5	0.5	1.0	1.0	2.0	2.0	4.0	4.0	4.0	6.0
460	0.5	0.5	1.0	1.0	2.0	2.0	4.0	4.0	4.0	6.0
480	0.5	0.5	0.5	1.0	2.0	2.0	4.0	4.0	4.0	6.0
550	0.5	0.5	0.5	1.0	1.0	2.0	2.0	4.0	4.0	4.0
575	0.5	0.5	0.5	1.0	1.0	2.0	2.0	4.0	4.0	4.0
600	0.5	0.5	0.5	1.0	2.0	2.0	2.0	4.0	4.0	4.0

Acceptable Maximum Rating of Secondary Overcurrent Protection ^①

Miniature Fuses 5 x 20 mm Timelag (IEC 127-2/III)

Sec. Voltage	50	75	100	150	200	250	300	350	500	750
23	2.50	4.00	5.00	8.00	10.0	12.00	16.00	16.00	25.00	—
24	2.50	4.00	5.00	8.00	10.0	12.00	16.00	16.00	25.00	32.00
25	2.50	4.00	5.00	8.00	10.0	12.00	16.00	16.00	25.00	32.00
90	0.63	1.00	1.25	2.00	2.50	3.15	4.00	4.00	6.30	10.00
95	0.63	0.80	1.25	1.60	2.50	3.15	4.00	4.00	6.30	8.00
100	0.50	0.80	1.00	1.60	2.00	2.50	3.15	4.00	5.00	8.00
110	0.50	0.80	1.00	1.60	2.00	2.50	3.15	4.00	5.00	8.00
115	0.50	0.80	1.00	1.60	2.00	2.50	3.15	3.15	5.00	8.00
120	0.50	0.63	1.00	1.25	2.00	2.50	2.50	3.15	5.00	6.30
220	0.25	0.40	0.50	0.80	1.00	1.25	1.60	1.60	2.50	4.00
230	0.25	0.40	0.50	0.80	1.00	1.25	1.60	1.60	2.50	4.00
240	0.25	0.32	0.50	0.63	1.00	1.25	1.25	1.60	2.50	3.15

Regulation Data Chart

Transformer VA Rating	Inrush VA at 20% Power Factor		
	NEMA/IEC 95% Sec. Voltage	NEMA/IEC 90% Sec. Voltage	NEMA/IEC 85% Sec. Voltage
25 ^②	100/—	130/—	150/—
50 ^②	170/190	200/220	240/270
75 ^②	310/350	410/460	450/600
100 ^②	370/410	540/600	730/810
150 ^③	780/850	930/1030	1150/1270
200 ^③	810/900	1150/1270	1450/1600
250 ^③	1400/1540	1900/2090	2300/2530
300 ^③	1900/2090	2700/2970	3850/4240
350 ^③	3100/3410	3650/4020	4800/5280
500 ^③	4000/4400	5300/5830	7000/7700
750 ^③	8300/9130	11,000/12,100	14,000/15,400
1000 ^③	15,000/16,500	21,000/23,000	27,000/29,500
1000 ^④	9000/9900	13,000/14,300	18,500/20,300
1500 ^④	10,500/11,500	15,000/16,500	20,500/22,500
2000 ^④	17,000/18,900	25,500/27,300	34,000/36,400
3000 ^④	24,000/25,700	36,000/38,500	47,500/50,200
5000 ^④	55,000/58,800	92,500/98,900	115,000/122,000

Notes

^① For values over 6.3A, use 10 x 38 mm timelag (IEC - 269-3-1). T_a = 40°C control type.

^② For units with Class 105°C insulation system.

^③ For units with Class 130°C insulation system.

^④ For units with Class 180°C insulation system.

To comply with NEMA standards that require all magnetic devices to operate successfully at 85% of rated voltage, the 90% secondary column is most often used in selecting a transformer. No comparable requirement is available for IEC.

Type AP Transformer



Contents

Description	Page
Type MTE	V7-T7-4
Type MTK	V7-T7-13
CE Marked	V7-T7-18
Type AP	
Catalog Number Selection	V7-T7-26
Product Selection	V7-T7-26
Technical Data and Specifications	V7-T7-26

Type AP

Product Description

- Encapsulated designs

Application Description

Transformers provide stepped-down voltages to machine tool control devices, enabling control circuits to be isolated from all power and lighting circuits. This allows the use of grounded or ungrounded circuits that are independent of the power or lighting grounds; thus, greater safety is afforded the operator. The control transformer line is particularly adaptable on applications where compact construction is demanded.

Features, Benefits and Functions

- Resin encapsulated
- 60 Hz operation
- 180°C insulation system
- 115°C rise standard; 80°C rise optional
- Convenient screw-type terminal board
- Bottom or side/wall-mounting designs
- Performance meets/exceeds requirements of ANSI/NEMA ST-1
- Regulation exceeds ANSI/NEMA requirements for all ratings

Standards and Certifications

- UL recognized



Industry Standards

All Eaton dry-type distribution and control transformers are built and tested in accordance with applicable NEMA, ANSI and IEEE Standards.

Catalog Number Selection

Please refer to **Page V7-T7-3**.

Product Selection

Additional Product Selection information is available in Volume 2, **CA08100003E**.

240/480 Volts to 120/240 Volts, 60 Hz

kVA	Mounting	Frame	Wiring Diagram ①	Weight Lbs (kg)	Style Number
3	Bottom	FR133	5	65 (29.5)	C0003P7GB
5	Bottom	FR99	5	104 (47.2)	C0005P7GB
7.5	Bottom	FR100	5	129 (58.6)	C0007P7GB
10	Bottom	FR101	5	148 (67.2)	C0010P7GB
15	Bottom	FR134	5	197 (89.4)	C0015P7GB
3	Side/Wall	FR292	5	65 (29.5)	C0003P7GS
5	Side/Wall	FR256	5	104 (47.2)	C0005P7GS
7.5	Side/Wall	FR257	5	129 (58.6)	C0007P7GS
10	Side/Wall	FR258	5	148 (67.2)	C0010P7GS
15	Side/Wall	FR259	5	197 (89.4)	C0015P7GS

Technical Data and Specifications**Overload Capability**

Short-term overload is designed into transformers as required by ANSI. Dry-type distribution transformers will deliver 200% nameplate load for one-half hour, 150% load for one hour and 125% load for four hours without being damaged, provided that a constant 50% load precedes and follows the overload. See ANSI C57.96-01.250 for additional limitations.

Continuous overload capacity is not deliberately designed into a transformer because the design objective is to be within the allowed winding temperature rise with nameplate loading.

Insulation System and Temperature Rise

Industry standards classify insulation systems and rise as shown below:

Insulation System Classification

Ambient	+ Winding Rise	+ Hot Spot	= Temp. Class
40°C	55°C	10°C	105°C
40°C	80°C	30°C	150°C
25°C	135°C	20°C	180°C
40°C	115°C	30°C	185°C
40°C	150°C	30°C	220°C

The design life of transformers having different insulation systems is the same—the lower-temperature systems are designed for the same life as the higher-temperature systems.

Sound Levels

All Eaton 600 volt class general-purpose dry-type distribution transformers are designed to meet NEMA ST-20 levels.

Winding Terminations

Eaton recommends external cables be rated 90°C (sized at 75°C ampacity) for encapsulated designs.

Series-Multiple Windings

Series-multiple windings consist of two similar coils in each winding that can be connected in series or parallel (multiple). Transformers with series-multiple windings are designated with an “x” or “/” between the voltage ratings, such as voltages of “120/240” or “240 x 480.” If the series-multiple winding is designated by an “x,” the winding can be connected only for a series or parallel.

With the “/” designation, a mid-point also becomes available in addition to the series or parallel connection. As an example, a 120 x 240 winding can be connected for either 120 (parallel) or 240 (series), but a 120/240 winding can be connected for 120 (parallel), 240 (series) or 240 with a 120 mid-point.

For additional information, please refer to Volume 2, **CA08100003E**.

Note: For additional information, refer to Eaton’s Industrial Control Transformer Binder B1228A. For other ratings or styles not shown, or for special enclosure types (including stainless steel), refer to Eaton.

Note

① See **Page V7-T7-22** for wiring diagrams.

Terminal Blocks, Fuse Blocks and Fuse Holders

Screw Connection



Spring Cage



Insulation Displacement Connection



8.1 IEC—XB Series

IEC— XB Series Overview	V7-T8-2
Screw Connection Terminal Blocks	V7-T8-4
Spring Cage Terminal Blocks	V7-T8-31
Pluggable Spring Cage Connection Terminal Blocks	V7-T8-58
IDC Terminal Blocks	V7-T8-67
Miniature Circuit Breakers	V7-T8-82
XB Series Accessories	V7-T8-90

8.2 NEMA

NEMA Overview	V7-T8-104
C381 Series Terminal Blocks, Rail Mounted	V7-T8-105
TB Series Terminal Blocks, Modular	V7-T8-109

8.3 Power Distribution

Power Distribution Overview	V7-T8-114
CHDB Series—Power Distribution Blocks	V7-T8-115
CH160 Series—Power Terminal Blocks	V7-T8-121
Power Terminal Block Accessories	V7-T8-124

8.4 Fuse Blocks and Fuse Holders

Fuse Blocks and Fuse Holders Overview	V7-T8-126
C383 Series Disconnect Fuse Holders	V7-T8-127
C350 Series Fuse Blocks and W Series Fuse Holders	V7-T8-129



8.1

Terminal Blocks, Fuse Blocks and Fuse Holders

IEC—XB Series

IEC—XB Series

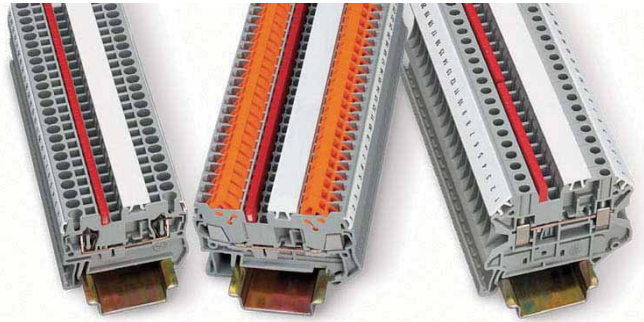

8

IEC—XB Series Overview

Product Description

The **XB** Series from Eaton offers a complete terminal block system with a universal range of accessories. Marking, bridging and testing accessories are standardized across the different termination technologies—reducing inventory and logistics costs. The modular terminal block design allows for use of the different terminal block types together or individually, providing the highest degree of flexibility.

Application Description

The metal portion of the **XB** Series terminal blocks are made from high-grade, strain-crack and corrosion-proof copper alloys. They won't experience any electrolytic corrosion or rusting, even when moisture is present. The metal surfaces are protected with a lead-free, galvanic nickel or tin plating. The good electrical conductivity permits only a low temperature rise. The Polyamide 6.6 housings allow for operating temperatures up to 257°F (125°C) and are certified for inflammability Class V0 in accordance with UL 94.

Features

Global acceptance—The **XB** Series terminal blocks are designed to worldwide standards and meet the latest international requirements.

Flexible Plug-in bridge system—All three technologies (screw, spring and IDC) use the same bridge system, allowing for individual potential distribution and quickly bridged connections among the same terminal block type or across different types. The **XB** Series terminal blocks have two bridge shafts arranged in one line, making flexible chain bridging and skip bridging between non-adjacent terminal blocks possible. Plug-in bridges are available from 2 to 50 positions. Reducing bridges are also available to connect a larger terminal block to a smaller one.

Contents

Description

Description	Page
IEC— XB Series	
Screw Connection Terminal Blocks	V7-T8-4
Spring Cage Terminal Blocks	V7-T8-31
Pluggable Spring Cage Connection Terminal Blocks.	V7-T8-58
IDC Terminal Blocks	V7-T8-67
Miniature Circuit Breakers.	V7-T8-82
XB Series Accessories	V7-T8-90

Large surface area for marking—All **XB** Series terminal blocks have generously sized surface areas for labeling. This allows for clearly labeled wiring that results in reduced startup time and simplifies activities such as testing and maintenance. There are provisions for marking individual terminal blocks and end stops, strips of terminal blocks, and large groups of terminal blocks.

Standardized testing system—All test plugs make contact in one of the easily accessible bridge shafts. A 2.3 mm diameter test plug is available for individual measuring wires. Modular test plugs are also available for more advanced testing.

Standards and Certifications

- UL® and cUL® recognized—File No. E67464
- CE approved
- LVD ①
 - EN 60947-7-1
 - EN 60947-7-2
 - EN 60998-2-3
 - EN 60352-4/A1



Note

① Not all standards apply to all terminal blocks. Contact Eaton for details.

Technical Data and Specifications**IEC—XB Series**

Description	Specification
Insulation material	Polyamide 6.6
Dielectric strength	600 kV/cm
Creep resistance	600 CTI
Internal insulation resistance	10^{12} ohms cm
Surface resistance	10^{10} ohms
Flammability rating	UL 94 V0
Continuous operating temperature	–40 to 257°F (–40 to 125°C)

8.1

Terminal Blocks, Fuse Blocks and Fuse Holders

IEC—XB Series

Screw Connection



8

Contents

Description

	<i>Page</i>
Screw Connection Terminal Blocks	
Single Level—Through-Feed	V7-T8-5
Single Level—Ground Blocks	V7-T8-10
Multi-Conductor Terminal Blocks	V7-T8-12
Multi-Conductor Ground Blocks	V7-T8-14
Double Level	V7-T8-16
Triple Level Sensor/Actuator	V7-T8-18
Fuse Terminal Blocks	V7-T8-21
Disconnect and Component Terminal Blocks	V7-T8-24
High Current Blocks	V7-T8-27
Mini Screw Connection	V7-T8-29



Drawings
Online

Screw Connection Terminal Blocks Overview

Product Description

The XBUT Series uses a screw connection system that is accepted worldwide and is suitable in most applications. The maintenance-free connection provides the reliability you expect from Eaton.

Application Description

Designed for applications with high demands, the XBUT Series screw terminal block has a maintenance-free wire connection. re-tightening of the terminal screws is not necessary to ensure proper operation. The screw locking technique prevents the screws from backing out. Copper wires can be clamped without pre-treatment or ferrules can be used for splicing protection. Multiple conductors can be connected in the same clamping mechanism, saving space.

Features

- Maintenance-free connections
- Global acceptance
- Multi-conductor connections
- Flexible Plug-in bridge system
- Large surface area for marking
- Standardized testing system
- Metal parts made of tin-plated copper alloy

Standards and Certifications

- UL and cUL recognized—File No. E67464
- CE approved
- LVD ①:
 - EN 60947-7-1
 - EN 60947-7-2
 - EN 60998-2-3
 - EN 60352-4/A1



Note

① Not all standards apply to all terminal blocks. Contact Eaton for details.

Single Level—Through-Feed



Single Level—Through-Feed

Product Description

The XBUT terminal blocks feature a compact design and maintenance-free screw connection. There is a double bridge shaft providing maximum flexibility.

The double bridge shaft can accommodate individual chain bridging and step-down bridging from other terminal blocks. There are numerous options for accessories,

Contents

Description

	<i>Page</i>
Single Level—Through-Feed	
Product Selection	V7-T8-6
Accessories	V7-T8-7
Technical Data and Specifications	V7-T8-9
Dimensions	V7-T8-9
Single Level—Ground Blocks	V7-T8-10
Multi-Conductor Terminal Blocks	V7-T8-12
Multi-Conductor Ground Blocks	V7-T8-14
Double Level.	V7-T8-16
Triple Level Sensor/Actuator	V7-T8-18
Fuse Terminal Blocks	V7-T8-21
Disconnect and Component Terminal Blocks	V7-T8-24
High Current Blocks	V7-T8-27
Mini Screw Connection	V7-T8-29

including those for testing and marking. Terminal blocks are available for wire cross-sections ranging from 12 AWG (2.5 mm²) to 2/0 AWG (150 mm²).

8.1

Terminal Blocks, Fuse Blocks and Fuse Holders

IEC—XB Series

Product Selection

XBUT4



Screw Connection Single Level—Through-Feed

Terminal Width	Maximum Wire Size	IEC 60 947-7-1 in V/A/AWG	EN 50 019 in V/A/AWG	UL-cUL Ratings in V/A/AWG	Color	Standard Pack	Catalog Number
5.2 mm	12 AWG/2.5 mm ²	800/32/26–12	750/22/28/26–12	600/20/26–12	Gray	50	XBUT25
					Blue	50	XBUT25BU
6.2 mm	10 AWG/4 mm ²	800/41/26–10	750/30/38/26–10	600/30/26–10	Gray	50	XBUT4
					Blue	50	XBUT4BU
					Orange	50	XBUT4OR
					Yellow	50	XBUT4YE
					Red	50	XBUT4RD
					White	50	XBUT4WH
					Black	50	XBUT4BK
8.2 mm	8 AWG/6 mm ²	800/57/24–8	750/40/50/24–8	600/50/24–8	Gray	50	XBUT6
					Blue	50	XBUT6BU
10.2 mm	6 AWG/10 mm ²	1000/76/20–6	750/54/69/20–6	600/65/20–6	Gray	50	XBUT10
					Blue	50	XBUT10BU
					Orange	50	XBUT10OR
					Yellow	50	XBUT10YE
					Red	50	XBUT10RD
12 mm	4 AWG/16 mm ²	1000/101/17–4	—	600/85/16–4	Gray	50	XBUT16
					Blue	50	XBUT16BU
16 mm	0 AWG/35 mm ²	1000/150/15–0	—	600/150/14–1/0	Gray	50	XBUT35
					Blue	50	XBUT35BU

Accessories

Screw Connection Single Level—Through-Feed

Description	Color	Number of Positions	Standard Pack	XBUT25 Catalog Number	XBUT4 Catalog Number	XBUT6 Catalog Number	XBUT10 Catalog Number	XBUT16 Catalog Number	XBUT35 Catalog Number
End cover	Gray	—	50	XBACUT10	XBACUT10	XBACUT10	XBACUT10	XBACUT16	①
Partition plate	Gray	—	50	XBATUT10	XBATUT10	XBATUT10	XBATUT10	—	—
Plug-in bridge— for cross connections in the bridge shaft	Red	2	10	XBAFBS25	XBAFBS26	XBAFBS28	XBAFBS210	XBAFBS212	XBAFBS216
		3	50	XBAFBS35	XBAFBS36	—	—	—	—
		5	50	XBAFBS55	XBAFBS56	—	—	—	—
		10	10	XBAFBS105	XBAFBS106	—	—	—	—
		50	10	XBAFBS505	XBAFBS506	—	—	—	—
Test adapter	—	—	10	XBATSPA14	XBATSPA14	XBATSPA14	—	—	—
2.3 mm diameter test plug	—	—	—	XBATSMPS- ①	XBATSMPS- ①	—	—	—	—
Modular test plug	—	—	10	XBATSPS5	XBATSPS6	XBATSPS8	—	—	—
Blank marker strip (strip of 10)	White	—	10	XBMZB5 ②	XBMZB6 ②	XBMZB8 ②	XBMZB10 ②	XBMZB12 ②	XBMZB15 ②

Notes

① Enclosed block, no end cover needed.

② For information on Printed Marking Tag Options, see **Page V7-T8-98**.For additional accessories, see **Page V7-T8-90**.

8.1

Terminal Blocks, Fuse Blocks and Fuse Holders

IEC—XB Series

XBUT with Reducing Bridge

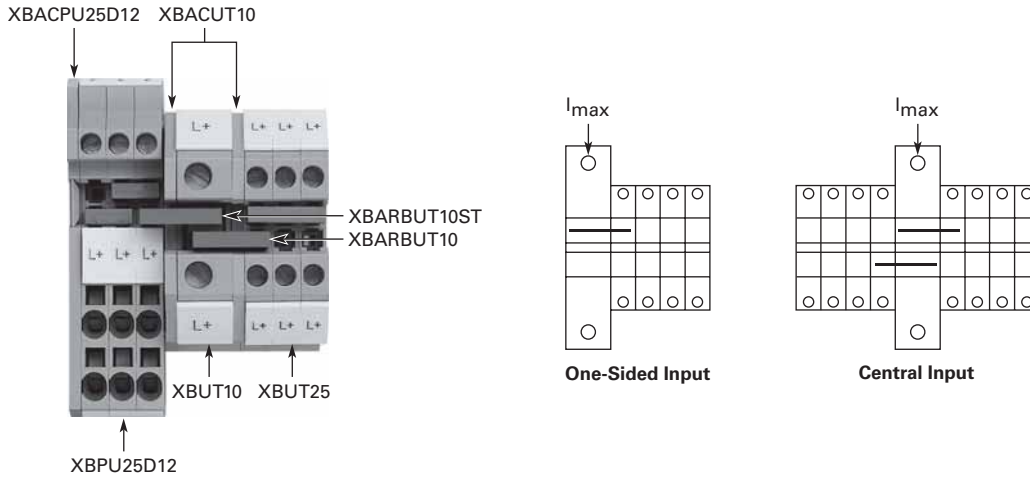

8

Step-Down Bridge with Standard Feed-Through Terminal Blocks

Input Terminal Blocks	Cross-Section	Pick-Off Terminal Blocks	Cross-Section AWG (mm ²)	One-Sided Input I _{max}	Central Input I _{max}	Bridge Catalog Number
XBUT10	6 AWG (10 mm ²)	XBUT25	12 (2.5)	40	65	XBARBUT10
		XBUT4	10 (4)	45	65	XBARBUT10
		XBPT25	12 (2.5)	40	65	XBARBUT10ST
		XBPT4	10 (4)	45	65	XBARBUT10ST
		XBQT15	14 (1.5)	35	65	XBARBUT10ST
		XBQT25	12 (2.5)	40	65	XBARBUT10ST
XBUT16	4 AWG (16 mm ²)	XBUT25	12 (2.5)	40	80	XBARBUT16
		XBUT4	10 (4)	45	90	XBARBUT16
		XBPT25	12 (2.5)	40	80	XBARBUT16ST
		XBPT4	10 (4)	45	90	XBARBUT16ST
		XBQT15	14 (1.5)	35	70	XBARBUT16ST
		XBQT25	12 (2.5)	40	80	XBARBUT16ST

Technical Data and Specifications

Screw Connection Single Level—Through-Feed

Description	XBUT25	XBUT4	XBUT6	XBUT10	XBUT16	XBUT35
Technical Data in Accordance with IEC						
Maximum load current in A/cross-section in mm ²	32/4	41/6	57/10	76/16	101/25	150/50
Rated surge voltage in kV/contamination class	8/3	8/3	8/3	8/3	8/3	8/3
Surge voltage category/insulating material group	III/II	III/I	III/I	III/I	III/I	III/I
Connection Capacity						
Stranded with ferrule/with ferrule and plastic sleeve in mm ²	0.25–2.5/0.25–2.5	0.25–4/0.25–4	0.25–6/0.25–6	0.5–10/0.5–10	1.0–16/1.0–16	1.5–35/1.5–35
Multi-Conductor Connection (same cross-section)						
Solid/stranded in mm ²	0.14–1.5/0.14–1.5	0.14–1.5/0.14–1.5	0.2–2.5/0.2–2.5	0.5–4/0.5–4	1.0–6/1.0–4	1.5–16/1.5–10
Stranded with ferrules without plastic sleeve in mm ²	0.25–1.5	0.25–1.5	0.25–1.5	0.5–2.5	1.0–4	1.5–10
Stranded with twin ferrule with plastic sleeve in mm ²	0.5–1.5	0.5–2.5	0.5–4	0.5–6	0.75–10	1.5–10
Stripping length in inches (mm)	0.35 (9)	0.35 (9)	0.39 (10)	0.39 (10)	0.39 (10)	0.63 (16)
Thread	M3	M3	M4	M4	M5	M6
Torque in in-lb (Nm)	5.3–7.1 (0.6–0.8)	5.3–7.1 (0.6–0.8)	13.3–15.9 (1.5–1.8)	13.3–15.9 (1.5–1.8)	22.1–26.6 (2.5–3)	28.3–32.7 (3.2–3.7)

Dimensions

Approximate Dimensions in Inches (mm)

Screw Connection Single Level—Through-Feed

Catalog Number	Width	Length	Cover Width	Height for—	
				35 x 7.5 in	35 x 15 in
XBUT25	0.20 (5.2)	1.85 (46.9)	0.09 (2.2)	1.87 (47.5)	2.17 (55.0)
XBUT4	0.24 (6.2)	1.85 (46.9)	0.09 (2.2)	1.87 (47.5)	2.17 (55.0)
XBUT6	0.32 (8.2)	1.85 (46.9)	0.09 (2.2)	1.87 (47.5)	2.17 (55.0)
XBUT10	0.40 (10.2)	1.85 (46.9)	0.09 (2.2)	1.87 (47.5)	2.17 (55.0)
XBUT16	0.47 (12.0)	2.08 (52.8)	0.09 (2.2)	2.16 (54.8)	2.45 (62.3)
XBUT35	0.63 (16.0)	2.37 (60.2)	—	2.59 (65.7)	2.88 (73.2)

Notes

- ① XBUT35 has an enclosed design. The use of an end cover is not required.
- ② For information on Printed Marking Tag Options, see **Page V7-T8-98**.

8.1

Terminal Blocks, Fuse Blocks and Fuse Holders

IEC—XB Series

Single Level—Ground Blocks



Contents

Description

<i>Description</i>	<i>Page</i>
Single Level—Through-Feed	V7-T8-5
Single Level—Ground Blocks	
Accessories	V7-T8-11
Technical Data and Specifications	V7-T8-11
Dimensions	V7-T8-11
Multi-Conductor Terminal Blocks	V7-T8-12
Multi-Conductor Ground Blocks	V7-T8-14
Double Level	V7-T8-16
Triple Level Sensor/Actuator	V7-T8-18
Fuse Terminal Blocks	V7-T8-21
Disconnect and Component Terminal Blocks	V7-T8-24
High Current Blocks	V7-T8-27
Mini Screw Connection	V7-T8-29

8

Single Level—Ground Blocks

Product Description

The ground terminal blocks have the same shape and pitch as the standard terminal block, in a green-yellow housing. They easily snap

onto the DIN rail to make a reliable mechanical and electrical contact that meets all requirements of IEC 60-947-7-2.

Product Selection

XBUT6PE



Screw Connection Single Level—Ground Blocks

Terminal Width	Maximum Wire Size	IEC 60 947-7-1 in V/A/AWG	EN 50 019 in V/A/AWG	UL-cUL Ratings in V/A/AWG	Color	Standard Pack	Catalog Number
5.2 mm	12 AWG/2.5 mm ²	—/—/26-12	—/—/26-12	—/—/26-12	Green/Yellow	50	XBUT25PE
6.2 mm	10 AWG/4 mm ²	—/—/26-10	—/—/26-10	—/—/26-10	Green/Yellow	50	XBUT4PE
8.2 mm	8 AWG/6 mm ²	—/—/24-8	—/—/24-8	—/—/24-8	Green/Yellow	50	XBUT6PE
10.2 mm	6 AWG/10 mm ²	—/76/20-6	—/54/69/20-6	—/—/20-6	Green/Yellow	50	XBUT10PE
12 mm	4 AWG/16 mm ²	—/101/15-4	—	—/—/16-4	Green/Yellow	50	XBUT16PE
16 mm	2 AWG/35 mm ²	—/125/15-2	—	—/—/14-1/0	Green/Yellow	50	XBUT35PE

Accessories

Screw Connection Single Level—Ground Blocks

Description	Color	Number of Positions	Standard Pack	XBUT25PE Catalog Number	XBUT4PE Catalog Number	XBUT6PE Catalog Number	XBUT10PE Catalog Number	XBUT16PE Catalog Number	XBUT35PE Catalog Number
End cover	Gray	—	50	XBACUT10	XBACUT10	XBACUT10	XBACUT10	XBACUT16	③
Partition plate	—	—	50	XBATUT10	XBATUT10	XBATUT10	XBATUT10	—	—
Plug-in bridge— for cross connections in the bridge shaft	Red	2	10	XBAFBS25	XBAFBS26	XBAFBS28	XBAFBS210	XBAFBS212	XBAFBS212
		3	50	XBAFBS35	XBAFBS36	—	—	—	—
		5	50	XBAFBS55	XBAFBS56	—	—	—	—
		10	10	XBAFBS105	XBAFBS106	—	—	—	—
		50	10	XBAFBS505	XBAFBS506	—	—	—	—
Test adapter	—	—	10	XBATSPA14	XBATSPA14	XBATSPA14	—	—	—
2.3 mm diameter test plug	—	—	—	XBATSMPS_ ①	XBATSMPS_ ①	—	—	—	—
Modular test plug	—	—	10	XBATSPS5	XBATSPS6	XBATSPS8	—	—	—
Blank marker strip (strip of 10)	White	—	10	XBMZB5 ②	XBMZB6 ②	XBMZB8 ②	XBMZB10 ②	XBMZB12 ②	XBMZB15 ②

Technical Data and Specifications

Screw Connection Single Level—Ground Blocks

Description	XBUT25PE	XBUT4PE	XBUT6PE	XBUT10PE	XBUT16PE	XBUT35PE
Technical Data in Accordance with IEC						
Maximum load current in A/cross-section in mm ²	—	—	—	76/16	101/25	125/50
Rated surge voltage in kV/contamination class	8/3	8/3	8/3	8/3	8/3	8/3
Surge voltage category/insulating material group	III/II	III/I	III/I	III/I	III/I	III/I
Connection Capacity						
Stranded with ferrule/with ferrule and plastic sleeve in mm ²	0.25–2.5/0.25–2.5	0.25–4/0.25–4	0.25–6/0.25–6	0.5–10/0.5–10	1.0–16/1.0–16	1.5–35/1.5–35
Multi-Conductor Connection (same cross-section)						
Solid/stranded in mm ²	0.14–1.5/0.14–1.5	0.14–1.5/0.14–1.5	0.2–2.5/0.2–2.5	0.5–4/0.5–4	1.0–6/1.0–4	1.5–16/1.5–10
Stranded with ferrules without plastic sleeve in mm ²	0.25–1.5	0.25–1.5	0.25–1.5	0.5–2.5	1.0–4	1.5–10
Stranded with twin ferrule with plastic sleeve in mm ²	0.5–1.5	0.5–2.5	0.5–4	0.5–6	0.75–10	1.5–10
Stripping length in inches (mm)	0.35 (9)	0.35 (9)	0.39 (10)	0.39 (10)	0.39 (10)	0.63 (16)
Thread	M3	M3	M4	M4	M5	M6
Torque in in-lb (Nm)	5.3–7.1 (0.6–0.8)	5.3–7.1 (0.6–0.8)	13.3–15.9 (1.5–1.8)	13.3–15.9 (1.5–1.8)	22.1–26.6 (2.5–3)	28.3–32.7 (3.2–3.7)

Dimensions

Approximate Dimensions in Inches (mm)

Screw Connection Single Level—Ground Blocks

Catalog Number	Width	Length	Cover Width	Height for—	
				35 x 7.5 in	35 x 15 in
XBUT25PE	0.20 (5.2)	1.85 (46.9)	0.09 (2.2)	1.87 (47.5)	2.17 (55.0)
XBUT4PE	0.24 (6.2)	1.85 (46.9)	0.09 (2.2)	1.87 (47.5)	2.17 (55.0)
XBUT6PE	0.32 (8.2)	1.85 (46.9)	0.09 (2.2)	1.87 (47.5)	2.17 (55.0)
XBUT10PE	0.40 (10.2)	1.85 (46.9)	0.09 (2.2)	1.87 (47.5)	2.17 (55.0)
XBUT16PE	0.47 (12.0)	2.08 (52.8)	0.09 (2.2)	2.16 (54.8)	2.45 (62.3)
XBUT35PE	0.63 (16.0)	2.37 (60.2)	—	2.59 (65.7)	2.88 (73.2)

Notes

- ① For ordering information, see **Page V7-T8-103**.
 ② For information on Printed Marking Tag Options, see **Page V7-T8-98**.
 ③ XBUT35PE has an enclosed design. The use of an end cover is not required.

For additional accessories, see **Page V7-T8-90**.

8.1

Terminal Blocks, Fuse Blocks and Fuse Holders

IEC—XB Series

Multi-Conductor Terminal Blocks

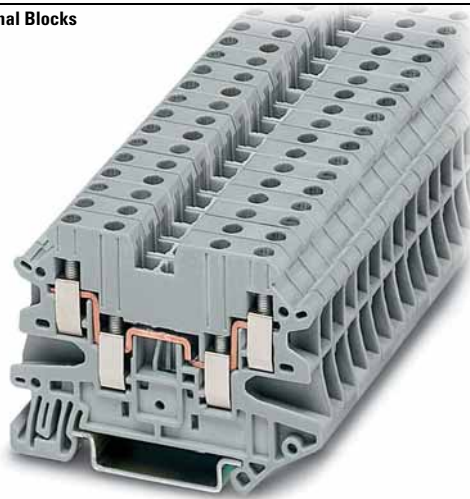

Contents

Description	Page
Single Level—Through-Feed	V7-T8-5
Single Level—Ground Blocks	V7-T8-10
Multi-Conductor Terminal Blocks	
Accessories	V7-T8-13
Technical Data and Specifications	V7-T8-13
Dimensions	V7-T8-13
Multi-Conductor Ground Blocks	V7-T8-14
Double Level	V7-T8-16
Triple Level Sensor/Actuator	V7-T8-18
Fuse Terminal Blocks	V7-T8-21
Disconnect and Component Terminal Blocks	V7-T8-24
High Current Blocks	V7-T8-27
Mini Screw Connection	V7-T8-29

8

Multi-Conductor Terminal Blocks

Product Description

The multi-conductor terminal blocks offer a space-saving alternative to standard feed-through terminal blocks allowing for high density wiring. Often, three

connections have to be led to one terminal block. The XBUT...D12 terminal block accomplishes this without any additional terminal blocks or bridging required.

The XBUT...D22 terminal blocks allow four wires to be connected to one potential—and can therefore be used as compact power distributors.

Product Selection

XBUT25D12



Screw Connection Multi-Conductor Terminal Blocks, Three-Wire

Terminal Width	Maximum Wire Size	IEC 60 947-7-1 in V/A/AWG	UL-cUL Ratings in V/A/AWG	Color	Standard Pack	Catalog Number
5.2 mm	12 AWG/2.5 mm ²	500/28/26–12	150/20/26–12	Gray	50	XBUT25D12
				Blue	50	XBUT25D12BU
6.2 mm	10 AWG/4 mm ²	500/39/26–10	150/30/26–10	Gray	50	XBUT4D12
				Blue	50	XBUT4D12BU

XBUT4D22



Screw Connection Multi-Conductor Terminal Blocks, Four-Wire

Terminal Width	Maximum Wire Size	IEC 60 947-7-1 in V/A/AWG	UL-cUL Ratings in V/A/AWG	Color	Standard Pack	Catalog Number
5.2 mm	12 AWG/2.5 mm ²	500/28/26–12	150/20/26–12	Gray	50	XBUT25D22
				Blue	50	XBUT25D22BU
6.2 mm	10 AWG/4 mm ²	500/39/26–10	150/30/26–10	Gray	50	XBUT4D22
				Blue	50	XBUT4D22BU

Accessories

Screw Connection Multi-Conductor Terminal Blocks

Description	Color	Number of Positions	Standard Pack	XBUT25D12	XBUT4D12	XBUT25D22	XBUT4D22
				Catalog Number	Catalog Number	Catalog Number	Catalog Number
End cover	Gray	—	50	XBACUT4D12	XBACUT4D12	XBACUT4D22	XBACUT4D22
End cover segment	Gray	—	50	XBASUT4	XBASUT4	XBASUT4	XBASUT4
Partition plate	—	—	50	XBATUTD12	XBATUTD12	XBATUTD22	XBATUTD22
Plug-in bridge—for cross connections in the bridge shaft	Red	2	10	XBAFBS25	XBAFBS26	XBAFBS25	XBAFBS26
		3	50	XBAFBS35	XBAFBS36	XBAFBS35	XBAFBS36
		5	50	XBAFBS55	XBAFBS56	XBAFBS55	XBAFBS56
		10	10	XBAFBS105	XBAFBS106	XBAFBS105	XBAFBS106
		50	10	XBAFBS505	XBAFBS506	XBAFBS505	XBAFBS506
Test adapter	—	—	10	XBATSPAI4	XBATSPAI4	XBATSPAI4	XBATSPAI4
2.3 mm diameter test plug	—	—	—	XBATSMPS-^①	XBATSMPS-^①	XBATSMPS-^①	XBATSMPS-^①
Modular test plug	—	—	10	XBATSPS5	XBATSPS6	XBATSPS5	XBATSPS6
Blank marker strip (strip of 10)	White	—	10	XBMZB5^②	XBMZB6^②	XBMZB5^②	XBMZB6^②

Technical Data and Specifications

Screw Connection Multi-Conductor Terminal Blocks

Description	XBUT25D12	XBUT4D12	XBUT25D22	XBUT4D22
Technical Data in Accordance with IEC				
Maximum load current in A/cross-section in mm ²	28/4	39/6	28/4	39/6
Rated surge voltage in kV/contamination class	6/3	6/3	6/3	6/3
Surge voltage category/insulating material group	III/I	III/I	III/I	III/I
Connection Capacity				
Stranded with ferrule/with ferrule and plastic sleeve in mm ²	0.25–2.5/0.25–2.5	0.25–4/0.25–4	0.25–2.5/0.25–2.5	0.25–4/0.25–4
Multi-Conductor Connection (same cross-section)				
Solid/stranded in mm ²	0.14–1.0/0.14–1.0	0.14–1.0/0.14–1.5	0.14–1.0/0.14–1.0	0.14–1.0/0.14–1.5
Stranded with ferrules without plastic sleeve in mm ²	0.25–1.0	0.25–1.5	0.25–1.0	0.25–1.5
Stranded with twin ferrule with plastic sleeve in mm ²	0.5–1.0	0.5–1.0	0.5–1.0	0.5–1.0
Stripping length in inches (mm)	0.31 (8)	0.31 (8)	0.31 (8)	0.31 (8)
Thread	M3	M3	M3	M3
Torque in in-lb (Nm)	5.3–7.1 (0.6–0.8)	5.3–7.1 (0.6–0.8)	5.3–7.1 (0.6–0.8)	5.3–7.1 (0.6–0.8)

Dimensions

Approximate Dimensions in Inches (mm)

Screw Connection Multi-Conductor Terminal Blocks

Catalog Number	Width	Length	Cover Width	Height for—	
				35 x 7.5 in	35 x 15 in
XBUT25D12	0.20 (5.2)	2.24 (56.8)	0.09 (2.2)	1.87 (47.5)	2.17 (55.0)
XBUT4D12	0.24 (6.2)	2.24 (56.8)	0.09 (2.2)	1.87 (47.5)	2.17 (55.0)
XBUT25D22	0.20 (5.2)	2.52 (64.1)	0.09 (2.2)	1.87 (47.5)	2.17 (55.0)
XBUT4D22	0.24 (6.2)	2.52 (64.1)	0.09 (2.2)	1.87 (47.5)	2.17 (55.0)

Notes

^① For ordering information, see **Page V7-T8-103**.

^② For information on Printed Marking Tag Options, see **Page V7-T8-98**.

For additional accessories, see **Page V7-T8-90**.

8.1

Terminal Blocks, Fuse Blocks and Fuse Holders

IEC—XB Series

Multi-Conductor Ground Blocks

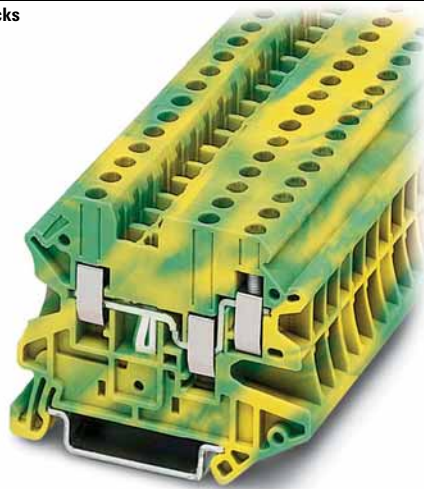

Contents

Description

	<i>Page</i>
Single Level—Through-Feed	V7-T8-5
Single Level—Ground Blocks	V7-T8-10
Multi-Conductor Terminal Blocks	V7-T8-12
Multi-Conductor Ground Blocks	
Accessories	V7-T8-15
Technical Data and Specifications	V7-T8-15
Dimensions	V7-T8-15
Double Level	V7-T8-16
Triple Level Sensor/Actuator	V7-T8-18
Fuse Terminal Blocks	V7-T8-21
Disconnect and Component Terminal Blocks	V7-T8-24
High Current Blocks	V7-T8-27
Mini Screw Connection	V7-T8-29

8

Multi-Conductor Ground Blocks

Product Description

The ground terminal blocks have the same shape and pitch as the standard terminal block, in a green-yellow housing. They easily snap

onto the DIN rail to make a reliable mechanical and electrical contact that meets all requirements of IEC 60-947-7-2.

Product Selection

XBUT4D12PE



Screw Connection Multi-Conductor Ground Blocks—Three-Wire

Terminal Width	Maximum Wire Size	IEC 60 947-7-1 in V/A/AWG	UL-cUL Ratings in V/A/AWG	Color	Standard Pack	Catalog Number
5.2 mm	12 AWG/2.5 mm ²	—/—/26-12	—/—/26-12	Green/Yellow	50	XBUT25D12PE
6.2 mm	10 AWG/4 mm ²	—/—/26-10	—/—/26-10	Green/Yellow	50	XBUT4D12PE

XBUT25D22PE



Screw Connection Multi-Conductor Ground Blocks—Four-Wire

Terminal Width	Maximum Wire Size	IEC 60 947-7-1 in V/A/AWG	UL-cUL Ratings in V/A/AWG	Color	Standard Pack	Catalog Number
5.2 mm	12 AWG/2.5 mm ²	—/—/26-12	—/—/26-12	Green/Yellow	50	XBUT25D22PE
6.2 mm	10 AWG/4 mm ²	—/—/26-10	—/—/26-10	Green/Yellow	50	XBUT4D22PE

Accessories

Screw Connection Multi-Conductor Ground Blocks

Description	Color	Number of Positions	Standard Pack	XBUT25D12PE	XBUT4D12PE	XBUT25D22PE	XBUT4D22PE
				Catalog Number	Catalog Number	Catalog Number	Catalog Number
End cover	Gray	—	50	XBACUT4D12	XBACUT4D12	XBACUT4D22	XBACUT4D22
End cover segment	Gray	—	50	XBASUT4	XBASUT4	XBASUT4	XBASUT4
Partition plate	—	—	50	XBATUTD12	XBATUTD12	XBATUTD22	XBATUTD22
Plug-in bridge—for cross connections in the bridge shaft	Red	2	10	XBAFBS25	XBAFBS26	XBAFBS25	XBAFBS26
		3	50	XBAFBS35	XBAFBS36	XBAFBS35	XBAFBS36
		5	50	XBAFBS55	XBAFBS56	XBAFBS55	XBAFBS56
		10	10	XBAFBS105	XBAFBS106	XBAFBS105	XBAFBS106
		50	10	XBAFBS505	XBAFBS506	XBAFBS505	XBAFBS506
Test adapter	—	—	10	XBATSPA14	XBATSPA14	XBATSPA14	XBATSPA14
2.3 mm diameter test plug	—	—	—	XBATSMPS-^①	XBATSMPS-^①	XBATSMPS-^①	XBATSMPS-^①
Modular test plug	—	—	10	XBATSPS5	XBATSPS5	XBATSPS5	XBATSPS5
Blank marker strip (strip of 10)	White	—	10	XBMZB5^②	XBMZB6^②	XBMZB5^②	XBMZB6^②

Technical Data and Specifications

Screw Connection Multi-Conductor Ground Blocks

Description	XBUT25D12PE	XBUT4D12PE	XBUT25D22PE	XBUT4D22PE
Technical Data in Accordance with IEC				
Maximum load current in A/cross-section in mm ²	—	—	—	—
Rated surge voltage in kV/contamination class	6/3	6/3	6/3	6/3
Surge voltage category/insulating material group	III/I	III/I	III/I	III/I
Connection Capacity				
Stranded with ferrule/with ferrule and plastic sleeve in mm ²	0.25–2.5/0.25–2.5	0.25–4/0.25–4	0.25–2.5/0.25–2.5	0.25–4/0.25–4
Multi-Conductor Connection (same cross-section)				
Solid/stranded in mm ²	0.14–1.0/0.14–1.0	0.14–1.0/0.14–1.5	0.14–1.0/0.14–1.0	0.14–1.0/0.14–1.5
Stranded with ferrules without plastic sleeve in mm ²	0.25–1.0	0.25–1.5	0.25–1.0	0.25–1.5
Stranded with twin ferrule with plastic sleeve in mm ²	0.5–1.0	0.5–1.0	0.5–1	0.5–1
Stripping length in inches (mm)	0.31 (8)	0.31 (8)	0.31 (8)	0.31 (8)
Thread	M3	M3	M3	M3
Torque in in-lb (Nm)	5.3–7.1 (0.6–0.8)	5.3–7.1 (0.6–0.8)	5.3–7.1 (0.6–0.8)	5.3–7.1 (0.6–0.8)

Dimensions

Approximate Dimensions in Inches (mm)

Screw Connection Multi-Connector Ground Blocks

Catalog Number	Width	Length	Cover Width	Height for—	
				35 x 7.5 in	35 x 15 in
XBUT25D12PE	0.20 (5.2)	2.24 (56.8)	0.09 (2.2)	1.87 (47.5)	2.17 (55.0)
XBUT4D12PE	0.24 (6.2)	2.24 (56.8)	0.09 (2.2)	1.87 (47.5)	2.17 (55.0)
XBUT25D22PE	0.20 (5.2)	2.52 (64.1)	0.09 (2.2)	1.87 (47.5)	2.17 (55.0)
XBUT4D22PE	0.24 (6.2)	2.52 (64.1)	0.09 (2.2)	1.87 (47.5)	2.17 (55.0)

Notes

① For ordering information, see **Page V7-T8-103**.② For information on Printed Marking Tag Options, see **Page V7-T8-98**.For additional accessories, see **Page V7-T8-90**.

8.1

Terminal Blocks, Fuse Blocks and Fuse Holders

IEC—XB Series

Double Level

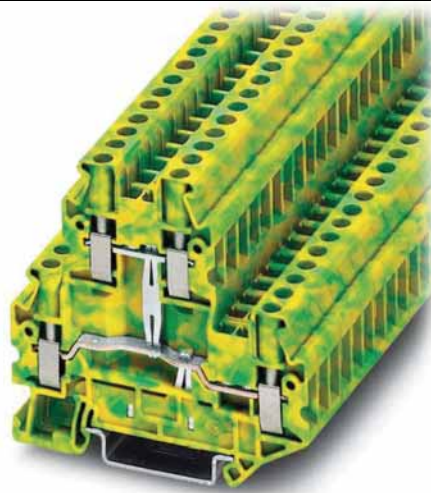

Contents

Description

Description	Page
Single Level—Through-Feed	V7-T8-5
Single Level—Ground Blocks	V7-T8-10
Multi-Conductor Terminal Blocks	V7-T8-12
Multi-Conductor Ground Blocks	V7-T8-14
Double Level	
Accessories	V7-T8-17
Technical Data and Specifications	V7-T8-17
Dimensions	V7-T8-17
Triple Level Sensor/Actuator	V7-T8-18
Fuse Terminal Blocks	V7-T8-21
Disconnect and Component Terminal Blocks	V7-T8-24
High Current Blocks	V7-T8-27
Mini Screw Connection	V7-T8-29

8

Double Level

Product Description

The potentials of the XBUTT double-level terminal blocks are on two levels to reduce space requirements by 50% over single-level terminal

blocks. The XBUTT Series can be bridged on both levels for maximum flexibility. Marking can be provided at each termination point.

Product Selection

XBUTT4



Screw Connection Double Level Blocks, XBUTT4

Terminal Width	Maximum Wire Size	IEC 60 947-7-1 in V/A/AWG	UL-cUL Ratings in V/A/AWG	Color	Standard Pack	Catalog Number
Screw Connection Double Level Blocks						
6.2 mm	10 AWG/4 mm ²	800/36/26–10	300/30/26–10	Gray	50	XBUTT4
				Blue	50	XBUTT4BU
				Red	50	XBUTT4RD
Screw Connection Double Level Block (terminal block with potential distribution between the levels)						
6.2 mm	10 AWG/4 mm ²	800/36/26–10	300/30/26–10	Gray	50	XBUTT4PV

XBUTT4PE



Screw Connection Double Level Ground Block, XBUTT4PE

Terminal Width	Maximum Wire Size	IEC 60 947-7-1 in V/A/AWG	UL-cUL Ratings in V/A/AWG	Color	Standard Pack	Catalog Number
Screw Connection Double Level—Ground Blocks						
6.2 mm	10 AWG/4 mm ²	—/—/26–10	—/—/26–10	Green/Yellow	50	XBUTT4PE

Accessories

Screw Connection Terminal/Ground Blocks, Double Level

Description	Color	Number of Positions	Standard Pack	XBUTT4	XBUTT4PE
				Catalog Number	Catalog Number
End cover	Gray	—	50	XBACUTT4	XBACUTT4
End cover segment	Gray	—	10	XBDPUTT4	XBDPUTT4
Partition plate	—	—	50	XBATUTT4	XBATUTT4
Plug-in bridge—for cross connections in the bridge shaft	Red	2	10	XBAFBS26	XBAFBS26
		3	50	XBAFBS36	XBAFBS36
		5	50	XBAFBS56	XBAFBS56
		10	10	XBAFBS106	XBAFBS106
		50	10	XBAFBS506	XBAFBS506
Test adapter	—	—	10	XBATSPA14	XBATSPA14
2.3 mm diameter test plug	—	—	—	XBATSMPS- ^①	XBATSMPS- ^①
Modular test plug	—	—	10	XBATSPS6	XBATSPS6
Blank marker strip (strip of 10)	White	—	10	XBMZB6 ^②	XBMZB6 ^②

Technical Data and Specifications

Screw Connection Double Level

Description	XBUTT4	XBUTT4PE
Technical Data in Accordance with IEC		
Maximum load current in A/cross-section in mm ²	30/6	—/6
Rated surge voltage in kV/contamination class	8/3	6/3
Surge voltage category/insulating material group	III/I	III/I
Connection Capacity		
Stranded with ferrule/with ferrule and plastic sleeve in mm ²	0.25–4/0.25–4	0.25–4/0.25–4
Multi-Conductor Connection (same cross-section)		
Solid/stranded in mm ²	0.14–1.5/0.14–1.5	0.14–1.5/0.14–1.5
Stranded with ferrules without plastic sleeve in mm ²	0.25–1.5	0.25–1.5
Stranded with twin ferrule with plastic sleeve in mm ²	0.5–2.5	0.5–2.5
Stripping length in inches (mm)	0.35 (9)	0.35 (9)
Thread	M3	M3
Torque in in-lb (Nm)	5.3–7.1 (0.6–0.8)	5.3–7.1 (0.6–0.8)

Dimensions

Approximate Dimensions in Inches (mm)

Screw Connection Double Level

Catalog Number	Width	Length	Cover Width	Height for—	
				35 x 7.5 in	35 x 15 in
XBUTT4	0.24 (6.2)	2.75 (69.9)	0.09 (2.2)	2.56 (65.0)	2.85 (72.5)
XBUTT4PE	0.24 (6.2)	2.75 (69.9)	0.09 (2.2)	2.56 (65.0)	2.85 (72.5)

Notes

^① For ordering information, see **Page V7-T8-103**.

^② For information on Printed Marking Tag Options, see **Page V7-T8-98**.

For additional accessories, see **Page V7-T8-90**.

8.1

Terminal Blocks, Fuse Blocks and Fuse Holders

IEC—XB Series

Triple Level Sensor/Actuator

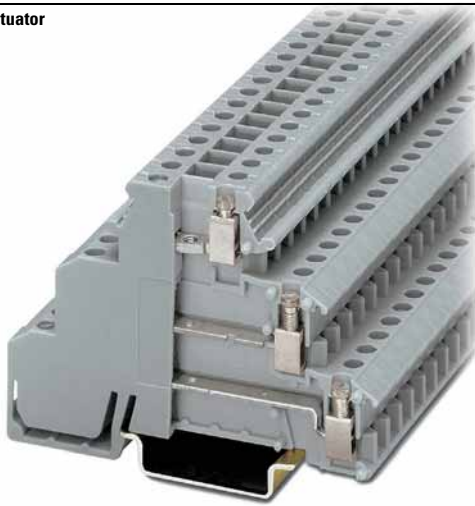

8

Contents

Description

	<i>Page</i>
Single Level—Through-Feed	V7-T8-5
Single Level—Ground Blocks	V7-T8-10
Multi-Conductor Terminal Blocks	V7-T8-12
Multi-Conductor Ground Blocks	V7-T8-14
Double Level	V7-T8-16
Triple Level Sensor/Actuator	
Accessories	V7-T8-19
Technical Data and Specifications	V7-T8-20
Dimensions	V7-T8-20
Fuse Terminal Blocks	V7-T8-21
Disconnect and Component Terminal Blocks	V7-T8-24
High Current Blocks	V7-T8-27
Mini Screw Connection	V7-T8-29

Triple Level Sensor/Actuator

Product Description

The XB3UK sensor terminal blocks reduce installation time by terminating three-wire devices such as photoelectric and proximity sensors in a single terminal block. The XB3UK Series accommodates a design where the positive and negative connections are

grouped so that only the signal lines and one pair of wires for the power supply need to be wired between the terminal box and the control. The upper level accommodates the markable feed-through terminals for the signal line. The two lower terminal points can be

bridged. These are used for the sensor power supply. The positive and negative potential can be fed into the bridges with XB3UKF25. The first sensor can also be connected to this three-wire feed-through block.

Product Selection

XB3UKA25



Screw Connection Triple Level Sensor/Actuator

Terminal Width	Maximum Wire Size	Connection Data in V/A/AWG	IEC 60 947-7-1 in V/A/AWG	UL-cUL Ratings in V/A/AWG	Color	Standard Pack	Catalog Number
Screw Connection Triple Level							
6.2 mm	14 AWG/2.5 mm ²	250/26/24-12	—	300/15/30-14	Gray	50	XB3UKA25
Screw Connection Triple Level with Red LED, 15-30 Vdc, 2.5-7.5A							
6.2 mm	14 AWG/2.5 mm ²	250/26/24-12	—	300/15/30-14	Gray	50	XB3UKA25L24

XB3UKF25



Screw Connection Triple Level Sensor/Actuator

Terminal Width	Maximum Wire Size	Connection Data in V/A/AWG	IEC 60 947-7-1 in V/A/AWG	UL-cUL Ratings in V/A/AWG	Color	Standard Pack	Catalog Number
Screw Connection Triple Level							
6.2 mm	14 AWG/2.5 mm ²	—	250/30/24-12	300/15/30-14	Gray	50	XB3UKF25

XB3UKA25PE



Screw Connection Triple Level Sensor/Actuator

Terminal Width	Maximum Wire Size	Connection Data in V/A/AWG	UL-cUL Ratings in V/A/AWG	Color	Standard Pack	Catalog Number
Screw Connection Triple Level						
6.2 mm	14 AWG/2.5 mm ²	250/26/24–12	300/15/30–14	Gray	50	XB3UKA25PE
Screw Connection Triple Level with Red LED, 15–30 Vdc, 2.5–7.5A						
6.2 mm	14 AWG/2.5 mm ²	250/26/24–12	300/15/30–14	Gray	50	XB3UKA25PEL24

XB3UKF25PE



Screw Connection Triple Level Sensor/Actuator

Terminal Width	Maximum Wire Size	Connection Data in V/A/AWG	UL-cUL Ratings in V/A/AWG	Color	Standard Pack	Catalog Number
Screw Connection Triple Level						
6.2 mm	14 AWG/2.5 mm ²	—	300/15/30–14	Gray	50	XB3UKF25PE

Accessories

Screw Connection Triple Level Sensor/Actuator

Description	Color	Number of Positions	Standard Pack	XB3UKA25	XB3UKF25	XB3UKA25PE	XB3UKF25PE
				Catalog Number	Catalog Number	Catalog Number	Catalog Number
Insertion bridge	Blue	80	1	XBAEB80DIKB	XBAEB80DIKB	XBAEB80DIKB	XBAEB80DIKB
	Red	80	1	XBAEB80DIKR	XBAEB80DIKR	XBAEB80DIKR	XBAEB80DIKR
Insertion bridge	Blue	10	10	XBAEB10DIKB	XBAEB10DIKB	XBAEB10DIKB	XBAEB10DIKB
	Red	10	10	XBAEB10DIKR	XBAEB10DIKR	XBAEB10DIKR	XBAEB10DIKR
Blank marker strip (strip of 10)	White	—	10	XBMZB6 ①	XBMZB6 ②	XBMZB6 ②	XBMZB6 ②

Notes

① For information on Printed Marking Tag Options, see **Page V7-T8-98**.

For additional accessories, see **Page V7-T8-90**.

8.1

Terminal Blocks, Fuse Blocks and Fuse Holders

IEC—XB Series

Technical Data and Specifications

Screw Connection Triple Level Sensor/Actuator

Description	XB3UKA25	XB3UKF25	XB3UKA25PE	XB3UKF25PE
Technical Data in Accordance with IEC				
Maximum load current in A/cross-section in mm ²	26/2.5	30/4	26/2.5	26/2.5
Maximum cross section with insertion bridge solid/stranded in mm ²	4/2.5	4/2.5	4/2.5	4/2.5
Rated surge voltage in kV/contamination class	4/3	4/3	4/3	6/3
Surge voltage category/insulating material group	III/1	III/1	III/1	III/1
Connection Capacity				
Stranded with ferrule/with ferrule and plastic sleeve in mm ²	0.25–2.5/0.25–2.5	0.25–2.5/0.25–2.5	0.25–2.5/0.25–2.5	0.25–2.5/0.25–2.5
Multi-Conductor Connection (same cross-section)				
Solid/stranded in mm ²	0.2–1.0/0.2–1.0	0.2–1.0/0.2–1.0	0.2–1.0/0.2–1.0	0.2–1.0/0.2–1.0
Stranded with ferrules without plastic sleeve in mm ²	0.25–1.0	0.25–1.0	0.25–1.0	0.25–1.0
Stranded with twin ferrule with plastic sleeve in mm ²	0.5–1.0	0.5–1.0	0.5–1.0	0.5–1.0
Stripping length in inches (mm)	0.31 (8)	0.31 (8)	0.31 (8)	0.31 (8)
Thread	M3	M3	M3	M3
Torque in in-lb (Nm)	4.4–5.3 (0.5–0.6)	4.4–5.3 (0.5–0.6)	4.4–5.3 (0.5–0.6)	4.4–5.3 (0.5–0.6)

Wiring for Three-Level Sensor Terminal Blocks

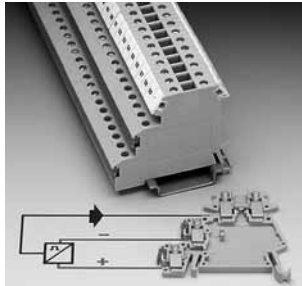

Wiring for Four-Level Sensor Terminal Blocks

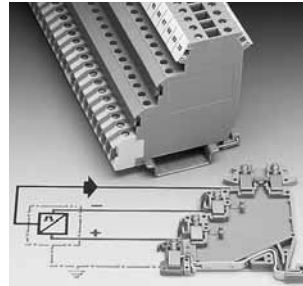

Dimensions

Approximate Dimensions in Inches (mm)

Screw Connection Triple Level Sensor/Actuator

Catalog Number	Width	Length	Height for—	
			35 x 7.5 in	35 x 15 in
XB3UKA25	0.24 (6.2)	2.17 (55.0)	2.15 (54.5)	2.44 (62.0)
XB3UKF25	0.24 (6.2)	2.85 (72.5)	2.15 (54.5)	2.44 (62.0)
XB3UKA25PE	0.24 (6.2)	2.46 (62.5)	2.76 (70.0)	3.05 (77.5)
XB3UKF25PE	0.24 (6.2)	3.25 (82.5)	2.76 (70.0)	3.05 (77.5)

Fuse Terminal Blocks



Contents

Description	Page
Single Level—Through-Feed	V7-T8-5
Single Level—Ground Blocks	V7-T8-10
Multi-Conductor Terminal Blocks	V7-T8-12
Multi-Conductor Ground Blocks	V7-T8-14
Double Level.	V7-T8-16
Triple Level Sensor/Actuator	V7-T8-18
Fuse Terminal Blocks	
Accessories	V7-T8-23
Technical Data and Specifications	V7-T8-23
Dimensions	V7-T8-23
Disconnect and Component Terminal Blocks	V7-T8-24
High Current Blocks	V7-T8-27
Mini Screw Connection	V7-T8-29

Fuse Terminal Blocks

Product Description

The UT Series fuse terminal blocks come in two varieties—lever type and cap. Each performs two functions. They act as a fuse carrier for most common North American and European fuses and they

allow for potential distribution with the double bridge shaft. The terminal blocks therefore allow bypass routing of two separate potentials next to each other. This has the advantage of a time-saving

potential infeed and a correct, functional configuration of the terminal strip. For signaling a triggered fuse, fuse terminal blocks with light indicators are available (for both AC and DC voltage).

Product Selection

XBUT4FBE



Screw Connection Fuse Terminal Blocks, for 5 x 20 mm Fuse

Terminal Width	Maximum Wire Size	IEC 60 947-7-3 in V/A/AWG	UL-cUL Ratings in V/A/AWG	Color	Standard Pack	Catalog Number
Fuse Terminal Blocks						
6.2 mm	10 AWG/4 mm ²	①/6.3/26–10	600/6.3/26–10	Black	50	XBUT4FBE
Fuse Terminal Blocks with LED 12–30V, 1–2.5 mA						
6.2 mm	10 AWG/4 mm ²	①/6.3/26–10	600/6.3/26–10	Black	50	XBUT4FBEL24
Fuse Terminal Blocks with LED 30–60V, 0.8–2.0 mA						
6.2 mm	10 AWG/4 mm ²	①/6.3/26–10	600/6.3/26–10	Black	50	XBUT4FBEL60
Fuse Terminal Blocks with LED 110–250V, 0.5–2.5 mA						
6.2 mm	10 AWG/4 mm ²	①/6.3/26–10	600/6.3/26–10	Black	50	XBUT4FBEL250

Note

① As disconnect terminal block 400V, as fuse terminal block 250V.

8.1

Terminal Blocks, Fuse Blocks and Fuse Holders

IEC—XB Series

XBUT6FBN



Screw Connection Fuse Terminal Blocks for 6.3 x 32 mm (1/4 in x 1-1/4 in) Fuse

Terminal Width	Maximum Wire Size	IEC 60 947-7-3 in V/A/AWG	UL-cUL Ratings in V/A/AWG	Color	Standard Pack	Catalog Number
Fuse Terminal Blocks						
8.2 mm	8 AWG/6 mm ²	①/10/24-8	400/10/24-8	Black	50	XBUT6FBN
Fuse Terminal Blocks with LED 12-30V, 1-2.5 mA						
8.2 mm	8 AWG/6 mm ²	①/10/24-8	400/10/24-8	Black	50	XBUT6FBNL24
Fuse Terminal Blocks with LED 30-60V, 0.8-2.0 mA						
8.2 mm	8 AWG/6 mm ²	①/10/24-8	400/10/24-8	Black	50	XBUT6FBNL60
Fuse Terminal Blocks with LED 110-250V, 0.5-2.5 mA						
8.2 mm	8 AWG/6 mm ²	①/10/24-8	400/10/24-8	Black	50	XBUT6FBNL250

8

XBUK10FBCE



Screw Connection Fuse Terminal Blocks, XBUK10FBCE

Terminal Width	Maximum Wire Size	IEC 60 947-7-3 with Fuse in V/A/AWG	IEC 60 947-7-3 as Disconnected t.b. in V/A/AWG	UL-cUL Ratings in V/A/AWG	Color	Standard Pack	Catalog Number
Fuse Terminal Blocks for 5 x 20 mm fuse							
12 mm	6 AWG/16 mm ²	①/①/20-4	800/10/20-6	300/20/22-6	Black	50	XBUK10FBCE
Fuse Terminal Blocks for 6.3 x 32 mm (1/4 in x 1-1/4 in) fuse							
12 mm	6 AWG/16 mm ²	①/①/20-4	800/10/20-6	300/20/22-6	Black	50	XBUK10FBCE
Fuse Terminal Blocks with Light Indicator 15-30V, 1-2.5 mA, 5 x 20 mm							
12 mm	6 AWG/16 mm ²	①/①/20-4	800/10/20-6	300/20/22-6	Black	50	XBUK10FBCE
Fuse Terminal Blocks with Light Indicator 15-30V, 1-2.5 mA, 6.3 x 32 mm							
12 mm	6 AWG/16 mm ²	①/①/20-4	800/10/20-6	300/20/22-6	Black	50	XBUK10FBCE
Fuse Terminal Blocks with Light Indicator 110-250V, 0.5-1.1A, 5 x 20 mm							
12 mm	6 AWG/16 mm ²	①/①/20-4	800/10/20-6	300/20/22-6	Black	50	XBUK10FBCE
Fuse Terminal Blocks with Light Indicator 110-250V, 0.5-1.1A, 6.3 x 32 mm							
12 mm	6 AWG/16 mm ²	①/①/20-4	800/10/20-6	300/20/22-6	Black	50	XBUK10FBCE

Cartridge Fuse Inserts 5 x 20 mm Based on DIN EN 60 947-7-3: 2003-7

Terminal Blocks	U (V)	Overload Protection		Short-Circuit Protection Only		I _{max.} (A)
		Individual	Interconnected	Individual	Interconnected	
XBUT4FBE	250	1.6W	1.6W	4W	2.5W	6.3

Notes

Max. power dissipation at 73.4°F (23°C) based on DIN EN 60 947-7-3: 2003-7.

When selecting cartridge fuse inserts, please ensure that the maximum power dissipation specified above is not exceeded. Details can be obtained from the fuse suppliers.

If the fuse is defective, the downstream circuit is not off load.

① As disconnect terminal block 500V, as fuse terminal block 400V.

Accessories

Screw Connection Fuse Terminal Blocks

Description	Color	Number of Positions	Standard Pack	XBUT4FBE Catalog Number	XBUT6FBN Catalog Number	XBUK10FBCE Catalog Number
End cover	—	—	—	①	①	—
Plug-in bridge—for cross connections in the bridge shaft	Red	2	10	XBAFBS26	XBAFBS28	—
		3	50	XBAFBS36	XBAFBS38	—
		5	50	XBAFBS56	XBAFBS58	—
		10	10	XBAFBS106	XBAFBS108	—
		50	10	XBAFBS506	—	—
Blank marker strip center labeling (strip of 10)	White	—	—	XBMZB5 ②	XBMZB6 ②	—
Blank marker strip external labeling (strip of 10)	White	—	—	XBMZB6 ②	XBMZB8 ②	—
Fixed bridge	—	2	10	—	—	XBAFB1212
Screw heads with insulating collar	—	10	10	—	—	XBAFB1012
Blank marker strip (strip of 10)	White	—	10	—	—	XBMZB6 ②

Technical Data and Specifications

Screw Connection Fuse Terminal Blocks

Description	XBUT4FBE	XBUT4FBN	XBUK10FBCE
Technical Data in Accordance with IEC			
Fuse type/dimensions in (mm)	—	—	G/5 x 20/5 x 25/6.3 x 32
Maximum cross section with insertion bridge solid/stranded in mm ²	6.3/6	10/10	10/10
Rated surge voltage in kV/contamination class	4/3	4/3	4/3
Surge voltage category/insulating material group	III/II	III/II	III/I
Connection Capacity			
Stranded with ferrule/with ferrule and plastic sleeve in mm ²	0.25–4/0.25–4	0.25–6/0.25–6	0.5–10/0.5–10
Multi-Conductor Connection (same cross-section)			
Solid/stranded in mm ²	0.14–1.5/0.14–1.5	—	0.5–4/0.5–4
Stranded with ferrules without plastic sleeve in mm ²	0.25–1.5	—	0.5–4
Stranded with twin ferrule with plastic sleeve in mm ²	0.5–2.5	0.5–4	0.5–10
Stripping length in inches (mm)	0.35 (9)	0.39 (10)	0.43 (11)
Thread	M3	M4	M4
Torque in in-lb (Nm)	5.3–7.1 (0.6–0.8)	13.3–15.9 (1.5–1.8)	13.3–15.9 (1.5–1.8)

Dimensions

Approximate Dimensions in Inches (mm)

Screw Connection Fuse Terminal Blocks

Catalog Number	Width	Length	Height for—		
			35 x 7.5 in	35 x 15 in	32 in
XBUT4FBE	0.24 (6.2)	2.24 (56.8)	2.87 (73.0)	3.17 (80.5)	—
XBUT4FBN	0.32 (8.2)	2.24 (56.8)	2.87 (73.0)	3.17 (80.5)	—
XBUK10FBCE	0.47 (12.0)	2.44 (62.0)	2.32 (59.0)	2.62 (66.5)	2.52 (64.0)

Notes

① XBUT4FBE and XBUT6FBN have an enclosed design. The use of an end cover is not required.

② For information on Printed Marking Tag Options, see **Page V7-T8-98**.

For additional accessories, see **Page V7-T8-90**.

8.1

Terminal Blocks, Fuse Blocks and Fuse Holders

IEC—XB Series

Disconnect and Component Terminal Blocks



8

Contents

<i>Description</i>	<i>Page</i>
Single Level—Through-Feed	V7-T8-5
Single Level—Ground Blocks	V7-T8-10
Multi-Conductor Terminal Blocks	V7-T8-12
Multi-Conductor Ground Blocks	V7-T8-14
Double Level	V7-T8-16
Triple Level Sensor/Actuator	V7-T8-18
Fuse Terminal Blocks	V7-T8-21
Disconnect and Component Terminal Blocks	
Product Selection	V7-T8-25
Accessories	V7-T8-26
Technical Data and Specifications	V7-T8-26
Dimensions	V7-T8-26
High Current Blocks	V7-T8-27
Mini Screw Connection	V7-T8-29

Disconnect and Component Terminal Blocks

Product Description

The **XB** Series includes application specific terminal blocks like the XBUT4TG disconnect block that accommodates disconnect component and fuse terminal blocks. It can also be bridged with standard terminal blocks via the double bridge shaft. The component plug XBPCO serves to accommodate different components such as resistors or capacitors.

5 x 20 mm fuses can be inserted into the fuse plug XBPFU, also available with light indication. The XBUT4MT knife disconnect terminal block features a compact design and a high current carrying capacity of 16A. Versions with test socket screws provide a test option for 2.3 mm diameter test plugs on both sides of the disconnect point.

Product Selection

XBUT4TG
Disconnect

Screw Connection Disconnect and Component Terminal Blocks

Terminal Width	Maximum Wire Size	Connection Data in V/A/AWG	UL-cUL Ratings for Disconnect in V/A/AWG	UL-cUL Ratings for Disconnect with Test Sockets in V/A/AWG	Color	Standard Pack	Catalog Number
Screw Connection Disconnect							
6.2 mm	10 AWG/4 mm ²	500/16/26–10	600/16/26–10	300/16/26–10	Gray	50	XBUT4TG
Screw Connection Disconnect with Test Sockets							
6.2 mm	10 AWG/4 mm ²	500/16/26–10	600/16/26–10	300/16/26–10	Gray	50	XBUT4TGP
Component Plug							
6.2 mm	10 AWG/4 mm ²	500/16/26–10	600/16/26–10	300/16/26–10	Gray	10	XBPCO
Fuse Plug							
6.2 mm	10 AWG/4 mm ²	500/16/26–10	600/16/26–10	300/16/26–10	Black	10	XBPFU
Fuse Plug with Light Indicator for 12–30V, 1–2.5 mA							
6.2 mm	10 AWG/4 mm ²	500/16/26–10	600/16/26–10	300/16/26–10	Black	10	XBPFUL24
Fuse Plug with Light Indicator for 110–250V, 0.5–2.5 mA							
6.2 mm	10 AWG/4 mm ²	500/16/26–10	600/16/26–10	300/16/26–10	Black	10	XBPFUL250
Screw Connection Disconnect Knife Disconnect							
6.2 mm	10 AWG/4 mm ²	500/16/26–10	600/16/26–10	300/16/26–10	Gray	50	XBUT4MT
Screw Connection Disconnect Knife Disconnect with Test Sockets							
6.2 mm	10 AWG/4 mm ²	500/16/26–10	600/16/26–10	300/16/26–10	Gray	50	XBUT4MTP
Screw Connection Terminal Blocks with Integrated Diodes							
6.2 mm	12 AWG/4 mm ²	500/32/24–10	600/30/26–10	—	Gray	50	XBUKK4DIO

XBTKT25 Thermal
Electric Voltage

Screw Connection Thermoelectric Voltage Terminal Blocks

Terminal Width	Maximum Wire Size	Connection Data in V/A/AWG	UL-cUL Ratings in V/A/AWG	Color	Standard Pack	Catalog Number
Copper/Constantan (CU/CUNI44)						
10.4 mm	12 AWG/2.5 mm ²	400/—/24–12	300/10/28–12	Gray	50	XBTKT25 (Type T)
Iron/Constantan (FE/CUNI44)						
10.4 mm	12 AWG/2.5 mm ²	400/—/24–12	300/10/28–12	Gray	50	XBTKJ25 (Type J)
Nickel-Chrome/Constantan (NICR/CUNI44)						
10.4 mm	12 AWG/2.5 mm ²	400/—/24–12	300/10/28–12	Gray	50	XBTKE25 (Type E)
Nickel-Chrome/Nickel (NICRNI)						
10.4 mm	12 AWG/2.5 mm ²	400/—/24–12	300/10/28–12	Gray	50	XBTKK25 (Type K)
Copper/Copper Nickel (E-CU/A-CU)						
10.4 mm	12 AWG/2.5 mm ²	400/—/24–12	300/10/28–12	Gray	50	XBTKR25 (Type R)

8.1

Terminal Blocks, Fuse Blocks and Fuse Holders

IEC—XB Series

Accessories

Screw Connection Disconnect and Component Terminal Blocks

Description	Color	Number of Positions	Standard Pack	XBUT4TG Catalog Number	XBUT4MT Catalog Number	XBUKK4D10 Catalog Number	XBTK25 Catalog Number
Plug-in bridge—for cross connections in the bridge shaft	Red	2	10	XBAFBS26	XBAFBS26	—	—
		3	50	XBAFBS36	XBAFBS36	—	—
		5	50	XBAFBS56	XBAFBS56	—	—
		10	10	XBAFBS106	XBAFBS106	—	—
		50	10	XBAFBS506	XBAFBS506	—	—
Test adapter	—	—	10	XBATSPA14	XBATSPA14	—	—
2.3 mm diameter test plug	—	—	—	XBATSMPS- ^①	XBATSMPS- ^①	—	—
Modular test plug	—	—	10	XBATSDPPS6	XBATSDPPS6	—	—
Blank marker strip (strip of 10)	White	—	10	XBMZB6 ^②	XBMZB6 ^②	XBMZB6 ^②	XBMZB10 ^②
End cover	Gray	—	10	—	—	XBACUKK35	XBACTK4
Spacer cover	Gray	—	10	—	—	XBADGUKK35	—
Spacer plate	—	—	10	—	—	XBADPUKK35	—
Partition plate	—	—	—	—	—	—	XBATTK4
Fixed bridge	—	10	10	—	—	XBAFB1106	—

Technical Data and Specifications

Screw Connection Disconnect and Component Terminal Blocks

Description	XBUT4TG	XBUT4MT	XBUKK4D10	XBTK
Technical Data in Accordance with IEC				
Maximum load current in A/cross-section in mm ²	16/6	16/6	32/4	—
Rated surge voltage in kV/contamination class	6/3	6/3	6/3	—
Surge voltage category/insulating material group	III/I	III/I	III/I	—
Connection Capacity				
Stranded with ferrule/with ferrule and plastic sleeve in mm ²	0.25–4/0.25–4	0.25–4/0.25–4	0.25–4/0.25–2.5	—
Multi-Conductor Connection (same cross-section)				
Solid/stranded in mm ²	0.14–1.5/0.14–1.5	0.14–1.5/0.14–1.5	0.2–1.5/0.2–1.5	—
Stranded with ferrules without plastic sleeve in mm ²	0.25–1.5	0.25–1.5	0.25–1.5	—
Stranded with twin ferrule with plastic sleeve in mm ²	0.5–2.5	0.5–2.5	0.5–1.5	—
Stripping length in inches (mm)	0.35 (9)	0.35 (9)	0.31 (8)	0.28 (7)
Thread	M3	M3	M3	M3
Torque in in-lb (Nm)	5.3–7.1 (0.6–0.8)	5.3–7.1 (0.6–0.8)	5.3–7.1 (0.6–0.8)	5.3–7.1 (0.6–0.8)

Dimensions

Approximate Dimensions in Inches (mm)

Screw Connection Disconnect and Component Terminal Blocks

Catalog Number	Width	Length	Cover Width	Height for—		
				35 x 7.5 in	35 x 15 in	32 in
XBUT4TG	0.24 (6.2)	2.24 (56.8)	—	1.87 (47.5)	2.17 (55.0)	—
XBUT4MT	0.24 (6.2)	2.24 (56.8)	—	1.87 (47.5)	2.17 (55.0)	—
XBUKK4D10	0.24 (6.2)	2.20 (56.0)	0.10 (2.5)	2.44 (62.0)	2.74 (69.5)	2.64 (67.0)
XBTK	0.20 (5.2)	1.81 (46.0)	0.04 (1.0)	1.57 (40.0)	1.87 (47.5)	1.77 (45.0)

Notes

① For ordering information, see **Page V7-T8-103**.

② For information on Printed Marking Tag Options, see **Page V7-T8-98**.

For additional accessories, see **Page V7-T8-90**.

High Current Blocks

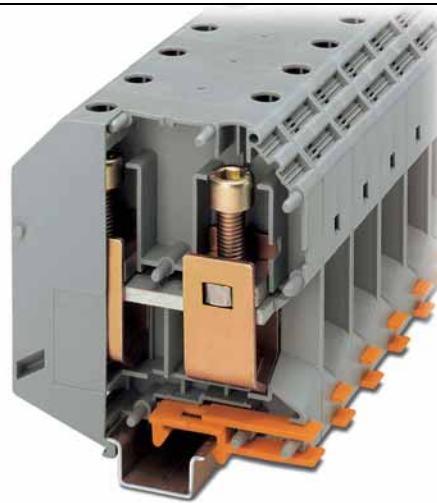

Contents

Description	Page
Single Level—Through-Feed	V7-T8-5
Single Level—Ground Blocks	V7-T8-10
Multi-Conductor Terminal Blocks	V7-T8-12
Multi-Conductor Ground Blocks	V7-T8-14
Double Level.	V7-T8-16
Triple Level Sensor/Actuator	V7-T8-18
Fuse Terminal Blocks	V7-T8-21
Disconnect and Component Terminal Blocks	V7-T8-24
High Current Blocks	
Accessories	V7-T8-28
Technical Data and Specifications	V7-T8-28
Dimensions	V7-T8-28
Mini Screw Connection	V7-T8-29

High Current Blocks

Product Description

Eaton's XBUK high current terminal blocks offer a reliable connection via the superior construction that includes three-point centering of the wire in the

prism-shaped sleeve base, a fluted contact surface for low contact resistance, and screws secured with spring-loaded elements. The terminal blocks have

an enclosed housing made from polyamide 6.6. Green-yellow ground terminal blocks are also available.

Product Selection

XBUK150



Screw Connection High Current Blocks

Terminal Width	Maximum Wire Size	IEC 60 947-7-1 in V/A/AWG	EN 50 019 in V/A/AWG	UL-cUL Ratings in V/A/AWG	Color	Standard Pack	Catalog Number
20.0 mm	1/0/50 mm ²	1000/150/1/0	750/135/1/0	600/150/1/0	Gray	10	XBUK50
					Blue	10	XBUK50BU
31.0 mm	300 kcmil/150 mm ²	1000/309/2–300	726/265/2–300	600/285/2 AWG–300 kcmil	Gray	10	XBUK150

XBUK95PE



Screw Connection High Current Ground Blocks

Terminal Width	Maximum Wire Size	IEC 60 947-7-1 in V/A/AWG	EN 50 019 in V/A/AWG	UL-cUL Ratings in V/A/AWG	Color	Standard Pack	Catalog Number
25.0 mm	000 AWG/95 mm ²	—/232/4–000	—/—/4–000	—/—/2–4/0	Green/Yellow	10	XBUK95PE

8.1

Terminal Blocks, Fuse Blocks and Fuse Holders

IEC—XB Series

Accessories

Screw Connection High Current Blocks

Description	Color	Number of Positions	Standard Pack	XBUK50 Catalog Number	XBUK150 Catalog Number	XBUK95PE Catalog Number
Fixed bridge, screw heads with insulating color	—	2	10	XBAFBI220	—	—
Insertion bridge	—	2	10	—	XBAEB231	—
Blank marker strip external labeling (strip of 10)	White	—	10	XBMZB10 ①	XBMZB10 ①	XBMZB10 ①

Technical Data and Specifications

Screw Connection High Current Blocks

8

Description	XBUK50	XBUK150	XBUK95PE
Technical Data in Accordance with IEC			
Maximum load current in A/cross-section in mm ²	150/50	309/150	232/95
Maximum cross-section with insertion bridge solid/stranded in mm ²	—/—	150/120	—/—
Rated surge voltage in kV/contamination class	8/3	8/3	8/3
Surge voltage category/insulating material group	III/I	III/I	III/I
Connection Capacity			
Stranded with ferrule/with ferrule and plastic sleeve in mm ²	25–50/25–50	50–150/50–150	35–95/35–95
Multi-Conductor Connection (same cross-section)			
Solid/stranded in mm ²	10–16/10–16	25–50/35–50	25–35/25–35
Stranded with ferrules without plastic sleeve in mm ²	10–16	25–50	16–35
Stripping length in inches (mm)	0.94 (24)	1.57 (40)	1.18 (30)
Thread	M6	M10	M8
Terminal point—thread/torque in in-lb (Nm)	53–71 (6–8)	221–267 (25–30)	133–177 (15–20)
Fastening—thread/torque in in-lb (Nm)	53–71 (6–8)	221–267 (25–30)	133–177 (15–20)

Dimensions

Approximate Dimensions in Inches (mm)

Screw Connection High Current Blocks

Catalog Number	Width	Length	Height for—		
			35 x 7.5 in	35 x 15 in	32 in
XBUK50	0.79 (20.0)	2.78 (70.5)	3.29 (83.5)	3.21 (81.5)	—
XBUK150	1.22 (31.0)	3.94 (100.0)	4.67 (118.5)	4.57 (116.0)	—
XBUK95PE	0.98 (25.0)	3.27 (83.0)	—	3.90 (99.0)	3.80 (96.5)

Notes

① For information on Printed Marking Tag Options, see **Page V7-T8-98**.

For additional accessories, see **Page V7-T8-90**.

Mini Screw Connection Terminal Blocks



Contents

Description	Page
Single Level—Through-Feed	V7-T8-5
Single Level—Ground Blocks	V7-T8-10
Multi-Conductor Terminal Blocks	V7-T8-12
Multi-Conductor Ground Blocks	V7-T8-14
Double Level.	V7-T8-16
Triple Level Sensor/Actuator	V7-T8-18
Fuse Terminal Blocks	V7-T8-21
Disconnect and Component Terminal Blocks	V7-T8-24
High Current Blocks	V7-T8-27
Mini Screw Connection	
Accessories	V7-T8-30
Technical Data and Specifications	V7-T8-30
Dimensions	V7-T8-30

Mini Screw Connection

Product Description

The **XB** miniature terminal blocks have a connection cross-section from 2 mm² through 4 mm² and mount on 15 mm DIN rail. There is an

opening for bridging with a fixed bridge in the center of the terminal blocks. These miniature terminal blocks also offer the same accessories

that you would find with the larger blocks—including marking tags, end covers, end stop and ground blocks.

Product Selection

XBMUK4



Mini Screw Connection Terminal Blocks

Terminal Width	Maximum Wire Size	IEC 60 947-7-1 in V/A/AWG	EN 50 019 in V/A/AWG	UL-cUL Ratings in V/A/AWG	Color	Standard Pack	Catalog Number
5.2 mm	12 AWG/2.5 mm ²	400/32/24–12	275/28/21/24–12	600/20/28–12	Gray	50	XBMUK25
					Blue	50	XBMUK25BU
6.2 mm	10 AWG/4 mm ²	500/41/24–10	—/—/—	600/10/26–10	Gray	50	XBMUK4
					Blue	50	XBMUK4BU

XBMUK25PE



Mini Screw Connection Ground Blocks

Terminal Width	Maximum Wire Size	IEC 60 947-7-2 in V/A/AWG	UL-cUL Ratings in V/A/AWG	Color	Standard Pack	Catalog Number
5.2 mm	12 AWG/2.5 mm ²	—/—/24–12	—/—/30–12	Green/ Yellow	50	XBMUK25PE
6.2 mm	10 AWG/2.4 mm ²	—/—/24–10	—/—/26–14	Green/ Yellow	50	XBMUK4PE

8.1

Terminal Blocks, Fuse Blocks and Fuse Holders

IEC—XB Series

Accessories

Mini Screw Connection Terminal/Ground Blocks

Description	Color	Number of Positions	Standard Pack	XBMUK25 Catalog Number	XBMUK4 Catalog Number	XBMUK25PE Catalog Number	XBMUK4PE Catalog Number
End cover	Gray	—	50	XBACMU254	XBACMU254	—	—
	Blue	—	50	XBACMU254B	XBACMU254B	—	—
Partition plate	—	—	50	XBATMU254	XBATMU254	—	—
Fixed bridge	—	10	10	XBAFBR105N	—	—	—
Separating plate	—	—	10	XBATMPKK15	XBATMPKK15	—	—
Blank marker strip (strip of 10)	White	—	10	XBMZB5 ①	XBMZB6 ①	XBMZB5 ①	XBMZB6 ①

8

Technical Data and Specifications

Mini Spring Cage Terminal/Ground Blocks

Description	XBMUK25	XBMUK4	XBMUK25PE	XBMUK4PE
Technical Data in Accordance with IEC				
Maximum load current in A/cross-section in mm ²	32/4	41/6	—	—
Maximum cross-section with insertion bridge (solid/stranded)	2.5/2.5	4/4	—	—
Rated surge voltage in kV/contamination class	6/3	6/3	6/3	6/3
Surge voltage category/insulating material group	III/I	III/I	III/I	III/I
Connection Cross-Section				
Stranded with ferrule with plastic sleeve in mm ²	0.25–1.5	0.25–2.5	0.25–1.5	0.25–2.5
Stranded with ferrule without plastic sleeve in mm ²	0.25–2.5	0.25–4	0.25–2.5	0.25–4
Multi-Conductor Connection (same cross-section)				
Solid/stranded in mm ²	0.2–1.0/0.2–1.5	0.2–1.5/0.2–1.5	0.2–1.0/0.2–1.5	0.2–1.5/0.2–1.5
Stranded with ferrule without plastic sleeve in mm ²	0.25–1.5	0.25–1.5	0.25–1.5	0.25–1.5
Stranded with ferrule with plastic sleeve in mm ²	0.5–1.0	0.5–2.5	0.5–1.5	0.5–2.5
Stripping length in Inches (mm)	0.31 (8)	0.31 (8)	0.31 (8)	0.31 (8)
Thread	M3	M3	M3	M3
Torque in in-lb (Nm)	5.3–7.1 (0.6–0.8)	4.4–5.3 (0.5–0.6)	5.3–7.1 (0.6–0.8)	5.3–7.1 (0.6–0.8)

Dimensions

Approximate Dimensions in Inches (mm)

Mini Spring Cage Terminal/Ground Blocks

Catalog Number	Width	Length	Cover Length	Height for— 15 in
XBMUK25	0.20 (5.2)	1.10 (28.0)	0.04 (1.0)	1.26 (32.0)
XBMUK4	0.24 (6.2)	1.10 (28.0)	0.04 (1.0)	1.26 (32.0)
XBMUK25PE	0.20 (5.2)	1.10 (28.0)	—	1.24 (31.5)
XBMUK4PE	0.24 (6.2)	1.10 (28.0)	—	1.26 (32.0)

Notes

① For information on Printed Marking Tag Options, see **Page V7-T8-98**.

For additional accessories, see **Page V7-T8-90**.

Spring Cage Connection



Contents

Description

	<i>Page</i>
Spring Cage Terminal Blocks	
Single Level—Through-Feed	V7-T8-32
Single Level—Ground Blocks	V7-T8-37
Multi-Conductor Terminal Blocks	V7-T8-39
Multi-Conductor Ground Blocks	V7-T8-42
Double Level Blocks	V7-T8-44
Triple Level Blocks	V7-T8-46
Fuse Terminal Blocks	V7-T8-48
Disconnect and Component Terminal Blocks . .	V7-T8-51
Hybrid Terminal Blocks	V7-T8-54
Mini Spring Cage	V7-T8-56



Drawings
Online

Spring Cage Terminal Blocks Overview

Product Description

The XBPT Series incorporates a spring cage connection system proven in applications that are sensitive to vibration. The spring mechanism always exerts the same constant force on the wire, resulting in a vibration-proof, gas-tight connection, independent of the user. The space-saving front connection, with the wire and screwdriver coming in parallel from the same direction, allows for simple wiring in places where there is little space available.

Application Description

The connection point is opened with a standard screwdriver. After the wire has been inserted into the wire guide of the terminal block, the screwdriver is removed and the wire automatically makes contact.

Features

- Vibration-resistance
- Global acceptance
- Multi-conductor connections
- Flexible Plug-in bridge system
- Large surface area for marking
- Standardized testing system

Standards and Certifications

- UL recognized—File No. E67464
- CE approved
- LVD ^①:
 - EN 60947-7-1
 - EN 60947-7-2
 - EN 60998-2-3
 - EN 60352-4/A1



Note

- ^① Not all standards apply to all terminal blocks. Contact Eaton for details.

8.1

Terminal Blocks, Fuse Blocks and Fuse Holders

IEC—XB Series

Single Level—Through-Feed



8

Single Level—Through-Feed

Product Description

The space-saving design and front entry design make the XBPT Series ideal for control systems where there is little space. Even so, they offer maximum connection space, resulting in fast wiring of stranded and solid conductors with or without ferrules.

XBPT terminal blocks are available with cross-sections from 2.5 mm² up to 35 mm². The double bridge shaft can accommodate individual chain bridging and step-down bridging from other terminal blocks.

Contents

Description

	<i>Page</i>
Single Level—Through-Feed	
Accessories	V7-T8-34
Technical Data and Specifications	V7-T8-36
Dimensions	V7-T8-36
Single Level—Ground Blocks	V7-T8-37
Multi-Conductor Terminal Blocks	V7-T8-39
Multi-Conductor Ground Blocks	V7-T8-42
Double Level Blocks	V7-T8-44
Triple Level Blocks	V7-T8-46
Fuse Terminal Blocks	V7-T8-48
Disconnect and Component Terminal Blocks	V7-T8-51
Hybrid Terminal Blocks	V7-T8-54
Mini Spring Cage	V7-T8-56

Product Selection

XBPT6



Spring Cage Connection Single Level—Through-Feed

Terminal Width	Maximum Wire Size	IEC 60 947-7-1 in V/A/AWG	EN 50 019 in V/A/AWG	UL-cUL Ratings in V/A/AWG	Color	Standard Pack	Catalog Number
5.2 mm	12 AWG/2.5 mm ²	800/31/28–12	550/25/21/24–12	600/20/26–12	Gray	50	XBPT25
					Blue	50	XBPT25BU
					White	50	XBPT25WH
					Red	50	XBPT25RD
					Black	50	XBPT25BK
6.2 mm	10 AWG/4 mm ²	800/40/28–10	550/34/30/24–10	600/30/20–10	Gray	50	XBPT4
					Blue	50	XBPT4BU
8.2 mm	8 AWG/6 mm ²	800/52/24–8	550/45/36/20–8	600/50/20–8	Gray	50	XBPT6
					Blue	50	XBPT6BU
10.2 mm	6 AWG/10 mm ²	800/65/24–6	550/50/63/16–6	600/65/16–6	Gray	50	XBPT10
					Blue	50	XBPT10BU
12 mm	4 AWG/16 mm ²	800/90/24–4	550/65/82/16–4	600/50/16–4	Gray	50	XBPT16
					Blue	50	XBPT16BU
16 mm	2 AWG/35 mm ²	800/125/14–2	750/108/14–2	600/115/14–2	Gray	10	XBPT35
					Blue	10	XBPT35BU

8.1

Terminal Blocks, Fuse Blocks and Fuse Holders

IEC—XB Series

Accessories

Spring Cage Connection Single Level—Through-Feed, XBPT25, XBPT4 and XBPT6

Description	Color	Number of Positions	Standard Pack	XBPT25 Catalog Number	XBPT4 Catalog Number	XBPT6 Catalog Number
End cover	Gray	—	50	XBACPT25	XBACPT4	XBACPT6
Partition plate	Gray	—	50	XBATPT4	XBATPT4	XBATPT6
Plug-in bridge—for cross connections in the bridge shaft	Red	2	10	XBAFBS25	XBAFBS26	XBAFBS28
		3	50	XBAFBS35	XBAFBS36	—
		5	50	XBAFBS55	XBAFBS56	—
		10	10	XBAFBS105	XBAFBS106	—
		50	10	XBAFBS505	XBAFBS506	—
Test adapter	—	—	10	XBATSPAI4	XBATSPAI4	XBATSPAI4
2.3 mm diameter test plug	—	—	—	XBATSMPS-^①	XBATSMPS-^①	XBATSMPS-^①
Modular test plug	—	—	10	XBATSPS5	XBATSPS6	XBATSPS8
Blank marker strip external labeling	White	—	10	XBMZBF5^②	XBMZBF6^②	XBMZBF8^②
Blank marker strip center labeling (strip of 10)	White	—	10	XBMZB5^②	XBMZB6^②	XBMZB8^②

Spring Cage Connection Single Level—Through-Feed, XBPT10, XBPT16 and XBPT35

Description	Color	Number of Positions	Standard Pack	XBPT10 Catalog Number	XBPT16 Catalog Number	XBPT35 Catalog Number
End cover	Gray	—	50	XBACPT10	XBACPT16	^③
Plug-in bridge—for cross connections in the bridge shaft	Red	2	10	XBAFBS210	XBAFBS212^①	XBAFBS216^②
2.3 mm diameter test plug	—	—	10	XBATSMPS-^①	XBATSMPS-^①	XBATSMPS-^①
Blank marker strip external labeling	White	—	10	XBMZF10^②	XBMZBF12^②	XBMZBF15^②
Blank marker strip center labeling (strip of 10)	White	—	10	XBMZB10^②	XBMZB12^②	XBMZB15^②

Notes

- ① For ordering information, see **Page V7-T8-103**.
- ② For information on Printed Marking Tag Options, see **Page V7-T8-98**.
- ③ XBPT35 has an enclosed design. The use of an end cover is not required.

For additional accessories, see **Page V7-T8-90**.

XBPT with Reducing Bridge

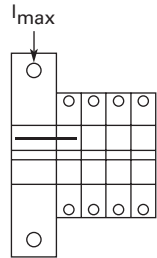
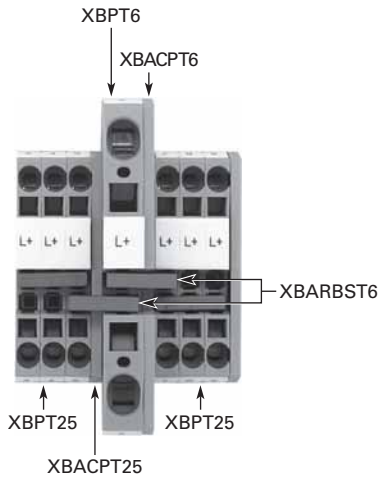

One-Sided Input

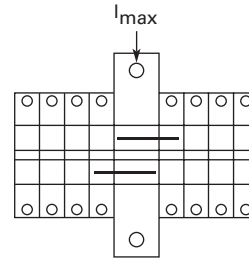

Central Input

Step-Down Bridge with Standard Feed-Through Terminal Blocks

Input Terminal Blocks	Cross-Section	Pick-Off Terminal Blocks	Cross-Section AWG (mm ²)	One-Sided Input I _{max}	Central Input I _{max}	Bridge Catalog Number
XBPT6	8 AWG (6 mm ²)	XBPT25	12 (2.5)	40	56	XBARBST6
		XBPT4	10 (4)	45	56	XBARBST6
		XBQT15	14 (1.5)	35	56	XBARBST6
		XBQT25	12 (2.5)	40	56	XBARBST6
XBPT10	6 AWG (10 mm ²)	XBPT25	12 (2.5)	40	65	XBARBST10
		XBPT4	10 (4)	45	65	XBARBST10
		XBQT15	14 (1.5)	35	65	XBARBST10
		XBQT25	12 (2.5)	40	65	XBARBST10
XBPT16	4 AWG (16 mm ²)	XBPT25	12 (2.5)	40	80	XBARBST16
		XBPT4	10 (4)	45	90	XBARBST16
		XBQT15	14 (1.5)	35	70	XBARBST16
		XBQT25	12 (2.5)	40	80	XBARBST16

8.1

Terminal Blocks, Fuse Blocks and Fuse Holders

IEC—XB Series

Technical Data and Specifications

Spring Cage Connection Single Level—Through-Feed

Description	XBPT25	XBPT4	XBPT6	XBPT10	XBPT16	XBPT35
Technical Data in Accordance with IEC						
Maximum load current in A/cross-section in mm ²	31/4	40/6	52/10	65/16	90/25	125/35
Rated surge voltage in kV/contamination class	8/3	8/3	8/3	8/3	8/3	8/3
Surge voltage category/insulating material group	III/I	III/I	III/I	III/I	III/I	III/I
Connection Capacity						
Stranded with ferrule/with ferrule and plastic sleeve in mm ²	0.25–2.5	0.25–4	0.25–6	0.25–10	0.25–16	2.5–35
Stranded with ferrules without plastic sleeve in mm ²	0.25–2.5	0.25–4	0.25–6	0.25–10	0.25–16	2.5–35
Stranded with twin ferrule with plastic sleeve in mm ²	0.5	0.5–1	0.5–1.5	1.5–2.5	1.5–4	2.5–10
Stripping length in inches (mm)	0.39 (10)	0.39 (10)	0.47 (12)	0.71 (18)	0.71 (18)	0.98 (25)

Dimensions

Approximate Dimensions in Inches (mm)

Spring Cage Connection Single Level—Through-Feed

Catalog Number	Width	Length	Cover Width	Height for—	
				35 x 7.5 in	35 x 15 in
XBPT25	0.20 (5.2)	1.91 (48.5)	0.09 (2.2)	1.45 (36.8)	1.73 (44.0)
XBPT4	0.24 (6.2)	2.20 (56.0)	0.09 (2.2)	1.45 (36.8)	1.73 (44.0)
XBPT6	0.32 (8.2)	2.74 (69.5)	0.09 (2.2)	1.71 (43.5)	2.01 (51.0)
XBPT10	0.39 (10.0)	2.81 (71.5)	0.09 (2.2)	1.99 (50.5)	2.30 (58.5)
XBPT16	0.47 (12.0)	3.15 (80.0)	0.09 (2.2)	2.01 (51.0)	2.30 (58.5)
XBPT35	0.63 (16.0)	3.94 (100.0)	①	2.32 (59.0)	2.62 (66.5)

Note

① XBPT35 has an enclosed design. The use of an end cover is not required.

Single Level—Ground Blocks



Contents

Description	Page
Single Level—Through-Feed	V7-T8-32
Single Level—Ground Blocks	
Accessories	V7-T8-38
Technical Data and Specifications	V7-T8-38
Dimensions	V7-T8-38
Multi-Conductor Terminal Blocks	V7-T8-39
Multi-Conductor Ground Blocks	V7-T8-42
Double Level Blocks	V7-T8-44
Triple Level Blocks	V7-T8-46
Fuse Terminal Blocks	V7-T8-48
Disconnect and Component Terminal Blocks	V7-T8-51
Hybrid Terminal Blocks	V7-T8-54
Mini Spring Cage	V7-T8-56

Single Level—Ground Blocks

Product Description

The XBPT ground blocks are the same shape as the feed-through terminal blocks with the same wide range of cross-sections available. They easily snap onto the

DIN rail to make a reliable mechanical and electrical contact that meets all requirements of IEC 60-947-7-2.

Product Selection

XBPT4PE



Spring Cage Connection Single Level—Ground Blocks

Terminal Width	Maximum Wire Size	IEC 60 947-7-2 in V/A/AWG	EN 50 019 in V/A/AWG	UL-cUL Ratings in V/A/AWG	Color	Standard Pack	Catalog Number
5.2 mm	12 AWG/2.5 mm ²	—/—/28-12	—/—/24-12	—/—/26-12	Green/Yellow	50	XBPT25PE
6.2 mm	10 AWG/4 mm ²	—/—/28-10	—/—/24-10	—/—/20-10	Green/Yellow	50	XBPT4PE
8.2 mm	8 AWG/6 mm ²	—/—/24-8	—/—/20-8	—/—/20-8	Green/Yellow	50	XBPT6PE
10.2 mm	6 AWG/10 mm ²	—/65/24-6	—/—/16-6	—/—/16-6	Green/Yellow	50	XBPT10PE
12 mm	4 AWG/16 mm ²	—/90/24-4	—/—/16-4	—/—/16-4	Green/Yellow	50	XBPT16PE
16 mm	2 AWG/35 mm ²	—/125/14-2	—/—/14-2	—/—/14-2	Green/Yellow	10	XBPT35PE

8.1

Terminal Blocks, Fuse Blocks and Fuse Holders

IEC—XB Series

Accessories

Spring Cage Connection Single Level Ground Blocks, XBPT25PE, XBPT4PE and XBPT6PE

Description	Color	Number of Positions	Standard Pack	XBPT25PE Catalog Number	XBPT4PE Catalog Number	XBPT6PE Catalog Number
End cover	Gray	—	50	XBACPT25	XBACPT4	XBACPT6
Blank marker strip external labeling	White	—	10	XBMZBF5 ①	XBMZBF6 ①	XBMZBF8 ①
Blank marker strip center labeling (strip of 10)	White	—	10	XBMZB5 ①	XBMZB6 ①	XBMZB8 ①

Spring Cage Connection Single Level Ground Blocks, XBPT10PE, XBPT16PE and XBPT35PE

Description	Color	Number of Positions	Standard Pack	XBPT10PE Catalog Number	XBPT16PE Catalog Number	XBPT35PE Catalog Number
End cover	Gray	—	50	XBACPT10	XBACPT16	②
Plug-in bridge—for cross connections in the bridge shaft	—	2	10	XBAFBS210	XBAFBS212	XBAFBS216
Blank marker strip external labeling	White	—	10	XBMZBF10 ①	XBMZBF12 ①	XBMZBF15 ①
Blank marker strip center labeling (strip of 10)	White	—	10	XBMZB10 ①	XBMZB12 ①	XBMZB15 ①

8

Technical Data and Specifications

Spring Cage Connection Single Level Ground Blocks

Description	XBPT25PE	XBPT4PE	XBPT6PE	XBPT10PE	XBPT16PE	XBPT35PE
Technical Data in Accordance with IEC						
Maximum load current in A/cross-section in mm ²	—	—	—	65/16	90/25	125/35
Rated surge voltage in kV/contamination class	8/3	8/3	8/3	8/3	8/3	8/3
Surge voltage category/insulating material group	III/I	III/I	III/I	III/I	III/I	III/I
Connection Capacity						
Stranded with ferrule with plastic sleeve in mm ²	0.25–2.5	0.25–4	0.25–6	0.25–10	0.25–16	2.5–35
Stranded with ferrules without plastic sleeve in mm ²	0.25–2.5	0.25–4	0.25–6	0.25–10	0.25–16	2.5–35
Stranded with twin ferrule with plastic sleeve in mm ²	0.5	0.5–1	0.5–1.5	1.5–2.5	1.5–4	2.5–10
Stripping length in inches (mm)	0.39 (10)	0.39 (10)	0.47 (12)	0.71 (18)	0.71 (18)	0.98 (25)

Dimensions

Approximate Dimensions in Inches (mm)

Spring Cage Connection Single Level Ground Blocks

Catalog Number	Width	Length	Cover Width	Height for—	
				35 x 7.5 in	35 x 15 in
XBPT25PE	0.20 (5.2)	1.91 (48.5)	0.09 (2.2)	1.45 (36.8)	1.73 (44.0)
XBPT4PE	0.24 (6.2)	2.20 (56.0)	0.09 (2.2)	1.45 (36.8)	1.73 (44.0)
XBPT6PE	0.32 (8.2)	2.74 (69.5)	0.09 (2.2)	1.71 (43.5)	2.01 (51.0)
XBPT10PE	0.39 (10.0)	2.81 (71.5)	0.09 (2.2)	1.99 (50.5)	2.28 (58.0)
XBPT16PE	0.47 (12.0)	3.15 (80.0)	0.09 (2.2)	2.01 (51.0)	2.30 (58.5)
XBPT35PE	0.63 (16.0)	3.94 (100.0)	—	2.32 (59.0)	2.62 (66.5)

Notes

① For information on Printed Marking Tag Options, see **Page V7-T8-98**.

② XBPT35PE has an enclosed design. The use of an end cover is not required.

For additional accessories, see **Page V7-T8-90**.

Multi-Conductor Terminal Blocks

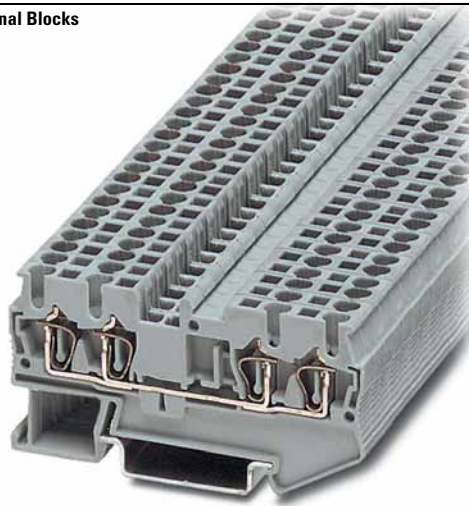

Contents

<i>Description</i>	<i>Page</i>
Single Level—Through-Feed	V7-T8-32
Single Level—Ground Blocks	V7-T8-37
Multi-Conductor Terminal Blocks	
Accessories	V7-T8-40
Technical Data and Specifications	V7-T8-41
Dimensions	V7-T8-41
Multi-Conductor Ground Blocks	V7-T8-42
Double Level Blocks	V7-T8-44
Triple Level Blocks	V7-T8-46
Fuse Terminal Blocks	V7-T8-48
Disconnect and Component Terminal Blocks	V7-T8-51
Hybrid Terminal Blocks	V7-T8-54
Mini Spring Cage	V7-T8-56

Multi-Conductor Terminal Blocks

Product Description

The multi-conductor terminal blocks offer a space-saving alternative to standard feed-through terminal blocks, allowing for high-density wiring. Often, three connections have to be led to one terminal block. The XBPT...D12 terminal block accomplishes this without

any additional terminal blocks or bridging required. The XBPT...D22 terminal blocks allow four wires to be connected to one potential—and can therefore be used as compact power distributors. There is also a version, XBPT25D22U or XBPT4D22U, with an interrupted bus bar in

the terminal center. This makes two feed-through terminal blocks available in one level. One side of this block can be bridged using the standard Plug-in bridges. Double marker carriers are available for clear marking of the feed-through levels.

Product Selection

XBPT4D12



Spring Cage Connection Multi-Conductor Terminal Blocks, Three-Wire

Terminal Width	Maximum Wire Size	IEC 60 947-7-1 in V/A/AWG	EN 50 019 in V/A/AWG	UL-cUL Ratings in V/A/AWG	Color	Standard Pack	Catalog Number
5.2 mm	12 AWG/2.5 mm ²	800/28/28–12	550/25/21/24–12	600/20/26–12	Gray	50	XBPT25D12
					Blue	50	XBPT25D12BU
6.2 mm	10 AWG/4 mm ²	800/40/28–10	550/34/29/24–10	600/30/20–10	Gray	50	XBPT4D12
					Blue	50	XBPT4D12BU

8.1

Terminal Blocks, Fuse Blocks and Fuse Holders

IEC—XB Series

XBPT25D22



Spring Cage Connection Multi-Conductor Terminal Blocks, Four-Wire

Terminal Width	Maximum Wire Size	IEC 60 947-7-1 in V/A/AWG	EN 50 019 in V/A/AWG	UL-cUL Ratings in V/A/AWG	Color	Standard Pack	Catalog Number
Spring Cage Multi-Conductor							
5.2 mm	12 AWG/2.5 mm ²	800/28/28-12	550/24/21/24-12	600/20/26-12	Gray	50	XBPT25D22
					Blue	50	XBPT25D22BU
6.2 mm	10 AWG/4 mm ²	800/40/28-10	550/34/25/24-10	600/30/20-10	Gray	50	XBPT4D22
					Blue	50	XBPT4D22BU
Spring Cage Multi-Conductor with Interrupted Bus Bar							
5.2 mm	12 AWG/2.5 mm ²	800/28/28-12	550/24/21/24-12	600/20/26-12	Blue	50	XBPT25D22U
6.2 mm	10 AWG/4 mm ²	800/40/28-10	550/34/25/24-10	600/30/20-10	Blue	50	XBPT4D22U

8

Accessories

Spring Cage Connection Multi-Conductor Terminal Blocks

Description	Color	Number of Positions	Standard Pack	XBPT25D12 Catalog Number	XBPT4D12 Catalog Number	XBPT25D22 Catalog Number	XBPT4D22 Catalog Number
End cover	Gray	—	50	XBACPT25D12	XBACPT4D12	XBACPT25D22	XBACPT4D22
End cover segment	Gray	—	10	XBASPT25	XBASPT4	XBASPT25	XBASPT4
Partition plate	—	—	50	XBATPTD12	XBATPTD12	XBATPTD22	XBATPTD22
Plug-in bridge—for cross connections in the bridge shaft	Red	2	10	XBAFBS25	XBAFBS26	XBAFBS25	XBAFBS26
		3	50	XBAFBS35	XBAFBS36	XBAFBS35	XBAFBS36
		5	50	XBAFBS55	XBAFBS56	XBAFBS55	XBAFBS56
		10	10	XBAFBS105	XBAFBS106	XBAFBS105	XBAFBS106
		50	10	XBAFBS505	XBAFBS506	XBAFBS505	XBAFBS506
Test adapter	—	—	10	XBATSPA14	XBATSPA14	XBATSPA14	XBATSPA14
2.3 mm diameter test plug	—	—	—	XBATSMPS-^①	XBATSMPS-^①	XBATSMPS-^①	XBATSMPS-^①
Modular test plug	—	—	10	XBATSPS5	XBATSPS6	XBATSPS5	XBATSPS6
Blank marker strip external labeling	White	—	10	XBMZBF5^②	XBMZBF6^②	XBMZBF5^②	XBMZBF6^②
Blank marker strip center labeling (strip of 10)	White	—	10	XBMZB5^②	XBMZB6^②	XBMZB5^②	XBMZB6^②

Notes

- ① For ordering information, see **Page V7-T8-103**.
 - ② For information on Printed Marking Tag Options, see **Page V7-T8-98**.
- For additional accessories, see **Page V7-T8-90**.

Technical Data and Specifications**Spring Cage Connection Multi-Conductor Terminal Blocks**

Description	XBPT25D12	XBPT4D12	XBPT25D22	XBPT4D22
Technical Data in Accordance with IEC				
Maximum load current in A/cross-section in mm ²	28/4	40/6	28/4	40/6
Rated surge voltage in kV/contamination class	8/3	8/3	8/3	8/3
Surge voltage category/insulating material group	III/I	III/I	III/I	III/I
Connection Capacity				
Stranded with ferrule with plastic sleeve in mm ²	0.25–2.5	0.25–4	0.25–2.5	0.25–4
Stranded with ferrules without plastic sleeve in mm ²	0.25–2.5	0.25–4	0.25–2.5	0.25–4
Stranded with twin ferrule with plastic sleeve in mm ²	0.5	0.5–1	0.5	0.5–1
Stripping length in inches (mm)	0.39 (10)	0.39 (10)	0.39 (10)	0.39 (10)

Dimensions

Approximate Dimensions in Inches (mm)

Spring Cage Connection Multi-Conductor Terminal Blocks

Catalog Number	Width	Length	Cover Width	Height for—	
				35 x 7.5 in	35 x 15 in
XBPT25D12	0.20 (5.2)	2.38 (60.5)	0.09 (2.2)	1.44 (36.5)	1.73 (44.0)
XBPT4D12	0.24 (6.2)	2.81 (71.5)	0.09 (2.2)	1.44 (36.5)	1.73 (44.0)
XBPT25D22	0.20 (5.2)	2.83 (72.0)	0.09 (2.2)	1.44 (36.5)	1.73 (44.0)
XBPT4D22	0.24 (6.2)	3.43 (87.0)	0.09 (2.2)	1.44 (36.5)	1.73 (44.0)

8.1

Terminal Blocks, Fuse Blocks and Fuse Holders

IEC—XB Series

Multi-Conductor Terminal Blocks



Contents

Description

<i>Description</i>	<i>Page</i>
Single Level—Through-Feed	V7-T8-32
Single Level—Ground Blocks	V7-T8-37
Multi-Conductor Terminal Blocks	V7-T8-39
Multi-Conductor Ground Blocks	
Accessories	V7-T8-43
Technical Data and Specifications	V7-T8-43
Dimensions	V7-T8-43
Double Level Blocks	V7-T8-44
Triple Level Blocks	V7-T8-46
Fuse Terminal Blocks	V7-T8-48
Disconnect and Component Terminal Blocks	V7-T8-51
Hybrid Terminal Blocks	V7-T8-54
Mini Spring Cage	V7-T8-56

8

Multi-Conductor Ground Blocks

Product Description

The ground terminal blocks have the same shape and pitch as the standard terminal block, in a green-yellow housing. They easily snap

onto the DIN rail to make a reliable mechanical and electrical contact that meets all requirements of IEC 60-947-7-2.

Product Selection

XBPT25D12PE



Spring Cage Connection Multi-Conductor Ground Blocks, Three-Wire

Terminal Width	Maximum Wire Size	IEC 60 947-7-2 in V/A/AWG	EN 50 019 in V/A/AWG	UL-cUL Ratings in V/A/AWG	Color	Standard Pack	Catalog Number
5.2 mm	12 AWG/2.5 mm ²	—/—/28-12	—/—/24-12	—/—/26-12	Green/Yellow	50	XBPT25D12PE
6.2 mm	10 AWG/4 mm ²	—/—/28-10	—/—/24-10	—/—/20-10	Green/Yellow	50	XBPT4D12PE

XBPT4D22PE



Spring Cage Connection Multi-Conductor Ground Blocks, Four-Wire

Terminal Width	Maximum Wire Size	IEC 60 947-7-2 in V/A/AWG	EN 50 019 in V/A/AWG	UL-cUL Ratings in V/A/AWG	Color	Standard Pack	Catalog Number
5.2 mm	12 AWG/2.5 mm ²	—/—/28-12	—/—/24-12	—/—/26-12	Green/Yellow	50	XBPT25D22PE
6.2 mm	10 AWG/4 mm ²	—/—/28-10	—/—/24-10	—/—/20-10	Green/Yellow	50	XBPT4D22PE

Accessories

Spring Cage Connection Multi-Conductor Ground Blocks

Description	Color	Number of Positions	Standard Pack	XBPT25D12PE	XBPT4D12PE	XBPT25D22PE	XBPT4D22PE
				Catalog Number	Catalog Number	Catalog Number	Catalog Number
End cover	Gray	—	50	XBACPT25D12	XBACPT4D12	XBACPT25D22	XBACPT4D22
End cover segment	Gray	—	10	XBASPT25	XBASPT4	XBASPT25	XBASPT4
Blank marker strip external labeling	White	—	10	XBMZBF5 ①	XBMZBF6 ①	XBMZBF5 ①	XBMZBF6 ①
Blank marker strip center labeling (strip of 10)	White	—	10	XBMZB5 ①	XBMZB6 ①	XBMZB5 ①	XBMZB6 ①

Technical Data and Specifications

Spring Cage Connection Multi-Conductor Ground Blocks

Description	XBPT25D12PE	XBPT4D12PE	XBPT25D22PE	XBPT4D22PE
Technical Data in Accordance with IEC				
Maximum load current in A/cross-section in mm ²	—	—	—	—
Rated surge voltage in kV/contamination class	8/3	8/3	8/3	8/3
Surge voltage category/insulating material group	III/1	III/1	III/1	III/1
Connection Capacity				
Stranded with ferrule with plastic sleeve in mm ²	0.25–2.5	0.25–4	0.25–2.5	0.25–4
Stranded with ferrules without plastic sleeve in mm ²	0.25–2.5	0.25–4	0.25–2.5	0.25–4
Stranded with twin ferrule with plastic sleeve in mm ²	0.5	0.5–1	0.5	0.5–1
Stripping length in inches (mm)	0.39 (10)	0.39 (10)	0.39 (10)	0.39 (10)

Dimensions

Approximate Dimensions in Inches (mm)

Spring Cage Connection Multi-Conductor Ground Blocks

Catalog Number	Width	Length	Cover Width	Height for—	
				35 x 7.5 in	35 x 15 in
XBPT25D12PE	0.20 (5.2)	2.38 (60.5)	0.09 (2.2)	1.44 (36.5)	1.73 (44.0)
XBPT4D12PE	0.24 (6.2)	2.81 (71.5)	0.09 (2.2)	1.44 (36.5)	1.73 (44.0)
XBPT25D22PE	0.20 (5.2)	2.83 (72.0)	0.09 (2.2)	1.44 (36.5)	1.73 (44.0)
XBPT4D22PE	0.24 (6.2)	3.43 (87.0)	0.09 (2.2)	1.44 (36.5)	1.73 (44.0)

Notes

① For information on Printed Marking Tag Options, see **Page V7-T8-98**.

For additional accessories, see **Page V7-T8-90**.

8.1

Terminal Blocks, Fuse Blocks and Fuse Holders

IEC—XB Series

Double Level Blocks



Contents

Description	Page
Single Level—Through-Feed	V7-T8-32
Single Level—Ground Blocks	V7-T8-37
Multi-Conductor Terminal Blocks	V7-T8-39
Multi-Conductor Ground Blocks	V7-T8-42
Double Level Blocks	
Accessories	V7-T8-45
Technical Data and Specifications	V7-T8-45
Dimensions	V7-T8-45
Triple Level Blocks	V7-T8-46
Fuse Terminal Blocks	V7-T8-48
Disconnect and Component Terminal Blocks	V7-T8-51
Hybrid Terminal Blocks	V7-T8-54
Mini Spring Cage	V7-T8-56

8

Double Level Blocks

Product Description

The potentials of the **XB** double level terminal blocks routed on two levels reduce space requirements by 50% compared with single level terminal blocks.

The XBPTT blocks can be bridged on both levels with the Plug-in bridge system and labeling options are available for each terminal point, resulting in maximum

customization for each application. The XBPTT25PV and XBPTT4PV terminal blocks have two interconnected levels.

Equipotential bonding is marked by an imprint on the housing. These terminal blocks can also be bridged and used to construct compact potential distributor blocks.

Product Selection

XBPTT4



Spring Cage Connection Double Level Blocks

Terminal Width	Maximum Wire Size	IEC 60 947-7-1 in V/A/AWG	EN 50 019 in V/A/AWG	UL-cUL Ratings in V/A/AWG	Color	Standard Pack	Catalog Number
Spring Cage Connection Double Level Blocks							
5.2 mm	12 AWG/2.5 mm ²	500/26/28-12	420/23/19/24-12	600/20/26-12	Gray	50	XBPTT25
					Blue	50	XBPTT25BU
6.2 mm	10 AWG/4 mm ²	500/32/28-10	420/32/27/24-10	300/30/20-10	Gray	50	XBPTT4
					Blue	50	XBPTT4BU
Spring Cage Connection Double Level Blocks (terminal block with potential distribution between the levels)							
5.2 mm	12 AWG/2.5 mm ²	500/26/28-12	420/23/19/24-12	600/20/26-12	Gray	50	XBPTT25PV
6.2 mm	10 AWG/4 mm ²	500/32/28-10	420/32/27/24-10	300/30/20-10	Gray	50	XBPTT4PV

XBPTT25PE



Spring Cage Connection Double Level Ground Blocks

Terminal Width	Maximum Wire Size	IEC 60 947-7-2 in V/A/AWG	EN 50 019 in V/A/AWG	UL-cUL Ratings in V/A/AWG	Color	Standard Pack	Catalog Number
6.2 mm	10 AWG/4 mm ²	—/—/28-10	—/—/24-10	—/—/20-10	Green/Yellow	50	XBPTT4PE

Accessories

Spring Cage Connection Double Level Blocks

Description	Color	Number of Positions	Standard Pack	XBPTT25 Catalog Number	XBPTT4 Catalog Number	XBPTT25PE Catalog Number	XBPTT4PE Catalog Number
End cover	Gray	—	50	XBACPTT25	XBACPTT4	XBACPTT25	XBACPTT4
Partition plate	—	—	50	XBATPTT4	XBATPTT4	—	—
Plug-in bridge—for cross connections in the bridge shaft	Red	2	10	XBAFBS25	XBAFBS26	XBAFBS25	XBAFBS26
		3	50	XBAFBS35	XBAFBS36	XBAFBS35	XBAFBS36
		5	50	XBAFBS55	XBAFBS56	XBAFBS55	XBAFBS56
		10	10	XBAFBS105	XBAFBS106	XBAFBS105	XBAFBS106
		50	10	XBAFBS505	XBAFBS506	XBAFBS505	XBAFBS506
Test adapter	—	—	10	XBATSPAI4	XBATSPAI4	—	—
Modular test plug	—	—	10	XBATSPS5	XBATSPS6	—	—
Blank marker strip (strip of 10)	White	—	10	XBMZBF5 ①	XBMZBF6 ①	XBMZBF5 ①	XBMZBF6 ①

Technical Data and Specifications

Spring Cage Connection Double Level Blocks

Description	XBPTT25	XBPTT4	XBPTT25PE	XBPTT4PE
Technical Data in Accordance with IEC				
Maximum load current in A/cross-section in mm ²	26/4	32/6	—	—
Rated surge voltage in kV/contamination class	6/3	6/3	6/3	6/3
Surge voltage category/insulating material group	III/I	III/I	III/I	III/I
Connection Capacity				
Stranded with ferrule with plastic sleeve in mm ²	0.25–2.5	0.25–4	0.25–2.5	0.25–4
Stranded with ferrules without plastic sleeve in mm ²	0.25–2.5	0.25–4	0.25–2.5	0.25–4
Stranded with twin ferrule with plastic sleeve in mm ²	0.5	0.5–1	0.5	0.5–1
Stripping length in inches (mm)	0.39 (10)	0.39 (10)	0.39 (10)	0.39 (10)

Dimensions

Approximate Dimensions in Inches (mm)

Spring Cage Connection Double Level Blocks

Catalog Number	Width	Length	Cover Width	Height for—	
				35 x 7.5 in	35 x 15 in
XBPTT25	0.20 (5.2)	2.66 (67.5)	0.09 (2.2)	1.87 (47.5)	2.17 (55.0)
XBPTT4	0.24 (6.2)	3.29 (83.5)	0.09 (2.2)	1.87 (47.5)	2.17 (55.0)
XBPTT25PE	0.20 (5.2)	2.66 (67.5)	0.09 (2.2)	1.87 (47.5)	2.17 (55.0)
XBPTT4PE	0.24 (6.2)	3.29 (83.5)	0.09 (2.2)	1.87 (47.5)	2.17 (55.0)

Notes

① For information on Printed Marking Tag Options, see **Page V7-T8-98**.

For additional accessories, see **Page V7-T8-90**.

8.1

Terminal Blocks, Fuse Blocks and Fuse Holders

IEC—XB Series

Triple Level Blocks

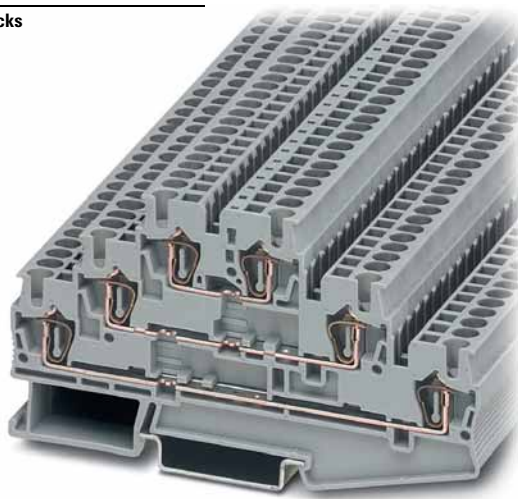

Contents

<i>Description</i>	<i>Page</i>
Single Level—Through-Feed	V7-T8-32
Single Level—Ground Blocks	V7-T8-37
Multi-Conductor Terminal Blocks	V7-T8-39
Multi-Conductor Ground Blocks	V7-T8-42
Double Level Blocks	V7-T8-44
Triple Level Blocks	
Accessories	V7-T8-47
Technical Data and Specifications	V7-T8-47
Dimensions	V7-T8-47
Fuse Terminal Blocks	V7-T8-48
Disconnect and Component Terminal Blocks	V7-T8-51
Hybrid Terminal Blocks	V7-T8-54
Mini Spring Cage	V7-T8-56

8

Triple Level Blocks

Product Description

The spring cage triple level terminal block incorporates three feed-through levels in a 5.2 mm wide housing. This is ideal for high density wiring, especially important

when switchgear space is restricted. There is a bridge shaft on each level allowing use of this block as a compact potential distributor or as a sensor terminal.

The XBPTK25PV has all six terminal points interconnected. All the triple level blocks can be labeled on each level.

Product Selection

XBPTK25

Spring Cage Connection Triple Level Blocks



Terminal Width	Maximum Wire Size	IEC 60 947-7-1 in V/A/AWG	UL-cUL Ratings in V/A/AWG	Color	Standard Pack	Catalog Number
5.2 mm	12 AWG/2.5 mm ²	500/28/28-12	600/20/26-12	Gray	50	XBPTK25
5.2 mm	12 AWG/2.5 mm ²	500/28/28-12	600/20/26-12	Gray	50	XBPTK25PV ①

Note

① Terminal block with potential distribution between the levels.

Accessories

Spring Cage Connection Triple Level Blocks

Description	Color	Number of Positions	Standard Pack	XBPTK25 Catalog Number	XBPTK25PV Catalog Number
End cover	Gray	—	50	XBACPT25K	XBACPT25K
Plug-in bridge—for cross connections in the bridge shaft	Red	2	10	XBAFBS25	XBAFBS25
		3	50	XBAFBS35	XBAFBS35
		5	50	XBAFBS55	XBAFBS55
		10	10	XBAFBS105	XBAFBS105
		50	10	XBAFBS505	XBAFBS505
Test adapter	—	—	10	XBATSPA14	XBATSPA14
Modular test plug	—	—	10	XBATSPS5	XBATSPS5
Blank marker strip (strip of 10)	White	—	10	XBMZBF5 ①	XBMZBF5 ①

Technical Data and Specifications

Spring Cage Connection Triple Level Blocks

Description	XBPTK25	XBPTK25PV
Technical Data in Accordance with IEC		
Maximum load current in A/cross-section in mm ²	28/4	28/4
Rated surge voltage in kV/contamination class	6/3	6/3
Surge voltage category/insulating material group	III/I	III/I
Connection Capacity		
Stranded with ferrule with plastic sleeve in mm ²	0.25–2.5	0.25–2.5
Stranded with ferrules without plastic sleeve in mm ²	0.25–2.5	0.25–2.5
Stranded with twin ferrule with plastic sleeve in mm ²	0.5	0.5
Stripping length in inches (mm)	0.39 (10)	0.39 (10)

Dimensions

Approximate Dimensions in Inches (mm)

Spring Cage Connection Triple Level Blocks

Catalog Number	Width	Length	Cover Length	Height for—	
				35 x 7.5 in	35 x 15 in
XBPTK25	0.20 (5.2)	3.92 (99.5)	0.09 (2.2)	2.28 (58.0)	2.58 (65.5)
XBPTK25PV	0.20 (5.2)	3.92 (99.5)	0.09 (2.2)	2.28 (58.0)	2.58 (65.5)

Notes

① For information on Printed Marking Tag Options, see **Page V7-T8-98**.For additional accessories, see **Page V7-T8-90**.

8.1

Terminal Blocks, Fuse Blocks and Fuse Holders

IEC—XB Series

Fuse Terminal Blocks



8

Contents

Description	Page
Single Level—Through-Feed	V7-T8-32
Single Level—Ground Blocks	V7-T8-37
Multi-Conductor Terminal Blocks	V7-T8-39
Multi-Conductor Ground Blocks	V7-T8-42
Double Level Blocks	V7-T8-44
Triple Level Blocks	V7-T8-46
Fuse Terminal Blocks	
Accessories	V7-T8-49
Technical Data and Specifications	V7-T8-50
Dimensions	V7-T8-50
Disconnect and Component Terminal Blocks	V7-T8-51
Hybrid Terminal Blocks	V7-T8-54
Mini Spring Cage	V7-T8-56

Fuse Terminal Blocks

Product Description

The spring cage fuse terminal blocks act as a fuse carrier for 5 x 20 mm or 6.3 x 32 mm fuses. They also allow for potential distribution with the

double bridge shaft. For signaling a triggered fuse, fuse terminal blocks with light indicators are available (for both AC and DC voltage).

Product Selection

XBPT4FBE

Spring Cage Connection Fuse Terminal Blocks, for 5 x 20 mm Fuse



Terminal Width	Maximum Wire Size	IEC 60 947-7-3 with Fuse in V/A/AWG	IEC 60 947-7-3 as Disconnect Terminal Blocks in V/A/AWG	UL-cUL Ratings in V/A/AWG	Color	Standard Pack	Catalog Number
Fuse Terminal Blocks							
6.2 mm	10 AWG/4 mm ²	①/①/28–10	250/6.3/28–10	300/6.3/24–10	Black	50	XBPT4FBE
Fuse Terminal Blocks with LED 15–30V, 3.5–8.1A							
6.2 mm	10 AWG/4 mm ²	①/①/28–10	250/6.3/28–10	300/6.3/24–10	Black	50	XBPT4FBEL24
Fuse Terminal Blocks with LED 30–60V, 0.8–2.0A							
6.2 mm	10 AWG/4 mm ²	①/①/28–10	250/6.3/28–10	300/6.3/24–10	Black	50	XBPT4FBEL60
Fuse Terminal Blocks with LED 110–250V, 0.5–1.0A							
6.2 mm	10 AWG/4 mm ²	①/①/28–10	250/6.3/28–10	300/6.3/24–10	Black	50	XBPT4FBEL250

Notes

The cartridge fuse holders should be selected according to the maximum power dissipation (self-heating) of the cartridge fuse inserts. The thermal conditions in closed fuse holes should be checked according to the application and installation.

Higher ambient temperatures are an additional strain on fuse inserts. In applications of this kind, the shift of the rated current should be taken into consideration accordingly.

Maximum power dissipation at 73.4°F (23°C) (in accordance with IEC 60 947-7-3).

When selecting cartridge fuse inserts, please ensure that the maximum power dissipation specified at right is not exceeded. Details can be obtained from the fuse suppliers.

Cartridge Fuse Inserts 5 x 20 and 6.3 x 32 mm in accordance with IEC 60 947-7-3.

① The current is determined by the fuse used, the voltage by the selected light indicator. See **Page V7-T8-49**.

XBPT4FBN



Spring Cage Connection Fuse Terminal Blocks, for 6.3 x 32 mm (1/4 in x 1-1/4 in) Fuse

Terminal Width	Maximum Wire Size	IEC 60 947-7-3 with Fuse in V/A/AWG	IEC 60 947-7-3 as Disconnect Terminal Blocks in V/A/AWG	UL-cUL Ratings in V/A/AWG	Color	Standard Pack	Catalog Number
Fuse Terminal Blocks							
8.2 mm	10 AWG/4 mm ²	400/10/28-10	400/10/28-10	300/10/24-10	Black	50	XBPT4FBN
Fuse Terminal Blocks with LED 12-30V, 1.0-2.5 mA							
8.2 mm	10 AWG/4 mm ²	400/10/28-10	400/10/28-10	300/10/24-10	Black	50	XBPT4FBNL24
Fuse Terminal Blocks with LED 110-250V, 0.5-2.5 mA							
8.2 mm	10 AWG/4 mm ²	400/10/28-10	400/10/28-10	300/10/24-10	Black	50	XBPT4FBNL250

Accessories

Spring Cage Connection Fuse Terminal Blocks

Description	Color	Number of Positions	Standard Pack	XBPT4FBE Catalog Number	XBPT4FBN Catalog Number
Partition plate	—	—	50	XBATPT4	XBATQTD12
Plug-in bridge—for cross connections in the bridge shaft	Red	2	10	XBAFBS26	XBAFBS28
		3	50	XBAFBS36	—
		5	50	XBAFBS56	—
		10	10	XBAFBS106	—
Blank marker strip external labeling	White	—	10	XBMZBF6 ①	XBMZBF8 ①
Blank marker strip center labeling (strip of 10)	White	—	10	XBMZB5 ①	XBMZB6 ①

Notes

The cartridge fuse holders should be selected according to the maximum power dissipation (self-heating) of the cartridge fuse inserts. The thermal conditions in closed fuse holes should be checked according to the application and installation.

Higher ambient temperatures are an additional strain on fuse inserts. In applications of this kind, the shift of the rated current should be taken into consideration accordingly.

Maximum power dissipation at 73.4°F (23°C) (in accordance with IEC 60 947-7-3).

When selecting cartridge fuse inserts, please ensure that the maximum power dissipation specified at right is not exceeded. Details can be obtained from the fuse suppliers.

Cartridge Fuse Inserts 5 x 20 and 6.3 x 32 mm in accordance with IEC 60 947-7-3.

① For information on Printed Marking Tag Options, see **Page V7-T8-98**.

For additional accessories, see **Page V7-T8-90**.

8.1

Terminal Blocks, Fuse Blocks and Fuse Holders

IEC—XB Series

Technical Data and Specifications

Overload and Short-Circuit Protection

Terminal Blocks	U (V)	Overload Protection		Short-Circuit Protection Only		I _{max} (A)
		Individual	Interconnected	Individual	Interconnected	
XBPT4FBN	400	1.6W	1.6W	4W	2.5W	10.0
XBPT4FBE	250	1.6W	1.6W	4W	2.5W	6.3

Spring Cage Connection Fuse Terminal Blocks

Description	XBPT4FBE	XBPT4FBN
Technical Data in Accordance with IEC		
Fuse type/dimensions in mm ²	G/5 x 20	G/6.3 x 32
Maximum current with single arrangement in A	6.3	10
Maximum Power Dissipation		
At 73.4°F (23°C) in accordance with IEC 60 947-7-3 in W	①	①
Rated surge voltage in kV/contamination class	4/3	6/3
Surge voltage category/insulating material group	III/I	III/I
Connection Capacity		
Stranded with ferrule/with ferrule and plastic sleeve in mm ²	0.25–4/0.25–4	0.25–4/0.25–4
Stranded with twin ferrule and plastic sleeve in mm ²	0.5	0.5
Stripping length in inches (mm)	0.39 (10)	0.39 (10)

Dimensions

Approximate Dimensions in Inches (mm)

Spring Cage Connection Fuse Terminal Blocks

Catalog Number	Width	Length	Height for—	
			35 x 7.5 in	35 x 15 in
XBPT4FBE	0.24 (6.2)	2.42 (61.5)	2.46 (62.5)	2.76 (70.0)
XBPT4FBN	0.32 (8.2)	3.01 (76.5)	2.72 (69.0)	3.01 (76.5)

Note

① The current is determined by the fuse used, the voltage by the selected light indicator. See **Page V7-T8-49**.

Disconnect and Component Terminal Blocks



Contents

Description	Page
Single Level—Through-Feed	V7-T8-32
Single Level—Ground Blocks	V7-T8-37
Multi-Conductor Terminal Blocks	V7-T8-39
Multi-Conductor Ground Blocks	V7-T8-42
Double Level Blocks	V7-T8-44
Triple Level Blocks	V7-T8-46
Fuse Terminal Blocks	V7-T8-48
Disconnect and Component Terminal Blocks	
Accessories	V7-T8-52
Technical Data and Specifications	V7-T8-53
Dimensions	V7-T8-53
Hybrid Terminal Blocks	V7-T8-54
Mini Spring Cage	V7-T8-56

Disconnect and Component Terminal Blocks

Product Description

The XBPT knife disconnect terminal blocks feature narrow construction and high current carrying capacity. They also have a test connection parallel to the disconnect point for a 2.3 mm

diameter test plug. Potential distribution is easily accomplished with the Plug-in bridges. There are front connection spring cage terminal blocks available for multi-conductor connections

in the smallest possible space. The XBPT4TG disconnect terminal block accommodates component plugs for resistors, diodes, or capacitors, and fuse plugs with or without indication.

Product Selection

XBPT25MT
Knife Disconnect



Disconnect and Component Terminal Blocks

Terminal Width	Maximum Wire Size	IEC 60 947-7-1 in V/A/AWG	UL-cUL Ratings in V/A/AWG	Color	Standard Pack	Catalog Number
Single Level Knife Disconnect						
5.2 mm	12 AWG/2.5 mm ²	400/16/28–12	600/16/26–12	Gray	50	XBPT25MT
6.2 mm	10 AWG/4 mm ²	400/16/28–10	300/6.3/24–10	Gray	50	XBPT4MT
Three-Wire Knife Disconnect						
5.2 mm	12 AWG/2.5 mm ²	400/16/28–12	600/16/26–12	Gray	50	XBPT25D12MT
Four-Wire Knife Disconnect						
5.2 mm	12 AWG/2.5 mm ²	400/16/28–12	600/16/26–12	Gray	50	XBPT25D22MT
Spring Cage Disconnect/Component Plug						
6.2 mm	10 AWG/4 mm ²	400/16/28–10	300/6.3/24–10	Gray	50	XBPT4TG
Component Plug						
6.2 mm	10 AWG/4 mm ²	400/16/28–10	300/6.3/24–10	Gray	10	XBPCO
Fuse Plug						
6.2 mm	10 AWG/4 mm ²	400/16/28–10	300/6.3/24–10	Black	10	XBPFU
Fuse Plug with Light Indicator for 12–30V, 1–2.5 mA						
6.2 mm	10 AWG/4 mm ²	400/16/28–10	300/6.3/24–10	Black	10	XBPFUL24
Fuse Plug with Light Indicator for 110–250V, 0.5–2.5 mA						
6.2 mm	10 AWG/4 mm ²	400/16/28–10	300/6.3/24–10	Black	10	XBPFUL250

8.1

Terminal Blocks, Fuse Blocks and Fuse Holders

IEC—XB Series

Accessories

Spring Cage Connection Disconnect and Component Terminal Blocks

Description	Color	Number of Positions	Standard Pack	XBPT25MT Catalog Number	XBPT25D12MT Catalog Number	XBPT25D22MT Catalog Number	XBPT4MT Catalog Number	XBPT4TG Catalog Number
End cover	Gray	—	50	XBACPT25D12	XBACPT25D22	XBACPT25D22MT	③	③
End cover segment	Gray	—	50	—	XBACPT25	XBACPT25	—	—
Partition plate	—	—	50	XBATPTD12	XBATPTD22	—	XBATPT4	XBATPT4
Plug-in bridge—for cross connections in the terminal center	Red	2	10	XBAFBS25	XBAFBS25	XBAFBS25	XBAFBS26	XBAFBS26
		3	50	XBAFBS35	XBAFBS35	XBAFBS35	XBAFBS36	XBAFBS36
		5	50	XBAFBS55	XBAFBS55	XBAFBS55	XBAFBS56	XBAFBS56
		10	10	XBAFBS105	XBAFBS105	XBAFBS105	XBAFBS106	XBAFBS106
		50	10	XBAFBS505	XBAFBS505	XBAFBS505	XBAFBS506	XBAFBS506
Test adapter	—	—	10	XBATSPA14	XBATSPA14	XBATSPA14	XBATSPA14	XBATSPA14
2.3 mm diameter test plug	—	—	—	XBATSMPS-^①	XBATSMPS-^①	XBATSMPS-^①	XBATSMPS-^①	XBATSMPS-^①
Modular test plug	—	—	10	XBATSPS5	XBATSPS5	XBATSPS5	XBATSPS6	XBATSPS6
Blank marker strip external labeling	White	—	10	XBMZBF5^②	XBMZBF5^②	XBMZBF5^②	XBMZBF6^②	XBMZBF6^②
Blank marker strip center labeling (strip of 10)	White	—	10	XBMZB5^②	XBMZB5^②	XBMZB5^②	XBMZB6^②	XBMZB6^②

Notes

- ① For ordering information, see **Page V7-T8-103**.
 - ② For information on Printed Marking Tag Options, see **Page V7-T8-98**.
 - ③ XBPT4MT and XBPT4TG have an enclosed design. The use of an end cover is not required.
- For additional accessories, see **Page V7-T8-90**.

Technical Data and Specifications

Spring Cage Connection Disconnect and Component Terminal Blocks, XBPT25MT, XBPT25D12MT and XBPT25D22MT

Description	XBPT25MT	XBPT25D12MT	XBPT25D22MT
Technical Data in Accordance with IEC			
Maximum load current in A/cross-section in mm ²	16/4	16/4	16/4
Rated surge voltage in kV/contamination class	6/3	6/3	6/3
Surge voltage category/insulating material group	III/1	III/1	III/1
Connection Capacity			
Stranded with ferrule with plastic sleeve in mm ²	0.25–2.5	0.25–2.5	0.25–2.5
Stranded with ferrules without plastic sleeve in mm ²	0.25–2.5	0.25–2.5	0.25–2.5
Stranded with twin ferrule with plastic sleeve in mm ²	0.5	0.5	0.5
Stripping length in inches (mm)	0.39 (10)	0.39 (10)	0.39 (10)

Spring Cage Connection Disconnect and Component Terminal Blocks, XBPT25D12MT and XBPT4TG

Description	XBPT4MT	XBPT4TG
Technical Data in Accordance with IEC		
Maximum load current in A/cross-section in mm ²	16/6	16/6
Rated surge voltage in kV/contamination class	6/3	6/3
Surge voltage category/insulating material group	III/1	III/1
Connection Capacity		
Stranded with ferrule with plastic sleeve in mm ²	0.25–4	0.25–4
Stranded with ferrules without plastic sleeve in mm ²	0.25–4	0.25–4
Stranded with twin ferrule with plastic sleeve in mm ²	0.5	0.5
Stripping length in inches (mm)	0.39 (10)	0.39 (10)

Dimensions

Approximate Dimensions in Inches (mm)

Spring Cage Connection Disconnect and Component Terminal Blocks

Catalog Number	Width	Length	Cover Length	Height for—	
				35 x 7.5 in	35 x 15 in
XBPT25MT	0.20 (5.2)	2.38 (60.5)	0.09 (2.2)	1.44 (36.5)	1.73 (44.0)
XBPT25D12MT	0.20 (5.2)	2.83 (72.0)	0.09 (2.2)	1.44 (36.5)	1.73 (44.0)
XBPT25D22MT	0.20 (5.2)	3.31 (84.0)	0.09 (2.2)	1.44 (36.5)	1.73 (44.0)
XBPT4MT	0.24 (6.2)	2.42 (61.5)	—	1.44 (36.5)	1.73 (44.0)
XBPT4TG	0.24 (6.2)	2.42 (61.5)	—	1.44 (36.5)	1.73 (44.0)

8.1

Terminal Blocks, Fuse Blocks and Fuse Holders

IEC—XB Series

Hybrid Terminal Blocks



Contents

Description

	<i>Page</i>
Single Level—Through-Feed	V7-T8-32
Single Level—Ground Blocks	V7-T8-37
Multi-Conductor Terminal Blocks	V7-T8-39
Multi-Conductor Ground Blocks	V7-T8-42
Double Level Blocks	V7-T8-44
Triple Level Blocks	V7-T8-46
Fuse Terminal Blocks	V7-T8-48
Disconnect and Component Terminal Blocks	V7-T8-51
Hybrid Terminal Blocks	
Accessories	V7-T8-55
Technical Data and Specifications	V7-T8-55
Dimensions	V7-T8-55
Mini Spring Cage	V7-T8-56

8

Hybrid Terminal Blocks

Product Description

The XBPU spring cage hybrid terminal blocks offer the best of both worlds. One side offers a spring cage connection and the other side offers the universal screw connection. Use the spring

cage connection on the internal (factory) control cabinet side and the screw connection on the end customer (field) side. Ground terminal blocks of the same shape are also available.

Product Selection

XBPU25D12



Spring Cage Hybrid Terminal Blocks

Terminal Width	Maximum Wire Size	IEC 60 947-7-1 with ...		IEC 60 947-7-2 with ...		UL-cUL Ratings with ...		Color	Std. Pack	Catalog Number
		Spring in V/A/AWG	Screw in V/A/AWG	Spring in V/A/AWG	Screw in V/A/AWG	Spring in V/A/AWG	Screw in V/A/AWG			
5.2 mm	12 AWG/ 2.5 mm ²	800/28/28-12	800/28/26-14	—	—	600/15/28-12	600/15/26-12	Gray	50	XBPU25D12

XBPU25D12PE



Spring Cage Hybrid Ground Blocks

Terminal Width	Maximum Wire Size	IEC 60 947-7-1 with ...		IEC 60 947-7-2 with ...		UL-cUL Ratings with ...		Color	Std. Pack	Catalog Number
		Spring in V/A/AWG	Screw in V/A/AWG	Spring in V/A/AWG	Screw in V/A/AWG	Spring in V/A/AWG	Screw in V/A/AWG			
5.2 mm	12 AWG/ 2.5 mm ²	—	—	—/—/28-12	—/—/26-14	—/—/28-12	—/—/28-12	Green/ Yellow	50	XBPU25D12PE

Accessories

Spring Cage Hybrid Terminal/Ground Blocks

Description	Color	Number of Positions	Standard Pack	XBPU25D12	XBPU25D12PE
				Catalog Number	Catalog Number
End cover	Gray	—	50	XBACPU25D12	XBACPU25D12
Plug-in bridge—for cross connections in the terminal center	Red	2	10	XBAFBS25	XBAFBS25
		3	50	XBAFBS35	XBAFBS35
		5	50	XBAFBS55	XBAFBS55
		10	10	XBAFBS105	XBAFBS105
		50	10	XBAFBS505	XBAFBS505
Test adapter	—	—	10	XBATSPAI4	—
2.3 mm diameter test plug	—	—	—	XBATSMPS-^①	—
Modular test plug	—	—	10	XBATSPS5	—
Blank marker strip external labeling	White	—	10	XBMZBF5^②	XBMZBF5^②
Blank marker strip center labeling (strip of 10)	White	—	10	XBMZB5^②	XBMZB5^②

Technical Data and Specifications

Spring Cage Hybrid Blocks

Description	XBPU25D12	XBPU25D12PE
Technical Data in Accordance with IEC		
Maximum load current in A/cross-section in mm ²	28/4	—
Rated surge voltage in kV/contamination class	8/3	8/3
Surge voltage category/insulating material group	III/1	III/1
Connection Capacity		
Stranded with ferrule with plastic sleeve in mm ²	0.25–2.5	0.25–2.5
Stranded with ferrules without plastic sleeve in mm ²	0.25–2.5	0.25–2.5
Stranded with twin ferrule with plastic sleeve in mm ²	0.5–1	0.5–1
Stripping length in inches (mm)	0.39 (10)	0.39 (10)

Dimensions

Approximate Dimensions in Inches (mm)

Spring Cage Hybrid Blocks

Catalog Number	Width	Length	Cover Length	Height for—	
				35 x 7.5 in	35 x 15 in
XBPU25D12	0.20 (5.2)	2.57 (65.3)	0.09 (2.2)	1.69 (42.8)	1.98 (50.3)
XBPU25D12PE	0.20 (5.2)	2.57 (65.3)	0.09 (2.2)	1.69 (42.8)	1.98 (50.3)

Notes

- ① For ordering information, see **Page V7-T8-103**.
 - ② For information on Printed Marking Tag Options, see **Page V7-T8-98**.
- For additional accessories, see **Page V7-T8-90**.

8.1

Terminal Blocks, Fuse Blocks and Fuse Holders

IEC—XB Series

Mini Spring Cage



Contents

Description

<i>Description</i>	<i>Page</i>
Single Level—Through-Feed	V7-T8-5
Single Level—Ground Blocks	V7-T8-10
Multi-Conductor Terminal Blocks	V7-T8-12
Multi-Conductor Ground Blocks	V7-T8-14
Double Level	V7-T8-16
Triple Level Sensor/Actuator	V7-T8-18
Fuse Terminal Blocks	V7-T8-21
Disconnect and Component Terminal Blocks	V7-T8-24
High Current Blocks	V7-T8-27
Mini Spring Cage	
Accessories	V7-T8-57
Technical Data and Specifications	V7-T8-57
Dimensions	V7-T8-57

Mini Spring Cage

Product Description

The **XB** miniature terminal blocks have a connection cross-section from 1.5 mm² through 4 mm² and mount on 15 mm DIN rail. There is an

opening for bridging with a fixed bridge in the center of the terminal blocks. These miniature terminal blocks also offer the same accessories

that you would find with the larger blocks—including marking tags, end covers, end stop and ground blocks.

Product Selection

XBMPK15



Mini Spring Cage Terminal Blocks

Terminal Width	Maximum Wire Size	IEC 60 947-7-1 in V/A/AWG	IEC 60 947-7-2 in V/A/AWG	UL-cUL Ratings in V/A/AWG	Color	Standard Pack	Catalog Number
5.2 mm	14 AWG/1.5 mm ²	800/24/26–14	—	600/15/26–14	Gray	50	XBMPK15
					Blue	50	XBMPK15BU

XBMPK15PE



Mini Spring Cage Ground Blocks

Terminal Width	Maximum Wire Size	IEC 60 947-7-1 in V/A/AWG	IEC 60 947-7-2 in V/A/AWG	UL-cUL Ratings in V/A/AWG	Color	Standard Pack	Catalog Number
5.2 mm	14 AWG/1.5 mm ²	—	—/—/26–14	—/—/26–14	Green/ Yellow	50	XBMPK15PE

XBMPKK15



Mini Spring Cage Terminal Blocks—Double Level

Terminal Width	Maximum Wire Size	IEC 60 947-7-1 in V/A/AWG	UL-cUL Ratings in V/A/AWG	Color	Standard Pack	Catalog Number
5.2 mm	14 AWG/1.5 mm ²	500/20/26–14	600/15/26–14	Gray	50	XBMPKK15

Accessories

Mini Spring Cage Terminal/Ground Blocks

Description	Color	Number of Positions	Standard Pack	XBMPK15 Catalog Number	XBMPK15PE Catalog Number	XBMPKK15 Catalog Number
End cover	Gray	—	10	XBACMPK15	XBACMPK15	XBACMPKK15
Fixed bridge	—	2	10	XBAFBR25N	—	XBAFBR25N
Separating plate	—	—	10	XBATMPKK15	—	XBATMPKK15
Blank marker strip	White	—	10	XBMZBF5 ^①	XBMZBF5 ^①	XBMZBF5 ^①

Technical Data and Specifications

Mini Spring Cage Terminal/Ground Blocks

Description	XBMPK15	XBMPK15PE	XBMPKK15
Technical Data in Accordance with IEC			
Maximum load current in A/cross-section in mm ²	24/2.5	—	20/2.5
Rated surge voltage in kV/contamination class	8/3	8/3	6/3
Surge voltage category/insulating material group	III/1	III/1	III/1
Connection Cross-Section			
Stranded with ferrule with plastic sleeve in mm ²	0.25–1.5	0.25–1.5	0.25–1.5
Stranded with ferrule without plastic sleeve in mm ²	0.25–1.5	0.25–1.5	0.25–1.5
Stranded with twin ferrule with plastic sleeve in mm ²	—	—	—
Stripping length in Inches (mm)	0.35 (9)	0.35 (9)	0.35 (9)

Dimensions

Approximate Dimensions in Inches (mm)

Mini Spring Cage Terminal/Ground Blocks

Catalog Number	Width	Length	Cover Length	Height for—		
				15 x 5.5 in	35 x 7.5 in	35 x 15 in
XBMPK15	0.20 (5.2)	1.57 (40.0)	0.04 (1.1)	1.36 (34.5)	—	—
XBMPK15PE	0.20 (5.2)	1.57 (40.0)	0.04 (1.1)	1.36 (34.5)	—	—
XBMPKK15	0.20 (5.2)	3.35 (85.0)	0.04 (1.1)	1.65 (42.0)	1.67 (42.5)	1.97 (50.0)

Notes

^① For information on Printed Marking Tag Options, see **Page V7-T8-98**.

For additional accessories, see **Page V7-T8-90**.

8.1

Terminal Blocks, Fuse Blocks and Fuse Holders

IEC—XB Series

Pluggable Spring Cage Terminal Blocks

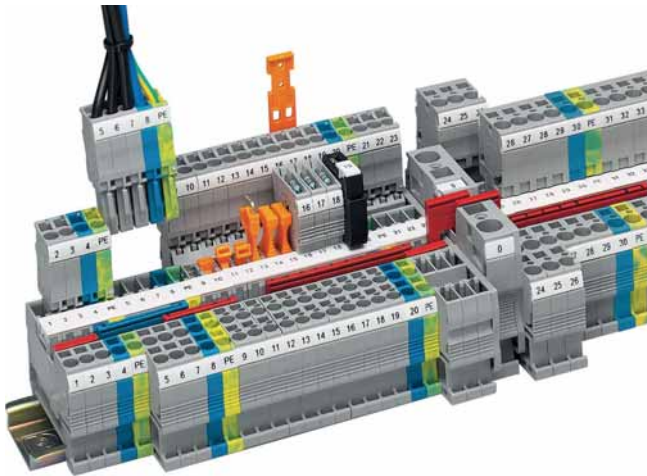

8

Contents

Description

	<i>Page</i>
Pluggable Spring Cage Terminal Blocks	
Connection Terminal Blocks	V7-T8-59
Connection Plugs	V7-T8-62
Connection Receptacles	V7-T8-64
Connection Accessories	V7-T8-66

 Drawings
Online

Pluggable Spring Cage Terminal Blocks Overview

Product Description

The pluggable spring cage connection terminal blocks allow signal and power wiring to be made pluggable. This complete pluggable system has a spring that provides maximum connection space in a space-saving design. The pluggable system accommodates stranded conductors with a nominal cross-section of 2.5 mm², with or without ferrules.

Application Description

For applications requiring pluggable wiring up to a rated current of 32A and a rated voltage of 800V. The integrated overspring meets the most stringent vibration requirements. Also ideal where safety is a concern and flexibility is required. The basic terminal blocks and the plugs are finger-safe, which also means the supply voltage can be input via either the terminal blocks or the plugs. With the XBAPSC receptacles, plug-in contacts can be accommodated safely in cable ducts and distributor shafts using minimal space. A test hole can accommodate a 2.3 mm diameter test plug in each receptacle, providing a practical solution. The XBAPSP plugs are intended for connecting one wire, while the XBAPSPDB plugs are designed to connect two wires and provide an optional bridge.

Features

- Space-saving design
- Powerful contact
- Finger-safe

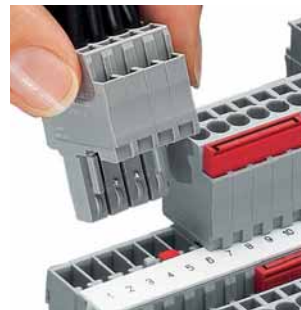

Pluggability

Standards and Certifications

- UL recognized—File No. E67464
- CE approved
- LVD ^①:
 - EN 60947-7-1
 - EN 60947-7-2
 - EN 60998-2-3
 - EN 60352-4/A1



Note

^① Not all standards apply to all terminal blocks. Contact Eaton for details.

Connection Terminal Blocks



Contents

Description	Page
Connection Terminal Blocks	
Accessories	V7-T8-60
Technical Data and Specifications	V7-T8-60
Dimensions	V7-T8-61
Connection Plugs	V7-T8-62
Connection Receptacles	V7-T8-64
Connection Accessories	V7-T8-66

Connection Terminal Blocks

Product Description

Contact to the DIN rail is made by simply snapping the terminal block onto the rail.

These blocks act as the stationary position of the pluggable terminal blocks.

Product Selection

XBPT25P

Pluggable Spring Cage Connection Terminal Blocks



Terminal Width	Maximum Wire Size	IEC 61 984 in V/A/AWG	UL-cUL Ratings in V/A/AWG	Color	Standard Pack	Catalog Number
Single Level						
5.2 mm	12 AWG/2.5 mm ²	500/24/28-12	300/20/26-12	Gray	50	XBPT25P
Three-Wire						
5.2 mm	12 AWG/2.5 mm ²	500/24/28-12	300/20/26-12	Gray	50	XBPT25PD12

8.1

Terminal Blocks, Fuse Blocks and Fuse Holders

IEC—XB Series

Accessories

Pluggable Spring Cage Connection Terminal Blocks

Description	Color	Number of Positions	Standard Pack	XBPT25P Catalog Number	XBPT25PD12 Catalog Number
End cover	Gray	—	50	XBACPT25	XBACPT25D12
End cover segment	Gray	—	10	—	XBASPT25
Partition plate	—	—	50	XBATPT4	XBATPTD12
Plug-in bridge—for cross connections in the terminal center	Red	2	10	XBAFBS25	XBAFBS25
		3	50	XBAFBS35	XBAFBS35
		5	50	XBAFBS55	XBAFBS55
		10	10	XBAFBS105	XBAFBS105
		50	10	XBAFBS505	XBAFBS505
Test adapter	—	—	10	XBATSPA14	XBATSPA14
2.3 mm diameter test plug	—	—	—	XBATSMPS- ^①	XBATSMPS- ^①
Modular test plug	—	—	10	XBATSPS5	XBATSPS5
Blank marker strip external labeling	White	—	10	XBMZBF5 ^②	XBMZBF5 ^②
Blank marker strip center labeling (strip of 10)	White	—	10	XBMZB5 ^②	XBMZB5 ^②

8

Technical Data and Specifications

Pluggable Spring Cage Connection Terminal Blocks

Description	XBPT25P	XBPT25PD12
Technical Data in Accordance with IEC		
Maximum load current in A/cross-section in mm ²	24/4	24/4
Rated surge voltage in kV/contamination class	6/3	6/3
Surge voltage category/insulating material group	III/1	III/1
Connection Capacity		
Stranded with ferrule with plastic sleeve in mm ²	0.25–2.5	0.25–2.5
Stranded with ferrules without plastic sleeve in mm ²	0.25–2.5	0.25–2.5
Stranded with twin ferrule with plastic sleeve in mm ²	0.5	0.5
Stripping length in inches (mm)	0.39 (10)	0.39 (10)

Derating Curve for Pluggable Terminal Blocks

XBPT25P and XBPT25PD12

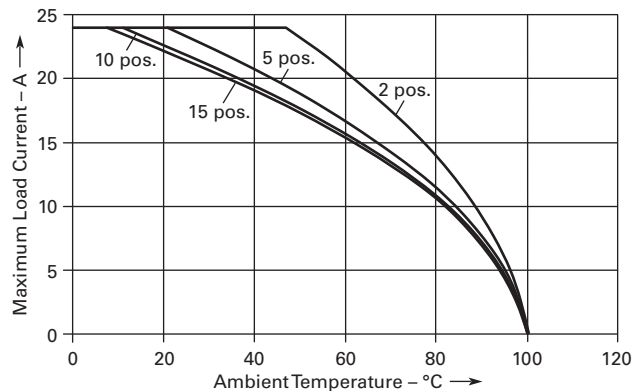

Notes

^① For ordering information, see **Page V7-T8-103**.

^② For information on Printed Marking Tag Options, see **Page V7-T8-98**.

For additional accessories, see **Page V7-T8-90**.

Dimensions

Approximate Dimensions in Inches (mm)

Pluggable Spring Cage Connection Terminal Blocks—Without Plug

Catalog Number	Width	Length	Cover Length	Height for—	
				35 x 7.5 in	35 x 15 in
XBPT25P	0.20 (5.2)	1.91 (48.5)	0.09 (2.2)	1.44 (36.5)	1.73 (44.0)
XBPT25PD12	0.20 (5.2)	2.38 (60.5)	0.09 (2.2)	1.44 (36.5)	1.73 (44.0)

XBPT25P

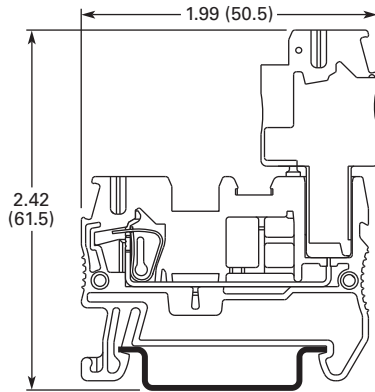

XBPT25PD12

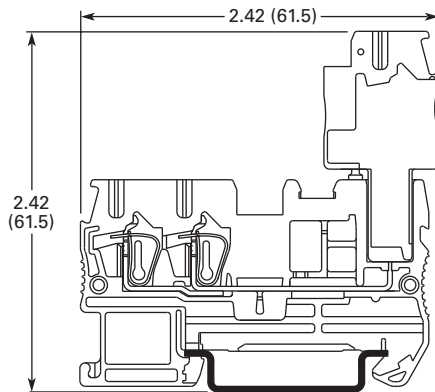

8.1

Terminal Blocks, Fuse Blocks and Fuse Holders

IEC—XB Series

Connection Plugs



8

Contents

Description	Page
Connection Terminal Blocks	V7-T8-59
Connection Plugs	
Accessories	V7-T8-63
Technical Data and Specifications	V7-T8-63
Dimensions	V7-T8-63
Connection Receptacles	V7-T8-64
Connection Accessories	V7-T8-66

Connection Plugs

Product Description

Just like the basic terminal blocks, the plugs also offer the perfect solution for every application. The XBAPSP25_ plugs are designed for

connecting one conductor. The XBAPSPDB25_ plug is designed for connecting two conductors and provides an additional bridging option.

Product Selection

XBAPSP25_

Spring Cage Connection Plugs, Single, Not Bridgeable



Terminal Width	Maximum Wire Size	Connection Data in V/A/AWG	UL-cUL Ratings in V/A/AWG	Color	Number of Positions	Standard Pack	Catalog Number
5.2 mm	12 AWG/2.5 mm ²	500/24/28-12	300/20/26-12	Gray	1	25	XBAPSP251
					2	25	XBAPSP252
					3	25	XBAPSP253
					4	25	XBAPSP254
					5	25	XBAPSP255
					6	25	XBAPSP256
					7	25	XBAPSP257
					8	25	XBAPSP258
					9	25	XBAPSP259
					10	25	XBAPSP2510
					11	10	XBAPSP2511
					12	10	XBAPSP2512

XBAPSPDB25_

Spring Cage Connection Plugs, Double, Bridgeable



Terminal Width	Maximum Wire Size	Connection Data in V/A/AWG	UL-cUL Ratings in V/A/AWG	Color	Number of Positions	Standard Pack	Catalog Number
5.2 mm	12 AWG/2.5 mm ²	500/24/28–12	300/20/26–12	Gray	1	25	XBAPSPDB251
					2	25	XBAPSPDB252
					3	25	XBAPSPDB253
					4	25	XBAPSPDB254
					5	25	XBAPSPDB255
					6	25	XBAPSPDB256
					7	25	XBAPSPDB257
					8	25	XBAPSPDB258
					9	25	XBAPSPDB259
					10	25	XBAPSPDB2510
					11	10	XBAPSPDB2511
					12	10	XBAPSPDB2512

Accessories

Spring Cage Connection Plugs

Description	Color	Number of Positions	Standard Pack	XBAPSP25_ Catalog Number	XBAPSPDB25_ Catalog Number
Plug-in bridge—for cross connections in the terminal center	Red	2	10	—	XBAFBS25
		3	50	—	XBAFBS35
		5	50	—	XBAFBS55
		10	10	—	XBAFBS105
Snap-lock fitting and strain relief	Orange	2	10	XBAPPRZ	XBAPPRZ
Snap-lock fitting	Orange	1	50	XBAPPR	XBAPPR
	Orange	2	50	XBAPPR2	XBAPPR2
Strain relief	Black	2	10	XBAPPZ2	XBAPPDZ2
	Black	4	10	XBAPPZ4	XBAPPDZ4
Blank marker strip	White	—	10	XBMZBF5 ①	XBMZBF5 ①

Technical Data and Specifications

Spring Cage Connection Plugs

Description	XBAPSP25_	XBAPSPDB25_
Technical Data in Accordance with IEC		
Maximum load current in A/cross-section in mm ²	24/4	24/4
Rated surge voltage in kV/contamination class	6/3	6/3
Surge voltage category/insulating material group	III/1	III/1
Connection Capacity		
Stranded with ferrule with plastic sleeve in mm ²	0.25–2.5	0.25–2.5
Stranded with ferrules without plastic sleeve in mm ²	0.25–2.5	0.25–2.5
Stranded with twin ferrule with plastic sleeve in mm ²	0.5	0.5
Stripping length in inches (mm)	0.39 (10)	0.39 (10)

Dimensions

See **Page V7-T8-61** for dimensions.

Notes

① For information on Printed Marking Tag Options, see **Page V7-T8-98**.

For additional accessories, see **Page V7-T8-90**.

8.1

Terminal Blocks, Fuse Blocks and Fuse Holders

IEC—XB Series

Connection Receptacles



8

Contents

<i>Description</i>	<i>Page</i>
Connection Terminal Blocks	V7-T8-59
Connection Plugs	V7-T8-62
Connection Receptacles	
Accessories	V7-T8-65
Technical Data and Specifications	V7-T8-65
Dimensions	V7-T8-65
Connection Accessories	V7-T8-66

Connection Receptacles

Product Description

With the XBAPSC25_ Plug-in contacts can be accommodated safely in cable ducts and distributor shafts without using much

space. The standard strain reliefs can also be used. Large-surface labeling makes it possible to mark the terminal points and the entire

receptacle. A test hole can accommodate a 2.3 mm diameter test plug in each receptacle element, providing a practical solution.

Product Selection

XBAPSC25_

Pluggable Spring Connection Receptacles



Terminal Width	Maximum Wire Size	Connection Data in V/A/AWG	UL-cUL Ratings in V/A/AWG	Color	Number of Positions	Standard Pack	Catalog Number
5.2 mm	12 AWG/2.5 mm ²	500/24/28–12	300/20/26–12	Gray	2	25	XBAPSC252
					3	25	XBAPSC253
					4	25	XBAPSC254
					5	25	XBAPSC255
					6	25	XBAPSC256
					7	25	XBAPSC257
					8	25	XBAPSC258
					9	25	XBAPSC259
					10	25	XBAPSC2510
					11	10	XBAPSC2511
					12	10	XBAPSC2512

Accessories

Pluggable Spring Connection Receptacles

Description	Color	Number of Positions	Standard Pack	XBAPSC25_ Catalog Number
2.3 mm diameter test plug	Red	—	—	XBATSMPS_- ^①
Strain relief	Black	2	10	XBAPPDZ2
	Black	4	10	XBAPPDZ4
Blank marker strip	White	—	10	XBMZBF5 ^②

Technical Data and Specifications

Spring Cage Connection Plugs

Description	XBAPSP25_
Technical Data in Accordance with IEC	
Maximum load current in A/cross-section in mm ²	24/4
Rated surge voltage in kV/contamination class	6/3
Surge voltage category/insulating material group	III/I
Connection Capacity	
Stranded with ferrule with plastic sleeve in mm ²	0.25–2.5
Stranded with ferrules without plastic sleeve in mm ²	0.25–2.5
Stranded with twin ferrule with plastic sleeve in mm ²	0.5
Stripping length in inches (mm)	0.39 (10)

Dimensions

Approximate Dimensions in Inches (mm)

Spring Cage Connection Plugs

Catalog Number	Width	Length	Cover Length	Height
XBAPSP25_	0.20 (5.2)	1.46 (37.2)	0.09 (2.2)	0.71 (18.0)

Receptacle Widths

Catalog Number	Width	Catalog Number	Width
XBAPSC252	0.41 (10.4)	XBAPSC258	1.64 (41.6)
XBAPSC253	0.61 (15.6)	XBAPSC259	1.84 (46.8)
XBAPSC254	0.82 (20.8)	XBAPSC2510	2.05 (52.0)
XBAPSC255	1.02 (26.0)	XBAPSC2511	2.25 (57.2)
XBAPSC256	1.23 (31.2)	XBAPSC2512	2.46 (62.4)
XBAPSC257	1.43 (36.4)		

Notes

① For ordering information, see **Page V7-T8-103**.

② For information on Printed Marking Tag Options, see **Page V7-T8-98**.

For additional accessories, see **Page V7-T8-90**.

8.1

Terminal Blocks, Fuse Blocks and Fuse Holders

IEC—XB Series

Connection Accessories

Product Description

The pluggable XBPT series features an extensive range of application-oriented accessories. Strain reliefs are available for the plugs and

can be snapped on at the required points as an option. The snap-lock fitting can be used for all plug variants. It is snapped into the outside of

the plug housing as an option and hooks onto the terminal block housing when the plug is snapped on.

Product Selection

Pluggable Spring Cage Connection Accessories

	Description	Number of Positions	Standard Pack	Catalog Number
XBAPPZ2	Strain relief for single plugs	2	10	XBAPPZ2
		4	50	XBAPPZ4
XBAPPDZ4	Strain relief for double plugs and receptacles	2	10	XBAPPDZ2
		4	10	XBAPPDZ4
XBAPPR2	Snap-lock fitting for plugs	1	50	XBAPPR
		2	50	XBAPPR2
XBAPPRZ	Snap-lock fitting and strain relief for plugs	2	10	XBAPPRZ

Strain Relief



Snap-Lock Fitting



Optional Accessory Recommendations

Number of Positions Receptacle	Strain Relief
2–4	XBAPPZ2
5–10	XBAPPZ4 or (2) XBAPPZ2
11–15	(2) XBAPPZ4 or (4) XBAPPZ2

IDC Terminal Blocks



Contents

Description

	Page
IDC Terminal Blocks	
Single Level	V7-T8-68
Multi-Conductor	V7-T8-70
Double Level	V7-T8-73
Fuse Terminal Blocks	V7-T8-75
Disconnect and Component Terminal Blocks ..	V7-T8-77
Hybrid Terminal Blocks	V7-T8-79

Drawings
Online**IDC (Insulation Displacement Connection) Terminal Blocks Overview****Product Description**

The superior design of Eaton's Insulation Displacement Connection (IDC) technology terminal blocks reduces wiring installation time and labor, especially in high-volume applications. IDC terminal blocks are suited for applications in automated equipment and machine tools, packaging and material handling machinery, railway/mass transit systems, petrochemical, and any other application requiring high-volume connections for low-voltage control and signal circuitry where labor cost reduction and ease of assembly is desired. These terminal blocks are designed for long-term use under demanding conditions.

The XBQT Series allows for wire to be connected without any prior stripping. The quick connection provides up to 60% reduction in wiring time. One turn of a standard screwdriver results in a simple, fast and reliable connection.

Application Description

The XBQT is operated with a standard screwdriver. The switching states are clearly signaled by engagement points in the start and end positions. Solid and stranded wires of 0.25 to 2.5 mm² can be wired without the use of ferrules. Stripping the wire is not required—the wire's insulation is cut open when it is properly connected. The wire is securely placed in the end position where it makes large-area, gas-tight contact. Connections are made in seconds!

Features

- Quick connection capability
- Global acceptance
- Flexible plug-in bridge system
- Large surface area for marking
- Standardized testing system

Standards and Certifications

- UL recognized—File No. E67464
- CE approved
- LVD ^①
 - EN 60947-7-1
 - EN 60947-7-2
 - EN 60998-2-3
 - EN 60352-4/A1

**Note**

- ^① Not all standards apply to all terminal blocks. Contact Eaton for details.

8.1

Terminal Blocks, Fuse Blocks and Fuse Holders

IEC—XB Series

Single Level



Contents

Description	Page
Single Level	
Accessories	V7-T8-69
Technical Data and Specifications	V7-T8-69
Dimensions	V7-T8-69
Multi-Conductor	V7-T8-70
Double Level	V7-T8-73
Fuse Terminal Blocks	V7-T8-75
Disconnect and Component Terminal Blocks	V7-T8-77
Hybrid Terminal Blocks	V7-T8-79

8

Single Level

Product Description

The XBQT IDC terminal block has the fastest connection time in a compact design. The space-saving front connection design offers additional space for wiring between the cable ducts. The double bridge shaft can

accommodate individual chain bridging and step-down bridging from other terminal blocks. The XBQT ground blocks are the same shape as the feed-through terminal blocks with the same wide range of cross-sections

available. They easily snap onto the DIN rail to make a reliable mechanical and electrical contact that meets all requirements of IEC 60-947-7-2.

Product Selection

XBQT25



IDC—Single Level Terminal Blocks

Terminal Width	Maximum Wire Size	Connection Data in V/A/AWG	EN 50 019 in V/A/AWG	UL-cUL Ratings in V/A/AWG	Color	Standard Pack	Catalog Number
5.2 mm	16 AWG/1.5 mm ²	800/17.5/24–16	550/16/24–16	600/10/24–16	Gray	50	XBQT15
					Blue	50	XBQT15BU
6.2 mm	14 AWG/2.5 mm ²	800/24/20–14	—	600/15/20–14	Gray	50	XBQT25
					Blue	50	XBQT25BU

XBQT15PE



IDC—Single Level Terminal Ground Blocks

Terminal Width	Maximum Wire Size	Connection Data in V/A/AWG	EN 50 019 in V/A/AWG	UL-cUL Ratings in V/A/AWG	Color	Standard Pack	Catalog Number
5.2 mm	16 AWG/1.5 mm ²	—/—/24–16	—/—/24–16	—/—/24–16	Green/Yellow	50	XBQT15PE
6.2 mm	14 AWG/2.5 mm ²	—/—/20–14	—	—/—/20–14	Green/Yellow	50	XBQT25PE

Accessories

IDC—Single Level Terminal/Ground Blocks

Description	Color	Number of Positions	Standard Pack	XBQT15 Catalog Number	XBQT25 Catalog Number	XBQT15PE Catalog Number	XBQT25PE Catalog Number
End cover	Gray	—	50	XBACQT15	XBACQT25	XBACQT15	XBACQT25
Partition plate	—	—	50	XBATQT25	XBATQT25	XBATQT25	XBATQT25
Plug-in bridge	Red	2	10	XBAFBS25	XBAFBS26	XBAFBS25	XBAFBS26
		3	50	XBAFBS35	XBAFBS36	XBAFBS35	XBAFBS36
		5	50	XBAFBS55	XBAFBS56	XBAFBS55	XBAFBS56
		10	10	XBAFBS105	XBAFBS106	XBAFBS105	XBAFBS106
		50	10	XBAFBS505	XBAFBS506	XBAFBS505	XBAFBS506
Test adapter	—	—	10	XBATSPA14	XBATSPA14	XBATSPA14	XBATSPA14
2.3 mm diameter test plug	—	—	—	XBATSMPS-^①	XBATSMPS-^①	XBATSMPS-^①	XBATSMPS-^①
Modular test plug	—	—	10	XBATSPS5	XBATSPS5	XBATSPS5	XBATSPS5
Blank marker strip center and external marking	White	—	10	XBMZBF5^②	XBMZBF6^②	XBMZBF5^②	XBMZBF6^②
Blank marker strip center labeling (strip of 10)	White	—	10	XBMZB5^②	XBMZB6^②	XBMZB5^②	XBMZB6^②

Technical Data and Specifications

IDC—Single Level Terminal/Ground Blocks

Description	XBQT15	XBQT25	XBQT15PE	XBQT25PE
Technical Data in Accordance with IEC				
Maximum load current in A/cross-section in mm ²	17.5/1.5	24/2.5	—	—
Rated surge voltage in kV/contamination class	8/3	8/3	8/3	8/3
Surge voltage category/insulating material group	III/I	III/I	III/I	III/I
Connection Cross-Section				
Core insulation	PVC/PE	PVC/PE	PVC/PE	PVC/PE
Single/multiple/fine strand in mm ²	1.5	2.5	1.5	2.5
Halogen-free in mm ²	1.5	2.5	1.5	2.5
Fine strand/superfine strand in AWG (mm ²)	24–16 (0.25–0.34)	20–14 (—)	24–16 (0.25–0.34)	20–14 (—)
Repeated connections minimum 100 x in mm ²	0.25–1.5	0.5–2.5	0.25–1.5	0.5–2.5

Dimensions

Approximate Dimensions in Inches (mm)

IDC—Single Level Terminal/Ground Blocks

Catalog Number	Width	Length	Cover Length	Height for—	
				35 x 7.5 in	35 x 15 in
XBQT15	0.20 (5.2)	2.31 (58.8)	0.09 (2.2)	1.55 (39.3)	1.84 (46.8)
XBQT25	0.24 (6.2)	2.46 (62.6)	0.09 (2.2)	1.55 (39.3)	1.84 (46.8)
XBQT15PE	0.20 (5.2)	2.31 (58.8)	0.09 (2.2)	1.55 (39.3)	1.84 (46.8)
XBQT25PE	0.24 (6.2)	2.46 (62.6)	0.09 (2.2)	1.55 (39.3)	1.84 (46.8)

Notes

① For ordering information, see **Page V7-T8-103**.② For information on Printed Marking Tag Options, see **Page V7-T8-98**.For additional accessories, see **Page V7-T8-90**.

8.1

Terminal Blocks, Fuse Blocks and Fuse Holders

IEC—XB Series

Multi-Conductor



Contents

Description	Page
Single Level	V7-T8-68
Multi-Conductor	
Accessories	V7-T8-71
Technical Data and Specifications	V7-T8-72
Dimensions	V7-T8-72
Double Level	V7-T8-73
Fuse Terminal Blocks	V7-T8-75
Disconnect and Component Terminal Blocks	V7-T8-77
Hybrid Terminal Blocks	V7-T8-79

8

Multi-Conductor

Product Description

The XBQT IDC terminal block has the fastest connection time in a compact design. The space-saving front connection design offers additional space for wiring between the cable ducts. The double bridge shaft can

accommodate individual chain bridging and step-down bridging from other terminal blocks. The XBQT ground blocks are the same shape as the feed-through terminal blocks with the same wide range of cross-sections

available. They easily snap onto the DIN rail to make a reliable mechanical and electrical contact that meets all requirements of IEC 60-947-7-2.

Product Selection

XBQT25D12

IDC—Multi-Conductor Terminal Blocks, Three-Wire



Terminal Width	Maximum Wire Size	Connection Data in V/A/AWG	EN 50 019 in V/A/AWG	UL-cUL Ratings in V/A/AWG	Color	Standard Pack	Catalog Number
5.2 mm	16 AWG/1.5 mm ²	800/17.5/24-16	550/16/24-16	600/10/24-16	Gray	50	XBQT15D12
					Blue	50	XBQT15D12BU
6.2 mm	14 AWG/2.5 mm ²	800/24/20-14	—	600/15/20-14	Gray	50	XBQT25D12
					Blue	50	XBQT25D12BU

XBQT15D22PE

IDC—Multi-Conductor Terminal Blocks, Four-Wire



Terminal Width	Maximum Wire Size	Connection Data in V/A/AWG	EN 50 019 in V/A/AWG	UL-cUL Ratings in V/A/AWG	Color	Standard Pack	Catalog Number
5.2 mm	16 AWG/1.5 mm ²	800/17.5/24-16	550/16/24-16	600/10/24-16	Gray	50	XBQT15D22
					Blue	50	XBQT15D22BU

IDC—Multi-Conductor Terminal Blocks, Four-Wire Ground Blocks

Terminal Width	Maximum Wire Size	Connection Data in V/A/AWG	EN 50 019 in V/A/AWG	UL-cUL Ratings in V/A/AWG	Color	Standard Pack	Catalog Number
5.2 mm	16 AWG/1.5 mm ²	—/—/24-16	—/—/24-16	—/—/24-16	Green/Yellow	50	XBQT15D22PE

XBQT15D12PE



IDC—Multi-Conductor Terminal Blocks, Three-Wire Ground Blocks

Terminal Width	Maximum Wire Size	Connection Data in V/A/AWG	EN 50 019 in V/A/AWG	UL-cUL Ratings in V/A/AWG	Color	Standard Pack	Catalog Number
5.2 mm	16 AWG/1.5 mm ²	—/—/24–16	—/—/24–16	—/—/24–16	Green/Yellow	50	XBQT15D12PE
6.2 mm	14 AWG/2.5 mm ²	—/—/20–14	—	—/—/20–14	Green/Yellow	50	XBQT25D12PE

Accessories

IDC—Multi-Conductor Terminal Blocks

Description	Color	Number of Positions	Standard Pack	XBQT15D12 Catalog Number	XBQT25D12 Catalog Number	XBQT15D22 Catalog Number
End cover	Gray	—	50	XBACQT15D12	XBACQT25D12	XBACQT15D22
End cover segment	Gray	—	10	XBASQT15	XBASQT25	XBASQT15
Partition plate	—	—	50	XBATQTD12	XBATQTD12	XBATQTD22
Plug-in bridge—for cross connections in the terminal center	Red	2	10	XBAFBS25	XBAFBS26	XBAFBS25
		3	50	XBAFBS35	XBAFBS36	XBAFBS35
		5	50	XBAFBS55	XBAFBS56	XBAFBS55
		10	10	XBAFBS105	XBAFBS106	XBAFBS105
		50	10	XBAFBS505	XBAFBS506	XBAFBS505
Test adapter	—	—	10	XBATSPA14	XBATSPA14	XBATSPA14
2.3 mm diameter test plug	—	—	—	XBATSMPS-^①	XBATSMPS-^①	XBATSMPS-^①
Modular test plug	—	—	10	XBATSPS5	XBATSPS6	XBATSPS5
Blank marker strip center and external marking	White	—	10	XBMZBF5^②	XBMZBF6^②	XBMZBF5^②
Blank marker strip center labeling (strip of 10)	White	—	10	XBMZB5^②	XBMZB6^②	XBMZB5^②

IDC—Multi-Conductor Terminal/Ground Blocks

Description	Color	Number of Positions	Standard Pack	XBQT15D12PE Catalog Number	XBQT25D12PE Catalog Number	XBQT15D22PE Catalog Number
End cover	Gray	—	50	XBACQT15D12	XBACQT25D12	XBACQT15D22
End cover segment	Gray	—	10	XBASQT15	XBASQT25	XBASQT15
Partition plate	—	—	50	XBATQTD12	XBATQTD12	XBATQTD22
Plug-in bridge—for cross connections in the terminal center	Red	2	10	XBAFBS25	XBAFBS26	XBAFBS25
		3	50	XBAFBS35	XBAFBS36	XBAFBS35
		5	50	XBAFBS55	XBAFBS56	XBAFBS55
		10	10	XBAFBS105	XBAFBS106	XBAFBS105
		50	10	XBAFBS505	XBAFBS506	XBAFBS505
Test adapter	—	—	10	XBATSPA14	XBATSPA14	XBATSPA14
2.3 mm diameter test plug	—	—	—	XBATSMPS-^①	XBATSMPS-^①	XBATSMPS-^①
Modular test plug	—	—	10	XBATSPS5	XBATSPS6	XBATSPS5
Blank marker strip center and external marking	White	—	10	XBMZBF5^②	XBMZBF6^②	XBMZBF5^②
Blank marker strip center labeling (strip of 10)	White	—	10	XBMZB5^②	XBMZB6^②	XBMZB5^②

Notes

① For ordering information, see **Page V7-T8-103**.

② For information on Printed Marking Tag Options, see **Page V7-T8-98**.

For additional accessories, see **Page V7-T8-90**.

8.1

Terminal Blocks, Fuse Blocks and Fuse Holders

IEC—XB Series

Technical Data and Specifications

IDC—Multi-Conductor Terminal Blocks

Description	XBQT15D12	XBQT25D12	XBQT15D12PE	XBQT25D12PE	XBQT15D22	XBQT15D22PE
Technical Data in Accordance with IEC						
Maximum load current in A/cross-section in mm ²	17.5/1.5	24/2.5	—	—	17.5/1.5	—
Rated surge voltage in kV/contamination class	8/3	8/3	8/3	8/3	8/3	8/3
Surge voltage category/insulating material group	III/I	III/I	III/I	III/I	III/I	III/I
Connection Cross-Section						
Core insulation	PVC/PE	PVC/PE	PVC/PE	PVC/PE	PVC/PE	PVC/PE
Single/multiple/fine strand in mm ²	1.5	2.5	1.5	2.5	1.5	1.5
Halogen-free in mm ²	1.5	2.5	1.5	2.5	1.5	1.5
Fine strand/superfine strand in AWG (mm ²)	24–16 (0.25–0.34)	20–14 (—)	24–16 (0.25–0.34)	20–14 (—)	24–16 (0.25–0.34)	24–16 (0.25–0.34)
Repeated connections minimum 100 x in mm ²	0.25–1.5	0.5–2.5	0.25–1.5	0.5–2.5	0.25–1.5	0.25–1.5

Dimensions

Approximate Dimensions in Inches (mm)

IDC—Multi-Conductor Terminal Blocks

Catalog Number	Width	Length	Cover Length	Height for—	
				35 x 7.5 in	35 x 15 in
XBQT15D12	0.20 (5.2)	3.01 (76.4)	0.09 (2.2)	1.55 (39.3)	1.84 (46.8)
XBQT25D12	0.24 (6.2)	3.25 (82.5)	0.09 (2.2)	1.69 (42.8)	1.98 (50.3)
XBQT15D12PE	0.20 (5.2)	3.01 (76.4)	0.09 (2.2)	1.55 (39.3)	1.84 (46.8)
XBQT25D12PE	0.20 (5.2)	3.25 (82.5)	0.09 (2.2)	1.69 (42.8)	1.98 (50.3)
XBQT15D22	0.20 (5.2)	3.70 (94.0)	0.09 (2.2)	1.55 (39.3)	1.84 (46.8)
XBQT15D22PE	0.20 (5.2)	3.70 (94.0)	0.09 (2.2)	1.55 (39.3)	1.84 (46.8)

Double Level

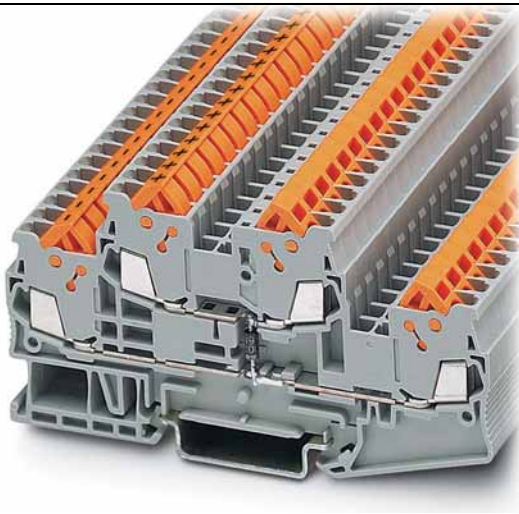

Contents

Description	Page
Single Level	V7-T8-68
Multi-Conductor	V7-T8-70
Double Level	
Accessories	V7-T8-74
Technical Data and Specifications	V7-T8-74
Dimensions	V7-T8-74
Fuse Terminal Blocks	V7-T8-75
Disconnect and Component Terminal Blocks	V7-T8-77
Hybrid Terminal Blocks	V7-T8-79

Double Level

Product Description

The XBQTT IDC terminal block has the fastest connection time in a compact design. The space-saving front connection design offers additional space for wiring between the cable ducts. The double bridge

shaft, found in each level, can accommodate individual chain bridging and step-down bridging from other terminal blocks. The XBQTT ground blocks are the same shape as the feed-through terminal blocks with the same wide

range of cross-sections available. They easily snap onto the DIN rail to make a reliable mechanical and electrical contact that meets all requirements of IEC 60-947-7-2.

Product Selection

XBQTT15



IDC—Double Level Terminal Blocks

Terminal Width	Maximum Wire Size	Connection Data in V/A/AWG	EN 50 019 in V/A/AWG	UL-cUL Ratings in V/A/AWG	Color	Standard Pack	Catalog Number
5.2 mm	16 AWG/1.5 mm ²	800/17.5/24–16	420/15/24–16	600/10/24–16	Gray	50	XBQTT15
					Blue	50	XBQTT15BU

XBQTT15PE



IDC—Double Level Ground Blocks

Terminal Width	Maximum Wire Size	Connection Data in V/A/AWG	EN 50 019 in V/A/AWG	UL-cUL Ratings in V/A/AWG	Color	Standard Pack	Catalog Number
6.2 mm	14 AWG/2.5 mm ²	—/—/24–16	—/—/24–16	—/—/24–16	Green/Yellow	50	XBQTT15PE

8.1

Terminal Blocks, Fuse Blocks and Fuse Holders

IEC—XB Series

Accessories

IDC—Double Level Terminal/Ground Blocks

Description	Color	Number of Positions	Standard Pack	XBQTT15 Catalog Number	XBQTT15PE Catalog Number
End cover	Gray	—	50	XBACQTT15	XBACQTT15
Partition plate	—	—	50	XBATQTT15	XBATQTT15
Plug-in bridge—for cross connections in the terminal center	Red	2	10	XBAFBS25	XBAFBS25
		3	50	XBAFBS35	XBAFBS35
		5	50	XBAFBS55	XBAFBS55
		10	10	XBAFBS105	XBAFBS105
		20	10	XBAFBS505	XBAFBS505
Test adapter	—	—	10	XBATSPA14	XBATSPA14
2.3 mm diameter test plug	—	—	—	XBATSMPS- ^①	XBATSMPS- ^①
Modular test plug	—	—	10	XBATSPS5	XBATSPS5
Blank marker strip	White	—	10	XBMZBF5 ^②	XBMZBF5 ^②

Technical Data and Specifications

IDC—Double Level Terminal/Ground Blocks

Description	XBQTT15	XBQTT15PE
Technical Data in Accordance with IEC		
Maximum load current in A/cross-section in mm ²	17.5/1.5	—
Rated surge voltage in kV/contamination class	6/3	6/3
Surge voltage category/insulating material group	III/I	III/I
Connection Cross-Section		
Core insulation	PVC/PE	PVC/PE
Single/multiple/fine strand in mm ²	1.5	1.5
Halogen-free in mm ²	1.5	1.5
Fine strand/superfine strand in AWG (mm ²)	24–16 (0.25–0.34)	24–16 (0.25–0.34)
Repeated connections minimum 100 x in mm ²	0.25–1.5	0.25–1.5

Dimensions

Approximate Dimensions in Inches (mm)

IDC—Double Level Terminal/Ground Blocks

Catalog Number	Width	Length	Cover Length	Height for—	
				35 x 7.5 in	35 x 15 in
XBQTT15	0.20 (5.2)	3.92 (99.6)	0.09 (2.2)	1.96 (49.9)	2.26 (57.4)
XBQTT15PE	0.20 (5.2)	3.92 (99.6)	0.09 (2.2)	1.96 (49.9)	2.26 (57.4)

Notes

- ① For ordering information, see **Page V7-T8-103**.
- ② For information on Printed Marking Tag Options, see **Page V7-T8-98**.

For additional accessories, see **Page V7-T8-90**.

Fuse Terminal Blocks



Contents

Description	Page
Single Level	V7-T8-68
Multi-Conductor	V7-T8-70
Double Level	V7-T8-73
Fuse Terminal Blocks	
Accessories	V7-T8-76
Technical Data and Specifications	V7-T8-76
Dimensions	V7-T8-76
Disconnect and Component Terminal Blocks	V7-T8-77
Hybrid Terminal Blocks	V7-T8-79

Fuse Terminal Blocks

Product Description

The XBQT lever-type fuse terminal blocks perform two main functions. It is a carrier for a 5 x 20 mm cartridge fuse insert and can also allow for potential distribution via the double bridge shaft.

This means that two potentials can be carried separately alongside each other. Versions with light indication (AC and DC voltage) are available to signal a triggered fuse.

Product Selection

XBQT25FB



IDC—Fuse Terminal Blocks

Terminal Width	Maximum Wire Size	Connection Data in V/A/AWG	UL-cUL Ratings in V/A/AWG	Color	Standard Pack	Catalog Number
IDC Fuse Terminal Blocks						
6.2 mm	14 AWG/2.5 mm ²	①/6.3/20–14	300/15/20–14	Black	50	XBQT25FBE
IDC Fuse Terminal Blocks with LED 12–30V, 1–2.5 mA						
6.2 mm	14 AWG/2.5 mm ²	①/6.3/20–14	300/15/20–14	Black	50	XBQT25FBEL24
IDC Fuse Terminal Blocks with LED 30–60V, 0.8–2.0 mA						
6.2 mm	14 AWG/2.5 mm ²	①/6.3/20–14	300/15/20–14	Black	50	XBQT25FBEL60
IDC Fuse Terminal Blocks with LED 110–250V, 0.5–2.5 mA						
6.2 mm	14 AWG/2.5 mm ²	①/6.3/20–14	300/15/20–14	Black	50	XBQT25FBEL250

Note

① As disconnect terminal block, 400V; as fuse terminal blocks 250V.

8.1

Terminal Blocks, Fuse Blocks and Fuse Holders

IEC—XB Series

Accessories

IDC—Fuse Terminal Blocks

Description	Color	Number of Positions	Standard Pack	XBQT25FBE	
				Catalog Number	
End cover	Gray	—	50	XBACQT25D12	
Partition plate	—	—	50	XBATQTD12	
Plug-in bridge—for cross connections in the terminal center	Red	2	10	XBAFBS26	
		3	50	XBAFBS36	
		5	50	XBAFBS56	
		10	10	XBAFBS106	
Test adapter	—	—	10	XBATSPA14	
2.3 mm diameter test plug	—	—	—	XBATSMPS-	①
Modular test plug	—	—	10	XBATSPS5	
Blank marker strip center and external marking	White	—	10	XBMZBF6	②
Blank marker strip lever labeling	White	—	10	XBMZB5	②
Blank marker strip center labeling (strip of 10)	White	—	10	XBMZB6	②

Technical Data and Specifications

IDC—Fuse Terminal Blocks

Description	XBQT25FBE
Technical Data in Accordance with IEC	
Maximum load current in A/cross-section in mm ²	6.3/2.5
Rated surge voltage in kV/contamination class	4/3
Surge voltage category/insulating material group	III/I
Connection Cross-Section	
Core insulation	PVC/PE
Single/multiple/fine strand in mm ²	2.5
Halogen-free in mm ²	2.5
Fine strand/superfine strand in AWG (mm ²)	24–14 (—)
Repeated connections minimum 100 x in mm ²	0.5–2.5

Dimensions

Approximate Dimensions in Inches (mm)

IDC—Fuse Terminal Blocks

Catalog Number	Width	Length	Cover Length	Height for—	
				35 x 7.5 in	35 x 15 in
XBQT25FBE	0.24 (6.2)	3.25 (82.5)	0.09 (2.2)	1.69 (42.8)	1.98 (50.3)

Notes

① For ordering information, see **Page V7-T8-103**.

② For information on Printed Marking Tag Options, see **Page V7-T8-98**.

For additional accessories, see **Page V7-T8-90**.

Disconnect and Component Terminal Blocks

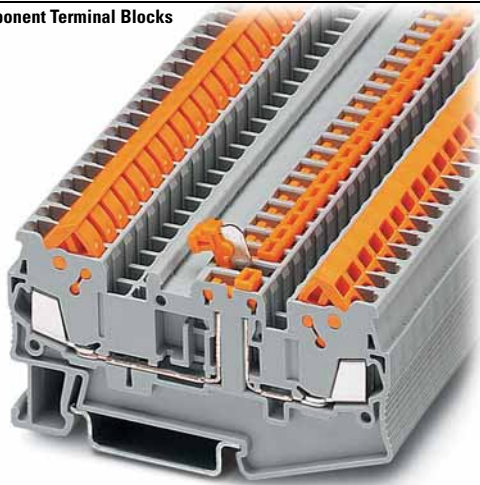

Contents

Description	Page
Single Level	V7-T8-68
Multi-Conductor	V7-T8-70
Double Level	V7-T8-73
Fuse Terminal Blocks	V7-T8-75
Disconnect and Component Terminal Blocks	
Accessories	V7-T8-78
Technical Data and Specifications	V7-T8-78
Dimensions	V7-T8-78
Hybrid Terminal Blocks	V7-T8-79

Disconnect and Component Terminal Blocks

Product Description

The **XB** Series includes application specific terminal blocks like disconnect blocks. The knife disconnect terminal blocks (XBQT15MT) has a fitted knife. The XBQT15TG

can accommodate component plugs for resistors or capacitors and fuse plugs for 5 x 20 mm fuses with or without a light indicator for signaling a triggered fuse.

Both terminal blocks have three bridge shafts—two in the standard positions and one on the other side of the disconnect point.

Product Selection

XBQT15MT
Knife Disconnect

IDC—Disconnect and Component Terminal Blocks

Terminal Width	Maximum Wire Size	Connection Data in V/A/AWG	UL-cUL Ratings in V/A/AWG	UL-cUL Ratings for Disconnect in V/A/AWG	UL-cUL Ratings for Disconnect with Test Sockets in V/A/AWG	Color	Standard Pack	Catalog Number
Knife Disconnect								
5.2 mm	16 AWG/1.5 mm ²	400/16/24–16	600/10/24–16	—	—	Gray	50	XBQT15MT
Component Disconnect								
5.2 mm	16 AWG/1.5 mm ²	400/16/24–16	600/10/24–16	—	—	Gray	50	XBQT15TG
6.2 mm	14 AWG/2.5 mm ²	400/16/20–14	300/10/20–14	—	—	Gray	50	XBQT25TG
Component Plug								
6.2 mm	10 AWG/4 mm ²	500/16/26–10	—	600/16/26–10	300/16/26–10	Gray	10	XBPCO
Fuse Plug								
6.2 mm	10 AWG/4 mm ²	500/16/26–10	—	600/16/26–10	300/16/26–10	Black	10	XBPFU
Fuse Plug with Light Indicator for 12–30V, 1–2.5 mA								
6.2 mm	10 AWG/4 mm ²	500/16/26–10	—	600/16/26–10	300/16/26–10	Black	10	XBPFUL24
Fuse Plug with Light Indicator for 110–250V, 0.5–2.5 mA								
6.2 mm	10 AWG/4 mm ²	500/16/26–10	—	600/16/26–10	300/16/26–10	Black	10	XBPFUL250

8.1

Terminal Blocks, Fuse Blocks and Fuse Holders

IEC—XB Series

Accessories

IDC—Disconnect and Component Terminal Blocks

Description	Color	Number of Positions	Standard Pack	XBQT15MT Catalog Number	XBQT15TG Catalog Number	XBQT25TG Catalog Number
End cover	Gray	—	50	XBACQT15D12	XBACQT15D12	XBACQT25D12
End cover segment	Gray	—	10	XBASQT15	XBASQT15	XBASQT25
Partition plate	—	—	50	XBATQTD12	XBATQTD12	XBATQTD12
Plug-in bridge	Red	2	10	XBAFBS25	XBAFBS25	XBAFBS26
		3	50	XBAFBS35	XBAFBS35	XBAFBS36
		5	50	XBAFBS55	XBAFBS55	XBAFBS56
		10	10	XBAFBS105	XBAFBS105	XBAFBS106
Test adapter	—	—	10	XBATSPA14	XBATSPA14	XBATSPA14
2.3 mm diameter test plug	—	—	—	XBATSMPS_ ^①	XBATSMPS_ ^①	XBATSMPS_ ^①
Modular test plug	—	—	10	XBATSPS5	XBATSPS5	XBATSPS5
Blank marker strip center and external marking	White	—	10	XBMZBF5 ^②	XBMZBF5 ^②	XBMZBF6 ^②
Blank marker strip center labeling (strip of 10)	White	—	10	XBMZB5 ^②	XBMZB5 ^②	XBMZB6 ^②

8

Technical Data and Specifications

IDC—Disconnect and Component Terminal Blocks

Description	XBQT15MT	XBQT15TG	XBQT25TG
Technical Data in Accordance with IEC			
Maximum load current in A/cross-section in mm ²	16/1.5	16/1.5	16/2.5
Rated surge voltage in kV/contamination class	6/3	6/3	6/3
Surge voltage category/insulating material group	III/I	III/I	III/I
Connection Cross-Section			
Core insulation	PVC/PE	PVC/PE	PVC/PE
Single/multiple/fine strand in mm ²	1.5	1.5	2.5
Halogen-free in mm ²	1.5	1.5	2.5
Fine strand/superfine strand in AWG (mm ²)	24–16 (0.25–0.34)	24–16 (0.25–0.34)	20–14 (—)
Repeated connections minimum 100 x in mm ²	0.25–1.5	0.25–1.5	0.5–2.5

Dimensions

Approximate Dimensions in Inches (mm)

IDC—Disconnect and Component Terminal Blocks

Catalog Number	Width	Length	Cover Length	Height for—	
				35 x 7.5 in	35 x 15 in
XBQT15MT	0.20 (5.2)	3.01 (76.4)	0.09 (2.2)	1.55 (39.3)	1.84 (46.8)
XBQT15TG	0.20 (5.2)	3.01 (76.4)	0.09 (2.2)	1.55 (39.3)	1.84 (46.8)
XBQT25TG	0.24 (6.2)	3.25 (82.5)	0.09 (2.2)	1.69 (42.8)	1.98 (50.3)

Notes

① For ordering information, see **Page V7-T8-103**.

② For information on Printed Marking Tag Options, see **Page V7-T8-98**.

For additional accessories, see **Page V7-T8-90**.

Hybrid Terminal Blocks



Contents

<i>Description</i>	<i>Page</i>
Single Level	V7-T8-68
Multi-Conductor	V7-T8-70
Double Level	V7-T8-73
Fuse Terminal Blocks	V7-T8-75
Disconnect and Component Terminal Blocks	V7-T8-77
Hybrid Terminal Blocks	
Accessories	V7-T8-80
Technical Data and Specifications	V7-T8-81
Dimensions	V7-T8-81

Hybrid Terminal Blocks

Product Description

The XBQT hybrid terminal blocks offer the best of both worlds. One side offers the time-saving advantage of our insulation displacement

connection technology, while the other side offers a universal screw connection. Use the IDC side on the internal (factory) control

cabinet side and the screw connection on the end customer (field) side. Ground terminal blocks of the same shape are also available

Product Selection

XBQU25



IDC—Hybrid Terminal Blocks, Single Level

Terminal Width	Maximum Wire Size	IEC Screw Connection in V/A/AWG	IEC IDC Connection in V/A/AWG	UL-cUL Screw Connection in V/A/AWG	UL-cUL IDC Connection in V/A/AWG	Color	Standard Pack	Catalog Number
5.2 mm	12 AWG/2.5 mm ²	800/17.5/26–12	800/17.5/24–16	600/10/26–12	600/10/24–16	Gray	50	XBQU15
6.2 mm	10 AWG/4 mm ²	800/24/26–10	800/24/20–14	600/15/26–10	600/15/20–14	Gray	50	XBQU25

XBQU15D12



IDC—Hybrid Terminal Blocks, Three-Wire

Terminal Width	Maximum Wire Size	IEC Screw Connection in V/A/AWG	IEC IDC Connection in V/A/AWG	UL-cUL Screw Connection in V/A/AWG	UL-cUL IDC Connection in V/A/AWG	Color	Standard Pack	Catalog Number
5.2 mm	12 AWG/2.5 mm ²	800/17.5/26–12	800/17.5/24–16	800/10/26–12	800/10/24–16	Gray	50	XBQU15D12
6.2 mm	10 AWG/4 mm ²	800/24/26–10	800/24/20–14	600/15/26–10	600/15/20–14	Gray	50	XBQU25D12

XBQU25PE



IDC—Hybrid Terminal/Ground Blocks

Terminal Width	Maximum Wire Size	IEC Screw Connection in V/A/AWG	IEC IDC Connection in V/A/AWG	UL-cUL Screw Connection in V/A/AWG	UL-cUL IDC Connection in V/A/AWG	Color	Standard Pack	Catalog Number
5.2 mm	12 AWG/2.5 mm ²	—/—/26–12	—/—/24–16	—/—/26–12	—/—/24–16	Gray	50	XBQU15PE
6.2 mm	10 AWG/4 mm ²	—/—/26–10	—/—/20–14	—/—/26–10	—/—/20–14	Gray	50	XBQU25PE

8.1

Terminal Blocks, Fuse Blocks and Fuse Holders

IEC—XB Series

Accessories

IDC—Hybrid Terminal Blocks

Description	Color	Number of Positions	Standard Pack	XBQU15 Catalog Number	XBQU25 Catalog Number	XBQU15D12 Catalog Number	XBQU25D12 Catalog Number
End cover	Gray	—	10	XBACQU15	XBACQU25	XBACQU15D12	XBACQU25D12
End segment	Gray	—	10	—	—	XBASQT15	XBASQT25
Partition plate	—	—	50	XBATQT25	XBATQT25	XBATQTD12	XBATQTD12
Plug-in bridge—for cross connections in the bridge shaft	Red	2	10	XBAFBS25	XBAFBS26	XBAFBS25	XBAFBS26
		3	50	XBAFBS35	XBAFBS36	XBAFBS35	XBAFBS36
		5	50	XBAFBS55	XBAFBS56	XBAFBS55	XBAFBS56
		10	10	XBAFBS105	XBAFBS106	XBAFBS105	XBAFBS106
		50	10	XBAFBS505	XBAFBS506	XBAFBS505	XBAFBS506
Test adapter	—	—	10	XBATSPAI4	XBATSPAI4	XBATSPAI4	XBATSPAI4
2.3 mm diameter test plug	—	—	—	XBATSMPS_①	XBATSMPS_①	XBATSMPS_①	XBATSMPS_①
Modular test plug	—	—	10	XBATSPS5	XBATSPS6	XBATSPS5	XBATSPS6
Blank marker strip center and external marking	White	—	10	XBMZBF5 ②	XBMZBF6 ②	XBMZBF5 ②	XBMZBF6 ②
Blank marker strip center labeling (strip of 10)	—	—	—	XBMZB5 ②	XBMZB6 ②	XBMZB5 ②	XBMZB6 ②

IDC—Hybrid Terminal/Ground Blocks

Description	Color	Number of Positions	Standard Pack	XBQU15PE Catalog Number	XBQU25PE Catalog Number
End cover	Gray	—	10	XBACQU15	XBACQU25
Partition plate	—	—	50	XBATQT25	XBATQT25
Plug-in bridge—for cross connections in the bridge shaft	Red	2	10	XBAFBS25	XBAFBS26
		3	50	XBAFBS35	XBAFBS36
		5	50	XBAFBS55	XBAFBS56
		10	10	XBAFBS105	XBAFBS106
		50	10	XBAFBS505	XBAFBS506
Test adapter	—	—	10	XBATSPAI4	XBATSPAI4
2.3 mm diameter test plug	—	—	—	XBATSMPS_①	XBATSMPS_①
Modular test plug	—	—	10	XBATSPS5	XBATSPS6
Blank marker strip center and external marking	White	—	10	XBMZBF5 ②	XBMZBF6 ②
Blank marker strip center labeling (strip of 10)	—	—	—	XBMZB5 ②	XBMZB6 ②

Notes

- ① For ordering information, see **Page V7-T8-103**.
 - ② For information on Printed Marking Tag Options, see **Page V7-T8-98**.
- For additional accessories, see **Page V7-T8-90**.

Technical Data and Specifications

Screw Connection Single Level—Through-Feed

Description	XBQU15	XBQU25	XBQU15PE	XBQU25PE	XBQU15D12	XBQU25D12
Technical Data in Accordance with IEC						
Maximum load current in A/cross-section in mm ²	17.5/1.5	24/2.5	—	—	17.5/1.5	24/2.5
Rated surge voltage in kV/contamination class	8/3	8/3	8/3	8/3	8/3	8/3
Surge voltage category/insulating material group	III/I	III/I	III/I	III/I	III/I	III/I
Connection Cross-Section						
Core insulation	PVC/PE	PVC/PE	PVC/PE	PVC/PE	PVC/PE	PVC/PE
Single/multiple/fine strand in mm ²	1.5	2.5	1.5	2.5	1.5	2.5
Halogen-free in mm ²	1.5	2.5	1.5	2.5	1.5	2.5
Fine strand/superfine strand in AWG (mm ²)	24–16 (0.25–0.34)	20–14 (—)	24–16 (0.25–0.34)	20–14 (—)	24–16 (0.25–0.34)	20–14 (—)
Repeated connections minimum 100 x in mm ²	0.25–1.5	0.5–2.5	0.25–1.5	0.5–2.5	0.25–1.5	0.5–2.5
Connection Capacity—Screw Connection						
Stranded with ferrule/with ferrule and plastic sleeve in mm ²	0.25–2.5/0.25–2.5	0.25–4/0.25–4	0.25–2.5/0.25–2.5	0.25–4/0.25–4	0.25–2.5/0.25–2.5	0.25–4/0.25–4
Multi-Conductor Connection (same cross-section)						
Solid/stranded in mm ²	0.14–1.5/0.14–1.5	0.14–1.5/0.14–1.5	0.14–1.5/0.14–1.5	0.14–1.5/0.14–1.5	0.14–1.5/0.14–1.5	0.14–1.5/0.14–1.5
Stranded with ferrules without plastic sleeve in mm ²	0.25–1.5	0.25–1.5	0.25–1.5	0.25–1.5	0.25–1.5	0.25–1.5
Stranded with twin ferrule with plastic sleeve in mm ²	0.5–1.5	0.5–2.5	0.5–1.5	0.5–2.5	0.5–1.5	0.5–2.5
Stripping length in inches (mm)	0.35 (9)	0.35 (9)	0.35 (9)	0.35 (9)	0.35 (9)	0.35 (9)
Thread	M3	M3	M3	M3	M3	M3
Torque in in-lb (Nm)	5.3–7.1 (0.6–0.8)	5.3–7.1 (0.6–0.8)	5.3–7.1 (0.6–0.8)	5.3–7.1 (0.6–0.8)	5.3–7.1 (0.6–0.8)	5.3–7.1 (0.6–0.8)

Dimensions

Approximate Dimensions in Inches (mm)

Screw Connection Single Level—Through-Feed

Catalog Number	Width	Length	Cover Width	Height for—	
				35 x 7.5 in	35 x 15 in
XBQU15	0.20 (5.2)	2.31 (58.8)	0.09 (2.2)	1.69 (42.8)	1.98 (50.3)
XBQU25	0.24 (6.2)	2.46 (62.6)	0.09 (2.2)	1.69 (42.8)	1.98 (50.3)
XBQU15PE	0.20 (5.2)	2.31 (58.8)	0.09 (2.2)	1.69 (42.8)	1.98 (50.3)
XBQU25PE	0.24 (6.2)	2.46 (62.6)	0.09 (2.2)	1.69 (42.8)	1.98 (50.3)
XBQU15D12	0.20 (5.2)	3.01 (76.4)	0.09 (2.2)	1.69 (42.8)	1.98 (50.3)
XBQU25D12	0.24 (6.2)	3.25 (82.5)	0.09 (2.2)	1.69 (42.8)	1.98 (50.3)

8.1

Terminal Blocks, Fuse Blocks and Fuse Holders

IEC—XB Series

Miniature Circuit Breakers



8

Contents

Description

	<i>Page</i>
Miniature Circuit Breakers	
Circuit Breakers	V7-T8-83
Flat-Type Fuse Terminal Blocks	V7-T8-86
Spring Cage Fuse Terminal Blocks	V7-T8-88

Miniature Circuit Breakers Overview

Product Description

The new **XB** Series thermal miniature circuit breaker offers convenient overload protection. This space-saving single-pole circuit breaker, available up to 10 amps, can be inserted into a screw connection fuse terminal block, XBUK6FSI, or a spring cage fuse terminal block, XBPT4FSI, which is available with or without light indication. The XBATCP combines the

reclosing capability of a circuit breaker with the overload protection of a fuse. The integrated switching function makes it possible to switch the circuit breaker back on immediately, guaranteeing system availability. The device can also be used for switching purposes, as an ON/OFF switch. The Plug-in design allows for quick and efficient replacement.

Standards and Certifications

- UL and cUL recognized
- UL 1077—File No. E301915
- CE approved



Circuit Breakers



Contents

Description	Page
Circuit Breakers	
Accessories	V7-T8-84
Technical Data and Specifications	V7-T8-84
Time/Current Curve	V7-T8-85
Dimensions	V7-T8-85
Flat-Type Fuse Terminal Blocks	V7-T8-86
Spring Cage Fuse Terminal Blocks	V7-T8-88

Circuit Breakers

Product Description

The thermal miniature circuit breaker can be switched back on again, has a compact design, and is available

in 10 finely graded steps for nominal currents from 0.1 to 10A.

Product Selection

XBAT

Thermal Miniature Circuit Breaker



Connection Data in Vac/Vdc	Nominal Current	Color	Standard Pack	Catalog Number
250/65	0.1A	Black	20	XBATCPT
	0.25A	Black	20	XBATCPQ
	0.5A	Black	20	XBATCPH
	1.0A	Black	20	XBATCP1
	2.0A	Black	20	XBATCP2
	3.0A	Black	20	XBATCP3
	4.0A	Black	20	XBATCP4
	6.0A	Black	20	XBATCP6
	8.0A	Black	20	XBATCP8
	10.0A	Black	20	XBATCP10

8.1

Terminal Blocks, Fuse Blocks and Fuse Holders

IEC—XB Series

Accessories

Thermal Miniature Circuit Breaker

Description	Color	Number of Positions	Standard Pack	XBAT Catalog Number
Blank marker strip	White	—	10	XBZBF5 ①
Flat type terminal blocks	—	—	—	XBK6FSI XBK6FSIL12 XBK6FSIL24 XBPT4FSI XBPT4FSIL12 XBPT4FSIL24

8

Technical Data and Specifications

Thermal Miniature Circuit Breaker

Description	XBAT
Technical Data in Accordance with IEC	
Nominal voltage in Vac/Vdc	250/65
Nominal current in A	0.25–10
Ambient temperature	–4 to 140°F (–20 to 60°C)
Maximum Power Dissipation	
Rated surge voltage in kV/contamination class	2.5/2
Surge voltage category/insulating material group	III/1
Switching Capacity	
Cycles with 1 x I _N (low-induction)	6000
Cycles with 1 x I _N (induction)	3000
Cycles with 2 x I _N (induction)	500
Switching Capacity I CN	
For nominal currents of 0.25–4A/6–10A	6 x I _N /8 x I _N
Switching capacity (UL 1077) 250 Vac/65 Vdc	2000/200

Nominal Currents and Internal Resistances

Nominal Current (A)	Internal Resistance (3/4)
0.25	14
0.5	3.4
1.0	0.9
2.0	0.25
3.0	0.11
4.0	0.07
6.0	≤0.05
8.0	≤0.05
10.0	≤0.05

Note

① For information on Printed Marking Tag Options, see **Page V7-T8-98**.

Time/Current Curve

Total Switch-Off Period for Nominal Current, 73.4°F (23°C)

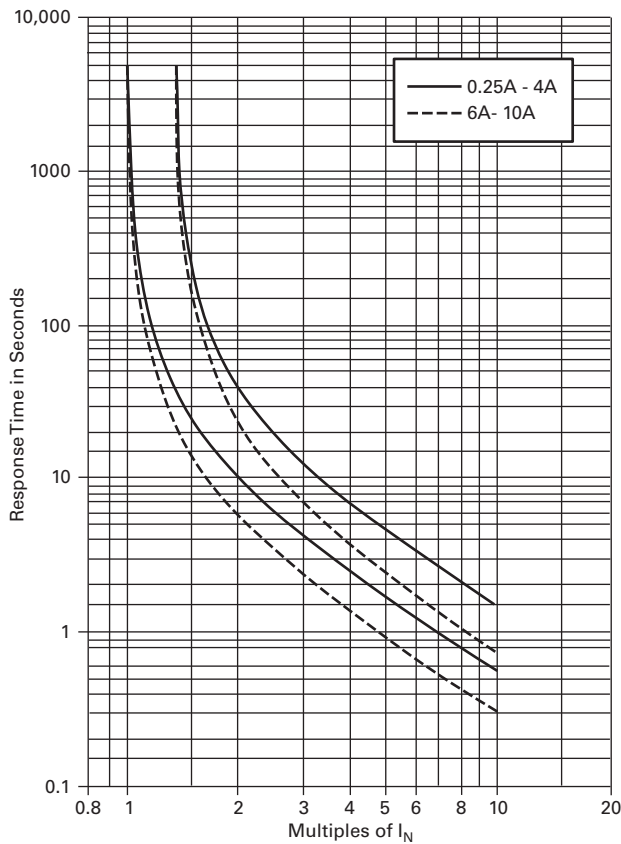

Note: When mounted in rows, the nominal current of the devices can only be transmitted at 80% or must be correspondingly over-dimensioned.

Temperature Factor

Ambient Temperature	Temperature Factor
-4°F (-20°C)	0.76
14°F (-10°C)	0.84
32°F (0°C)	0.91
73.4°F (23°C)	1.00
104°F (40°C)	1.08
122°F (50°C)	1.16
140°F (60°C)	1.24

Dimensions

Approximate Dimensions in Inches (mm)

XBUK6FSI with XBAT

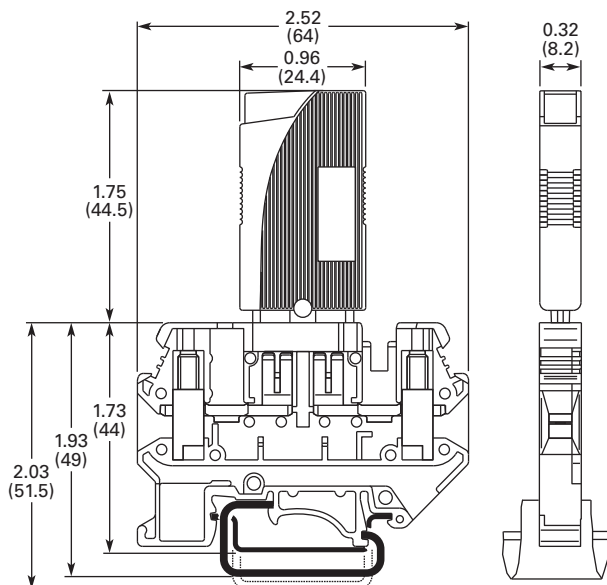

XBPT4FSI with XBAT

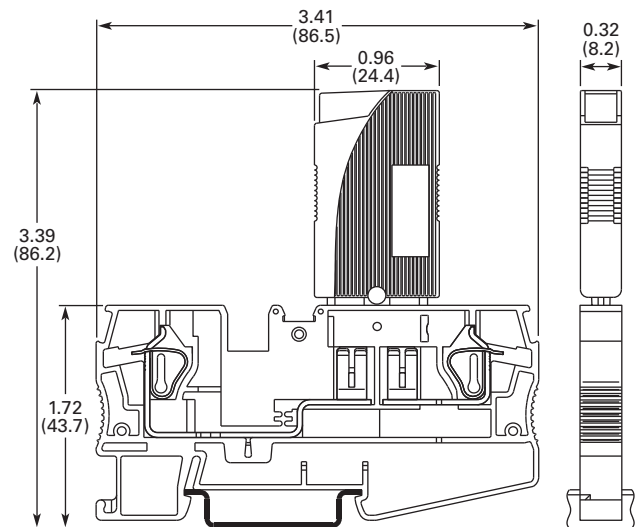

8.1

Terminal Blocks, Fuse Blocks and Fuse Holders

IEC—XB Series

Flat-Type Fuse Terminal Blocks

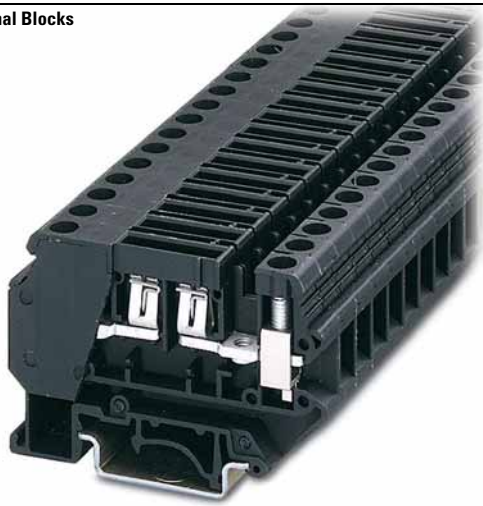

Contents

Description

	<i>Page</i>
Circuit Breakers	V7-T8-83
Flat-Type Fuse Terminal Blocks	
Accessories	V7-T8-86
Technical Data and Specifications	V7-T8-87
Dimensions	V7-T8-87
Spring Cage Fuse Terminal Blocks	V7-T8-88

8

Flat-Type Fuse Terminal Blocks

Product Description

The fuse terminal blocks can be used as a basic terminal blocks for the XBAT overload miniature circuit breaker, see **Page V7-T8-83**.

Product Selection

XBUK6FSI

Screw Connection Flat-Type Fuse Terminal Blocks



Terminal Width	Maximum Wire Size	Connection Data in V/A/AWG	UL-cUL Ratings in V/A/AWG	Color	Standard Pack	Catalog Number
Flat-Type Fuse Terminal Block						
8.2 mm	8 AWG/6 mm ²	250/—/24–8	300/30/26–8	Black	50	XBUK6FSI
Flat-Type Fuse Terminal Block with LED, Red 12 Vdc, 2.0 mA						
8.2 mm	8 AWG/6 mm ²	250/—/24–8	300/30/26–8	Black	50	XBUK6FSIL12
Flat-Type Fuse Terminal Block with LED, Red 24 Vdc, 2.0 mA						
8.2 mm	8 AWG/6 mm ²	250/—/24–8	300/30/26–8	Black	50	XBUK6FSIL24

Accessories

Flat-Type Fuse Terminal Blocks

Description	Color	Number of Positions	Standard Pack	XBUK6FSI Catalog Number	XBUK6FSIL_ Catalog Number
Blank marker strip	White	—	10	XBMZB8 ①	XBMZB8 ①

Note

① For information on Printed Marking Tag Options, see **Page V7-T8-98**.

Technical Data and Specifications

Flat-Type Fuse Terminal Blocks

Description	XBUK6FSI	XBUK6FSIL ₂
Technical Data in Accordance with IEC		
Fuse type ISO	C	C
Maximum current with single arrangement in A	30	30
Maximum Power Dissipation		
Rated surge voltage in kV/contamination class	4/3	4/3
Surge voltage category/insulating material group	III/1	III/1
Connection Capacity		
Stranded with ferrule with plastic sleeve in mm ²	0.25–4	0.25–4
Stranded with ferrule without plastic sleeve in mm ²	0.25–6	0.25–6
Stranded with twin ferrule with plastic sleeve in mm ²	—	—
Multi-Conductor Connection (same cross-section)		
Solid/stranded in mm ²	0.2–2.5/0.2–2.5	0.2–2.5/0.2–2.5
Stranded with ferrules without plastic sleeve in mm ²	0.25–2.5	0.25–2.5
Stranded with twin ferrule with plastic sleeve in mm ²	0.5–4.0	0.5–4.0
Stripping length in inches (mm)	0.39 (10)	0.39 (10)
Thread	M4	M4
Torque in in-lb (Nm)	13.3–14.2 (1.5–1.6)	13.3–14.2 (1.5–1.6)

Dimensions

Approximate Dimensions in Inches (mm)

Flat-Type Fuse Terminal Blocks

Catalog Number	Width	Length	Height for—		
			32 in	35 x 7.5 in	35 x 15 in
XBUK6FSI	0.32 (8.2)	2.91 (74.0)	2.24 (57.0)	2.05 (52.0)	2.34 (59.5)
XBUK6FSIL12	0.32 (8.2)	2.91 (74.0)	2.24 (57.0)	2.05 (52.0)	2.34 (59.5)
XBUK6FSIL24	0.32 (8.2)	2.91 (74.0)	2.24 (57.0)	2.05 (52.0)	2.34 (59.5)

8.1

Terminal Blocks, Fuse Blocks and Fuse Holders

IEC—XB Series

Spring Cage Fuse Terminal Blocks

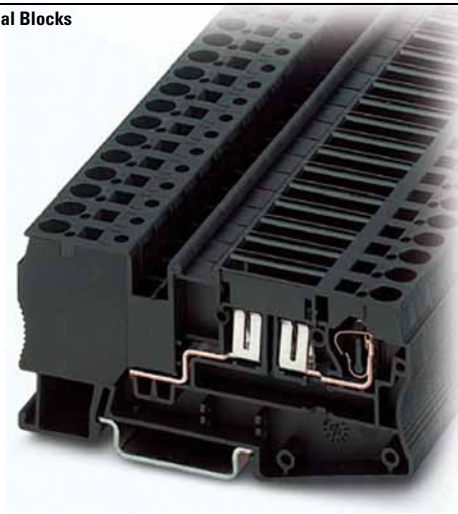

Contents

<i>Description</i>	<i>Page</i>
Circuit Breakers	V7-T8-83
Flat-Type Fuse Terminal Blocks	V7-T8-86
Spring Cage Fuse Terminal Blocks	
Accessories	V7-T8-88
Technical Data and Specifications	V7-T8-89
Dimensions	V7-T8-89

Spring Cage Fuse Terminal Blocks

Product Description

Flat-type fuses or the XBAT miniature circuit breaker (see **Page V7-T8-83**) can be used as the fuse element in these XBPT

Spring Cage Fuse Terminal Blocks. Terminal blocks with a light indicator are available for quick error diagnosis.

Product Selection

XBPT4FSI

Spring Cage Fuse Terminal Blocks



Terminal Width	Maximum Wire Size	Connection Data in V/A/AWG	UL-cUL Ratings in V/A/AWG	Color	Standard Pack	Catalog Number
Spring Cage Fuse Terminal Block						
8.2 mm	10 AWG/4 mm ²	400/30/28–10	300/30/24–10	Black	50	XBPT4FSI
Spring Cage Fuse Terminal Block with LED, Red 12 Vdc, 2.0 mA						
8.2 mm	10 AWG/4 mm ²	400/30/28–10	300/30/24–10	Black	50	XBPT4FSIL12
Spring Cage Fuse Terminal Block with LED, Red 24 Vdc, 2.0 mA						
8.2 mm	10 AWG/4 mm ²	400/30/28–10	300/30/24–10	Black	50	XBPT4FSIL24

Accessories

Flat-Type Fuse Terminal Blocks

Description	Color	Number of Positions	Standard Pack	XBPT4FSI Catalog Number	XBPT4FSIL_ Catalog Number
Test adapter	—	—	10	XBATSPA14	XBATSPA14
2.3 mm diameter test plug	—	—	—	XBATSMPS-^①	XBATSMPS-^①
Modular test plug	—	—	10	XBATSPS8	XBATSPS8
Blank marker strip center and external marking	White	—	10	XBMZBF8^②	XBMZBF8^②
Blank marker strip center labeling (strip of 10)	White	—	10	XBMZB8^②	XBMZB8^②

Notes

- ① For ordering information, see **Page V7-T8-103**.
- ② For information on Printed Marking Tag Options, see **Page V7-T8-98**.

Technical Data and Specifications

Flat-Type Fuse Terminal Blocks

Description	XBPT4FSI	XBPT4FSIL_
Technical Data in Accordance with IEC		
Fuse type ISO	C	C
Maximum current with single arrangement in A	30	30
Maximum Power Dissipation		
Rated surge voltage in kV/contamination class	6/3	6/3
Surge voltage category/insulating material group	III/1	III/1
Connection Capacity		
Stranded with ferrule with plastic sleeve in mm ²	0.25–4	0.25–4
Stranded with ferrule without plastic sleeve in mm ²	0.25–4	0.25–4
Stranded with twin ferrule with plastic sleeve in mm ²	0.5	0.5
Stripping length in inches (mm)	0.39 (10)	0.39 (10)

Dimensions

Approximate Dimensions in Inches (mm)

Flat-Type Fuse Terminal Blocks

Catalog Number	Width	Length	Height for—	
			35 x 7.5 in	35 x 15 in
XBPT4FSI	0.32 (8.2)	3.41 (86.5)	1.71 (43.5)	2.01 (51.0)
XBPT4FSIL12	0.32 (8.2)	3.41 (86.5)	1.71 (43.5)	2.01 (51.0)
XBPT4FSIL24	0.32 (8.2)	3.41 (86.5)	1.71 (43.5)	2.01 (51.0)

8.1

Terminal Blocks, Fuse Blocks and Fuse Holders

IEC—XB Series

XB Series Accessories

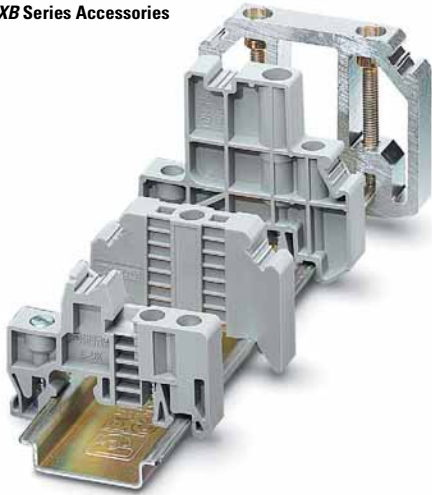

8

Contents

Description	Page
XB Series Accessories	
End Stops	V7-T8-91
DIN Rails	V7-T8-92
Angled Mounting Brackets	V7-T8-93
Ferrules	V7-T8-94
Hand Tools	V7-T8-97
Marking Accessories	V7-T8-98
Testing Accessories	V7-T8-103
Separating Plates, Covers and Bridges	V7-T8-103

XB Series Accessories Overview

End Stops

The end stop provides an anchor point at each end of the rail assembly by attaching directly to the DIN rail. A wide range of end stop options are available, including those that mount with one or multiple screws and those that do not require screws for mounting. End stops also have a location for marking material to be placed.

DIN Rail

Eaton offers ways for time-saving and secure mounting of components needed for electrical connections. DIN rail provides the basis for the inner design of the control cabinet and ensures a firm hold of the rail-mountable components. Eaton offers a wide range of standard DIN rails sizes and materials, solid or slotted. Or, contact us about custom lengths of pre-cut rail or ordering pre-drilled rail. The DIN rails are designed in accordance with the European standard EN 60715.

Angled Mounting Brackets

Angled mounting brackets are used to mount DIN rail at a more accessible angle for wiring and troubleshooting.

Ferrules

Ferrules are available with or without an insulating sleeve. The plastic insulating sleeve simplifies the fitting of the conductor and the color indicates the size of the cross-section. The closer the connections are, the more reliable the insulation is and the less likely the wires are to splice. Twin ferrules are also available allowing two wires to be easily compressed in one ferrule. Chain bridging, frequently used in industry, becomes easier with twin ferrules.

Hand Tools

Eaton offers an array of hand tools to make it easier to work with our terminal blocks. The XBTCUTSTP tool is recommended for cutting and stripping PVC insulated wires. The ergonomically shaped crimping pliers, XBTCRMP66, result in fatigue-free work by spreading the manual force equally between the six jaws. The XBTDVR screwdrivers have a rotating cap that prevents user discomfort even at high torques and allows rapid rotation. The ergonomically shaped handle further aids the user's comfort. The blade is made from CVM steel, hardened and chrome-plated.

Marking Accessories

The marking system provides logical and clear identification of the modular terminal blocks and interface modules. The blank marker strip is designed for marking terminal blocks, equipment and smaller modules with marker grooves. The marker strip is available in all common pitches in printed and unprinted versions.

Testing Accessories

The range of test accessories available includes different test plugs, so that an optimum solution can be realized for every application. In addition to pre-assembled test plugs, plugs are also available that can be configured individually to form test adapters.

End Stops

Product Selection

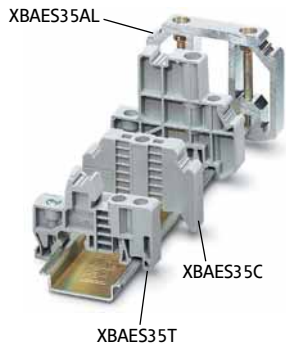

Snap-On End Stop (15 mm)

Standard Pack	Catalog Number
50	XBAES15N

Snap-On End Stop (35 mm)

Standard Pack	Catalog Number
50	XBAES35N

Snap-on end stops for 35 mm and 15 mm DIN rails can be fitted with blank marker strips and adjustable terminal strip markers, parking facility for bridges and testing accessories.

Universal End Stop (15 mm)

Standard Pack	Catalog Number
50	XBAES15C

Universal End Stop (35 mm)

Standard Pack	Catalog Number
50	XBAES35T
50	XBAES35C

Screwed on, labeling with blank marker strips and terminal strip markers.

Aluminum End

Standard Pack	Catalog Number
10	XBAES35AL

Snaps on, for end support of 50–240 mm terminal blocks, labeling with XBMZB10.

Cross-Reference of Terminal Blocks Marking, End Stops

Catalog Number	XBMKLM2	XBMGLMA	XBMUBE
XBAES35N	X	—	—
XBAES35T	—	X	X

Dimensions

Approximate Dimensions in Inches (mm)

Snap-On End Stop

XBAES35N

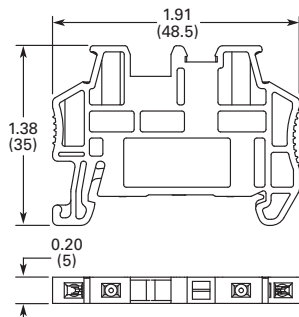

XBAES15N

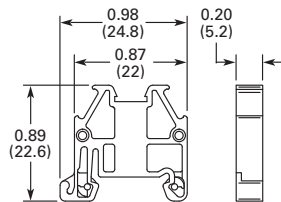

Aluminum End Stop

XBAES35AL

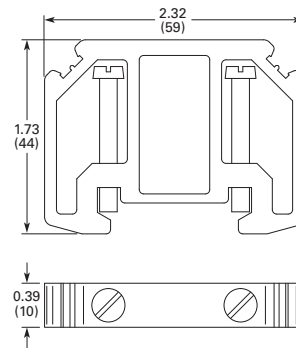

Universal End Stop

XBAES35T

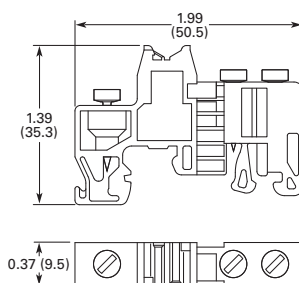

XBAES35C

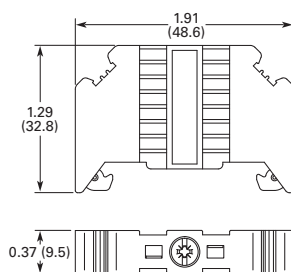

XBAES15C

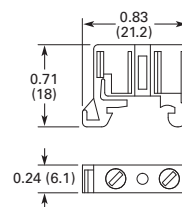

8.1

Terminal Blocks, Fuse Blocks and Fuse Holders

IEC—XB Series

DIN Rails

Product Selection



Perforated and unperforated DIN rails in accordance with E 60715.

Features

- High dimensional accuracy
- Restricted tolerances
- Double surface tempering, galvanized and chromated
- All 2m in length
- Customization available

35 x 7.5 mm x 2m

Standard Pack	Catalog Number
Slotted	
25	XBANS3575P
Solid	
25	XBANS3575U

35 x 15 mm x 2m

Standard Pack	Catalog Number
Slotted	
25	XBANS3515P
Solid	
25	XBANS3515U

15 x 5.5 mm x 2m

Standard Pack	Catalog Number
25	XBANS15P

Aluminum DIN Rails (Perforated)

Standard Pack	Catalog Number
35/7.5/2m	
25	XBANS3575PL
35/5.8/2m	
6	XBANS35PL

8

Dimensions

Approximate Dimensions in Inches (mm)

35 x 7.5 mm DIN Rail

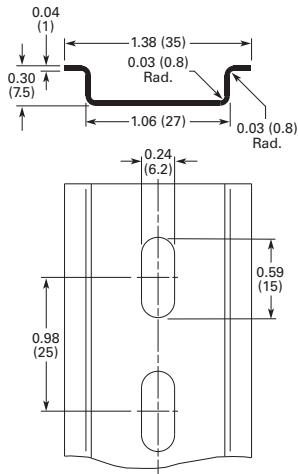

35 x 15 mm DIN Rail

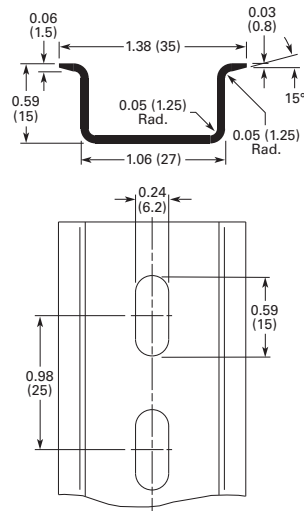

15 x 5.5 mm x 2m DIN Rail

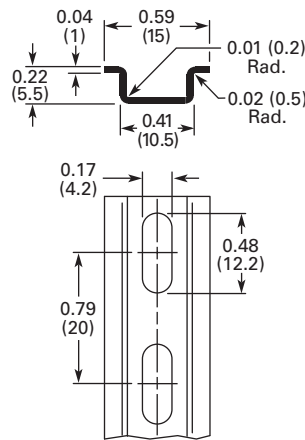

XBANS35PL Raised Rail

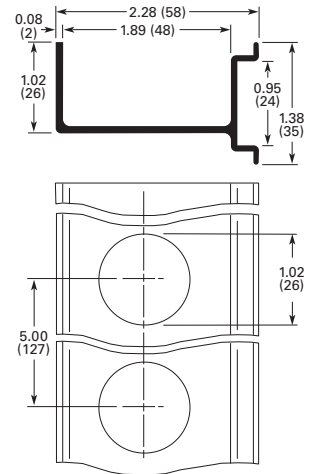

Angled Mounting Brackets

Product Selection



The angled brackets enable the DIN rail to be mounted with a spacing or at an angle of 30°.

Features

- For mounting DIN rail at 30° angle
- For use with M6 screw
- Chromated steel
- Provides better visibility

Angled Mounting Bracket

Standard Pack	Catalog Number
Height Inches (mm) 1.39 (35.4)	
10	XBANBGS
Height Inches (mm) 1.81 (46)	
10	XBANBGSH

Dimensions

Approximate Dimensions in Inches (mm)

XBANBGS

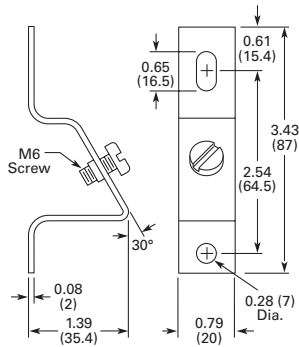

XBANBGSH

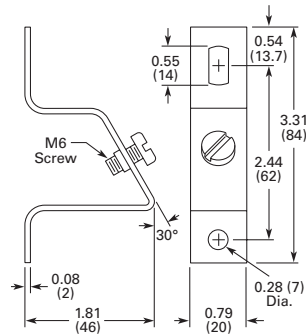

8.1

Terminal Blocks, Fuse Blocks and Fuse Holders

IEC—XB Series

Ferrules

Product Selection

Ferrules are offered in two basic designs—an insulated style available in models for wire sizes 20 through 4 AWG and a non-insulated type available in models for wire sizes 22 through 6 AWG.

Note: UL Ratings do not typically pertain to the use of Ferrules—Ferrules are covered under DIN VDE 0611.

Insulated

- Tube: soft electrolytic copper (E-CU), tin plated
- Plastic sleeve: polypropylene
 - Long-term temperature 105°C
 - Short-term temperature 120°C

XBAF1



Insulated Ferrules

Wire Size AWG (mm ²)	Color ^①	Standard Pack ^②	Catalog Number
20 (0.5)	White	100	XBAF1
18 (0.75)	Gray	100	XBAF3
18 (1)	Red	100	XBAF4
16 (1.5)	Black	100	XBAF6
14 (2.5)	Blue	100	XBAF9
14 (2.5)	Blue	100	XBAF10
12 (4)	Gray	100	XBAF11
12 (4)	Gray	100	XBAF12
10 (6)	Yellow	100	XBAF13
10 (6)	Yellow	100	XBAF14
8 (10)	Red	100	XBAF15
8 (10)	Red	100	XBAF16
6 (16)	Blue	100	XBAF17
6 (16)	Blue	100	XBAF18
4 (25)	Yellow	100	XBAF19

Non-Insulated

- Tube: soft electrolytic copper (E-CU), tin plated

XBAF20



Non-Insulated Ferrules

Wire Size AWG (mm ²)	Standard Pack ^②	Catalog Number
20 (0.5)	100	XBAF20
18 (0.75)	100	XBAF21
18 (1)	100	XBAF23
16 (1.5)	100	XBAF24
14 (2.5)	100	XBAF25
12 (4)	100	XBAF26
10 (6)	100	XBAF27
8 (10)	100	XBAF28
6 (16)	100	XBAF29

Special Applications

The twin ferrules allow two conductors to be compressed practically in one ferrule.

The colored coding of the various cross sections corresponds to DIN 46 228-4.

XBAFT1



Non-Insulated Twin Ferrules

Wire Size AWG (mm ²)	Color ^①	Standard Pack ^②	Catalog Number
20 (0.5)	White	100	XBAFT1
18 (0.75)	Gray	100	XBAFT3
18 (1)	Red	100	XBAFT4
16 (1.5)	Black	100	XBAFT6
14 (2.5)	Blue	100	XBAFT9
12 (4)	Gray	100	XBAFT11
10 (6)	Yellow	100	XBAFT13
8 (10)	Red	100	XBAFT15
6 (16)	Blue	100	XBAFT18

Notes

- ^① The colored coding of the various cross-sections corresponds to DIN 46 228-4.
- ^② Standard pack is the number of ferrules that come in each bag. Must order in multiples of standard pack.
Example: XBAF1—an order for 200 pieces will receive 2 bags of ferrules, each with 100 pieces.

Dimensions

Approximate Dimensions in Inches (mm)

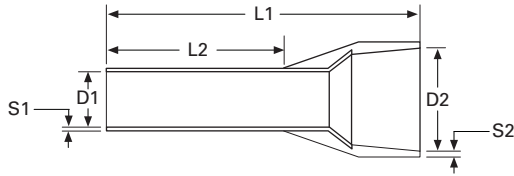
Ferrules with Insulating Collar

Catalog Number	Approximate Dimensions					
	D1	D2	L1	L2	S1	S2
XBAF1	0.04 (1.1)	0.10 (2.5)	0.55 (14.0)	0.31 (8.0)	0.006 (0.15)	0.010 (0.25)
XBAF3	0.05 (1.3)	0.11 (2.8)	0.55 (14.0)	0.31 (8.0)	0.006 (0.15)	0.010 (0.25)
XBAF4	0.06 (1.5)	0.12 (3.0)	0.55 (14.0)	0.31 (8.0)	0.006 (0.15)	0.012 (0.30)
XBAF6	0.07 (1.8)	0.13 (3.4)	0.55 (14.0)	0.31 (8.0)	0.006 (0.15)	0.012 (0.30)
XBAF9	0.09 (2.3)	0.17 (4.2)	0.55 (14.0)	0.31 (8.0)	0.006 (0.15)	0.012 (0.30)
XBAF10	0.09 (2.3)	0.17 (4.2)	0.94 (24.0)	0.71 (18.0)	0.006 (0.15)	0.012 (0.30)
XBAF11	0.11 (2.8)	0.19 (4.8)	0.67 (17.0)	0.39 (10.0)	0.008 (0.20)	0.012 (0.30)
XBAF12	0.11 (2.8)	0.19 (4.8)	1.02 (26.0)	0.71 (18.0)	0.008 (0.20)	0.012 (0.30)
XBAF13	0.14 (3.5)	0.24 (6.2)	0.79 (20.0)	0.47 (12.0)	0.008 (0.20)	0.012 (0.30)
XBAF14	0.14 (3.5)	0.24 (6.2)	1.02 (26.0)	0.71 (18.0)	0.008 (0.20)	0.012 (0.30)
XBAF15	0.18 (4.6)	0.30 (7.5)	0.87 (22.0)	0.47 (12.0)	0.008 (0.20)	0.012 (0.30)
XBAF16	0.18 (4.6)	0.30 (7.5)	1.10 (28.0)	0.71 (18.0)	0.008 (0.20)	0.012 (0.30)
XBAF17	0.23 (5.8)	0.35 (8.8)	0.94 (24.0)	0.47 (12.0)	0.008 (0.20)	0.016 (0.40)
XBAF18	0.23 (5.8)	0.35 (8.8)	1.10 (28.0)	0.71 (18.0)	0.008 (0.20)	0.016 (0.40)
XBAF19	0.29 (7.3)	0.43 (11.0)	1.26 (32.0)	0.71 (18.0)	0.008 (0.20)	0.020 (0.50)

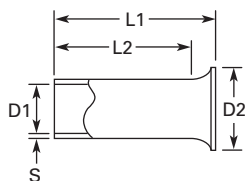
Ferrules without Insulating Collar

Catalog Number	Approximate Dimensions				
	D1	D2	L1	L2	S
XBAF20	0.04 (1.0)	0.08 (2.1)	0.24 (6.0)	0.21 (5.3)	0.006 (0.15)
XBAF21	0.05 (1.2)	0.09 (2.3)	0.24 (6.0)	0.21 (5.3)	0.006 (0.15)
XBAF23	0.06 (1.4)	0.10 (2.5)	0.24 (6.0)	0.21 (5.3)	0.006 (0.15)
XBAF24	0.07 (1.7)	0.11 (2.8)	0.28 (7.0)	0.24 (6.0)	0.006 (0.15)
XBAF25	0.09 (2.2)	0.13 (3.4)	0.28 (7.0)	0.24 (6.0)	0.006 (0.15)
XBAF26	0.11 (2.8)	0.16 (4.0)	0.35 (9.0)	0.31 (8.0)	0.008 (0.20)
XBAF27	0.14 (3.5)	0.19 (4.7)	0.47 (12.0)	0.35 (9.0)	0.008 (0.20)
XBAF28	0.18 (4.5)	0.23 (5.8)	0.47 (12.0)	0.43 (10.8)	0.008 (0.20)
XBAF29	0.23 (5.8)	0.30 (7.5)	0.47 (12.0)	0.41 (10.5)	0.008 (0.20)

8.1

Terminal Blocks, Fuse Blocks and Fuse Holders

IEC—XB Series

Approximate Dimensions in Inches (mm)

Twin Ferrules

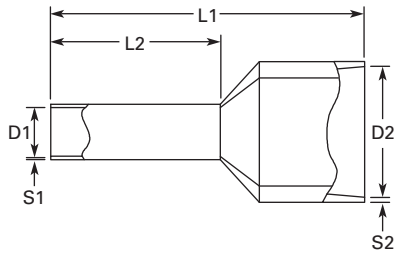

8

Catalog Number	Approximate Dimensions		L1	L2	S1	S2
	D1	D2				
XBAFT1	0.06 (1.5)	0.10 (2.5)	0.59 (15.0)	0.31 (8.0)	0.006 (0.15)	0.010 (0.25)
XBAFT3	0.07 (1.8)	0.11 (2.8)	0.59 (15.0)	0.31 (8.0)	0.006 (0.15)	0.010 (0.25)
XBAFT4	0.08 (2.1)	0.13 (3.4)	0.59 (15.0)	0.31 (8.0)	0.006 (0.15)	0.012 (0.30)
XBAFT6	0.09 (2.3)	0.14 (3.6)	0.63 (16.0)	0.31 (8.0)	0.006 (0.15)	0.012 (0.30)
XBAFT9	0.11 (2.9)	0.17 (4.2)	0.73 (18.5)	0.39 (10.0)	0.008 (0.20)	0.012 (0.30)
XBAFT11	0.15 (3.8)	0.19 (4.9)	0.91 (23.0)	0.47 (12.0)	0.008 (0.20)	0.012 (0.30)
XBAFT13	0.19 (4.9)	0.23 (5.9)	0.98 (25.0)	0.55 (14.0)	0.008 (0.20)	0.016 (0.40)
XBAFT15	0.26 (6.5)	0.28 (7.2)	1.02 (26.0)	0.55 (14.0)	0.008 (0.20)	0.016 (0.40)
XBAFT18	0.33 (8.5)	0.35 (8.8)	1.22 (31.0)	0.63 (16.0)	0.008 (0.20)	0.020 (0.50)

Hand Tools**Stripping Tools****Product Selection****Stripping Tools**

Standard Pack	Catalog Number
1	XBTCUTSTP

Technical Data and Specifications**Conductor/Cable Stripping Range**

Description	Specification
Conductor/cable	0.2–6 mm ² /24–10 AWG
Wire cutter	6 mm ² /10 AWG

Dimensions

Approximate Dimensions in Inches (mm)

Stripping Tools

Length	Stripping Length	Weight In lbs (g)
8.07 (205)	Up to 18 mm	0.44 (200)

Slotted Screwdrivers

The crimping pliers deform the ferrules hexagonally. For 0.25–6 mm² ferrules in accordance with DIN 46 228-1: 1992-08 and DIN 46 228-4: 1990-09.

Product Selection**Slotted Screwdrivers**

Standard Pack	Catalog Number
3.5 mm	
1	XBTDVR35
4.0 mm	
1	XBTDVR40

8.1

Terminal Blocks, Fuse Blocks and Fuse Holders

IEC—XB Series

Marking Accessories

Printed Marking Tag Options

Horizontally Printed Marking Tags and Marking Directions

1	2	3	4	5	6	7	8	9	10
---	---	---	---	---	---	---	---	---	----

Marking Direction: Horizontal

1	2	3	4	5	6	7	8	9	10
---	---	---	---	---	---	---	---	---	----

Marking Direction: Vertical

8

Marking Tags for 5.2 mm Wide Terminal Blocks

Standard Pack	Number Sequence	Catalog Number
ZB5 Tags Vertically Numbered		
10	1–10 ①	XBMZB5V/1
10	11–20	XBMZB5V/11
10	21–30	XBMZB5V/21
10	31–40	XBMZB5V/31
10	41–50	XBMZB5V/41
10	51–60	XBMZB5V/51
10	61–70	XBMZB5V/61
10	71–80	XBMZB5V/71
10	81–90	XBMZB5V/81
10	91–100	XBMZB5V/91
ZBF5 Tags Vertically Numbered		
10	1–10 ①	XBMZBF5V/1
10	11–20	XBMZBF5V/11
10	21–30	XBMZBF5V/21
10	31–40	XBMZBF5V/31
10	41–50	XBMZBF5V/41
10	51–60	XBMZBF5V/51
10	61–70	XBMZBF5V/61
10	71–80	XBMZBF5V/71
10	81–90	XBMZBF5V/81
10	91–100	XBMZBF5V/91

Marking Tags for 6.2 mm Wide Terminal Blocks

Standard Pack	Number Sequence	Catalog Number
ZB6 Tags Vertically Numbered		
10	1–10 ①	XBMZB6V/1
10	11–20	XBMZB6V/11
10	21–30	XBMZB6V/21
10	31–40	XBMZB6V/31
10	41–50	XBMZB6V/41
10	51–60	XBMZB6V/51
10	61–70	XBMZB6V/61
10	71–80	XBMZB6V/71
10	81–90	XBMZB6V/81
10	91–100	XBMZB6V/91
ZBF6 Tags Vertically Numbered		
10	1–10 ①	XBMZBF6V/1
10	11–20	XBMZBF6V/11
10	21–30	XBMZBF6V/21
10	31–40	XBMZBF6V/31
10	41–50	XBMZBF6V/41
10	51–60	XBMZBF6V/51
10	61–70	XBMZBF6V/61
10	71–80	XBMZBF6V/71
10	81–90	XBMZBF6V/81
10	91–100	XBMZBF6V/91

Note

① For text printed horizontally, change “V” in catalog number to “H.”

Marking Tags for 8.2 mm Wide Terminal Blocks

Standard Pack	Number Sequence	Catalog Number
ZB8 Tags Vertically Numbered		
10	1–10 ①	XBMZB8V/1
10	11–20	XBMZB8V/11
10	21–30	XBMZB8V/21
10	31–40	XBMZB8V/31
10	41–50	XBMZB8V/41
10	51–60	XBMZB6V/51
10	61–70	XBMZB8V/61
10	71–80	XBMZB8V/71
10	81–90	XBMZB8V/81
10	91–100	XBMZB8V/91
ZBF8 Tags Vertically Numbered		
10	1–10 ①	XBMZBF8V/1
10	11–20	XBMZBF8V/11
10	21–30	XBMZBF8V/21
10	31–40	XBMZBF8V/31
10	41–50	XBMZBF8V/41
10	51–60	XBMZBF8V/51
10	61–70	XBMZBF8V/61
10	71–80	XBMZBF8V/71
10	81–90	XBMZBF8V/81
10	91–100	XBMZBF8V/91

Marking Tags for 10.2 mm Wide Terminal Blocks

Standard Pack	Number Sequence	Catalog Number
ZB10 Tags Vertically Numbered		
10	1–10 ①	XBMZB10V/1
10	11–20	XBMZB10V/11
10	21–30	XBMZB10V/21
ZBF10 Tags Vertically Numbered		
10	1–10 ①	XBMZBF10V/1
10	11–20	XBMZBF10V/11
10	21–30	XBMZBF10V/21

Marking Tags for 12 mm Wide Terminal Blocks

Standard Pack	Number Sequence	Catalog Number
ZB12 Tags Vertically Numbered		
10	1–10 ①	XBMZB12V/1
10	11–20	XBMZB12V/11
10	21–30	XBMZB12V/21
ZBF12 Tags Vertically Numbered		
10	1–10 ①	XBMZBF12V/1
10	11–20	XBMZBF12V/11
10	21–30	XBMZBF12V/21

Marking Tags for 16 mm Wide Terminal Blocks

Standard Pack	Number Sequence	Catalog Number
ZB15 Tags Vertically Numbered		
10	1–10 ①	XBMZB15V/1
10	11–20	XBMZB15V/11
10	21–30	XBMZB15V/21
ZBF15 Tags Vertically Numbered		
10	1–10 ①	XBMZBF15V/1
10	11–20	XBMZBF15V/11
10	21–30	XBMZBF15V/21

Note

① For text printed horizontally, change “V” in catalog number to “H.”

8.1

Terminal Blocks, Fuse Blocks and Fuse Holders

IEC—XB Series

Pre-Printed Marking Tags

Terminal Blocks Marking Tags

The tags are made of white self-extinguishing polyamide 6.6 and the imprint is hot stamped with rubproof black ink.

- White marking strip available preprinted. Strip covers 10 terminals. Marking 1–10, 11–20, up to 991–999. Contact Eaton for more options.
 - XBMZB5 or XBMZBF5 for terminal blocks 5.2 mm wide
 - XBMZB6 or XBMZBF6 for terminal blocks 6.2 mm wide
 - XBMZB8 or XBMZBF8 for terminal blocks 8.2 mm wide
 - XBMZB10 or XBMZBF10 for terminal blocks 10.2 mm wide
 - XBMZB12 or XBMZBF12 for terminal blocks 12 mm wide
 - XBMZB15 or XBMZBF15 for terminal blocks 16 mm wide

8

Marking Tag Sizes

Note: Marking Tag Sizes are for all catalog numbers starting with given prefix, EXCEPT FUSE TERMINAL Blocks.

Proper Marking Tag Size

XBMZB5	XBMZBF5	XBMZB6	XBMZBF6	XBMZB8	XBMZBF8	XBMZB10	XBMZBF10	XBMZB12	XBMZBF12	XBMZB15	XBMZBF15	XBMSSZB
XBUT25	XBPT25 ^②	XBUT4	XBPT4 ^②	XBUT6	XBPT6 ^②	XBUT10	XBPT10 ^②	XBPT16 ^①	XBPT16 ^②	XBUT35	XBPT35 ^②	XBMKLMZ
XBUT4FBE ^①	XBPTT25	XBUTT4	XBPTT4	XBPT6 ^①	XBPT4FBN ^②	XBUT16	—	—	—	XBPT35 ^①	—	—
XBUT6FBN ^①	XBPTK	XB3UKA	XBPT4FBE ^②	XBUK6	XBPT4FSI ^②	XBTK	—	—	—	—	—	—
XBPT25 ^①	XBPU25 ^②	XB3UKF	XBQT25 ^③	XBPT4FSI ^①	—	XBUK50	—	—	—	—	—	—
XBPT4FBE ^①	XBAP ...	XBUT4FBE ^②	XBQT25FBE ^③	—	—	XBUK150	—	—	—	—	—	—
XBPU25 ^①	XBQT15 ^③	XBUT6FBN ^②	XBQU25 ^③	—	—	XBUK95	—	—	—	—	—	—
XBQT15 ^①	XBQT15	XBUK10	—	—	—	XBPT10 ^①	—	—	—	—	—	—
XBQT25FBE ^④	XBQU15 ^③	XBUK4	—	—	—	XBMKLMZ ^⑤	—	—	—	—	—	—
XBQU15 ^①	XBMPK15	XBPT4 ^①	—	—	—	—	—	—	—	—	—	—
XBMUK25	XBMPK15	XBPT4FBN ^①	—	—	—	—	—	—	—	—	—	—
—	XBATCP...	XBQT25 ^①	—	—	—	—	—	—	—	—	—	—
—	—	XBQT25FBE ^①	—	—	—	—	—	—	—	—	—	—
—	—	XBQU25 ^①	—	—	—	—	—	—	—	—	—	—
—	—	XBMUK4	—	—	—	—	—	—	—	—	—	—

Notes

- ① For center labeling.
- ② For external labeling.
- ③ For center and outside labeling.
- ④ For lever labeling.
- ⑤ Two (2) XBMZB10 tags fit in one (1) XBMKLMZ.

Marker Strips and Sheets (for use with plotter)

The **XB** Series marking system provides logical and clear identification of the modular terminal blocks and interface modules.

Product Selection**XBMZB_****Marker Strips (Strip of 10)**

Terminal Width	Standard Pack	Catalog Number
Blank Strips		
5.2 mm	10	XBMZB5
6.2 mm	10	XBMZB6
8.2 mm	10	XBMZB8
10.2 mm	10	XBMZB10
12 mm	10	XBMZB12
16 mm	10	XBMZB15 ^①
Flat Strips		
5.2 mm	10	XBMZBF5
6.2 mm	10	XBMZBF6
8.2 mm	10	XBMZBF8
10.2 mm	10	XBMZBF10
12 mm	10	XBMZBF12
16 mm	10	XBMZBF15

Marker Sheets (Strip of 10)

Terminal Width)	Color	Standard Pack	Catalog Number
Marker Sheets (10 rows of 12)			
5.2 mm	White	50	XBMPZB5
	Blue	50	XBMPZB5BU
	Red	50	XBMPZB5RD
	Yellow	50	XBMPZB5YE
	Green	50	XBMPZB5GN
Marker Sheets (10 rows of 10)			
6.2 mm	White	50	XBMPZB6
	Blue	50	XBMPZB6BU
	Red	50	XBMPZB6RD
	Yellow	50	XBMPZB6YE
	Green	50	XBMPZB6GN
Flat Marker Sheets (10 rows of 10)			
5.2 mm	White	10	XBMPZBF5
	Orange	10	XBMPZBF5OG
	White	10	XBMPZBF6
	Orange	10	XBMPZBF6OG
	White	10	XBMPZBF8

XBMPZB_**XBMPZBF_****Label Sheets for Laser Printers**

The XBM labels have been specially developed for laser printers and have considerable advantages:

- Can be printed on all commercially available laser printers
- Or can use plotter or pen for printing
- Good adhesive properties
- A4 size
- XBMKL25X12WH designed to fit XBGBS2512 group marker
- XBMLMAL447 is perforated for terminal strip marker XBMGLMA and is 44 x 7 mm

Product Selection**XBM_****Label Sheets**

Standard Pack	Catalog Number
10	XBMKL25X12WH
10	XBMLMAL447

Note

^① All markers are strips of 10, except XBMZB15, which is a strip of 5.

8.1

Terminal Blocks, Fuse Blocks and Fuse Holders

IEC—XB Series

Terminal Block Group Marking

Terminal block groups are marked using marking labels that are snapped into the marker strip groove of the terminal blocks. The group is marked using either labels or insert markers.

Product Selection

XBGBS2512



Terminal Block Group Marking ^①

Standard Pack	Catalog Number
100	XBGBS2512

8

Terminal Strip Markers

Adjustable height for end bracket labeling.

Product Selection

XBM_



Terminal Strip Markers ^①

Standard Pack	Catalog Number
20 x 8 mm Wide	
10	XBMKLM2
44 x 7 mm Wide	
10	XBMGLMA

Terminal Strip Marker Carriers

For labeling terminal groups, for mounting on DIN rail. Lettering field is 40 x 17 mm.

Product Selection

XBMUB_



Terminal Strip Marker Carriers

Standard Pack	Catalog Number
10	XBMUBE
10	XBMUBED

Insert Markers for Laser Printers

One sheet = 56 labels. Lettering field is 40 x 17 mm.

Product Selection

XBMUBEL4017



Insert Markers for XBMUBE(D)

Standard Pack	Catalog Number
10	XBMUBEL4017

Refillable Marker Pen

Refillable marker pen for manual labeling, line thickness 0.35 mm.

Product Selection

XBMXPEN



Terminal Strip Marker Pen ^①

Standard Pack	Catalog Number
1	XBMXPEN

Non-Refillable Marker Pen

For manual labeling, line thickness 0.5 mm.

Product Selection

XBMUBE



Non-Refillable Marker Pen

Standard Pack	Catalog Number
1	XBMBSTIFT

Note

^① See **Page V7-T8-101** for insert labels.

Testing Accessories

Test Adapter

For 4 mm diameter test plug and 4 mm diameter safety test plug. Makes contact in the bridge shaft.

Product Selection

XBATSPA14	Test Adapter	
	Standard Pack	Catalog Number
	1	XBATSPA14

Modular Test Plugs

For individual assembly of test plug strips.



Product Selection

XBATS_	Modular Test Plugs	
	Standard Pack	Catalog Number
	Test Plugs	
	10	XBATSPS5
	10	XBATSPS6
	10	XBATSPS8
	Spacer Plate	
	10	XBATSDPPS5
	10	XBATSDPPS6
	10	XBATSDPPS8

Test Plugs

Consisting of metal part for socket hole and insulating sleeve.

Product Selection

XBATSMP_	Test Plugs	
	Standard Pack	Catalog Number
	2.3 mm	
	10	—
	10	Blue
	10	White
	10	Red
	10	Black
	4 mm	
	10	—
	10	Blue
	10	White
	10	Red
	10	Black

Separating Plates, Covers and Bridges

End Cover

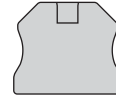

Used to cover an open end of terminal block when changing sizes within an assembly and/or for last terminal block in a row.

Partition Plate

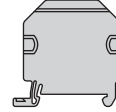

Protrudes over the terminal block and is used to increase electrical clearance between terminals. Also provides visual indications of the functions of terminal blocks. For example, terminal blocks between two partition plates may provide an exact location for test points.

End Cover Segment



Covers protruding terminal block segments of three- and four-wire terminal blocks when next to a two-wire blocks. This ensures that all is touch-proof and saves space over using a standard end cover.

Jumper/Bridge

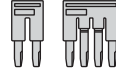

Provides the ability to electrically connect terminal blocks. Non-adjacent blocks may be bridged by snapping off the contact tabs of the standard bridge. The reducing bridge permits simple connection of terminal blocks with different nominal cross-sections.

Note

See these accessories as listed with terminal blocks for more information.

8.2

Terminal Blocks, Fuse Blocks and Fuse Holders

NEMA

NEMA



8

Contents

Description

Page

NEMA

C381 Series Terminal Blocks, Rail Mounted . . .

V7-T8-105

TB Series Terminal Blocks, Modular

V7-T8-109

NEMA Overview

Product Description

NEMA terminal blocks provide a panel or DIN rail mount block that can be assembled from modular pieces. These blocks accommodate wire from 22 to 1/0 AWG and up to 175A and 600V.

Standards and Certifications

- UL File #E67464 and #E56797

C381 Series Terminal Blocks, Rail Mounted



Contents

Description	Page
C381 Series Terminal Blocks, Rail Mounted	
Product Selection	V7-T8-106
Accessories	V7-T8-107
Modifications	V7-T8-107
Technical Data and Specifications	V7-T8-108
Dimensions	V7-T8-108
TB Series Terminal Blocks, Modular	V7-T8-109

C381 Series Terminal Blocks, Rail Mounted

Product Description

- 600V
- Snap-fit nylon sections
 - Control circuit blocks
 - Power circuit blocks
 - Fuse blocks
 - Switch blocks
- Sections can be interlocked in any quantity and any mixture for direct panel mounting or channel mounting
- Three terminal choices in control circuit blocks, up to 32 circuits per foot
- Power circuit blocks for heavy-duty applications, up to 16 circuits per foot
- Fuse blocks accommodate any 0.406 x 1.5 in (10.3 x 38.1 mm) ferrule type cartridge fuse up to 30A
- Switch blocks have removable blade for extra safety

Standards and Certifications

- UL File #E67464



A Typical Mixture of Control Circuit Blocks, Power Blocks, Switch and Fuse Blocks in a Mounting Channel

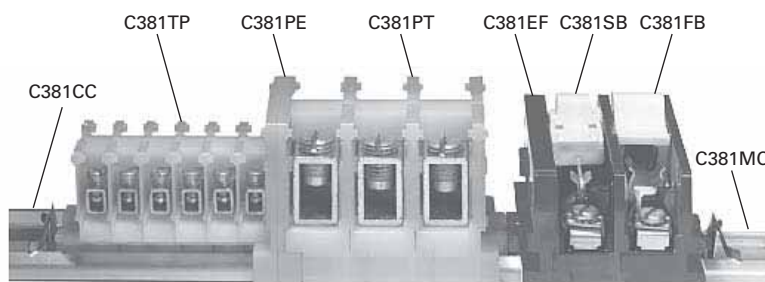

8.2

Terminal Blocks, Fuse Blocks and Fuse Holders

NEMA

Product Selection

When Ordering Specify

Catalog number and quantity, which must be in a multiple of the available minimum standard package.

Examples:









- 200 Cat. No. C381ST
- 20 Cat. No. C381PT
- 100 Cat. No. C381CC

Catalog number and quantity of end sections also in minimum quantity standard package.

Example:

- 25 Cat. No. C381ES

Control, Power, Switch and Fuse Blocks ^①

	Description	AWG Wire Size	Standard Pack ^②	Catalog Number
Control Circuit Terminal Blocks—Rated 50A				
	C381ST Type ST (screw terminal)	22–14 AWG	100	C381ST
	C381TP Type TP (tubular pressure plt)	22–10	100	C381TP
	C381TS Type TS (tubular screw) end section	18–8	100	C381TS
	C381ES End section	—	25	C381ES
Power Circuit Terminal Blocks—Rated 155A				
	C381PT Type PT (tubular screw)	10–1/0	10	C381PT
	C381PE End section	—	10	C381PE
Switch Blocks—Rated 15A and Fuse Blocks—Rated 30A				
	C381SB Switch blocks	18–8	10	C381SB
	C381FB Fuse blocks	18–8	10	C381FB
	C381EF End section	—	10	C381EF

Notes

- ① Available only in minimum quantity standard packages.
- ② Must be ordered in standard package quantity or in multiples of these quantities.

Accessories

C381 Series Terminal Blocks, Rail Mounted ^①

Description	Standard Pack ^②	Catalog Number
Aluminum mounting channel—6 ft (1.8m) lengths	25	C381MC
Screw type channel clamp (one required each end) ^③	100	C381VC
Spring type channel clamp (one required each end) ^③	100	C381CC
Vinyl marking strip—3/8 in x 25 ft (9.5 mm x 7.6m) coil	1	C381MS
Marking paper—pressure sensitive—5/16 x 11-11/16 in (7.9 x 296.9 mm), 24 strips/sheet	5 sheets	C381MP
Marking strip retainer (one required/grouping)		
For use on control circuit blocks	100	C381SR
For use on power circuit blocks	100	C381SP
Fanning strip—for type TP and/or TS	50	C381TF
Fanning strip—for type ST	50	C381SF
Terminal jumper (two-pole) ^④	100	C381TJ
Ganging rod—1/8 in x 6 in (3.2 mm x 152.4 mm) ^⑤	10	C381GR

Modifications

Pull Apart Terminal Blocks ^①

Description	AWG Wire Size	Standard Pack ^②	Catalog Number
One-pole stationary section (tubular pressure plt)	22–10	100	C381PS
Three-pole movable section (tubular pressure plt)	22–10	12	C381PM
End section	—	25	C381ES
Polarizing plug (promotes alignment of poles) ^⑥	—	100	C381PP

Pull Apart Terminal Blocks

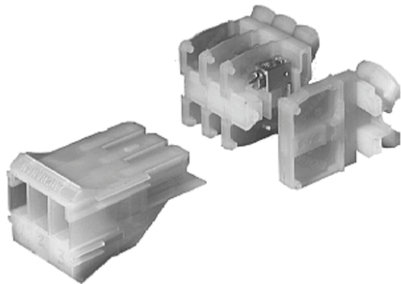

Illustrates: One–Three-Pole Movable Section, Three–One-Pole Stationary Sections and One–End Piece

Notes

- ① Available only in minimum quantity standard packages.
- ② Must be ordered in standard package quantity or in multiples of these quantities.
- ③ C381CC is a snap-in, one time use disposable type. C381VC can be readjusted or reused as desired.
- ④ For use on adjacent Type TP and/or TS control circuit sections.
- ⑤ May be used on section covers or to gang fuse and/or switch blocks.
- ⑥ L shaped plug installs in end of stationary section, Catalog Number C381PS, and prevents incorrect installation of movable section, Catalog Number C381PM.

8.2

Terminal Blocks, Fuse Blocks and Fuse Holders

NEMA

Technical Data and Specifications

Formulas for Calculating Blocks and Channel Lengths

N = Number of Blocks

C381 Series Terminal Blocks, Rail Mounted

Description	Blocks Length
Control blocks and pull apart blocks	$0.762 + (0.375 \times N)$
Power circuit blocks	$0.812 + (0.750 \times N)$
Fuse and switch blocks	$0.812 + (0.755 \times N)$
Mounting channel (minimum channel length)	$0.75 + \text{blocks length}$

Dimensions

Approximate Dimensions in Inches (mm)

8

C381 Series Terminal Blocks, Rail Mounted

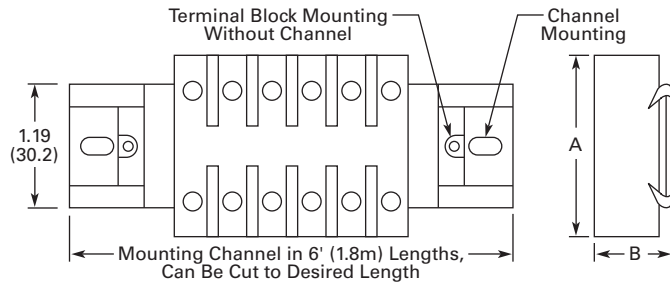

Block	A	B
Control circuit blocks	1.25 (31.8)	1.55 (39.4)
Power circuit blocks	1.75 (44.5)	2.00 (50.8)
Fuse blocks	2.75 (69.9)	2.00 (50.8)
Switch blocks	2.75 (69.9)	2.00 (50.8)
Pull apart blocks	1.88 (47.8)	2.75 (69.9)

TB Series Terminal Blocks, Modular



Contents

<i>Description</i>	<i>Page</i>
C381 Series Terminal Blocks, Rail Mounted	V7-T8-105
TB Series Terminal Blocks, Modular	
Product Selection	V7-T8-110
Accessories	V7-T8-111
Technical Data and Specifications	V7-T8-112
Dimensions	V7-T8-113

TB Series Terminal Blocks, Modular

Product Description

TBA and TBD modular terminal blocks are designed to conserve space, while allowing maximum flexibility and ease of installation. Available as one-, two- and three-pole circuits, simple and uniform installation is possible because their design is based on 5/8 in (15.9 mm) modules. Standard blocks are white nylon.

Breathing Action Clamping Collar

The unique design of the clamping collar permits the collar to breathe as the wire expands and contracts, maintaining a constant and permanent clamping pressure. This eliminates loose connections resulting from the gradual flattening of conductors and joint deterioration caused by heating and cooling cycles.

Features

Blocks—Design Features

- Compact design permits mounting 48–600V or 90–300V terminals per foot
- Fully shielded construction, 600V spacings
- Nylon construction provides anti-tracking and impact resistance
- TBA types are available in rail mounted, base mounted and power distribution types
- Terminal blocks easily snap on or off mounting rails; not necessary to disturb adjacent units
- No end pieces or backing plates are needed when rail mounting
- A 12 circuit subminiature blocks, rated 20A at 300V, is available for “high density” applications
- Popular blocks are also available in dual mount for use with standard TBA or 35 mm DIN rails

Terminals—Design Features

- Insulated walls of lug guide wire into lug
- Blocks are shipped with clamping screw backed out
- Constant locking torque keeps terminal screws in position
- Terminal screws are captive; cannot be lost in shipment or handling
- Hardened stainless steel clamping collar eliminates stripped threads
- Large opening in clamping collar accommodates oversized conductors; smallest collar will accept three 14 AWG stranded conductors

Standards and Certifications

- UL recognized: File No. E56797
- CE approved



8.2

Terminal Blocks, Fuse Blocks and Fuse Holders

NEMA

Product Selection

TBA Modular Terminal Blocks

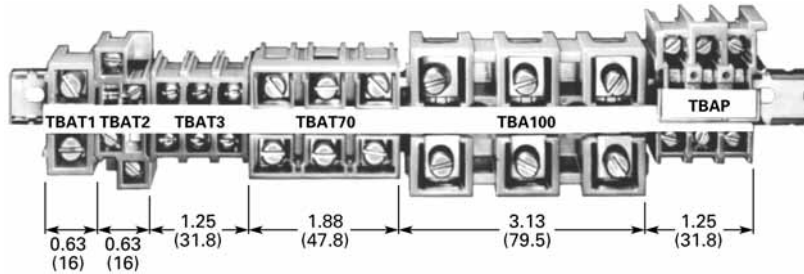

8

Rail and Base Mounted Terminal Blocks

Description	AWG Wire Size	Number of Poles	Ampacity (per Circuit) ^①	Carton Quantity ^②	TBA Rail Catalog Number	DIN Rail ^③ Catalog Number
Rail Mounted—600V						
Subminiature blocks	(2) 14–12	12	5A	100	TBDSM12 ^④	TBDSM12 ^④
Miniature blocks	22–10	4	30A	100	TBDV4	TBDV4
Standard blocks—screw terminals with tang clamping collars	18–2	1	90A	100	—	TBDT1
	22–8	2	40A	100	TBAT2	—
	22–8	3	40A	20	TBAT3-20	TBDT3-20
	18–4	3	90A	100	TBDT70	TBDT70
High current blocks	14–2/0	3	175A	12	TBA100 ^⑤	—
Standard blocks—plug-in terminals	22–8	3	40A	20	TBAP	—
	18–4	3	70A	20	TBAP70	—
	14–8	3	40A	20	TBAPL70	—
Panel mount blocks	22–10	3	30A	100	TBAL30	—
	8–4	3	115A	12	TBAL90	—
Disconnect blocks—for 1/4 in (6.4 mm) dia. by 1–1/16 in (25.4–36.5 mm) fuse	22–8	1	30A	50	TBAD	—
Fuse blocks—for 13/32 in (10.3 mm) dia. by 1-1/2 in (38.1 mm) fuse	22–8	1	30A	50	TBDTF	TBDTF
Base Mounted—600V						
Miniature blocks—screw terminals with tang clamping collars	22–10	4	30A (600V)	90	TBBT4	—
Standard blocks—standard screw terminals	22–8	3	40A	80	TBAPT3	—
Universal mounting blocks	8 maximum	4	50A ^⑥	25	TBU4	—
	8 maximum	6	50A ^⑥	60	TBU6	—
	8 maximum	8	50A ^⑥	45	TBU8	—
	8 maximum	12	50A ^⑥	35	TBU12	—

Notes

- ① Based on 50°C rise, test at 25°C ambient while using maximum wire size.
- ② Must be ordered in standard package quantity or in multiples of these quantities.
- ③ Dual mounting blocks—mount on either TMR/TBA rail or 35 mm DIN rail.
- ④ May also be mounted on mini-DIN rail (15 mm). Catalog Number C383TS15.
- ⑤ May also be base mounted.
- ⑥ TBU Series = 60A with crimped wire.

Accessories**TB Series Terminal Blocks, Modular**

Description	Length ^①	Number of Poles	Carton Quantity ^②	Catalog Number
Mounting Rail				
Aluminum	12.5 (317.5)	—	25	TMR12
	37.5 (952.5)	—	25	TMR37
	72.0 (1828.8)	—	25	TBATR72
35 mm DIN—steel	1m	—	20	MC382MA1-20
Marking Strips				
Miniature blocks—TBDV4 and TBBT4	6.0 (152.4)	—	50	TMS6
TBU Series—matte finish	7.5 (190.5)	—	25	TMSU
All other blocks	12.5 (317.5)	—	50	TMS
Jumpers				
TBAT1 and TBAP70	—	2-pole	100	TJ1
TBAT2	—	2-pole	100	TJ2
TBAT3, TBABT3, TBAP and TBBP	—	2-pole	100	TJ3
TBDV4 and TBBT4	—	4-pole	100	TJ4
TBAD and TBATF	—	2-pole	100	TJ5
TBAL30	—	2-pole	100	TJ6
TBU	—	12-pole	10	TJ7
TBDT3	—	2-pole	100	TJ8
Miscellaneous				
End piece for TBABT3 and TBBP	—	—	50	TAD
Lug shield for TBA100 and TBAL90	—	—	50	TAS
Fuse puller	—	—	50	TBP
Lighted fuse puller—blown fuse indication	—	—	25	TBLP

Notes

- ① Length in inches (mm) except as noted.
 ② Must be ordered in standard package quantity or in multiples of these quantities.

8.2

Terminal Blocks, Fuse Blocks and Fuse Holders

NEMA

Technical Data and Specifications

TB Series Terminal Blocks, Modular

Description	Specification
Continuous temperature	212°F (100°C)
Tensile strength	10,000–12,000 psi
Impact resistance	2.0 ft-lb/in (arc)
Arc resistance	140 seconds

- Chemical resistance to:
 - Acetone
 - Ammonia gas
 - Benzene
 - Gasoline
 - Mineral oil
 - Sodium bisulfate
 - Sodium chloride
 - Sodium nitrate
 - Water up to 50°C

Flashover Voltages

Catalog Number	Vac rms, 60 Hz	
	Opposite Polarity	To Ground
TBAT1	9100	6600
TBAT2	9600	7300
TBAT3	8600	7300

Recommended Terminal Tightening Torque

Wire Size	Torque
Up to 8 AWG	20 lb-in
Up to 4 AWG	35 lb-in
Up to 2/0 AWG	50 lb-in

8

To find a current rating, place a straight edge horizontally at the value of anticipated maximum internal panel ambient (scale on the left), and read the current rating for the device on the bottom scale. *Example:* at 60°C, TBAT3 is rated 54 amperes.

Ampere rating is based on maximum allowable temperature—ambient temperature plus temperature rise due to current.

Ratings based on 90°C total temperature of a three-pole block with each pole carrying current and wired with largest size conductors.

Temperature Rating

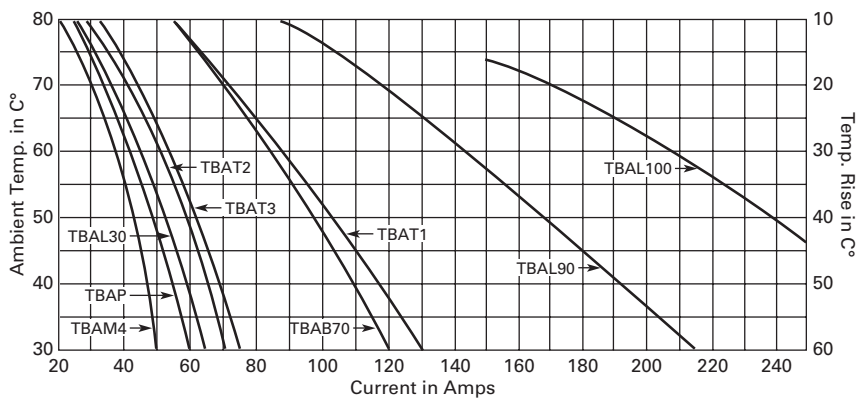

Dimensions

Approximate Dimensions in Inches (mm)

TB Series Terminal Blocks, Modular

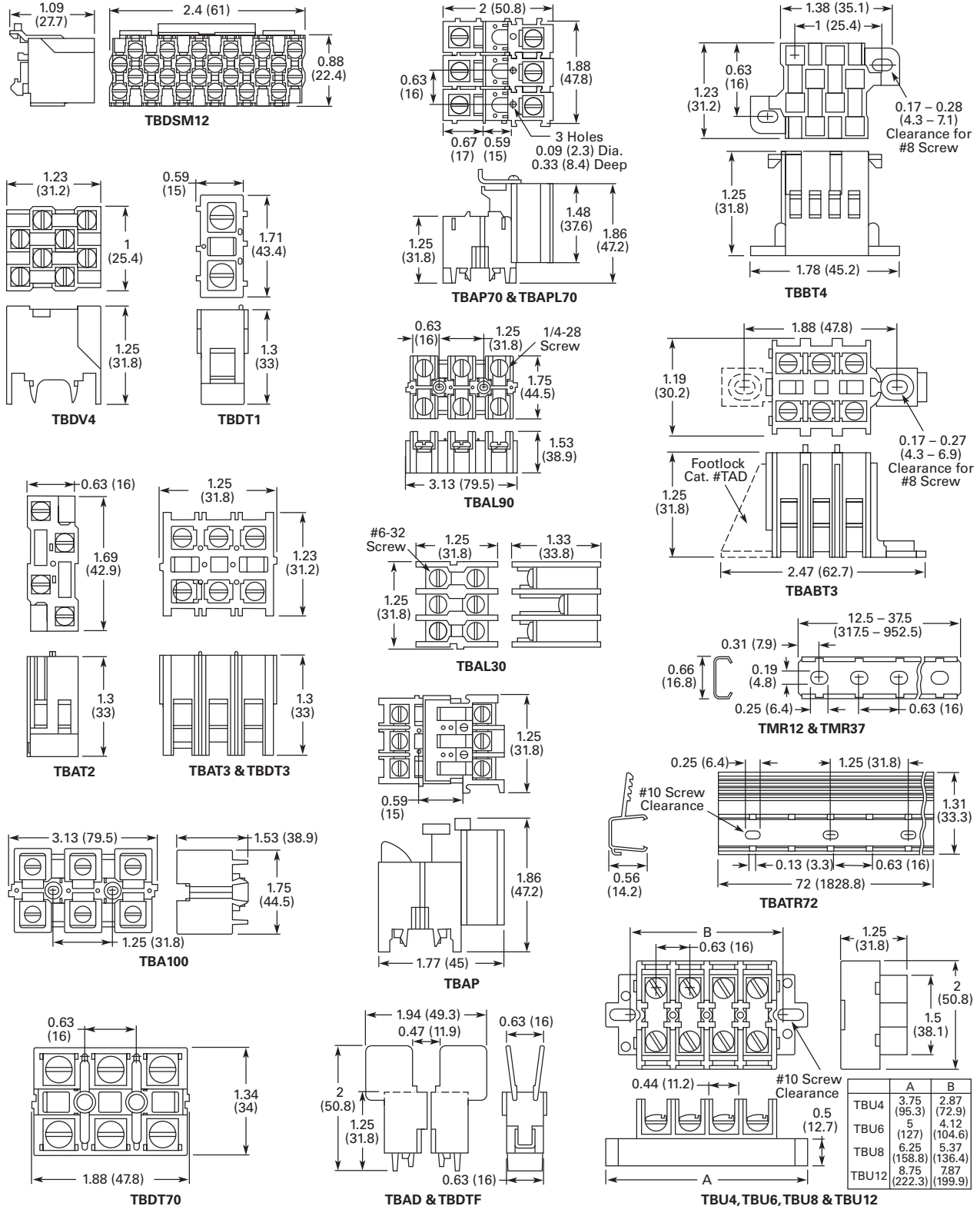

8.3

Terminal Blocks, Fuse Blocks and Fuse Holders

Power Distribution

Power Distribution Products



Contents

Description

Page

Power Distribution	
CHDB Series—Power Distribution Blocks	V7-T8-115
CH160 Series—Power Terminal Blocks	V7-T8-121
Power Terminal Block Accessories	V7-T8-124

Power Distribution Overview

Product Selection Guide

Series	Current Range	UL Certification	High Short Circuit Current Rating ^①	UL 508A Approved for Industrial Control Panels		
				Branch Circuits	Feeder Circuits	HVAC UL 1995
CH162	115–175A	UL 1059 Recognized	No	Yes	No ^②	Yes
CH163	175–420A	UL 1059 Recognized	No	Yes	No ^②	Yes
CH165	620–840A	UL 1059 Recognized	No	Yes	No ^②	Yes
CHDB	175–570A	UL 1953 Listed	Yes	Yes	Yes	Yes

Notes

- ① Refer to **Page V7-T8-116** to determine short circuit current ratings with fuses and **Pages V7-T8-117** and **V7-T8-118** to determine short circuit current ratings in conjunction with specific Eaton circuit breakers.
- ② Single-pole units, when installed with proper spacings, may meet requirements for UL 508A feeder circuits.

CHDB Series—Power Distribution Blocks, Enclosed and Open**Contents**

Description	Page
CHDB Series—Power Distribution Blocks	
Product Selection	V7-T8-116
Technical Data and Specifications	V7-T8-116
Dimensions	V7-T8-119
CH160 Series—Power Terminal Blocks	V7-T8-121
Power Terminal Block Accessories	V7-T8-124

CHDB Series—Power Distribution Blocks**Product Description**

Eaton's CHDB Series of Power Distribution Blocks was designed for high short circuit current rating (SCCR) applications up to 200,000 amperes. They are assembled with the minimum spacing to meet UL 1953 requirements for feeder circuits in UL 508A industrial control panels, and provide significant wiring flexibility.

Available in three-pole open style and single-pole enclosed style with a variety of terminal arrangements and current-carrying capability up to 570 amperes.

Features and Benefits**Enclosed Style**

- IP20 finger-safe enclosure
- 600 Vac or Vdc (UL 1953), 690 Vac or Vdc
- DIN rail or panel mount
- Captive termination screws prevent lost screws
- Single-pole, gang mountable for multi-pole applications
- Tin plated Al connections suitable for Cu conductors
- Flammability, UL 94V-0

Open Style

- 600 Vac or Vdc (UL 1953)
- Panel mount
- Three-pole open design for easy wiring
- Tin-plated Al connections suitable for Cu conductors
- Flammability, UL 94V-0
- Available covers for additional protection (does not meet IP20)

Standards and Certifications

- UL Listed 1953, Guide QPOS, File E256146
- CSA Certified, Class 6228-01, File 15364 (enclosed style)
- CE Component IEC 60947-7-1 (enclosed style)
- IEC 60529, IP20 (finger-safe) under specific wiring conditions (enclosed style)











8.3

Terminal Blocks, Fuse Blocks and Fuse Holders

Power Distribution

Product Selection

CHDB Series—Power Distribution Blocks

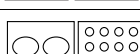
	Line Connection	Load Connection	Configuration	Amperes	Style	Poles	Catalog Number
	2/0-#8 AWG	(4) #4-#14 AWG		175	Open	3	CHDB2203
	2/0-#8 AWG	(6) #4-#14 AWG		175	Open	3	CHDB3213
	300 kcmil-#4 AWG	(6) #4-#12 AWG		310	Open	3	CHDB3233
	300 kcmil-#4 AWG	(12) #4-#14 AWG		310	Open	3	CHDB3703
	300 kcmil-#4 AWG	(6) #2-#12 AWG (3) 1/0-#12 AWG		310 310	Open Open	3 3	CHDB3713 CHDB3713
	2/0-#8 AWG	2/0-#8 AWG		175	Enclosed ①	1	CHDB204F
	500 kcmil-#6 AWG	(6) #2-#14 AWG		380	Enclosed ①	1	CHDB330F
	300 kcmil-#4 AWG	(12) #4-#14 AWG		570	Enclosed ①	1	CHDB377F

8

Technical Data and Specifications

Power Terminal Block Short-Circuit Current Ratings (SCCR) with Fuses

Catalog Number	Terminal Copper Conductors		Maximum Fuse Class and Amperes						
			J	T	RK-1	RK-5	SCCR (kA)		
Line	Load	LPJ	JJS/JJN	LPS-RK/LPN-RK	FRS-R/FRN-R				
CHDB2203	2/0-#8 AWG	#4-#12 AWG	200	200	200	60	200		
		#4-#14 AWG	175	175	100	60	100		
			200	200	100	60	50		
CHDB3213	2/0-#8 AWG	#4-#12 AWG	400	400	200	100	200		
			400	400	400	100	100		
		#4-#14 AWG	175	175	100	60	100		
CHDB3233	300 kcmil-#4 AWG	#4-#8 AWG	400	400	200	100	200		
			400	400	400	100	100		
		#4-#12 AWG	175	175	100	60	100		
CHDB3703	300 kcmil-#4 AWG	#4-#8 AWG	400	400	200	100	200		
		#4-#14 AWG	400	400	400	100	100		
			175	175	100	60	100		
CHDB3713	300 kcmil-#4 AWG	1/0-#6 AWG	400	400	200	100	200		
		#4-#12 AWG	400	400	400	100	100		
			175	175	100	60	100		
CHDB204F	2/0-#8 AWG	2/0-#8 AWG	200	200	100	60	200		
		CHDB330F	500 kcmil-#6 AWG	#2-#6 AWG	400	400	200	100	200
				#2-#14 AWG	200	200	100	30	50
CHDB377F	300 kcmil	#4-#8 AWG	600	600	400	200	200		
		300 kcmil-#4 AWG	#4 AWG	600	600	400	200	50	
			#4-#14 AWG	200	200	100	30	50	

Note

① Finger-safe.

Power Terminal Block Short-Circuit Ratings (SCCR) for UL 508A Applications with Circuit Breakers

Catalog Number	Description	Enclosure Size in Inches (mm)	Current Rating	Opening per Pole		Line Conductors Cu	Load Conductors Cu	SCCR @ 480V (Load Side)	Eaton Breaker	Available Breaker Current Ratings
				Line	Load					
CHDB2203	Feeder Listed Open PDB	16.00 x 16.00 x 6.75 (406.4 x 406.4 x 171.5)	175			2/0-#8	#4-#10 #12 #14	18 kA 18 kA 14 kA	EGB125	15, 20, 25, 30, 35, 40, 45, 50, 60, 70, 80, 90, 100, 125
CHDB2203	Feeder Listed Open PDB	16.00 x 16.00 x 6.75 (406.4 x 406.4 x 171.5)	175			2/0-#8	#4-#10 #12 #14	25 kA 22 kA 14 kA	EGE125	15, 20, 25, 30, 35, 40, 45, 50, 60, 70, 80, 90, 100, 125
CHDB2203	Feeder Listed Open PDB	16.00 x 16.00 x 6.75 (406.4 x 406.4 x 171.5)	175			2/0-#8	#4-#10 #12 #14	50 kA 22 kA 14 kA	EGS125	15, 20, 25, 30, 35, 40, 45, 50, 60, 70, 80, 90, 100, 125
CHDB2203	Feeder Listed Open PDB	16.00 x 16.00 x 6.75 (406.4 x 406.4 x 171.5)	175			2/0-#8	#4-#10 #12 #14	65 kA 22 kA 14 kA	EGH125	15, 20, 25, 30, 35, 40, 45, 50, 60, 70, 80, 90, 100, 125
CHDB2203	Feeder Listed Open PDB	16.00 x 16.00 x 6.75 (406.4 x 406.4 x 171.5)	175			2/0-#8	#4-#10 #12 #14	65 kA 22 kA 14 kA	EGC125 ^①	15, 20, 25, 30, 35, 40, 45, 50, 60, 70, 80, 90, 100, 125
CHDB3213	Feeder Listed Open PDB	24.00 x 20.00 x 6.75 (609.6 x 508.0 x 171.5)	175			2/0-#8	#4-#10 #12 #14	18 kA 18 kA 18 kA	EGB125	15, 20, 25, 30, 35, 40, 45, 50, 60, 70, 80, 90, 100, 125
CHDB3213	Feeder Listed Open PDB	24.00 x 20.00 x 6.75 (609.6 x 508.0 x 171.5)	175			2/0-#8	#4-#10 #12 #14	25 kA 22 kA 18 kA	EGE125	15, 20, 25, 30, 35, 40, 45, 50, 60, 70, 80, 90, 100, 125
CHDB3213	Feeder Listed Open PDB	24.00 x 20.00 x 6.75 (609.6 x 508.0 x 171.5)	175			2/0-#8	#4-#10 #12 #14	50 kA 22 kA 18 kA	EGS125	15, 20, 25, 30, 35, 40, 45, 50, 60, 70, 80, 90, 100, 125
CHDB3213	Feeder Listed Open PDB	24.00 x 20.00 x 6.75 (609.6 x 508.0 x 171.5)	175			2/0-#8	#4-#10 #12 #14	65 kA 22 kA 18 kA	EGH125	15, 20, 25, 30, 35, 40, 45, 50, 60, 70, 80, 90, 100, 125
CHDB3213	Feeder Listed Open PDB	24.00 x 20.00 x 6.75 (609.6 x 508.0 x 171.5)	175			2/0-#8	#4-#10 #12 #14	65 kA 22 kA 18 kA	EGC125 ^①	15, 20, 25, 30, 35, 40, 45, 50, 60, 70, 80, 90, 100, 125
CHDB204F	Feeder Listed Enclosed PDB	16.00 x 16.00 x 6.75 (406.4 x 406.4 x 171.5)	175			2/0-#8	2/0-#8	18 kA	EGB125	15, 20, 25, 30, 35, 40, 45, 50, 60, 70, 80, 90, 100, 125
CHDB204F	Feeder Listed Enclosed PDB	16.00 x 16.00 x 6.75 (406.4 x 406.4 x 171.5)	175			2/0-#8	2/0-#8	25 kA	EGE125	15, 20, 25, 30, 35, 40, 45, 50, 60, 70, 80, 90, 100, 125
CHDB204F	Feeder Listed Enclosed PDB	16.00 x 16.00 x 6.75 (406.4 x 406.4 x 171.5)	175			2/0-#8	2/0-#8	35 kA	EGS125	15, 20, 25, 30, 35, 40, 45, 50, 60, 70, 80, 90, 100, 125
CHDB204F	Feeder Listed Enclosed PDB	16.00 x 16.00 x 6.75 (406.4 x 406.4 x 171.5)	175			2/0-#8	2/0-#8	65 kA	EGH125	15, 20, 25, 30, 35, 40, 45, 50, 60, 70, 80, 90, 100, 125
CHDB204F	Feeder Listed Enclosed PDB	16.00 x 16.00 x 6.75 (406.4 x 406.4 x 171.5)	175			2/0-#8	2/0-#8	65 kA	EGC125 ^①	15, 20, 25, 30, 35, 40, 45, 50, 60, 70, 80, 90, 100, 125
CHDB3233	Feeder Listed Open PDB	24.00 x 20.00 x 6.75 (609.6 x 508.0 x 171.5)	310			350 kmil-#4	#4-#6 #8 #10	25 kA 25 kA 14 kA	JGE250	70, 90, 100, 125, 150, 175, 200, 225, 250
CHDB3233	Feeder Listed Open PDB	24.00 x 20.00 x 6.75 (609.6 x 508.0 x 171.5)	310			350 kmil-#4	#4-#6 #8 #10	35 kA 35 kA 14 kA	JGS250	70, 90, 100, 125, 150, 175, 200, 225, 250
CHDB3233	Feeder Listed Open PDB	24.00 x 20.00 x 6.75 (609.6 x 508.0 x 171.5)	310			350 kmil-#4	#4-#6 #8 #10	65 kA 42 kA 14 kA	JGH250	70, 90, 100, 125, 150, 175, 200, 225, 250
CHDB3233	Feeder Listed Open PDB	24.00 x 20.00 x 6.75 (609.6 x 508.0 x 171.5)	310			350 kmil-#4	#4-#6 #8 #10	65 kA 42 kA 25 kA	JGC250 ^①	70, 90, 100, 125, 150, 175, 200, 225, 250

Note

① This breaker frame is marked current limiting and suitable for use as current limiting per UL 508A SB.4.3.2.

8.3

Terminal Blocks, Fuse Blocks and Fuse Holders

Power Distribution

Power Terminal Block Short-Circuit Ratings (SCCR) for UL 508A Applications with Circuit Breakers, continued

Catalog Number	Description	Enclosure Size in Inches (mm)	Current Rating	Opening per Pole		Line Conductors Cu	Load Conductors Cu	SCCR at 480V (Load Side)	Eaton Breaker	Available Breaker Current Ratings
				Line	Load					
CHDB3703	Feeder Listed Open PDB	24.00 x 20.00 x 6.75 (609.6 x 508.0 x 171.5)	310			350 kmil-#4	#4-#6 #8 #10	25 kA 25 kA 14 kA	JGE250	70, 90, 100, 125, 150, 175, 200, 225, 250
CHDB3703	Feeder Listed Open PDB	24.00 x 20.00 x 6.75 (609.6 x 508.0 x 171.5)	310			350 kmil-#4	#4-#6 #8 #10	35 kA 35 kA 14 kA	JGS250	70, 90, 100, 125, 150, 175, 200, 225, 250
CHDB3703	Feeder Listed Open PDB	24.00 x 20.00 x 6.75 (609.6 x 508.0 x 171.5)	310			350 kmil-#4	#4-#6 #8 #10	65 kA 42 kA 14 kA	JGH250	70, 90, 100, 125, 150, 175, 200, 225, 250
CHDB3703	Feeder Listed Open PDB	24.00 x 20.00 x 6.75 (609.6 x 508.0 x 171.5)	310			350 kmil-#4	#4-#6 #8 #10	65 kA 42 kA 25 kA	JGC250 ①	70, 90, 100, 125, 150, 175, 200, 225, 250
CHDB3713	Feeder Listed Open PDB	24.00 x 20.00 x 6.75 (609.6 x 508.0 x 171.5)	310			350 kmil-#4	#4-#6 #8 #10	25 kA 25 kA 14 kA	JGE250	70, 90, 100, 125, 150, 175, 200, 225, 250
CHDB3713	Feeder Listed Open PDB	24.00 x 20.00 x 6.75 (609.6 x 508.0 x 171.5)	310			350 kmil-#4	#4-#6 #8 #10	35 kA 35 kA 14 kA	JGS250	70, 90, 100, 125, 150, 175, 200, 225, 250
CHDB3713	Feeder Listed Open PDB	24.00 x 20.00 x 6.75 (609.6 x 508.0 x 171.5)	310			350 kmil-#4	#4-#6 #8 #10	50 kA 42 kA 14 kA	JGH250	70, 90, 100, 125, 150, 175, 200, 225, 250
CHDB3713	Feeder Listed Open PDB	24.00 x 20.00 x 6.75 (609.6 x 508.0 x 171.5)	310			350 kmil-#4	#4-#6 #8 #10	65 kA 50 kA 25 kA	JGC250 ①	70, 90, 100, 125, 150, 175, 200, 225, 250
CHDB330F	Feeder Listed Enclosed PDB	24.00 x 20.00 x 6.75 (609.6 x 508.0 x 171.5)	380			500 kmil-#3	#2-#8	14 kA	LGE400	250, 300, 350, 400
CHDB330F	Feeder Listed Enclosed PDB	24.00 x 20.00 x 6.75 (609.6 x 508.0 x 171.5)	380			500 kmil-#3	#2-#8	14 kA	LGS400	250, 300, 350, 400
CHDB330F	Feeder Listed Enclosed PDB	24.00 x 20.00 x 6.75 (609.6 x 508.0 x 171.5)	380			500 kmil-#3	#2-#8	14 kA	LGH400	250, 300, 350, 400
CHDB330F	Feeder Listed Enclosed PDB	24.00 x 20.00 x 6.75 (609.6 x 508.0 x 171.5)	380			500 kmil-#3	#2-#8	25 kA	LGC400 ①	250, 300, 350, 400
CHDB377F	Feeder Listed Enclosed PDB	24.00 x 20.00 x 6.75 (609.6 x 508.0 x 171.5)	570			(2) 300 kmil-#2	#4 #6 #8	30 kA 18 kA 14 kA	LGE600	250, 300, 350, 400, 500, 600
CHDB377F	Feeder Listed Enclosed PDB	24.00 x 20.00 x 6.75 (609.6 x 508.0 x 171.5)	570			(2) 300 kmil-#2	#4 #6 #8	30 kA 18 kA 14 kA	LGS600	250, 300, 350, 400, 500, 600
CHDB377F	Feeder Listed Enclosed PDB	24.00 x 20.00 x 6.75 (609.6 x 508.0 x 171.5)	570			(2) 300 kmil-#2	#4 #6 #8	30 kA 18 kA 14 kA	LGH600	250, 300, 350, 400, 500, 600
CHDB377F	Feeder Listed Enclosed PDB	24.00 x 20.00 x 6.75 (609.6 x 508.0 x 171.5)	570			(2) 300 kmil-#2	#4 #6 #8	42 kA 35 kA 14 kA	LGC600 ①	250, 300, 350, 400, 500, 600

Note

① This breaker frame is marked current limiting and suitable for use as current limiting per UL 508A SB.4.3.2.

Dimensions

Approximate Dimensions in Inches (mm)

CHDB2203

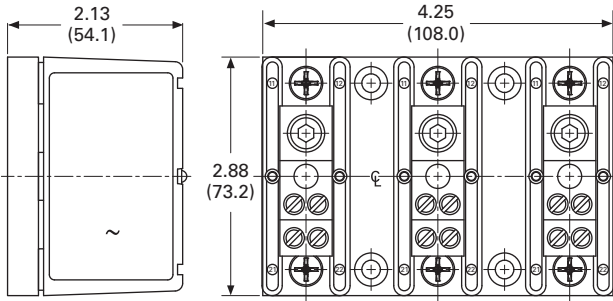

CHDB3713

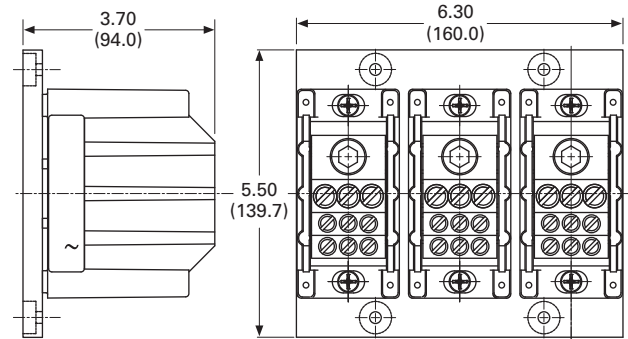

CHDB3213

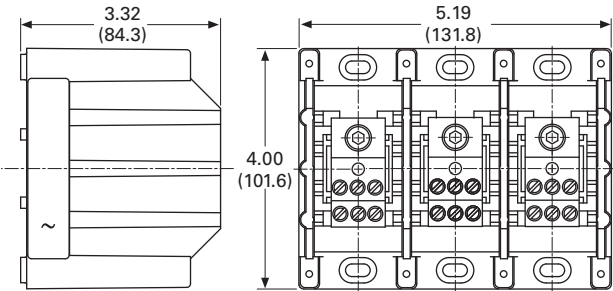

CHDB204F

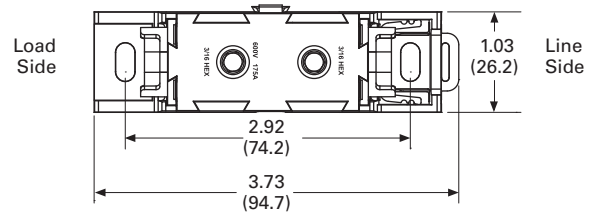

CHDB3233

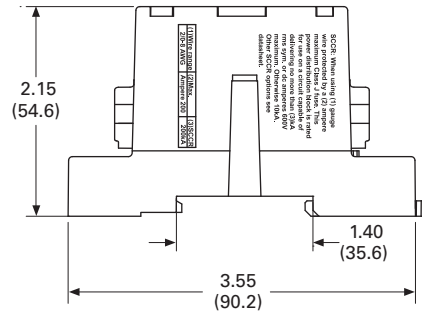
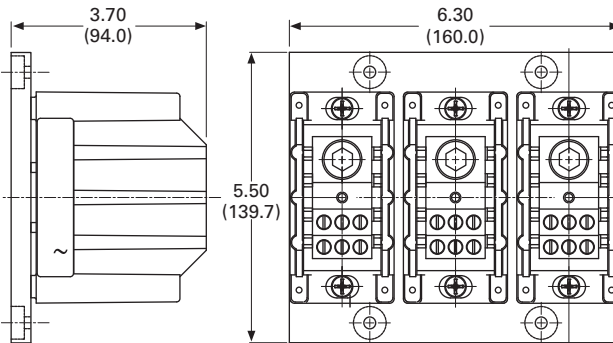

CHDB3703

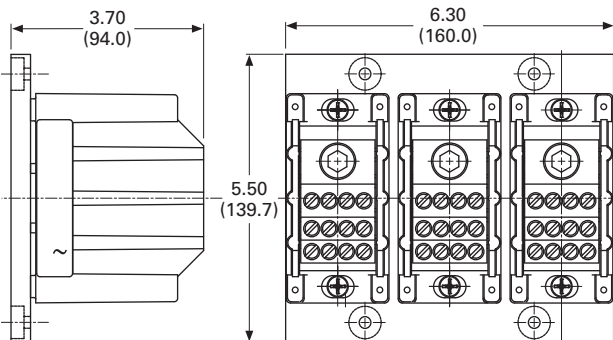

8.3

Terminal Blocks, Fuse Blocks and Fuse Holders

Power Distribution

Approximate Dimensions in Inches (mm)

CHDB330F

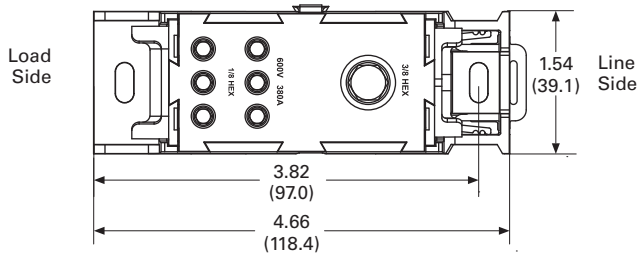

CHDB377F

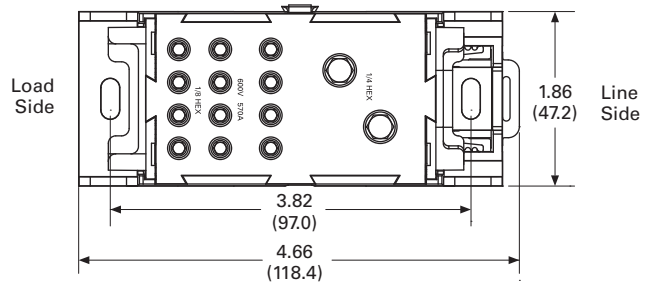

8

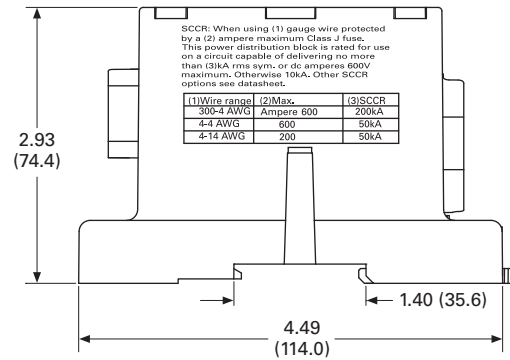
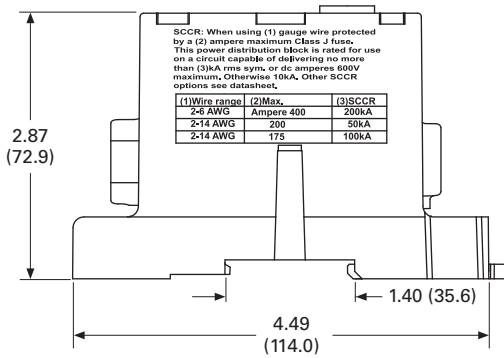

CH160 Series—Power Terminal Blocks**Contents**

Description	Page
CHDB Series—Power Distribution Blocks	V7-T8-115
CH160 Series—Power Terminal Blocks	
Product Selection	V7-T8-122
Technical Data and Specifications	V7-T8-123
Dimensions	V7-T8-123
Power Terminal Block Accessories	V7-T8-124

CH160 Series—Power Terminal Blocks**Product Description**

The CH160 Series of Power Terminal Blocks are UL 1059 recognized power terminal blocks for branch circuit applications. All short circuit current ratings (SCCR) are 10 kA per UL 508A Table SB4.1. The blocks are available in a wide variety of wiring configurations, providing excellent flexibility.

Features and Benefits

- Ratings: To 840A, 600V
- Materials
 - Molded material; black, UL rated 94V-0 thermoplastic
- Operating temperature: 302°F (150°C)
- Optional cover:
See **Page V7-T8-123**

Standards and Certifications

- UL Recognized
- CSA Certified



8.3

Terminal Blocks, Fuse Blocks and Fuse Holders

Power Distribution

Product Selection

When Ordering, Specify

- Catalog number
- Number of poles (up to three-pole available)

CH160 Power Terminal Blocks—CH162 Series

Line Connection	Load Connection	Connector Material and Ampacity	Catalog Number ^①
#2-#14 Cu/#8 Al	#2-#14 Cu/#8 Al	Al 115A	CH16200_
1/0-#14 Cu	1/0-#14 Cu	Cu 150A	CH16201_
2/0-#8 Cu/Al	2/0-#8 Cu/Al	Al 175A	CH16204_
2/0-#14 Cu/#8 Al	(4) #4-#14 Cu/#8 Al	Al 175A	CH16220_

8

CH160 Power Terminal Blocks—CH163 Series

Line Connection	Load Connection	Connector Material and Ampacity	Catalog Number ^①
250 kcmil-#6 Cu	250 kcmil-#6 Cu	Cu 255A	CH16301_
350 kcmil-#6 Cu/Al	350 kcmil-#6 Cu/Al	Al 310A	CH16303_
500 kcmil-#6 Cu/Al	500 kcmil-#6 Cu/Al	Al 380A	CH16306_
2/0-#14 Cu/Al	(6) #4-#14 Cu/#8 Al	Al 175A	CH16321_
350 kcmil-#6 Cu/Al	(6) #4-#14 Cu/#8 Al	Al 310A	CH16323_
(2) 2/0-#14 Cu/#8 Al	(6) #4-#14 Cu/#8 Al	Al 350A	CH16325_
500 kcmil-#6 Cu/Al	(6) #2-#14 Cu/#8 Al	Al 380A	CH16330_
350 kcmil-#6 Cu/Al	(3) #2-#14 Cu/#8 Al	Al 310A	CH16332_
	(2) 1/0-#14 Cu/#8 Al	Al 310A	CH16332_
350 kcmil-#6 Cu/Al	(12) #4-#14 Cu/#8 Al	Al 310A	CH16370_
350 kcmil-#6 Cu/Al	(6) #2-#14 Cu/#8 Al	Al 310A	CH16371_
	(3) 1/0-#14 Cu/#8 Al	Al 310A	CH16371_
350 kcmil-#6 Cu/Al	(21) #10-#14 Cu/#10 Al	Al 310A	CH16372_
350 kcmil-#6 Cu/Al	(3) 1/0-#14 Cu/#8 Al	Al 310A	CH16373_
	(14) #10-#14 Cu/#8 Al	Al 310A	CH16373_
600 kcmil-#2 Cu/Al	(12) #4-#14 Cu/#8 Al	Al 420A	CH16375_
600 kcmil-#2 Cu/Al	(6) #2-#14 Cu/#8 Al	Al 420A	CH16376_
	(3) 1/0-#14 Cu/#8 Al	Al 420A	CH16376_

CH160 Power Terminal Blocks—CH165 Series

Line Connection	Load Connection	Connector Material and Ampacity	Catalog Number ^①
(2) 350 kcmil-4 Cu/Al	(2) 350 kcmil-4 Cu/Al	Al 620A	CH16500_
(2) 500 kcmil-#6 Cu/Al	(2) 500 kcmil-#6 Cu/Al	Al 760A	CH16504_
(2) 600 kcmil-#2 Cu/Al	(4) 3/0-#8 Cu/Al	Al 840A	CH16528_
	(4) #4-#14 Cu/#8 Al	Al 840A	CH16528_
(2) 500 kcmil-#6 Cu/Al	(12) #4-#14 Cu/#8 Al	Al 760A	CH16530_

Note

- ^① Incomplete catalog number—add code suffix **-1**, **-2**, **-3** for number of poles.
 Example: For a 150A 1/0-#14 Cu to 1/0-#14 Cu three-pole PDB, order CH16201-3.

Technical Data and Specifications

CH160 Power Terminal Blocks

Description	Specification
Ratings	To 840A, 600V
Materials	Molded material; black, UL rated 94V-0 thermoplastic
Operating temperature	302°F (150°C)

Note: For optional cover, see Power Terminal Block Accessories, **Page V7-T8-124**.

Dimensions

Approximate Dimensions in Inches (mm)

Series CH163 (Single-, Two- and Three-Pole Available)

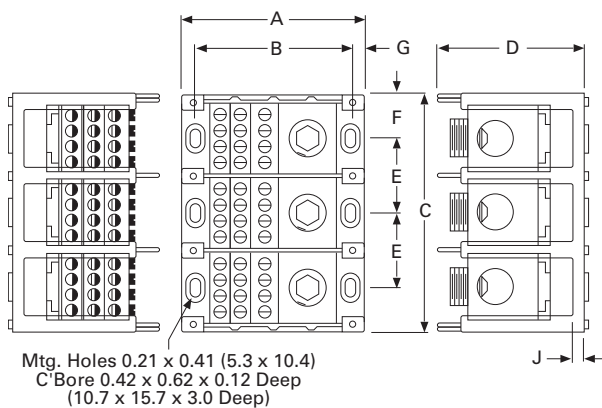

Series CH162 and CH165 (Single-, Two- and Three-Pole Available)

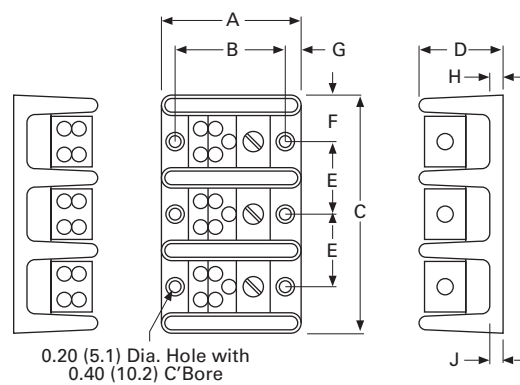

CH160 Power Terminal Block Dimensions

Series	A	B	C			D	E4	F	G	H	J
			Single-Pole	Two-Pole	Three-Pole						
CH162	2.87 (72.9)	2.25 (57.2)	1.06 (26.9)	1.87 (47.5)	2.68 (68.1)	1.75 (44.5)	0.81 (20.6)	0.53 (13.5)	0.31 (7.9)	0.84 (21.3)	0.31 (7.9)
CH163	4.00 (101.6)	3.37 (85.6)	1.96 (49.8)	3.58 (90.9)	5.20 (132.1)	3.32 (84.3)	1.62 (41.1)	0.97 (24.6)	0.31 (7.9)	0.87 (22.1)	0.35 (8.9)
CH165	5.50 (139.7)	4.75 (120.7)	3.12 (79.2)	5.81 (147.6)	8.50 (215.9)	3.12 (79.2)	2.68 (68.1)	1.56 (39.6)	0.37 (9.4)	1.37 (34.8)	0.62 (15.7)

8.3

Terminal Blocks, Fuse Blocks and Fuse Holders

Power Distribution

Power Terminal Block Accessories



Contents

<i>Description</i>	<i>Page</i>
CHDB Series—Power Distribution Blocks	V7-T8-115
CH160 Series—Power Terminal Blocks	V7-T8-121
Power Terminal Block Accessories	
Technical Data and Specifications	V7-T8-125
Dimensions	V7-T8-125

Power Terminal Block Accessories

Product Description

Protective Cover

- Guards against accidental contact
- Clear with write-on surface for field termination identification
- Available in single-, two- and three-pole

Standards and Certifications

TB Series Power Blocks

- Contact Eaton for the latest UL 508A short circuit ratings on terminal blocks
- UL Recognized: File No. E62622
- CSA Certified: File No. LR15364



Product Selection

When Ordering, Specify

- Catalog number

CH163 Series Cover

Description	Catalog Number
Single-pole cover	CHCPDB-1 ①
Two-pole cover	CHCPDB-2 ①
Three-pole cover	CHCPDB-3 ①

TB Series Power Blocks

Line Connection	Load Connection	Catalog Number
#300 kcmil-#6 Cu/Al	(6) #6-#14 Cu/#8Al	TBAN63

Note

① Standard pack, five pieces.

Technical Data and Specifications

TB Series Power Blocks

Description	Specification
Ratings	285A, 600V; UL/CSA
Materials	Molded material; black, UL rated 94V-2 thermoplastic
Operating temperature	257°F (125°C)

Dimensions

Approximate Dimensions in Inches (mm)

CH163 Series Cover

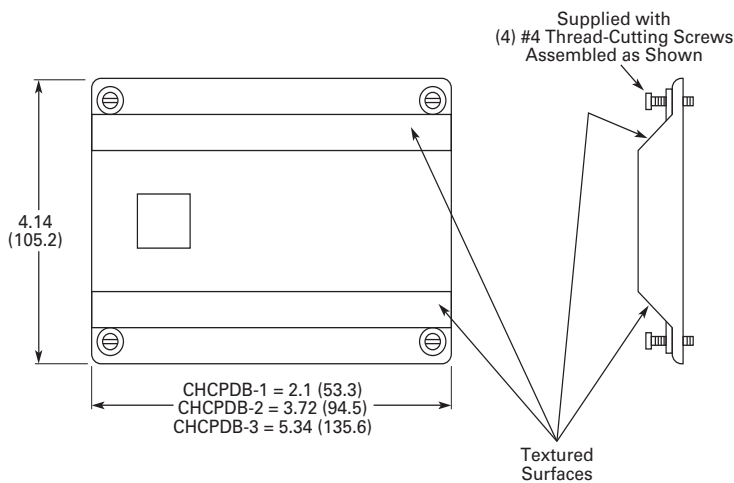

TB Series Power Blocks

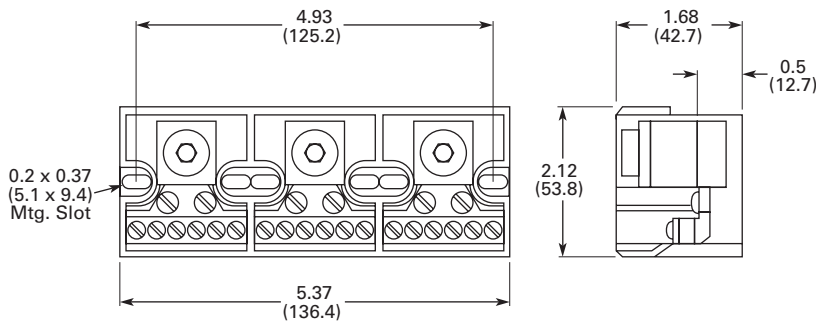

8.4

Terminal Blocks, Fuse Blocks and Fuse Holders

Fuse Blocks and Fuse Holders

Fuse Blocks and Fuse Holders



Contents

Description

Page

Fuse Blocks and Fuse Holders	
C383 Series Disconnect Fuse Holders	V7-T8-127
C350 Series Fuse Blocks and W Series Fuse Holders	V7-T8-129

Fuse Blocks and Fuse Holders Overview

Product Description

Available in compact finger safe (C383) and an open (C350) design. Eaton's fuse blocks and holders provide a simple DIN mounting device for protection in control circuits.

Application Description

Fuse holders and blocks available for Class CC, midget, H, M and R.

Standards and Certifications

- UL listed
- CSA certified (may not apply to all styles)



C383 Series Fuse Holders**Contents**

Description	Page
C383 Series Disconnect Fuse Holders	
Product Selection	V7-T8-128
Accessories	V7-T8-128
Technical Data and Specifications	V7-T8-128
Dimensions	V7-T8-128
C350 Series Fuse Blocks and W Series Fuse Holders	V7-T8-129

C383 Series Disconnect Fuse Holders**Product Description**

Eaton's C383 Series disconnect fuse holders offer 600V fused circuit protection and subsequently "no load" switching.

These compact disconnects are designed as components in switchboards, panels and control consoles where positive and safe circuit protection is required and where space is at a premium.

The C383 fuse holders mount directly on standard TS35 DIN rails.

Features

- "Finger-Safe" design— Recessed termination screws and a fuse extraction door afford you IP20 grade protection and qualify as "finger-safe" per IEC standards
- Easy to adjust position on rail—Simply unlatch the DIN rail adapter, slide the holder to desired position and relock
- Quick change of fuse— A permanently attached pivoting fuse door simplifies and speeds fuse extraction. No tools or accessories needed
- Class CC model is UL listed and CSA certified for branch circuit protection. Midget models are UL Recognized and CSA certified for supplementary and high-speed protection
- Runs cool—The vented design provides adequate air flow around the holders at all times
- Self-extinguishing UL 94-VO rated polyester material

Standards and Certifications

Rated voltage:

- CSA/UL: 600 Vac/Vdc, 30A
- IEC (midget only): 690 Vac, 32A



8.4

Terminal Blocks, Fuse Blocks and Fuse Holders

Fuse Blocks and Fuse Holders

Product Selection

C383FH_



Disconnect Fuse Holders

Description	Standard Pack	Catalog Number
For Class CC Fuse		
Single-pole fuse holder	12	C383FHCC
For Midget Fuse (1-1/2 in x 13/32 in)		
Single-pole fuse holder	12	C383FHMD

Accessories

Disconnect Fuse Holders

Description	Standard Pack	Catalog Number
Midget or Class CC Fuse Holder		
Multi-pole connection links	100	C383MPCL
Multi-pole handle pins	100	C383MPHP

Accessory Details

C383MPCL

Multi-pole connection links can be used to connect fuse holders together for multi-pole applications. Use two per connection.

C383MPHP

Handle pins can be used to connect handles in multi-pole applications.

Technical Data and Specifications

Disconnect Fuse Holders ①

Description	Specification
Housing	Polyester UL 94-V0 rated
Color	White
Wire size	8–18 AWG ②
Torque	22 lb-in (2.5 Nm)
Fuse size	0.41 x 1.5 in

Dimensions

Approximate Dimensions in Inches (mm)

CH163 Series Cover

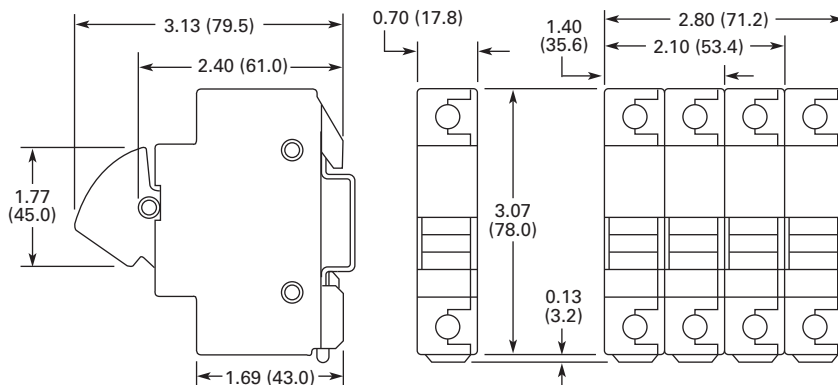

Notes

- ① For additional technical information, consult the Eaton web site or Customer Support Center.
- ② UL recognizes both solid and stranded wire. Ferrules are not required. CSA requires ferrules on stranded wire to achieve approval.

C350 Series Fuse Blocks and W Series Fuse Holders



Contents

<i>Description</i>	<i>Page</i>
C383 Series Disconnect Fuse Holders	V7-T8-127
C350 Series Fuse Blocks and W Series Fuse Holders	
Product Selection	V7-T8-130
Accessories	V7-T8-131
Technical Data and Specifications	V7-T8-131
Dimensions	V7-T8-131

C350 Series Fuse Blocks and W Series Fuse Holders

Product Description

Fuse Blocks

These space-saving Type C350 Fuse Blocks are UL approved for motor loads and are rated 600V, 30A.

Fuse Holders

- Class H, M and R

Features

Fuse Blocks

- Mount to 35 mm flat and 32 mm asymmetrical DIN rails
- 600V, 30A rated captive pressure plate terminals with copper alloy fuse clips
- Interlocking fuse blocks permit single, double or three-pole application—reduce inventory
- Class CC fuses have an interrupting rating of 200,000A
- Rejection feature prevents insertion of fuses with lower interrupting or voltage ratings

Fuse Holders

- Break-resistant: molded of heat-stabilized nylon
- Fuse clips: spring-reinforced for cool operation
- Fuse clip terminations: one-piece construction
- Universal mounting dimensions, for easy assembly and retrofit
- Breathing action collar: maintenance-free
- Pressure wire connectors: vibration resistant

Standards and Certifications

Contact Eaton for the latest UL 508A short circuit ratings on terminal blocks.

Fuse Blocks

- UL listed
- CSA certified



Fuse Holders

- UL tested for OEM subfeed applications



Fuse Blocks and Adapters

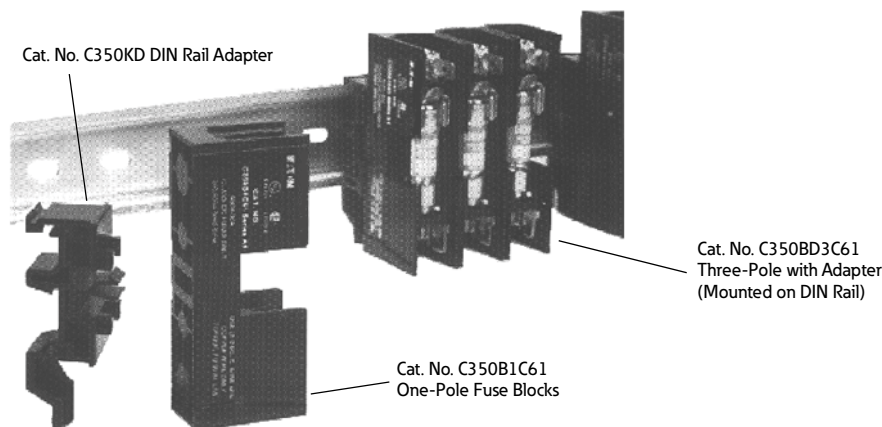

8.4

Terminal Blocks, Fuse Blocks and Fuse Holders

Fuse Blocks and Fuse Holders

Product Selection

Class CC Fuse Blocks

Type	Catalog Number
Three-pole ^①	C350BD3C61
Single-pole	C350B1C61
DIN adapter	C350KD

Class R, Three-Pole Fuse Holder



Fuse Holders—250V

Wire Termination		Number of Poles	Carton Qty.	30A Catalog Number	Carton Qty.	60A Catalog Number
Class H Fuse Holders						
Single collar (box lug)—sized to ampere rating		1	10	W231HA	10	W261HA
		2	5	W232HA	5	W262HA
		3	5	W233HA	5	W263HA
Class R Fuse Holders						
Single collar (box lug)—sized to ampere rating		1	10	WR231HA	—	—
		2	—	—	—	—
		3	5	WR233HA	1	WR263HA

Fuse Holders—600V

Wire Termination		Number of Poles	Carton Qty.	30A Catalog Number	Carton Qty.	60A Catalog Number
Class H Fuse Holders						
Single collar (box lug)—sized to ampere rating		1	10	W631HA	1	W661HA
		2	5	W632HA	1	W662HA
		3	1	W633HA	2	W663HA
Class M Fuse Holders						
Combination of double quick-connect, 20A max., and binding head screw, #10 max., Cu/Al		1	10	WM631F	—	—
		2	8	WM632F	—	—
		3	6	WM633F	—	—
Combination of double quick-connect, 20A max., and pressure plate screw, #10 max., Cu only		1	10	WM631G	—	—
		2	8	WM632G	—	—
		3	6	WM633G	—	—
Class R Fuse Holders						
Single collar (box lug)—sized to ampere rating		1	10	WR631HA	—	—
		2	5	WR632HA	—	—
		3	5	WR633HA	5	WR663HA
Combination of double quick-connect, 20A max., and binding head screw, #10 max., Cu/Al		1	—	—	—	—
		2	1	WMR632F	—	—
		3	6	WMR633F	—	—
Combination of double quick-connect, 20A max., and pressure plate screw, #10 max., Cu only		1	10	WMR631G	—	—
		3	6	WMR633G	—	—
Class R Fuse Holder, Type WRR Control Transformer Fuse Blocks						
Combination of double quick-connect, 20A max., and pressure plate screw, #14–#10 Cu only		3	6	WRR633G	—	—

Note

^① Three-pole device is supplied with DIN rail adapter.

Accessories

Fuse Holder Accessories

Description	Catalog Number
Fuse puller	TBP
Lighted fuse puller (120 Vac)	TBLP

Technical Data and Specifications

Fuse Blocks

Description	Specification
Voltage rating	600V
Ampere rating	Pressure plate terminals rated for 30A
Dielectric strength	1200V maximum
Ambient temperature	221°F (105°C) maximum
Clip/terminals	Tin-plated copper alloy
Screw and captive pressure plate	Zinc-plated steel
Base	Thermoplastic UL 94V0 flammability rating
DIN rail adapter	Thermoplastic UL 94V0 flammability rating

Dimensions

Approximate Dimensions in Inches (mm)

Fuse Blocks

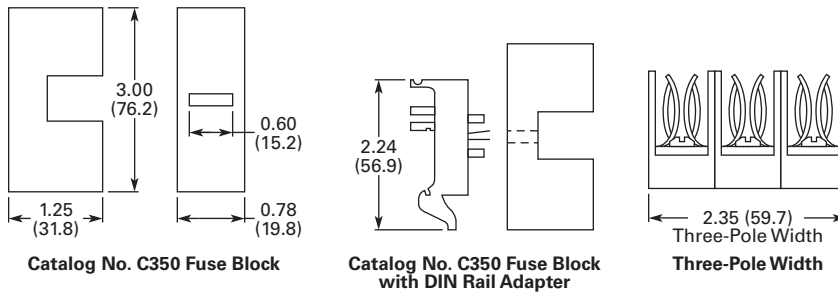

Fuse Holders

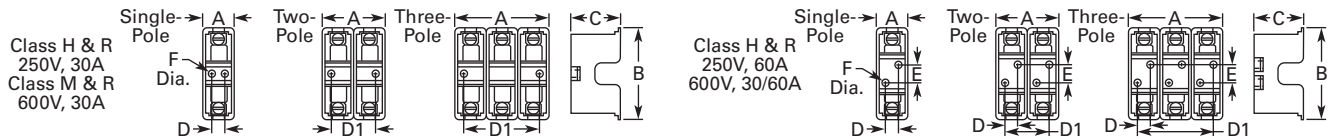

Class	Volts/ Amperes	Width A			Height B	Depth C	Mounting Holes			Diameter F	Number of Mounting Holes			
		Single- Pole	Two- Pole	Three- Pole			D	Two-Pole D1	Three-Pole D1		E	Single- Pole	Two- Pole	Three- Pole
H, R	250V, 30A	1.00 (25.4)	2.00 (50.8)	3.00 (76.2)	3.13 (79.5)	1.56 (39.6)	0.38 (9.7)	1.25 (31.8)	2.50 (63.5)	—	0.22 (5.6)	2	2	2
	250V, 60A	1.44 (36.6)	2.88 (73.2)	4.31 (109.5)	4.75 (120.7)	2.06 (52.3)	0.50 (12.7)	1.81 (46.0)	3.13 (79.5)	1.25 (31.8)	0.22 (5.6)	2	4	4
	600V, 30/60A	1.69 (42.9)	3.38 (85.9)	5.06 (128.5)	6.94 (176.3)	2.63 (66.8)	0.63 (16.0)	2.19 (55.6)	3.75 (95.3)	3.13 (79.5)	0.28 (7.1)	2	4	4
M, R	600V, 30A	0.84 (21.3)	1.63 (41.4)	2.41 (61.2)	3.00 (76.2)	1.28 (32.5)	0.38 (9.7)	0.75 (19.1)	1.50 (38.1)	—	0.17 (4.3)	2	2	2

SmartWire-DT



XV Series HMI-PLC with SmartWire-DT



Machine Mount (IP67) I/O Modules



9.1 SmartWire-DT In Panel and On Machine Wiring Solution

System Overview	
System Components	V7-T9-4
System Overview Diagram	V7-T9-6
Gateway Modules and System Controllers	
System Control Overview	V7-T9-10
Gateway Modules	V7-T9-11
XV-100/-300 Series HMI-PLC with SmartWire-DT	V7-T9-12
XC152 Series PLC with SmartWire-DT	V7-T9-12
easy802/806 Programmable Relays with SmartWire-DT	V7-T9-13
I/O and Powerfeed Modules, System Connectivity Components	
Powerfeed Modules	V7-T9-15
I/O Modules	V7-T9-15
System Connectivity Components	V7-T9-16
Motor Control Modules	
Product Identification	V7-T9-19
XTPE Electronic Manual Motor Protectors	V7-T9-20
XTCE Contactor Modules	V7-T9-23
EMS Electronic Motor Starters	V7-T9-26
DS7 Soft Start Controllers	V7-T9-27
DE1 Variable Speed Starters	V7-T9-28
DC1 Variable Frequency Drives	V7-T9-30
DA1 Variable Frequency Drives	V7-T9-32
Pilot Device Modules	
M22 Contact and LED Modules	V7-T9-34
M22 Control Stations (8-Conductor)	V7-T9-37
Stacklight Base Modules with SmartWire-DT	
SL4 and SL7 Stacklight Base Modules	V7-T9-40
Machine Mount Components	
Machine Mount I/O Modules—Digital	V7-T9-43
Machine Mount I/O Modules—Analog	V7-T9-45
I/O Splitters	V7-T9-46
Other I/O Connections	V7-T9-46
Valve Connectors	V7-T9-47
Machine Mount Powerfeed Modules	V7-T9-47
Panel Transition Components	V7-T9-48
SmartWire-DT Round Bus Cables	V7-T9-49
Other System Components	V7-T9-52
Enclosed (IP67) Pilot Devices	
Enclosed M22 Pilot Device Examples	V7-T9-54
Enclosures	V7-T9-54
M12 Wiring Receptacles	V7-T9-54
Remote Machine Mount Stacklights	
Stacklight Mounting Modules—Fast Mounting System	V7-T9-56
Stacklight Mounting Modules—Post Mounting System	V7-T9-57
Technical Data and Specifications	V7-T9-58
Dimensions	V7-T9-102

SmartWire-DT In Panel and On Machine Wiring Solution

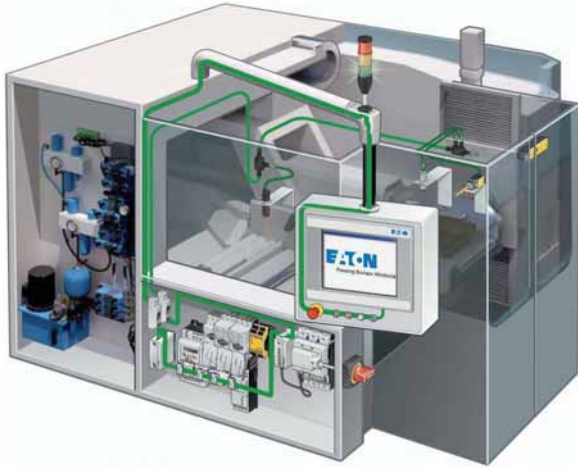

Contents

Description	Page
System Overview	
Features	V7-T9-3
Standards and Certifications	V7-T9-3
System Components	V7-T9-4
System Overview Diagram	V7-T9-6

System Overview

Product Description

The SmartWire-DT® In Panel and On Machine wiring system uses a single green cable inside a machine control cabinet and across the machine itself to connect motor starters, variable frequency drives, soft starters, pushbuttons, sensors, pneumatic and hydraulic valves, stacklights and other indicator lights.

Inside the machine control cabinet the continuous SmartWire-DT green cable is flat. The flat cable connects directly to in panel motor starters, variable frequency drives, soft starters, panel-mounted pushbutton actuators, stacklights and other indicator lights. It eliminates the need for most of the conventional point-to-point control wiring done in a traditionally wired control panel—and even integrates 24 Vdc control

power for contactor coils on the single SmartWire-DT cable. The start of the SmartWire-DT system is either an Eaton PLC or a combination HMI/PLC with SmartWire-DT embedded or a simple gateway.

These SmartWire-DT gateways establish the connection between a SmartWire-DT system and standard programmable logic controller (PLC) fieldbuses, such as EtherNet/IP, Modbus TCP, EtherCAT, PROFINET, POWERLINK, PROFIBUS DP, SERCOS and CANopen. The gateway works without any conventional PLC I/O required because SmartWire-DT directly integrates the input/output (I/O) level in the switching devices.

Inside the control cabinet, typical faults such as loose connections and miswired terminations are eliminated using the flat cable and the specialized connectors. Outside the cabinet on the machine, the SmartWire-DT machine mount I/O modules connect using industry standard keyed M12 connectors to eliminate the possibility of miswiring. Further, dramatic wiring reductions are possible given the single SmartWire-DT cable connection that brings 24 Vdc power to and carries signals to and from devices.

Each SmartWire-DT machine mount I/O module has diagnostic LEDs built in, reducing commissioning time and troubleshooting in the field.

Nodes on the SmartWire-DT network both inside and outside the main control cabinet are automatically assigned addresses by the gateway or the HMI/PLC device with the simple push of a button—assigning addresses in the order that the nodes are connected. The system employs time monitoring and a watchdog timeout using the established target configuration as a reference—safely monitoring the integrity of the control scheme. SmartWire-DT has a maximum network length of 2000 feet and can connect up to 99 nodes per gateway. A software program called SWD-Assist enables the layout, planning and system configuration of a SmartWire-DT network.

Features

Connects directly to:

- XTPE electronic manual motor protectors
- XTCE contactors
- XTRE control relays
- Electronic motor starters
- DS7 soft start controllers
- DE1 variable speed starters
- DC1 VFDs
- DA1 VFDs
- M22 pilot devices
- SL4 and SL7 stacklights
- On Machine devices including sensors, limit switches, pneumatic and hydraulic valves, remote contactors, pushbuttons, stacklights and other command and control components

Gateways support fieldbus integration, including:

- EtherNet/IP
- Modbus TCP
- EtherCAT
- PROFINET
- POWERLINK
- PROFIBUS DP
- SERCOS
- CANopen
- Supports up to 99 nodes (58 nodes when connected to PROFIBUS DP Gateway)
- Automatically assigns node addresses
- Integrates and supplies 24 Vdc power to contactor coils
- Includes diagnostic bi-color LEDs on each node connection

Standards and Certifications

- UL listed
- UL tested to Canadian safety standards
- CE Certified
- RoHS compliant



System Components



Contents

Description

Page

System Components	
System Overview	V7-T9-2
System Overview Diagram	V7-T9-6

System Components

Product Description

The start of the SmartWire-DT system is usually a gateway module connected to a PLC or controller fieldbus. This means that SmartWire-DT connected components will work with most third-party PLCs without having to create a new program. These devices are typically located within the main control cabinet for a machine.

To plan and lay out a SmartWire-DT network, an MS Windows-compatible software program called SWD-Assist is available as a free download from the Eaton website. The SWD-Assist configuration software allows a user to drag-and-drop system components like motor starters, drives, pushbuttons and indicator lights, and will calculate the control power requirements needed and generate a bill of materials of all the required SmartWire-DT components.

To download the SWD-Assist configuration software, visit www.eaton.com/smartwiredt.

In Panel Components

Gateway Modules

Gateway modules connect the SmartWire-DT system to the PLC. They are connected as nodes to the existing PLC fieldbus and are the start of the SmartWire-DT connection system. Gateways are available with EtherNet/IP, Modbus TCP, EtherCAT, PROFINET, POWERLINK, PROFIBUS DP, SERCOS III and CANopen protocols.

System Controllers

In the event that the Gateway module plus third-party PLC architecture is not used, system controllers from Eaton can operate a SmartWire-DT system. System controllers include an integrated SmartWire-DT gateway and are available as PLCs or HMI-PLCs using a CoDeSys programming platform or as programmable relays using simple ladder logic programming.

Motor Control Modules

Contactors fit into standard XT contactors and control relays directly on top, in place of a top-mounted auxiliary contact block. The modules fit all XTCE size B and C frame contactors and XTRE control relays.

Variable Speed Starters and Variable Frequency Drives connect to the SmartWire-DT system with plug-in modules similar to the approach with contactor modules.

Soft Start Controllers and Electronic Motor Starters with built-in SmartWire-DT functionality connect directly to the SmartWire-DT flat cable without the need for a supplemental module.

Pilot Device Modules

Pilot device modules fit into standard M22 pilot devices in both front-mount and base-mount configurations and replace the standard contact block and light units. Single and double contact modules with and without LEDs are available to meet a wide variety of control circuit requirements.

Stacklight Base Modules

Stacklight modules connect SL4 and SL7 Series stacklights when mounted to the control cabinet with Eaton's Fast Mount Base. A variety of incandescent, LED, high-power LED and audible signal modules are available to meet machine indication requirements.

In Panel Components**Digital and Analog I/O Modules**

Digital and analog I/O modules are connected as nodes on the SmartWire-DT network and allow standard or generic devices to be connected to the SmartWire-DT system. They can be connected anywhere along the flat cable network and can therefore be positioned in the control panel to help reduce I/O wiring.

Powerfeed Modules

Powerfeed modules feed auxiliary 24 Vdc power and/or 15 Vdc network power into the SmartWire-DT flat cable. The auxiliary 24 Vdc power is needed for the power supply of contactors and the 15 Vdc network power is used for supplying power to additional SmartWire-DT nodes. Powerfeed modules are also used to create zone control or groups of devices controlled by a single Emergency Stop.

SmartWire-DT Flat Cable

The flat cable is an 8-conductor cable that is flexible, durable and rated for 600 V so that it can be placed in the panel wiring duct along with 480 V or 600 V power conductors. It has two prominent features: (a) arrows indicating the front of the cable and the direction away from the gateway and (b) black edging indicating the polarity of the flat cable, the 15 Vdc wire and the reference mark for installing the device plugs and flat plugs.

Other System Accessories

Other accessories for the SmartWire-DT system include connectors, jumpers, bushings, plugs and sockets, terminating resistors and crimping tools.

On Machine Components

At the edge of the control cabinet the SmartWire-DT system transitions from the 8-conductor flat cable to a 5-conductor round cable with standard DC M12 barrel connectors, using simple transition adapters that mount through the panel wall.

SmartWire-DT Round Cable

The round cable has 5 conductors, uses standard DC M12 barrel connectors, and is 300 V rated. It is used outside the control panel to connect SmartWire-DT machine mount I/O modules to the SmartWire-DT system for use with peripherals such as sensors, enclosed pushbuttons, pneumatic and hydraulic valves, stacklights and other remote devices. This single cable is used both to provide power to connected devices and to carry I/O signals.

Machine Mount I/O Modules

Machine mountable I/O modules are connected as nodes on the SmartWire-DT network and allow standard or generic devices to be connected to the SmartWire-DT system. They are suitable for washdown environments and can be connected anywhere around the machine with up to 2000 feet and 99 devices possible with a single cable connection.

Accessory Cables

A variety of accessory cables are available to make the connection between remote devices (including sensors, stacklights, hydraulic and pneumatic valves, enclosed pilot devices, and other command and control devices) and the SmartWire-DT machine mounted I/O modules.

Enclosed Pilot Device Stations

Pilot device modules mounted in IP67 enclosures for use in remote machine locations can be assembled from standard components supplied by Eaton, and contacts can be wired for direct connection to a SmartWire-DT machine mount I/O module using a standard device accessory cable as described in the section above. Examples of such devices include pilot lights, pushbuttons, illuminated pushbuttons, selector switches and key switches.

Remote Stacklights

Stacklights for use in remote machine locations can be assembled from standard components supplied by Eaton with contacts wired for direct connection to a SmartWire-DT machine mount I/O module using a standard device accessory cable.

Machine Mount Powerfeed Modules

Powerfeed modules feed 4 A of auxiliary 24 Vdc power into the SmartWire-DT round cable when needed to supply power to additional SmartWire-DT nodes. Eaton's SWD-Assist software can be used to quickly and easily calculate the need for Powerfeed modules in a round cable system.

High-Speed Operations

Normal SmartWire-DT system bus speeds of 125 Kbaud and 250 Kbaud are sufficient for most machine operations, but certain machine processes require higher speeds. In those cases, certain SmartWire-DT system controllers can operate the On Machine components in the SmartWire-DT system up to 2 Mbaud bus speeds. Consult later sections in this catalog for specific details.



System Overview Diagram

SmartWire-DT Contactor Modules

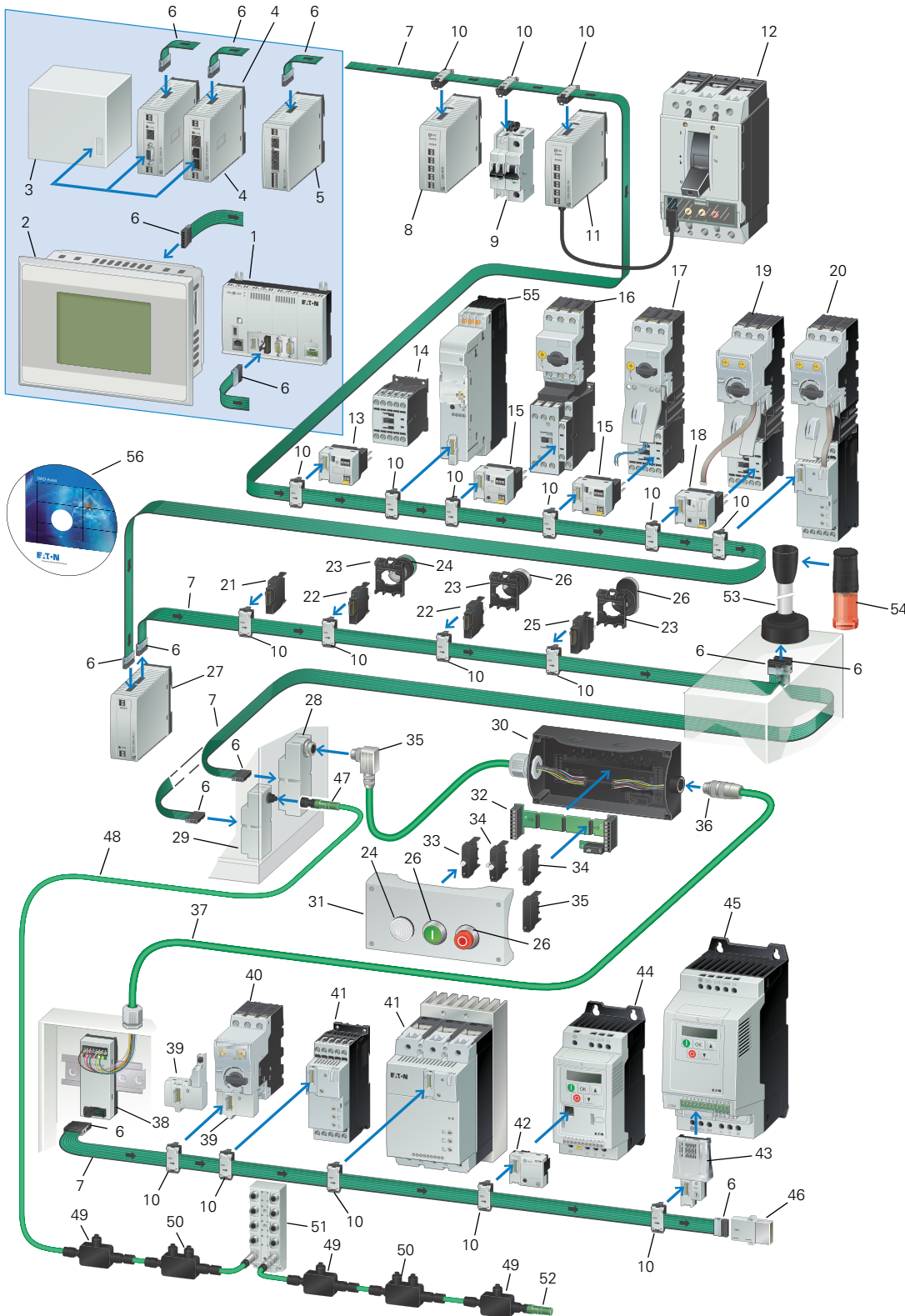

SmartWire-DT In Panel and On Machine Wiring Solution

Item Number	Description
1	SmartWire-DT PLC XC-152
2	SmartWire-DT XV HMI-PLC
3	PLC with field bus interface
4	SmartWire-DT Gateways
5	Control relay easy800 with SmartWire-DT
6	SmartWire-DT blade terminal, 8-pole
7	SmartWire-DT 8-pin ribbon cable
8	SmartWire-DT I/O module
9	SmartWire-DT module for miniature circuit-breakers and residual-current circuit breakers
10	SmartWire-DT external device plug, 8-pole
11	SmartWire-DT connection for NZM
12	NZM circuit-breakers
13	SmartWire-DT contactor module
14	DILM contactor
15	SmartWire-DT contactor module with Hand-Off-Automatic switch
16	Motor protective circuit-breakers
17	Motor starter MSC
18	SmartWire-DT PKE module (motor starter)
19	Motor starter with PKE electronic motor protection
20	Soft starter DS7 with electronic motor protection from PKE
21	SmartWire-DT universal module, front mount
22	SmartWire-DT LED elements, front mount
23	RMQ-Titan mounting clamp for flush mounting plates
24	RMQ-Titan indicator light
25	SmartWire-DT function elements for front mount
26	SmartWire-DT operating elements
27	SmartWire-DT Powerfeed card
28	SmartWire-DT enclosure cable gland for converting a ribbon cable to an 8-pin round cable, M20

Item Number	Description
29	SmartWire-DT enclosure cable gland for converting a ribbon cable to a 5-pin round cable, M12
30	Surface mounting enclosure RMQ-Titan
31	Surface mounting enclosure RMQ-Titan
32	SmartWire-DT card for function elements, base fixing
33	SmartWire-DT LED elements for base fixing
34	SmartWire-DT function elements for base fixing
35	SmartWire-DT Universal slave for base fixing
36	SmartWire-DT 8-pin connector
37	SmartWire-DT round cable, 8-pole
38	SmartWire-DT adapter for flat/round cable for top-hat rail mounting
39	SmartWire-DT PKE (motor-protective circuit-breaker)
40	PKE motor-protective circuit-breakers
41	DS7 soft starter
42	SmartWire-DT function element for DC1 variable frequency drives
43	SmartWire-DT function element for DA1 variable frequency drives
44	DC1 variable frequency drives
45	DA1 variable frequency drives
46	SmartWire-DT bus termination resistor for 8-pin ribbon cable
47	5-pin M12 plug connector
48	Round cable, 5-pole
49	SmartWire-DT machine mount I/O module, 2 I/O
50	SmartWire-DT machine mount I/O module, 4 I/O
51	SmartWire-DT machine mount I/O module, max. 16 I/O
52	SmartWire-DT machine mount bus termination resistor for 5-pin round cable, M12
53	SmartWire-DT connection to SL4/SL7 signal tower
54	Signal towers SL4 /SL7
55	Electronic motor starter EMS
56	SmartWire-DT planning and ordering aid, SWD-Assist

Gateway Modules and System Controllers

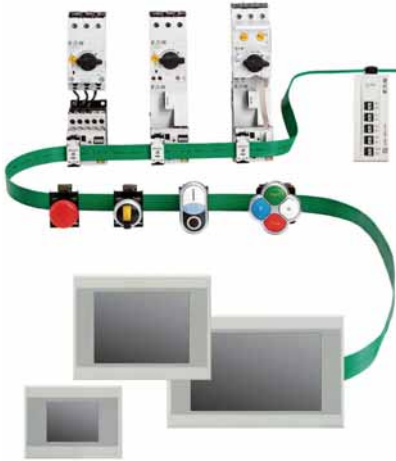

Contents

<i>Description</i>	<i>Page</i>
Gateway Modules and System Controllers	
System Control Overview	V7-T9-10
Gateway Modules	V7-T9-11
XV-100/-300 HMI/PLC	V7-T9-12
XC PLC	V7-T9-12
XV and XC Accessories	V7-T9-12
easy800 with SmartWire-DT	V7-T9-13

Gateway Modules and System Controllers

Gateway Modules

Product Description

SmartWire-DT Gateway modules allow easy connection to a wide variety of systems using standard fieldbus interfaces.

Gateways can be used to connect the SmartWire-DT communication system to PLCs and operating systems from any manufacturer using standardized fieldbus interfaces. SmartWire-DT can communicate via EtherNet/IP, Modbus TCP, EtherCAT, PROFINET, POWERLINK, PROFIBUS DP, SERCOS and CANopen with simple connection and configuration and with no changes required to the core PLC program in use.

Features

- Easy plug & play connection to the SmartWire-DT network
- Models available for all standard fieldbus protocols
- Simple interface to third-party PLCs
- Allow OEMs to easily transition between customer-specified PLCs without changing underlying in panel and on machine wiring
- High-speed operation of the SmartWire-DT On Machine system, up to 2 Mbaud, permitted using new EtherNet/IP Modbus TCP Gateway

System Controllers

XV-300 Series HMI-PLC with SmartWire-DT

Product Description

The XV-300 HMI-PLC is the most powerful combination of logic and visualization available today. The XV-300's logic software CoDeSys is based on the open IEC 61131 programming platform. Ideal for small, mid-range and full-scale PLC applications, the integrated SmartWire-DT master can control 99 nodes on a 2000-foot-long network.

Features

- Built-in SmartWire-DT master for 99 nodes
- Brilliant image display with 65,536 colors and 1024 x 600 pixel resolution in both 7-inch and 10.1-inch screen sizes
- High resolution, wide screen, multi-touch projected capacitive touchscreen (PCT)
- Single high-speed Ethernet standard with optional second high-speed independent Ethernet for multiple subnet connectivity, e.g., Machine network + Plant network, or Machine network + Wireless cellular modem
- Software bundles for XSoft-CoDeSys 3 PLC logic and visualization and/or Visual Designer HMI-SCADA graphical user interface
- Easy connection direct to motor control and other I/O both inside and outside the machine control cabinet using the SmartWire-DT machine wiring system

Standards and Certifications

- CE Mark
- UL
- cUL
- RoHS
- ATEX



XV-100 Series HMI-PLC with SmartWire-DT

Product Description

The XV HMI-PLC controller with SmartWire-DT master is a powerful combination of logic, visualization and motor control connectivity. It is ideal for small to mid-range PLC applications where integrated logic and visualization is advantageous and/or where remote administration is critical. The integrated SmartWire-DT master can control 99 nodes on a 2000-foot-long network.

Features

- Built-in SmartWire-DT master for 99 nodes
- Brilliant image display with 65,536 colors
- High resolution resistive touch TFT displays
- 3.5-inch, 5.7-inch or 7-inch wide screen displays in robust plastic housings and bezels, or 5.7-inch, 8.4-inch or 10.4-inch displays in high-end aluminum front bezels and metal housings
- Ethernet and RS-485 serial ports on all models
- PROFIBUS DP or CANopen master on all models larger than 3.5 inches
- Programmable with IEC 61131-3 compliant XSoft-CoDeSys software
- Easy connection direct to motor control and other I/O both inside and outside the machine control cabinet using the SmartWire-DT machine wiring system

Standards and Certifications

- cULus
- CE
- RoHS



XC152 Series PLC with SmartWire-DT

Product Description

The XC152 compact PLC combines plenty of processing power with a large number of communication interfaces. This makes the device particularly well-suited to standardized automation solutions in modular machine building applications.

The XC152 not only provides machine segment control functions that can be programmed with CoDeSys, but it can store module-specific visualizations. These visualizations can be retrieved and displayed on a central HMI or a computer as needed.

In addition, the XC152 connects a SmartWire-DT wiring network to standard fieldbus systems via built-in interfaces. This enables the XC152 PLC to support Eaton's Lean Automation strategy while enabling users to design automation systems in a flexible manner and run them cost-effectively.

Features

- CoDeSys PLC and Web visualization
- Galileo/CoDeSys remote visualization
- Ethernet port on all models
- Windows® CE 5 OS
- 32-bit 400 MHz RISC CPU
- 64 MB internal memory
- SD external memory slot
- Run/Stop switch
- Integrated SmartWire-DT master for 99 nodes
- Optional: RS-232, RS-485, PROFIBUS DP/MPI, CANopen/easyNet

Standards and Certifications

- IEC/EN 61131-2, EN 50178
- EN 61000-6-2, EN 61000-6-4
- cULus
- CE
- RoHS



easy802/806 Programmable Relays with SmartWire-DT

Product Description

The new easy800 with integrated SmartWire-DT can control up to 99 SmartWire-DT devices with up to 166 inputs and outputs. These easy800 devices feature an integrated power feeder for regulating power to connected devices, and offer built-in LEDs for visual feedback on the state of the SmartWire-DT system.

To support programming, networking and communications, the easy800 has a range of built-in interfaces. Programming is accomplished using a simple USB cable, and connection of remote text displays, touch panels and to Ethernet is straightforward.

Within the easy800 family, a model is available that features four fast inputs (5 kHz) on the controller itself. Two of the four inputs can also be configured as fast outputs (5 kHz). In addition, this model supports the interconnection of multiple controllers to enable up to 1360 inputs/outputs on a single system.

Standards

- EN 50178
- IEC/EN 60947
- UL 508

Certifications

- cULus
- CE
- C-Tick
- RoHS

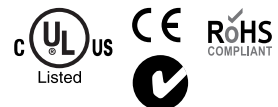

9.1

Connectivity Solutions

SmartWire-DT In Panel and On Machine Wiring Solution

System Control Overview

Lean Solution Architecture #1

Gateway SmartWire-DT to any PLC

- Advantages of SmartWire-DT without changing your control architecture
- Optimize and standardize your control cabinet
- Simplify PLC transitions



Lean Solution Architecture #2

XV HMI-PLC with Integrated SmartWire-DT

- Fully optimize your machine design
- Powerful control and visualization capabilities
- Combine SmartWire-DT with broad fieldbus and enterprise networking capabilities



Lean Solution Architecture #3

XC152 SmartWire-DT PLC

- When local visualization is not required
- Powerful CoDeSys-based control
- Combine SmartWire-DT with broad fieldbus and enterprise networking capabilities
- Web visualization and remote access



Lean Solution Architecture #4

easy802/806 Programmable Relays with SmartWire-DT

- Bring the value of SmartWire-DT to small machines
- Simple configuration using easySoft-Pro ladder logic programming software with integrated SWD-Assist configuration utility





Product Selection

Gateway Modules

Gateway modules connect the SmartWire-DT system to the programmable logic controller (PLC). Gateways are nodes on the PLC fieldbus and are the start of the SmartWire system. All Gateways support 125/250 Kbaud SmartWire bus speeds for In Panel components. Gateways to support SmartWire On Machine module operation at higher bus speeds when demanded by machine requirements are shown below.

EtherNet Gateway		EtherNet/IP Modbus TCP Gateway			
Description		Fieldbus Baud Rates	SmartWire-DT Baud Rates	Number of SmartWire-DT Nodes	Catalog Number
 <p>For connection to EtherNet/IP or Modbus TCP fieldbus Connection via two-port Ethernet switch (RJ45) Separate RS-232 diagnostics interface (RJ45)</p>		10/100 MBit/s	Up to 2 Mbaud	Max. 99	EU5C-SWD-EIP-MODTCP

PROFINET Gateway		PROFINET Gateway			
Description		Fieldbus Baud Rates	SmartWire-DT Baud Rates	Number of SmartWire-DT Nodes	Catalog Number
 <p>For connection to PROFINET fieldbus Connection via two-port Ethernet switch (RJ45) Separate USB diagnostics interface (Mini USB)</p>		100 MBit/s	125/250 Kbaud	Max. 99	EU5C-SWD-PROFINET

POWERLINK Gateway		POWERLINK Gateway			
Description		Fieldbus Baud Rates	SmartWire-DT Baud Rates	Number of SmartWire-DT Nodes	Catalog Number
 <p>For connection to POWERLINK fieldbus Connection via two-port Ethernet switch (RJ45) Separate USB diagnostics interface (Mini USB)</p>		100 MBit/s	125/250 Kbaud	Max. 99	EU5C-SWD-POWERLINK

EtherCAT Gateway		EtherCAT Gateway			
Description		Fieldbus Baud Rates	SmartWire-DT Baud Rates	Number of SmartWire-DT Nodes	Catalog Number
 <p>For connection to EtherCAT fieldbus Connection via two-port Ethernet switch (RJ45) Separate USB diagnostics interface (Mini USB)</p>		100 MBit/s	125/250 Kbaud	Max. 99	EU5C-SWD-ETHERCAT

PROFIBUS DP Gateway		PROFIBUS DP Gateway			
Description		Fieldbus Baud Rates	SmartWire-DT Baud Rates	Number of SmartWire-DT Nodes	Catalog Number
 <p>For connection to PROFIBUS DP fieldbuses Connection via 9-pin Sub-D socket Separate RS-232 diagnostics interface (RJ45)</p>		Up to 12 MBit/s	125/250 Kbaud	Max. 58	EU5C-SWD-DP

CANopen Gateway		CANopen Gateway			
Description		Fieldbus Baud Rates	SmartWire-DT Baud Rates	Number of SmartWire-DT Nodes	Catalog Number
 <p>For connection to CANopen fieldbus Connection via 9-pin Sub-D socket Separate RS-232 diagnostics interface (RJ45)</p>		Up to 1 MBit/s Should this be 12?	125/250 Kbaud	Max. 99	EU5C-SWD-CAN

SERCOS Gateway		SERCOS Gateway			
Description		Fieldbus Baud Rates	SmartWire-DT Baud Rates	Number of SmartWire-DT Nodes	Catalog Number
 <p>For connection to SERCOS III fieldbus Connection via two-port Ethernet switch (RJ45) Separate USB diagnostics interface (Mini USB)</p>		100 MBit/s	125/250 Kbaud	Max. 99 (depends on SERCOS master capability)	EU5C-SWD-SERCOS

XV-100/-300 HMI/PLC

XV-300 HMI/PLC



XV-300 HMI/PLC with SmartWire-DT

Display Size/Type	Display Resolution	Programming Software	Visual Designer Run Time	Fieldbus Type	RS-485 (DB9)	Ethernet (RJ45)	Catalog Number
7.0 in PCT	1024x600	XSoft CoDeSys-3	No	CANopen	Yes	Single	XV-303-70-BE0-A00-1C
7.0 in PCT	1024x600	XSoft CoDeSys-3	No	CANopen	Yes	Dual	XV-303-70-CE0-A00-1C
7.0 in PCT	1024x600	XSoft CoDeSys-3	Yes	CANopen	Yes	Single	XV-303-70-BE0-A00-1E
10.0 in PCT	1024x600	XSoft CoDeSys-3	No	CANopen	Yes	Dual	XV-303-10-CE0-A00-1C
10.0 in PCT	1024x600	XSoft CoDeSys-3	No	CANopen	Yes	Single	XV-303-10-BE0-A00-1C
10.0 in PCT	1024x600	XSoft CoDeSys-3	Yes	CANopen	Yes	Dual	XV-303-10-CE0-A00-1E

XV-100 HMI/PLC



XV-100 HMI/PLC with SmartWire-DT

Display Size/Type	Display Resolution	Programming Software	Fieldbus Type	RS-485 (DB9)	Ethernet (RJ45)	Catalog Number
Plastic Housing						
3.5 in TFT	QVGA 320x240	XSoft CoDeSys-2 or -3	None	None	Yes	XV-102-BE-35TQRC-10
5.7 in TFT	VGA 640x480	XSoft CoDeSys-2 or -3	CANopen	Yes	Yes	XV-102-E6-57TVRC-10
		XSoft CoDeSys-2 or -3	PROFIBUS DP	Yes	Yes	XV-102-E8-57TVRC-10
7.0 in TFT	WGA 800x480	XSoft CoDeSys-2 or -3	CANopen	Yes	Yes	XV-102-E6-70TWRC-10
		XSoft CoDeSys-2 or -3	PROFIBUS DP	Yes	Yes	XV-102-E8-70TWRC-10
Metal Housing						
5.7 in TFT	VGA 640x480	XSoft CoDeSys-2 or -3	CANopen	Yes	Yes	XV-152-E6-57TVRC-10
		XSoft CoDeSys-2 or -3	PROFIBUS DP	Yes	Yes	XV-152-E8-57TVRC-10
8.4 in TFT	VGA 640x480	XSoft CoDeSys-2 or -3	CANopen	Yes	Yes	XV-152-E6-84TVRC-10
		XSoft CoDeSys-2 or -3	PROFIBUS DP	Yes	Yes	XV-152-E8-84TVRC-10
10.4 in TFT	VGA 640x480	XSoft CoDeSys-2 or -3	CANopen	Yes	Yes	XV-152-E6-10TVRC-10
		XSoft CoDeSys-2 or -3	PROFIBUS DP	Yes	Yes	XV-152-E8-10TVRC-10

XC PLC

XC152 PLC SmartWire-DT



XC152 PLC SmartWire-DT

Programming Software	Fieldbus Type	RS-232 (DB9)	RS-485 (DB9)	Ethernet (RJ45)	Catalog Number
XSoft CoDeSys-2 or -3	None	Yes	None	Yes	XC-152-E3-11
XSoft CoDeSys-2 or -3	CANopen	None	Yes	Yes	XC-152-E6-11
XSoft CoDeSys-2 or -3	PROFIBUS DP	None	Yes	Yes	XC-152-E8-11

XV and XC Accessories

XV HMI/PLC and XC PLC Accessories

Description	Catalog Number
PLC programming software, single seat license	SW-XSOFT-CODESYS-3-S
PLC programming software, multiple seat license	SW-XSOFT-CODESYS-3-M
SD memory card	MEMORY-SD-A1-S

easy800 with SmartWire-DT

EASY802-DC-SWD



easy800 with SmartWire-DT

Description	Programming Software	Fieldbus Type	RS-232 (RJ45)	Inputs 24 Vac 5 kHz	Outputs 24 Vdc ①	SmartWire-DT Baud Rates	Catalog Number
Control relay with SmartWire-DT	EASY-SOFT-PRO	None	Yes	None	None	Up to 2 Mbaud	EASY802-DC-SWD

EASY806-DC-SWD



Control relay with SmartWire-DT, four inputs, two of which can be used as outputs (transistor 24 Vdc, 0.1 A), easyNet onboard	EASY-SOFT-PRO	easyNet	Yes	4	2 ①	Up to 2 Mbaud	EASY806-DC-SWD
---	---------------	---------	-----	---	-----	---------------	-----------------------



Remote Displays

Both the EASY802 and EASY806 controllers can be connected to a MFD remote display or a XV touch panel display with Galileo.

EASY-SWD Accessories

MFD-80



Accessories—easy800

Description	Catalog Number
MFD display, NEMA 4X indoor rated	MFD-80

MFD-CP4



24 Vdc power / communication module	MFD-CP4
easy802/806 to MFD-CP4 communication cable, 1.5 m	EU4A-RJ45-CAB2
easy802/806 to XV HMI communication cable, 2 m	EU4A-RJ45-CAB1
Programming software with SWD-Assist configuration software integrated	EASY-SOFT-PRO

Note

① Use of outputs will result in a decrease in an equal number of available inputs.

I/O and Powerfeed Modules, System Connectivity Components



Contents

Description

Page

I/O and Powerfeed Modules, System Connectivity Components	
Powerfeed Modules	V7-T9-15
I/O Modules	V7-T9-15
System Connectivity Components	V7-T9-16

I/O and Powerfeed Modules, System Connectivity Components

Product Description

I/O and Powerfeed modules mount easily to DIN rail inside the control cabinet and connect directly to the SmartWire-DT system with snap-in connections to the 8-conductor flat SmartWire-DT cable.

I/O modules provide a means of easy connection of digital and analog devices to the SmartWire-DT network. Powerfeed modules allow the insertion of 24 Vdc and/or 15 Vdc power where necessary based on the power demands of components connected to the SmartWire-DT network.

Connectivity components are designed to make connection of devices to the 8-conductor flat SmartWire-DT cable simple and trouble-free.

Features

- I/O modules available in digital input and output, analog input and output, and RTD input versions in various combinations to simplify panel configuration
- Relay output version available for high-current loads
- Temperature input versions have wide operating ranges to support a variety of application requirements
- Powerfeed modules can be used to create zoned control arrangements to support integration of Emergency Stop devices into a network

Product Selection

Powerfeed Modules

Powerfeed Module



Powerfeed Modules

Powerfeed modules feed and regulate auxiliary 24 Vdc power and/or 15 Vdc network power into the SmartWire-DT flat cable. The auxiliary 24 Vdc power is needed for the power supply of contactors and the 15 Vdc network power is used for supplying power to additional SmartWire-DT nodes. Powerfeed modules are also used to create zone control or groups of devices controlled by a single Emergency Stop.

Description	Pkg. Qty.	Catalog Number
Powerfeed module 1 (for 24 Vdc auxiliary power)	1	EU5C-SWD-PF1-1
Powerfeed module 2 (for 24 Vdc auxiliary power and 15 Vdc network power)	1	EU5C-SWD-PF2-1

I/O Modules

Digital I/O Module



Digital I/O Modules

Digital input/output (I/O) modules are connected as nodes on the SmartWire-DT network and allow standard or generic devices to be connected to the SmartWire-DT system. They can be connected anywhere along the flat cable network and can therefore be positioned in the control panel to help reduce the I/O wiring.

Description	Pkg. Qty.	Catalog Number
Digital module with 8 digital inputs 24 Vdc	1	EU5E-SWD-8DX
Digital module with 8 digital outputs 24 Vdc / 0.5 A	1	EU5E-SWD-X8D
Digital module with 4 digital inputs 24 Vdc and 4 transistor outputs 24 Vdc/0.5 A	1	EU5E-SWD-4D4D
Digital module with 4 digital inputs 24 Vdc and 2 relay outputs 250 Vac/3 A	1	EU5E-SWD-4D2R
Digital module with 4 digital inputs 24 Vdc three-wire connections for sensor inputs	1	EU5E-SWD-4DX

Analog I/O Module



Analog I/O Modules

Analog input/output (I/O) modules are connected as nodes on the SmartWire-DT network and allow standard or generic devices to be connected to the SmartWire-DT system. They can be connected anywhere along the flat cable network and can therefore be positioned in the control panel to help reduce the I/O wiring.

Description	Pkg. Qty.	Catalog Number
Analog module with 4 analog inputs 0–10 V or 0–20 mA	1	EU5E-SWD-4AX
Analog module with 2 analog inputs 0–10 V or 0–20 mA and 2 analog outputs 0–10 V or 0–20 mA	1	EU5E-SWD-2A2A

Temperature Input Module



Temperature Input Modules

Temperature input modules are connected as nodes on the SmartWire-DT network and allow standard or generic devices to be connected to the SmartWire-DT system. They can be connected anywhere along the flat cable network and can therefore be positioned in the control panel to help reduce the I/O wiring.

Description	Pkg. Qty.	Catalog Number
RTD module with 4 temperature inputs Pt100, Pt 1000 or Ni1000; –58 to +392 °F (–50 to +200 °C)	1	EU5E-SWD-4PT
RTD module with 4 temperature inputs Pt100, Pt 1000 or Ni1000; –148 to +752 °F (–100 to +400 °C) ①	1	EU5E-SWD-4PT-2

Note

① EU5E-SWD-4PT-2 with hardware version V3 (HWW03) have a lower temperature range of –100 °C (–148 °F); earlier versions have a lower temperature range of only –50 °C (–58 °F).

System Connectivity Components

In Panel Components

System connectivity components for the SmartWire-DT system includes cables, connectors, jumpers, bushings, plugs, sockets, flat to round cable adapters, and crimping tools.

In Panel Components









	Description	Length	Pkg. Qty.	Catalog Number
Flat Cable 	Flat Cable, 8 AWG 24, 600 V			
	For SmartWire-DT network inside the control panel	328.1 ft (100 m)	1	SWD4-100LF8-24
	Complete with flat plugs SWD4-8MF2 installed at both ends	9.8 ft (3 m)	1	SWD4-3LF8-24-2S
		16.4 ft (5 m)	1	SWD4-5LF8-24-2S
		32.8 ft (10 m)	1	SWD4-10LF8-24-2S
Device Plug 	Device Plug			
	For connection to SmartWire-DT modules or nodes. Position as required based on node layout and crimp with tool SWD4-CRP-1	—	10	SWD4-8SF2-5
Flat Plug 	Flat Plug			
	For connection to SmartWire-DT system components: gateways, Powerfeed modules, coupling and terminating resistor. To make a custom length flat cable, simply cut flat cabling to required length and install these end connectors with tool SWD4-CRP-2	—	10	SWD4-8MF2
Device Plug Jumper 	Device Plug Jumper			
	For bridging open, spare or inverted device plugs	—	5	SWD4-SEL8-10
Universal Modules 	Universal (Placeholder) Module			
	Front mount. For use to hold a network address location for a node that may be installed at some time in the future	—	20	M22-SWD-NOP
	Back mount. For use in enclosures with back mounting features	—	20	M22-SWD-NOPC
Coupling 	Coupling			
	For connecting or joining flat cables with flat plugs	—	1	SWD4-8SFF2-5
Terminating Resistor 	Terminating Resistor			
	For terminating the end of the network on a flat cable	—	1	SWD4-RC8-10
Device Plug Tool 	Crimping Tools			
	Device plug crimping tool (for SWD4-8SF2-5)	—	1	SWD4-CRP-1
Flat Plug Tool 				
	Flat plug crimping tool (for SWD4-8MF2)	—	1	SWD4-CRP-2

Outside-the-Panel Components

The 8-conductor SmartWire-DT flat cable can be extended outside the cabinet to another cabinet or to pushbutton control stations using cable adapters and 8-conductor round cables.

Note: These cables and components are not compatible with On Machine I/O system as described starting on Page V7-T9-42.

Outside-the-Panel Components

	Description	Length	Pkg. Qty.	Catalog Number
Round Cable	Round Cable, 4 AWG 20 and 4 AWG 24, 300 V			
	For SmartWire-DT network outside the control panel (8-wire version)	164.0 ft (50 m)	1	SWD4-50LR8-24
Connectors for Round 8-Pole Cables				
Connector Socket	Round cable 8-pole plug for cabinet-to-cabinet connection	—	1	SWD4-SF8-67
				
Connector Plug	Round cable 8-pole plug for cabinet-to-cabinet connection	—	1	SWD4-SM8-67
				
Connector (Right Angle—Socket)	Right angle round cable 8-pole socket	—	1	SWD4-SF8-67W
				
Connector (Right Angle—Socket)	Right angle round cable 8-pole plug	—	1	SWD4-SM8-67W
				
Panel Cable Adapter				
Adapter	For flat cable (plug) to round cable terminals	—	1	SWD4-8FRF-10
				
Cabinet Cable Adapter Socket				
Adapter Socket	For flat cable (plug) to round cable (plug)	—	1	SWD4-SFL8-20
				
Cabinet Cable Adapter Plug				
Adapter Plug	For flat cable (plug) to round cable (socket)	—	1	SWD4-SML8-20
				

Motor Control Modules



Contents

<i>Description</i>	<i>Page</i>
Motor Control Modules	
Product Identification	V7-T9-19
XTPE Electronic Manual Motor Protectors	V7-T9-20
XTCE Contactor Modules	V7-T9-23
EMS Electronic Motor Starters	V7-T9-26
DS7 Soft Start Controllers	V7-T9-27
DE1 Variable Speed Starters	V7-T9-28
DC1 Variable Frequency Drives	V7-T9-30
DA1 Variable Frequency Drives	V7-T9-32

Motor Control Modules

Product Description

Contactors fit onto standard XT contactors and control relays directly on top, in place of a top mounted auxiliary contact block. The modules fit all XTCE size B and C frame contactors and XTRE control relays.

Soft Start Controllers, Variable Speed Starters and Variable Frequency Drives connect to the SmartWire-DT system with plug-in modules similar to the approach with Contactor Modules.

Electronic Motor Starters with built-in SmartWire-DT functionality connect directly to the SmartWire-DT flat cable without the need for a supplemental module.

These modules facilitate direct connection to the SmartWire-DT flat cable and eliminate the traditional point-to-point wiring to the PLC input and output modules as well as wiring to the contactor coils.

Features

- Integrated 24 Vdc coil power on network and plug-in modules
- Integrated switch position polling and mechanical switch position display on contactor modules
- Integrated feedback circuit to PLC
- Built-in diagnostic bi-color LEDs on each module
- Connection to SmartWire-DT flat cable via quick disconnect device plugs

Product Identification

SmartWire-DT Contactor Modules

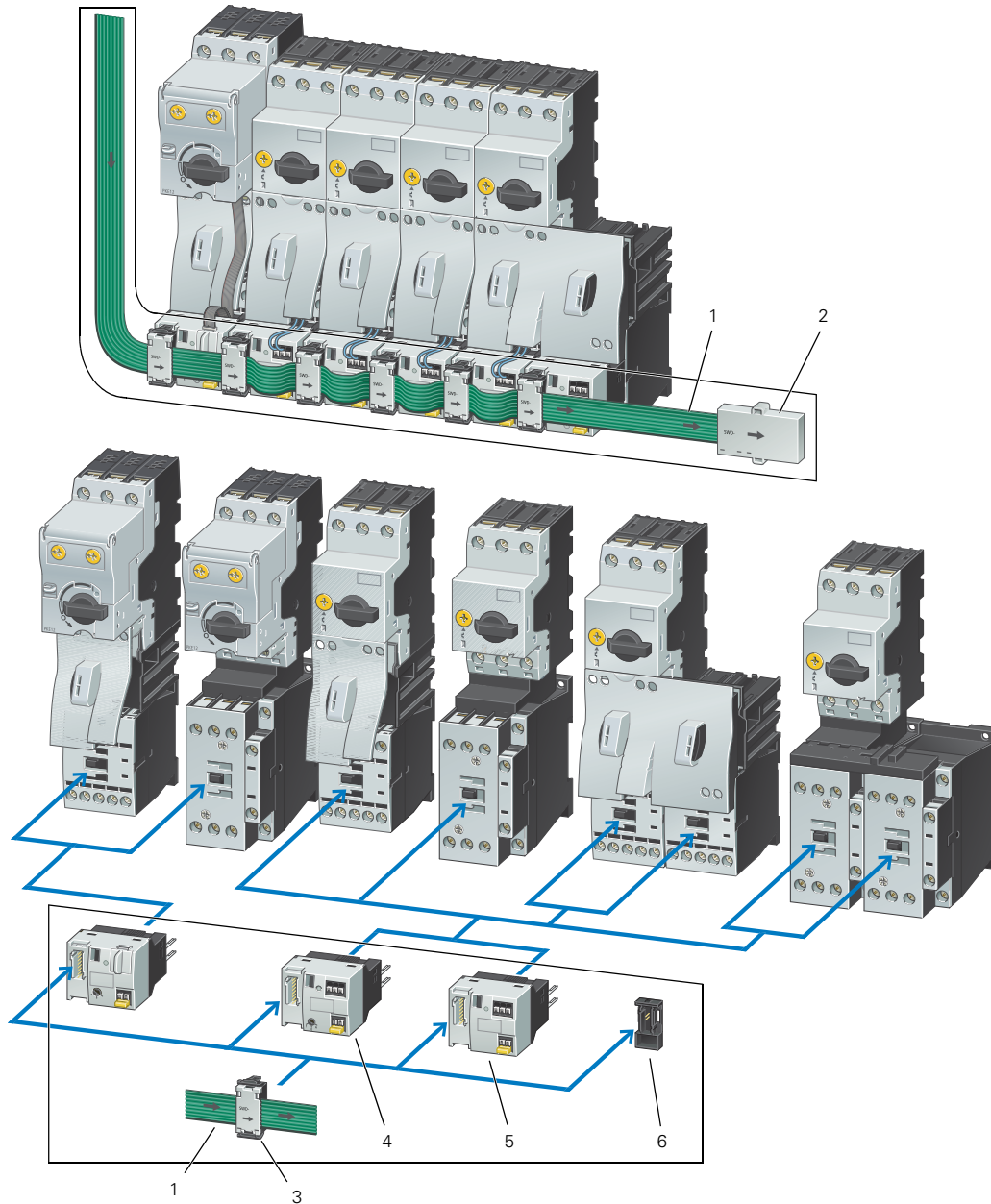

Item Number	Description
1	Flat cable
2	Terminating resistor (SWD4-RC8-10)
3	Device plug (SWD4-85F2-5)
4	Modules for XT contactors with XTPR manual motor protectors, with 1-0-A switch (DIL-SWD-32-002)
5	Modules for XT contactors with XTPR manual motor protectors (DIL-SWD-32-001)
6	Device plug jumper (SWD4-SEL8-10)

XT Electronic Manual Motor Protector



9

Contents

Description	Page
Motor Control Modules	
Product Identification	V7-T9-19
XTPE Electronic Manual Motor Protectors	
Product Selection	V7-T9-21
XTCE Contactor Modules	V7-T9-23
EMS Electronic Motor Starters	V7-T9-26
DS7 Soft Start Controllers	V7-T9-27
DE1 Variable Speed Starters	V7-T9-28
DC1 Variable Frequency Drives	V7-T9-30
DA1 Variable Frequency Drives	V7-T9-32

XTPE Electronic Manual Motor Protectors

Product Description

The **XT** Electronic Manual Motor Protector provides the same functionality as the **XT** thermal manual motor protector, but with an added level of flexibility and selectability. The XTPE incorporates electronic control technology to enable more options and larger dial setting ranges. The trip units are interchangeable, allowing users to exchange as needed using the same base. The reduced number of part numbers decreases bill of material complexity while reducing inventory demands. The XTPE electronic manual motor protector includes the following features:

- 4:1 max to min overcurrent dial setting range
- Selectable trip class (5, 10, 15, 20)
- Interchangeable trip units
- Three base units (12, 32 and 65A)
- Common accessories with the XTPR

Features and Benefits

Advanced Trip Unit



In addition to the selectability, the XTPE is also available with an advanced trip unit that can communicate system data and protector data thru SmartWire-DT. SmartWire-DT is an innovative cost effective connection technology that enables quick installation of control wiring to the starter through a single green cable. When on SmartWire-DT, the XTPE can communicate the following:

- Current Values
 - Maximum phase current
 - Overload warning

- Diagnostics Data
 - Overload fault
 - Cause of trip (overcurrent or short circuit)
 - Phase loss
 - Trip via TEST
- Status Messages
 - Control unit type
 - Overload setting
 - Time-lag
 - Switching status

XTPE Electronic MMP



The XTPE Electronic MMP provides the selectability, control, and insight options that give panel builders and OEMs the solutions necessary to enhance motor control designs while reducing total costs.

Standards and Certifications



- CE approved
- UL Listed File No. E36332
- UL 508 group motor and Type E
- IEC/EN 60947
- CSA File 012528, Class 3211-05



Product Selection

XT Electronic Manual Motor Protector

MMP Advanced Trip Units Used with SmartWire-DT

	Overload Release Setting Amp Range	For Use with Base Catalog Number	UL/CSA				IEC					Trip Unit Type Number	Catalog Number
			Maximum Three-Phase hp Ratings				Maximum Motor kW Ratings						
			200 V	240 V	480 V	600 V	220 V 230 V 240 V	380 V 400 V 415 V	440 V	500 V	600 V 690 V		
B Frame	B Frame												
	0.3–1.2	XTPE012B	①	①	0.5	0.5	0.18	0.37	0.37	0.37	0.75	PKE-XTUA-1,2	XTPEXTA1P2B
	1–4	XTPE012B	0.75	0.75	2	3	0.75	1.5	1.5	2.2	3	PKE-XTUA-4	XTPEXTA004B
	3–12	XTPE012B	3	3	7.5	10	3	5.5	5.5	5.5	7.5	PKE-XTUA-12	XTPEXTA012B
	8–32	XTPE032B	5	7.5	15	20	7.5	15	15	18.5	30	PKE-XTUA-32	XTPEXTA032B
D Frame	D Frame												
	8–32	XTPE065D	7.5	7.5	20	25	7.5	15	15	18.5	30	PKE-XTUWA-32	XTPEXTA032D
	16–65	XTPE065D	15	15	40	40	18.5	30	37	45	55	PKE-XTUA-65	XTPEXTA065D

9

MMP Used with SmartWire-DT—Complete Assembly

	Overload Release Setting Amp Range	UL/CSA				IEC					Complete Manual Motor Protector	
		Maximum Motor hp Ratings				Maximum Motor kW Ratings					Type Number	Catalog Number
		200 V	230 V	460 V	575 V	220 V 230 V 240 V	380 V 400 V 415 V	440 V	500 V	600 V 690 V		
B Frame	B Frame											
	0.3–1.2	①	①	0.5	0.5	0.18	0.37	0.37	0.37	0.75	PKE12/XTUA-1,2	XTPE1P2BCA
	1–4	0.75	0.75	2	3	0.75	1.5	1.5	2.2	3	PKE12/XTUA-4	XTPE004BCA
	3–12	3	3	7.5	10	3	5.5	5.5	5.5	7.5	PKE12/XTUA-12	XTPE012BCA
	8–32	5	7.5	15	20	7.5	15	15	18.5	30	PKE32/XTUA-32	XTPE032BCA

UL 508 Type E XT Electronic Combination Motor Controllers—Complete Assembly Including Trip Unit

B Frame Electronic MMP with C Frame Contactor

	Overload Release Setting Amp Range	UL/CSA						Maximum Single-Phase hp Ratings			Catalog Number With SmartWire-DT
		Maximum Three-Phase hp Ratings						115 V	200 V	240 V	
		200 V	240 V	380 Y/ 415 V	480 Y/ 277 V	600 Y/ 347 V					
B Frame	B Frame										
	0.3–1.2	①	①	①	①	0.5	①	①	①	XTFC1P2BCCATD ②	
	1–4	0.75	0.75	1.5	2	—	0.125	0.25	0.33	XTFC004BCCATD ③	
	3–12	3	3	5	7.5	—	0.5	1	1.5	XTFC012BCCATD ③	
	8–32	5	5	10	15	—	1.5	3	3	XTFC032BCCATD ③	

Notes

- ① In this range, calculate motor rating according to rated current. Specified values to NEC 430.6 (A) (1).
- ② SCCR: 14 kA, 600 Vac
- ③ SCCR: 18 kA, 480 Vac

9.1

Connectivity Solutions

SmartWire-DT In Panel and On Machine Wiring Solution

PKE-SWD-SP



SmartWire-DT PKE MMP Module

SmartWire-DT module for connecting XTPE manual motor protector (MMP) advanced trip units.

Description	For Use With ...	Pkg. Qty.	Catalog Number
Enables monitoring of XTPE switch position/status			
Commands: – Remote tripping of MMP – Motor current in % – Thermal motor image in % – Set value of trip unit class/setting – Cause of trip (overload vs. short-circuit)	XTPEXTA	1	PKE-SWD-SP

PKE32-COM



SmartWire-DT PKE MMP Cable

Communication cable for connecting PKE contactor modules and DS7 soft start controllers to XTPE manual motor protector (MMP).

Description	For Use With ...	Pkg. Qty.	Catalog Number
Order as needed to connect DS7-34D soft start controllers to XTPE MMPs (up to 32 A)	DS7-34D_		
This cable is included with the PKE-SWD-32 PKE contactor modules	PKE-SWD-32	1	PKE32-COM

XT Family of Contactors



Contents

Description	Page
Motor Control Modules	
Product Identification	V7-T9-19
XTPE Electronic Manual Motor Protectors	V7-T9-20
XTCE Contactor Modules	
Product Selection	V7-T9-24
EMS Electronic Motor Starters	V7-T9-26
DS7 Soft Start Controllers	V7-T9-27
DE1 Variable Speed Starters	V7-T9-28
DC1 Variable Frequency Drives	V7-T9-30
DA1 Variable Frequency Drives	V7-T9-32

XTCE Contactor Modules

Product Description

The Eaton **XT** contactors include non-reversing and reversing contactors, and a variety of related accessories. Because **XT** meets IEC, UL®, CSA® and CE standards, it is the perfect product solution for IEC applications all over the world. The compact, space saving and easy to install **XT** line of IEC contactors is the efficient and effective solution for customer applications.

Application Description

The **XT** line of IEC power control was engineered to provide highly effective control and protection for a variety of loads, including motors, compressors, pumps, resistive, capacitor banks, isolation, and others. **XT** also includes IEC ratings for lighting applications as well.

Features and Benefits

- Available with screw or spring cage terminals
- Reversing or non-reversing contactors and starters
- IP20 finger and back-of-hand proof
- Large ambient temperature range, -25 to 50 °C [-13 to 122 °F]
- Low power consumption DC coils
- Built-in NO or NC auxiliary contacts to 32 A
- Plug-in accessories for reduced installation time
- Integrated suppressor 7–150 Vdc operated contactors

Standards and Certifications

- IEC EN 60947
- CE approved
- UL
- CSA
- ATEX
- RoHS



Product Selection

Full Voltage, Non-Reversing Contactors

Frame B



Three-Pole Contactors, Frame B—UL/CSA Ratings

UL General Purpose Ampere Rating	Single-Phase hp Ratings			Three-Phase hp Ratings				Auxiliary Contacts	Screw Terminal Catalog Number ^①
	115 V	200 V	230 V	200 V	230 V	460 V	575 V		
20	1/4	3/4	1	1-1/2	2	3	5	1NO	XTCE007B10TD
20	1/4	3/4	1	1-1/2	2	3	5	1NC	XTCE007B01TD
20	1/2	1	1-1/2	3	3	5	7-1/2	1NO	XTCE009B10TD
20	1/2	1	1-1/2	3	3	5	7-1/2	1NC	XTCE009B01TD
20	1	2	2	3	3	10 ^②	10	1NO	XTCE012B10TD
20	1	2	2	3	3	10 ^②	10	1NC	XTCE012B01TD
20	1	2	3	5	5	10 ^②	10	1NO	XTCE015B10TD
20	1	2	3	5	5	10 ^②	10	1NC	XTCE015B01TD

9

Frame C



Three-Pole Contactors, Frame C—UL/CSA Ratings

UL General Purpose Ampere Rating	Single-Phase hp Ratings			Three-Phase hp Ratings				Auxiliary Contacts	Screw Terminal Catalog Number ^①
	115 V	200 V	230 V	200 V	230 V	460 V	575 V		
40	2	2	3	5	5	10	15	1NO	XTCE018C10TD
40	2	2	3	5	5	10	15	1NC	XTCE018C01TD
40	2	3	5	7-1/2	10	15	20	1NO	XTCE025C10TD
40	2	3	5	7-1/2	10	15	20	1NC	XTCE025C01TD
40	3	5	5	10	10	20	25	1NO	XTCE032C10TD
40	3	5	5	10	10	20	25	1NC	XTCE032C01TD

Notes

The 7–32A XTCE contactors have positively driven contacts between the integrated auxiliary contact and the auxiliary contact module as well as within the auxiliary contact modules.

DC operated contactors (Frames B–G, 7–150 A) have a built-in suppressor circuit.

^① For spring cage terminals, insert **C** after the fourth digit of the catalog number. Example: XTCE**C**007B10A.

For 7–12A XTCEC contactors, the power, auxiliary and coil terminals are spring cage.

For 18–32A XTCEC contactors, the auxiliary and coil terminals are spring cage.

For 40–150A XTCEC contactors, the coil terminals only are spring cage.

Contactor Modules

Contactor Modules



Contactor Modules ①②③

SmartWire-DT module for attachment to XTCE007–XTCE032 contactors and XTRE control relays. One module is required per contactor.

Description	Pkg. Qty.	Catalog Number
Two digital inputs for voltage-free contacts. One electrical interlock for the surface mounting of reversing combinations. Messages: Switch status contactor, status of the digital inputs 1 and 2. Commands: Contactor actuation.	5	DIL-SWD-32-001
Two digital inputs for voltage-free contacts. One electrical interlock for the surface mounting of reversing combinations. 1-0-A switch for manual or automatic operation. Messages: Contactor switching position, status of the digital inputs 1 and 2, 1-0-A switch position. Commands: Contactor actuation.	5	DIL-SWD-32-002

PKE Contactor Module



PKE Contactor Module

SmartWire-DT module for connection of XTPE manual motor controllers. One module is required per contactor and XTPE manual motor protector.

Description	Pkg. Qty.	Catalog Number
Connecting cable between module and XTPE trip block included as standard. One electrical interlock for the surface mounting of reversing starters. 1-0-A switch for manual or automatic operation. Selectable overload relay function for connecting the contactor on overload. Messages: Switch position contactor/PKE/1-0-A switch Motor current in % Thermal motor image in % Trip-indicating auxiliary contact (Overload, Short-circuit,...) Set value of overload releases Set value Verification time (CLASS), Part no. Trip block. Commands: Contactor actuation, activation of overload relay function (ZMR)	4	PKE-SWD-32

Design Note

The number of motor starters or XTCE contactors that can be connected is dependent upon the power consumption of the contactor coils. To increase the number of SmartWire-DT modules that can be connected, Powerfeed modules can be used. The SWD-Assist configuration program (download from www.eaton.com/smartwiredt) will automatically check and insert Powerfeed modules as needed based on the number of contactors used and the utilization factors selected.

24 Vdc		XTCE007	XTCE009	XTCE012	XTCE015	XTCE018	XTCE025	XTCE032
Pick-up power	W	3	3	4.5	4.5	12	12	12
Sealing power	W	3	3	4.5	4.5	0.5	0.5	0.5

Reversing Contactors

Reversing Contactor



Reversing Contactors

When using the tool-less reversing link kits on Frame B contactors, a different reversing bridge is required without the A2 coil bridge.

Description	Pkg. Qty.	Catalog Number
Reversing bridge for Frame B contactors on SmartWire-DT	20	XTCEXRBB-0A2

Notes

- ① Take account of the maximum current consumption of the contactor coils per SmartWire-DT line.
- ② A2 connections must not be linked.
- ③ Connection terminals for electrical interlocking are not suitable for safety technology.

EMS Electronic Motor Starters

Product Selection

EMS-DOS-...
EMS-ROS-...



Electronic Motor Starters—Complete Devices

Electronic Motor Starters with SmartWire-DT built in do not require a separate module for connection to the SmartWire-DT network. Connection is made directly to the SmartWire-DT flat cable.

Description	Max. Equivalent hp Rating for Three-Phase Motors, 60 Hz				Setting Range of Overload Releases I_r A 	DC Operation 24 Vdc Catalog Number
	208 V	480 V	AC1	AC3		
DOL starting, Motor protection, For connecting to SmartWire-DT. Circuit design: Safety output stage with bypass, three-phase disconnect.	— 2	1 5	2.4 9.0	2.4 7.6	0.18–2.4 1.5–9 7 (AC–53a)	EMS-DO-T-2.4-SWD EMS-DO-T-9-SWD
DOL starting, Motor protection, Emergency-stop actuator. Circuit design: Safety output stage with bypass, three-phase disconnect.	— 2	1 5	2.4 9.0	2.4 7.6	0.18–2.4 1.5–9 7 (AC–53a)	EMS-DOS-T-2.4-SWD ① EMS-DOS-T-9-SWD ①
DOL starting, Reversing start, Motor protection, For connecting to SmartWire-DT. Circuit design: Safety output stage with bypass, three-phase disconnect.	— 2	1 5	2.4 9.0	2.4 7.6	0.18–2.4 1.5–9 7 (AC–53a)	EMS-RO-T-2.4-SWD EMS-RO-T-9-SWD
DOL starting, Reversing start, Motor protection, Emergency-stop actuator. Circuit design: Safety output stage with bypass, three-phase disconnect.	— 2	1 5	2.4 9.0	2.4 7.6	0.18–2.4 1.5–9 7 (AC–53a)	EMS-ROS-T-2.4-SWD ① EMS-ROS-T-9-SWD ①

Note

① EMS-DOS and EMS-ROS starters with emergency stop function have an additional terminal that needs to be connected to 0 V / 24 Vdc to provide an enable signal. (This is in addition to the SmartWire-DT signal.) Actuation of an E-stop will interrupt the 0 V / 24 Vdc connection and also override the SmartWire-DT signal.

DS7 Soft Start Controllers

Product Selection

Soft Start Controllers—Complete Devices

DS7 Series Soft Start Controllers with SmartWire-DT built in do not require a separate module for connection to the SmartWire-DT network. Connection is made directly to the SmartWire-DT flat cable.

Soft starters for three-phase variable-torque loads.
Mains supply voltage (208–480 Vac, 60 Hz).

DS7-... (4 to 12 A)

4 to 12 A



Rated Operational Current A	Assigned Motor Rating at 480 V, 60 Hz hp	U _c 24 Vac/Vdc U _s 24 Vac/Vdc Expanded Temperature Range (Down to –40 °C) Catalog Number
4	2	DS7-34DSX004N0-D ①
7	5	DS7-34DSX007N0-D ①
9	5	DS7-34DSX009N0-D ①
12	10	DS7-34DSX012N0-D ①

DS7-... (16 to 32 A)

16 to 32 A



Rated Operational Current A	Assigned Motor Rating at 480 V, 60 Hz hp	U _c 24 Vac/Vdc U _s 24 Vac/Vdc Expanded Temperature Range (Down to –40 °C) Catalog Number
16	10	DS7-34DSX016N0-D ①
24	15	DS7-34DSX024N0-D ①
32	25	DS7-34DSX032N0-D ①

DS7-... (41 to 100 A)

41 to 100 A



Rated Operational Current A	Assigned Motor Rating at 480 V, 60 Hz hp	U _c 24 Vac/Vdc U _s 24 Vac/Vdc Expanded Temperature Range (Down to –40 °C) Catalog Number
41	30	DS7-34DSX041N0-D
55	40	DS7-34DSX055N0-D
70	50	DS7-34DSX070N0-D
81	60	DS7-34DSX081N0-D
100	75	DS7-34DSX100N0-D

DS7-... (135 to 200 A)

135 to 200 A



Rated Operational Current A	Assigned Motor Rating at 480 V, 60 Hz hp	U _c 24 Vac/Vdc U _s 24 Vac/Vdc Expanded Temperature Range (Down to –40 °C) Catalog Number
135	100	DS7-34DSX135N0-D
160	125	DS7-34DSX160N0-D
200	150	DS7-34DSX200N0-D

Note

① DS7 controllers up to 32 A can be connected with XTPE manual motor protectors (MMP) with the PKE32-COM cable (see **Page V7-T9-21** for details).

PowerXL DE1 Series



DE1 Variable Speed Starters

Product Description

Eaton's PowerXL® DE1 variable speed starter offers the advantages of both a motor starter and a variable frequency drive in a single device. The DE1 is a compact and easy-to-use device with the ability to change the speed of the motor with the simplicity of a contactor starter. With 14 basic parameters, SmartWire-DT connectivity and an intuitive configuration module, the DE1 setup and commissioning is easy for any panel builder and MOEM. The DE1 was designed for customers who have concerns of the complexity of a VFD but still require variable frequency and advanced motor protection.

Models rated at 480 volts, three-phase, 50/60 Hz are available in sizes ranging from 0.5 to 10 hp. Models rated at 230 volts, single-phase in/three-phase out, 50/60 Hz are available in sizes ranging from 0.33 to 3 hp.

The DE1 VSS is designed without a keypad to provide a simplistic, cost effective solution. Units are shipped without a keypad. In order to change parameters, there are accessories such as the configuration module that can change up to 5 parameters or connectivity products to connect to the drivesConnect PC Tool.

Contents

Description	Page
Motor Control Modules	
Product Identification	V7-T9-19
XTPE Electronic Manual Motor Protectors	V7-T9-20
XTCE Contactor Modules	V7-T9-23
EMS Electronic Motor Starters	V7-T9-26
DS7 Soft Start Controllers	V7-T9-27
DE1 Variable Speed Starters	
Product Selection	V7-T9-29
DC1 Variable Frequency Drives	V7-T9-30
DA1 Variable Frequency Drives	V7-T9-32

Features

- Compact, space-saving design
- Rugged design rated up to 60 °C without derating
- DIN rail and screw mountable
- Narrow footprint for true side-by-side installation
- Rated for group motor applications
- Low capacitor design for low harmonics
- Control terminal blocks
 - Three digital inputs
 - One digital/analog (programmable) input
 - One relay output
- Contactor style power wiring
- RS-485/Modbus as standard
- Efficient, simple design without a keypad
 - Three indicating LEDs for fault and condition status
- Reliable design—
 - 150% for 60 s
 - 175% for 2 s

Standards and Certifications

Product

- Complies with EN 61800-3

Safety

- IEC 61800-5-1
- CE
- UL
- CSA/cUL
- cTick
- UKRSekpro
- GOST R
- RoHS compliant



Product Selection

IP20

DE1 Series IP20 Enclosure Drives



hp ^①	kW	Volts	100% Continuous Current (A)	Frame Size	Catalog Number ^②
0.33	0.25	200–240 V single-phase in/ 230 V three-phase out	1.4	1	DE1-121D4NN-N20N
0.5	0.37		2.3	1	DE1-122D3NN-N20N
0.75	0.55		2.7	1	DE1-122D7NN-N20N
1	0.75		4.3	1	DE1-124D3NN-N20N
2	1.5		7	1	DE1-127D0NN-N20N
3	2.2		9.6	2	DE1-129D6NN-N20N
0.5	0.37	380–480 V three-phase in/ 480 V three-phase out	1.3	1	DE1-341D3NN-N20N
1	0.75		2.1	1	DE1-342D1NN-N20N
2	1.5		3.6	1	DE1-343D6NN-N20N
3	2.2		5	2	DE1-345D0NN-N20N
4	3		6.6	2	DE1-346D6NN-N20N
5	4		8.5	2	DE1-348D5NN-N20N
7.5	5.5		11.3	2	DE1-34011NN-N20N
10	7.5		16	2	DE1-34016NN-N20N

DX-NET-SWD3

SmartWire-DT DE1 VSS Module



SmartWire-DT module for connecting DE1 variable speed starters (VSS) to the SmartWire-DT network.

Description	For Use With ...	Pkg. Qty.	Catalog Number
1-0-A switch for manual or automatic operation	DE1 DC1	1	DX-NET-SWD3

Notes

- ① For all applications, select the unit such that the motor current is less than or equal to the rated continuous output current.
- ② These are constant torque/high overload rated drives.

PowerXL DC1 Series Drives



DC1 Variable Frequency Drives

Product Description

Eaton's PowerXL® DC1 variable frequency drives are the next generation of drives specifically engineered for today's machinery applications.

The DC1 is compact with only 14 basic parameters, SmartWire-DT connectivity, and outstanding ease of mounting and installation. The DC1 is perfect for quick commissioning and is ideal for panel builders. This drive supports single-phase motor applications, and detachable terminal blocks make control wiring much easier.

Models rated at 480 volts, three-phase, 50/60 Hz are available in sizes ranging from 1 to 30 hp ②. Models rated at 240 volts, single- or three-phase, 50/60 Hz are available in sizes ranging from 0.5 to 15 hp ②. Models rated at 115 volts, single-phase, 50/60 Hz are available in the 0.5 to 3 hp size range.

Features

- Compact, space-saving design
- Rugged and reliable—175% for 2 s, 50 °C rated
- DIN rail and screw mountable (FS1 and FS2)
- Side-by-side installation
- Industry-leading efficiency delivers energy savings to the customer
- Optional integrated EMC filters make the unit suitable for commercial and industrial networks
- Brake chopper as standard in frames 2 and higher
- Temperature-controlled fan
- RS-485/Modbus® and CANopen™ as standard
- PI controller as standard
- SmartWire capability
- Removable I/O terminal blocks
- Contactor style power wiring
- Designed for shaded-pole, single-phase motors and permanent split capacitor single-phase motors
- Designed to run surface mounted (SPM) and rotor in-built (IPM) permanent magnet motors ③

Standards and Certifications

Product

- Complies with EN61800-3 (2004)

EMC (At Default Settings)

- EMC Category C1, C2 and C3 at default settings (1 m, 5 m, 25 m)

Safety ①

- 61800-5-1
- EN 60529
- CE
- UL
- cUL
- UkrSepuro
- c-Tick
- RoHS compliant



Notes

- ① See unit nameplate for more detailed approvals.
- ② Available June 2015.
- ③ Available September 2015.

Contents

Description

Page

Motor Control Modules	
Product Identification	V7-T9-19
XTPE Electronic Manual Motor Protectors	V7-T9-20
XTCE Contactor Modules	V7-T9-23
EMS Electronic Motor Starters	V7-T9-26
DS7 Soft Start Controllers	V7-T9-27
DE1 Variable Speed Starters	V7-T9-28
DC1 Variable Frequency Drives	
Product Selection	V7-T9-31
DA1 Variable Frequency Drives	V7-T9-32

Product Selection

IP20

DC1 Series IP20 Enclosure Drives ^①



hp ^②	kW	Volts	100% Continuous Current In (A)	Frame Size ^③	Catalog Number
0.5	0.37	115 V single-phase in/ ^④	7	1	DC1-S17D0NN-A20N
0.75	0.55	115 V single-phase out	10.5	2	DC1-S1011NB-A20N
0.5	0.37	200–240 V single-phase in/ ^④	4.3	1	DC1-S24D3NN-A20N ^⑤
1	0.75	200–240 V single-phase out	7	1	DC1-S27D0NN-A20N ^⑤
1.5	1.1		10	2	DC1-S2011NB-A20N ^⑤
0.5	0.37	115 V single-phase in/ 230 V three-phase out	2.3	1	DC1-1D2D3NN-A20N
1	0.75		4.3	1	DC1-1D4D3NN-A20N
1.5	1.1		5.8	2	DC1-1D5D8NB-A20N
0.5	0.37	200–240 V single-phase in/ 230 V three-phase out	2.3	1	DC1-122D3NN-A20N ^⑤
1	0.75		4.3	1	DC1-124D3NN-A20N ^⑤
2	1.5		7	1	DC1-127D0NN-A20N ^⑤
2	1.5		7	2	DC1-127D0NB-A20N ^⑤
3	2.2		10.5	2	DC1-12011NB-A20N ^⑤
5	4		15	3	DC1-12015NB-A20N
0.5	0.37	200–240 V three-phase in/ 230 V three-phase out	2.3	1	DC1-322D3NN-A20N
1	0.75		4.3	1	DC1-324D3NN-A20N
2	1.5		7	1	DC1-327D0NN-A20N
2	1.5		7	2	DC1-327D0NB-A20N ^⑤
3	2.2		10.5	2	DC1-32011NB-A20N ^⑤
5	4		18	3	DC1-32018NB-A20N ^⑤
7.5	5.5		24	4	DC1-32024NB-A20N ^{⑤⑥}
10	7.5		30	4	DC1-32030NB-A20N ^{⑤⑥}
15	11		46	4	DC1-32046NB-A20N ^{⑤⑥}
1	0.75	380–480 V three-phase in/ 480 V three-phase out	2.2	1	DC1-342D2NN-A20N ^⑤
2	1.5		4.1	1	DC1-344D1NN-A20N ^⑤
2	1.5		4.1	2	DC1-344D1NB-A20N ^⑤
3	2.2		5.8	2	DC1-345D8NB-A20N ^⑤
5	4		9.5	2	DC1-349D5NB-A20N ^⑤
7.5	5.5		14	3	DC1-34014NB-A20N ^⑤
10	7.5		18	3	DC1-34018NB-A20N ^⑤
15	11		24	3	DC1-34024NB-A20N ^⑤
20	15		30	4	DC1-34030NB-A20N ^{⑤⑥}
25	18.5		39	4	DC1-34039NB-A20N ^{⑤⑥}
30	22		46	4	DC1-34046NB-A20N ^{⑤⑥}

DX-NET-SWD3

SmartWire-DT DC1 VFD Module



SmartWire-DT module for connecting DC1 variable frequency drive (VFD) to the SmartWire-DT network.

Description	For Use With ...	Pkg. Qty.	Catalog Number
1-0-A switch for manual or automatic operation	DE1 DC1	1	DX-NET-SWD3

Notes

- ① These are constant torque/high overload rated drives.
- ② For all applications, select the unit such that the motor current is less than or equal to the rated continuous output current.
- ③ Brake chopper circuit available as standard in frames 2 and 3.
- ④ Only for use with shaded pole or split capacitor single-phase motors.
- ⑤ RFI version available. Substitute with DC1-*****F*-***** for this option.
- ⑥ Frame size 4 available June 2016.

PowerXL DA1 Series Drives



DA1 Variable Frequency Drives

Product Description

Eaton's PowerXL® DA1 variable frequency drives are the next generation of drives specifically engineered for today's machinery applications.

DA1 is the perfect match for demanding OEM applications. High-performance processor, safe torque off, multiple fieldbus protocols including SmartWire-DT, sensorless vector control and the possibility to operate permanent magnet motors are sure to leave a lasting impression.

Models rated at 480 volts, three-phase, 50/60 Hz are available in sizes ranging from 1 to 15 hp. Models rated at 240 volts, single- or three-phase, 50/60 Hz are available in sizes ranging from 0.5 to 7.5 hp. Models rated at 575 volts, three-phase, 50/60 Hz are available in sizes ranging from 1 to 20 hp.

Features

- Compact, space-saving design
- Rugged and reliable—200% for 4 s 50 °C rated
- DIN rail and screw mountable (FS1 and FS2)
- Side-by-side installation
- Industry-leading efficiency delivers energy savings to the customer
- Integrated EMC filters make the unit suitable for commercial and industrial networks
- Brake chopper as standard
- Temperature-controlled fan
- RS-485/Modbus® and CANopen™ as standard
- PID controller as standard
- Removable I/O terminal blocks
- Contactor style power wiring
- 200% torque at zero speed
- Designed to run surface mounted (SPM) and rotor in-built (IPM) permanent magnet motors
- PLC programming
- Closed loop
- Conformal coated boards
- Optional SmartWire-DT connection module

Standards and Certifications

Product

- Complies with EN61800-3 (2004)

EMC (At Default Settings)

- EMC Category C1, C2 and C3 at default settings (1 m, 5 m, 25 m)

Safety^①

- 61800-5-1
- EN 60529
- CE
- UL
- cUL
- DNV
- UkrSepro
- c-Tick
- RoHS compliant



Note

- ① See unit nameplate for more detailed approvals.

Contents

Description

Description	Page
Motor Control Modules	
Product Identification	V7-T9-19
XTPE Electronic Manual Motor Protectors	V7-T9-20
XTCE Contactor Modules	V7-T9-23
EMS Electronic Motor Starters	V7-T9-26
DS7 Soft Start Controllers	V7-T9-27
DE1 Variable Speed Starters	V7-T9-28
DC1 Variable Frequency Drives	V7-T9-30
DA1 Variable Frequency Drives	
Product Selection	V7-T9-33

Product Selection

IP20

DA1 Series IP20 Enclosure Drives ^①



hp ^②	kW	Volts	100% Continuous Current In (A)	Frame Size ^③	Catalog Number
1	0.75	200–240 V single-phase in/ 230 V three-phase out	4.3	2	DA1-124D3FB-A20C
2	1.5		7	2	DA1-127D0FB-A20C
3	2.2		10.5	2	DA1-12011FB-A20C
1	0.75	200–240 V three-phase in/ 230 V three-phase out	4.3	2	DA1-324D3FB-A20C
2	1.5		7	2	DA1-327D0FB-A20C
3	2.2		10.5	2	DA1-32011FB-A20C
5	4		18	3	DA1-32018FB-A20C
7.5	5.5		24	3	DA1-32024FB-A20C
1	0.75	380–480 V three-phase in/ 460 V three-phase out	2.2	2	DA1-342D2FB-A20C
2	1.5		4.1	2	DA1-344D1FB-A20C
3	2.2		5.8	2	DA1-345D8FB-A20C
5	4		9.5	2	DA1-349D5FB-A20C
7.5	5.5		14	3	DA1-34014FB-A20C
10	7.5		18	3	DA1-34018FB-A20C
15	11		24	3	DA1-34024FB-A20C
1	0.75	500–600 V three-phase in/ 575 V three-phase out	2.1	2	DA1-352D1NB-A20C
2	4.5		3.1	2	DA1-353D1NB-A20C
3	2.2		4.1	2	DA1-354D1NB-A20C
5	4		6.5	2	DA1-356D5NB-A20C
7.5	5.5		9	2	DA1-359D0NB-A20C
10	7.5		12	3	DA1-35012NB-A20C
15	11		17	3	DA1-35017NB-A20C
20	15		22	3	DA1-35022NB-A20C

9

DX-NET-SWD

SmartWire-DT DA1 VFD Modules



Description	For Use With ...	Pkg. Qty.	Catalog Number
1-0-A switch for manual or automatic operation	DA1	1	DX-NET-SWD1

Notes

- ① These are constant torque/high overload rated drives.
- ② For all applications, select the unit such that the motor current is less than or equal to the rated continuous output current.
- ③ Brake chopper circuit available as standard in frames 2 and 3.

Pilot Device Modules



Contents

Description

Page

Pilot Device Modules	
M22 Contact and LED Modules	
Product Selection	V7-T9-35
Accessories	V7-T9-36
M22 Control Stations (8-Conductor)	V7-T9-37

Pilot Device Modules

M22 Contact and LED Modules

Product Description

Pilot device modules fit onto standard M22 and M22M (metal bezel) pilot devices. Single and double contact modules with and without LEDs are available to meet a wide variety of control circuit requirements.

These modules facilitate direct connection to the SmartWire-DT flat cable and eliminate the traditional point-to-point wiring to the PLC input and output modules.

Features

- Built-in diagnostic bi-color LEDs on each module
- Connection to SmartWire-DT flat cable

M22 and M22M Pushbuttons— Non-Illuminated and Illuminated

See Volume 7—Logic Control, Operator Interface and Connectivity Solutions, CA08100008E, Tab 1 for complete product selection.

Product Selection

M22 Pilot Device Modules Connections

M22 Front Mount Contact Modules, without LEDs

	Number of SPDT Contacts	Contact Symbol	Mounting Positions	Pkg. Qty.	Catalog Number
M22-SWD-K11	1			20	M22-SWD-K11
M22-SWD-K22	2			10	M22-SWD-K22



M22 Front Mount Contact Modules, with LEDs

	Number of SPDT Contacts	Contact Symbol	Mounting Positions	Color LED	Pkg. Qty.	Catalog Number
M22-SWD-K11LED_	1				20	M22-SWD-K11LED-W
						M22-SWD-K11LED-B
						M22-SWD-K11LED-G
						M22-SWD-K11LED-R
M22-SWD-K22LED_	2				10	M22-SWD-K22LED-W
						M22-SWD-K22LED-B
						M22-SWD-K22LED-G
						M22-SWD-K22LED-R



M22 Front Mount LED Modules

Mounting Positions	Color LED	Pkg. Qty.	Catalog Number
		20	M22-SWD-LED-W
			M22-SWD-LED-B
			M22-SWD-LED-G
			M22-SWD-LED-R

M22 Potentiometer

	Description	Pkg. Qty.	Catalog Number
M22-R-SWD-R	M22 SmartWire-DT complete potentiometer (front element, potentiometer module and adapter)	1	M22-R-SWD-R
			
M22-R-SWD	M22 potentiometer front element	1	M22-R-SWD
			
M22-SWD-R	M22 potentiometer SmartWire-DT module	1	M22-SWD-R
			

M22 Tuner Selectors

	Description	Pkg. Qty.	Catalog Number
M22-INC-SWD-INC	M22 SmartWire-DT complete tuner selector	1	M22-INC-SWD-INC
			
M22-INC-SWD	M22 tuner selector front element	1	M22-INC-SWD
			
M22-SWD-R	M22 tuner selector SmartWire-DT module	1	M22-SWD-INC
			

Accessories

M22-SWD-A4



Contact Block/Module Adapter

For M22 four-way pushbuttons and joysticks using SmartWire-DT, a special contact block/module adapter is required.

Description	Pkg. Qty.	Catalog Number
Four-way adapter for SmartWire-DT modules	10	M22-SWD-A4

M22 Control Stations



Contents

Description

Page

Pilot Device Modules	
M22 Contact and LED Modules	V7-T9-34
M22 Control Stations (8-Conductor)	V7-T9-37

M22 Control Stations (8-Conductor)

Product Description

M22 and M22M control stations are available in 1, 2, 3, 4 and 6-element configurations. Standard M22 surface mount enclosures accept the SmartWire-DT printed circuit board (PCB) interface. The M22 base mount modules connect to the PCB and attach to the base of the enclosure.

These PCB require the use of the 8-conductor round cable and can be wired directly with quick disconnect enclosure bushings. See **Page V7-T9-17** for details on this round cabling.





Remote pushbutton enclosures can also be constructed and connected to the 5-conductor round SmartWire-DT On Machine cabling system. See **Page V7-T9-53** for details.

Product Selection



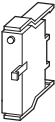

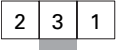
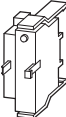

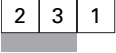



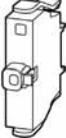

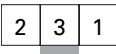
Surface Mounting Enclosures

Description	Catalog Number
M22-IY1-PG 	M22-IY1
One-element enclosure	M22-11
Two-element enclosure	M22-12
Three-element enclosure	M22-13
Four-element enclosure	M22-14
Six-element enclosure	M22-16

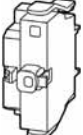



M22 Base Mount Contact Modules, without LEDs

	Number of SPDT Contacts	Contact Symbol	Mounting Positions	Pkg. Qty.	Catalog Number
M22-SWD-KC11	Base Mount				
	1			20	M22-SWD-KC11
M22-SWD-KC22	Base Mount				
	2			10	M22-SWD-KC22

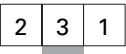

M22 Base Mount Contact Modules, with LEDs

	Number of SPDT Contacts	Contact Symbol	Mounting Positions	Color LED	Pkg. Qty.	Catalog Number
M22-SWD-K11LED_	Base Mount					
	1			 20		M22-SWD-K11LEDC-W
						M22-SWD-K11LEDC-B
						M22-SWD-K11LEDC-G
						M22-SWD-K11LEDC-R
M22-SWD-K22LED_	Base Mount					
	2			 10		M22-SWD-K22LEDC-W
						M22-SWD-K22LEDC-B
						M22-SWD-K22LEDC-G
						M22-SWD-K22LEDC-R

M22 Base Mount LED Modules

Mounting Positions	Color LED	Pkg. Qty.	Catalog Number
Base Mount			
	 20		M22-SWD-LEDC-W
			M22-SWD-LEDC-B
			M22-SWD-LEDC-G
			M22-SWD-LEDC-R

Other Components

Description	Length	Pkg. Qty.	Catalog Number
Universal Base			
			
Universal (Placeholder) Module			
Base mount	—	20	M22-SWD-NOPC
PCB Jumper			
			
Control Station PCB Jumper			
For bringing open mounting locations on the control station printed circuit board	—	1	M22-SWD-SEL8-10

PCB



Control Station PCBs

Description	Pkg. Qty.	Catalog Number
For surface mounting M22 enclosures and for base-mount pilot device modules. Includes a built-in switchable terminating resistor.		
Element enclosure PCB 1	1	M22-SWD-11-LP01
Element enclosure PCB 2	1	M22-SWD-12-LP01
Element enclosure PCB 3	1	M22-SWD-13-LP01
Element enclosure PCB 4	1	M22-SWD-14-LP01
Element enclosure PCB 6	1	M22-SWD-16-LP01

Enclosure Bushings

Bushing Socket



Description	Pkg. Qty.	Catalog Number
Enclosure bushing, 8-pole socket, M20	1	SWD4-SF8-20

Bushing Socket



Enclosure bushing, 8-pole plug, M20	1	SWD4-SM8-20
-------------------------------------	---	--------------------

Cord Grip



Round cable cord grip, M20	1	V-M20
----------------------------	---	--------------

Stacklight Modules with SmartWire-DT



Contents

Description

Page

Stacklight Modules with SmartWire-DT	
SL4 and SL7 Stacklight Base Modules	
Product Selection	V7-T9-41

Stacklight Base Modules with SmartWire-DT

Product Description

SL7 and SL4 Stacklights from Eaton provide reliable control over all key processes and machine availability. Now available in two sizes, 70 mm (SL7) and 40 mm (SL4), the new stacklights are engineered to keep you informed about potential material requirements, downtime and hazards. Modules are available in a wide selection of audible, illuminating and mounting options that are well suited to adapt to any industrial application.

Highly Modular and Versatile Line

- Easily configurable components
- Simple bayonet mounting mechanism for quick assembly
- Flexible mounting and lighting options
- Volume-adjustable alarms

Optimal Performance in Rugged Applications

- All elements have IP66 and UL Type 4/4X/13 ratings for protection against strong jets of water
- Bright and efficient LEDs with a lifespan of up to 100,000 hours
- High-performance LEDs for maximum illumination in direct sunlight
- Acoustic modules with up to 100 dB sound levels
- Operating temperatures: -22 to +140 °F (-30 to +60 °C)

Features

- Six lens colors: red, amber, yellow, green, blue, white
- Continuous, flashing, strobe and multi-strobe lighting functions
- Mono-tone, dual-tone and multi-tone audible alarms
- LED or incandescent lighting options
- Control up to five modules on a single stack

Benefits

- Simplified twist-and-lock assembly, no tools required
- Compact components reduce inventory requirements and increase flexibility
- Versatile hardware for quick installation and minimized downtime
- Slim 40 mm size is ideal for applications with constrained space
- Simplified wiring with SmartWire-DT connectivity
- Ideal for indoor and outdoor usage

Standards and Certifications

- UL 508—File No. E29184
- IEC/EN 60947-5-1
- CSA C22.2 No. 14-10
- CSA C22.2 No. 94-91
- CSA Class No. NKCR7



SL4 and SL7



See Volume 7—Logic Control, Operator Interface and Connectivity Solutions, CA08100008E, Tab 2 for complete product selection.

Stacklight Base Modules

Product Selection

SL4 and SL7—SmartWire-DT Versions for Control Cabinet Mounting

When mounted to a control cabinet, SL4 and SL7 stacklight base modules connect directly to the SmartWire-DT flat cable with two flat plug sockets. Stacklights in this case can be configured with up to five 24 Vdc light modules including an alarm unit. Jumpers on the base module select whether the stacklight is powered from the flat cable or an external 24 Vdc power supply. For this application, select the stacklight base models listed below.

	Description	Tube Length	For Use With	Catalog Number
<p>SL4-SWD</p> 	<p>Base with base adapter for rapid mounting and wiring Blade terminal SWD4-8MF2 Max. 0.3 A per module External power supply connectable (24 Vdc)</p>	100 mm	<p>SL4 40 mm diameter stacklights 24 Vdc</p> <p>See Volume 7, Tab 2 for light and alarm module selection</p>	SL4-SWD
<p>SL7-SWD</p> 	<p>Base with base adapter for rapid mounting and wiring Blade terminal SWD4-8MF2 Max. 0.3 A per module External power supply connectable (24 Vdc)</p>	100 mm	<p>SL7 70 mm diameter stacklights 24 Vdc</p> <p>See Volume 7, Tab 2 for light and alarm module selection</p>	SL7-SWD

SL4 and SL7—SmartWire-DT Versions for On Machine Mounting

Remote stacklights with up to three elements can also be constructed and connected to the 5-conductor round SmartWire-DT On Machine cabling system when the stacklight is located away from the main machine control cabinet.

See **Page V7-T9-55** for details.

On Machine Components



On Machine Components

Product Description

At the edge of the control cabinet, the SmartWire-DT system transitions from the 8-conductor flat cable to a 5-conductor round cable with standard DC M12 barrel connectors, using simple transition adapters that mount through the panel wall.

This round cable has five conductors, uses standard DC M12 barrel connectors, and is 300 V rated. It is used outside the control panel to connect machine mount (IP69K washdown-rated) I/O modules to the SmartWire-DT system for use with peripherals such as sensors, enclosed pushbuttons, remote enclosed contactors, pneumatic and hydraulic valves, stacklights and other remote devices. This single cable is used both to provide power to connected devices and to carry I/O signals.

Machine mountable I/O modules are connected as nodes on the SmartWire-DT network and allow standard or generic devices to be connected to the SmartWire-DT system. They can be connected anywhere around the machine with up to 2000 ft and 99 machine mount I/O modules possible with a single cable connection.

Features

- Modules with digital and analog channels to accommodate a wide variety of input and output devices
- Modules available in, single connector (1–2 I/O channel), dual connector (2–4 I/O channel), quad connector (4–8 I/O channel), and octal connector (8–16 I/O channel) versions to size exactly to your machine I/O needs at a particular device mounting location (quad and octal versions available in Q4 2016)
- Quad and octal block versions with separate power connection for discrete control of dedicated output channels
- Compatible with a wide range of sensors and actuators for easy integration into any machine design
- Most models offer 2 I/O channels per connection point when used with accessory splitters
- Special version available with 3 I/O channels on a single connection point to be compatible with 3-element stacklights and 3-element pushbutton stations using a single I/O cable
- Most versions provide configurable I/O channels to allow for selection as input or output in any combination
- Integrated 24 Vdc power and communications with single 5-conductor cable using standard DC M12 connectors
- Complete Plug & Play solution, integrated with In Panel SmartWire-DT wiring components including auto-addressing feature
- Connection of up to 99 modules and up to 2000 feet of cable on a single branch of the wiring system
- Built-in diagnostic bi-color LEDs on each module
- IP69K enclosure ratings for use in harsh washdown applications
- Tool-free mounting options
- Vertical and flat mounting possible

Contents

Description

Page

On Machine Components	
Machine Mount I/O Modules—Digital	V7-T9-43
Machine Mount I/O Modules—Analog	V7-T9-45
I/O Splitters	V7-T9-46
Other I/O Connections	V7-T9-46
Valve Connectors	V7-T9-47
Machine Mount Powerfeed Modules	V7-T9-47
Panel Transition Components	V7-T9-48
SmartWire-DT Round Bus Cables	V7-T9-49
Power Cables—Externally Powered	
I/O Models	V7-T9-50
Other System Components	V7-T9-52

Product Selection

Machine Mount I/O Modules—Digital

SmartWire-DT I/O modules for connection to most digital input and output devices. All EU1E and EU2E models receive power and I/O communications signals on the SmartWire-DT round bus cable shown on **Page V7-T9-49**. EU6E and EU8E models are offered in two versions—the first version is similar to the EU1E/EU2E models and receives power and I/O communications signals on the SmartWire-DT round bus cable. The second version offers an external power connection that gives the user discrete control of machine actuation outputs. This can be useful in a variety of different machine control situations including machine safety applications.

EU1E Models



EU2E Models



**EU6E Models
No external power**



**EU8E Models
No external power**





**EU6E Models
External power**





**EU8E Models
External power**



	Description	Number of Dedicated Inputs	Number of Dedicated Outputs	Number of Configurable Input/Output Channels	Catalog Number
EU1E-SWD_ 	One digital input channel Messages: Status of the digital input 1 Commands: None	1	0	0	EU1E-SWD-1DX
	Two digital input channels Messages: Status of the digital inputs 1 and 2 Commands: None	2	0	0	EU1E-SWD-2DX
	Two configurable digital input/output channels Messages: Status of the digital inputs 1 and/or 2 (if configured as inputs) Commands: Actuation of outputs 1 and/or 2 (if configured as outputs)	0	0	2	EU1E-SWD-2DD
EU2E-SWD_ 	Two digital input channels Messages: Status of the digital inputs 1 and 2 Commands: None	2	0	0	EU2E-SWD-2DX
	Four digital input channels Messages: Status of the digital inputs 1, 2, 3 and 4 Commands: None	4	0	0	EU2E-SWD-4DX
	Four configurable digital input/output channels Messages: Status of the digital inputs 1 and/or 2 and/or 3 and/or 4 (if configured as inputs) Commands: Actuation of outputs 1 and/or 2 and/or 3 and/or 4 (if configured as outputs) Note: I/O channels are arranged with channels 1 and 2 wired to I/O connector X1 and channels 3 and 4 wired to I/O connector X2	0	0	4	EU2E-SWD-4DD
	Four configurable digital input/output channels Messages: Status of the digital inputs 1 and/or 2 and/or 3 and/or 4 (if configured as inputs) Commands: Actuation of outputs 1 and/or 2 and/or 3 and/or 4 (if configured as outputs) Note: I/O channels are arranged with channel 1 wired to I/O connector X1 and channels 2, 3 and 4 wired to I/O connector X2	0	0	4	EU2E-SWD-4DD-1

Machine Mount I/O Modules—Digital, continued

SmartWire-DT I/O modules for connection to most digital input and output devices.

	Description	Number of Dedicated Inputs	Number of Dedicated Outputs	Number of Configurable Input/Output Channels	Catalog Number	
	Quad: 4/8-Channel Multiblock Modules—no external power required					
	Eight digital input channels Messages: Status of the digital inputs 1, 2, 3, 4, 5, 6, 7 and 8 Commands: None Note: This model receives power from regular SmartWire-DT cabling and does not require any external power connection	8	0	0		EU6E-SWD-8DX
	Eight configurable digital input/output channels Messages: Status of the digital inputs 1 and/or 2 and/or 3 and/or 4 and/or 5 and/or 6 and/or 7 and/or 8 (if configured as inputs) Commands: Actuation of the digital outputs 1 and/or 2 and/or 3 and/or 4 and/or 5 and/or 6 and/or 7 and/or 8 (if configured as outputs) Note: This model receives power from regular SmartWire-DT cabling and does not require any external power connection	0	0	8		EU6E-SWD-8DD
	4/8-Channel Multiblock Modules—external power required					
	Two digital input channels, two digital output channels Messages: Status of the digital inputs 1 and 2 Commands: Actuation of the digital outputs 1 and 2 Note: This model has an external power connection for power to output channels only	2	2	0		EU6E-SWD-2D2D-1
	Two digital input channels, two digital output channels Messages: Status of the digital inputs 1 and 2 Commands: Actuation of the digital outputs 1 and 2 Note: This model has an external power connection for power to output channels only Note: This model has high-current output channels rated for 2 A each channel	2	2	0		EU6E-SWD-2D2D-2
	Four digital output channels Messages: None Commands: Actuation of the digital outputs 1, 2, 3 and 4 Note: This model has an external power connection for power to output channels only	0	4	0		EU6E-SWD-4XD-1
	Four digital output channels Messages: None Commands: Actuation of the digital outputs 1, 2, 3 and 4 Note: This model has an external power connection for power to output channels only Note: This model has high-current output channels rated for 2 A each channel	0	4	0		EU6E-SWD-4XD-2
	Four digital input channels, four digital output channels Messages: Status of the digital inputs 1, 2, 3 and 4 Commands: Actuation of the digital outputs 1, 2, 3 and 4 Note: This model has an external power connection for power to output channels only	4	4	0		EU6E-SWD-4D4D-1
	Four digital input channels, four digital output channels Messages: Status of the digital inputs 1, 2, 3 and 4 Commands: Actuation of the digital outputs 1, 2, 3 and 4 Note: This model has an external power connection for power to output channels only Note: This model has high-current output channels rated for 2 A each channel	4	4	0		EU6E-SWD-4D4D-2
	Eight digital output channels Messages: None Commands: Actuation of the digital outputs 1, 2, 3, 4, 5, 6, 7 and 8 Note: This model has an external power connection for power to output channels only	0	8	0		EU6E-SWD-8XD-1
	Octal: 8/16-Channel Multiblock Modules—no external power required					
		Sixteen digital input channels Messages: Status of the digital inputs 1, 2, 3, 4, 5, 6, 7, 8, 9, 10, 11, 12, 13, 14, 15 and 16 Commands: None Note: This model receives power from regular SmartWire-DT cabling and does not require any external power connection	16	0	0	
	Sixteen configurable digital input/output channels Messages: Status of the digital inputs 1 and/or 2 and/or 3 and/or 4 and/or 5 and/or 6 and/or 7 and/or 8 and/or 9 and/or 10 and/or 11 and/or 12 and/or 13 and/or 14 and/or 15 and/or 16 (if configured as inputs) Commands: Actuation of the digital outputs 1 and/or 2 and/or 3 and/or 4 and/or 5 and/or 6 and/or 7 and/or 8 and/or 9 and/or 10 and/or 11 and/or 12 and/or 13 and/or 14 and/or 15 and/or 16 (if configured as outputs) Note: This model receives power from regular SmartWire-DT cabling and does not require any external power connection	0	0	16		EU8E-SWD-16DD

Machine Mount I/O Modules—Digital, continued

SmartWire-DT I/O modules for connection to most digital input and output devices.

EU8E-SWD_



Description	Number of Dedicated Inputs	Number of Dedicated Outputs	Number of Configurable Input/Output Channels	Catalog Number
8/16-Channel Multiblock Modules—external power required				
Four digital input channels, four digital output channels Messages: Status of the digital inputs 1, 2, 3 and 4 Commands: Actuation of the digital outputs 1, 2, 3 and 4 Note: This model has an external power connection for power to output channels only	4	4	0	EU8E-SWD-4D4D-1
Eight digital input channels, eight digital output channels Messages: Status of the digital inputs 1, 2, 3, 4, 5, 6, 7 and 8 Commands: Actuation of the digital outputs 1, 2, 3, 4, 5, 6, 7 and 8 Note: This model has an external power connection for power to output channels only	8	8	0	EU8E-SWD-8D8D-1
Eight digital output channels Messages: None Commands: Actuation of the digital outputs 1, 2, 3, 4, 5, 6, 7 and 8 Note: This model has an external power connection for power to output channels only	0	8	0	EU8E-SWD-8XD-1
Sixteen digital output channels Messages: None Commands: Actuation of the digital outputs 1, 2, 3, 4, 5, 6, 7, 8, 9, 10, 11, 12, 13, 14, 15 and 16 Note: This model has an external power connection for power to output channels only	0	16	0	EU8E-SWD-16XD-1

9

Machine Mount I/O Modules—Analog

SmartWire-DT I/O modules for connection to various analog input and output devices.

EU1E-SWD_



Description	Number of Dedicated Inputs	Number of Dedicated Outputs	Number of Configurable Input/Output Channels	Catalog Number
One analog input channel 0–10 Vdc Messages: Analog input level Commands: None	1	0	0	EU1E-SWD-1AX-1
One analog input channel 0–20 mA Messages: Analog input level Commands: None	1	0	0	EU1E-SWD-1AX-2
One analog output channel 0–10 Vdc Messages: None Commands: Analog output level	0	1	0	EU1E-SWD-1XA-1
One analog output channel 0–20 mA Messages: None Commands: Analog output level	0	1	0	EU1E-SWD-1XA-2
One encoder input channel 30 kHz Messages: Encoder count signals Commands: None	1	0	0	EU1E-SWD-1CX

EU2E-SWD_



Two RTD temperature input channels Messages: Temperature input level Commands: None	2	0	0	EU2E-SWD-2PT
---	---	---	---	--------------

9.1

Connectivity Solutions

SmartWire-DT In Panel and On Machine Wiring Solution





I/O Splitters

To allow for use of both available channels on applicable digital input/output modules.

	Description	Pkg Qty.	Catalog Number
	Combines two devices into a single I/O connection point. Both device connections are 4-pin DC M12. Power is common between devices, and the splitter module is wired to Pin 4 for each connected sensor, actuator or other device.	1	SWD4-SP-4124
	Combines two devices into a single I/O connection point. Both device connections are 4-pin DC M12. Power is common between devices, and the splitter module is wired to Pin 2 for each connected sensor, actuator or other device.	1	SWD4-SP-4122
	Combines two devices into a single I/O connection point. Both device connections are 4-pin M8. Power is common between devices, and the splitter module is wired to Pin 4 for each connected sensor, actuator or other device.	1	SWD4-SP-4084
	Combines two devices into a single I/O connection point. Both device connections are 4-pin M8. Power is common between devices, and the splitter module is wired to Pin 2 for each connected sensor, actuator or other device.	1	SWD4-SP-4082
	Combines two devices into a single I/O connection point. Both device connections are 3-pin M8. Power is common between devices, and the splitter module is wired to Pin 2 for each connected sensor, actuator or other device.	1	SWD4-SP-3084

Other I/O Connections

For connection to I/O devices with and without built-in M12 connections.

	Description	Pkg Qty.	Catalog Number
	Enclosure and Remote Device M12 Receptacles		
	M12 5-pin male receptacle, 1/2 inch NPT back threads, 3.2 ft (1 m) wiring leads. For use with Eaton SL4/SL7 Series Stacklights with post-mount bases. Also for connection of remote panel Contactors and other devices to On Machine I/O modules.	1	SWD4-PRM5-1-S
	M12 5-pin female receptacle, 1/2 inch NPT back threads, 3.2 ft (1 m) wiring leads. For use where needed in remote panel wiring situations.	1	SWD4-PRF5-1-S
	M12 5-pin male receptacle, M20 front threads, 5 inch wiring leads. For use with Eaton SL4/SL7 Series Stacklights with fast-mount bases. Also for use with Eaton M22 Series remote pushbutton enclosures.	1	SWD4-PRM5-2-S
	M12 5-pin female receptacle, M20 front threads, 5 inch wiring leads. For use where needed in remote enclosure wiring situations.	1	SWD4-PRF5-2-S
	I/O Device Cables Double-Ended		
	6 in (0.1 m) length	1	SWD4-M1LR5-1-2S
	1 ft (0.3 m) length	1	SWD4-M3LR5-1-2S
	2 ft (0.6 m) length	1	SWD4-M6LR5-1-2S
	3.2 ft (1 m) length	1	SWD4-1LR5-1-2S
6.5 ft (2 m) length	1	SWD4-2LR5-1-2S	
	I/O Device Cables Single-Ended		
	1 ft (0.3 m) length	1	SWD4-M3LR5-S
	2 ft (0.6 m) length	1	SWD4-M6LR5-S
	3.2 ft (1 m) length	1	SWD4-1LR5-S
	6.5 ft (2 m) length	1	SWD4-2LR5-S
	Cord Grips		
	Round cable cord grip, M20	1	V-M20
	Round cable cord grip, 1/2 inch NPT	1	V-12NPT

Valve Connectors

For connections to Proportional and ON/OFF valves with EN 175301803 / DIN 43650, Industry Standard and M12 connections.

	Description	Pkg Qty.	Catalog Number
 EU3E-SWD-X1H-1	Proportional/ON/OFF Valve Connectors EN/DIN Proportional/ON/OFF Valve Connectors are designed for compact, electronic control of non-feedback hydraulic proportional and switching valves conforming to ISO 4400/DIN 43650. No separate T-Connector is required as the SmartWire-DT round bus cables found on Page V7-T9-49 wire directly in and out of two M12 connection points. Interface: ISO 4400/DIN 43650 Type A (18 mm)	1	EU3E-SWD-X1H-1

	Description	Valve Power Limit	Pkg Qty.	Catalog Number
 SWD4-V	ON/OFF Valve Connectors—EN/DIN/IS Connectors mount directly to valves and have single M12 connectors for wiring to T-Connectors. When used with standard "I/O Device Cables Double-Ended" listed on Page V7-T9-46 to make the connection between T-Connectors and these valve connectors, these connectors will support up to 10 W hydraulic and pneumatic valves. When used with "Valve Device Cables Double-Ended" listed below, up to 30 W valves are supported.			
	EN 175301803 / DIN 43650 Type A 18 mm (terminal spacing) ON/OFF valve	30 W	1	SWD4-VA3-1-S
	EN 175301803 / DIN 43650 Type B 10 mm (terminal spacing) ON/OFF valve	30 W	1	SWD4-VB3-1-S
	Industry standard mini/Form B 11 mm (terminal spacing) ON/OFF valve	30 W	1	SWD4-VB3-2-S
	EN 175301803 / DIN 43650 Type C 8 mm (terminal spacing) ON/OFF valve	30 W	1	SWD4-VC3-1-S
	Industry standard sub-micro/Form C 9.4 mm (terminal spacing) ON/OFF valve	30 W	1	SWD4-VC3-2-S

	Description	Pkg Qty.	Catalog Number
 SWD4-2LR5-3-2S	Valve Device Cables Double-Ended Connector cables with special wiring to allow higher-wattage valves to be used with standard T-Connectors. In these connectors, all three potential output channels from standard T-Connectors are wired to the valve terminals. Each output channel is nominally rated at 500 mA. If two or three output channels are used and are turned on simultaneously, the use of these special cable versions will connect those multiple outputs to the valve coil terminals. With two channels simultaneously energized, up to 20 W valves are supported. With three channels simultaneously energized, up to 30 W valves are supported.		
	1 ft (0.3 m) length	1	SWD4-M3LR5-3-2S
	2 ft (0.6 m) length	1	SWD4-M6LR5-3-2S
	3.2 ft (1 m) length	1	SWD4-1LR5-3-2S
	6.5 ft (2 m) length	1	SWD4-2LR5-3-2S

EU1S-SWD-PF1-2



Machine Mount Powerfeed Modules

Machine mount Powerfeed modules feed auxiliary 24 Vdc power into the On Machine SmartWire-DT round cable system. Supplemental 24 Vdc power is only needed if the total power consumption of devices connected to the On Machine SmartWire-DT system exceeds the available power from the main control cabinet connection. These modules can be connected at any location in the system, and there is no limit to the number of Powerfeed modules that can be connected in a system branch.

Description	Maximum Powerfeed Capacity	Pkg Qty.	Catalog Number
Provides connection point for external 24 Vdc power supply input.	4 A	1	EU1S-SWD-PF1-2





9.1

Connectivity Solutions



SmartWire-DT In Panel and On Machine Wiring Solution

Powerfeed Cables

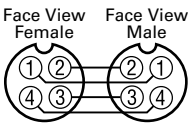
Powerfeed cables are used to connect from a source of 24 Vdc power to the power input connection on the EU1S-SWD-PF1-2 Powerfeed module.

	Voltage Style	Number of Pins	Gauge	Length	Pin Configuration/Wire Colors (Face View Female Shown)	PVC Jacket Catalog Number	PUR Jacket Catalog Number
CSDS4A4_ 	DC	4-pin, 4-wire	22 AWG	6.0 ft (2 m)		CSDS4A4CY2202	CSDS4A4RY2202
				16.4 ft (5 m)		CSDS4A4CY2205	CSDS4A4RY2205
				32.8 ft (10 m)		CSDS4A4CY2210	CSDS4A4RY2210
				65.6 ft (20 m)		CSDS4A4CY2220	—
CSDR4A4_ 	DC	4-pin, 4-wire	22 AWG	6.0 ft (2 m)		CSDR4A4CY2202	CSDR4A4RY2202
				16.4 ft (5 m)		CSDR4A4CY2205	CSDR4A4RY2205
				32.8 ft (10 m)		CSDR4A4CY2210	CSDR4A4RY2210
CSDS4A4_ 	DC	4-pin, 4-wire	22 AWG	3.0 ft (1 m)		CSDS4A4CY2201-D	—
				5.0 ft (1.5 m)		CSDS4A4CY2201.5-D	—
				6.0 ft (2 m)		CSDS4A4CY2202-D	—
				10.0 ft (3 m)		CSDS4A4CY2203-D	—
				16.4 ft (5 m)		CSDS4A4CY2205-D	—

Panel Transition Components



Description	Pkg Qty.	Catalog Number
SWD4-SFL8-12  Flat-to-Round Cabinet Transition Adapter To transition between in-cabinet flat cabling and on machine round cabling. Wiring terminals allow external 24 Vdc power supply at this location if desired. Jumper these terminals to utilize 24 Vdc power from the incoming flat cable.	1	SWD4-SFL8-12
SWD4-SML8-12  Round-to-Flat Cabinet Transition Adapter To transition between on machine round cabling and in-cabinet flat cabling. Wiring terminals allow external 24 Vdc power supply at this location if desired. Jumper these terminals to utilize 24 Vdc power from the incoming round cable.	1	SWD4-SML8-12
SWD4-SML5-12  Cabinet Cable Pass-Through Adapter For passing the SmartWire-DT round cable connection easily through a panel or a cabinet wall.	1	SWD4-SML5-12

Note

① SmartWire-DT round bus cables shown on **Page V7-T9-49** have 22 AWG power conductors and can also be used as Powerfeed cables, offering additional length options.



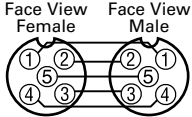

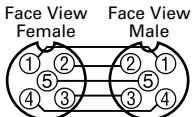
Right Angle Adapter Cables

These adapters are typically used to create a lower profile at the panel transition wiring point.

Voltage Style	Number of Pins	Gauge	Length	Pin Configuration/Wire Colors (Face View Female Shown)	PVC Jacket Catalog Number	
SWD4-M1LR5-RS 	Right Angle					SWD4-M1LR5-RS
	DC	5-pin	22 AWG	6 in (0.1 m)		
SWD4-M1LR5-SR 	Micro-Style Right Angle Female/Straight Male					SWD4-M1LR5-SR
	DC	5-pin	22 AWG	6 in (0.1 m)		

SmartWire-DT Round Bus Cables

These cables are used to connect between the panel transition wiring adapter and the Machine Mount I/O modules on the system.

Description	Pkg Qty.	Catalog Number	
SWD4-__ 	Round Cable		
	Each cable is 5-conductor, with one male DC M12 and one female DC M12 connector at each end.		
	6 in (0.1 m) length	1	SWD4-M1LR5-2S
	1 ft (0.3 m) length	1	SWD4-M3LR5-2S
	2 ft (0.6 m) length	1	SWD4-M6LR5-2S
	3.2 ft (1 m) length	1	SWD4-1LR5-2S
	4.9 ft (1.5 m) length	1	SWD4-1M5LR5-2S
	6.5 ft (2 m) length	1	SWD4-2LR5-2S
	9.8 ft (3 m) length	1	SWD4-3LR5-2S
	13.1 ft (4 m) length	1	SWD4-4LR5-2S
	16.4 ft (5 m) length	1	SWD4-5LR5-2S
	32.8 ft (10 m) length	1	SWD4-10LR5-2S
65.6 ft (20 m) length	1	SWD4-20LR5-2S	
SWD4-XXXLR5 	Bulk Cable and Field-Wireable Connectors for Non-Standard Cable Lengths		
	Non-standard cable lengths can be easily constructed using the raw cable and field-installable connectors in this section.		
Bulk cable (to build non-standard lengths)	Order in meters	SWD4-XXXLR5	
SWD4-SF5-67 	Female (to terminate raw cable)	1 SWD4-SF5-67	
SWD4-SM5-67 	Male (to terminate raw cable)	1 SWD4-SM5-67	







9.1

Connectivity Solutions

SmartWire-DT In Panel and On Machine Wiring Solution

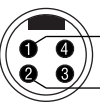

Power Cables—Externally Powered I/O Models

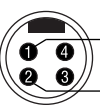
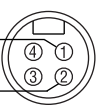
To bring power to and pass power between externally powered EU6E and EU8E models starting on **Page V7-T9-43**.

	Current Rating at 600 V	Voltage Style	Number of Pins	Gauge	Length	Pin Configuration/Wire Colors (Face View Female Shown)	Catalog Number
Mini-Style Straight Female 	10 A	AC/DC	4-pin, 4-wire	16 AWG	6.5 ft (2 m)	 1-Brown 2-White 3-Blue 4-Black	SWD4-2LR4P-S
					13 ft (4 m)		SWD4-4LR4P-S
					19.5 ft (6 m)		SWD4-6LR4P-S
					32.5 ft (10 m)		SWD4-10LR4P-S
					65 ft (20 m)		SWD4-20LR4P-S
Mini-Style Right-Angle Female 	10 A	AC/DC	4-pin, 4-wire	16 AWG	6.5 ft (2 m)	 1-Brown 2-White 3-Blue 4-Black	SWD4-2LR4P-R
					13 ft (4 m)		SWD4-4LR4P-R
					19.5 ft (6 m)		SWD4-6LR4P-R
					32.5 ft (10 m)		SWD4-10LR4P-R
					65 ft (20 m)		SWD4-20LR4P-R
Mini-Style Straight Female/Male 	10 A	AC/DC	4-pin, 4-wire	16 AWG	1 ft (0.3 m)	Face View Male  Face View Female 	SWD4-M3LR4P-2S
					2 ft (0.6 m)		SWD4-M6LR4P-2S
					3.2 ft (1 m)		SWD4-1LR4P-2S
					4.9 ft (1.5 m)		SWD4-1M5LR4P-2S
					6.5 ft (2 m)		SWD4-2LR4P-2S
					10 ft (3 m)		SWD4-3LR4P-2S
					13 ft (4 m)		SWD4-4LR4P-2S
					16.4 ft (5 m)		SWD4-5LR4P-2S
					32.5 ft (10 m)		SWD4-10LR4P-2S
					65 ft (20 m)		SWD4-20LR4P-2S
Mini-Style Right-Angle Female/Male 	10 A	AC/DC	4-pin, 4-wire	16 AWG	1 ft (0.3 m)	Face View Male  Face View Female 	SWD4-M3LR4P-2R
					2 ft (0.6 m)		SWD4-M6LR4P-2R
					3.2 ft (1 m)		SWD4-1LR4P-2R
					4.9 ft (1.5 m)		SWD4-1M5LR4P-2R
					6.5 ft (2 m)		SWD4-2LR4P-2R
					10 ft (3 m)		SWD4-3LR4P-2R
					13 ft (4 m)		SWD4-4LR4P-2R
					16.4 ft (5 m)		SWD4-5LR4P-2R
					32.5 ft (10 m)		SWD4-10LR4P-2R
					65 ft (20 m)		SWD4-20LR4P-2R



Power Cables—Externally Powered I/O Models, continued

To bring power to and pass power between externally powered EU6E and EU8E models starting on **Page V7-T9-43**.

	Description	Pkg Qty.	Catalog Number
	Bulk Cable and Field-Wireable Connectors for Non-Standard Cable Lengths Non-standard cable lengths can be easily constructed using the raw cable and field-installable connectors in this section.		
	Bulk cable (4-conductor, 16 AWG)	Order in meters	SWD4-XXLR4P
	Female straight (to terminate raw cable)	1	SWD4-SF4P-67
	Male straight (to terminate raw cable)	1	SWD4-SM4P-67
	Female right angle (to terminate raw cable)	1	SWD4-SF4P-67R
	Male right angle (to terminate raw cable)	1	SWD4-SM4P-67R

Other Power Cabling Connections

To provide a panel transition for the 24 Vdc power feed to I/O modules with external power connection.

Voltage Style	Number of Pins	Gauge	Length	Mounting Hole Size	Pin Configuration/Wire Colors (Face View Female Shown)	Catalog Number	
Panel Transition Adapter							
To easily bring power for externally powered I/O modules through a panel wall.							
	AC/DC	4-pin, 4-wire	16 AWG	3.2 ft (1 m)	1/2-14 in NPT back threads	 1-Brown 2-White 3-Blue 4-Black	SWD4-PRF4P-1-S

9.1

Connectivity Solutions

SmartWire-DT In Panel and On Machine Wiring Solution

Other System Components

	Description	Pkg Qty.	Catalog Number
SWD4-RC5-10	Bus Termination Module To terminate the end of an on machine SmartWire-DT round cable network branch	1	SWD4-RC5-10
			
	Connector Caps		
SWD4-ACAP-10	Active cap—allows for remote monitoring of the health of an unused device connection on a machine mount I/O module over the SmartWire-DT network	1	SWD4-ACAP-10
			
SWD4-PCAP-F	Passive cap—to provide physical protection and sealing if nothing is connected to the female M12 connector on a machine mount I/O module	1	SWD4-PCAP-F
			
SWD4-PCAP-M	Passive cap—to provide physical protection and sealing if nothing is connected to the male M12 connector on a machine mount I/O module	1	SWD4-PCAP-M
			
SWD4-PCAPP-F	Passive cap—to provide physical protection and sealing if nothing is connected to the female-mini (7/8 in) external power connection on a machine mount I/O module	1	SWD4-PCAPP-F
			
SWD4-PCAPP-M	Passive cap—to provide physical protection and sealing if nothing is connected to the male-mini (7/8 in) external power connection on a machine mount I/O module	1	SWD4-PCAPP-M
			
	Mounting Accessories		
SWD4-MNT-VER	Clip mount—for easy mounting of a machine mount I/O module to any flat or channeled surface, including cylinders and other mounting situations where T-channels are present. Once the bracket is mounted, the I/O Module can be removed and reinstalled without tools	1	SWD4-MNT-VER
			
SWD4-MNT-DIN	DIN rail mount—for easy mounting of an EU1E_ or EU2E_ machine mount I/O Module to DIN rail	2	SWD4-MNT-DIN
			
	Universal (Placeholder) Module		
EU1M-SWD-NOP	For use to hold a network address location for a node that may be installed at some time in the future	1	EU1M-SWD-NOP
			

Enclosed (IP67) Pilot Devices



Contents

Description

Page

Enclosed (IP67) Pilot Devices	
Enclosed M22 Pilot Device Examples	V7-T9-54
Enclosures	V7-T9-54
M12 Wiring Receptacles	V7-T9-54

Enclosed (IP67) Pilot Devices

Product Description

Many remote pilot devices of various types and from various manufacturers can be connected to a machine’s control cabinet using the SmartWire-DT On Machine wiring system. This section describes a series of easy to assemble versions of a range of pilot devices from within Eaton’s M22 standard catalog family to make this connection quick and easy. With simple assembly using standard catalog components, enclosed devices can easily be connected to the SmartWire-DT On Machine wiring system at any mounting location on the machine. This approach to remote device wiring can help the OEM eliminate wiring, terminal blocks and PLC input/output modules in the machine control cabinet.

Features

- Simple assembly with catalog components achieves IP67 sealing and offers plug & play connection to the SmartWire-DT network
- Base-mount contact blocks and LED modules allow for simple removal of the enclosure cover without disturbing switch wiring
- Simple connection via standard cable accessories to SmartWire-DT Machine Mount I/O modules
- Wide variety of enclosures, pushbuttons, selector switches, key switches, pilot lights, and other devices make solving a range of machine applications easy

Product Selection

M22 operators and indicating lights including momentary and maintained pushbuttons, pilot lights, hand and key operated selector switches, and palm switches.

Enclosed M22 Pilot Device Examples



Pushbutton	Double Pushbutton	Selector Switch	Key Selector Switch	Palm Switch
------------	-------------------	-----------------	---------------------	-------------

M22-I_



Enclosures

This is a representative subset of Eaton's line of sealed mounting enclosures for M22 devices. Receptacles in the next section require M20 enclosure knockouts, which are present in all M22 enclosures offered by Eaton but are most common in the enclosures listed in this section.

Description	Catalog Number
One-element enclosure	M22-I1
Two-element enclosure	M22-I2
Three-element enclosure	M22-I3
Four-element enclosure	M22-I4
Six-element enclosure	M22-I6

SWD4-PRM5-...



M12 Wiring Receptacles

Panel-mount M12 connector receptacles designed expressly for mounting in M20 enclosure knockouts in sealed M22 mounting enclosures listed in the previous section.

Description	Catalog Number
5-inch wiring leads, M20 front threads	SWD4-PRM5-2-S
1-meter wiring leads, M20 front threads	SWD4-PRM5-1-S

Assembly Instructions

1. Select pushbutton or pilot light operator and required contact blocks/light modules from catalog Volume 7 Tab 1.
2. Select enclosure from above listing.
3. Select receptacle from above listing.
4. Mount receptacle in enclosure knockout.
5. Wire receptacle to contact blocks and/or light modules as follows:
 - a. To wire a pushbutton or other pilot device as an input to the SmartWire-DT system
 - 1) The receptacle brown lead is wired to one side of the switch contact
 - 2) The receptacle black, white or gray Ⓞ lead is wired to the other side of the switch contact
 - b. To wire an indicating light or actuator as an output from the SmartWire-DT system
 - 1) The receptacle blue lead is wired to one side of the actuator or pilot light contact
 - 2) The receptacle black, white, or gray Ⓞ lead is wired to the other side of the actuator or pilot light contact

Note

Ⓞ SmartWire-DT machine mount I/O modules (see [Page V7-T9-43](#)) are offered in versions with multiple input and output channels per M12 connection point. In the receptacle wiring scheme, one channel is available on the black wire, the second channel is available on the white wire, and a third channel (if available) is carried on the gray wire. If three channels on a single device connector are needed for a 3-element stacklight or 3-element pushbutton station, see EU2E-SWD-4DD-1 in the main T-connector model listing.

Remote Machine Mount Stacklights



Contents

<i>Description</i>	<i>Page</i>
Remote Machine Mount Stacklights	
Stacklight Mounting Modules— Fast Mounting System	V7-T9-56
Stacklight Mounting Modules— Post Mounting System	V7-T9-57

Remote Machine Mount Stacklights

Product Description

Stacklights located remotely on a machine can be easily connected to a machine’s logic control using SmartWire-DT. This section describes how to easily add an M12 connector to the base of the SL4 and SL7 standard catalog stacklight families to make this SmartWire-DT connection quick and easy.

These assembled stacklights can then be directly connected to SmartWire-DT machine mount I/O modules. This plug & play connection scheme speeds machine assembly, installation and commissioning, and helps the OEM eliminate wiring, terminal blocks and PLC input/output modules in the control cabinet.

Features

- Simple wiring receptacle mounts directly to stacklight base units to provide IP67 sealing for stacklights remotely located on the machine
- Wiring receptacles are fully compatible with Eaton’s rapid mount and aluminum tube bases
- A single cable connection operates up to 3 light or audible modules from the SL7 or SL4 families in any combination
- Simple connection with a single standard cable to SmartWire-DT Machine Mount I/O modules
- Plug & play wiring and auto-addressing means no special setup is required

Stacklight Mounting Modules—Fast Mounting System

Includes Cover, Maximum 3 Modules



Description	Tube Length	Color	Standard Pack	For use with ...	Catalog Number
Base with base adapter for rapid mount/dismount Screw terminals SL7 Series Stacklights	100 mm	Black with	1	SL7-L-...	SL7-FMS-100
	250 mm	Aluminum- color tube		SL7-BL-...	SL7-FMS-250
	400 mm			SL7-FL-... SL7-AP-...	SL7-FMS-400
Base with base adapter for rapid mount/dismount Screw terminals SL4 Series Stacklights	100 mm	Black with	1	SL4-L-...	SL4-FMS-100
	250 mm	Aluminum- color tube		SL4-BL-...	SL4-FMS-250
	400 mm			SL4-FL-... SL4-AP-...	SL4-FMS-400

9

M12 Wiring Receptacles

Description	Detail	Catalog Number
SWD4-PRM5-2-S For wiring an SL7/SL4 Stacklight with a Fast Mount (FMS) base	M12 5-pin male receptacle, M20 front threads, 5-inch wiring leads	SWD4-PRM5-2-S

Assembly Instructions

1. Select Stacklight light modules from catalog Volume 7 Tab 2.
2. Select Stacklight mounting base from above listings.
3. Select receptacle appropriate for chosen Stacklight mounting base from above listing.
If using the Post Mount base, also select a Stacklight Mounting Adapter from that section above.
4. Mount receptacle in Fast Mount base or Post Mount base adapter.
5. Wire receptacle to Stacklight terminals as follows:
 - a. The receptacle blue lead is wired to Terminal #0 on the Stacklight
 - b. The receptacle black, white or gray lead is wired to the numbered terminal for the light module in question

Note

① SmartWire-DT On Machine I/O modules (see **Page V7-T9-43**) are offered in versions with multiple input and output channels per M12 connection point. In the receptacle wiring scheme, one channel is available on the black wire, the second channel is available on the white wire, and a third channel (if available) is carried on the gray wire. If three channels on a single device connector are needed for a 3-element stacklight or 3-element pushbutton station, see EU2E-SWD-4DD-1 in the model listing on **Page V7-T9-43**.

Stacklight Mounting Modules—Post Mounting System

Includes Cover, Maximum 3 Modules

	Description	Tube Length	Color	Standard Pack	For use with ...	Catalog Number	
 <p>SLx-PIB/CB-T</p>	Base with aluminum tube and 3/4 in NPT threaded base Spring-loaded terminals SL7 Series Stacklights	100 mm	Black with Aluminum-color tube	1	SL7-L-...	SL7-CB-T-100	
		250 mm			SL7-BL-...	SL7-CB-T-250	
		400 mm			SL7-FL-...	SL7-CB-T-400	
		Base with aluminum tube and 3/4 in NPT threaded base Spring-loaded terminals SL4 Series Stacklights	100 mm	Black with Aluminum-color tube	1	SL4-L-...	SL4-PIB-T-100
			250 mm			SL4-BL-...	SL4-PIB-T-250
			400 mm			SL4-FL-...	SL4-PIB-T-400

Stacklight Mounting Adapter

	Description	Detail	Catalog Number
 <p>SL7/4-FW-T</p>	Mounting adapter to allow wiring receptacle to mount to stacklight post mount base	Mounting adapter kit	SL7/4-FW-T

M12 Wiring Receptacles

	Description	Detail	Catalog Number
 <p>SWD4-PRM5-1-S</p>	For wiring an SL7/SL4 Stacklight with post-mount base	M12 5-pin male receptacle, 1/2 inch NPT back threads, 1-meter leads	SWD4-PRM5-1-S

Assembly Instructions

1. Select Stacklight light modules from catalog Volume 7 Tab 2.
2. Select Stacklight mounting base from above listings.
3. Select receptacle appropriate for chosen Stacklight mounting base from above listing.
If using the Post Mount base, also select a Stacklight Mounting Adapter from that section above.
4. Mount receptacle in Fast Mount base or Post Mount base adapter.
5. Wire receptacle to Stacklight terminals as follows:
 - a. The receptacle blue lead is wired to Terminal #0 on the Stacklight
 - b. The receptacle black, white or gray lead is wired to the numbered terminal for the light module in question

Note

SmartWire-DT On Machine I/O modules (see **Page V7-T9-43**) are offered in versions with multiple input and output channels per M12 connection point. In the receptacle wiring scheme, one channel is available on the black wire, the second channel is available on the white wire, and a third channel (if available) is carried on the gray wire. If three channels on a single device connector are needed for a 3-element stacklight or 3-element pushbutton station, see EU2E-SWD-4DD-1 in the model listing on **Page V7-T9-43**.

Technical Data and Specifications

Gateway Modules

Description	Unit	EU5C-SWD-EIP-MODTCP Gateway	EU5C-SWD-PROFINET Gateway	EU5C-SWD-DP Gateway	EU5C-SWD-ETHERCAT Gateway	EU5C-SWD-CAN Gateway	EU5C-SWD-POWERLINK Gateway	EU5C-SWD-SERCOS Gateway
General								
Standards		IEC/EN 61131-2 EN 50178	IEC/EN 61131-2 EN 50178	IEC/EN 61131-2 EN 50178	IEC/EN 61131-2 EN 50178	IEC/EN 61131-2 EN 50178	IEC/EN 61131-2 EN 50178	IEC/EN 61131-2 EN 50178
Dimensions (W x H x D)	in (mm)	1.38 x 3.54 x 4.88 (35 x 90 x 124)	1.38 x 3.54 x 4.88 (35 x 90 x 124)	1.38 x 3.54 x 5.0 (35 x 90 x 127)	1.38 x 3.54 x 5.0 (35 x 90 x 127)	1.38 x 3.54 x 5.0 (35 x 90 x 127)	1.38 x 3.54 x 5.0 (35 x 90 x 127)	1.38 x 3.54 x 5.0 (35 x 90 x 127)
Weight	lbs (kg)	0.37 (0.17)	0.37 (0.17)	0.35 (0.16)	0.35 (0.16)	0.35 (0.16)	0.35 (0.16)	0.35 (0.16)
Mounting		DIN rail IEC/EN 60715, 35 mm			DIN rail IEC/EN 60715, 35 mm		DIN rail IEC/EN 60715, 35 mm	
Mounting position		Vertical	Vertical	Vertical	Vertical	Vertical	Vertical	Vertical
Ambient Conditions, Mechanical								
Degree of protection (IEC/EN 60529)		IP20	IP20	IP20	IP20	IP20	IP20	IP20
Vibrations (IEC/EN 61131-2:2008)								
Constant amplitude 3.5 mm	Hz	5–8.4	5–8.4	5–8.4	5–8.4	5–8.4	5–8.4	5–8.4
Constant acceleration 1 g	Hz	8.4–150	8.4–150	8.4–150	8.4–150	8.4–150	8.4–150	8.4–150
Mechanical shock resistance (IEC/EN 60068-2-27) semi-sinusoidal 15 g/11 ms								
Drop to IEC/EN 60068-2-31 (drop height)	in (mm)	1.97 (50)	1.97 (50)	1.97 (50)	1.97 (50)	1.97 (50)	1.97 (50)	1.97 (50)
Free fall, packaged (IEC/EN 60068-2-32)	ft (m)	1.0 (0.3)	1.0 (0.3)	1.0 (0.3)	1.0 (0.3)	1.0 (0.3)	1.0 (0.3)	1.0 (0.3)
Electromagnetic Compatibility (EMC)								
Overvoltage category		II	II	II	II	II	II	II
Pollution degree		2	2	2	2	2	2	2
Electrostatic discharge (IEC/EN 61131-2:2008)								
Air discharge (Level 3)	kV	8	8	8	8	8	8	8
Contact discharge (Level 2)	kV	4	4	4	4	4	4	4
Electromagnetic fields (IEC/EN 61131-2:2008)								
80–1000 MHz	V/m	10	10	10	10	10	10	10
1.4–2 GHz	V/m	3	3	3	3	3	3	3
2–2.7 GHz	V/m	1	1	1	1	1	1	1
Radio interference suppression (SmartWire-DT)		EN 55011 Class A			EN 55011 Class A		EN 55011 Class A	
Burst (IEC/EN 61131-2:2008, Level 3)								
Supply cables	kV	2	2	2	2	2	2	2
CAN/DP bus cable	kV	1	1	1	1	1	1	1
SmartWire-DT cables	kV	1	1	1	1	1	1	1
Surge (IEC/EN 61131-2:2008, Level 1)								
Supply cables	kV	0.5	0.5	0.5	0.5	0.5	0.5	0.5
CAN/DP bus cable	kV	1	1	1	1	1	1	1
Radiated RFI (IEC/EN 61131-2:2008, Level 3)	V	10	10	10	10	10	10	10
Climatic Environmental Conditions								
Operating ambient temperature (IEC 60068-2)	°F (°C)	–13° to 131° (–25° to 55°)			–13° to 131° (–25° to 55°)		–13° to 131° (–25° to 55°)	
Condensation		Prevent with suitable measures			Prevent with suitable measures		Prevent with suitable measures	
Storage	°F (°C)	–40° to 158° (–40° to 70°)			–40° to 158° (–40° to 70°)		–40° to 158° (–40° to 70°)	
Relative humidity, noncondensing (IEC/EN 60068-2-30)	%	5–95	5–95	5–95	5–95	5–95	5–95	5–95
Supply Voltage U_{Aux}								
SM Puffer Bremer	V	24 Vdc (–15%/+20%)			24 Vdc (–15%/+20%)		24 Vdc (–15%/+20%)	
Residual ripple on the input voltage	%	≤5	≤5	5	5	5	5	5
Protection against polarity reversal		Yes	Yes	Yes	Yes	Yes	Yes	Yes
Max. current (I _{max})	A	2 ^①	2 ^①	2 ^①	2 ^①	2 ^①	2 ^①	2 ^①
Short-circuit rating		No, external fuse FAZ Z3			No, external fuse FAZ Z3		No, external fuse FAZ Z3	
Power loss	W	Normally 1	Normally 1	Normally 1	Normally 1	Normally 1	Normally 1	Normally 1
Potential isolation		No	No	No	No	No	No	No
Rated operating voltage of 24 Vdc modes	V	Typ. U _{Aux} –0.2	Typ. U _{Aux} –0.2	Typ. U _{Aux} –0.2	Typ. U _{Aux} –0.2	Typ. U _{Aux} –0.2	Typ. U _{Aux} –0.2	Typ. U _{Aux} –0.2

Note

① If contactors with a total current consumption >2 A are connected, a Powerfeed module EU5C-SWD-PF1/2 has to be used.

Gateway Modules, continued

Description	Unit	EU5C-SWD-EIP-MODTCP Gateway	EU5C-SWD-PROFINET Gateway	EU5C-SWD-DP Gateway	EU5C-SWD-ETHERCAT Gateway	EU5C-SWD-CAN Gateway	EU5C-SWD-POWERLINK Gateway	EU5C-SWD-SERCOS Gateway
Supply Voltage U_{Pow}								
Supply voltage	V	24 Vdc (-15%/+20%)						
Input voltage ripple	%	≤5	≤5	≤5	≤5	≤5	≤5	≤5
Siemens MPI, (optional)		Yes	Yes	Yes	Yes	Yes	Yes	Yes
Rated current (I)	A	0.7	0.7	0.7	0.7	0.7	0.7	0.7
Overload proof		Yes	Yes	Yes	Yes	Yes	Yes	Yes
Inrush current and duration	A	12.5 A/6 ms	12.5 A/6 ms	12.5 A/6 ms	12.5 A/6 ms	12.5 A/6 ms	12.5 A/6 ms	12.5 A/6 ms
Heat dissipation at 24 Vdc	W	3.8	3.8	3.8	3.8	3.8	3.8	3.8
Potential isolation between U _{Pow} and 15 V SmartWire-DT supply voltage		No	No	No	No	No	No	No
Bridging voltage dips	ms	10	10	10	10	10	10	10
Repetition rate	s	1	1	1	1	1	1	1
Status indication (LED)		Yes	Yes	Yes	Yes	Yes	Yes	Yes
SmartWire-DT Supply Voltage								
Rated operating voltage (U ₀)	V	14.5 ±3%	14.5 ±3%	14.5 ±3%	14.5 ±3%	14.5 ±3%	14.5 ±3%	14.5 ±3%
Max. current (I _{max})	A	0.7 ①	0.7 ①	0.7 ①	0.7 ①	0.7 ①	0.7 ①	0.7 ①
Short-circuit proof		Yes	Yes	Yes	Yes	Yes	Yes	Yes
Connection Supply Voltages								
Connection type		Push in terminals	Push in terminals	Push in terminals	Push in terminals	Push in terminals	Push in terminals	Push in terminals
Solid	mm ²	0.2–1.5 (AWG 24–16)	0.2–1.5 (AWG 24–16)	0.2–1.5 (AWG 24–16)	0.2–1.5 (AWG 24–16)	0.2–1.5 (AWG 24–16)	0.2–1.5 (AWG 24–16)	0.2–1.5 (AWG 24–16)
Flexible with ferrule	mm ²	0.25–1.5	0.25–1.5	0.25–1.5	0.25–1.5	0.25–1.5	0.25–1.5	0.25–1.5
SmartWire-DT Network								
Station type		SmartWire-DT master	SmartWire-DT master	SmartWire-DT master	SmartWire-DT master	SmartWire-DT master	SmartWire-DT master	SmartWire-DT master
Number of SmartWire-DT nodes		99	99	58	99	99	99	99 ②
Baud rates		125k, 500k, 2M 250k, 1M	125k 250k	125k 250k	125k 250k	125k 250k	125k 250k	125k 250k
Address allocation		Automatic	Automatic	Automatic	Automatic	Automatic	Automatic	Automatic
Status indication (LED)								
SmartWire-DT master		Green	Green	Green	Green	Green	Green	Green
Configurations		Red	Red	Red	Red	Red	Red	Red
Connections		Plug, 8-pole	Plug, 8-pole	Plug, 8-pole	Plug, 8-pole	Plug, 8-pole	Plug, 8-pole	Plug, 8-pole
Plug connectors		Flat plug SWD4-8MF2	Flat plug SWD4-8MF2	Flat plug SWD4-8MF2	Flat plug SWD4-8MF2	Flat plug SWD4-8MF2	Flat plug SWD4-8MF2	Flat plug SWD4-8MF2
Fieldbus Interface								
Bus protocol		Ethernet IP/Modbus TCP	PROFINET	PROFIBUS DP	EtherCAT	CANopen	POWERLINK	SERCOS
Baud rates		10/100 MB	10/100 MB	Up to 12 MB	Up to 12 MB	To 1 MB	To 1 MB	100 MB
Address allocation		Automatic	Automatic	Automatic	Automatic	Automatic	Automatic	Automatic
Station address		—	—	2–125	2–125	2–32	2–32	2–32
Address allocation		DIP switch/DHCP/BOOTP selection via DIP switch		DIP switch	DIP switch	DIP switch	DIP switch	DIP switch
Status display fieldbus interface (LED)		Link status: yellow (10 MB), green (100 MB) flashing			Two-colored red/green			
Terminating resistor		—	—	Switchable via plug	Switchable via plug	DIP switches	DIP switches	DIP switches
Connection design for field bus		2 x RJ45 (2-channel switch)	2 x RJ45 (2-channel switch)	1 x SUB-D socket, 9-pole	2 x RJ45, (2-channel switch)	1 x SUB-D socket, 9-pole	2 x RJ45, (2-channel switch)	2 x RJ45, (2-channel switch)
Potential isolation		Yes	Yes	Yes	Yes	Yes	Yes	Yes

Notes

① If contactors with a total current consumption >0.7 A are connected, a Power Feeder module EU5C-SWD-PF2 has to be used.

② Depends on SERCOS master capability.

Powerfeed Modules

Description	Unit	EU5C-SWD-PF1-1 Powerfeed	EU5C-SWD-PF2-1 Powerfeed
General			
Standards		IEC/EN 61131-2 EN 50178	IEC/EN 61131-2 EN 50178
Dimensions (W x H x D)	in (mm)	1.38 x 3.54 x 4.88 (35 x 90 x 124)	1.38 x 3.54 x 4.88 (35 x 90 x 124)
Weight	lbs (kg)	0.24 (0.11)	0.37 (0.17)
Mounting		DIN rail IEC/EN 60715, 35 mm	DIN rail IEC/EN 60715, 35 mm
Mounting position		Vertical	Vertical
Ambient Conditions, Mechanical			
Degree of protection (IEC/EN 60529)		IP20	IP20
Vibrations (IEC/EN 61131-2:2008)			
Constant amplitude 3.5 mm	Hz	5–8.4	5–8.4
Constant acceleration 1 g	Hz	8.4–150	8.4–150
Mechanical shock resistance (IEC/EN 60068-2-27) semi-sinusoidal 15 g/11 ms	Impacts	9	9
Drop to IEC/EN 60068-2-31 (drop height)	in (mm)	1.97 (50)	1.97 (50)
Free fall, packaged (IEC/EN 60068-2-32)	ft (m)	1.0 (0.3)	1.0 (0.3)
Electromagnetic Compatibility (EMC)			
Overvoltage category		II	II
Pollution degree		2	2
Electrostatic discharge (IEC/EN 61131-2:2008)			
Air discharge (Level 3)	kV	8	8
Contact discharge (Level 2)	kV	4	4
Electromagnetic fields (IEC/EN 61131-2:2008)			
80–1000 MHz	V/m	10	10
1.4–2 GHz	V/m	3	3
2–2.7 GHz	V/m	1	1
Radio interference suppression (SmartWire-DT)		EN 55011 Class A	EN 55011 Class A
Burst (IEC/EN 61131-2:2008, Level 3)			
Supply cables	kV	2	2
CAN/DP bus cable	kV	—	—
SmartWire-DT cables	kV	1	1
Surge (IEC/EN 61131-2:2008, Level 1)			
Supply cables	kV	0.5	0.5
CAN/DP bus cable	kV	1	1
Radiated RFI (IEC/EN 61131-2:2008, Level 3)	V	10	10
Climatic Environmental Conditions			
Operating ambient temperature (IEC 60068-2)	°F (°C)	–13° to 131° (–25° to 55°)	–13° to 131° (–25° to 55°)
Condensation		Prevent with suitable measures	Prevent with suitable measures
Storage	°F (°C)	–40° to 158° (–40° to 70°)	–40° to 158° (–40° to 70°)
Relative humidity, noncondensing (IEC/EN 60068-2-30)	%	5–95	5–95
Supply Voltage U_{Aux}			
SM Puffer Bremer	V	24 Vdc (–15%/+20%)	24 Vdc (–15%/+20%)
Residual ripple on the input voltage	%	5	5
Protection against polarity reversal		Yes	Yes
Max. current (I _{max})	A	3	3
Short-circuit rating		No, external fuse FAZ Z3	No, external fuse FAZ Z3
Power loss	W	Normally 1	Normally 1
Potential isolation		No	No
Rated operating voltage of 24 Vdc modes	V	Typ. U _{Aux} –0.2	Typ. U _{Aux} –0.2

Powerfeed Modules, continued

Description	Unit	EU5C-SWD-PF1-1 Powerfeed	EU5C-SWD-PF2-1 Powerfeed
Supply Voltage U_{Pow}			
Supply voltage	V	24 Vdc (–15%/+20%)	24 Vdc (–15%/+20%)
Input voltage ripple	%	≤5	≤5
Siemens MPI, (optional)		—	Yes
Rated current (I)	A	0.7	0.7
Overload proof		Yes	Yes
Inrush current and duration	A	12.5 A/6 ms	12.5 A/6 ms
Heat dissipation at 24 Vdc	W	3.8	3.8
Potential isolation between U_{Pow} and 15 V SmartWire-DT supply voltage		—	Yes
Bridging voltage dips	ms	—	10
Repetition rate	s	—	1
Status indication (LED)		No	Yes
SmartWire-DT Supply Voltage			
Rated operating voltage (U_g)	V	14.5 ±3%	14.5 ±3%
Max. current (I_{max})	A	0.7	0.7
Short-circuit proof		No	Yes
Connection Supply Voltages			
Connection type		Push in terminals	Push in terminals
Solid	mm ²	0.2–1.5 (AWG 24–16)	0.2–1.5 (AWG 24–16)
Flexible with ferrule	mm ²	0.25–1.5	0.25–1.5
SmartWire-DT Network			
Station type		—	—
Number of SmartWire-DT modes		—	—
Baud rates		—	—
Address allocation		None	None
Status indication (LED)			
SmartWire-DT master		Green	Green
Configurations		Red	Red
Connections		2 x plug, 8-pole	2 x plug, 8-pole
Plug connectors		Two flat plugs SWD4-8MF2	Two flat plugs SWD4-8MF2
Fieldbus Interface			
Bus protocol		—	—
Baud rates		—	—
Address allocation		—	—
Station address		—	—
Address allocation		—	—
Status display fieldbus interface (LED)		—	—
Terminating resistor		—	—
Connection design for field bus		—	—
Potential isolation		—	—

XV-102 Series HMI-PLCs and XC-152 Series PLCs

Model	XV-102			XC-152		
	3.5 in	5.7 in	7.0 in	5.7 in	8.4 in	10.4 in
Operating system	WinCE 5.0 Professional	WinCE 5.0 Professional	WinCE 5.0 Professional	WinCE 5.0 Professional	WinCE 5.0 Professional	WinCE 5.0 Professional
Touchscreen technology	Resistive	Resistive	Resistive	Resistive	Resistive	Resistive
Display, colors	Color TFT, 64 k colors	Color TFT, 64 k colors	Color TFT, 64 k colors	Color TFT, 64 k colors	Color TFT, 64 k colors	Color TFT, 64 k colors
Pixel resolution (landscape) portrait mode also available	QVGA 320 x 240	VGA 640 x 480	WVGA 800 x 480	VGA 640 x 480	VGA 640 x 480	VGA 640 x 480
Brightness (cd/m ²)	250	250	250	350	350	350
Backlight	LED, selectable dimming	LED, selectable dimming	LED, selectable dimming	LED, selectable dimming	LED, selectable dimming	LED, selectable dimming
Lifespan of backlight (half-life)	40,000 hrs	40,000 hrs	40,000 hrs	40,000 hrs	40,000 hrs	40,000 hrs
Processor	32 bit RISC, 400 MHz	32 bit RISC, 400 MHz	32 bit RISC, 400 MHz	32 bit RISC, 400 MHz	32 bit RISC, 400 MHz	32 bit RISC, 400 MHz
Volatile memory	64 MB DRAM	64 MB DRAM	64 MB DRAM	64 MB DRAM	64 MB DRAM	64 MB DRAM
Non-volatile memory	125 KB NVRAM/64 MB NAND, 1 SD card slot	125 KB NVRAM/64 MB NAND/ 2 MB NOR, 1 SD card slot		125 KB NVRAM/64 MB NAND/ 2 MB NOR, 1 SD card slot		
Real time clock	Yes	Yes	Yes	Yes	Yes	Yes
Communication ports	Ethernet 10/100, RS-485 or RS-232 USB Device		Ethernet 10/100, RS-485, RS-232 USB Host, USB Device	Ethernet 10/100, RS-485, RS-232 USB Host, USB Device		
Slots for COMM modules	None	None	None	None	None	None
Power supply rated voltage	24 Vdc nominal (–20%/+25%) with polarity protection			24 Vdc nominal (–20%/+25%) with polarity protection		
Continuous current consumption (max. amps)	0.2	0.4	0.4	0.4	0.6	0.6
Starting current inrush (A ² s)	1.5	1.5	1.5	1.5	1.5	1.5
Ambient conditions						
Operation—relative humidity, noncondensing	0 to 50 °C, 10 to 95%	0 to 50 °C, 10 to 95%	0 to 50 °C, 10 to 95%	0 to 50 °C, 10 to 95%	0 to 50 °C, 10 to 95%	0 to 50 °C, 10 to 95%
Storage/transport—relative humidity, noncondensing	–20 to 60 °C, 10 to 95%	–20 to 60 °C, 10 to 95%	–20 to 60 °C, 10 to 95%	–20 to 60 °C, 10 to 95%	–20 to 60 °C, 10 to 95%	–20 to 60 °C, 10 to 95%
Shock	IEC 60068-2-27 15 g for 11 ms duration			IEC 60068-2-27 15 g for 11 ms duration		
Vibration	IEC 60068-2-6 5–9 Hz: 3.5 mm displacement 9–60 Hz: 0.15 mm displacement 60–150 Hz: 2 g acceleration			IEC 60068-2-6 5–9 Hz: 3.5 mm displacement 9–60 Hz: 0.15 mm displacement 60–150 Hz: 2 g acceleration		
Agency certifications and standards	CE, UL/cUL, CSA (pending), RoHS			CE, UL/cUL, CSA (pending), RoHS		
Protection type						
Front	IP65, NEMA 4X (indoor)	IP65, NEMA 4X (indoor)	IP65, NEMA 4X (indoor)	IP65, NEMA 4X (indoor)	IP65, NEMA 4X (indoor)	IP65, NEMA 4X (indoor)
Rear	IP20, NEMA 1	IP20, NEMA 1	IP20, NEMA 1	IP20, NEMA 1	IP20, NEMA 1	IP20, NEMA 1
Housing material	Plastic	Plastic	Plastic	Metal	Metal	Metal
Dimensions WxHxD (mm)	136 x 100 x 30	170 x 130 x 39	210 x 135 x 38	212 x 156 x 53	275 x 208 x 53	345 x 260 x 54
Mounting cutout WxH (mm)	123 x 87	157 x 117	197 x 122	198 x 142	261 x 194	329 x 238
Approximate weight lbs (kg)	0.7 (0.3)	1.3 (0.6)	1.3 (0.6)	2.9 (1.3)	4.3 (2.1)	6.1 (3.0)
Ability to run third party software	No	No	No	No	No	No
XSoft-CoDeSys-2 development software	SW-XSOFT-CODESYS-2-S SW-XSOFT-CODESYS-2-M			SW-XSOFT-CODESYS-2-S SW-XSOFT-CODESYS-2-M		
XSoft-CoDeSys-3 development software	SW-XSOFT-CODESYS-3-S SW-XSOFT-CODESYS-3-M			SW-XSOFT-CODESYS-3-S SW-XSOFT-CODESYS-3-M		

SmartWire-DT In Panel and On Machine Wiring Solution

Digital I/O Modules

Description	Unit	EU5E-SWD-8DX	EU5E-SWD-4DX	EU5E-SWD-4D4D	EU5E-SWD-4D2R	EU5E-SWD-X8D
General						
Standards		IEC/EN 61131-2; EN 50178	IEC/EN 61131-2; EN 50178	IEC/EN 61131-2; EN 50178	IEC/EN 61131-2; EN 50178	IEC/EN 61131-2; EN 50178
Dimensions (W x H x D)	in (mm)	1.38 x 3.54 x 3.97 (35 x 90 x 101)	1.38 x 3.54 x 3.97 (35 x 90 x 101)	1.38 x 3.54 x 3.97 (35 x 90 x 101)	1.38 x 3.54 x 3.97 (35 x 90 x 101)	1.38 x 3.54 x 3.97 (35 x 90 x 101)
Weight	lbs (kg)	0.22 (0.10)	0.22 (0.10)	0.22 (0.10)	0.22 (0.10)	0.22 (0.10)
Mounting		DIN rail IEC/EN 60715, 35 mm	Top-hat rail IEC/ EN 60715, 35 mm	DIN rail IEC/EN 60715, 35 mm	DIN rail IEC/EN 60715, 35 mm	Top-hat rail IEC/ EN 60715, 35 mm
Mounting position		Vertical	Vertical	Vertical	Vertical	Vertical
Ambient Conditions, Mechanical						
Degree of protection (IEC/EN 60529)		IP20	IP20	IP20	IP20	IP20
Vibrations (IEC/EN 61131-2:2008)						
Constant amplitude 3.5 mm	Hz	5–8.4	5–8.4	5–8.4	5–8.4	5–8.4
Constant acceleration 1 g	Hz	8.4–150	8.4–150	8.4–150	8.4–150	8.4–150
Mechanical shock resistance (IEC/EN 60068-2-27) semi-sinusoidal 15 g/11 ms	Impacts	9	9	9	9	9
Drop to IEC/EN 60068-2-31 (drop height)	in (mm)	1.97 (50)	1.97 (50)	1.97 (50)	1.97 (50)	1.97 (50)
Free fall, packaged (IEC/EN 60068-2-32)	ft (m)	1.0 (0.3)	1.0 (0.3)	1.0 (0.3)	1.0 (0.3)	1.0 (0.3)
Electromagnetic Compatibility (EMC)						
Overvoltage category		II	II	II	II	II
Pollution degree		2	2	2	2	2
Electrostatic discharge (IEC/EN 61131-2:2008)						
Air discharge (Level 3)	kV	8	8	8	8	8
Contact discharge (Level 2)	kV	4	4	4	4	4
Electromagnetic fields (IEC/EN 61131-2:2008)						
80–1000 MHz	V/m	10	10	10	10	10
1.4–2 GHz	V/m	3	3	3	3	3
2–2.7 GHz	V/m	1	1	1	1	1
Radio interference suppression (SmartWire-DT)		EN 55011 Class A	EN 55011 Class A	EN 55011 Class A	EN 55011 Class A	EN 55011 Class A
Burst (IEC/EN 61131-2:2008, Level 3)						
Supply cables	kV	2	2	2	2	2
Signal lines	kV	1	1	1	1	1
SmartWire-DT cables	kV	1	1	1	1	1
Surge (IEC/EN 61131-2:2008, Level 1)						
Supply cables	kV	0.5	0.5	0.5	0.5	0.5
Radiated RFI (IEC/EN 61131-2:2008, Level 3)	V	10	10	10	10	10
Climatic Environmental Conditions						
Operating ambient temperature (IEC 60068-2)	°F (°C)	–13° to 131° (–25° to 55°)	–13° to 131° (–25° to 55°)	–13° to 131° (–25° to 55°)	–13° to 131° (–25° to 55°)	–13° to 131° (–25° to 55°)
Condensation		Prevent with suitable measures	Prevent with suitable measures	Prevent with suitable measures	Prevent with suitable measures	Prevent with suitable measures
Storage	°F (°C)	–40° to 158° (–40° to 70°)	–40° to 158° (–40° to 70°)	–40° to 158° (–40° to 70°)	–40° to 158° (–40° to 70°)	–40° to 158° (–40° to 70°)
Relative humidity, noncondensing (IEC/ EN 60068-2-30)	%	5–95	5–95	5–95	5–95	5–95
SmartWire-DT Network						
Station type		SmartWire-DT (node)	SmartWire-DT (node)	SmartWire-DT (node)	SmartWire-DT (node)	SmartWire-DT (node)
Address allocation		Automatic	Automatic	Automatic	Automatic	Automatic
SmartWire-DT status (LED)		Green	Green	Green	Green	Green
Connection						
Plug		8-pole	Plug, 8-pole	8-pole	8-pole	Plug, 8-pole
Connection plug		External device plug SWD4-8SF2-5	External device plug SWD4-8SF2-5	External device plug SWD4-8SF2-5	External device plug SWD4-8SF2-5	External device plug SWD4-8SF2-5
Current consumption (15 V SWD supply)		16 mA	33 mA	33 mA	45 mA	43 mA

Digital I/O Modules, continued

Description	Unit	EU5E-SWD-8DX	EU5E-SWD-4DX	EU5E-SWD-4D4D	EU5E-SWD-4D2R	EU5E-SWD-X8D
Connection Supply and I/O						
Connection type		Push in terminals	Push in terminals	Push in terminals	Push in terminals	Push in terminals
Solid	mm ²	0.2–1.5 (AWG 24–16)	0.2–1.5 (AWG 24–16)	0.2–1.5 (AWG 24–16)	0.2–1.5 (AWG 24–16)	0.2–1.5 (AWG 24–16)
Flexible with ferrule ^①	mm ²	0.25–1.5 (AWG 24–16)	0.25–1.5	0.25–1.5	0.25–1.5	0.25–1.5 (AWG 24–16)
24 Vdc Supply for Output Supply						
Rated operational voltage (U_e)	V	24 Vdc (–15%/+20%)	24 Vdc (–15%/+20%)	24 Vdc (–15%/+20%)	24 Vdc (–15%/+20%)	24 Vdc (–15%/+20%)
Residual ripple on the input voltage	%	—	≤5	5	—	≤5
Protection against polarity reversal		—	Yes	Yes	—	Yes
Digital Inputs						
Quantity		8	4 ^①	4	4	—
Input current	mA	Typ. 4 at 24 Vdc	Typ. 4 at 24 Vdc	Typ. 4 at 24 Vdc	Typ. 4 at 24 Vdc	Typ. 4 at 24 Vdc
Voltage level to IEC/EN 61131-2						
Limit value type 1		Low <5 Vdc; High >15 Vdc				
Input delay						
High		<0.2 ms	<0.2 ms	<0.2 ms	<0.2 ms	<0.2 ms
Low		<0.2 ms	<0.2 ms	<0.2 ms	<0.2 ms	<0.2 ms
SmartWire-DT status (LED)		Yellow	Yellow	Yellow	Yellow	—
Power Supply I+, I-						
Overload proof		—	Yes, with diagnostics	—	—	—
Output current per input supply	A	—	≤0.5	—	—	—
Supply voltage	V	—	U_e 0.16 V	—	—	—
Transistor Outputs						
Number		—	—	4	—	8
Output current	A	—	—	Normally 0.5 at 24 Vdc	—	Normally 0.5 at 24 Vdc
Short-circuit tripping current	A	—	—	Max. 1.2 over 3 ms	—	Max. 1.2 over 3 ms
Lamp load (R_{LL})	W	—	—	3	—	≤3
Overload proof		—	—	Yes, with diagnostics	—	Yes, with diagnostics
Switching capacity		—	—	EN 60947-5-1 utilization category DC-13	—	EN 60947-5-1 utilization category DC-13
Status display	LED	—	—	—	—	Yellow
Relay Outputs						
Number		—	—	—	2	—
Contact type art		—	—	—	N/O contact	—
Operations						
Utilization category AC-1, 250 V, 6 A		—	—	—	>6 x 10 ⁴	—
Utilization category AC-15, 250 V, 3 A		—	—	—	>5 x 10 ⁴	—
Utilization category DC-13, 24 V, 1 A		—	—	—	>2 x 10 ⁵	—
Safe isolation	Vac	—	—	—	230	—
Minimum load current	mA	—	—	—	100 mA, 12 Vdc	—
Pick-up/drop-out time	ms	—	—	—	5/2.5	—
Bounce duration	ms	—	—	—	Normally 1.5	—
Short-circuit protection		—	—	—	External 4A gL/gG	—
Status display outputs (LED)		—	—	Yellow	Yellow	—
Potential Isolation						
Inputs for SmartWire-DT		Yes	Yes	Yes	Yes	Yes
Transistor outputs for SmartWire-DT		—	Yes	Yes	—	—
Transistor outputs for inputs		—	—	No	—	—
Relays for SmartWire-DT		—	—	—	Yes	—
Relays for inputs		—	—	—	Yes	—
Relays for relays		—	—	—	Yes	—

Note

^① Three-wire connection with power supply I+, I-.

SmartWire-DT In Panel and On Machine Wiring Solution

Analog I/O Modules

Description	Unit	EU5E-SWD-4AX	EU5E-SWD-2A2A	EU5E-SWD-4PT	EU5E-SWD-4PT-2
General					
Standards		IEC/EN 61131-2/EN 50178	IEC/EN 61131-2/EN 50178	IEC/EN 61131-2/EN 50178	IEC/EN 61131-2/EN 50178
Dimensions (W x H x D)	in (mm)	1.38 x 3.54 x 3.97 (35 x 90 x 101)	1.38 x 3.54 x 3.97 (35 x 90 x 101)	1.38 x 3.54 x 3.97 (35 x 90 x 101)	1.38 x 3.54 x 3.97 (35 x 90 x 101)
Weight	lbs (kg)	0.22 (0.10)	0.22 (0.10)	0.22 (0.10)	0.22 (0.10)
Mounting		Top-hat rail IEC/EN 60715, 35 mm	Top-hat rail IEC/EN 60715, 35 mm	Top-hat rail IEC/EN 60715, 35 mm	Top-hat rail IEC/EN 60715, 35 mm
Mounting position		Vertical	Vertical	Vertical	Vertical
Ambient Conditions, Mechanical					
Protection type (IEC/EN 60529)		IP20	IP20	IP20	IP20
Vibrations (IEC/EN 61131-2:2008)					
Constant amplitude 3.5 mm	Hz	5–8.4	5–8.4	5–8.4	5–8.4
Constant acceleration 1 g	Hz	8.4–150	8.4–150	8.4–150	8.4–150
Mechanical shock resistance (IEC/EN 60068-2-27) semi-sinusoidal 15 g/11 ms	Impacts	9	9	9	9
Drop to IEC/EN 60068-2-31 (drop height)	in (mm)	1.97 (50)	1.97 (50)	1.97 (50)	1.97 (50)
Free fall, packaged (IEC/EN 60068-2-32)	ft (m)	1.0 (0.3)	1.0 (0.3)	1.0 (0.3)	1.0 (0.3)
Electromagnetic Compatibility (EMC)					
Overvoltage category		II	II	II	II
Pollution degree		2	2	2	2
Electrostatic discharge (IEC/EN 61131-2:2008)					
Air discharge (Level 3)	kV	8	8	8	8
Contact discharge (Level 2)	kV	4	4	4	4
Electromagnetic fields (IEC/EN 61131-2:2008)					
80–1000 MHz	V/m	10	10	10	10
1.4–2 GHz	V/m	3	3	3	3
2–2.7 GHz	V/m	1	1	1	1
Radio interference suppression (SmartWire-DT)		EN 55011 Class A	EN 55011 Class A	EN 55011 Class A	EN 55011 Class A
Burst (IEC/EN 61131-2:2008, Level 3)					
Supply cables	kV	2	2	2	2
Signal lines	kV	2	2	2	2
SmartWire-DT cables	kV	2	2	2	2
Surge (IEC/EN 61131-2:2008, Level 1)		Supply cables 1.0 kV	Supply cables 1.0 kV	Supply cables 1.0 kV	Supply cables 1.0 kV
Radiated RFI (IEC/EN 61131-2:2008, Level 3)	V	10	10	10	10
Climatic Environmental Conditions					
Operating ambient temperature (IEC 60068-2)	°F (°C)	13° to 131° (–25° to 55°)	13° to 131° (–25° to 55°)	13° to 131° (–25° to 55°)	13° to 131° (–25° to 55°)
Condensation		Prevent with suitable measures	Prevent with suitable measures	Prevent with suitable measures	Prevent with suitable measures
Storage	°F (°C)	–40° to 158° (–40° to 70°)	–40° to 158° (–40° to 70°)	–40° to 158° (–40° to 70°)	–40° to 158° (–40° to 70°)
Relative humidity, noncondensing (IEC/EN 60068-2-30)	%	5–95	5–95	5–95	5–95
SmartWire-DT Network					
Station type		SmartWire-DT slave	SmartWire-DT slave	SmartWire-DT slave	SmartWire-DT slave
Baud rate setting		Automatic	Automatic	Automatic	Automatic
SmartWire-DT status LED	LED	Green	Green	Green	Green
Connection		Plug: 8-pole/Connection plug: External device plug SWD4-8SF2-5			
Current consumption (15 V SWD supply)		22 mA	22 mA	22 mA	22 mA
Connection Supply and I/O					
Connection type		Push in terminals	Push in terminals	Push in terminals	Push in terminals
Solid	mm ²	0.25–1.5 (AWG 24–16)	0.25–1.5 (AWG 24–16)	0.25–1.5 (AWG 24–16)	0.25–1.5 (AWG 24–16)
Flexible with ferrule	mm ²	0.25–1.5 (AWG 24–16)	0.25–1.5 (AWG 24–16)	0.25–1.5 (AWG 24–16)	0.25–1.5 (AWG 24–16)
24 Vdc Supply for Output Supply					
Rated operational voltage (U _o)	V	24 Vdc –15%/+20%	24 Vdc –15%/+20%	24 Vdc –15%/+20%	24 Vdc –15%/+20%
Residual ripple on the input voltage	%	≤5	≤5	≤5	≤5
Current consumption	mA	10	50	—	—
Protection against polarity reversal		Yes	Yes	Yes	Yes

Analog I/O Modules, continued

Description	Unit	EU5E-SWD-4AX	EU5E-SWD-2A2A	EU5E-SWD-4PT	EU5E-SWD-4PT-2
Analog Inputs					
Quantity		Four (two-wire connection, screened, length <10m)	Two (two-wire connection, screened, length <10m)	—	—
Parameterization					
Part no.		Voltage, current	Voltage, current	—	—
Averaging		Adjustable	Adjustable	—	—
Voltage					
Input voltage	V	0–10	0–10	—	—
Input impedance	k ohms	13.3	13.3	—	—
Maximum current					
Input current	mA	0–20	0–20	—	—
Input impedance	ohms	< 250	< 250	—	—
Resolution	Bit	12	12	—	—
Conversion time	ms	20	20	—	—
Total error	%	±1	±1	—	—
Repetition accuracy	%	±0.5	±0.5	—	—
Dielectric strength	V	±30	±30	—	—
Analog Outputs					
Number		—	Two (two-wire connection, screened)	—	—
Parameterization					
Part no.		—	Voltage, current	—	—
Averaging		—	—	—	—
Voltage					
Output voltage	V	—	0–10	—	—
Maximum output current	mA	—	10	—	—
Maximum current					
Output current	mA	—	0–20	—	—
Load resistance	ohms	—	<500	—	—
Overload and short-circuit proof		—	Yes	—	—
Resolution	Bit	—	12	—	—
Conversion time	ms	—	20	—	—
Total error	%	—	±1	—	—
Repetition accuracy	%	—	±0.5	—	—
Temperature Inputs					
Number		—	—	Four (two-, three-wire connection, screened, length <10m)	Four (two-, three-wire connection, screened, length <10m)
Parameterization					
Averaging		—	—	Adjustable	Adjustable
Temperature sensor		—	—	PT100, PT1000, Ni1000	PT100, PT1000, Ni1000
Temperature range	°F (°C)	—	—	PT100, PT1000: –58° to 392° (–50° to 200°) Ni1000: –58° to 302° (–50° to 150°)	PT100, PT1000: –148° to 752° (–100° to 400°) Ni1000: –58° to 302° (–50° to 150°)
Resolution	°F (°C)	—	—	32° (0.1°)	32° (0.1°)
Conversion time	ms	—	—	250	250
Display		—	—	°C, °F, raw value	°C, °F, raw value
Total error	%	—	—	±1	±1
Repetition accuracy	%	—	—	±0.5	±0.5
Potential Isolation					
Inputs for SmartWire-DT		Yes	Yes	Yes	Yes
Outputs to SmartWire-DT		—	Yes	—	—
Input to input		No	No	No	No
Output to input		—	No	—	—
Output to output		—	No	—	—

Accessories

Description	Unit	SWD4-RC8-10 Resistor	SWD4-8SF2-5 Plug	SWD4-8SFF2-5 Coupling	SWD4-SF8-20 Bushing
General					
Standards		IEC/EN 61131-2; EN 50178	IEC/EN 61131-2; EN 50178	IEC/EN 61131-2; EN 50178	IEC/EN 61131-2; EN 50178
Dimensions (W x H x D)	in (mm)	1.91 x 1.36 x 0.34 (48.5 x 34.5 x 10)	0.59 x 1.44 x 0.69 (15 x 36.5 x 17.5)	1.91 x 1.36 x 0.34 (48.5 x 34.5 x 10)	0.94 x 1.02 x 6.34 (24 x 26 x 162)
Weight	lbs (g)	0.022 (10)	0.012.1 (5.5)	0.010 (4.5)	0.044 (20)
Mounting position		As required	As required	As required	As required
Ambient Conditions, Mechanical					
Degree of protection (IEC/EN 60529)		IP20	IP20	IP20	IP67
Vibrations (IEC/EN 61131-2:2008)					
Constant amplitude 3.5 mm	Hz	5–8.4	5–8.4	5–8.4	—
Constant acceleration 1 g	Hz	8.4–150	8.4–150	8.4–150	—
Mechanical shock resistance (IEC/EN 60068-2-27) semi-sinusoidal 15 g/11 ms	Impacts	9	9	9	—
Drop to IEC/EN 60068-2-31 (drop height)	in (mm)	1.97 (50)	—	—	—
Free fall, packaged (IEC/EN 60068-2-32)	ft (m)	1.0 (0.3)	—	—	—
Electromagnetic Compatibility (EMC)					
Overvoltage category		II	—	—	—
Pollution degree		2	—	—	—
Electrostatic discharge (IEC/EN 61131-2:2008)					
Air discharge (Level 3)	kV	8	—	—	—
Contact discharge (Level 2)	kV	4	—	—	—
Electromagnetic fields (IEC/EN 61131-2:2008)					
80–1000 MHz	V/m	10	—	—	—
1.4–2 GHz	V/m	3	—	—	—
2–2.7 GHz	V/m	1	—	—	—
Radio interference suppression (SmartWire-DT)		EN 55011 Class A	—	—	—
Burst (IEC/EN 61131-2:2008, Level 3)					
SmartWire-DT cables	kV	1	—	—	—
Radiated RFI (IEC/EN 61131-2:2008, Level 3)	V	10	—	—	—
Climatic Environmental Conditions					
Operating ambient temperature (IEC 60068-2)	°F (°C)	–13° to 131° (–25° to 55°)	–13° to 131° (–25° to 55°)	–13° to 131° (–25° to 55°)	–13° to 131° (–25° to 55°)
Condensation		Prevent with suitable measures			
Storage	°F (°C)	–40° to 158° (–40° to 70°)	–40° to 158° (–40° to 70°)	–40° to 158° (–40° to 70°)	–40° to 158° (–40° to 70°)
Relative humidity, noncondensing (IEC/EN 60068-2-30)	%	5–95	5–95	5–95	5–95
Connection Options					
SWD-In		Plug, 8-pole	Plug connector	Plug, 8-pole	—
Number of insertion cycles		≥200	1	>200	—
SWD-Out		—	Socket, 8-pole	Plug, 8-pole	Socket, 8-pole
Number of insertion cycles		—	≥200	≥200	≥500
Current consumption (15 V SWD supply)		17 mA	—	—	—

Accessories, continued

Description	Unit	SWD4-SM8-20 Bushing	SWD4-8FRF-10 Adapter	SWD4-SFL8-20 Adapter	SWD4-SML8-20 Adapter
General					
Standards		IEC/EN 61131-2; EN 50178	IEC/EN 61131-2; EN 50178	IEC/EN 61131-2; EN 50178	IEC/EN 61131-2; EN 50178
Dimensions (W x H x D)	in (mm)	0.94 x 1.02 x 6.69 (24 x 26 x 170)	1.38 x 3.54 x 1.38 (35 x 90 x 35)	1.38 x 3.27 x 1.57 (35 x 83 x 40)	1.38 x 3.27 x 1.82 (35 x 83 x 46)
Weight	lbs (g)	0.050 (22.5)	0.093 (42)	0.110 (50)	0.110 (50)
Mounting position		As required	As required	As required	As required
Ambient Conditions, Mechanical					
Degree of protection (IEC/EN 60529)		IP67	IP20	IP67	IP67
Vibrations (IEC/EN 61131-2:2008)					
Constant amplitude 3.5 mm	Hz	—	5–8.4	5–8.4	5–8.4
Constant acceleration 1 g	Hz	—	8.4–150	8.4–150	8.4–150
Mechanical shock resistance (IEC/EN 60068-2-27) semi-sinusoidal 15 g/11 ms	Impacts	—	9	9	9
Drop to IEC/EN 60068-2-31 (drop height)	in (mm)	—	—	—	—
Free fall, packaged (IEC/EN 60068-2-32)	ft (m)	—	—	—	—
Electromagnetic Compatibility (EMC)					
Overvoltage category		—	—	—	—
Pollution degree		—	—	—	—
Electrostatic discharge (IEC/EN 61131-2:2008)					
Air discharge (Level 3)	kV	—	8	8	8
Contact discharge (Level 2)	kV	—	4	4	4
Electromagnetic fields (IEC/EN 61131-2:2008)					
80–1000 MHz	V/m	—	—	10	10
1.4–2 GHz	V/m	—	—	3	3
2–2.7 GHz	V/m	—	—	1	1
Radio interference suppression (SmartWire-DT)					
Burst (IEC/EN 61131-2:2008, Level 3)		—	—	—	—
SmartWire-DT cables	kV	—	—	—	—
Radiated RFI (IEC/EN 61131-2:2008, Level 3)	V	—	—	10	10
Climatic Environmental Conditions					
Operating ambient temperature (IEC 60068-2)	°F (°C)	–13° to 131° (–25° to 55°)	–13° to 131° (–25° to 55°)	–13° to 131° (–25° to 55°)	–13° to 131° (–25° to 55°)
Condensation		Prevent with suitable measures			
Storage	°F (°C)	–40° to 158° (–40° to 70°)	–40° to 158° (–40° to 70°)	–40° to 158° (–40° to 70°)	–40° to 158° (–40° to 70°)
Relative humidity, noncondensing (IEC/EN 60068-2-30)	%	5–95	5–95	5–95	5–95
Connection Options					
SWD-In		Plug, 8-pole	Plug, 8-pole	Plug, 8-pole	Plug, 8-pole
Number of insertion cycles		≥500	≥200	≥200	≥500
SWD-Out		—	Push in terminals	Socket, 8-pole	Plug, 8-pole
Number of insertion cycles		—	—	≥500	≥200

SmartWire-DT In Panel and On Machine Wiring Solution

Machine Mount I/O Modules

Description	Unit	EU1E-SWD-1DX	EU1E-SWD-2DX	EU1E-SWD-2DD	EU1E-SWD-1AX-1	EU1E-SWD-1AX-2	EU1E-SWD-1XA-1
General							
Standards		IEC / EN 61131-2, EN50178, IEC / EN 60529					
Dimensions (W x H x L)—reference only	mm	41 x 20 x 59	41 x 20 x 59	41 x 20 x 59	41 x 20 x 59	41 x 20 x 59	41 x 20 x 59
Weight	g / oz	65 / 2.3	65 / 2.3	65 / 2.3	65 / 2.3	65 / 2.3	65 / 2.3
Form factor		Single-T	Single-T	Single-T	Single-T	Single-T	Single-T
Enclosure material		MM 6208 (black)	MM 6208 (black)	MM 6208 (black)	MM 6208 (black)	MM 6208 (black)	MM 6208 (black)
Mounting	Qty	2 mounting holes or with bracket accessory	2 mounting holes or with bracket accessory	2 mounting holes or with bracket accessory	2 mounting holes or with bracket accessory	2 mounting holes or with bracket accessory	2 mounting holes or with bracket accessory
Ambient Conditions, Mechanical							
Protection type	Type	IP69K	IP69K	IP69K	IP69K	IP69K	IP69K
EN/IEC 60529	Type	IP6X / IPX7	IP6X / IPX7	IP6X / IPX7	IP6X / IPX7	IP6X / IPX7	IP6X / IPX7
UL Type		1	1	1	1	1	1
Vibrations							
Displacement 3.5 mm	Hz	5–8.4	5–8.4	5–8.4	5–8.4	5–8.4	5–8.4
Acceleration 1 g	Hz	8.4–150	8.4–150	8.4–150	8.4–150	8.4–150	8.4–150
Shock IEC 60068-2-27 1/2 sine 30 g/11 ms	Impacts	9	9	9	9	9	9
Drop to	Height, mm	50	50	50	50	50	50
Drop freefall	m	0.3	0.3	0.3	0.3	0.3	0.3
EMC							
Overvoltage category		II	II	II	II	II	II
Pollution degree		3	3	3	3	3	3
Electrostatic discharge		Performance Criterion B	Performance Criterion B	Performance Criterion B	Performance Criterion B	Performance Criterion B	Performance Criterion B
Air discharge (level 3)	kV	8	8	8	8	8	8
Contact discharge (level 2)	kV	4	4	4	4	4	4
Electromagnetic fields		Performance Criterion A	Performance Criterion A	Performance Criterion A	Performance Criterion A	Performance Criterion A	Performance Criterion A
80–1000 MHz	V/m	10	10	10	10	10	10
1.4–2 G	V/m	3	3	3	3	3	3
2–2.7 G	V/m	1	1	1	1	1	1
Radio interference suppression (SmartWire-DT) (emission and conducted interface voltage)	EN 55011	Class A	Class A	Class A	Class A	Class A	Class A
Burst (level 3)		Performance Criterion B	Performance Criterion B	Performance Criterion B	Performance Criterion B	Performance Criterion B	Performance Criterion B
Supply cables	kV	2	2	2	2	2	2
Signal cables	kV	1	1	1	1	1	1
SmartWire-DT cables	kV	1	1	1	2	2	2
Surge (level 1)		Performance Criterion B	Performance Criterion B	Performance Criterion B	Performance Criterion B	Performance Criterion B	Performance Criterion B
Supply cables	kV	0.5	0.5	0.5	0.5	0.5	0.5
I/O cables	kV	1	1	1	1	1	1
SmartWire-DT cables	kV	1	1	1	1	1	1
Radiated RFI (level 3) (150 kHz – 80 MHz)		Performance Criterion A	Performance Criterion A	Performance Criterion A	Performance Criterion A	Performance Criterion A	Performance Criterion A
Supply cables	V	10	10	10	10	10	10
I/O cables	V	10	10	10	10	10	10
SmartWire-DT cables	V	10	10	10	10	10	10
Voltage drops & interrupts	mS	10	10	10	10	10	10
Climatic Environmental Conditions							
Ambient temperature	Degrees C	–25 to +70	–25 to +70	–25 to +70	–25 to +70	–25 to +70	–25 to +70
Storage temperature	Degrees C	–40 to +70	–40 to +70	–40 to +70	–40 to +70	–40 to +70	–40 to +70
Humidity	% RH	95 at 55 °C / 5–95 condensation permitted	95 at 55 °C / 5–95 condensation permitted	95 at 55 °C / 5–95 condensation permitted	95 at 55 °C / 5–95 condensation permitted	95 at 55 °C / 5–95 condensation permitted	95 at 55 °C / 5–95 condensation permitted

Machine Mount I/O Modules, continued

Description	Unit	EU1E-SWD-1DX	EU1E-SWD-2DX	EU1E-SWD-2DD	EU1E-SWD-1AX-1	EU1E-SWD-1AX-2	EU1E-SWD-1XA-1
SmartWire-DT Network							
Stations type		SmartWire-DT slave	SmartWire-DT slave	SmartWire-DT slave	SmartWire-DT slave	SmartWire-DT slave	SmartWire-DT slave
Baud rate setting		Automatic	Automatic	Automatic	Automatic	Automatic	Automatic
Maximum	Bit/sec	2 M	2 M	2 M	2 M	2 M	2 M
SW-DT Status LED		Green (625 nm)	Green (625 nm)	Green (625 nm)	Green (625 nm)	Green (625 nm)	Green (625 nm)
Connectors, (IEC-61076-2-101)	M12 A Coding	—	—	—	—	—	—
SW-DT network input connector		M12-M / 5-pole	M12-M / 5-pole	M12-M 5-pole	M12-M 5-pole	M12-M 5-pole	M12-M 5-pole
Pin 1		24 Vdc	24 Vdc	24 Vdc	24 Vdc	24 Vdc	24 Vdc
Pin 2		Data A	Data A	Data A	Data A	Data A	Data A
Pin 3		GND	GND	GND	GND	GND	GND
Pin 4		Data B	Data B	Data B	Data B	Data B	Data B
Pin 5		SEL (IN)	SEL (IN)	SEL (IN)	SEL (IN)	SEL (IN)	SEL (IN)
SW-DT network output connector		M12-F / 5-pole	M12-F / 5-pole	M12-F 5-pole	M12-F 5-pole	M12-F 5-pole	M12-F 5-pole
Pin 1		24 Vdc	24 Vdc	24 Vdc	24 Vdc	24 Vdc	24 Vdc
Pin 2		Data A	Data A	Data A	Data A	Data A	Data A
Pin 3		GND	GND	GND	GND	GND	GND
Pin 4		Data B	Data B	Data B	Data B	Data B	Data B
Pin 5		SEL (OUT)	SEL (OUT)	SEL (OUT)	SEL (OUT)	SEL (OUT)	SEL (OUT)
24 Vdc Power							
SWD-T bus 24 Vdc							
Rated operational voltage	V/U _e	24 V –15% +20%	24 V –15% +20%	24 V –15% +20%	24 V –15% +20%	24 V –15% +20%	24 V –15% +20%
Residual ripple on the input voltage	%	≤5	≤5	≤5	≤5	≤5	≤5
Reverse Polarity Protection		Yes	Yes	Yes	Yes	Yes	Yes
Rated supply current	mA	55	55	58	46	46	52
Actuator external 24 Vdc							
Rated operational voltage	V/U _e	—	—	—	—	—	—
Reverse polarity protection		—	—	—	—	—	—
Maximum Current (total)	A	—	—	—	—	—	—
Connectors		—	—	—	—	—	—
Power in	Male	—	—	—	—	—	—
Pin 1	Std len	—	—	—	—	—	—
Pin 2	Std len	—	—	—	—	—	—
Pin 3	Std len	—	—	—	—	—	—
Pin 4	Ext len	—	—	—	—	—	—
Power out	Female	—	—	—	—	—	—
Pin 1		—	—	—	—	—	—
Pin 2		—	—	—	—	—	—
Pin 3		—	—	—	—	—	—
Pin 4		—	—	—	—	—	—
Power indication LED	Power in	—	—	—	—	—	—
Digital Inputs							
Input current	mA	Nominal 4 at 24 Vdc	Nominal 4 at 24 Vdc	Nominal 4 at 24 Vdc	—	—	—
Voltage level to (IEC / EN 61131-2)							
Limit value type 1		L < 5 Vdc; H > 15 Vdc	L < 5 Vdc; H > 15 Vdc	L < 5 Vdc; H > 15 Vdc	—	—	—
Input delay		H->L or L->H < 0.2 ms	H->L or L->H < 0.2 ms	H->L or L->H < 0.2 ms	—	—	—
Status display	LED	Yellow	Yellow	Yellow	—	—	—

Machine Mount I/O Modules, continued

Description	Unit	EU1E-SWD-1DX	EU1E-SWD-2DX	EU1E-SWD-2DD	EU1E-SWD-1AX-1	EU1E-SWD-1AX-2	EU1E-SWD-1XA-1
Digital Outputs							
Output driver circuit power source	Bus/ext	—	—	Bus	—	—	—
Output current	A	—	—	0.5 at 24 Vdc	—	—	—
Trip current SC	A	—	—	1.2 over 3 ms	—	—	—
Lamp load	W	—	—	≤3	—	—	—
Overload proof (IEC / EN 61131-2)		—	—	Yes w/diag	—	—	—
Switching capacity IEC 60947-5-1		—	—	DC-13	—	—	—
Status display	LED	—	—	Yellow	—	—	—
Total current all outputs	A	—	—	1	—	—	—
Analog							
Parameter setting							
Refresh rate	mS	—	—	—	20, 100, 250, 500	20, 100, 250, 500	—
Averaging (5 msec sample interval)	ON/OFF	—	—	—	ON/OFF	ON/OFF	—
Voltage							
Input voltage	V	—	—	—	0–10 Vdc	—	—
Input impedance	kohm	—	—	—	20	—	—
Output voltage	V	—	—	—	—	—	0–10 Vdc
Maximum output current	mA	—	—	—	—	—	10
Source impedance	kohm	—	—	—	—	—	0.22
Current							
Input current	mA	—	—	—	—	0–20 mA	—
Input impedance	ohms	—	—	—	—	225	—
Output current	mA	—	—	—	—	—	—
Source impedance	ohms	—	—	—	—	—	—
Converter							
Resolution	Bit	—	—	—	12	12	12
Conversion time	ms	—	—	—	20	20	20
Cumulative error	%	—	—	—	±1.0	±1.0	±1.0
Repetition accuracy	%	—	—	—	±0.5	±0.5	±0.5
Encoder							
Frequency response	Hz	—	—	—	—	—	—
Status indication LED							
Count pulse		—	—	—	—	—	—
Encoder status (input byte 0)	Bit	—	—	—	—	—	—
Referencing active status	0	—	—	—	—	—	—
Reference status	1	—	—	—	—	—	—
Reference line state	2	—	—	—	—	—	—
Zero crossing	3	—	—	—	—	—	—
Control settings (output byte 0)	Bit	—	—	—	—	—	—
Count control	0	—	—	—	—	—	—
Reference enable (ActRef)	1	—	—	—	—	—	—
Reference control	2	—	—	—	—	—	—
Asynchronous reset	3	—	—	—	—	—	—
Zero crossing acknowledge	4	—	—	—	—	—	—

Machine Mount I/O Modules, continued

Description	Unit	EU1E-SWD-1DX	EU1E-SWD-2DX	EU1E-SWD-2DD	EU1E-SWD-1AX-1	EU1E-SWD-1AX-2	EU1E-SWD-1XA-1
Temperature							
Parameter setting							
Temperature sensor		—	—	—	—	—	—
Averaging		—	—	—	—	—	—
Range		—	—	—	—	—	—
Temperature range							
PT100 (1)	°C	—	—	—	—	—	—
PT1000 (1)	°C	—	—	—	—	—	—
Ni1000 (1)	°C	—	—	—	—	—	—
PT100 (2)	°C	—	—	—	—	—	—
PT1000 (2)	°C	—	—	—	—	—	—
Ni1000 (2)	°C	—	—	—	—	—	—
Converter							
Resolution (converter)	Bit	—	—	—	—	—	—
Conversion time	ms	—	—	—	—	—	—
Cumulative error	%	—	—	—	—	—	—
Repetition accuracy	%	—	—	—	—	—	—
Display		—	—	—	—	—	—
Resolution (temperature)	°C	—	—	—	—	—	—
I/O Configurations							
24 Vdc bus power to I/O devices	Y/N	Yes	Yes	Yes	Yes	Yes	Yes
Galvanic isolation of I/O circuitry	Y/N	No	No	No	No	No	No
Operating power per connection	A	0.3	0.3	0.3	0.3	0.3	0.3
Internally power limited (PTC)	Y/N	Yes	Yes	Yes	Yes	Yes	Yes
Overload threshold per connection	A	0.6	0.6	0.6	0.6	0.6	0.6
Overload recovery time	S	0.6	0.6	0.6	0.6	0.6	0.6
Maximum allowed total current	A	1	1	1	1	1	1
I/O types							
Configurable (digital I/O)	I/O point	—	—	2	—	—	—
Digital IN (sinking)	I/O point	1	2	Up to 2	—	—	—
Digital OUT (sourcing)	I/O point	—	—	Up to 2	—	—	—
Analog IN	I/O point	—	—	—	1	1	—
Analog OUT	I/O point	—	—	—	—	—	1
Encoder IN	I/O point	—	—	—	—	—	—
Temperature sensor input	I/O point	—	—	—	—	—	—
I/O connectors, (IEC-61076-2-101)	M12 A Coding	1x M12-F / 5-pole	1x M12-F / 5-pole	1x M12-F / 5-pole	1x M12-F / 5-pole	1x M12-F / 5-pole	1x M12-F / 5-pole
Active circuits loaded in connector	Circuits	3	4	4	4	4	4

Machine Mount I/O Modules, continued

Description	Unit	EU1E-SWD-1DX	EU1E-SWD-2DX	EU1E-SWD-2DD	EU1E-SWD-1AX-1	EU1E-SWD-1AX-2	EU1E-SWD-1XA-1
I/O Configurations, continued							
I/O connector pin outs		—	—	—	—	—	—
I/O Connector-1							
Pin 1		24 Vdc	24 Vdc	24 Vdc	24 Vdc	24 Vdc	24 Vdc
Pin 2		N/C	Input Ch 1	I/O Ch 1	In -	In -	Out -
Pin 3		GND	GND	GND	GND	GND	GND
Pin 4		Input Ch 0	Input Ch 0	I/O Ch 0	In +	In +	Out +
Pin 5		N/C	N/C	N/C	N/C	N/C	N/C
Pin 6		—	—	—	—	—	—
Pin 7		—	—	—	—	—	—
Pin 8		—	—	—	—	—	—
I/O Connector-2							
Pin 1		—	—	—	—	—	—
Pin 2		—	—	—	—	—	—
Pin 3		—	—	—	—	—	—
Pin 4		—	—	—	—	—	—
Pin 5		—	—	—	—	—	—
I/O Connector-3							
Pin 1		—	—	—	—	—	—
Pin 2		—	—	—	—	—	—
Pin 3		—	—	—	—	—	—
Pin 4		—	—	—	—	—	—
Pin 5		—	—	—	—	—	—
I/O Connector-4							
Pin 1		—	—	—	—	—	—
Pin 2		—	—	—	—	—	—
Pin 3		—	—	—	—	—	—
Pin 4		—	—	—	—	—	—
Pin 5		—	—	—	—	—	—
I/O Connector-5							
Pin 1		—	—	—	—	—	—
Pin 2		—	—	—	—	—	—
Pin 3		—	—	—	—	—	—
Pin 4		—	—	—	—	—	—
Pin 5		—	—	—	—	—	—
I/O Connector-6							
Pin 1		—	—	—	—	—	—
Pin 2		—	—	—	—	—	—
Pin 3		—	—	—	—	—	—
Pin 4		—	—	—	—	—	—
Pin 5		—	—	—	—	—	—
I/O Connector-7							
Pin 1		—	—	—	—	—	—
Pin 2		—	—	—	—	—	—
Pin 3		—	—	—	—	—	—
Pin 4		—	—	—	—	—	—
Pin 5		—	—	—	—	—	—
I/O Connector-8							
Pin 1		—	—	—	—	—	—
Pin 2		—	—	—	—	—	—
Pin 3		—	—	—	—	—	—
Pin 4		—	—	—	—	—	—
Pin 5		—	—	—	—	—	—

Machine Mount I/O Modules, continued

Description	Unit	EU1E-SWD-1XA-2	EU1E-SWD-1CX	EU2E-SWD-2DX	EU2E-SWD-4DX	EU2E-SWD-4DD	EU2E-SWD-4DD-1
General							
Standards		IEC / EN 61131-2, EN50178, IEC / EN 60529					
Dimensions (W x H x L)—reference only	mm	41 x 20 x 59	41 x 20 x 59	41 x 20 x 71	41 x 20 x 71	41 x 20 x 71	41 x 20 x 71
Weight	g / oz	65 / 2.3	65 / 2.3	85 / 3.0	85 / 3.0	85 / 3.0	85 / 3.0
Form factor		Single-T	Single-T	Dual-T	Dual-T	Dual-T	Dual-T
Enclosure material		MM 6208 (black)	MM 6208 (black)	MM 6208 (black)	MM 6208 (black)	MM 6208 (black)	MM 6208 (black)
Mounting	Qty	2 mounting holes or with bracket accessory	2 mounting holes or with bracket accessory	2 mounting holes or with bracket accessory	2 mounting holes or with bracket accessory	2 mounting holes or with bracket accessory	2 mounting holes or with bracket accessory
Ambient Conditions, Mechanical							
Protection type	Type	IP69K	IP69K	IP69K	IP69K	IP69K	IP69K
EN/IEC 60529	Type	IP6X / IPX7	IP6X / IPX7	IP6X / IPX7	IP6X / IPX7	IP6X / IPX7	IP6X / IPX7
UL Type		1	1	1	1	1	1
Vibrations							
Displacement 3.5 mm	Hz	5–8.4	5–8.4	5–8.4	5–8.4	5–8.4	5–8.4
Acceleration 1 g	Hz	8.4–150	8.4–150	8.4–150	8.4–150	8.4–150	8.4–150
Shock IEC 60068-2-27 1/2 sine 30 g/11 ms	Impacts	9	9	9	9	9	9
Drop to	Height, mm	50	50	50	50	50	50
Drop freefall	m	0.3	0.3	0.3	0.3	0.3	0.3
EMC							
Overvoltage category		II	II	II	II	II	II
Pollution degree		3	3	3	3	3	3
Electrostatic discharge		Performance Criterion B	Performance Criterion B	Performance Criterion B	Performance Criterion B	Performance Criterion B	Performance Criterion B
Air discharge (level 3)	kV	8	8	8	8	8	8
Contact discharge (level 2)	kV	4	4	4	4	4	4
Electromagnetic fields		Performance Criterion A	Performance Criterion A	Performance Criterion A	Performance Criterion A	Performance Criterion A	Performance Criterion A
80–1000 MHz	V/m	10	10	10	10	10	10
1.4–2 G	V/m	3	3	3	3	3	3
2–2.7 G	V/m	1	1	1	1	1	1
Radio interference suppression (SmartWire-DT) (emission and conducted interface voltage)	EN 55011	Class A	Class A	Class A	Class A	Class A	Class A
Burst (level 3)		Performance Criterion B	Performance Criterion B	Performance Criterion B	Performance Criterion B	Performance Criterion B	Performance Criterion B
Supply cables	kV	2	2	2	2	2	2
Signal cables	kV	1	1	1	1	1	1
SmartWire-DT cables	kV	2	1	1	1	1	1
Surge (level 1)		Performance Criterion B	Performance Criterion B	Performance Criterion B	Performance Criterion B	Performance Criterion B	Performance Criterion B
Supply cables	kV	0.5	0.5	0.5	0.5	0.5	0.5
I/O cables	kV	1	1	1	1	1	1
SmartWire-DT cables	kV	1	1	1	1	1	1
Radiated RFI (level 3) (150 kHz – 80 MHz)		Performance Criterion A	Performance Criterion A	Performance Criterion A	Performance Criterion A	Performance Criterion A	Performance Criterion A
Supply cables	V	10	10	10	10	10	10
I/O cables	V	10	10	10	10	10	10
SmartWire-DT cables	V	10	10	10	10	10	10
Voltage drops & interrupts	mS	10	10	10	10	10	10
Climatic Environmental Conditions							
Ambient temperature	Degrees C	–25 to +70	–25 to +70	–25 to +70	–25 to +70	–25 to +70	–25 to +70
Storage temperature	Degrees C	–40 to +70	–40 to +70	–40 to +70	–40 to +70	–40 to +70	–40 to +70
Humidity	% RH	95 at 55 °C / 5–95 condensation permitted	95 at 55 °C / 5–95 condensation permitted	95 at 55 °C / 5–95 condensation permitted	95 at 55 °C / 5–95 condensation permitted	95 at 55 °C / 5–95 condensation permitted	95 at 55 °C / 5–95 condensation permitted

Machine Mount I/O Modules, continued

Description	Unit	EU1E-SWD-1XA-2	EU1E-SWD-1CX	EU2E-SWD-2DX	EU2E-SWD-4DX	EU2E-SWD-4DD	EU2E-SWD-4DD-1
SmartWire-DT Network							
Stations type		SmartWire-DT slave	SmartWire-DT slave	SmartWire-DT slave	SmartWire-DT slave	SmartWire-DT slave	SmartWire-DT slave
Baud rate setting		Automatic	Automatic	Automatic	Automatic	Automatic	Automatic
Maximum	Bit/sec	2 M	2 M	2 M	2 M	2 M	2 M
SW-DT Status LED		Green (625 nm)	Green (625 nm)	Green (625 nm)	Green (625 nm)	Green (625 nm)	Green (625 nm)
Connectors, (IEC-61076-2-101)	M12 A Coding	—	—	—	—	—	—
SW-DT network input connector		M12-M 5-pole	M12-M 5-pole	M12-M 5-pole	M12-M 5-pole	M12-M 5-pole	M12-M 5-pole
Pin 1		24 Vdc	24 Vdc	24 Vdc	24 Vdc	24 Vdc	24 Vdc
Pin 2		Data A	Data A	Data A	Data A	Data A	Data A
Pin 3		GND	GND	GND	GND	GND	GND
Pin 4		Data B	Data B	Data B	Data B	Data B	Data B
Pin 5		SEL (IN)	SEL (IN)	SEL (IN)	SEL (IN)	SEL (IN)	SEL (IN)
SW-DT network output connector		M12-F 5-pole	M12-F 5-pole	M12-F 5-pole	M12-F 5-pole	M12-F 5-pole	M12-F 5-pole
Pin 1		24 Vdc	24 Vdc	24 Vdc	24 Vdc	24 Vdc	24 Vdc
Pin 2		Data A	Data A	Data A	Data A	Data A	Data A
Pin 3		GND	GND	GND	GND	GND	GND
Pin 4		Data B	Data B	Data B	Data B	Data B	Data B
Pin 5		SEL (OUT)	SEL (OUT)	SEL (OUT)	SEL (OUT)	SEL (OUT)	SEL (OUT)
24 Vdc Power							
SWD-T bus 24 Vdc							
Rated operational voltage	V/U _e	24 V –15% +20%	24 V –15% +20%	24 V –15% +20%	24 V –15% +20%	24 V –15% +20%	24 V –15% +20%
Residual ripple on the input voltage	%	≤5	≤5	≤5	≤5	≤5	≤5
Reverse Polarity Protection		Yes	Yes	Yes	Yes	Yes	Yes
Rated supply current	mA	67	57	55	75	2080	2080
Actuator external 24 Vdc							
Rated operational voltage	V/U _e	—	—	—	—	—	—
Reverse polarity protection		—	—	—	—	—	—
Maximum Current (total)	A	—	—	—	—	—	—
Connectors		—	—	—	—	—	—
Power in	Male	—	—	—	—	—	—
Pin 1	Std len	—	—	—	—	—	—
Pin 2	Std len	—	—	—	—	—	—
Pin 3	Std len	—	—	—	—	—	—
Pin 4	Ext len	—	—	—	—	—	—
Power out	Female	—	—	—	—	—	—
Pin 1		—	—	—	—	—	—
Pin 2		—	—	—	—	—	—
Pin 3		—	—	—	—	—	—
Pin 4		—	—	—	—	—	—
Power indication LED	Power in	—	—	—	—	—	—
Digital Inputs							
Input current	mA	—	Nominal 4 at 24 Vdc	Nominal 4 at 24 Vdc	Nominal 4 at 24 Vdc	Nominal 4 at 24 Vdc	Nominal 4 at 24 Vdc
Voltage level to (IEC / EN 61131-2)		—	—	—	—	—	—
Limit value type 1		—	L < 5 Vdc; H > 15 Vdc	L < 5 Vdc; H > 15 Vdc	L < 5 Vdc; H > 15 Vdc	L < 5 Vdc; H > 15 Vdc	L < 5 Vdc; H > 15 Vdc
Input delay		—	H->L or L->H < 0.01ms	H->L or L->H < 0.2 ms	H->L or L->H < 0.2 ms	H->L or L->H < 0.2 ms	H->L or L->H < 0.2 ms
Status display	LED	—	—	Yellow	Yellow	Yellow	Yellow

Machine Mount I/O Modules, continued

Description	Unit	EU1E-SWD-1XA-2	EU1E-SWD-1CX	EU2E-SWD-2DX	EU2E-SWD-4DX	EU2E-SWD-4DD	EU2E-SWD-4DD-1
Digital Outputs							
Output driver circuit power source	Bus/ext	—	—	—	—	Bus	Bus
Output current	A	—	—	—	—	0.5 at 24 Vdc	0.5 at 24 Vdc
Trip current SC	A	—	—	—	—	1.2 over 3 ms	1.2 over 3 ms
Lamp load	W	—	—	—	—	≤3	≤3
Overload proof (IEC / EN 61131-2)		—	—	—	—	Yes w/diag	Yes w/diag
Switching capacity IEC 60947-5-1		—	—	—	—	DC-13	DC-13
Status display	LED	—	—	—	—	Yellow	Yellow
Total current all outputs	A	—	—	—	—	2	1.5
Analog							
Parameter setting							
Refresh rate	mS	—	—	—	—	—	—
Averaging (5 msec sample interval)	ON/OFF	—	—	—	—	—	—
Voltage							
Input voltage	V	—	—	—	—	—	—
Input impedance	kohm	—	—	—	—	—	—
Output voltage	V	—	—	—	—	—	—
Maximum output current	mA	—	—	—	—	—	—
Source impedance	kohm	—	—	—	—	—	—
Current							
Input current	mA	—	—	—	—	—	—
Input impedance	ohms	—	—	—	—	—	—
Output current	mA	0–20 mA	—	—	—	—	—
Source impedance	ohms	100	—	—	—	—	—
Converter							
Resolution	Bit	12	—	—	—	—	—
Conversion time	ms	20	—	—	—	—	—
Cumulative error	%	±1.0	—	—	—	—	—
Repetition accuracy	%	±0.5	—	—	—	—	—
Encoder							
Frequency response	Hz	—	max 15 K	—	—	—	—
Status indication LED							
Count pulse		—	Yellow	—	—	—	—
Encoder status (input byte 0)	Bit	—	—	—	—	—	—
Referencing active status	0	—	1 = Set by ActRef;	—	—	—	—
Reference status	1	—	1 = Referenced	—	—	—	—
Reference line state	2	—	1 = (R=1); 0 = (R=0)	—	—	—	—
Zero crossing	3	—	1 = (Cnt= 0); 0 = (Cnt <>0)	—	—	—	—
Control settings (output byte 0)	Bit	—	—	—	—	—	—
Count control	0	—	1 = Hold; 0 = Count	—	—	—	—
Reference enable (ActRef)	1	—	1 = Enable;	—	—	—	—
Reference control	2	—	1 = Permanent; 0 = Once	—	—	—	—
Asynchronous reset	3	—	1 = Async Reset (Cntr = Ref);	—	—	—	—
Zero crossing acknowledge	4	—	1 = Reset ZCA bit; 0	—	—	—	—

Machine Mount I/O Modules, continued

Description	Unit	EU1E-SWD-1XA-2	EU1E-SWD-1CX	EU2E-SWD-2DX	EU2E-SWD-4DX	EU2E-SWD-4DD	EU2E-SWD-4DD-1
Temperature							
Parameter setting							
Temperature sensor		—	—	—	—	—	—
Averaging		—	—	—	—	—	—
Range		—	—	—	—	—	—
Temperature range							
PT100 (1)	°C	—	—	—	—	—	—
PT1000 (1)	°C	—	—	—	—	—	—
Ni1000 (1)	°C	—	—	—	—	—	—
PT100 (2)	°C	—	—	—	—	—	—
PT1000 (2)	°C	—	—	—	—	—	—
Ni1000 (2)	°C	—	—	—	—	—	—
Converter							
Resolution (converter)	Bit	—	—	—	—	—	—
Conversion time	ms	—	—	—	—	—	—
Cumulative error	%	—	—	—	—	—	—
Repetition accuracy	%	—	—	—	—	—	—
Display		—	—	—	—	—	—
Resolution (temperature)	°C	—	—	—	—	—	—
I/O Configurations							
24 Vdc bus power to I/O devices	Y/N	—	—	—	—	—	—
Galvanic isolation of I/O circuitry	Y/N	Yes	Yes	Yes	Yes	Yes	Yes
Operating power per connection	A	No	No	No	No	No	No
Internally power limited (PTC)	Y/N	0.3	0.3	0.3	0.3	0.3	0.3
Overload threshold per connection	A	Yes	Yes	Yes	Yes	Yes	Yes
Overload recovery time	S	0.6	0.6	0.6	0.6	0.6	0.6
Maximum allowed total current	A	1	1	1	2	2	2
I/O types		1	1	2	2	2	2
Configurable (digital I/O)	I/O point	—	—	—	—	—	—
Digital IN (sinking)	I/O point	—	—	—	—	4	4
Digital OUT (sourcing)	I/O point	—	—	2	4	Up to 4	Up to 4
Analog IN	I/O point	—	—	—	—	Up to 4	Up to 4
Analog OUT	I/O point	—	—	—	—	—	—
Encoder IN	I/O point	1	—	—	—	—	—
Temperature sensor input	I/O point	—	3	—	—	—	—
I/O connectors, (IEC-61076-2-101)	M12 A Coding	—	—	—	—	—	—
Active circuits loaded in connector	Circuits	1x M12-F / 5-pole	1x M12-F / 5-pole	2x M12-F / 5-pole	2x M12-F / 5-pole	2x M12-F / 5-pole	2x M12-F / 5-pole

Machine Mount I/O Modules, continued

Description	Unit	EU1E-SWD-1XA-2	EU1E-SWD-1CX	EU2E-SWD-2DX	EU2E-SWD-4DX	EU2E-SWD-4DD	EU2E-SWD-4DD-1
I/O Configurations, continued							
I/O connector pin outs							
I/O Connector-1							
Pin 1	24 Vdc	24 Vdc	24 Vdc	24 Vdc	24 Vdc	24 Vdc	24 Vdc
Pin 2	Out -	Ch B	N/C	In Ch 1	I/O Ch 1	N/C	N/C
Pin 3	GND	GND	GND	GND	GND	GND	GND
Pin 4	Out +	Ch A	In Ch 0	In Ch 0	I/O Ch 0	I/O Ch 0	I/O Ch 0
Pin 5	N/C	Ch R	N/C	In Ch 3	N/C	N/C	N/C
Pin 6	—	—	—	—	—	—	—
Pin 7	—	—	—	—	—	—	—
Pin 8	—	—	—	—	—	—	—
I/O Connector-2							
Pin 1	—	—	24 Vdc	24 Vdc	24 Vdc	24 Vdc	24 Vdc
Pin 2	—	—	N/C	In Ch 3	I/O Ch 3	I/O Ch 3	I/O Ch 3
Pin 3	—	—	GND	GND	GND	GND	GND
Pin 4	—	—	In Ch 2	In Ch 2	I/O Ch 2	I/O Ch 2	I/O Ch 2
Pin 5	—	—	N/C	In Ch 1	N/C	I/O Ch 1	I/O Ch 1
I/O Connector-3							
Pin 1	—	—	—	—	—	—	—
Pin 2	—	—	—	—	—	—	—
Pin 3	—	—	—	—	—	—	—
Pin 4	—	—	—	—	—	—	—
Pin 5	—	—	—	—	—	—	—
I/O Connector-4							
Pin 1	—	—	—	—	—	—	—
Pin 2	—	—	—	—	—	—	—
Pin 3	—	—	—	—	—	—	—
Pin 4	—	—	—	—	—	—	—
Pin 5	—	—	—	—	—	—	—
I/O Connector-5							
Pin 1	—	—	—	—	—	—	—
Pin 2	—	—	—	—	—	—	—
Pin 3	—	—	—	—	—	—	—
Pin 4	—	—	—	—	—	—	—
Pin 5	—	—	—	—	—	—	—
I/O Connector-6							
Pin 1	—	—	—	—	—	—	—
Pin 2	—	—	—	—	—	—	—
Pin 3	—	—	—	—	—	—	—
Pin 4	—	—	—	—	—	—	—
Pin 5	—	—	—	—	—	—	—
I/O Connector-7							
Pin 1	—	—	—	—	—	—	—
Pin 2	—	—	—	—	—	—	—
Pin 3	—	—	—	—	—	—	—
Pin 4	—	—	—	—	—	—	—
Pin 5	—	—	—	—	—	—	—
I/O Connector-8							
Pin 1	—	—	—	—	—	—	—
Pin 2	—	—	—	—	—	—	—
Pin 3	—	—	—	—	—	—	—
Pin 4	—	—	—	—	—	—	—
Pin 5	—	—	—	—	—	—	—

SmartWire-DT In Panel and On Machine Wiring Solution

Machine Mount I/O Modules, continued

Description	Unit	EU2E-SWD-2PT	EU6E-SWD-4DX	EU6E-SWD-4XD-1	EU6E-SWD-4XD-2	EU6E-SWD-2D2D-1	EU6E-SWD-2D2D-2
General							
Standards		IEC / EN 61131-2, EN50178, IEC / EN 60529					
Dimensions (W x H x L)—reference only	mm	41 x 20 x 71	60 x 20 x As Req	60 x 20 x As Req	60 x 20 x As Req	60 x 20 x As Req	60 x 20 x As Req
Weight	g / oz	85 / 3.0	234 / 8.3	267 / 9.4	267 / 9.4	267 / 9.4	267 / 9.4
Form factor		Dual-T	MultiBlock (Quad)	MultiBlock (Quad)	MultiBlock (Quad)	MultiBlock (Quad)	MultiBlock (Quad)
Enclosure material		MM 6208 (black)	Polyester	Polyester	Polyester	Polyester	Polyester
Mounting	Qty	2 mounting holes or with bracket accessory	5 mounting holes or with bracket accessory	5 mounting holes or with bracket accessory	5 mounting holes or with bracket accessory	5 mounting holes or with bracket accessory	5 mounting holes or with bracket accessory
Ambient Conditions, Mechanical							
Protection type	Type	IP69K	IP69K	IP69K	IP69K	IP69K	IP69K
EN/IEC 60529	Type	IP6X / IPX7	IP6X / IPX7	IP6X / IPX7	IP6X / IPX7	IP6X / IPX7	IP6X / IPX7
UL Type		1	1	1	1	1	1
Vibrations							
Displacement 3.5 mm	Hz	5–8.4	5–8.4	5–8.4	5–8.4	5–8.4	5–8.4
Acceleration 1 g	Hz	8.4–150	8.4–150	8.4–150	8.4–150	8.4–150	8.4–150
Shock IEC 60068-2-27 1/2 sine 30 g/11 ms	Impacts	9	9	9	9	9	9
Drop to	Height, mm	50	50	50	50	50	50
Drop freefall	m	0.3	0.3	0.3	0.3	0.3	0.3
EMC							
Overvoltage category		II	II	II	II	II	II
Pollution degree		3	3	3	3	3	3
Electrostatic discharge		Performance Criterion B	Performance Criterion B	Performance Criterion B	Performance Criterion B	Performance Criterion B	Performance Criterion B
Air discharge (level 3)	kV	8	8	8	8	8	8
Contact discharge (level 2)	kV	4	4	4	4	4	4
Electromagnetic fields		Performance Criterion A	Performance Criterion A	Performance Criterion A	Performance Criterion A	Performance Criterion A	Performance Criterion A
80–1000 MHz	V/m	10	10	10	10	10	10
1.4–2 G	V/m	3	3	3	3	3	3
2–2.7 G	V/m	1	1	1	1	1	1
Radio interference suppression (SmartWire-DT) (emission and conducted interface voltage)	EN 55011	Class A	Class A	Class A	Class A	Class A	Class A
Burst (level 3)		Performance Criterion B	Performance Criterion B	Performance Criterion B	Performance Criterion B	Performance Criterion B	Performance Criterion B
Supply cables	kV	2	2	2	2	2	2
Signal cables	kV	1	1	1	1	1	1
SmartWire-DT cables	kV	2	1	1	1	1	1
Surge (level 1)		Performance Criterion B	Performance Criterion B	Performance Criterion B	Performance Criterion B	Performance Criterion B	Performance Criterion B
Supply cables	kV	0.5	0.5	0.5	0.5	0.5	0.5
I/O cables	kV	1	1	1	1	1	1
SmartWire-DT cables	kV	1	1	1	1	1	1
Radiated RFI (level 3) (150 kHz – 80 MHz)		Performance Criterion A	Performance Criterion A	Performance Criterion A	Performance Criterion A	Performance Criterion A	Performance Criterion A
Supply cables	V	10	10	10	10	10	10
I/O cables	V	10	10	10	10	10	10
SmartWire-DT cables	V	10	10	10	10	10	10
Voltage drops & interrupts	mS	10	10	10	10	10	10
Climatic Environmental Conditions							
Ambient temperature	Degrees C	–25 to +70	–25 to +70	–25 to +70	–25 to +70	–25 to +70	–25 to +70
Storage temperature	Degrees C	–40 to +70	–40 to +70	–40 to +70	–40 to +70	–40 to +70	–40 to +70
Humidity	% RH	95 at 55 °C / 5–95 condensation permitted	95 at 55 °C / 5–95 condensation permitted	95 at 55 °C / 5–95 condensation permitted	95 at 55 °C / 5–95 condensation permitted	95 at 55 °C / 5–95 condensation permitted	95 at 55 °C / 5–95 condensation permitted

Machine Mount I/O Modules, continued

Description	Unit	EU2E-SWD-2PT	EU6E-SWD-4DX	EU6E-SWD-4XD-1	EU6E-SWD-4XD-2	EU6E-SWD-2D2D-1	EU6E-SWD-2D2D-2
SmartWire-DT Network							
Stations type		SmartWire-DT slave	SmartWire-DT slave	SmartWire-DT slave	SmartWire-DT slave	SmartWire-DT slave	SmartWire-DT slave
Baud rate setting		Automatic	Automatic	Automatic	Automatic	Automatic	Automatic
Maximum	Bit/sec	2 M	2 M	2 M	2 M	2 M	2 M
SW-DT Status LED		Green (625 nm)	Green (625 nm)	Green (625 nm)	Green (625 nm)	Green (625 nm)	Green (625 nm)
Connectors, (IEC-61076-2-101)	M12 A Coding	—	—	—	—	—	—
SW-DT network input connector		M12-M 5-pole	M12-M 5-pole	M12-M 5-pole	M12-M 5-pole	M12-M 5-pole	M12-M 5-pole
Pin 1		24 Vdc	24 Vdc	24 Vdc	24 Vdc	24 Vdc	24 Vdc
Pin 2		Data A	Data A	Data A	Data A	Data A	Data A
Pin 3		GND	GND	GND	GND	GND	GND
Pin 4		Data B	Data B	Data B	Data B	Data B	Data B
Pin 5		SEL (IN)	SEL (IN)	SEL (IN)	SEL (IN)	SEL (IN)	SEL (IN)
SW-DT network output connector		M12-F 5-pole	M12-F 5-pole	M12-F 5-pole	M12-F 5-pole	M12-F 5-pole	M12-F 5-pole
Pin 1		24 Vdc	24 Vdc	24 Vdc	24 Vdc	24 Vdc	24 Vdc
Pin 2		Data A	Data A	Data A	Data A	Data A	Data A
Pin 3		GND	GND	GND	GND	GND	GND
Pin 4		Data B	Data B	Data B	Data B	Data B	Data B
Pin 5		SEL (OUT)	SEL (OUT)	SEL (OUT)	SEL (OUT)	SEL (OUT)	SEL (OUT)
24 Vdc Power							
SWD-T bus 24 Vdc							
Rated operational voltage	V/U _e	24 V –15% +20%	24 V –15% +20%	24 V –15% +20%	24 V –15% +20%	24 V –15% +20%	24 V –15% +20%
Residual ripple on the input voltage	%	≤5	≤5	≤5	≤5	≤5	≤5
Reverse Polarity Protection		Yes	Yes	Yes	Yes	Yes	Yes
Rated supply current	mA	37	—	—	—	—	—
Actuator external 24 Vdc							
Rated operational voltage	V/U _e	—	—	24 V	24 V	24 V	24 V
Reverse polarity protection		—	—	Yes	Yes	Yes	Yes
Maximum Current (total)	A	—	—	8	8	8	8
Connectors		—	—	7/8 in mini	7/8 in mini	7/8 in mini	7/8 in mini
Power in	Male	—	—	Male, 4-pole	Male, 4-pole	Male, 4-pole	Male, 4-pole
Pin 1	Std len	—	—	24 Vdc	24 Vdc	24 Vdc	24 Vdc
Pin 2	Std len	—	—	24 Vdc	24 Vdc	24 Vdc	24 Vdc
Pin 3	Std len	—	—	GND	GND	GND	GND
Pin 4	Ext len	—	—	GND	GND	GND	GND
Power out	Female	—	—	Female, 4-pole	Female, 4-pole	Female, 4-pole	Female, 4-pole
Pin 1		—	—	24 Vdc	24 Vdc	24 Vdc	24 Vdc
Pin 2		—	—	24 Vdc	24 Vdc	24 Vdc	24 Vdc
Pin 3		—	—	GND	GND	GND	GND
Pin 4		—	—	GND	GND	GND	GND
Power indication LED	Power in	—	—	Green (625 nm)	Green (625 nm)	Green (625 nm)	Green (625 nm)
Digital Inputs							
Input current	mA	—	Nominal 4 at 24 Vdc	—	—	Nominal 4 at 24 Vdc	Nominal 4 at 24 Vdc
Voltage level to (IEC / EN 61131-2)		—	—	—	—	—	—
Limit value type 1		—	L < 5 Vdc; H > 15 Vdc	—	—	L < 5 Vdc; H > 15 Vdc	L < 5 Vdc; H > 15 Vdc
Input delay		—	H->L or L->H < 0.2 ms	—	—	H->L or L->H < 0.2 ms	H->L or L->H < 0.2 ms
Status display	LED	—	Yellow	—	—	Yellow	Yellow

Machine Mount I/O Modules, continued

Description	Unit	EU2E-SWD-2PT	EU6E-SWD-4DX	EU6E-SWD-4XD-1	EU6E-SWD-4XD-2	EU6E-SWD-2D2D-1	EU6E-SWD-2D2D-2
Digital Outputs							
Output driver circuit power source	Bus/ext	—	—	External	External	External	External
Output current	A	—	—	0.5 at 24 Vdc	2 at 24 Vdc	0.5 at 24 Vdc	2 at 24 Vdc
Trip current SC	A	—	—	1.2 over 3 ms	1.2 over 3 ms	1.2 over 3 ms	1.2 over 3 ms
Lamp load	W	—	—	≤3	≤3	≤3	≤3
Overload proof (IEC / EN 61131-2)		—	—	Yes w/diag	Yes w/diag	Yes w/diag	Yes w/diag
Switching capacity IEC 60947-5-1		—	—	DC-13	DC-13	DC-13	DC-13
Status display	LED	—	—	Yellow	Yellow	Yellow	Yellow
Total current all outputs	A	—	—	2	8	1	4
Analog							
Parameter setting							
Refresh rate	mS	—	—	—	—	—	—
Averaging (5 msec sample interval)	ON/OFF	—	—	—	—	—	—
Voltage							
Input voltage	V	—	—	—	—	—	—
Input impedance	kohm	—	—	—	—	—	—
Output voltage	V	—	—	—	—	—	—
Maximum output current	mA	—	—	—	—	—	—
Source impedance	kohm	—	—	—	—	—	—
Current							
Input current	mA	—	—	—	—	—	—
Input impedance	ohms	—	—	—	—	—	—
Output current	mA	—	—	—	—	—	—
Source impedance	ohms	—	—	—	—	—	—
Converter							
Resolution	Bit	—	—	—	—	—	—
Conversion time	ms	—	—	—	—	—	—
Cumulative error	%	—	—	—	—	—	—
Repetition accuracy	%	—	—	—	—	—	—
Encoder							
Frequency response	Hz	—	—	—	—	—	—
Status indication LED							
Count pulse		—	—	—	—	—	—
Encoder status (input byte 0)	Bit	—	—	—	—	—	—
Referencing active status	0	—	—	—	—	—	—
Reference status	1	—	—	—	—	—	—
Reference line state	2	—	—	—	—	—	—
Zero crossing	3	—	—	—	—	—	—
Control settings (output byte 0)	Bit	—	—	—	—	—	—
Count control	0	—	—	—	—	—	—
Reference enable (ActRef)	1	—	—	—	—	—	—
Reference control	2	—	—	—	—	—	—
Asynchronous reset	3	—	—	—	—	—	—
Zero crossing acknowledge	4	—	—	—	—	—	—

Machine Mount I/O Modules, continued

Description	Unit	EU2E-SWD-2PT	EU6E-SWD-4DX	EU6E-SWD-4XD-1	EU6E-SWD-4XD-2	EU6E-SWD-2D2D-1	EU6E-SWD-2D2D-2
Temperature							
Parameter setting							
Temperature sensor		PT100, PT1000, Ni1000	—	—	—	—	—
Averaging		Adjustable	—	—	—	—	—
Range		Selectable (1 of 2)	—	—	—	—	—
Temperature range							
PT100 (1)	°C	–50 to +200	—	—	—	—	—
PT1000 (1)	°C	–50 to +200	—	—	—	—	—
Ni1000 (1)	°C	–50 to +200	—	—	—	—	—
PT100 (2)	°C	–100 to +400	—	—	—	—	—
PT1000 (2)	°C	–100 to +400	—	—	—	—	—
Ni1000 (2)	°C	–100 to +400	—	—	—	—	—
Converter							
Resolution (converter)	Bit	12	—	—	—	—	—
Conversion time	ms	250	—	—	—	—	—
Cumulative error	%	±1.0	—	—	—	—	—
Repetition accuracy	%	±0.5	—	—	—	—	—
Display		°C, °F, raw value	—	—	—	—	—
Resolution (temperature)	°C	0.1	—	—	—	—	—
I/O Configurations							
24 Vdc bus power to I/O devices	Y/N	No	Yes	Yes	Yes	Yes	Yes
Galvanic isolation of I/O circuitry	Y/N	No	No	No	No	No	No
Operating power per connection	A	N/A	0.3	0.3	0.3	0.3	0.3
Internally power limited (PTC)	Y/N	No	Yes	Yes	Yes	Yes	Yes
Overload threshold per connection	A	N/A	0.6	0.6	0.6	0.6	0.6
Overload recovery time	S	N/A	0.6	0.6	0.6	0.6	0.6
Maximum allowed total current	A	N/A	4	4	4	4	4
I/O types							
Configurable (digital I/O)	I/O point	—	—	—	—	—	—
Digital IN (sinking)	I/O point	—	4	—	—	2	2
Digital OUT (sourcing)	I/O point	—	—	4	4	2	2
Analog IN	I/O point	—	—	—	—	—	—
Analog OUT	I/O point	—	—	—	—	—	—
Encoder IN	I/O point	—	—	—	—	—	—
Temperature sensor input	I/O point	2x 2 / 3 wire	—	—	—	—	—
I/O connectors, (IEC-61076-2-101)	M12 A Coding	2x M12-F / 5-pole	4x M12-F / 5-pole	4x M12-F / 5-pole	4x M12-F / 5-pole	4x M12-F / 5-pole	4x M12-F / 5-pole
Active circuits loaded in connector	Circuits	5	3	3	3	3	3

Machine Mount I/O Modules, continued

Description	Unit	EU2E-SWD-2PT	EU6E-SWD-4DX	EU6E-SWD-4XD-1	EU6E-SWD-4XD-2	EU6E-SWD-2D2D-1	EU6E-SWD-2D2D-2
I/O Configurations, continued							
I/O connector pin outs							
I/O Connector-1							
Pin 1		SWD Active Cap Detect	24 Vdc	24 Vdc	24 Vdc	24 Vdc	24 Vdc
Pin 2		T1b	N/C	N/C	N/C	N/C	N/C
Pin 3		GND	GND	GND	GND	GND	GND
Pin 4		T1a	In Ch 0	Out Ch 0	Out Ch 0	Out Ch 0	Out Ch 0
Pin 5		T1	N/C	N/C	N/C	N/C	N/C
Pin 6		—	—	—	—	—	—
Pin 7		—	—	—	—	—	—
Pin 8		—	—	—	—	—	—
I/O Connector-2							
Pin 1		SWD Active Cap Detect	24 Vdc	24 Vdc	24 Vdc	24 Vdc	24 Vdc
Pin 2		T2b	N/C	N/C	N/C	N/C	N/C
Pin 3		GND	GND	GND	GND	GND	GND
Pin 4		T2a	In Ch 2	Out Ch 2	Out Ch 2	Out Ch 2	Out Ch 2
Pin 5		T2	N/C	N/C	N/C	N/C	N/C
I/O Connector-3							
Pin 1		—	24 Vdc	24 Vdc	24 Vdc	24 Vdc	24 Vdc
Pin 2		—	N/C	N/C	N/C	N/C	N/C
Pin 3		—	GND	GND	GND	GND	GND
Pin 4		—	In Ch 4	Out Ch 4	Out Ch 4	In Ch 4	In Ch 4
Pin 5		—	N/C	N/C	N/C	N/C	N/C
I/O Connector-4							
Pin 1		—	24 Vdc	24 Vdc	24 Vdc	24 Vdc	24 Vdc
Pin 2		—	N/C	N/C	N/C	N/C	N/C
Pin 3		—	GND	GND	GND	GND	GND
Pin 4		—	In Ch 6	Out Ch 6	Out Ch 6	In Ch 6	In Ch 6
Pin 5		—	N/C	N/C	N/C	N/C	N/C
I/O Connector-5							
Pin 1		—	—	—	—	—	—
Pin 2		—	—	—	—	—	—
Pin 3		—	—	—	—	—	—
Pin 4		—	—	—	—	—	—
Pin 5		—	—	—	—	—	—
I/O Connector-6							
Pin 1		—	—	—	—	—	—
Pin 2		—	—	—	—	—	—
Pin 3		—	—	—	—	—	—
Pin 4		—	—	—	—	—	—
Pin 5		—	—	—	—	—	—
I/O Connector-7							
Pin 1		—	—	—	—	—	—
Pin 2		—	—	—	—	—	—
Pin 3		—	—	—	—	—	—
Pin 4		—	—	—	—	—	—
Pin 5		—	—	—	—	—	—
I/O Connector-8							
Pin 1		—	—	—	—	—	—
Pin 2		—	—	—	—	—	—
Pin 3		—	—	—	—	—	—
Pin 4		—	—	—	—	—	—
Pin 5		—	—	—	—	—	—

Machine Mount I/O Modules, continued

Description	Unit	EU6E-SWD-4D4D-1	EU6E-SWD-4D4D-2	EU6E-SWD-8DX	EU6E-SWD-8XD-1	EU6E-SWD-8DD	EU8E-SWD-8XD-1
General							
Standards		IEC / EN 61131-2, EN50178, IEC / EN 60529					
Dimensions (W x H x L)—reference only	mm	60 x 20 x As Req	60 x 20 x As Req	60 x 20 x As Req	60 x 20 x As Req	60 x 20 x As Req	60 x 20 x As Req
Weight	g / oz	267 / 9.4	267 / 9.4	234 / 8.3	267 / 9.4	234 / 8.3	369 / 13.0
Form factor		MultiBlock (Quad)	MultiBlock (Quad)	MultiBlock (Quad)	MultiBlock (Quad)	MultiBlock (Quad)	MultiBlock (Octal)
Enclosure material		Polyester	Polyester	Polyester	Polyester	Polyester	Polyester
Mounting	Qty	5 mounting holes or with bracket accessory	5 mounting holes or with bracket accessory	5 mounting holes or with bracket accessory	5 mounting holes or with bracket accessory	5 mounting holes or with bracket accessory	5 mounting holes or with bracket accessory
Ambient Conditions, Mechanical							
Protection type	Type	IP69K	IP69K	IP69K	IP69K	IP69K	IP69K
EN/IEC 60529	Type	IP6X / IPX7	IP6X / IPX7	IP6X / IPX7	IP6X / IPX7	IP6X / IPX7	IP6X / IPX7
UL Type		1	1	1	1	1	1
Vibrations							
Displacement 3.5 mm	Hz	5–8.4	5–8.4	5–8.4	5–8.4	5–8.4	5–8.4
Acceleration 1 g	Hz	8.4–150	8.4–150	8.4–150	8.4–150	8.4–150	8.4–150
Shock IEC 60068-2-27 1/2 sine 30 g/11 ms	Impacts	9	9	9	9	9	9
Drop to	Height, mm	50	50	50	50	50	50
Drop freefall	m	0.3	0.3	0.3	0.3	0.3	0.3
EMC							
Overvoltage category		II	II	II	II	II	II
Pollution degree		3	3	3	3	3	3
Electrostatic discharge		Performance Criterion B	Performance Criterion B	Performance Criterion B	Performance Criterion B	Performance Criterion B	Performance Criterion B
Air discharge (level 3)	kV	8	8	8	8	8	8
Contact discharge (level 2)	kV	4	4	4	4	4	4
Electromagnetic fields		Performance Criterion A	Performance Criterion A	Performance Criterion A	Performance Criterion A	Performance Criterion A	Performance Criterion A
80–1000 MHz	V/m	10	10	10	10	10	10
1.4–2 G	V/m	3	3	3	3	3	3
2–2.7 G	V/m	1	1	1	1	1	1
Radio interference suppression (SmartWire-DT) (emission and conducted interface voltage)	EN 55011	Class A	Class A	Class A	Class A	Class A	Class A
Burst (level 3)		Performance Criterion B	Performance Criterion B	Performance Criterion B	Performance Criterion B	Performance Criterion B	Performance Criterion B
Supply cables	kV	2	2	2	2	2	2
Signal cables	kV	1	1	1	1	1	1
SmartWire-DT cables	kV	1	1	1	1	1	1
Surge (level 1)		Performance Criterion B	Performance Criterion B	Performance Criterion B	Performance Criterion B	Performance Criterion B	Performance Criterion B
Supply cables	kV	0.5	0.5	0.5	0.5	0.5	0.5
I/O cables	kV	1	1	1	1	1	1
SmartWire-DT cables	kV	1	1	1	1	1	1
Radiated RFI (level 3) (150 kHz – 80 MHz)		Performance Criterion A	Performance Criterion A	Performance Criterion A	Performance Criterion A	Performance Criterion A	Performance Criterion A
Supply cables	V	10	10	10	10	10	10
I/O cables	V	10	10	10	10	10	10
SmartWire-DT cables	V	10	10	10	10	10	10
Voltage drops & interrupts	mS	10	10	10	10	10	10
Climatic Environmental Conditions							
Ambient temperature	Degrees C	–25 to +70	–25 to +70	–25 to +70	–25 to +70	–25 to +70	–25 to +70
Storage temperature	Degrees C	–40 to +70	–40 to +70	–40 to +70	–40 to +70	–40 to +70	–40 to +70
Humidity	% RH	95 at 55 °C / 5–95 condensation permitted	95 at 55 °C / 5–95 condensation permitted	95 at 55 °C / 5–95 condensation permitted	95 at 55 °C / 5–95 condensation permitted	95 at 55 °C / 5–95 condensation permitted	95 at 55 °C / 5–95 condensation permitted

SmartWire-DT In Panel and On Machine Wiring Solution

Machine Mount I/O Modules, continued

Description	Unit	EU6E-SWD-4D4D-1	EU6E-SWD-4D4D-2	EU6E-SWD-8DX	EU6E-SWD-8XD-1	EU6E-SWD-8DD	EU8E-SWD-8XD-1
SmartWire-DT Network							
Stations type		SmartWire-DT slave	SmartWire-DT slave	SmartWire-DT slave	SmartWire-DT slave	SmartWire-DT slave	SmartWire-DT slave
Baud rate setting		Automatic	Automatic	Automatic	Automatic	Automatic	Automatic
Maximum	Bit/sec	2 M	2 M	2 M	2 M	2 M	2 M
SW-DT Status LED		Green (625 nm)	Green (625 nm)	Green (625 nm)	Green (625 nm)	Green (625 nm)	Green (625 nm)
Connectors, (IEC-61076-2-101)	M12 A Coding	—	—	—	—	—	—
SW-DT network input connector		M12-M 5-pole	M12-M 5-pole	M12-M 5-pole	M12-M 5-pole	M12-M 5-pole	M12-M 5-pole
Pin 1		24 Vdc	24 Vdc	24 Vdc	24 Vdc	24 Vdc	24 Vdc
Pin 2		Data A	Data A	Data A	Data A	Data A	Data A
Pin 3		GND	GND	GND	GND	GND	GND
Pin 4		Data B	Data B	Data B	Data B	Data B	Data B
Pin 5		SEL (IN)	SEL (IN)	SEL (IN)	SEL (IN)	SEL (IN)	SEL (IN)
SW-DT network output connector		M12-F 5-pole	M12-F 5-pole	M12-F 5-pole	M12-F 5-pole	M12-F 5-pole	M12-F 5-pole
Pin 1		24 Vdc	24 Vdc	24 Vdc	24 Vdc	24 Vdc	24 Vdc
Pin 2		Data A	Data A	Data A	Data A	Data A	Data A
Pin 3		GND	GND	GND	GND	GND	GND
Pin 4		Data B	Data B	Data B	Data B	Data B	Data B
Pin 5		SEL (OUT)	SEL (OUT)	SEL (OUT)	SEL (OUT)	SEL (OUT)	SEL (OUT)
24 Vdc Power							
SWD-T Bus 24 Vdc							
Rated operational voltage	V/U _e	24 V –15% +20%	24 V –15% +20%	24 V –15% +20%	24 V –15% +20%	24 V –15% +20%	24 V –15% +20%
Residual ripple on the input voltage	%	≤5	≤5	≤5	≤5	≤5	≤5
Reverse Polarity Protection		Yes	Yes	Yes	Yes	Yes	Yes
Rated supply current	mA	—	—	—	—	—	—
Actuator external 24 Vdc							
Rated operational voltage	V/U _e	24 V	24 V	—	24 V	—	24 V
Reverse polarity protection		Yes	Yes	—	Yes	—	Yes
Maximum Current (total)	A	8	8	—	8	—	8
Connectors		7/8 in mini	7/8 in mini	—	7/8 in mini	—	7/8 in mini
Power in	Male	Male, 4-pole	Male, 4-pole	—	Male, 4-pole	—	Male, 4-pole
Pin 1	Std len	24 Vdc	24 Vdc	—	24 Vdc	—	24 Vdc
Pin 2	Std len	24 Vdc	24 Vdc	—	24 Vdc	—	24 Vdc
Pin 3	Std len	GND	GND	—	GND	—	GND
Pin 4	Ext len	GND	GND	—	GND	—	GND
Power out	Female	Female, 4-pole	Female, 4-pole	—	Female, 4-pole	—	Female, 4-pole
Pin 1		24 Vdc	24 Vdc	—	24 Vdc	—	24 Vdc
Pin 2		24 Vdc	24 Vdc	—	24 Vdc	—	24 Vdc
Pin 3		GND	GND	—	GND	—	GND
Pin 4		GND	GND	—	GND	—	GND
Power indication LED	Power in	Green (625 nm)	Green (625 nm)	—	Green (625 nm)	—	Green (625 nm)
Digital Inputs							
Input current	mA	Nominal 4 at 24 Vdc	Nominal 4 at 24 Vdc	Nominal 4 at 24 Vdc	—	Nominal 4 at 24 Vdc	—
Voltage level to (IEC / EN 61131-2)							
Limit value type 1		L < 5 Vdc; H > 15 Vdc	L < 5 Vdc; H > 15 Vdc	L < 5 Vdc; H > 15 Vdc	—	L < 5 Vdc; H > 15 Vdc	—
Input delay		H->L or L->H < 0.2 ms	H->L or L->H < 0.2 ms	H->L or L->H < 0.2 ms	—	H->L or L->H < 0.2 ms	—
Status display	LED	Yellow	Yellow	Yellow	—	Yellow	—

Machine Mount I/O Modules, continued

Description	Unit	EU6E-SWD-4D4D-1	EU6E-SWD-4D4D-2	EU6E-SWD-8DX	EU6E-SWD-8XD-1	EU6E-SWD-8DD	EU8E-SWD-8XD-1
Digital Outputs							
Output driver circuit power source	Bus/ext	External	External	—	External	Bus	External
Output current	A	0.5 at 24 Vdc	2 at 24 Vdc	—	0.5 at 24 Vdc	0.5 at 24 Vdc	0.5 at 24 Vdc
Trip current SC	A	1.2 over 3 ms	1.2 over 3 ms	—	1.2 over 3 ms	1.2 over 3 ms	1.2 over 3 ms
Lamp load	W	≤3	≤3	—	≤3	≤3	≤3
Overload proof (IEC / EN 61131-2)		Yes w/diag	Yes w/diag	—	Yes w/diag	Yes w/diag	Yes w/diag
Switching capacity IEC 60947-5-1		DC-13	DC-13	—	DC-13	DC-13	DC-13
Status display	LED	Yellow	Yellow	—	Yellow	Yellow	Yellow
Total current all outputs	A	2	8	—	4	4	4
Analog							
Parameter setting							
Refresh rate	mS	—	—	—	—	—	—
Averaging (5 msec sample interval)	ON/OFF	—	—	—	—	—	—
Voltage							
Input voltage	V	—	—	—	—	—	—
Input impedance	kohm	—	—	—	—	—	—
Output voltage	V	—	—	—	—	—	—
Maximum output current	mA	—	—	—	—	—	—
Source impedance	kohm	—	—	—	—	—	—
Current							
Input current	mA	—	—	—	—	—	—
Input impedance	ohms	—	—	—	—	—	—
Output current	mA	—	—	—	—	—	—
Source impedance	ohms	—	—	—	—	—	—
Converter							
Resolution	Bit	—	—	—	—	—	—
Conversion time	ms	—	—	—	—	—	—
Cumulative error	%	—	—	—	—	—	—
Repetition accuracy	%	—	—	—	—	—	—
Encoder							
Frequency response	Hz	—	—	—	—	—	—
Status indication LED							
Count pulse		—	—	—	—	—	—
Encoder status (input byte 0)	Bit	—	—	—	—	—	—
Referencing active status	0	—	—	—	—	—	—
Reference status	1	—	—	—	—	—	—
Reference line state	2	—	—	—	—	—	—
Zero crossing	3	—	—	—	—	—	—
Control settings (output byte 0)							
Count control	0	—	—	—	—	—	—
Reference enable (ActRef)	1	—	—	—	—	—	—
Reference control	2	—	—	—	—	—	—
Asynchronous reset	3	—	—	—	—	—	—
Zero crossing acknowledge	4	—	—	—	—	—	—

Machine Mount I/O Modules, continued

Description	Unit	EU6E-SWD-4D4D-1	EU6E-SWD-4D4D-2	EU6E-SWD-8DX	EU6E-SWD-8XD-1	EU6E-SWD-8DD	EU8E-SWD-8XD-1
Temperature							
Parameter setting							
Temperature sensor		—	—	—	—	—	—
Averaging		—	—	—	—	—	—
Range		—	—	—	—	—	—
Temperature range							
PT100 (1)	°C	—	—	—	—	—	—
PT1000 (1)	°C	—	—	—	—	—	—
Ni1000 (1)	°C	—	—	—	—	—	—
PT100 (2)	°C	—	—	—	—	—	—
PT1000 (2)	°C	—	—	—	—	—	—
Ni1000 (2)	°C	—	—	—	—	—	—
Converter							
Resolution (converter)	Bit	—	—	—	—	—	—
Conversion time	ms	—	—	—	—	—	—
Cumulative error	%	—	—	—	—	—	—
Repetition accuracy	%	—	—	—	—	—	—
Display		—	—	—	—	—	—
Resolution (temperature)	°C	—	—	—	—	—	—
I/O Configurations							
24 Vdc bus power to I/O devices	Y/N	Yes	Yes	Yes	Yes	Yes	Yes
Galvanic isolation of I/O circuitry	Y/N	No	No	No	No	No	No
Operating power per connection	A	0.3	0.3	0.3	0.3	0.3	0.3
Internally power limited (PTC)	Y/N	Yes	Yes	Yes	Yes	Yes	Yes
Overload threshold per connection	A	0.6	0.6	0.6	0.6	0.6	0.6
Overload recovery time	S	0.6	0.6	0.6	0.6	0.6	0.6
Maximum allowed total current	A	4	8	4	4	4	4
I/O types							
Configurable (digital I/O)	I/O point	—	—	—	—	8	—
Digital IN (sinking)	I/O point	4	4	8	—	Up to 8	—
Digital OUT (sourcing)	I/O point	4	4	—	8	Up to 8	8
Analog IN	I/O point	—	—	—	—	—	—
Analog OUT	I/O point	—	—	—	—	—	—
Encoder IN	I/O point	—	—	—	—	—	—
Temperature sensor input	I/O point	—	—	—	—	—	—
I/O connectors, (IEC-61076-2-101)	M12 A Coding	4x M12-F / 5-pole	4x M12-F / 5-pole	4x M12-F / 5-pole	4x M12-F / 5-pole	4x M12-F / 5-pole	8x M12-F / 5-pole
Active circuits loaded in connector	Circuits	4	4	4	4	4	3

Machine Mount I/O Modules, continued

Description	Unit	EU6E-SWD-4D4D-1	EU6E-SWD-4D4D-2	EU6E-SWD-8DX	EU6E-SWD-8XD-1	EU6E-SWD-8DD	EU8E-SWD-8XD-1
I/O Configurations, continued							
I/O connector pin outs							
I/O Connector-1							
Pin 1		24 Vdc	24 Vdc	24 Vdc	24 Vdc	24 Vdc	24 Vdc
Pin 2		Out Ch 1	Out Ch 1	In Ch 1	Out Ch 1	I/O Ch 1	N/C
Pin 3		GND	GND	GND	GND	GND	GND
Pin 4		Out Ch 0	Out Ch 0	In Ch 0	Out Ch 0	I/O Ch 0	Out Ch 0
Pin 5		N/C	N/C	N/C	N/C	N/C	N/C
Pin 6		—	—	—	—	—	—
Pin 7		—	—	—	—	—	—
Pin 8		—	—	—	—	—	—
I/O Connector-2							
Pin 1		24 Vdc	24 Vdc	24 Vdc	24 Vdc	24 Vdc	24 Vdc
Pin 2		Out Ch 3	Out Ch 3	In Ch 3	Out Ch 3	I/O Ch 3	N/C
Pin 3		GND	GND	GND	GND	GND	GND
Pin 4		Out Ch 2	Out Ch 2	In Ch 2	Out Ch 2	I/O Ch 2	Out Ch 2
Pin 5		N/C	N/C	N/C	N/C	N/C	N/C
I/O Connector-3							
Pin 1		24 Vdc	24 Vdc	24 Vdc	24 Vdc	24 Vdc	24 Vdc
Pin 2		In Ch 5	In Ch 5	In Ch 5	Out Ch 5	I/O Ch 5	N/C
Pin 3		GND	GND	GND	GND	GND	GND
Pin 4		In Ch 4	In Ch 4	In Ch 4	Out Ch 4	I/O Ch 4	Out Ch 4
Pin 5		N/C	N/C	N/C	N/C	N/C	N/C
I/O Connector-4							
Pin 1		24 Vdc	24 Vdc	24 Vdc	24 Vdc	24 Vdc	24 Vdc
Pin 2		In Ch 7	In Ch 7	In Ch 7	Out Ch 7	I/O Ch 7	N/C
Pin 3		GND	GND	GND	GND	GND	GND
Pin 4		In Ch 6	In Ch 6	In Ch 6	Out Ch 6	I/O Ch 6	Out Ch 6
Pin 5		N/C	N/C	N/C	N/C	N/C	N/C
I/O Connector-5							
Pin 1		—	—	—	—	—	24 Vdc
Pin 2		—	—	—	—	—	N/C
Pin 3		—	—	—	—	—	GND
Pin 4		—	—	—	—	—	Out Ch 8
Pin 5		—	—	—	—	—	N/C
I/O Connector-6							
Pin 1		—	—	—	—	—	24 Vdc
Pin 2		—	—	—	—	—	N/C
Pin 3		—	—	—	—	—	GND
Pin 4		—	—	—	—	—	Out Ch 10
Pin 5		—	—	—	—	—	N/C
I/O Connector-7							
Pin 1		—	—	—	—	—	24 Vdc
Pin 2		—	—	—	—	—	N/C
Pin 3		—	—	—	—	—	GND
Pin 4		—	—	—	—	—	Out Ch 12
Pin 5		—	—	—	—	—	N/C
I/O Connector-8							
Pin 1		—	—	—	—	—	24 Vdc
Pin 2		—	—	—	—	—	N/C
Pin 3		—	—	—	—	—	GND
Pin 4		—	—	—	—	—	Out Ch 14
Pin 5		—	—	—	—	—	N/C

Machine Mount I/O Modules, continued

Description	Unit	EU8E-SWD-4D4D-1	EU8E-SWD-8D8D-1	EU8E-SWD-16DX	EU8E-SWD-16XD-1	EU8E-SWD-16DD	EU1M-SWD-NOP
General							
Standards		IEC / EN 61131-2, EN50178, IEC / EN 60529					
Dimensions (W x H x L)—reference only	mm	60 x 20 x As Req	60 x 20 x As Req	60 x 20 x As Req	60 x 20 x As Req	60 x 20 x As Req	41 x 20 x 59
Weight	g / oz	369 / 13.0	369 / 13.0	335 / 11.8	369 / 13.0	335 / 11.8	65 / 2.3
Form factor		MultiBlock (Octal)	MultiBlock (Octal)	MultiBlock (Octal)	MultiBlock (Octal)	MultiBlock (Octal)	Single-T
Enclosure material		Polyester	Polyester	Polyester	Polyester	Polyester	MM 6208 (black)
Mounting	Qty	5 mounting holes or with bracket accessory	5 mounting holes or with bracket accessory	5 mounting holes or with bracket accessory	5 mounting holes or with bracket accessory	5 mounting holes or with bracket accessory	2 mounting holes or with bracket accessory
Ambient Conditions, Mechanical							
Protection type	Type	IP69K	IP69K	IP69K	IP69K	IP69K	IP69K
EN/IEC 60529	Type	IP6X / IPX7	IP6X / IPX7	IP6X / IPX7	IP6X / IPX7	IP6X / IPX7	IP6X / IPX7
UL Type		1	1	1	1	1	1
Vibrations							
Displacement 3.5 mm	Hz	5–8.4	5–8.4	5–8.4	5–8.4	5–8.4	5–8.4
Acceleration 1 g	Hz	8.4–150	8.4–150	8.4–150	8.4–150	8.4–150	8.4–150
Shock IEC 60068-2-27 1/2 sine 30 g/11 ms	Impacts	9	9	9	9	9	9
Drop to	Height, mm	50	50	50	50	50	50
Drop freefall	m	0.3	0.3	0.3	0.3	0.3	0.3
EMC							
Overvoltage category		II	II	II	II	II	II
Pollution degree		3	3	3	3	3	3
Electrostatic discharge		Performance Criterion B	Performance Criterion B	Performance Criterion B	Performance Criterion B	Performance Criterion B	Performance Criterion B
Air discharge (level 3)	kV	8	8	8	8	8	8
Contact discharge (level 2)	kV	4	4	4	4	4	4
Electromagnetic fields		Performance Criterion A	Performance Criterion A	Performance Criterion A	Performance Criterion A	Performance Criterion A	Performance Criterion A
80–1000 MHz	V/m	10	10	10	10	10	10
1.4–2 G	V/m	3	3	3	3	3	3
2–2.7 G	V/m	1	1	1	1	1	1
Radio interference suppression (SmartWire-DT) (emission and conducted interface voltage)	EN 55011	Class A	Class A	Class A	Class A	Class A	Class A
Burst (level 3)		Performance Criterion B	Performance Criterion B	Performance Criterion B	Performance Criterion B	Performance Criterion B	Performance Criterion B
Supply cables	kV	2	2	2	2	2	2
Signal cables	kV	1	1	1	1	1	1
SmartWire-DT cables	kV	1	1	1	1	1	1
Surge (level 1)		Performance Criterion B	Performance Criterion B	Performance Criterion B	Performance Criterion B	Performance Criterion B	Performance Criterion B
Supply cables	kV	0.5	0.5	0.5	0.5	0.5	0.5
I/O cables	kV	1	1	1	1	1	1
SmartWire-DT cables	kV	1	1	1	1	1	1
Radiated RFI (level 3) (150 kHz – 80 MHz)		Performance Criterion A	Performance Criterion A	Performance Criterion A	Performance Criterion A	Performance Criterion A	Performance Criterion A
Supply cables	V	10	10	10	10	10	10
I/O cables	V	10	10	10	10	10	10
SmartWire-DT cables	V	10	10	10	10	10	10
Voltage drops & interrupts	mS	10	10	10	10	10	10
Climatic Environmental Conditions							
Ambient temperature	Degrees C	–25 to +70	–25 to +70	–25 to +70	–25 to +70	–25 to +70	–25 to +70
Storage temperature	Degrees C	–40 to +70	–40 to +70	–40 to +70	–40 to +70	–40 to +70	–40 to +70
Humidity	% RH	95 at 55 °C / 5–95 condensation permitted	95 at 55 °C / 5–95 condensation permitted	95 at 55 °C / 5–95 condensation permitted	95 at 55 °C / 5–95 condensation permitted	95 at 55 °C / 5–95 condensation permitted	95 at 55 °C / 5–95 condensation permitted

Machine Mount I/O Modules, continued

Description	Unit	EU8E-SWD-4D4D-1	EU8E-SWD-8D8D-1	EU8E-SWD-16DX	EU8E-SWD-16XD-1	EU8E-SWD-16DD	EU1M-SWD-NOP
SmartWire-DT Network							
Stations type		SmartWire-DT slave	SmartWire-DT slave	SmartWire-DT slave	SmartWire-DT slave	SmartWire-DT slave	SmartWire-DT slave
Baud rate setting		Automatic	Automatic	Automatic	Automatic	Automatic	Automatic
Maximum	Bit/sec	2 M	2 M	2 M	2 M	2 M	2 M
SW-DT Status LED		Green (625 nm)	Green (625 nm)	Green (625 nm)	Green (625 nm)	Green (625 nm)	Green (625 nm)
Connectors, (IEC-61076-2-101)	M12 A Coding	—	—	—	—	—	—
SW-DT network input connector		M12-M 5-pole	M12-M 5-pole	M12-M 5-pole	M12-M 5-pole	M12-M 5-pole	M12-M 5-pole
Pin 1		24 Vdc	24 Vdc	24 Vdc	24 Vdc	24 Vdc	24 Vdc
Pin 2		Data A	Data A	Data A	Data A	Data A	Data A
Pin 3		GND	GND	GND	GND	GND	GND
Pin 4		Data B	Data B	Data B	Data B	Data B	Data B
Pin 5		SEL (IN)	SEL (IN)	SEL (IN)	SEL (IN)	SEL (IN)	SEL (IN)
SW-DT network output connector		M12-F 5-pole	M12-F 5-pole	M12-F 5-pole	M12-F 5-pole	M12-F 5-pole	M12-F 5-pole
Pin 1		24 Vdc	24 Vdc	24 Vdc	24 Vdc	24 Vdc	24 Vdc
Pin 2		Data A	Data A	Data A	Data A	Data A	Data A
Pin 3		GND	GND	GND	GND	GND	GND
Pin 4		Data B	Data B	Data B	Data B	Data B	Data B
Pin 5		SEL (OUT)	SEL (OUT)	SEL (OUT)	SEL (OUT)	SEL (OUT)	SEL (OUT)
24 Vdc Power							
SWD-T Bus 24 Vdc							
Rated operational voltage	V/U _e	24 V –15% +20%	24 V –15% +20%	24 V –15% +20%	24 V –15% +20%	24 V –15% +20%	24 V –15% +20%
Residual ripple on the input voltage	%	≤5	≤5	≤5	≤5	≤5	≤5
Reverse Polarity Protection		Yes	Yes	Yes	Yes	Yes	Yes
Rated supply current	mA	—	—	—	—	—	55
Actuator external 24 Vdc							
Rated operational voltage	V/U _e	24 V	24 V	—	24 V	—	—
Reverse polarity protection		Yes	Yes	—	Yes	—	—
Maximum Current (total)	A	8	8	—	8	—	—
Connectors		7/8 in mini	7/8 in mini	—	7/8 in mini	—	—
Power in	Male	Male, 4-pole	Male, 4-pole	—	Male, 4-pole	—	—
Pin 1	Std len	24 Vdc	24 Vdc	—	24 Vdc	—	—
Pin 2	Std len	24 Vdc	24 Vdc	—	24 Vdc	—	—
Pin 3	Std len	GND	GND	—	GND	—	—
Pin 4	Ext len	GND	GND	—	GND	—	—
Power out	Female	Female, 4-pole	Female, 4-pole	—	Female, 4-pole	—	—
Pin 1		24 Vdc	24 Vdc	—	24 Vdc	—	—
Pin 2		24 Vdc	24 Vdc	—	24 Vdc	—	—
Pin 3		GND	GND	—	GND	—	—
Pin 4		GND	GND	—	GND	—	—
Power indication LED	Power in	Green (625 nm)	Green (625 nm)	—	Green (625 nm)	—	—
Digital Inputs							
Input current	mA	Nominal 4 at 24 Vdc	Nominal 4 at 24 Vdc	Nominal 4 at 24 Vdc	—	Nominal 4 at 24 Vdc	—
Voltage level to (IEC / EN 61131-2)							
Limit value type 1		L < 5 Vdc; H > 15 Vdc	L < 5 Vdc; H > 15 Vdc	L < 5 Vdc; H > 15 Vdc	—	L < 5 Vdc; H > 15 Vdc	—
Input delay		H->L or L->H < 0.2 ms	H->L or L->H < 0.2 ms	H->L or L->H < 0.2 ms	—	H->L or L->H < 0.2 ms	—
Status display	LED	Yellow	Yellow	Yellow	—	Yellow	—

Machine Mount I/O Modules, continued

Description	Unit	EU8E-SWD-4D4D-1	EU8E-SWD-8D8D-1	EU8E-SWD-16DX	EU8E-SWD-16XD-1	EU8E-SWD-16DD	EU1M-SWD-NOP
Digital Outputs							
Output driver circuit power source	Bus/ext	External	External	—	External	Bus	—
Output current	A	0.5 at 24 Vdc	0.5 at 24 Vdc	—	0.5 at 24 Vdc	0.5 at 24 Vdc	—
Trip current SC	A	1.2 over 3 ms	1.2 over 3 ms	—	1.2 over 3 ms	1.2 over 3 ms	—
Lamp load	W	≤3	≤3	—	≤3	≤3	—
Overload proof (IEC / EN 61131-2)		Yes w/diag	Yes w/diag	—	Yes w/diag	Yes w/diag	—
Switching capacity IEC 60947-5-1		DC-13	DC-13	—	DC-13	DC-13	—
Status display	LED	Yellow	Yellow	—	Yellow	Yellow	—
Total current all outputs	A	2	4	—	8	8	—
Analog							
Parameter setting							
Refresh rate	mS	—	—	—	—	—	—
Averaging (5 msec sample interval)	ON/OFF	—	—	—	—	—	—
Voltage							
Input voltage	V	—	—	—	—	—	—
Input impedance	kohm	—	—	—	—	—	—
Output voltage	V	—	—	—	—	—	—
Maximum output current	mA	—	—	—	—	—	—
Source impedance	kohm	—	—	—	—	—	—
Current							
Input current	mA	—	—	—	—	—	—
Input impedance	ohms	—	—	—	—	—	—
Output current	mA	—	—	—	—	—	—
Source impedance	ohms	—	—	—	—	—	—
Converter							
Resolution	Bit	—	—	—	—	—	—
Conversion time	ms	—	—	—	—	—	—
Cumulative error	%	—	—	—	—	—	—
Repetition accuracy	%	—	—	—	—	—	—
Encoder							
Frequency response	Hz	—	—	—	—	—	—
Status indication LED							
Count pulse		—	—	—	—	—	—
Encoder status (input byte 0)	Bit	—	—	—	—	—	—
Referencing active status	0	—	—	—	—	—	—
Reference status	1	—	—	—	—	—	—
Reference line state	2	—	—	—	—	—	—
Zero crossing	3	—	—	—	—	—	—
Control settings (output byte 0)	Bit	—	—	—	—	—	—
Count control	0	—	—	—	—	—	—
Reference enable (ActRef)	1	—	—	—	—	—	—
Reference control	2	—	—	—	—	—	—
Asynchronous reset	3	—	—	—	—	—	—
Zero crossing acknowledge	4	—	—	—	—	—	—

Machine Mount I/O Modules, continued

Description	Unit	EU8E-SWD-4D4D-1	EU8E-SWD-8D8D-1	EU8E-SWD-16DX	EU8E-SWD-16XD-1	EU8E-SWD-16DD	EU1M-SWD-NOP
Temperature							
Parameter setting							
Temperature sensor		—	—	—	—	—	—
Averaging		—	—	—	—	—	—
Range		—	—	—	—	—	—
Temperature range							
PT100 (1)	°C	—	—	—	—	—	—
PT1000 (1)	°C	—	—	—	—	—	—
Ni1000 (1)	°C	—	—	—	—	—	—
PT100 (2)	°C	—	—	—	—	—	—
PT1000 (2)	°C	—	—	—	—	—	—
Ni1000 (2)	°C	—	—	—	—	—	—
Converter							
Resolution (converter)	Bit	—	—	—	—	—	—
Conversion time	ms	—	—	—	—	—	—
Cumulative error	%	—	—	—	—	—	—
Repetition accuracy	%	—	—	—	—	—	—
Display		—	—	—	—	—	—
Resolution (temperature)	°C	—	—	—	—	—	—
I/O Configurations							
24 Vdc bus power to I/O devices	Y/N	Yes	Yes	Yes	Yes	Yes	—
Galvanic isolation of I/O circuitry	Y/N	No	No	No	No	No	—
Operating power per connection	A	0.3	0.3	0.3	0.3	0.3	—
Internally power limited (PTC)	Y/N	Yes	Yes	Yes	Yes	Yes	—
Overload threshold per connection	A	0.6	0.6	0.6	0.6	0.6	—
Overload recovery time	S	0.6	0.6	0.6	0.6	0.6	—
Maximum allowed total current	A	4	4	4	8	8	—
I/O types							
Configurable (digital I/O)	I/O point	—	—	—	—	16	—
Digital IN (sinking)	I/O point	4	8	16	—	Up to 16	—
Digital OUT (sourcing)	I/O point	4	8	—	16	Up to 16	—
Analog IN	I/O point	—	—	—	—	—	—
Analog OUT	I/O point	—	—	—	—	—	—
Encoder IN	I/O point	—	—	—	—	—	—
Temperature sensor input	I/O point	—	—	—	—	—	—
I/O connectors, (IEC-61076-2-101)	M12 A Coding	8x M12-F / 5-pole	8x M12-F / 5-pole	8x M12-F / 5-pole	8x M12-F / 5-pole	8x M12-F / 5-pole	—
Active circuits loaded in connector	Circuits	3	4	4	4	4	—

Machine Mount I/O Modules, continued

Description	Unit	EU8E-SWD-4D4D-1	EU8E-SWD-8D8D-1	EU8E-SWD-16DX	EU8E-SWD-16XD-1	EU8E-SWD-16DD	EU1M-SWD-NOP
I/O Configurations, continued							
I/O connector pin outs							
I/O Connector-1							
Pin 1		24 Vdc	24 Vdc	24 Vdc	24 Vdc	24 Vdc	—
Pin 2		N/C	Out Ch 1	In Ch 1	Out Ch 1	I/O Ch 1	—
Pin 3		GND	GND	GND	GND	GND	—
Pin 4		Out Ch 0	Out Ch 0	In Ch 0	Out Ch 0	I/O Ch 0	—
Pin 5		N/C	N/C	N/C	N/C	N/C	—
Pin 6		—	—	—	—	—	—
Pin 7		—	—	—	—	—	—
Pin 8		—	—	—	—	—	—
I/O Connector-2							
Pin 1		24 Vdc	24 Vdc	24 Vdc	24 Vdc	24 Vdc	—
Pin 2		N/C	Out Ch 3	In Ch 3	Out Ch 3	I/O Ch 3	—
Pin 3		GND	GND	GND	GND	GND	—
Pin 4		Out Ch 2	Out Ch 2	In Ch 2	Out Ch 2	I/O Ch 2	—
Pin 5		N/C	N/C	N/C	N/C	N/C	—
I/O Connector-3							
Pin 1		24 Vdc	24 Vdc	24 Vdc	24 Vdc	24 Vdc	—
Pin 2		N/C	Out Ch 5	In Ch 5	Out Ch 5	I/O Ch 5	—
Pin 3		GND	GND	GND	GND	GND	—
Pin 4		Out Ch 4	Out Ch 4	In Ch 4	Out Ch 4	I/O Ch 4	—
Pin 5		N/C	N/C	N/C	N/C	N/C	—
I/O Connector-4							
Pin 1		24 Vdc	24 Vdc	24 Vdc	24 Vdc	24 Vdc	—
Pin 2		N/C	Out Ch 7	In Ch 7	Out Ch 7	I/O Ch 7	—
Pin 3		GND	GND	GND	GND	GND	—
Pin 4		Out Ch 6	Out Ch 6	In Ch 6	Out Ch 6	I/O Ch 6	—
Pin 5		N/C	N/C	N/C	N/C	N/C	—
I/O Connector-5							
Pin 1		24 Vdc	24 Vdc	24 Vdc	24 Vdc	24 Vdc	—
Pin 2		N/C	In Ch 9	In Ch 9	Out Ch 9	I/O Ch 9	—
Pin 3		GND	GND	GND	GND	GND	—
Pin 4		In Ch 8	In Ch 8	In Ch 8	Out Ch 8	I/O Ch 8	—
Pin 5		N/C	N/C	N/C	N/C	N/C	—
I/O Connector-6							
Pin 1		24 Vdc	24 Vdc	24 Vdc	24 Vdc	24 Vdc	—
Pin 2		N/C	In Ch 11	In Ch 11	Out Ch 11	I/O Ch 11	—
Pin 3		GND	GND	GND	GND	GND	—
Pin 4		In Ch 10	In Ch 10	In Ch 10	Out Ch 10	I/O Ch 10	—
Pin 5		N/C	N/C	N/C	N/C	N/C	—
I/O Connector-7							
Pin 1		24 Vdc	24 Vdc	24 Vdc	24 Vdc	24 Vdc	—
Pin 2		N/C	In Ch 13	In Ch 13	Out Ch 13	I/O Ch 13	—
Pin 3		GND	GND	GND	GND	GND	—
Pin 4		In Ch 12	In Ch 12	In Ch 12	Out Ch 12	I/O Ch 12	—
Pin 5		N/C	N/C	N/C	N/C	N/C	—
I/O Connector-8							
Pin 1		24 Vdc	24 Vdc	24 Vdc	24 Vdc	24 Vdc	—
Pin 2		N/C	In Ch 15	In Ch 15	Out Ch 15	I/O Ch 15	—
Pin 3		GND	GND	GND	GND	GND	—
Pin 4		In Ch 14	In Ch 14	In Ch 14	Out Ch 14	I/O Ch 14	—
Pin 5		N/C	N/C	N/C	N/C	N/C	—

SWD Accessories

Specification	Unit	EU1S-SWD-PF1-2	SWD4-RC5-10	SWD4-ACAP-10	SWD4-SML8-12	SWD4-SFL8-12	SWD4-MNT-VER	SWD4-MNT-DIN
General								
Standards		IEC/EN 61131-2, EN50178, IEC / EN 60529	IEC/EN 61131-2, EN50178, IEC / EN 60529	IEC/EN 61131-2, EN50178, IEC / EN 60529	IEC/EN 61131-2, EN50178, IEC / EN 60529	IEC/EN 61131-2, EN50178, IEC / EN 60529	IEC/EN 61131-2, EN50178, IEC / EN 60529	IEC/EN 61131-2, EN50178, IEC / EN 60529
Dimensions (W x H x L)—reference only	mm	41 x 20 x 59	41 x 20 x 15	13 (dia) x 20 (len)	35 x 83 x 46	35 x 83 x 46	16.1 x 30.7 x 15.5	10.2 x 43 x 19
M12 I/O Connector spacing (L)	mm	—	—	—	—	—	—	—
Weight	g / oz	65 / 2.3	13 / 0.45	15 / 0.525	65/2.3	65/2.3	3.4 / 0.12	6.8 / 0.24
Form factor		Single-T	IP67 bus term	M12-M overload	IP20 enclosure	IP20 enclosure	M20 quick clip	DIN rail clips
Enclosure material	Tee	MM 6208 (black)	MM 6208 (black)	TPV	Thermoplastic	Thermoplastic	Thermoplastic	Thermoplastic
Mounting	Qty	2 mounting holes or with bracket accessory	Integral M12-M	Integral M12-M	Panel mount M12-M	Panel mount M12-F	Single mounting hole	To DIN rail
Ambient Conditions, Mechanical								
Protection type	Type	IP69K	IP69K	IP69K	IP69K	IP69K	—	—
EN/IEC 60529	Type	IP6X / IPX7	IP6X / IPX7	IP6X / IPX7	IP20	IP20	—	—
UL Type		1	1	1	1	1	—	—
Vibrations								
Displacement 3.5 mm	Hz	5–8.4	5–8.4	5–8.4	5–8.4	5–8.4	5–8.4	5–8.4
Acceleration 1 g	Hz	8.4–150	8.4–150	8.4–150	8.4–150	8.4–150	8.4–150	8.4–150
Shock IEC 60068-2-27 1/2 sine 30 g/11 ms	Impacts	9	9	9	9	9	9	9
Drop to	Height, mm	50	50	50	50	50	50	50
Drop freefall	m	0.3	0.3	0.3	0.3	0.3	0.3	0.3
EMC								
Overvoltage category		II	II	II	II	II	—	—
Pollution degree		3	3	3	2	2	—	—
Electrostatic discharge								
Air discharge (level 3)	kV	8	8	8	8	8	—	—
Contact discharge (level 2)	kV	4	4	4	4	4	—	—
Electromagnetic fields								
		Performance Criterion A	Performance Criterion A	Performance Criterion A	Performance Criterion A	Performance Criterion A	—	—
80–1000 MHz	V/m	10	10	10	10	10	—	—
1.4–2 G	V/m	3	3	3	3	3	—	—
2–2.7 G	V/m	1	1	1	1	1	—	—
Radio interference suppression (SmartWire-DT) (emission and conducted interface voltage)	EN 55011	Class A	Class A	Class A	Class A	Class A	—	—
Burst (level 3)		Performance Criterion B	Performance Criterion B	Performance Criterion B	Performance Criterion B	Performance Criterion B	—	—
Supply cables	kV	2	2	2	2	2	—	—
Signal cables	kV	1	2	2	1	1	—	—
SmartWire-DT cables	kV	1	2	2	1	1	—	—
Surge (level 1)		Performance Criterion B	Performance Criterion B	Performance Criterion B	Performance Criterion B	Performance Criterion B	—	—
Supply cables	kV	0.5	1	1	0.5	0.5	—	—
I/O cables	kV	1	1	1	1	1	—	—
SmartWire-DT cables	kV	1 kV (not possible according to EN61000-6-2 Table 2)					—	—
Radiated RFI (level 3) (150 kHz – 80 MHz)		Performance Criterion A	Performance Criterion A	Performance Criterion A	Performance Criterion A	Performance Criterion A	—	—
Supply cables	V	10	10	10	10	10	—	—
I/O cables	V	10	10	10	10	10	—	—
SmartWire-DT cables	V	10	10	10	10	10	—	—
Voltage drops & interrupts	mS	10	10	10	10	10	—	—

SWD Accessories, continued

Specification	Unit	EU1S-SWD-PF1-2	SWD4-RC5-10	SWD4-ACAP-10	SWD4-SML8-12	SWD4-SFL8-12	SWD4-MNT-VER	SWD4-MNT-DIN
Climatic Environmental Conditions								
Ambient temperature	Degrees C	-25 to +70	-25 to +70	-25 to +70	-25 to +70	-25 to +70	-25 to +70	-25 to +70
Storage temperature	Degrees C	-40 to +70	-40 to +70	-40 to +70	-40 to +70	-40 to +70	-40 to +70	-40 to +70
Humidity	% RH	95 at 55 °C / 5–95% condensation permitted						
SmartWire-DT Network								
Stations type		N/A	N/A	N/A	N/A	N/A	—	—
Baud rate setting		—	—	—	—	—	—	—
Maximum	bit / sec	—	—	—	—	—	—	—
SW-DT Status LED		—	—	—	—	—	—	—
Connectors, (IEC-61076-2-101)	M12 A Coding	—	—	—	—	—	—	—
SW-DT network input connector		1x M12-M / 5-pole	1x M12-M / 5-pole	1x M12-M / 5-pole	1x M12-M / 5-pole	1x Lumberg (LT-307.597.1)	—	—
Pin 1		N/C	24 Vdc	24 Vdc	24 Vdc	15 V	—	—
Pin 2		Data A	Data A	N/C	Data A	SEL	—	—
Pin 3		GND	GND	GND	GND	GND	—	—
Pin 4		Data B	Data B	N/C	Data B	Data A	—	—
Pin 5		SEL (IN)	SEL (IN)	N/C	SEL (IN)	Data B	—	—
Pin 6		—	—	—	—	GND	—	—
Pin 7		—	—	—	—	0 V	—	—
Pin 8		—	—	—	—	24 Vdc	—	—
SW-DT network output connector		1x M12-F / 5-pole	—	—	1x Lumberg (LT-307.597.1)	1x M12-F / 5-pole	—	—
Pin 1		24 Vdc	—	—	15 V	24 Vdc	—	—
Pin 2		Data A	—	—	SEL	Data A	—	—
Pin 3		GND	—	—	GND	GND	—	—
Pin 4		Data B	—	—	Data A	Data B	—	—
Pin 5		SEL (OUT)	—	—	Data B	SEL (OUT)	—	—
Pin 6		—	—	—	GND	—	—	—
Pin 7		—	—	—	0V	—	—	—
Pin 8		—	—	—	24 Vdc	—	—	—
SW-DT network branch connector		—	—	—	—	—	—	—
Pin 1		—	—	—	—	—	—	—
Pin 2		—	—	—	—	—	—	—
Pin 3		—	—	—	—	—	—	—
Pin 4		—	—	—	—	—	—	—
Pin 5		—	—	—	—	—	—	—
Pin 6		—	—	—	—	—	—	—
Pin 7		—	—	—	—	—	—	—
Pin 8		—	—	—	—	—	—	—
24 Vdc Supply (SWD4-R)								
Rated operational voltage	V/U _e	—	24 V -15% +20%	—	—	—	—	—
Residual ripple on the input voltage	%	—	≤5	—	—	—	—	—
Reverse Polarity		—	Yes	—	—	—	—	—
Rated supply current	mA	—	12	—	—	—	—	—
24 Vdc Supply (PF1-2)								
Rated operational voltage	V/U _e	24 V -15% +20%	—	—	—	—	—	—
Residual ripple on the input voltage	%	≤5	—	—	—	—	—	—
Rated supply current	A	4	—	—	—	—	—	—
Connectors, (IEC-61076-2-101)	M12 A Coding	—	—	—	—	—	—	—

SWD Accessories, continued

Specification	Unit	EU1S-SWD-PF1-2	SWD4-RC5-10	SWD4-ACAP-10	SWD4-SML8-12	SWD4-SFL8-12	SWD4-MNT-VER	SWD4-MNT-DIN
24 Vdc Supply (PF1-2), continued								
PF1 24 Vdc input connector		1x M12-M / 5-pole	—	—	—	—	—	—
Pin 1		24 Vdc	—	—	—	—	—	—
Pin 2		N/C	—	—	—	—	—	—
Pin 3		GND	—	—	—	—	—	—
Pin 4		N/C	—	—	—	—	—	—
Pin 5		N/C	—	—	—	—	—	—
Power indicator LED		Green (625 nm)	—	—	—	—	—	—
Active Cap (-ACAP-10)								
Rated operational voltage	V/U _e	—	—	24 V -15% +20%	—	—	—	—
Reverse Polarity		—	—	N/A	—	—	—	—
Rated supply current	mA	—	—	≥1 mA	—	—	—	—
Connectors, (IEC-61076-2-101)	M12 A Coding	—	—	—	—	—	—	—
Active Cap M12-M		—	—	1x M12-M / 2 Pole	—	—	—	—
Pin 1		—	—	24 Vdc	—	—	—	—
Pin 2		—	—	N/C	—	—	—	—
Pin 3		—	—	GND	—	—	—	—
Pin 4		—	—	N/C	—	—	—	—
Pin 5		—	—	N/C	—	—	—	—
Parameter		—	—	—	—	—	—	—
Diagnostic per M12 I/O connector		—	—	ON/OFF	—	—	—	—
15 Vdc Supply (to Flat Cable)								
Rated operational voltage	V/U _e	—	—	—	14,5V +/- 3%	—	—	—
Residual ripple on the input voltage	%	—	—	—	≤5	—	—	—
Short Circuit Protection		—	—	—	Yes	—	—	—
Output Power	mA	—	—	—	120	—	—	—
24 Vdc Out (Push In Terminals)								
Rated operational voltage	V/U _e	—	—	—	24 V	24 V	—	—
Short circuit protection		—	—	—	No	No	—	—
Connectors		—	—	—	—	—	—	—
24 V Out 1		—	—	—	LSF-SMT3.5	LSF-SMT3.5	—	—
Pin 1		—	—	—	24 Vdc	24 Vdc	—	—
Pin 2		—	—	—	0 V	0 V	—	—
24 V Out 2		—	—	—	LSF-SMT3.5	—	—	—
Pin 1		—	—	—	24 Vdc	—	—	—
Pin 2		—	—	—	0 V	—	—	—
24 Vdc In (Push In Terminals)								
Rated operational voltage	V/U _e	—	—	—	—	24 Vdc -15%/+20%	—	—
Residual ripple on the input voltage	%	—	—	—	—	≤5	—	—
Reverse polarity protection		—	—	—	—	Yes	—	—
Rated current	A	—	—	—	—	4	—	—
Short Circuit Protection		—	—	—	—	No	—	—
Connectors		—	—	—	—	—	—	—
24 V In 1		—	—	—	—	LSF-SMT3.5	—	—
Pin 1		—	—	—	—	24 Vdc	—	—
Pin 2		—	—	—	—	0 V	—	—

Contactors Modules

Description	Unit	DIL-SWD-32-001	DIL-SWD-32-002	PKE-SWD-32
General				
Standards		IEC/EN 61131-2 EN 50178 IEC/EN 60947	IEC/EN 61131-2 EN 50178 IEC/EN 60947	IEC/EN 61131-2 EN 50178 IEC/EN 60947
Dimensions (W x H x D)	in (mm)	1.77 x 1.50 x 3.0 (45 x 38 x 76)	1.77 x 1.50 x 3.0 (45 x 38 x 76)	1.77 x 1.50 x 3.0 (45 x 38 x 76)
Weight	lbs (kg)	0.9 (0.04)	0.9 (0.04)	0.9 (0.04)
Mounting		on XTCE007–XTCE032	on XTCE007–XTCE032	—
Mounting position		as XTCE007–XTCE032	as XTCE007–XTCE032	—
Ambient Conditions, Mechanical				
Degree of protection (IEC/EN 60529)		IP20	IP20	—
Vibrations (IEC/EN 61131-2:2008)				
Constant amplitude 3.5 mm	Hz	5–8.4	5–8.4	5–8.4
Constant acceleration 1 g	Hz	8.4–150	8.4–150	8.4–150
Mechanical shock resistance (IEC/EN 60068-2-27) semi-sinusoidal 15 g/11 ms	Impacts	9	9	9
Drop to IEC/EN 60068-2-31 (drop height)	in (mm)	1.97 (50)	1.97 (50)	1.97 (50)
Free fall, packaged (IEC/EN 60068-2-32)	ft (m)	1.0 (0.3)	1.0 (0.3)	1.0 (0.3)
Electromagnetic Compatibility (EMC)				
Overvoltage category		II	II	II
Pollution degree		2	2	2
Electrostatic discharge (IEC/EN 61131-2:2008)				
Air discharge (Level 3)	kV	8	8	8
Contact discharge (Level 2)	kV	4	4	4
Electromagnetic fields (IEC/EN 61131-2:2008)				
80–1000 MHz	V/m	10	10	10
1.4–2 GHz	V/m	3	3	3
2–2.7 GHz	V/m	1	1	1
Radio interference suppression (SmartWire-DT)		EN 55011 Class A	EN 55011 Class A	EN 55011 Class A
Burst (IEC/EN 61131-2:2008, Level 3)				
CAN/DP bus cable	kV	1	1	1
SmartWire-DT cables	kV	1	1	1
Radiated RFI (IEC/EN 61131-2:2008, Level 3)	V	10	10	10
Climatic Environmental Conditions				
Operating ambient temperature (IEC 60068-2)	°F (°C)	–13° to 140° (–25° to 60°)	–13° to 140° (–25° to 60°)	–13° to 140° (–25° to 60°)
Condensation		Prevent with suitable measures	Prevent with suitable measures	Prevent with suitable measures
Storage	°F (°C)	–22° to 158° (–30° to 70°)	–22° to 158° (–30° to 70°)	–22° to 158° (–30° to 70°)
Relative humidity, noncondensing (IEC/EN 60068-2-30)	%	5–95	5–95	5–95

Contactor Modules, continued

Description	Unit	DIL-SWD-32-001	DIL-SWD-32-002	PKE-SWD-32
SmartWire-DT Network				
Station type		SmartWire-DT station (mode)	SmartWire-DT station (mode)	SmartWire-DT (slave)
Address allocation		Automatic	Automatic	Automatic
SmartWire-DT status LED		Green/orange	Green/orange	Green/orange
Connections				
Plug		8-pole	8-pole	8-pole
Plug connectors		External device plug SWD4-8SF2-5	External device plug SWD4-8SF2-5	External device plug SWD4-8SF2-5
Current consumption (15 V SWD supply)		40 mA	40 mA	58 mA
Mode Parameter				
Manual/automatic mode		No	Yes	Yes
Setting		—	Rotary switch	Rotary switch
Connection Auxiliary Contact				
Number		2	2	—
Rated voltage (U_b) ^①	Vdc	15	15	—
Input current at 1 signal, typical	mA	3	3	—
Potential isolation		No	No	—
Cable length	ft (m)	≤9.2 (2.8)	≤9.2 (2.8)	≤9.2 (2.8)
Connection type		Push in terminals	Push in terminals	Push in terminals
Terminal Capacities				
Solid	mm ²	0.2–1.5 (AWG 24–16)	0.2–1.5 (AWG 24–16)	0.2–1.5 (AWG 24–16)
Flexible with ferrule ^②	mm ²	0.25–1.5	0.25–1.5	0.25–1.5

Notes

① Own supply.

② Minimum length: 8 mm.

Pilot Device Modules

Description	Unit	M22-SWD-K11	M22-SWD-KC11	M22-SWD-LED_	M22-SWD-LEDC_	M22-SWD-K11-LED_
General						
Standards		IEC/EN 61131-2 EN 50178	IEC/EN 61131-2 EN 50178	IEC/EN 61131-2 EN 50178	IEC/EN 61131-2 EN 50178	IEC/EN 61131-2 EN 50178
Dimensions (W x H x D)	in (mm)	0.47 x 1.65 x 1.54 (12 x 42 x 39)	0.47 x 1.77 x 1.46 (12 x 45 x 37)	0.39 x 1.65 x 1.77 (10 x 42 x 45)	0.39 x 1.77 x 1.65 (10 x 45 x 42)	0.47 x 1.65 x 1.77 (12 x 42 x 45)
Weight	lbs (g)	0.022 (10)	0.022 (10)	0.022 (10)	0.022 (10)	0.022 (10)
Mounting position		As required	As required	As required	As required	As required
Ambient Conditions, Mechanical						
Degree of protection (IEC/EN 60529)		IP20	IP20	IP20	IP20	IP20
Vibrations (IEC/EN 61131-2:2008)						
Constant amplitude 3.5 mm	Hz	5–8.4	5–8.4	5–8.4	5–8.4	5–8.4
Constant acceleration 1 g	Hz	8.4–150	8.4–150	8.4–150	8.4–150	8.4–150
Mechanical shock resistance (IEC/EN 60068-2-27) semi-sinusoidal 15 g/11 ms	Impacts	9	9	9	9	9
Drop to IEC/EN 60068-2-31 (drop height)	in (mm)	1.97 (50)	1.97 (50)	1.97 (50)	1.97 (50)	1.97 (50)
Free fall, packaged (IEC/EN 60068-2-32)	ft (m)	1.0 (0.3)	1.0 (0.3)	1.0 (0.3)	1.0 (0.3)	1.0 (0.3)
Electromagnetic Compatibility (EMC)						
Overvoltage category		Not applicable	Not applicable	Not applicable	Not applicable	Not applicable
Pollution degree		2	2	2	2	2
Electrostatic discharge (IEC/EN 61131-2:2008)						
Air discharge (Level 3)	kV	8	8	8	8	8
Contact discharge (Level 2)	kV	4	4	4	4	4
Electromagnetic fields (IEC/EN 61131-2:2008)						
80–1000 MHz	V/m	10	10	10	10	10
1.4–2 GHz	V/m	3	3	3	3	3
2–2.7 GHz	V/m	1	1	1	1	1
Radio interference suppression (SmartWire-DT)		EN 55011 Class A	EN 55011 Class A	EN 55011 Class A	EN 55011 Class A	EN 55011 Class A
Burst (IEC/EN 61131-2:2008, Level 3)						
Supply cables	kV	2	2	2	2	2
SmartWire-DT cables	kV	1	1	1	1	1
Radiated RFI (IEC/EN 61131-2:2008, Level 3)	V	10	10	10	10	10
Climatic Environmental Conditions						
Operating ambient temperature (IEC 60068-2)	°F (°C)	–22° to 131° (–30° to 55°)	–22° to 131° (–30° to 55°)	–22° to 131° (–30° to 55°)	–22° to 131° (–30° to 55°)	–22° to 131° (–30° to 55°)
Condensation		Prevent with suitable measures				
Storage	°F (°C)	–40° to 176° (–40° to 80°)	–40° to 176° (–40° to 80°)	–40° to 176° (–40° to 80°)	–40° to 176° (–40° to 80°)	–40° to 176° (–40° to 80°)
Relative humidity, noncondensing (IEC/EN 60068-2-30)	%	9–95	9–95	9–95	9–95	9–95
SmartWire-DT Network						
Station type		SmartWire-DT station (node)				
Address allocation		Automatic	Automatic	Automatic	Automatic	Automatic
SmartWire-DT status LED		Green	Green	Green	Green	Green
Connections						
Plug		8-pole	8-pole	8-pole	8-pole	8-pole
Plug connectors		SWD4-8SF2-5	M22-SWD-I_LP	SWD4-8SF2-5	M22-SWD-I_LP	SWD4-8SF2-5
Number of insertion cycles		≥50	≥50	≥50	≥50	≥50
Current consumption (15 V SWD supply)		10 mA	10 mA	22 mA	22 mA	22 mA
Function Element						
Contacts		1 changeover contact	1 changeover contact	—	—	1 changeover contact
Lifespan mechanical/electrical (operations)		1 x 10 ⁶	1 x 10 ⁶	—	—	1 x 10 ⁶
LED display		No	No	Yes	Yes	Yes
Diagnostics		Yes	Yes	No	No	Yes
Mounting		Front mount	Base mount	Front mount	Base mount	Front mount

Pilot Device Modules, continued

Description	Unit	M22-SWD-K11LEDC_	M22-SWD-K22	M22-SWD-KC22	M22-SWD-K22-LED_	M22-SWD-K22LEDC_
General						
Standards		IEC/EN 61131-2 EN 50178	IEC/EN 61131-2 EN 50178	IEC/EN 61131-2 EN 50178	IEC/EN 61131-2 EN 50178	IEC/EN 61131-2 EN 50178
Dimensions (W x H x D)	in (mm)	0.47 x 1.77 x 1.65 (12 x 45 x 42)	0.67 x 1.65 x 1.54 (17 x 42 x 39)	0.67 x 1.77 x 1.46 (17 x 45 x 37)	0.67 x 1.65 x 1.77 (17 x 42 x 45)	0.67 x 1.77 x 1.65 (17 x 45 x 42)
Weight	lbs (g)	0.022 (10)	0.030 (14)	0.030 (14)	0.030 (14)	0.030 (14)
Mounting position		As required	As required	As required	As required	As required
Ambient Conditions, Mechanical						
Degree of protection (IEC/EN 60529)		IP20	IP20	IP20	IP20	IP20
Vibrations (IEC/EN 61131-2:2008)						
Constant amplitude 3.5 mm	Hz	5–8.4	5–8.4	5–8.4	5–8.4	5–8.4
Constant acceleration 1 g	Hz	8.4–150	8.4–150	8.4–150	8.4–150	8.4–150
Mechanical shock resistance (IEC/EN 60068-2-27) semi-sinusoidal 15 g/11 ms	Impacts	9	9	9	9	9
Drop to IEC/EN 60068-2-31 (drop height)	in (mm)	1.97 (50)	1.97 (50)	1.97 (50)	1.97 (50)	1.97 (50)
Free fall, packaged (IEC/EN 60068-2-32)	ft (m)	1.0 (0.3)	1.0 (0.3)	1.0 (0.3)	1.0 (0.3)	1.0 (0.3)
Electromagnetic Compatibility (EMC)						
Overvoltage category		Not applicable	Not applicable	Not applicable	Not applicable	Not applicable
Pollution degree		2	2	2	2	2
Electrostatic discharge (IEC/EN 61131-2:2008)						
Air discharge (Level 3)	kV	8	8	8	8	8
Contact discharge (Level 2)	kV	4	4	4	4	4
Electromagnetic fields (IEC/EN 61131-2:2008)						
80–1000 MHz	V/m	10	10	10	10	10
1.4–2 GHz	V/m	3	3	3	3	3
2–2.7 GHz	V/m	1	1	1	1	1
Radio interference suppression (SmartWire-DT)		EN 55011 Class A	EN 55011 Class A	EN 55011 Class A	EN 55011 Class A	EN 55011 Class A
Burst (IEC/EN 61131-2:2008, Level 3)						
Supply cables	kV	2	2	2	2	2
SmartWire-DT cables	kV	1	1	1	1	1
Radiated RFI (IEC/EN 61131-2:2008, Level 3)	V	10	10	10	10	10
Climatic Environmental Conditions						
Operating ambient temperature (IEC 60068-2)	° F (°C)	–22° to 131° (–30° to 55°)	–22° to 131° (–30° to 55°)	–22° to 131° (–30° to 55°)	–22° to 131° (–30° to 55°)	–22° to 131° (–30° to 55°)
Condensation		Prevent with suitable measures				
Storage	° F (°C)	–40° to 176° (–40° to 80°)	–40° to 176° (–40° to 80°)	–40° to 176° (–40° to 80°)	–40° to 176° (–40° to 80°)	–40° to 176° (–40° to 80°)
Relative humidity, noncondensing (IEC/EN 60068-2-30)	%	9–95	5–95	5–95	5–95	5–95
SmartWire-DT Network						
Station type		SmartWire-DT station (node)				
Address allocation		Automatic	Automatic	Automatic	Automatic	Automatic
SmartWire-DT status LED		Green	Green	Green	Green	Green
Connections						
Plug		8-pole	8-pole	8-pole	8-pole	8-pole
Plug connectors		M22-SWD-I_LP	SWD4-8SF2-5	M22-SWD-I_LP	SWD4-8SF2-5	M22-SWD-I_LP
Number of insertion cycles		≥50	≥50	≥50	≥50	≥50
Current consumption (15 V SWD supply)		22 mA	10 mA	10 mA	22 mA	22 mA
Function Element						
Contacts		1 contact	2 contacts	2 contacts	2 contacts	2 contacts
Lifespan mechanical/electrical (operations)		1 x 10 ⁶	1 x 10 ⁶	1 x 10 ⁶	1 x 10 ⁶	1 x 10 ⁶
LED display		Yes	No	No	Yes	Yes
Diagnostics		Yes	Yes	Yes	Yes	Yes
Mounting		Base mount	Front mount	Base mount	Front mount	Base mount

Stacklight Modules—SL4/SL7 Series**SL4/SL7 General Specifications**

Description	Specification
Standards	IEC/EN 60947-5-1
Lens color	Blue, green, red, clear, yellow, amber
Number of signal elements	Max. 5 with standard base Max. 10 with base for mounting on both sides
Mechanical Ratings	
Shock (IEC 68-2-27)	11 ms, 15g
Vibration (IEC 68-2-6)	20 sweeps 10–150 Hz, 1g
Climate Conditions	
Climatic proofing	Damp heat, constant, to IEC 60068-2-78 Damp heat, cyclic, to IEC 60069-2-30
Operating temperature	–22° to +140°F (–30° to +60°C)
Storage temperature	–22° to +185°F (–30° to +85°C)
Environmental Ratings	
IEC degree of protection	UL Type 4/4X/13, IP66 IEC/EN 60529
Protection type UL	Type 4/4X/13
Materials	
Cover	Polycarbonate
Lenses	Polycarbonate
Stacklight base	Polycarbonate
Tubes	Aluminum
Terminal Capacity	
Solid or flexible conductor	0.13–2.5 mm ²
Flexible with ferrule with plastic collar	0.25–1.5 mm ² AWG 24–AWG 14
Contacts	
Rated impulse withstand voltage (U _{imp})	4000 Vac
Rated insulation voltage (U _i)	250V
Overvoltage category/pollution degree	III/3

9.1

Connectivity Solutions

SmartWire-DT In Panel and On Machine Wiring Solution

Dimensions

Approximate Dimensions in Inches (mm)

Gateways

EU5C-SWD_

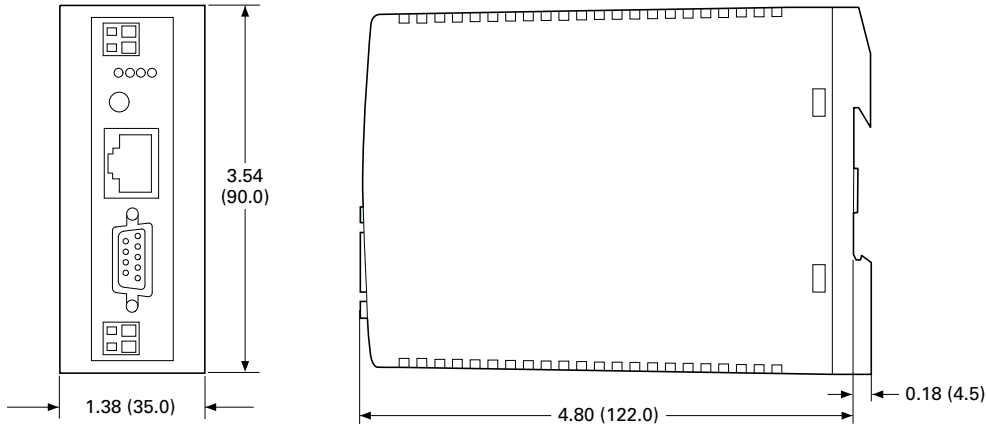

Powerfeed Modules

EU5C-SWD-PF_

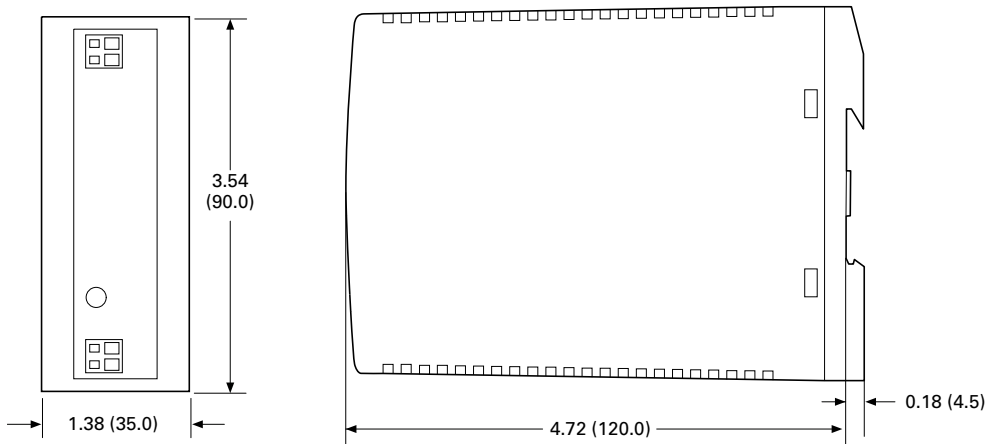

I/O Modules

EU5E-SWD_

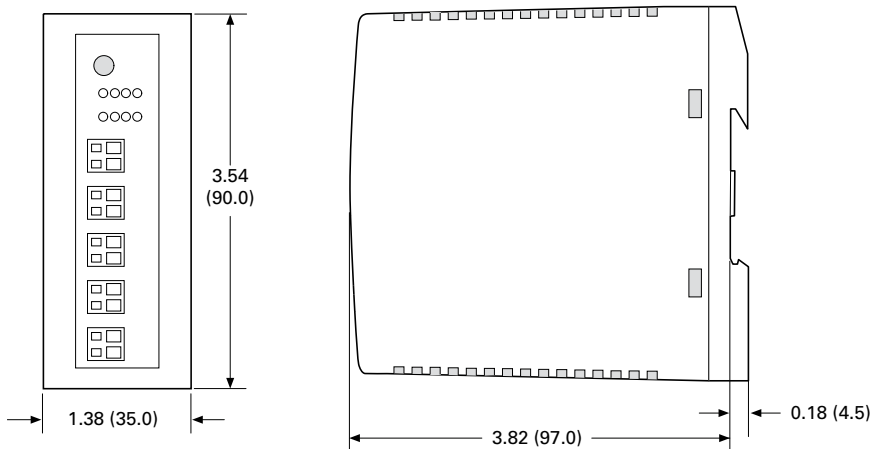

Approximate Dimensions in Inches (mm)

Terminating Resistor

SWD4-RC8-10

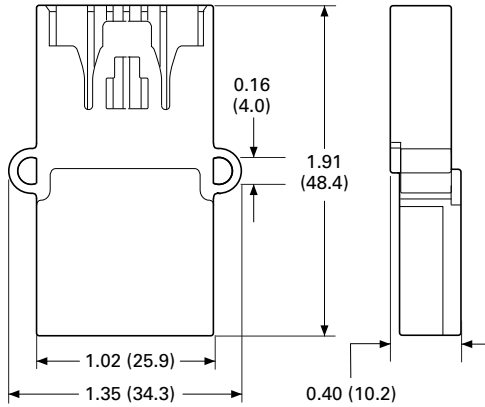

Coupling

SWD4-8SFF2-5

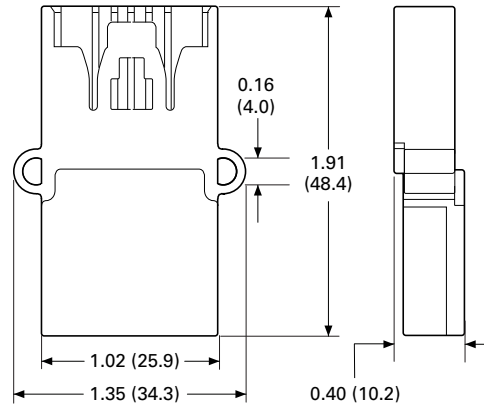

Enclosure Bushing Plug

SWD4-SM8-20

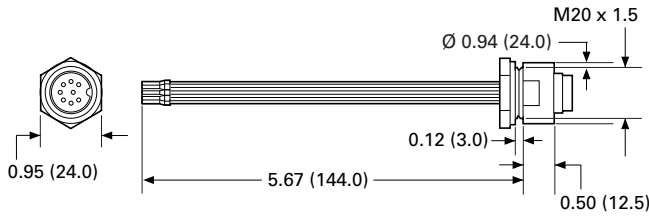

Enclosure Bushing Socket

SWD4-SF8-20

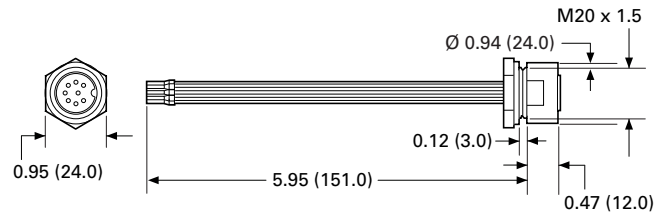

Cabinet Cable Adapter Plug

SWD4-SML8-20

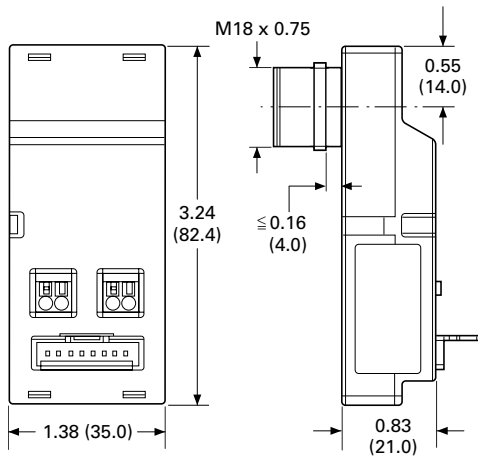

Cabinet Cable Adapter Socket

SWD4-SFL8-20

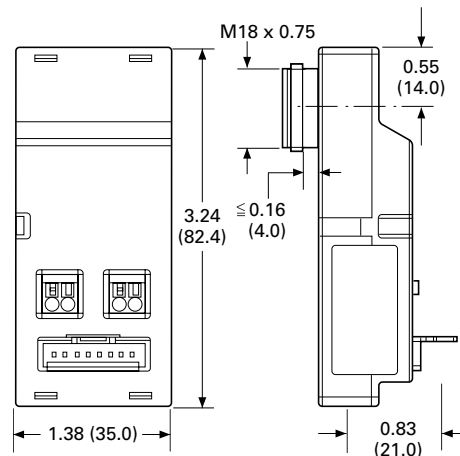

9.1

Connectivity Solutions

SmartWire-DT In Panel and On Machine Wiring Solution

Approximate Dimensions in Inches (mm)

Panel Cable Adapter

SWD4-8FRF-10

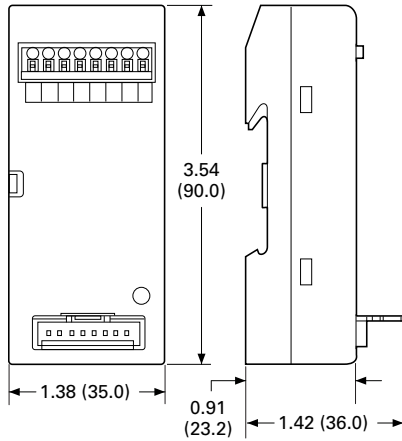

Round Cable Socket

SWD4-SF8-67

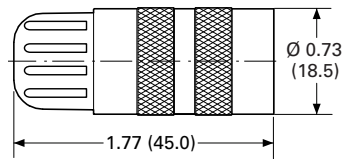

Round Cable Plug

SWD4-SM8-67

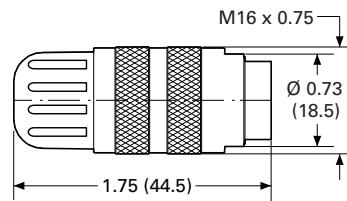

Right Angle Round Cable Socket

SWD4-SF8-67W

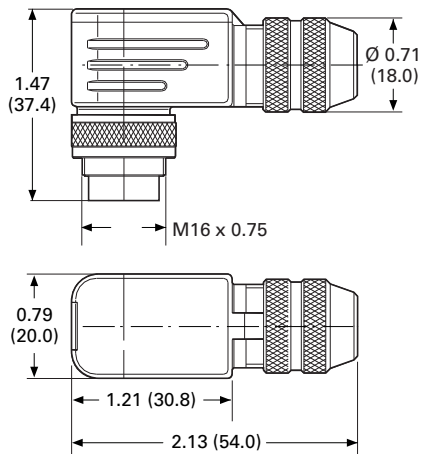

Right Angle Round Cable Plug

SWD4-SM8-67W

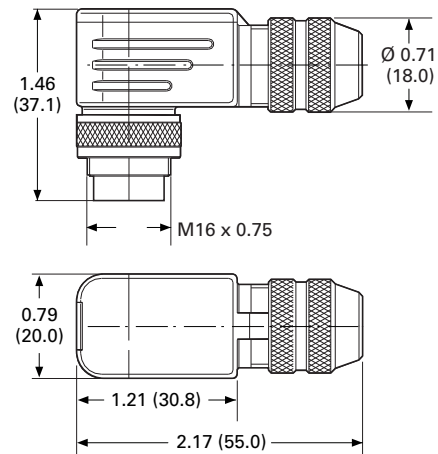

Approximate Dimensions in Inches (mm)

Contactor Modules

DIL-SWD-32-001 and DIL-SWD-32-002

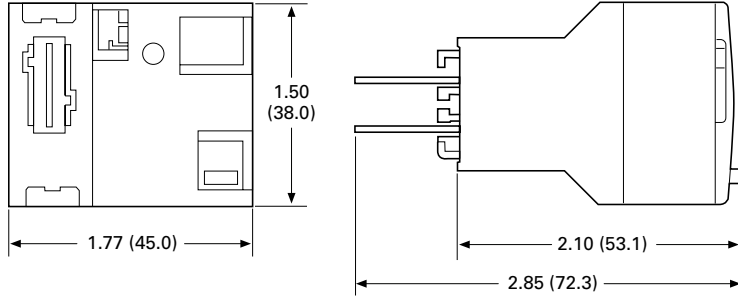

SmartWire-DT PKE Modules

PKE-SWD-32

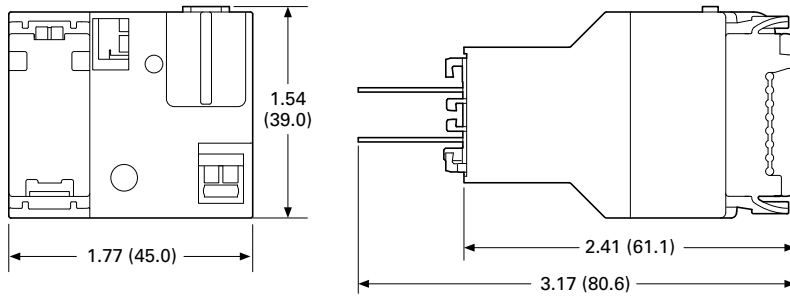

Pilot Device Modules

M22-SWD-K_, M22-SWD-LED_

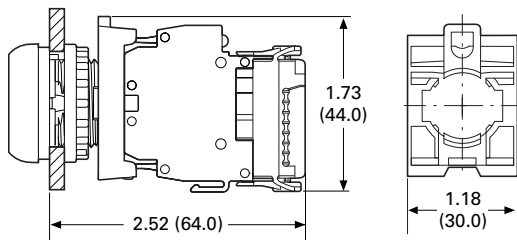

9.1

Connectivity Solutions

SmartWire-DT In Panel and On Machine Wiring Solution

Approximate Dimensions in Inches (mm)

Stacklight Modules

SL7-SWD, SL4-SWD

SL7-FMS-...

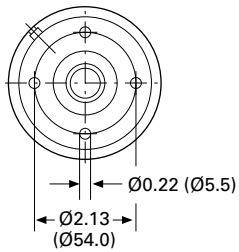
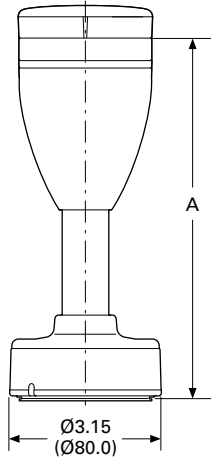

SL7-SWD ①

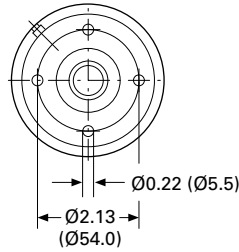
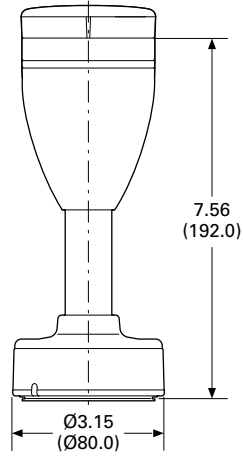

SL4-FMS-...

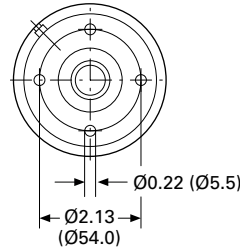
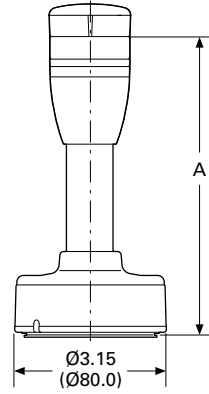

SL4-SWD ①

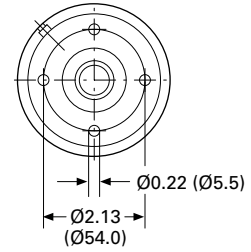
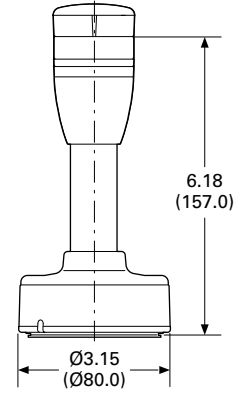

Catalog Number	A
SL7-FMS-100	7.55 (192.0)
SL7-FMS-250	13.46 (342.0)
SL7-FMS-400	19.37 (192.0)

Note

① For connecting to SmartWire-DT.

Catalog Number	A
SL4-FMS-100	6.18 (157.0)
SL4-FMS-250	12.09 (307.0)
SL4-FMS-400	17.99 (457.0)

Note

① For connecting to SmartWire-DT.

Device Plug

SWD4-8SF2-5

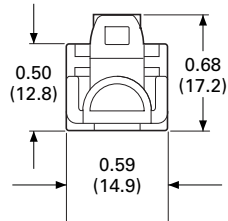
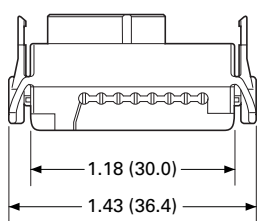

Approximate Dimensions in Inches (mm)

On Machine I/O Modules (T Connectors)

Single T Connector

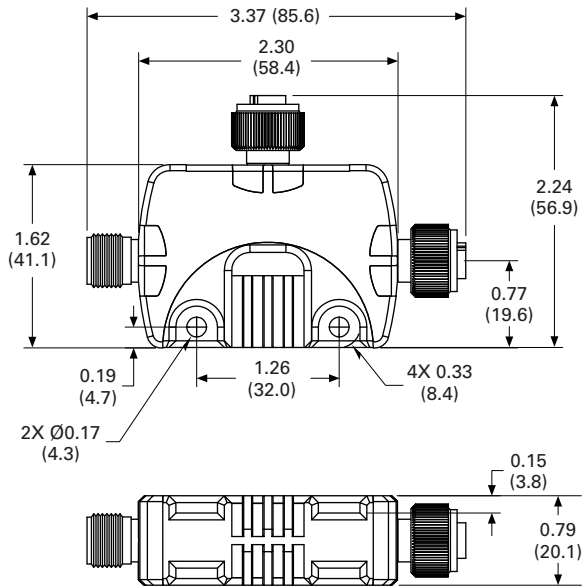

Dual T Connector

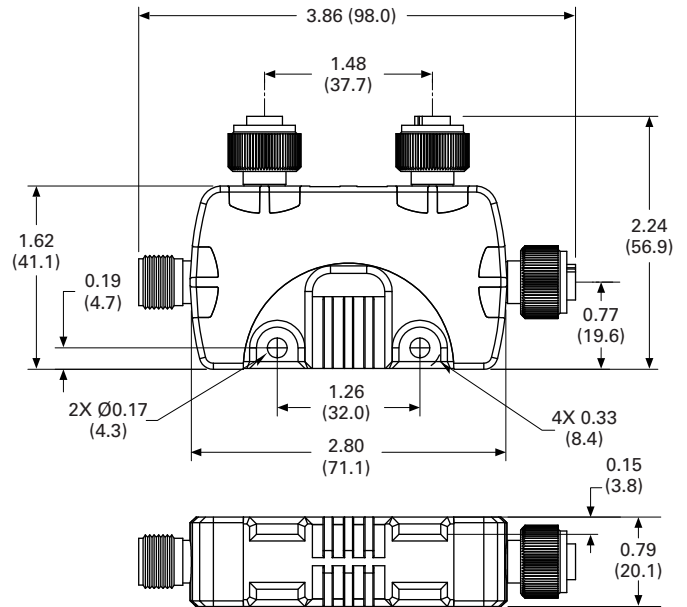

Powerfeed T Connector

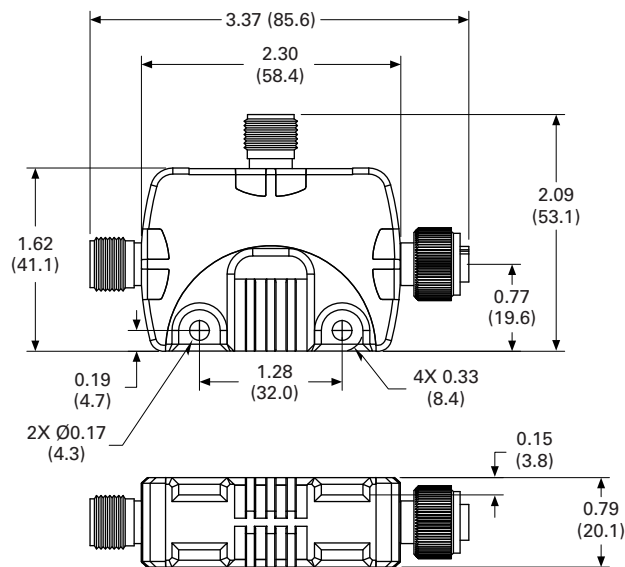

NOP Module

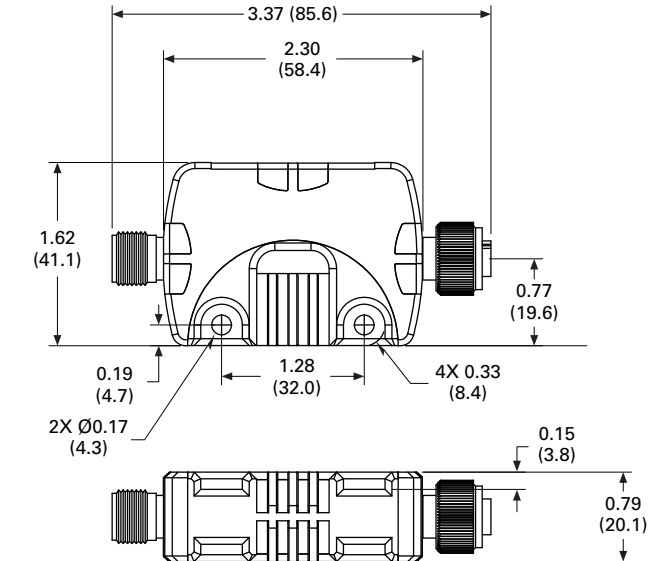

9.1

Connectivity Solutions

SmartWire-DT In Panel and On Machine Wiring Solution

Approximate Dimensions in Inches (mm)

Quad: 4/8-Channel Multiblock Modules

EU6E-SWD-

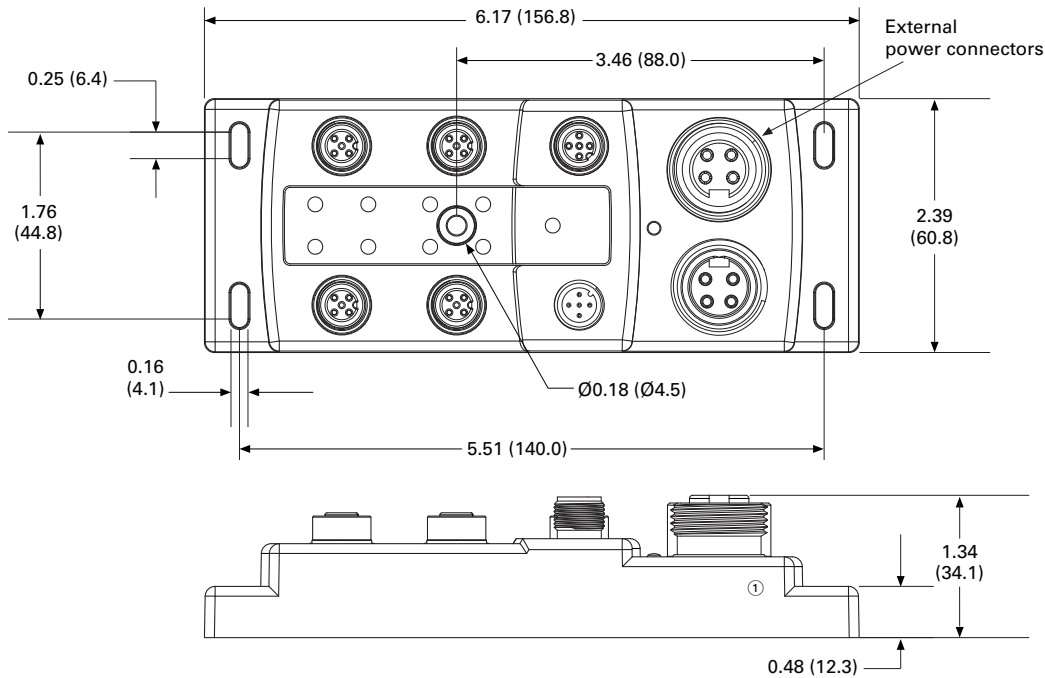

Octal: 8/16-Channel Multiblock Modules

EU8E-SWD-

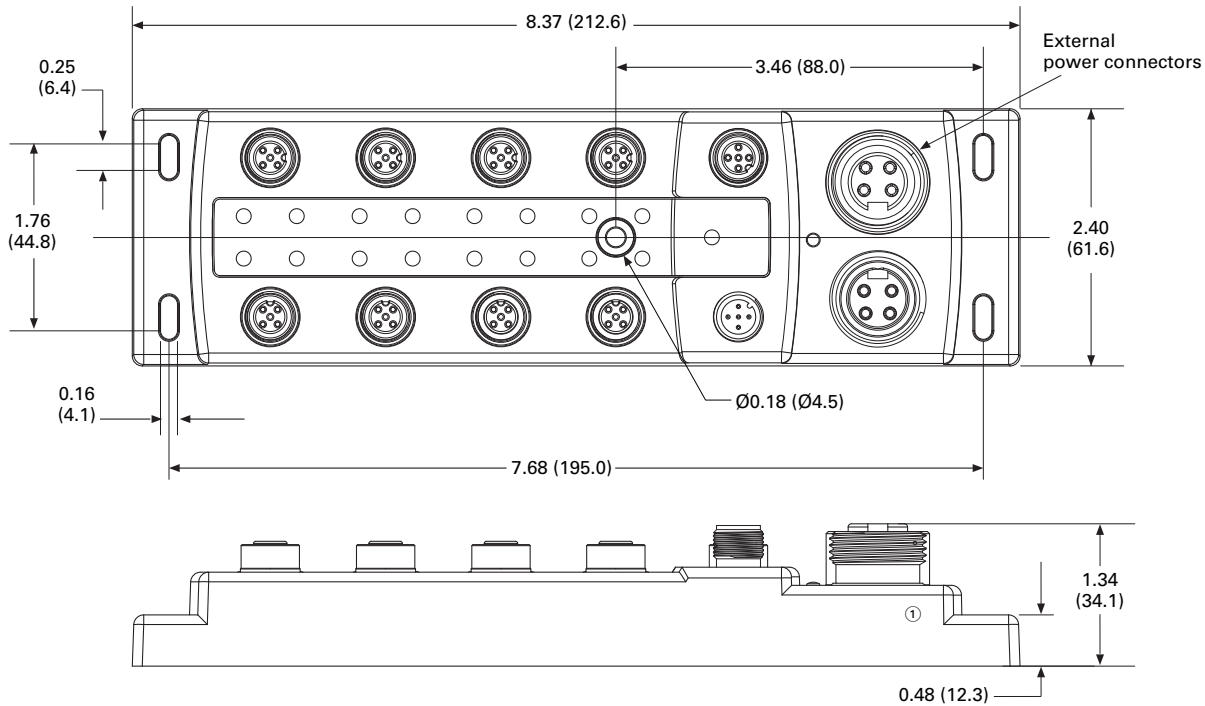

Note

① External power connectors only present in EU6E/EU8E models ending in -1 or -2.

Approximate Dimensions in Inches (mm)

Panel Adapters

SWD4-SFL8-12

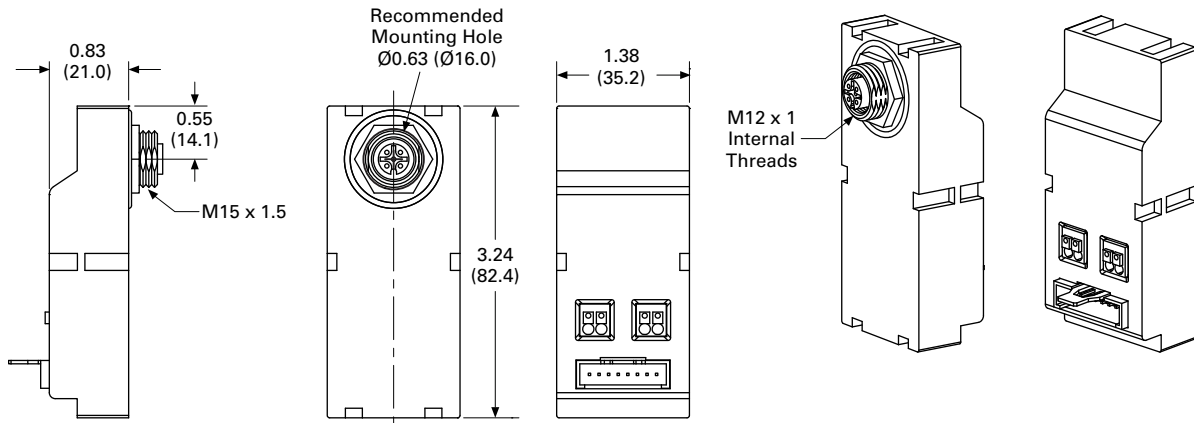

SWD4-SML8-12

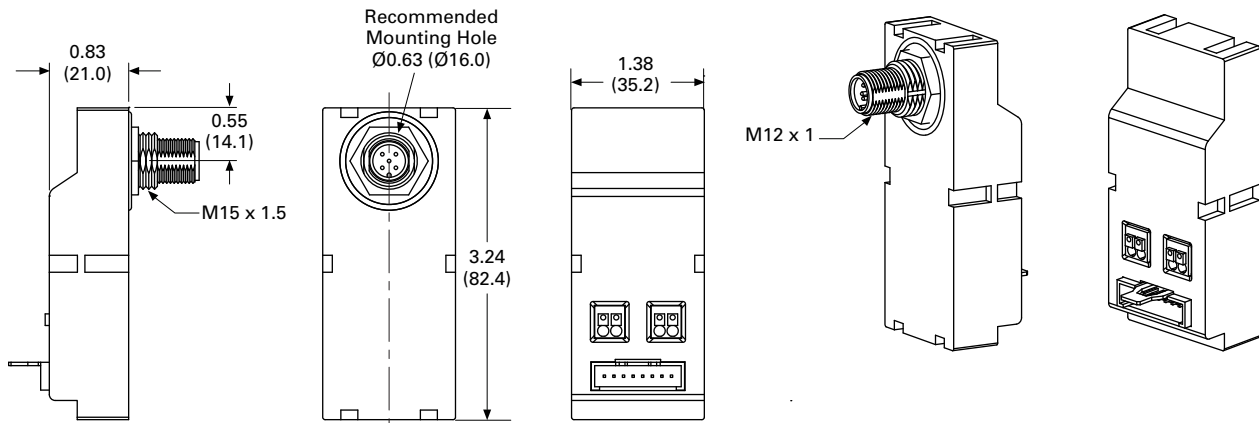

SWD4-SML5-12

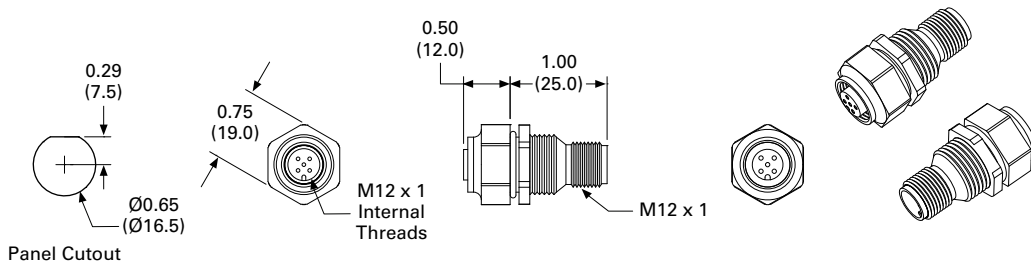

9.1

Connectivity Solutions

SmartWire-DT In Panel and On Machine Wiring Solution

Approximate Dimensions in Inches (mm)

Receptacles

SWD4-PRM5-1-S

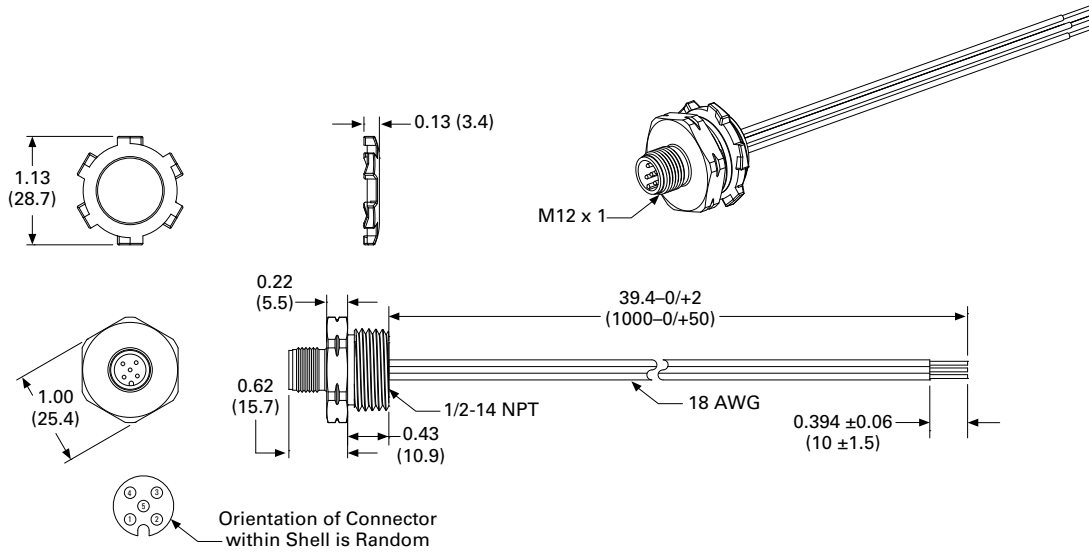

9

SWD4-PRM5-2-S

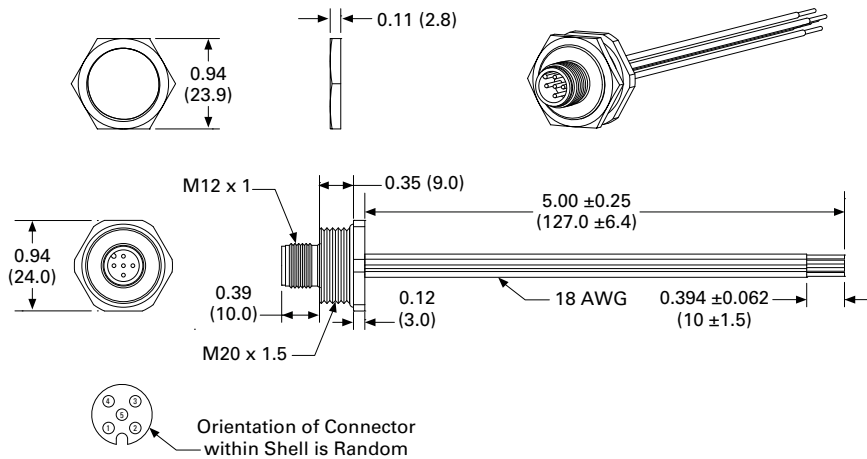

Approximate Dimensions in Inches (mm)

SWD4-PRF5-1-S

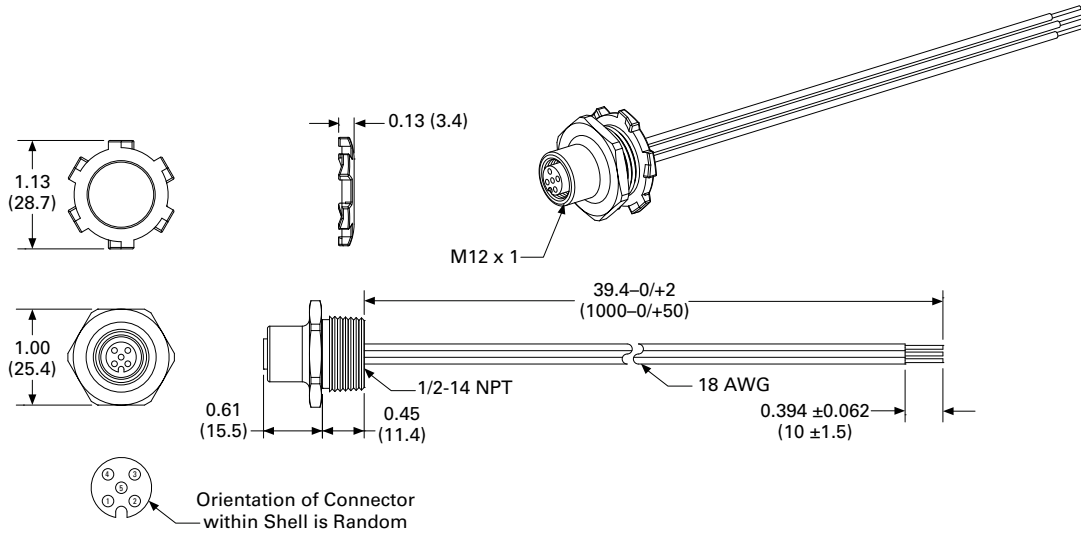

SWD4-PRF5-2-S

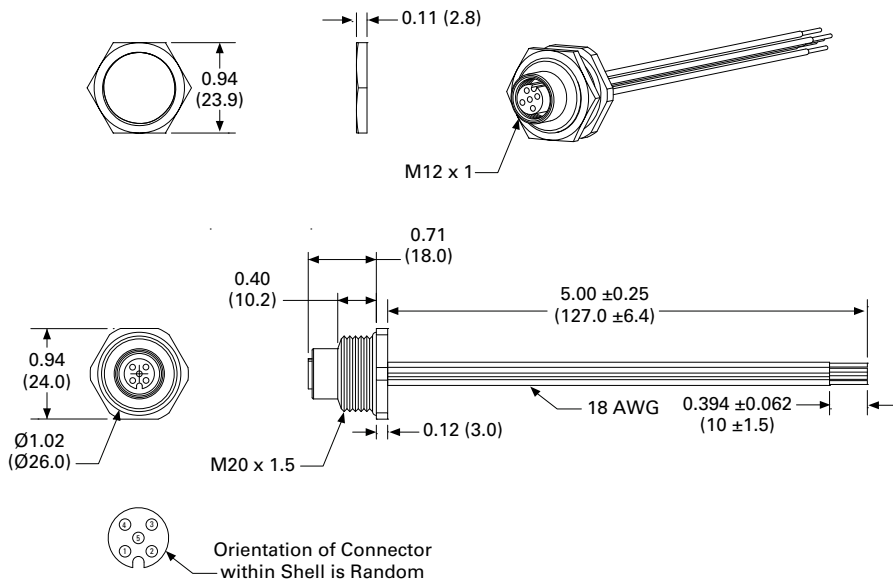

SWD4-PRF4P-1-S

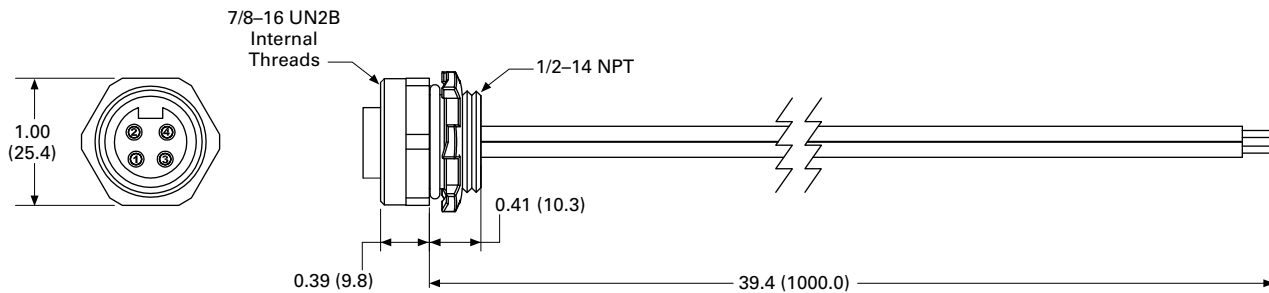

9.1

Connectivity Solutions

SmartWire-DT In Panel and On Machine Wiring Solution

Approximate Dimensions in Inches (mm)

Mounting Brackets

SWD4-MNT-VER

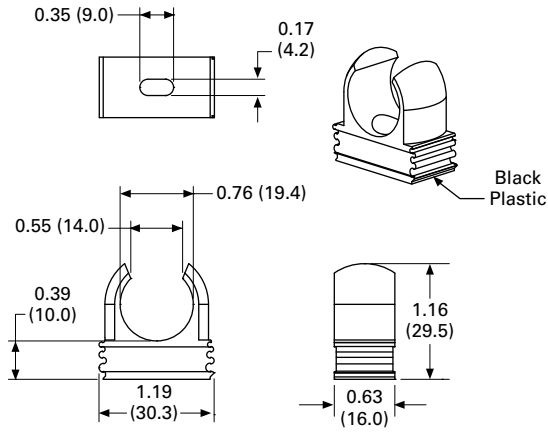

SWD4-MNT-DIN

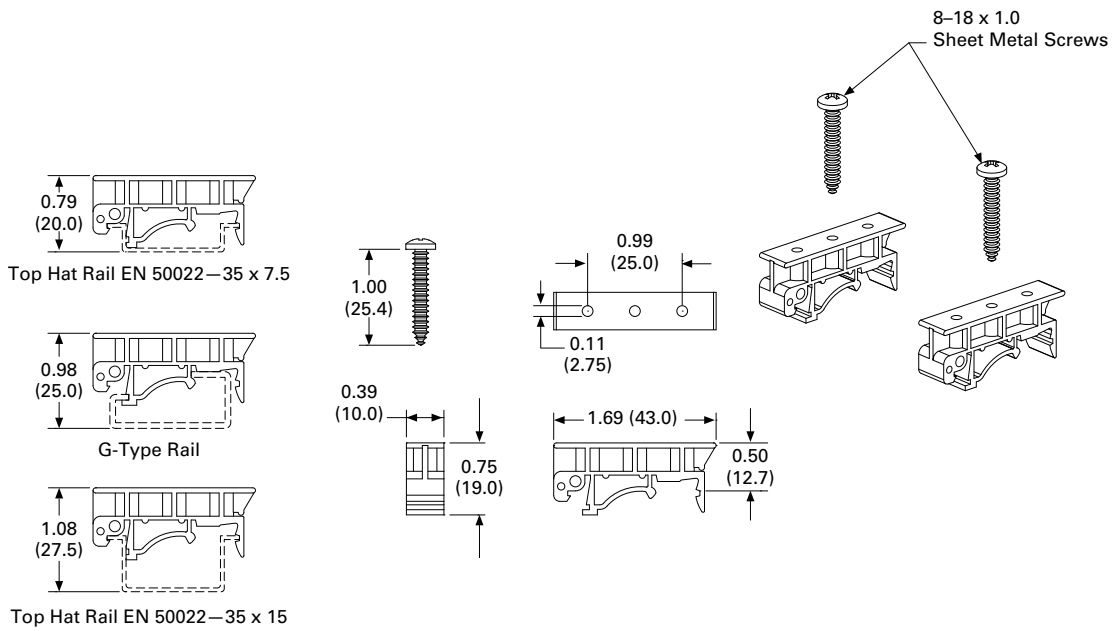

Approximate Dimensions in Inches (mm)

Field Wireable Connectors

SWD4-SF4P-67

7/8-16 UN2A

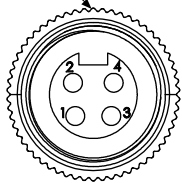

Face View of Female

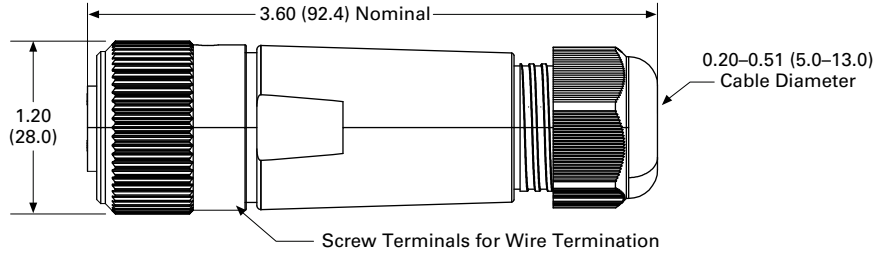

SWD4-SM4P-67

7/8-16 UN2B

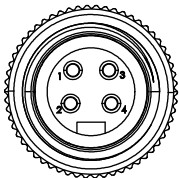

Face View of Male

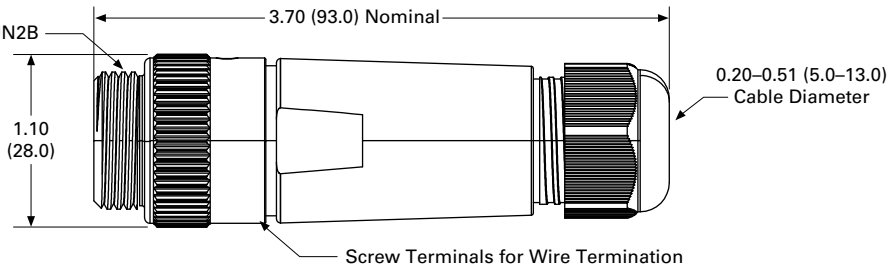

SWD4-SF4P-67R

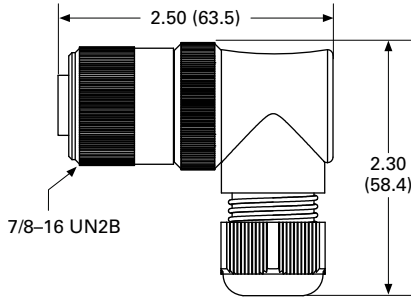

Note: Screw Terminals for Wire Termination

SWD4-SM4P-67R

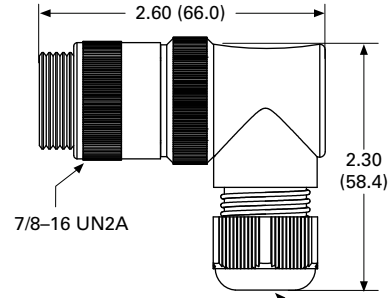

Note: Screw Terminals for Wire Termination

SWD4-SM5-67

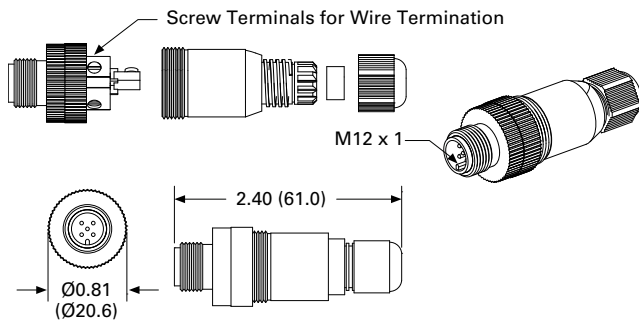

SWD4-SF5-67

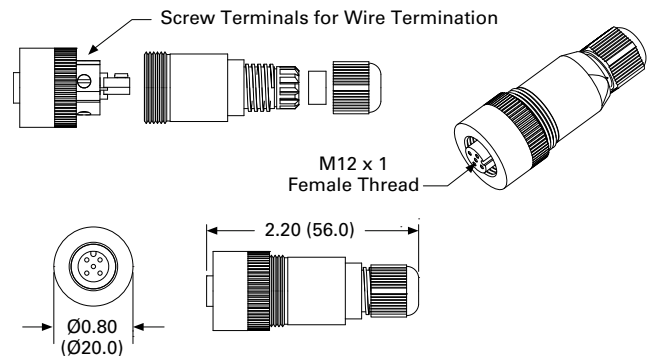

9.1

Connectivity Solutions

SmartWire-DT In Panel and On Machine Wiring Solution

Approximate Dimensions in Inches (mm)

Splitters

SWD4-SP-4122/4124

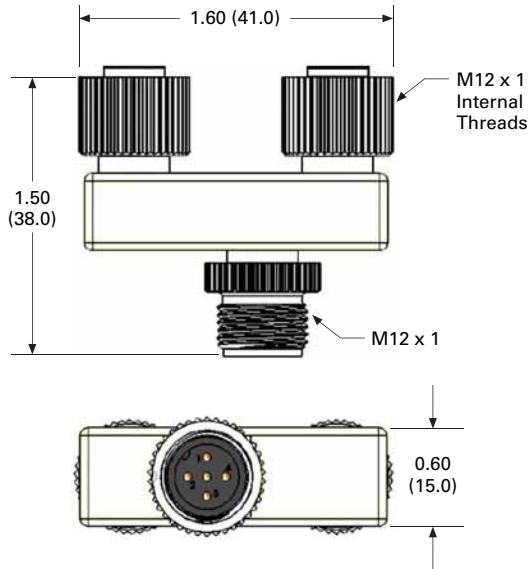

SWD4-SP-3084

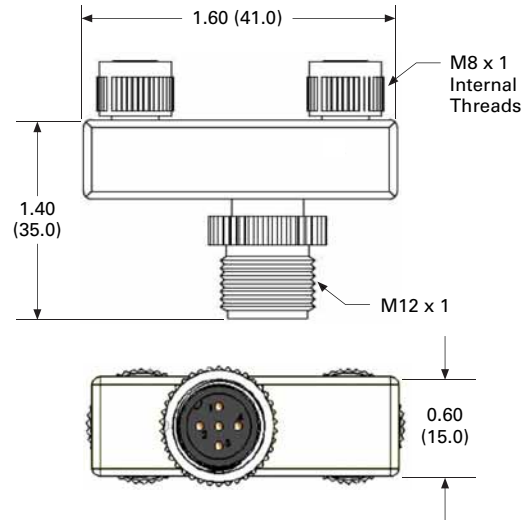

9

Other Wiring Accessories

SWD4-RC5-10

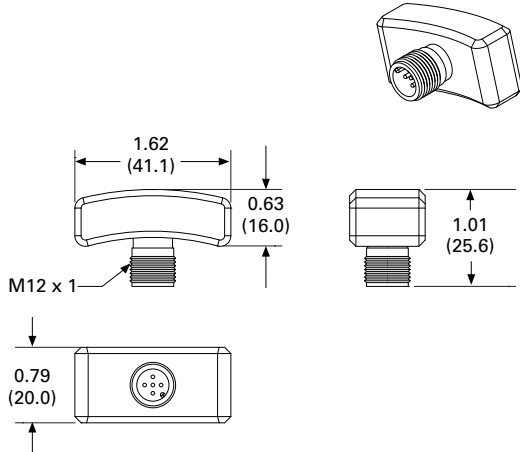

SWD4-ACAP-10

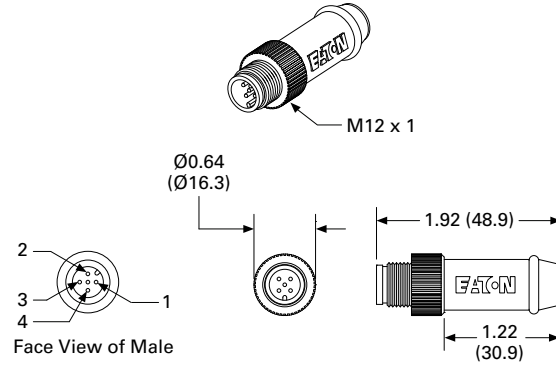

Approximate Dimensions in Inches (mm)

Cord Grips

V-M20

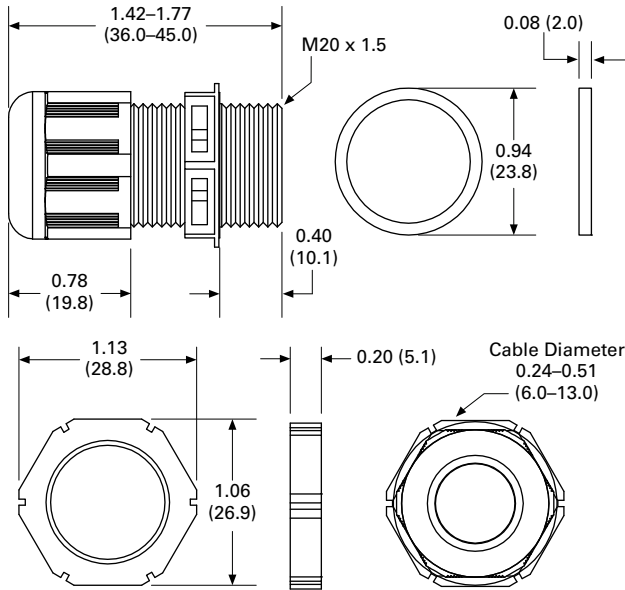

V-12NPT

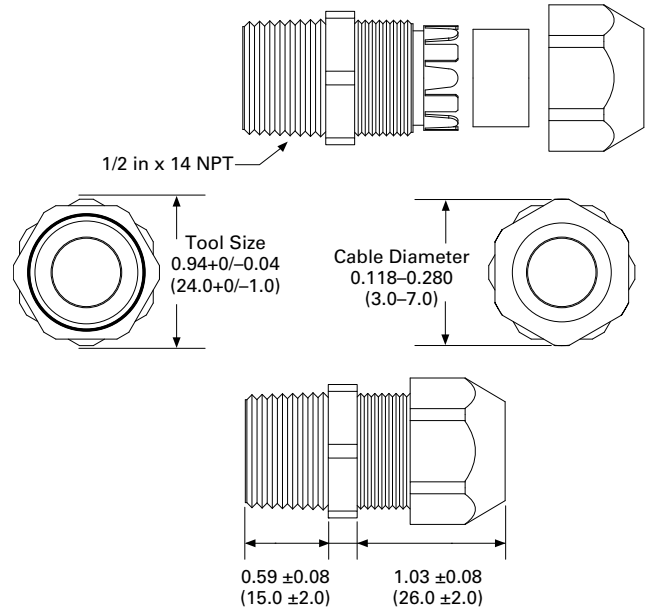

Hydraulic Valve Connector

EU3E-SWD-X1H-1

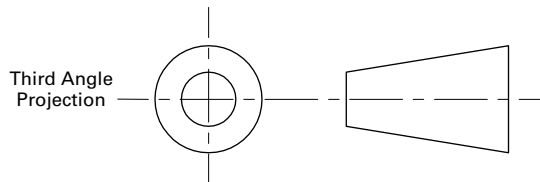
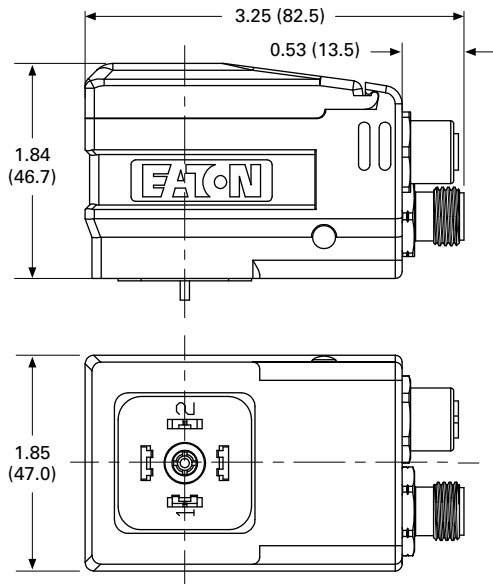

Solenoid Connections

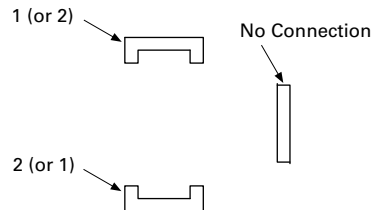

Eaton Terms & Conditions



Terms & Conditions



Contents

<i>Description</i>	<i>Page</i>
Terms and Conditions of Sale	V7-A1-1
Terms of Payment	V7-A1-2
Freight	V7-A1-3
Warranty	V7-A1-3

Selling Policy (Supersedes Selling Policy 25-000, dated November 1, 2008)

Terms and Conditions of Sale

The Terms and Conditions of Sale set forth herein, and any supplements which may be attached hereto, constitute the full and final expression of the contract for the sale of products or services (hereinafter referred to as Product(s) or Services by Eaton Corporation (hereinafter referred to as Seller) to the Buyer, and supersedes all prior quotations, purchase orders, correspondence or communications whether written or oral between the Seller and the Buyer. Notwithstanding any contrary language in the Buyer's purchase order, correspondence or other form of acknowledgment, Buyer shall be bound by these Terms and Conditions of Sale when it sends a purchase order or otherwise indicates acceptance of this contract, or when it accepts delivery from Seller of the Products or Services.

THE CONTRACT FOR SALE OF THE PRODUCTS OR SERVICES IS EXPRESSLY LIMITED TO THE TERMS AND CONDITIONS OF SALE STATED HEREIN. ANY ADDITIONAL OR DIFFERENT TERMS PROPOSED BY BUYER ARE REJECTED UNLESS EXPRESSLY AGREED TO IN WRITING BY SELLER. No contract shall exist except as herein provided.

Complete Agreement

No amendment or modification hereto nor any statement, representation or warranty not contained herein shall be binding on the Seller unless made in writing by an authorized representative of the Seller. Prior dealings, usage of the trade or a course of performance shall not be relevant to determine the meaning of this contract even though the accepting or acquiescing party had knowledge of the nature of the performance and opportunity for objection.

Quotations

Written quotations are valid for 30 days from its date unless otherwise stated in the quotation or terminated sooner by notice.

Verbal quotations, unless accepted, expire the same day they are made.

A complete signed order must be received by Seller within 20 calendar days of notification of award, otherwise the price and shipment will be subject to re-negotiation.

Termination and Cancellation

Products

Any order may be terminated by the Buyer only by written notice and upon payment of reasonable termination charges, including all progress billings and all incurred direct manufacturing costs.

Services

Any order may be terminated by the Buyer only by written notice and upon payment of reasonable termination charges including all costs plus profit.

Seller shall have the right to cancel any order at any time by written notice if Buyer breaches any of the terms hereof, becomes the subject of any proceeding under state or federal law for the relief of debtors, or otherwise becomes insolvent or bankrupt, generally does not pay its debts as they become due or makes an assignment for the benefit of creditors.

Appendix 1—General Terms and Conditions of Sale

Effective Date: November 1, 2017

Prices

All prices are subject to change without notice. In the event of a price change, the effective date of the change will be the date of the new price or discount sheet, letter or telegram. All quotations made or orders accepted after the effective date will be on the new basis. For existing orders, the price of the unshipped portion of an order will be the price in effect at time of shipment.

Price Policy—Products and Services

When prices are quoted as firm for quoted shipment, they are firm provided the following conditions are met:

1. The order is released with complete engineering details.
2. Shipment of Products are made, and Services purchased are provided within the quoted lead time.
3. When drawings for approval are required for any Products, the drawings applicable to those Products must be returned within 30* calendar days from the date of the original mailing of the drawings by Seller. The return drawings must be released for manufacture and shipment and must be marked "APPROVED" or "APPROVED AS NOTED." Drawing re-submittals which are required for any other reason than to correct Seller errors will not extend the 30-day period.

* 60 days for orders through contractors to allow time for their review and approval before and after transmitting them to their customers.

If the Buyer initiates or in any way causes delays in shipment, provision of Services or return of approval drawings beyond the periods stated above, the price of the Products or Services will be increased 1% per month or fraction thereof up to a maximum of 18 months from the date of the Buyer's order. For delays resulting in shipment or provision of Services beyond 18 months from the date of the Buyer's order, the price must be renegotiated.

Price Policy—BLS

Refer to Price Policy 25-050.

Minimum Billing

Orders less than \$1,000 will be assessed a shipping and handling charge of 5% of the price of the order, with a minimum charge of \$25.00 unless noted differently on Product discount sheets.

Taxes

The price does not include any taxes. Buyer shall be responsible for the payment of all taxes applicable to, or arising from the transaction, the Products, its sale, value, or use, or any Services performed in connection therewith regardless of the person or entity actually taxed.

Terms of Payment

Products

Acceptance of all orders is subject to the Buyer meeting Seller's credit requirements. Terms of payment are subject to change for failure to meet such requirements. Seller reserves the right at any time to demand full or partial payment before proceeding with a contract of sale as a result of changes in the financial condition of the Buyer. Terms of Payment are either Net 30 days from the date of invoice of each shipment or carry a cash discount based on Product type. Specific payment terms for Products are outlined in the applicable Product discount schedules.

Services

Terms of payment are net within 30 days from date of invoice for orders amounting to less than \$50,000.00.

Terms of payment for orders exceeding \$50,000.00 shall be made according to the following:

1. Twenty percent (20%) of order value with the purchase order payable 30 days from date of invoice.
2. Eighty percent (80%) of order value in equal monthly payments over the performance period payable 30 days from date of invoice.

Except for work performed (i) under a firm fixed price basis or (ii) pursuant to terms of a previously priced existing contract between Seller and Buyer, invoices for work performed by Seller shall have added and noted on each invoice a charge of 3% (over and above the price of the work) which is related to Seller compliance with present and proposed environmental, health, and safety regulations associated with prescribed requirements covering hazardous materials management and employee training, communications, personal protective equipment, documentation and record keeping associated therewith.

Adequate Assurances

If, in the judgment of Seller, the financial condition of the Buyer, at any time during the period of the contract, does not justify the terms of payment specified, Seller may require full or partial payment in advance.

Delayed Payment

If payments are not made in accordance with these terms, a service charge will, without prejudice to the right of Seller to immediate payment, be added in an amount equal to the lower of 1.5% per month or fraction thereof or the highest legal rate on the unpaid balance.

Freight

Freight policy will be listed on the Product discount sheets, or at option of Seller one of the following freight terms will be quoted.

F.O.B.—P/S—Frt./Ppd. and Invoiced

Products are sold F.O.B. point of shipment freight prepaid and invoiced to the Buyer.

F.O.B.—P/S—Frt./Ppd. and Allowed

Products sold are delivered F.O.B. point of shipment, freight prepaid and included in the price.

F.O.B. Destination—Frt./Ppd. and Allowed

At Buyer's option, Seller will deliver the Products F.O.B. destination freight prepaid and 2% will be added to the net price.

The term "freight prepaid" means that freight charges will be prepaid to the accessible common carrier delivery point nearest the destination for shipments within the United States and Puerto Rico unless noted differently on the Product discount sheets. For any other destination, contact Seller's representative.

Shipment and Routing

Seller shall select the point of origin of shipment, the method of transportation, the type of carrier equipment and the routing of the shipment.

If the Buyer specifies a special method of transportation, type of carrier equipment, routing, or delivery requirement, Buyer shall pay all special freight and handling charges.

When freight is included in the price, no allowance will be made in lieu of transportation if the Buyer accepts shipment at factory, warehouse, or freight station or otherwise supplies its own transportation.

Risk of Loss

Risk of loss or damage to the Products shall pass to Buyer at the F.O.B. point.

Concealed Damage

Except in the event of F.O.B. destination shipments, Seller will not participate in any settlement of claims for concealed damage.

When shipment has been made on an F.O.B. destination basis, the Buyer must unpack immediately and, if damage is discovered, must:

1. Not move the Products from the point of examination.
2. Retain shipping container and packing material.
3. Notify the carrier in writing of any apparent damage.
4. Notify Seller representative within 72 hours of delivery.
5. Send Seller a copy of the carrier's inspection report.

Witness Tests/Customer Inspection

Standard factory tests may be witnessed by the Buyer at Seller's factory for an additional charge calculated at the rate of \$2,500 per day (not to exceed eight (8) hours) per Product type. Buyer may final inspect Products at the Seller's factory for \$500 per day per Product type.

Witness tests will add one (1) week to the scheduled shipping date. Seller will notify Buyer fourteen (14) calendar days prior to scheduled witness testing or inspection. In the event Buyer is unable to attend, the Parties shall mutually agree on a rescheduled date. However, Seller reserves the right to deem the witness tests waived with the right to ship and invoice Products.

Held Orders

For any order held, delayed or rescheduled at the request of the Buyer, Seller may, at its sole option (1) require payment to be based on any reasonable basis, including but not limited to the contract price, and any additional expenses, or cost resulting from such a delay; (2) store Products at the sole cost and risk of loss of the Buyer; and/ or (3) charge to the Buyer those prices under the applicable price policy. Payment for such price, expenses and costs, in any such event, shall be due by Buyer within thirty (30) days from date of Seller's invoice. Any order so held delayed or rescheduled beyond six (6) months will be treated as a Buyer termination.

Drawing Approval

Seller will design the Products in line with, in Seller's judgment, good commercial practice. If at drawing approval Buyer makes changes outside of the design as covered in their specifications, Seller will then be paid reasonable charges and allowed a commensurate delay in shipping date based on the changes made.

Drawing Re-Submittal

When Seller agrees to do so in its quotation, Seller shall provide Buyer with the first set of factory customer approval drawing(s) at Seller's expense. The customer approval drawing(s) will be delivered at the quoted delivery date. If Buyer requests drawing changes or additions after the initial factory customer approval drawing(s) have been submitted by Seller, the Seller, at its option, may assess Buyer drawing charges. Factory customer approval drawing changes required due to misinterpretation by Seller will be at Seller's expense. Approval drawings generated by Bid Manager are excluded from this provision.

Warranty

Warranty for Products

Seller warrants that the Products manufactured by it will conform to Seller's applicable specifications and be free from failure due to defects in workmanship and material for one (1) year from the date of installation of the Product or eighteen (18) months from the date of shipment of the Product, whichever occurs first.

In the event any Product fails to comply with the foregoing warranty, Seller will, at its option, either (a) repair or replace the defective Product, or defective part or component thereof, F.O.B. Seller's facility freight prepaid, or (b) credit Buyer for the purchase price of the Product. All warranty claims shall be made in writing.

Seller requires all non-conforming Products be returned at Seller's expense for evaluation unless specifically stated otherwise in writing by Seller.

This warranty does not cover failure or damage due to storage, installation, operation or maintenance not in conformance with Seller's recommendations and industry standard practice or due to accident, misuse, abuse or negligence. This warranty does not cover reimbursement for labor, gaining access, removal, installation, temporary power or any other expenses, which may be incurred in connection with repair or replacement.

This warranty does not apply to equipment not manufactured by Seller. Seller limits itself to extending the same warranty it receives from the supplier.

Appendix 1—General Terms and Conditions of Sale

Effective Date: November 1, 2017

Extended Warranty for Products

If requested by the Buyer and specifically accepted in writing by Seller, the foregoing standard warranty for Products will be extended from the date of shipment for the period and price indicated below:

- 24 months—2% of Contract Price
- 30 months—3% of Contract Price
- 36 months—4% of Contract Price

Special Warranty (In and Out) for Products

If requested by the Buyer and specifically accepted in writing by Seller, Seller will, during the warranty period for Products, at an additional cost of 2% of the contract price, be responsible for the direct cost of:

1. Removing the Product from the installed location.
2. Transportation to the repair facility and return to the site.
3. Reinstallation on site.

The total liability of Seller for this Special Warranty for Products is limited to 50% of the contract price of the particular Product being repaired and excludes expenses for removing adjacent apparatus, walls, piping, structures, temporary service, etc.

Warranty for Services

Seller warrants that the Services performed by it hereunder will be performed in accordance with generally accepted professional standards.

The Services, which do not so conform, shall be corrected by Seller upon notification in writing by the Buyer within one (1) year after completion of the Services.

Unless otherwise agreed to in writing by Seller, Seller assumes no responsibility with respect to the suitability of the Buyer's, or its customer's, equipment or with respect to any latent defects in equipment not supplied by Seller. This warranty does not cover damage to Buyer's, or its customer's, equipment, components or parts resulting in whole or in part from improper maintenance or operation or from their deteriorated condition. Buyer will, at its cost, provide Seller with unobstructed access to the defective Services, as well as adequate free working space in the immediate vicinity of the defective Services and such facilities and systems, including, without limitation, docks, cranes and utility disconnects and connects, as may be necessary in order that Seller may perform its warranty obligations. The conducting of any tests shall be mutually agreed upon and Seller shall be notified of, and may be present at, all tests that may be made.

Warranty for Power Systems Studies

Seller warrants that any power systems studies performed by it will conform to generally accepted professional standards. Any portion of the study, which does not so conform, shall be corrected by Seller upon notification in writing by the Buyer within six (6) months after completion of the study. All warranty work shall be performed in a single shift straight time basis Monday through Friday. In the event that the study requires correction of warranty items on an overtime schedule, the premium portion of such overtime shall be for the Buyer's account.

Limitation on Warranties for Products, Services and Power Systems Studies

THE FOREGOING WARRANTIES ARE EXCLUSIVE EXCEPT FOR WARRANTY OF TITLE. SELLER DISCLAIMS ALL OTHER WARRANTIES INCLUDING ANY IMPLIED WARRANTIES OF MERCHANTABILITY AND FITNESS FOR A PARTICULAR PURPOSE.

CORRECTION OF NON-CONFORMITIES IN THE MANNER AND FOR THE PERIOD OF TIME PROVIDED ABOVE SHALL CONSTITUTE SELLER'S SOLE LIABILITY AND BUYER'S EXCLUSIVE REMEDY FOR FAILURE OF SELLER TO MEET ITS WARRANTY OBLIGATIONS, WHETHER CLAIMS OF THE BUYER ARE BASED IN CONTRACT, IN TORT (INCLUDING NEGLIGENCE OR STRICT LIABILITY), OR OTHERWISE.

Asbestos

Federal Law requires that building or facility owners identify the presence, location and quantity of asbestos containing material (hereinafter "ACM") at work sites. Seller is not licensed to abate ACM. Accordingly, for any contract which includes the provision of Services, prior to (i) commencement of work at any site under a specific Purchase Order, (ii) a change in the work scope of any Purchase Order, the Buyer will certify that the work area associated with the Seller's scope of work includes the handling of Class II ACM, including but not limited to generator wedges and high temperature gaskets which include asbestos materials. The Buyer shall, at its expense, conduct abatement should the removal, handling, modification or reinstallation, or some or all of them, of said Class II ACM be likely to generate airborne asbestos fibers; and should such abatement affect the cost of or time of performance of the work, then Seller shall be entitled to an equitable adjustment in the schedule, price and other pertinent affected provisions of the contract.

Compliance with Nuclear Regulation

Seller's Products are sold as commercial grade Products not intended for application in facilities or activities licensed by the United States Nuclear Regulatory Commission for atomic purposes. Further certification will be required for use of the Products in any safety-related application in any nuclear facility licensed by the U.S. Nuclear Regulatory Commission.

Returning Products

Authorization and shipping instructions for the return of any Products must be obtained from Seller before returning the Products.

When return is occasioned due to Seller error, full credit including all transportation charges will be allowed.

Product Notices

Buyer shall provide the user (including its employees) of the Products with all Seller supplied Product notices, warnings, instructions, recommendations, and similar materials.

Force Majeure

Seller shall not be liable for failure to perform or delay in performance due to fire, flood, strike or other labor difficulty, act of God, act of any governmental authority or of the Buyer, riot, embargo, fuel or energy shortage, car shortage, wrecks or delays in transportation, or due to any other cause beyond Seller's reasonable control. In the event of delay in performance due to any such cause, the date of delivery or time for completion will be extended by a period of time reasonably necessary to overcome the effect of such delay.

Liquidated Damages

Contracts which include liquidated damage clauses for failure to meet shipping or job completion promises are not acceptable or binding on Seller, unless such clauses are specifically accepted in writing by an authorized representative of the Seller at its headquarters office.

Patent Infringement

Seller will defend or, at its option, settle any suit or proceeding brought against Buyer, or Buyer's customers, to the extent it is based upon a claim that any Product or part thereof, manufactured by Seller or its subsidiaries and furnished hereunder, infringes any United States patent, other than a claim of infringement based upon use of a Product or part thereof in a process, provided Seller is notified in reasonable time and given authority, information and assistance (at Seller's expense) for the defense of same. Seller shall pay all legal and court costs and expenses and court-assessed damages awarded therein against Buyer resulting from or incident to such suit or proceeding. In addition to the foregoing, if at any time Seller determines there is a substantial question of infringement of any United States patent, and the use of such Product is or may be enjoined, Seller may, at its option and expense: either (a) procure for Buyer the right to continue using and selling the Product; (b) replace the Product with non-infringing apparatus; (c) modify the Product so it becomes non-infringing; or (d) as a last resort, remove the Product and refund the purchase price, equitably adjusted for use and obsolescence. In no case does Seller agree to pay any recovery based upon its Buyer's savings or profit through use of Seller's Products whether the use be special or ordinary. The foregoing states the entire liability of Seller for patent infringement.

The preceding paragraph does not apply to any claim of infringement based upon: (a) any modification made to a Product other than by Seller; (b) any design and/or specifications of Buyer to which a Product was manufactured; or (c) the use or combination of Product with other products where the Product does not itself infringe. As to the above-identified claim situations where the preceding paragraph does not apply, Buyer shall defend and hold Seller harmless in the same manner and to the extent as Seller's obligations described in the preceding paragraph. Buyer shall be responsible for obtaining (at Buyer's expense) all license rights required for Seller to be able to use software products in the possession of Buyer where such use is required in order to perform any Service for Buyer.

With respect to a Product or part thereof not manufactured by Seller or its subsidiaries, Seller will attempt to obtain for Buyer, from the supplier(s), the patent indemnification protection normally provided by the supplier(s) to customers.

Compliance with OSHA

Seller offers no warranty and makes no representation that its Products comply with the provisions or standards of the Occupational Safety and Health Act of 1970, or any regulation issued thereunder. In no event shall Seller be liable for any loss, damage, fines, penalty or expenses arising under said Act.

Limitation of Liability

THE REMEDIES OF THE BUYER SET FORTH IN THIS CONTRACT ARE EXCLUSIVE AND ARE ITS SOLE REMEDIES FOR ANY FAILURE OF SELLER TO COMPLY WITH ITS OBLIGATIONS HEREUNDER.

NOTWITHSTANDING ANY PROVISION IN THIS CONTRACT TO THE CONTRARY, IN NO EVENT SHALL SELLER BE LIABLE IN CONTRACT, IN TORT (INCLUDING NEGLIGENCE OR STRICT LIABILITY) OR OTHERWISE FOR DAMAGE TO PROPERTY OR EQUIPMENT OTHER THAN PRODUCTS SOLD HEREUNDER, LOSS OF PROFITS OR REVENUE, LOSS OF USE OF PRODUCTS, COST OF CAPITAL, CLAIMS OF CUSTOMERS OF THE BUYER OR ANY SPECIAL, INDIRECT, INCIDENTAL OR CONSEQUENTIAL DAMAGES WHATSOEVER, REGARDLESS OF WHETHER SUCH POTENTIAL DAMAGES ARE FORESEEABLE OR IF SELLER HAS BEEN ADVISED OF THE POSSIBILITY OF SUCH DAMAGES.

THE TOTAL CUMULATIVE LIABILITY OF SELLER ARISING FROM OR RELATED TO THIS CONTRACT WHETHER THE CLAIMS ARE BASED IN CONTRACT, IN TORT (INCLUDING NEGLIGENCE OR STRICT LIABILITY) OR OTHERWISE, SHALL NOT EXCEED THE PRICE OF THE PRODUCT OR SERVICES ON WHICH SUCH LIABILITY IS BASED.

A

APP V7-T5-17
 AR V7-T3-154
 ARA V7-T3-155
 ARC V7-T3-154
 ARD V7-T3-154, V7-T3-155
 ARM V7-T3-155
 ARO V7-T3-154
 ARS V7-T3-155

B

BF V7-T3-148, V7-T3-149
 BFD V7-T3-148, V7-T3-149
 BFM V7-T3-150

C

CE0 V7-T7-19, V7-T7-20
 CE1 V7-T7-20
 CE2 V7-T7-20
 CE3 V7-T7-20
 CE5 V7-T7-20
 CHCP V7-T8-124
 CHD V7-T8-116
 CH16 V7-T8-122
 CSDR V7-T9-48
 CSDS V7-T9-48
 C0 V7-T7-14
 C00 V7-T7-5-V7-T7-9, V7-T7-26
 C01 V7-T7-5-V7-T7-9
 C02 V7-T7-5-V7-T7-9
 C03 V7-T7-5-V7-T7-9
 C05 V7-T7-5-V7-T7-9
 C07 V7-T7-5-V7-T7-8
 C1 V7-T7-14
 C10 V7-T7-5-V7-T7-7
 C15 V7-T7-5-V7-T7-7
 C2 V7-T7-14
 C22 V7-T1-141-V7-T1-148
 C22-L V7-T1-150
 C22-P V7-T1-152, V7-T1-153
 C22S V7-T1-141-V7-T1-148
 C22S-W V7-T1-155-V7-T1-158
 C22-W V7-T1-155-V7-T1-158
 C3 V7-T7-14
 C320 V7-T3-143, V7-T3-144
 C321 V7-T3-144
 C350 V7-T8-130
 C381 V7-T8-106, V7-T8-107
 C383 V7-T8-128
 C5 V7-T7-14

D

DA1 V7-T9-33
 DC1 V7-T9-31
 DIL-SWD V7-T9-25
 D1RA V7-T3-54
 D1RF V7-T3-54
 D15C V7-T3-143
 D2PA V7-T3-60
 D2PJ V7-T3-60, V7-T3-116
 D2PR V7-T3-59
 D26 V7-T3-164, V7-T3-165
 D26M V7-T3-159-V7-T3-161
 D3PA V7-T3-70, V7-T3-177, V7-T3-180, V7-T3-184,
 V7-T3-189
 D3PF V7-T3-69
 D3PJ V7-T3-70, V7-T3-83, V7-T3-116
 D4PA V7-T3-77
 D4PR V7-T3-77
 D5PA V7-T3-83, V7-T3-177
 D5PF V7-T3-82
 D5PR V7-T3-82
 D65C V7-T3-180, V7-T3-184, V7-T3-189
 D7PA V7-T3-92
 D8PA V7-T3-104
 D8PR V7-T3-104
 D851 V7-T3-189
 D852 V7-T3-189
 D9PR V7-T3-109
 D93 V7-T3-124
 D96 V7-T3-131
 D99 V7-T3-136

E

EASY V7-T3-23, V7-T3-31, V7-T3-40, V7-T3-43,
 V7-T3-45, V7-T6-27
 EASY-LINK V7-T3-45
 EASY-NT V7-T4-37
 EASYSOFT V7-T3-44
 EASY802 V7-T9-13
 EASY806 V7-T9-13
 ELC V7-T4-11-V7-T4-15, V7-T5-7-V7-T5-9, V7-T5-17,
 V7-T6-24
 ELC-AC V7-T4-17
 ELC-ACC V7-T4-18
 ELC-BAT V7-T4-18
 ELC-CB V7-T4-17
 ELC-IO V7-T4-18
 ELCM V7-T4-4, V7-T4-5
 ELC-PS V7-T4-17
 ELCSOFT V7-T4-16
 ELC-SP V7-T4-18
 ELC2 V7-T4-9, V7-T4-10

Appendix 2—Catalog Parent Number Index

EMS	V7-T9-26	E34T	V7-T1-260, V7-T1-262, V7-T1-279, V7-T1-280, V7-T1-332, V7-T1-333
ESR5	V7-T3-194	E34V	V7-T1-263, V7-T1-272, V7-T1-276, V7-T1-278, V7-T1-330, V7-T1-331, V7-T1-334, V7-T1-350, V7-T1-353
ES16	V7-T1-41	E34X	V7-T1-262, V7-T1-333
ES4P	V7-T3-200EU1EV7-T9-43	E8	V7-T1-40
EU4A-RJ45	V7-T4-37	F	
EU5	V7-T9-11	FAK	V7-T1-109, V7-T1-110
EU5C	V7-T9-11, V7-T9-15	FSK	V7-T7-10, V7-T7-21
EU5E	V7-T9-15	H	
E01	V7-T1-40	HMI	V7-T5-15–V7-T5-17
E10	V7-T1-40	HMIVU	V7-T5-15
E10E	V7-T1-4, V7-T1-5, V7-T1-9	HT8A	V7-T1-298, V7-T1-299, V7-T1-311, V7-T1-314
E10P	V7-T1-5	HT8B	V7-T1-314, V7-T1-315
E10T	V7-T1-4, V7-T1-5, V7-T1-9	HT8C	V7-T1-298, V7-T1-306, V7-T1-314
E22B	V7-T2-40	HT8D	V7-T1-306, V7-T1-314
E22C	V7-T1-175, V7-T1-229, V7-T1-280	HT8E	V7-T1-314
E22L	V7-T1-239, V7-T1-271, V7-T1-343	HT8F	V7-T1-298, V7-T1-307, V7-T1-311
E26B	V7-T2-36, V7-T2-38, V7-T2-39	HT8G	V7-T1-298, V7-T1-300–V7-T1-305, V7-T1-311
E26S	V7-T2-37, V7-T2-38, V7-T2-40	HT8H	V7-T1-304, V7-T1-305
E26X	V7-T2-35	HT8J	V7-T1-298, V7-T1-308, V7-T1-309
E29K	V7-T1-229	HT8L	V7-T1-309, V7-T1-311–V7-T1-313, V7-T1-315
E30A	V7-T1-166, V7-T1-167	HT8P	V7-T1-312
E30B	V7-T1-167	HT8R	V7-T1-312
E30C	V7-T1-167	HT8S	V7-T1-312, V7-T1-313
E30D	V7-T1-168	HT8W	V7-T1-311
E30E	V7-T1-168	HT8X	V7-T1-311
E30J	V7-T1-168	I	
E30K	V7-T1-169–V7-T1-175, V7-T1-178, V7-T1-229	ISH	V7-T1-40
E34A	V7-T1-277, V7-T1-351	I8	V7-T1-40
E34C	V7-T1-262, V7-T1-264, V7-T1-270, V7-T1-333, V7-T1-336, V7-T1-342	L	
E34E	V7-T1-260, V7-T1-261, V7-T1-328	LEDWB	V7-T1-40
E34EX	V7-T1-23, V7-T1-324, V7-T1-325, V7-T1-327, V7-T1-330, V7-T1-331, V7-T1-335–V7-T1-339, V7-T1-344, V7-T1-345	LIC-OPT	V7-T4-66, V7-T5-31
E34F	V7-T1-260, V7-T1-262, V7-T1-284, V7-T1-332, V7-T1-333	M	
E34G	V7-T1-263–V7-T1-268, V7-T1-332, V7-T1-334, V7-T1-340	MC	V7-T8-111
E34H	V7-T1-263, V7-T1-334	MFD	V7-T3-35, V7-T3-44
E34J	V7-T1-260, V7-T1-261, V7-T1-264, V7-T1-270, V7-T1-329, V7-T1-336, V7-T1-342	MOD	V7-T3-54, V7-T3-60, V7-T3-70, V7-T3-83, V7-T3-92, V7-T3-113
E34K	V7-T1-276, V7-T1-277, V7-T1-350, V7-T1-351	M22-A	V7-T1-106, V7-T1-108, V7-T1-112, V7-T1-117
E34L	V7-T1-202, V7-T1-260, V7-T1-261, V7-T1-267, V7-T1-277, V7-T1-281, V7-T1-282, V7-T1-329, V7-T1-351	M22-B	V7-T1-117
E34M	V7-T1-265, V7-T1-270, V7-T1-337, V7-T1-342	M22-C	V7-T1-16, V7-T1-55, V7-T1-57, V7-T1-59, V7-T1-61, V7-T1-65, V7-T1-67, V7-T1-69, V7-T1-71, V7-T1-77, V7-T1-83, V7-T1-87, V7-T1-91, V7-T1-95, V7-T1-97, V7-T1-101, V7-T1-103, V7-T1-105, V7-T1-110, V7-T1-112, V7-T1-113
E34N	V7-T1-233, V7-T1-262, V7-T1-283, V7-T1-333, V7-T1-356	M22-D	V7-T1-51, V7-T1-53–V7-T1-71, V7-T1-94–V7-T1-97, V7-T1-99, V7-T1-100, V7-T1-103, V7-T1-107
E34P	V7-T1-260, V7-T1-261, V7-T1-263, V7-T1-267, V7-T1-282, V7-T1-328	M22-E	V7-T1-77, V7-T1-91, V7-T1-116
E34R	V7-T1-260, V7-T1-262, V7-T1-282, V7-T1-332, V7-T1-333		
E34S	V7-T1-262, V7-T1-278, V7-T1-281, V7-T1-282, V7-T1-333, V7-T1-353		

M22-G V7-T1-117
M22G-X V7-T1-77, V7-T1-117
M22-H V7-T1-116
M22-I V7-T1-116, V7-T1-117, V7-T9-37
M22-K V7-T1-55, V7-T1-57, V7-T1-59, V7-T1-61,
V7-T1-65, V7-T1-67, V7-T1-69, V7-T1-71,
V7-T1-77, V7-T1-83, V7-T1-87, V7-T1-91,
V7-T1-95, V7-T1-97, V7-T1-101, V7-T1-103,
V7-T1-105, V7-T1-110, V7-T1-112, V7-T1-117
M22-L V7-T1-51, V7-T1-65, V7-T1-67, V7-T1-69,
V7-T1-71–V7-T1-73, V7-T1-77, V7-T1-87,
V7-T1-101, V7-T1-112, V7-T1-113
M22-M V7-T1-117
M22M-D V7-T1-53–V7-T1-71, V7-T1-94–V7-T1-97
M22M-W V7-T1-80–V7-T1-91
M22-P V7-T1-51, V7-T1-75–V7-T1-77
M22-R V7-T1-106, V7-T1-107
M22S-B V7-T1-117
M22S-D V7-T1-53–V7-T1-71, V7-T1-94–V7-T1-97,
V7-T1-99, V7-T1-100, V7-T1-103
M22S-R V7-T1-106, V7-T1-117
M22S-S V7-T1-114, V7-T1-115
M22S-T V7-T1-68
M22S-W V7-T1-80–V7-T1-91, V7-T1-104
M22-SWD V7-T9-35
M22-T V7-T1-68, V7-T1-117
M22-U V7-T1-116
M22-W V7-T1-51, V7-T1-80–V7-T1-91, V7-T1-104
M22-X V7-T1-55, V7-T1-57, V7-T1-59, V7-T1-61,
V7-T1-65, V7-T1-67, V7-T1-69, V7-T1-71,
V7-T1-73, V7-T1-77, V7-T1-83, V7-T1-87,
V7-T1-91, V7-T1-95, V7-T1-97, V7-T1-106,
V7-T1-107, V7-T1-111–V7-T1-117
M22(S) V7-T1-118

P

PFC V7-T3-54, V7-T3-60, V7-T3-92, V7-T3-117
PFK V7-T7-10
PFP V7-T3-54, V7-T3-60, V7-T3-70, V7-T3-83,
V7-T3-92, V7-T3-104
PKE-SWD V7-T9-25
PMC V7-T3-54, V7-T3-92, V7-T3-114, V7-T3-115
POC V7-T3-60, V7-T3-70, V7-T3-83, V7-T3-92,
V7-T3-114, V7-T3-115
PSG V7-T6-5
PSS V7-T6-34
PS2 V7-T6-31
PWC V7-T3-60, V7-T3-115
PWF V7-T3-70, V7-T3-83, V7-T3-116
PYC V7-T3-60, V7-T3-92

Q

Q18B V7-T1-40
Q18D V7-T1-32
Q18DR V7-T1-32
Q18LF V7-T1-34
Q18LH V7-T1-34
Q18LT V7-T1-33
Q18LTR V7-T1-33
Q18S1 V7-T1-38, V7-T1-39
Q18S3 V7-T1-38, V7-T1-39
Q18S3R V7-T1-38
Q18WK V7-T1-36
Q25A V7-T1-40
Q25B V7-T1-40
Q25D V7-T1-32
Q25DR V7-T1-32
Q25LF V7-T1-34
Q25LH V7-T1-34
Q25LPV V7-T1-35
Q25LT V7-T1-33
Q25LTR V7-T1-33
Q25PV V7-T1-35
Q25S1 V7-T1-38, V7-T1-39
Q25S3 V7-T1-38, V7-T1-39
Q25S3R V7-T1-39
Q25TS V7-T1-41
Q25WK V7-T1-36

S

SFC V7-T7-10, V7-T7-21
SKF V7-T3-45
SL4-AP V7-T2-16
SL4-BL V7-T2-15
SL4-FL V7-T2-15, V7-T2-16
SL4-FMS V7-T2-18
SL4-L V7-T2-14, V7-T2-16, V7-T2-19
SL4-PIB V7-T2-17, V7-T2-18
SL4-SWD V7-T2-18
SL4-100 V7-T2-14
SL7-AP V7-T2-9
SL7-BL V7-T2-7
SL7-CB V7-T2-10, V7-T2-11
SL7-FL V7-T2-7, V7-T2-8
SL7-FMS V7-T2-11, V7-T9-56, V7-T9-57
SL7-L V7-T2-6, V7-T2-8, V7-T2-19
SL7-SWD V7-T2-11
SL7-100 V7-T2-6
SL7/4 V7-T2-19
SQT V7-T1-41
SRA V7-T1-40
SRT V7-T1-41
SWD4 V7-T9-16, V7-T9-17, V7-T9-46
SW-GALILEO V7-T5-37
SW-XSOFT V7-T4-38, V7-T4-58, V7-T4-62, V7-T5-38,
V7-T9-12

Appendix 2—Catalog Parent Number Index

T	
TA	V7-T8-111
TB	V7-T8-110, V7-T8-111, V7-T8-124, V7-T8-131
TBAN.	V7-T8-124
TBLP	V7-T8-131
TBP	V7-T8-131
TJ	V7-T8-111
TM	V7-T8-111
TMRP	V7-T3-186
TMR5	V7-T3-180
TMR6	V7-T3-184
TRF	V7-T3-177
TRL	V7-T3-173
TRN	V7-T3-177
TRW	V7-T3-173
V	
V-M20	V7-T1-116
VS	V7-T1-40
W	
WBG	V7-T1-40
WBLED	V7-T1-40
WMR	V7-T8-130
WM63	V7-T8-130
WRR	V7-T8-130
WR23	V7-T8-130
WR26	V7-T8-130
WR63	V7-T8-130
WR66	V7-T8-130
W23	V7-T8-130
W26	V7-T8-130
W63	V7-T8-130
W66	V7-T8-130
X	
XBAC	V7-T8-7, V7-T8-11, V7-T8-13, V7-T8-15, V7-T8-17, V7-T8-26, V7-T8-30, V7-T8-34, V7-T8-38, V7-T8-40, V7-T8-43, V7-T8-45, V7-T8-47, V7-T8-52, V7-T8-55, V7-T8-57, V7-T8-60, V7-T8-69, V7-T8-71, V7-T8-74, V7-T8-76, V7-T8-78, V7-T8-80
XBAD	V7-T8-26
XBAE	V7-T8-19, V7-T8-28, V7-T8-91
XBAF	V7-T8-7, V7-T8-11, V7-T8-13, V7-T8-15, V7-T8-17, V7-T8-23, V7-T8-26, V7-T8-28, V7-T8-30, V7-T8-34, V7-T8-38, V7-T8-40, V7-T8-45, V7-T8-47, V7-T8-49, V7-T8-52, V7-T8-55, V7-T8-57, V7-T8-60, V7-T8-63, V7-T8-69, V7-T8-71, V7-T8-74, V7-T8-76, V7-T8-78, V7-T8-80, V7-T8-94
XBAN	V7-T3-144, V7-T8-92, V7-T8-93
XBAP	V7-T8-62–V7-T8-66
XBAR	V7-T8-8, V7-T8-35
XBAS	V7-T8-13, V7-T8-15, V7-T8-40, V7-T8-43, V7-T8-60, V7-T8-71, V7-T8-78, V7-T8-80
XBAT	V7-T8-7, V7-T8-11, V7-T8-13, V7-T8-15, V7-T8-17, V7-T8-26, V7-T8-30, V7-T8-34, V7-T8-40, V7-T8-45, V7-T8-47, V7-T8-49, V7-T8-52, V7-T8-55, V7-T8-57, V7-T8-60, V7-T8-65, V7-T8-69, V7-T8-71, V7-T8-74, V7-T8-76, V7-T8-78, V7-T8-80, V7-T8-83, V7-T8-88, V7-T8-103
XBDP	V7-T8-17
XBGB	V7-T8-102
XBMB	V7-T8-102
XBMG	V7-T8-102
XBMK	V7-T8-101, V7-T8-102
XBML	V7-T8-101
XBMP	V7-T8-56, V7-T8-101
XBMU	V7-T8-29, V7-T8-102
XBMX	V7-T8-102
XBMZ	V7-T8-7, V7-T8-11, V7-T8-13, V7-T8-15, V7-T8-17, V7-T8-19, V7-T8-23, V7-T8-26, V7-T8-28, V7-T8-30, V7-T8-34, V7-T8-38, V7-T8-40, V7-T8-43, V7-T8-45, V7-T8-47, V7-T8-49, V7-T8-52, V7-T8-55, V7-T8-57, V7-T8-60, V7-T8-63, V7-T8-65, V7-T8-69, V7-T8-71, V7-T8-74, V7-T8-76, V7-T8-78, V7-T8-80, V7-T8-84, V7-T8-86, V7-T8-88, V7-T8-98, V7-T8-99, V7-T8-101
XBPC	V7-T8-25, V7-T8-51, V7-T8-77
XBPF	V7-T8-25, V7-T8-51, V7-T8-77
XBPT	V7-T8-33, V7-T8-37, V7-T8-39, V7-T8-40, V7-T8-42, V7-T8-44, V7-T8-46, V7-T8-48, V7-T8-49, V7-T8-51, V7-T8-59, V7-T8-84, V7-T8-88
XBPU	V7-T8-54
XBQT	V7-T8-68, V7-T8-70, V7-T8-71, V7-T8-73, V7-T8-75, V7-T8-77
XBQU	V7-T8-79
XBTC	V7-T8-97
XBTD	V7-T8-97
XBTK	V7-T8-25
XBUK	V7-T8-22, V7-T8-25, V7-T8-27, V7-T8-84, V7-T8-86
XBUT	V7-T8-6, V7-T8-10, V7-T8-12, V7-T8-14, V7-T8-16, V7-T8-21, V7-T8-22, V7-T8-25
XB3U	V7-T8-18, V7-T8-19
XC-CPU	V7-T4-33, V7-T4-34
XC-152	V7-T9-12
XIO	V7-T4-33
XIOC	V7-T4-34–V7-T4-37
XN	V7-T4-80–V7-T4-86
XN-ANBZ	V7-T4-87
XNE	V7-T4-78, V7-T4-79
XN-KO	V7-T4-87
XN-LABEL	V7-T4-87
XN-PS	V7-T4-87
XN-QV	V7-T4-87
XN-WEW	V7-T4-87
XN-322	V7-T4-69
XRA	V7-T3-18
XRP	V7-T3-5

XRR	V7-T3-5, V7-T3-13, V7-T3-16	10250T3.	V7-T1-17, V7-T1-21, V7-T1-186, V7-T1-187, V7-T1-192-V7-T1-194, V7-T1-202, V7-T1-212, V7-T1-216, V7-T1-220, V7-T1-236-V7-T1-238, V7-T1-286, V7-T1-287, V7-T1-333, V7-T1-349
XRU	V7-T3-5, V7-T3-13, V7-T3-16	10250T4.	V7-T1-186, V7-T1-191, V7-T1-192, V7-T1-194, V7-T1-198, V7-T1-201, V7-T1-204, V7-T1-207, V7-T1-213, V7-T1-215-V7-T1-218, V7-T1-236-V7-T1-238, V7-T1-286, V7-T1-287, V7-T1-333, V7-T1-340
XT-CAT	V7-T4-37	10250T5.	V7-T1-17, V7-T1-186, V7-T1-188, V7-T1-196, V7-T1-197, V7-T1-199, V7-T1-204, V7-T1-214, V7-T1-216, V7-T1-236-V7-T1-238, V7-T1-286, V7-T1-287, V7-T1-328, V7-T1-340, V7-T1-352
XT-CPU	V7-T4-37	10250T6.	V7-T1-205, V7-T1-214, V7-T1-236, V7-T1-238, V7-T1-286, V7-T1-341, V7-T1-352
XT-FIL	V7-T4-37	10250T7.	V7-T1-22, V7-T1-192, V7-T1-193, V7-T1-205, V7-T1-219, V7-T1-236-V7-T1-238, V7-T1-286, V7-T1-287, V7-T1-324-V7-T1-326, V7-T1-335, V7-T1-336, V7-T1-341, V7-T1-344, V7-T1-345
XT-MEM	V7-T4-36	10250T8.	V7-T1-205, V7-T1-330, V7-T1-331, V7-T1-337-V7-T1-339, V7-T1-341
XTPE	V7-T9-21	10250T9.	V7-T1-198, V7-T1-201, V7-T1-204, V7-T1-205, V7-T1-340, V7-T1-341
XT-RJ45	V7-T4-37	11-11	V7-T1-240, V7-T1-288
XT-SUB	V7-T4-37	11-16	V7-T1-240, V7-T1-288
XV-10	V7-T5-28	11-20	V7-T1-26, V7-T1-27, V7-T1-240, V7-T1-288
XV-102	V7-T4-62, V7-T5-29, V7-T9-12	11-21	V7-T1-26
XV-152	V7-T4-62, V7-T5-28	11-45	V7-T1-240, V7-T1-288
XV-303	V7-T4-65	11-46	V7-T1-27
		11-54	V7-T1-240, V7-T1-288
		11-57	V7-T1-27
		11-95	V7-T1-27
		15-15	V7-T1-240, V7-T1-288
		15-18	V7-T1-179
		15-19	V7-T1-240, V7-T1-288
		16-MS	V7-T1-40
		16-15	V7-T1-240, V7-T1-288
		16-19	V7-T1-26
		16-20	V7-T1-179, V7-T1-240, V7-T1-288
		16-34	V7-T1-240
		17-16	V7-T1-27
		17-19	V7-T1-27
		24-50	V7-T1-240
		24-65	V7-T1-240
		25-18	V7-T1-240, V7-T1-288
		28-10	V7-T1-179
		28-15	V7-T1-179
		28-22	V7-T1-239, V7-T1-287
		28-30	V7-T1-239, V7-T1-287
		28-37	V7-T1-239, V7-T1-287
		28-49	V7-T1-27, V7-T1-239, V7-T1-287
		28-51	V7-T1-239, V7-T1-287
		28-88	V7-T1-27
		28-90	V7-T1-27
		28-94	V7-T1-179
		29-37	V7-T1-240, V7-T1-288
Z			
ZB4	V7-T3-45		
Numerics			
10250ED	V7-T1-18, V7-T1-19, V7-T1-188, V7-T1-190, V7-T1-191, V7-T1-197, V7-T1-199, V7-T1-204, V7-T1-207, V7-T1-212, V7-T1-226, V7-T1-228, V7-T1-239, V7-T1-287, V7-T1-349		
10250H	V7-T1-18-V7-T1-20, V7-T1-23, V7-T1-27		
10250T	V7-T1-269		
10250TA	V7-T1-189, V7-T1-190, V7-T1-217, V7-T1-225-V7-T1-229, V7-T1-240, V7-T1-279, V7-T1-280, V7-T1-288		
10250TB	V7-T1-21, V7-T1-197, V7-T1-198, V7-T1-206, V7-T1-336, V7-T1-342		
10250TC	V7-T1-195, V7-T1-200, V7-T1-206, V7-T1-213, V7-T1-330-V7-T1-332, V7-T1-334, V7-T1-337, V7-T1-342		
10250TD	V7-T1-354		
10250TE	V7-T1-215, V7-T1-230, V7-T1-278, V7-T1-281, V7-T1-352, V7-T1-353		
10250TF	V7-T1-215, V7-T1-228, V7-T1-234, V7-T1-278, V7-T1-280, V7-T1-352, V7-T1-353		
10250TG	V7-T1-21		
10250TJ	V7-T1-197, V7-T1-198, V7-T1-206, V7-T1-218, V7-T1-232, V7-T1-336, V7-T1-342		
10250TK	V7-T1-213, V7-T1-227		
10250TL	V7-T1-213, V7-T1-230, V7-T1-232, V7-T1-281		
10250TM	V7-T1-228, V7-T1-230-V7-T1-232, V7-T1-280		
10250TN	V7-T1-232, V7-T1-233, V7-T1-283, V7-T1-356		
10250TP	V7-T1-231, V7-T1-232		
10250TR	V7-T1-231, V7-T1-232, V7-T1-240, V7-T1-288		
10250TS	V7-T1-213, V7-T1-230-V7-T1-232, V7-T1-234, V7-T1-281, V7-T1-284		
10250T1	V7-T1-17, V7-T1-187, V7-T1-188, V7-T1-193, V7-T1-194, V7-T1-198, V7-T1-201, V7-T1-204, V7-T1-211, V7-T1-212, V7-T1-218, V7-T1-236-V7-T1-238, V7-T1-286, V7-T1-287, V7-T1-328, V7-T1-329, V7-T1-332, V7-T1-333, V7-T1-340, V7-T1-349, V7-T1-354		
10250T2	V7-T1-17, V7-T1-186, V7-T1-187, V7-T1-193, V7-T1-194, V7-T1-207, V7-T1-218-V7-T1-220, V7-T1-236-V7-T1-238, V7-T1-286, V7-T1-287, V7-T1-332, V7-T1-333		

Appendix 2—Catalog Parent Number Index

30-44	V7- T1 -240, V7- T1 -288	53-31	V7- T1 -240
32-25	V7- T1 -27	54-12	V7- T1 -240
32-80	V7- T1 -240, V7- T1 -288	54-71	V7- T1 -240
35-15	V7- T1 -179	54-72	V7- T1 -240
41-78	V7- T1 -240, V7- T1 -288	56-10	V7- T1 -240, V7- T1 -288
42-26	V7- T1 -179	56-93	V7- T1 -227
49-34	V7- T1 -26	57-25	V7- T1 -179
49-35	V7- T1 -26	69-25	V7- T1 -26
4977	V7- T3 -150	73-13	V7- T1 -27
52-11	V7- T1 -179	79-66	V7- T1 -26, V7- T1 -27
52-12	V7- T1 -240	80-55	V7- T1 -240, V7- T1 -288
52-91	V7- T1 -240	86-25	V7- T1 -26, V7- T1 -27
53-11	V7- T1 -26	86-35	V7- T1 -27
53-12	V7- T1 -26	911-3	V7- T1 -27
53-13	V7- T1 -240, V7- T1 -288	9575	V7- T3 -119

A

Accessories

ELC2 Series PLCs	V7-T4-17
M22 and Commercial Control Stations	V7-T1-111–V7-T1-117
Power Distribution Blocks	V7-T8-124
Pushbutton Control Stations	V7-T1-111–V7-T1-117
M22 and Commercial	V7-T1-23
Pushbuttons	
10250T 30.5 mm Heavy-Duty	
Watertight/Oiltight	V7-T1-225–V7-T1-229
E30 30.5 mm Square Multifunction	
Watertight/Oiltight	V7-T1-175
E34 30.5 mm Corrosion Resistant	
Watertight/Oiltight	V7-T1-279
HT800 30.5 mm Watertight/Oiltight	V7-T1-311
RMQ	V7-T1-40
Stacklights	
SL7 and SL4 Series	V7-T2-19
Toggle Switches	
E10	V7-T1-5
XB Series Terminal Blocks	V7-T8-90–V7-T8-103
DIN Rails	V7-T8-92
End Stops	V7-T8-91
Ferrules	V7-T8-94
Hand Tools	V7-T8-97
Marking Accessories	V7-T8-98–V7-T8-102
Mounting Brackets	V7-T8-93
Plates, Covers and Bridges	V7-T8-103
Testing Accessories	V7-T8-103
XC Series PLCs	V7-T4-36
XI/ON Series I/O Modules	V7-T4-87
XV Series HMI-PLCs	V7-T4-58, V7-T4-62, V7-T9-12

Acoustic Devices

B buzzers	V7-T1-106
Complete Devices	V7-T1-106

ASi Adapter Modules	V7-T1-108
-------------------------------	-----------

B

Bulkhead Interfaces	V7-T1-107
-------------------------------	-----------

Button Plates

RMQ	V7-T1-42
---------------	----------

C

CE Marked

Industrial Control Transformers	V7-T7-18
---	----------

Commercial Control Stations

10250H Series Heavy-Duty	V7-T1-20, V7-T1-21
Class I Division 2 10250T Series Heavy-Duty	V7-T1-22
Class I Division 2 E34 Series Corrosion Resistant	V7-T1-23
Custom Assembled	V7-T1-24
General Purpose	V7-T1-18
Key Specifications	V7-T1-17
Special Purpose	V7-T1-19

Connectivity Solutions

SmartWire-DT	V7-T9-1
------------------------	---------

Control Relays and Timers

Alternating Relays	V7-T3-188
Catalog Number Selection	V7-T3-3
EZ Programmable Relays	V7-T3-19–V7-T3-48
General Purpose Plug-In Relays	V7-T3-49–V7-T3-117
Machine Tool Relays	V7-T3-141–V7-T3-166
Product Overview	V7-T3-2
Solid-State Relays	V7-T3-122–V7-T3-140
Timing Relays	V7-T3-167–V7-T3-187
XR Series Terminal Block Relays	V7-T3-3–V7-T3-18

Control Station Components, M22

Acoustic Devices	V7-T1-106
ASi Adapter Modules	V7-T1-108
Bulkhead Interfaces	V7-T1-107
Double Pushbuttons	V7-T1-99
Emergency Stops, Illuminated	V7-T1-76
Four-Way Pushbuttons	V7-T1-103
Indicating Lights, Flush	V7-T1-73
Joysticks	V7-T1-104
Mushroom Head Pushbuttons,	
Non-Illuminated	V7-T1-95, V7-T1-97
Palm Switches	V7-T1-109
Potentiometers	V7-T1-106
Pushbuttons	
Illuminated	V7-T1-65, V7-T1-67, V7-T1-69, V7-T1-71
Non-Illuminated	V7-T1-55, V7-T1-57, V7-T1-59, V7-T1-61
Selector Switches, Illuminated	V7-T1-85, V7-T1-86
Selector Switches, Key-Operated	V7-T1-88–V7-T1-91
Selector Switches, Non-Illuminated	V7-T1-81–V7-T1-83
Symbols Library	V7-T1-129
Through-the-Door Operators	V7-T1-107

Control Stations—Assembled	V7-T1-14–V7-T1-131
--------------------------------------	--------------------

D

Double Pushbutton Components	V7-T1-99
--	----------

Double Pushbuttons

Catalog Number Selection	V7-T1-98
Extended and Flush, Center Light	V7-T1-100

E

E10

Hesitation Switches, Heavy-Duty	V7-T1-5
Pushbuttons, Non-Illuminated	V7-T1-5
Toggle Switches, General Purpose Toggles	V7-T1-4

E10E

Econoswitch	V7-T1-9
Molded-In Screw Terminal	V7-T1-9
Switch Guard	V7-T1-9

EASY Programmable Relays

EASY MFD (Multi-Function Displays)	V7-T3-33
EASY/MFD Accessories	V7-T3-43
EASY/MFD Communication Modules	V7-T3-40
EASY/MFD Expansion Modules	V7-T3-30
EASY/MFD Power Supplies	V7-T3-43
EASY/MFD Software	V7-T3-43

Appendix 3—Alphabetical Product Index

easySafety Relays and Timers	V7-T3-199–V7-T3-204
Eaton Terms & Conditions	
Freight	V7-A1-3
Limitation of Liability	V7-A1-5
Terms and Conditions of Sale	V7-A1-1
Terms of Payment	V7-A1-2
Warranty	V7-A1-3
ELC Graphics Panels	V7-T5-5
Cable	V7-T5-8
Products	V7-T5-7
Protocols	V7-T5-5
Software and Accessories	V7-T5-8
Technical Data	V7-T5-10
ELC2 Series Programmable Logic Controllers	
Digital Expansion Modules (Right Side Bus)	V7-T4-14
ELC Modular PLCs	V7-T4-6
ELCM Modular Brick PLCs	V7-T4-4
Master Communication Modules	V7-T4-12
Remote I/O Adapters	V7-T4-13
Emergency Stop Components	
Illuminated	V7-T1-76
Emergency Stops	
Catalog Number Selection	V7-T1-74
Illuminated	V7-T1-75, V7-T1-76
Non-Illuminated	V7-T1-75, V7-T1-76
RMQ	V7-T1-35
F	
Four-Way Pushbutton Components	V7-T1-103
Four-Way Pushbuttons	
Catalog Number Selection	V7-T1-102
Fuse Blocks and Fuse Holders	V7-T8-126–V7-T8-132
C350 Series Fuse Blocks	V7-T8-129
C383 Series Fuse Holders	V7-T8-127
W Series Fuse Holders	V7-T8-129
G	
Galileo Software	V7-T5-37
General Purpose Plug-In Relays	
Accessories	V7-T3-112–V7-T3-117
D1PR/D1PF Series	V7-T3-54
D2PR/D2PF Series	V7-T3-60
D3PR/D3PF Series	V7-T3-70
D5PR/D5PF Series	V7-T3-83
D7PR/D7PF Series	V7-T3-92
D1RR/D1RF Series	V7-T3-53
D2PR/D2PF Series	V7-T3-57
D3PR/D3PF Series	V7-T3-67
D4 Series	V7-T3-76
D5PR/D5PF Series	V7-T3-80
D7PR/D7PF Series	V7-T3-89
D8 Series	V7-T3-103
D9 Series	V7-T3-108

General Purpose Relays	
9575H Series 3000	V7-T3-118
Accessories	
Type AA	V7-T3-119
Type AA	V7-T3-118
Type AA, AC and DC	V7-T3-118

Graphics Panels	
Power Supplies	V7-T5-9

H

HMI Operator Interface	V7-T5-13
Products	V7-T5-15
Protocols	V7-T5-14
Software and Accessories	V7-T5-16
Technical Data	V7-T5-18

I

IEC—XB Series Terminal Blocks	
IDC (Insulation Displacement Connection)	V7-T8-67–V7-T8-81
Miniature Circuit Breakers	V7-T8-82–V7-T8-89
Pluggable Spring Cage	V7-T8-58–V7-T8-66
Product Overview	V7-T8-2
Screw Connection	V7-T8-4–V7-T8-30
Spring Cage	V7-T8-31–V7-T8-57

Indicating Lights

10250T/E34 30.5 mm Class I Division 2	
Hazardous Locations	V7-T1-321–V7-T1-359
E34 30.5 mm Class I Division 2	V7-T1-332
HT800 30.5 mm Watertight/Oiltight	V7-T1-296–V7-T1-317
M22, Flush	V7-T1-72
Catalog Number Selection	V7-T1-72
Components	V7-T1-73
Ratings	V7-T1-360
RMQ	V7-T1-34
Symbols Library	V7-T1-129

Industrial Control Transformers	V7-T7-2–V7-T7-26
CE Marked	V7-T7-18
Type AP	V7-T7-25
Type MTE	V7-T7-4
Type MTK	V7-T7-13

J

Joystick Components	V7-T1-104
Joysticks	
10250T 30.5 mm Heavy-Duty	V7-T1-216
M22	V7-T1-104, V7-T1-105

K

Key-Operated Selector Switch Components	V7-T1-88–V7-T1-91
Key-Operated Selector Switches	V7-T1-88–V7-T1-91
Catalog Number Selection	V7-T1-88

M

M22 Assembled Control Stations	V7-T1-16
Machine Tool Relays	
Accessories	
AR/ARD Series	V7-T3-155
D15 Series	V7-T3-144
AR/ARD Series	V7-T3-153
BF/BFD Series	V7-T3-147
D15 Series	V7-T3-142
D26 Series—Type M, 600 Vac	V7-T3-158
D26 Series—Type M, DC	V7-T3-163
Options	
AR/ARD Series	V7-T3-155
BF/BFD Series	V7-T3-150
Mushroom Head Pushbutton Components	
Non-Illuminated	
Maintained	V7-T1-97
Momentary	V7-T1-95
Mushroom Head Pushbuttons	
Catalog Number Selection	V7-T1-93
Non-Illuminated	
Maintained	V7-T1-96, V7-T1-97
Momentary	V7-T1-94, V7-T1-95

N

NEMA	
Terminal Blocks	V7-T8-104–V7-T8-113

O

On Machine Components	V7-T9-42
Operator Components	
E30, Square Multifunction	V7-T1-169–V7-T1-173
Operator Interface Products	V7-T5-1
ELC Graphics Panels	V7-T5-5–V7-T5-12
HMI Operator Interface	V7-T5-13–V7-T5-20
Visual Designer Software	V7-T5-34
XP and XV Operator Interface	V7-T5-21–V7-T5-38
XP and XV Operator Interface with Visual Designer and XSoft-CoDeSys-2	V7-T5-38
XP with Visual Designer	V7-T5-21–V7-T5-23
Operators	
10250T 30.5 mm Heavy-Duty	
Watertight/Oiltight	V7-T1-182–V7-T1-247
10250T/E34 30.5 mm Class I Division 2	
Hazardous Locations	V7-T1-321–V7-T1-359
E30 30.5 mm Square Multifunction	
Watertight/Oiltight	V7-T1-164–V7-T1-181
E30 Square Multifunction Components ..	V7-T1-169–V7-T1-173
E30, Square Multifunction	V7-T1-166
E30, Square Multifunction and	V7-T1-169–V7-T1-173
Indicating Lights	
E30, Square Multifunction Components ..	V7-T1-174
E34 30.5 mm Corrosion Resistant	
Watertight/Oiltight	V7-T1-254–V7-T1-293
Symbols Library	V7-T1-129

Options

10250T/E34 30.5 mm Class I Division 2	
Hazardous Locations	V7-T1-354
Pushbuttons	
10250T 30.5 mm Heavy-Duty	
Watertight/Oiltight	V7-T1-230
E30 30.5 mm Square Multifunction	
Watertight/Oiltight	V7-T1-176–V7-T1-178
E34 30.5 mm Corrosion Resistant	
Watertight/Oiltight	V7-T1-281
HT800 30.5 mm Watertight/Oiltight	V7-T1-312
Toggle Switches	
E10E	V7-T1-8

P

Palm Switches	
Catalog Number Selection	V7-T1-109
Complete Devices	V7-T1-109
Components	V7-T1-110
Panel Wiring	
SmartWire-DT	V7-T9-1
Contactor Modules Diagram	V7-T9-6
PanelMate Operator Interface	
Product Selection Guide	V7-T5-2
PLC, I/O and Communication Products	V7-T4-1
ELC Series Programmable	
Logic Controllers	V7-T4-2–V7-T4-28
XC Series Programmable	
Logic Controllers	V7-T4-29–V7-T4-56
XI/ON Series Remote I/O	V7-T4-70–V7-T4-115
XV-100 Series HMI-PLCs	V7-T4-61, V7-T4-62
XV-300 Series HMI-PLCs	V7-T4-63–V7-T4-67
Potentiometers	
Complete Devices	V7-T1-106
Components	V7-T1-106
Power Distribution Blocks	V7-T8-114–V7-T8-125
CH160 Series	V7-T8-121
CHDB Series	V7-T8-115
Terminal Block Accessories	V7-T8-124
Power Supplies	V7-T6-1–V7-T6-36
ELC Series	V7-T6-23
EZ Power Supply	V7-T6-26
PSG Series	V7-T6-3
PSS Series	V7-T6-33
Sensor Power Supply	V7-T6-30
Programmable Relays	
easy500/700/800	V7-T3-20
easy802/806 with SmartWire-DT	V7-T3-26
Pushbutton Components, M22	
Illuminated	
Extended, Maintained	V7-T1-71
Extended, Momentary	V7-T1-69
Flush, Maintained	V7-T1-67
Flush, Momentary	V7-T1-65

Appendix 3—Alphabetical Product Index

Pushbutton Components, M22, continued

Non-Illuminated	
Extended, Maintained	V7-T1-61
Extended, Momentary	V7-T1-59
Flush, Maintained	V7-T1-57
Flush, Momentary	V7-T1-55

Pushbutton Control Stations

Coding Adapter Guide	V7-T1-118
Commercial	V7-T1-17
10250H Series Heavy-Duty	V7-T1-20
10250T Series Heavy-Duty	V7-T1-21
Class I Division 2 10250T Series Heavy-Duty	V7-T1-22
Class I Division 2 E34 Series Corrosion Resistant	V7-T1-23
General Purpose	V7-T1-18
Special Purpose	V7-T1-19
Custom Assembled	V7-T1-24

Pushbutton Control Stations—Assembled

Pushbuttons

10250T	
Catalog Number Selection	V7-T1-184, V7-T1-185
Point-of-Purchase Packaging	V7-T1-186
10250T 30.5 mm Heavy-Duty	
Emergency Stops	V7-T1-196–V7-T1-201
Indicating Light Units	V7-T1-193, V7-T1-194
Joystick Units	V7-T1-215–V7-T1-217
Key Operators	V7-T1-211
Operators and Pushbutton Units	V7-T1-190
Potentiometers	V7-T1-202
Push-Pull Operators	V7-T1-203
Roto-Push	V7-T1-219–V7-T1-224
Selector Switches	V7-T1-207
10250T 30.5 mm Heavy-Duty	
Watertight/Oiltight	V7-T1-182–V7-T1-247
10250T/E34 30.5 mm Class I Division 2	
Hazardous Locations	V7-T1-321–V7-T1-359
E30 30.5 mm Square Multifunction	
Watertight/Oiltight	V7-T1-164–V7-T1-181
E34 30.5 mm Corrosion Resistant	
Watertight/Oiltight	V7-T1-254–V7-T1-293
HT800 30.5 mm Watertight/Oiltight	V7-T1-296–V7-T1-317
Illuminated	
E34	V7-T1-262
E34 30.5 mm Class I Division 2	V7-T1-330
HT800	V7-T1-300
Key Operators, E34	V7-T1-276
M22	
Button Plates	V7-T1-111
Double	V7-T1-98
Emergency Stops	V7-T1-74
Four-Way	V7-T1-102
Illuminated	
Catalog Number Selection	V7-T1-62
Extended, Maintained	V7-T1-70, V7-T1-71
Extended, Momentary	V7-T1-68, V7-T1-69
Flush, Maintained	V7-T1-66, V7-T1-67
Flush, Momentary	V7-T1-63–V7-T1-65

Pushbuttons, continued

Key-Operated Selector Switches	V7-T1-88
Mushroom Head	V7-T1-92
Non-Illuminated	
Catalog Number Selection	V7-T1-53
Extended, Maintained	V7-T1-60, V7-T1-61
Extended, Momentary	V7-T1-58, V7-T1-59
Flush, Maintained	V7-T1-56, V7-T1-57
Flush, Momentary	V7-T1-53–V7-T1-55
Product Selection Guide	V7-T1-48–V7-T1-51
Selector Switches	V7-T1-78
Momentary Units	
E34 30.5 mm Class I Division 2	V7-T1-324
Non-Illuminated	
E34	V7-T1-260
E34 30.5 mm Class I Division 2	V7-T1-328
HT800	V7-T1-298
Push-Pull Units	
E34	V7-T1-264
E34 30.5 mm Class I Division 2	V7-T1-335
HT800	V7-T1-306
Ratings	V7-T1-360
RMQ	
Button Plates	V7-T1-42
Illuminated	V7-T1-33
Non-Illuminated	V7-T1-32
Product Selection Guide	V7-T1-31
Selector Switches	
E34	V7-T1-272
E34 30.5 mm Class I Division 2	V7-T1-344
HT800	V7-T1-308
Symbols Library	V7-T1-129
Pushbuttons and Indicating Lights	V7-T1-1

R

Relays and Timers	
easySafety	V7-T3-199–V7-T3-204
Renewal Parts	
M22 and Commercial Control Stations	V7-T1-26
Replacement Parts	
Pushbuttons	
10250T 30.5 mm Heavy-Duty	
Watertight/Oiltight	V7-T1-239
E30 30.5 mm Square Multifunction	
Watertight/Oiltight	V7-T1-179
E34 30.5 mm Corrosion Resistant	
Watertight/Oiltight	V7-T1-287
HT800 30.5 mm Watertight/Oiltight	V7-T1-315
Stacklights, E26 Series	V7-T2-40
RMQ	
16.22 mm Pushbuttons	V7-T1-30–V7-T1-46
Accessories	V7-T1-40

S

Selector Switch Components	
Illuminated	V7-T1-85, V7-T1-86
Non-Illuminated	V7-T1-81–V7-T1-83
Selector Switches	
10250T 30.5 mm Heavy-Duty	
Watertight/Oiltight	V7-T1-182–V7-T1-247
10250T/E34 30.5 mm Class I Division 2	
Hazardous Locations	V7-T1-321–V7-T1-359
E34 30.5 mm Corrosion Resistant	
Watertight/Oiltight	V7-T1-254–V7-T1-293
HT800 30.5 mm Watertight/Oiltight	V7-T1-296–V7-T1-317
M22	
Catalog Number Selection	
Illuminated	V7-T1-84
Non-Illuminated	V7-T1-79
Illuminated	V7-T1-85
Non-Illuminated	V7-T1-80–V7-T1-83
RMQ	
Illuminated	V7-T1-37
Keyed	V7-T1-38, V7-T1-39
Non-Illuminated	V7-T1-36
Sensor Power Supply	V7-T6-30
SmartWire-DT In Panel and On Machine	
Wiring Solution	V7-T9-2–V7-T9-116
SmartWire-DT	
I/O and Powerfeed Modules, System	
Connectivity Components	V7-T9-14
Motor Control Modules	V7-T9-18
Stacklight Modules with SmartWire-DT	V7-T9-40
System Components	V7-T9-4
System Connectivity Components	
In Panel Components	V7-T9-16
Outside-the-Panel Components	V7-T9-17
System Control	
easy800	V7-T9-13
EASY-SWD Accessories	V7-T9-13
Gateway Modules	V7-T9-11
XC152 PLC	V7-T9-12
XV HMI/PLC	V7-T9-12
System Controllers	V7-T9-8
System Overview	V7-T9-2
Solid-State Relays	
Accessories	
D93 Series	V7-T3-124
D93 Series	V7-T3-123
D93, D96 and D99 Series	
Catalog Number Selection	V7-T3-122
Overview	V7-T3-122
D96 Series	V7-T3-130
D99 Series	V7-T3-135

Stacklights

E26 Series	V7-T2-32
Assembled Units	V7-T2-35
Components	V7-T2-38
LEDs—Cylindrical or Cluster	V7-T2-37
Light and Xenon Strobe Modules	V7-T2-36

SL4 Series

Acoustic Modules	V7-T2-16
Base Modules	V7-T2-17, V7-T2-18
Complete Devices	V7-T2-14
Component Identification	V7-T2-12, V7-T2-13
Light Modules	V7-T2-14–V7-T2-16

SL7 Series

Acoustic Modules	V7-T2-9
Base Modules	V7-T2-10, V7-T2-11
Complete Devices	V7-T2-6
Component Identification	V7-T2-4, V7-T2-5
Light Modules	V7-T2-6–V7-T2-8

T

Terminal Blocks

IDC (Insulation Displacement Connection)	V7-T8-67–V7-T8-81
Miniature Circuit Breakers	V7-T8-82–V7-T8-89
NEMA	V7-T8-104–V7-T8-113
C381 Series	V7-T8-105
TB Series	V7-T8-109
Pluggable Spring Cage	V7-T8-58–V7-T8-66
Screw Connection	V7-T8-4–V7-T8-30
Spring Cage	V7-T8-31–V7-T8-57

Terminal Blocks, Fuse Blocks and Fuse Holders V7-T8-1

Through-the-Door Operators

Complete Devices	V7-T1-107
Components	V7-T1-107

Timing Relays

Accessories	
TMR5 Series	V7-T3-180
TMR6 Series	V7-T3-184
TR Series	V7-T3-177
Product Selection Guide	V7-T3-167
TMR5 Series	V7-T3-179
TMR6 Series	V7-T3-183
TMRP Series	V7-T3-185
TR Series	V7-T3-176
Universal TR Series	V7-T3-172

Toggle Switches

E10	V7-T1-2–V7-T1-7
Accessories	V7-T1-5
E10E Environmentally Sealed	V7-T1-8–V7-T1-11
Options	V7-T1-8

Transformers

Industrial Control	V7-T7-1–V7-T7-26
------------------------------	------------------

Type AP

Industrial Control Transformers	V7-T7-25
---	----------

Type MTE

Industrial Control Transformers	V7-T7-4
---	---------

Type MTK

Industrial Control Transformers	V7-T7-13
---	----------

Appendix 3—Alphabetical Product Index

V

Visual Designer Software	V7-T5-34
Products	V7-T5-35

X

XC Series Programmable Logic Controllers	
XC101 Modular PLCs	V7-T4-33
XC121 Compact PLC CPU	V7-T4-33
XC121 I/O Expansion Module	V7-T4-33
XC201 Modular PLCs	V7-T4-34
XC202 Modular PLCs	V7-T4-34
XI/ON Series Remote I/O	
Base Modules	V7-T4-84
XN Series	V7-T4-80
XNE Series	V7-T4-78
XP and XV Operator Interface	V7-T5-21
XP and XV Operator Interface with Visual Designer	
Product Selection Guide	V7-T4-64, V7-T5-26

XP Operator Interface	
Products	V7-T5-22
XP with Visual Designer	V7-T5-21
Technical Data	V7-T5-23
XR Series Terminal Block Relays	
Accessories	V7-T3-18
High Current	V7-T3-15
OptoCoupler	V7-T3-12
Standard	V7-T3-4
XSoft-CoDeSys-2	V7-T5-24
Products	V7-T5-38
XSoft-CoDeSys-3	V7-T5-38
XV Operator Interface	
Products	V7-T5-28, V7-T5-29, V7-T5-30
XV Series HMI-PLCs	V7-T4-61, V7-T4-63
XV with Visual Designer	V7-T5-24
XV with Visual Designer or XSoft-CoDeSys	
Technical Data	V7-T5-32
XV with XSoft-CoDeSys-3	V7-T5-24