

# RGC2P, RGC3P



## 3-phase proportional switching controllers



### Description

This series gives the possibility to control output power of 3-phase loads with an analog control input. The **RGC2P** is a 2-pole switching product whilst the **RGC3P** switches all 3 poles.

Input types cover a wide range of current and voltage ranges. Local setting by an external potentiometer is also possible. Switching modes cover phase angle control, distributed full cycle control and soft start for limiting inrush current of loads having a high temperature coefficient, such as short wave infrared heaters.

Detection of mains loss, load loss, SSR short circuit and overtemperature is integrated in some models. Alarm condition is signalled through an EMR output and is visually indicated by the alarm LED. Additional LEDs indicate input and load status.

Specifications are at a surrounding temperature of 25°C unless otherwise specified.

### Applications

Plastic injection machines, thermoformers, dryers, electrical ovens, shrink tunnels, air handling units, climatic chambers, industrial printers, ovens and furnaces, battery manufacturing machines

### Main features

- 3-phase (2-pole or 3-pole) proportional switching controllers with Phase angle switching mode, Full cycle firing, Burst firing or Soft starting switching mode
- Analog current (0-20/4-20/12-20 mA) or voltage (0-5/1-5/0-10 V or external potentiometer) control signal
- Ratings up to 660 VAC 75 AAC (RGC2P), 65 AAC (RGC3P) @  $T_A$  40°C
- Integrated monitoring for load loss, over-temperature of the RGC2/3P, mains loss or malfunction of the RGC2/3P controller

### Benefits

- **Elimination of Analog to Digital converters.** The RGC2/3P can be directly controlled with an analog signal. The power output from the RGC2/3P is directly proportional to the analog control input. Output switching modes include phase angle, distributed full cycle, burst and soft starting switching.
- **Panel space savings.** Concentrated power; the RGC 3-phase switching range can handle up to 65 AAC per pole (or 75 AAC for 2-pole switching) in a 70 mm wide footprint.
- **Long lifetime.** Wire bonding technology reduces thermal and mechanical stresses of the output chips resulting in a larger number of possible operational cycles compared to other assembly technologies.
- **Low machine downtime.** Integrated overvoltage protection prevents the solid state relay from breaking down due to uncontrolled transients that may occur on the lines.
- **Ease of use.** The RGC2P and RGC3P are ready to use solutions provided with integrated heatsink thus eliminating the need for the user to calculate the size of heatsink needed for adequate thermal dissipation.
- **Fast wiring.** Power connections for models rated  $\geq 30$  A are equipped with terminals that can handle cables up to 25 mm<sup>2</sup> / AWG3 cables.
- **Integrated monitoring for timely detection of malfunctions.** The 3-phase RGC controllers can detect mains loss, load loss on any of the phases, over temperature and malfunction of the RGC2/3P controller.
- **Accommodates UL508A requirements for Industrial Control Panels.** The RGC 3-phase range is certified as a listed product. All models carry a 100 kArms Short Circuit Current Rating.

## Order code

 **RGC2 P 60**

Enter the code entering the corresponding option instead of . Refer to selection guide section for valid part numbers.

Code	Option	Description	Comments
R	-	Solid State Relay (RG)	
G	-		
C	-	With integrated heatsink	
2	-	2-pole switching, 1-pole direct	
P	-	Switching mode: proportional	
60	-	Rated voltage: 180-660 VAC, 1200 Vp	
<input type="checkbox"/>	AA	Control input: 4 - 20 mADC	Not available with monitoring 'M', not available with RGC..75
	I	Control input: 0 - 20 mADC, 4 - 20 mADC, 12 - 20 mADC	Requires external supply (Us)
	V	Control input: 0-5 VDC, 1-5 VDC, 0-10 VDC	
<input type="checkbox"/>	25	Rated current/pole @ 40°C: 25 AAC	
	40	Rated current/pole @ 40°C: 40 AAC	
	75	Rated current/pole @ 40°C: 75 AAC	
<input type="checkbox"/>	C1	Switching mode: 1 FC ON, 1 FC OFF @ 50% input	
	C4	Switching mode: 4 FC ON, 4 FC OFF @ 50% input	
<input type="checkbox"/>	D	External supply: 24 VAC/DC	
	A	External supply: 90 - 250 VAC	
<input type="checkbox"/>	F	Integrated fan	For RGC..75 only
<input type="checkbox"/>	M	Monitoring for Mains loss, Load loss, SSR short circuit, open circuit and OTP with EMR alarm output	Not available with control input type 'AA'

FC = Full Cycle  
 OTP = Over-Temperature Protection  
 EMR = Electromechanical Relay

## Order code

 **RGC3 P 60**

Enter the code entering the corresponding option instead of . Refer to selection guide section for valid part numbers.

Code	Option	Description	Comments
R	-	Solid State Relay (RG)	
G	-		
C	-	With integrated heatsink	
3	-	3-pole switching	
P	-	Switching mode: proportional	
60	-	Rated voltage: 180-660 VAC, 1200 Vp	
<input type="checkbox"/>	AA	Control input: 4 - 20 mADC	Not available with monitoring 'M' or 'P', not available with RGC..65
	I	Control input: 0 - 20 mADC, 4 - 20 mADC, 12 - 20 mADC	Requires external supply (Us)
	V	Control input: 0-5 VDC, 1-5 VDC, 0-10 VDC	
<input type="checkbox"/>	20	Rated current/pole @ 40°C: 20 AAC	
	30	Rated current/pole @ 40°C: 30 AAC	
	65	Rated current/pole @ 40°C: 65 AAC	
<input type="checkbox"/>	E	Switching mode: Phase Angle	Not available with RGC..M
	C1	Switching mode: 1 FC ON, 1 FC OFF @ 50% input	
	C4	Switching mode: 4 FC ON, 4 FC OFF @ 50% input	
	C16	Switching mode: 16 FC ON, 16 FC OFF @ 50% input	
	S	Switching mode: Soft Start with digital input 5-10 V	With control input type 'V' only
	S16	Switching mode: Soft Start + mode C16	
<input type="checkbox"/>	D	External supply: 24 VAC/DC	
	A	External supply: 90 - 250 VAC	
<input type="checkbox"/>	F	Integrated fan	For RGC..65 only
<input type="checkbox"/>	P	Integrated over temperature protection (OTP) and Mains loss with EMR alarm output	Applicable to switching mode 'E' only. Not available with control input type 'AA'
	M	Monitoring for Mains loss, Load loss, SSR short circuit, open circuit and OTP with EMR alarm output	Applicable to all switching modes except for mode 'E'. Not available with control input type 'AA'

FC = Full Cycle  
 OTP = Over-Temperature Protection  
 EMR = Electromechanical Relay

## Selection guide: 2-pole switching, 1-pole direct (RGC2P)

Current rating @ 40°C (I <sup>2</sup> t)	Input type	External supply	Switching mode		Part number
			C1	C4	
<b>25 AAC</b> (1800 A <sup>2</sup> s)	AA: 4-20 mADC	-	•		RGC2P60AA25C1
	I: 0-20 mADC 4-20 mADC 12-20 mADC	24 VAC/DC	•		RGC2P60I25C1DM
				•	RGC2P60I25C4DM
	V: 0-5 VDC 1-5 VDC 0-10 VDC	24 VAC/DC	•		RGC2P60V25C1DM
<b>40 AAC</b> (6600 A <sup>2</sup> s)	AA: 4-20 mADC	-	•		RGC2P60AA40C1
	I: 0-20 mADC 4-20 mADC 12-20 mADC	24 VAC/DC	•		RGC2P60I40C1DM
				•	RGC2P60I40C4DM
	V: 0-5 VDC 1-5 VDC 0-10 VDC	24 VAC/DC	•		RGC2P60V40C1DM
<b>75 AAC</b> (15000 A <sup>2</sup> s)	I: 0-20 mADC 4-20 mADC 12-20 mADC	24 VAC/DC	•		RGC2P60I75C1DFM
				•	RGC2P60I75C4DFM
		90-250 VAC	•		RGC2P60I75C1AFM
				•	RGC2P60I75C4AFM
	V: 0-5 VDC 1-5 VDC 0-10 VDC	24 VAC/DC	•		RGC2P60V75C1DFM
		90-250 VAC	•		RGC2P60V75C1AFM



## Selection guide: 3-pole switching (RGC3P)

Current rating @ 40°C (I <sup>2t</sup> )	Input type	External supply	Switching mode						Part number	
			E	C1	C4	C16	S	S16		
20 AAC (1800 A²s)	AA: 4-20 mADC	-	•						RGC3P60AA20E	
				•					RGC3P60AA20C1	
	I: 0-20 mADC 4-20 mADC 12-20 mADC	24 VAC/DC	•						RGC3P60I20EDP	
				•					RGC3P60I20C1DM	
					•				RGC3P60I20C4DM	
						•			RGC3P60I20C16DM	
	V: 0-5 VDC 1-5 VDC 0-10 VDC	24 VAC/DC	•						RGC3P60V20EDP	
				•					RGC3P60V20C1DM	
					•				RGC3P60V20C4DM	
						•			RGC3P60V20C16DM	
								•	RGC3P60V20S16DM	
								•	RGC3P60V20SDM	
	5-10 V, digital i/p	24 VAC/DC					•		RGC3P60V20SDM	
	30 AAC (6600 A²s)	AA: 4-20 mADC	-	•						RGC3P60AA30E
				•					RGC3P60AA30C1	
I: 0-20 mADC 4-20 mADC 12-20 mADC		24 VAC/DC	•						RGC3P60I30EDP	
				•					RGC3P60I30C1DM	
					•				RGC3P60I30C4DM	
						•			RGC3P60I30C16DM	
		90-250 VAC	•							RGC3P60I30EAP
				•						RGC3P60I30C1AM
					•					RGC3P60I30C4AM
						•				RGC3P60I30C16AM
V: 0-5 VDC 1-5 VDC 0-10 VDC		24 VAC/DC	•							RGC3P60V30EDP
				•						RGC3P60V30C1DM
					•					RGC3P60V30C4DM
						•				RGC3P60V30C16DM
								•		RGC3P60V30S16DM
								•		RGC3P60V30SDM
		90-250 VAC	•							RGC3P60V30EAP
				•						RGC3P60V30C1AM
					•					RGC3P60V30C4AM
						•				RGC3P60V30C16AM
5-10 V, digital i/p	24 VAC/DC					•		RGC3P60V30SDM		



## Selection guide: 3-pole switching (RGC3P)

Current rating @ 40°C (I <sup>2</sup> t)	Input type	External supply	Switching mode						Part number	
			E	C1	C4	C16	S	S16		
<b>65 AAC</b> (15000 A <sup>2</sup> s)	I: 0-20 mADC 4-20 mADC 12-20 mADC	24 VAC/DC	•						RGC3P60I65EDFP	
				•					RGC3P60I65C1DFM	
					•					RGC3P60I65C4DFM
						•				RGC3P60I65C16DFM
		90-250 VAC	•							RGC3P60I65EAFP
				•						RGC3P60I65C1AFM
					•					RGC3P60I65C4AFM
						•				RGC3P60I65C16AFM
	V: 0-5 VDC 1-5 VDC 0-10 VDC	24 VAC/DC	•							RGC3P60V65EDFP
				•						RGC3P60V65C1DFM
					•					RGC3P60V65C4DFM
						•				RGC3P60V65C16DFM
									•	RGC3P60V65S16DFM
										RGC3P60V65EAFP
		90-250 VAC	•							RGC3P60V65EAFP
				•						RGC3P60V65C1AFM
					•					RGC3P60V65C4AFM
						•				RGC3P60V65C16AFM
									•	RGC3P60V65SDFM
										RGC3P60V65SDFM

## Carlo Gavazzi compatible components

Description	Component code	Notes
Fans	RG3FAN60	Fan accessory for RGC2..75 and RGC3..65

# Structure

RGC3P..AA..

RGC3P..I..  
RGC3P..V..

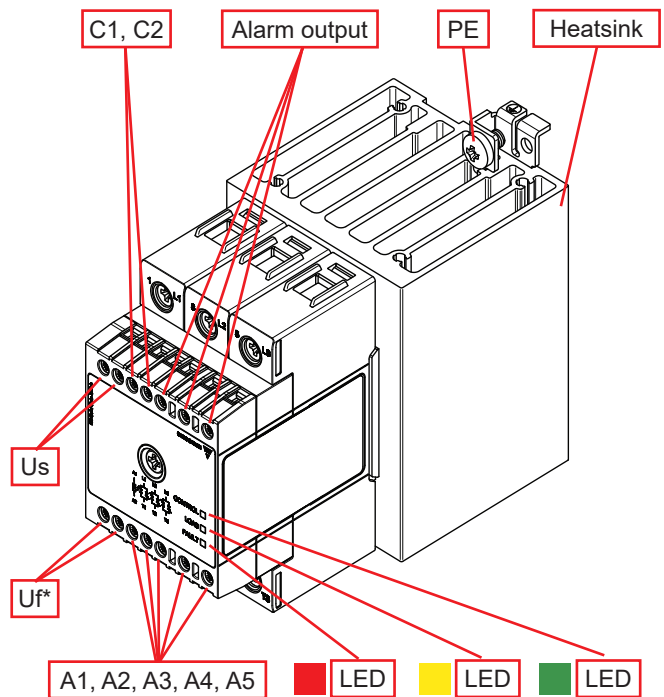
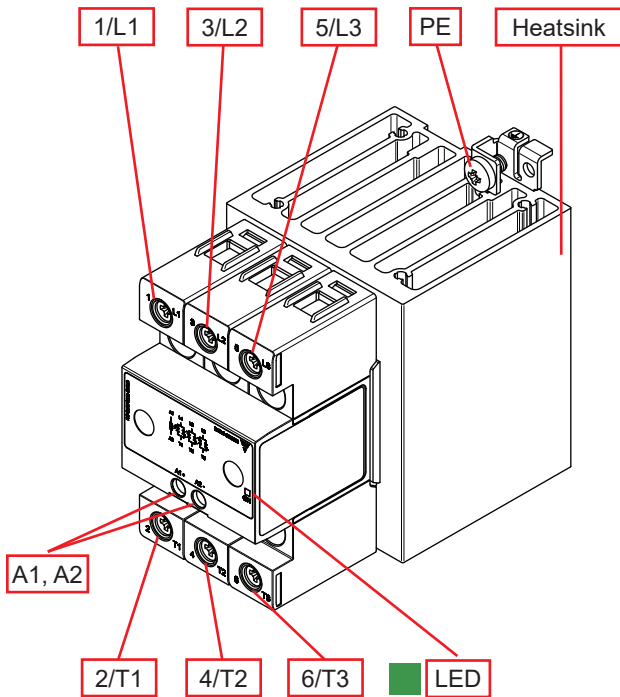

Element	Component	Function
1/L1, 3/L2, 5/L3	Power connections	Mains connection
2/T1, 4/T2, 6/T3	Power connections	Load connection
A1, A2	Control input	4-20 mA (RGC..AA..), 4-20 mA (RGC..I..), 1-5 V (RGC..V..)
A1, A3	Control input	12-20 mA (RGC..I..), 0-5 V (RGC..V..)
A1, A4	Control input	0-20 mA (RGC..I..), 0-10 V (RGC..V..)
A5	Potentiometer input	External Potentiometer input (RGC..V..)
Us	Supply connection	Terminals for supply voltage
C1, C2	Configuration	External short link ONLY for 4-wire, 3-phase systems
Uf*	Fan connection	Terminals for fan supply voltage. Connection terminated by manufacturer
Alarm output	Electro mechanical relay	Alarm output; normally open, normally closed
Green LED	CONTROL indicator	Indicates presence of control voltage and supply voltage
Yellow LED	LOAD indicator	Indicates the load status
Red LED	ALARM indicator	Indicates presence of an alarm condition
Heatsink	Integrated heatsink	DIN rail mounting
PE	Protective Earth	Connection for Protective Earth

\* only for RGC2..75, RGC3..65 versions that have an integrated fan

## Features

### General data

<b>Material</b>	PA6 or PA66 (UL94 V0), RAL7035 conforms to the glow wire requirements of IEC/EN 60335-1	
<b>Mounting</b>	DIN rail	
<b>Touch protection</b>	IP20	
<b>Overvoltage category</b>	III, 6 kV (1.2/50 $\mu$ s) rated impulse withstand voltage	
<b>Isolation</b>	Input and Output to Case: Input to Output: External supply to input: Us to A1, A2, A3, A4, A5, Uf, C1, C2, 11, 12, 14 External supply & input to EMR: Us, A1, A2, A3, A4, A5, Uf, C1, C2 to 11, 12, 14	4000 Vrms 2500 Vrms 1500 Vrms (n/a for RGC..AA..) 1500 Vrms (n/a for RGC..AA..)
<b>Weight</b>	RGC2..25 (M): RGC3..20 (M or P): RGC2..40, RGC3..30 (M or P): RGC2..75, RGC3..65:	approx. 600 g (660 g) approx. 600 g (670 g) approx. 840 g (920 g) approx. 990 g

## Performance

### RGC2.. Output

	RGC2..25	RGC2..40	RGC2..75
<b>Operational voltage range, Ue</b> Line to line voltage, L1/L2/L3	180-660 VAC		
<b>Permissible voltage unbalance</b>	10% between L1/L2/L3		
<b>Blocking voltage</b>	1200 Vp		
<b>Max. operational current per pole<sup>1</sup>: AC-51 @ Ta=25°C</b>	32 AAC	50 AAC	85 AAC
<b>Max. operational current per pole<sup>1</sup>: AC-51 @ Ta=40°C</b>	27 AAC	40 AAC	75 AAC
<b>Max. operational current per pole<sup>2</sup>: AC-55b @ Ta=40°C</b>	27 AAC	40 AAC	75 AAC
<b>Output power</b>	0 to 100%		
<b>Operational frequency range</b>	45 to 65 Hz		
<b>Output protection</b>	Integrated varistor across each pole		
<b>Leakage current @ rated voltage</b>	5 mAAC per pole		
<b>Minimum operational current</b>	500 mAAC	1 AAC	1 AAC
<b>Repetitive overload current, PF= 0.7, UL508: Ta=40°C, t<sub>ON</sub>=1 s, t<sub>OFF</sub>=9 s, 50 cycles</b>	61 AAC	107 AAC	154 AAC
<b>Non-repetitive surge current (I<sub>TSM</sub>), t=10 ms</b>	600 Ap	1150 Ap	1750 Ap
<b>I<sup>2</sup>t for fusing (t=10 ms), minimum</b>	1800 A <sup>2</sup> s	6600 A <sup>2</sup> s	15000 A <sup>2</sup> s
<b>No. of starts per hour<sup>2</sup></b>	35	10	240
<b>Power factor</b>	> 0.7 @ rated voltage		
<b>Critical dV/dt (@Tj init = 40°C)</b>	1000 V/ $\mu$ s		

1. Refer to Current derating curves

2. Overload profile for AC-55b, Ie: AC-55b: 6x Ie - 0.2: 80 - x, where Ie = nominal current (AAC), 6x Ie = overload current (AAC), 0.2 = duration of overload current (s), 80 = ON duty cycle (%), x= number of starts. The overload profile for RGC2..75 is AC-55b: 3.2x Ie - 0.2: 80 - x



## RGC3.. Output

	RGC3..20	RGC3..30	RGC3..65
Operational voltage range, Ue Line to line voltage, L1/L2/L3	180-660 VAC		
Permissible voltage unbalance	10% between L1/L2/L3		
Blocking voltage	1200 Vp		
Max. operational current per pole <sup>1</sup> : AC-51 @ Ta=25°C	25 AAC	37 AAC	71 AAC
Max. operational current per pole <sup>1</sup> : AC-51 @ Ta=40°C	20 AAC	30 AAC	66 AAC
Max. operational current per pole <sup>2</sup> : AC-55b @ Ta=40°C	20 AAC	30 AAC	66 AAC
Output power	0 to 100%		
Operational frequency range	45 to 65 Hz		
Output protection	Integrated varistor across each pole		
Leakage current @ rated voltage	5 mAAC per pole		
Minimum operational current	500 mACC	1 AAC	1 AAC
Repetitive overload current, PF= 0.7, UL508: Ta=40°C, t <sub>ON</sub> =1 s, t <sub>OFF</sub> =9 s, 50 cycles	61 AAC	107 AAC	154 AAC
Non-repetitive surge current (I <sub>TSM</sub> ), t=10 ms	600 Ap	1150 Ap	1750 Ap
I <sup>2</sup> t for fusing (t=10 ms), minimum	1800 A <sup>2</sup> s	6600 A <sup>2</sup> s	15000 A <sup>2</sup> s
No. of starts per hour <sup>2</sup>	140	18	230
Power factor	> 0.7 @ rated voltage		
Critical dV/dt (@Tj init = 40°C)	1000 V/μs		

1. Refer to Current derating curves

2. Overload profile for AC-55b, I<sub>e</sub>: AC-55b: 6x I<sub>e</sub> - 0.2: 80 - x, where I<sub>e</sub> = nominal current (AAC), 6x I<sub>e</sub> = overload current (AAC), 0.2 = duration of overload current (s), 80 = ON duty cycle (%), x= number of starts. The overload profile for RGC3..65 is AC-55b: 3.6x I<sub>e</sub> - 0.2: 80 - x

## Inputs

	RGC..AA..	RGC..I..	RGC..V..
Control input	4 - 20 mADC	0 - 20 mADC 4 - 20 mADC 12 - 20 mADC	0 - 5 VDC 1 - 5 VDC 0 - 10 VDC 5 - 10 VDC (digital)
Drop out voltage RGC3P..S	n/a		< 4 VDC
External potentiometer input	n/a		10 kΩ (terminal A1, A3, A5)
Maximum initialisation time	250 ms		
Response time (Input to Output) RGC..E, S RGC..C1, C4, C16, S16	2 half cycles 3 half cycles		
Input impedance	n/a	< 250 Ω	100 kΩ
Linearity, Output resolution	Refer to Transfer Characteristics section		
Voltage drop	< 10 VDC @ 20 mA	n/a	
Reverse protection	Yes		
Maximum allowable input current	50 mA for max. 30 s		n/a
Input protection vs. surges	Yes		
Overvoltage protection	n/a		Up to 24 VDC

Note: Control input serial connection of multiple units is ONLY possible for RGC..AA versions and versions that require an AC external supply and hence the RGC..I..AM, RGC..I..AFM, RGC..I..AP and RGC..I..AFP models

## Transfer characteristics

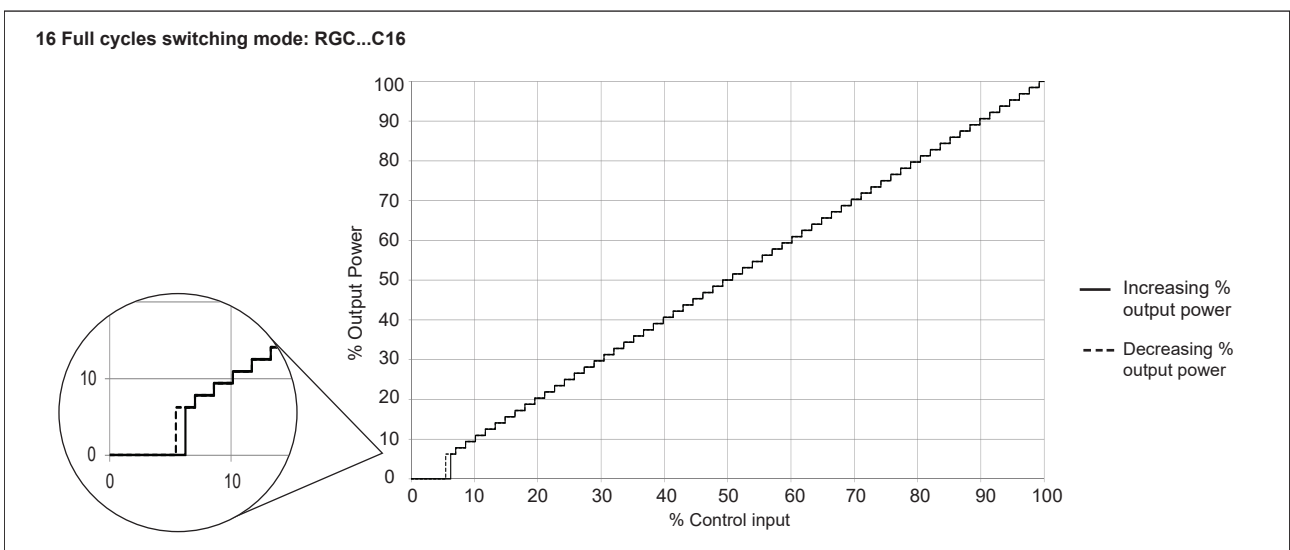
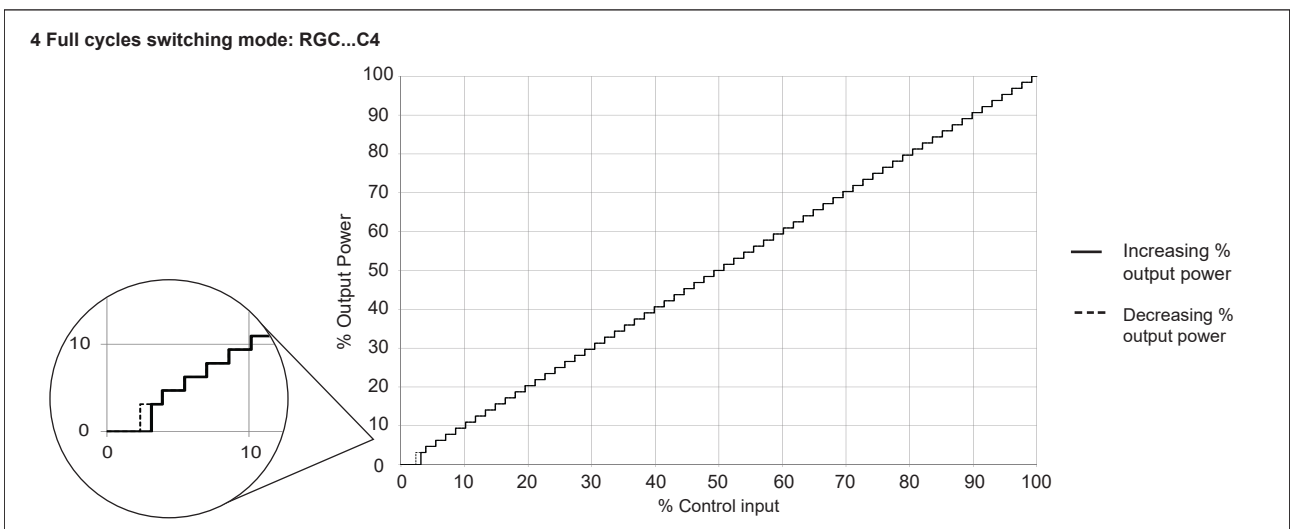
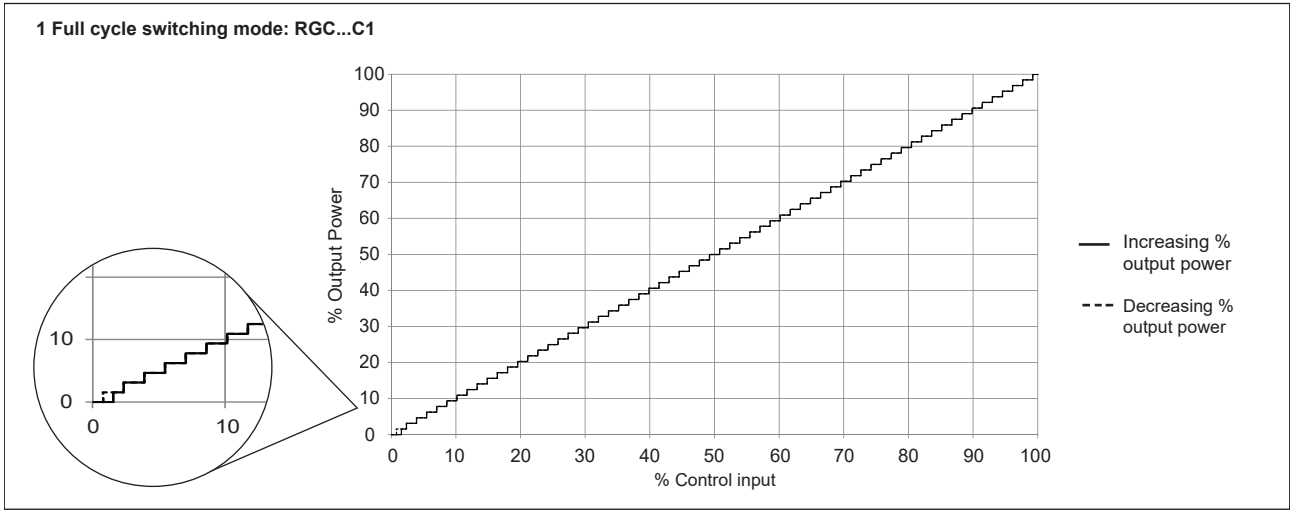

Transfer characteristics (continued)

Phase angle switching mode: RGC3P..E

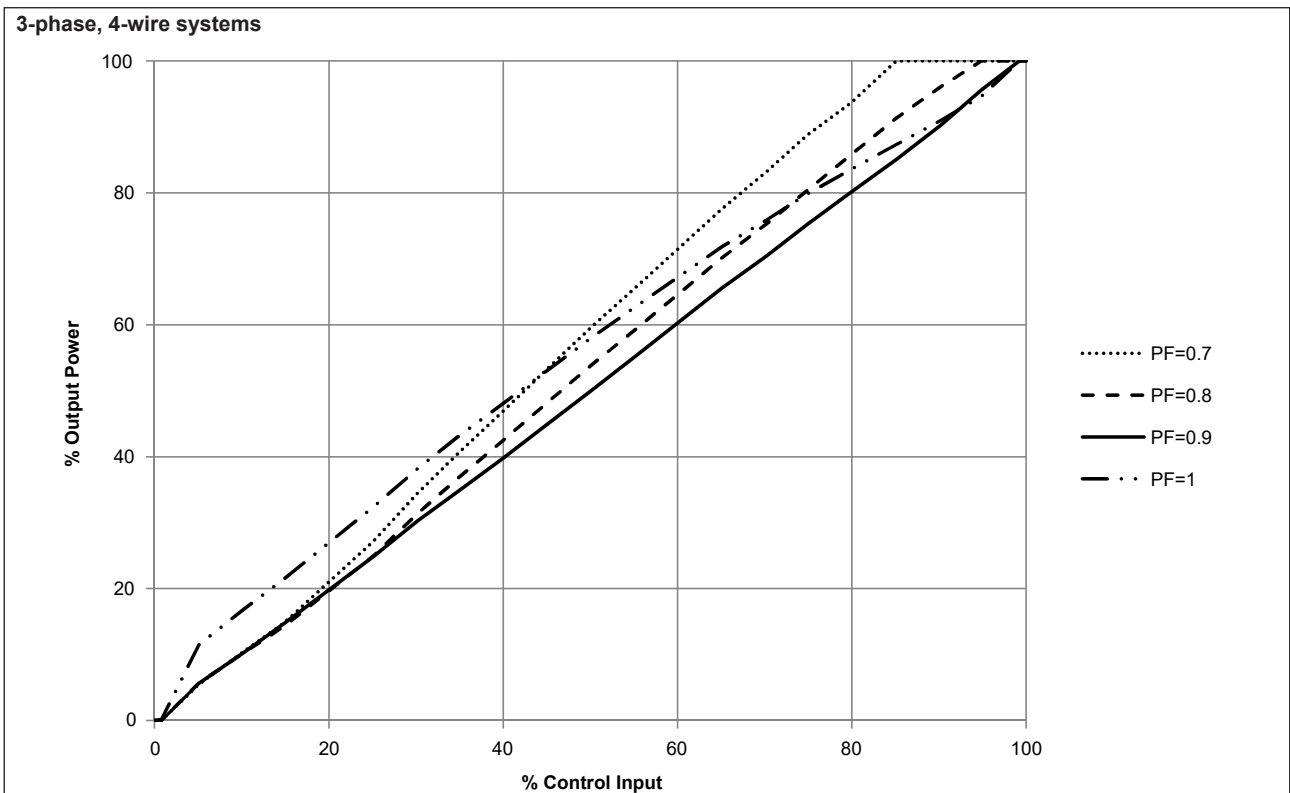
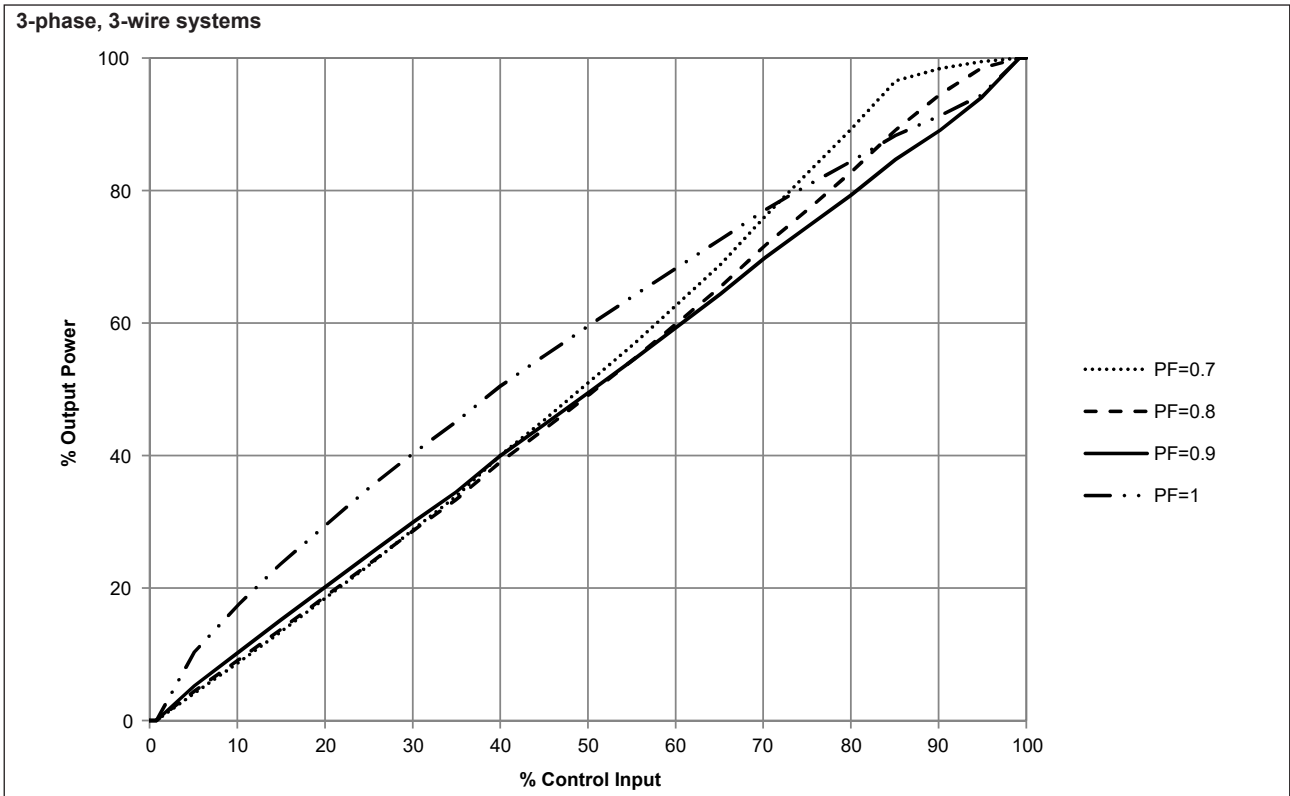

## Power supply specifications

	RGC..D..	RGC..A..
Supply voltage range, Us	24 VDC, -15% / +20% 24 VAC, -15% / +15%	90-250 VAC
Overvoltage protection	Up to 32 VDC/AC for 30 seconds	n/a
Reverse polarity protection	Yes	n/a
Max. supply current no fan, RGC..P, RGC..M with fan, RGC..FP, RGC..FM	90 mA 175 mA	30 mA 60 mA
Surge protection	Yes, integrated	Yes

## Alarm output specifications (12, 14, 11)

	RGC..P, RGC..M
Function	Operates in case of an alarm condition on the RGC..P or the RGC..M
Output type	EMR, 1 Form C Normally closed (12-11) Normally open (14-11)
Contact rating	2 A @ 250 VAC / 30 VDC
Isolation between open contacts	1000 VAC

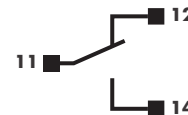

## Output power dissipation

### RGC2

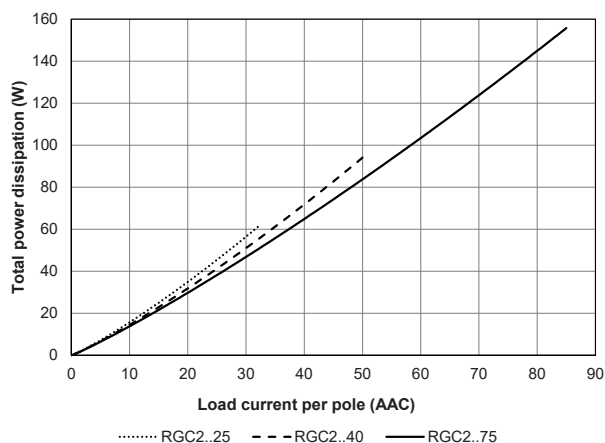

### RGC3

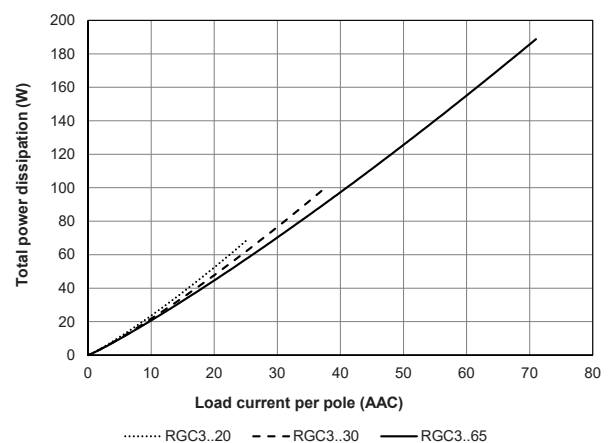

**Current derating**

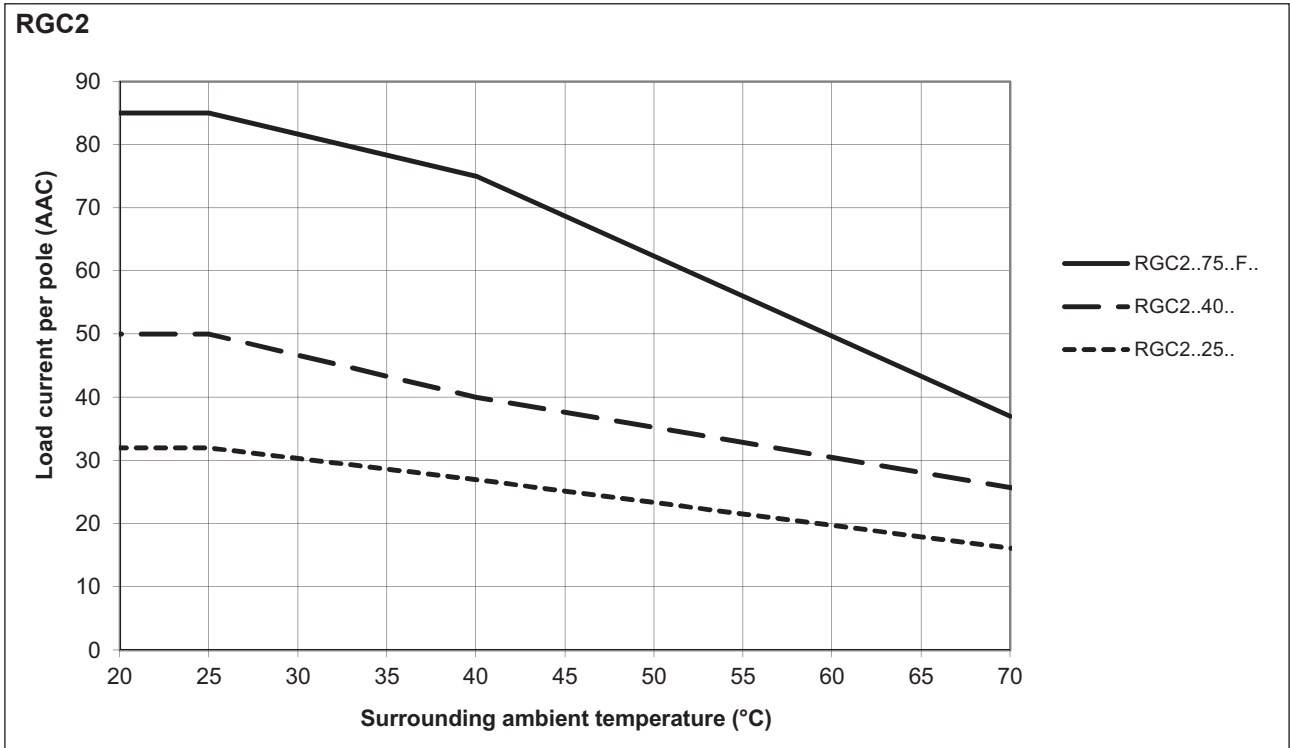

Note: Versions that utilise 24 VAC external supply (Us) are limited to a maximum operating temperature of 60°C (140°F)

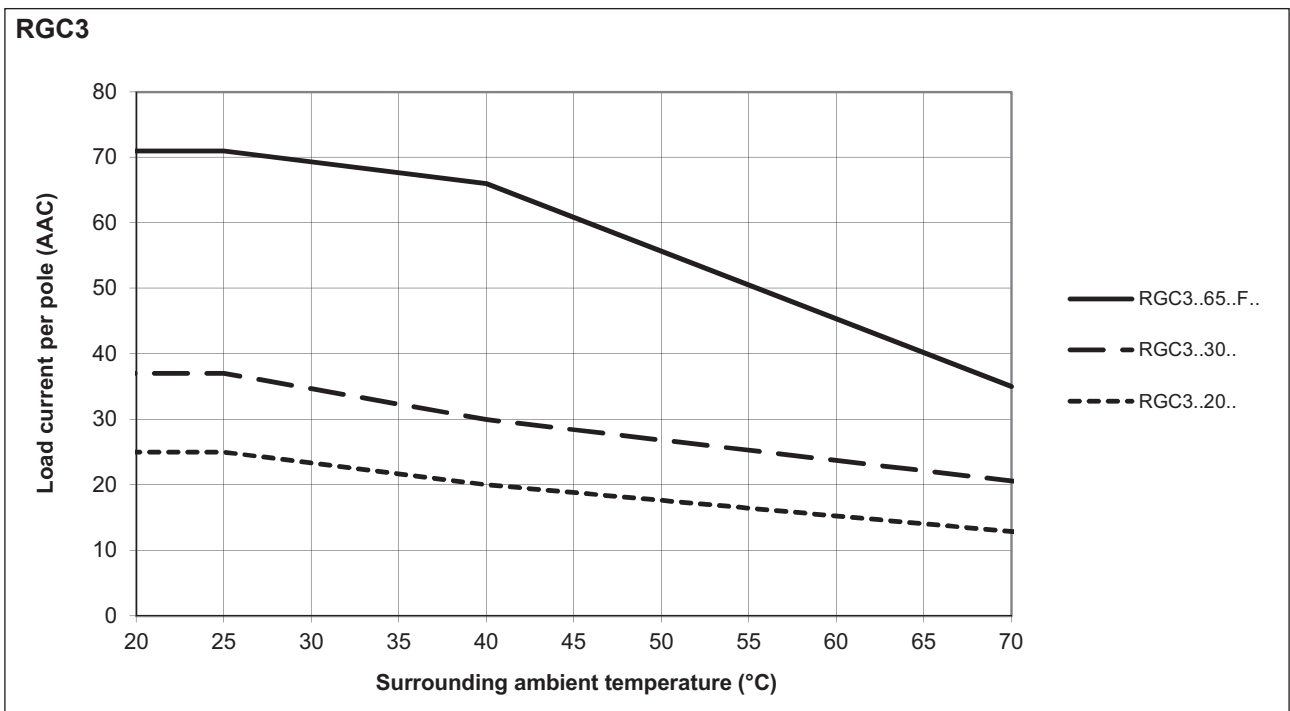

Note: Versions that utilise 24 VAC external supply (Us) are limited to a maximum operating temperature of 60°C (140°F)

▶ Current derating with 0 mm spacing

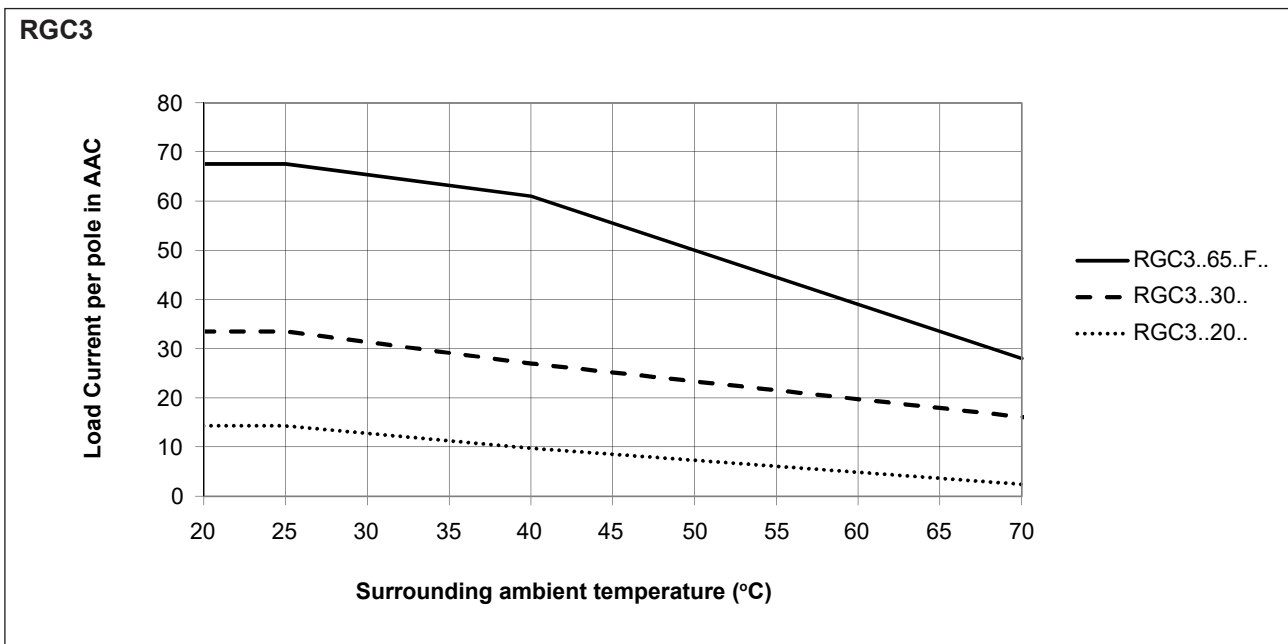
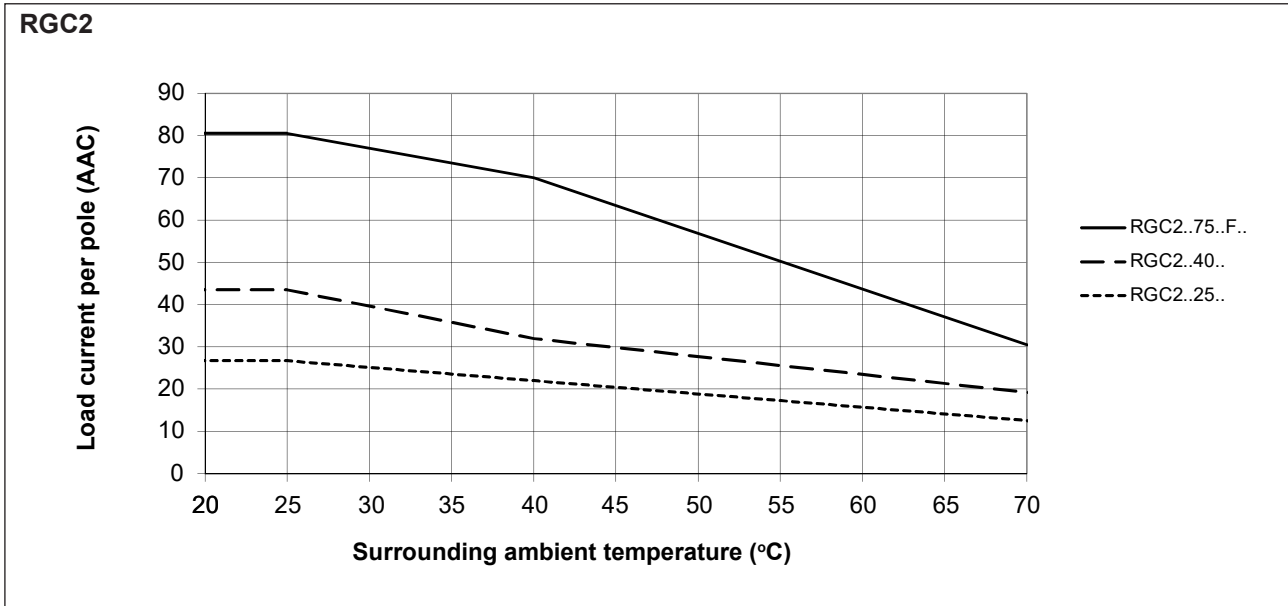



**Compatibility and conformance**

<b>Approvals</b>	
<b>Standards compliance</b>	LVD: EN 60947-4-3 EMCD: EN 60947-4-3 EE: EN 60947-4-3 EMC: EN 60947-4-3 UL: UL508 (E172877), NMFT cUL: C22.2 No. 14 (E172877), NMFT7 CCC: GB/T 14048.5-2017 (IEC 60947-5-1)
<b>UL short circuit current rating</b>	100 kArms (refer to short circuit current section, Type 1 – UL508)

<b>Electromagnetic compatibility (EMC) - Immunity</b>	
<b>Electrostatic discharge (ESD)</b>	EN/IEC 61000-4-2 8 kV air discharge, 4 kV contact (PC2)
<b>Radiated radio frequency</b>	EN/IEC 61000-4-3 10 V/m, from 80 MHz to 1 GHz (PC1) 10 V/m, from 1.4 to 2 GHz (PC1) 3 V/m, from 2 to 2.7 GHz (PC1)
<b>Electrical fast transient (burst)</b>	EN/IEC 61000-4-4 Output: 2 kV, 5 kHz (PC1) Input (A1, A2, A3, A4, A5): 1 kV, 5 kHz (PC1) Signal (Us, 11, 12, 14): 1 kV, 5 kHz (PC1)
<b>Conducted radio frequency</b>	EN/IEC 61000-4-6 10 V/m, from 0.15 to 80 MHz (PC1)
<b>Electrical surge</b>	EN/IEC 61000-4-5 Output, line to line: 1 kV (PC2) Output, line to earth: 2 kV (PC2) A1, A2, line to line: 500 V (PC1) A1, A2, line to earth: 500 V (PC1) Us+, Us-, line to line: 500 V (PC2) Us+, Us-, line to earth: 500 V (PC2) A1, A2, A3, A4, A5, line to earth: 1 kV (PC2) Us~, 11, 12, 14, line to line: 1 kV (PC2) Us~, 11, 12, 14, line to earth: 2 kV (PC2)
<b>Voltage dips</b>	EN/IEC 61000-4-11 0% for 0.5, 1 cycle (PC2) 40% for 10 cycles (PC2) 70% for 25 cycles (PC2) 80% for 250 cycles (PC2)
<b>Voltage interruptions</b>	EN/IEC 61000-4-11 0% for 5000 ms (PC2)

<b>Electromagnetic compatibility (EMC) - Emissions</b>	
<b>Radio interference field emission (radiated)</b>	EN/IEC 55011 Class A: from 30 to 1000 MHz
<b>Radio interference voltage emissions (conducted)</b>	EN/IEC 55011 Class A: from 0.15 to 30 MHz (with external filtering)

## Filter connection diagrams

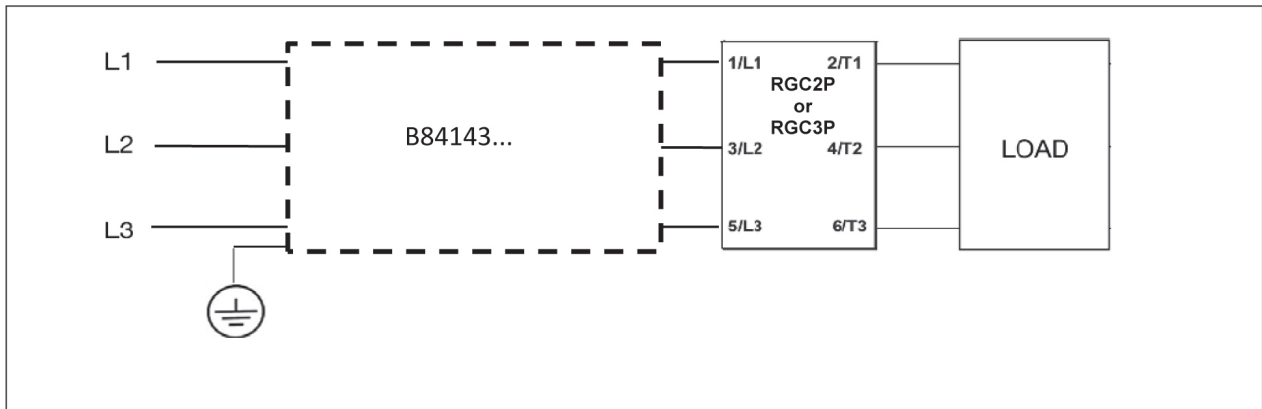
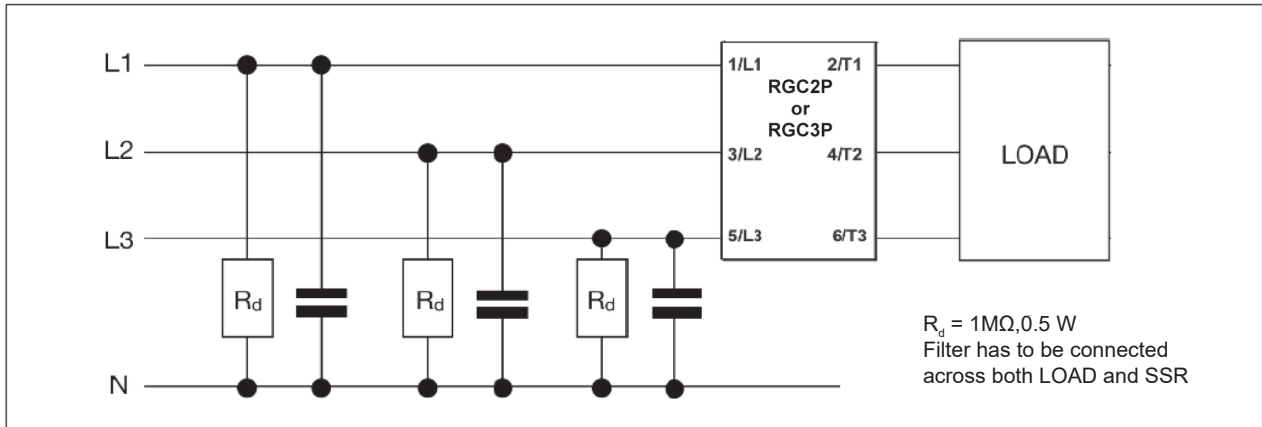

## Filtering

Part number	Suggested filter for EN 55011 Class A compliance	Maximum heater current
RGC2P..C1..	2.2 uF, max. 760 VAC / X1	25 AAC
		40 AAC
RGC2P..C4..	1.0 uF, max. 760 VAC / X1	25 AAC
		40 AAC
RGC3P..E..	Epcos, B84143A0025R105 / 530 VAC Epcos, B84143D0050R127 / 530 VAC	20 AAC
		30 AAC
RGC3P..C1..	2.2 uF, max. 760 VAC / X1	20 AAC
		30 AAC
RGC3P..C4..	1.0 uF, max. 760 VAC / X1	20 AAC
		30 AAC
RGC3P..C16..	1.0 uF, max. 760 VAC / X1	20 AAC
		30 AAC
RGC3P..S..	1.0 uF, max. 760 VAC / X1	20 AAC
		30 AAC



**Filtering (continued)**

Part number	Suggested filter for EN 55011 Class B compliance	Maximum heater current
RGC2P..C1..	Epcos, B84143A0025R105 / 530 VAC	25 AAC
	Epcos, B84143A0050R105 / 530 VAC	40 AAC
RGC2P..C4..	Epcos, B84143A0025R105 / 530 VAC	25 AAC
	Epcos, B84143A0050R105 / 530 VAC	40 AAC
RGC3P..E..	Epcos, B84143A0025R105 / 530 VAC	13 AAC
RGC3P..C1..	Epcos, B84143A0025R105 / 530 VAC	20 AAC
	Epcos, B84143A0050R105 / 530 VAC	30 AAC
RGC3P..C4..	Epcos, B84143A0025R105 / 530 VAC	20 AAC
	Epcos, B84143A0050R105 / 530 VAC	30 AAC
RGC3P..C16..	Epcos, B84143A0025R105 / 530 VAC	20 AAC
	Epcos, B84143A0050R105 / 530 VAC	30 AAC
RGC3P..S..	Epcos, B84143A0025R105 / 530 VAC	20 AAC
	Epcos, B84143A0050R105 / 530 VAC	30 AAC

The suggested filtering is determined by tests carried out on a representative setup and load. The RGC2P.., RGC3P.. is intended to be integrated within a system where conditions may differentiate from conditions utilised for tests, such as load, cable lengths and other auxiliary components that may exist within the end system. It shall be the responsibility of the system integrator to ensure that the system containing the above component complies with the applicable rules and regulations.

Epcos installation recommendations shall be taken in consideration when utilising such filters.

**Note:**

- Control input lines must be installed together to maintain products' susceptibility to Radio Frequency interference.
- Use of AC solid state relays may, according to the application and the load current, cause conducted radio interferences. Use of mains filters may be necessary for cases where the user must meet E.M.C requirements. The capacitor values given inside the filtering specification tables should be taken only as indications, the filter attenuation will depend on the final application.
- This product has been designed for Class A equipment. Use of this product in domestic environments may cause radio interference, in which case the user may be required to employ additional mitigation methods.
- Surge tests on RGC..A models were carried out with the signal line impedance network. In case the line impedance is less than 40Ω, it is suggested that AC supply is provided through a secondary circuit where the short circuit limit between conductors or between conductors and ground is 1500VA or less.
- A deviation of one step in the distributed full cycle models and up to 1.5% Full Scale Deviation in phase angle models is considered to be within PC1 criteria.
- Performance Criteria 1 (PC1): No degradation of performance or loss of function is allowed when the product is operated as intended.
- Performance Criteria 2 (PC2): During the test, degradation of performance or partial loss of function is allowed. However when the test is complete the product should return operating as intended by itself.
- Performance Criteria 3 (PC3): Temporary loss of function is allowed, provided the function can be restored by manual operation of the controls.

## Environmental specifications

<b>Operating temperature</b>	-40°C to +70°C (-40°F to +158°F) -40°C to +60°C (-40°F to +140°F) if Us = 24 VAC
<b>Storage temperature</b>	-40 to +100°C (-40 to +212°F)
<b>Relative humidity</b>	95% non-condensing @ 40°C
<b>Pollution degree</b>	2
<b>Installation altitude</b>	0-1000 m. Above 1000 m derate linearly by 1% of FLC per 100 m up to a maximum of 2000 m
<b>Vibration resistance</b>	2g / axis (2-100Hz, IEC60068-2-6, EN50155, EN61373)
<b>Impact resistance</b>	15/11 g/ms (EN50155, EN61373)
<b>EU RoHS compliant</b>	Yes
<b>China RoHS</b>	

The declaration in this section is prepared in compliance with People's Republic of China Electronic Industry Standard SJ/T11364-2014: Marking for the Restricted Use of Hazardous Substances in Electronic and Electrical Products.

Part Name	Toxic or Harardous Substances and Elements					
	Lead (Pb)	Mercury (Hg)	Cadmium (Cd)	Hexavalent Chromium (Cr(VI))	Polybrominated biphenyls (PBB)	Polybrominated diphenyl ethers (PBDE)
<b>Power Unit Assembly</b>	x	o	o	o	o	o

O: Indicates that said hazardous substance contained in homogeneous materials for this part are below the limit requirement of GB/T 26572.

X: Indicates that said hazardous substance contained in one of the homogeneous materials used for this part is above the limit requirement of GB/T 26572.

这份申明根据中华人民共和国电子工业标准 SJ/T11364-2014：标注在电子电气产品中限定使用的有害物质

零件名称	有毒或有害物质与元素					
	铅 (Pb)	汞 (Hg)	镉 (Cd)	六价铬 (Cr(VI))	多溴化联苯 (PBB)	多溴联苯醚 (PBDE)
功率单元	x	o	o	o	o	o

O:此零件所有材料中含有的该有害物低于GB/T 26572的限定。

X: 此零件某种材料中含有的该有害物高于GB/T 26572的限定。



## Short circuit protection

### Protection Co-ordination, Type 1 vs Type 2:

Type 1 protection implies that after a short circuit, the device under test will no longer be in a functioning state. In Type 2 co-ordination the device under test will still be functional after the short circuit. In both cases, however the short circuit has to be interrupted. The fuse between enclosure and supply shall not open. The door or cover of the enclosure shall not be blown open. There shall be no damage to conductors or terminals and the conductors shall not separate from terminals. There shall be no breakage or cracking of insulating bases to the extent that the integrity of the mounting of live parts is impaired. Discharge of parts or any risk of fire shall not occur.

The product variants listed in the table hereunder are suitable for use on a circuit capable of delivering not more than 100,000 Arms Symmetrical Amperes, 600 Volts maximum when protected by fuses. Tests at 100,000 A were performed with Class J fuses, fast acting; please refer to the table below for maximum allowed ampere rating of the fuse. Use fuses only. Tests with Class J fuses are representative of Class CC fuses.

Protection co-ordination Type 1 according to UL 508				
Part number	Prospective short circuit current [kArms]	Max fuse size [A]	Class	Voltage [VAC]
RGC2..25 RGC3..20	100	30	J or CC	Max. 600
RGC2..40 RGC3..30		40	J	
RGC2..75 RGC3..65		60 <sup>3</sup>	J	

3. Consult a Carlo Gavazzi sales representative for use of 70 A class J fuses

Protection co-ordination Type 2						
Part number	Prospective short circuit current [kArms]	Ferraz Shawmut (Mersen)		Siba		Voltage [VAC]
		Max fuse size [A]	Part number	Max fuse size [A]	Part number	
RGC2..25	10	40	660 URC 14x51/40	32	50 142 06 32	600
	100		6.9xx gRC URD 22x58/40			
			660 URD 22x58/40			
RGC2..40	10	63	A70QS40-4	63	50 194 20 63	
	100		6.9xx gRC URC 14x51/63			
			6.9xx gRC URD 22x58/63			
RGC2..75	10	100	A70QS60-4	125	50 196 20 125	
	100		6.9xx gRC URD 22x58/100			
			660 URQ 27x60/100			
RGC3..20	10	32	660 URQ 27x60/100	32	50 142 06 32	
	100		6.9xx gRC URC 14x51/32			
			A70QS40-4			
RGC3..30	10	40	6.9xx gRC URC 14x51/32	40	50 194 20 40	
	100		6.9xx gRC URC 14x51/40			
			A70QS40-4			
RGC3..65	10	100	6.9xx gRC URC 14x51/40	125	50 196 20 125	
	100		660 URD 22x58/90			
			A70QS100-4			

Protection co-ordination Type 2 with Miniature Circuit Breakers (M.C.B.s)				
Solid State Relay type	ABB Model no. for Z - type M. C. B. (rated current)	ABB Model no. for B - type M. C. B. (rated current)	Wire cross sectional area [mm <sup>2</sup> ]	Minimum length of Cu wire conductor [m] <sup>4</sup>
RGC2..25 RGC3..20 (1800 A <sup>2</sup> s)	S203 - Z10 (10 A)	S203 - B4 (4 A)	1.0	7.6
			1.5	11.4
			2.5	19.0
	S203 - Z16 (16 A)	S203 - B6 (6 A)	1.0	5.2
			1.5	7.8
			2.5	13.0
			4.0	20.8
	S203 - Z20 (20 A)	S203 - B10 (10 A)	1.5	12.6
			2.5	21.0
	S203 - Z25 (25 A)	S203 - B13 (13 A)	2.5	25.0
			4.0	40.0
	RGC2..40 RGC3..30 (6600 A <sup>2</sup> s)	S203 - Z20 (20 A)	S203 - B10 (10 A)	1.5
2.5				7.0
4.0				11.2
S203 - Z32 (32 A)		S203 - B16 (16 A)	2.5	13
			4.0	20.8
			6.0	31.2
RGC2..75 RGC3..65 (15000 A <sup>2</sup> s)	S203 - Z25 (25 A)	S203 - B16 (16 A)	2.5	3.1
			4.0	5.0
			6.0	7.5
	S203 - Z50 (50 A)	S203 - B25 (25 A)	4.0	8.0
			6.0	12.0
			10.0	20.0
			16.0	32.0
	S203 - Z63 (63 A)	S203 - B32 (32 A)	6.0	11.3
			10.0	18.8
16.0			30.0	

4. Between MCB and Load (including return path which goes back to the mains)

Note: A prospective current of 6 kA and a 230 / 400 V power supply is assumed for the above suggested specifications. For cables with different cross section than those mentioned above please consult Carlo Gavazzi's Technical Support Group.

**Fan operation for versions with integrated fan**

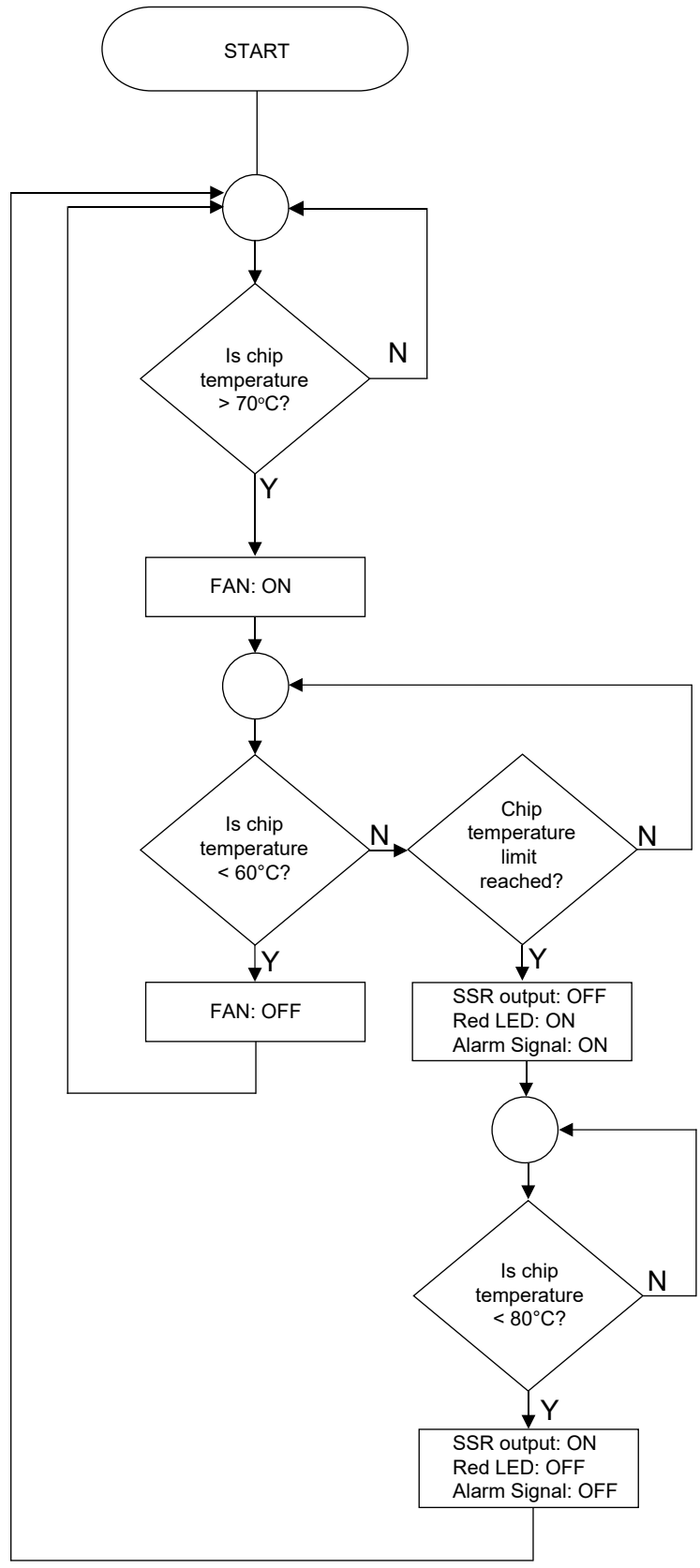

## Switching modes

### PHASE ANGLE switching - Mode E

The Phase angle switching mode works in accordance with the phase angle control principle. The power delivered to the load is controlled by the firing of the thyristors over each half supply cycle. The firing angle varies in relation to the input signal level which determines the output power to be delivered to the load.

Output with Phase angle switching mode @ 50% input level:

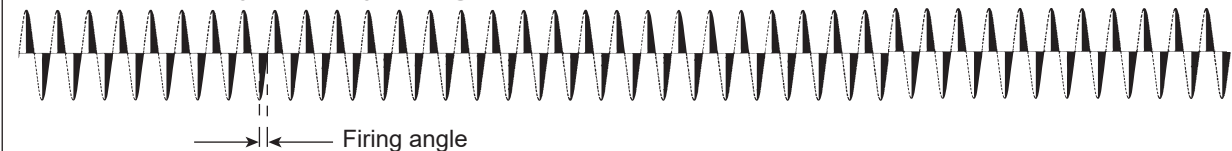

### Full cycle switching:

#### Single full cycle switching - Mode C1

In this switching mode only full cycles are switched. The number of full cycles delivered to the load over a specific time base is determined by the level of the analog input. The full cycles are DISTRIBUTED over this time base so as to ensure a fast and accurate control of the load. In mode C1, the switching resolution is 1 full cycle. Hence, @ an input level of 50% the output switching will be 1 FC ON, 1 FC OFF, @ 25% input 1 FC ON, 3 FC OFF and @ 75% input 1 FC OFF, 3 FC ON as shown in figure below.

Output with 1 FC switching mode @ 25% input level:



Output with 1 FC switching mode @ 50% input level:

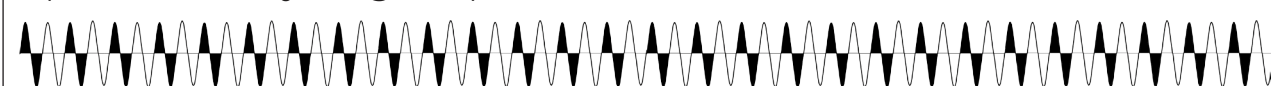

Output with 1 FC switching mode @ 75% input level:

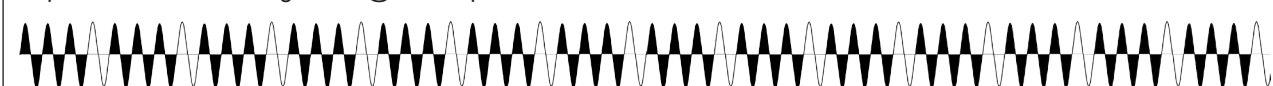

Output with 1 FC switching mode @ 100% input level:



#### Burst full cycle switching - Mode C4 and Mode C16

The modes C4 and C16 work on the same principle of the C1 mode and hence a number of full cycles are switched in accordance to the input level distributed over a specific time base. In the case of mode C4 the lowest resolution is 4 full cycles whilst for mode C16 it is 16 full cycles. These modes are suitable for loads which have a low thermal inertia.

Output with 4 FC switching mode @ 50% input level:



Output with 16 FC switching mode @ 50% input level:



## Switching modes (continued)

### Soft Start switching:

In this mode the thyristor firing angle is gradually increased in order to apply the voltage (and current) to the load smoothly and thus reduce the start-up current of loads which have a high cold to hot resistance ratio such as short wave infrared heaters.

### Soft start with digital input - Mode S

On power up, the RGC3P60V..S.. performs a soft start as soon as a control input is applied. The ramp time can be set to a maximum of 5 seconds through an onboard potentiometer. After the ramp is completed, full cycles are delivered to the output as long as a control voltage (between 5 - 10V) is present on terminals A1-A4. Soft start is not performed every time the control input is applied but only in the cases where firing has been cut off for more than 5 seconds. If for some reason ramping is stopped before ramp completion, a start is assumed to have been performed and hence the 5 seconds count start once ramping is stopped.

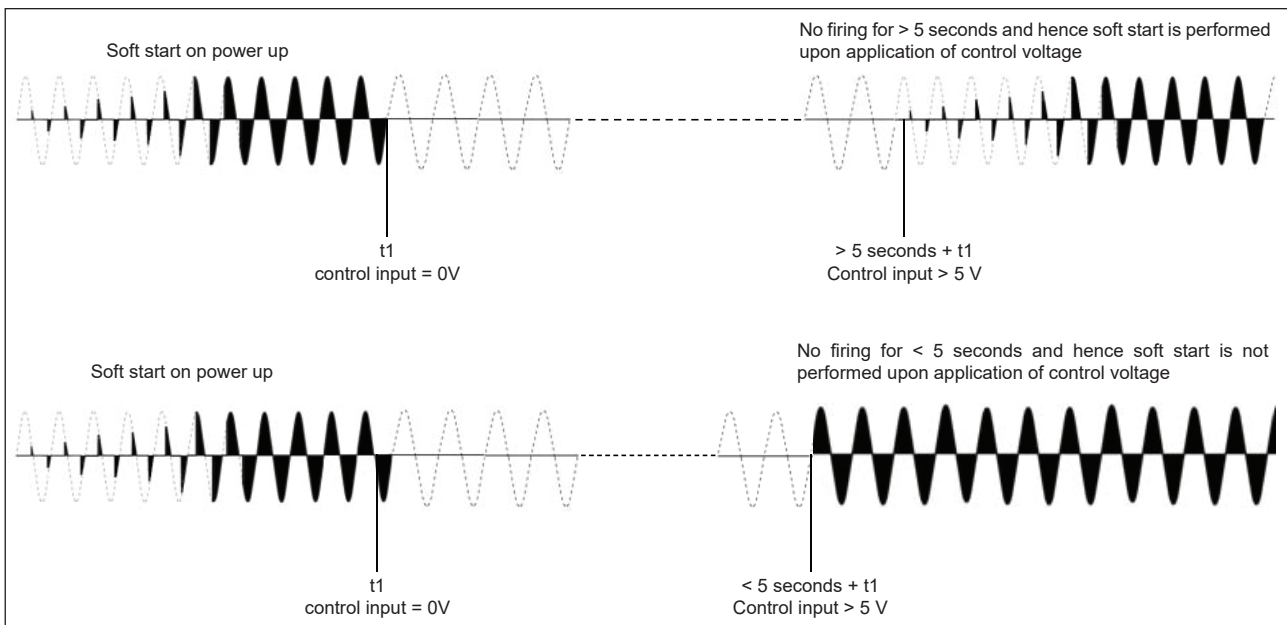

### Soft start with analog input - Mode S16

This switching mode is a combination of 2 switching modes described above and hence soft start with mode S and full cycle control with mode C16. The RGC3P60V..S16 switching mode works on the principle of the mode C16 but on power up soft starting is performed to limit inrush currents loads which have a low resistance when cold. After the soft start is completed, where ramping time can be set to maximum of 5 seconds through an onboard potentiometer, the mode C16 comes into affect. Full cycles are thus delivered to the load in accordance to the input level. Soft starting is performed on power up and in case firing has been cut in the previous 5 seconds. If for some reason ramping is stopped before ramp completion, a start is assumed to have been performed and hence the 5 seconds count start once ramping is stopped.

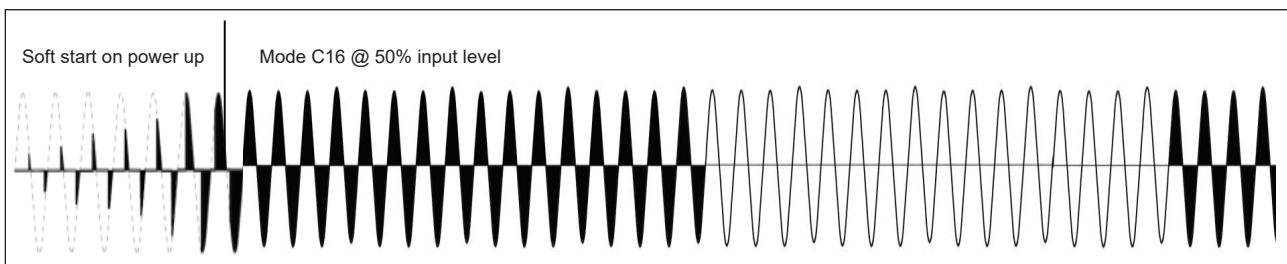

## Mode of operation

### RGC..AA...

The diagram below, Operation diagram 1, indicates the behaviour of models having input type 'AA' in different operating conditions. The models with this type of input are able to detect abnormal conditions such as Mains Loss and SSR Internal Fault. The presence of these abnormal conditions is indicated through the green LED which in normal operating conditions is associated with status of the control input. A flashing sequence of this LED is utilised to distinguish such abnormal conditions. Refer to LED Indications section for further details.

### Operation diagram 1:

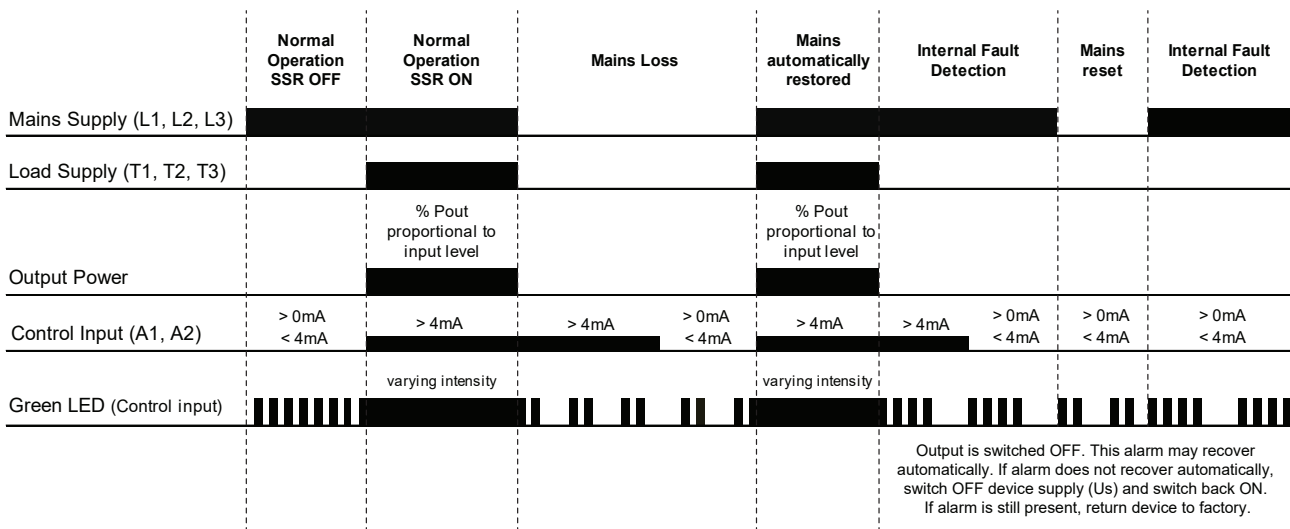

### RGC..I, RGC..V..

The versions with input type 'I' or 'V' have integrated system monitoring for the detection of system and also SSR faults. An external supply of 24VDC/AC or 90-250VAC, selectable through part no. configuration, is required for the operation of these models.

In case of a fault condition, an alarm signal is issued through an EMR. A red LED is also used for visual indication with a specific flash rate for easy identification of the alarm type. Refer to section LED Indications for further details. Additionally, a yellow LED is present on the models with 'I' or 'V' input type which gives an indication of the status of the load. This LED is ON every time the SSR output, and hence the load, is in the ON state.

System monitoring is identified with suffix 'P' or 'M' at the end of the RGC part no. The following is a description of the difference between the two suffixes.

Note: Monitoring for system and SSR faults is not active during the soft start function available with models RGC3P60V..S.. and RGC3P60V..S16.



## Mode of operation (continued)

### 1. RGC..I..P, RGC..V..P

The versions with suffix 'P' are available only with switching mode 'E', i.e., phase angle. The detectable alarm conditions in this series are the following:

- Mains Loss (Operation diagram 2)
- SSR Over Temperature (Operation diagram 3)
- SSR Internal Fault (Operation diagram 3)

The following operation diagrams show the behaviour of the RGC..I..P and RGC..V..P under different operating and abnormal conditions.

#### Operation diagram 2:

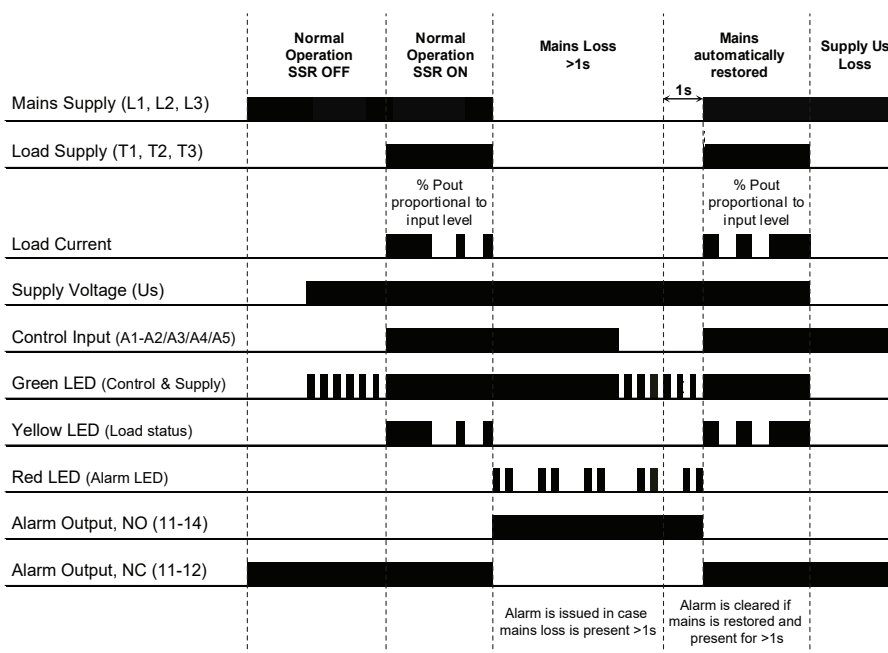

#### Operation diagram 3:

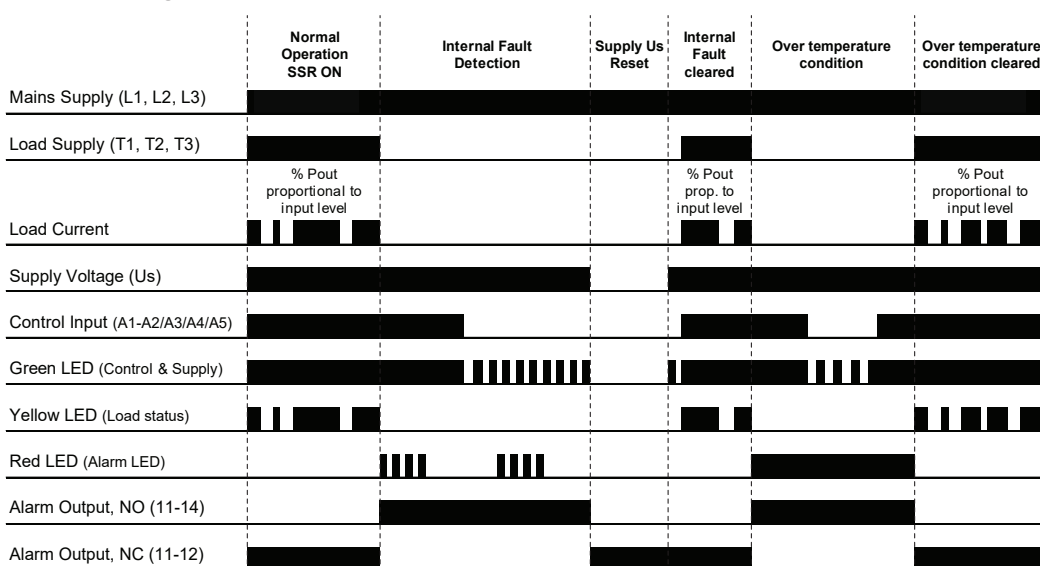

## Mode of operation (continued)

### 2. RGC..I..M, RGC..V..M

Suffix 'M' is available with all switching modes apart from mode 'E'. The detectable alarm conditions for the versions with suffix 'M' are the following:

- Mains Loss (Operation diagram 2)
- SSR Over Temperature (Operation diagram 3)
- SSR Internal Fault (Operation diagram 3)
- Load Loss (Operation diagram 4)
- SSR Open Circuit (Operation diagram 4)
- SSR Short Circuit (Operation diagram 5)

The operation diagrams for Mains Loss, SSR Over Temperature and SSR Internal Fault for the RGC..I..M and RGC..V..M are identical to those of RGC..I..P and RGC..V..P shown in Operation Diagrams 2 and 3. The following diagrams show the behaviour of the RGC..I..M and RGC..V..M under the additional detectable abnormal conditions available only with the 'M' suffix versions.



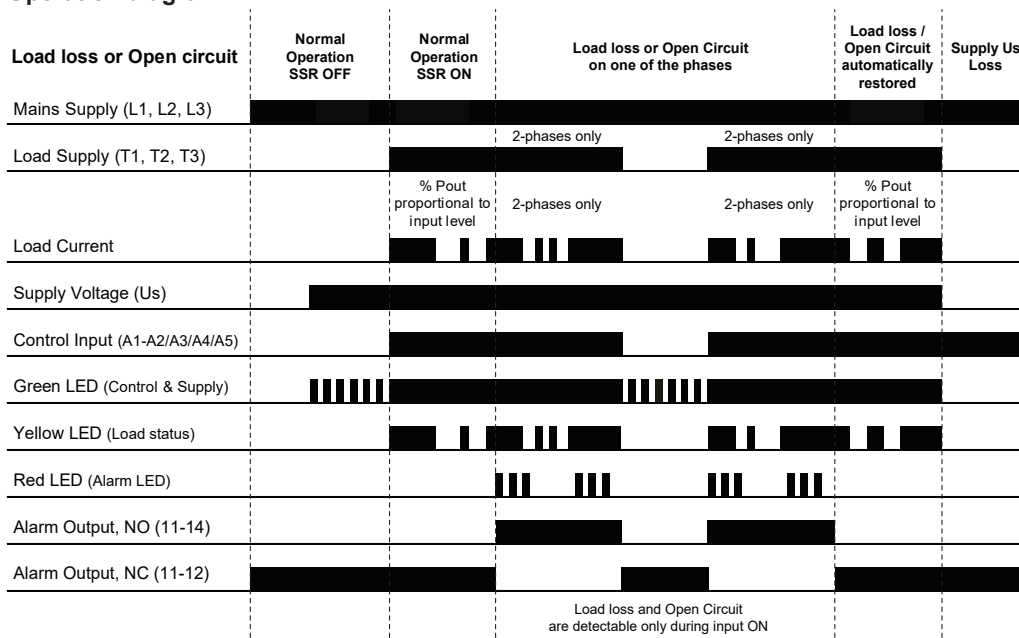

#### Operation diagram 4:

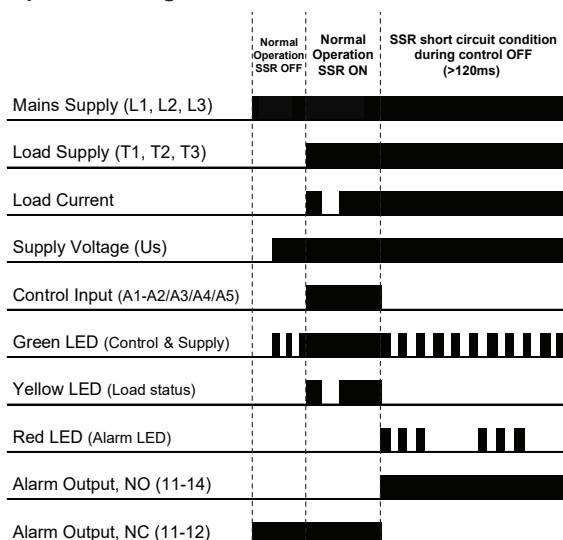



#### Operation diagram 5:



## LED indicators

		RGC..AA..	RGC..I., RGC..V..
<b>CONTROL</b>	Green 	Control >4 mA: varying intensity with control level Control <4 mA: Flashing 0.5 s ON, 0.5 s OFF	Supply ON, Control ON: ON Supply ON, Control OFF: Flashing 0.5 s ON, 0.5 s OFF
<b>LOAD</b>	Yellow 	n/a	Load ON: ON
<b>ALARM</b>	Red 	n/a	Refer to Alarm management section
	Green 	Refer to Alarm Management section (Mains loss and SSR internal fault only)	n/a

## Alarm management

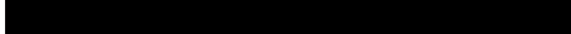
Flashes	Description of Fault	Timing Diagram
2	Mains loss	
3	Load loss, SSR open circuit or SSR short circuit	
4	SSR internal fault	
100%	SSR over temperature	

In case of an internal error, attempt to reset the Mains supply by Switching OFF and back ON to clear the error condition. If this condition is still present, return device to factory.

## Dimensions

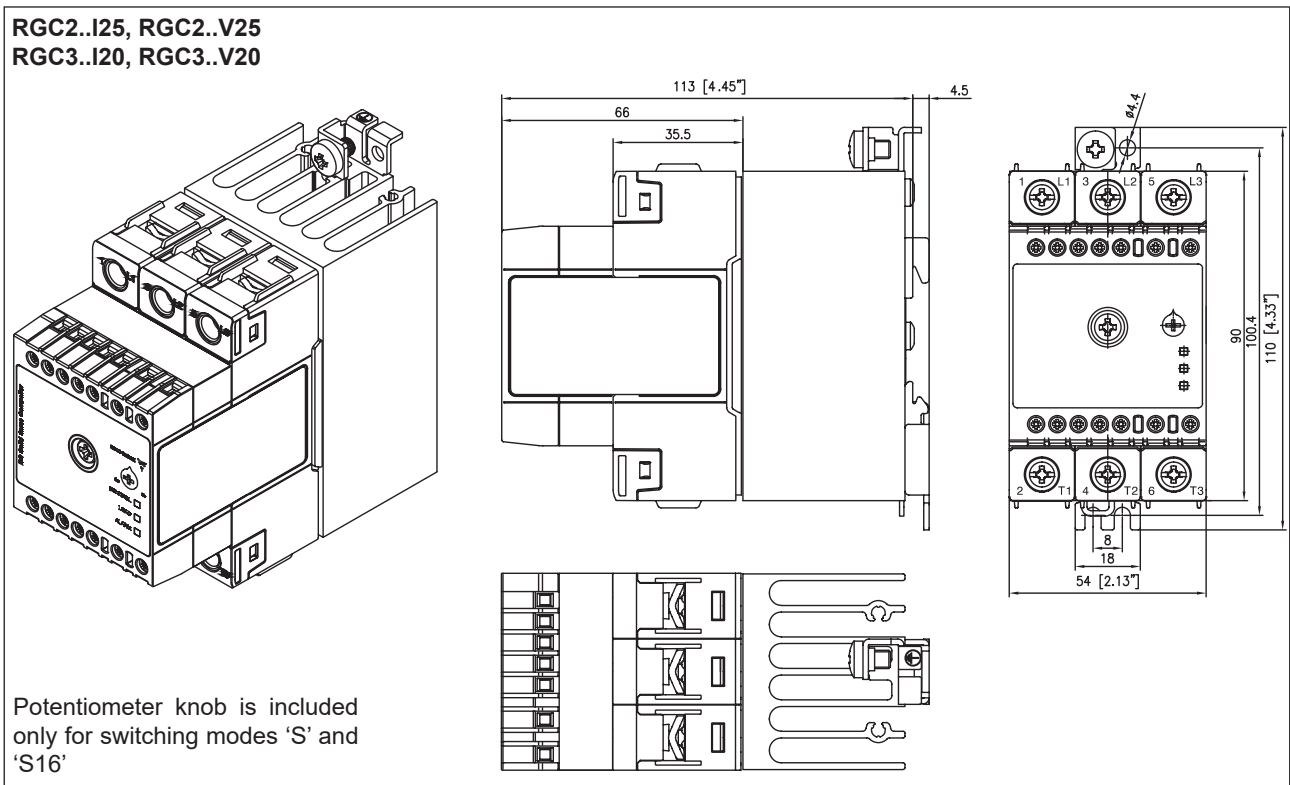
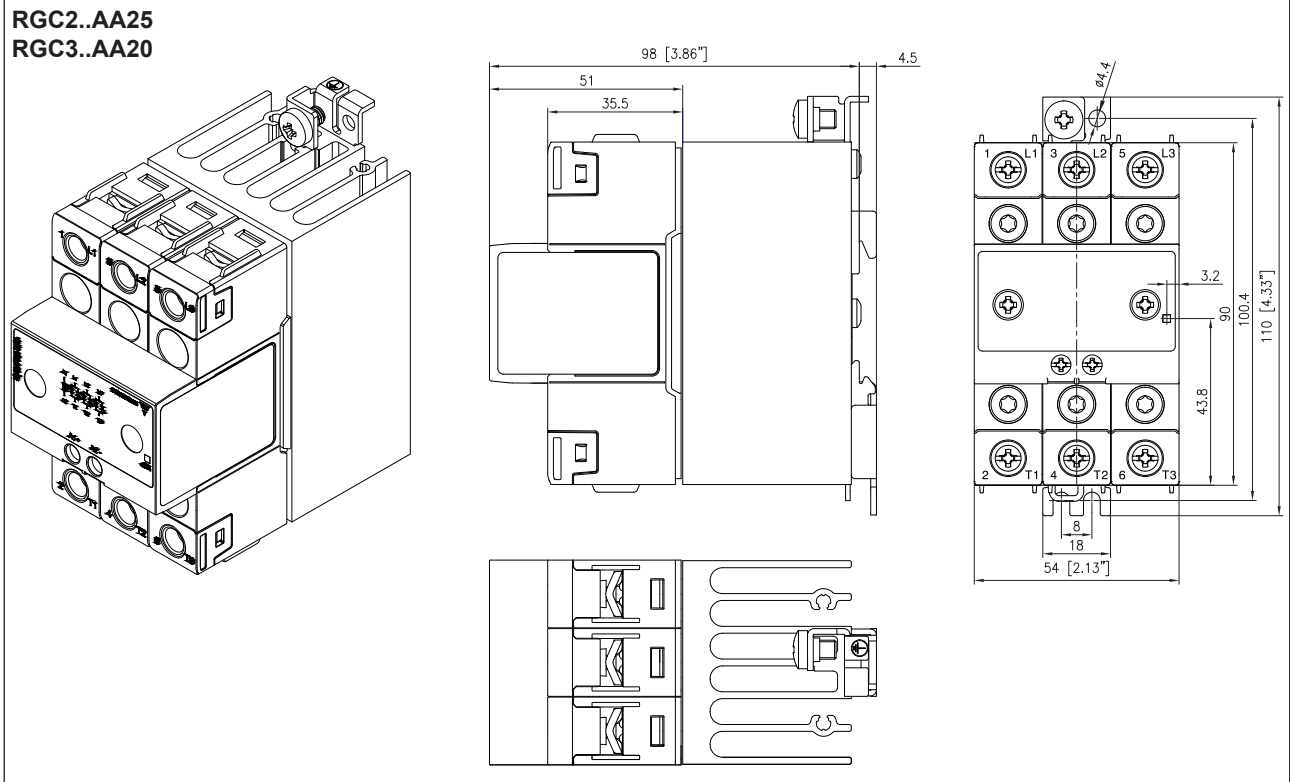

Housing width tolerance +0.5mm, -0mm as per DIN 43880. All other tolerances +/- 0.5mm. Dimensions in mm.

## Dimensions (continued)

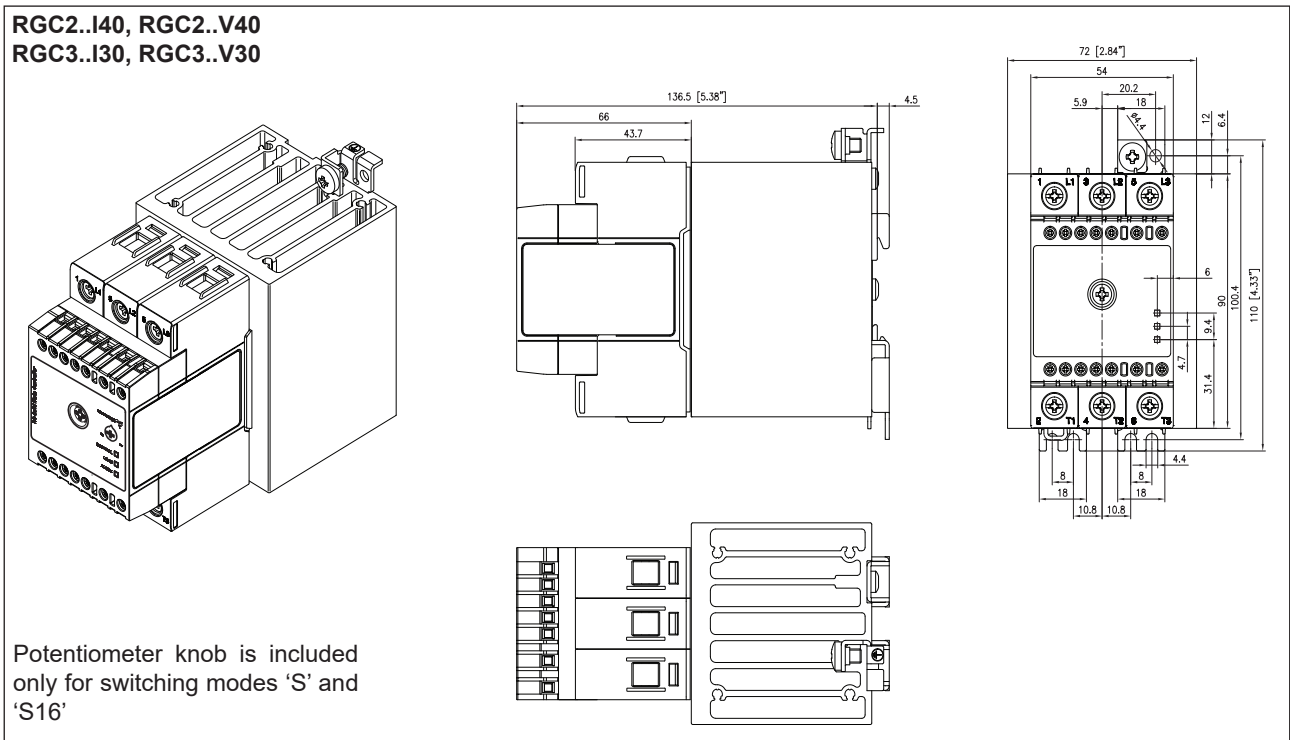
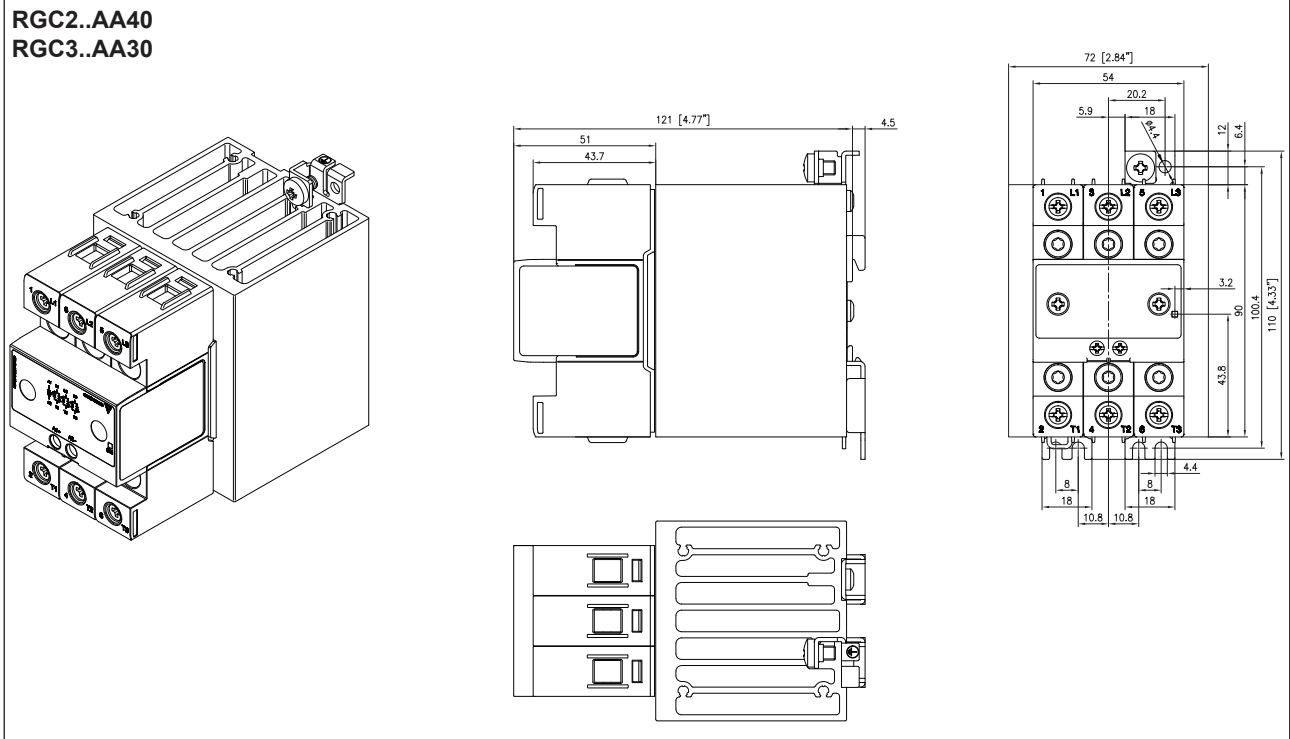

Housing width tolerance +0.5mm, -0mm as per DIN 43880. All other tolerances +/- 0.5mm.  
Dimensions in mm.

## ▶ Dimensions (continued)

RGC2..I75, RGC2..V75  
RGC3..I65, RGC3..V65

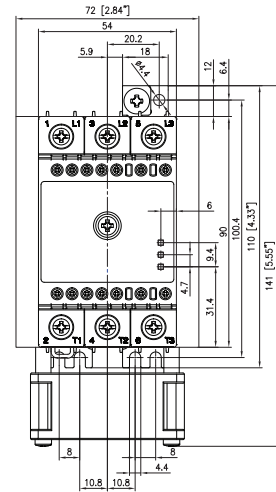
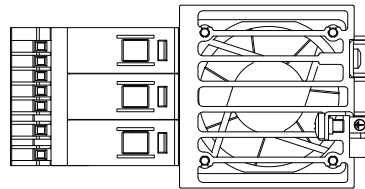
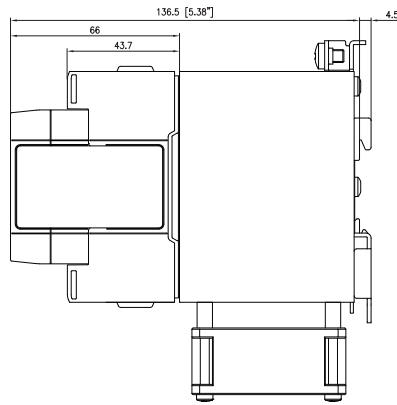
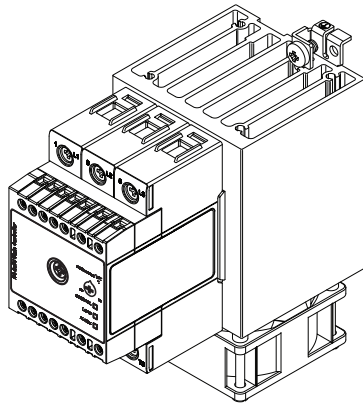

Potentiometer knob is included only for switching modes 'S' and 'S16'

Housing width tolerance +0.5mm, -0mm as per DIN 43880. All other tolerances +/- 0.5mm.  
Dimensions in mm.

## Terminal layout

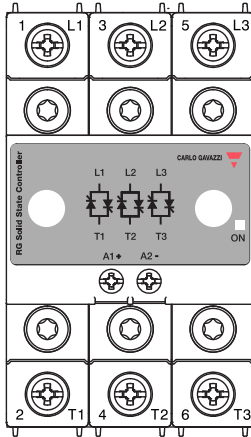

RGC2P..AA25, RGC2P..AA40  
RGC3P..AA20, RGC3P..AA30

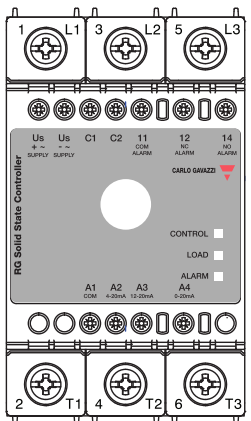

RGC2P..I25, RGC2P..I40  
RGC3P..I20, RGC3P..I30

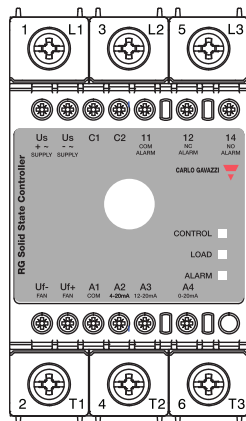

RGC2P..I75  
RGC3P..I65

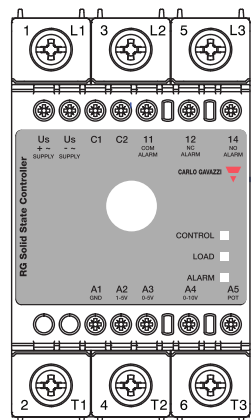

RGC2P..V25, RGC2P..V40  
RGC3P..V20, RGC3P..V30

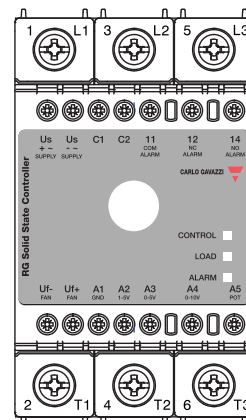

RGC2P..V75  
RGC3P..V65

### Terminals labelling:

- 1/L1, 2/L2, 3/L3: Line connections
- 2/T1, 4/T2, 6/T3: Load connections
- A1, A2: Control input  
4-20 mA (RGC..AA..), 4-20 mA (RGC..I..),  
1-5 V (RGC..V..)
- A1, A3: Control input  
12-20 mA (RGC..I..), 0-5 V (RGC..V..)
- A1, A4: Control input  
0-20 mA (RGC..I..), 0-10 V (RGC..V..)
- A5: External Potentiometer input (RGC..V..)
- Us (+, ~): External supply, positive signal  
(RGC..DM, DFM, DP, DFP),  
AC signal (RGC..AM, AFM, AP, AFP)
- Us (-, ~): External supply, ground  
(RGC..DM, DFM, DP, DFP),  
AC signal (RGC..AM, AFM, AP, AFP)
- C1, C2: Configuration mode selection  
External short link between C1 & C2 is  
required ONLY in case of 4-wire, 3-phase  
systems
- Uf+: Fan supply positive signal
- Uf -: Fan supply ground



Connections to Uf-, Uf+ are readily terminated by manufacturer. No other connection is required by end user.

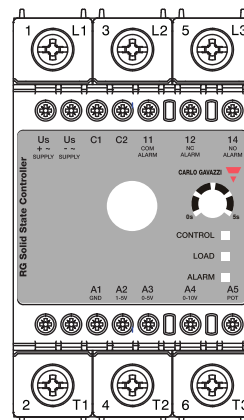

RGC3P..V20S.., RGC3P..V30S..

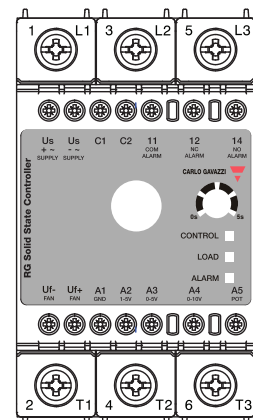

RGC3P..V65S..

# Connection diagrams

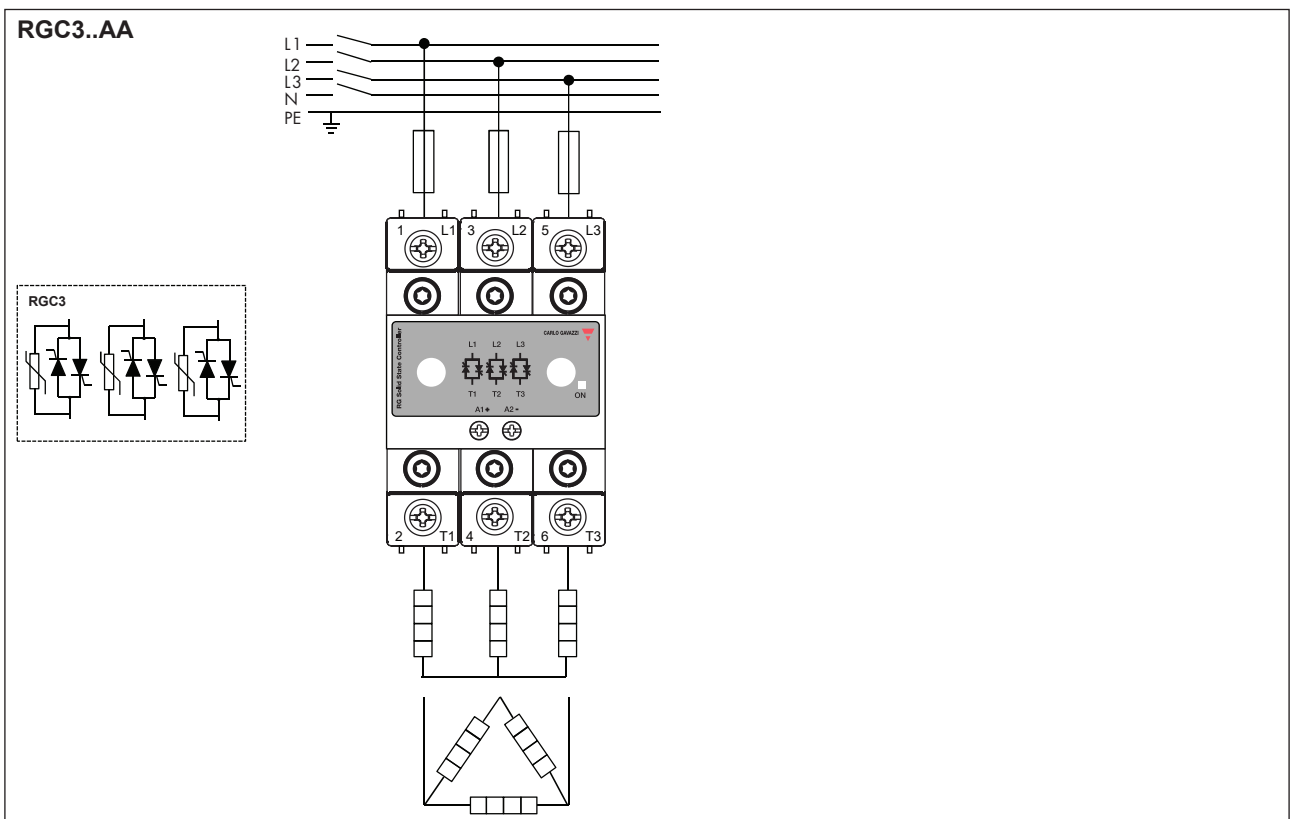
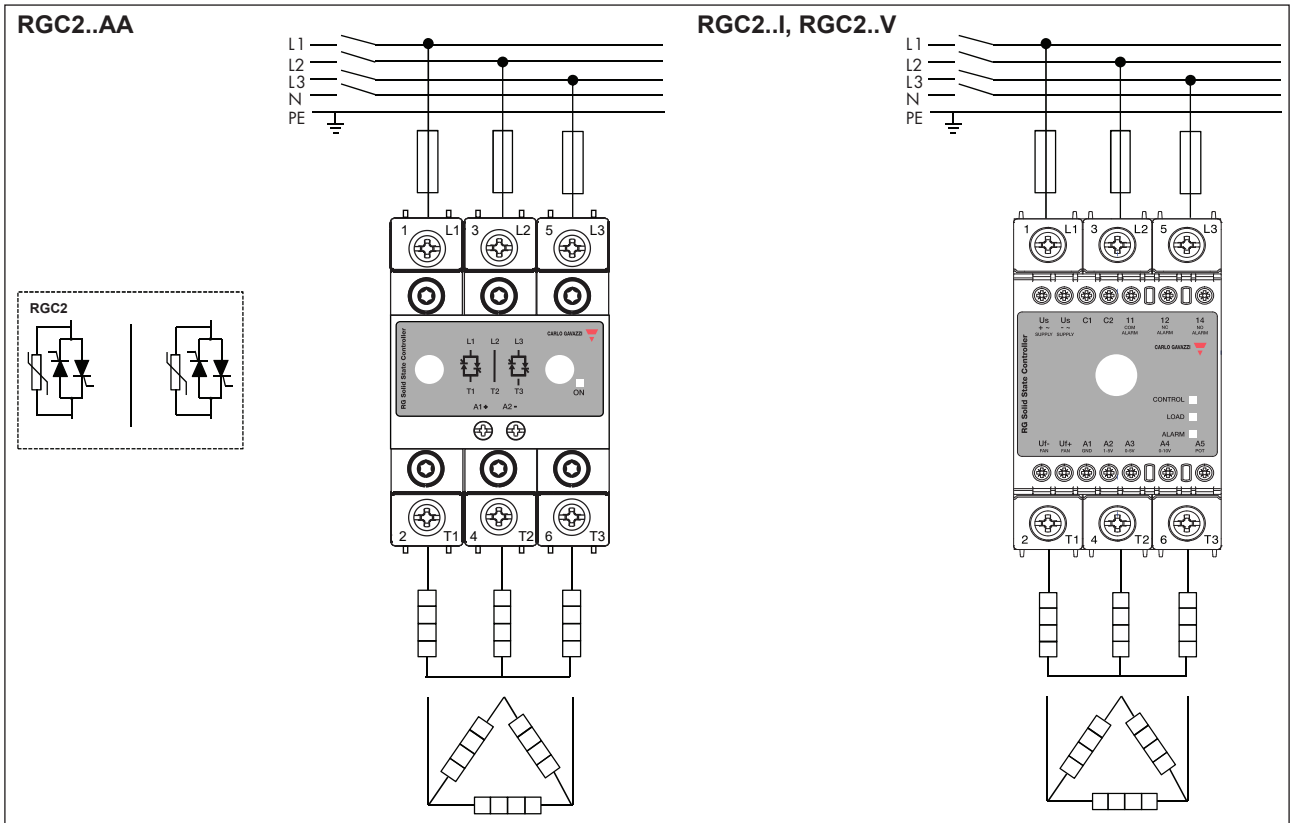



# Connection diagrams (continued)

RGC3..I, RGC3..V

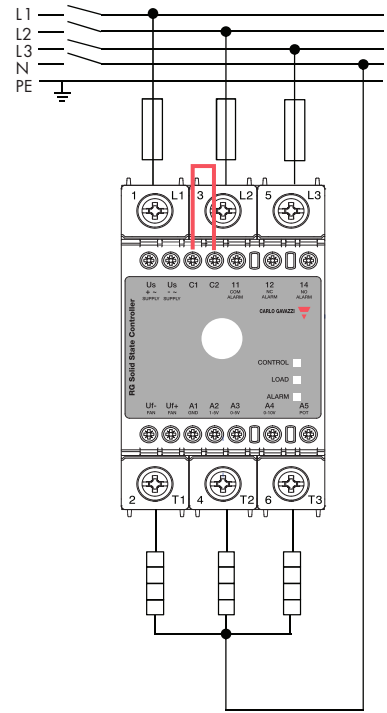
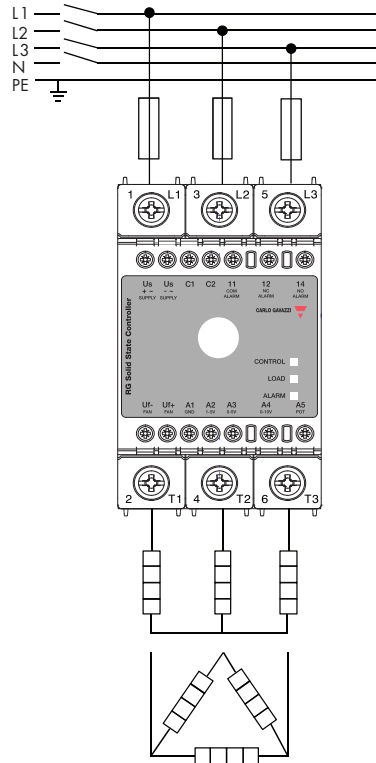
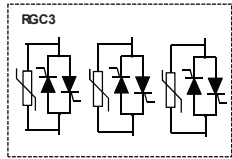

Note: Short link external connection is required between C1 and C2 terminals for 4-wire 3-phase systems.

## Connection configuration

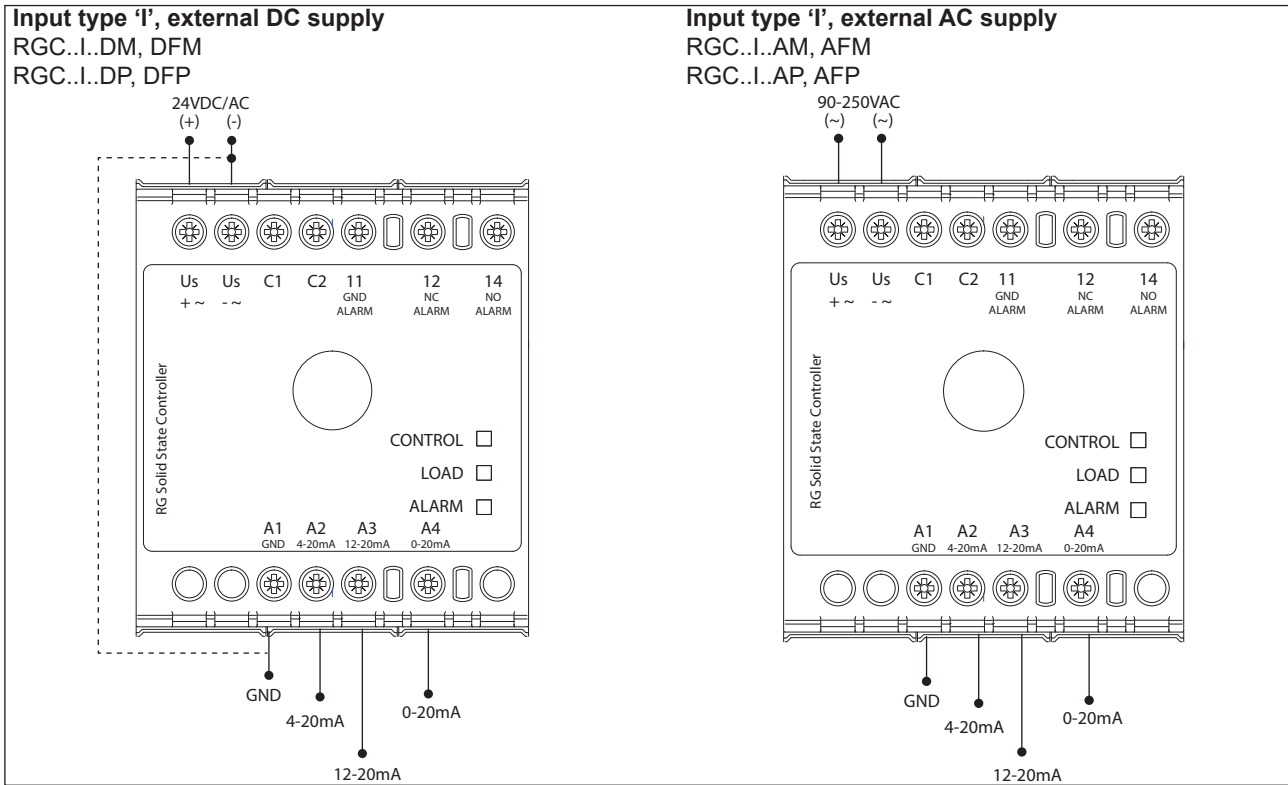

Note: Control input shall be connected either to A1-A2 or A1-A3 or A1-A4 only

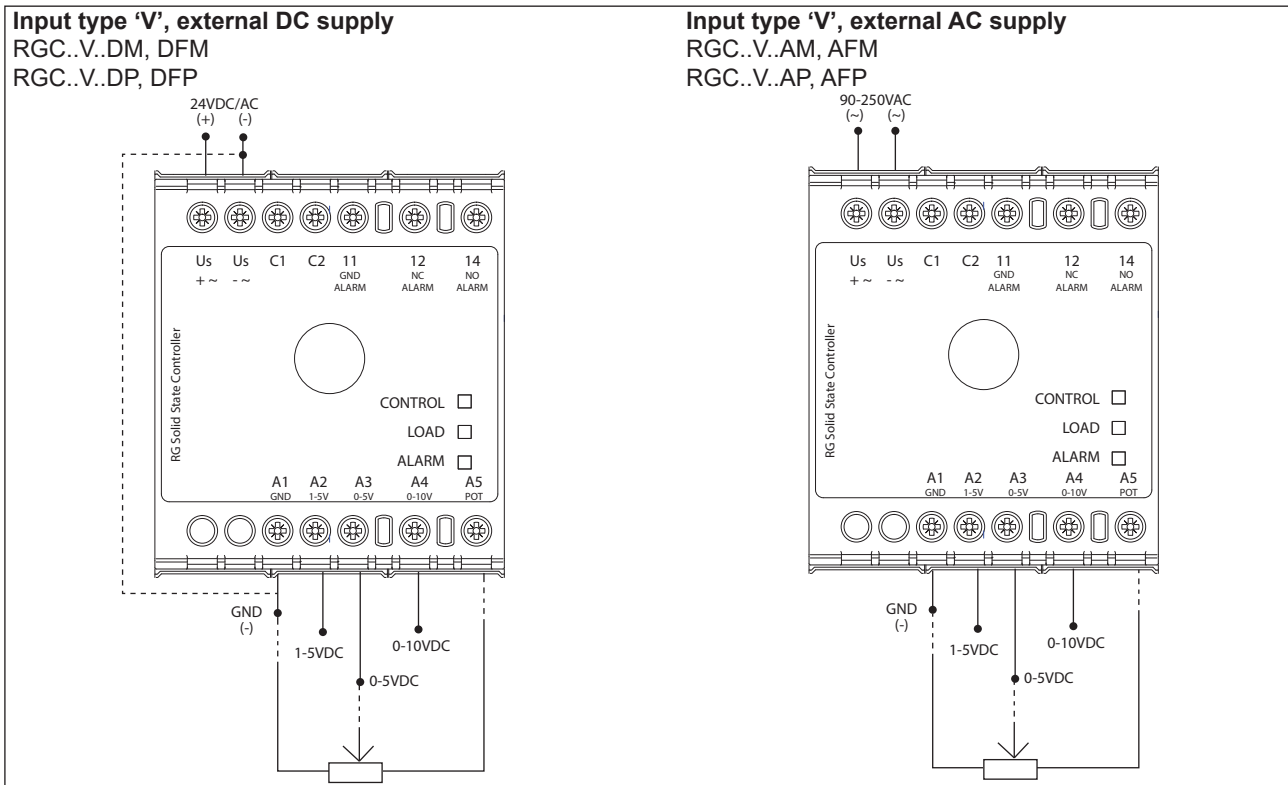

Note: Control input shall be connected either to A1-A2 or A1-A3 or A1-A4 or A1-A3-A5 in case an external potentiometer is used.

## Connection configuration (continued)

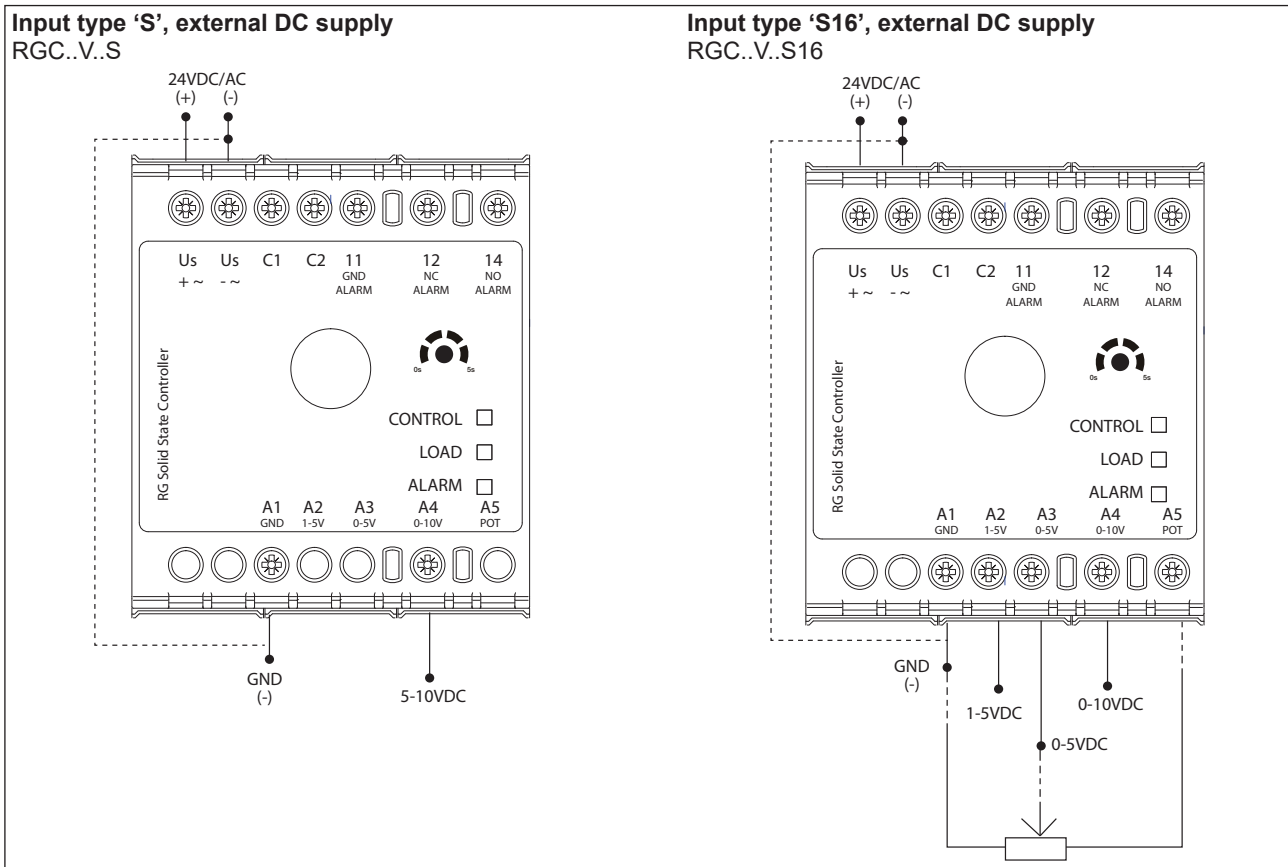





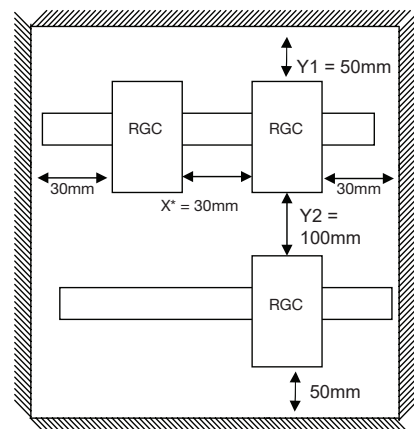
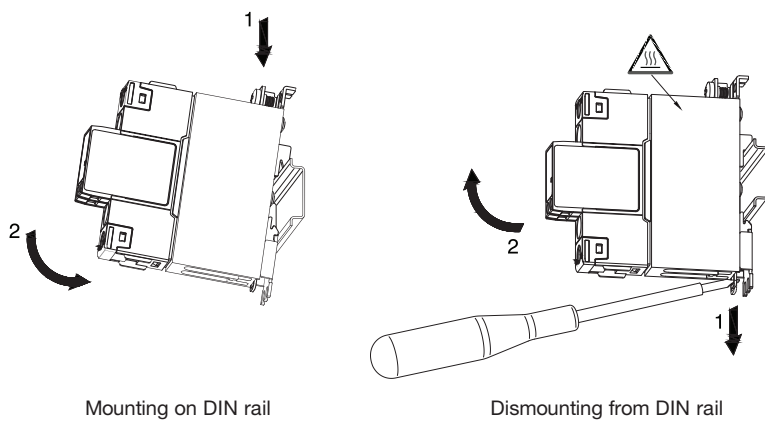

Note: Control input shall be connected to terminals A1-A4 in the case of the RGC3P..S.. In the case of the RGC3P..S16.., the control input shall be connected to either A1-A2 or A1-A3 or A1-A4 or A1-A3-A5 in case an external potentiometer is used.

## Installation

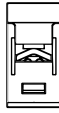
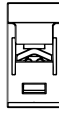

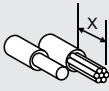



\* Refer to Current Derating curves at 0mm for 0mm spacing between units

## Connection specifications

Power connection			
Terminal	1/L1, 3/L2, 5/L3, 2/T1, 4/T2, 6/T3		
Conductors	Use 75°C copper (Cu) conductors		
	<b>RGC2..25</b> <b>RGC3..20</b>		<b>RGC2..40, RGC2..75</b> <b>RGC3..30, RGC3..65</b>
			
Stripping length	12 mm		11 mm
Connection type	M4 screw with captivated washer		M5 screw with box clamp
Rigid (solid & stranded) UL/cUL rated data		2 x 2.5 – 6.0 mm <sup>2</sup> 2 x 14 – 10 AWG	1 x 2.5 – 6.0 mm <sup>2</sup> 1 x 14 – 10 AWG
			1 x 2.5 – 25.0 mm <sup>2</sup> 1 x 14 – 3 AWG
Flexible with end sleeve		2 x 1.0 – 2.5 mm <sup>2</sup> 2 x 2.5 – 4.0 mm <sup>2</sup> 2 x 18 – 14 AWG 2 x 14 – 12 AWG	1 x 1.0 – 4.0 mm <sup>2</sup> 1 x 18 – 12 AWG
			1 x 2.5 – 16.0 mm <sup>2</sup> 1 x 14 – 6 AWG
Flexible without end sleeve		2 x 1.0 – 2.5 mm <sup>2</sup> 2 x 2.5 – 6.0 mm <sup>2</sup> 2 x 18 – 14 AWG 2 x 14 – 10 AWG	1 x 1.0 – 6.0 mm <sup>2</sup> 1 x 18 – 10 AWG
			1 x 4.0 – 25.0 mm <sup>2</sup> 1 x 12 – 3 AWG
Torque specifications		Posidrive bit 2 UL: 2.0 Nm (17.7 lb-in) IEC: 1.5 – 2.0 Nm (13.3 – 17.7 lb-in)	Posidrive bit 2 UL: 2.5 Nm (22 lb-in) IEC: 2.5 – 3.0 Nm (22 – 26.6 lb-in)
Aperture for termination lug (fork or ring)	12.3 mm		n/a
Protective Earth (PE) connection	M5, 1.5 Nm (13.3 lb-in) M5 PE screw is not provided with the solid state relay. PE connection is required when product is intended to be used in Class 1 applications according to EN/IEC 61140		

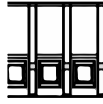
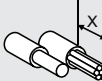
## Connection specifications (continued)

Control, supply and alarm connection			
Terminals	A1, A2		A1, A2, A3, A4, A5, Us, Uf, 11, 12, 14, C1, C2
	RGC..AA..		RGC..I.., RGC..V..
			
Conductors	Use 60/75°C copper (Cu) conductors		
Stripping length	8 mm		8 mm
Connection type	M3 screw with captivated washer		M3 screw with box clamp
Rigid (solid & stranded) UL/cUL rated data		2 x 0.5 - 2.5 mm <sup>2</sup> 2 x 18 - 12 AWG	1 x 0.5 - 2.5 mm <sup>2</sup> 1 x 18 - 12 AWG
Flexible with end sleeve		2 x 0.5 - 2.5 mm <sup>2</sup> 2 x 18 - 12 AWG	1 x 0.5 - 2.5 mm <sup>2</sup> 1 x 20 - 12 AWG
Torque specification		Posidrive 1 UL: 0.5 Nm (4.4 lb-in) IEC: 0.5-0.6 Nm (4.4-5.3 lb-in)	Posidrive 1 UL: 0.5 Nm (4.4 lb-in) IEC: 0.4-0.5 Nm (3.5-4.4 lb-in)



COPYRIGHT ©2023  
 Content subject to change.  
 Download the PDF: <https://gavazziautomation.com>