

MC Contactors 3 Pole



Technical Datasheet

Key Features

- Up to 22A AC3
- Up to 32A AC1
- DIN Rail Mounting
- International Approvals
- Data according to IEC 947 / EN 60947

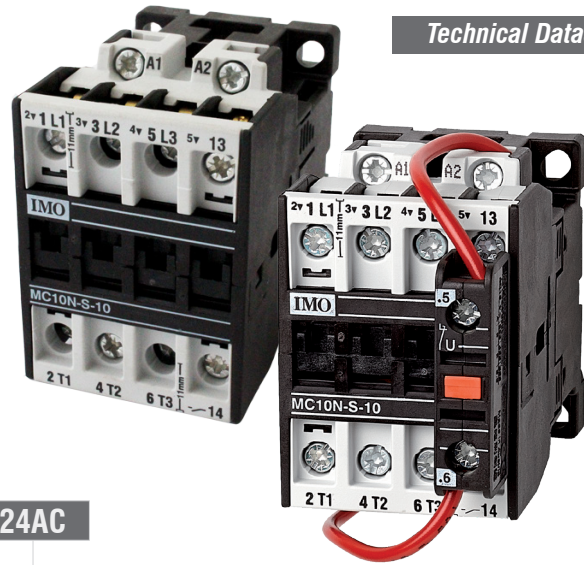

Options & Ordering Codes

MC 10N - S - 10 - 24AC

Series

Standard Contactor **MC**

AC3 Rating

4kW / 10A	10N
5.5kW / 14A	14N
7.5kW / 18A	18N
11kW / 22A	22N

Switching Type

Standard **S**

Aux. Contact Configuration

10	Normally Open (NO)
01	Normally Closed (NC)

Coil Voltage*

24AC	24DC
110AC	48DC
230AC	110DC
400AC	

* Other coil voltages available. Please contact IMO for more information.

Technical Data acc. to IEC / EN 60947-4-1

Part Number	MC10N-S-10	MC14N-S-10	MC18N-S-10	MC22N-S-10	
Main Contact Ratings	AC1 690V $I_e (=I_{th})$ open at 40°C	25A	25A	32A	32A
	AC2, AC3, 380-440V	4kW / 10A	5.5kW / 14A	7.5kW / 18A	11kW / 22A
	AC2, AC3, 500-690V	5.5kW	7.5kW	10kW	10kW
	DC1 / 3 / 5, 24VDC (1 pole/3 poles in series)	20A	25A	32A	32A
	Fuse "Typ1" gl. (gG)	63A max.	63A max.	63A max.	63A max.
	Rated Insulation Voltage U_i^{*4}	690V~	690V~	690V~	690V~
	Making Capacity I_{eff} at $U_e = 690V\sim$	200A	200A	200A	200A
	Breaking Capacity I_{br} 400V~	180A	180A	200A	200A
$\cos\theta = 0.65$ 500V~	150A	150A	180A	180A	
Max. Ambient Temp	Operation Open	-40 to +60°C (+90°C)*1			
	Operation Enclosed	-40 to +40°C			
	with Thermal Overload Relay Open	-25 to +60°C			
	with Thermal Overload Relay Enclosed	-25 to +40°C			
Storage	-50 to +90°C				
Frequency of Operations z Ops/hr	Switching Without Load	10,000			
	AC3, I_e	600			
	AC4, I_e	120			
	DC3, I_e	600			
Switching Time at Control Voltage $U_c \pm 10\%^{*2, *3}$	AC Operated	Make Time	8 - 16ms		
		Release Time	5 - 13ms		
		Arc Duration	10 - 15ms		
	DC Operated	Make Time	8 - 12ms		
		Release Time	8 - 13ms		
		Arc Duration	10 - 15ms		
Mech. Life	AC Operated	10 x 10 ⁶			
	DC Operated with Dual-Wound Coils	10 x 10 ⁶			
Curr. Heat Loss	Power Loss Per Pole (I_e /AC3 400V)	0.21W	0.35W	0.5W	0.75W
	Contact Resistance Per Pole	2.1mΩ	1.8mΩ	1.5mΩ	1.5mΩ
Shock Resistance acc. to IEC60068-2-27 - 20ms Sine Wave NO		10g			
Shock Resistance acc. to IEC60068-2-27 - 20ms Sine Wave NC		6g			

*1 With reduced control voltage range 0.9 up to 1.0 x U_c and with reduced rated current I_e / AC1 according to I_e / AC3

*2 Total breaking time = release time + arc duration

*3 Values for delay of the release time of the make contact and the make time of the break contact will be increased if magnet coils are protected against voltage peaks with integrated suppressor

*4 Suitable at 690V for earthed-neutral systems, overvoltage category I to IV, pollution degree 3 (standard industry); $U_{imp} = 8kV$. Data for other conditions upon request

MC Contactors 3 Pole



Technical Datasheet

Technical Data continued acc. to IEC / EN 60947-4-1

Part Number		MC10N-S-10..+MCA..	MC14N-S-10..+MCA..	MC18N-S-10..+MCA..	MC22N-S-10..+MCA..
Aux Contact Ratings MCA10 (NO) MCA01 (NC)	AC1 690V I _e (=I _{th}) open at 40°C	10A	10A	10A	10A
	AC15, 220-240V	3A	3A	3A	3A
	AC15, 380-440V	2A	2A	2A	2A
	Fuse "Typ1" gl. (gG)	20A max.	20A max.	20A max.	20A max.

NOTE: Maximum number of auxiliaries that can be added to AC operated contactors is 4. Maximum that can be added to DC operated contactors is 3.

Technical Data acc. to UL508

Part Number				MC10N	MC14N	MC18N	MC22N	
Main Contact Ratings	Rated Operational Current "General Use"			25A	25A	25A	25A	
Motor DOL 3-Phase at 60Hz	Rated Operational Power	110-120V	hp	1.5	2	2	3	
		200V	hp	3	3	5	5	
		220-240V	hp	3	3	7.5	7.5	
		277V	hp	3	5	7.5	7.5	
		380-415V	hp	5	5	10	10	
		440-480V	hp	5	7.5	10	15	
Motor DOL 1-Phase at 60Hz	Rated Operational Power AC Motors at 60Hz (1ph)	550-600V	hp	7.5	10	15	20	
		110-120V	hp	0.5	0.75	1	1.5	
		200V	hp	1	1.5	2	3	
		220-240V	hp	1.5	2	3	3	
		277V	hp	2	3	3	5	
		380-415V	hp	3	3	5	5	
Motor DOL 3-phase acc. to ASME A17.5	Rated Operational Current	440-480V	hp	3	5	5	7.5	
		550-600V	hp	3	5	7.5	10	
	Rated Operational Power 3-phase Motors for Elevators (500,000 Operations)	600V	A	-	-	-	-	
		110-120V	hp	-	-	-	-	
		200V	hp	-	-	-	-	
		220-240V	hp	-	-	-	-	
	Rated Current 2 Series Contacts		600V	A	-	-	-	-
	Fuse Class RK5 / Short-circuit current			A/kA	50/5	50/5	70/5	90/5
Fuse Class T / Short-circuit current			A/kA	45/100	50/100	70/100	90/100	
Rated voltage			V	600	600	600	600	
Auxiliary Contacts (cULus)				A600	A600	A600	A600	

Cable Cross Sections

	Contacts	Coils
Solid Strand (mm ²)	0.75 - 6.0	0.75 - 2.5
Flexible Strand (mm ²)	1.0 - 4.0	0.5 - 2.5
Solid Strand (AWG)	18 - 10	14 - 12
Flexible Strand (AWG)	18 - 10	18 - 12
Cables per Clamp	1	2
Terminal Screws	M3.5	M3.5
Screwdriver	Pozidrive Pz2	Pozidrive Pz2
Tightening Torque (Nm)	0.8 - 1.4	0.8 - 1.4
Tightening Torque (lb.inch)	7 - 12	7 - 12

Coil

	AC Operated	DC Operated
Operation Range	0.85 - 1.1	0.8 - 1.1
Inrush	33 - 45VA	75W
Sealed	7 - 10VA	2W

Weights & Dimensions

	AC Operated	DC Operated
Single Unit (inc. packaging)	0.23kg	0.25kg
Dimensions	67 x 46 x 67mm	70 x 47 x 85mm

Resistance to Climatic Conditions acc. to IEC60068

Open-type devices are climate-resistant in the constant climate according to IEC60068-2-78 (this is a climate with an ambient temperature of 40°C and an atmospheric humidity of 90 to 95%). Enclosed devices are climate-resistant in an alternating climate according to IEC 68-2-30 (this is a moist alternating climate with a 24-hour cycle between climates with an ambient temperature of 25°C, and an atmospheric humidity of 95 to 100% and an ambient temperature of 40°C, and an atmospheric humidity of 90 to 96% in the presence of condensation during rises in temperature). Note: Maximum operating altitude of 2000m above sea level.

MC Contactors 3 Pole



Technical Datasheet

Dimensions (mm)

AC Operated

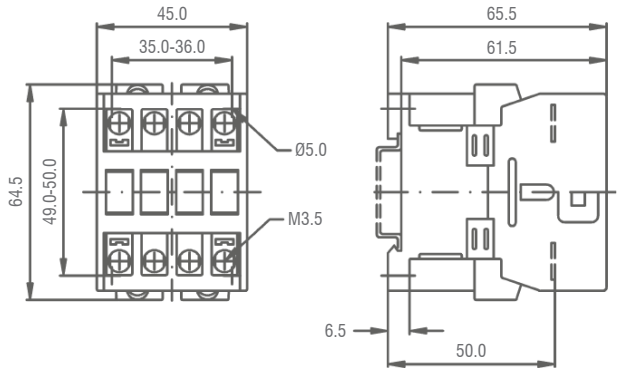

DC Operated

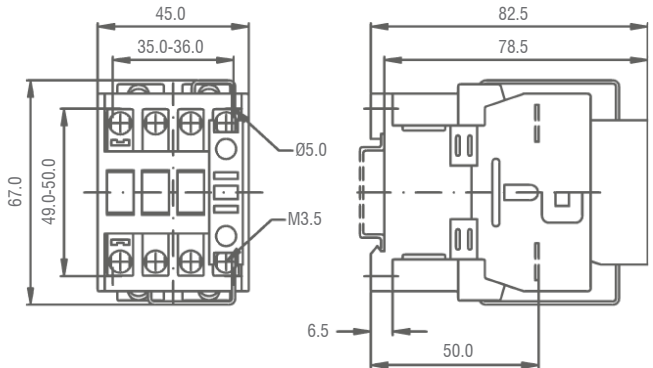

Wiring Diagrams

AC Operated

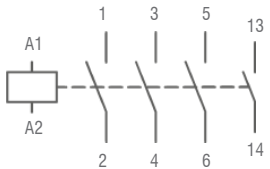

13-14 Normally Open (NO) Auxiliary

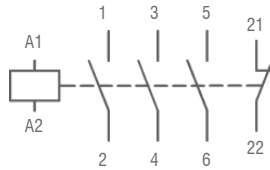

21-22 Normally Closed (NC) Auxiliary

DC Operated

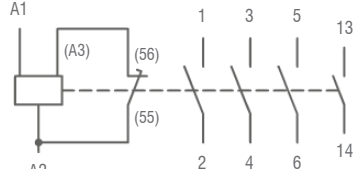

13-14 Normally Open (NO) Auxiliary

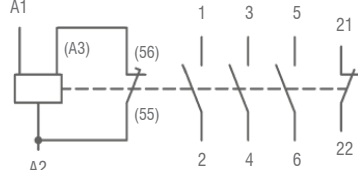

21-22 Normally Closed (NC) Auxiliary

Mounting Position

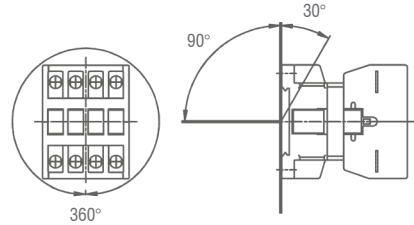

MC Contactors 3 Pole



Key Features

- Up to 40A AC3
- Up to 80A AC1
- DIN Rail Mounting
- International Approvals
- Data according to IEC 947 / EN 60947



Options & Ordering Codes

MC 24 - S - 00 - 24

Series	Standard Contactor	MC
AC3 Rating	11kW / 24A	24
	15kW / 32A	32
	18.5kW / 40A	40
Switching Type	Standard	S
Aux. Contact Configuration	00	
Coil Voltage*	24 (24AC)	= 24 (24DC)
	110 (110AC)	
	230 (230AC)	
	400 (400AC)	

* Other coil voltages available. Please contact IMO for more information.

Technical Data acc. to IEC / EN 60947-4-1

Part Number	MC24-S-00	MC32-S-00	MC40-S-10	
Main Contact Ratings	AC1 690V I _e (=I _{th}) open at 40°C	50A	65A	
	AC2, AC3, 380-440V	11kW / 24A	15kW / 32A	
	AC2, AC3, 500-690V	15kW	18.5kW	
	DC1 / 3 / 5, 24VDC (1 pole/3 poles in series)	50A	65A	
	Fuse "Typ1" gl. (gG)	100A max.	100A max.	
	Rated Insulation Voltage U _i *4	690V~	690V~	
	Making Capacity I _{eff} at U _e = 690V~	400A	500A	
	Breaking Capacity I _{br} 400V~	380A	400A	
Max. Ambient Temp	Operation Open	-40 to +60°C (+90°C)*1		
	Operation Enclosed	-40 to +40°C		
	with Thermal Overload Relay Open	-25 to +60°C		
	with Thermal Overload Relay Enclosed	-25 to +40°C		
Frequency of Operations z Ops/hr	Storage	-50 to +90°C		
	Switching Without Load	7,000		
	AC3, I _e	600		
Switching Time at Control Voltage Us ±10%*2, *3	DC3, I _e	600		
	AC Operated	Make Time	10 - 25ms	
		Release Time	8 - 15ms	
		Arc Duration	10 - 15ms	
	DC Operated	Make Time	10 - 20ms	
		Release Time	10 - 15ms	
Arc Duration		10 - 15ms		
Mech. Life	AC Operated	10 x 10 ⁶		
	DC Operated with Dual-Wound COILs	10 x 10 ⁶		
Curr. Heat Loss	Power Loss Per Pole (I _e /AC3 400V)	0.7W	1.3W	
	Contact Resistance Per Pole	1.2mΩ	1.2mΩ	
Shock Resistance acc. to IEC60068-2-27 - 20ms Sine Wave NO		8g		
Shock Resistance acc. to IEC60068-2-27 - 20ms Sine Wave NC		-		

*1 With reduced control voltage range 0.9 up to 1.0 x Us and with reduced rated current I_e / AC1 according to I_e / AC3

*2 Total breaking time = release time + arc duration

*3 Values for delay of the release time of the make contact and the make time of the break contact will be increased if magnet coils are protected against voltage peaks with integrated suppressor

*4 Suitable at 690V for earthed-neutral systems, overvoltage category I to IV, pollution degree 3 (standard industry); U_{imp} = 8kV. Data for other conditions upon request

MC Contactors 3 Pole



Technical Datasheet

Technical Data continued acc. to IEC / EN 60947-4-1

Part Number		MC24-S-00..+MCA..	MC32-S-00..+MCA..	MC40-S-00..+MCA..
Aux Contact Ratings MCA10 (NO) MCA01 (NC)	AC1 690V I _e (=I _{th}) open at 40°C	10A	10A	10A
	AC15, 220-240V	3A	3A	3A
	AC15, 380-440V	2A	2A	2A
	Fuse "Typ1" gl. (gG)	20A max.	20A max.	20A max.

NOTE: Maximum number of auxiliaries that can be added to AC operated contactors is 4. Maximum that can be added to DC operated contactors is 3.

Technical Data acc. to UL508

Part Number				MC24	MC32	MC40	
Main Contact Ratings	Rated Operational Current "General Use"			50A	65A	80A	
Motor DOL 3-Phase at 60Hz	Rated Operational Power	110-120V	hp	5	5	7.5	
		200V	hp	7.5	10	10	
		220-240V	hp	10	10	15	
		277V	hp	7.5	10	15	
		380-415V	hp	10	15	20	
		440-480V	hp	15	20	25	
Motor DOL 1-Phase at 60Hz	Rated Operational Power AC Motors at 60Hz (1ph)	550-600V	hp	20	25	30	
		110-120V	hp	1.5	2	3	
		200V	hp	3	5	7.5	
		220-240V	hp	5	5	7.5	
		277V	hp	5	7.5	10	
		380-415V	hp	5	7.5	10	
Motor DOL 3-phase acc. to ASME A17.5	Rated Operational Current	600V	A	15	22	-	
		110-120V	hp	2	3	-	
	Rated Operational Power 3-phase Motors for Elevators (500,000 Operations)	200V	hp	3	5	-	
		220-240V	hp	5	7.5	-	
		440-480V	hp	10	15	-	
		550-600V	hp	10	20	-	
	Rated Current 2 Series Contacts		600V	A	22	27	-
	Fuse Class RK5 / Short-circuit current			A/kA	90/5	125/5	175/5
Fuse Class T / Short-circuit current			A/kA	110/100	150/100	150/100	
Rated voltage			V	600	600	600	
Auxiliary Contacts (cULus)				-	-	-	

Cable Cross Sections

	Contacts	Coils
Solid Strand (mm ²)	1.5 - 25.0	0.75 - 2.5
Flexible Strand (mm ²)	2.5 - 16.0	0.5 - 2.5
Solid Strand (AWG)	16 - 10	14 - 12
Flexible Strand (AWG)	14 - 4	18 - 12
Cables per Clamp	1	2
Terminal Screws	M5	M3.5
Screwdriver	Pozidrive Pz2	Pozidrive Pz2
Tightening Torque (Nm)	2.5 - 3.0	0.8 - 1.4
Tightening Torque (lb.inch)	22 - 26	7 - 12

Coil

	AC Operated	DC Operated
Operation Range	0.85 - 1.1	0.8 - 1.1
Inrush	90 - 115VA	140W
Sealed	9 - 13VA	2W

Weights & Dimensions

	AC Operated	DC Operated
Single Unit (inc. packaging)	0.48kg	0.55kg
Dimensions	75 x 46 x 88mm	83 x 46 x 105mm

Resistance to Climatic Conditions acc. to IEC60068

Open-type devices are climate-resistant in the constant climate according to IEC60068-2-78 (this is a climate with an ambient temperature of 40°C and an atmospheric humidity of 90 to 95%). Enclosed devices are climate-resistant in an alternating climate according to IEC 68-2-30 (this is a moist alternating climate with a 24-hour cycle between climates with an ambient temperature of 25°C, and an atmospheric humidity of 95 to 100% and an ambient temperature of 40°C, and an atmospheric humidity of 90 to 96% in the presence of condensation during rises in temperature). Note: Maximum operating altitude of 2000m above sea level.

MC Contactors 3 Pole



Technical Datasheet

Dimensions (mm) AC Operated

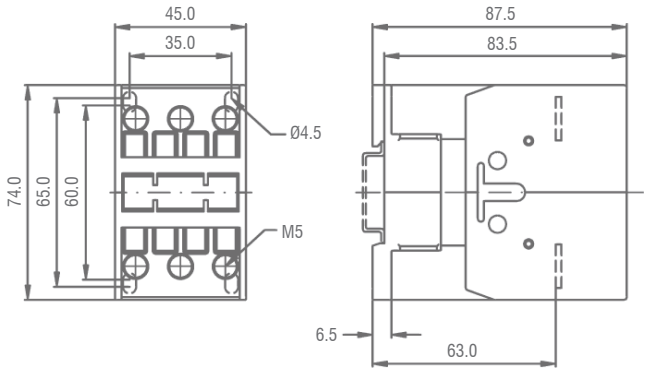

DC Operated

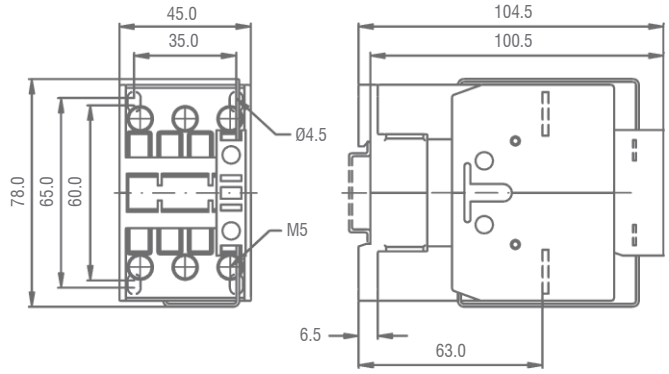

Wiring Diagrams AC Operated

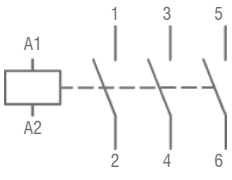

DC Operated

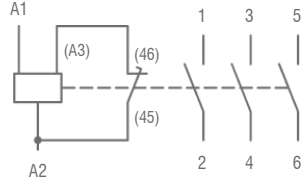

Mounting Position

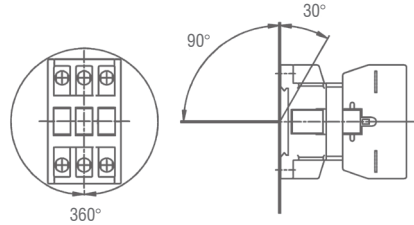

MC Contactors 3 Pole



Technical Datasheet

Key Features

- Up to 74A AC3
- Up to 130A AC1
- DIN Rail Mounting
- International Approvals
- Data according to IEC 947 / EN 60947



Options & Ordering Codes

MC 50 - S - 00 - 24

Series	Standard Contactor	MC
AC3 Rating	22kW / 50A	50
	30kW / 62A	62
	37kW / 74A	74
Switching Type	Standard	S
Aux. Contact Configuration	00	
Coil Voltage*	24 (24AC)	= 24 (24DC)
	110 (110AC)	
	230 (230AC)	
	400 (400AC)	

* Other coil voltages available. Please contact IMO for more information.

Technical Data acc. to IEC / EN 60947-4-1

Part Number	MC50-S-00	MC62-S-00	MC74-S-10	
Main Contact Ratings	AC1 690V I _e (=I _{th}) open at 40°C	110A	120A	130A
	AC2, AC3, 380-440V	22kW / 50A	30kW / 62A	37kW / 74A
	AC2, AC3, 500-690V	30kW	37kW	45kW
	DC1 / 3 / 5, 24VDC (1 pole/3 poles in series)	110A	120A	130A
	Fuse "Typ1" gl. (gG)	160A max.	160A max.	160A max.
	Rated Insulation Voltage U _i *4	830V~	830V~	830V~
	Making Capacity I _{eff} at U _e = 690V~	700A	900A	900A
	Breaking Capacity I _{br} 400V~	600A	800A	800A
cosθ = 0.35 500V~	500A	700A	700A	
Max. Ambient Temp	Operation Open	-40 to +60°C (+90°C)*1		
	Operation Enclosed	-40 to +40°C		
	with Thermal Overload Relay Open	-25 to +60°C		
	with Thermal Overload Relay Enclosed	-25 to +40°C		
Storage	-50 to +90°C			
Frequency of Operations z Ops/hr	Switching Without Load	7,000		
	AC3, I _e	400		
	AC4, I _e	120		
Switching Time at Control Voltage Us ±10% (z, *3)	AC Operated	Make Time	12 - 28ms	
		Release Time	8 - 15ms	
		Arc Duration	10 - 15ms	
	DC Operated	Make Time	12 - 23ms	
		Release Time	10 - 18ms	
Mech. Life	AC Operated	10 x 10 ⁶		
	DC Operated with Dual-Wound Coils	10 x 10 ⁶		
Curr. Heat Loss	Power Loss Per Pole (I _e /AC3 400V)	2.2W	3.9W	5.5W
	Contact Resistance Per Pole	1.0mΩ	1.0mΩ	1.0mΩ
Shock Resistance acc. to IEC60068-2-27 - 20ms Sine Wave NO		8g		
Shock Resistance acc. to IEC60068-2-27 - 20ms Sine Wave NC		-		

*1 With reduced control voltage range 0.9 up to 1.0 x Us and with reduced rated current I_e / AC1 according to I_e / AC3

*2 Total breaking time = release time + arc duration

*3 Values for delay of the release time of the make contact and the make time of the break contact will be increased if magnet coils are protected against voltage peaks with integrated suppressor

*4 Suitable at 690V for earthed-neutral systems, overvoltage category I to IV, pollution degree 3 (standard industry); U_{imp} = 8kV. Data for other conditions upon request

MC Contactors 3 Pole



Technical Datasheet

Technical Data continued acc. to IEC / EN 60947-4-1

Part Number		MC50-S-00..+MCA..	MC62-S-00..+MCA..	MC74-S-00..+MCA..
Aux Contact Ratings MCA10 (NO) MCA01 (NC)	AC1 690V I _e (=I _{th}) open at 40°C	10A	10A	10A
	AC15, 220-240V	3A	3A	3A
	AC15, 380-440V	2A	2A	2A
	Fuse "Typ1" gl. (gG)	20A max.	20A max.	20A max.

NOTE: Maximum number of auxiliaries that can be added to AC operated contactors is 4. Maximum that can be added to DC operated contactors is 3.

Technical Data acc. to UL508

Part Number				MC50	MC62	MC74	
Main Contact Ratings	Rated Operational Current "General Use"			110A	120A	130A	
Motor DOL 3-Phase at 60Hz	Rated Operational Power	110-120V	hp	10	10	10	
		200V	hp	15	20	25	
		220-240V	hp	20	25	30	
		277V	hp	20	25	30	
		380-415V	hp	25	30	40	
		440-480V	hp	30	40	50	
Motor DOL 1-Phase at 60Hz	Rated Operational Power AC Motors at 60Hz (1ph)	550-600V	hp	40	50	50	
		110-120V	hp	3	5	7.5	
		200V	hp	7.5	10	15	
		220-240V	hp	10	15	15	
		277V	hp	10	15	15	
		380-415V	hp	15	20	20	
Motor DOL 3-phase acc. to ASME A17.5	Rated Operational Current	440-480V	hp	20	25	25	
		550-600V	hp	25	30	30	
	Rated Operational Power 3-phase Motors for Elevators (500,000 Operations)	600V	A	27	37	-	
		110-120V	hp	3	5	-	
		200V	hp	7.5	10	-	
		220-240V	hp	7.5	10	-	
	Rated Current 2 Series Contacts		600V	A	44	52	66
	Fuse Class RK5 / Short-circuit current			A/kA	200/5	250/5	300/5
Fuse Class T / Short-circuit current			A/kA	175/100	175/100	175/100	
Rated voltage			V	600	600	600	
Auxiliary Contacts (cULus)				-	-	-	

Cable Cross Sections

	Contacts	Coils
Solid Strand (mm ²)	4.0 - 50.0	0.75 - 2.5
Flexible Strand (mm ²)	10.0 - 35.0	0.5 - 2.5
Solid Strand (AWG)	12 - 10	14 - 12
Flexible Strand (AWG)	10 - 0	18 - 12
Cables per Clamp	1	2
Terminal Screws	M6	M3.5
Screwdriver	Pozidrive Pz3	Pozidrive Pz2
Tightening Torque (Nm)	3.5 - 4.5	0.8 - 1.4
Tightening Torque (lb.inch)	31 - 40	7 - 12

Coil

	AC Operated	DC Operated
Operation Range	0.85 - 1.1	0.8 - 1.1
Inrush	140 - 165VA	200W
Sealed	13 - 18VA	6W

Weights & Dimensions

	AC Operated	DC Operated
Single Unit (inc. packaging)	0.85kg	0.90kg
Dimensions	112 x 63 x 99mm	112 x 62 x 115mm

Resistance to Climatic Conditions acc. to IEC60068

Open- type devices are climate-resistant in the constant climate according to IEC60068-2-78 (this is a climate with an ambient temperature of 40°C and an atmospheric humidity of 90 to 95%). Enclosed devices are climate-resistant in an alternating climate according to IEC 68-2-30 (this is a moist alternating climate with a 24-hour cycle between climates with an ambient temperature of 25°C, and an atmospheric humidity of 95 to 100% and an ambient temperature of 40°C, and an atmospheric humidity of 90 to 96% in the presence of condensation during rises in temperature). Note: Maximum operating altitude of 2000m above sea level.

MC Contactors 3 Pole



Technical Datasheet

Dimensions (mm)

AC Operated

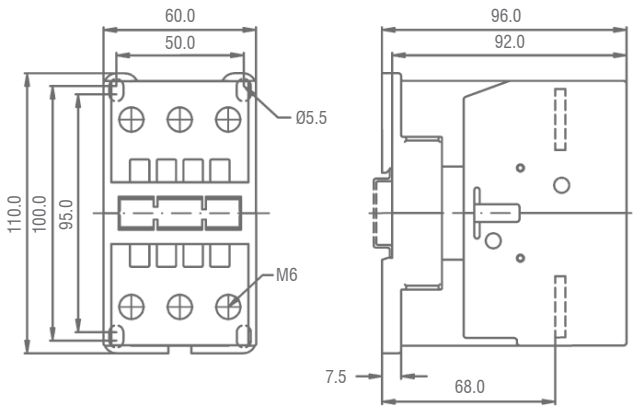

DC Operated

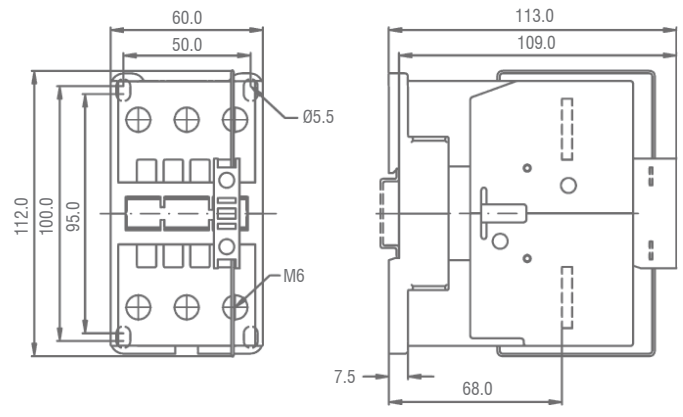

Wiring Diagrams

AC Operated

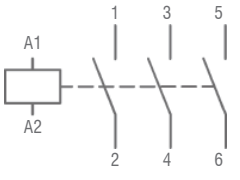

DC Operated

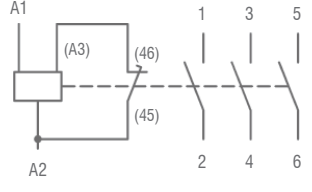

Mounting Position

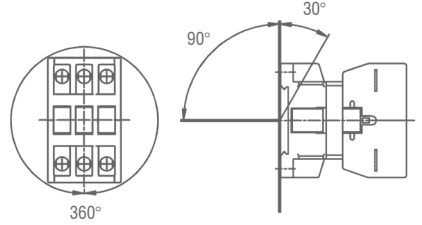

MC Contactors 3 Pole



Key Features

- Up to 115A AC3
- Up to 200A AC1
- International Approvals
- Data according to IEC 947 / EN 60947



Options & Ordering Codes

MC **90** - **S** - **00** - **24**

Series

Standard Contactor	MC
--------------------	-----------

AC3 Rating

45kW / 90A	90
55kW / 115A	115

Switching Type

Standard	S
----------	----------

Aux. Contact Configuration

00

Coil Voltage

24	24VAC/DC
48	48VAC/DC
110	110VAC/DC
230	230VAC/DC
110AC	110VAC
230AC	230VAC
400AC	400VAC

Technical Data acc. to IEC / EN 60947-4-1

Part Number		MC90-S-00	MC115-S-00
Main Contact Ratings	AC1 690V I _e (=I _{th}) open at 40°C	160A	200A
	AC2, AC3, 380-440V	45kW / 90A	55kW / 115A
	AC2, AC3, 500-690V	55kW	55kW
	Fuse "Typ1" gl. (gG)	250A max.	250A max.
	Rated Insulation Voltage U _i *4	1000V~	1000V~
	Making Capacity I _{eff} at U _e =690V~	1100A	1200A
	Breaking Capacity I _{br} 400V~	950A	1100A
	cosφ= 0.35 500V~	850A	1000A
Max. Ambient Temp	Operation Open	-40 to +60°C (+90°C)*1	
	Operation Enclosed	-40 to +40°C	
	with Thermal Overload Relay Open	-25 to +60°C	
	with Thermal Overload Relay Enclosed	-25 to +40°C	
	Storage	-50 to +90°C	
Frequency of Operations z Ops/hr	Switching Without Load	3,000	
	AC3, I _e	300	
	AC4, I _e	120	
	DC3, I _e	300	
Switching Time at Control Voltage Us ±10%*2,*3	AC Operated	Make Time	20 - 35ms
		Release Time	35 - 50ms
		Arc Duration	10 - 15ms
	DC Operated	Make Time	20 - 35ms
		Release Time	35 - 50ms
		Arc Duration	10 - 15ms
Mech. Life	AC Operated	5 x 10 ⁶	
	DC Operated	5 x 10 ⁶	
Curr. Heat Loss	Power Loss Per Pole (I _e /AC3 400V)	4.8W	7.9W
	Contact Resistance Per Pole	0.6mΩ	0.5mΩ
Shock Resistance acc. to IEC60068-2-27 - 20ms Sine Wave NO		7g	
Shock Resistance acc. to IEC60068-2-27 - 20ms Sine Wave NC		5g	

*1 With reduced control voltage range 0.9 up to 1.0 x U_s and with reduced rated current I_e / AC1 according to I_e / AC3

*2 Total breaking time = release time + arc duration

*3 Values for delay of the release time of the make contact and the make time of the break contact will be increased if magnet coils are protected against voltage peaks with integrated suppressor

*4 Suitable at 690V for earthed-neutral systems, overvoltage category I to IV, pollution degree 3 (standard industry); U_{imp} = 8kV. Data for other conditions upon request

MC Contactors 3 Pole



Technical Datasheet

Technical Data continued acc. to IEC / EN 60947-4-1

Part Number		MC90-S-00.. + MCA..	MC115-S-00.. + MCA..
Aux Contact Ratings MCA10 (NO) MCA01 (NC)	AC1 690V I _e (=I _{th}) open at 40°C	10A	10A
	AC15, 220-240V	3A	3A
	AC15, 380-440V	2A	2A
	Fuse "Typ1" gl. (gG)	20A max.	20A max.

Technical Data acc. to UL508

Part Number			MC90	MC115
Main Contact Ratings	Rated Operational Current "General Use"		160A	200A
Motor DOL 3-Phase at 60Hz	Rated Operational Power	110-120V hp	15	20
		200V hp	25	35
		220-240V hp	35	40
		277V hp	-	-
		380-415V hp	50	60
		440-480V hp	65	75
Motor DOL 1-Phase at 60Hz	Rated Operational Power AC Motors at 60Hz (1ph)	110-120V hp	8	10
		200V hp	15	20
		220-240V hp	20	25
		277V hp	20	25
		380-415V hp	30	40
		440-480V hp	40	50
Motor DOL 3-phase acc. to ASME A17.5	Rated Operational Current	600V A	-	-
		110-120V hp	-	-
	Rated Operational Power 3-phase Motors for Elevators (500,000 Operations)	200V hp	-	-
		220-240V hp	-	-
		440-480V hp	-	-
		550-600V hp	-	-
	Rated Current 2 Series Contacts	600V A	-	-
	Fuse Class RK5 / Short-circuit current	A/kA	300/10	300/10
	Fuse Class T / Short-circuit current	A/kA	300/10*	300/10*
	Rated voltage	V	600	600
Auxiliary Contacts (cULus)			-	-

* Class T and Class RK1

Cable Cross Sections

	Contacts	Coils
Solid Strand (mm ²)	0.5 - 95.0 + 10.0 - 120.0	0.75 - 2.5
Flexible Strand (mm ²)	0.5 - 70.0 + 25.0 - 95.0	0.5 - 2.5
Solid Strand (AWG)	18 - 10	14 - 12
Flexible Strand (AWG)	-	18 - 12
Cables per Clamp	1	2
Terminal Screws	M8	M3.5
Screwdriver	4mm Allen Key	Pozidrive Pz2
Tightening Torque (Nm)	4.0 - 6.5	0.8 - 1.4
Tightening Torque (lb.inch)	35 - 57	7 - 12

Coil

	AC Operated	DC Operated
Operation Range	0.85 - 1.1	0.8 - 1.1
Inrush	165 - 220VA	250W
Sealed	2.5 - 5VA	5W

Weights & Dimensions

Single Unit (inc. packaging)	2.20kg
Dimensions	157 x 92 x 155mm

Resistance to Climatic Conditions acc. to IEC60068

Open- type devices are climate-resistant in the constant climate according to IEC60068-2-78 (this is a climate with an ambient temperature of 40°C and an atmospheric humidity of 90 to 95%). Enclosed devices are climate-resistant in an alternating climate according to IEC 68-2-30 (this is a moist alternating climate with a 24-hour cycle between climates with an ambient temperature of 25°C, and an atmospheric humidity of 95 to 100% and an ambient temperature of 40°C, and an atmospheric humidity of 90 to 96% in the presence of condensation during rises in temperature). Note: Maximum operating altitude of 2000m above sea level.

MC Contactors 3 Pole

Dimensions (mm)

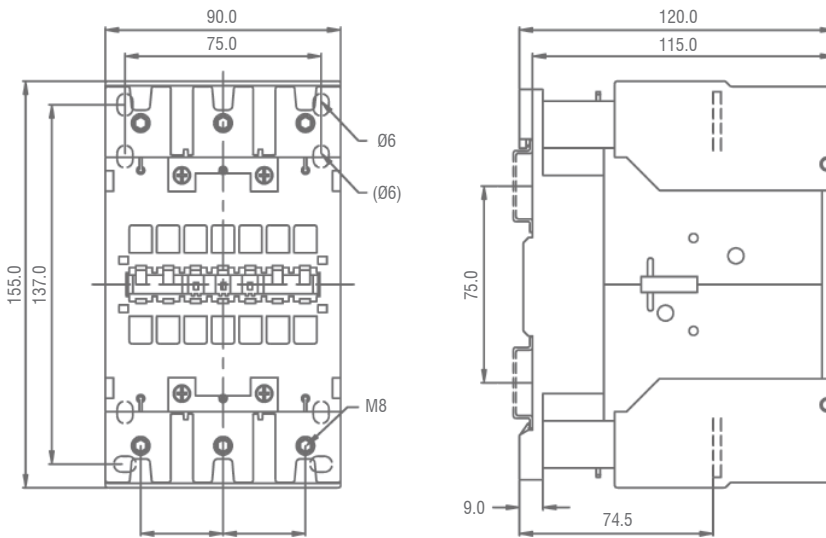

Wiring Diagrams

AC Operated

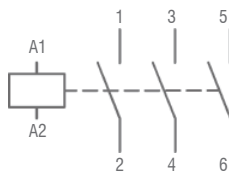

DC Operated

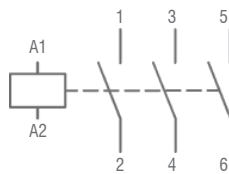

Mounting Position

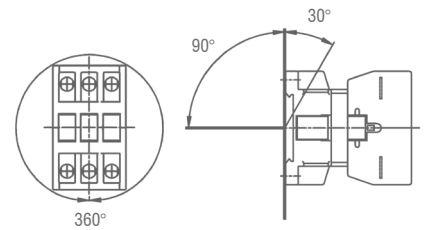

MC Contactors 3 Pole



Technical Datasheet

Key Features

- Up to 175A AC3
- Up to 300A AC1
- 3 Pole
- International Approvals
- Data according to IEC 947 / EN 60947



Options & Ordering Codes

MC 151 - S - 00 - 24

Series: Standard Contactor **MC**

AC3 Rating: 75kW / 150A **151**, 90kW / 175A **176**

Switching Type: Standard **S**

Aux. Contact Configuration: **00**

Coil Voltage: **24** (24VAC/DC), **48** (48VAC/DC), **110** (110VAC/DC), **230** (230VAC/DC), **110AC** (110VAC), **230AC** (230VAC), **400AC** (400VAC)

Technical Data acc. to IEC / EN 60947-4-1

Part Number		MC151-S-00	MC176-S-00
Main Contact Ratings	AC1 690V $I_e (=I_n)$ open at 40°C	250A	300A
	AC2, AC3, 380-440V	75kW / 150A	90kW / 175A
	AC2, AC3, 500-690V	90kW	110kW
	Fuse "Typ1" gl. (gG)	250A max.	315A max.
	Rated Insulation Voltage U_i^{*1}	1000VAC	1000VAC
	Making Capacity I_{eff} at $U_e=690V\sim$	1500A	2000A
	Making Capacity I_{eff} at $U_e=1000V\sim$	720A	840A
	Breaking Capacity I_{eff} 400V~	1200A	1500A
	Breaking Capacity $\cos\theta = 0.65$ 500V~	1200A	1500A
	Breaking Capacity $\cos\theta = 0.35$ 690V~	1000A	800A
Breaking Capacity $\cos\theta = 0.35$ 1000V~	500A	600A	
Max. Ambient Temp	Operation Open	-25 to +55°C (+70°C)*2	
	Operation Enclosed	-25 to +40°C	
	with Thermal Overload Relay Open	-25 to +55°C	
	with Thermal Overload Relay Enclosed	-25 to +40°C	
Storage	-55 to +80°C		
Frequency of Operations z Ops/hr	Switching Without Load	1200	
	AC3, I_e	300	
Switching Time at Control Voltage Us $\pm 10\%^{*3, *4}$	AC Operated	Make Time	30 - 60ms
		Release Time	30 - 80ms
	DC Operated	Make Time	30 - 60ms
		Release Time	30 - 80ms
Mech. Life	AC Operated	10 x 10 ⁶	
	DC Operated	10 x 10 ⁶	
Curr. Heat Loss	Power Loss Per Pole ($I_e/AC3$ 400V)	9W	11W
	Contact Resistance Per Pole	0.4mΩ	0.35mΩ

*1 Suitable at 690V for earthed-neutral systems, overvoltage category I to IV, pollution degree 3 (standard industry); $U_{imp}=8kV$. Data for other conditions upon request

*2 With reduced control voltage range 0.9 up to 1.0 x Us and with reduced rated current $I_e / AC1$ according to $I_e / AC3$

*3 Values for delay of the release time of the make contact and the make time of the break contact will be increased if magnet coils are protected against voltage peaks (varistor, RC unit, diode unit)

*4 Total breaking time = release time + arc duration

MC Contactors 3 Pole



Technical Datasheet

Technical Data acc. to UL508

Part Number				MC151	MC176		
Main Contact Ratings	Rated Operational Current "General Use"			180A	220A		
Motor DOL 3-Phase at 60Hz	Rated Operational Power	110-120V	hp	-	-		
		200V	hp	40	50		
		220-240V	hp	50	60		
		277V	hp	-	-		
		380-415V	hp	-	-		
		440-480V	hp	100	125		
Motor DOL 1-Phase at 60Hz	Rated Operational Power AC Motors at 60Hz (1ph)	550-600V	hp	125	150		
		110-120V	hp	15	25		
		200V	hp	-	-		
		220-240V	hp	25	30		
		277V	hp	-	-		
		380-415V	hp	-	-		
Motor DOL 3-phase acc. to ASME A17.5	Rated Operational Power 3-phase Motors for Elevators (500,000 Operations)	440-480V	hp	-	-		
		550-600V	hp	-	-		
		Rated Operational Current		600V	A	-	-
		Rated Operational Power		110-120V	hp	-	-
	Rated Current 2 Series Contacts		200V	hp	-	-	
	Fuse Class RK5 / Short-circuit current		220-240V	hp	-	-	
	Fuse Class T / Short-circuit current		440-480V	hp	-	-	
	Rated voltage		550-600V	hp	-	-	
Auxiliary Contacts (cULus)			600V	A	-	-	
			A/kA	300/10	350-10		
			A/kA	-	-		
			V	600	600		
				-	-		

Cable Cross Sections

	Contacts	Coils
Solid Strand (mm ²)	Busbar 18 x 4 screw M8	1.0 - 2.5
Flexible Strand (mm ²)		1.0 - 2.5
Solid Strand (AWG)		16 - 12
Flexible Strand (AWG)		16 - 12
Cables per Clamp		2

Coil

	AC Operated	DC Operated
Operation Range	0.85 - 1.1	0.85 - 1.1
Inrush	350VA	350W
Sealed	5W	5W

Weights & Dimensions

Single Unit (inc. packaging)	4.0kg
Dimensions	170 x 110 x 162mm

Resistance to Climatic Conditions acc. to IEC60068

Open-type devices are climate-resistant in the constant climate according to IEC60068-2-78 (this is a climate with an ambient temperature of 40°C and an atmospheric humidity of 90 to 95%). Enclosed devices are climate-resistant in an alternating climate according to IEC 68-2-30 (this is a moist alternating climate with a 24-hour cycle between climates with an ambient temperature of 25°C, and an atmospheric humidity of 95 to 100% and an ambient temperature of 40°C, and an atmospheric humidity of 90 to 96% in the presence of condensation during rises in temperature). Note: Maximum operating altitude of 2000m above sea level.

Dimensions (mm)

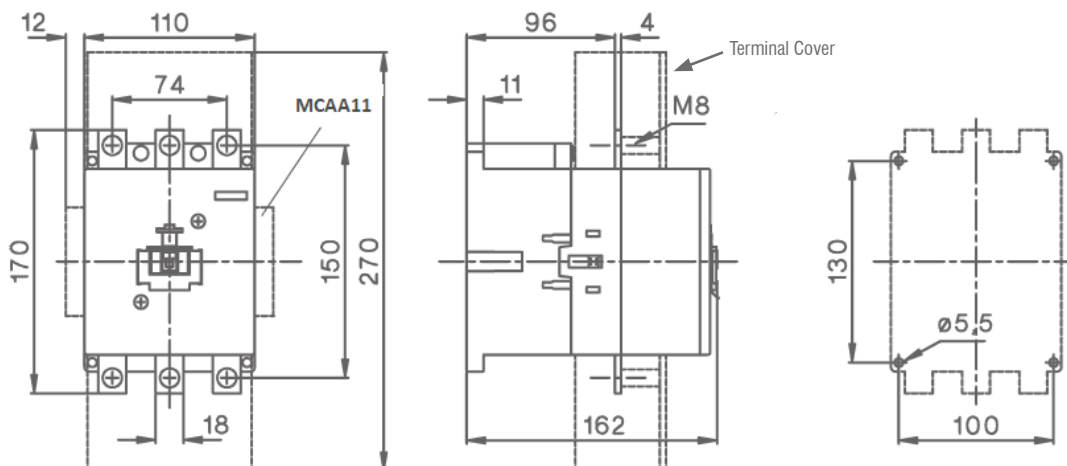

MC Contactors 3 Pole



Technical Datasheet

Key Features

- Up to 315A AC3
- Up to 600A AC1
- 3 Pole
- International Approvals
- Data according to IEC 947 / EN 60947



Options & Ordering Codes

MC 210 - S - 00 - 24

Series	Standard Contactor	MC
AC3 Rating	110kW / 210A	210
	132kW / 260A	260
	160kW / 315A	316
Switching Type	Standard	S
Aux. Contact Configuration	00	
Coil Voltage	24	24VAC/DC
	48	48VAC/DC
	110	110VAC/DC
	230	230VAC/DC
	400AC	400VAC

Technical Data acc. to IEC / EN 60947-4-1

Part Number		MC210-S-00	MC260-S-00	MC316-S-00
Main Contact Ratings	AC1 690V $I_e (=I_n)$ open at 40°C	350A	450A	600A
	AC2, AC3, 380-440V	110kW / 210A	132kW / 260A	160kW / 315A
	AC2, AC3, 500-690V	132kW	160kW	210kW
	Fuse "Typ1" gl. (gG)	400A max.	450A max.	500A max.
	Rated Insulation Voltage U_i^{*1}	1000VAC		
	Making Capacity I_{eff} at $U_e=690V\sim$	2100A	2600A	3200A
	Making Capacity I_{eff} at $U_e=1000V\sim$	1020A	1200A	1500A
	Breaking Capacity I_{eff} 400V~	1600A	2100A	2600A
	Breaking Capacity $\cos\theta = 0.65$ 500V~	1600A	2100A	2600A
	Breaking Capacity $\cos\theta = 0.35$ 690V~	1200A	1900A	2300A
Breaking Capacity $\cos\theta = 0.35$ 1000V~	700A	850A	1000A	
Max. Ambient Temp	Operation Open	-25 to +55°C (+70°C)*2		
	Operation Enclosed	-25 to +40°C		
	with Thermal Overload Relay Open	-25 to +55°C		
	with Thermal Overload Relay Enclosed	-25 to +40°C		
	Storage	-55 to +80°C		
Frequency of Operations z Ops/hr	Switching Without Load	1200		
	AC3, I_e	150		
Switching Time at Control Voltage $U_c \pm 10\%^{*2, *3}$	AC Operated	Make Time	40 - 60ms	
		Release Time	15 - 45ms	
	DC Operated	Make Time	40 - 60ms	
		Release Time	15 - 45ms	
Mech. Life	AC Operated	5 x 10 ⁶		
	DC Operated	5 x 10 ⁶		
Curr. Heat Loss	Power Loss Per Pole ($I_e/AC3$ 400V)	8W	11W	14.9W
	Contact Resistance Per Pole	0.18mΩ	0.16mΩ	0.15mΩ

*1 Suitable at 690V for earthed-neutral systems, overvoltage category I to IV, pollution degree 3 (standard industry); $U_{imp} = 8kV$. Data for other conditions upon request

*2 With reduced control voltage range 0.9 up to 1.0 x U_c and with reduced rated current $I_e / AC1$ according to $I_e / AC3$

MC Contactors 3 Pole



Technical Datasheet

Technical Data acc. to UL508

Part Number				MC210	MC260	MC316
Main Contact Ratings	Rated Operational Current "General Use"			250A	300A	350A
Motor DOL 3-Phase at 60Hz	Rated Operational Power	110-120V	hp	-	-	-
		200V	hp	60	75	100
		220-240V	hp	75	100	125
		277V	hp	-	-	-
		380-415V	hp	-	-	-
		440-480V	hp	150	200	250
		550-600V	hp	200	250	300
Motor DOL 1-Phase at 60Hz	Rated Operational Power AC Motors at 60Hz (1ph)	110-120V	hp	-	-	-
		200V	hp	-	-	-
		220-240V	hp	40	50	50
		277V	hp	-	-	-
		380-415V	hp	-	-	-
		440-480V	hp	-	-	-
		550-600V	hp	-	-	-
Motor DOL 3-phase acc. to ASME A17.5	Rated Operational Current	600V	A	-	-	-
	Rated Operational Power 3-phase Motors for Elevators (500,000 Operations)	110-120V	hp	-	-	-
		200V	hp	-	-	-
		220-240V	hp	-	-	-
		440-480V	hp	-	-	-
		550-600V	hp	-	-	-
	Rated Current 2 Series Contacts	600V	A	-	-	-
	Fuse Class RK5 / Short-circuit current		A/kA	400/18	500/18	500/18
Fuse Class T / Short-circuit current		A/kA	-	-	-	
Rated voltage		V	600	600	600	
Auxiliary Contacts (cULus)				-	-	-

Cable Cross Sections

	Contacts	Coils
Solid Strand (mm ²)	Busbar 25 x 6 screw M10	1.0 - 2.5
Flexible Strand (mm ²)		1.0 - 2.5
Solid Strand (AWG)		16 - 12
Flexible Strand (AWG)		16 - 12
Cables per Clamp		2

Coil

	AC Operated	DC Operated
Operation Range	0.85 - 1.1	0.85 - 1.1
Inrush	360VA	360W
Sealed	5W	5W

Weights & Dimensions

Single Unit (inc. packaging)	7.2kg
Dimensions	200 x 145 x 208mm

Resistance to Climatic Conditions acc. to IEC60068

Open-type devices are climate-resistant in the constant climate according to IEC60068-2-78 (this is a climate with an ambient temperature of 40°C and an atmospheric humidity of 90 to 95%). Enclosed devices are climate-resistant in an alternating climate according to IEC 68-2-30 (this is a moist alternating climate with a 24-hour cycle between climates with an ambient temperature of 25°C, and an atmospheric humidity of 95 to 100% and an ambient temperature of 40°C, and an atmospheric humidity of 90 to 96% in the presence of condensation during rises in temperature). Note: Maximum operating altitude of 2000m above sea level.

Dimensions (mm)

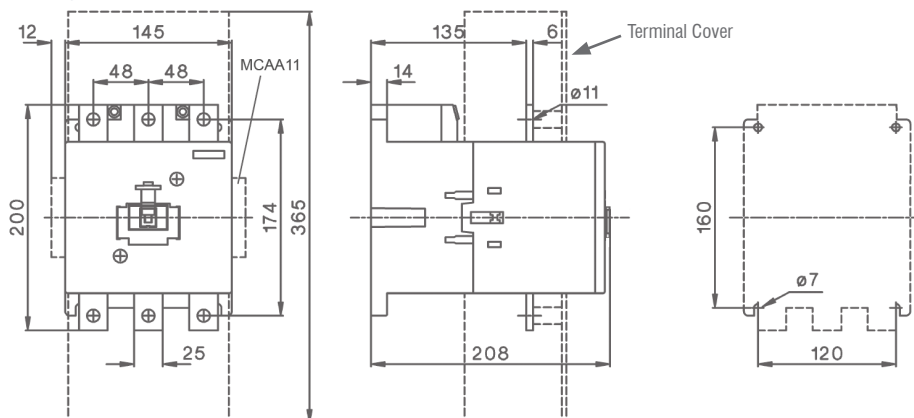

MC Contactors 3 Pole



Key Features

- Up to 860A AC3
- Up to 1100A AC1
- 3 Pole
- International Approvals
- Data according to IEC 947 / EN 60947



Options & Ordering Codes

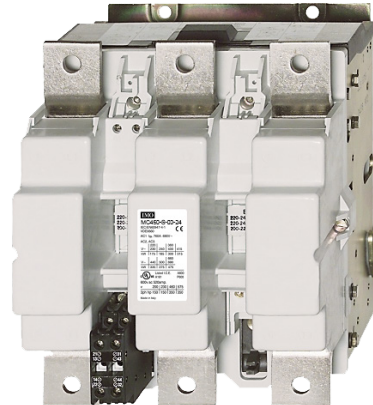

MC 450 - S - 22 - 24

Series
Standard Contactor **MC**

AC3 Rating	
250kW / 450A	450
300kW / 550A	550
400kW / 700A	700
500kW / 860A	860

Switching Type
Standard **S**

Aux. Contact Configuration
22 2NO + 2NC

Coil Voltage	
24	24VAC/DC
48	48VAC/DC
110	110VAC/DC
230	230VAC/DC
400AC	400VAC

Technical Data acc. to IEC / EN 60947-4-1

Part Number	MC450-S-00	MC550-S-00	MC700-S-00	MC860-S-00	
Main Contact Ratings	AC1 690V I _e (=I _{th}) open at 40°C	700A	800A	1000A	1100A
	AC2, AC3, 380-440V	250kW / 450A	300kW / 550A	400kW / 700A	500kW / 860A
	AC2, AC3, 500-(600-690V)	300/375kW	325/500kW	500/630kW	600/700kW
	Fuse "Typ1" gl. (gG)	630A max.	630A max.	800A max.	1000A max.
	Rated Insulation Voltage U _i *1	1000VAC		690VAC	
	Making Capacity I _{eff} at U _e =690V~	4500A	5500A	7000A	8600A
	Making Capacity I _{eff} at U _e =1000V~	2400A	3000A	-	-
	Breaking Capacity I _{eff} 400V~	4500A	5500A	7000A	8000A
	Breaking Capacity cosθ = 0.65 500V~	4500A	5500A	7000A	8000A
	Breaking Capacity cosθ = 0.35 690V~	3200A	4400A	5600A	6900A
Breaking Capacity cosθ = 0.35 1000V~	-	-	-	-	
Max. Ambient Temp	Operation Open	-25 to +55°C (+70°C)*2			
	Operation Enclosed	-25 to +40°C			
	with Thermal Overload Relay Open	-25 to +55°C			
	with Thermal Overload Relay Enclosed	-25 to +40°C			
	Storage	-55 to +80°C			
Frequency of Operations z Ops/hr	Switching Without Load	1200			
	AC3, I _e	50			
	AC4, I _e	25			
Switching Time at Control Voltage Us ±10%*2,*3	AC Operated	Make Time	50 - 100ms		
		Release Time	150 - 200ms / 500 - 1000ms *3		
Mech. Life	AC Operated	5 x 10 ⁶			
	DC Operated	5 x 10 ⁶			
Curr. Heat Loss	Power Loss Per Pole (I _e /AC3 400V)	26.3W	33.3W	49.0W	59.2W

*1 Suitable at 690V for earthed-neutral systems, overvoltage category I to IV, pollution degree 3 (standard industry): U_{imp} = 8kV. Data for other conditions upon request

*2 With reduced control voltage range 0.9 up to 1.0 x U_s and with reduced rated current I_e / AC1 according to I_e / AC3

*3 Normal or delayed drop is adjustable

MC Contactors 3 Pole



Technical Datasheet

Technical Data acc. to UL508

Part Number				MC450	MC550	MC700	MC860
Main Contact Ratings	Rated Operational Current "General Use"			420A	520A	700A	810A
Motor DOL 3-Phase at 60Hz	Rated Operational Power	110-120V	hp	-	-	-	-
		200V	hp	125	150	200	250
		220-240V	hp	125	150	250	300
		277V	hp	-	-	-	-
		380-415V	hp	-	-	-	-
		440-480V	hp	250	350	500	600
		550-600V	hp	250	350	500	600
Motor DOL 1-Phase at 60Hz	Rated Operational Power AC Motors at 60Hz (1ph)	110-120V	hp	-	-	-	-
		200V	hp	-	-	-	-
		220-240V	hp	-	-	-	-
		277V	hp	-	-	-	-
		380-415V	hp	-	-	-	-
		440-480V	hp	-	-	-	-
		550-600V	hp	-	-	-	-
Motor DOL 3-phase acc. to ASME A17.5	Rated Operational Current		600V	A	-	-	-
	Rated Operational Power 3-phase Motors for Elevators (500,000 Operations)	110-120V	hp	-	-	-	-
		200V	hp	-	-	-	-
		220-240V	hp	-	-	-	-
		440-480V	hp	-	-	-	-
		550-600V	hp	-	-	-	-
	Rated Current 2 Series Contacts		600V	A	-	-	-
	Fuse Class RK5 / Short-circuit current			A/kA	1200/18	1200/18	2000/30
Fuse Class T / Short-circuit current			A/kA	-	-	-	-
Rated voltage			V	600	600	600	600
Auxiliary Contacts (cULus)				A600	A600	A600	A600

Cable Cross Sections

	Contacts				Coils
	MC450	MC550	MC700	MC860	
Solid Strand (mm ²)	Busbar 30 x 5 screw M12	Busbar 40 x 6 screw M12	Busbar 50 x 8 screw M12	Busbar 50 x 8 screw M14	1.0 - 2.5
Flexible Strand (mm ²)					1.0 - 2.5
Solid Strand (AWG)					16 - 12
Flexible Strand (AWG)					16 - 12
Cables per Clamp					2

Coil

	AC Operated				DC Operated		
	MC450	MC550	MC700	MC860	MC450	MC550	MC700
Operation Range	0.85 - 1.1						
Inrush	800 - 950VA		1350 - 1600VA		700 - 850W		1300 - 1550W
Sealed	9 - 11W		21 - 25W		8 - 10W		18 - 22W

Weights & Dimensions

	MC450	MC550	MC700	MC860
Single Unit (inc. packaging)	13.0kg	13.5kg	26.5kg	27.6kg

Resistance to Climatic Conditions acc. to IEC60068

Open-type devices are climate-resistant in the constant climate according to IEC60068-2-78 (this is a climate with an ambient temperature of 40°C and an atmospheric humidity of 90 to 95%). Enclosed devices are climate-resistant in an alternating climate according to IEC 68-2-30 (this is a moist alternating climate with a 24-hour cycle between climates with an ambient temperature of 25°C, and an atmospheric humidity of 95 to 100% and an ambient temperature of 40°C, and an atmospheric humidity of 90 to 96% in the presence of condensation during rises in temperature). Note: Maximum operating altitude of 2000m above sea level.

MC Contactors 3 Pole



Technical Datasheet

Dimensions (mm)

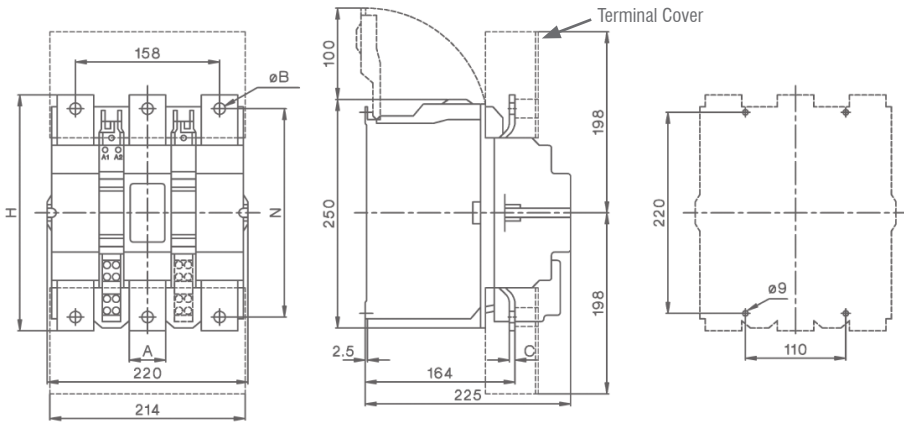

Type	A	B	C	H	N
MC450	40	10.5	4	233	206
MC550	40	12.5	6	258	228

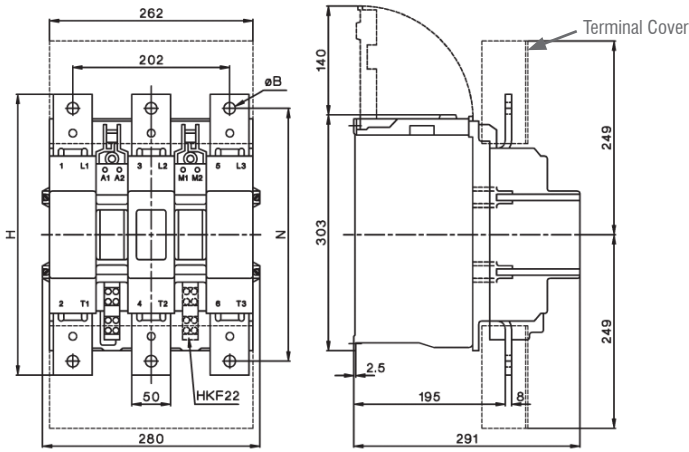

Type	B	H	N
MC700	13	310	277
MC860	15	361	325

MC Contactors 3 Pole



Key Features

- Up to 1200A AC3
- Up to 1350A AC1
- 3 Pole
- International Approvals
- Data according to IEC 947 / EN 60947

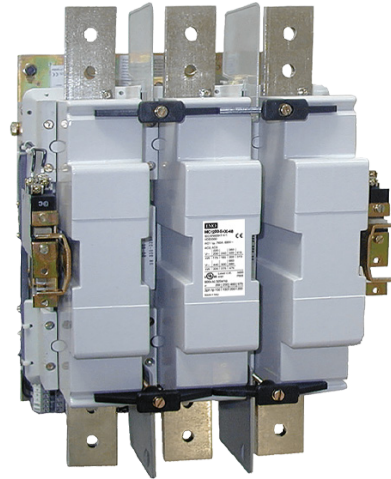

Technical Datasheet

Options & Ordering Codes

MC 1000 - S - 12 - 110

Series	Standard Contactor	MC
AC3 Rating	580kW / 1000A	1000
	680kW / 1200A	1200
Switching Type	Standard	S
Aux. Contact Configuration	12	1NO + 2NC
Coil Voltage	110	110VAC
	230	230VAC
	400	400VAC
	440	440VAC

Technical Data acc. to IEC / EN 60947-4-1

Part Number	MC1000-S-12	MC1200-S-12	
Main Contact Ratings	AC1 690V $I_e (=I_{th})$ open at 40°C	1200A	1350A
	AC2, AC3, 380-440V	580kW / 1000A	680kW / 1200A
	AC2, AC3, 500-(600-690V)	720/850kW	850/1000kW
	Fuse "Typ1" gl. (gG)	1000A max.	1250A max.
	Rated Insulation Voltage U_i^{*1}	690VAC	
	Making Capacity I_{eff} at $U_e=690V\sim$	10000A	12000A
	Making Capacity I_{eff} at $U_e=1000V\sim$	-	-
	Breaking Capacity I_{eff} 400V~	8000A	10000A
	Breaking Capacity $\cos\theta = 0.65$ 500V~	8000A	10000A
Breaking Capacity $\cos\theta = 0.35$ 690V~	7000A	8000A	
Breaking Capacity $\cos\theta = 0.35$ 1000V~	-	-	
Max. Ambient Temp	Operation Open	-25 to +55°C (+70°C)*2	
	Operation Enclosed	-25 to +40°C	
	with Thermal Overload Relay Open	-25 to +55°C	
	with Thermal Overload Relay Enclosed	-25 to +40°C	
	Storage	-55 to +80°C	
Frequency of Operations z	Switching Without Load	300	
	AC3, I_e	20	
Switching Time at Control Voltage $U_s \pm 10\%^{*2,*3}$	AC Operated	Make Time	50 - 100ms
		Release Time	25 - 50ms
Mech. Life	AC Operated	$5 \times 10^6^{*4}$	
	DC Operated	$5 \times 10^6^{*4}$	
Cur. Heat Loss	Power Loss Per Pole (I_e /AC3 400V)	60W	72W

*1 Suitable at 690V for earthed-neutral systems, overvoltage category I to IV, pollution degree 3 (standard industry); $U_{imp} = 8kV$. Data for other conditions upon request
 *2 With reduced control voltage range 0.9 up to 1.0 x U_s and with reduced rated current I_e / AC1 according to I_e / AC3
 *3 Normal or delayed drop is adjustable
 *4 After each 1x106 operations magnetic core and built-in auxiliary contact block must be changed

MC Contactors 3 Pole



Technical Datasheet

Technical Data acc. to UL508

Part Number				MC1000	MC1200
Main Contact Ratings	Rated Operational Current "General Use"			-	1215A
Motor DOL 3-Phase at 60Hz	Rated Operational Power	110-120V	hp	-	-
		200V	hp	-	450
		220-240V	hp	-	450
		277V	hp	-	-
		380-415V	hp	-	-
		440-480V	hp	-	900
		550-600V	hp	-	900
Motor DOL 1-Phase at 60Hz	Rated Operational Power AC Motors at 60Hz (1ph)	110-120V	hp	-	-
		200V	hp	-	-
		220-240V	hp	-	-
		277V	hp	-	-
		380-415V	hp	-	-
		440-480V	hp	-	-
		550-600V	hp	-	-
Motor DOL 3-phase acc. to ASME A17.5	Rated Operational Current	600V	A	-	-
	Rated Operational Power 3-phase Motors for Elevators (500,000 Operations)	110-120V	hp	-	-
		200V	hp	-	-
		220-240V	hp	-	-
		440-480V	hp	-	-
		550-600V	hp	-	-
	Rated Current 2 Series Contacts	600V	A	-	-
	Fuse Class RK5 / Short-circuit current		A/kA	-	2000/42
Fuse Class T / Short-circuit current		A/kA	-	-	
Rated voltage		V	-	600	
Auxiliary Contacts (cULus)				-	A600

Cable Cross Sections

	Contacts	Coils
Solid Strand (mm ²)	Busbar 50 x 10 screw 2 x M12	1.0 - 2.5
Flexible Strand (mm ²)		1.0 - 2.5
Solid Strand (AWG)		16 - 12
Flexible Strand (AWG)		16 - 12
Cables per Clamp		2

Coil

	AC Operated	DC Operated
Operation Range	0.85 - 1.1	0.85 - 1.1
Inrush	2400VA	2100W
Sealed	70W	60W

Weights & Dimensions

	MC1000	MC1200
Single Unit (inc. packaging)	49.0kg	53.0kg

Resistance to Climatic Conditions acc. to IEC60068

Open-type devices are climate-resistant in the constant climate according to IEC60068-2-78 (this is a climate with an ambient temperature of 40°C and an atmospheric humidity of 90 to 95%). Enclosed devices are climate-resistant in an alternating climate according to IEC 68-2-30 (this is a moist alternating climate with a 24-hour cycle between climates with an ambient temperature of 25°C, and an atmospheric humidity of 95 to 100% and an ambient temperature of 40°C, and an atmospheric humidity of 90 to 96% in the presence of condensation during rises in temperature). Note: Maximum operating altitude of 2000m above sea level.

Dimensions (mm)

