

DIN Timers TDM10



- Multi-function time delay
- Multi-time range
- Compact design
- Universal voltage input 24~300V AC/DC
- Single module size

Specification

	TDM10
Operating Voltage	24..300V AC/DC
Operating Frequency	50 .. 60Hz
Adjustable values / Time Range	1s / 1 second
	10s / 10 second
	100s / 100 second
	1m / 1 minute
	10m / 10 minute
	1h / 1 hour
	10h / 10 hour
	100h / 100 hour
	1d / 1 day
	10d / 10 day
Multiplier	0.1 - 0.2 - 0.3 - 0.4 - 0.5 - 0.6 - 0.7 - 0.8 - 0.9 - 1
Output Contact	1 C/O 10A, 250VAC
Operating Temperature	-25°C .. 70°C
Storage Temperature	-40°C .. 85°C
Protection Class	IP20
Connection	Rail mounts

Dimensions (mm)

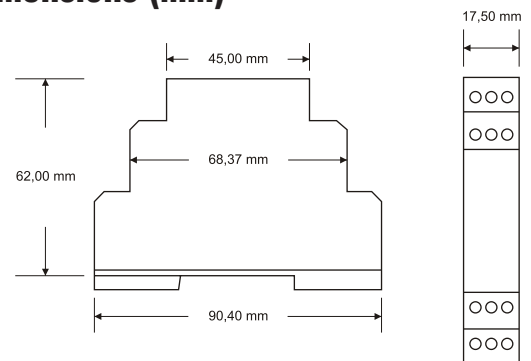

Time Settings

Time range selector switch selects full scale time range. The t multiplier selector switch provides fine adjustment of time value, t, within the full scale time range. Selector switch positions are latched upon startup to avoid accidental changes during operation. Therefore changing selector switch positions have no effect when the device is operational. The below example shows how to set a t value.

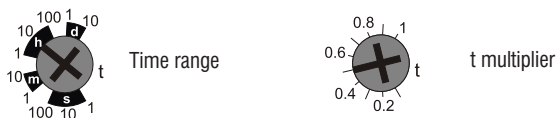

In the above figure: $t = 10h \times 0.5 = 5 \text{ hour}$

Note: All the pot values are digitalised. Cannot be set to mid values.

Connections

Power Input

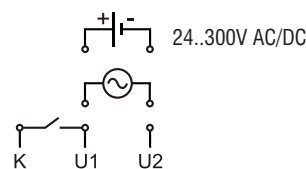

Relay

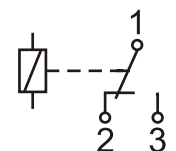

Mode functions

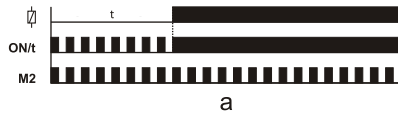

A On Delay

The output relay is initially de-energised after an adjustable time delay, t .

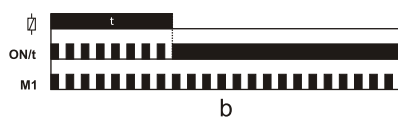

B Off delay

The output relay is initially energised and de-energised after an adjustable time delay, t .

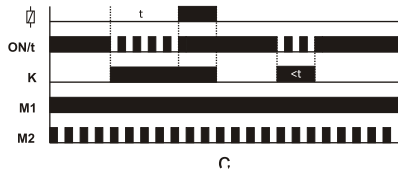

C On-delay with control input

The output relay is initially de-energised. A contact closure on K input triggers an adjustable time delay, t , which energises the output relay when expired. The output relay stays energised as long as the K input is active. Delay time, t , is cleared when the contact on K input opens.

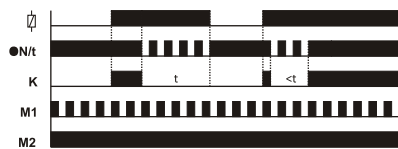

D Off delay with control input

The output relay is initially de-energised and energised when a contact closure on K input is detected. A contact release on K input triggers an adjustable time delay, t , which de-energises the output relay when expired. Reclosure of the contact on K input before the time delay is expired restarts time delay, t , and keeps the output relay energised.

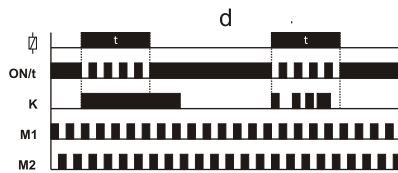

E Rising edge triggered Off delay

The output relay is initially de-energised. A contact closure on K input both energised the output relay and triggers an adjustable time delay, t , which de-energises the output relay when expired. During the time delay, K input is insensitive to state changes and becomes sensitive when time delay, t , expired.

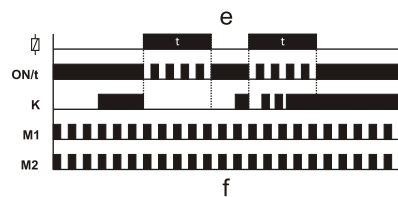

F Falling edge triggered Off delay

The output relay is initially de-energised. A state change of the contact on K input from closed to open both energises the output relay and triggers an adjustable time delay, t , which de-energises the output relay when expired. During the time delay, K input is insensitive to state changes and becomes sensitive when time delay t , expired.

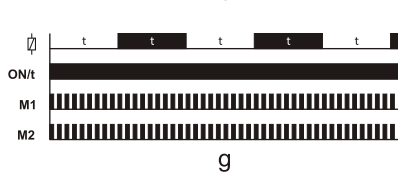

G Off flasher

The output relay is initially de-energised and energised after an adjustable time delay, t , and stays energised for the period, t , and the de-energised. This loop is repeated until the device is powered off.

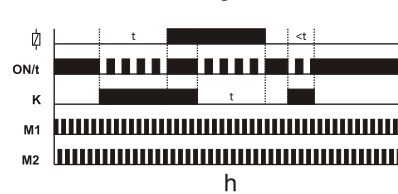

H On and Off delay with control input

The output relay is initially de-energised. A contact closure on K input triggers an adjustable time delay, t , which energises the output relay when expired. Similarly contact release of K input triggers the time delay, t , which de-energises the output relay when expired. Delay time, t , is cleared when the contact state of K input changes.

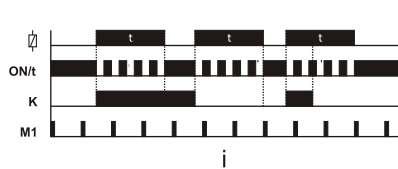

I Adjustable pulse output with control input

The output relay is initially de-energised. A state change on K input both energises the output relay and triggers an adjustable time delay, t , which de-energises the output relay when expired. During the time delay, K input is insensitive to state changes and becomes sensitive when time delay, t , expired.

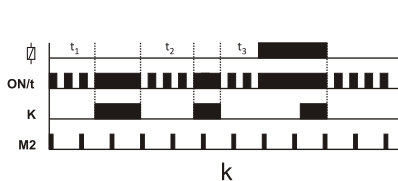

K On delay with memory

The output relay is initially de-energised. If K input is open, adjustable time delay, t , counts down and output relay energises when t is expired. Any contact closure on K input pauses the count down process, and the process continues when the contact release on K input occurs. A contact release is needed to restart the cycle, after the output relay is energised.

$$t = t_1 + t_2 + t_3$$

■ On
□ Off