



Main catalog

Motor protection and control

Manual motor starters, A9 ... A300 contactors and overload relays

Motor rated operational powers and currents

The currents given below concern standard three-phase four-pole cage motors (1500 r.p.m. at 50 Hz 1800 r.p.m. at 60 Hz). These values are given for guidance and may vary according to the motor manufacturer and depending on the number of poles.

IEC Motor power kW	Motor nominal current: standardized values in blue colour (according to IEC 60947-4-1 Annex G)									
	220 V A	230 V A	240 V A	380 V A	400 V A	415 V A	440 V A	500 V A	660 V A	690 V A
0.06	0.37	0.35	0.34	0.21	0.2	0.19	0.18	0.16	0.13	0.12
0.09	0.54	0.52	0.50	0.32	0.3	0.29	0.26	0.24	0.18	0.17
0.12	0.73	0.7	0.67	0.46	0.44	0.42	0.39	0.32	0.24	0.23
0.18	1	1	1	0.63	0.6	0.58	0.53	0.48	0.37	0.35
0.25	1.6	1.5	1.4	0.9	0.85	0.82	0.74	0.68	0.51	0.49
0.37	2.0	1.9	1.8	1.2	1.1	1.1	1	0.88	0.67	0.64
0.55	2.7	2.6	2.5	1.6	1.5	1.4	1.3	1.2	0.91	0.87
0.75	3.5	3.3	3.2	2.0	1.9	1.8	1.7	1.5	1.15	1.1
1.1	4.9	4.7	4.5	2.8	2.7	2.6	2.4	2.2	1.7	1.6
1.5	6.6	6.3	6	3.8	3.6	3.5	3.2	2.9	2.2	2.1
2.2	8.9	8.5	8.1	5.2	4.9	4.7	4.3	3.9	2.9	2.8
3	11.8	11.3	10.8	6.8	6.5	6.3	5.7	5.2	4	3.8
4	15.7	15	14.4	8.9	8.5	8.2	7.4	6.8	5.1	4.9
5.5	20.9	20	19.2	12.1	11.5	11.1	10.1	9.2	7	6.7
7.5	28.2	27	25.9	16.3	15.5	14.9	13.6	12.4	9.3	8.9
11	39.7	38	36.4	23.2	22	21.2	19.3	17.6	13.4	12.8
15	53.3	51	48.9	30.5	29	28	25.4	23	17.8	17
18.5	63.8	61	58.5	36.8	35	33.7	30.7	28	22	21
22	75.3	72	69	43.2	41	39.5	35.9	33	25.1	24
30	100	96	92	57.9	55	53	48.2	44	33.5	32
37	120	115	110	69	66	64	58	53	40.8	39
45	146	140	134	84	80	77	70	64	49.1	47
55	177	169	162	102	97	93	85	78	59.6	57
75	240	230	220	139	132	127	116	106	81	77
90	291	278	266	168	160	154	140	128	97	93
110	355	340	326	205	195	188	171	156	118	113
132	418	400	383	242	230	222	202	184	140	134
160	509	487	467	295	280	270	245	224	169	162
200	637	609	584	368	350	337	307	280	212	203
250	782	748	717	453	430	414	377	344	261	250
315	983	940	901	568	540	520	473	432	327	313
355	1109	1061	1017	642	610	588	535	488	370	354
400	1255	1200	1150	726	690	665	605	552	418	400
500	1545	1478	1416	895	850	819	745	680	515	493
560	1727	1652	1583	1000	950	916	832	760	576	551
630	1928	1844	1767	1116	1060	1022	929	848	643	615
710	2164	2070	1984	1253	1190	1147	1043	952	721	690
800	2446	2340	2243	1417	1346	1297	1179	1076	815	780
900	2760	2640	2530	1598	1518	1463	1330	1214	920	880
1000	3042	2910	2789	1761	1673	1613	1466	1339	1014	970

UL / CSA Motor power hp	Motor nominal current: standardized values (according to IEC 60947-4-1 Annex G and UL 508)				
	208 V A	220-240 V A	380-415 V A	440-480 V A	550-600 V A
1/2	2.4	2.2	1.3	1.1	0.9
3/4	3.5	3.2	1.8	1.6	1.3
1	4.6	4.2	2.3	2.1	1.7
1-1/2	6.6	6	3.3	3	2.4
2	7.5	6.8	4.3	3.4	2.7
3	10.6	9.6	6.1	4.8	3.9
5	16.7	15.2	9.7	7.6	6.1
7-1/2	24.2	22	14	11	9
10	30.8	28	18	14	11
15	46.2	42	27	21	17
20	59.4	54	34	27	22
25	74.8	68	44	34	27
30	88	80	51	40	32
40	114	104	66	52	41
50	143	130	83	65	52
60	169	154	103	77	62
75	211	192	128	96	77
100	273	248	165	124	99
125	343	312	208	156	125
150	396	360	240	180	144
200	528	480	320	240	192
250	-	604	403	302	242
300	-	722	482	361	289
350	-	828	560	414	336
400	-	954	636	477	382
450	-	1030	-	515	412
500	-	1180	786	590	472

Motor protection and control

Manual motor starters, contactors and overload relays

Overview

1

Manual motor starters

2

A contactors and N contactor relays

3

Thermal overload relays

4

General technical data

5

Index

6

You can access to more product details, click on the order code

A9 ... A16 3-pole contactors
4 to 7.5 kW
AC operated

Description
A9 ... A16 contactors are mainly used for controlling 3-phase motors and power circuits up to 690 V AC or 220 V DC.
These contactors are of the block type design with:
- 3 main poles and 1 built-in auxiliary contact
- control circuit: AC operated
- add-on auxiliary contact blocks for front or side mounting and a wide range of accessories.

Ordering details

EC	UL/CSA	Rated control circuit voltage (Uc)	Auxiliary contacts (front)	Type	Order code	Weight (kg)
4	25	5	21	24	24	
		48	48			
		110	110...120			
		220...230	220...240			
		230...240	240...260			
		380...400	400...415			
		400...415	415...440			

Order codes:
1SBL141001R8110
1SBL141001R8101
1SBL141001R8310
1SBL141001R8301
1SBL141001R8310
1SBL141001R8301

Connect to

Block Contactors

Overview | Data | Contacts

A9-30-10 48V 50Hz / 48V 60Hz

[Print View](#)
[Print to Pdf](#)
[Downloads](#)

General Information

Extended Product Type: A9-30-10 48V 50Hz / 48V 60Hz
Product ID: 1SBL141001R8310
EAN: 3471522031639
Catalog Description: A9-30-10 48V 50Hz / 48V 60Hz Contactor
Long Description: A 9 contactors are mainly used for controlling 3-phase motors and generally for controlling power circuits up to 690 V AC or 220 V DC. The contactors can also be used for many other applications such as isolation, capacitor switching, lighting.
The A... series 1-stack 3-pole contactors are of the block type design.
- Main poles and auxiliary contact blocks: 3 main poles, 1 built-in auxiliary contact, front and side-mounted add-on auxiliary contact blocks
- Control circuit: AC operated with laminated magnet circuit
- Accessories: a wide range of accessories is available.

3-pole contactors, for motor control and power switching

1



IEC (1)	AC-3 Rated operational power	$\theta \leq 55^\circ\text{C}$, 400 V	kW	4	5.5	7.5	11	15	18.5
UL/CSA	3-phase motor rating	480 V	hp	5	7.5	10	20	25	30
AC Control supply		Type		A9	A12	A16	A26	A30	A40
IEC	AC-3 Rated operational current	$\theta \leq 55^\circ\text{C}$, 400 V	A	9	12	17	26	32	37
	AC-1 Rated operational current	$\theta \leq 40^\circ\text{C}$, 690 V	A	25	27	30	45	55	60
UL/CSA	General use rating	600 V	A	21	25	30	40	50	60
NEMA	NEMA Size			00	0	—	1	1P	—

(1) 1000 V IEC ratings available for A50 ... A300 contactors.

Main accessories

Auxiliary contact blocks	Front mounting	CA5-10 (1 x N.O.) CA5-01 (1 x N.C.)		
	Side mounting	CAL5-11 (1 x N.O. + 1 x N.C.)		
Timers	Electronic	TEF5-ON TEF5-OFF TE5S (for star-delta starters - direct timing - separate mounting)		
		Interlocking units	Mechanical	VM5-1
		Mechanical / Electrical	VE5-1	
Surge suppressors	Varistor (AC/DC)	RV5 (24...440 V)		
	RC Type (AC)	RC5-1 (24...440 V)		

Overload relays

Thermal relays	Class 10A (Class 10A or 20 for TA80DU) (Class 30 for TA450SU)	TA25DU-M (0.10...32 A)
		TA42DU-M (18...42 A)



Manual motor starters

	Thermal / magnetic protection Class 10	MS116 (0.10...32 A) lcs up to 50 kA for class 10 A	MS450 (28...50 A) lcs up to 50 kA
	Magnetic only types	MS132 (0.10...32 A) lcs up to 100 kA	MS497 (22...100 A) lcs up to 100 kA
MO132 (0.16...32 A) lcs up to 100 kA		MO496 (32...100 A) lcs up to 100 kA	
		MO450 (40...50 A) lcs up to 50 kA	

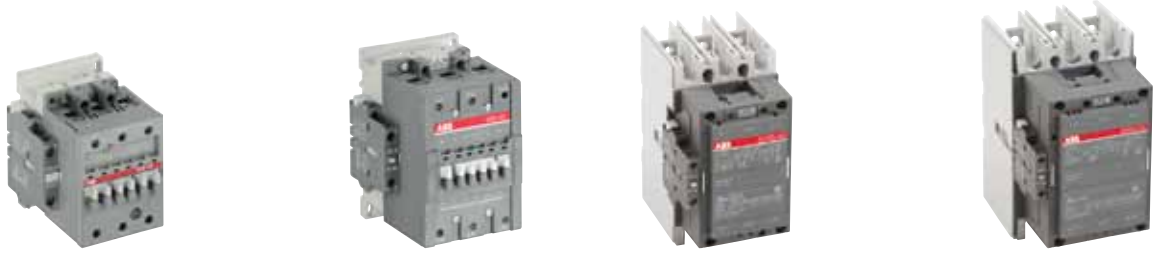

22	30	37	45	55	75	90	110	140	160
40	60	60	60	75	100	125	150	200	250
A50	A63	A75	A95	A110	A145	A185	A210	A260	A300
50	65	75	96	110	145	185	210	260	305
100	115	125	145	160	250	275	350	400	500
80	90	105	125	150	230	250	300	350	400
2	—	3	—	—	4	—	—	5	—

		CAL18-11 (1 x N.O. + 1 x N.C.)	
VE5-2		VM300H VM300V	
RC5-2 (24...440 V)		RC5-3 (250...440 V)	

TA75DU-M (18...80 A)	TA80DU (29...80 A) TA110DU (66...110 A)	TA200DU (66...200 A)	TA450DU (130...310 A) TA450SU (40...310 A)
-----------------------------	--	-----------------------------	---

Short-circuit protection devices

Tmax Circuit breaker and accessories

MS495 (45...100 A) Ics up to 50 kA	MO495 (63...100 A) Ics up to 50 kA
--	--



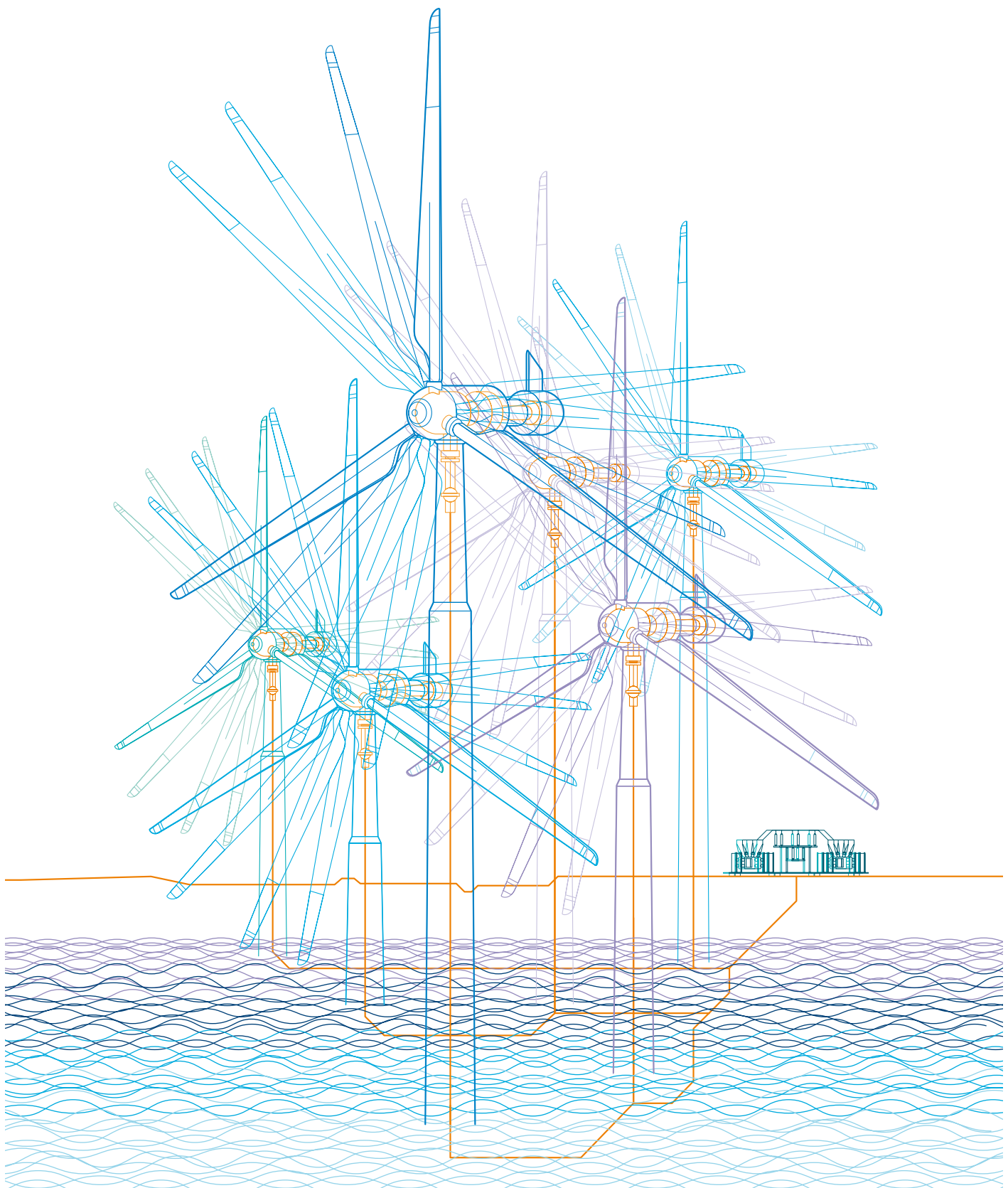

4-pole contactors



IEC	AC-1 Rated operational current	$\theta \leq 40\text{ }^{\circ}\text{C}$, 690 V	A	25	30	45	70	100	125
UL/CSA	General use rating	600 V	A	21	30	40	65	80	105
AC Control supply			Type	A9	A16	A26	A45	A50	A75
IEC	AC-1 Rated operational current	$\theta \leq 40\text{ }^{\circ}\text{C}$	A	25	30	45	70	100	125
		$\theta \leq 55\text{ }^{\circ}\text{C}$	A	22	27	40	60	85	105
		$\theta \leq 70\text{ }^{\circ}\text{C}$	A	18	23	32	50	70	85
	With conductor cross sectional area		mm ²	2.5	4	6	25	35	50
	Rated operational voltage Ue max.		V	690	690	690	1000	1000	1000

Main accessories

Auxiliary contact blocks	Front mounting	CA5-10 (1 x N.O.) CA5-01 (1 x N.C.)
	Side mounting	CAL5-11 (1 x N.O. + 1 x N.C.)
Timers	Electronic	TEF5-ON TEF5-OFF
		TE5S (for star-delta starters - direct timing - separate mounting)
Interlocking units	Mechanical	VM5-1
	Mechanical / Electrical	VE5-1 VE5-2
Surge suppressors	Varistor (AC / DC)	RV5 (24...440 V)
	RC Type (AC)	RC5-1 (24...440 V) RC5-2 (24...440 V)



Manual motor starters

[Overview](#) 2/2

2

0.10 to 32 A – with thermal and electromagnetic protection

Ics up to 50 kA

MS116 manual motor starters	2/4
Technical data	2/5

Ics up to 100 kA

MS132 manual motor starters	2/8
Technical data	2/9

0.16 to 32 A – with electromagnetic protection

Ics up to 100 kA

MO132 manual motor starters	2/12
Technical data	2/13

Main accessories for MS116, MS132, MO132	2/16
--	------

22 to 100 A – with thermal and electromagnetic protection

Ics up to 50 kA

MS450, MS495, MS497 manual motor starters	2/24
Technical data	2/25

32 to 100 A – with electromagnetic protection

Ics up to 50 kA

MO450, MO495, MO496 manual motor starters	2/28
Technical data	2/29

Main accessories for MS450, MS495, MS497, MO450, MO495, MO496	2/32
---	------

[General accessories](#) 2/38

Manual motor starters

2



2CDC24109R0011



1SBC101232F0010

Thermal and electromagnetic protection	Type	MS116	MS132	
Electromagnetic protection	Type	-		MO132
Phase loss sensitivity		Yes	Yes	No
Switch position		ON/OFF	ON/OFF/TRIP	
Magnetic trip indication		-	Yes	
Lockable handle without accessories		-	Yes	
Disconnecting feature		Yes	Yes	
Width		45 mm	45 mm	
Rated operational current I_e		0.16...32 A	0.16...32 A	0.16...32 A
Setting range for thermal release		0.10...32 A	0.10...32 A	-
Rated operational voltage U_e		690 V AC	690 V AC / 250 V DC	
Rated frequency		50/60 Hz	DC, 50/60 Hz	
Trip class		10A	10	
Short-circuit breaking capacity I_{cs}	400 V AC	Up to 50 kA	Up to 100 kA	
Ambient air temperature open compensated		-25...+55 °C	-25...+60 °C	

Main accessories

Auxiliary contacts			
Front mounting		HKF1	
Side mounting		HK1	
Signalling contacts			
Tripped alarm		SK1	
Short-circuit alarm		-	CK1
Auxiliary trip units			
Shunt trip		AA1	
Undervoltage release		UA1	
Busbar systems			
3-phase busbar		PS1	
Feeder terminals		S1	



2CDC241004F0009



1SBC101184F0014



2CDC241020F0011

MS450		MS495		MS497	
MO450		MO495		MO496	
Yes	No	Yes	No	Yes	No
ON/OFF/TRIP		ON/OFF/TRIP		ON/OFF/TRIP	
-		-		-	
Yes		Yes		Yes	
Yes		Yes		Yes	
55 mm		70 mm		70 mm	
40...50 A	40...50 A	63...100 A	63...100 A	32...100 A	32...100 A
28...50 A	-	45...100 A	-	22...100 A	-
690 V AC / 440 V DC		690 V AC / 440 V DC		690 V AC / 440 V DC	
DC, 50/60 Hz		DC, 50/60 Hz		DC, 50/60 Hz	
10		10		10	
Up to 50 kA		Up to 50 kA		Up to 100 kA	
-20...+60 °C		-20...+60 °C		-20...+60 °C	
HK4					
HKS4					
SK4					
SK4					
AA4					
UA4					
PS4		-			
S4		-			

2CDC131046C0201

MS116 manual motor starters

0.10 to 32 A – with thermal and electromagnetic protection

2



MS116-16

2CDC241010F0011



MS116-25

2CDC241010F0011



MS116-0.16-HKF1-11

2CDC241013F0011



MS116-32-HKF1-11

2CDC241012F0011

Description

Manual motor starters (MMS) are protection devices for the main circuit. They combine motor control and protection in a single device. MMS are used mainly to switch motors manually ON/OFF and protect them and the installation fuse less against short-circuit, overload and phase failures. Fuse less protection with a manual motor starter saves costs, space and ensures a quick reaction under short-circuit condition, by switching off the motor within milliseconds.

MS116 is a compact and economic range for motor protection up to 15.5 kW (400 V) / 32 A in width of 45 mm. Further features are the build-in disconnect function, temperature compensation, trip-free mechanism and a rotary handle with a clear switch position indication. The manual motor starter is suitable for three- and single-phase applications. Auxiliary contacts, signalling contacts, undervoltage releases, shunt trips, three-phase bus bars, power in-feed blocks and locking devices for protection against unauthorized changes are available as accessory.

Ordering details

Rated operational power 400 V AC-3	Setting range	Short-circuit breaking capacity Ics at 400 V AC	Rated instantaneous short-circuit current setting Ii	Type	Order code	Weight (1 pce)
kW	A	kA	A			kg
0.03	0.10...0.16	50	1.56	MS116-0.16	1SAM250000R1001	0.225
0.06	0.16...0.25	50	2.44	MS116-0.25	1SAM250000R1002	0.225
0.09	0.25...0.40	50	3.90	MS116-0.4	1SAM250000R1003	0.225
0.12	0.40...0.63	50	6.14	MS116-0.63	1SAM250000R1004	0.225
0.25	0.63...1.00	50	11.50	MS116-1.0	1SAM250000R1005	0.225
0.55	1.00...1.60	50	18.40	MS116-1.6	1SAM250000R1006	0.265
0.75	1.60...2.50	50	28.75	MS116-2.5	1SAM250000R1007	0.265
1.5	2.50...4.00	50	50.00	MS116-4.0	1SAM250000R1008	0.265
2.2	4.00...6.30	50	78.75	MS116-6.3	1SAM250000R1009	0.265
4.0	6.30...10.0	50	150	MS116-10	1SAM250000R1010	0.265
5.5	8.00...12.0	25	180	MS116-12	1SAM250000R1012	0.265
7.5	10.0...16.0	16	240	MS116-16	1SAM250000R1011	0.265
9.0	16.0...20.0	10	300	MS116-20	1SAM250000R1013	0.310
12.5	20.0...25.0	10	375	MS116-25	1SAM250000R1014	0.310
15.5	25.0...32.0	10	480	MS116-32	1SAM250000R1015	0.310

Auxiliary contacts mounted on the front (1 N.O. + 1 N.C.)

0.03	0.10...0.16	50	1.56	MS116-0.16-HKF1-11	1SAM250005R1001	0.240
0.06	0.16...0.25	50	2.44	MS116-0.25-HKF1-11	1SAM250005R1002	0.240
0.09	0.25...0.40	50	3.90	MS116-0.4-HKF1-11	1SAM250005R1003	0.240
0.12	0.40...0.63	50	6.14	MS116-0.63-HKF1-11	1SAM250005R1004	0.240
0.25	0.63...1.00	50	11.50	MS116-1.0-HKF1-11	1SAM250005R1005	0.240
0.55	1.00...1.60	50	18.40	MS116-1.6-HKF1-11	1SAM250005R1006	0.280
0.75	1.60...2.50	50	28.75	MS116-2.5-HKF1-11	1SAM250005R1007	0.280
1.5	2.50...4.00	50	50.00	MS116-4.0-HKF1-11	1SAM250005R1008	0.280
2.2	4.00...6.30	50	78.75	MS116-6.3-HKF1-11	1SAM250005R1009	0.280
4.0	6.30...10.0	50	150	MS116-10.0-HKF1-11	1SAM250005R1010	0.280
5.5	8.00...12.0	25	180	MS116-12.0-HKF1-11	1SAM250005R1012	0.280
7.5	10.0...16.0	16	240	MS116-16.0-HKF1-11	1SAM250005R1011	0.280
9.0	16.0...20.0	10	300	MS116-20-HKF1-11	1SAM250005R1013	0.326
12.5	20.0...25.0	10	375	MS116-25-HKF1-11	1SAM250005R1014	0.326
15.5	25.0...32.0	10	480	MS116-32-HKF1-11	1SAM250005R1015	0.326

Main dimensions mm, inches

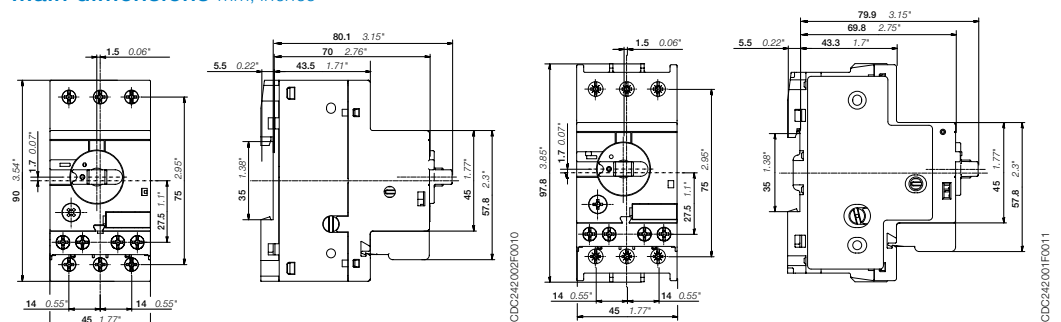

MS116 ≤ 16 A & MS116-HKF1-11 ≤ 16 A

MS116 ≥ 20 A & MS116-HKF1-11 ≥ 20 A

MS116 manual motor starters

Technical data

Main circuit – Utilization characteristics according to IEC/EN

Type	MS116	
Standards	IEC/EN 60947-2, IEC/EN 60947-4-1, IEC/EN 60947-1	
Rated operational voltage U_e	690 V AC	
Rated frequency	50/60 Hz	
Trip class	10A	
Number of poles	3	
Duty time	100 %	
Mechanical durability	100000 cycles	
Electrical durability	up to 16 A	100000 cycles
	20 ... 32 A	50000 cycles
Rated impulse withstand voltage U_{imp}	6 kV	
Rated insulation voltage U_i	690 V AC	
Rated operational current I_e	See ordering details	
Rated instantaneous short-circuit current setting I_{cs}	See ordering details	
Rated service short-circuit breaking capacity I_{cs}	See table "Short-circuit breaking capacity and back-up fuses"	
Rated ultimate short-circuit breaking capacity I_{cu}	See table "Short-circuit breaking capacity and back-up fuses"	

Short-circuit breaking capacity and back-up fuses

I_{cs} Rated service short-circuit breaking capacity

I_{cu} Rated ultimate short-circuit breaking capacity

I_{cc} Prospective short-circuit current at installation location

Note: Maximum rated current of the back-up fuses if $I_{cc} > I_{cs}$

Type	230 V AC			400 V AC			440 V AC			500 V AC			690 V AC		
	I_{cs} kA	I_{cu} kA	gG, aM A	I_{cs} kA	I_{cu} kA	gG, aM A	I_{cs} kA	I_{cu} kA	gG, aM A	I_{cs} kA	I_{cu} kA	gG, aM A	I_{cs} kA	I_{cu} kA	gG, aM A
MS116-0.16															
MS116-0.25															
MS116-0.4															
MS116-0.63															
MS116-1.0	No back-up fuse required up to $I_{cc} = 50$ kA														
MS116-1.6	No back-up fuse required up to $I_{cc} = 50$ kA														
MS116-2.5							10	10	25	10	10	25	5	5	25
MS116-4.0							6	6	25	6	6	25	2	2	25
MS116-6.3							6	6	63	6	6	63	2	2	40
MS116-10							6	6	63	6	6	63	2	2	50
MS116-12	25	25	80	25	25	80	6	6	63	6	6	63	2	2	50
MS116-16	16	16	80	16	16	80	6	6	63	4	4	63	2	2	63
MS116-20	10	15	-	10	15	-	3	6	-	3	4	-	2	2	-
MS116-25	10	15	-	10	15	-	3	6	-	3	4	-	2	2	-
MS116-32	10	10	-	10	10	-	3	6	-	3	4	-	2	2	-

MS116-10: No need for back-up fuse in networks with a prospective current of up to 50 kA at 400 V.

MS116-16: No need for back-up fuse in networks with a prospective current of up to 16 kA at 400 V.

With an appropriate 80 A type gG fuse the device can be used in a network with a prospective current of up to 100 kA.

MS116-32: No need for back-up fuse in networks with a prospective current of up to 10 kA at 400 V.

MS116 manual motor starters

Technical data

Main circuit – Utilization characteristics according to UL/CSA

Type	MS116	
Standards	UL 508, CSA 22.2 No. 14	
Maximum operational voltage	600 V AC	
Manual motor controller ratings	See table "UL 508 – Manual motor controller"	
Trip rating	125 % FLA	
Motor ratings	Horse power	See table "Motor rating, three phase"
	Full load amps (FLA)	See table "Motor rating, three phase"
	Locked rotor amps (LRA)	See table "Motor rating, three phase"

Motor rating, three phase

hp Horse power

FLA Full load amps

LRA Locked rotor amps

Type	220-240 V AC			440-480 V AC			500-600 V AC		
	hp	FLA	LRA	hp	FLA	LRA	hp	FLA	LRA
MS116-0.16	-	0.16	0.96	-	0.16	0.96	-	0.16	0.96
MS116-0.25	-	0.25	1.5	-	0.25	1.5	-	0.25	1.5
MS116-0.4	-	0.4	2.4	-	0.4	2.4	-	0.4	2.4
MS116-0.63	-	0.63	3.78	-	0.63	3.78	-	0.63	3.78
MS116-1.0	-	1.0	6.0	-	1.0	6.0	1/2	0.9	8
MS116-1.6	-	1.6	9.6	3/4	1.6	12.5	3/4	1.3	10
MS116-2.5	1/2	2.2	20	1	2.1	15	1-1/2	2.4	16
MS116-4.0	1	4.2	30	2	3.4	25	3	3.9	25.6
MS116-6.3	1-1/2	6.4	40	3	4.8	32	5	6.1	36.8
MS116-10	3	9.6	64	5	7.6	46	7-1/2	9	50.8
MS116-12	3	9.6	64	7-1/2	11	63.5	10	11	64.8
MS116-16	5	15.2	92	10	14	81	10	11	64.8
MS116-20	5	15.2	92	10	14	81	15	17	93
MS116-25	7-1/2	22	127	15	21	116	20	22	116
MS116-32	10	28	162	20	27	145	25	27	146

UL 508 – Manual motor controller

Type	Maximum fuse type K5 o. RK5 per UL/NEC		Maximum short-circuit current for motor disconnect ¹⁾		for group installation	
	480 V / 600 V		600 V		600 V	
	A	kA	kA	kA	kA	kA
MS116-0.16	100	30	5	30	5	
MS116-0.25	100	30	5	30	5	
MS116-0.4	100	30	5	30	5	
MS116-0.63	100	30	5	30	5	
MS116-1.0	100	30	5	30	5	
MS116-1.6	100	30	5	30	5	
MS116-2.5	100	30	5	30	5	
MS116-4.0	100	18	5	18	5	
MS116-6.3	100	18	5	18	5	
MS116-10	100	18	5	18	5	
MS116-12	100	18	5	18	5	
MS116-16	100	18	5	18	5	
MS116-20	100	18	5	18	5	
MS116-25	100	18	5	18	5	
MS116-32	100	18	5	18	5	

¹⁾ Suitable as motor disconnect only when provided with padlock SA1 or SA3...





MS116 manual motor starters

Technical data

General technical data

Type	MS116	
Pollution degree	3	
Phase loss sensitivity	Yes	
Disconnect function acc. to IEC/EN 60947-2	Yes	
Ambient air temperature		
Operation	Open - compensated	-25 ... +55 °C
	Open	-25 ... +70 °C
	Enclosed (IB132)	0 ... +40 °C
Storage	-50 ... +80 °C	
Ambient air temperature compensation	Acc. to IEC/EN60947-4-1	
Maximum operating altitude permissible	2000 m	
Resistance to shock acc. to IEC 60068-2-27	25g / 11 ms	
Resistance to vibrations acc. to IEC 60068-2-6	5g / 3 ... 150 Hz	
Mounting position	Position 1-6 (optional for single mounting)	
Mounting	DIN-rail (EN 60715)	
Group mounting	On request	
Minimum distance to other units same type	Horizontal	0 mm
	Vertical	150 mm
Minimum distance to electrical conductive board	Horizontal, up to 400 V	0 mm
	Horizontal, up to 690 V	> 1.5 mm
	Vertical	75 mm
Degree of protection	Housing	IP20
	Main circuit terminals	IP20

Connecting characteristics

Main circuit		MS116 ≤ 16 A	MS116 ≥ 20 A
Connecting capacity			
	Rigid	1 or 2 x 1 ... 4 mm ²	2.5 ... 6 mm ²
	Flexible with ferrule	1 or 2 x 0.75 ... 2.5 mm ²	1 ... 6 mm ²
	Flexible with insulated ferrule	1 or 2 x 0.75 ... 2.5 mm ²	1 ... 6 mm ²
	Flexible	1 or 2 x 0.75 ... 2.5 mm ²	1 ... 6 mm ²
	Stranded acc. to UL/CSA	1 or 2 x AWG 16-12	AWG 12-8
	Flexible acc. to UL/CSA	1 or 2 x AWG 16-12	AWG 12-8
Stripping length		9 mm	10 mm
Tightening torques		0.8 ... 1.2 Nm / 10 ... 12 lb.in	2.0 Nm / 18 lb.in
Connection screw		M3.5 (Pozi driv 2 / 5.5 mm)	M4 (Pozi driv 2 / 6.5 mm)

MS132 manual motor starters

0.10 to 32 A – with thermal and electromagnetic protection

2



1SBC10122FF010

MS132-10



2DC24101FF0011

MS132-32



2DC241014FF011

MS132-0.16-HKF1-11



2DC241015FF0011

MS132-32-HKF1-11

Description

Manual motor starters (MMS) are protection devices for the main circuit. They combine motor control and protection in a single device. MMS are used mainly to switch motors manually ON/OFF and protect them and the installation fuse less against short-circuit, overload and phase failures. Fuse less protection with a manual motor starter saves costs, space and ensures a quick reaction under short-circuit condition, by switching off the motor within milliseconds.

MS132 is a compact and powerful range for motor protection up 15.5 kW (400 V) / 32 A in width of 45 mm. Further features are the build-in disconnect function, temperature compensation, trip-free mechanism and a rotary handle with a clear switch position indication. The manual motor starter is suitable for three- and single-phase applications. The handle is lockable to protect against unauthorized changes. Auxiliary contacts, signalling contacts, undervoltage releases, shunt trips, three-phase bus bars, power in-feed blocks.

Ordering details

Rated operational power 400 V AC-3	Setting range	Short-circuit breaking capacity Ics at 400 V AC	Rated instantaneous short-circuit current setting Ii	Type	Order code	Weight (1 pce)
kW	A	kA	A			kg
0.03	0.10...0.16	100	1.56	MS132-0.16	1SAM350000R1001	0.215
0.06	0.16...0.25	100	2.44	MS132-0.25	1SAM350000R1002	0.215
0.09	0.25...0.40	100	3.90	MS132-0.4	1SAM350000R1003	0.215
0.12	0.40...0.63	100	6.14	MS132-0.63	1SAM350000R1004	0.215
0.25	0.63...1.00	100	11.50	MS132-1.0	1SAM350000R1005	0.215
0.55	1.00...1.60	100	18.40	MS132-1.6	1SAM350000R1006	0.265
0.75	1.60...2.50	100	28.75	MS132-2.5	1SAM350000R1007	0.265
1.5	2.50...4.00	100	50.00	MS132-4.0	1SAM350000R1008	0.265
2.2	4.00...6.30	100	78.75	MS132-6.3	1SAM350000R1009	0.265
4.0	6.30...10.0	100	150	MS132-10	1SAM350000R1010	0.265
5.5	8.00...12.0	100	180	MS132-12	1SAM350000R1012	0.310
7.5	10.0...16.0	100	240	MS132-16	1SAM350000R1011	0.310
9.0	16.0...20.0	100	300	MS132-20	1SAM350000R1013	0.310
12.5	20.0...25.0	50	375	MS132-25	1SAM350000R1014	0.310
15.5	25.0...32.0	25	480	MS132-32	1SAM350000R1015	0.310

Auxiliary contacts mounted on the front (1 N.O. + 1 N.C.)

0.03	0.10...0.16	100	1.56	MS132-0.16-HKF1-11	1SAM350005R1001	0.231
0.06	0.16...0.25	100	2.44	MS132-0.25-HKF1-11	1SAM350005R1002	0.231
0.09	0.25...0.40	100	3.90	MS132-0.4-HKF1-11	1SAM350005R1003	0.231
0.12	0.40...0.63	100	6.14	MS132-0.63-HKF1-11	1SAM350005R1004	0.231
0.25	0.63...1.00	100	11.50	MS132-1.0-HKF1-11	1SAM350005R1005	0.231
0.55	1.00...1.60	100	18.40	MS132-1.6-HKF1-11	1SAM350005R1006	0.281
0.75	1.60...2.50	100	28.75	MS132-2.5-HKF1-11	1SAM350005R1007	0.281
1.5	2.50...4.00	100	50.00	MS132-4.0-HKF1-11	1SAM350005R1008	0.281
2.2	4.00...6.30	100	78.75	MS132-6.3-HKF1-11	1SAM350005R1009	0.281
4.0	6.30...10.0	100	150	MS132-10.0-HKF1-11	1SAM350005R1010	0.281
5.5	8.00...12.0	100	180	MS132-12.0-HKF1-11	1SAM350005R1012	0.326
7.5	10.0...16.0	100	240	MS132-16.0-HKF1-11	1SAM350005R1011	0.326
9.0	16.0...20.0	100	300	MS132-20-HKF1-11	1SAM350005R1013	0.326
12.5	20.0...25.0	50	375	MS132-25-HKF1-11	1SAM350005R1014	0.326
15.5	25.0...32.0	25	480	MS132-32-HKF1-11	1SAM350005R1015	0.326

Main dimensions mm, inches

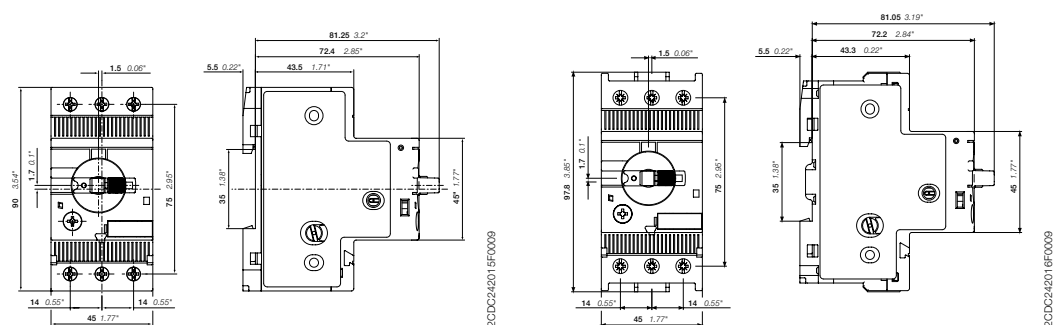

MS132 ≤ 10 A

MS132 ≥ 12 A

MS132 manual motor starters

Technical data

Main circuit – Utilization characteristics according to IEC/EN

Type	MS132
Standards	IEC/EN 60947-2, IEC/EN 60947-4-1, IEC/EN 60947-1
Rated operational voltage U_e	690 V AC / 250 V DC
Rated frequency	DC, 50/60 Hz
Trip class	10 (10A for 1SAM350000R1001)
Number of poles	3
Duty time	100 %
Mechanical durability	100000 cycles
Electrical durability	50000 cycles
Rated impulse withstand voltage U_{imp}	6 kV
Rated insulation voltage U_i	690 V AC
Rated operational current I_n	See ordering details
Rated operational current DC-5 I_e	See "Rated operational current I_e "
3 conducting paths in series up to 250 V	
Rated instantaneous short-circuit current setting I_{cs}	See ordering details
Rated service short-circuit breaking capacity I_{cs}	See table "Short-circuit breaking capacity and back-up fuses"
Rated ultimate short-circuit breaking capacity I_{cu}	See table "Short-circuit breaking capacity and back-up fuses"
Rated service short-circuit breaking capacity DC I_{cs}	10 kA
3 conducting paths in series up to 250 V	

Short-circuit breaking capacity and back-up fuses

I_{cs} Rated service short-circuit breaking capacity

I_{cu} Rated ultimate short-circuit breaking capacity

I_{cc} Prospective short-circuit current at installation location

Note: Maximum rated current of the back-up fuses if $I_{cc} > I_{cs}$

Type	230 V AC			400 V AC			440 V AC			500 V AC			690 V AC		
	I_{cs} kA	I_{cu} kA	gG, aM A	I_{cs} kA	I_{cu} kA	gG, aM A	I_{cs} kA	I_{cu} kA	gG, aM A	I_{cs} kA	I_{cu} kA	gG, aM A	I_{cs} kA	I_{cu} kA	gG, aM A
MS132-0.16															
MS132-0.25															
MS132-0.4															
MS132-0.63	No back-up fuse required up to $I_{cc} = 100$ kA														
MS132-1.0															
MS132-1.6															
MS132-2.5															
MS132-4.0							20	20	35	20	20	35	3	3	32
MS132-6.3							20	20	63	20	20	63	3	3	50
MS132-10							20	20	100	20	20	100	3	3	50
MS132-12							20	20	100	20	20	100	3	3	63
MS132-16							20	20	125	20	20	125	3	3	63
MS132-20							20	20	125	20	20	125	3	3	80
MS132-25	50	50	125	50	50	125	20	20	125	10	10	125	3	3	100
MS132-32	25	50	125	25	50	125	20	20	125	10	10	125	3	3	100

MS132-16: No need for back-up fuse in networks with a prospective current of up to 100 kA at 400 V.

MS132-32: No need for back-up fuse in networks with a prospective current of up to 50 kA at 400 V.

With an appropriate 125 A type gG fuse the device can be used in a network with a prospective current of up to 100 kA.

MS132 manual motor starters

Technical data

Main circuit – Utilization characteristics according to UL/CSA

Type	MS132	
Standards	UL 508, CSA 22.2 No. 14	
Maximum operational voltage	600 V AC	
Manual motor controller ratings	See table "UL 508 – Manual motor controller"	
Trip rating	125 % FLA	
Motor ratings	Horse power	See table "Motor rating, three phase"
	Full load amps (FLA)	See table "Motor rating, three phase"
	Locked rotor amps (LRA)	See table "Motor rating, three phase"

Motor rating, single phase

hp Horse power

FLA Full load amps

LRA Locked rotor amps

Type	120 V AC			220-240 V AC		
	hp	FLA	LRA	hp	FLA	LRA
MS132-0.16	-	0.16	0.96	-	0.16	0.96
MS132-0.25	-	0.25	1.5	-	0.25	1.5
MS132-0.4	-	0.4	2.4	-	0.4	2.4
MS132-0.63	-	0.63	3.78	-	0.63	3.78
MS132-1.0	-	1	6	-	1	6
MS132-1.6	-	1.6	9.6	1/10	1.6	9.6
MS132-2.5	-	2.5	15	1/6	2.5	15
MS132-4.0	1/8	4	24	1/3	4	24
MS132-6.3	1/4	6.3	37.8	1/2	6.3	37.8
MS132-10	1/2	9.8	58.8	1-1/2	10	60
MS132-12	1/2	9.8	58.8	2	12	72
MS132-16	1	16	96	2	12	72
MS132-20	1-1/2	20	120	3	17	92
MS132-25	2	24	144	3	17	127
MS132-32	2	24	144	5	28	162

Motor rating, three phase

hp Horse power

FLA Full load amps

LRA Locked rotor amps

Type	220-240 V AC			440-480 V AC			500-600 V AC		
	hp	FLA	LRA	hp	FLA	LRA	hp	FLA	LRA
MS132-0.16	-	0.16	0.96	-	0.16	0.96	-	0.16	0.96
MS132-0.25	-	0.25	1.5	-	0.25	1.5	-	0.25	1.5
MS132-0.4	-	0.4	2.4	-	0.4	2.4	-	0.4	2.4
MS132-0.63	-	0.63	3.78	-	0.63	3.78	-	0.63	3.78
MS132-1.0	-	1.0	6.0	-	1.0	6.0	1/2	1.0	6.0
MS132-1.6	-	1.6	9.6	3/4	1.6	9.6	3/4	1.6	9.6
MS132-2.5	1/2	2.5	15.0	1	2.5	15.0	1-1/2	2.5	15.0
MS132-4.0	1	4.0	24.0	2	4.0	24.0	3	3.9	26.0
MS132-6.3	1-1/2	6.3	37.8	3	4.8	32.0	5	6.1	37.0
MS132-10	3	9.6	64.0	5	7.6	46.0	7-1/2	9.0	51.0
MS132-12	3	9.6	64.0	7-1/2	11.0	64.0	10	11.0	65.0
MS132-16	5	15.2	92.0	10	14.0	81.0	10	11.0	65.0
MS132-20	5	15.2	92.0	10	14.0	81.0	15	17.0	93.0
MS132-25	7-1/2	22.0	127.0	15	21.0	116.0	20	22.0	116.0
MS132-32	10	28.0	162.0	20	27.0	145.0	25	27.0	146.0

MS132 manual motor starters

Technical data

UL 508 – Manual motor controller





Type	Maximum short-circuit current for motor disconnect		for group installation		for self-protected combination motor controller (type E) in combination with feeder block S1-M3-xx		for tap conductor protection	
	480 V kA	600 V kA	480 V kA	600 V kA	480Y / 277 V kA	600Y / 347 V kA	480 V kA	600 V kA
MS132-0.16	65	47	65	47	65	47	65	47
MS132-0.25	65	47	65	47	65	47	65	47
MS132-0.4	65	47	65	47	65	47	65	47
MS132-0.63	65	47	65	47	65	47	65	47
MS132-1.0	65	47	65	47	65	47	65	47
MS132-1.6	65	47	65	47	65	47	65	47
MS132-2.5	65	47	65	47	65	47	65	47
MS132-4.0	65	18	65	30	65	18	65	18
MS132-6.3	65	18	65	30	65	18	65	18
MS132-10	65	18	65	30	65	18	65	18
MS132-12	30	18	30	30	30	-	30	18
MS132-16	30	18	30	30	30	-	30	18
MS132-20	30	18	30	30	30	-	30	18
MS132-25	30	18	30	30	30	-	30	18
MS132-32	30	18	30	30	30	-	30	18

General technical data

Type	MS132	
Pollution degree	3	
Phase loss sensitivity	Yes	
Disconnect function acc. to IEC/EN 60947-2	Yes	
Ambient air temperature		
Operation	Open - compensated	-25 ... +60 °C
	Open	-25 ... +70 °C
	Enclosed (IB132)	0 ... +40 °C
Storage	-50 ... +70 °C	
Ambient air temperature compensation	Acc. to IEC/EN60947-4-1	
Maximum operating altitude permissible	2000 m	
Resistance to shock acc. to IEC 60068-2-27	25g / 11 ms	
Resistance to vibrations acc. to IEC 60068-2-6	5g / 3 ... 150 Hz	
Mounting position	Position 1-6 (optional for single mounting)	
Mounting	DIN-rail (EN 60715)	
Group mounting	On request	
Minimum distance to other units same type	Horizontal	0 mm
	Vertical	150 mm
Minimum distance to electrical conductive board	Horizontal, up to 400 V	0 mm
	Horizontal, up to 690 V	> 1.5 mm
	Vertical	75 mm
Degree of protection	Housing	IP20
	Main circuit terminals	IP20

Connecting characteristics

Main circuit

Type	MS132-0.16 ... MS132-10	MS132-12 ... MS132-16	MS132-20 ... MS132-32
Connecting capacity			
 Rigid	1 or 2 x 1 ... 4 mm ²	1 ... 4 mm ²	2.5 ... 6 mm ²
 Flexible with ferrule	1 or 2 x 1 ... 4 mm ²	1 ... 4 mm ²	2.5 ... 6 mm ²
 Flexible with insulated ferrule	1 or 2 x 1 ... 4 mm ²	1 ... 4 mm ²	2.5 ... 6 mm ²
 Flexible	1 or 2 x 1 ... 4 mm ²	1 ... 4 mm ²	2.5 ... 6 mm ²
Stranded acc. to UL/CSA	1 or 2 x AWG 16-12	AWG 16-12	AWG 12-8
Flexible acc. to UL/CSA	1 or 2 x AWG 16-12	AWG 16-12	AWG 12-8
Stripping length	9 mm	10 mm	10 mm
Tightening torques	0.8 ... 1.2 Nm / 10 ... 12 lb.in	1.5 Nm / 14 lb.in	2.0 Nm / 18 lb.in
Connection screw	M3.5 (Pozidriv 2)	M4 (Pozidriv 2)	M4 (Pozidriv 2)

MO132 manual motor starters magnetic only

0.16 to 32 A – with electromagnetic protection

2



2CDC241009F0011

MO132-6.3



2CDC241009F0011

MO132-32

Description

Manual motor starters magnetic only are electromechanical protection devices for the main circuit. They are used mainly to switch motors manually ON/OFF and protect them fuse less against short-circuit.

Fuse less protection with a manual motor starter saves costs, space and ensures a quick reaction under short-circuit condition, by switching off the motor within milliseconds. Fuse less starter combinations are setup together with contactors and overload relays.

Ordering details

Rated operational power 400 V AC-3 (1)	Rated operational current	Short-circuit breaking capacity Ics at 400 V AC	Rated instantaneous short-circuit current setting Ii	Type	Order code	Weight (1 pce)
kW	A	kA	A			kg
0.03	0.16	100	1.56	MO132-0.16	1SAM360000R1001	0.215
0.06	0.25	100	2.44	MO132-0.25	1SAM360000R1002	0.215
0.09	0.40	100	3.90	MO132-0.4	1SAM360000R1003	0.215
0.12	0.63	100	6.14	MO132-0.63	1SAM360000R1004	0.215
0.25	1.0	100	11.50	MO132-1.0	1SAM360000R1005	0.215
0.55	1.6	100	18.40	MO132-1.6	1SAM360000R1006	0.265
0.75	2.5	100	28.75	MO132-2.5	1SAM360000R1007	0.265
1.5	4.0	50	50.00	MO132-4.0	1SAM360000R1008	0.265
2.2	6.3	50	78.75	MO132-6.3	1SAM360000R1009	0.265
4.0	10	50	125.00	MO132-10	1SAM360000R1010	0.265
5.5	12	50	150.00	MO132-12	1SAM360000R1012	0.310
7.5	16	50	200.00	MO132-16	1SAM360000R1011	0.310
9.0	20	50	250.00	MO132-20	1SAM360000R1013	0.310
12.5	25	50	312.50	MO132-25	1SAM360000R1014	0.310
15.5	32	25	400.00	MO132-32	1SAM360000R1015	0.310

(1) For overload protection of motors, an appropriate thermal or electronic overload relay must be used.

Main dimensions mm, inches

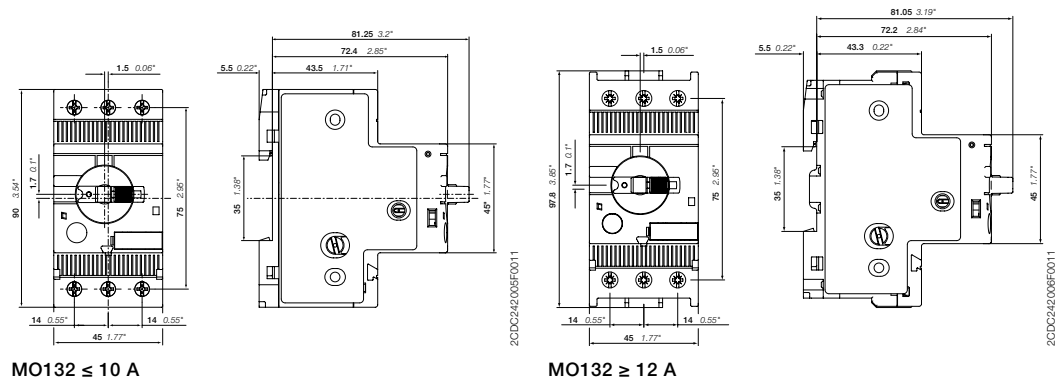

MO132 manual motor starters magnetic only

Technical data

Main circuit – Utilization characteristics according to IEC/EN

Type	MO132
Standards	IEC/EN 60947-2, IEC/EN 60947-4-1, IEC/EN 60947-1
Rated operational voltage U_n	690 V AC
Rated frequency	50/60 Hz
Number of poles	3
Duty time	100 %
Mechanical durability	100000 cycles
Electrical durability	50000 cycles
Rated impulse withstand voltage U_{imp}	6 kV
Rated insulation voltage U_i	690 V AC
Rated operational current I_n	See ordering details
Rated instantaneous short-circuit current setting I_{sc}	See ordering details
Rated service short-circuit breaking capacity I_{cs}	See table "Short-circuit breaking capacity and back-up fuses"
Rated ultimate short-circuit breaking capacity I_{cu}	See table "Short-circuit breaking capacity and back-up fuses"

Short-circuit breaking capacity and back-up fuses

I_{cs} Rated service short-circuit breaking capacity

I_{cu} Rated ultimate short-circuit breaking capacity

I_{cc} Prospective short-circuit current at installation location

Note: Maximum rated current of the back-up fuses if $I_{cc} > I_{cs}$

Type	230 V AC			400 V AC			440 V AC			500 V AC			690 V AC		
	I_{cs} kA	I_{cu} kA	gG, aM A	I_{cs} kA	I_{cu} kA	gG, aM A	I_{cs} kA	I_{cu} kA	gG, aM A	I_{cs} kA	I_{cu} kA	gG, aM A	I_{cs} kA	I_{cu} kA	gG, aM A
MO132-0.16															
MO132-0.25															
MO132-0.4															
MO132-0.63	No back-up fuse required up to $I_{cc} = 100$ kA														
MO132-1.0															
MO132-1.6															
MO132-2.5															
MO132-4.0							20	20	35	20	20	35	3	3	32
MO132-6.3							20	20	63	20	20	63	3	3	50
MO132-10							20	20	100	20	20	100	3	3	50
MO132-12							20	20	100	20	20	100	3	3	63
MO132-16							20	20	125	20	20	125	3	3	63
MO132-20							20	20	125	20	20	125	3	3	80
MO132-25	50	50	125	50	50	125	10	10	125	10	10	125	3	3	100
MO132-32	25	50	125	25	50	125	10	10	125	10	10	125	3	3	100

MO132-20: No need for back-up fuse in networks with a prospective current of up to 100 kA at 400 V.

MO132-32: No need for back-up fuse in networks with a prospective current of up to 50 kA at 400 V.

With an appropriate 125 A type gG fuse the device can be used in a network with a prospective current of up to 100 kA.

MO132 manual motor starters magnetic only

Technical data

Main circuit – Utilization characteristics according to UL/CSA

Type	MO132	
Standards	UL 508, CSA 22.2 No. 14	
Maximum operational voltage	600 V AC	
Manual motor controller ratings	See table "UL 508 – Manual motor controller"	
Trip rating	125 % FLA	
Motor ratings	Horse power	See table "Motor rating, three phase"
	Full load amps (FLA)	See table "Motor rating, three phase"
	Locked rotor amps (LRA)	See table "Motor rating, three phase"

Motor rating, single phase

hp Horse power
 FLA Full load amps
 LRA Locked rotor amps

Type	120 V AC			220 ... 240 V AC		
	hp	FLA	LRA	hp	FLA	LRA
MO132-0.16	-	0.16	0.96	-	0.16	0.96
MO132-0.25	-	0.25	1.5	-	0.25	1.5
MO132-0.4	-	0.4	2.4	-	0.4	2.4
MO132-0.63	-	0.63	3.78	-	0.63	3.78
MO132-1.0	-	1	6	-	1	6
MO132-1.6	-	1.6	9.6	1/10	1.6	9.6
MO132-2.5	-	2.5	15	1/6	2.5	15
MO132-4.0	1/8	4	24	1/3	4	24
MO132-6.3	1/4	6.3	37.8	1/2	6.3	37.8
MO132-10	1/2	9.8	58.8	1-1/2	10	60
MO132-12	1/2	9.8	58.8	2	12	72
MO132-16	1	16	96	2	12	72
MO132-20	1-1/2	20	120	3	17	92
MO132-25	2	24	144	3	17	127
MO132-32	2	24	144	5	28	162

Motor rating, three phase

hp Horse power
 FLA Full load amps
 LRA Locked rotor amps

Type	220 ... 240 V AC			440 ... 480 V AC			500 ... 600 V AC		
	hp	FLA	LRA	hp	FLA	LRA	hp	FLA	LRA
MO132-0.16	-	0.16	0.96	-	0.16	0.96	-	0.16	0.96
MO132-0.25	-	0.25	1.5	-	0.25	1.5	-	0.25	1.5
MO132-0.4	-	0.4	2.4	-	0.4	2.4	-	0.4	2.4
MO132-0.63	-	0.63	3.78	-	0.63	3.78	-	0.63	3.78
MO132-1.0	-	1	6	-	1	6	1/2	1	6
MO132-1.6	-	1.6	9.6	3/4	1.6	9.6	3/4	1.6	9.6
MO132-2.5	1/2	2.5	15	1	2.5	15	1-1/2	2.5	15
MO132-4.0	1	4	24	2	4	24	3	3.9	26
MO132-6.3	1-1/2	6.3	37.8	3	4.8	32	5	6.1	37
MO132-10	3	9.6	64	5	7.6	46	7-1/2	9	51
MO132-12	3	9.6	64	7-1/2	11	64	10	11	65
MO132-16	5	15.2	92	10	14	81	10	11	65
MO132-20	5	15.2	92	10	14	81	15	17	93
MO132-25	7-1/2	22	127	15	21	116	20	22	116
MO132-32	10	28	162	20	27	145	25	27	146

MO132 manual motor starters magnetic only

Technical data





UL 508 – Manual motor controller

Type	Circuit breaker or class R fuse per UL/NEC 480 V / 600 V	Maximum short-circuit current rating	
		480 V kA	600 V kA
MO132-0.16	with minimum interrupting rating of 35,000 rms symmetrical amperes	30	18
MO132-0.25		30	18
MO132-0.4		30	18
MO132-0.63		30	18
MO132-1.0		30	18
MO132-1.6		30	18
MO132-2.5		30	18
MO132-4.0		30	18
MO132-6.3		30	18
MO132-10		30	18
MO132-12		30	18
MO132-16		30	18
MO132-20		30	18
MO132-25		30	18
MO132-32		30	18

General technical data

Type	MO132	
Pollution degree	3	
Phase loss sensitivity	No	
Disconnect function acc. to IEC/EN 60947-2	Yes	
Ambient air temperature		
Operation	Open	-25 ... +60 °C
	Enclosed (IB132)	0 ... +40 °C
Storage	-50 ... +80 °C	
Ambient air temperature compensation	-	
Maximum operating altitude permissible	2000 m	
Resistance to shock acc. to IEC 60068-2-27	25g / 11 ms	
Resistance to vibrations acc. to IEC 60068-2-6	5g / 3 ... 150 Hz	
Mounting position	Position 1-6 (optional for single mounting)	
Mounting	DIN-rail (EN 60715)	
Group mounting	On request	
Minimum distance to other units same type	Horizontal	0 mm
	Vertical	150 mm
Minimum distance to electrical conductive board	Horizontal, up to 400 V	0 mm
	Horizontal, up to 690 V	> 1.5 mm
	Vertical	75 mm
Degree of protection	Housing	IP20
	Main circuit terminals	IP20

Connecting characteristics

Main circuit			MO132-0.16 ... MO132-10	MO132-12 ... MO132-16	MO132-20 ... MO132-32
Type					
Connecting capacity					
	Rigid	1 or 2 x	1 ... 4 mm ²	1 ... 4 mm ²	2.5 ... 6 mm ²
	Flexible with ferrule	1 or 2 x	0.75 ... 2.5 mm ²	0.75 ... 2.5 mm ²	1 ... 6 mm ²
	Flexible with insulated ferrule	1 or 2 x	0.75 ... 2.5 mm ²	0.75 ... 2.5 mm ²	1 ... 6 mm ²
	Flexible	1 or 2 x	0.75 ... 2.5 mm ²	0.75 ... 2.5 mm ²	1 ... 6 mm ²
	Stranded acc. to UL/CSA	1 or 2 x	AWG 16-12	AWG 16-12	AWG 12-8
	Flexible acc. to UL/CSA	1 or 2 x	AWG 16-12	AWG 16-12	AWG 12-8
Stripping length			9 mm	10 mm	10 mm
Tightening torques			0.8 ... 1.2 Nm / 10 ... 12 lb.in	1.5 Nm / 14 lb.in	2.0 Nm / 18 lb.in
Connection screw			M3.5 (Pozidriv 2)	M4 (Pozidriv 2)	M4 (Pozidriv 2)

MS116, MS132, MO132 manual motor starters

Main accessories

MS116, MO132 manual motor starters with accessories

2

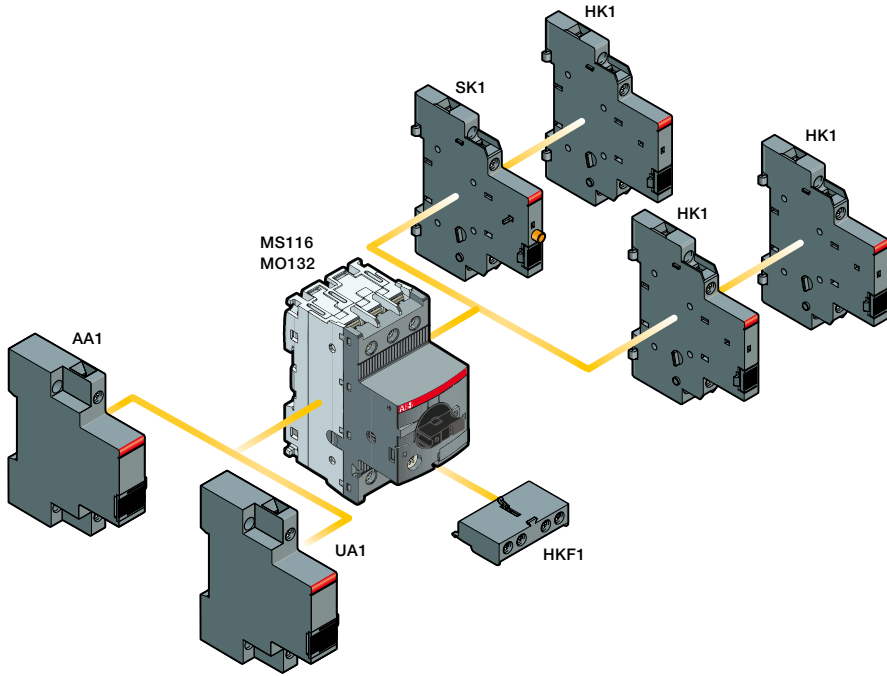

2CDC246001F0013

MS132 manual motor starters with accessories

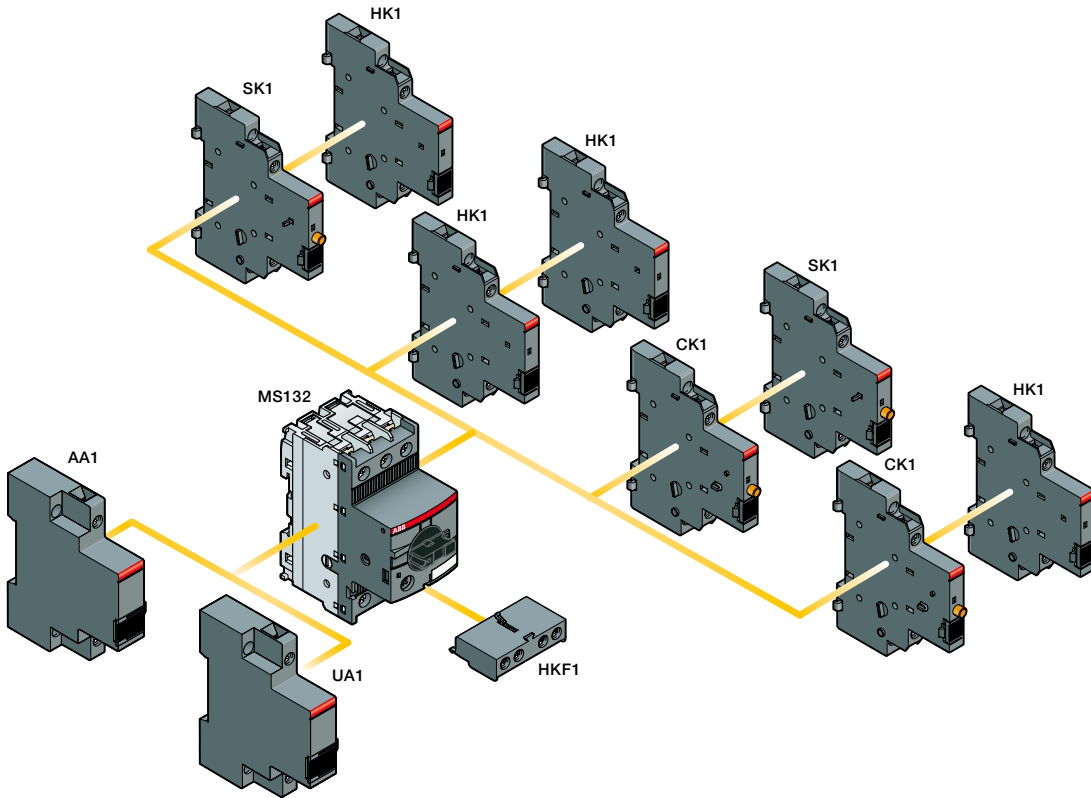

1SBSC0031F0000

2CDC131050C0201

MS116, MS132, MO132 manual motor starters

Main accessories



HKF1-11

1SBC101208F0014



HK1-11

1SBC101209F0014



SK1-11

1SBC101210F0014



CK1-11

1SBC101286F0014

Description

Manual motor starters can be equipped with auxiliary contacts for lateral/front mounting, signalling contact for lateral mounting, undervoltage release and shunt trips. Two different signalling contacts are available. The accessories can be fitted wiring free and without tools. A variety of combinations is possible as required for the application. The auxiliary contacts change position with the main contacts. The signalling contact SK signals tripping regardless if it was caused by short-circuit or overload. The signalling contact CK signals tripping in case it was caused by short-circuit. Undervoltage release are used for remote tripping of the manual motor starter especially for emergency stop circuits. Shunt trips release the MMS used for remote tripping.

Ordering details

Suitable for	Auxiliary contacts N.O.	Auxiliary contacts N.C.	Description	Type	Order code	Pkg qty	Weight (1 pce)
							kg
Auxiliary contacts – mountable on the front							
MS116, MS132, MO132	1	1		HKF1-11	1SAM201901R1001	10	0.015
	2	0		HKF1-20	1SAM201901R1002	10	0.015
Auxiliary contacts – mountable on the right							
MS116, MS132, MO132	1	1	max. 2 pieces	HK1-11	1SAM201902R1001	2	0.035
	2	0	max. 2 pieces	HK1-20	1SAM201902R1002	2	0.035
	0	2	max. 2 pieces	HK1-02	1SAM201902R1003	2	0.035
	2	0	with lead contacts	HK1-20L	1SAM201902R1004	2	0.035
Signalling contacts – mountable on the right							
MS116, MS132, MO132	1	1	for tripped alarm, max. 2 pieces	SK1-11	1SAM201903R1001	2	0.035
	2	0	for tripped alarm, max. 2 pieces	SK1-20	1SAM201903R1002	2	0.035
	0	2	for tripped alarm, max. 2 pieces	SK1-02	1SAM201903R1003	2	0.035
MS132	1	1	for short-circuit alarm, max. 2 pieces	CK1-11	1SAM301901R1001	2	0.035
	2	0	for short-circuit alarm, max. 2 pieces	CK1-20	1SAM301901R1002	2	0.035
	0	2	for short-circuit alarm, max. 2 pieces	CK1-02	1SAM301901R1003	2	0.035

Main dimensions mm, inches

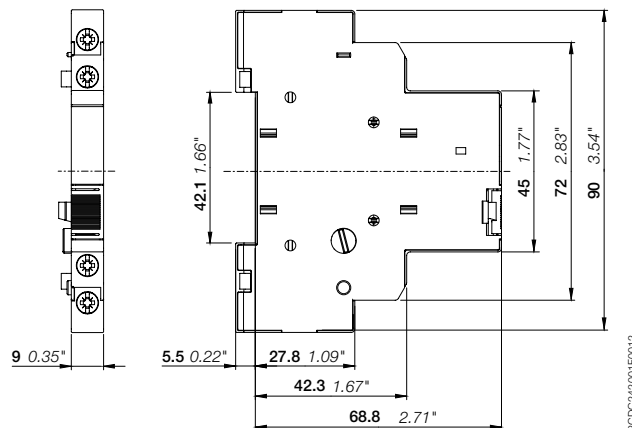

HK1

2DC0246001F0012

2CDC131050C0201

MS116, MS132, MO132 manual motor starters

Main accessories

2



AA1-24

1SBC101211F0014



UA1-24

1SBC101212F0014

Ordering details

Suitable for	Rated control supply voltage	Frequency	Type	Order code	Pkg qty	Weight (1 pce)
	V	Hz				kg

Shunt trips – mountable on the left

MS116, MS132, MO132	20...24	50/60	AA1-24	1SAM201910R1001	1	0.100
	110	50/60	AA1-110	1SAM201910R1002	1	0.100
	200...240	50/60	AA1-230	1SAM201910R1003	1	0.100
	350...415	50/60	AA1-400	1SAM201910R1004	1	0.100

Undervoltage releases – mountable on the left

MS116, MS132, MO132	24	50	UA1-24	1SAM201904R1001	1	0.100
	48	50	UA1-48	1SAM201904R1002	1	0.100
	60	50	UA1-60	1SAM201904R1003	1	0.100
	110...120	50/60	UA1-110	1SAM201904R1004	1	0.100
	208	60	UA1-208	1SAM201904R1008	1	0.100
	230...240	50/60	UA1-230	1SAM201904R1005	1	0.100
	400	50	UA1-400	1SAM201904R1006	1	0.100
	415...480	50/60	UA1-415	1SAM201904R1007	1	0.100

Main dimensions mm, inches

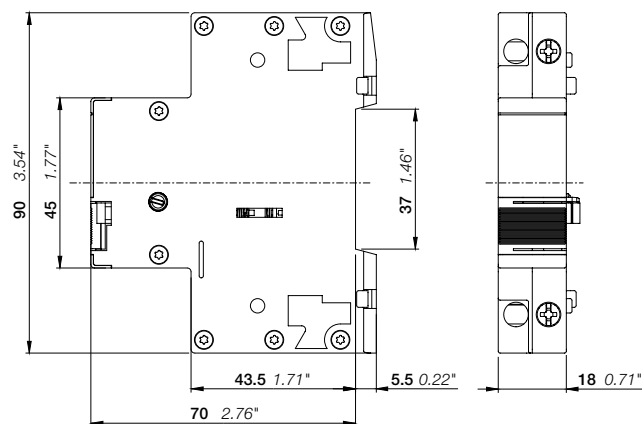

AA1, UA1

2CDC240002F0012

2CDC131050C0201

MS116, MS132, MO132 manual motor starters





Main accessories

General technical data

Type	HK1	SK1	HKF1
Standards	IEC/EN 60947-2, IEC/EN 60947-4-1, IEC/EN 60947-1		
Rated operational voltage U _e	690 V AC / 600 DC		250 V AC / 250 V DC
Conventional free-air thermal current I _{th}	6 A		5 A
Rated frequency	50/60 Hz		
Rated impulse withstand voltage U _{imp}	6 kV		
Rated insulation voltage U _i	690 V AC		250 V AC
Pollution degree	3		
Ambient air temperature	Operation	-25 ... +70 °C	
	Storage	-50 ... +80 °C	
Resistance to shock acc. to IEC 60068-2-27	25g / 11 ms		
Resistance to vibrations acc. to IEC 60068-2-6	5g / 3 ... 150 Hz		
I _e / Rated operational current AC-15 acc. to IEC/EN 60947-5-1 for utilization category			
	24 V, 120 V	6 A	3 A
	240 V	4 A	1.5 A
	400 V	3 A	-
	440 V, 690 V	1 A	-
I _e / Rated operational current DC-13 acc. to IEC/EN 60947-5-1 for utilization category			
	24 V	2 A	1 A
	125 V	0.55 A	0.27 A
	250 V	0.27 A	0.11 A
	440 V, 600 V	0.15 A	-
Minimum switching capacity	17 V / 5 mA		
Short-circuit protective device	N.C., 95-96	10 A Type gG	
	N.O., 97-98	10 A Type gG	
Duty time	100 %		
Mounting	Right side of MMS		Front of MMS
Mounting positions	1-6		
Mechanical durability	50000 cycles		-
Electrical durability	50000 cycles		-

Connecting characteristics

Auxiliary circuit

Type	HK1	SK1	HKF1
Connecting capacity			
 Rigid	1 or 2 x	1 ... 1.5 mm ²	
 Flexible with ferrule	1 or 2 x	0.75 ... 1.5 mm ²	
 Flexible with insulated ferrule	1 or 2 x	0.75 ... 1.5 mm ²	
 Flexible	1 or 2 x	0.75 ... 1.5 mm ²	
Stranded acc. to UL/CSA	1 or 2 x	AWG 16-14	
Flexible acc. to UL/CSA	1 or 2 x	AWG 16-14	
Stripping length	8 mm		
Tightening torques	0.8 ... 1.2 Nm / 7 lb.in		
Connection screw	M3 (Pozidriv 2)		

MS116, MS132, MO132 manual motor starters

Main accessories

Manual motor starter with three-phase busbar systems

2

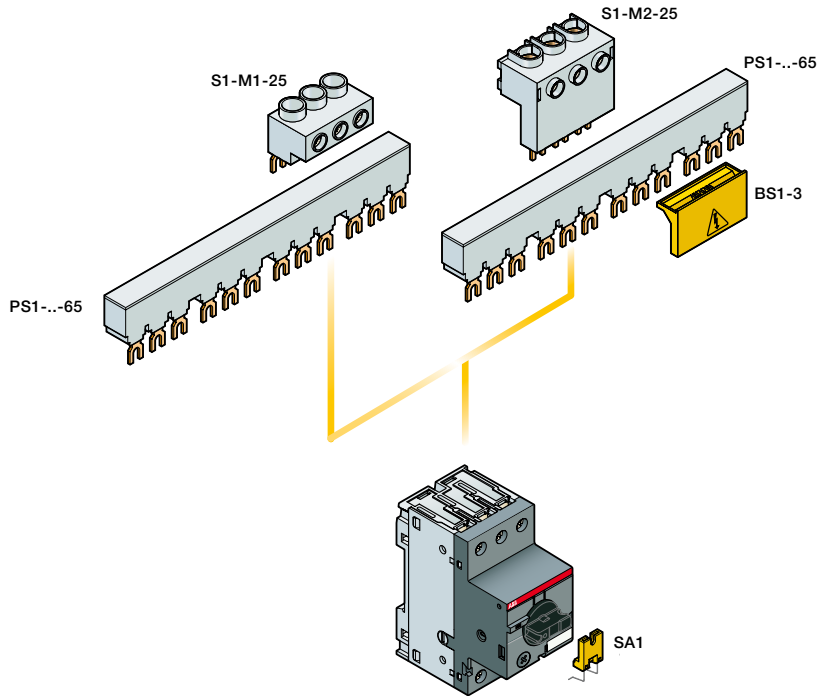

2CDC242000F0013

Three-phase busbar up to 65 A

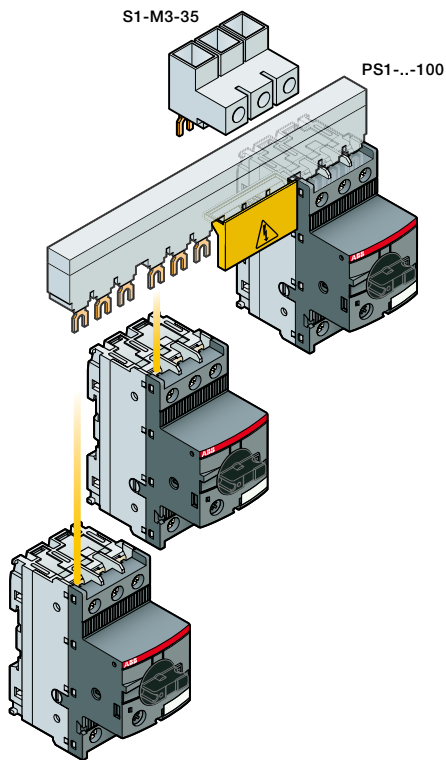

2CDC242021 F0013

Three-phase busbar up to 100 A

2CDC131050C0201

MS116, MS132, MO132 manual motor starters

Main accessories

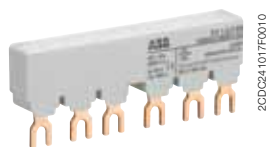

PS1-2-0-65

2CDC241017F0010

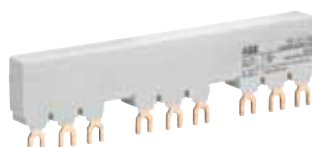

PS1-3-1-100

2CDC241014F0010



S1-M1-25

1SBC101228F0014



S1-M2-25

1SBC101266F0014



SA1

SK0108B01



SA2

2CDC241023F0013

Description

Three-phase busbars ensure a quick and safe connection and are therefore a cost effective solution. A variety of different three-phase busbars up to 100 A are in the assortment. Between 2 and 5 manual motor starters with none, one or two lateral auxiliary contacts can be connected. Different three-phase feeder terminals are available according to the application.

Ordering details

Suitable for	Rated operational current A	Number of MMS	Number of lateral aux.	Type	Order code	Pkg qty	Weight (1 pce) kg
Three-phase busbars							
MS116, MS132, MO132	65	2	0	PS1-2-0-65	1SAM201906R1102	10	0.034
	65	3	0	PS1-3-0-65	1SAM201906R1103	10	0.055
	65	4	0	PS1-4-0-65	1SAM201906R1104	10	0.077
	65	5	0	PS1-5-0-65	1SAM201906R1105	10	0.098
	65	2	1	PS1-2-1-65	1SAM201906R1112	10	0.036
	65	3	1	PS1-3-1-65	1SAM201906R1113	10	0.060
	65	4	1	PS1-4-1-65	1SAM201906R1114	10	0.087
	65	5	1	PS1-5-1-65	1SAM201906R1115	10	0.108
	65	2	2	PS1-2-2-65	1SAM201906R1122	10	0.040
MS116, MS132, MO132	100	3	0	PS1-3-0-100	1SAM201916R1103	10	0.084
	100	4	0	PS1-4-0-100	1SAM201916R1104	10	0.117
	100	5	0	PS1-5-0-100	1SAM201916R1105	10	0.154
	100	3	1	PS1-3-1-100	1SAM201916R1113	10	0.094
	100	4	1	PS1-4-1-100	1SAM201916R1114	10	0.134
	100	5	1	PS1-5-1-100	1SAM201916R1115	10	0.172
	100	3	2	PS1-3-2-100	1SAM201916R1123	10	0.105

Suitable for	Rated operational current A	Rated cross section mm ²	Mounting form	Type	Order code	Pkg qty	Weight (1 pce) kg
Three-phase feeder terminals							
MS116, MS132, MO132	65	25	Flat	S1-M1-25	1SAM201907R1101	10	0.038
	65	25	High	S1-M2-25	1SAM201907R1102	10	0.051
	65	25	UL type E and IEC	S1-M3-25	1SAM201907R1103	10	0.042
	100	35	UL type E and IEC	S1-M3-35	1SAM201913R1103	10	0.060

Suitable for	Description	Type	Order code	Pkg qty	Weight (1 pce) kg
MS116, MS132, MO132	Protection cover for busbars	BS1-3	1SAM201908R1001	50	0.003
	Screw fixing kit	FS116	1SAM201909R1001	1	0.020
	Padlock + two keys	SA2	GJF1101903R0002	10	0.020
MS116	Lock handle	SA1	GJF1101903R0001	10	0.003
	Lock handle box SA1/SA2	SA3	GJF1101903R0003	10	0.050

MS116, MS132, MO132 manual motor starters





Main accessories

General technical data

Type	PS1-xxx-65	PS1-xxx-100	S1-Mx-25	S1-Mx-35
Standards	IEC/EN 60947-4-1, IEC/EN 60947-1			
Rated operational voltage U _e	690 V			
Rated operational current I _e	65 A	100 A	65 A	100 A
Rated frequency	50/60 Hz			
Rated impulse withstand voltage U _{imp}	6 kV			
Rated insulation voltage U _i	690 V AC			
Pollution degree	3			
Cross-section	10 mm ²	16 mm ²	25 mm ²	35 mm ²
Ambient air temperature	Operation -25 ... +70 °C Storage -50 ... +80 °C			
Resistance to shock acc. to IEC 60068-2-27	25g / 11 ms			
Resistance to vibrations acc. to IEC 60068-2-6	5g / 3 ... 150 Hz			

Electrical connection

Main circuit

Type	S1-Mx-25	S1-Mx-35
Connecting capacity		
 Rigid	1 x : 6 ... 25 mm ²	10 ... 35 mm ²
 Flexible with ferrule	1 x : 6 ... 16 mm ²	10 ... 35 mm ²
 Flexible with insulated ferrule	1 x : 6 ... 16 mm ²	10 ... 35 mm ²
 Flexible	1 x : 6 ... 16 mm ²	10 ... 35 mm ²
Stranded acc. to UL/CSA	1 x : AWG 10-4	AWG 8-2
Flexible acc. to UL/CSA	1 x : AWG 10-6	AWG 8-2
Stripping length	10 mm	12 mm
Tightening torques	2.5 Nm / 22 lb.in	4.5 Nm / 40 lb.in
Connection screw	PZ2 (6 mm)	Hexagon SW4

MS116, MS132, MO132 manual motor starters

Main accessories



IB132-Y

2CDC241004F0010



IB132-G

2CDC241003F0010



DMS132-Y

2CDC241002F0010



DMS132-G

2CDC241001F0010

Description

IB132 are IP65 enclosures for single MMS installation. Additional mounting of auxiliary and signalling contacts, shunt trips and undervoltage release is possible. The handle is lockable in OFF position. For detailed specification see installation instruction.

DMS132 are IP65 door mounting kits for MMS installation in any enclosure. Additional mounting of auxiliary, signalling, shunt trips and undervoltage release is possible. The handle is lockable in OFF position. For detailed specification see installation instruction.

Ordering details

Suitable for	Description	Color	Type	Order code	Pkg qty	Weight (1 pce) kg
IP65 enclosures (UL: Type 12)						
MS116,	Padlockable max. 3 padlocks with bail diameter 4...6.5 mm	Yellow/red	IB132-Y	1SAM201911R1011	1	0.370
MS132, MO132		Grey/black	IB132-G	1SAM201911R1010	1	0.370
IP65 door mounting kits (UL: Type 12)						
MS116,	Padlockable max. 3 padlocks with bail diameter 4...6.5 mm	Yellow/red	DMS132-Y	1SAM201912R1011	1	0.170
MS132, MO132		Grey/black	DMS132-G	1SAM201912R1010	1	0.170

Indication I-O-T and ON-OFF-T.

Main dimensions mm, inches

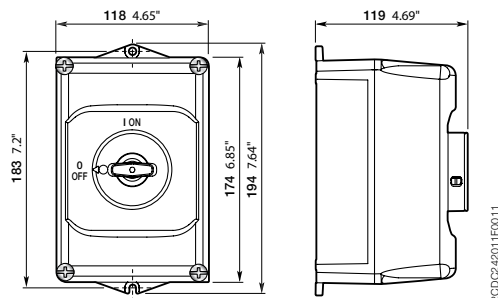

IB132

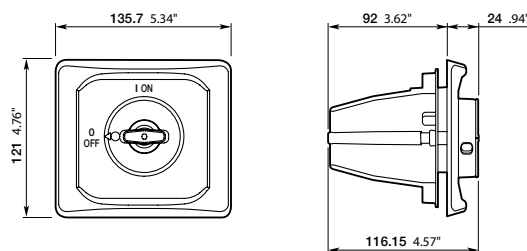

DMS132

MS450, MS495, MS497 manual motor starters

22 to 100 A – with thermal and electromagnetic protection

2



2CDC241004F0009

MS450-40



1SBC101184F0014

MS495-40



2CDC241020F0011

MS497-100

Description

Manual motor starters (MMS) are protection devices for the main circuit. They combine motor control and protection in a single device. MMS are used mainly to switch motors manually ON/OFF and protect them and the installation fuse less against short-circuit, overload and phase failures. Fuse less protection with a manual motor starter saves costs, space and ensures a quick reaction under short-circuit condition, by switching off the motor within milliseconds.

Further features are the build-in disconnect function, temperature compensation, trip-free mechanism and a rotary handle with a clear switch position indication. The manual motor starter is suitable for three- and single-phase applications. The handle is lockable to protect against unauthorized changes. Auxiliary contacts, signalling contacts, undervoltage releases, shunt trips, three-phase busbars, power in-feed blocks are available as accessory.

Ordering details

Rated operational power 400 V AC-3 kW	Setting range A	Short-circuit breaking capacity Ics at 400 V AC kA	Rated instantaneous short-circuit current setting Ii A	Type	Order code	Weight (1 pce) kg
MS450 manual motor starters						
15.8	28.0...40.0	25	520.00	MS450-40	1SAM450000R1005	1.047
22	36.0...45.0	25	585.00	MS450-45	1SAM450000R1006	1.039
22	40.0...50.0	25	650.00	MS450-50	1SAM450000R1007	1.027
MS495 manual motor starters						
30	45.0...63.0	25	819.00	MS495-63	1SAM550000R1007	2.247
37	57.0...75.0	25	975.00	MS495-75	1SAM550000R1008	2.253
45	70.0...90.0	25	1170.00	MS495-90	1SAM550000R1009	2.280
55	80.0...100.0	25	1235.00	MS495-100	1SAM550000R1010	2.295
MS497 manual motor starters						
15	22.0...32.0	50	416.00	MS497-32	1SAM580000R1004	2.222
18.5	28.0...40.0	50	520.00	MS497-40	1SAM580000R1005	2.203
22	36.0...50.0	50	650.00	MS497-50	1SAM580000R1006	2.230
30	45.0...63.0	50	819.00	MS497-63	1SAM580000R1007	2.255
37	57.0...75.0	50	975.00	MS497-75	1SAM580000R1008	2.266
45	70.0...90.0	50	1170.00	MS497-90	1SAM580000R1009	2.268
55	80.0...100.0	50	1235.00	MS497-100	1SAM580000R1010	2.275

Main dimensions mm, inches

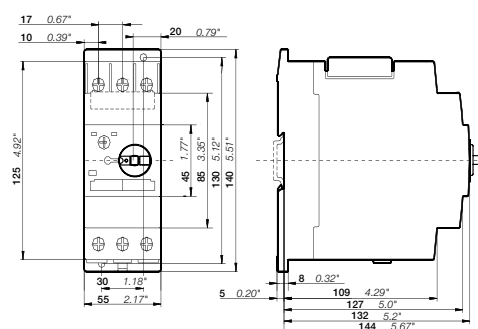

MS450

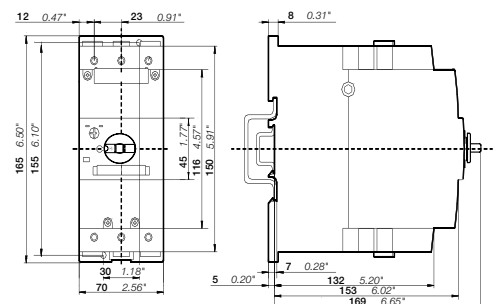

MS495, MS497

MS450, MS495, MS497 manual motor starters

Technical data

Main circuit – Utilization characteristics according to IEC/EN

Type	MS450, MS495, MS497
Standards	IEC/EN 60947-2, IEC/EN 60947-4-1, IEC/EN 60947-1
Rated operational voltage U _e	690 V AC / 450 V DC
Rated frequency	50/60 Hz
Trip class	10
Number of poles	3
Duty time	100 %
Mechanical durability	50000 cycles
Electrical durability	25000 cycles
Rated impulse withstand voltage U _{imp}	6 kV
Rated insulation voltage U _i	690 V AC
Rated operational current I _e	See ordering details
Rated instantaneous short-circuit current setting I _{cc}	See ordering details
Rated service short-circuit breaking capacity I _{cs}	See table "Short-circuit breaking capacity and back-up fuses"
Rated ultimate short-circuit breaking capacity I _{cu}	See table "Short-circuit breaking capacity and back-up fuses"

Short-circuit breaking capacity and back-up fuses

I_{cs} Rated service short-circuit breaking capacity

I_{cu} Rated ultimate short-circuit breaking capacity

I_{cc} Prospective short-circuit current at installation location

Note: Maximum rated current of the back-up fuses if I_{cc} > I_{cs}

Type	240 V AC			400 V AC			440 V AC			500 V AC			690 V AC		
	I _{cs} kA	I _{cu} kA	gG, aM A	I _{cs} kA	I _{cu} kA	gG, aM A	I _{cs} kA	I _{cu} kA	gG, aM A	I _{cs} kA	I _{cu} kA	gG, aM A	I _{cs} kA	I _{cu} kA	gG, aM A

Short-circuit protection MS450

MS450-40	No back-up fuse required up to I _{cc} = 100 kA	25	50	160	15	50	125	5	10	100	2	4	63
MS450-45		25	50	160	15	50	125	5	10	100	2	4	63
MS450-50		25	50	160	15	50	125	5	10	100	2	4	80

MS450: No need for back-up fuse in networks with a prospective current of up to 50 kA at 400 V.
With an appropriate 160 A type gG fuse the device can be used in a network with a prospective current of up to 100 kA.

Short-circuit protection MS495

MS495-40	No back-up fuse required up to I _{cc} = 100 kA	25	50	125	20	50	125	6	12	125	3	6	63
MS495-50		25	50	125	20	50	125	6	12	125	3	6	80
MS495-63		25	50	160	20	50	160	6	12	160	3	6	80
MS495-75		25	50	160	20	50	160	6	8	160	3	5	100
MS495-90		25	50	160	20	50	160	6	8	160	3	5	125
MS495-100		25	50	160	20	50	160	6	8	160	3	5	125

MS495-40: No need for back-up fuse in networks with a prospective current of up to 50 kA at 400 V.
With an appropriate 125 A type gG fuse the device can be used in a network with a prospective current of up to 100 kA.
MS495-100: No need for back-up fuse in networks with a prospective current of up to 50 kA at 400 V.
With an appropriate 160 A type gG fuse the device can be used in a network with a prospective current of up to 100 kA.

Short-circuit protection MS497

MS497-32	No back-up fuse required up to I _{cc} = 100 kA	50	100	No back-up fuse required up to I _{cc} = 100 kA	50	100	No back-up fuse required up to I _{cc} = 100 kA	11	22	100	7	12	63	
MS497-40		50	100		50	100		9	18	160	6	12	80	
MS497-50		50	100		50	100		7.5	15	160	5	10	100	
MS497-63		50	100		50	70		200	7.5	15	160	4	7.5	100
MS497-75		50	100		50	70		200	5	10	160	3	6	125
MS497-90		50	100		50	70		200	5	10	160	3	6	160
MS497-100		50	100		50	70		200	5	10	160	3	6	160

MS497-32: No need for back-up fuse in networks with a prospective current of up to 100 kA at 440 V.
MS497-90: No need for back-up fuse in networks with a prospective current of up to 70 kA at 440 V.
With an appropriate 200 A type gG fuse the device can be used in a network with a prospective current of up to 100 kA.

MS450, MS495, MS497 manual motor starters

Technical data

Main circuit – Utilization characteristics according to UL/CSA

Type	MS450, MS495, MS497	
Standards	UL 508, CSA 22.2 No. 14	
Maximum operational voltage	600 V AC	
Manual motor controller ratings	See table "UL 508 – Manual motor controller"	
Trip rating	125 % FLA	
Motor ratings	Horse power	See table "Motor rating, three phase"
	Full load amps (FLA)	See table "Motor rating, three phase"
	Locked rotor amps (LRA)	See table "Motor rating, three phase"

Motor rating, three phase

hp Horse power

FLA Full load amps

LRA Locked rotor amps

Type	General purpose rating at max. 600 V AC	Full load amps	200 - 208 V AC	230 V AC	460 V AC	575 V AC
	A	FLA	hp	hp	hp	hp
MS450-40	40	40	10	15	30	40
MS450-45	45	45	15	15	30	40
MS450-50	50	50	15	20	40	50
MS495-63	63	63	20	25	50	60
MS495-75	75	75	25	25	60	75
MS495-90	90	90	30	30	75	100
MS495-100	100	100	40	40	75	100
MS497-32	32	32	10	10	25	30
MS497-40	40	40	15	15	30	40
MS497-50	50	50	15	20	40	50
MS497-63	63	63	20	25	50	60
MS497-75	75	75	25	25	60	75
MS497-90	90	90	30	30	75	100
MS497-100	100	100	30	40	75	100

UL 508 – Manual motor controller

Type	Circuit breaker or class R fuse per UL/NEC		Maximum short-circuit current for motor disconnect				for tap conductor		for protection		UL 508	
	480/600 V		480 V		600 V		480Y/277V		600Y/347V		Type E *	Type E
	A	A	kA	kA	kA	kA	kA	kA	kA	kA	kA	kA
MS450-40	150	350	65	25	65	25	65	25	65	25	65	25
MS450-45	175	350	65	25	65	25	65	25	65	25	65	25
MS450-50	200	350	65	25	65	25	65	25	65	25	65	25
MS495-63	250	500	65	30	65	30	65	30	65	30	65	30
MS495-75	300	500	65	30	65	30	65	30	65	30	65	30
MS495-90	350	500	65	10	65	10	65	-	65	-	65	-
MS495-100	400	500	65	10	65	10	65	-	65	-	65	-
MS497-32	120	500	65	30	65	30	65	30	65	30	65	30
MS497-40	160	500	65	30	65	30	65	30	65	30	65	30
MS497-50	200	500	65	30	65	30	65	30	65	30	65	30
MS497-63	250	500	65	30	65	30	65	30	65	30	65	30
MS497-75	300	500	65	30	65	30	65	30	65	30	65	30
MS497-90	350	500	65	10	65	10	-	-	65	-	65	-
MS497-100	400	500	65	10	65	10	-	-	65	-	65	-

* only with use DX495



MS450, MS495, MS497 manual motor starters

Technical data

General technical data

Type		MS450	MS495	MS497
Pollution degree		3		
Phase loss sensitivity		Yes		
Disconnect function acc. to IEC/EN 60947-2		Yes		
Ambient air temperature				
Operation	Open - compensated	-20 ... +60 °C		
	Open	-20 ... +70 °C		
	Enclosed	-20 ... +35 °C		
Storage		-50 ... +80 °C		
Ambient air temperature compensation		Acc. to IEC/EN60947-4-1		
Maximum operating altitude permissible		2000 m		
Resistance to shock acc. to IEC 60068-2-27		25g / 11 ms	-	
Resistance to vibrations acc. to IEC 60068-2-6		2g / 5-150 Hz		
Mounting position		Position 1-6 (optional for single mounting)		
Mounting		DIN-rail 35 mm (EN 60715)	DIN-rail 15 mm / 75 mm (EN 60715)	
Minimum distance to other units same type	Horizontal	0 mm	0 mm	
	Vertical - up to 240 V	-	50 mm	
	Vertical - up to 440 V	-	70 mm	
	Vertical - up to 500 V	-	110 mm	
	Vertical - up to 690 V	-	150 mm	
	Vertical	50 mm	-	
Minimum distance to electrical conductive board	Horizontal	10 mm	-	
	Horizontal - up to 500 V	-	10 mm	
	Horizontal - up to 690 V	-	30 mm	
	Vertical - up to 240 V	-	50 mm	
	Vertical - up to 440 V	-	70 mm	
	Vertical - up to 500 V	-	110 mm	
	Vertical - up to 690 V	-	150 mm	
	Vertical	50 mm	-	
Degree of protection	Housing	IP20		
	Main circuit terminals	IP00		

Connecting characteristics

Main circuit			MS450	MS495	MS497
Type					
Connecting capacity					
 Rigid	1 or 2 x		0.75 ... 16 mm ²	2.5 ... 16 mm ²	2.5 ... 16 mm ²
 Flexible with ferrule	1 x		0.75 ... 35 mm ²	10 ... 70 mm ²	10 ... 70 mm ²
	2 x		0.75 ... 25 mm ²	10 ... 50 mm ²	10 ... 50 mm ²
 Flexible	1 x		0.75 ... 35 mm ²	10 ... 70 mm ²	10 ... 70 mm ²
	2 x		0.75 ... 25 mm ²	10 ... 50 mm ²	10 ... 50 mm ²
		Stranded acc. to UL/CSA	1 x AWG 18-2	AWG 10-2/0	AWG 10-2/0
			2 x AWG 18-2	AWG 10-1/0	AWG 10-1/0
		Flexible acc. to UL/CSA	1 x AWG 18-2	AWG 10-2/0	AWG 10-2/0
			2 x AWG 18-2	AWG 10-1/0	AWG 10-1/0
Stripping length			13 mm	17 mm	17 mm
Tightening torques			3 - 4.5 Nm / 27 ... 40 lb.in	4 - 6 Nm / 35 - 53 lb.in	4 - 6 Nm / 35 - 53 lb.in
Connection screw			Pozidriv 2	Hexagon 4	Hexagon 4

MO450, MO495, MO496 manual motor starters magnetic only 32 to 100 A – with electromagnetic protection

2



ST02601

MO450-40



ST02601

MO495-75



2CDC241021F0011

MO496-100

Description

The manual motor starter magnetic only is used to manually switch on and off motors and to protect them reliably and without the need for a fuse from short-circuits.

Further features are the build-in disconnect function, trip-free mechanism and a rotary handle with a clear switch position indication. The manual motor starter magnetic only is suitable for three- and single-phase applications. The handle is lockable to protect against unauthorized changes. Auxiliary contacts, signalling contacts, undervoltage releases, shunt trips, three-phase busbars, power in-feed blocks are available as accessory.

Ordering details

Rated operational power 400 V AC-3 (1)	Rated operational current	Short-circuit breaking capacity Ics at 400 V AC	Rated instantaneous short-circuit current setting Ii	Type	Order code	Weight (1 pce)
kW	A	kA	A			kg
MO450 manual motor starter magnetic only						
15.8	40	25	520.00	MO450-40	1SAM460000R1005	1.033
22	45	25	585.00	MO450-45	1SAM460000R1006	1.040
22	50	25	650.00	MO450-50	1SAM460000R1007	1.019
MO495 manual motor starter magnetic only						
30	63	25	819.00	MO495-63	1SAM560000R1007	2.244
37	75	25	975.00	MO495-75	1SAM560000R1008	2.247
45	90	25	1170.00	MO495-90	1SAM560000R1009	2.269
55	100	25	1235.00	MO495-100	1SAM560000R1010	2.292
MO496 manual motor starter magnetic only						
15	32	50	416.00	MO496-32	1SAM590000R1004	2.208
18.5	40	50	520.00	MO496-40	1SAM590000R1005	2.218
22	50	50	650.00	MO496-50	1SAM590000R1006	2.218
30	63	50	819.00	MO496-63	1SAM590000R1007	2.248
37	75	50	975.00	MO496-75	1SAM590000R1008	2.278
45	90	50	1170.00	MO496-90	1SAM590000R1009	2.266
55	100	50	1235.00	MO496-100	1SAM590000R1010	2.293

(1) For overload protection of motors, an appropriate thermal or electronic overload relay must be used.

Main dimensions mm, inches

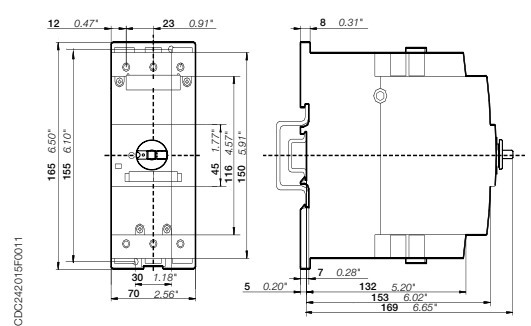
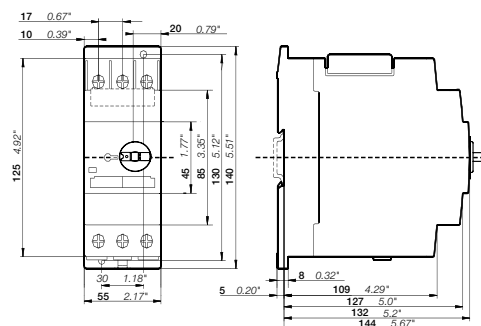

MO450, MO495, MO496 manual motor starters magnetic only

Technical data

Main circuit – Utilization characteristics according to IEC/EN

Type	MO450, MO495, MO496
Standards	IEC/EN 60947-2, IEC/EN 60947-4-1, IEC/EN 60947-1
Rated operational voltage U_e	690 V AC / 450 V DC
Rated frequency	50/60 Hz
Number of poles	3
Duty time	100 %
Mechanical durability	50000 cycles
Electrical durability	25000 cycles
Rated impulse withstand voltage U_{imp}	6 kV
Rated insulation voltage U_i	690 V AC
Rated operational current I_e	See ordering details
Rated instantaneous short-circuit current setting I_{sc}	See ordering details
Rated service short-circuit breaking capacity I_{cs}	See table "Short-circuit breaking capacity and back-up fuses"
Rated ultimate short-circuit breaking capacity I_{cu}	See table "Short-circuit breaking capacity and back-up fuses"

Short-circuit breaking capacity and back-up fuses

I_{cs} Rated service short-circuit breaking capacity

I_{cu} Rated ultimate short-circuit breaking capacity

I_{cc} Prospective short-circuit current at installation location

Note: Maximum rated current of the back-up fuses if $I_{cc} > I_{cs}$

Type	240 V AC			400 V AC			440 V AC			500 V AC			690 V AC			
	I_{cs} kA	I_{cu} kA	gG, aM A	I_{cs} kA	I_{cu} kA	gG, aM A	I_{cs} kA	I_{cu} kA	gG, aM A	I_{cs} kA	I_{cu} kA	gG, aM A	I_{cs} kA	I_{cu} kA	gG, aM A	
Short-circuit protection MO450																
MO450-40	No back-up fuse required up to $I_{cc} = 100$ kA			25	50	160	15	50	125	5	10	100	2	4	63	
MO450-45				25	50	160	15	50	125	5	10	100	2	4	63	
MO450-50				25	50	160	15	50	125	5	10	100	2	4	80	

MO450: No need for back-up fuse in networks with a prospective current of up to 50 kA at 400 V.
With an appropriate 160 A type gG fuse the device can be used in a network with a prospective current of up to 100 kA.

Short-circuit protection MO495

MO495-63	No back-up fuse required up to $I_{cc} = 100$ kA			25	50	160	20	50	160	6	12	160	3	6	80
MO495-75				25	50	160	20	50	160	6	8	160	3	5	100
MO495-90				25	50	160	20	50	160	6	8	160	3	5	125
MO495-100				25	50	160	20	50	160	6	8	160	3	5	125

MO495-100: No need for back-up fuse in networks with a prospective current of up to 50 kA at 400 V.
With an appropriate 160 A type gG fuse the device can be used in a network with a prospective current of up to 100 kA.

Short-circuit protection MO496

MO496-32	No back-up fuse required up to $I_{cc} = 100$ kA			50	100	No back-up fuse required up to $I_{cc} = 100$ kA	50	100	No back-up fuse required up to $I_{cc} = 100$ kA	11	22	100	7	12	63
MO496-40				50	100		50	100	9	18	160	6	12	80	
MO496-50				50	100		50	100	7.5	15	160	5	10	100	
MO496-63				50	100		50	70	200	7.5	15	160	4	7.5	100
MO496-75				50	100		50	70	200	5	10	160	3	6	125
MO496-90				50	100		50	70	200	5	10	160	3	6	160
MO496-100				50	100		50	70	200	5	10	160	3	6	160

MO496-32: No need for back-up fuse in networks with a prospective current of up to 100 kA at 440 V.
MO496-90: No need for back-up fuse in networks with a prospective current of up to 70 kA at 440 V.
With an appropriate 200 A type gG fuse the device can be used in a network with a prospective current of up to 100 kA.

MO450, MO495, MO496 manual motor starters magnetic only

Technical data

Main circuit – Utilization characteristics according to UL/CSA

Type	MO450, MO495, MO496	
Standards	UL 508, CSA 22.2 No. 14	
Maximum operational voltage	600 V AC	
Manual motor controller ratings	See table "UL 508 – Manual motor controller"	
Trip rating	125 % FLA	
Motor ratings	Horse power	See table "Motor rating, three phase"
	Full load amps (FLA)	See table "Motor rating, three phase"
	Locked rotor amps (LRA)	See table "Motor rating, three phase"

Motor rating, three phase

hp Horse power

FLA Full load amps

LRA Locked rotor amps

Type	General purpose rating at max. 600 V AC	Full load amps	200 - 208 V AC	230 V AC	460 V AC	575 V AC
	A	FLA	hp	hp	hp	hp
MO450-40	40	40	10	15	30	40
MO450-45	45	45	15	15	30	40
MO450-50	50	50	15	20	40	50
MO495-63	63	63	20	25	50	60
MO495-75	75	75	25	25	60	75
MO495-90	90	90	30	30	75	100
MO495-100	100	100	40	40	75	100
MO496-32	32	32	10	10	25	30
MO496-40	40	40	15	15	30	40
MO496-50	50	50	15	20	40	50
MO496-63	63	63	20	25	50	60
MO496-75	75	75	25	25	60	75
MO496-90	90	90	30	30	75	100
MO496-100	100	100	30	40	75	100

UL 508 – Manual motor controller

Type	Circuit breaker or class R fuse per UL/NEC		Max. circuit breaker or fuse per UL/NEC		Maximum short-circuit current for motor disconnect		for group installation	
	480/600 V		480/600 V		480 V		600 V	
	A	A	kA	kA	kA	kA	kA	kA
MO450-40	150	-	65	25	65	25		
MO450-45	175	-	65	25	65	25		
MO450-50	200	-	65	25	65	25		
MO495-63	60	500	65	30	65	30		
MO495-75	250	500	65	30	65	30		
MO495-90	300	500	65	30	65	30		
MO495-100	350	500	65	10	65	10		
MO496-32	120	500	65	30	65	30		
MO496-40	160	500	65	30	65	30		
MO496-50	200	500	65	30	65	30		
MO496-63	250	500	65	30	65	30		
MO496-75	300	500	65	30	65	30		
MO496-90	350	500	65	10	65	10		
MO496-100	400	500	65	10	65	10		

* only with use DX495

MO450, MO495, MO496 manual motor starters magnetic only



Technical data

General technical data

Type		MO450	MO495	MO496
Pollution degree		3		
Phase loss sensitivity		No		
Disconnect function acc. to IEC/EN 60947-2		Yes		
Ambient air temperature				
Operation	Open - compensated	-20 ... +60 °C		
	Open	-20 ... +70 °C (above 60° C, current derating)		
	Enclosed	-20 ... +35 °C		
Storage		-50 ... +80 °C		
Ambient air temperature compensation		-		
Maximum operating altitude permissible		2000 m		
Resistance to shock acc. to IEC 60068-2-27		25g / 11 ms		
Resistance to vibrations acc. to IEC 60068-2-6		2g / 5-150 Hz		
Mounting position		Position 1-6 (optional for single mounting)		
Mounting		DIN-rail 35 mm (EN 60715)	DIN-rail 15 mm / 75 mm (EN 60715)	
Minimum distance to other units same type	Horizontal	0 mm	0 mm	
	Vertical - up to 240 V	-	50 mm	
	Vertical - up to 440 V	-	70 mm	
	Vertical - up to 500 V	-	110 mm	
	Vertical - up to 690 V	-	150 mm	
	Vertical	50 mm	-	
Minimum distance to electrical conductive board	Horizontal	10 mm	-	
	Horizontal - up to 500 V	-	10 mm	
	Horizontal - up to 690 V	-	30 mm	
	Vertical - up to 240 V	-	50 mm	
	Vertical - up to 440 V	-	70 mm	
	Vertical - up to 500 V	-	110 mm	
	Vertical - up to 690 V	-	150 mm	
	Vertical	50 mm	-	
Degree of protection	Housing	IP20		
	Main circuit terminals	IP20		

Connecting characteristics

Main circuit

Type		MO450	MO495	MO496
Connecting capacity				
 Rigid	1 or 2 x	0.75 ... 16 mm ²	2.5 ... 16 mm ²	2.5 ... 16 mm ²
 Flexible with ferrule	1 x	0.75 ... 35 mm ²	10 ... 70 mm ²	10 ... 70 mm ²
	2 x	0.75 ... 25 mm ²	10 ... 50 mm ²	10 ... 50 mm ²
 Flexible	1 x	0.75 ... 35 mm ²	10 ... 70 mm ²	10 ... 70 mm ²
	2 x	0.75 ... 25 mm ²	10 ... 50 mm ²	10 ... 50 mm ²
Stranded acc. to UL/CSA	1 x	AWG 18-2	AWG 10-2/0	AWG 10-2/0
	2 x	AWG 18-2	AWG 10-1/0	AWG 10-1/0
Flexible acc. to UL/CSA	1 x	AWG 18-2	AWG 10-2/0	AWG 10-2/0
	2 x	AWG 18-2	AWG 10-1/0	AWG 10-1/0
Stripping length		13 mm	17 mm	17 mm
Tightening torques		3 - 4.5 Nm / 27 ... 40 lb.in	4 - 6 Nm / 35 - 53 lb.in	4 - 6 Nm / 35 - 53 lb.in
Connection screw		Pozidriv 2	Hexagon 4	Hexagon 4

MS45x, MS49x, MO45x, MO49x manual motor starters Main accessories

MS45x and MS49x manual motor starters with accessories

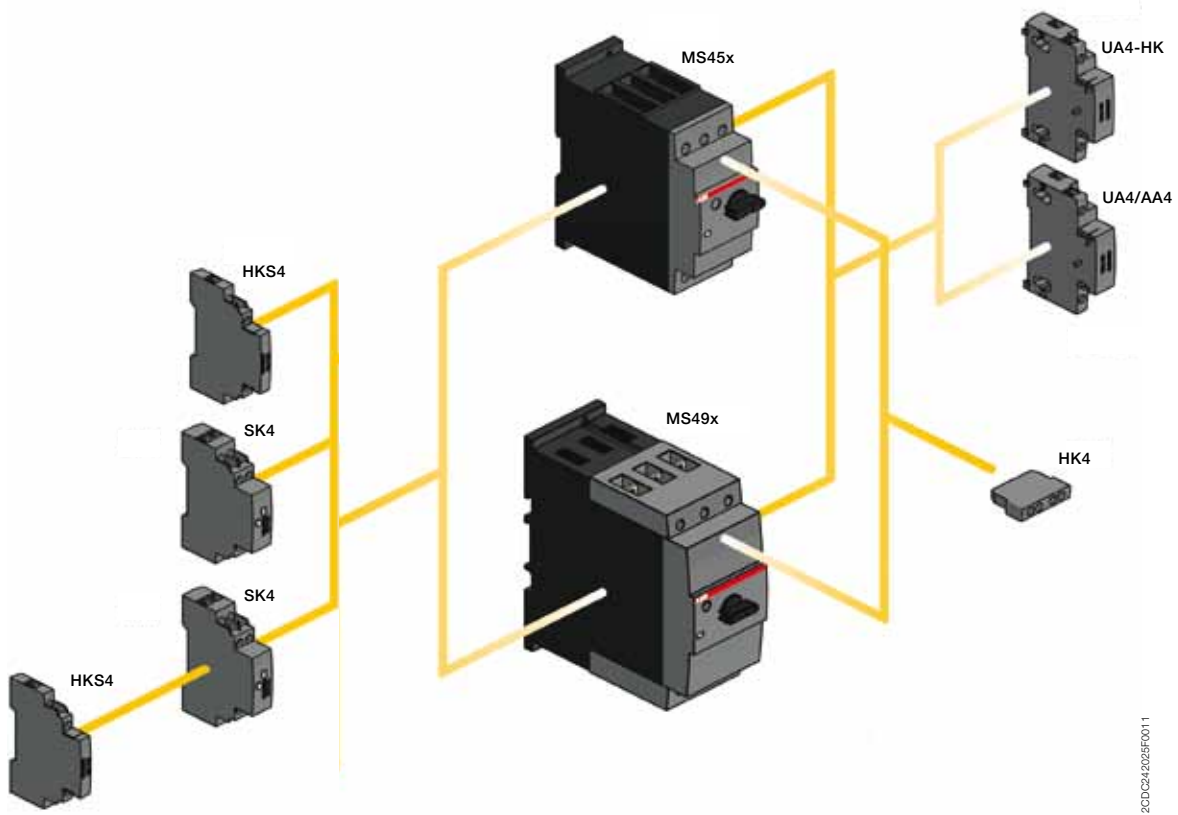

MO45x and MO49x manual motor starters with accessories

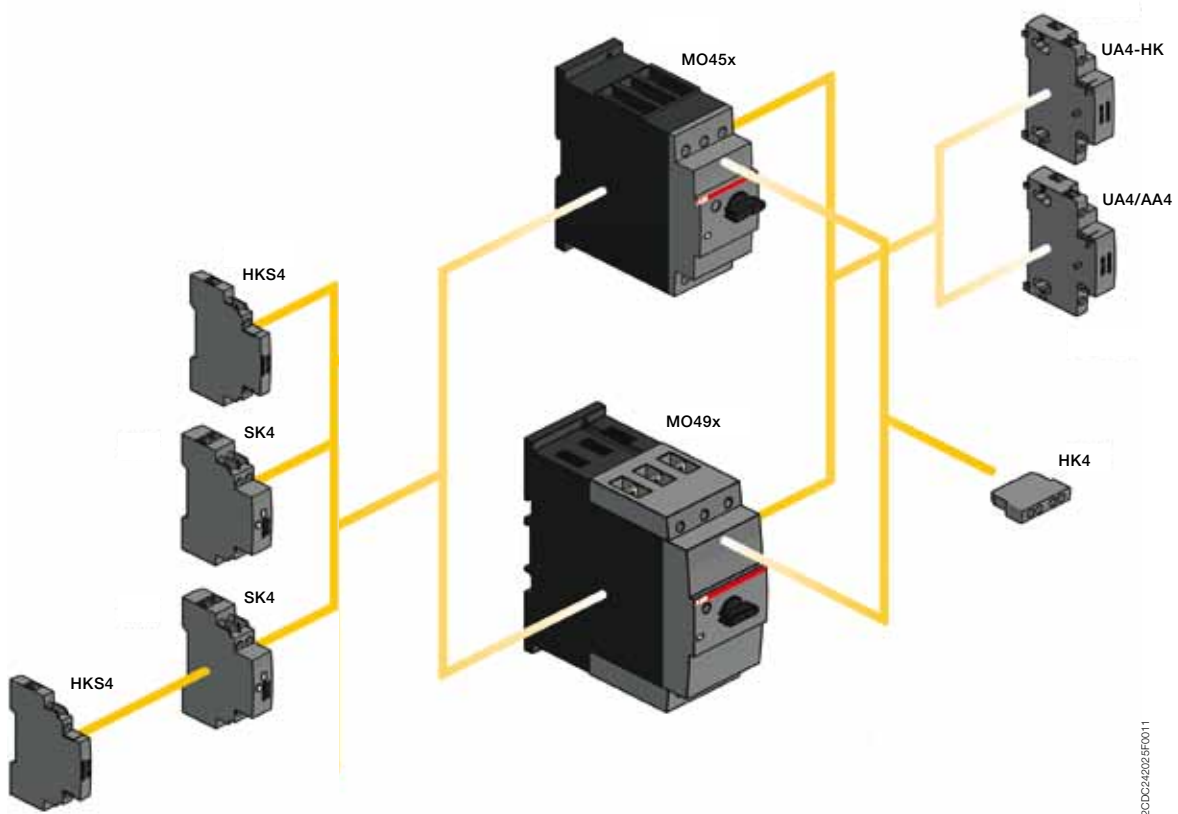

MS45x, MS49x, MO45x, MO49x manual motor starters

Main accessories



HK4-11

2CDC241028F0011



HKS4-20

2CDC241022F0011



SK4-11

2CDC241024F0011



AA4-24

2CDC241023F0011



UA4-110

2CDC241025F0011

Description

Manual motor starters can be equipped with auxiliary contacts for lateral/front mounting, signalling contact for lateral mounting, undervoltage release and shunt trips. The accessories can be fitted wiring free and without tools. A variety of combinations is possible as required for the application. The auxiliary contacts change position with the main contacts. Undervoltage release are used for remote tripping of the manual motor starter especially for emergency stop circuits. Shunt trips release the MMS used for remote tripping.

Ordering details

Suitable for	Auxiliary contacts N.O.	Auxiliary contacts N.C.	Description	Type	Order code	Pkg qty	Weight (1 pce)
							kg

Auxiliary contacts – mountable on the front

MS45x, MS49x, MO45x, MO49x	1	1	Changeover	HK4-11 HK4-W	1SAM401901R1001 1SAM401901R1002	10 10	0.017 0.015
----------------------------	---	---	------------	-----------------	------------------------------------	----------	----------------

Auxiliary contacts – mountable on the left

MS45x, MS49x, MO45x, MO49x	1 2 0	1 0 2	Max. 1 piece	HKS4-11 HKS4-20 HKS4-02	1SAM401902R1001 1SAM401902R1002 1SAM401902R1003	2 2 2	0.045 0.045 0.045
----------------------------	-------------	-------------	--------------	-------------------------------	---	-------------	-------------------------

Signalling contacts – mountable on the left

MS45x, MS49x, MO45x, MO49x	2	2	Separate signalling acc. UL508E 1 N.O. + 1 N.C. for short circuit alarm and 1 N.O. + 1 N.C. for tripped alarm, max. 1x SK4-11 + 1 x HKS4-xx	SK4-11	1SAM401904R1001	1	0.093
----------------------------	---	---	---	--------	-----------------	---	-------

Suitable for	Rated control supply voltage	Frequency	Type	Order code	Pkg qty	Weight (1 pce)
	V	Hz				kg

Shunt trip units – mountable on the right

MS45x, MS49x, MO45x, MO49x	20...24 90...110 200...240 350...415	50/60 50/60 50/60 50/60	AA4-24 AA4-110 AA4-230 AA4-400	1SAM401907R1001 1SAM401907R1002 1SAM401907R1003 1SAM401907R1004	1 1 1 1	0.135 0.135 0.128 0.125
----------------------------	---	----------------------------------	---	--	------------------	----------------------------------

Undervoltage releases – mountable on the right

MS45x, MS49x, MO45x, MO49x	24 110/120 230/240 400/440 230/240 400/440	50/60 50/60 50/60 50/60 50/60 50/60	UA4-24 UA4-110 UA4-230 UA4-400 UA4-HK-230 UA4-HK-400	1SAM401905R1004 1SAM401905R1001 1SAM401905R1002 1SAM401905R1003 1SAM401906R1001 1SAM401906R1002	1 1 1 1 1 1	0.134 0.134 0.131 0.129 0.140 0.137
----------------------------	---	--	---	--	----------------------------	--

MS45x, MS49x, MO45x, MO49x manual motor starters

Main accessories

General technical data





Type	HK4-11	HK4-W	HKS4	SK4
Standards	IEC/EN 60947-1, IEC/EN 60947-5-1, UL 508, CSA22.2 No. 14			
Rated operational voltage U_e	230 V AC / 220 V DC	690 V AC / 220 V DC	690 V AC	690 V AC
Conventional free-air thermal current I_{th}	2.5 A	5 A	10 A	10 A
Rated frequency	DC, 50/60 Hz			
Rated impulse withstand voltage U_{imp}	6 kV			
Rated insulation voltage U_i	300 V	300 V	690 V	690 V
Pollution degree	3			
Ambient air temperature	Operation -20 ... +70 °C Storage -50 ... +80 °C			
Resistance to shock acc. to IEC 60068-2-27	25g / 11 ms			
Resistance to vibrations acc. to IEC 60068-2-6	2g / 5 ... 150 Hz			
Number of poles	1 N.C. + 1 N.O.	Changeover	1 N.C. + 1 N.O. / 2 N.O. / 2 N.C.	2 N.C. + 2 N.O.
I_e / Rated operational current AC-15 acc. to IEC/EN 60947-5-1 for utilization category				
	24 V 2 A	4 A	6 A	6 A
	230 V 0.5 A	3 A	4 A	4 A
	400 V -	1.5 A	3 A	3 A
	690 V -	0.5 A	1 A	1 A
I_e / Rated operational current DC-13 acc. to IEC/EN 60947-5-1 for utilization category				
	24 V 1 A	1 A	2 A	2 A
	48 V 0.3 A	-	-	-
	60 V 0.15 A	-	-	-
	110 V -	0.22 A	0.5 A	0.5 A
	230 V -	0.1 A	0.25 A	0.25 A
Minimum switching capacity	17 V / 1 mA			
Short-circuit protective device	10 A Type gG			
Duty time	100 %			
Mounting	Front of MMS	Front of MMS	Left side of MMS	Left side of MMS
Mounting positions	1-6			
Mechanical durability	100000 cycles			
Electrical durability	100000 cycles			

Type	UA4-xxx	AA4-xxx
Power consumption		
Pull-in	AC 20.2/13 VA/W	20.2/13 VA/W
	DC 20 W	13 ... 80 W
Holding	AC 7.2/2.4 VA/W	-
	DC 2.1 W	-
Operating voltage		
Tripping	0.35 ... 0.7 V x U_e	0.7 ... 1.1 V x U_e
Coil operating voltage	0.85 ... 1.1 V x U_e	-

MS45x, MS49x, MO45x, MO49x manual motor starters

Main accessories

Connecting characteristics

Auxiliary circuit		HK4-11	HK4-W	HKS4	SK4
Connecting capacity					
 Rigid	1 x	0.5... 2.5 mm ²			
	2 x	0.5 ... 1.5 mm ² or 0.75 ... 2.5 mm			
 Flexible with ferrule	1 x	0.5 ... 2.5 mm ²			
	2 x	0.5 ... 1.5 mm ² or 0.75 ... 2.5 mm			
 Flexible	1 x	0.5 ... 2.5 mm ²			
	2 x	0.5 ... 1.5 mm ² or 0.75 ... 2.5 mm			
 Flexible	1 x	0.5 ... 2.5 mm ²			
	2 x	0.5 ... 1.5 mm ² or 0.75 ... 2.5 mm			
Stranded acc. to UL/CSA		1 or 2 x	AWG 18-14		
Flexible acc. to UL/CSA		1 or 2 x	AWG 18-14		
Stripping length		10 mm			
Tightening torques		0.8 ... 1.2 Nm / 7 ... 10.3 lb.in			
Connection screw		Pozidriv 2			

MS45x, MS49x, MO45x, MO49x manual motor starters

Main accessories

2



PS4-2-0

2CDC241003F0012



PS4-3-0

2CDC241004F0012



PS4-4-0

2CDC241005F0012



SA2

2CDC241023F0013

Description

Three-phase busbars ensure a quick and safe connection and are therefore a cost effective solution. A variety of different three-phase busbars up to 108 A are in the assortment. Between 2 and 4 manual motor starter with none or two lateral auxiliary contacts can be connected.

Ordering details

Suitable for	Rated operational current A	Number of MMS	Number of lateral aux.	Type	Order code	Pkg qty	Weight (1 pce) kg
--------------	--------------------------------	---------------	------------------------	------	------------	---------	----------------------

Three-phase busbars

MS450, MO450	108 A	2	0	PS4-2-0	1SAM401911R1001	5	0.134
	108 A	3	0	PS4-3-0	1SAM401911R1002	5	0.206
	108 A	4	0	PS4-4-0	1SAM401911R1003	5	0.280
	108 A	2	1	PS4-2-2	1SAM401911R1004	5	0.148
	108 A	3	1	PS4-3-2	1SAM401911R1005	5	0.250
	108 A	4	1	PS4-4-2	1SAM401911R1006	5	0.362

Suitable for	Rated operational current A	Rated cross section mm ²	Mounting form	Type	Order code	Pkg qty	Weight (1 pce) kg
--------------	--------------------------------	--	---------------	------	------------	---------	----------------------

Three-phase feeder terminals

MS450, MO450	108 A	25	Flat	S4-M1	1SAM401911R1007	2	0.106
--------------	-------	----	------	-------	-----------------	---	-------

Suitable for	Description	Type	Order code	Pkg qty	Weight (1 pce) kg
MS450, MO450	Protection cover for busbar	BS4-3	1SAM401911R1008	10	0.001
	Disconnecter module	TB450	1SAM401910R1001	1	0.315
	Terminal shroud	KA450	1SAM401908R1001	1	0.154
MS495, MS497, MO495, MO496	Terminal shroud	KA495	1SAM501901R1001	10	0.018
	Terminal shroud	KA495C (1)	1SAM501902R1001	10	0.038
	Terminal insulation barrier for UL508E	DX495	1SAM401912R1001	1	0.154
MS450, MS495, MS497, MO450, MO495, MO496	Padlock + two keys	SA2	GJF1101903R0002	10	0.020

(1) Is plugged onto the housing after removing the box terminals, if using cable lugs.

MS45x, MS49x, MO45x, MO49x manual motor starters



Main accessories

General technical data

Type	PS4-xxx	S4-M1
Standards	IEC/EN 60947-1	
Rated operational voltage U_n	690 V AC	
Rated operational current I_n	108 A	
Rated frequency	50/60 Hz	
Rated impulse withstand voltage U_{imp}	6 kV	
Rated insulation voltage U_i	690 V AC	
Pollution degree	3	
Cross-section	10 mm ²	25 mm ²
Ambient air temperature	Operation	-25 ... +70 °C
	Storage	-50 ... +80 °C

Connecting characteristics

Main circuit

Type	S4-M1	
Connecting capacity		
 Rigid	1 x	2.5 ... 50 mm ²
 Flexible with ferrule	1 x	4 ... 16 mm ²
 Flexible	1 x	4 ... 16 mm ²
Stranded acc. to UL/CSA	1 x	AWG 14-4
Flexible acc. to UL/CSA	1 x	AWG 14-4
Tightening torques	4 Nm	
Connection screw	Pozidriv 2	

MS116, MS132, MO132, MS4xx, MO4xx manual motor starters

General accessories

2



2CDC241003R0011

MSHD-LB



2CDC241002S0011

MSHD-LY



2CDC241004F0011

MSMN



2CDC241001F0012

MSH-AR



2CDC241017V0013

MSAH1

Description

With this solution of door coupling rotary mechanism it is possible to operate a Manual Motor Starter in the back of a switch cabinet from outside. The door coupling mechanism prevents opening of the door of a switch cabinet with the Manual Motor Starter in ON position.

The complete mechanism includes handle, shaft, driver, shaft alignment ring and shaft supporter.

All accessories fit for 6 mm shafts with a maximum length of 180 mm. The degree of protection for handles MSHD is IP64.

Ordering details

Suitable for	Description	Shaft length mm	Color	Type	Order code	Pkg qty	Weight (1 pce) kg
Shafts							
MS116, MS132, MO132, MS4xx, MO4xx	For MSHD handles. Shaft diameter 6 mm. Shaft extension for door coupling driver.	85		OXS6X85	1SCA101647R1001	1	0.020
		105		OXS6X105	1SCA108043R1001	1	0.020
		130		OXS6X130	1SCA101655R1001	1	0.030
		180		OXS6X180	1SCA101659R1001	1	0.040
IP64 handles (UL: Type 1, 3R, 12)							
MS116, MS132, MO132, MS4xx, MO4xx	Padlockable max. 3 padlocks with bail diameter 5 ... 8 mm, door interlock in ON position defeatable, for use with 6 mm OXS6...types up to 180 mm or driver shafts MSOX.		Black	MSHD-LB (1)	1SAM201920R1001	1	0.065
			Yellow	MSHD-LY (1)	1SAM201920R1002	1	0.065
			Black	MSHD-LTB (2)	1SAM201920R1011	1	0.065
			Yellow	MSHD-LTY (2)	1SAM201920R1012	1	0.065
Driver							
MS116, MS132, MO132, MS4xx, MO4xx	Coupling driver for use with 6 mm OXS6... types up to 180 mm.			MSMN (3)	1SAM101923R0002	1	0.002
				MSMNO (4)	1SAM101923R0012	1	0.002
Shaft alignment ring							
MS116, MS132, MO132, MS4xx, MO4xx	The MSH-AR supports the long shafts for alignment to the handle inlet. It makes closing panel doors more easy. Use for OXS6X > 105 mm.			MSH-AR	1SAM201920R1000	1	0.010
Shaft supporter							
MS116, MS132, MO132	With the MSAH1 it is possible to support the shaft in the extension of handle (MSHD). It is mandatory for the usage of shafts > 130 mm.			MSAH1	1SAM201909R1021	1	0.035

(1) Indication I-O and ON-OFF (recommended for MS116, MS4xx, MO4xx).

(2) Indication I-O and ON-OFF + Trip indication.

(3) Coded - Positioning of ON indication dependent from mounting orientation of the MMS.

(4) Uncoded - Positioning of ON indication independent from mounting orientation of the MMS.

MS116, MS132, MO132, MS4xx, MO4xx manual motor starters

General accessories

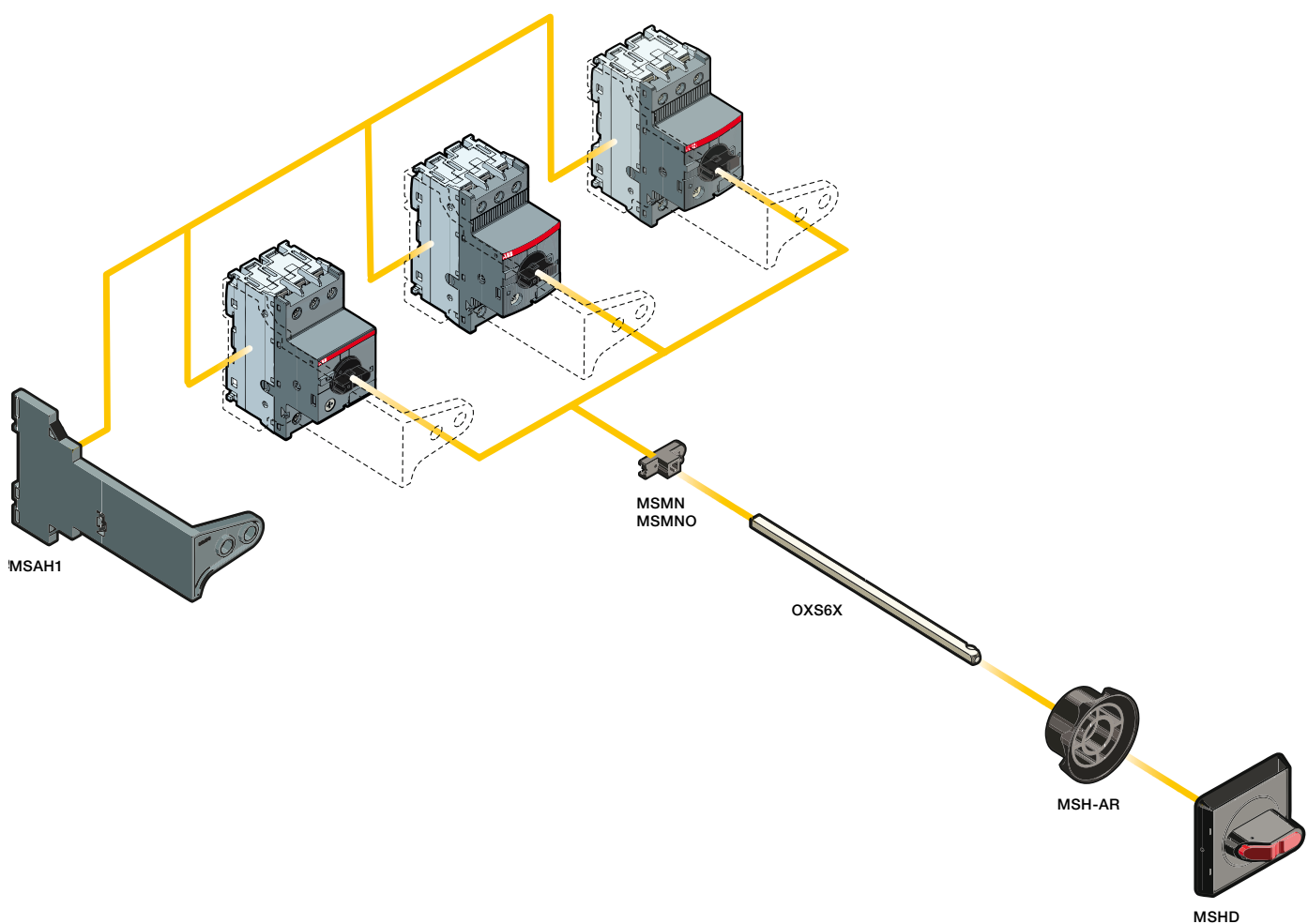

2CDC242022FX013



A contactors and N contactor relays

A 3-pole contactors

Overview	3/2
4 to 55 kW / 5 to 75 hp	
A9 ... A16 AC operated	3/4
A26 ... A40 AC operated	3/5
A50 ... A75 AC operated	3/6
A95 ... A110 AC operated	3/7
Main accessories	3/8
75 to 160 kW / 100 to 250 hp	
A145 ... A300 AC operated	3/11
Main accessories	3/12
Technical data	3/14
Terminal marking and positioning	3/27
Star-delta starting of three-phase asynchronous motors	3/28

A 4-pole contactors

Overview	3/30
25 to 125 A AC-1	
A9 ... A16 AC operated	3/31
A26 AC operated	3/32
A45 ... A75 AC operated	3/33
Main accessories	3/34
Technical data	3/36
Terminal marking and positioning	3/44

N contactor relays

N AC operated	3/45
Main accessories	3/46
Technical data	3/48
Terminal marking and positioning	3/50

Accessories for A contactors and N contactor relays

Auxiliary contact blocks	3/52
Electronic timers	3/55
Mechanical and electrical interlock units	3/58
Electronic timers for star-delta starters	3/60
Surge suppressors for contactor coils	3/62
Interface relays	3/64
Mechanical latching units	3/66
Function markers - Impulse contact blocks	3/68
Terminal shrouds, terminal enlargements, terminal extensions, connector terminals	3/69

Voltage code table	3/70
--------------------	------

3-pole contactors, for motor control and power switching

3



IEC (1)	AC-3 Rated operational power	$\theta \leq 55^\circ\text{C}$, 400 V	kW	4	5.5	7.5	11	15	18.5
UL/CSA	3-phase motor rating	480 V	hp	5	7.5	10	20	25	30
AC Control supply			Type	A9	A12	A16	A26	A30	A40
IEC	AC-3 Rated operational current	$\theta \leq 55^\circ\text{C}$, 400 V	A	9	12	17	26	32	37
	AC-1 Rated operational current	$\theta \leq 40^\circ\text{C}$, 690 V	A	25	27	30	45	55	60
UL/CSA	General use rating	600 V	A	21	25	30	40	50	60
NEMA	NEMA Size			00	0	—	1	1P	—

(1) 1000 V IEC ratings available for A50 ... A300 contactors.

Main accessories

Auxiliary contact blocks	Front mounting	CA5-10 (1 x N.O.) CA5-01 (1 x N.C.)
	Side mounting	CAL5-11 (1 x N.O. + 1 x N.C.)
Timers	Electronic	TEF5-ON TEF5-OFF TE5S (for star-delta starters - direct timing - separate mounting)
		VM5-1
		VE5-1
Interlocking units	Mechanical	RV5 (24...440 V) RC5-1 (24...440 V)
	Mechanical / Electrical	
Surge suppressors	Varistor (AC/DC)	
	RC Type (AC)	

Overload relays

Thermal relays	Class 10A (Class 10A or 20 for TA80DU) (Class 30 for TA450SU)	TA25DU-M (0.10...32 A)
		TA42DU-M (18...42 A)



Manual motor starters

	Thermal / magnetic protection Class 10	MS116 (0.10...32 A) lcs up to 50 kA for class 10 A	MS450 (28...50 A) lcs up to 50 kA
		MS132 (0.10...32 A) lcs up to 100 kA	MS497 (22...100 A) lcs up to 100 kA
	Magnetic only types	MO132 (0.16...32 A) lcs up to 100 kA	MO496 (32...100 A) lcs up to 100 kA
			MO450 (40...50 A) lcs up to 50 kA



22	30	37	45	55	75	90	110	140	160
40	60	60	60	75	100	125	150	200	250
A50	A63	A75	A95	A110	A145	A185	A210	A260	A300
50	65	75	96	110	145	185	210	260	305
100	115	125	145	160	250	275	350	400	500
80	90	105	125	150	230	250	300	350	400
2	—	3	—	—	4	—	—	5	—

		CAL18-11 (1 x N.O. + 1 x N.C.)	
VE5-2		VM300H VM300V	
RC5-2 (24...440 V)		RC5-3 (250...440 V)	

TA75DU-M (18...80 A)	TA80DU (29...80 A) TA110DU (66...110 A)	TA200DU (66...200 A)	TA450DU (130...310 A) TA450SU (40...310 A)
-----------------------------	--	-----------------------------	---

Short-circuit protection devices

Tmax Circuit breaker and accessories

MS495 (45...100 A) Ics up to 50 kA	
MO495 (63...100 A) Ics up to 50 kA	

A9 ... A16 3-pole contactors

4 to 7.5 kW

AC operated



1SBC573 122FC001

3

A9-30-10

Description

A9 ... A16 contactors are mainly used for controlling 3-phase motors and power circuits up to 690 V AC or 220 V DC.

These contactors are of the block type design with:

- 3 main poles and 1 built-in auxiliary contact
- control circuit: AC operated
- add-on auxiliary contact blocks for front or side mounting and a wide range of accessories.

Ordering details

IEC		UL/CSA		Rated control circuit voltage U _c		Auxiliary contacts fitted	Type	Order code	Weight
Rated operational power	current θ ≤ 40 °C	3-phase motor rating	General use rating	V 50 Hz	V 60 Hz				
400 V AC-3	AC-1	480 V	600 V AC						
kW	A	hp	A					kg	
4	25	5	21	24	24	1 0	A9-30-10	1SBL141001R8110	0.340
						0 1	A9-30-01	1SBL141001R8101	0.340
				48	48	1 0	A9-30-10	1SBL141001R8310	0.340
						0 1	A9-30-01	1SBL141001R8301	0.340
				110	110...120	1 0	A9-30-10	1SBL141001R8410	0.340
						0 1	A9-30-01	1SBL141001R8401	0.340
				220...230	230...240	1 0	A9-30-10	1SBL141001R8010	0.340
						0 1	A9-30-01	1SBL141001R8001	0.340
				230...240	240...260	1 0	A9-30-10	1SBL141001R8810	0.340
						0 1	A9-30-01	1SBL141001R8801	0.340
				380...400	400...415	1 0	A9-30-10	1SBL141001R8510	0.340
						0 1	A9-30-01	1SBL141001R8501	0.340
				400...415	415...440	1 0	A9-30-10	1SBL141001R8610	0.340
						0 1	A9-30-01	1SBL141001R8601	0.340
5.5	27	7.5	25	24	24	1 0	A12-30-10	1SBL161001R8110	0.340
						0 1	A12-30-01	1SBL161001R8101	0.340
				48	48	1 0	A12-30-10	1SBL161001R8310	0.340
						0 1	A12-30-01	1SBL161001R8301	0.340
				110	110...120	1 0	A12-30-10	1SBL161001R8410	0.340
						0 1	A12-30-01	1SBL161001R8401	0.340
				220...230	230...240	1 0	A12-30-10	1SBL161001R8010	0.340
						0 1	A12-30-01	1SBL161001R8001	0.340
				230...240	240...260	1 0	A12-30-10	1SBL161001R8810	0.340
						0 1	A12-30-01	1SBL161001R8801	0.340
				380...400	400...415	1 0	A12-30-10	1SBL161001R8510	0.340
						0 1	A12-30-01	1SBL161001R8501	0.340
				400...415	415...440	1 0	A12-30-10	1SBL161001R8610	0.340
						0 1	A12-30-01	1SBL161001R8601	0.340
7.5	30	10	30	24	24	1 0	A16-30-10	1SBL181001R8110	0.340
						0 1	A16-30-01	1SBL181001R8101	0.340
				48	48	1 0	A16-30-10	1SBL181001R8310	0.340
						0 1	A16-30-01	1SBL181001R8301	0.340
				110	110...120	1 0	A16-30-10	1SBL181001R8410	0.340
						0 1	A16-30-01	1SBL181001R8401	0.340
				220...230	230...240	1 0	A16-30-10	1SBL181001R8010	0.340
						0 1	A16-30-01	1SBL181001R8001	0.340
				230...240	240...260	1 0	A16-30-10	1SBL181001R8810	0.340
						0 1	A16-30-01	1SBL181001R8801	0.340
				380...400	400...415	1 0	A16-30-10	1SBL181001R8510	0.340
						0 1	A16-30-01	1SBL181001R8501	0.340
				400...415	415...440	1 0	A16-30-10	1SBL181001R8610	0.340
						0 1	A16-30-01	1SBL181001R8601	0.340

(1) Other control voltages see voltage code table.

Main dimensions mm, inches

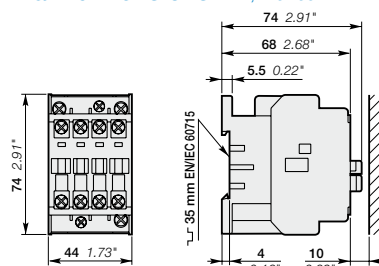

A9, A12, A16

1SBC10186550201

A26 ... A40 3-pole contactors

11 to 18.5 kW

AC operated



A26-30-10



A40-30-10

Description

A26 ... A40 contactors are mainly used for controlling 3-phase motors and power circuits up to 690 V AC or 220 V DC.

These contactors are of the block type design with:

- 3 main poles and 1 built-in auxiliary contact
- control circuit: AC operated
- add-on auxiliary contact blocks for front or side mounting and a wide range of accessories.

Ordering details

IEC		UL/CSA		Rated control circuit voltage		Auxiliary contacts fitted	Type	Order code	Weight	
Rated operational power	current	3-phase motor rating	General use rating	Uc (1)						Pkg (1 pce)
400 V AC-3	AC-1	480 V	600 V AC	V 50 Hz	V 60 Hz			kg		
11 kW	45 A	20 hp	40 A	24	24	1 0	A26-30-10	1SBL241001R8110	0.600	
						0 1	A26-30-01	1SBL241001R8101	0.600	
					48	48	1 0	A26-30-10	1SBL241001R8310	0.600
						0 1	A26-30-01	1SBL241001R8301	0.600	
					110	110...120	1 0	A26-30-10	1SBL241001R8410	0.600
						0 1	A26-30-01	1SBL241001R8401	0.600	
					220...230	230...240	1 0	A26-30-10	1SBL241001R8010	0.600
						0 1	A26-30-01	1SBL241001R8001	0.600	
					230...240	240...260	1 0	A26-30-10	1SBL241001R8810	0.600
						0 1	A26-30-01	1SBL241001R8801	0.600	
					380...400	400...415	1 0	A26-30-10	1SBL241001R8510	0.600
						0 1	A26-30-01	1SBL241001R8501	0.600	
					400...415	415...440	1 0	A26-30-10	1SBL241001R8610	0.600
						0 1	A26-30-01	1SBL241001R8601	0.600	
15 kW	55 A	25 hp	50 A	24	24	1 0	A30-30-10	1SBL281001R8110	0.710	
						0 1	A30-30-01	1SBL281001R8101	0.710	
					48	48	1 0	A30-30-10	1SBL281001R8310	0.710
						0 1	A30-30-01	1SBL281001R8301	0.710	
					110	110...120	1 0	A30-30-10	1SBL281001R8410	0.710
						0 1	A30-30-01	1SBL281001R8401	0.710	
					220...230	230...240	1 0	A30-30-10	1SBL281001R8010	0.710
						0 1	A30-30-01	1SBL281001R8001	0.710	
					230...240	240...260	1 0	A30-30-10	1SBL281001R8810	0.710
						0 1	A30-30-01	1SBL281001R8801	0.710	
					380...400	400...415	1 0	A30-30-10	1SBL281001R8510	0.710
						0 1	A30-30-01	1SBL281001R8501	0.710	
					400...415	415...440	1 0	A30-30-10	1SBL281001R8610	0.710
						0 1	A30-30-01	1SBL281001R8601	0.710	
18.5 kW	60 A	30 hp	60 A	24	24	1 0	A40-30-10	1SBL321001R8110	0.710	
						0 1	A40-30-01	1SBL321001R8101	0.710	
					48	48	1 0	A40-30-10	1SBL321001R8310	0.710
						0 1	A40-30-01	1SBL321001R8301	0.710	
					110	110...120	1 0	A40-30-10	1SBL321001R8410	0.710
						0 1	A40-30-01	1SBL321001R8401	0.710	
					220...230	230...240	1 0	A40-30-10	1SBL321001R8010	0.710
						0 1	A40-30-01	1SBL321001R8001	0.710	
					230...240	240...260	1 0	A40-30-10	1SBL321001R8810	0.710
						0 1	A40-30-01	1SBL321001R8801	0.710	
					380...400	400...415	1 0	A40-30-10	1SBL321001R8510	0.710
						0 1	A40-30-01	1SBL321001R8501	0.710	
					400...415	415...440	1 0	A40-30-10	1SBL321001R8610	0.710
						0 1	A40-30-01	1SBL321001R8601	0.710	

(1) Other control voltages see voltage code table.

Main dimensions mm, inches

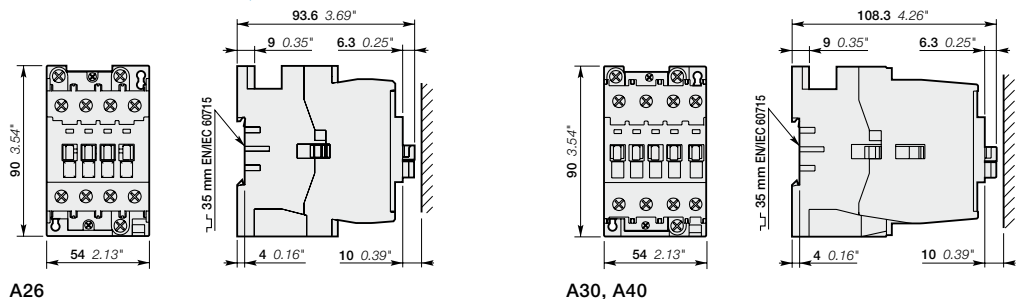

A26

A30, A40

1SBC101856S0201

A50 ... A75 3-pole contactors

22 to 37 kW

AC operated



1SBC10136450201

A50-30-11

3

Description

A50 ... A75 contactors are mainly used for controlling 3-phase motors and power circuits up to 690 V AC / 1000 V AC or 220 V DC.

These contactors are of the block type design with:

- 3 main poles
- control circuit: AC operated
- add-on auxiliary contact blocks for front or side mounting and a wide range of accessories.

Ordering details

IEC Rated operational power 400 V AC-3 kW	UL/CSA 3-phase motor rating 480 V AC-1 A	General use rating 600 V AC hp	General use rating 600 V AC A	Rated control circuit voltage Uc (1)		Auxiliary contacts fitted 	Type	Order code	Weight kg Pkg (1 pce)
				V 50 Hz	V 60 Hz				
22	100	40	80	24	24	1 1	A50-30-11	1SBL351001R8111	1.200
				48	48	1 1	A50-30-11	1SBL351001R8311	1.200
				110	110...220	1 1	A50-30-11	1SBL351001R8411	1.200
				220...230	230...240	1 1	A50-30-11	1SBL351001R8011	1.200
				230...240	240...260	1 1	A50-30-11	1SBL351001R8811	1.200
				380...400	400...415	1 1	A50-30-11	1SBL351001R8511	1.200
30	115	60	90	24	24	1 1	A63-30-11	1SBL371001R8111	1.200
				48	48	1 1	A63-30-11	1SBL371001R8311	1.200
				110	110...220	1 1	A63-30-11	1SBL371001R8411	1.200
				220...230	230...240	1 1	A63-30-11	1SBL371001R8011	1.200
				230...240	240...260	1 1	A63-30-11	1SBL371001R8811	1.200
				380...400	400...415	1 1	A63-30-11	1SBL371001R8511	1.200
37	125	60	105	24	24	1 1	A75-30-11	1SBL411001R8111	1.200
				48	48	1 1	A75-30-11	1SBL411001R8311	1.200
				110	110...220	1 1	A75-30-11	1SBL411001R8411	1.200
				220...230	230...240	1 1	A75-30-11	1SBL411001R8011	1.200
				230...240	240...260	1 1	A75-30-11	1SBL411001R8811	1.200
				380...400	400...415	1 1	A75-30-11	1SBL411001R8511	1.200
				400...415	415...440	1 1	A75-30-11	1SBL411001R8611	1.200

(1) Other control voltages see voltage code table.

Main dimensions mm, inches

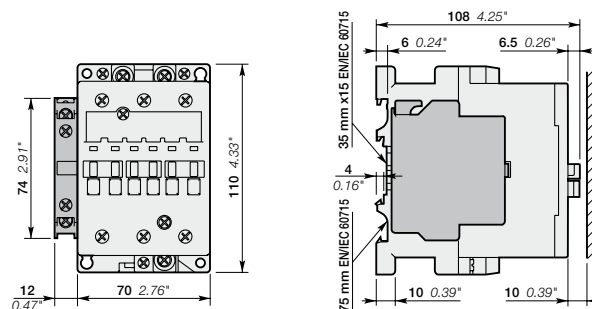

A50, A63, A75

1SBC10136450201

A95 ... A110 3-pole contactors

45 to 55 kW

AC operated



A95-30-11

1SBC573242F0001

Description

A95 ... A110 contactors are mainly used for controlling 3-phase motors and power circuits up to 690 / 1000 V AC or 220 V DC.

These contactors are of the block type design with:

- 3 main poles
- control circuit: AC operated
- add-on auxiliary contact blocks for front or side mounting and a wide range of accessories.

Ordering details

IEC		UL / CSA		Rated control circuit voltage Uc (1)		Auxiliary contacts fitted	Type	Order code	Weight
Rated operational power	Rated operational current $\theta \leq 40^\circ\text{C}$	3-phase motor rating	General use rating	V 50 Hz	V 60 Hz				
400 V AC-3	AC-1	480 V	600 V AC						kg
45 kW	145 A	60 hp	125 A	24	24	1 1	A95-30-11	1SFL431001R8111	2.040
				48	48	1 1	A95-30-11	1SFL431001R8311	2.040
				110	110...120	1 1	A95-30-11	1SFL431001R8411	2.040
				220...230	230...240	1 1	A95-30-11	1SFL431001R8011	2.040
				230...240	240...260	1 1	A95-30-11	1SFL431001R8811	2.040
				380...400	400...415	1 1	A95-30-11	1SFL431001R8511	2.040
				400...415	415...440	1 1	A95-30-11	1SFL431001R8611	2.040
55 kW	160 A	75 hp	140 A	24	24	1 1	A110-30-11	1SFL451001R8111	2.040
				48	48	1 1	A110-30-11	1SFL451001R8311	2.040
				110	110...120	1 1	A110-30-11	1SFL451001R8411	2.040
				220...230	230...240	1 1	A110-30-11	1SFL451001R8011	2.040
				230...240	240...260	1 1	A110-30-11	1SFL451001R8811	2.040
				380...400	400...415	1 1	A110-30-11	1SFL451001R8511	2.040
				400...415	415...440	1 1	A110-30-11	1SFL451001R8611	2.040

(1) Other control voltages see voltage code table.

Main dimensions mm, inches

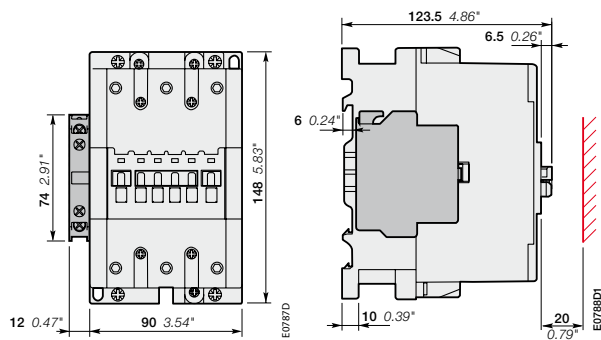

A95, A110

A9 ... A110 3-pole contactors

Main accessories

Contactor and main accessories (other accessories available)

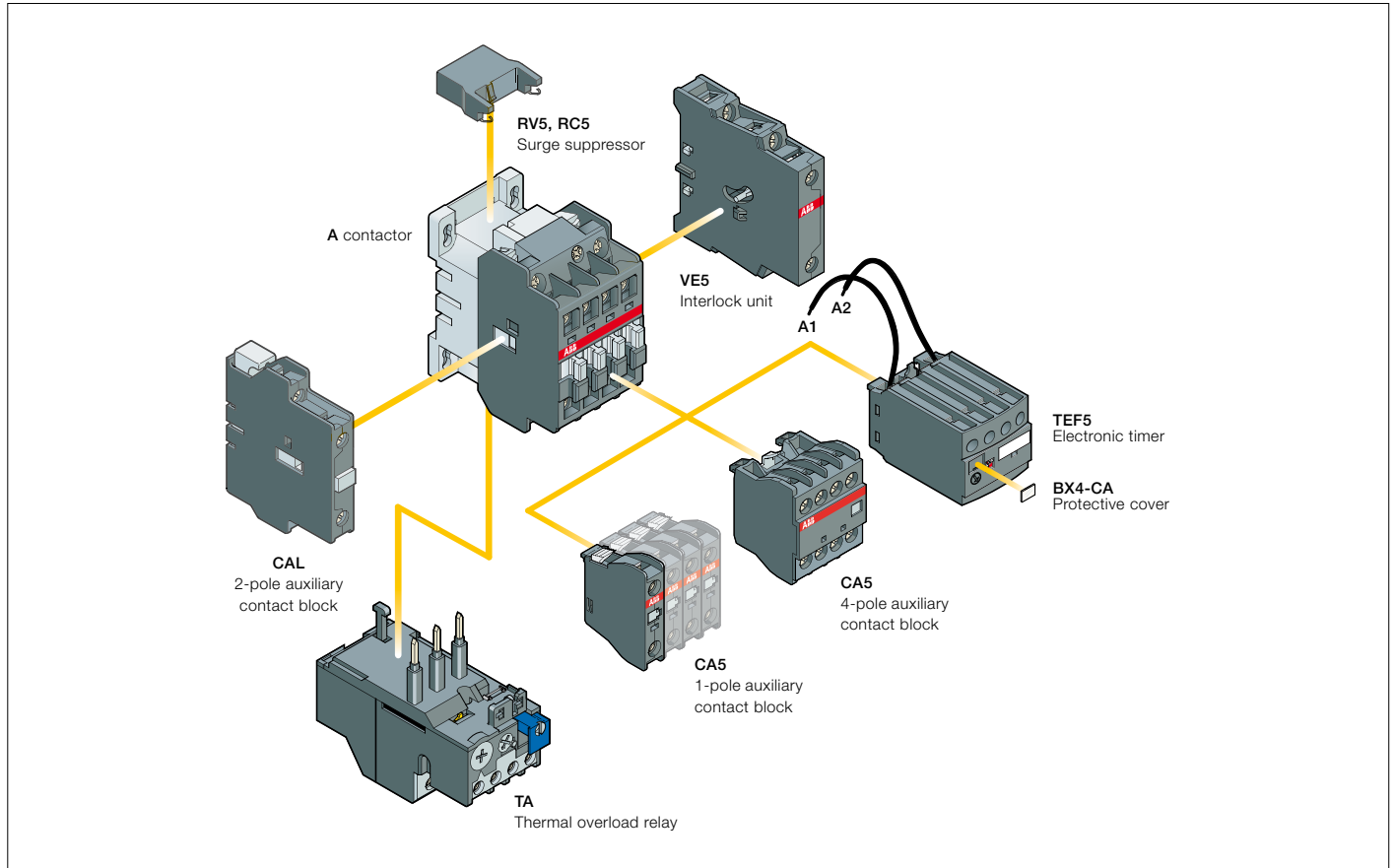

Main accessory fitting details

Many configurations of accessories are possible depending on whether these are front-mounted or side-mounted.

Contactor types	Main poles	Built-in auxiliary contacts	Front-mounted accessories		Side-mounted accessories			
			Auxiliary contact blocks	Electronic timer	Auxiliary contact blocks	Interlock unit		
			1-pole CA5	4-pole CA5	TEF5	2-pole CAL	VM5 or VE5	
A9 ... A26	3 0	1 0	1 to 4 x CA5	or 1 x CA5 (4-pole)	or 1 x TEF5	+	1 to 2 x CAL5-11	or 1 x VM5-1 or VE5-1 + 1 x CAL5-11
A30, A40	3 0	1 0	1 to 5 x CA5	or 1 x CA5 (4-pole) + 1 x 1-pole CA5	or 1 x TEF5 + 1 x CA5 (1-pole)	+	1 to 2 x CAL5-11	or 1 x VM5-1 or VE5-1 + 1 x CAL5-11
A50 ... A75	3 0	1 1	1 to 6 x CA5	or 1 x CA5 (4-pole) + 2 x 1-pole CA5	or 1 x TEF5 + 2 x CA5 (1-pole)	+	1 x CAL5-11	or 1 x VE5-2
A95, A110	3 0	1 1	1 to 6 x CA5	or 1 x CA5 (4-pole) + 2 x 1-pole CA5	-	+	1 x CAL18-11	or 1 x VE5-2

(1) 2 N.C. CA5 auxiliary contacts maximum in mounting position 5.

Overload relays fitting details (2)

Contactor types	Thermal overload relays
A9 ... A26	TA25DU-M (0.1...0.32 A)
A30, A40	TA25DU-M (0.1...0.32 A) or TA42DU-M (18...42 A)
A50 ... A75	TA75DU-M (18...80 A)
A95, A110	TA80DU (29...80 A) or TA110DU (65...110 A)

The addition of a thermal overload relay on the contactor does not prevent fitting of many other accessories as shown above.

(2) Direct mounting - No kit required.

A9 ... A110 3-pole contactors

Main accessories



CA5-10



CAL5-11



VE5-1

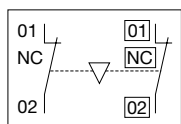

VE5-1, VE5-2
Terminal marking and positioning



TEF5-OFF



RV5/50

Ordering details (1)

For contactors	Auxiliary contacts	Type	Order code	Pkg qty	Weight (1 pce)
					kg

Front-mounted instantaneous auxiliary contact blocks

A9 ... A110	1 -	CA5-10	1SBN010010R1010	10	0.014
	- 1	CA5-01	1SBN010010R1001	10	0.014
A9-30-10 ... A40-30-10	2 2	CA5-22M	1SBN010040R1122	2	0.060
A9-30-01 ... A40-30-01	2 2	CA5-22U	1SBN010040R1322	2	0.060
A50 ... A110	2 2	CA5-22E	1SBN010040R1022	2	0.060

Side-mounted instantaneous auxiliary contact block

A9 ... A75	1 1	CAL5-11	1SBN010020R1011	2	0.050
A95, A110	1 1	CAL18-11	1SFN010720R1011	2	0.050

Interlock units

A9 ... A40	Mechanical	- -	VM5-1	1SBN030100R1000	1	0.066
	Mechanical and electrical	- 2	VE5-1	1SBN030110R1000	1	0.076
A50 ... A110	Mechanical and electrical	- 2	VE5-2	1SBN030210R1000	1	0.146

For contactors	Time delay range selected by switch	Delay type	Auxiliary contacts	Type	Order code	Pkg qty	Weight (1 pce)
							kg

Electronic timers

A9 ... A75	0.1...1 s	ON-delay	1 1	TEF5-ON	1SBN020312R1000	1	0.065
	1...10 s	OFF-delay	1 1	TEF5-OFF	1SBN020314R1000	1	0.065
	10...100 s						

Note: Rated control circuit voltage U_c 24...240 V 50/60 Hz or DC.

For contactors	Rated control circuit voltage U_c		Type	Order code	Pkg qty	Weight (1 pce)
	V	AC DC				

Surge suppressors

A9 ... A110	24...50	● ●	RV5/50	1SBN050010R1000	2	0.015
	50...133	● ●	RV5/133	1SBN050010R1001	2	0.015
	110...250	● ●	RV5/250	1SBN050010R1002	2	0.015
	250...440	● ●	RV5/440	1SBN050010R1003	2	0.015
A9 ... A40	24...50	● -	RC5-1/50	1SBN050100R1000	2	0.012
	50...133	● -	RC5-1/133	1SBN050100R1001	2	0.012
	110...250	● -	RC5-1/250	1SBN050100R1002	2	0.012
	250...440	● -	RC5-1/440	1SBN050100R1003	2	0.012
A50 ... A110	24...50	● -	RC5-2/50	1SBN050200R1000	2	0.015
	50...133	● -	RC5-2/133	1SBN050200R1001	2	0.015
	110...250	● -	RC5-2/250	1SBN050200R1002	2	0.015
	250...440	● -	RC5-2/440	1SBN050200R1003	2	0.015

(1) See "Main accessory fitting details" table.

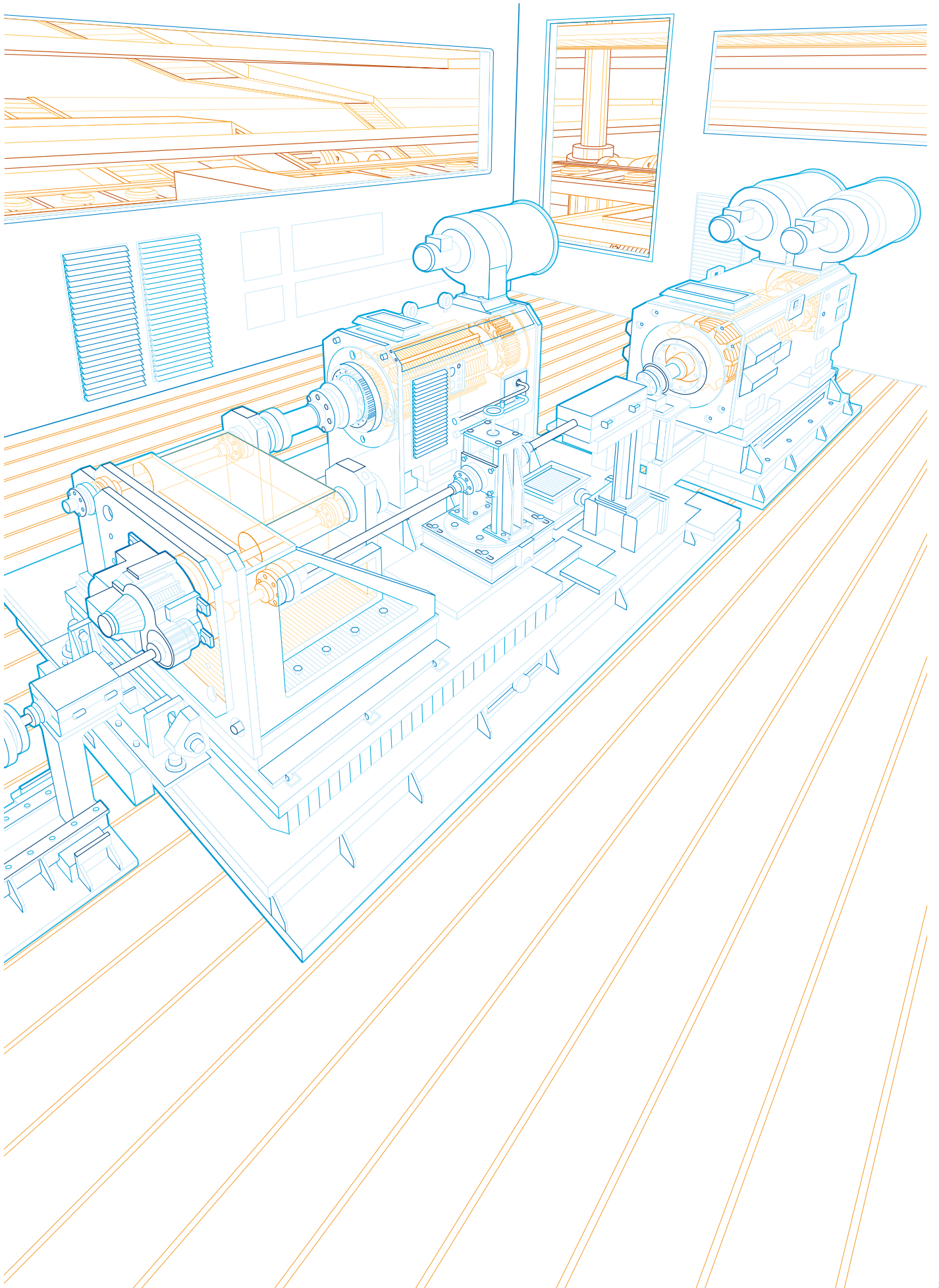

A145 ... A300 3-pole contactors

75 to 160 kW

AC operated



A185-30-11

1SFC101029F0201



A300-30-11

1SFC101030F0201

Description

A145 ... A300 contactors are mainly used for controlling 3-phase motors and power circuits up to 690 / 1000 V AC (2) or 220 V DC.

These contactors are of the block type design with:

- 3 main poles
- control circuit: AC operated
- add-on auxiliary contact blocks for side mounting and a wide range of accessories.

Ordering details

IEC		UL / CSA		Rated control circuit voltage		Auxiliary contacts fitted	Type	Order code	Weight
Rated operational power	Rated current $\theta \leq 40^\circ\text{C}$	3-phase motor rating	General use rating	Uc (1)					
400 V AC-3	690 V AC-1	480 V	600 V AC						
kW	A	hp	A	V 50 Hz	V 60 Hz			kg	
75	250	100	230	24	24	1 1	A145-30-11	1SFL471001R8111	3.500
				48	48	1 1	A145-30-11	1SFL471001R8311	3.500
				110	110...120	1 1	A145-30-11	1SFL471001R8411	3.500
				220...230	230...240	1 1	A145-30-11	1SFL471001R8011	3.500
				230...240	240...260	1 1	A145-30-11	1SFL471001R8811	3.500
				380...400	400...415	1 1	A145-30-11	1SFL471001R8511	3.500
				400...415	415...440	1 1	A145-30-11	1SFL471001R8611	3.500
90	275	125	250	24	24	1 1	A185-30-11	1SFL491001R8111	3.500
				48	48	1 1	A185-30-11	1SFL491001R8311	3.500
				110	110...120	1 1	A185-30-11	1SFL491001R8411	3.500
				220...230	230...240	1 1	A185-30-11	1SFL491001R8011	3.500
				230...240	240...260	1 1	A185-30-11	1SFL491001R8811	3.500
				380...400	400...415	1 1	A185-30-11	1SFL491001R8511	3.500
				400...415	415...440	1 1	A185-30-11	1SFL491001R8611	3.500
110	350	150	300	24	24	1 1	A210-30-11	1SFL511001R8111	6.100
				48	48	1 1	A210-30-11	1SFL511001R8311	6.100
				110	110...120	1 1	A210-30-11	1SFL511001R8411	6.100
				220...230	230...240	1 1	A210-30-11	1SFL511001R8011	6.100
				230...240	240...260	1 1	A210-30-11	1SFL511001R8811	6.100
				380...400	400...415	1 1	A210-30-11	1SFL511001R8511	6.100
				400...415	415...440	1 1	A210-30-11	1SFL511001R8611	6.100
140	400	200	350	24	24	1 1	A260-30-11	1SFL531001R8111	6.100
				48	48	1 1	A260-30-11	1SFL531001R8311	6.100
				110	110...120	1 1	A260-30-11	1SFL531001R8411	6.100
				220...230	230...240	1 1	A260-30-11	1SFL531001R8011	6.100
				230...240	240...260	1 1	A260-30-11	1SFL531001R8811	6.100
				380...400	400...415	1 1	A260-30-11	1SFL531001R8511	6.100
				400...415	415...440	1 1	A260-30-11	1SFL531001R8611	6.100
160	500	250	400	24	24	1 1	A300-30-11	1SFL551001R8111	6.100
				48	48	1 1	A300-30-11	1SFL551001R8311	6.100
				110	110...120	1 1	A300-30-11	1SFL551001R8411	6.100
				220...230	230...240	1 1	A300-30-11	1SFL551001R8011	6.100
				230...240	240...260	1 1	A300-30-11	1SFL551001R8811	6.100
				380...400	400...415	1 1	A300-30-11	1SFL551001R8511	6.100
				400...415	415...440	1 1	A300-30-11	1SFL551001R8611	6.100

(1) Other control voltages see voltage code table.

(2) 690 V AC for A210 ... A300, 1000 V AC for A145, A185.

Main dimensions mm, inches

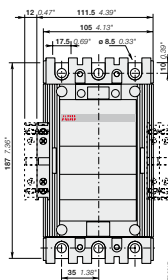

A145, A185

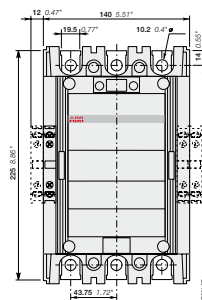
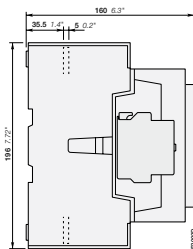

A210, A260, A300

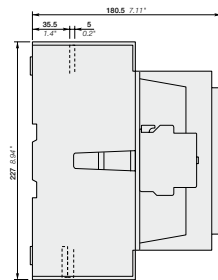

A145 ... A300 3-pole contactors

Main accessories

Main accessories (other accessories available)

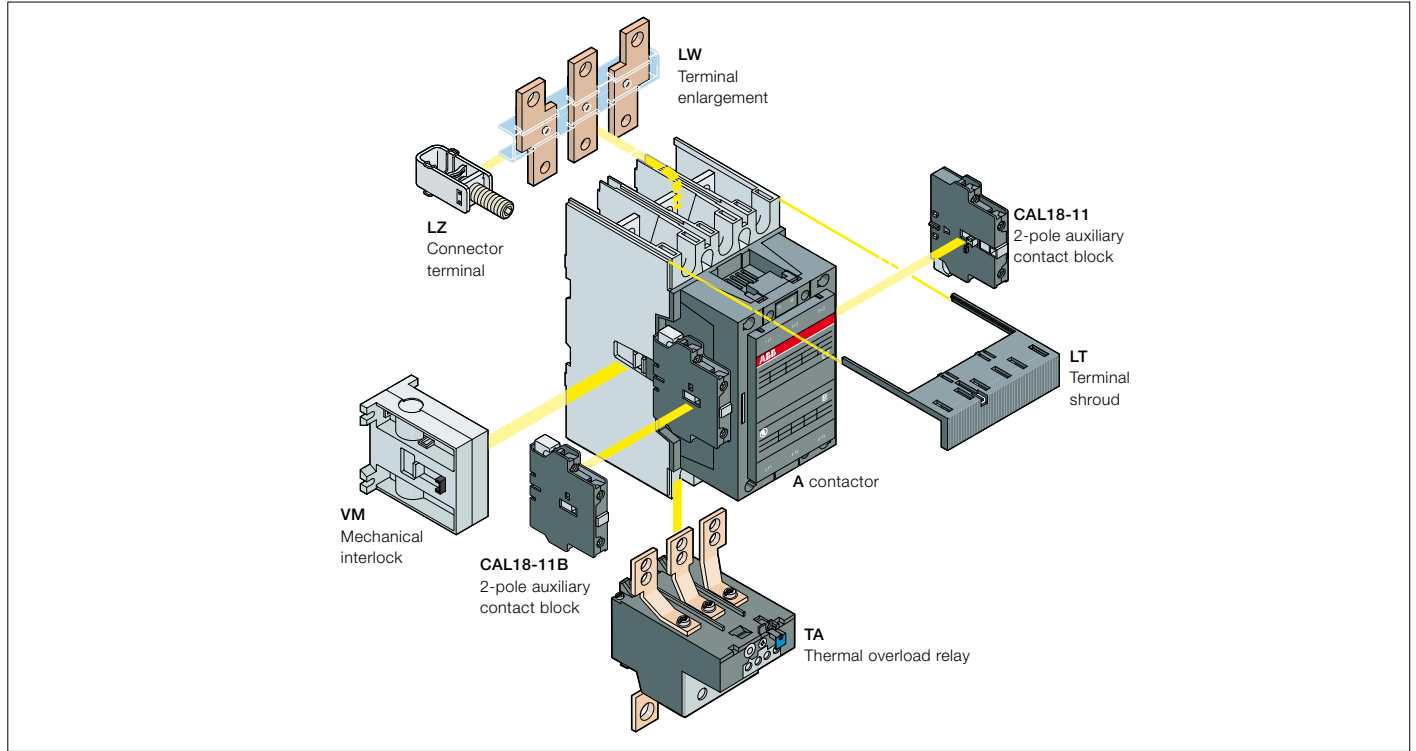

Main accessory fitting details

Contactor types	Main poles	Available auxiliary contacts	Side-mounted accessories		Mechanical interlock units	Mounting and positioning
			Add-on auxiliary contact blocks			
			CAL18-11, CAL18-11B			Factory mounted auxiliary contacts Add-on CAL18-11 auxiliary contacts Add-on CAL18-11B auxiliary contacts

Contactors + auxiliary contact blocks

A145 ... A300	3	0	1	1	1 x CAL18-11	+	2 x CAL18-11B	-	
---------------	---	---	---	---	--------------	---	---------------	---	--

Contactors with mechanical interlocking + auxiliary contact blocks

A145 ... A185	3	0	1	1	2 x CAL18-11 (1)	+	3 x CAL18-11B (1)	+	VM...H (2)	
A210 ... A300	3	0	1	1	2 x CAL18-11 (1)	+	4 x CAL18-11B (1)	+	VM...H (2)	

(1) Total number of auxiliary contact blocks for the two contactors.

(2) Interlock type, according to the contactor ratings (see "Accessories").

Overload relays fitting details

Contactor types	Thermal overload relays
A145, A185	TA200DU (66...200 A) (3)
A210, A300	TA450DU (130...310 A) (3) or TA450SU (40...310 A) (4)

The addition of a thermal or electronic overload relay on the contactor does not prevent fitting of many other accessories as shown in "Main accessory fitting details" table.

(3) Direct mounting - No kit required.

(4) Mounting kit required.

A145 ... A300 3-pole contactors

Main accessories



CAL18-11



VM300H



LT...AC



LT...AL



LT...AY



LW



LX



LZ



LZ



LZ

Ordering details (1)

For contactors	Auxiliary contacts	Type	Order code	Pkg qty	Weight (1 pce)
					kg

Side-mounted instantaneous auxiliary contact blocks

A145 ... A300	1 1	CAL18-11	1SFN010720R1011	2	0.050
	1 1	CAL18-11B	1SFN010720R3311	2	0.050

Mechanical interlock unit for two horizontal mounted contactors

A145 ... A300	VM300H	1SFN034700R1000	1	0.150
---------------	--------	-----------------	---	-------

Terminal shrouds

A145 ... A185 with connectors	LT185-AC	1SFN124701R1000	2	0.050
A145 ... A185 with lugs	LT185-AL	1SFN124703R1000	2	0.220
A145 ... A185 with short bar LY185 or between A145 and TA200DU or between A185 and TA200DU	LT185-AY	1SFN124704R1000	1	0.050
A210 ... A300 with connectors	LT300-AC	1SFN125101R1000	2	0.070
A210 ... A300 with lugs	LT300-AL	1SFN125103R1000	2	0.280
A210 ... A300 with short bar LY300	LT300-AY	1SFN125104R1000	1	0.075

For contactors	Dimensions		Type	Order code	Pkg qty	Weight (1 pce)
	hole Ø	bar				kg
	mm	mm				

Terminal enlargements

A145, A185	10.5	20 x 5	LW185	1SFN074707R1000	1	0.250
A210 ... A300	10.5	25 x 5	LW300	1SFN075107R1000	1	0.450

Terminal extension

A145, A185	8.5	20 x 5	LX185	1SFN074710R1000	1	0.250
A210 ... A300	10.5	20 x 5	LX300	1SFN075110R1000	1	0.350

Cables	For contactors	Cable cross section	Type	Order code	Pkg qty	Weight (1 pce)
		mm ²				kg

Connector terminals

Single Cu	A145, A185	6...185	-	1SDA023354R0001	3	0.200
	A210 ... A300	16...240	-	1SDA023368R0001	3	0.400
Single Al & Cu	A145, A185	35...95	-	1SDA023356R0001	3	0.100
	A145, A185	25...150	-	1SDA023357R0001	3	0.100
	A210 ... A300	120...240	-	1SDA023370R0001	3	0.200
Double Cu	A145, A185	2 x (50...120)	LZ185-2C/120	1SFN074709R1000	3	0.300
	A210 ... A300	2 x (95...120)	-	1SDA025766R0001	3	0.400

(1) For each contactor type, refer to "Main accessory fitting details" table.

For contactors	Rated control circuit voltage	Type	Order code	Pkg qty	Weight (1 pce)
	U _c				kg
	V AC				

A145 ... A300	250...440	RC5-3/440	1SFN050300R1003	2	0.028
---------------	-----------	-----------	-----------------	---	-------

A9 ... A30 3-pole contactors

Technical data

Main pole - Utilization characteristics according to IEC

Contactors types	AC operated	A9	A12	A16	A26	A30
Standards		IEC 60947-1 / 60947-4-1 and EN 60947-1 / 60947-4-1				
Rated operational voltage U_e max.		690 V				
Rated frequency (without derating)		50 / 60 Hz				
Conventional free-air thermal current I_{th}						
acc. to IEC 60947-4-1, open contactors, $\theta \leq 40^\circ\text{C}$		26 A	28 A	30 A	45 A	65 A
With conductor cross-sectional area		4 mm ²	4 mm ²	4 mm ²	6 mm ²	16 mm ²
AC-1 Utilization category						
For air temperature close to contactor						
I_e / Rated operational current AC-1						
U _e max. $\leq 690\text{ V}$, 50/60 Hz	$\theta \leq 40^\circ\text{C}$	25 A	27 A	30 A	45 A	55 A
	$\theta \leq 55^\circ\text{C}$	22 A	25 A	27 A	40 A	55 A
	$\theta \leq 70^\circ\text{C}$	18 A	20 A	23 A	32 A	39 A
With conductor cross-sectional area		2.5 mm ²	4 mm ²	4 mm ²	6 mm ²	10 mm ²
AC-3 Utilization category						
For air temperature close to contactor $\theta \leq 55^\circ\text{C}$						
I_e / Max. rated operational current AC-3 (1)						
	220-230-240 V	9 A	12 A	17 A	26 A	33 A
	380-400 V	9 A	12 A	17 A	26 A	32 A
	415 V	9 A	12 A	17 A	26 A	32 A
	440 V	9 A	12 A	16 A	26 A	32 A
	500 V	9 A	12 A	14 A	22 A	28 A
	690 V	7 A	9 A	10 A	17 A	21 A
Rated operational power AC-3 (1)						
	220-230-240 V	2.2 kW	3 kW	4 kW	6.5 kW	9 kW
	380-400 V	4 kW	5.5 kW	7.5 kW	11 kW	15 kW
	415 V	4 kW	5.5 kW	9 kW	11 kW	15 kW
	440 V	4 kW	5.5 kW	9 kW	15 kW	18.5 kW
	500 V	5.5 kW	7.5 kW	9 kW	15 kW	18.5 kW
	690 V	5.5 kW	7.5 kW	9 kW	15 kW	18.5 kW
Rated making capacity AC-3		10 x I _e AC-3 acc. to IEC 60947-4-1				
Rated breaking capacity AC-3		8 x I _e AC-3 acc. to IEC 60947-4-1				
AC-8a Utilization category						
(without thermal overload relay - U _e 400 V 50/60 Hz - $\theta \leq 40^\circ\text{C}$)						
I_e / Rated operational current AC-8a		12 A	16 A	22 A	30 A	40 A
Rated operational power AC-8a		5.5 kW	7.5 kW	11 kW	15 kW	20 kW
Short-circuit protection device for contactors						
without thermal overload relay - Motor protection excluded (2)						
U _e $\leq 500\text{ V AC}$ - gG type fuse		25 A	32 A	32 A	50 A	63 A
Rated short-time withstand current I_{cw}						
at 40 °C ambient temperature, in free air from a cold state	1 s	250 A	280 A	300 A	400 A	600 A
	10 s	100 A	120 A	140 A	210 A	400 A
	30 s	60 A	70 A	80 A	110 A	225 A
	1 min	50 A	55 A	60 A	90 A	150 A
	15 min	26 A	28 A	30 A	45 A	65 A
Maximum breaking capacity						
cos $\phi = 0.45$	at 440 V	250 A			420 A	820 A
	at 690 V	90 A			170 A	340 A
Power dissipation per pole						
	I _e / AC-1	0.8 W	1 W	1.2 W	1.8 W	2.5 W
	I _e / AC-3	0.1 W	0.2 W	0.35 W	0.6 W	0.9 W
Max. electrical switching frequency						
	AC-1	600 cycle/h				
	AC-3	1200 cycle/h				
	AC-2, AC-4	300 cycle/h				

(1) For the corresponding kW/A or hp/A values of 1500 r.p.m. 50 Hz or 1800 r.p.m. 60 Hz, 3-phase motors, see "Motor rated operational powers and currents".

(2) For the protection of motor starters against short circuits, see "Coordination with short-circuit protection devices".

A40 ... A110 3-pole contactors

Technical data

Main pole - Utilization characteristics according to IEC

Contactor types	AC operated	A40	A50	A63	A75	A95	A110
Standards		IEC 60947-1 / 60947-4-1 and EN 60947-1 / 60947-4-1					
Rated operational voltage U_e max.		690 V	1000 V				
Rated frequency (without derating)		50/60 Hz					
Conventional free-air thermal current I_{th} acc. to IEC 60947-4-1, open contactors, $\theta \leq 40\text{ °C}$		65 A	100 A	125 A	125 A	145 A	160 A
With conductor cross-sectional area		16 mm ²	35 mm ²	50 mm ²	50 mm ²	50 mm ²	70 mm ²
AC-1 Utilization category For air temperature close to contactor							
I_e / Rated operational current AC-1 U _e max. $\leq 690\text{ V}$, 50/60 Hz	$\theta \leq 40\text{ °C}$	60 A	100 A	115 A	125 A	145 A	160 A
	$\theta \leq 55\text{ °C}$	60 A	85 A	95 A	105 A	135 A	145 A
	$\theta \leq 70\text{ °C}$	42 A	70 A	80 A	85 A	115 A	130 A
With conductor cross-sectional area		16 mm ²	35 mm ²	50 mm ²	50 mm ²	50 mm ²	70 mm ²
AC-3 Utilization category For air temperature close to contactor $\theta \leq 55\text{ °C}$							
I_e / Max. rated operational current AC-3 (1)							
	220-230-240 V	40 A	53 A	65 A	75 A	96 A	110 A
	380-400 V	37 A	50 A	65 A	75 A	96 A	110 A
	415 V	37 A	50 A	65 A	75 A	96 A	110 A
	440 V	37 A	45 A	65 A	70 A	93 A	100 A
	500 V	33 A	45 A	55 A	65 A	80 A	100 A
	690 V	25 A	35 A	43 A	46 A	65 A	82 A
	1000 V	–	23 A	25 A	28 A	30 A	30 A
Rated operational power AC-3 (1)							
	220-230-240 V	11 kW	15 kW	18.5 kW	22 kW	25 kW	30 kW
	380-400 V	18.5 kW	22 kW	30 kW	37 kW	45 kW	55 kW
	415 V	18.5 kW	25 kW	37 kW	40 kW	55 kW	59 kW
	440 V	22 kW	25 kW	37 kW	40 kW	55 kW	59 kW
	500 V	22 kW	30 kW	37 kW	45 kW	55 kW	59 kW
	690 V	22 kW	30 kW	37 kW	40 kW	55 kW	75 kW
	1000 V	–	30 kW	33 kW	37 kW	40 kW	40 kW
Rated making capacity AC-3		10 x I _e AC-3 acc. to IEC 60947-4-1					
Rated breaking capacity AC-3		8 x I _e AC-3 acc. to IEC 60947-4-1					
AC-8a Utilization category (without thermal overload relay - U _e 400 V 50/60 Hz - $\theta \leq 40\text{ °C}$)							
I_e / Rated operational current AC-8a		50 A	63 A	85 A	95 A	120 A	140 A
Rated operational power AC-8a		22 kW	30 kW	45 kW	45 kW	55 kW	75 kW
Short-circuit protection device for contactors without thermal overload relay - Motor protection excluded (2) U _e $\leq 500\text{ V AC}$ - gG type fuse		63 A	100 A	125 A	160 A	160 A	200 A
Rated short-time withstand current I_{cw} at 40 °C ambient temperature, in free air from a cold state	1 s	600 A	1000 A			1320 A	
	10 s	400 A	650 A			800 A	
	30 s	225 A	370 A			500 A	
	1 min	150 A	250 A			350 A	
	15 min	65 A	110 A	135 A	135 A	160 A	175 A
Maximum breaking capacity cos $\phi = 0.45$	at 440 V	820 A	1300 A			1160 A	
	at 690 V	340 A	630 A			800 A	
Power dissipation per pole	I_e / AC-1	3 W	5 W	6.5 W	7 W	6.5 W	7.5 W
	I_e / AC-3	1.3 W	1.3 W	1.5 W	2 W	2.7 W	3.6 W
Max. electrical switching frequency	AC-1	600 cycles/h				300 cycles/h	
	AC-3	1200 cycles/h	600 cycles/h		300 cycles/h		
	AC-2, AC-4	300 cycles/h	150 cycles/h				



3-phase motors



1500 r.p.m. 50 Hz
1800 r.p.m. 60 Hz
3-phase motors

(1) For the corresponding kW/A or hp/A values of 1500 r.p.m, 50 Hz or 1800 r.p.m, 60 Hz, 3-phase motors, see "Motor rated operational powers and currents".
(2) For the protection of motor starters against short circuits, see "Coordination with short-circuit protection devices".

A145 ... A300 3-pole contactors

Technical data

Main pole - Utilization characteristics according to IEC

Contactor types	AC operated	A145	A185	A210	A260	A300
Standards		IEC 60947-1 / 60947-4-1 and EN 60947-1 / 60947-4-1				
Rated operational voltage U_e max.		1000 V			690 V	
Rated frequency (without derating)		50/60 Hz				
Conventional free-air thermal current I_{th}						
acc. to IEC 60947-4-1, open contactors, $\theta \leq 40^\circ\text{C}$		250 A	275 A	350 A	400 A	500 A (4)
With conductor cross-sectional area (3)		120 mm ²	150 mm ²	185 mm ²	240 mm ²	300 mm ² (4)
AC-1 Utilization category						
For air temperature close to contactor						
I_e / Rated operational current AC-1	$\theta \leq 40^\circ\text{C}$	250 A	275 A	350 A	400 A	500 A (4)
U_e max. ≤ 690 V, 50/60 Hz	$\theta \leq 55^\circ\text{C}$	230 A	250 A	300 A	350 A	400 A (4)
	$\theta \leq 70^\circ\text{C}$	180 A	180 A	240 A	290 A	325 A (4)
I_e / Rated operational current AC-1	$\theta \leq 40^\circ\text{C}$	180 A	200 A	–	–	–
U_e max. ≤ 1000 V, 50/60 Hz	$\theta \leq 55^\circ\text{C}$	180 A	200 A	–	–	–
	$\theta \leq 70^\circ\text{C}$	180 A	180 A	–	–	–
With conductor cross-sectional area		120 mm ²	150 mm ²	185 mm ²	240 mm ²	300 mm ² (4)
AC-3 Utilization category						
For air temperature close to contactor $\theta \leq 55^\circ\text{C}$						
I_e / Max. rated operational current AC-3 (1)						
	220-230-240 V	145 A	185 A	210 A	260 A	305 A
	380-400 V	145 A	185 A	210 A	260 A	305 A
	415 V	145 A	185 A	210 A	260 A	300 A
	440 V	145 A	185 A	210 A	240 A	280 A
	500 V	145 A	170 A	210 A	240 A	280 A
	690 V	120 A	170 A	210 A	220 A	280 A
	1000 V	80 A	95 A	–	–	–
Rated operational power AC-3 (1)						
	220-230-240 V	45 kW	55 kW	59 kW	80 kW	90 kW
	380-400 V	75 kW	90 kW	110 kW	140 kW	160 kW
	415 V	75 kW	90 kW	110 kW	140 kW	160 kW
	440 V	75 kW	90 kW	110 kW	140 kW	160 kW
	500 V	90 kW	110 kW	132 kW	180 kW	200 kW
	690 V	110 kW	132 kW	160 kW	200 kW	250 kW
	1000 V	110 kW	132 kW	–	–	–
Rated making capacity AC-3		10 x I_e AC-3 acc. to IEC 60947-4-1				
Rated breaking capacity AC-3		8 x I_e AC-3 acc. to IEC 60947-4-1				
Short-circuit protection device for contactors						
without thermal overload relay - Motor protection excluded (2)						
$U_e \leq 500$ V AC - gG type fuse		315 A	355 A	400 A	500 A	500 A
Rated short-time withstand current I_{cw}	1 s	1800 A	2000 A	2500 A	3500 A	3500 A
at 40 °C ambient temperature,	10 s	1200 A	1500 A	1700 A	2400 A	2400 A
in free air from a cold state	30 s	800 A	1000 A	1200 A	1500 A	1500 A
	1 min	600 A	800 A	1000 A	1100 A	1100 A
	15 min	280 A	320 A	400 A	500 A	500 A
Maximum breaking capacity						
$\cos \varphi = 0.45$	at 440 V	1500 A	2000 A	2300 A	2600 A	3000 A
($\cos \varphi = 0.35$ for $I_e > 100$ A)	at 690 V	1200 A	1600 A	2000 A	2400 A	2500 A
Power dissipation per pole	I_e / AC-1	13 W	16 W	18 W	25 W	32 W
	I_e / AC-3	5 W	8 W	9 W	14 W	18 W
Max. electrical switching frequency	AC-1	300 cycles/h			300 cycles/h	
	AC-3	300 cycles/h			300 cycles/h	
	AC-2, AC-4	150 cycles/h			150 cycles/h	

(1) For the corresponding kW/A or hp/A values of 1500 r.p.m, 50 Hz or 1800 r.p.m, 60 Hz, 3-phase motors, see "Motor rated operational powers and currents".

(2) For the protection of motor starters against short circuits, see "Coordination with short-circuit protection devices".

(3) Conductors with preparation.

(4) Use terminal extension / enlargement pieces (LX 300 / LW 300).

A9 ... A30 3-pole contactors

Technical data

Main pole - Utilization characteristics according to UL / NEMA / CSA

Contactor types	AC operated	A9	A12	A16	A26	A30	
Standards		UL 508, CSA C22.2 N°14					
Max. operational voltage		600 V					
NEMA size		00	0	-	1	1P	
NEMA continuous amp rating	Thermal current	9 A	18 A	-	27 A	36 A	
NEMA maximum horse power ratings 1-phase, 60 Hz	115 V AC	1/3 hp	1 hp	-	2 hp	3 hp	
	230 V AC	1 hp	2 hp	-	3 hp	5 hp	
NEMA maximum horse power ratings 3-phase, 60 Hz	200 V AC	1-1/2 hp	3 hp	-	7-1/2 hp	-	
	230 V AC	1-1/2 hp	3 hp	-	7-1/2 hp	-	
	460 V AC	1-1/2 hp	5 hp	-	10 hp	-	
	575 V AC	2 hp	5 hp	-	10 hp	-	
UL / CSA general use rating 600 V AC With conductor cross-sectional area		21 A	25 A	30 A	40 A	50 A	
		AWG 10		AWG 8			
UL / CSA maximum 1-phase motor rating	Full load current	120 V AC	9.8 A	13.8 A	16 A	28 A	34 A
		240 V AC	12 A	12 A	17 A	24 A	40 A
	Horse power rating	120 V AC	1/2 hp	3/4 hp	1 hp	2 hp	3 hp
		240 V AC	2 hp	2 hp	3 hp	5 hp	7.5 hp
UL / CSA maximum 3-phase motor rating	Full load current (1)	200-208 V AC	7.8 A	11 A	17.5 A	25.3 A	32.2 A
		220-240 V AC	6.8 A	9.6 A	15.2 A	28 A	28 A
		440-480 V AC	7.6 A	11 A	14 A	27 A	34 A
		550-600 V AC	9 A	11 A	17 A	27 A	32 A
	Horse power rating (1)	200-208 V AC	2 hp	3 hp	5 hp	7.5 hp	10 hp
		220-240 V AC	2 hp	3 hp	5 hp	10 hp	10 hp
		440-480 V AC	5 hp	7.5 hp	10 hp	20 hp	25 hp
		550-600 V AC	7.5 hp	10 hp	15 hp	25 hp	30 hp
Short-circuit protection device for contactors without thermal overload relay - Motor protection excluded							
Fuse rating		35 A	35 A	60 A	90 A	150 A	
Fuse type, 600 V		FRS-R					
Max. electrical switching frequency	For general use	600 cycles/h					
	For motor use	1200 cycles/h					

(1) For the corresponding kW/A or hp/A values of 1500 r.p.m, 50 Hz or 1800 r.p.m, 60 Hz, 3-phase motors, see "Motor rated operational powers and currents".

General technical data

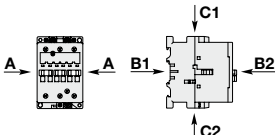
Contactor types	AC operated	A9	A12	A16	A26	A30
Rated insulation voltage U_i	acc. to IEC 60947-4-1	1000 V				
	acc. to UL / CSA	600 V				
Rated impulse withstand voltage U_{imp}		8 kV				
Ambient air temperature close to contactor	Operation	Fitted with thermal overload relay	-25...+55 °C			
		Without thermal overload relay	-40...+70 °C			
	Storage	-60...+80 °C				
Climatic withstand		acc. to IEC 60068-2-30 and 60068-2-11 - UTE C 63-100 specification II				
Maximum operating altitude (without derating)		3000 m				
Mechanical durability	Number of operating cycles		10 millions operating cycles			
	Max. switching frequency		3600 cycles/h			
	Shock withstand					
acc. to IEC 60068-2-27 and EN 60068-2-27						
Mounting position 1						
	Shock direction	1/2 sinusoidal shock for 11 ms: no change in contact position, closed or open position				
	A	20 g				
	B1	10 g closed position / 5 g open position				
	B2	15 g				
	C1	20 g				
	C2	20 g				

A40 ... A110 3-pole contactors

Technical data

Main pole - Utilization characteristics according to UL / NEMA / CSA

Contactor types	AC operated	A40	A50	A63	A75	A95	A110
Standards		UL 508, CSA C22.2 N°14					
Max. operational voltage		600 V					
NEMA size		-	2	-	3	-	-
NEMA continuous amp rating	Thermal current	-	45 A	-	90 A	-	-
NEMA maximum horse power ratings							
1-phase, 60 Hz	115 V AC	-	3 hp	-	-	-	-
	230 V AC	-	7-1/2	-	-	-	-
NEMA maximum horse power ratings							
3-phase, 60 Hz	200 V AC	-	10 hp	-	25 hp	-	-
	230 V AC	-	15 hp	-	30 hp	-	-
	460 V AC	-	25 hp	-	50 hp	-	-
	575 V AC	-	25 hp	-	50 hp	-	-
UL / CSA general use rating							
600 V AC		60 A	80 A	90 A	105 A	125 A	150 A
With conductor cross-sectional area		AWG 6	AWG 4	AWG 3	AWG 2	AWG 1	AWG 1/0
UL / CSA maximum 1-phase motor rating							
Full load current	120 V AC	34 A	34 A	56 A	80 A	80 A	100 A
	240 V AC	40 A	40 A	50 A	68 A	88 A	110 A
Horse power rating	120 V AC	3 hp	3 hp	5 hp	7.5 hp	7.5 hp	10 hp
	240 V AC	7.5 hp	7.5 hp	10 hp	15 hp	20 hp	25 hp
UL / CSA maximum 3-phase motor rating							
Full load current (1)	200-208 V AC	32.2 A	48.3 A	62.1 A	78.2 A	92 A	92 A
	220-240 V AC	42 A	54 A	68 A	80 A	80 A	104 A
	440-480 V AC	40 A	52 A	77 A	77 A	77 A	96 A
	550-600 V AC	41 A	52 A	77 A	77 A	77 A	99 A
Horse power rating (1)	200-208 V AC	10 hp	15 hp	20 hp	25 hp	30 hp	30 hp
	220-240 V AC	15 hp	20 hp	25 hp	30 hp	30 hp	40 hp
	440-480 V AC	30 hp	40 hp	60 hp	60 hp	60 hp	75 hp
	550-600 V AC	40 hp	50 hp	75 hp	75 hp	75 hp	100 hp
Short-circuit protection device for contactors							
without thermal overload relay - Motor protection excluded							
Fuse rating		150 A	175 A	200 A	200 A	200 A	200 A
Fuse type, 600 V		FRS-R		J			
Max. electrical switching frequency							
For general use		600 cycles/h				300 cycles/h	
For motor use		1200 cycles/h	600 cycles/h		300 cycles/h		

(1) For the corresponding kW/A or hp/A values of 1500 r.p.m, 50 Hz or 1800 r.p.m, 60 Hz, 3-phase motors, see "Motor rated operational powers and currents".

General technical data

Contactor types	AC operated	A40	A50	A63	A75	A95	A110
Rated insulation voltage Ui		1000 V					
acc. to IEC 60947-4-1		600 V					
acc. to UL / CSA		8 kV					
Rated impulse withstand voltage Uimp.		8 kV					
Ambient air temperature close to contactor							
Operation	Fitted with thermal overload relay	-25...+55 °C					
	Without thermal overload relay	-40...+70 °C					
Storage		-60...+80 °C				-40...+70 °C	
Climatic withstand		acc. to IEC 60068-2-30 and 60068-2-11 UTE C 63-100 specification II				acc. to IEC 60068-2-30	
Maximum operating altitude (without derating)		3000 m					
Mechanical durability							
Number of operating cycles		10 millions operating cycles					
Max. switching frequency		3600 cycles/h					
Shock withstand							
acc. to IEC 60068-2-27 and EN 60068-2-27							
Mounting position 1							
	Shock direction	1/2 sinusoidal shock for 11 ms: no change in contact position, closed or open position (2)					
	A	20 g					
	B1	10 g closed position / 5 g open position					
	B2	15 g					
	C1	20 g					
	C2	20 g					

(2) These values are not valid for rail mounting with contactors A95 ... A110.

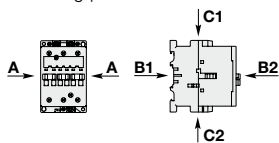

A145 ... A300 3-pole contactors

Technical data

Main pole - Utilization characteristics according to UL / NEMA / CSA

Contactor types	AC operated	A145	A185	A210	A260	A300
Standards		UL 508, CSA C22.2 N°14				
Maximum operational voltage		600 V				
NEMA size		4	-	-	5	-
NEMA maximum horse power ratings						
1-phase, 60 Hz	115 V AC	-	-	-	-	-
	230 V AC	-	-	-	-	-
NEMA maximum horse power ratings						
3-phase, 60 Hz	200 V AC	40 hp			75 hp	
	230 V AC	50 hp			100 hp	
	460 V AC	100 hp			200 hp	
	575 V AC	200 hp			200 hp	
UL / CSA general use rating						
600 V AC		230 A	250 A	300 A	350 A	400 A
UL / CSA maximum 1-phase motor rating						
Full load current	240 V AC	-	-	-	-	-
Horse power rating	240 V AC	-	-	-	-	-
UL / CSA maximum 3-phase motor rating						
Full load current (1)	200-208 V AC	119.6 A	149.5 A	166.8 A	220.8 A	285.2 A
	220-240 V AC	130 A	145 A	192 A	248 A	248 A
	440-480 V AC	124 A	156 A	180 A	240 A	302 A
	550-600 V AC	125 A	144 A	192 A	242 A	289 A
Horse power rating (1)	200-208 V AC	40 hp	50 hp	60 hp	75 hp	100 hp
	220-240 V AC	50 hp	60 hp	75 hp	100 hp	100 hp
	440-480 V AC	100 hp	125 hp	150 hp	200 hp	250 hp
	550-600 V AC	125 hp	150 hp	200 hp	250 hp	300 hp
Short-circuit protection device for contactors						
without thermal overload relay - Motor protection excluded						
Fuse rating		300 A	400 A	800 A	800 A	800 A
Fuse type, 600 V		J/K5				
Maximum electrical switching frequency						
For general use		300 cycles/h				
For motor use		300 cycles/h				

(1) For the corresponding kW/A or hp/A values of 1500 r.p.m, 50 Hz or 1800 r.p.m, 60 Hz, 3-phase motors, see "Motor rated operational powers and currents".

General technical data

Contactor types	AC operated	A145	A185	A210	A260	A300
Rated insulation voltage U_i						
acc. to IEC 60947-4-1		1000 V				
acc. to UL / CSA		600 V				
Rated impulse withstand voltage U_{imp}		8 kV				
Ambient air temperature close to contactor						
Operation Fitted with thermal overload relay		-25 to +55 °C				
Storage		-40 to +70 °C				
Climatic withstand		acc. to IEC 60068-2-30				
Maximum operating altitude (without derating)		3000 m				
Mechanical durability						
Number of operating cycles		5 millions operating cycles				
Max. switching frequency		3600 cycles/h				
Shock withstand						
acc. to IEC 60068-2-27 and EN 60068-2-27						
Mounting position 1						
Shock direction		1/2 sinusoidal shock for 30 ms: no change in contact position, closed or open position				
A		5 g				
B1		5 g				
B2		5 g				
C1		5 g				
C2		5 g				

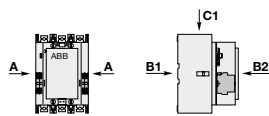

A9 ... A30 3-pole contactors

Technical data

Magnet system characteristics

Contactor types		AC operated	A9	A12	A16	A26	A30
Coil operating limits		AC supply	at $\theta \leq 55^\circ\text{C}$ 0.85...1.1 x U_c				
acc. to IEC 60947-4-1			Please also refer to "Mounting characteristics and conditions for use"				
AC control voltage 50/60 Hz							
Rated control circuit voltage U_c		at 50 Hz	24...690 V				
		at 60 Hz	24...690 V				
Coil consumption	Average pull-in value	50 Hz	70 VA			120 VA	
		60 Hz	80 VA			140 VA	
	Average holding value	50/60 Hz (1)	74 VA / 70 VA			125 VA / 120 VA	
		50 Hz	8 VA / 2 W			12 VA / 3 W	
		60 Hz	8 VA / 2 W			12 VA / 3 W	
		50/60 Hz (1)	8 VA / 2 W			12 VA / 3 W	
Drop-out voltage			approx. 40...65 % of U_c				
Operating time							
Between coil energization and:	N.O. contact closing		10...26 ms			8...21 ms	
	N.C. contact opening		7...21 ms			6...18 ms	
Between coil de-energization and:	N.O. contact opening		4...11 ms			4...11 ms	
	N.C. contact closing		9...16 ms			7...14 ms	

(1) 50/60 Hz coils: see "Coil voltage code table".

Mounting characteristics and conditions for use

Contactor types		AC operated	A9	A12	A16	A26	A30
Mounting positions							
Control voltage / Ambient temperature			Max. N.O. or N.C. built-in and add-on N.O. or N.C. auxiliary contacts: see accessory fitting details for 3-pole contactor A9 ... A30				
Mounting positions	1, 1±30°, 2, 3, 4, 5	at $\theta \leq 55^\circ\text{C}$	0.85...1.1 x U_c				
		at $\theta \leq 70^\circ\text{C}$	U_c				
	6	at $\theta \leq 55^\circ\text{C}$	0.95...1.1 x U_c				
		at $\theta \leq 70^\circ\text{C}$	Unauthorized				
Mounting distances			The contactors can be assembled side by side				
Fixing							
On rail according to IEC 60715, EN 60715			35 x 7.5 mm or 35 x 15 mm				
By screws (not supplied)			2 x M4 screws placed diagonally				

A40 ... A110 3-pole contactors

Technical data

Magnet system characteristics

Contactor types	AC operated	A40	A50	A63	A75	A95	A110
Coil operating limits	AC supply	At $\theta \leq 55^\circ\text{C}$ 0.85...1.1 x U_c				at $\theta \leq 70^\circ\text{C}$ 0.85...1.1 x U_c	
acc. to IEC 60947-4-1		Please also refer to "Mounting characteristics and conditions for use"					
AC control voltage 50/60 Hz							
Rated control circuit voltage U_c		at 50 Hz 24...690 V					
		at 60 Hz 24...690 V					
Coil consumption	Average pull-in value	50 Hz	120 VA	180 VA		350 VA	
		60 Hz	140 VA	210 VA		450 VA	
	Average holding value	50/60 Hz (1)	125 VA / 120 VA	190 VA / 180 VA		410 VA / 365 VA	
		50 Hz	12 VA / 3 W	18 VA / 5.5 W		22 VA / 6.5 W	
		60 Hz	12 VA / 3 W	18 VA / 5.5 W		26 VA / 8 W	
		50/60 Hz (1)	12 VA / 3 W	18 VA / 5.5 W		27 VA / 7.5 W	
Drop-out voltage		Approx. 40...65 % of U_c					
Operating time							
Between coil energization and:	N.O. contact closing	8...21 ms	8...27 ms			10...25 ms	
	N.C. contact opening	6...18 ms	7...22 ms			7...22 ms	
Between coil de-energization and:	N.O. contact opening	4...11 ms	4...11 ms			7...15 ms	
	N.C. contact closing	7...14 ms	7...14 ms			10...18 ms	

(1) 50/60 Hz coils: see "Coil voltage code table".

Mounting characteristics and conditions for use

Contactor types	AC operated	A40	A50	A63	A75	A95	A110
Mounting positions							
		Max. built-in and add-on N.O. or N.C. auxiliary contacts: see accessory fitting details for 3-pole contactor A40 ... A110					
Control voltage / Ambient temperature							
Mounting positions	1, 1±30°, 2, 3, 4, 5	at $\theta \leq 55^\circ\text{C}$	0.85...1.1 x U_c			0.85...1.1 x U_c	
		at $\theta \leq 70^\circ\text{C}$	U_c			0.85...1.1 x U_c	
	6	at $\theta \leq 55^\circ\text{C}$	0.95...1.1 x U_c			Unauthorized	
		at $\theta \leq 70^\circ\text{C}$	Unauthorized			Unauthorized	
Mounting distances		The contactors can be assembled side by side					
Fixing							
On rail according to IEC 60715, EN 60715		35 x 7.5 mm or 35 x 15 mm	35 x 15 mm or 75 x 25 mm			-	
By screws (not supplied)		2 x M4 screws placed diagonally	2 x M6 screws placed diagonally			2 x M6 screws placed diagonally	

A145 ... A300 3-pole contactors

Technical data

Magnet system characteristics

Contactor types		AC operated	A145	A185	A210	A260	A300	
Coil operating limits		AC supply	At $\theta \leq 70^\circ\text{C}$ 0.85...1.1 x U_c					
acc. to IEC 60947-4-1			Please also refer to "Mounting characteristics and conditions for use"					
AC control voltage	Rated control circuit voltage U_c	at 50 Hz	24...690 V					
		at 60 Hz	24...690 V					
Coil consumption	Average pull-in value	50 Hz	550 VA		1350 VA			
		60 Hz	600 VA		1550 VA			
		50/60 Hz (1)	700 VA / 650 VA		1700 VA / 1550 VA			
		Average holding value	50 Hz	35 VA / 11 W		60 VA / 16 W		
			60 Hz	40 VA / 12 W		65 VA / 19 W		
			50/60 Hz (1)	44 VA / 13 W		80 VA / 21 W		
Drop-out voltage			Approx. 40...65 % of U_c min.					
Operating time								
Between coil energization and:	N.O. contact closing		13...27 ms		17...35 ms			
	N.C. contact opening		8...22 ms		12...30 ms			
Between coil de-energization and:	N.O. contact opening		5...10 ms		7...13 ms			
	N.C. contact closing		9...13 ms		10...16 ms			

(1) 50/60 Hz coils: see "Voltage code table".











Mounting characteristics and conditions for use

Contactor types		AC operated	A145	A185	A210	A260	A300
Mounting positions							
Control voltage / Ambient temperature			Max. add-on N.O. or N.C. auxiliary contacts: see accessory fitting details for 3-pole contactor A145 ... A300				
Mounting positions	1, $1 \pm 30^\circ$, 2, 3, 4, 5	at $\theta \leq 70^\circ\text{C}$	0.85 x U_c ...1.1 x U_c				
	6		Unauthorized				
Mounting distances			The contactors can be assembled side by side				
Fixing	On rail according to IEC 60715, EN 60715		-				
	By screws (not supplied)		4 x M5				

A9 ... A30 3-pole contactors

Technical data

Connecting characteristics











Contactor types	AC operated	A9	A12	A16	A26	A30
Main terminals		 Screw terminals with cable clamp				 Screw terminals with double connector 2 x (5.6 x 6.5 mm)
Connection capacity (min. ... max.)						
Main conductors (poles)						
 Rigid	Solid ($\leq 4 \text{ mm}^2$)	} 1 x 1...4 mm ²			1.5...6 mm ²	2.5...16 mm ²
 Stranded ($\geq 6 \text{ mm}^2$)			2 x 1...4 mm ²		1.5...6 mm ²	2.5...16 mm ²
 Flexible with ferrule		1 x 0.75...2.5 mm ²			0.75...4 mm ²	2.5...10 mm ²
 Flexible with ferrule		2 x 0.75...2.5 mm ²			0.75...4 mm ²	2.5...10 mm ²
 Bars or lugs		L < 7.7 mm			10 mm	-
		l < 3.7 mm			4.2 mm	-
Connection capacity acc. to UL / CSA		1 or 2 x AWG 18...10			AWG 12...8	AWG 8...4
Tightening torque	Recommended				1.7 Nm / 15 lb.in	2.3 Nm / 20 lb.in
	Max.				2.20 Nm	2.60 Nm
Auxiliary conductors (built-in auxiliary terminals + coil terminals)						
 Rigid solid		1 x 1...4 mm ²				
		2 x 1...4 mm ²				
 Flexible with ferrule		1 x 0.75...2.5 mm ²				
		2 x 0.75...2.5 mm ²				
 Lugs		L < 7.7 mm			(1)	8 mm
		l < 3.7 mm			(1)	3.7 mm
Connection capacity acc. to UL / CSA		1 or 2 x AWG 18...14				
Tightening torque	Coil terminals					
		Recommended	1 Nm / 9 lb.in			
	Max.	1.20 Nm				
Built-in auxiliary terminals	Recommended	1 Nm / 9 lb.in			1.7 Nm / 15 lb.in	1 Nm / 9 lb.in
	Max.	1.20 Nm			2.20 Nm	1.20 Nm
Degree of protection						
acc. to IEC 60947-1 / EN 60947-1 and IEC 60529 / EN 60529						
Main terminals		IP20				
Coil terminals		IP20				
Built-in auxiliary terminals		IP20				
Screw terminals		Delivered in open position, screws of unused terminals must be tightened				
Main terminals		M3.5			M4	M5
	Screwdriver type	Flat Ø 5.5 / Pozidriv 2				Flat Ø 6.5 / Pozidriv 2
Coil terminals		M3.5				
	Screwdriver type	Flat Ø 5.5 / Pozidriv 2				
Built-in auxiliary terminals		M3.5			M4	M3.5
	Screwdriver type	Flat Ø 5.5 / Pozidriv 2				

(1) L \leq 8 and l $>$ 3.7 for coil terminals - L \leq 10 and l $>$ 4.2 for built-in auxiliary terminals.

A40 ... A110 3-pole contactors

Technical data

Connecting characteristics

Contactor types	AC operated	A40	A50	A63	A75	A95	A110	
Main terminals		 Screw terminals with double connector 2 x (5.6 x 6.5 mm)	 Screw terminals with single connector (13 x 10 mm)			 Screw terminals with single connector (14 x 14 mm)		
Connection capacity (min. ... max.)								
Main conductors (poles)								
 Rigid	Solid ($\leq 4 \text{ mm}^2$)	} 1 x 2.5...16 mm ²	} 6...50 mm ²			} 10...95 mm ²		
 Stranded ($\geq 6 \text{ mm}^2$)								2 x 2.5...16 mm ²
 Flexible with ferrule		1 x 2.5...10 mm ²	6...35 mm ²			10...70 mm ² (1)		
 Flexible with ferrule		2 x 2.5...10 mm ²	6...16 mm ²			6...35 mm ² (1)		
 Bars or lugs		L < -	-			30 mm (2)		
		l < -	-			6 mm		
Connection capacity acc. to UL / CSA	1 or 2 x	AWG 8...4	AWG 8...1			AWG 6...2/0		
Tightening torque	Recommended	2.30 Nm / 20 lb.in	4.00 Nm / 35 lb.in			8 Nm / 71 lb.in		
	Max.	2.60 Nm	4.50 Nm			9 Nm		
Auxiliary conductors (built-in auxiliary terminals + coil terminals)								
 Rigid solid		1 x 1...4 mm ²				0.75...2.5 mm ²		
		2 x 1...4 mm ²				0.75...2.5 mm ²		
 Flexible with ferrule		1 x 0.75...2.5 mm ²	1...2.5 mm ²			0.75...2.5 mm ²		
		2 x 0.75...2.5 mm ²						
 Lugs		L < 8 mm						
		l < 3.7 mm						
Connection capacity acc. to UL / CSA	1 or 2 x	AWG 18...14						
Tightening torque								
Coil terminals	Recommended	1.00 Nm / 9 lb.in						
	Max.	1.20 Nm						
Built-in auxiliary terminals	Recommended	1.00 Nm / 9 lb.in	-			-		
	Max.	1.20 Nm	-			-		
Degree of protection acc. to IEC 60947-1 / EN 60947-1 and IEC 60529 / EN 60529								
Main terminals		IP20	IP10					
Coil terminals		IP20						
Built-in auxiliary terminals		IP20	-			-		
Screw terminals		Delivered in open position, screws of unused terminals must be tightened						
Main terminals		M5	M6			M8		
	Screwdriver type	Flat Ø 6.5 / Pozidriv 2				Hexagon socket (s = 4 mm)		
Coil terminals		M3.5						
	Screwdriver type	Flat Ø 5.5 / Pozidriv 2						
Built-in auxiliary terminals		M3.5	-					
	Screwdriver type	Flat Ø 5.5 / Pozidriv 2	-					







(1) A95 / A110: use flexible without ferrule.

(2) With LW110 enlargement piece, see "Accessories".

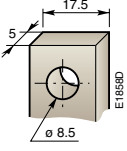
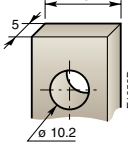
A145 ... A300 3-pole contactors

Technical data

Connecting characteristics

Contactor types	AC operated	A145	A185	A210	A260	A300
Main terminals Flat type						
Connection capacity (min. ... max.)						
Main conductors (poles)						
 Rigid with connector	Single for Cu cable	6...185 mm ²		16...240 mm ²		
	Single for Al/Cu cable	25...150 mm ²		120...240 mm ²		
	Double for Al/Cu cable	–		2 x 95...120 mm ²		
 Bars or lugs	L ≤	24 mm		32 mm		
	Ø >	8 mm		10 mm		
Connection capacity acc. to UL / CSA	1 or 2 x	6 - 250 MCM		4 - 500 MCM (1)		
Tightening torque	Recommended	18 Nm / 160 lb.in		28 Nm / 247 lb.in		
	Max.	20 Nm		30 Nm		
Auxiliary conductors (coil terminals)						
 Rigid solid	1 x	1...4 mm ²				
	2 x	1...4 mm ²				
 Flexible with ferrule	1 x	0.75...2.5 mm ²				
	2 x	0.75...2.5 mm ²				
 Lugs	L ≤	8 mm				
	l >	3.7 mm				
Connection capacity acc. to UL / CSA	1 or 2 x	AWG 18...14				
Tightening torque	Recommended	1.00 Nm / 9 lb.in				
	Max.	1.20 Nm				
Degree of protection acc. to IEC 60947-1 / EN 60947-1 and IEC 60529 / EN 60529						
Main terminals		IP00				
Coil terminals		IP20				
Screw terminals						
Main terminals		M8		M10		
		Screws and bolts				
Coil terminals (delivered in open position)		M3.5				
	Screwdriver type	Flat Ø 5.5 mm / Pozidriv 2				

(1) With LW110 enlargement piece: see "Accessories".

A9 ... A40 3-pole contactors

Technical data

Built-in auxiliary contacts according to IEC - Other auxiliary contacts see "Accessories"

Contactor types	AC operated	A9	A12	A16	A26	A30	A40
Rated operational voltage U _e max.		690 V					
Rated frequency (without derating)		50/60 Hz					
Conventional free air thermal current I _{th} - θ ≤ 40 °C		16 A					
le / Rated operational current AC-15 acc. to IEC 60947-5-1		10 x I _e AC-15 acc. to IEC 60947-5-1					
	24-127 V 50/60 Hz	6 A					
	220-240 V 50/60 Hz	4 A					
	380-440 V 50/60 Hz	3 A					
	500 V 50/60 Hz	2 A					
	690 V 50/60 Hz	2 A					
Making capacity AC-15		10 x I _e AC-15 acc. to IEC 60947-5-1					
Breaking capacity AC-15		10 x I _e AC-15 acc. to IEC 60947-5-1					
le / Rated operational current DC-13 acc. to IEC 60947-5-1		10 x I _e DC-13 acc. to IEC 60947-5-1					
	24 V DC	6 A / 144 W					
	48 V DC	2.8 A / 134 W					
	72 V DC	2 A / 144 W					
	110 V DC	1.1 A / 121 W					
	125 V DC	1.1 A / 138 W					
	220 V DC	0.55 A / 121 W					
	250 V DC	0.55 A / 138 W					
Short-circuit protection device gG type fuse		10 A					
Rated short-time withstand current I _{cw}	for 1.0 s	100 A					
	for 0.1 s	140 A					
Minimum switching capacity with failure rate acc. to IEC 60947-5-4		17 V / 5 mA ≤ 10 ⁻⁷ for AL40 and TAL40 contactors					
Non-overlapping time between N.O. and N.C. contacts		≥ 2 ms					
Power dissipation per pole at 6 A		0.1 W					
Max. electrical switching frequency	AC-15	1200 cycles/h					
	DC-13	900 cycles/h					
Mechanically linked contacts acc. to annex L of IEC 60947-5-1		Built-in N.O. or N.C. auxiliary contacts and additional N.O. or N.C. auxiliary contacts of 4-pole CA5 are mechanically linked contacts.					
Mirror contacts acc. to annex F of IEC 60947-4-1		Built-in N.C. auxiliary contacts or additional N.C. auxiliary contacts (CA5, CAL5-11) are mirror contacts.					

Built-in auxiliary contacts according to UL / CSA

Contactor types	AC operated	A9	A12	A16	A26	A30	A40
Max. operational voltage		600 V AC, 600 V DC					
Pilot duty		A600, P300					
AC thermal rated current		10 A					
AC maximum volt-ampere making		7200 VA					
AC maximum volt-ampere breaking		720 VA					
DC thermal rated current		5 A					
DC maximum volt-ampere making-breaking		138 VA					

A9 ... A300 3-pole contactors

Terminal marking and positioning

A9 ... A110 contactors - AC operated

Standard devices without addition of auxiliary contacts

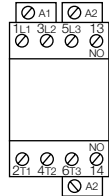

A9 ... A40-30-10

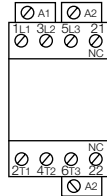

A9 ... A40-30-01

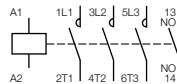

A9 ... A40-30-10

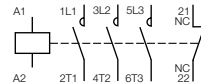

A9 ... A40-30-01

Standard devices with factory mounted auxiliary contacts

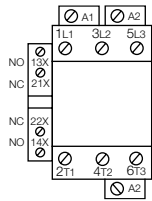

A50 ... A110-30-11

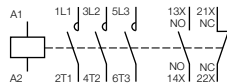

A50 ... A110-30-11

Other possible contact combinations with auxiliary contacts added by the user

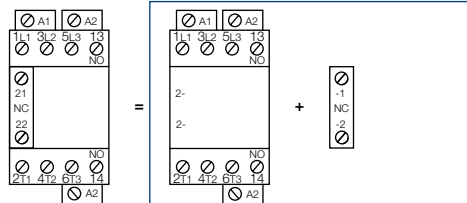

Combination 11 = A9 ... A40-30-10 + CA5-01

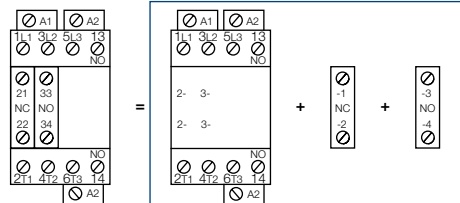

Combination 21 = A9 ... A40-30-10 + CA5-01 + CA5-10

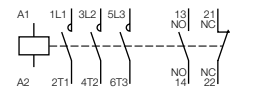

Combination 11



Combination 21

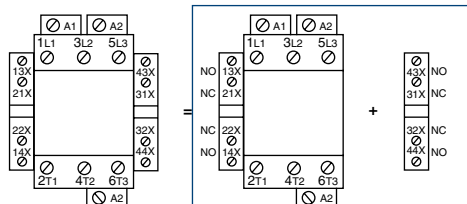

Combination 22 = A50 ... A75-30-11 + CAL5-11

A145 ... A300 contactors - AC operated

Standard devices with factory mounted auxiliary contacts

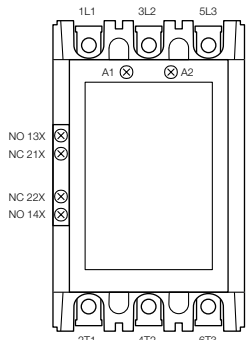

A145 ... A300-30-11

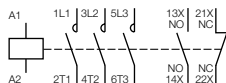

A145 ... A300-30-11

Star-delta starting of three-phase asynchronous motors

Contactor selection

General

Star-delta starting is the most common method to reduce the starting current of a motor. This system can be used on all the squirrel cage motors, which are normally used in delta connection.

In this type of starting, it is recommended to choose motors having high starting torque i.e. much higher than the resistive torque in order to reach sufficient high speed when the motor is connected in star.

3

Star-delta starting

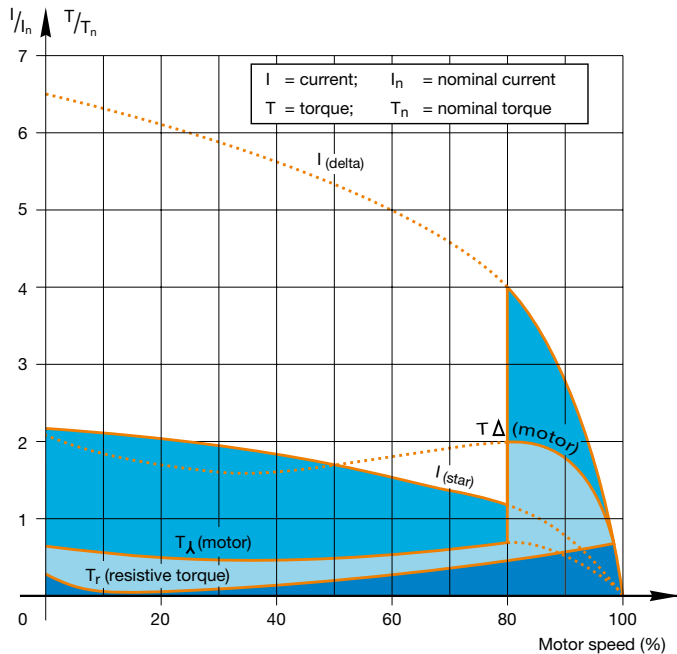

Technical Data

When starting:

- inrush current is reduced to a third of direct starting current
- motor torque is reduced to a third or even less of direct starting torque.

Transient current is generated when switching from star to delta connection.

Utilization

During the initial starting phase ("star" connection), the resistive torque of the driven load must remain, irrespective of speed, less than the "star" motor torque until "star-delta" switching occurs.

This starting mode is therefore ideal for machines having low starting torque such as:

- pumps
- centrifugal compressors
- wood-working machines, etc.

In order to prevent a high current peak, at least 85 % of nominal speed must be reached before switching from star to delta.

Precautions

Motor nominal voltage in delta connection must be equal to that of the mains.

Example:

A motor for 400 V star-delta starting must be designed for 400 V in "delta" connection. Its usual designation is "400 V / 690 V motor". The motor must be constructed with 6 terminal windings.

Sequence

Starting is a three-stage process:

1st stage - "Star" connection

Press the "On" button on the control circuit to close the KM2 "star" contactor. The KM1 "line" contactor then closes and the motor starts. Countdown of programmed starting time (normally 6 to 10 s) then begins.

2nd stage - "Star" to "Delta" switching

When the programmed starting time is over, the KM2 "star" contactor opens.

3rd stage - "Delta" connection

A transition time (or dwelling time) of 50 ms is fixed between opening of the "star" contactor and closing of the "delta" contactor by the use of TE5S timer. This prevents short circuit between "star" and "delta".

Note: An electrical interlock between star and delta is mandatory such as VE 5 or through auxiliary contacts.

Furthermore, in open transition, the current interruption may reach up to 95 ms: it shall be checked that this duration is compatible with the application i.e. mainly if the decreasing in rotation speed is acceptable during the starting phase.

Star-delta starting of three-phase asynchronous motors

Contactor selection

Rated operational power (1)					Max. starting time from a cold state (2)	Line contactor KM1	Delta contactor KM3	Star contactor KM2	Overload relay (3)	Timer
230 V AC-3 kW	400 V AC-3 kW	415 V AC-3 kW	500 V AC-3 kW	690 V AC-3 kW						
4	7.5	7.5	5.5	5.5	15	A9	A9	A9	TA25DU-M	TE5S
5.5	11	11	7.5	7.5	15	A12	A12	A9	TA25DU-M	TE5S
9	15	15	15	11	15	A16	A16	A12	TA25DU-M	TE5S
12.5	22	22	22	15	15	A26	A26	A16	TA25DU-M	TE5S
15	25	25	25	18.5	15	A30	A30	A26	TA25DU-M	TE5S
18.5	37	37	37	37	30	A40	A40	A26	TA42DU-M	TE5S
25	45	45	45	45	30	A50	A50	A30	TA75DU-M	TE5S
30	55	55	63	59	30	A63	A63	A40	TA75DU-M	TE5S
37	63	70	75	63	30	A75	A75	A50	TA75DU-M	TE5S
45	75	75	90	90	20	A95	A95	A75	TA110DU	TE5S
55	90	100	110	132	20	A110	A110	A95	TA110DU	TE5S
75	132	132	160	160	20	A145	A145	A110	TA200DU	TE5S
90	160	160	200	250	20	A185	A185	A145	TA200DU	TE5S
110	200	200	250	315	20	A210	A210	A185	TA450DU	TE5S
140	220	250	295	355	20	A260	A260	A210	TA450DU	TE5S
160	250	250	355	450	20	A300	A300	A260	TA450DU	TE5S

- Notes:
- (1) Ambient temperature ≤ 55 °C for A9 ... A300
 - (2) Usual time value = 6...10 s.
 - (3) The setting current value is: nominal motor current x 0.58.

For motors above 670 kW / 400 V, it is recommended to use Closed Transition Star-Delta starting. Contact your ABB Office for selection.

Power circuit diagram

A9 ... A300 contactors

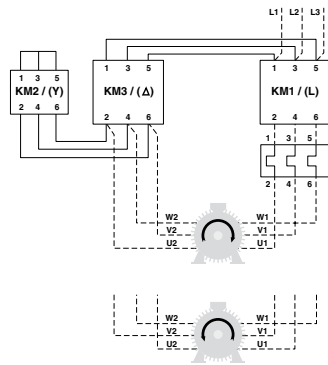

Control circuit diagrams - Remote control

A9 ... A300 contactors

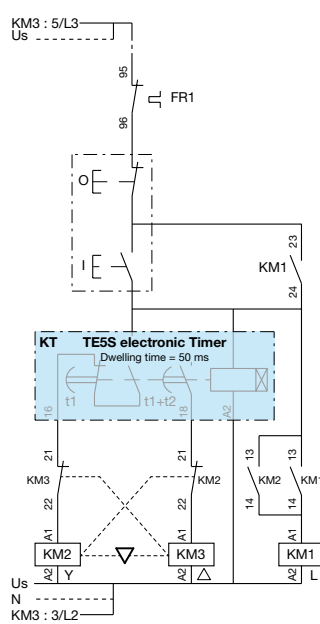

4-pole contactors

3



IEC	AC-1 Rated operational current	$\theta \leq 40\text{ °C}$, 690 V	A	25	30	45	70	100	125
UL/CSA	General use rating	600 V	A	21	30	40	65	80	105
AC Control supply			Type	A9	A16	A26	A45	A50	A75
IEC	AC-1 Rated operational current	$\theta \leq 40\text{ °C}$	A	25	30	45	70	100	125
		$\theta \leq 55\text{ °C}$	A	22	27	40	60	85	105
		$\theta \leq 70\text{ °C}$	A	18	23	32	50	70	85
	With conductor cross sectional area		mm ²	2.5	4	6	25	35	50
	Rated operational voltage Ue max.		V	690	690	690	1000	1000	1000

Main accessories

Auxiliary contact blocks	Front mounting	CA5-10 (1 x N.O.) CA5-01 (1 x N.C.)
	Side mounting	CAL5-11 (1 x N.O. + 1 x N.C.)
Timers	Electronic	TEF5-ON TEF5-OFF TE5S (for star-delta starters - direct timing - separate mounting)
	Mechanical	VM5-1
Interlocking units	Mechanical / Electrical	VE5-1 VE5-2
	Varistor (AC / DC)	RV5 (24...440 V)
Surge suppressors	RC Type (AC)	RC5-1 (24...440 V) RC5-2 (24...440 V)

A9 ... A16 4-pole contactors

25 to 30 A AC-1

AC operated



A9-40-00

Description

A9 ... A16 4-pole contactors are mainly used for controlling non-inductive or slightly inductive loads (i.e. resistance furnaces...) and generally for controlling power circuits up to 690 V AC and 440 V DC.

These contactors are of the block type design with:

- 4 main poles
- control circuit: AC operated
- add-on auxiliary contact blocks for front or side mounting and a wide range of accessories.

Ordering details

IEC Rated operational current $\theta \leq 40^\circ\text{C}$ AC-1	UL/CSA General use rating 600 V AC	Rated control circuit voltage U_c (1)		Auxiliary contacts fitted	Type	Order code	Weight Pkg (1 pce) kg
		V 50 Hz	V 60 Hz				
4 N.O. main poles							
25	21	24	24	0 0	A9-40-00	1SBL141201R8100	0.340
		48	48	0 0	A9-40-00	1SBL141201R8300	0.340
		110	110...120	0 0	A9-40-00	1SBL141201R8400	0.340
		220...230	230...240	0 0	A9-40-00	1SBL141201R8000	0.340
		230...240	240...260	0 0	A9-40-00	1SBL141201R8800	0.340
		380...400	400...415	0 0	A9-40-00	1SBL141201R8500	0.340
		400...415	415...440	0 0	A9-40-00	1SBL141201R8600	0.340
30	30	24	24	0 0	A16-40-00	1SBL181201R8100	0.340
		48	48	0 0	A16-40-00	1SBL181201R8300	0.340
		110	110...120	0 0	A16-40-00	1SBL181201R8400	0.340
		220...230	230...240	0 0	A16-40-00	1SBL181201R8000	0.340
		230...240	240...260	0 0	A16-40-00	1SBL181201R8800	0.340
		380...400	400...415	0 0	A16-40-00	1SBL181201R8500	0.340
		400...415	415...440	0 0	A16-40-00	1SBL181201R8600	0.340
2 N.O. + 2 N.C. main poles (2)							
25	21	24	24	0 0	A9-22-00	1SBL141501R8100	0.340
		48	48	0 0	A9-22-00	1SBL141501R8300	0.340
		110	110...120	0 0	A9-22-00	1SBL141501R8400	0.340
		220...230	230...240	0 0	A9-22-00	1SBL141501R8000	0.340
		230...240	240...260	0 0	A9-22-00	1SBL141501R8800	0.340
		380...400	400...415	0 0	A9-22-00	1SBL141501R8500	0.340
		400...415	415...440	0 0	A9-22-00	1SBL141501R8600	0.340
30	30	24	24	0 0	A16-22-00	1SBL181501R8100	0.340
		48	48	0 0	A16-22-00	1SBL181501R8300	0.340
		110	110...120	0 0	A16-22-00	1SBL181501R8400	0.340
		220...230	230...240	0 0	A16-22-00	1SBL181501R8000	0.340
		230...240	240...260	0 0	A16-22-00	1SBL181501R8800	0.340
		380...400	400...415	0 0	A16-22-00	1SBL181501R8500	0.340
		400...415	415...440	0 0	A16-22-00	1SBL181501R8600	0.340

(1) Other control voltages see voltage code table.

(2) These contactors are not suitable for a reversing starter or star-delta starter or for controlling a single load from 2 separate supplies. Please see technical data.

Main dimensions mm, inches

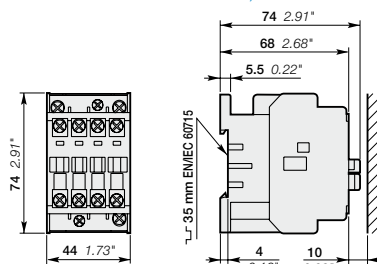

A9, A16

A26 4-pole contactors

45 A AC-1

AC operated



1SBC570081FC001

3

A26-40-00

Description

A26 4-pole contactors are mainly used for controlling non-inductive or slightly inductive loads (i.e. resistance furnaces...) and generally for controlling power circuits up to 690 V AC and 220 V DC.

These contactors are of the block type design with:

- 4 main poles
- control circuit: AC operated
- add-on auxiliary contact blocks for front or side mounting and a wide range of accessories.

Ordering details

IEC Rated operational current $\theta \leq 40^\circ\text{C}$ AC-1	UL/CSA General use rating 600 V AC	Rated control circuit voltage U_c (1)		Auxiliary contacts fitted	Type	Order code	Weight Pkg (1 pce) kg
A	A	V 50 Hz	V 60 Hz				
4 N.O. main poles							
45	40	24	24	0 0	A26-40-00	1SBL241201R8100	0.610
		48	48	0 0	A26-40-00	1SBL241201R8300	0.610
		110	110...120	0 0	A26-40-00	1SBL241201R8400	0.610
		220...230	230...240	0 0	A26-40-00	1SBL241201R8000	0.610
		230...240	240...260	0 0	A26-40-00	1SBL241201R8800	0.610
		380...400	400...415	0 0	A26-40-00	1SBL241201R8500	0.610
		400...415	415...440	0 0	A26-40-00	1SBL241201R8600	0.610
2 N.O. + 2 N.C. main poles (2)							
45	40	24	24	0 0	A26-22-00	1SBL241501R8100	0.610
		48	48	0 0	A26-22-00	1SBL241501R8300	0.610
		110	110...120	0 0	A26-22-00	1SBL241501R8400	0.610
		220...230	230...240	0 0	A26-22-00	1SBL241501R8000	0.610
		230...240	240...260	0 0	A26-22-00	1SBL241501R8800	0.610
		380...400	400...415	0 0	A26-22-00	1SBL241501R8500	0.610
		400...415	415...440	0 0	A26-22-00	1SBL241501R8600	0.610

(1) Other control voltages see voltage code table.

(2) These contactors are not suitable for a reversing starter or star-delta starter or for controlling a single load from 2 separate supplies. Please see technical data.

Main dimensions mm, inches

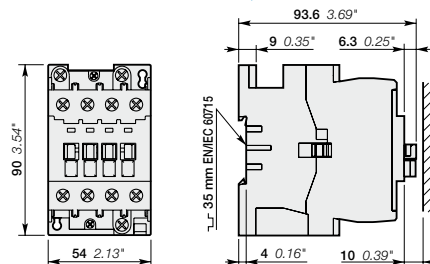

A26

1SBC101863S0201

A45 ... A75 4-pole contactors

70 to 125 A AC-1

AC operated



A45-40-00

Description

A45 ... A75 4-pole contactors are mainly used for controlling non-inductive or slightly inductive loads (i.e. resistance furnaces...) and generally for controlling power circuits up to 690 V AC and 220 V DC.

These contactors are of the block type design with:

- 4 main poles
- control circuit: AC operated
- add-on auxiliary contact blocks for front or side mounting and a wide range of accessories.

Ordering details

IEC	UL/CSA	Rated control circuit voltage U_c		Auxiliary contacts fitted	Type	Order code	Weight
Rated operational current $\theta \leq 40^\circ\text{C}$ AC-1	General use rating 600 V AC	V 50 Hz	V 60 Hz				Pkg (1 pce) kg

4 N.O. main poles

Rated operational current	General use rating	V 50 Hz	V 60 Hz	NO	NC	Type	Order code	Weight
70	65	24	24	0	0	A45-40-00	1SBL331201R8100	1.390
		48	48	0	0	A45-40-00	1SBL331201R8300	1.390
		110	110...120	0	0	A45-40-00	1SBL331201R8400	1.390
		220...230	230...240	0	0	A45-40-00	1SBL331201R8000	1.390
		230...240	240...260	0	0	A45-40-00	1SBL331201R8800	1.390
		380...400	400...415	0	0	A45-40-00	1SBL331201R8500	1.390
		400...415	415...440	0	0	A45-40-00	1SBL331201R8600	1.390
100	80	24	24	0	0	A50-40-00	1SBL351201R8100	1.390
		48	48	0	0	A50-40-00	1SBL351201R8300	1.390
		110	110...120	0	0	A50-40-00	1SBL351201R8400	1.390
		220...230	230...240	0	0	A50-40-00	1SBL351201R8000	1.390
		230...240	240...260	0	0	A50-40-00	1SBL351201R8800	1.390
		380...400	400...415	0	0	A50-40-00	1SBL351201R8500	1.390
		400...415	415...440	0	0	A50-40-00	1SBL351201R8600	1.390
125	105	24	24	0	0	A75-40-00	1SBL411201R8100	1.390
		48	48	0	0	A75-40-00	1SBL411201R8300	1.390
		110	110...120	0	0	A75-40-00	1SBL411201R8400	1.390
		220...230	230...240	0	0	A75-40-00	1SBL411201R8000	1.390
		230...240	240...260	0	0	A75-40-00	1SBL411201R8800	1.390
		380...400	400...415	0	0	A75-40-00	1SBL411201R8500	1.390
		400...415	415...440	0	0	A75-40-00	1SBL411201R8600	1.390

2 N.O. + 2 N.C. main poles (2)

Rated operational current	General use rating	V 50 Hz	V 60 Hz	NO	NC	Type	Order code	Weight
70	65	24	24	0	0	A45-22-00	1SBL331501R8100	1.400
		48	48	0	0	A45-22-00	1SBL331501R8300	1.400
		110	110...120	0	0	A45-22-00	1SBL331501R8400	1.400
		220...230	230...240	0	0	A45-22-00	1SBL331501R8000	1.400
		230...240	240...260	0	0	A45-22-00	1SBL331501R8800	1.400
		380...400	400...415	0	0	A45-22-00	1SBL331501R8500	1.400
		400...415	415...440	0	0	A45-22-00	1SBL331501R8600	1.400
125	105	24	24	0	0	A75-22-00	1SBL411501R8100	1.400
		48	48	0	0	A75-22-00	1SBL411501R8300	1.400
		110	110...120	0	0	A75-22-00	1SBL411501R8400	1.400
		220...230	230...240	0	0	A75-22-00	1SBL411501R8000	1.400
		230...240	240...260	0	0	A75-22-00	1SBL411501R8800	1.400
		380...400	400...415	0	0	A75-22-00	1SBL411501R8500	1.400
		400...415	415...440	0	0	A75-22-00	1SBL411501R8600	1.400

(1) Other control voltages see voltage code table.

(2) These contactors are not suitable for a reversing starter or star-delta starter or for controlling a single load from 2 separate supplies. Please see technical data.

Main dimensions mm, inches

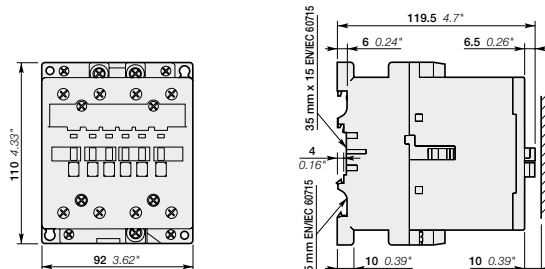

A45, A50, A75

A9 ... A75 4-pole contactors

Main accessories

Contactor and main accessories (other accessories available)

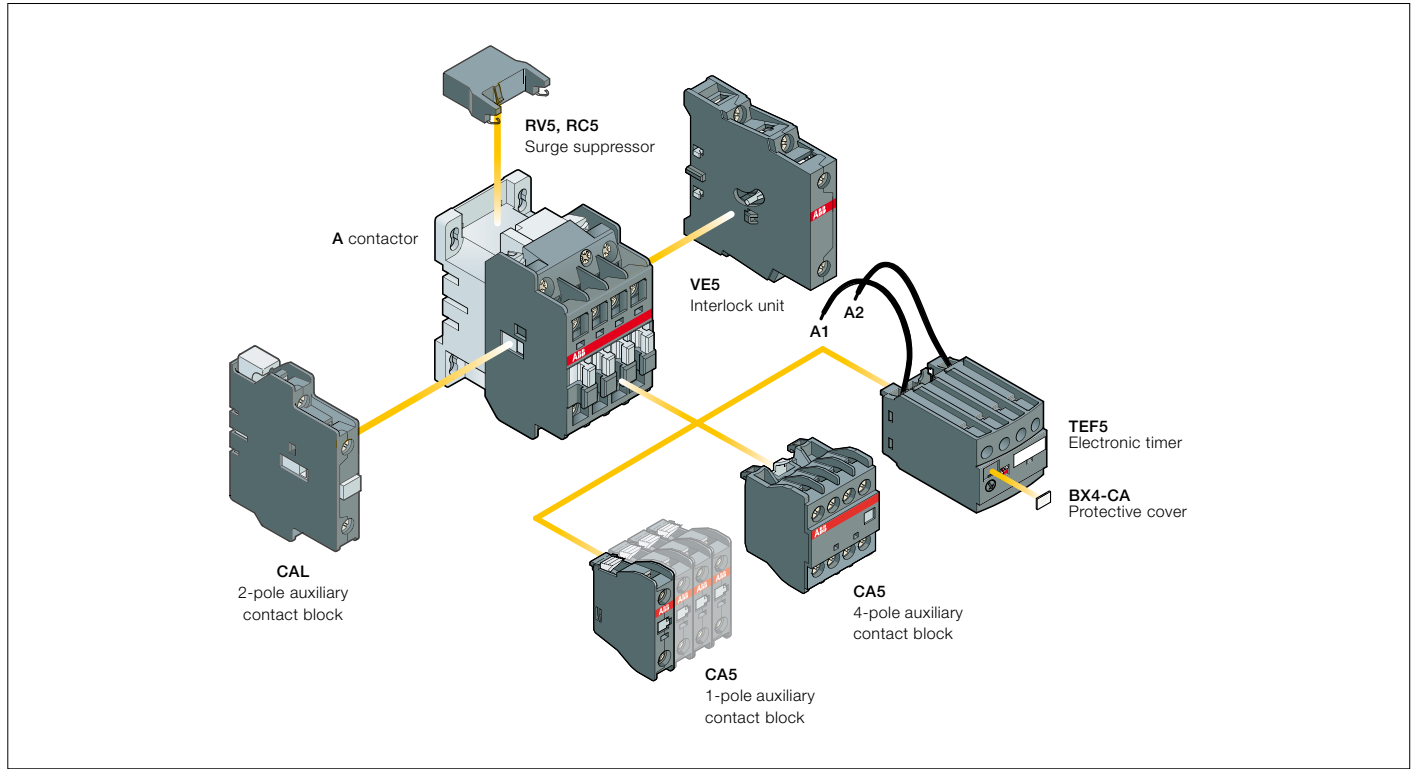

Main accessory fitting details

Many configurations of accessories are possible depending on whether these are front-mounted or side-mounted.

Contactor types	Main poles	Built-in auxiliary contacts	Front-mounted accessories			Side-mounted accessories		
			Auxiliary contact blocks		Electronic timer	Auxiliary contact blocks	Interlock unit	
			1-pole CA5	4-pole CA5	TEF5		2-pole CAL5-11	VM5 or VE5
A9, A16	4 0	0 0	1 to 4 x CA5	or 1 x CA5 (4-pole)	or 1 x TEF5	+	1 to 2 x CAL5-11	or 1 x VM5-1 or VE5-1 + 1 x CAL5-11
	2 2	0 0 (1)	1 to 4 x CA5	or 1 x CA5 (4-pole)	or 1 x TEF5	+	1 to 2 x CAL5-11	–
A26	4 0	0 0	1 to 4 x CA5	or 1 x CA5 (4-pole)	or 1 x TEF5	+	1 to 2 x CAL5-11	or 1 x VM5-1 or VE5-1 + 1 x CAL5-11
	2 2	0 0 (1)	1 to 4 x CA5	or 1 x CA5 (4-pole)	or 1 x TEF5	+	1 to 2 x CAL5-11	–
A45 ... A75	4 0	0 0	1 to 6 x CA5	or 1 x CA5 (4-pole) + 2 x 1-pole CA5	or 1 x TEF5 + 2 x CA5 (1-pole)	+	1 to 2 x CAL5-11	or 1 x VE5-2 + 1 x CAL5-11
	2 2	0 0 (2)	1 to 6 x CA5	or 1 x CA5 (4-pole) + 2 x 1-pole CA5	or 1 x TEF5 + 2 x CA5 (1-pole)	+	1 to 2 x CAL5-11	–

(1) 2 N.C. CA5 auxiliary contacts maximum in mounting position 5.

(2) 2 N.C. CA5 auxiliary contacts maximum.

A9 ... A75 4-pole contactors

Main accessories



CA5-10



CAL5-11

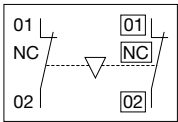

VE5-2

Terminal marking and positioning



TEF5-OFF



RV5/50

Ordering details (1)

For contactors	Auxiliary contacts	Type	Order code	Pkg qty	Weight (1 pce)
					kg

Front-mounted instantaneous auxiliary contact blocks

A9 ... A75	1 -	CA5-10	1SBN010010R1010	10	0.014
	- 1	CA5-01	1SBN010010R1001	10	0.014
A9 ... A75	2 2	CA5-22E	1SBN010040R1022	2	0.060

Side-mounted instantaneous auxiliary contact block

A9 ... A75	1 1	CAL5-11	1SBN010020R1011	2	0.050
------------	-----	---------	-----------------	---	-------

Interlock units

A9 ... A26	Mechanical	- -	VM5-1	1SBN030100R1000	1	0.066
	Mechanical and electrical	- 2	VE5-1	1SBN030110R1000	1	0.076
A45 ... A75	Mechanical and electrical	- 2	VE5-2	1SBN030210R1000	1	0.146

For contactors	Time delay range selected by switch	Delay type	Auxiliary contacts	Type	Order code	Pkg qty	Weight (1 pce)
							kg

Electronic timers

A9 ... A75	0.1...1 s	ON-delay	1 1	TEF5-ON	1SBN020312R1000	1	0.065
	1...10 s						
	10...100 s	OFF-delay	1 1	TEF5-OFF	1SBN020314R1000	1	0.065

Note: Rated control circuit voltage U_c 24...240 V 50/60 Hz or DC.

For contactors	Rated control circuit voltage U_c		Type	Order code	Pkg qty	Weight (1 pce)
	V	AC DC				
						kg

Surge suppressors

A9 ... A75	24...50	● ●	RV5/50	1SBN050010R1000	2	0.015
	50...133	● ●	RV5/133	1SBN050010R1001	2	0.015
	110...250	● ●	RV5/250	1SBN050010R1002	2	0.015
	250...440	● ●	RV5/440	1SBN050010R1003	2	0.015
A9 ... A26	24...50	● -	RC5-1/50	1SBN050100R1000	2	0.012
	50...133	● -	RC5-1/133	1SBN050100R1001	2	0.012
	110...250	● -	RC5-1/250	1SBN050100R1002	2	0.012
	250...440	● -	RC5-1/440	1SBN050100R1003	2	0.012
A45 ... A75	24...50	● -	RC5-2/50	1SBN050200R1000	2	0.015
	50...133	● -	RC5-2/133	1SBN050200R1001	2	0.015
	110...250	● -	RC5-2/250	1SBN050200R1002	2	0.015
	250...440	● -	RC5-2/440	1SBN050200R1003	2	0.015

(1) See "Main accessory fitting details" table.

A9 ... A26 4-pole contactors

Technical data

Main pole - Utilization characteristics according to IEC

Contactor types	AC operated	A9	A16	A26
Standards		IEC 60947-1 / 60947-4-1 and EN 60947-1 / 60947-4-1		
Rated operational voltage U_e max.		690 V		
Rated frequency (without derating)		50 / 60 Hz		
Conventional free-air thermal current I_{th}				
acc. to IEC 60947-4-1, open contactors, $\theta \leq 40^\circ\text{C}$		26 A	30 A	45 A
With conductor cross-sectional area		4 mm ²	4 mm ²	6 mm ²
AC-1 Utilization category				
For air temperature close to contactor				
I_e / Rated operational current AC-1	$\theta \leq 40^\circ\text{C}$	25 A	30 A	45 A
U_e max. ≤ 690 V, 50/60 Hz	$\theta \leq 55^\circ\text{C}$	22 A	27 A	40 A
	$\theta \leq 70^\circ\text{C}$	18 A	23 A	32 A
With conductor cross-sectional area		2.5 mm ²	4 mm ²	6 mm ²
AC-3 Utilization category				
For air temperature close to contactor $\theta \leq 55^\circ\text{C}$				
I_e / Max. rated operational current AC-3 (1)				
	220-230-240 V	9 A	17 A	26 A
	380-400 V	9 A	17 A	26 A
	415 V	9 A	17 A	26 A
	440 V	9 A	16 A	26 A
	500 V	9 A	14 A	22 A
	690 V	7 A	10 A	17 A
Rated operational power AC-3 (1)				
	220-230-240 V	2.2 kW	4 kW	6.5 kW
	380-400 V	4 kW	7.5 kW	11 kW
	415 V	4 kW	9 kW	11 kW
	440 V	4 kW	9 kW	15 kW
	500 V	5.5 kW	9 kW	15 kW
	690 V	5.5 kW	9 kW	15 kW
Rated making capacity AC-3		10 x I_e AC-3 acc. to IEC 60947-4-1		
Rated breaking capacity AC-3		8 x I_e AC-3 acc. to IEC 60947-4-1		
Short-circuit protection device for contactors				
without thermal overload relay - Motor protection excluded				
$U_e \leq 500$ V AC - gG type fuse		25 A	32 A	50 A
Rated short-time withstand current I_{cw}				
at 40°C ambient temperature, in free air from a cold state	1 s	250 A	300 A	400 A
	10 s	100 A	140 A	210 A
	30 s	60 A	80 A	110 A
	1 min	50 A	60 A	90 A
	15 min	26 A	30 A	45 A
Power dissipation per pole				
	I_e / AC-1	0.8 W	1.2 W	1.8 W
	I_e / AC-3	0.1 W	0.35 W	0.6 W
Max. electrical switching frequency				
	AC-1	600 cycle/h		
	AC-3	1200 cycle/h		

(1) For the corresponding kW/A or hp/A values of 1500 r.p.m, 50 Hz or 1800 r.p.m, 60 Hz, 3-phase motors, see "Motor rated operational powers and currents".



Main pole - Utilization characteristics according to UL / CSA

Contactor types	AC operated	A9	A16	A26
Standards		UL 508, CSA C22.2 N°14		
Max. operational voltage		600 V		
UL / CSA general use rating				
600 V AC		21 A	30 A	40 A
With conductor cross-sectional area		AWG 10		AWG 8
Max. electrical switching frequency		600 cycles/h		
For general use				

A45 ... A75 4-pole contactors

Technical data

Main pole - Utilization characteristics according to IEC

Contactor types	AC operated	A45	A50	A75
Standards		IEC 60947-1 / 60947-4-1 and EN 60947-1 / 60947-4-1		
Rated operational voltage U _e max.		1000 V		
Rated frequency (without derating)		50 / 60 Hz		
Conventional free-air thermal current I _{th} acc. to IEC 60947-4-1, open contactors, $\theta \leq 40\text{ °C}$ With conductor cross-sectional area		100 A 35 mm ²	100 A 35 mm ²	125 A 50 mm ²
AC-1 Utilization category For air temperature close to contactor I_e / Rated operational current AC-1 U _e max. $\leq 690\text{ V}$, 50/60 Hz				
	$\theta \leq 40\text{ °C}$	70 A	100 A	125 A
	$\theta \leq 55\text{ °C}$	60 A	85 A	105 A
	$\theta \leq 70\text{ °C}$	50 A	70 A	85 A
	With conductor cross-sectional area	25 mm ²	35 mm ²	50 mm ²
AC-3 Utilization category For air temperature close to contactor $\theta \leq 55\text{ °C}$ I_e / Max. rated operational current AC-3 (1)				
	220-230-240 V	40 A	53 A	75 A
	380-400 V	37 A	50 A	75 A
	415 V	37 A	50 A	75 A
	440 V	37 A	45 A	70 A
	500 V	33 A	45 A	65 A
	690 V	25 A	35 A	46 A
	1000 V	–	23 A	28 A
 3-phase motors				
Rated operational power AC-3 (1)				
	220-230-240 V	11 kW	15 kW	22 kW
	380-400 V	18.5 kW	22 kW	37 kW
	415 V	18.5 kW	25 kW	40 kW
	440 V	22 kW	25 kW	40 kW
	500 V	22 kW	30 kW	45 kW
	690 V	22 kW	30 kW	40 kW
	1000 V	–	30 kW	37 kW
 1500 r.p.m. 50 Hz 1800 r.p.m. 60 Hz 3-phase motors				
Rated making capacity AC-3		10 x I _e AC-3 acc. to IEC 60947-4-1		
Rated breaking capacity AC-3		8 x I _e AC-3 acc. to IEC 60947-4-1		
Short-circuit protection device for contactors without thermal overload relay - Motor protection excluded U _e $\leq 500\text{ V AC}$ - gG type fuse		80 A	100 A	160 A
Rated short-time withstand current I_{cw} at 40 °C ambient temperature, in free air from a cold state				
	1 s	1000 A		
	10 s	650 A		
	30 s	370 A		
	1 min	250 A		
	15 min	110 A	110 A	135 A
Power dissipation per pole				
	I _e / AC-1	2.5 W	5 W	7 W
	I _e / AC-3	0.65 W	1.3 W	2 W
Max. electrical switching frequency				
	AC-1	600 cycles/h		
	AC-3	600 cycles/h		

(1) For the corresponding kW/A or hp/A values of 1500 r.p.m, 50 Hz or 1800 r.p.m, 60 Hz, 3-phase motors, see "Motor rated operational powers and currents".

Main pole - Utilization characteristics according to UL / CSA

Contactor types	AC operated	A45	A50	A75
Standards		UL 508, CSA C22.2 N°14		
Max. operational voltage		600 V		
UL / CSA general use rating 600 V AC With conductor cross-sectional area		65 A AWG 6	80 A AWG 4	105 A AWG 2
Max. electrical switching frequency For general use		600 cycles/h		

A9 ... A26 4-pole contactors

Technical data

Magnet system characteristics

Contactor types		AC operated	A9	A16	A26
Coil operating limits		AC supply	at $\theta \leq 55^\circ\text{C}$ $0.85 \dots 1.1 \times U_c$ Please also refer to "Mounting characteristics and conditions for use"		
acc. to IEC 60947-4-1					
AC control voltage 50/60 Hz					
Rated control circuit voltage U_c		at 50 Hz	24...690 V		
		at 60 Hz	24...690 V		
Coil consumption	Average pull-in value	50 Hz	70 VA		120 VA
		60 Hz	80 VA		140 VA
		50/60 Hz (1)	74 VA / 70 VA		125 VA / 120 VA
Average holding value		50 Hz	8 VA / 2 W		12 VA / 3 W
		60 Hz	8 VA / 2 W		12 VA / 3 W
		50/60 Hz (1)	8 VA / 2 W		12 VA / 3 W
Drop-out voltage			approx. 40...65 % of U_c		
Operating time					
Between coil energization and:	N.O. contact closing		10...26 ms		8...21 ms
	N.C. contact opening		7...21 ms		6...18 ms
Between coil de-energization and:	N.O. contact opening		4...11 ms		4...11 ms
	N.C. contact closing		9...16 ms		7...14 ms

(1) 50/60 Hz coils: see "Coil voltage code table".

Mounting characteristics and conditions for use

Contactor types		AC operated	A9	A16	A26
Mounting positions					
			Max. N.O. or N.C. built-in and add-on N.O. or N.C. auxiliary contacts: see accessory fitting details for 4-pole contactor A9 ... A26		
Control voltage / Ambient temperature					
Mounting positions	1, $1 \pm 30^\circ$, 2, 3, 4, 5	at $\theta \leq 55^\circ\text{C}$	$0.85 \dots 1.1 \times U_c$		
		at $\theta \leq 70^\circ\text{C}$	U_c		
		at $\theta \leq 55^\circ\text{C}$	$0.95 \dots 1.1 \times U_c$		
		at $\theta \leq 70^\circ\text{C}$	unauthorized		
Mounting distances			The contactors can be assembled side by side		
Fixing					
On rail according to IEC 60715, EN 60715			35 x 7.5 mm or 35 x 15 mm		
By screws (not supplied)			2 x M4 screws placed diagonally		

A45 ... A75 4-pole contactors

Technical data

Magnet system characteristics

Contactor types		AC operated	A45	A50	A75
Coil operating limits		AC supply	At $\theta \leq 55\text{ °C}$ 0.85...1.1 x U_c		
acc. to IEC 60947-4-1			Please also refer to "Mounting characteristics and conditions for use"		
AC control voltage					
Rated control circuit voltage U_c		at 50 Hz	24...690 V		
		at 60 Hz	24...690 V		
Coil consumption	Average pull-in value	50 Hz	180 VA		
		60 Hz	210 VA		
		50/60 Hz (1)	190 VA / 180 VA		
Coil consumption	Average holding value	50 Hz	18 VA / 5.5 W		
		60 Hz	18 VA / 5.5 W		
		50/60 Hz (1)	18 VA / 5.5 W		
Drop-out voltage			approx. 40...65 % of U_c		
Operating time					
Between coil energization and:	N.O. contact closing		8...27 ms		
	N.C. contact opening		7...22 ms		
Between coil de-energization and:	N.O. contact opening		4...11 ms		
	N.C. contact closing		7...14 ms		

(1) 50/60 Hz coils: see "Coil voltage code table".

Mounting characteristics and conditions for use

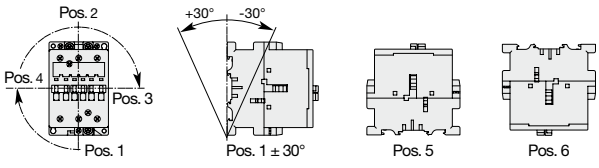
Contactor types		AC operated	A45	A50	A75
Mounting positions					
			Pos. 5 unauthorized for A45-22-00, A75-22-00		
			Max. add-on N.O. or N.C. auxiliary contacts: see accessory fitting details for 4-pole contactor A45 ... A75		
Control voltage / Ambient temperature					
Mounting positions (1)	1, 1±30°, 2, 3, 4, 5	at $\theta \leq 55\text{ °C}$	0.85...1.1 x U_c		
		at $\theta \leq 70\text{ °C}$	U_c		
6		at $\theta \leq 55\text{ °C}$	0.95...1.1 x U_c		
		at $\theta \leq 70\text{ °C}$	Unauthorized		
Mounting distances			The contactors can be assembled side by side		
Fixing					
On rail according to IEC 60715, EN 60715			35 x 15 mm or 75 x 25 mm		
By screws (not supplied)			2 x M6 screws placed diagonally		

(1) For 60 Hz coil voltage: (only for devices fitted with CA 5-... and CAL 5-11 auxiliary contacts).

– A45-40-00, A50-40-00 and A75-40-00 contactors.

Mounting positions 1 to 5 and ambient temperature $\leq 55\text{ °C}$: tolerance reduced to 0.9...1.1 U_c (instead of 0.85...1.1 U_c) for coil voltage codes 70 to 79 and 80 to 89.

– A45-22-00 and A75-22-00 contactors.

Mounting positions 1 to 4 and ambient temperature $\leq 55\text{ °C}$: tolerance reduced to 0.9...1.1 U_c (instead of 0.85...1.1 U_c) for coil voltage codes 70 to 79 and 80 to 89.

For mounting position 6 or ambient temperature of 55 to 70 °C the information given on this page remains applicable.

A9 ... A26 4-pole contactors

Technical data

General technical data

Contactor types	AC operated	A9	A16	A26
Rated insulation voltage U_i acc. to IEC 60947-4-1 acc. to UL / CSA		1000 V 600 V		
Rated impulse withstand voltage U_{imp}		8 kV		
Ambient air temperature close to contactor Operation in free air Storage		-40...+70 °C -60...+80 °C		
Climatic withstand		acc. to IEC 60068-2-30 and 60068-2-11 - UTE C 63-100 specification II		
Maximum operating altitude (without derating)		3000 m		
Mechanical durability Number of operating cycles Max. switching frequency		10 millions operating cycles 3600 cycles/h		
Shock withstand acc. to IEC 60068-2-27 and EN 60068-2-27 Mounting position 1				
	Shock direction	1/2 sinusoidal shock for 11 ms: no change in contact position, closed or open position		
	A	20 g		
	B1	10 g closed position / 5 g open position		
	B2	15 g		
	C1	20 g		
	C2	20 g		

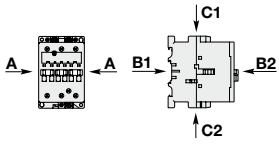

Remark for 4-pole contactors fitted with 2 N.O. + 2 N.C. main poles

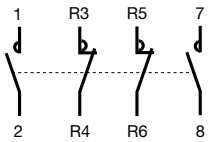

These contactors are suitable for controlling 2 separate circuits, i.e. 2 loads with 2 separate supplies, or 1 circuit comprising 2 separate loads with a single supply (see diagrams below). When the contactor operates there is no mechanical overlapping between the N.O. poles and the N.C. poles: BREAK before MAKE.



These contactors are not suitable for a reversing starter or for controlling a single load from 2 separate supplies.

Block diagrams

– Single supply and 2 separate loads

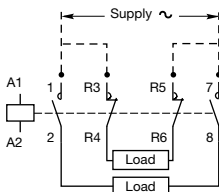

– 2 separate supplies and 2 separate loads

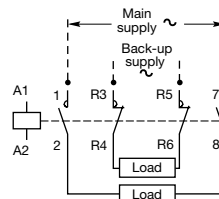

A45 ... A75 4-pole contactors

Technical data

General technical data

Contactor types	AC operated	A45	A50	A75
Rated insulation voltage U_i acc. to IEC 60947-4-1 acc. to UL / CSA		1000 V 600 V		
Rated impulse withstand voltage U_{imp}		8 kV		
Ambient air temperature close to contactor Operation in free air Storage		-40...+70 °C -60...+80 °C		
Climatic withstand		acc. to IEC 60068-2-30 and 60068-2-11 - UTE C 63-100 specification II		
Maximum operating altitude (without derating)		3000 m		
Mechanical durability Number of operating cycles Max. switching frequency		10 millions operating cycles 3600 cycles/h		
Shock withstand acc. to IEC 60068-2-27 and EN 60068-2-27 Mounting position 1				
	Shock direction	1/2 sinusoidal shock for 11 ms: no change in contact position, closed or open position		
	A	20 g		
	B1	10 g closed position / 5 g open position		
	B2	15 g		
	C1	20 g		
	C2	20 g		

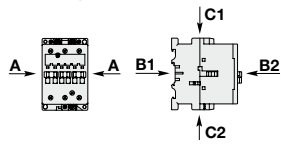

Remark for 4-pole contactors fitted with 2 N.O. + 2 N.C. main poles

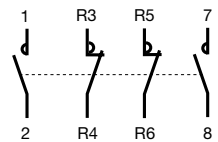

These contactors are suitable for controlling 2 separate circuits, i.e. 2 loads with 2 separate supplies, or 1 circuit comprising 2 separate loads with a single supply (see diagrams below). When the contactor operates there is no mechanical overlapping between the N.O. poles and the N.C. poles: BREAK before MAKE.



These contactors are not suitable for a reversing starter or for controlling a single load from 2 separate supplies.

Block diagrams

– Single supply and 2 separate loads

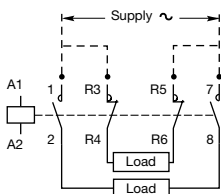



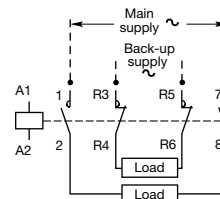







– 2 separate supplies and 2 separate loads



A9 ... A26 4-pole contactors

Technical data

Connecting characteristics











Contactor types	AC operated	A9	A16	A26
Main terminals		 Screw terminals with cable clamp		
Connection capacity (min. ... max.)				
Main conductors (poles)				
 Rigid	Solid ($\leq 4 \text{ mm}^2$)	} 1 x 1...4 mm ² 2 x 1...4 mm ²	1.5...6 mm ²	
 Stranded ($\geq 6 \text{ mm}^2$)			1.5...6 mm ²	
 Flexible with ferrule		1 x 0.75...2.5 mm ²	0.75...4 mm ²	
 Flexible with ferrule		2 x 0.75...2.5 mm ²	0.75...4 mm ²	
 Bars or lugs		L < 7.7 mm	10 mm	
		l < 3.7 mm	4.2 mm	
Connection capacity acc. to UL / CSA		1 or 2 x AWG 18...10	AWG 12...8	
Tightening torque		Recommended	1 Nm / 9 lb.in	
		Max.	1.2 Nm	
Auxiliary conductors (coil terminals)				
 Rigid solid		1 x 1...4 mm ²		
 Rigid solid		2 x 1...4 mm ²		
 Flexible with ferrule		1 x 0.75...2.5 mm ²		
 Flexible with ferrule		2 x 0.75...2.5 mm ²		
 Lugs		L < 7.7 mm	(1)	
		l < 3.7 mm	(1)	
Connection capacity acc. to UL / CSA		1 or 2 x AWG 18...14		
Tightening torque		Recommended	1 Nm / 9 lb.in	
		Max.	1.2 Nm	
Degree of protection				
acc. to IEC 60947-1 / EN 60947-1 and IEC 60529 / EN 60529				
Main terminals		IP20		
Coil terminals		IP20		
Screw terminals				
Main terminals		Delivered in open position, screws of unused terminals must be tightened		
		M3.5	M4	
		Screwdriver type	Flat Ø 5.5 / Pozidriv 2	
Coil terminals		M3.5		
		Screwdriver type	Flat Ø 5.5 / Pozidriv 2	

(1) L ≤ 8 and l > 3.7 for coil terminals - L ≤ 10 and l > 4.2 for built-in auxiliary terminals.

A45 ... A75 4-pole contactors

Technical data

Connecting characteristics

Contactor types	AC operated	A45	A50	A75
Main terminals				
		Screw terminals with single connector (13 x 10 mm)		
Connection capacity (min. ... max.)				
Main conductors (poles)				
 Rigid Solid ($\leq 4 \text{ mm}^2$)	}	1 x	6...50 mm ²	
 Stranded ($\geq 6 \text{ mm}^2$)		2 x	6...25 mm ²	
 Flexible with ferrule		1 x	6...35 mm ²	
 Flexible with ferrule		2 x	6...16 mm ²	
 Bars or lugs		L <	-	
		I <	-	
Connection capacity acc. to UL / CSA		1 or 2 x	AWG 8...1	
Tightening torque	Recommended		4.00 Nm / 35 lb.in	
	Max.		4.50 Nm	
Auxiliary conductors (coil terminals)				
 Rigid solid		1 x	1...4 mm ²	
 Rigid solid		2 x	1...4 mm ²	
 Flexible with ferrule		1 x	1...2.5 mm ²	
 Flexible with ferrule		2 x	0.75...2.5 mm ²	
 Lugs		L <	8 mm	
		I <	3.7 mm	
Connection capacity acc. to UL / CSA		1 or 2 x	AWG 18...14	
Tightening torque	Recommended		1.00 Nm / 9 lb.in	
	Max.		1.20 Nm	
Degree of protection acc. to IEC 60947-1 / EN 60947-1 and IEC 60529 / EN 60529				
Main terminals			IP10	
Coil terminals			IP20	
Screw terminals			Delivered in open position, screws of unused terminals must be tightened	
Main terminals			M6	
	Screwdriver type		Flat Ø 6.5 / Pozidriv 2	
Coil terminals			M3.5	
	Screwdriver type		Flat Ø 5.5 / Pozidriv 2	

A9 ... A75 4-pole contactors

Terminal marking and positioning

A9 ... A75 contactors - AC operated

Standard devices without addition of auxiliary contacts

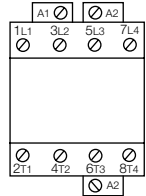

A9 ... A75-40-00

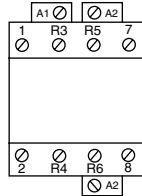

A9 ... A75-22-00

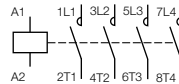

A9 ... A75-40-00

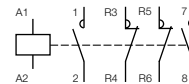

A9 ... A75-22-00

N 4-pole contactor relays

AC operated



N40E

Description

N contactor relays are used for switching auxiliary circuits and control circuits.

These contactor relays are of the block type design with:

- 4 poles. Contactor relays have mechanically linked auxiliary contact elements
- control circuit: AC operated
- add-on auxiliary contact blocks for front or side mounting and a wide range of accessories.

Ordering details

Number of contacts	Rated control circuit voltage U _c (1)		Type	Order code	Weight Pkg (1 pce) kg
	V 50 Hz	V 60 Hz			
	24	24	N22E	1SBH141001R8122	0.340
	48	48	N22E	1SBH141001R8322	0.340
	110	110...120	N22E	1SBH141001R8422	0.340
	220...230	230...240	N22E	1SBH141001R8022	0.340
	230...240	240...260	N22E	1SBH141001R8822	0.340
	380...400	400...415	N22E	1SBH141001R8522	0.340
400...415	415...440	N22E	1SBH141001R8622	0.340	
	24	24	N31E	1SBH141001R8131	0.340
	48	48	N31E	1SBH141001R8331	0.340
	110	110...120	N31E	1SBH141001R8431	0.340
	220...230	230...240	N31E	1SBH141001R8031	0.340
	230...240	240...260	N31E	1SBH141001R8831	0.340
	380...400	400...415	N31E	1SBH141001R8531	0.340
400...415	415...440	N31E	1SBH141001R8631	0.340	
	24	24	N40E	1SBH141001R8140	0.340
	48	48	N40E	1SBH141001R8340	0.340
	110	110...120	N40E	1SBH141001R8440	0.340
	220...230	230...240	N40E	1SBH141001R8040	0.340
	230...240	240...260	N40E	1SBH141001R8840	0.340
	380...400	400...415	N40E	1SBH141001R8540	0.340
400...415	415...440	N40E	1SBH141001R8640	0.340	

(1) Other control voltages see voltage code table.

Main dimensions mm, inches

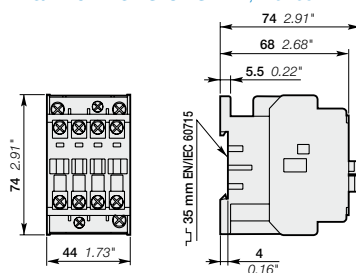

N22E, N31E, N40E

N 4-pole contactor relays

Main accessories

Contactor and main accessories (other accessories available)

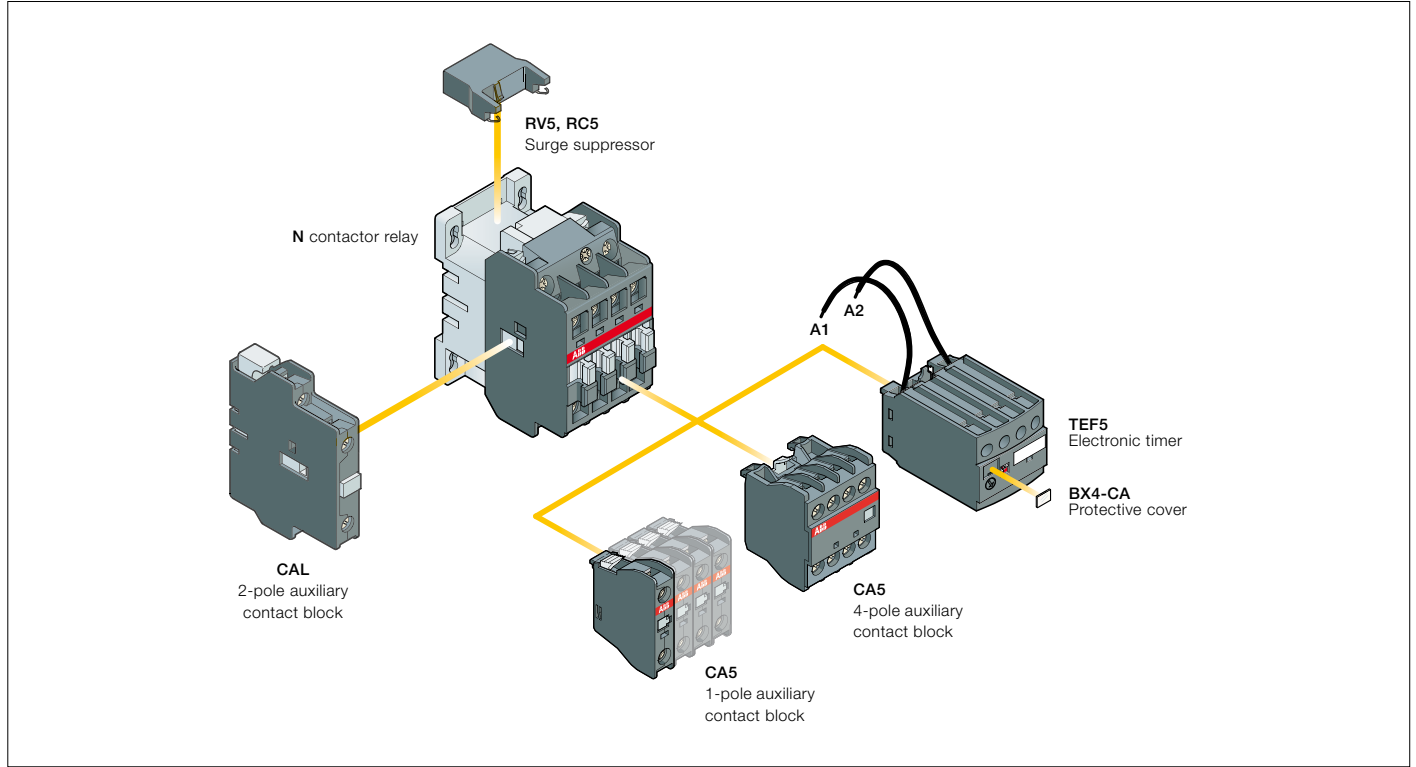

Main accessory fitting details

Many configurations of accessories are possible depending on whether these are front-mounted or side-mounted.

Contactor types	Main poles	Front-mounted accessories			Side-mounted accessories
		Auxiliary contact blocks		Electronic timer	Auxiliary contact blocks
		1-pole CA5	4-pole CA5	TEF5	2-pole CAL5-11
N	2 2 E (1) 3 1 E (1) 4 0 E	1 to 4 x CA5	or 1 x CA5 (4-pole)	or 1 x TEF5	+ 1 to 2 x CAL5-11

(1) 2 N.C. front mounted auxiliary contacts maximum in mounting position 5.

N 4-pole contactor relays

Main accessories



CA5-10



CAL5-11



TEF5-OFF



RV5/50

Ordering details (1)

For contactors	Auxiliary contacts	Type	Order code	Pkg qty	Weight (1 pce)
					kg

Front-mounted instantaneous auxiliary contact blocks

4-pole N	1 -	CA5-10	1SBN010010R1010	10	0.014
	- 1	CA5-01	1SBN010010R1001	10	0.014
	2 2	CA5-22N	1SBN010040R1222	2	0.060

Side-mounted instantaneous auxiliary contact block

N	1 1	CAL5-11	1SBN010020R1011	2	0.050
---	-----	---------	-----------------	---	-------

For contactors	Time delay range selected by switch	Delay type	Auxiliary contacts	Type	Order code	Pkg qty	Weight (1 pce)
							kg

Electronic timers

4-pole N	0.1...1 s 1...10 s 10...100 s	ON-delay	1 1	TEF5-ON	1SBN020312R1000	1	0.065
		OFF-delay	1 1	TEF5-OFF	1SBN020314R1000	1	0.065

Note: Rated control circuit voltage U_c 24...240 V 50/60 Hz or DC.

For contactors	Rated control circuit voltage U_c		Type	Order code	Pkg qty	Weight (1 pce)
	V	AC DC				

Surge suppressors

N	24...50	● ●	RV5/50	1SBN050010R1000	2	0.015
	50...133	● ●	RV5/133	1SBN050010R1001	2	0.015
	110...250	● ●	RV5/250	1SBN050010R1002	2	0.015
	250...440	● ●	RV5/440	1SBN050010R1003	2	0.015
N	24...50	● -	RC5-1/50	1SBN050100R1000	2	0.012
	50...133	● -	RC5-1/133	1SBN050100R1001	2	0.012
	110...250	● -	RC5-1/250	1SBN050100R1002	2	0.012
	250...440	● -	RC5-1/440	1SBN050100R1003	2	0.012

(1) See "Main accessory fitting details" table.

N contactor relays

Technical data

Contact utilization characteristics according to IEC

Contact relay types	AC operated	N
Standards		IEC 60947-1 / 60947-5-1 and EN 60947-1 / 60947-5-1
Rated operational voltage U_e max.		690 V
Rated frequency (without derating)		50 / 60 Hz
Conventional free-air thermal current I_{th} θ ≤ 40 °C		16 A
I_e / Rated operational current AC-15		
acc. to IEC 60947-5-1	24-127 V 50/60 Hz	6 A
	230-240 V 50/60 Hz	4 A
	400-415 V 50/60 Hz	3 A
	500 V 50/60 Hz	2 A
	690 V 50/60 Hz	2 A
Rated making capacity AC-15		10 x I _e AC-15 acc. to IEC 60947-5-1
Rated breaking capacity AC-15		10 x I _e AC-15 acc. to IEC 60947-5-1
I_e / Rated operational current DC-13		
acc. to IEC 60947-5-1	24 V DC	6 A / 144 W
	48 V DC	2.8 A / 134 W
	72 V DC	1 A / 72 W
	110 V DC	0.55 A / 60 W
	125 V DC	0.55 A / 69 W
	220 V DC	0.30 A / 66 W
	250 V DC	0.30 A / 75 W
Short-circuit protection device for contactors		
U _e ≤ 500 V AC - gG type fuse		10 A
Rated short-time withstand current I_{cw}		
at 40 °C ambient temperature, in free air from a cold state	for 1.0 s	100 A
	for 0.1 s	140 A
Minimum switching capacity		17 V / 5 mA
with failure rate acc. to IEC 60947-5-4		10 ⁶
Non-overlapping time between N.O. and N.C. contacts		≥ 2 ms
Power dissipation per pole at 6 A		0.1 W
Max. electrical switching frequency	AC-15	1200 cycles/h

Contact utilization characteristics according to UL / CSA

Contact relay types	AC operated	N
Standards		UL 508, CSA C22.2 N°14
Max. operational voltage		600 V AC
Pilot duty		A600, Q300

General technical data

Contact relay types	AC operated	N
Rated insulation voltage U_i		
acc. to IEC 60947-5-1		690 V
acc. to UL / CSA		600 V
Rated impulse withstand voltage U_{imp}.		8 kV
Ambient air temperature		
Operation in free air		-40...+70 °C
Storage		-60...+80 °C
Climatic withstand		acc. to IEC 60068-2-30 and 60068-2-11 - UTE C 63-100 specification II
Maximum operating altitude (without derating)		3000 m
Mechanical durability		
Number of operating cycles		≥ 20 millions operating cycles
Max. switching frequency		6000 cycles/h
Shock withstand		
acc. to IEC 60068-2-27 and EN 60068-2-27		
Mounting position 1		
	Shock direction	1/2 sinusoidal shock for 11 ms: no change in contact position, closed or open position
	A	20 g
	B1	5 g
	B2	15 g
	C1	20 g
	C2	20 g

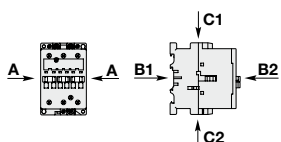

N contactor relays

Technical data

Magnet system characteristics

Contactor relay types	AC operated	N	
Coil operating limits acc. to IEC 60947-4-1	AC supply	at $\theta \leq 55\text{ °C}$ 0.85...1.1 x Uc Please also refer to "Mounting characteristics and conditions for use"	
AC control voltage 50/60 Hz			
Rated control circuit voltage Uc	at 50 Hz	24...690 V	
	at 60 Hz	24...690 V	
Coil consumption	Average pull-in value	50 Hz	70 VA
		60 Hz	80 VA
	50/60 Hz (1)	74 VA / 70 VA	
Average holding value	50 Hz	8 VA / 2 W	
	60 Hz	8 VA / 2 W	
	50/60 Hz (1)	8 VA / 2 W	
Drop-out voltage		approx. 40...65 % of Uc	
Operating time			
Between coil energization and:	N.O. contact closing	10...26 ms	
	N.C. contact opening	7...21 ms	
Between coil de-energization and:	N.O. contact opening	4...11 ms	
	N.C. contact closing	9...16 ms	

(1) 50/60 Hz coils: see "Coil voltage code table".

Mounting characteristics and conditions for use

Contactor relay types	AC operated	N
Mounting positions		
Control voltage / Ambient temperature		
Mounting positions	1, 1±30°, 2, 3, 4, 5	at $\theta \leq 55\text{ °C}$ 0.85...1.1 x Uc
		at $\theta \leq 70\text{ °C}$ Uc
	6	at $\theta \leq 55\text{ °C}$ 0.95...1.1 x Uc
		> 55 °C unauthorized
Mounting distances		The contactors can be assembled side by side
Fixing		
On rail according to IEC 60715, EN 60715		35 x 7.5 mm or 35 x 15 mm
By screws (not supplied)		2 x M4 screws placed diagonally

Connecting characteristics

Contactor relay types	AC operated	N	
Main terminals	<p>Screw terminals with cable clamp</p>		
Connection capacity (min. ... max.)			
Main conductors (poles)	Rigid	1 x	1...4 mm ²
		2 x	1...4 mm ²
Flexible with ferrule	1 x	0.75...2.5 mm ²	
	2 x	0.75...2.5 mm ²	
Bars or lugs	Pole terminals	L <	7.7 mm
		I <	3.7 mm
	Coil terminals	L <	8 mm
		I <	3.7 mm
Connection capacity acc. to UL / CSA	1 or 2 x	AWG 18...14	
Tightening torque	Recommended	1 Nm / 9 lb.in	
	Max.	1.20 Nm	
Degree of protection acc. to IEC 60947-1 / EN 60947-1 and IEC 60529 / EN 60529		IP20	
All terminals		Delivered in open position, screws of unused terminals must be tightened	
Screw terminals		M3.5	
All terminals	Screwdriver type	Flat Ø 5.5 / Pozidriv 2	

N 4-pole contactor relays

Terminal marking and positioning

N contactor relays - AC operated

Standard devices without addition of auxiliary contacts

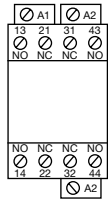

N22E

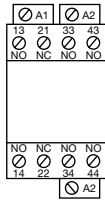

N31E

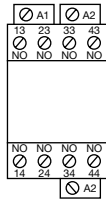

N40E

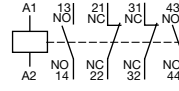

N22E

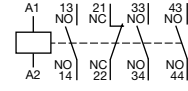

N31E

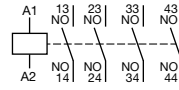

N40E

3

Other possible contact combinations with auxiliary contacts added by the user

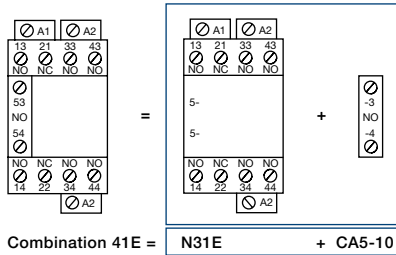

Combination 41E =

N31E + CA5-10

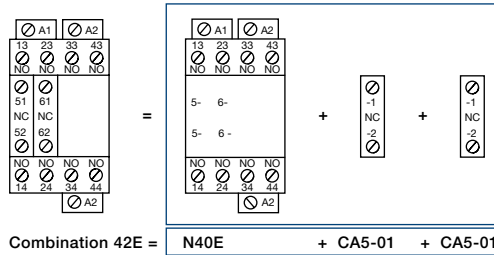

Combination 42E =

N40E + CA5-01 + CA5-01

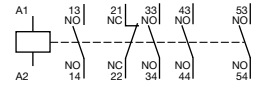

Combination 41E

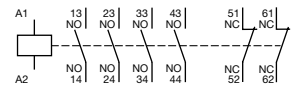

Combination 42E

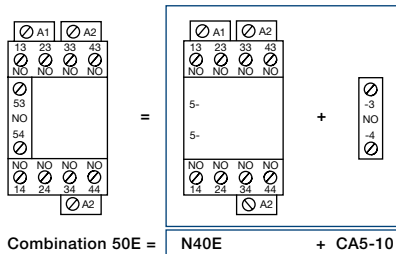

Combination 50E =

N40E + CA5-10

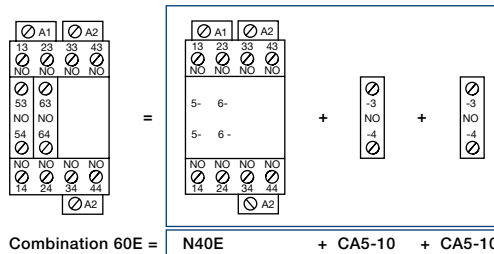

Combination 60E =

N40E + CA5-10 + CA5-10

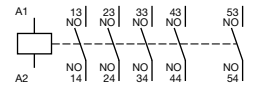

Combination 50E

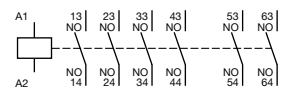

Combination 60E

Notes

A series of horizontal dotted lines for writing notes, spanning the width of the page.

Auxiliary contact blocks



CA5-10

3



CA5-40E



CAL5-11



CAL18-11

Description

The auxiliary contact blocks are used for the operation of auxiliary circuits and control circuits for standard industrial environments.

Types of auxiliary contact blocks for front mounting:

- CA5 1 or 4-pole block, instantaneous with N.O., N.C. contacts
- CC5 1-pole block, with N.O. leading contact or N.C. lagging contact.

Select the 4-pole auxiliary contact blocks CA5 type, according to the contactor type for compliance with the standard requirements (see "Terminal marking and positioning").

Types of auxiliary contact blocks for side mounting:

- CAL 2-pole block instantaneous N.O. + N.C. contacts.

For clipping onto the right- and/or left-hand side of the contactors.

The CAL18-11B is a second block for mounting in addition to a first CAL18-11 block, right- and/or left-hand of the A145 ... A300 contactors.

The auxiliary contact blocks are equipped with screw type connecting terminals delivered open, protected against accidental direct contact and bear the corresponding function marking.

Ordering details (1)

For contactors	Auxiliary contacts	Type	Order code	Pkg qty	Weight (1 pce)
					kg
Front-mounted instantaneous auxiliary contact blocks, 1-pole					
A9 ... A110	1 0	– –	CA5-10	1SBN010010R1010	10 0.014
N 4-pole	0 1	– –	CA5-01	1SBN010010R1001	10 0.014
	– –	1 0	CC5-10	1SBN010011R1010	10 0.014
	– –	0 1	CC5-01	1SBN010011R1001	10 0.014
Front-mounted instantaneous auxiliary contact blocks, 4-pole					
A9 ... A26-40-00	2 2	– –	CA5-22E	1SBN010040R1022	2 0.060
A9 ... A26-22-00	3 1	– –	CA5-31E	1SBN010040R1031	2 0.060
A45 ... A110	4 0	– –	CA5-40E	1SBN010040R1040	2 0.060
	0 4	– –	CA5-04E	1SBN010040R1004	2 0.060
	1 1	1 1	CA5-11/11E	1SBN010040R1018	2 0.060
A9 ... A40-30-10	2 2	– –	CA5-22M	1SBN010040R1122	2 0.060
	3 1	– –	CA5-31M	1SBN010040R1131	2 0.060
	1 3	– –	CA5-13M	1SBN010040R1113	2 0.060
	0 4	– –	CA5-04M	1SBN010040R1104	2 0.060
	1 1	1 1	CA5-11/11M	1SBN010040R1118	2 0.060
A9 ... A40-30-01	2 2	– –	CA5-22U	1SBN010040R1322	2 0.060
	3 1	– –	CA5-31U	1SBN010040R1331	2 0.060
	4 0	– –	CA5-40U	1SBN010040R1340	2 0.060
	0 4	– –	CA5-04U	1SBN010040R1304	2 0.060
N 4-pole	2 2	– –	CA5-22N	1SBN010040R1222	2 0.060
	3 1	– –	CA5-31N	1SBN010040R1231	2 0.060
	1 3	– –	CA5-13N	1SBN010040R1213	2 0.060
	0 4	– –	CA5-04N	1SBN010040R1204	2 0.060
	4 0	– –	CA5-40N	1SBN010040R1240	2 0.060
Side-mounted instantaneous auxiliary contact blocks, 2-pole					
A9 ... A75	1 1	– –	CAL5-11	1SBN010020R1011	2 0.050
N	– –	1 1	CCL5-11	1SBN011421R1008	2 0.050
A9 ... A16	– –	1 1	CCL5-11	1SBN011421R1008	2 0.050
N	– –	1 1	CCL5-11	1SBN011421R1008	2 0.050
A95 ... A300	1 1	– –	CAL18-11	1SFN010720R1011	2 0.050
A145 ... A300 (2)	1 1	– –	CAL18-11B	1SFN010720R3311	2 0.050

Side-mounted instantaneous auxiliary contact blocks, 2-pole

A9 ... A75	1 1	– –	CAL5-11	1SBN010020R1011	2 0.050
N	– –	1 1	CCL5-11	1SBN011421R1008	2 0.050
A9 ... A16	– –	1 1	CCL5-11	1SBN011421R1008	2 0.050
N	– –	1 1	CCL5-11	1SBN011421R1008	2 0.050
A95 ... A300	1 1	– –	CAL18-11	1SFN010720R1011	2 0.050
A145 ... A300 (2)	1 1	– –	CAL18-11B	1SFN010720R3311	2 0.050

(1) For each contactor type, refer to "Accessory fitting details" table.

(2) 2 blocks CAL18-11 + 2 blocks CAL18-11B.

Auxiliary contact blocks

Technical data

Types	Front mounted 1-pole CA5 , 1-pole CC5 , 4-pole CA5	Side mounted CAL5-11, CCL5-11	CAL18-11, CAL18-11B
-------	--	--	----------------------------



Contact utilization characteristics according to IEC

Standards	IEC 60947-5-1 and EN 60947-5-1		
Rated insulation voltage U_i acc. to IEC 60947-5-1	690 V		
Rated operational voltage U_e max. 24...690 V AC	24...690 V AC		
Conventional thermal current I_{th} - $\theta \leq 40^\circ\text{C}$ I_e / Rated operational current AC-15 acc. to IEC 60947-5-1	16 A		
	24-127 V 50/60 Hz	6 A	
	220-240 V 50/60 Hz	4 A	
	380-440 V 50/60 Hz	3 A	
	500-690 V 50/60 Hz	2 A	
Making capacity	10 x I_e AC-15 acc. to IEC 60947-5-1		
Breaking capacity I_e / Rated operational current DC-13 acc. to IEC 60947-5-1	10 x I_e AC-15 acc. to IEC 60947-5-1		
	24 V DC	6 A / 144 W	
	48 V DC	2.8 A / 134 W	
	72 V DC	1 A / 72 W	
	110 V DC	0.55 A / 60 W	
	125 V DC	0.55 A / 69 W	
	220 V DC	0.3 A / 66 W	
	250 V DC	0.3 A / 75 W	
Short-circuit protection device gG type fuse	10 A		
Rated short-time withstand current I_{cw} $\theta = 40^\circ\text{C}$	for 1.0 s	100 A	
	for 0.1 s	140 A	
Minimum switching capacity			
A40 ... A75 contactors with failure rate acc. to IEC 60947-5-4	17 V / 1 mA		-
	$\leq 10^{-7}$		-
A95 ... A110 contactors with failure rate acc. to IEC 60947-5-4	24 V / 50 mA		24 V / 50 mA (0.5 million of operating cycles)
	-	-	$\leq 10^{-6}$
Power dissipation per pole at 6 A	0.1 W		0.15 W
Mechanical durability			
Number of operating cycles	10 millions (A9 ... A75) 3 millions (A95 ... A110)	10 millions	5 millions (A95 ... A185) 3 millions (A210 ... A300)
Max. switching frequency	3600 cycles/h		
Electrical durability			
Number of operating cycles	see "Electrical durability" curves		
Max. switching frequency	AC-15	1200 cycles/h	
	DC-13	900 cycles/h	

Contact utilization characteristics according to UL / CSA

Standards	UL 508, CSA C22.2 N°14
Max. operational voltage	600 V AC, 250 V DC
Pilot duty	A600, Q300
AC thermal rated current	10 A

Connecting characteristics

Connection capacity (min. ... max.)			
 Rigid solid	1 x	1...4 mm ²	
	2 x	1...4 mm ²	
 Flexible with ferrule	1 x	0.75...2.5 mm ²	
	2 x	0.75...2.5 mm ²	
 Lugs	L ≤	7.7 mm	8 mm
	I >	3.7 mm	3.7 mm
Connection capacity acc. to UL / CSA	1 or 2 x	AWG 18...14	
Tightening torque	1 Nm / 9 lb.in		
Degree of protection	Terminals	IP20	
acc. to IEC 60947-1 / EN 60947-1 and IEC 60529 / EN 60529			
Screw terminals	Delivered in open position, screws of unused terminals must be tightened		
All terminals	M3.5		
Screwdriver type	Flat Ø 5.5 / Pozidriv 2		

Add-on auxiliary contacts

Terminal marking and positioning

1-pole auxiliary contacts

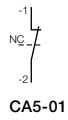

CA5-01

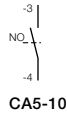

CA5-10



CC5-01

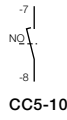

CC5-10

3

2-pole auxiliary contacts

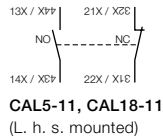

CAL5-11, CAL18-11
(L. h. s. mounted)

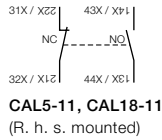

CAL5-11, CAL18-11
(R. h. s. mounted)

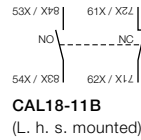

CAL18-11B
(L. h. s. mounted)

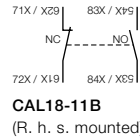

CAL18-11B
(R. h. s. mounted)

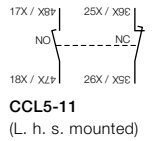

CCL5-11
(L. h. s. mounted)

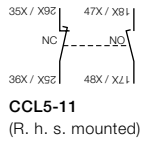

CCL5-11
(R. h. s. mounted)

4-pole auxiliary contacts

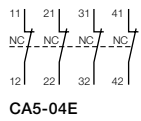

CA5-04E

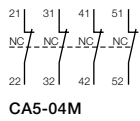

CA5-04M

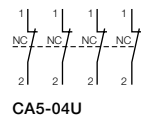

CA5-04U

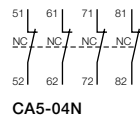

CA5-04N

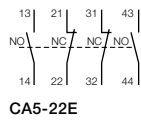

CA5-22E

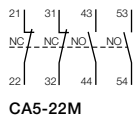

CA5-22M

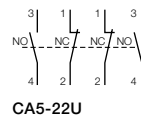

CA5-22U

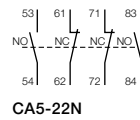

CA5-22N

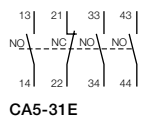

CA5-31E

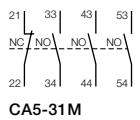

CA5-31M

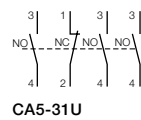

CA5-31U

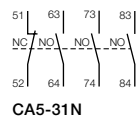

CA5-31N

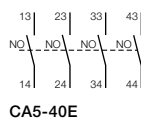

CA5-40E

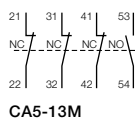

CA5-13M

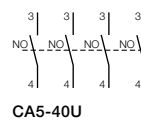

CA5-40U

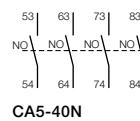

CA5-40N

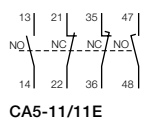

CA5-11/11E

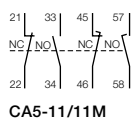

CA5-11/11M

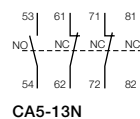

CA5-13N

Electronic timers



TEF5-OFF

1SBC101386F0014

Description

TEF5 frontal electronic timers are used for realizing timing function and are available in ON-delay and OFF-delay versions.

Compact solution in cabinet compared to separate timers

TEF5 electronic timers are front-mounted and locked on A contactors or N contactor relays. A mechanical indicator allows to show the state of the contactor.

TEF5 electronic timers are supplied by direct wiring to the coil terminals A1 - A2 of the contactor or contactor relay. A varistor is integrated on the timer to offer a built-in protection against surges in the contactor coil.

Available for a wide control voltage range 24...240 V AC / DC

TEF5-ON or TEF5-OFF allow time-delayed functions up to 100 s in 3 distinct time ranges, independently of the control system. The time delay ranges are selected by a switch and the time delay can be adjusted by means of a rotary switch. The timing function is activated by closing or opening the device on which the timer is mounted. The OFF-delay version operates without additional control supply.

Ordering details

For contactors, contactor relays	Time delay range selected by switch	Delay type	Rated control circuit voltage U_c V 50/60 Hz or DC	Auxiliary contacts 	Type	Order code	Weight Pkg (1 pce) kg
A9 ... A75 N	0.1...1 s 1...10 s 10...100 s	ON-delay	24...240	1 1	TEF5-ON	1SBN020312R1000	0.065
		OFF-delay	24...240	1 1	TEF5-OFF	1SBN020314R1000	0.065

Electronic timers

Technical data

Contact utilization characteristics according to IEC

Types	TEF5-ON	TEF5-OFF
Standards	IEC 60947-5-1 and EN 60947-5-1	
Rated insulation voltage U_i	400 V	
acc. to IEC 60947-5-1		
Rated impulse withstand voltage U_{imp}	4 kV	
Rated operational voltage U_e max.	240 V	
Rated frequency (without derating)	50 / 60 Hz	
Conventional thermal current $I_{th} - \theta \leq 40^\circ\text{C}$	5 A	
I_e / Rated operational current AC-15		
acc. to IEC 60947-5-1	24-127 V 50/60 Hz	3 A
	220-240 V 50/60 Hz	1.5 A
Making capacity	10 x I_e AC-15 acc. to IEC 60947-5-1	
Breaking capacity	10 x I_e AC-15 acc. to IEC 60947-5-1	
I_e / Rated operational current DC-13		
acc. to IEC 60947-5-1	24 V DC	1 A / 24 W
Short-circuit protection device gG type fuse	6 A	
Rated short-time withstand current I_{cw}		
$\theta = 40^\circ\text{C}$	for 1.0 s	8 A
	for 0.1 s	8 A
Minimum switching capacity	12 V / 3 mA	
with failure rate acc. to IEC 60947-5-4	24 V DC	10^{-7}
Power dissipation per pole at 3 A	0.1 W	
Function diagram	ON-delay	OFF-delay
	Bistable relay inside. Before use, once apply U_c then switch it off in order to initialize position of the contacts.	
Control circuit voltage		
AC control voltage	Rated control circuit voltage U_c	24...240 V AC
50/60 Hz	Average consumption	1.5 mA RMS
		1 mA RMS
DC control voltage	Rated control circuit voltage U_c	24...240 V DC
	Average consumption	1.5 mA
		1 mA
Rated frequency limits	50 / 60 Hz	
Supply voltage range	0.85...1.1 x U_c (at $\theta \leq 70^\circ\text{C}$)	
Overvoltage protection	Varistor included	
Time delay range (t) selected by switch	0.1...1 s	<input type="checkbox"/>
	1...10 s	<input type="checkbox"/>
	10...100 s	<input type="checkbox"/>
On-load reiteration accuracy under constant conditions	$\leq 1\%$	
Minimum ON period	0.1 s	
Recovery time	0.15 s	
	0.1 s	
Ambient air temperature	Operation	-25 °C ... +70 °C
	Storage	-40 °C ... +80 °C
Climatic withstand	Category B according to IEC 60947-1 Annex Q	
Maximum operating altitude	2000 m	
Mounting positions	Acc. to mounting positions permitted on contactors or contactor relays	
Shock withstand	1/2 sinusoidal shock for 11 ms: no change in contact position	
acc. to IEC 60068-2-27 and EN 60068-2-27	Same as contactor or contactor relay	
(Mounting position 1)		
Mechanical durability		
	Number of operating cycles	5 millions operating cycles
	Max. switching frequency	3600 cycles/h
		1800 cycles/h
Max. electrical switching frequency		
	AC-15	1200 cycles/h
	DC-13	900 cycles/h

Electronic timers





Technical data

Contact utilization characteristics according to UL / CSA

Types	TEF5-ON	TEF5-OFF
Standards	UL 508, CSA C22.2 N°14	
Rated insulation voltage Ui	300 V	
acc. to UL / CSA	240 V	
Max. operational voltage	B300, R300	
Pilot duty	5 A	
AC thermal rated current	3600 VA	
AC maximum volt-ampere making	360 VA	
AC maximum volt-ampere breaking	1 A	
DC thermal rated current	28 VA	
DC maximum volt-ampere making-breaking		

3

Connecting characteristics

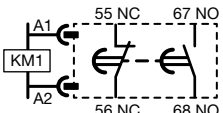
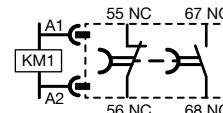
Connection capacity (min. ... max.)		
 Rigid solid	1 x	1...2.5 mm ²
	2 x	1...2.5 mm ²
 Flexible with non insulated ferrule	1 x	0.75...2.5 mm ²
	2 x	0.75...2.5 mm ²
 Flexible with insulated ferrule	1 x	0.75...2.5 mm ²
	2 x	0.75...1.5 mm ²
 Lugs	L ≤	8 mm
	L >	3.7 mm
Connection capacity acc. to UL / CSA	1 or 2 x	AWG 18...14
Stripping length		10 mm
Tightening torque		1 N.m / 9 lb.in
Degree of protection		IP20
acc. to IEC 60947-1 / EN 60947-1 and IEC 60529 / EN 60529		
Screw terminals		Delivered in open position, screws of unused terminals should be tightened
All terminals		M3.5
Screwdriver type		Flat Ø 5.5 / Pozidriv 2
Terminal Marking		

Mechanical and electrical interlock units



1SBC580411F0301

VM300H

Description

When mounted between two contactors, the mechanical interlock unit prevents one of the contactors from closing as long as the other contactor is closed.

- VM interlock units for mechanical interlocking of two horizontal or vertical mounted AC or DC operated contactors
- VE interlock units for mechanical and electrical interlocking of two horizontal mounted AC or DC operated contactors.

Ordering details (1)

Left side contactor	Right side contactor	Mounting	Type	Order code	Pkg qty	Weight (1 pce) kg
---------------------	----------------------	----------	------	------------	---------	-------------------

Mechanical interlock units for two horizontal mounted contactors (2)

A9 ... A40	A9 ... A40	Rail mounting or mounting plate to be ordered separately (3)	VM5-1	1SBN030100R1000	1	0.066
A9 ... A40	A45 ... A110	See table below with VE5 type	–	–	–	–
A45 ... A75	A45 ... A110	–	–	–	–	–
A95 ... A185	A45 ... A110	–	–	–	–	–
A95 ... A185	A145 ... A300	Additional plate (not supplied)	VM300H	1SFN034700R1000	1	0.150
A210 ... A300	A145 ... A300	–	VM300H	1SFN034700R1000	1	0.150

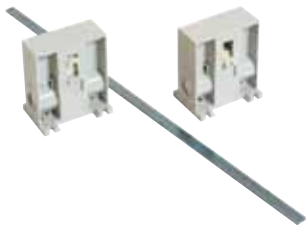

1SBC580411F0301

VM300V

Up contactor	Down contactor	Mounting	Type	Order code	Pkg qty	Weight (1 pce) kg
--------------	----------------	----------	------	------------	---------	-------------------

Mechanical interlock units for two vertical mounted contactors (4)

A95 ... A185	A145 ... A300	Additional plate (not supplied)	VM300V	1SFN034701R1000	1	0.150
A210 ... A300	A145 ... A300	–	VM300V	1SFN034701R1000	1	0.150



1SBC572822F0301

VE5-1

Left side contactor	Right side contactor	Mounting	Type	Order code	Pkg qty	Weight (1 pce) kg
---------------------	----------------------	----------	------	------------	---------	-------------------

Mechanical and electrical interlock units for two horizontal mounted contactors

A9 ... A40	A9 ... A40	Rail mounting or mounting plate to be ordered separately (3)	VE5-1	1SBN030110R1000	1	0.076
A30 ... A75	A45 ... A75	–	VE5-2	1SBN030210R1000	1	0.146
A45 ... A75	A30 ... A75	–	VE5-2	1SBN030210R1000	1	0.146
A45 ... A75	A95 ... A110	Additional plate (not supplied)	VE5-2 (5)	1SBN030210R1000	1	0.146
A95 ... A110	A45 ... A75	–	VE5-2 (5)	1SBN030210R1000	1	0.146
A95 ... A110	A95 ... A110	–	VE5-2	1SBN030210R1000	1	0.146

(1) For each contactor type, refer to "Accessory fitting details".

(2) Mechanical durability: VM5-1 = 5 millions cycles, VM300H = 1 million cycles.

(3) Rail mounting for: 2 x A9 ... A40 contactors only
2 x A30, A40 contactors + MMS.

PM26-23 mounting plate for: 2 x A9 ... A26 contactors + MMS.

(4) Mechanical durability: VM300V = 1 million cycles.

(5) The combination of A45 ... A75 contactors interlocked with A95, A110 contactors cannot be mounted on symmetrical rail (75 mm, IEC/EN 60715).

Mechanical and electrical interlock units

Technical data

Types	VE5-1	VE5-2
-------	-------	-------



Contact utilization characteristics according to IEC

Standards	IEC 60947-5-1 and EN 60947-5-1	
Rated insulation voltage U_i acc. to IEC 60947-5-1	690 V	
Rated operational voltage U_e max.	24...690 V	
Conventional thermal current I_{th} - $\theta \leq 40$ °C	16 A	
le / Rated operational current AC-15 acc. to IEC 60947-5-1	24-127 V 50/60 Hz	6 A
	220-240 V 50/60 Hz	4 A
	380-440 V 50/60 Hz	3 A
	500-690 V 50/60 Hz	2 A
Making capacity	10 x I_e AC-15 acc. to IEC 60947-5-1	
Breaking capacity	10 x I_e AC-15 acc. to IEC 60947-5-1	
le / Rated operational current DC-13 acc. to IEC 60947-5-1	24 V DC	6 A
	48 V DC	2.8 A
	72 V DC	1 A
	125 V DC	0.55 A
	250 V DC	0.3 A
Short-circuit protection device - gG type fuse	10 A	
Rated short-time withstand current I_{sw} $\theta = 40$ °C	for 1.0 s	100 A
	for 0.1 s	140 A
Power dissipation per pole at 6 A	0.15 W	
Mechanical durability	5 millions operating cycles	
Number of operating cycles	5 millions operating cycles	
Max. switching frequency	600 cycles/h	

Utilization characteristics according to UL / CSA

Standards	UL 508, CSA C22.2 N°14
Max. operational voltage	600 V

Connecting characteristics

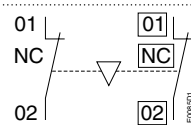
Connection capacity (min. ... max.)		
 Rigid solid	1 x	1...4 mm ²
	2 x	1...4 mm ²
 Flexible with ferrule	1 x	0.75...2.5 mm ²
	2 x	0.75...2.5 mm ²
 Lugs	L <	8 mm
	L >	3.5 mm
Tightening torque	Recommended	1 Nm
	Max.	1.2 Nm
Degree of protection acc. to IEC 60947-1 / EN 60947-1 and IEC 60529 / EN 60529	IP20	
Screw terminals All terminals	Delivered in open position, screws of unused terminals must be tightened M3.5	
Screwdriver type	Flat \varnothing 5.5 / Pozidriv 2	
Terminal marking		

Technical note: when, during switching, the arc time is estimated to more than 40 ms, the closing signal of one of the two contactors must be delayed with respect to the opening signal of the other contactor in order to prevent a short-circuit.

Use a TEF5 or TE5S electronic timer according to application use with time lapse for A contactors.

Electronic timer for star-delta starters

3



TE5S...

Description

When used in star-delta starters, the TE5S lags the star connection and provides a lapse of 50 ms before the switch over to delta connection.

According to the type of device chosen, the electronic circuit has a 24 V AC / DC, 110 to 120 V AC, 220 to 240 V AC or 380 to 440 V AC supply. An output relay with reversing contact ensures high current switching. A two-position switch allows selection of one of the two time delay ranges: 0.8 to 8 s or 6 to 60 s. The 0.1 to 1.0 graduated button allows an initial setting without steps within the previously selected range which can then be adjusted using a chronometer.

Note: We recommend that you allow for temperature drift for the final adjustment of the time delay setting. Drift: -0.2 % per °C.

For example, a setting made at 20 °C will yield a time delay shorter by 7 % at 55 °C in a cubicle (-0.2 % per °C i.e. $-0.2 \times 35 = -7 \%$).

Regardless of these settings the TE5S provides a fixed "lapse" of 50 ms between the opening of contact 15-16 and the closing of contact 15-18. This time delay prevents from arc short-circuit during star to delta switching.

Operation

On energization, the green U indicator light (voltage applied) comes on. Contact 15-16 then immediately moves to the closed position.

Count-down of the programmed time immediately commences. When the time delay has elapsed, contact 15-16 opens and at the same time the 50 ms lapse, t_2 , begins after which contact 15-18 moves to the closed position. The yellow R indicator light comes on.

On de-energization, the U and R indicator lights go out and, after the 250 ms resetting time, the device is ready for a new cycle.

Mounting

On 35 x 7.5 mm or 35 x 15 mm mounting rail according to IEC/EN 60715.

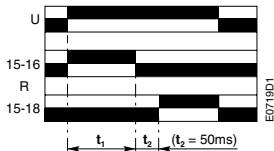

Chart

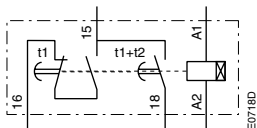

Equivalent diagram

Ordering details

For contactors	Rated control circuit voltage		Type	Order code	Pkg qty	Weight (1 pce)
	V 50/60 Hz	V DC				
A9 ... A300	24	24	TE5S-24	1SBN020010R1001	1	0.080
	110...120	-	TE5S-120	1SBN020010R1002	1	0.080
	220...240	-	TE5S-240	1SBN020010R1003	1	0.080
	380...440	-	TE5S-440	1SBN020010R1004	1	0.080

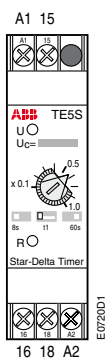

Front face

Main dimensions mm, inches

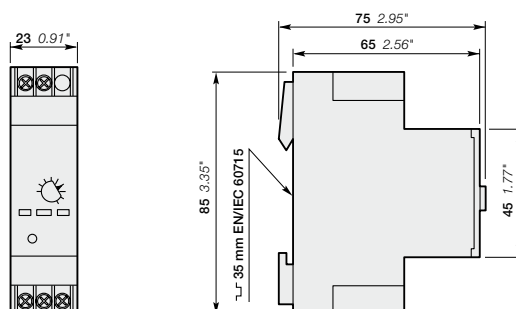

Electronic timer for star-delta starters

Technical data

Types	TE5S-24	TE5S-120	TE5S-240	TE5S-440	
Utilization characteristics according to IEC					
Standards	IEC 60947-5-1 and EN 60947-5-1				
Rated insulation voltage Ui acc. to IEC 60947-5-1	440 V				
Rated operational voltage Ue max.	24 V DC		-		
	24...240 V AC		440 V AC		
Conventional free air thermal current Ith	10 A				
le / Rated operational current AC-15 acc. to IEC 60947-5-1	24-120 V 50/60 Hz	5 A	-		
	220-240 V 50/60 Hz	4 A	-		
	380-440 V 50/60 Hz	-	3 A		
le / Rated operational current DC-13 acc. to IEC 60947-5-1	24 V DC	4 A	-		
Short-circuit protection device - gG type fuse					
Control circuit voltage					
AC control voltage	Rated supply voltage U _c	24 V AC	110...120 V AC	220...240 V AC	380...440 V AC
	Average consumption	1.5 VA	3.5 VA	6.5 VA	12.5 VA
DC control voltage	Rated supply voltage U _c	24 V DC	-	-	-
	Average consumption	0.7 W	-	-	-
	Rated frequency limits	48...63 Hz			
	Supply voltage range	0.85...1.1 x U _c			
	Overvoltage protection	Built-in varistor			
	Load factor	100 %			
Time delay range (t1) selected by switch					
	Temperature drift	0.8...8 s and 6...60 s			
	Mechanical setting accuracy	-0.2 % per °C			
	On-load reiteration accuracy under constant conditions	±15 % of the setting range			
	On-load reiteration accuracy under constant conditions	±2 % after 1 million operating cycles			
Minimum time lapse (t2)					
	Minimum time lapse after 1 million of operating cycles	50 ms			
	Minimum time lapse after 1 million of operating cycles	40 ms			
Resetting time (max.)					
	Resetting time (max.)	250 ms			
Front panel display					
	green indicator light	Energization			
	yellow indicator light	Output relay activated			
Ambient air temperature					
	Operation	-25...+60 °C			
	Storage	-40...+85 °C			
Shock withstand acc. to IEC 60068-2-27 and EN 6006-2-27					
		Shock direction			
		A	20 g / 11 ms		
		B	15 g / 11 ms		
		C	20 g / 11 ms		
Vibration withstand acc. to IEC 60068-2-6 and EN 60068-2-6					
	Vibration withstand	10 to 300 Hz in the 3 directions			
	Vibration withstand	3 g			
Mechanical durability					
	Mechanical durability	5 millions operating cycles			
Electrical durability					
	Electrical durability	1 million operating cycles			
	On-load maximum switching frequency	720 cycles/h		600 cycles/h	
Fixing					
	On rail according to IEC 60715, EN 60715	35 x 7.5 mm or 35 x 15 mm			

Connecting characteristics

Connection capacity (min. ... max.)					
	Rigid solid	1 x	1...2.5 mm ²		
	Flexible with ferrule	2 x	1...2.5 mm ²		
	Rigid solid	1 x	0.75...2.5 mm ²		
	Flexible with ferrule	2 x	0.75...2.5 mm ²		
Tightening torque		Recommended	0.6 Nm		
		Max.	0.8 Nm		
Degree of protection acc. to IEC 60947-1 / EN 60947-1 and IEC 60529 / EN 60529					
	Degree of protection	IP20			
Screw terminals					
	Screw terminals	Delivered in open position, screws of unused terminals must be tightened			
	All terminals	M2.5			
Screwdriver type					
	Screwdriver type	Flat Ø 4 / Pozidriv 1			

Surge suppressors for contactor coils

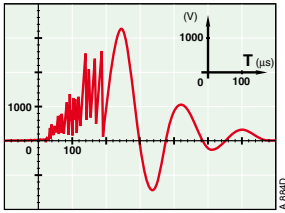

Description

The operation of inductive circuits causes overvoltages, in particular on opening of the contactor coil.

The electromagnetic energy stored in the coil during contactor closing is restored on opening in the form of surges, the slope and amplitude of which may rise to several kilovolts. A number of drawbacks are observed ranging from interference on the electronic devices to breakdown of insulators and even destruction of certain sensitive components.

The graph opposite reproduces the oscillogram showing voltage discharges at the terminals of a 42 V / 50 Hz coil without peak clipping. The coil was switched by 8 series-connected poles of a contactor relay.

Following a burst of discharges with a very steep slope a damped oscillation emerges with a peak value of 3500 V.

Overvoltage Factor

The overvoltage factor k is defined as the ratio of the maximum overvoltage peak value \hat{U}_s to the peak value \hat{U}_c of the coil rated control voltage U_c :

$$k = \frac{\hat{U}_s \text{ max.}}{\hat{U}_c} \quad \text{in DC: } k = \frac{\hat{U}_s \text{ max.}}{U_c} \quad \text{or in AC: } k = \frac{\hat{U}_s \text{ max.}}{U_c \sqrt{2}}$$

For example the following is obtained for the above graph: $k = \frac{3500}{42 \sqrt{2}} \approx 60$

To reduce the harmful effects of these overvoltages, ABB has developed a range of surge suppressors designed to reduce the k factor defined above and to limit or even completely eliminate the high pre-damping voltage frequencies.

Each case is different, but the technical data tolerances and the generous sizing of parts have enabled us to reduce the number of variants.

We have chosen the following solutions: transil diodes, varistors and RC blocks.

Note: A varistor is a resistor whose value decreases to a very large extent when a certain voltage is applied at its terminals.



RV5/50



RC5-1/50

Ordering details

For contactors	Rated control circuit voltage U_c		Type	Order code	Pkg qty	Weight (1 pce) kg
	V	AC DC				
A9 ... A110	24...50	● ●	RV5/50	1SBN050010R1000	2	0.015
	50...133	● ●	RV5/133	1SBN050010R1001	2	0.015
	110...250	● ●	RV5/250	1SBN050010R1002	2	0.015
	250...440	● ●	RV5/440	1SBN050010R1003	2	0.015
A9 ... A40	24...50	● -	RC5-1/50	1SBN050100R1000	2	0.012
	50...133	● -	RC5-1/133	1SBN050100R1001	2	0.012
	110...250	● -	RC5-1/250	1SBN050100R1002	2	0.012
	250...440	● -	RC5-1/440	1SBN050100R1003	2	0.012
A45 ... A110	24...50	● -	RC5-2/50	1SBN050200R1000	2	0.015
	50...133	● -	RC5-2/133	1SBN050200R1001	2	0.015
	110...250	● -	RC5-2/250	1SBN050200R1002	2	0.015
	250...440	● -	RC5-2/440	1SBN050200R1003	2	0.015
A145 ... A300	250...440	● -	RC5-3/440	1SBN050300R1003	2	0.028

Surge suppressors for contactor coils

Technical data

Varistor	RV5/50	RV5/133	RV5/250	RV5/440
Rated control circuit voltage U _c	24...50 V AC 24...50 V DC	50...133 V AC 50...133 V DC	110...250 V AC 110...250 V DC	250...440 V AC 250...440 V DC
Residual overvoltage (clipping voltage)	132 V AC 132 V DC	270 V AC 270 V DC	480 V AC 480 V DC	825 V AC 825 V DC
Opening time growth factor	1.1...1.5			
Operating temperature	-20...+70 °C			
Connection to the coil terminals (parallel mounting)	Clip-on for both fixing and connection.			
Fixing	Clipped onto the top part of the contactor base without change in contactor overall dimensions.			
Advantages	High energy absorption: good damping - Unpolarized system.			
Drawback	Clipping as from U _{vdr} (1), thus voltage front up to this point.			

(1) U_{vdr} = Varistor operating voltage (voltage dependent resistor), tolerance ±10 %.

RC type	RC5-1/50	RC5-1/133	RC5-1/250	RC5-1/440
	RC5-2/50	RC5-2/133	RC5-2/250	RC5-2/440
	-	-	-	RC5-3/440
Rated control circuit voltage U _c	24...50 V AC	50...133 V AC	110...250 V AC	250...440 V AC
Residual overvoltage (clipping voltage)	2 to 3 x U _c max.			
Opening time growth factor	1.2...1.3			
Operating temperature	-20...+70 °C			
Connection to the coil terminals (parallel mounting)	Clip-on for both fixing and connection.			
Fixing	Clipped onto the top part of the contactor base without change in contactor overall dimensions.			
Advantages	Very fast clipping - Attenuation of steep fronts and thus of high frequencies. No operating delays.			

Wiring diagrams

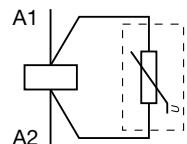

Varistor

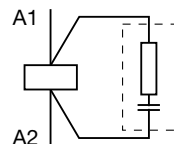

RC type

Dimensions

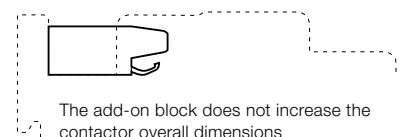

RV5, RC5

Interface relays



3

RA5-1

Description

RA5-1 interface relay is designed to receive 24 V DC signals delivered by PLC's or other sources with a low output power and to restore them with sufficient power to operate the coils of the relevant A9 ... A110 contactors.

RA5-1 interface relay is made up of a miniature electromechanical relay equipped with a N.O. contact and with a low consumption 24 V DC coil.

The interface relay coil is controlled by the PLC while the N.O. contact ensures switching of the power contactor.

Coil switching gives rise to overvoltages which have adverse effects on the electronic devices, insulators and, more generally, on component lifetime. The RA5-1 is equipped with surge suppressors:

- on the 24 V DC relay coil via a diode,
- on the power contactor coil via a varistor.

Furthermore, the RA5-1 is protected against relay pole reversal by a diode inserted between the E1 and E2 input terminals.

Ordering details





For contactors	Coil voltages	Rated control circuit voltage Uc	Type	Order code	Pkg qty	Weight (1 pce)
	V 50/60 Hz	V DC				kg
A9 ... A110	24...250	24	RA5-1	1SBN060300R1000	1	0.050
			RA5-1	1SBN060300T1000	10	0.050

Interface relays

Technical data

Type	RA5-1
Utilization characteristics according to IEC	
Standards	IEC 60255-5
Rated insulation voltage U_i acc. to IEC 60947-4-1	250 V AC
Ambient air temperature	
In free air operation	at $U_c = 24$ V DC (between E1 and E2) from 0.85 to 1.1 x U_c
Storage	
-25...+70 °C	
-25...+55 °C	
-40...+70 °C	
Climatic withstand	Complies with that of associated contactors
Maximum operating altitude	3000 m
Mounting positions	No limitation
Fixing	Using the contactor A1 and A2 terminal connecting parts

Connecting characteristics

Connection capacity (min. ... max.)			
	Rigid solid	1 x	1...4 mm ²
	Flexible with ferrule	2 x	1...4 mm ²
	Flexible with ferrule	1 x	0.75...2.5 mm ²
	Flexible with ferrule	2 x	0.75...2.5 mm ²
	Lugs	L <	8 mm
		L >	3.5 mm
Tightening torque	Recommended		1 Nm
	Max.		1.2 Nm
Degree of protection	Protection against direct contact in acc. with EN 50274		
acc. to IEC 60947-1 / EN 60947-1 and IEC 60529 / EN 60529	RA5-1 wired and mounted on the associated contactor		
Screw terminals	Delivered in open position, screws of unused terminals must be tightened		
All terminals	M3.5		
Screwdriver type	Flat Ø 5.5 / Pozidriv 2		

Working data

Surge suppression		
For contactor coil		Varistor
For interface relay coil		Diode
Protection against polarity reversal between terminals E1 and E2		Diode
Interface relay operating time		Closing and drop-out ≤ 10 ms
Total operating time, interface relay + contactor		
Between energization and:	N.O. contact closing	20...37 ms
	N.C. contact opening	17...32 ms
Between de-energization and:	N.O. contact opening	17...25 ms
	N.C. contact closing	20...28 ms

Electrical input data

Control voltage (E1 and E2 terminals) U_c		
Rated value		24 V DC
Max. range at ambient temperature 20 °C		19...30 V DC
Max. consumption for $U_c = 24$ V DC, $\theta = 20$ °C		0.3 W
"0" status (relay open)	for U_c	≤ 2.4 V DC
	for I_c	< 1 mA
"1" status (relay closed)	for U_c	≥ 19 V DC
Max. short supply interruption immunity time		2 ms

Electrical output data

Switching voltage (A0 and A2 terminals)	≤ 250 V AC
Electrical durability	
Number of operating cycles	2 millions (600 cycles/h) on A9 ... A75 contactors or N contactor relays 0.5 million (600 cycles/h) on A95 and A110 contactors

Connection

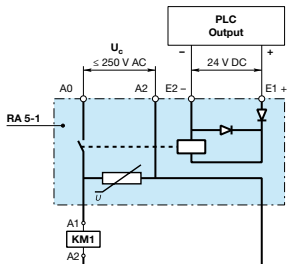
	<p>The "E1+" and "E2-" input terminals must be connected, according to their polarity, to the PLC output. The RA5-1 is equipped with two terminal pads for connection to the A1 and the A2 terminals of the contactor coil.</p> <p>This coil is supplied between the A0 and the A2 terminals of the RA 5-1.</p> <p>Mounting: terminals pads clamped inside the contactor coil terminals.</p>
---	--

Mechanical latching units



1SBC665483F0301

WB75-A

3

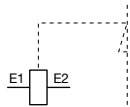

Terminal marking

Description

For converting standard contactors into latched contactors.

The WB75-A block contains a mechanical latching device with electromagnetic impulse unlatching (AC or DC) or manual unlatching.

Captive screw type connecting terminals, built-in cable clamps, M3.5 (+, -) pozidriv 2 screw with screwdriver guidance; delivered untightened and protected against accidental direct contact.

Operation

After closing, the contactor continues to be held in the closed position by the latching mechanism should the supply voltage fail at the contactor coil terminals.

Contactor opening can be controlled:

- electrically by an impulse (AC or DC) on the WB75-A block coil.
(the coil is not designed to be permanently energized)
- manually by pressing the pushbutton on the front face of the WB75-A block.

Mounting

The WB75-A block is clipped onto the front face of the 1-stack contactor where it takes up two slots. The two other slots may accept CA5... single pole auxiliary contacts (1 block on each side of the mechanical latch).

Ordering details

For contactors	Rated control circuit voltage U _c		Type	Order code	Pkg qty	Weight (1 pce) kg
	V 50 Hz or DC	V 60 Hz				
A9 ... A75	24	24...28	WB75-A	FPTN372726R1001	1	0.120
	42	42...48	WB75-A	FPTN372726R1002	1	0.120
	48	48...55	WB75-A	FPTN372726R1003	1	0.120
	110	110...127	WB75-A	FPTN372726R1004	1	0.120
	220...230	220...255	WB75-A	FPTN372726R1006	1	0.120
	230...240	230...277	WB75-A	FPTN372726R1005	1	0.120
	380...415	380...440	WB75-A	FPTN372726R1007	1	0.120
	415...440	440...480	WB75-A	FPTN372726R1008	1	0.120

1SBC101903S0201

Mechanical latching units



Technical data

Type	WB75-A
------	--------

Utilization characteristics according to IEC

Rated insulation voltage U_i acc. to IEC 60947-1	690 V
Max. electrical impulse time	
On AC coil (with load factor 5 %)	20 s
On DC coil (with load factor 3 %)	8 s
Min. electrical impulse time	
For latching (energizing of the contactor coil) AC	50 ms
For pull-out (energizing of the WB block coil) AC	30 ms
Coil operating limits AC or DC supply	0.85...1.1 x U_c
AC control voltage 50/60 Hz	
Rated control circuit voltage U_c	24...480 V AC
Coil consumption	Average pull-in value 90 VA
	Average holding value 60 VA
DC control voltage	
Rated control circuit voltage U_c	24...440 V DC
Coil consumption	Average pull-in value 110 W
	Average holding value 110 W
Operating time	
On contactor closing (latching)	
Between coil energization and:	
	N.O. contact closing No difference with the operation of a contactor without mechanical latching unit
	N.C. contact opening No difference with the operation of a contactor without mechanical latching unit
On contactor opening (unlatching)	
Between WB coil energization and:	
	N.O. contact opening 5...25 ms
	N.C. contact closing 7...28 ms
Mechanical durability	
Number of operating cycles	1 million operating cycles
Max. switching frequency	3600 cycles/h with on-load factor of 8 %

Connecting characteristics

Connection capacity (min. ... max.)		
 Rigid solid	1 x	1...4 mm ²
	2 x	1...4 mm ²
 Flexible with ferrule	1 x	0.75...2.5 mm ²
	2 x	0.75...2.5 mm ²
 Lugs	L <	8 mm
	I >	3.5 mm
Tightening torque	Recommended	1 Nm
	Max.	1.2 Nm
Screw terminals	Delivered in open position, screws of unused terminals must be tightened	
All terminals	M3.5	
Screwdriver type	Flat Ø 5.5 / Pozidriv 2	

Function markers

Impulse contact blocks

3



BA5-50

1SBC574974FC001

BA5-50 function markers

Description

Set of 50 function markers designed to be clipped onto the front face of devices. Details can be added to these markers using a ball point pen, indelible felt-tip pen or pentel white.

Self-adhesive labels (not supplied) can also be added to them.

Marker dimensions: 7 x 19 mm (0.276" x 0.748").

Ordering details

For contactors	Type	Order code	Pkg qty	Weight (1 pce) kg
Contactors, thermal overload relays and accessories	BA5-50	1SBN110000R1000	1	0.017

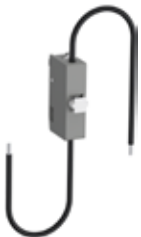

CB5

1SBC100039A0014

CB5 impulse contact blocks

Description

Impulse contact blocks are designed for use in enclosures, in association with an adjustable mechanical pushbutton. Two types are available:

- CB5-10: N.O. contact with a black actuator ("ON" function)
- CB5-01: N.C. contact with a light grey actuator ("OFF" function).

These blocks are equipped with 2 connecting leads 0.5 mm² with end, approximately 18 cm long.

Mounting: Clipped onto the front face of the contactors.

Ordering details

For contactors	Contacts	Type	Order code	Pkg qty	Weight (1 pce) kg
A9 ... A110	1 -	CB5-10	1SBN010013R1010	1	0.012
	- 1	CB5-01	1SBN010013R1001	1	0.012

Main dimensions mm, inches

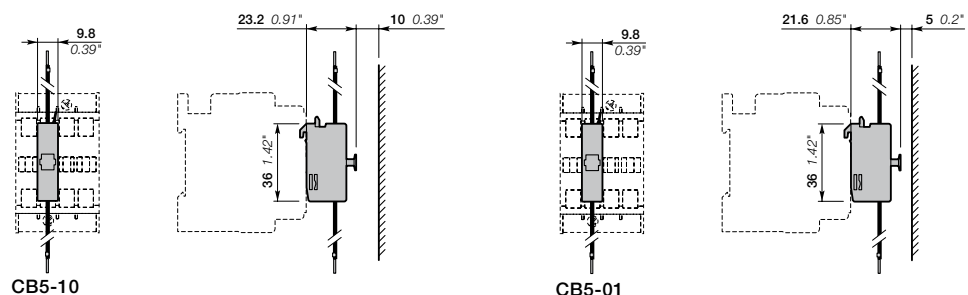

CB5-10

CB5-01

1SBC101896S0201

Terminal shrouds, terminal enlargements, terminal extensions

Connector terminals



1SFT98099-019C3

LT...-AC



1SFT98099-125

LT...-AL



1SFT98000-014

LT...-AY



1SFT98000-011C3

LW...



1SFT98000-012C3

LX...



1SFT98099-00211C1

LZ...



1SFT98099-096C2

LZ...



1SBC580542F0302

LZ...

Terminal shrouds

Description

Main terminal protection for A145 ... A300 contactors.

The auxiliary contact blocks and coils are designed to provide an IP20 degree of protection.

The main terminals, equipped with lugs or connectors, can be protected against accidental direct contact after wiring (EN 50274) by the addition of terminal shrouds (see table below).

Ordering details

For contactors	Type	Order code	Pkg qty	Weight (1 pce) kg
A145 ... A185 with connectors	LT185-AC	1SFN124701R1000	2	0.050
A145 ... A185 with lugs	LT185-AL	1SFN124703R1000	2	0.220
A145 ... A185 with short. bar LY185 or between A145 and TA200DU or between A185 and TA200DU	LT185-AY	1SFN124704R1000	1	0.050
A210 ... A300 with connectors	LT300-AC	1SFN125101R1000	2	0.070
A210 ... A300 with lugs	LT300-AL	1SFN125103R1000	2	0.280
A210 ... A300 with short. bar LY300	LT300-AY	1SFN125104R1000	1	0.075

LW... Terminal enlargements

Description

Enlargement pieces designed to increase the width of the contactor terminal pads in order to allow larger connections to be mounted.

Sets containing 3 tin plated copper bars fixed by an isolating spacer.

Ordering details

For contactors	Dimensions		Type	Order code	Pkg qty	Weight (1 pce) kg
	hole Ø mm	bar mm				
A95, A110	6.5	15 x 3	LW110	1SFN074307R1000	1	0.100
A145, A185	10.5	20 x 5	LW185	1SFN074707R1000	1	0.250
A210 ... A300	10.5	25 x 5	LW300	1SFN075107R1000	1	0.450

LX... Terminal extension

Description

Extension pieces designed to extend the main terminals of contactors for combined mounting of contactors and connection sets.

Sets containing 3 tin plated copper bars fixed by an isolating spacer.

Ordering details

For contactors	Dimensions		Type	Order code	Pkg qty	Weight (1 pce) kg
	hole Ø mm	bar mm				
A145, A185	8.5	20 x 5	LX185	1SFN074710R1000	1	0.250
A210 ... A300	10.5	20 x 5	LX300	1SFN075110R1000	1	0.350

Connector terminals

Description

Connection of copper and aluminium cables to the terminal pads of the poles of A contactors.

Ordering details

Cables	For contactors	Cable cross section	Type	Order code	Pkg qty	Weight (1 pce) kg
		mm ²				
Single Cu	A145, A185	6...185	-	1SDA023354R0001	3	0.200
	A210 ... A300	16...240	-	1SDA023368R0001	3	0.400
Single Al & Cu	A145, A185	35...95	-	1SDA023356R0001	3	0.100
	A145, A185	25...150	-	1SDA023357R0001	3	0.100
	A210 ... A300	120...240	-	1SDA023370R0001	3	0.200
	A145, A185	2 x (50...120)	LZ185-2C/120	1SFN074709R1000	3	0.300
Double Al & Cu	A210 ... A300	2 x (95...120)	-	1SDA025766R0001	3	0.400

Voltage code table

The below tables indicate the available coil voltages and corresponding digits for order codes. When placing an order, please give the order code. Select a standard contactor from ordering detail pages. Change the **coil voltage code** in the order code according to the table below. Example: for contactor A50-30-00 and coil 48 V 50/60 Hz, the order code is 1SBL351001R**83**00.

A contactors

3

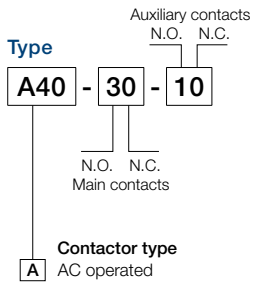

Order code

1SBL321001R **80** **10**

AC coil code
Contactors: A

	50 Hz	60 Hz
81	24 V	24 V
82	42 V	42 V
83	48 V	48 V
84	110 V	110...120 V
36	190 V	220 V
80	220...230 V	230...240 V
88	230...240 V	240...260 V
85	380...400 V	400...415 V
86	400...415 V	415...440 V

Codes in bold for dual frequency coils.

N contactor relays

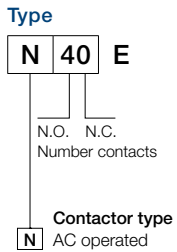

Order code

1SBH141001R **80** **40**

AC coil code
Contactors: A

	50 Hz	60 Hz
81	24 V	24 V
82	42 V	42 V
83	48 V	48 V
84	110 V	110...120 V
36	190 V	220 V
80	220...230 V	230...240 V
88	230...240 V	240...260 V
85	380...400 V	400...415 V
86	400...415 V	415...440 V

Codes in bold for dual frequency coils.

Notes

A series of horizontal dotted lines for taking notes, spanning the width of the page.

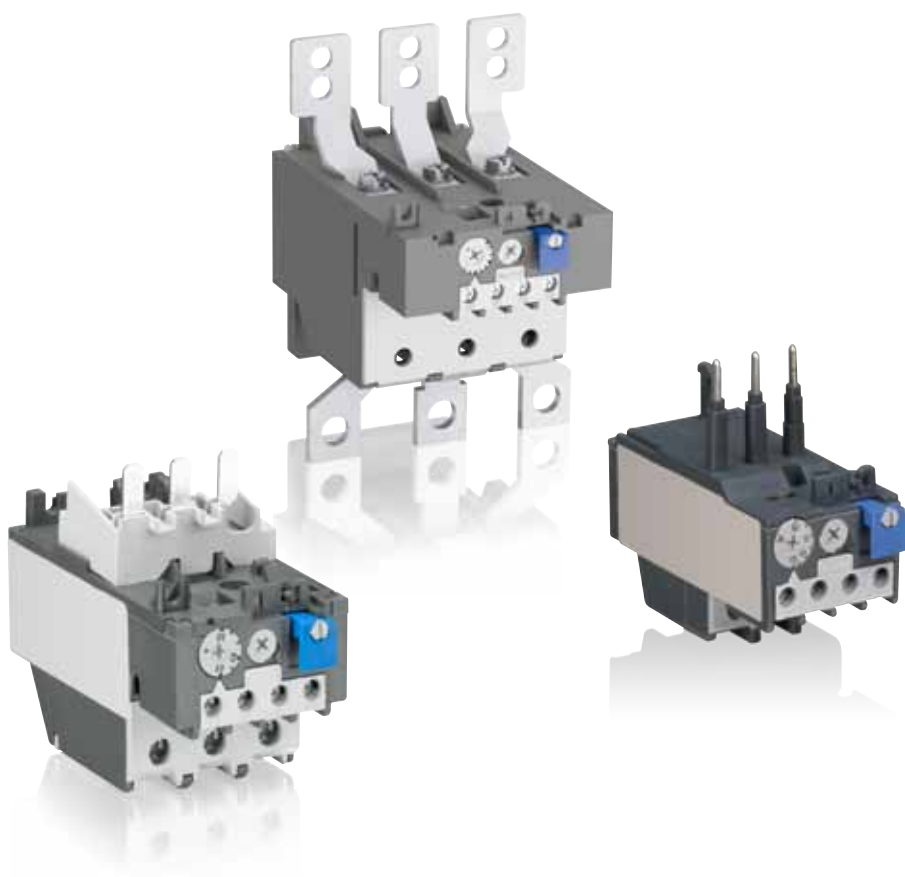

Overload relays

Overview

4/2

Thermal overload relays

TA25DU-M (0.10 ... 32 A)

Ordering details 4/4

Technical data 4/5

TA42DU-M (18 ... 42 A)

Ordering details 4/8

Technical data 4/9

TA75DU-M (18 ... 80 A)

Ordering details 4/11

Technical data 4/12

TA80DU (29 ... 80 A)

Ordering details 4/14

Technical data 4/15

TA110DU (66 ... 110 A)

Ordering details 4/18

Technical data 4/19

TA200DU (66 ... 200 A)

Ordering details 4/22

Technical data 4/23

TA450DU, TA450SU (40 ... 310 A)

Ordering details 4/26

Technical data 4/27

Thermal overload relays



Type	TA25DU-M	TA42DU-M	TA75DU-M	
Current range	0.10 ... 32 A	18 ... 42 A	18 ... 80 A	
Trip class	10A	10A	10A	
Single mounting kit	-	DB80	DB80	

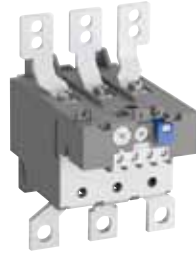

TA80DU	TA110DU	TA200DU	TA450DU / TA450SU
29 ... 80 A	66 ... 110 A	66 ... 200 A	130 ... 310 A / 40 ... 310 A
10A	10A	10A	10A / 30
DB80	DB200	DB200	-

TA25DU-M thermal overload relays

With screw terminals - 0.10 ... 32.0 A



TA25DU-19M

2CDC231019C0013

Description

The TA25DU-M thermal overload relays are economic electromechanical protection devices for the main circuit. They offer reliable protection for motors in the event of overload or phase failure. The devices have trip class 10A.

The thermal overload relays are three pole relays with bimetal tripping elements. The motor current flows through the bimetal tripping elements and heats them directly and indirectly. In case of an overload (over current), the bimetal elements bent as a result of the heating. This leads to a release of the relay and a change of the contacts switching position (95-96 / 97-98).

- Manual or automatic reset selectable
- Phase loss sensitive acc. to IEC/EN 60947-4-1
- Two electrically isolated auxiliary contacts – 1 N.O. + 1 N.C.
- TEST and STOP function – Trip indication on the front
- Temperature compensation
- Suitable for three- and single-phase applications

Ordering details

Setting range	Short-circuit protective device	Trip class	Type	Order code	Weight (1 pce) kg
0.10 ... 0.16	0.50 A, Fuse type F	10A	TA25DU-0.16M	1SAZ211201R2005	0.150
0.16 ... 0.25	0.63 A, Fuse type F	10A	TA25DU-0.25M	1SAZ211201R2009	0.150
0.25 ... 0.40	1.25 A, Fuse type F	10A	TA25DU-0.4M	1SAZ211201R2013	0.150
0.40 ... 0.63	2 A, Fuse type gG / -	10A	TA25DU-0.63M	1SAZ211201R2017	0.150
0.63 ... 1.00	4 A, Fuse type gG / 2 A aM	10A	TA25DU-1.0M	1SAZ211201R2021	0.150
1.00 ... 1.40	6 A, Fuse type gG / 2 A aM	10A	TA25DU-1.4M	1SAZ211201R2023	0.150
1.30 ... 1.80	6 A, Fuse type gG / 4 A aM	10A	TA25DU-1.8M	1SAZ211201R2025	0.150
1.70 ... 2.40	6 A, Fuse type gG / 4 A aM	10A	TA25DU-2.4M	1SAZ211201R2028	0.150
2.20 ... 3.10	10 A, Fuse type gG / 6 A aM	10A	TA25DU-3.1M	1SAZ211201R2031	0.150
2.80 ... 4.00	10 A, Fuse type gG / 6 A aM	10A	TA25DU-4.0M	1SAZ211201R2033	0.150
3.50 ... 5.00	16 A, Fuse type gG / 10 A aM	10A	TA25DU-5.0M	1SAZ211201R2035	0.150
4.50 ... 6.50	20 A, Fuse type gG / 16 A aM	10A	TA25DU-6.5M	1SAZ211201R2038	0.150
6.00 ... 8.50	20 A, Fuse type gG / 20 A aM	10A	TA25DU-8.5M	1SAZ211201R2040	0.150
7.50 ... 11.00	35 A, Fuse type gG / 25 A aM	10A	TA25DU-11M	1SAZ211201R2043	0.150
10.00 ... 14.00	35 A, Fuse type gG / 25 A aM	10A	TA25DU-14M	1SAZ211201R2045	0.150
13.00 ... 19.00	50 A, Fuse type gG / 35 A aM	10A	TA25DU-19M	1SAZ211201R2047	0.170
18.00 ... 25.00	63 A, Fuse type gG / 50 A aM	10A	TA25DU-25M	1SAZ211201R2051	0.170
24.00 ... 32.00	80 A, Fuse type gG / 63 A aM	10A	TA25DU-32M	1SAZ211201R2053	0.200

Main dimensions mm, inches

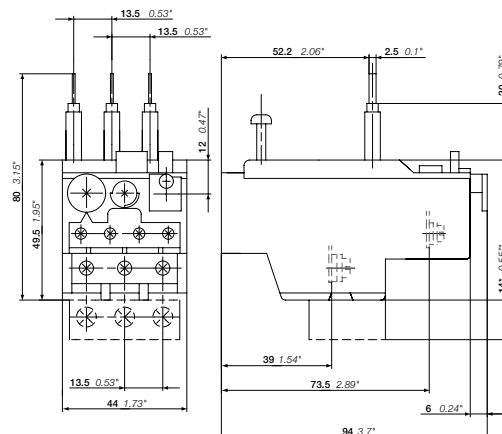

TA25DU-M + DX25

2CDC231023F0011

2CDC106056C0201

TA25DU-M thermal overload relays

Technical data

Main circuit – Utilization characteristics according to IEC/EN

Type	TA25DU-M
Standards	IEC/EN 60947-4-1, IEC/EN 60947-5-1, IEC/EN 60947-1
Rated operational voltage U_n	690 V AC
Rated frequency	DC, 50/60 Hz
Frequency range	0 ... 400 Hz
Trip class	10A
Number of poles	3
Duty time	100 %
Operating frequency without early tripping	Up to 15 operations/h, see "Technical diagram – Intermittent periodic duty"
Rated impulse withstand voltage U_{imp}	6 kV
Rated insulation voltage U_i	690 V AC

Auxiliary circuit according to IEC/EN

Type	TA25DU-M
Rated operational voltage U_n	500 V AC, 440 V DC
Conventional free air thermal current I_{th}	N.C., 95-96 10 A N.O., 97-98 6 A
Rated frequency	DC, 50/60 Hz
Number of poles	1 N.O. + 1 N.C.
I_a / Rated operational current AC-15 acc. to IEC/EN 60947-5-1 for utilization category	
110-120 V	N.C., 95-96 3.00 A N.O., 97-98 1.50 A
220-230-240 V	N.C., 95-96 3.00 A N.O., 97-98 1.50 A
440 V	N.C., 95-96 1.00 A N.O., 97-98 1.00 A
480-500 V	N.C., 95-96 1.00 A N.O., 97-98 1.00 A
I_a / Rated operational current DC-13 acc. to IEC/EN 60947-5-1 for utilization category	
24 V	N.C., 95-96 1.25 A N.O., 97-98 1.25 A
60 V	N.C., 95-96 0.25 A N.O., 97-98 0.25 A
110-120-125 V	N.C., 95-96 0.25 A N.O., 97-98 0.25 A
250 V	N.C., 95-96 0.12 A N.O., 97-98 0.04 A
Minimum switching capacity	17 V / 3 mA
Short-circuit protective device	N.C., 95-96 10 A, Fuse type gG N.O., 97-98 6 A, Fuse type gG
Rated impulse withstand voltage U_{imp}	6 kV
Rated insulation voltage U_i	690 V

Technical diagram – Intermittent periodic duty

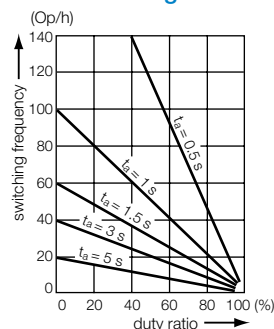

t_s : Motor starting time

2CDC32005F0211

2CDC106056C0201

TA25DU-M thermal overload relays



Technical data

General technical data

Type	TA25DU-M	
Pollution degree	3	
Phase loss sensitive	Yes	
Ambient air temperature		
Operation	Open - compensated	-25 ... +55 °C
	Open	-25 ... +55 °C
Storage	-40 ... +70 °C	
Ambient air temperature compensation	Acc. to IEC/EN60947-4-1	
Maximum operating altitude permissible	2000 m	
Resistance to shock acc. to IEC 60068-2-27	12g / 15 ms	
Mounting position	Position 1-6	
Mounting	Mount on the contactor and tighten the screws of the main circuit terminals or with single mounting kit on DIN rail (35 mm)	
Degree of protection	Housing	IP20
	Main circuit terminals	IP10



Electrical connection

Main circuit

Type		TA25DU-M (0.16-11 A)	TA25DU-M (14-25 A)	TA25DU-M (32 A)
Connecting capacity				
 Rigid	1 x	0.75 ... 4 mm ²	1.5 ... 6 mm ²	1.5 ... 10 mm ²
	2 x	0.75 ... 4 mm ²	1.5 ... 6 mm ²	-
 Flexible with insulated ferrule	1 x or 2 x ¹⁾	0.75 ... 4 mm ²	1.5 ... 4 mm ²	1.5 ... 6 mm ²
Stripping length		12 mm	12 mm	15 mm
Tightening torques		1.4 - 2.0 Nm	1.4 - 2.0 Nm	2.5 - 3.2 Nm
Connection screw		M4 (Pozidriv 2)	M4 (Pozidriv 2)	M5 (Pozidriv 2)

¹⁾ Combination of different wires not possible

Auxiliary circuit

Type		TA25DU-M
Connecting capacity		
 Rigid	1 x or 2 x	0.75 ... 4 mm ²
 Flexible	1 x or 2 x	0.75 ... 2.5 mm ²
Stripping length		9 mm
Tightening torques		0.8 ... 1.3 Nm
Connection screw		M3.5 (Pozidriv 2)

TA25DU-M thermal overload relays

Accessories



SST01494

DX25



2CDC231017F0006

DB25/25A



SST20591

DR25-A-220/380



1SFC151402F0001

KPR-101L

Description

The single mounting kits offer the possibility to mount the overload relays separately from the contactor. The DS25-A allows electrically remote tripping of TA25DU-M. DR25-A coil for remote reset of TA25DU-M.

Ordering details

For thermal overload relays	Description	Type	Order code	Weight (1 pce) kg
Terminal block and mounting kits				
TA25DU-0.16M; ... 25M / DB25/25 A	Terminal block 10 mm ²	DX25	1SAZ201307R0002	0.030
TA25DU-0.16M ... 25M	Single mounting kit	DB25/25A	1SAZ201108R0001	0.055
TA25DU-32M	Single mounting kit	DB25/32A	1SAZ201108R0002	0.080
Remote reset coil				
TA25DU-M	24 V, 50/60 Hz	DR25-A-24	1SAZ201504R0001	0.050
TA25DU-M	48 V, 50/60 Hz	DR25-A-48	1SAZ201504R0002	0.050
TA25DU-M	110 V, 50/60 Hz	DR25-A-110	1SAZ201504R0003	0.050
TA25DU-M	220/380 V, 50/60 Hz	DR25-A-220/380	1SAZ201504R0005	0.050
TA25DU-M	500 V, 50/60 Hz	DR25-A-500	1SAZ201504R0006	0.050

The remote reset coil is to be connected to auxiliary contact 97-98 of TA25DU-M. The coil is not suitable for Continuous operation. Impulse duration: maximum 0.2 seconds.

Accessories for reset function

TA25DU-M	Reset push button*	KPR-101L	1SFA616162R1014	0.027
----------	--------------------	----------	-----------------	-------

*Note: for more information see catalogue 1SFC151004C0201

Main dimensions mm, inches

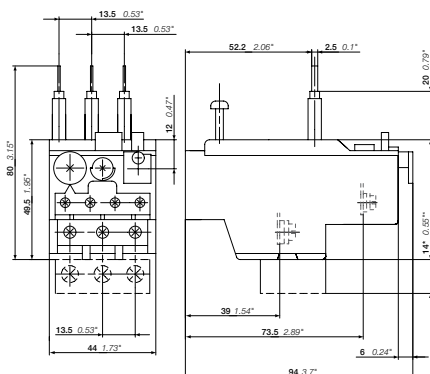

TA25DU-M + DX25

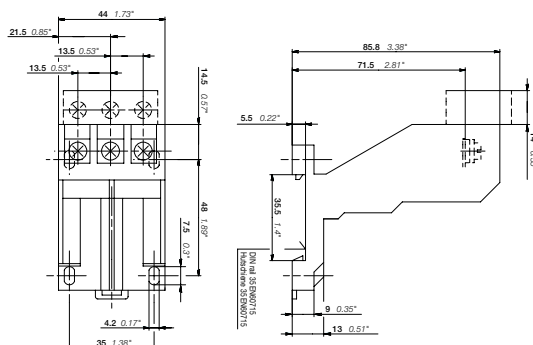

DB25

TA42DU-M thermal overload relays

18.0 ... 42.0 A



2CDC23102RF0013

TA42DU-32M



2CDC231007F0010

DB80



1SFC151402F0001

KPR-101L

Description

The TA42DU-M thermal overload relays are economic electromechanical protection devices for the main circuit. They offer reliable protection for motors in the event of overload or phase failure. The devices have trip class 10A.

The thermal overload relays are three pole relays with bimetal tripping elements. The motor current flows through the bimetal tripping elements and heats them directly and indirectly. In case of an overload (over current), the bimetal elements bent as a result of the heating. This leads to a release of the relay and a change of the contacts switching position (95-96 / 97-98).

- Manual or automatic reset selectable
- Phase loss sensitive acc. to IEC/EN 60947-4-1
- Two electrically isolated auxiliary contacts – 1 N.O. + 1 N.C.
- TEST and STOP function – Trip indication on the front
- Temperature compensation
- Suitable for three- and single-phase applications

Ordering details

Setting range	Short-circuit protective device	Trip class	Type	Order code	Weight (1 pce) kg
A					
18 ... 25	63 A, Fuse type gG / 50 A aM	10A	TA42DU-25M	1SAZ311201R2001	0.335
22 ... 32	80 A, Fuse type gG / 63 A aM	10A	TA42DU-32M	1SAZ311201R2002	0.335
29 ... 42	100 A, Fuse type gG / 80 A aM	10A	TA42DU-42M	1SAZ311201R2003	0.335

Ordering details accessories

For thermal overload relays	Description	Type	Order code	Weight (1 pce) kg
A				
TA42DU-M	Single mounting kit	DB80	1SAZ301110R0001	0.155
TA42DU-M	Reset push button*	KPR-101L	1SFA616162R1014	0.027

*Note: for more information see catalogue 1SFC151004C0201

Main dimensions mm, inches

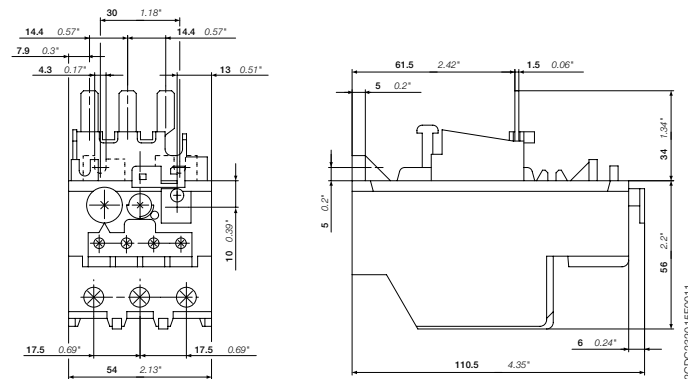

TA42DU-M

TA42DU-M thermal overload relays

Technical data

Main circuit – Utilization characteristics according to IEC/EN

Type	TA42DU-M
Standards	IEC 60947-1 / 60947-4-1 and EN 60947-1 / 60947-4-1
Rated operational voltage U_n	690 V AC
Rated frequency	DC, 50/60 Hz
Trip class	10A
Number of poles	3
Duty time	100 %
Operating frequency without early tripping	Up to 15 operations/h, see "Technical diagram – Intermittent periodic duty"
Rated impulse withstand voltage U_{imp}	6 kV
Rated insulation voltage U_i	690 V AC

Auxiliary circuit according to IEC/EN

Type	TA42DU-M
Rated operational voltage U_n	500 V AC, 440 V DC
Conventional free air thermal current I_{th}	N.C., 95-96 10 A N.O., 97-98 6 A
Rated frequency	DC, 50/60 Hz
Number of poles	1 N.O. + 1 N.C.
I_e / Rated operational current AC-15 acc. to IEC/EN 60947-5-1 for utilization category	
110-120 V	N.C., 95-96 3.00 A N.O., 97-98 1.50 A
220-230-240 V	N.C., 95-96 3.00 A N.O., 97-98 1.50 A
440 V	N.C., 95-96 1.00 A N.O., 97-98 1.00 A
480-500 V	N.C., 95-96 1.00 A N.O., 97-98 1.00 A
I_e / Rated operational current DC-13 acc. to IEC/EN 60947-5-1 for utilization category	
24 V	N.C., 95-96 1.25 A N.O., 97-98 1.25 A
60 V	N.C., 95-96 0.25 A N.O., 97-98 0.25 A
110-120-125 V	N.C., 95-96 0.25 A N.O., 97-98 0.25 A
250 V	N.C., 95-96 0.12 A N.O., 97-98 0.04 A
Minimum switching capacity	17 V / 3 mA
Short-circuit protective device	N.C., 95-96 10 A, Fuse type gG N.O., 97-98 6 A, Fuse type gG
Rated impulse withstand voltage U_{imp}	6 kV
Rated insulation voltage U_i	690 V

Technical diagram – Intermittent periodic duty

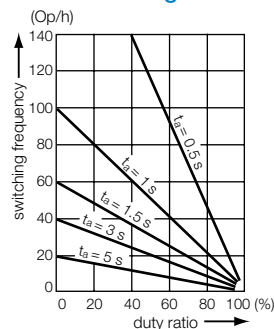

t_s : Motor starting time

TA42DU-M thermal overload relays



Technical data

General technical data





Type	TA42DU-M	
Pollution degree	3	
Phase loss sensitive	Yes	
Ambient air temperature		
Operation	Open - compensated	-25 ... +55 °C
	Open	-25 ... +55 °C
Storage	-40 ... +70 °C	
Ambient air temperature compensation	Acc. to IEC/EN60947-4-1	
Maximum operating altitude permissible	2000 m	
Resistance to shock acc. to IEC 60068-2-27	12g / 15 ms	
Mounting position	Position 1-6	
Mounting	Mount on the contactor and tighten the screws of the main circuit terminals or with single mounting kit on DIN rail (35 mm)	
Degree of protection	Housing	IP20
	Main circuit terminals	IP10

Electrical connection

Main circuit

Type	TA42DU-M	
Connecting capacity		
 Rigid	1 x	2.5 ... 25 mm ²
	2 x	2.5 ... 16 mm ²
 Flexible with insulated ferrule	1 x	2.5 ... 25 mm ²
	2 x	2.5 ... 10 mm ²
Stripping length	14 mm	
Tightening torques	4.5 Nm	
Connection screw	M6 (Pozidriv 2)	

Auxiliary circuit

Type	TA42DU-M	
Connecting capacity		
 Rigid	1 x or 2 x	0.75 ... 4 mm ²
 Flexible with ferrule	1 x or 2 x	0.75 ... 2.5 mm ²
 Flexible with insulated ferrule	1 x or 2 x	0.75 ... 2.5 mm ²
 Flexible	1 x or 2 x	0.75 ... 2.5 mm ²
Stripping length	9 mm	
Tightening torques	0.8 ... 1.3 Nm	
Connection screw	M3.5 (Pozidriv 2)	

TA75DU-M thermal overload relays

18 ... 80 A



2CDC231022F0013

TA75DU-63M



2CDC2311007F0010

DB80



1SFC151402F0001

KPR-101L

Description

The TA75DU-M thermal overload relays are economic electromechanical protection devices for the main circuit. They offer reliable protection for motors in the event of overload or phase failure. The devices have trip class 10A.

The thermal overload relays are three pole relays with bimetal tripping elements. The motor current flows through the bimetal tripping elements and heats them directly and indirectly. In case of an overload (over current), the bimetal elements bent as a result of the heating. This leads to a release of the relay and a change of the contacts switching position (95-96 / 97-98).

- Manual or automatic reset selectable
- Phase loss sensitive acc. to IEC/EN 60947-4-1
- Two electrically isolated auxiliary contacts – 1 N.O. + 1 N.C.
- TEST and STOP function – Trip indication on the front
- Temperature compensation
- Suitable for three- and single-phase applications

Ordering details

Setting range	Short-circuit protective device	Trip class	Type	Order code	Weight (1 pce) kg
A					
18 ... 25	63 A, Fuse type gG / 50 A aM	10A	TA75DU-25M	1SAZ321201R2001	0.335
22 ... 32	80 A, Fuse type gG / 63 A aM	10A	TA75DU-32M	1SAZ321201R2002	0.335
29 ... 42	100 A, Fuse type gG / 80 A aM	10A	TA75DU-42M	1SAZ321201R2003	0.335
36 ... 52	125 A, Fuse type gG / 100 A aM	10A	TA75DU-52M	1SAZ321201R2004	0.335
45 ... 63	160 A, Fuse type gG / 125 A aM	10A	TA75DU-63M	1SAZ321201R2005	0.335
60 ... 80	200 A, Fuse type gG / 160 A aM	10A	TA75DU-80M	1SAZ321201R2006	0.370

Ordering details accessories

For thermal overload relays	Description	Type	Order code	Weight (1 pce) kg
A				
TA75DU-M	Single mounting kit	DB80	1SAZ301110R0001	0.155
TA75DU-M	Reset push button*	KPR-101L	1SFA616162R1014	0.027

*Note: for more information see catalogue 1SFC151004C0201

Main dimensions mm, inches

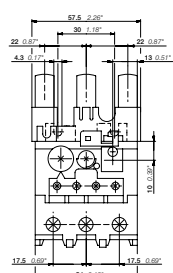

TA75DU-M

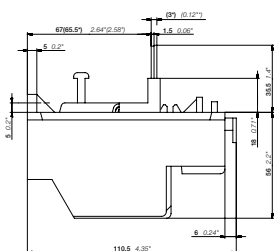

2CDC232017F0011

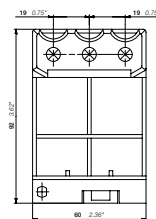

DB80

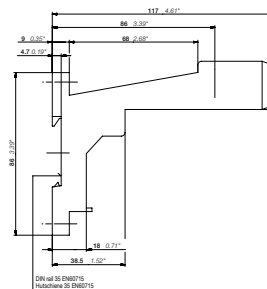

2CDC232025F0011

2CDC106058C0201

TA75DU-M thermal overload relays

Technical data

Main circuit – Utilization characteristics according to IEC/EN

Type	TA75DU-M
Standards	IEC 60947-1 / 60947-4-1 and EN 60947-1 / 60947-4-1
Rated operational voltage U_e	690 V AC
Rated frequency	DC, 50/60 Hz
Trip class	10A
Number of poles	3
Duty time	100 %
Operating frequency without early tripping	Up to 15 operations/h, see "Technical diagram – Intermittent periodic duty"
Rated impulse withstand voltage U_{imp}	6 kV
Rated insulation voltage U_i	690 V AC

Auxiliary circuit according to IEC/EN

Type	TA75DU-M
Rated operational voltage U_e	500 V AC, 440 V DC
Conventional free air thermal current I_{th}	N.C., 95-96 10 A N.O., 97-98 6 A
Rated frequency	DC, 50/60 Hz
Number of poles	1 N.O. + 1 N.C.
I_e / Rated operational current AC-15 acc. to IEC/EN 60947-5-1 for utilization category	
110-120 V	N.C., 95-96 3.00 A N.O., 97-98 1.50 A
220-230-240 V	N.C., 95-96 3.00 A N.O., 97-98 1.50 A
440 V	N.C., 95-96 1.00 A N.O., 97-98 1.00 A
480-500 V	N.C., 95-96 1.00 A N.O., 97-98 1.00 A
I_e / Rated operational current DC-13 acc. to IEC/EN 60947-5-1 for utilization category	
24 V	N.C., 95-96 1.25 A N.O., 97-98 1.25 A
60 V	N.C., 95-96 0.25 A N.O., 97-98 0.25 A
110-120-125 V	N.C., 95-96 0.25 A N.O., 97-98 0.25 A
250 V	N.C., 95-96 0.12 A N.O., 97-98 0.04 A
Minimum switching capacity	17 V / 3 mA
Short-circuit protective device	N.C., 95-96 10 A, Fuse type gG N.O., 97-98 6 A, Fuse type gG
Rated impulse withstand voltage U_{imp}	6 kV
Rated insulation voltage U_i	690 V

Technical diagram – Intermittent periodic duty

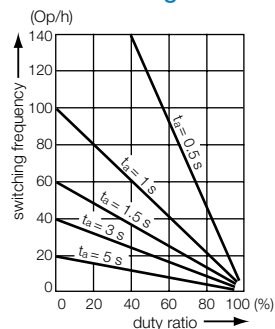

t_a : Motor starting time

2CDC232005F0211

TA75DU-M thermal overload relays



Technical data

General technical data





Type	TA75DU-M	
Pollution degree	3	
Phase loss sensitive	Yes	
Ambient air temperature		
Operation	Open - compensated	-25 ... +55 °C
	Open	-25 ... +55 °C
Storage	-40 ... +70 °C	
Ambient air temperature compensation	Acc. to IEC/EN60947-4-1	
Maximum operating altitude permissible	2000 m	
Resistance to shock acc. to IEC 60068-2-27	12g / 15 ms	
Mounting position	Position 1-6	
Mounting	Mount on the contactor and tighten the screws of the main circuit terminals or with single mounting kit on DIN rail (35 mm)	
Degree of protection	Housing	IP20
	Main circuit terminals	IP10

Electrical connection

Main circuit

Type	TA75DU-M	
Connecting capacity		
	 Rigid	1 x 2.5 ... 25 mm ² 2 x 2.5 ... 16 mm ²
	 Flexible with insulated ferrule	1 x 2.5 ... 25 mm ² 2 x 2.5 ... 10 mm ²
Stripping length	14 mm	
Tightening torques	4.5 Nm	
Connection screw	M6 (Pozidriv 2)	

Auxiliary circuit

Type	TA75DU-M	
Connecting capacity		
	 Rigid	1 x or 2 x 0.75 ... 4 mm ²
	 Flexible with ferrule	1 x or 2 x 0.75 ... 2.5 mm ²
	 Flexible with insulated ferrule	1 x or 2 x 0.75 ... 2.5 mm ²
	 Flexible	1 x or 2 x 0.75 ... 2.5 mm ²
Stripping length	9 mm	
Tightening torques	0.8 ... 1.3 Nm	
Connection screw	M3.5 (Pozidriv 2)	

TA80DU thermal overload relays

29 ... 80 A



2CDC231008F0011

TA80DU-80

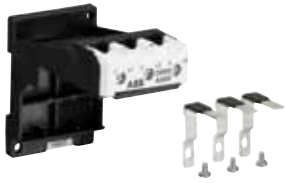

2CDC23100750010

DB80



1SFC151402F0001

KPR-101L

Description

The TA80DU thermal overload relays are economic electromechanical protection devices for the main circuit. They offer reliable protection for motors in the event of overload or phase failure. The devices have trip class 10A.

The thermal overload relays are three pole relays with bimetal tripping elements. The motor current flows through the bimetal tripping elements and heats them directly and indirectly. In case of an overload (over current), the bimetal elements bent as a result of the heating. This leads to a release of the relay and a change of the contacts switching position (95-96 / 97-98).

- Manual or automatic reset selectable
- Phase loss sensitive acc. to IEC/EN 60947-4-1
- Two electrically isolated auxiliary contacts – 1 N.O. + 1 N.C.
- TEST and STOP function – Trip indication on the front
- Temperature compensation
- Suitable for three- and single-phase applications

Ordering details

Setting range	Short-circuit protective device	Trip class	Type	Order code	Weight (1 pce) kg
A					
29 ... 42	100 A, Fuse type gG / 80 A aM	10A	TA80DU-42	1SAZ331201R1003	0.360
36 ... 52	125 A, Fuse type gG / 100 A aM	10A	TA80DU-52	1SAZ331201R1004	0.365
45 ... 63	160 A, Fuse type gG / 125 A aM	10A	TA80DU-63	1SAZ331201R1005	0.365
60 ... 80	200 A, Fuse type gG / 160 A aM	10A	TA80DU-80	1SAZ331201R1006	0.375

Ordering details accessories

For thermal overload relay	Description	Type	Order code	Weight (1 pce) kg
A				
TA80DU	Single mounting kit	DB80	1SAZ301110R0001	0.155
TA80DU	Reset push button*	KPR-101L	1SFA616162R1014	0.027

*Note: for more information see catalogue 1SFC151004C0201

Main dimensions mm, inches

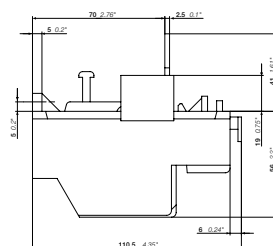
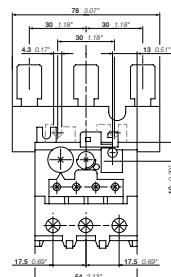

2CDC232018F0011

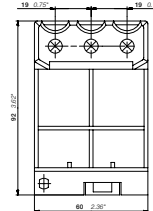

DB80

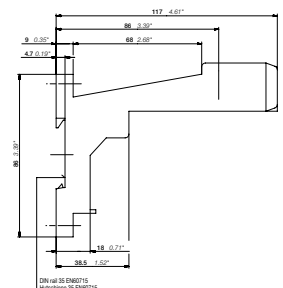

2CDC232025F0011

2CDC106044C0201

TA80DU thermal overload relays

Technical data

Main circuit – Utilization characteristics according to IEC/EN

Type	TA80DU
Standards	IEC 60947-1 / 60947-4-1 and EN 60947-1 / 60947-4-1
Rated operational voltage U_n	690 V AC
Rated frequency	DC, 50/60 Hz
Frequency range	0 ... 400 Hz
Trip class	10A
Number of poles	3
Duty time	100 %
Operating frequency without early tripping	Up to 15 operations/h, see "Technical diagram – Intermittent periodic duty"
Rated impulse withstand voltage U_{imp}	6 kV
Rated insulation voltage U_i	690 V AC

Auxiliary circuit according to IEC/EN

Type	TA80DU
Rated operational voltage U_n	500 V AC, 440 V DC
Conventional free air thermal current I_{th}	N.C., 95-96 10 A N.O., 97-98 6 A
Rated frequency	DC, 50/60 Hz
Number of poles	1 N.O. + 1 N.C.
I_e / Rated operational current AC-15 acc. to IEC/EN 60947-5-1 for utilization category	
110-120 V	N.C., 95-96 3.00 A N.O., 97-98 1.50 A
220-230-240 V	N.C., 95-96 3.00 A N.O., 97-98 1.50 A
440 V	N.C., 95-96 1.00 A N.O., 97-98 1.00 A
480-500 V	N.C., 95-96 1.00 A N.O., 97-98 1.00 A
I_e / Rated operational current DC-13 acc. to IEC/EN 60947-5-1 for utilization category	
24 V	N.C., 95-96 1.25 A N.O., 97-98 1.25 A
60 V	N.C., 95-96 0.25 A N.O., 97-98 0.25 A
110-120-125 V	N.C., 95-96 0.25 A N.O., 97-98 0.25 A
250 V	N.C., 95-96 0.12 A N.O., 97-98 0.04 A
Minimum switching capacity	17 V / 3 mA
Short-circuit protective device	N.C., 95-96 10 A, Fuse type gG N.O., 97-98 6 A, Fuse type gG
Rated impulse withstand voltage U_{imp}	6 kV
Rated insulation voltage U_i	690 V

Technical diagram – Intermittent periodic duty

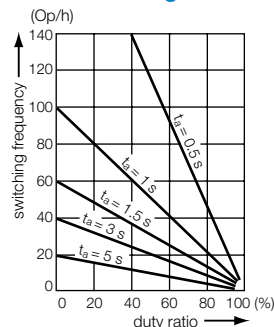

t_s : Motor starting time

2CDC32005F0211

2CDC106044C0201

TA80DU thermal overload relays

Technical data

Main circuit – Utilization characteristics according to UL/CSA

Type	TA80DU
Standards	UL 508, CSA 22.2 No. 14
Maximum operational voltage	600 V AC
Trip rating	125 % of FLA
Full load amps (FLA)	See table "Full load amps and short-circuit protective device"
Short-circuit rating RMS symmetrical	See table "Full load amps and short-circuit protective device"
Short-circuit protective device	See table "Full load amps and short-circuit protective device"

4 Auxiliary circuit according to UL/CSA

Type	TA80DU
Contact rating	N.C., 95-96 C600 N.O., 97-98 B600
Conventional thermal current	5 A

Full load amps and short-circuit protective device

Type	Full load amps (FLA)	Short-circuit protective device		
		480 / 600 V AC Short circuit rating RMS symmetrical	Fuse type	Listed circuit breaker
TA80DU-42	42 A	5 kA	150 A, K5 / RK5	80 A
TA80DU-52	52 A	5 kA	175 A, K5 / RK5	125 A
TA80DU-63	63 A	10 kA	200 A, K5 / RK5	125 A
TA80DU-80	80 A	10 kA	250 A, K5 / RK5	125 A

TA80DU thermal overload relays



Technical data

General technical data





Type	TA80DU	
Pollution degree	3	
Phase loss sensitive	Yes	
Ambient air temperature		
Operation	Open - compensated	-25 ... +55 °C
	Open	-25 ... +55 °C
Storage	-40 ... +70 °C	
Ambient air temperature compensation	Acc. to IEC/EN60947-4-1	
Maximum operating altitude permissible	2000 m	
Resistance to shock acc. to IEC 60068-2-27	12g / 15 ms	
Mounting position	Position 1-6	
Mounting	Mount on the contactor and tighten the screws of the main circuit terminals or with single mounting kit on DIN rail (35 mm)	
Degree of protection	Housing	IP20
	Main circuit terminals	IP10

Electrical connection

Main circuit

Type	TA80DU	
Connecting capacity		
 Rigid	1 x	2.5 ... 25 mm ²
	2 x	2.5 ... 16 mm ²
 Flexible with insulated ferrule	1 x	2.5 ... 25 mm ²
	2 x	2.5 ... 10 mm ²
	Stranded acc. to UL/CSA	1 x or 2 x AWG 8-1
	Flexible acc. to UL/CSA	1 x or 2 x AWG 8-1
Stripping length	14 mm	
Tightening torques	4.5 Nm / 40 lb.in	
Connection screw	M6 (Pozidriv 2)	

Auxiliary circuit

Type	TA80DU	
Connecting capacity		
 Rigid	1 x or 2 x	0.75 ... 4 mm ²
 Flexible with ferrule	1 x or 2 x	0.75 ... 2.5 mm ²
 Flexible with insulated ferrule	1 x or 2 x	0.75 ... 2.5 mm ²
 Flexible	1 x or 2 x	0.75 ... 2.5 mm ²
	Stranded acc. to UL/CSA	1 x or 2 x AWG 18-14
	Flexible acc. to UL/CSA	1 x or 2 x AWG 18-14
Stripping length	9 mm	
Tightening torques	0.8 ... 1.3 Nm / 12 lb.in	
Connection screw	M3.5 (Pozidriv 2)	

TA110DU thermal overload relays

66 ... 110 A



2CDC2311009F0011

TA110DU-110



1SFC1514029F0001

KPR-101L

Description

The TA110DU thermal overload relays are economic electromechanical protection devices for the main circuit. They offer reliable protection for motors in the event of overload or phase failure. The devices have trip class 10A.

The thermal overload relays are three pole relays with bimetal tripping elements. The motor current flows through the bimetal tripping elements and heats them directly and indirectly. In case of an overload (over current), the bimetal elements bent as a result of the heating. This leads to a release of the relay and a change of the contacts switching position (95-96 / 97-98).

- Manual or automatic reset selectable
- Phase loss sensitive acc. to IEC/EN 60947-4-1
- Two electrically isolated auxiliary contacts – 1 N.O. + 1 N.C.
- TEST and STOP function – Trip indication on the front
- Temperature compensation
- Suitable for three- and single-phase applications

Ordering details

Setting range	Short-circuit protective device	Trip class	Type	Order code	Weight (1 pce) kg
A					
66 ... 90	200 A, Fuse type gG / 160 A aM	10A	TA110DU-90	1SAZ411201R1001	0.750
80 ... 110	224 A, Fuse type gG / 200 A aM	10A	TA110DU-110	1SAZ411201R1002	0.755

Ordering details accessories

For thermal overload relays	Description	Type	Order code	Weight (1 pce) kg
A				
TA110DU	Single mounting kit	DB200	1SAZ401110R0001	0.225
TA110DU	Reset push button*	KPR-101L	1SFA616162R1014	0.027

*Note: for more information see catalogue 1SFC151004C0201

Main dimensions mm, inches

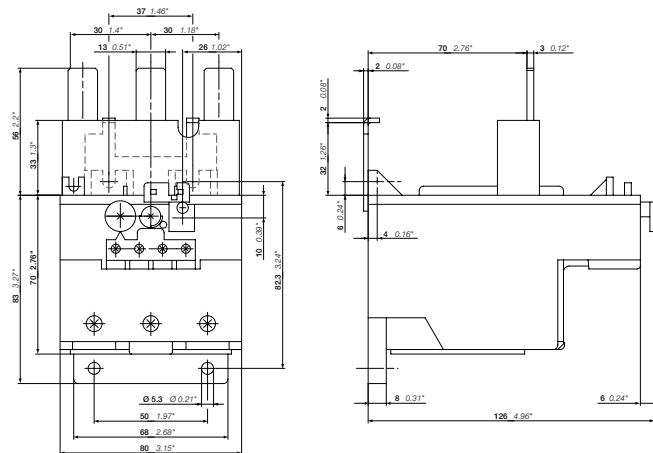

TA110DU

2CDC23020F0011

2CDC106037C0201

TA110DU thermal overload relays

Technical data

Main circuit – Utilization characteristics according to IEC/EN

Type	TA110DU
Standards	IEC 60947-1 / 60947-4-1 and EN 60947-1 / 60947-4-1
Rated operational voltage U_n	690 V AC
Rated frequency	DC, 50/60 Hz
Frequency range	0 ... 400 Hz
Trip class	10A
Number of poles	3
Duty time	100 %
Operating frequency without early tripping	Up to 15 operations/h, see "Technical diagram – Intermittent periodic duty"
Rated impulse withstand voltage U_{imp}	6 kV
Rated insulation voltage U_i	690 V AC

Auxiliary circuit according to IEC/EN

Type	TA110DU
Rated operational voltage U_n	500 V AC, 440 V DC
Conventional free air thermal current I_{th}	N.C., 95-96 10 A N.O., 97-98 6 A
Rated frequency	DC, 50/60 Hz
Number of poles	1 N.O. + 1 N.C.
I_e / Rated operational current AC-15 acc. to IEC/EN 60947-5-1 for utilization category	
110-120 V	N.C., 95-96 3.00 A N.O., 97-98 1.50 A
220-230-240 V	N.C., 95-96 3.00 A N.O., 97-98 1.50 A
440 V	N.C., 95-96 1.00 A N.O., 97-98 1.00 A
480-500 V	N.C., 95-96 1.00 A N.O., 97-98 1.00 A
I_e / Rated operational current DC-13 acc. to IEC/EN 60947-5-1 for utilization category	
24 V	N.C., 95-96 1.25 A N.O., 97-98 1.25 A
60 V	N.C., 95-96 0.25 A N.O., 97-98 0.25 A
110-120-125 V	N.C., 95-96 0.25 A N.O., 97-98 0.25 A
250 V	N.C., 95-96 0.12 A N.O., 97-98 0.04 A
Minimum switching capacity	17 V / 3 mA
Short-circuit protective device	N.C., 95-96 10 A, Fuse type gG N.O., 97-98 6 A, Fuse type gG
Rated impulse withstand voltage U_{imp}	6 kV
Rated insulation voltage U_i	690 V

Technical diagram – Intermittent periodic duty

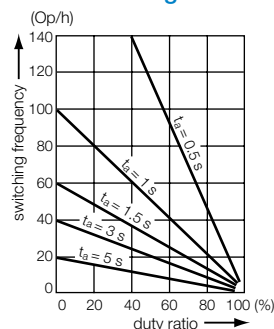

t_s : Motor starting time

2CDC32005F0211

2CDC106037C0201

TA110DU thermal overload relays

Technical data

Main circuit – Utilization characteristics according to UL/CSA

Type	TA110DU
Standards	UL 508, CSA 22.2 No. 14
Maximum operational voltage	600 V AC
Trip rating	125 % of FLA
Full load amps (FLA)	See table "Full load amps and short-circuit protective device"
Short-circuit rating RMS symmetrical	See table "Full load amps and short-circuit protective device"
Short-circuit protective device	See table "Full load amps and short-circuit protective device"

4 Auxiliary circuit according to UL/CSA

Type	TA110DU
Contact rating	N.C., 95-96 C600 N.O., 97-98 B600
Conventional thermal current	5 A

Full load amps and short-circuit protective device

Type	Full load amps (FLA)	Short-circuit protective device							
		480 / 600 V AC		Fuse type		Listed circuit breaker		Listed circuit breaker	
		Short circuit rating RMS symmetrical	Fuse type	Listed circuit breaker	Short circuit rating RMS symmetrical	Fuse type	Short circuit rating RMS symmetrical	Listed circuit breaker	
TA110DU-90	90 A	10 kA	250 A, K5 / RK5	150 A	65 kA	200 A, Class J	65 / 25 kA	150 A	
TA110DU-110	110 A	10 kA	250 A, K5 / RK5	250 A	65 kA	200 A, Class J	65 / 25 kA	150 A	

TA110DU thermal overload relays



Technical data

General technical data





Type	TA110DU	
Pollution degree	3	
Phase loss sensitive	Yes	
Ambient air temperature		
Operation	Open - compensated	-25 ... +55 °C
	Open	-25 ... +55 °C
Storage	-40 ... +70 °C	
Ambient air temperature compensation	Acc. to IEC/EN60947-4-1	
Maximum operating altitude permissible	2000 m	
Resistance to shock acc. to IEC 60068-2-27	12g / 15 ms	
Mounting position	Position 1-6	
Mounting	Mount on the contactor and tighten the screws of the main circuit terminals or with single mounting kit	
Degree of protection	Housing	IP20
	Main circuit terminals	IP10

Electrical connection

Main circuit

Type	TA110DU	
Connecting capacity		
 Rigid	1 x	16 ... 35 mm ²
	2 x	-
 Flexible	1 x	16 ... 35 mm ²
	2 x	-
	Stranded acc. to UL/CSA	1 x or 2 x AWG 6-2/0
	Flexible acc. to UL/CSA	1 x or 2 x AWG 6-2/0
Stripping length	25 mm	
Tightening torques	7.2 ... 9.6 Nm / 40 lb.in	
Connection screw	M8 (Hexagon)	

Auxiliary circuit

Type	TA110DU	
Connecting capacity		
 Rigid	1 x or 2 x	0.75 ... 4 mm ²
 Flexible with ferrule	1 x or 2 x	0.75 ... 2.5 mm ²
 Flexible with insulated ferrule	1 x or 2 x	0.75 ... 2.5 mm ²
 Flexible	1 x or 2 x	0.75 ... 2.5 mm ²
	Stranded acc. to UL/CSA	1 x or 2 x AWG 18-14
	Flexible acc. to UL/CSA	1 x or 2 x AWG 18-14
Stripping length	9 mm	
Tightening torques	0.8 ... 1.3 Nm / 12 lb.in	
Connection screw	M3.5 (Pozidriv 2)	

TA200DU thermal overload relays

66 ... 200 A



2CDC23201F0013

TA200DU

4



1SFC151402F0001

KPR-101L

Description

The TA200DU thermal overload relays are economic electromechanical protection devices for the main circuit. They offer reliable protection for motors in the event of overload or phase failure. The devices have trip class 10A.

The thermal overload relays are three pole relays with bimetal tripping elements. The motor current flows through the bimetal tripping elements and heats them directly and indirectly. In case of an overload (over current), the bimetal elements bent as a result of the heating. This leads to a release of the relay and a change of the contacts switching position (95-96 / 97-98).

- Manual or automatic reset selectable
- Phase loss sensitive acc. to IEC/EN 60947-4-1
- TEST and STOP function – Trip indication on the front
- Temperature compensation
- Suitable for three- and single-phase applications

Ordering details

Setting range	Short-circuit protective device	Trip class	Type	Order code	Weight (1 pce) kg
A					
66 ... 90	200 A, Fuse type gG / 125 A aM	10A	TA200DU-90	1SAZ421201R1001	0.755
80 ... 110	224 A, Fuse type gG / 160 A aM	10A	TA200DU-110	1SAZ421201R1002	0.760
100 ... 135	224 A, Fuse type gG / 200 A aM	10A	TA200DU-135	1SAZ421201R1003	0.760
110 ... 150	250 A, Fuse type gG / 200 A aM	10A	TA200DU-150	1SAZ421201R1004	0.760
130 ... 175	315 A, Fuse type gG / 250 A aM	10A	TA200DU-175	1SAZ421201R1005	0.770
150 ... 200	315 A, Fuse type gG / 250 A aM	10A	TA200DU-200	1SAZ421201R1006	0.785

Ordering details accessories

For thermal overload relays	Description	Type	Order code	Weight (1 pce) kg
A				
TA200DU	Terminal shroud	LT200/A	1SAZ401901R1001	0.090
TA200DU	Single mounting kit	DB200	1SAZ401110R0001	0.225
TA200DU	Reset push button*	KPR-101L	1SFA616162R1014	0.027

*Note: for more information see catalogue 1SFC151004C0201

Main dimensions mm, inches

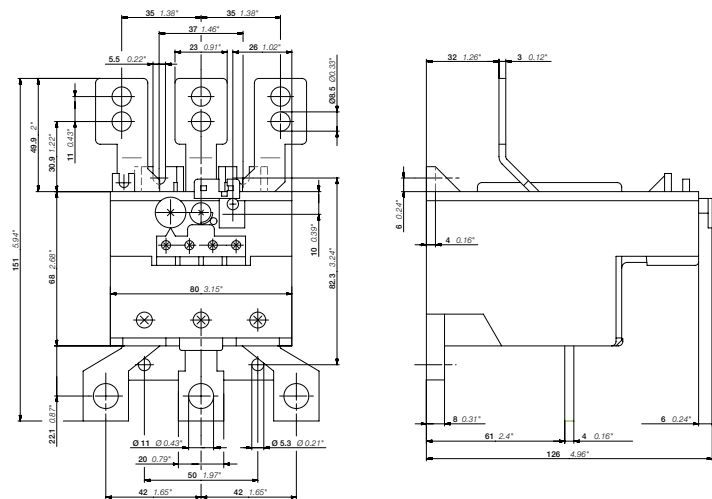

TA200DU

2CDC23201F0011

2CDC106038C0201

TA200DU thermal overload relays

Technical data

Main circuit – Utilization characteristics according to IEC/EN

Type	TA200DU
Standards	IEC/EN 60947-1, IEC/EN 60947-4-1
Rated operational voltage U_n	690 V AC
Rated frequency	DC, 50/60 Hz
Frequency range	0 ... 400 Hz
Trip class	10A
Number of poles	3
Duty time	100 %
Operating frequency without early tripping	Up to 15 operations/h, see "Technical diagram – Intermittent periodic duty"
Rated impulse withstand voltage U_{imp}	6 kV
Rated insulation voltage U_i	690 V AC

Auxiliary circuit according to IEC/EN

Type	TA200DU
Rated operational voltage U_n	500 V AC, 440 V DC
Conventional free air thermal current I_{th}	N.C., 95-96 10 A N.O., 97-98 6 A
Rated frequency	DC, 50/60 Hz
Number of poles	1 N.O. + 1 N.C.
I_e / Rated operational current AC-15 acc. to IEC/EN 60947-5-1 for utilization category	
110-120 V	N.C., 95-96 3.00 A N.O., 97-98 1.50 A
220-230-240 V	N.C., 95-96 3.00 A N.O., 97-98 1.50 A
440 V	N.C., 95-96 1.00 A N.O., 97-98 1.00 A
480-500 V	N.C., 95-96 1.00 A N.O., 97-98 1.00 A
I_e / Rated operational current DC-13 acc. to IEC/EN 60947-5-1 for utilization category	
24 V	N.C., 95-96 1.25 A N.O., 97-98 1.25 A
60 V	N.C., 95-96 0.25 A N.O., 97-98 0.25 A
110-120-125 V	N.C., 95-96 0.25 A N.O., 97-98 0.25 A
250 V	N.C., 95-96 0.12 A N.O., 97-98 0.04 A
Minimum switching capacity	17 V / 3 mA
Short-circuit protective device	N.C., 95-96 10 A, Fuse type gG N.O., 97-98 6 A, Fuse type gG
Rated impulse withstand voltage U_{imp}	6 kV
Rated insulation voltage U_i	690 V

Technical diagram – Intermittent periodic duty

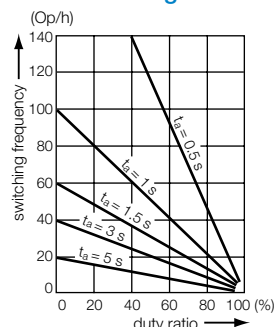

t_s : Motor starting time

2CDC32005F0211

2CDC106038C0201

TA200DU thermal overload relays

Technical data

Main circuit – Utilization characteristics according to UL/CSA

Type	TA200DU
Standards	UL 508, CSA 22.2 No. 14
Maximum operational voltage	600 V AC
Trip rating	125 % of FLA
Full load amps (FLA)	See table "Full load amps and short-circuit protective device"
Short-circuit rating RMS symmetrical	See table "Full load amps and short-circuit protective device"
Short-circuit protective device	See table "Full load amps and short-circuit protective device"

4 Auxiliary circuit according to UL/CSA

Type	TA200DU	
Contact rating	N.C., 95-96	C600
	N.O., 97-98	B600
Conventional thermal current	5 A	

Full load amps and short-circuit protective device

Type	Full load amps (FLA)	Short-circuit protective device							
		480 / 600 V AC							
		Short circuit rating RMS symmetrical	Fuse type	Listed circuit breaker	Short circuit rating RMS symmetrical	Fuse type	Short circuit rating RMS symmetrical	Listed circuit breaker	
TA200DU-90	90 A	10 kA	250 A, K5 / RK5	225 A	100 kA	250 A, Class J	100 kA	250 A	
TA200DU-110	110 A	10 kA	250 A, K5 / RK5	225 A	100 kA	250 A, Class J	100 kA	250 A	
TA200DU-135	135 A	10 kA	300 A, K5 / RK5	225 A	100 kA	250 A, Class J	100 kA	250 A	
TA200DU-150	150 A	10 kA	300 A, K5 / RK5	225 A	100 kA	250 A, Class J	100 kA	250 A	
TA200DU-175	175 A	10 kA	300 A, K5 / RK5	225 A	100 kA	300 A, Class J	100 kA	300 A	
TA200DU-200	200 A	10 kA	400 A, K5 / RK5	400 A	100 kA	400 A, Class J	100 kA	400 A	

TA200DU thermal overload relays



Technical data

General technical data





Type	TA200DU	
Pollution degree	3	
Phase loss sensitive	Yes	
Ambient air temperature		
Operation	Open - compensated	-25 ... +55 °C
	Open	-25 ... +55 °C
Storage	-40 ... +70 °C	
Ambient air temperature compensation	Acc. to IEC/EN60947-4-1	
Maximum operating altitude permissible	2000 m	
Resistance to shock acc. to IEC 60068-2-27	12g / 15 ms	
Mounting position	Position 1-6	
Mounting	Mount on the contactor and tighten the screws of the main circuit terminals or with single mounting kit	
Degree of protection	Housing	IP20
	Main circuit terminals	IP00

Electrical connection

Main circuit

Type	TA200DU	
Connecting capacity		
 Rigid	1 x	25 ... 120 mm ²
 Flexible	1 x	25 ... 120 mm ²
	Stranded acc. to UL/CSA	1 x AWG 4 ... 0000
	Flexible acc. to UL/CSA	1 x AWG 4 ... 0000
	Lugs	L > 10 mm
Tightening torques	25 Nm / 220 lb.in	
Connection screw	Open bars	

Auxiliary circuit

Type	TA200DU	
Connecting capacity		
 Rigid	1 x or 2 x	0.75 ... 4 mm ²
 Flexible with ferrule	1 x or 2 x	0.75 ... 2.5 mm ²
 Flexible with insulated ferrule	1 x or 2 x	0.75 ... 2.5 mm ²
 Flexible	1 x or 2 x	0.75 ... 2.5 mm ²
	Stranded acc. to UL/CSA	1 x or 2 x AWG 18 ... 14
	Flexible acc. to UL/CSA	1 x or 2 x AWG 18 ... 14
Stripping length	9 mm	
Tightening torques	0.8 ... 1.3 Nm / 12 lb.in	
Connection screw	M3.5 (Pozidriv 2)	

TA450DU, TA450SU thermal overload relays

40 ... 310 A



2CDC33101F0011

TA450DU-310



1SFC151402F0001

KPR-101L

Description

The TA450DU, TA450SU thermal overload relays are economic electromechanical protection devices for the main circuit. They offer reliable protection for motors in the event of overload or phase failure. The TA450DU devices have trip class 10A, the TA450SU devices have trip class 30.

The thermal overload relays are three pole relays with bimetal tripping elements. The motor current flows through the bimetal tripping elements and heats them directly and indirectly. In case of an overload (over current), the bimetal elements bent as a result of the heating. This leads to a release of the relay and a change of the contacts switching position (95-96 / 97-98).

- Manual or automatic reset selectable
- Phase loss sensitive acc. to IEC/EN 60947-4-1
- Two electrically isolated auxiliary contacts - 1 N.O. + 1 N.C.
- TEST and STOP function - Trip indication on the front
- Temperature compensation
- Suitable for three- and single-phase applications

Ordering details

Setting range	Short-circuit protective device	Trip class	Type	Order code	Weight (1 pce) kg
A					
Thermal overload relays TA450DU					
130 ... 185	not applicable	10A	TA450DU-185	1SAZ511201R1001	1.500
165 ... 235	not applicable	10A	TA450DU-235	1SAZ511201R1002	1.500
220 ... 310	not applicable	10A	TA450DU-310	1SAZ511201R1003	1.500
Thermal overload relays TA450SU					
40 ... 60	not applicable	30	TA450SU-60	1SAZ611201R1005	1.500
55 ... 80	not applicable	30	TA450SU-80	1SAZ611201R1006	1.500
70 ... 105	not applicable	30	TA450SU-105	1SAZ611201R1007	1.500
95 ... 140	not applicable	30	TA450SU-140	1SAZ611201R1008	1.500
130 ... 185	not applicable	30	TA450SU-185	1SAZ611201R1001	1.500
165 ... 235	not applicable	30	TA450SU-235	1SAZ611201R1002	1.500
220 ... 310	not applicable	30	TA450SU-310	1SAZ611201R1003	1.500

Ordering details accessories

For thermal overload relays	Description	Type	Order code	Weight (1 pce) kg
A				
TA450DU, TA450SU	Terminal shroud	DT450/A185	1SAZ501901R1001	1.070
TA450DU, TA450SU	Terminal shroud	DT450/A300	1SAZ501902R1001	1.180
TA450DU, TA450SU	Reset push button*	KPR-101L	1SFA616162R1014	0.027

*Note: for more information see catalogue 1SFC151004C0201

Main dimensions mm, inches

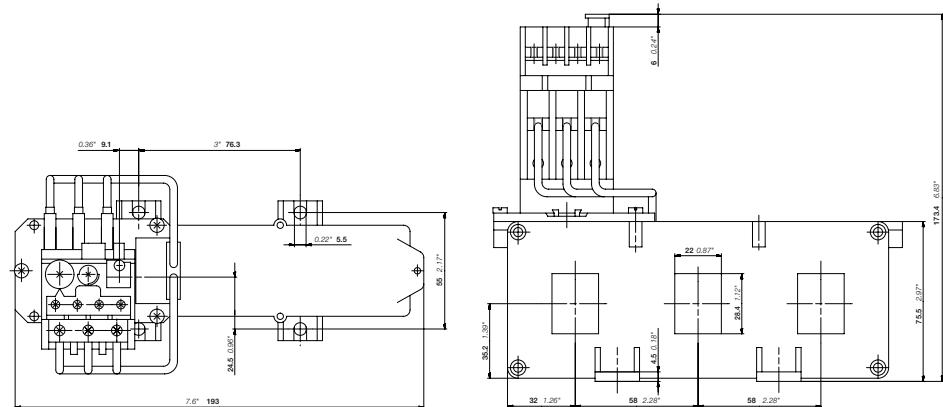

TA450DU, TA450SU

2CDC33202F0011

2CDC106041C0201

TA450DU, TA450SU thermal overload relays

Technical data

Main circuit – Utilization characteristics according to IEC/EN

Type	TA450DU, TA450SU
Standards	IEC 60947-1 / 60947-4-1 and EN 60947-1 / 60947-4-1
Rated operational voltage U_n	1000 V AC
Rated frequency	50/60 Hz
Trip class	10A / 30
Number of poles	3
Duty time	100 %
Operating frequency without early tripping	Up to 15 operations/h, see "Technical diagram – Intermittent periodic duty"
Rated impulse withstand voltage U_{imp}	8 kV
Rated insulation voltage U_i	1000 V AC

Auxiliary circuit according to IEC/EN

Type	TA450DU, TA450SU
Rated operational voltage U_n	500 V AC, 440 V DC
Conventional free air thermal current I_{th}	N.C., 95-96 10 A N.O., 97-98 6 A
Rated frequency	DC, 50/60 Hz
Number of poles	1 N.O. + 1 N.C.
I_e / Rated operational current AC-15 acc. to IEC/EN 60947-5-1 for utilization category	
110-120 V	N.C., 95-96 3.00 A N.O., 97-98 1.50 A
220-230-240 V	N.C., 95-96 3.00 A N.O., 97-98 1.50 A
440 V	N.C., 95-96 1.00 A N.O., 97-98 1.00 A
480-500 V	N.C., 95-96 1.00 A N.O., 97-98 1.00 A
I_e / Rated operational current DC-13 acc. to IEC/EN 60947-5-1 for utilization category	
24 V	N.C., 95-96 1.25 A N.O., 97-98 1.25 A
60 V	N.C., 95-96 0.25 A N.O., 97-98 0.25 A
110-120-125 V	N.C., 95-96 0.25 A N.O., 97-98 0.25 A
250 V	N.C., 95-96 0.12 A N.O., 97-98 0.04 A
Minimum switching capacity	17 V / 3 mA
Short-circuit protective device	N.C., 95-96 10 A, Fuse type gG N.O., 97-98 6 A, Fuse type gG
Rated impulse withstand voltage U_{imp}	6 kV
Rated insulation voltage U_i	500 V

Technical diagram – Intermittent periodic duty

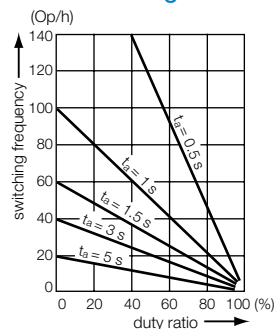

t_s : Motor starting time

2CDC232005F0211

2CDC106041C0201

TA450DU, TA450SU thermal overload relays

Technical data

Main circuit – Utilization characteristics according to UL/CSA

Type	TA450DU, TA450SU
Standards	UL 508, CSA 22.2 No. 14
Maximum operational voltage	600 V AC
Trip rating	125 % of FLA
Full load amps (FLA)	See table "Full load amps and short-circuit protective device"
Short-circuit rating RMS symmetrical	See table "Full load amps and short-circuit protective device"
Short-circuit protective device	See table "Full load amps and short-circuit protective device"

4 Auxiliary circuit according to UL/CSA

Type	TA450DU, TA450SU	
Contact rating	N.C., 95-96	C600
	N.O., 97-98	B600
Conventional thermal current	5 A	

Full load amps and short-circuit protective device

Type	Full load amps (FLA)	Short-circuit protective device		
		480 / 600 V AC Short circuit rating RMS symmetrical	Fuse type	Listed circuit breaker
TA450DU-185	185 A	10 kA	na	na
TA450DU-235	235 A	10 kA	na	na
TA450DU-310	310 A	18 kA	na	na

TA450DU, TA450SU thermal overload relays

Technical data

General technical data





Type	TA450DU, TA450SU	
Pollution degree	3	
Phase loss sensitive	Yes	
Ambient air temperature		
Operation	Open - compensated	-25 ... +55 °C
	Open	-25 ... +55 °C
Storage	-40 ... +70 °C	
Ambient air temperature compensation	Acc. to IEC/EN60947-4-1	
Maximum operating altitude permissible	2000 m	
Resistance to shock acc. to IEC 60068-2-27	12g / 15 ms	
Mounting position	Position 1-6	
Degree of protection	Housing	IP20
	Main circuit terminals	IP10

Electrical connection

Main circuit

Type	TA450DU, TA450SU	
Connecting capacity		
	Bar	Max. 21 x 28.4 mm

Auxiliary circuit

Type	TA450DU, TA450SU	
Connecting capacity		
 Rigid	1 x or 2 x	0.75 ... 4 mm ²
 Flexible with ferrule	1 x or 2 x	0.75 ... 2.5 mm ²
 Flexible with insulated ferrule	1 x or 2 x	0.75 ... 2.5 mm ²
 Flexible	1 x or 2 x	0.75 ... 2.5 mm ²
	Stranded acc. to UL/CSA	AWG 18-14
	Flexible acc. to UL/CSA	AWG 18-14
Stripping length	9 mm	
Tightening torques	0.8 ... 1.3 Nm / 12 lb.in	
Connection screw	M3.5 (Pozidriv 2)	

Coordination with short-circuit protection devices

In compliance with standards IEC 60947-4-1 and EN 60947-4-1, we define for the contactors and starters the type, rating and characteristics of the short-circuit protection devices SCPD which allow selective protection against overloads and ensure protection against short circuits.

Basic functions

Any starter is designed to:

- start motors,
- ensure continuous functioning of motors,
- disconnect motors from the supply line,
- guarantee protection of motors against overloads.

The starter is typically made up of a switching device (contactor) and an overload protection device (thermal overload relay or electronic overload relay).

These two devices MUST be coordinated with equipment capable of providing protection against short circuit (SCPD: short circuit protective device): typically a circuit breaker with magnetic release only or a switch fuse. These are not necessarily part of the starter.

5

Applicable standards

IEC 60947-4-1 (EN 60947-4-1) precisely defines the different points to be considered in order to carry out correct coordination.

Complete coordination for a combination includes the following points:

- Selectivity test between the overload relay and the short-circuit protection device SCPD.
- Short-circuit condition tests:
 - at prospective "r" currents - These currents depend on the rated operational current of the starter (**I_e** AC-3) and are given by the standard (Table 13). For example:
 - r = 1kA for **I_e** AC-3 < 16 A
 - r = 3 kA for 16 A < **I_e** AC-3 < 63 A
 - r = 5 kA for 63 A < **I_e** AC-3 < 125 A etc.
 - at the rated conditional short-circuit current "**I_q**" - This is the maximum prospective current that the combination can withstand, for example 50 kA.

Types of coordination

IEC 60947-4-1 (EN 60947-4-1) defines two types of coordination according to the expected level of service continuity. Acceptable extreme damage for the switchgear is divided into two types.

Type 1: In short-circuit conditions, the contactor or starter does not endanger persons or installations and will not be able to then operate without being repaired or having parts replaced.

Type 2: In short-circuit conditions, the contactor or starter does not endanger persons or installations and will be able to operate afterwards. The risk of contacts light welding is acceptable. In this case, the manufacturer must stipulate the measures to be taken with respect to maintenance of the equipment.

The complete ABB offer

ABB has acquired years of experience with respect to problems of coordination and is able to make a complete offer based on tests performed in its qualified laboratories. This offer includes 400 V, 500 V, 690 V networks.

A complete data base of coordination tables, according to IEC 60947-4-1 (EN 60947-4-1), is available on the ABB Website.

In the coordination tables the following short-circuit protection devices are recommended:

- Moulded case circuit-breakers (MCCBs)
- Miniature circuit-breakers (MCBs)
- Switch-disconnector-fuses (aM, gG and BS)
- Manual Motor Starters (MMS).

General remarks applicable to all tables

- Each table is defined for a maximum ambient temperature of 40 °C. For higher temperatures, apply a derating factor according to the following rules:
 - Fuses: factor of 0.8 applied to **I_n** for an ambient temperature of 70 °C
 - MCCBs and MCBs: factor of 0.8 applied to **I_n** for an ambient temperature of 60 °C
 - The starter derating factor depends on the operating conditions of thermal overload relays:
 - Factor of 0.9 applied to **I_n** for an ambient temperature of 70 °C.
- Each table is defined for motor currents: 3-phase motors, 4-pole
- **Normal starting** means a starting time < 2 s. - **Difficult starting** means an accelerating time 10 s < **t_s** < 30 s
- **Tripping classes** of thermal overload relays according to IEC 60947-4-1 (EN 60947-4-1): 10A and 10
- **Tripping classes** of electronic overload relays according to IEC 60947-4-1 (EN 60947-4-1): 10E, 20E, 30E selectable
- In the tables with MCCBs, these are fitted with the magnetic relay alone. Setting is always carried out at > 12.3 **I_e** AC-3 so that the transient current peak occurring during starting does not lead to tripping.

Coordination with short-circuit protection devices

A complete data base of coordination tables, according to [IEC 60947-4-1](#) (EN 60947-4-1) or [UL 508 / UL 60947-4-1](#), is available on the ABB Website: see below.

Selection

Simple or multiple selections all from the same screen.

Short-circuit protection devices

- Air circuit breakers
- Fuses "gG" or "aM"
- Miniature circuit breaker
- Moulded case circuit breaker
- Manual motor starter

Starter type

- Direct-on-line normal start
- Direct-on-line heavy duty
- Star-delta normal start
- Soft starter normal start

Coordination

- IEC type 1 or type 2
- UL type A to Type F

Results

- Search results displayed at the bottom of the selection page.
- Only the most appropriate solutions to your application, will be displayed at the bottom of the page.
- "Enable Smart Current Search" function featured for the short-circuit current where "near to" selected values also are included in the result.
- Possible to print the page to a pdf file or from your printer.
- "Clear selection" function to deselect all selected.

Fuses, 400 V, 80 kA, DOL-N5, Coordination type IEC Type 2							
Motor	Fuses IEC	Contactor	Overload Relay				
Rated Power [kW]	Rated Current [A]	Switch-Fuse Type	Rating [A]	Type and Size	Type	Current setting range [A]	Max allowed load current [A]
0.37	1.1	OS32D	2	OFAM 80kM AS	E18DU2 7 10	1.30 - 2.70	1.4
0.37	1.1	OS32D	2	OFAM 80kM AS	TA2SDU 1.4	1.00 - 1.40	1.4
0.37	1.1	OS32D	3	OFAM 80kM AS	UMC22/100 10	0.24 - 03.00	1.4
0.37	1.1	OS32D	4	OPAA 60H AS	UMC22/100 10	0.24 - 03.00	1.3
0.37	1.1	OS32D	4	OPAA 60H AS	E18DU2 7 10	1.30 - 2.70	1.3
0.37	1.1	OS32D	4	OPAA 60H AS	TA2SDU 1.4	1.00 - 1.40	1.4

Fuses, 400 V, 80 kA, DOL-N5, Coordination type IEC Type 2, Overload Relay TOL							
Motor	Fuses IEC	Contactor	Overload Relay				
Rated Power [kW]	Rated Current [A]	Switch-Fuse Type	Rating [A]	Type and Size	Type	Current setting range [A]	Max allowed load current [A]
0.25	0.85	OS32D	2	OFAF 50kM AF29	TF42-1.6	0.74 - 1.00	1
0.12	0.44	OS32D	2	OFAF 30kH AF09	TF42-0.6E	0.42 - 0.55	0.55

Access

To find the coordination tables for motor protection, please see:

www.abb.com/lowvoltage then go to the right menu: "Support", select: "[Online Product Selection Tools](#)" then select "[Coordination Tables for motor protection](#)"

Index

Order code classification

Order code	Type	Page	Order code	Type	Page	Order code	Type	Page
1SAM101923R0002	MSMN	2/38	1SAM201920R1002	MSHD-LY	2/38	1SAM350005R1005	MS132-1.0-HKF1-11	2/8
1SAM101923R0012	MSMNO	2/38	1SAM201920R1011	MSHD-LTB	2/38	1SAM350005R1006	MS132-1.6-HKF1-11	2/8
1SAM201901R1001	HKF1-11	2/17	1SAM201920R1012	MSHD-LTY	2/38	1SAM350005R1007	MS132-2.5-HKF1-11	2/8
1SAM201901R1002	HKF1-20	2/17	1SAM250000R1001	MS116-0.16	2/4	1SAM350005R1008	MS132-4.0-HKF1-11	2/8
1SAM201902R1001	HK1-11	2/17	1SAM250000R1002	MS116-0.25	2/4	1SAM350005R1009	MS132-6.3-HKF1-11	2/8
1SAM201902R1002	HK1-20	2/17	1SAM250000R1003	MS116-0.4	2/4	1SAM350005R1010	MS132-10.0-HKF1-11	2/8
1SAM201902R1003	HK1-02	2/17	1SAM250000R1004	MS116-0.63	2/4	1SAM350005R1011	MS132-16.0-HKF1-11	2/8
1SAM201902R1004	HK1-20L	2/17	1SAM250000R1005	MS116-1.0	2/4	1SAM350005R1012	MS132-12.0-HKF1-11	2/8
1SAM201903R1001	SK1-11	2/17	1SAM250000R1006	MS116-1.6	2/4	1SAM350005R1013	MS132-20-HKF1-11	2/8
1SAM201903R1002	SK1-20	2/17	1SAM250000R1007	MS116-2.5	2/4	1SAM350005R1014	MS132-25-HKF1-11	2/8
1SAM201903R1003	SK1-02	2/17	1SAM250000R1008	MS116-4.0	2/4	1SAM350005R1015	MS132-32-HKF1-11	2/8
1SAM201904R1001	UA1-24	2/18	1SAM250000R1009	MS116-6.3	2/4	1SAM360000R1001	MO132-0.16	2/12
1SAM201904R1002	UA1-48	2/18	1SAM250000R1010	MS116-10	2/4	1SAM360000R1002	MO132-0.25	2/12
1SAM201904R1003	UA1-60	2/18	1SAM250000R1011	MS116-16	2/4	1SAM360000R1003	MO132-0.4	2/12
1SAM201904R1004	UA1-110	2/18	1SAM250000R1012	MS116-12	2/4	1SAM360000R1004	MO132-0.63	2/12
1SAM201904R1005	UA1-230	2/18	1SAM250000R1013	MS116-20	2/4	1SAM360000R1005	MO132-1.0	2/12
1SAM201904R1006	UA1-400	2/18	1SAM250000R1014	MS116-25	2/4	1SAM360000R1006	MO132-1.6	2/12
1SAM201904R1007	UA1-415	2/18	1SAM250000R1015	MS116-32	2/4	1SAM360000R1007	MO132-2.5	2/12
1SAM201904R1008	UA1-208	2/18	1SAM250005R1001	MS116-0.16-HKF1-11	2/4	1SAM360000R1008	MO132-4.0	2/12
1SAM201906R1102	PS1-2-0-65	2/21	1SAM250005R1002	MS116-0.25-HKF1-11	2/4	1SAM360000R1009	MO132-6.3	2/12
1SAM201906R1103	PS1-3-0-65	2/21	1SAM250005R1003	MS116-0.4-HKF1-11	2/4	1SAM360000R1010	MO132-10	2/12
1SAM201906R1104	PS1-4-0-65	2/21	1SAM250005R1004	MS116-0.63-HKF1-11	2/4	1SAM360000R1011	MO132-16	2/12
1SAM201906R1105	PS1-5-0-65	2/21	1SAM250005R1005	MS116-1.0-HKF1-11	2/4	1SAM360000R1012	MO132-12	2/12
1SAM201906R1112	PS1-2-1-65	2/21	1SAM250005R1006	MS116-1.6-HKF1-11	2/4	1SAM360000R1013	MO132-20	2/12
1SAM201906R1113	PS1-3-1-65	2/21	1SAM250005R1007	MS116-2.5-HKF1-11	2/4	1SAM360000R1014	MO132-25	2/12
1SAM201906R1114	PS1-4-1-65	2/21	1SAM250005R1008	MS116-4.0-HKF1-11	2/4	1SAM360000R1015	MO132-32	2/12
1SAM201906R1115	PS1-5-1-65	2/21	1SAM250005R1009	MS116-6.3-HKF1-11	2/4	1SAM401901R1001	HK4-11	2/33
1SAM201906R1122	PS1-2-2-65	2/21	1SAM250005R1010	MS116-10.0-HKF1-11	2/4	1SAM401901R1002	HK4-W	2/33
1SAM201906R1123	PS1-3-2-65	2/21	1SAM250005R1011	MS116-16.0-HKF1-11	2/4	1SAM401902R1001	HKS4-11	2/33
1SAM201906R1124	PS1-4-2-65	2/21	1SAM250005R1012	MS116-12.0-HKF1-11	2/4	1SAM401902R1002	HKS4-20	2/33
1SAM201906R1125	PS1-5-2-65	2/21	1SAM250005R1013	MS116-20-HKF1-11	2/4	1SAM401902R1003	HKS4-02	2/33
1SAM201907R1101	S1-M1-25	2/21	1SAM250005R1014	MS116-25-HKF1-11	2/4	1SAM401904R1001	SK4-11	2/33
1SAM201907R1102	S1-M2-25	2/21	1SAM250005R1015	MS116-32-HKF1-11	2/4	1SAM401905R1001	UA4-110	2/33
1SAM201907R1103	S1-M3-25	2/21	1SAM301901R1001	CK1-11	2/17	1SAM401905R1002	UA4-230	2/33
1SAM201908R1001	BS1-3	2/21	1SAM301901R1002	CK1-20	2/17	1SAM401905R1003	UA4-400	2/33
1SAM201909R1001	FS116	2/21	1SAM301901R1003	CK1-02	2/17	1SAM401905R1004	UA4-24	2/33
1SAM201909R1021	MSAH1	2/38	1SAM350000R1001	MS132-0.16	2/8	1SAM401906R1001	UA4-HK-230	2/33
1SAM201910R1001	AA1-24	2/18	1SAM350000R1002	MS132-0.25	2/8	1SAM401906R1002	UA4-HK-400	2/33
1SAM201910R1002	AA1-110	2/18	1SAM350000R1003	MS132-0.4	2/8	1SAM401907R1001	AA4-24	2/33
1SAM201910R1003	AA1-230	2/18	1SAM350000R1004	MS132-0.63	2/8	1SAM401907R1002	AA4-110	2/33
1SAM201910R1004	AA1-400	2/18	1SAM350000R1005	MS132-1.0	2/8	1SAM401907R1003	AA4-230	2/33
1SAM201911R1010	IB132-G	2/23	1SAM350000R1006	MS132-1.6	2/8	1SAM401907R1004	AA4-400	2/33
1SAM201911R1011	IB132-Y	2/23	1SAM350000R1007	MS132-2.5	2/8	1SAM401908R1001	KA450	2/36
1SAM201912R1010	DMS132-G	2/23	1SAM350000R1008	MS132-4.0	2/8	1SAM401910R1001	TB450	2/36
1SAM201912R1011	DMS132-Y	2/23	1SAM350000R1009	MS132-6.3	2/8	1SAM401911R1001	PS4-2-0	2/36
1SAM201913R1103	S1-M3-35	2/21	1SAM350000R1010	MS132-10	2/8	1SAM401911R1002	PS4-3-0	2/36
1SAM201916R1103	PS1-3-0-100	2/21	1SAM350000R1011	MS132-16	2/8	1SAM401911R1003	PS4-4-0	2/36
1SAM201916R1104	PS1-4-0-100	2/21	1SAM350000R1012	MS132-12	2/8	1SAM401911R1004	PS4-2-2	2/36
1SAM201916R1105	PS1-5-0-100	2/21	1SAM350000R1013	MS132-20	2/8	1SAM401911R1005	PS4-3-2	2/36
1SAM201916R1113	PS1-3-1-100	2/21	1SAM350000R1014	MS132-25	2/8	1SAM401911R1006	PS4-4-2	2/36
1SAM201916R1114	PS1-4-1-100	2/21	1SAM350000R1015	MS132-32	2/8	1SAM401911R1007	S4-M1	2/36
1SAM201916R1115	PS1-5-1-100	2/21	1SAM350005R1001	MS132-0.16-HKF1-11	2/8	1SAM401911R1008	BS4-3	2/36
1SAM201916R1123	PS1-3-2-100	2/21	1SAM350005R1002	MS132-0.25-HKF1-11	2/8	1SAM401912R1001	DX495	2/36
1SAM201920R1000	MSH-AR	2/38	1SAM350005R1003	MS132-0.4-HKF1-11	2/8	1SAM450000R1005	MS450-40	2/24
1SAM201920R1001	MSHD-LB	2/38	1SAM350005R1004	MS132-0.63-HKF1-11	2/8	1SAM450000R1006	MS450-45	2/24

Index

Order code classification

Order code	Type	Page	Order code	Type	Page	Order code	Type	Page
1SAM450000R1007	MS450-50	2/24	1SAZ311201R2001	TA42DU-25M	4/8	1SBH141001R8840	N40E	3/45
1SAM460000R1005	MO450-40	2/28	1SAZ311201R2002	TA42DU-32M	4/8	1SBL141001R8001	A9-30-01	3/4
1SAM460000R1006	MO450-45	2/28	1SAZ311201R2003	TA42DU-42M	4/8	1SBL141001R8010	A9-30-10	3/4
1SAM460000R1007	MO450-50	2/28	1SAZ321201R2001	TA75DU-25M	4/11	1SBL141001R8101	A9-30-01	3/4
1SAM501901R1001	KA495	2/36	1SAZ321201R2002	TA75DU-32M	4/11	1SBL141001R8110	A9-30-10	3/4
1SAM501902R1001	KA495C	2/36	1SAZ321201R2003	TA75DU-42M	4/11	1SBL141001R8301	A9-30-01	3/4
1SAM550000R1007	MS495-63	2/24	1SAZ321201R2004	TA75DU-52M	4/11	1SBL141001R8310	A9-30-10	3/4
1SAM550000R1008	MS495-75	2/24	1SAZ321201R2005	TA75DU-63M	4/11	1SBL141001R8401	A9-30-01	3/4
1SAM550000R1009	MS495-90	2/24	1SAZ321201R2006	TA75DU-80M	4/11	1SBL141001R8410	A9-30-10	3/4
1SAM550000R1010	MS495-100	2/24	1SAZ331201R1003	TA80DU-42	4/14	1SBL141001R8501	A9-30-01	3/4
1SAM560000R1007	MO495-63	2/28	1SAZ331201R1004	TA80DU-52	4/14	1SBL141001R8510	A9-30-10	3/4
1SAM560000R1008	MO495-75	2/28	1SAZ331201R1005	TA80DU-63	4/14	1SBL141001R8601	A9-30-01	3/4
1SAM560000R1009	MO495-90	2/28	1SAZ331201R1006	TA80DU-80	4/14	1SBL141001R8610	A9-30-10	3/4
1SAM560000R1010	MO495-100	2/28	1SAZ401110R0001	DB200	4/18	1SBL141001R8801	A9-30-01	3/4
1SAM580000R1004	MS497-32	2/24	1SAZ401901R1001	LT200/A	4/22	1SBL141001R8810	A9-30-10	3/4
1SAM580000R1005	MS497-40	2/24	1SAZ411201R1001	TA110DU-90	4/18	1SBL141201R8000	A9-40-00	3/31
1SAM580000R1006	MS497-50	2/24	1SAZ411201R1002	TA110DU-110	4/18	1SBL141201R8100	A9-40-00	3/31
1SAM580000R1007	MS497-63	2/24	1SAZ421201R1001	TA200DU-90	4/22	1SBL141201R8300	A9-40-00	3/31
1SAM580000R1008	MS497-75	2/24	1SAZ421201R1002	TA200DU-110	4/22	1SBL141201R8400	A9-40-00	3/31
1SAM580000R1009	MS497-90	2/24	1SAZ421201R1003	TA200DU-135	4/22	1SBL141201R8500	A9-40-00	3/31
1SAM580000R1010	MS497-100	2/24	1SAZ421201R1004	TA200DU-150	4/22	1SBL141201R8600	A9-40-00	3/31
1SAM590000R1004	MO496-32	2/28	1SAZ421201R1005	TA200DU-175	4/22	1SBL141201R8800	A9-40-00	3/31
1SAM590000R1005	MO496-40	2/28	1SAZ421201R1006	TA200DU-200	4/22	1SBL141501R8000	A9-22-00	3/31
1SAM590000R1006	MO496-50	2/28	1SAZ501901R1001	DT450/A185	4/26	1SBL141501R8100	A9-22-00	3/31
1SAM590000R1007	MO496-63	2/28	1SAZ501902R1001	DT450/A300	4/26	1SBL141501R8300	A9-22-00	3/31
1SAM590000R1008	MO496-75	2/28	1SAZ511201R1001	TA450DU-185	4/26	1SBL141501R8400	A9-22-00	3/31
1SAM590000R1009	MO496-90	2/28	1SAZ511201R1002	TA450DU-235	4/26	1SBL141501R8500	A9-22-00	3/31
1SAM590000R1010	MO496-100	2/28	1SAZ511201R1003	TA450DU-310	4/26	1SBL141501R8600	A9-22-00	3/31
1SAZ201108R0001	DB25/25A	4/7	1SAZ611201R1001	TA450SU-185	4/26	1SBL141501R8800	A9-22-00	3/31
1SAZ201108R0002	DB25/32A	4/7	1SAZ611201R1002	TA450SU-235	4/26	1SBL161001R8001	A12-30-01	3/4
1SAZ201307R0002	DX25	4/7	1SAZ611201R1003	TA450SU-310	4/26	1SBL161001R8010	A12-30-10	3/4
1SAZ201504R0001	DR25-A-24	4/7	1SAZ611201R1005	TA450SU-60	4/26	1SBL161001R8101	A12-30-01	3/4
1SAZ201504R0002	DR25-A-48	4/7	1SAZ611201R1006	TA450SU-80	4/26	1SBL161001R8110	A12-30-10	3/4
1SAZ201504R0003	DR25-A-110	4/7	1SAZ611201R1007	TA450SU-105	4/26	1SBL161001R8301	A12-30-01	3/4
1SAZ201504R0005	DR25-A-220/380	4/7	1SAZ611201R1008	TA450SU-140	4/26	1SBL161001R8310	A12-30-10	3/4
1SAZ201504R0006	DR25-A-500	4/7	1SBH141001R8022	N22E	3/45	1SBL161001R8401	A12-30-01	3/4
1SAZ211201R2005	TA25DU-0.16M	4/4	1SBH141001R8031	N31E	3/45	1SBL161001R8410	A12-30-10	3/4
1SAZ211201R2009	TA25DU-0.25M	4/4	1SBH141001R8040	N40E	3/45	1SBL161001R8501	A12-30-01	3/4
1SAZ211201R2013	TA25DU-0.4M	4/4	1SBH141001R8122	N22E	3/45	1SBL161001R8510	A12-30-10	3/4
1SAZ211201R2017	TA25DU-0.63M	4/4	1SBH141001R8131	N31E	3/45	1SBL161001R8601	A12-30-01	3/4
1SAZ211201R2021	TA25DU-1.0M	4/4	1SBH141001R8140	N40E	3/45	1SBL161001R8610	A12-30-10	3/4
1SAZ211201R2023	TA25DU-1.4M	4/4	1SBH141001R8322	N22E	3/45	1SBL161001R8801	A12-30-01	3/4
1SAZ211201R2025	TA25DU-1.8M	4/4	1SBH141001R8331	N31E	3/45	1SBL161001R8810	A12-30-10	3/4
1SAZ211201R2028	TA25DU-2.4M	4/4	1SBH141001R8340	N40E	3/45	1SBL161001R8810	A12-30-10	3/4
1SAZ211201R2031	TA25DU-3.1M	4/4	1SBH141001R8422	N22E	3/45	1SBL181001R8001	A16-30-01	3/4
1SAZ211201R2033	TA25DU-4.0M	4/4	1SBH141001R8431	N31E	3/45	1SBL181001R8010	A16-30-10	3/4
1SAZ211201R2035	TA25DU-5.0M	4/4	1SBH141001R8440	N40E	3/45	1SBL181001R8101	A16-30-01	3/4
1SAZ211201R2038	TA25DU-6.5M	4/4	1SBH141001R8522	N22E	3/45	1SBL181001R8110	A16-30-10	3/4
1SAZ211201R2040	TA25DU-8.5M	4/4	1SBH141001R8531	N31E	3/45	1SBL181001R8301	A16-30-01	3/4
1SAZ211201R2043	TA25DU-11M	4/4	1SBH141001R8540	N40E	3/45	1SBL181001R8310	A16-30-10	3/4
1SAZ211201R2045	TA25DU-14M	4/4	1SBH141001R8622	N22E	3/45	1SBL181001R8401	A16-30-01	3/4
1SAZ211201R2047	TA25DU-19M	4/4	1SBH141001R8631	N31E	3/45	1SBL181001R8410	A16-30-10	3/4
1SAZ211201R2051	TA25DU-25M	4/4	1SBH141001R8640	N40E	3/45	1SBL181001R8501	A16-30-01	3/4
1SAZ211201R2053	TA25DU-32M	4/4	1SBH141001R8822	N22E	3/45	1SBL181001R8510	A16-30-10	3/4
1SAZ301110R0001	DB80	4/8	1SBH141001R8831	N31E	3/45	1SBL181001R8601	A16-30-01	3/4
						1SBL181001R8610	A16-30-10	3/4

Index

Order code classification

Order code	Type	Page	Order code	Type	Page	Order code	Type	Page
1SBL181001R8801	A16-30-01	3/4	1SBL281001R8610	A30-30-10	3/5	1SBL411001R8411	A75-30-11	3/6
1SBL181001R8810	A16-30-10	3/4	1SBL281001R8801	A30-30-01	3/5	1SBL411001R8511	A75-30-11	3/6
1SBL181201R8000	A16-40-00	3/31	1SBL281001R8810	A30-30-10	3/5	1SBL411001R8611	A75-30-11	3/6
1SBL181201R8100	A16-40-00	3/31	1SBL321001R8001	A40-30-01	3/5	1SBL411001R8811	A75-30-11	3/6
1SBL181201R8300	A16-40-00	3/31	1SBL321001R8010	A40-30-10	3/5	1SBL411201R8000	A75-40-00	3/33
1SBL181201R8400	A16-40-00	3/31	1SBL321001R8101	A40-30-01	3/5	1SBL411201R8100	A75-40-00	3/33
1SBL181201R8500	A16-40-00	3/31	1SBL321001R8110	A40-30-10	3/5	1SBL411201R8300	A75-40-00	3/33
1SBL181201R8600	A16-40-00	3/31	1SBL321001R8301	A40-30-01	3/5	1SBL411201R8400	A75-40-00	3/33
1SBL181201R8800	A16-40-00	3/31	1SBL321001R8310	A40-30-10	3/5	1SBL411201R8500	A75-40-00	3/33
1SBL181501R8000	A16-22-00	3/31	1SBL321001R8401	A40-30-01	3/5	1SBL411201R8600	A75-40-00	3/33
1SBL181501R8100	A16-22-00	3/31	1SBL321001R8410	A40-30-10	3/5	1SBL411201R8800	A75-40-00	3/33
1SBL181501R8300	A16-22-00	3/31	1SBL321001R8501	A40-30-01	3/5	1SBL411501R8000	A75-22-00	3/33
1SBL181501R8400	A16-22-00	3/31	1SBL321001R8510	A40-30-10	3/5	1SBL411501R8100	A75-22-00	3/33
1SBL181501R8500	A16-22-00	3/31	1SBL321001R8601	A40-30-01	3/5	1SBL411501R8300	A75-22-00	3/33
1SBL181501R8600	A16-22-00	3/31	1SBL321001R8610	A40-30-10	3/5	1SBL411501R8400	A75-22-00	3/33
1SBL181501R8800	A16-22-00	3/31	1SBL321001R8801	A40-30-01	3/5	1SBL411501R8500	A75-22-00	3/33
1SBL241001R8001	A26-30-01	3/5	1SBL321001R8810	A40-30-10	3/5	1SBL411501R8600	A75-22-00	3/33
1SBL241001R8010	A26-30-10	3/5	1SBL331201R8000	A45-40-00	3/33	1SBL411501R8800	A75-22-00	3/33
1SBL241001R8101	A26-30-01	3/5	1SBL331201R8100	A45-40-00	3/33	1SBN010010R1001	CA5-01	3/9
1SBL241001R8110	A26-30-10	3/5	1SBL331201R8300	A45-40-00	3/33	1SBN010010R1010	CA5-10	3/9
1SBL241001R8301	A26-30-01	3/5	1SBL331201R8400	A45-40-00	3/33	1SBN010011R1001	CC5-01	3/52
1SBL241001R8310	A26-30-10	3/5	1SBL331201R8500	A45-40-00	3/33	1SBN010011R1010	CC5-10	3/52
1SBL241001R8401	A26-30-01	3/5	1SBL331201R8600	A45-40-00	3/33	1SBN010013R1001	CB5-01	3/68
1SBL241001R8410	A26-30-10	3/5	1SBL331201R8800	A45-40-00	3/33	1SBN010013R1010	CB5-10	3/68
1SBL241001R8501	A26-30-01	3/5	1SBL331501R8000	A45-22-00	3/33	1SBN010020R1011	CAL5-11	3/9
1SBL241001R8510	A26-30-10	3/5	1SBL331501R8100	A45-22-00	3/33	1SBN010040R1004	CA5-04E	3/52
1SBL241001R8601	A26-30-01	3/5	1SBL331501R8300	A45-22-00	3/33	1SBN010040R1018	CA5-11/11E	3/52
1SBL241001R8610	A26-30-10	3/5	1SBL331501R8400	A45-22-00	3/33	1SBN010040R1022	CA5-22E	3/9
1SBL241001R8801	A26-30-01	3/5	1SBL331501R8500	A45-22-00	3/33	1SBN010040R1031	CA5-31E	3/52
1SBL241001R8810	A26-30-10	3/5	1SBL331501R8600	A45-22-00	3/33	1SBN010040R1040	CA5-40E	3/52
1SBL241201R8000	A26-40-00	3/32	1SBL331501R8800	A45-22-00	3/33	1SBN010040R1104	CA5-04M	3/52
1SBL241201R8100	A26-40-00	3/32	1SBL351001R8011	A50-30-11	3/6	1SBN010040R1113	CA5-13M	3/52
1SBL241201R8300	A26-40-00	3/32	1SBL351001R8111	A50-30-11	3/6	1SBN010040R1118	CA5-11/11M	3/52
1SBL241201R8400	A26-40-00	3/32	1SBL351001R8311	A50-30-11	3/6	1SBN010040R1122	CA5-22M	3/9
1SBL241201R8500	A26-40-00	3/32	1SBL351001R8411	A50-30-11	3/6	1SBN010040R1131	CA5-31M	3/52
1SBL241201R8600	A26-40-00	3/32	1SBL351001R8511	A50-30-11	3/6	1SBN010040R1204	CA5-04N	3/52
1SBL241201R8800	A26-40-00	3/32	1SBL351001R8611	A50-30-11	3/6	1SBN010040R1213	CA5-13N	3/52
1SBL241501R8000	A26-22-00	3/32	1SBL351001R8811	A50-30-11	3/6	1SBN010040R1222	CA5-22N	3/47
1SBL241501R8100	A26-22-00	3/32	1SBL351201R8000	A50-40-00	3/33	1SBN010040R1231	CA5-31N	3/52
1SBL241501R8300	A26-22-00	3/32	1SBL351201R8100	A50-40-00	3/33	1SBN010040R1240	CA5-40N	3/52
1SBL241501R8400	A26-22-00	3/32	1SBL351201R8300	A50-40-00	3/33	1SBN010040R1304	CA5-04U	3/52
1SBL241501R8500	A26-22-00	3/32	1SBL351201R8400	A50-40-00	3/33	1SBN010040R1322	CA5-22U	3/9
1SBL241501R8600	A26-22-00	3/32	1SBL351201R8500	A50-40-00	3/33	1SBN010040R1331	CA5-31U	3/52
1SBL241501R8800	A26-22-00	3/32	1SBL351201R8600	A50-40-00	3/33	1SBN010040R1340	CA5-40U	3/52
1SBL281001R8001	A30-30-01	3/5	1SBL351201R8800	A50-40-00	3/33	1SBN011421R1008	CCL5-11	3/52
1SBL281001R8010	A30-30-10	3/5	1SBL371001R8011	A63-30-11	3/6	1SBN020010R1001	TE5S-24	3/60
1SBL281001R8101	A30-30-01	3/5	1SBL371001R8111	A63-30-11	3/6	1SBN020010R1002	TE5S-120	3/60
1SBL281001R8110	A30-30-10	3/5	1SBL371001R8311	A63-30-11	3/6	1SBN020010R1003	TE5S-240	3/60
1SBL281001R8301	A30-30-01	3/5	1SBL371001R8411	A63-30-11	3/6	1SBN020010R1004	TE5S-440	3/60
1SBL281001R8310	A30-30-10	3/5	1SBL371001R8511	A63-30-11	3/6	1SBN020312R1000	TEF5-ON	3/9
1SBL281001R8401	A30-30-01	3/5	1SBL371001R8611	A63-30-11	3/6	1SBN020314R1000	TEF5-OFF	3/9
1SBL281001R8410	A30-30-10	3/5	1SBL371001R8811	A63-30-11	3/6	1SBN030100R1000	VM5-1	3/9
1SBL281001R8501	A30-30-01	3/5	1SBL411001R8011	A75-30-11	3/6	1SBN030110R1000	VE5-1	3/9
1SBL281001R8510	A30-30-10	3/5	1SBL411001R8111	A75-30-11	3/6	1SBN030210R1000	VE5-2	3/9
1SBL281001R8601	A30-30-01	3/5	1SBL411001R8311	A75-30-11	3/6	1SBN050010R1000	RV5/50	3/9

Index

Order code classification

Order code	Type	Page	Order code	Type	Page	Order code	Type	Page
1SBN050010R1001	RV5/133	3/9	1SFL511001R8311	A210-30-11	3/11			
1SBN050010R1002	RV5/250	3/9	1SFL511001R8411	A210-30-11	3/11			
1SBN050010R1003	RV5/440	3/9	1SFL511001R8511	A210-30-11	3/11			
1SBN050100R1000	RC5-1/50	3/9	1SFL511001R8611	A210-30-11	3/11			
1SBN050100R1001	RC5-1/133	3/9	1SFL511001R8811	A210-30-11	3/11			
1SBN050100R1002	RC5-1/250	3/9	1SFL531001R8011	A260-30-11	3/11			
1SBN050100R1003	RC5-1/440	3/9	1SFL531001R8111	A260-30-11	3/11			
1SBN050200R1000	RC5-2/50	3/9	1SFL531001R8311	A260-30-11	3/11			
1SBN050200R1001	RC5-2/133	3/9	1SFL531001R8411	A260-30-11	3/11			
1SBN050200R1002	RC5-2/250	3/9	1SFL531001R8511	A260-30-11	3/11			
1SBN050200R1003	RC5-2/440	3/9	1SFL531001R8611	A260-30-11	3/11			
1SBN060300R1000	RA5-1	3/64	1SFL531001R8811	A260-30-11	3/11			
1SBN060300T1000	RA5-1	3/64	1SFL551001R8011	A300-30-11	3/11			
1SBN110000R1000	BA5-50	3/68	1SFL551001R8111	A300-30-11	3/11			
1SCA101647R1001	OXS6X85	2/38	1SFL551001R8311	A300-30-11	3/11			
1SCA101655R1001	OXS6X130	2/38	1SFL551001R8411	A300-30-11	3/11			
1SCA101659R1001	OXS6X180	2/38	1SFL551001R8511	A300-30-11	3/11			
1SCA108043R1001	OXS6X105	2/38	1SFL551001R8611	A300-30-11	3/11			
1SDA023354R0001	-	3/13	1SFL551001R8811	A300-30-11	3/11			
1SDA023356R0001	-	3/13	1SFN010720R1011	CAL18-11	3/9			
1SDA023357R0001	-	3/13	1SFN010720R3311	CAL18-11B	3/13			
1SDA023368R0001	-	3/13	1SFN034700R1000	VM300H	3/13			
1SDA023370R0001	-	3/13	1SFN034701R1000	VM300V	3/58			
1SDA025766R0001	-	3/13	1SFN050300R1003	RC5-3/440	3/13			
1SFA616162R1014	KPR-101L	4/7	1SFN074307R1000	LW110	3/69			
1SFL431001R8011	A95-30-11	3/7	1SFN074707R1000	LW185	3/13			
1SFL431001R8111	A95-30-11	3/7	1SFN074709R1000	LZ185-2C/120	3/13			
1SFL431001R8311	A95-30-11	3/7	1SFN074710R1000	LX185	3/13			
1SFL431001R8411	A95-30-11	3/7	1SFN075107R1000	LW300	3/13			
1SFL431001R8511	A95-30-11	3/7	1SFN075110R1000	LX300	3/13			
1SFL431001R8611	A95-30-11	3/7	1SFN124701R1000	LT185-AC	3/13			
1SFL431001R8811	A95-30-11	3/7	1SFN124703R1000	LT185-AL	3/13			
1SFL451001R8011	A110-30-11	3/7	1SFN124704R1000	LT185-AY	3/13			
1SFL451001R8111	A110-30-11	3/7	1SFN125101R1000	LT300-AC	3/13			
1SFL451001R8311	A110-30-11	3/7	1SFN125103R1000	LT300-AL	3/13			
1SFL451001R8411	A110-30-11	3/7	1SFN125104R1000	LT300-AY	3/13			
1SFL451001R8511	A110-30-11	3/7	FPTN372726R1001	WB75-A	3/66			
1SFL451001R8611	A110-30-11	3/7	FPTN372726R1002	WB75-A	3/66			
1SFL451001R8811	A110-30-11	3/7	FPTN372726R1003	WB75-A	3/66			
1SFL471001R8011	A145-30-11	3/11	FPTN372726R1004	WB75-A	3/66			
1SFL471001R8111	A145-30-11	3/11	FPTN372726R1005	WB75-A	3/66			
1SFL471001R8311	A145-30-11	3/11	FPTN372726R1006	WB75-A	3/66			
1SFL471001R8411	A145-30-11	3/11	FPTN372726R1007	WB75-A	3/66			
1SFL471001R8511	A145-30-11	3/11	FPTN372726R1008	WB75-A	3/66			
1SFL471001R8611	A145-30-11	3/11	GJF1101903R0001	SA1	2/21			
1SFL471001R8811	A145-30-11	3/11	GJF1101903R0002	SA2	2/21			
1SFL491001R8011	A185-30-11	3/11	GJF1101903R0003	SA3	2/21			
1SFL491001R8111	A185-30-11	3/11						
1SFL491001R8311	A185-30-11	3/11						
1SFL491001R8411	A185-30-11	3/11						
1SFL491001R8511	A185-30-11	3/11						
1SFL491001R8611	A185-30-11	3/11						
1SFL491001R8811	A185-30-11	3/11						
1SFL511001R8011	A210-30-11	3/11						
1SFL511001R8111	A210-30-11	3/11						

Index

Type classification

Type	Order code	Page	Type	Order code	Page	Type	Order code	Page
A110-30-11	1SFL451001R8011	3/7		1SBL181201R8800	3/31		1SFL551001R8611	3/11
	1SFL451001R8111	3/7	A185-30-11	1SFL491001R8011	3/11		1SFL551001R8811	3/11
	1SFL451001R8311	3/7		1SFL491001R8111	3/11	A30-30-01	1SBL281001R8001	3/5
	1SFL451001R8411	3/7		1SFL491001R8311	3/11		1SBL281001R8101	3/5
	1SFL451001R8511	3/7		1SFL491001R8411	3/11		1SBL281001R8301	3/5
	1SFL451001R8611	3/7		1SFL491001R8511	3/11		1SBL281001R8401	3/5
	1SFL451001R8811	3/7		1SFL491001R8611	3/11		1SBL281001R8501	3/5
		1SFL491001R8811		3/11	1SBL281001R8601		3/5	
				1SBL281001R8801	3/5			
A12-30-01	1SBL161001R8001	3/4	A210-30-11	1SFL511001R8011	3/11	A30-30-10	1SBL281001R8010	3/5
	1SBL161001R8101	3/4		1SFL511001R8111	3/11		1SBL281001R8110	3/5
	1SBL161001R8301	3/4		1SFL511001R8311	3/11		1SBL281001R8310	3/5
	1SBL161001R8401	3/4		1SFL511001R8411	3/11		1SBL281001R8410	3/5
	1SBL161001R8501	3/4		1SFL511001R8511	3/11		1SBL281001R8510	3/5
	1SBL161001R8601	3/4		1SFL511001R8611	3/11		1SBL281001R8610	3/5
	1SBL161001R8801	3/4		1SFL511001R8811	3/11		1SBL281001R8810	3/5
A12-30-10	1SBL161001R8010	3/4	A260-30-11	1SFL531001R8011	3/11	A40-30-01	1SBL321001R8001	3/5
	1SBL161001R8110	3/4		1SFL531001R8111	3/11		1SBL321001R8101	3/5
	1SBL161001R8310	3/4		1SFL531001R8311	3/11		1SBL321001R8301	3/5
	1SBL161001R8410	3/4		1SFL531001R8411	3/11		1SBL321001R8401	3/5
	1SBL161001R8510	3/4		1SFL531001R8511	3/11		1SBL321001R8501	3/5
	1SBL161001R8610	3/4		1SFL531001R8611	3/11		1SBL321001R8601	3/5
	1SBL161001R8810	3/4		1SFL531001R8811	3/11		1SBL321001R8801	3/5
A145-30-11	1SFL471001R8011	3/11	A26-22-00	1SBL241501R8000	3/32	A40-30-10	1SBL321001R8010	3/5
	1SFL471001R8111	3/11		1SBL241501R8100	3/32		1SBL321001R8110	3/5
	1SFL471001R8311	3/11		1SBL241501R8300	3/32		1SBL321001R8310	3/5
	1SFL471001R8411	3/11		1SBL241501R8400	3/32		1SBL321001R8410	3/5
	1SFL471001R8511	3/11		1SBL241501R8500	3/32		1SBL321001R8510	3/5
	1SFL471001R8611	3/11		1SBL241501R8600	3/32		1SBL321001R8610	3/5
	1SFL471001R8811	3/11		1SBL241501R8800	3/32		1SBL321001R8810	3/5
A16-22-00	1SBL181501R8000	3/31	A26-30-01	1SBL241001R8001	3/5	A45-22-00	1SBL331501R8000	3/33
	1SBL181501R8100	3/31		1SBL241001R8101	3/5		1SBL331501R8100	3/33
	1SBL181501R8300	3/31		1SBL241001R8301	3/5		1SBL331501R8300	3/33
	1SBL181501R8400	3/31		1SBL241001R8401	3/5		1SBL331501R8400	3/33
	1SBL181501R8500	3/31		1SBL241001R8501	3/5		1SBL331501R8500	3/33
	1SBL181501R8600	3/31		1SBL241001R8601	3/5		1SBL331501R8600	3/33
	1SBL181501R8800	3/31		1SBL241001R8801	3/5		1SBL331501R8800	3/33
A16-30-01	1SBL181001R8001	3/4	A26-30-10	1SBL241001R8010	3/5	A45-40-00	1SBL331201R8000	3/33
	1SBL181001R8101	3/4		1SBL241001R8110	3/5		1SBL331201R8100	3/33
	1SBL181001R8301	3/4		1SBL241001R8310	3/5		1SBL331201R8300	3/33
	1SBL181001R8401	3/4		1SBL241001R8410	3/5		1SBL331201R8400	3/33
	1SBL181001R8501	3/4		1SBL241001R8510	3/5		1SBL331201R8500	3/33
	1SBL181001R8601	3/4		1SBL241001R8610	3/5		1SBL331201R8600	3/33
	1SBL181001R8801	3/4		1SBL241001R8810	3/5		1SBL331201R8800	3/33
A16-30-10	1SBL181001R8010	3/4	A26-40-00	1SBL241201R8000	3/32	A50-30-11	1SBL351001R8011	3/6
	1SBL181001R8110	3/4		1SBL241201R8100	3/32		1SBL351001R8111	3/6
	1SBL181001R8310	3/4		1SBL241201R8300	3/32		1SBL351001R8311	3/6
	1SBL181001R8410	3/4		1SBL241201R8400	3/32		1SBL351001R8411	3/6
	1SBL181001R8510	3/4		1SBL241201R8500	3/32		1SBL351001R8511	3/6
	1SBL181001R8610	3/4		1SBL241201R8600	3/32		1SBL351001R8611	3/6
	1SBL181001R8810	3/4		1SBL241201R8800	3/32		1SBL351001R8811	3/6
A16-40-00	1SBL181201R8000	3/31	A300-30-11	1SFL551001R8011	3/11	A50-40-00	1SBL351201R8000	3/33
	1SBL181201R8100	3/31		1SFL551001R8111	3/11		1SBL351201R8100	3/33
	1SBL181201R8300	3/31		1SFL551001R8311	3/11		1SBL351201R8300	3/33
	1SBL181201R8400	3/31		1SFL551001R8411	3/11		1SBL351201R8400	3/33
	1SBL181201R8500	3/31		1SFL551001R8511	3/11			
	1SBL181201R8600	3/31						
	1SBL181201R8800	3/31						

Index

Type classification

Type	Order code	Page	Type	Order code	Page	Type	Order code	Page
	1SBL351201R8500	3/33		1SBL141201R8400	3/31	DB25/25A	1SAZ201108R0001	4/7
	1SBL351201R8600	3/33		1SBL141201R8500	3/31	DB25/32A	1SAZ201108R0002	4/7
	1SBL351201R8800	3/33		1SBL141201R8600	3/31	DB80	1SAZ301110R0001	4/8
A63-30-11	1SBL371001R8011	3/6		1SBL141201R8800	3/31	DMS132-G	1SAM201912R1010	2/23
	1SBL371001R8111	3/6	A95-30-11	1SFL431001R8011	3/7	DMS132-Y	1SAM201912R1011	2/23
	1SBL371001R8311	3/6		1SFL431001R8111	3/7	DR25-A-110	1SAZ201504R0003	4/7
	1SBL371001R8411	3/6		1SFL431001R8311	3/7	DR25-A-220/380	1SAZ201504R0005	4/7
	1SBL371001R8511	3/6		1SFL431001R8411	3/7	DR25-A-24	1SAZ201504R0001	4/7
	1SBL371001R8611	3/6		1SFL431001R8511	3/7	DR25-A-48	1SAZ201504R0002	4/7
	1SBL371001R8811	3/6		1SFL431001R8611	3/7	DR25-A-500	1SAZ201504R0006	4/7
A75-22-00	1SBL411501R8000	3/33		1SFL431001R8811	3/7	DT450/A185	1SAZ501901R1001	4/26
	1SBL411501R8100	3/33	AA1-110	1SAM201910R1002	2/18	DT450/A300	1SAZ501902R1001	4/26
	1SBL411501R8300	3/33	AA1-230	1SAM201910R1003	2/18	DX25	1SAZ201307R0002	4/7
	1SBL411501R8400	3/33	AA1-24	1SAM201910R1001	2/18	DX495	1SAM401912R1001	2/36
	1SBL411501R8500	3/33	AA1-400	1SAM201910R1004	2/18	FS116	1SAM201909R1001	2/21
	1SBL411501R8600	3/33	AA4-110	1SAM401907R1002	2/33	HK1-02	1SAM201902R1003	2/17
	1SBL411501R8800	3/33	AA4-230	1SAM401907R1003	2/33	HK1-11	1SAM201902R1001	2/17
A75-30-11	1SBL411001R8011	3/6	AA4-24	1SAM401907R1001	2/33	HK1-20	1SAM201902R1002	2/17
	1SBL411001R8111	3/6	AA4-400	1SAM401907R1004	2/33	HK1-20L	1SAM201902R1004	2/17
	1SBL411001R8311	3/6	BA5-50	1SBN110000R1000	3/68	HK4-11	1SAM401901R1001	2/33
	1SBL411001R8411	3/6	BS1-3	1SAM201908R1001	2/21	HK4-W	1SAM401901R1002	2/33
	1SBL411001R8511	3/6	BS4-3	1SAM401911R1008	2/36	HKF1-11	1SAM201901R1001	2/17
	1SBL411001R8611	3/6	CA5-01	1SBN010010R1001	3/9	HKF1-20	1SAM201901R1002	2/17
	1SBL411001R8811	3/6	CA5-04E	1SBN010040R1004	3/52	HKS4-02	1SAM401902R1003	2/33
A75-40-00	1SBL411201R8000	3/33	CA5-04M	1SBN010040R1104	3/52	HKS4-11	1SAM401902R1001	2/33
	1SBL411201R8100	3/33	CA5-04N	1SBN010040R1204	3/52	HKS4-20	1SAM401902R1002	2/33
	1SBL411201R8300	3/33	CA5-04U	1SBN010040R1304	3/52	IB132-G	1SAM201911R1010	2/23
	1SBL411201R8400	3/33	CA5-10	1SBN010010R1010	3/9	IB132-Y	1SAM201911R1011	2/23
	1SBL411201R8500	3/33	CA5-11/11E	1SBN010040R1018	3/52	KA450	1SAM401908R1001	2/36
	1SBL411201R8600	3/33	CA5-11/11M	1SBN010040R1118	3/52	KA495	1SAM501901R1001	2/36
	1SBL411201R8800	3/33	CA5-13M	1SBN010040R1113	3/52	KA495C	1SAM501902R1001	2/36
A9-22-00	1SBL141501R8000	3/31	CA5-13N	1SBN010040R1213	3/52	KPR-101L	1SFA616162R1014	4/7
	1SBL141501R8100	3/31	CA5-22E	1SBN010040R1022	3/9	LT185-AC	1SFN124701R1000	3/13
	1SBL141501R8300	3/31	CA5-22M	1SBN010040R1122	3/9	LT185-AL	1SFN124703R1000	3/13
	1SBL141501R8400	3/31	CA5-22N	1SBN010040R1222	3/47	LT185-AY	1SFN124704R1000	3/13
	1SBL141501R8500	3/31	CA5-22U	1SBN010040R1322	3/9	LT200/A	1SAZ401901R1001	4/22
	1SBL141501R8600	3/31	CA5-31E	1SBN010040R1031	3/52	LT300-AC	1SFN125101R1000	3/13
	1SBL141501R8800	3/31	CA5-31M	1SBN010040R1131	3/52	LT300-AL	1SFN125103R1000	3/13
A9-30-01	1SBL141001R8001	3/4	CA5-31N	1SBN010040R1231	3/52	LT300-AY	1SFN125104R1000	3/13
	1SBL141001R8101	3/4	CA5-31U	1SBN010040R1331	3/52	LW110	1SFN074307R1000	3/69
	1SBL141001R8301	3/4	CA5-40E	1SBN010040R1040	3/52	LW185	1SFN074707R1000	3/13
	1SBL141001R8401	3/4	CA5-40N	1SBN010040R1240	3/52	LW300	1SFN075107R1000	3/13
	1SBL141001R8501	3/4	CA5-40U	1SBN010040R1340	3/52	LX185	1SFN074710R1000	3/13
	1SBL141001R8601	3/4	CAL18-11	1SFN010720R1011	3/9	LX300	1SFN075110R1000	3/13
	1SBL141001R8801	3/4	CAL18-11B	1SFN010720R3311	3/13	LZ185-2C/120	1SFN074709R1000	3/13
A9-30-10	1SBL141001R8010	3/4	CAL5-11	1SBN010020R1011	3/9	MO132-0.16	1SAM360000R1001	2/12
	1SBL141001R8110	3/4	CB5-01	1SBN010013R1001	3/68	MO132-0.25	1SAM360000R1002	2/12
	1SBL141001R8310	3/4	CB5-10	1SBN010013R1010	3/68	MO132-0.4	1SAM360000R1003	2/12
	1SBL141001R8410	3/4	CC5-01	1SBN010011R1001	3/52	MO132-0.63	1SAM360000R1004	2/12
	1SBL141001R8510	3/4	CC5-10	1SBN010011R1010	3/52	MO132-1.0	1SAM360000R1005	2/12
	1SBL141001R8610	3/4	CCL5-11	1SBN011421R1008	3/52	MO132-1.6	1SAM360000R1006	2/12
	1SBL141001R8810	3/4	CK1-02	1SAM301901R1003	2/17	MO132-10	1SAM360000R1010	2/12
A9-40-00	1SBL141201R8000	3/31	CK1-11	1SAM301901R1001	2/17	MO132-12	1SAM360000R1012	2/12
	1SBL141201R8100	3/31	CK1-20	1SAM301901R1002	2/17	MO132-16	1SAM360000R1011	2/12
	1SBL141201R8300	3/31	DB200	1SAZ401110R0001	4/18	MO132-2.5	1SAM360000R1007	2/12

Index

Type classification

Type	Order code	Page	Type	Order code	Page	Type	Order code	Page
MO132-20	1SAM360000R1013	2/12	MS132-0.63	1SAM350000R1004	2/8		1SBH141001R8331	3/45
MO132-25	1SAM360000R1014	2/12	MS132-0.63-HKF1-11	1SAM350005R1004	2/8		1SBH141001R8431	3/45
MO132-32	1SAM360000R1015	2/12	MS132-1.0	1SAM350000R1005	2/8		1SBH141001R8531	3/45
MO132-4.0	1SAM360000R1008	2/12	MS132-1.0-HKF1-11	1SAM350005R1005	2/8		1SBH141001R8631	3/45
MO132-6.3	1SAM360000R1009	2/12	MS132-1.6	1SAM350000R1006	2/8		1SBH141001R8831	3/45
MO450-40	1SAM460000R1005	2/28	MS132-1.6-HKF1-11	1SAM350005R1006	2/8	N40E	1SBH141001R8040	3/45
MO450-45	1SAM460000R1006	2/28	MS132-10	1SAM350000R1010	2/8		1SBH141001R8140	3/45
MO450-50	1SAM460000R1007	2/28	MS132-10.0-HKF1-11	1SAM350005R1010	2/8		1SBH141001R8340	3/45
MO495-100	1SAM560000R1010	2/28	MS132-12	1SAM350000R1012	2/8		1SBH141001R8440	3/45
MO495-63	1SAM560000R1007	2/28	MS132-12.0-HKF1-11	1SAM350005R1012	2/8		1SBH141001R8540	3/45
MO495-75	1SAM560000R1008	2/28	MS132-16	1SAM350000R1011	2/8		1SBH141001R8640	3/45
MO495-90	1SAM560000R1009	2/28	MS132-16.0-HKF1-11	1SAM350005R1011	2/8		1SBH141001R8840	3/45
MO496-100	1SAM590000R1010	2/28	MS132-2.5	1SAM350000R1007	2/8	OX6X105	1SCA108043R1001	2/38
MO496-32	1SAM590000R1004	2/28	MS132-2.5-HKF1-11	1SAM350005R1007	2/8	OX6X130	1SCA101655R1001	2/38
MO496-40	1SAM590000R1005	2/28	MS132-20	1SAM350000R1013	2/8	OX6X180	1SCA101659R1001	2/38
MO496-50	1SAM590000R1006	2/28	MS132-20-HKF1-11	1SAM350005R1013	2/8	OX6X85	1SCA101647R1001	2/38
MO496-63	1SAM590000R1007	2/28	MS132-25	1SAM350000R1014	2/8	PS1-2-0-65	1SAM201906R1102	2/21
MO496-75	1SAM590000R1008	2/28	MS132-25-HKF1-11	1SAM350005R1014	2/8	PS1-2-1-65	1SAM201906R1112	2/21
MO496-90	1SAM590000R1009	2/28	MS132-32	1SAM350000R1015	2/8	PS1-2-2-65	1SAM201906R1122	2/21
MS116-0.16	1SAM250000R1001	2/4	MS132-32-HKF1-11	1SAM350005R1015	2/8	PS1-3-0-100	1SAM201916R1103	2/21
MS116-0.16-HKF1-11	1SAM250005R1001	2/4	MS132-4.0	1SAM350000R1008	2/8	PS1-3-0-65	1SAM201906R1103	2/21
MS116-0.25	1SAM250000R1002	2/4	MS132-4.0-HKF1-11	1SAM350005R1008	2/8	PS1-3-1-100	1SAM201916R1113	2/21
MS116-0.25-HKF1-11	1SAM250005R1002	2/4	MS132-6.3	1SAM350000R1009	2/8	PS1-3-1-65	1SAM201906R1113	2/21
MS116-0.4	1SAM250000R1003	2/4	MS132-6.3-HKF1-11	1SAM350005R1009	2/8	PS1-3-2-100	1SAM201916R1123	2/21
MS116-0.4-HKF1-11	1SAM250005R1003	2/4	MS450-40	1SAM450000R1005	2/24	PS1-3-2-65	1SAM201906R1123	2/21
MS116-0.63	1SAM250000R1004	2/4	MS450-45	1SAM450000R1006	2/24	PS1-4-0-100	1SAM201916R1104	2/21
MS116-0.63-HKF1-11	1SAM250005R1004	2/4	MS450-50	1SAM450000R1007	2/24	PS1-4-0-65	1SAM201906R1104	2/21
MS116-1.0	1SAM250000R1005	2/4	MS495-100	1SAM550000R1010	2/24	PS1-4-1-100	1SAM201916R1114	2/21
MS116-1.0-HKF1-11	1SAM250005R1005	2/4	MS495-63	1SAM550000R1007	2/24	PS1-4-1-65	1SAM201906R1114	2/21
MS116-1.6	1SAM250000R1006	2/4	MS495-75	1SAM550000R1008	2/24	PS1-4-2-65	1SAM201906R1124	2/21
MS116-1.6-HKF1-11	1SAM250005R1006	2/4	MS495-90	1SAM550000R1009	2/24	PS1-5-0-100	1SAM201916R1105	2/21
MS116-10	1SAM250000R1010	2/4	MS497-100	1SAM580000R1010	2/24	PS1-5-0-65	1SAM201906R1105	2/21
MS116-10.0-HKF1-11	1SAM250005R1010	2/4	MS497-32	1SAM580000R1004	2/24	PS1-5-1-100	1SAM201916R1115	2/21
MS116-12	1SAM250000R1012	2/4	MS497-40	1SAM580000R1005	2/24	PS1-5-1-65	1SAM201906R1115	2/21
MS116-12.0-HKF1-11	1SAM250005R1012	2/4	MS497-50	1SAM580000R1006	2/24	PS1-5-2-65	1SAM201906R1125	2/21
MS116-16	1SAM250000R1011	2/4	MS497-63	1SAM580000R1007	2/24	PS4-2-0	1SAM401911R1001	2/36
MS116-16.0-HKF1-11	1SAM250005R1011	2/4	MS497-75	1SAM580000R1008	2/24	PS4-2-2	1SAM401911R1004	2/36
MS116-2.5	1SAM250000R1007	2/4	MS497-90	1SAM580000R1009	2/24	PS4-3-0	1SAM401911R1002	2/36
MS116-2.5-HKF1-11	1SAM250005R1007	2/4	MSAH1	1SAM201909R1021	2/38	PS4-3-2	1SAM401911R1005	2/36
MS116-20	1SAM250000R1013	2/4	MSH-AR	1SAM201920R1000	2/38	PS4-4-0	1SAM401911R1003	2/36
MS116-20-HKF1-11	1SAM250005R1013	2/4	MSHD-LB	1SAM201920R1001	2/38	PS4-4-2	1SAM401911R1006	2/36
MS116-25	1SAM250000R1014	2/4	MSHD-LTB	1SAM201920R1011	2/38	RA5-1	1SBN060300R1000	3/64
MS116-25-HKF1-11	1SAM250005R1014	2/4	MSHD-LTY	1SAM201920R1012	2/38		1SBN060300T1000	3/64
MS116-32	1SAM250000R1015	2/4	MSHD-LY	1SAM201920R1002	2/38	RC5-1/133	1SBN050100R1001	3/9
MS116-32-HKF1-11	1SAM250005R1015	2/4	MSMN	1SAM101923R0002	2/38	RC5-1/250	1SBN050100R1002	3/9
MS116-4.0	1SAM250000R1008	2/4	MSMNO	1SAM101923R0012	2/38	RC5-1/440	1SBN050100R1003	3/9
MS116-4.0-HKF1-11	1SAM250005R1008	2/4	N22E	1SBH141001R8022	3/45	RC5-1/50	1SBN050100R1000	3/9
MS116-6.3	1SAM250000R1009	2/4		1SBH141001R8122	3/45	RC5-2/133	1SBN050200R1001	3/9
MS116-6.3-HKF1-11	1SAM250005R1009	2/4		1SBH141001R8322	3/45	RC5-2/250	1SBN050200R1002	3/9
MS132-0.16	1SAM350000R1001	2/8		1SBH141001R8422	3/45	RC5-2/440	1SBN050200R1003	3/9
MS132-0.16-HKF1-11	1SAM350005R1001	2/8		1SBH141001R8522	3/45	RC5-2/50	1SBN050200R1000	3/9
MS132-0.25	1SAM350000R1002	2/8		1SBH141001R8622	3/45	RC5-3/440	1SBN050300R1003	3/13
MS132-0.25-HKF1-11	1SAM350005R1002	2/8		1SBH141001R8822	3/45	RV5/133	1SBN050010R1001	3/9
MS132-0.4	1SAM350000R1003	2/8	N31E	1SBH141001R8031	3/45	RV5/250	1SBN050010R1002	3/9
MS132-0.4-HKF1-11	1SAM350005R1003	2/8		1SBH141001R8131	3/45	RV5/440	1SBN050010R1003	3/9

Index

Type classification

Type	Order code	Page	Type	Order code	Page	Type	Order code	Page
RV5/50	1SBN050010R1000	3/9	TA75DU-52M	1SAZ321201R2004	4/11			
S1-M1-25	1SAM201907R1101	2/21	TA75DU-63M	1SAZ321201R2005	4/11			
S1-M2-25	1SAM201907R1102	2/21	TA75DU-80M	1SAZ321201R2006	4/11			
S1-M3-25	1SAM201907R1103	2/21	TA80DU-42	1SAZ331201R1003	4/14			
S1-M3-35	1SAM201913R1103	2/21	TA80DU-52	1SAZ331201R1004	4/14			
S4-M1	1SAM401911R1007	2/36	TA80DU-63	1SAZ331201R1005	4/14			
SA1	GJF1101903R0001	2/21	TA80DU-80	1SAZ331201R1006	4/14			
SA2	GJF1101903R0002	2/21	TB450	1SAM401910R1001	2/36			
SA3	GJF1101903R0003	2/21	TE5S-120	1SBN020010R1002	3/60			
SK1-02	1SAM201903R1003	2/17	TE5S-24	1SBN020010R1001	3/60			
SK1-11	1SAM201903R1001	2/17	TE5S-240	1SBN020010R1003	3/60			
SK1-20	1SAM201903R1002	2/17	TE5S-440	1SBN020010R1004	3/60			
SK4-11	1SAM401904R1001	2/33	TEF5-OFF	1SBN020314R1000	3/9			
TA110DU-110	1SAZ411201R1002	4/18	TEF5-ON	1SBN020312R1000	3/9			
TA110DU-90	1SAZ411201R1001	4/18	UA1-110	1SAM201904R1004	2/18			
TA200DU-110	1SAZ421201R1002	4/22	UA1-208	1SAM201904R1008	2/18			
TA200DU-135	1SAZ421201R1003	4/22	UA1-230	1SAM201904R1005	2/18			
TA200DU-150	1SAZ421201R1004	4/22	UA1-24	1SAM201904R1001	2/18			
TA200DU-175	1SAZ421201R1005	4/22	UA1-400	1SAM201904R1006	2/18			
TA200DU-200	1SAZ421201R1006	4/22	UA1-415	1SAM201904R1007	2/18			
TA200DU-90	1SAZ421201R1001	4/22	UA1-48	1SAM201904R1002	2/18			
TA25DU-0.16M	1SAZ211201R2005	4/4	UA1-60	1SAM201904R1003	2/18			
TA25DU-0.25M	1SAZ211201R2009	4/4	UA4-110	1SAM401905R1001	2/33			
TA25DU-0.4M	1SAZ211201R2013	4/4	UA4-230	1SAM401905R1002	2/33			
TA25DU-0.63M	1SAZ211201R2017	4/4	UA4-24	1SAM401905R1004	2/33			
TA25DU-1.0M	1SAZ211201R2021	4/4	UA4-400	1SAM401905R1003	2/33			
TA25DU-1.4M	1SAZ211201R2023	4/4	UA4-HK-230	1SAM401906R1001	2/33			
TA25DU-1.8M	1SAZ211201R2025	4/4	UA4-HK-400	1SAM401906R1002	2/33			
TA25DU-11M	1SAZ211201R2043	4/4	VE5-1	1SBN030110R1000	3/9			
TA25DU-14M	1SAZ211201R2045	4/4	VE5-2	1SBN030210R1000	3/9			
TA25DU-19M	1SAZ211201R2047	4/4	VM300H	1SFN034700R1000	3/13			
TA25DU-2.4M	1SAZ211201R2028	4/4	VM300V	1SFN034701R1000	3/58			
TA25DU-25M	1SAZ211201R2051	4/4	VM5-1	1SBN030100R1000	3/9			
TA25DU-3.1M	1SAZ211201R2031	4/4	WB75-A	FPTN372726R1001	3/66			
TA25DU-32M	1SAZ211201R2053	4/4		FPTN372726R1002	3/66			
TA25DU-4.0M	1SAZ211201R2033	4/4		FPTN372726R1003	3/66			
TA25DU-5.0M	1SAZ211201R2035	4/4		FPTN372726R1004	3/66			
TA25DU-6.5M	1SAZ211201R2038	4/4		FPTN372726R1005	3/66			
TA25DU-8.5M	1SAZ211201R2040	4/4		FPTN372726R1006	3/66			
TA42DU-25M	1SAZ311201R2001	4/8		FPTN372726R1007	3/66			
TA42DU-32M	1SAZ311201R2002	4/8		FPTN372726R1008	3/66			
TA42DU-42M	1SAZ311201R2003	4/8						
TA450DU-185	1SAZ511201R1001	4/26						
TA450DU-235	1SAZ511201R1002	4/26						
TA450DU-310	1SAZ511201R1003	4/26						
TA450SU-105	1SAZ611201R1007	4/26						
TA450SU-140	1SAZ611201R1008	4/26						
TA450SU-185	1SAZ611201R1001	4/26						
TA450SU-235	1SAZ611201R1002	4/26						
TA450SU-310	1SAZ611201R1003	4/26						
TA450SU-60	1SAZ611201R1005	4/26						
TA450SU-80	1SAZ611201R1006	4/26						
TA75DU-25M	1SAZ321201R2001	4/11						
TA75DU-32M	1SAZ321201R2002	4/11						
TA75DU-42M	1SAZ321201R2003	4/11						

Contact us

You can find the address of your local sales organisation on the ABB home page



www.abb.com/lowvoltage

Note

We reserve the right to make technical changes or modify the contents of this document without prior notice.

ABB does not accept any responsibility whatsoever for potential errors or possible lack of information in this document.

We reserve all rights in this document and in the subject matter and illustrations contained therein. Any reproduction, disclosure to third parties or utilization of its contents – in whole or in parts – is forbidden without prior written consent of ABB.

Copyright© 2013 ABB - All rights reserved

1SBC100179C0201 (06.2013)