

Low Voltage Switchgear

Rotary Cam Switches





Innovation. Technology. Quality.

Switchgear from Sälzer: Solutions for the future!

Since 1956 Sälzer has specialised in the development, manufacture and sale of low voltage switchgear.

The large selection of types, switching programmes and mounting forms mean that practical reliable solutions can be achieved quickly. Whatever the switch, all individual parts are optimally co-ordinated, easy to assemble and combine.

Whether in switching and automation systems, mechanical engineering and construction, in the heating, climatic and ventilation industry, environmental technology or other areas: Sälzer switches provide safety!

Product support, training and service as well as a Certified Quality Management to DIN EN ISO 9001 are an essential part of our daily work. Our switches comply with national and international standards (IEC / cUL / GOST) and are suitable for world-wide application.

Special requirements?

Call us, we'll help you find an individual solution for your switching needs.

Our project engineers are here to understand the special requirements of your project and assist to develop a solution as a partner.

Should your requirements not be covered by our extensive standard product range we have our own Design and Development Department for special switches in order to flexibly, promptly and cost effectively meet your individual requirements.

Rotary Cam Switches

as of p.6

Safe Switching and Controlling

SMD – Sälzer Modular Design



Faster delivery by SMD!

The SMD (Sälzer Modular Design) is based on a modular product idea so that very high flexibility in product options is possible.

SMD modules are individually prefabricated and tested complete modules. By combining these basic elements, different switch configurations can be realised within short time spans. The switches required by you, the customer, are available for despatch following the assembly of the basic switch module to the mounting form and operator modules (SMD Service).

Within 24 hours, the solution matched to your requirements is ready for despatch – worldwide.

Table of Contents

	Page
Rotary Cam Switches	6
Product overview, mounting options	8
Setup of order code number	9
Front mounting	10
Two hole mounting 20 mm	10
Four hole mounting 36 × 36 mm	12
Four hole mounting 48 × 48 mm	15
Four hole mounting 68 × 68 mm	16
Four hole mounting 104 × 104 mm	17
Single hole mounting Ø 16 mm/22,5 mm	18
Single hole mounting Ø 22,5 mm	22
Flush wall mounting	27
Base mounting	28
Snap-on mounting	28
Snap-on mounting for DIN rail	29
Snap-on mounting Door clutch with modular shaft extension	30
Snap-on mounting Door interlock with modular shaft extension	32
Four hole mounting 68 × 68 mm	34
Four hole mounting 68 × 68 mm / door clutch	36
Four hole mounting 68 × 68 mm / door interlock	38
Four hole mounting 104 × 104 mm	40
Four hole mounting 104 × 104 mm / door clutch	41
Four hole mounting 104 × 104 mm / door interlock	42

	Page
Enclosed switches	43
Insulated enclosure 68 × 68 × 53 mm	43
Insulated enclosure 100 × 80 × 65 mm	45
Insulated enclosure 100 × 80 × 85 mm	48
Insulated enclosure 125 × 100 × 133 mm	52
Technical information	56
Switching programmes	56
Switching diagrams	66
Legend plates	76
Accessories	83
Key removable positions	85
Operator variants	86
How to order special switches / Copy form for special switches	88
How to order special engravings / Copy form for special engravings	90
Utilization categories	92
Rated currents of three-phase motors	93
Degree of protection	94
Mounting form table	95
Technical data	96
Contacts	98

Rotary Cam Switches



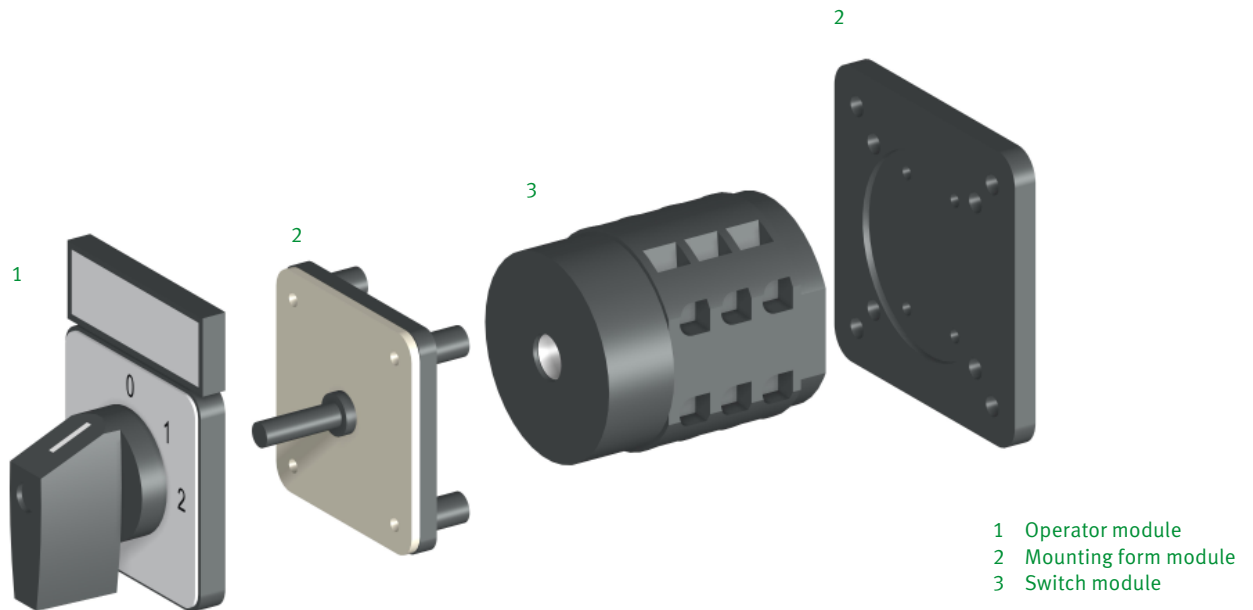

Rorary Cam Switches

Safe Switching and Controlling

Rotary Cam Switches from Sälzer Electric are independently programmable, manually operated control switches for main and auxiliary circuits with up to 24 contacts and are offered with switching angles of 30°, 45°, 60° or 90°. Therefore a maximum of 12 switching positions can be provided.

Design and Function

- 30°, 45°, 60° or 90° switching angle
- forced open contacts
- finger protected (degree of protection up to IP20)
- short-circuit rating
- fulfills the load break requirements up to 690 V
- terminal screws in open position

Applications

Rotary Cam Switches offer ideal features for their use as:

- ON-OFF Switches
- Changeover Switches
- Multi-step Switches
- Code Switches
- Gang Switches
- Instrument Switches
- Motor Switches

Conformity

Our products are designed, manufactured and tested according to the following standards:

- IEC 60947
- IEC 60204-1
- EN 60947
- EN 60204-1
- cUL 508
- GOST R500 30.3-99

Rotary Cam Switches

Product overview

Mounting options:



Front mounting

- Two hole mounting
- Four hole mounting
- Single hole mounting
- Flush wall mounting



Base mounting

- Snap-on mounting
(DIN rail 35 mm DIN EN 60715)
- Four hole mounting



Enclosed switches

- Insulated enclosure

Our modular technology allows us to build custom switching solutions for up to 24 poles!

All products are available
in different versions

Setup of order code number:

The 16 digit order code number for complete switches consists of the three ident numbers for type, switching programme and mounting form:



- the **type** specifies the physical size and power rating of the switch
- the **switching programme** specifies the switching arrangement and the switching angle
- the **mounting form** specifies the mounting, types of handle and optional extras.

In addition to the order code number, each complete switch is assigned a machine readable 13 digit EAN Code.

Ordering example:



Order code number: M220 - 61040 - 003M1

- **Type M220**
for a switch of the product line M200, operational current $I_e = 20$ A
- **Switching programme 61199**
for a 4 pole Changeover Switch without OFF
- **Mounting form 033M4**
for a front mounting switch with four hole mounting 36×36 mm
and M-handle silver/black.

Additional switching programmes can be found from page 56 where the new order code number for the switching programme can be identified. Please note that the identification number of the switching programme must now be replaced by the new selection.

Rotary Cam Switches

Front mounting Two hole mounting 20 mm

Front mounting switches with two hole mounting 20 mm

- 10 A
- 1 up to 16 contacts
- IP66 (front)



- Control Switch
- ON-OFF Switch
- Multi-step Switch
- Instrument Switch
- Changeover Switch
- Motor Switch

Setup of order code number: Type - Switching programme - Mounting form

Ordering example:

2 pole Multi-Step Switch without OFF, 10 A, M-handle silver/black →

Type	Switching programme	Mtg. form
P110	61070	003M1
Order code no.	P110-61070-003M1	

Type	Rated data (IEC 60947)			Degree of Protection	Terminal accessibility
	Operational current I_e	Operational power (at 380–440 V)			
	AC-21A (A)	AC-23A (kW)	AC-3A (kW)	Terminals	
P110	10	3	2.2	IP20	Terminals accessible from mounting direction

Switching programme	Stages	Contacts	Description
61191	1	1	ON-OFF Switch 90°, 1 pole
61192	1	2	ON-OFF Switch 90°, 2 pole
61001	1	1	ON-OFF Switch 60°, 1 pole
61002	1	2	ON-OFF Switch 60°, 2 pole
61351	1	1	ON-OFF Switch with spring return, 1 pole
61025	1	2	Changeover Switch with centre OFF 60°, 1 pole
61026	2	4	Changeover Switch with centre OFF 60°, 2 pole
61037	1	2	Changeover Switch without OFF 60°, 1 pole
61049	2	3	Multi-step Switch without OFF, 3 steps, 1 pole
61050	2	4	Multi-step Switch without OFF, 4 steps, 1 pole
61070	4	8	Multi-step Switch without OFF, 4 steps, 1 pole
61109	1	2	Gang Switch, 2 gangs, 1 pole
61111	3	6	Gang Switch, 2 gangs, 3 pole

Switching diagrams and further switching programmes from page 56.

Mounting form	Operator
003M1	M-handle silver/black

Dimensions in mm:

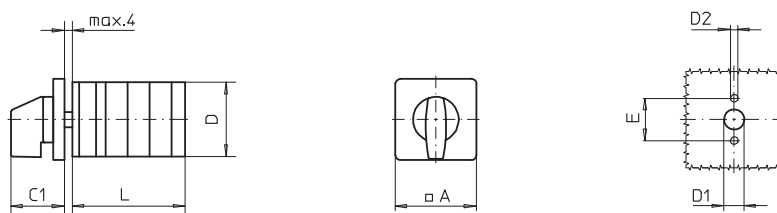

Type	A	C1	D	D1	D2	E	L with ... stages (max. 8)							
							1	2	3	4	5	6	7	8
P110	30	24	29	8	3.2	20	39	51	63	75	87	99	111	123

Rotary Cam Switches

Front mounting Two hole mounting 20 mm

Front mounting switches with two hole mounting 20 mm

- 10 A
- 1 up to 16 contacts
- IP66 (front)



- Main/Emergency-Off Switch
- Main Switch

Setup of order code number: Type - Switching programme - Mounting form Ordering example: 1 pole Main/Emergency-Off Switch 90°, 10 A, padlock device with M-handle yellow/red →	Type	Switching programme	Mtg. form
	P110	61191	033M4
	Order code no. P110-61191-033M4		

Type	Rated data (IEC 60947)			Degree of Protection	Terminal accessibility
	Operational current I_e	Operational power (at 380–440 V)			
	AC-21A (A)	AC-23A (kW)	AC-3A (kW)	Terminals	
P110	10	3	2.2	IP20	Terminals accessible from mounting direction

Switching programme	Stages	Contacts	Description
61191	1	1	ON-OFF Switch 90°, 1 pole
61192	1	2	ON-OFF Switch 90°, 2 pole
61199	2	3	ON-OFF Switch 90°, 3 pole
61194	2	4	ON-OFF Switch 90°, 4 pole, 1 pole early make/late break
61906	3	6	ON-OFF Switch 90°, 6 pole
61919	4	8	ON-OFF Switch 90°, 8 pole, 2 pole early make/late break

Switching diagrams and further switching programmes from page 56.

Mounting form	Operator	Main/Emergency-Off Switch	Mounting form	Operator	Main Switch
033M4		padlock device with M-handle yellow/red	033M1		padlock device with M-handle black

Dimensions in mm:

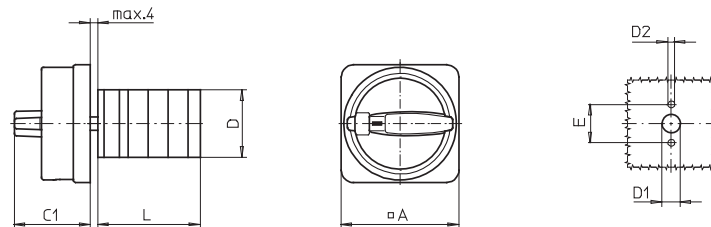

Type	A	C1	D	D1	D2	E	L with ... stages (max. 8)							
							1	2	3	4	5	6	7	8
P110	48	31	29	8	3.2	20	39	51	63	75	87	99	111	123

Rotary Cam Switches

Front mounting Four hole mounting 36 × 36 mm

Front mounting switches with four hole mounting 36 × 36 mm

- 20 A / 25 A / 32 A
- 1 up to 24 contacts
- IP66 (front)



- Control Switch
- ON-OFF Switch
- Multi-step Switch
- Instrument Switch
- Changeover Switch
- Motor Switch

Setup of order code number: Type - Switching programme - Mounting form

Ordering example:

4 pole Changeover Switch without OFF 60°, 20 A, M-handle silver/black →

Type	Switching programme	Mtg. form
M220	61040	003M1
Order code no.	M220-61040-003M1	

Type	Rated data (IEC 60947)			Degree of Protection Terminals	Terminal accessibility
	Operational current I_e AC-21A (A)	Operational power (at 380–440 V) AC-23A (kW) AC-3A (kW)			
P220 P225	20 25	7.5 11	5.5 7.5	IP1B IP1B	Terminals accessible from mounting direction
M220 M225	20 25	7.5 11	5.5 7.5	IP20 IP20	Terminals accessible laterally
T225	32	15	11	IP20	Terminals accessible laterally

Switching programme	Stages	Contacts	Description
61191	1	1	ON-OFF Switch 90°, 1 pole
61192	1	2	ON-OFF Switch 90°, 2 pole
61001	1	1	ON-OFF Switch 60°, 1 pole
61002	1	2	ON-OFF Switch 60°, 2 pole
61025	1	2	Changeover Switch with centre OFF 60°, 1 pole
61026	2	4	Changeover Switch with centre OFF 60°, 2 pole
61027	3	6	Changeover Switch with centre OFF 60°, 3 pole
61037	1	2	Changeover Switch without OFF 60°, 1 pole
61040	4	8	Changeover Switch without OFF 60°, 4 pole
61050	2	4	Multi-step Switch without OFF, 4 steps, 1 pole
61313	3	6	Voltmeter Selector Switch with centre OFF, 3 phase line to line + 3 phase line to N
61325	3	6	Ammeter Selector Switch with centre OFF, 3 transformers, 1 pole
61211	3	5	Motor Reversing Switch, 3 pole

Switching diagrams and further switching programmes from page 56.

Mounting form	Operator
003M1	 M-handle silver/black

Dimensions in mm:

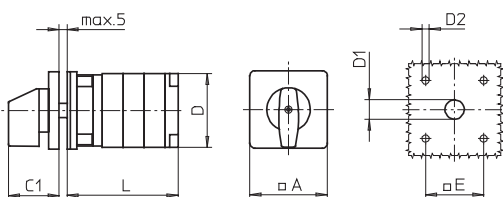

Type	L with ... stages (max. 12)											each additional
	A	C1	D	D1	D2	E	1	2	3	4	5	
P220	48	32	44	12	4.5	36	47	60	73	86	99	13
P225	48	32	46	12	4.5	36	51	66	81	96	111	15
M220	48	32	46	12	4.5	36	40	50	60	70	80	10
M225	48	32	48	12	4.5	36	43	56	69	82	95	13
T225	48	32	50	12	4.5	36	45	60	75	90	105	15

Rotary Cam Switches

Front mounting Four hole mounting 36 × 36 mm

Front mounting switches with four hole mounting 36 × 36 mm

- with dust protective cover
- 20 A / 25 A / 32 A
- 1 up to max. 8 contacts
- IP66



- Control Switch
- ON-OFF Switch
- Multi-step Switch
- Instrument Switch
- Changeover Switch
- Motor Switch

Setup of order code number: Type - Switching programme - Mounting form

Ordering example:

2 pole Changeover Switch with centre OFF and spring return 60°, 20 A, M-handle silver/black →

Type	Switching programme	Mtg. form
M220	61362	005M1
Order code no.	M220-61362M005M1	

Type	Contacts	Rated data (IEC 60947)			Degree of Protection Terminals	Terminal accessibility
		Operational current I_e AC-21A (A)	Operational power (at 380–440 V) AC-23A (kW) AC-3A (kW)			
P220	1 to 6	20	7.5	5.5	IP66	 Terminals accessible from mounting direction
P225	1 to 4	25	11	7.5	IP66	
M220	1 to 8	20	7.5	5.5	IP66	 Terminals accessible laterally
M225	1 to 6	25	11	7.5	IP66	
T225	1 to 4	32	15	11	IP66	 Terminals accessible laterally

Switching programme	Stages	Contacts	Description
61191	1	1	ON-OFF Switch 90°, 1 pole
61192	1	2	ON-OFF Switch 90°, 2 pole
61199	2	3	ON-OFF Switch 90°, 3 pole
61194	2	4	ON-OFF Switch 90°, 4 pole, 1 pole early make/late break
61001	1	1	ON-OFF Switch 60°, 1 pole
61002	1	2	ON-OFF Switch 60°, 2 pole
61003	2	3	ON-OFF Switch 60°, 3 pole
61025	1	2	Changeover Switch with centre OFF 60°, 1 pole
61027	3	6	Changeover Switch with centre OFF 60°, 3 pole
61362	2	4	Changeover Switch with centre OFF and spring return 60°, 2 pole
61037	1	2	Changeover Switch without OFF 60°, 1 pole
61049	2	3	Multi-step Switch without OFF, 3 steps, 1 pole
61050	2	4	Multi-step Switch without OFF, 4 steps, 1 pole

Switching diagrams and further switching programmes from page 56.

Mounting form	Operator
005M1	M-handle silver/black

Dimensions in mm:

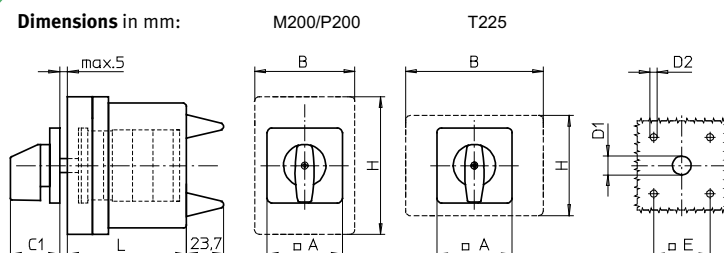

Type	L with ... stages							L with ... stages			
	A	B	C1	D1	D2	E	H	1	2	3	4
P220	48	64	32	12	4.5	36	88	80	80	80	-
P225	48	64	32	12	4.5	36	88	80	80	-	-
M220	48	64	32	12	4.5	36	88	80	80	80	80
M225	48	64	32	12	4.5	36	88	80	80	80	-
T225	48	88	32	12	4.5	36	64	80	80	-	-

Rotary Cam Switches

Front mounting Four hole mounting 36 × 36 mm

Front mounting switches with four hole mounting 36 × 36 mm

- 20 A / 25 A / 32 A
- 1 up to 24 contacts
- IP66 (front)



- Main/Emergency-Off Switch
- Main Switch

Setup of order code number: Type - Switching programme - Mounting form Ordering example: 2 pole Main/Emergency-Off Switch 90°, 20 A, padlock device with M-handle yellow/red →	Type	Switching programme	Mtg. form
	M220	61192	033M4
	Order code no. M220-61192-033M4		

Type	Rated data (IEC 60947)			Degree of Protection	Terminal accessibility
	Operational current I _e AC-21A (A)	Operational power (at 380–440 V) AC-23A (kW) AC-3A (kW)			
P220 P225	20 25	7.5 11	5.5 7.5	IP1B IP1B	Terminals accessible from mounting direction
M220 M225	20 25	7.5 11	5.5 7.5	IP20 IP20	Terminals accessible laterally
T225	32	15	11	IP20	Terminals accessible laterally

Switching programme	Stages	Contacts	Description
61191	1	1	ON-OFF Switch 90°, 1 pole
61192	1	2	ON-OFF Switch 90°, 2 pole
61199	2	3	ON-OFF Switch 90°, 3 pole
61194	2	4	ON-OFF Switch 90°, 4 pole, 1 pole early make/late break
61906	3	6	ON-OFF Switch 90°, 6 pole
61919	4	8	ON-OFF Switch 90°, 8 pole, 2 pole early make/late break

Switching diagrams and further switching programmes from page 56.

Mounting form	Operator	Main/Emergency-Off Switch	Mounting form	Operator	Main Switch
033N4		padlock device with N-handle yellow/red	033N1		padlock device with N-handle black
033M4		padlock device with M-handle yellow/red	033M1		padlock device with M-handle black
033V4		padlockable with V-handle yellow/red	033V1		padlockable with V-handle silver/black

Dimensions in mm:

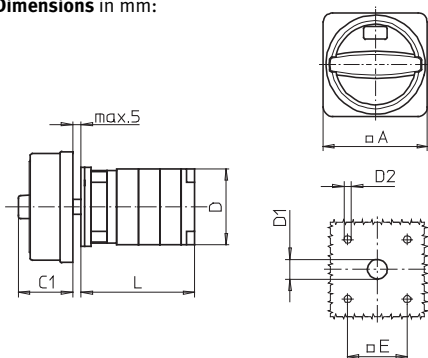

Type	Mounting form	A	C1	D	D1	D2	E	L with ... stages (max. 12)					each additional
								1	2	3	4	5	
P220	033N4/033N1	67	33	44	15	4.5	36	47	60	73	86	99	13
	033M4/033M1	67	38	44	15	4.5	36	47	60	73	86	99	13
	033V4/033V1	48	32	44	12	4.5	36	47	60	73	86	99	13
P225	033N4/033N1	67	33	46	15	4.5	36	51	66	81	96	111	15
	033M4/033M1	67	38	46	15	4.5	36	51	66	81	96	111	15
	033V4/033V1	48	32	46	12	4.5	36	51	66	81	96	111	15
M220	033N4/033N1	67	33	46	15	4.5	36	40	50	60	70	80	10
	033M4/033M1	67	38	46	15	4.5	36	40	50	60	70	80	10
	033V4/033V1	48	32	46	12	4.5	36	40	50	60	70	80	10
M225	033N4/033N1	67	33	48	15	4.5	36	43	56	69	82	95	13
	033M4/033M1	67	38	48	15	4.5	36	43	56	69	82	95	13
	033V4/033V1	48	32	48	12	4.5	36	43	56	69	82	95	13
T225	033N4/033N1	67	33	50	15	4.5	36	45	60	75	90	105	15
	033M4/033M1	67	38	50	15	4.5	36	45	60	75	90	105	15
	033V4/033V1	48	32	50	12	4.5	36	45	60	75	90	105	15

Rotary Cam Switches

Front mounting Four hole mounting 48 × 48 mm

Front mounting switches with four hole mounting 48 × 48 mm

- 50 A / 63 A
- 1 up to 24 contacts
- IP55 (front)



- ON-OFF Switch
- Multi-step Switch
- Changeover Switch
- Motor Switch

Setup of order code number: Type - Switching programme - Mounting form

Ordering example:

3 pole ON-OFF Switch 90°, 50 A, M-handle silver/black →

Type	Switching programme	Mtg. form
S432	61199	003M1
Order code no.	S432-61199-003M1	

Type	Rated data (IEC 60947)			Terminal accessibility
	Operational current I_n AC-21A (A)	Operational power (at 380–440 V) AC-23A (kW) AC-3A (kW)		
S432	50	22	22	Terminals accessible laterally
S440	63	30	30	

Switching programme	Stages	Contacts	Description
61191	1	1	ON-OFF Switch 90°, 1 pole
61192	1	2	ON-OFF Switch 90°, 2 pole
61199	2	3	ON-OFF Switch 90°, 3 pole
61194	2	4	ON-OFF Switch 90°, 4 pole, 1 pole early make/late break
61001	1	1	ON-OFF Switch 60°, 1 pole
61002	1	2	ON-OFF Switch 60°, 2 pole
61003	2	3	ON-OFF Switch 60°, 3 pole
61025	1	2	Changeover Switch with centre OFF 60°, 1 pole
61027	3	6	Changeover Switch with centre OFF 60°, 3 pole
61037	1	2	Changeover Switch without OFF 60°, 1 pole
61050	2	4	Multi-step Switch without OFF, 4 steps, 1 pole
61211	3	5	Motor Reversing Switch, 3 pole

Switching diagrams and further switching programmes from page 56.

Mounting form	Operator
003M1	M-handle silver/black

Dimensions in mm:

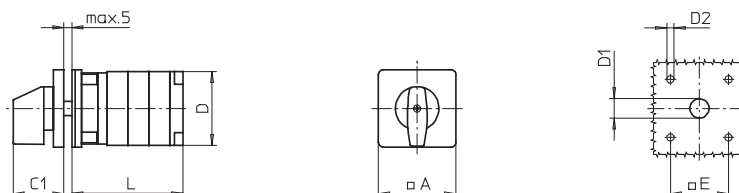

Type	A	C1	D	D1	D2	E	L with ... stages (max. 12)							each additional
							1	2	3	4	5	6	7	
S432	64	39	65	12	5	48	51	69	87	105	123	141	159	18
S440	64	39	70	12	5	48	56	77	98	119	140	161	182	21

Rotary Cam Switches

Front mounting Four hole mounting 68 × 68 mm

Front mounting switches with four hole mounting 68 × 68 mm

- 80 A / 100 A / 160 A
- 1 up to 24 contacts
- IP55 (front)



- ON-OFF Switch
- Multi-step Switch
- Changeover Switch
- Motor Switch

Setup of order code number: Type - Switching programme - Mounting form Ordering example: 3 pole ON-OFF Switch 90°, 80 A, G-handle silver/black →	Type	Switching programme	Mtg. form
	S606	61199	003G1
	Order code no. S606-61199-003G1		

Type	Rated data (IEC 60947)			Terminal accessibility
	Operational current I _e AC-21A (A)	Operational power (at 380–440 V) AC-23A (kW) AC-3A (kW)		
S606	80	45	30	Terminals accessible laterally
S608	100	55	37	
S612	160	75	45	

Switching programme	Stages	Contacts	Description
61191	1	1	ON-OFF Switch 90°, 1 pole
61192	1	2	ON-OFF Switch 90°, 2 pole
61199	2	3	ON-OFF Switch 90°, 3 pole
61194	2	4	ON-OFF Switch 90°, 4 pole, 1 pole early make/late break
61001	1	1	ON-OFF Switch 60°, 1 pole
61002	1	2	ON-OFF Switch 60°, 2 pole
61003	2	3	ON-OFF Switch 60°, 3 pole
61025	1	2	Changeover Switch with centre OFF 60°, 1 pole
61027	3	6	Changeover Switch with centre OFF 60°, 3 pole
61037	1	2	Changeover Switch without OFF 60°, 1 pole
61050	2	4	Multi-step Switch without OFF, 4 steps, 1 pole
61211	3	5	Motor Reversing Switch, 3 pole

Switching diagrams and further switching programmes from page 56.

Mounting form	Operator	Mounting form	Operator
003M1	M-handle silver/black	003G1	G-handle silver/black

Dimensions in mm:

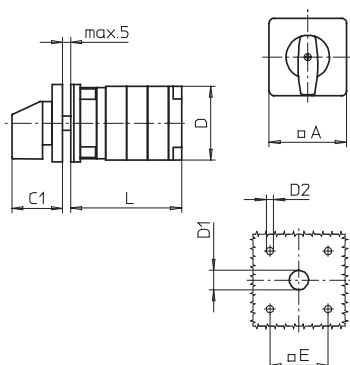

Type	Mtg. form	A	C1	D	D1	D2	E	L with ... stages (max. 12)					each additional
								1	2	3	4	5	
S606	003M1	88	52	84	15	5.5	68	59	81	103	125	147	22
	003G1	88	66	84	15	5.5	68	59	81	103	125	147	22
S608	003M1	88	52	88	15	5.5	68	66	92	118	144	170	26
	003G1	88	66	88	15	5.5	68	66	92	118	144	170	26
S612	003M1	88	52	88	15	5.5	68	72	104	136	168	200	32
	003G1	88	66	88	15	5.5	68	72	104	136	168	200	32

Rotary Cam Switches

Front mounting Four hole mounting 104 × 104 mm

Front mounting switches with four hole mounting 104 × 104 mm

- 315 A
- 1 up to 24 contacts
- IP55 (front)



- ON-OFF Switch
- Multi-step Switch
- Changeover Switch
- Motor Switch

Setup of order code number: Type - Switching programme - Mounting form	Type	Switching programme	Mtg. form
Ordering example: 4 pole ON-OFF Switch 90°, 315 A, G-handle silver/black →	S825	61194	003G1
	Order code no.	S825-61194-003G1	

Type	Rated data (IEC 60947)			Terminal accessibility
	Operational current I _e AC-21A (A)	Operational power (at 380–440 V) AC-23A (kW) AC-3A (kW)		
S825	315	132	55	Terminals accessible laterally

Switching programme	Stages	Contacts	Description
61191	1	1	ON-OFF Switch 90°, 1 pole
61192	1	2	ON-OFF Switch 90°, 2 pole
61199	2	3	ON-OFF Switch 90°, 3 pole
61194	2	4	ON-OFF Switch 90°, 4 pole, 1 pole early make/late break
61001	1	1	ON-OFF Switch 60°, 1 pole
61002	1	2	ON-OFF Switch 60°, 2 pole
61003	2	3	ON-OFF Switch 60°, 3 pole
61025	1	2	Changeover Switch with centre OFF 60°, 1 pole
61027	3	6	Changeover Switch with centre OFF 60°, 3 pole
61037	1	2	Changeover Switch without OFF 60°, 1 pole
61050	2	4	Multi-step Switch without OFF, 4 steps, 1 pole

Switching diagrams and further switching programmes from page 56.

Mounting form	Operator
003G1	G-handle silver/black

Dimensions in mm:

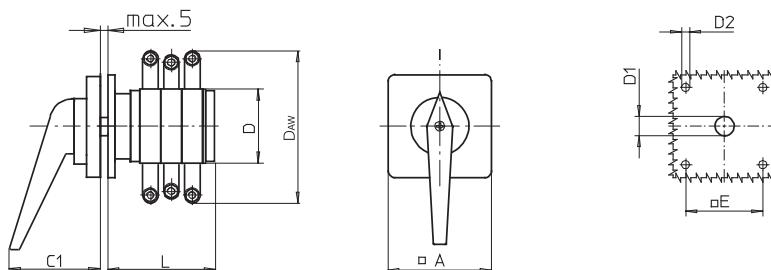

Type	A	C1	D	D _{AW}	D1	D2	E	L with ... stages (max. 12)							each additional
								1	2	3	4	5	6	7	
S825	130	74	120	210	20	5.5	104	89	125	161	197	233	269	305	36

Rotary Cam Switches

Front mounting Single hole mounting Ø 16 mm/22.5 mm

Front mounting switches with single hole mounting Ø 16 mm/22.5 mm

- 10 A
- 1 up to 16 contacts
- IP66 (front)



- Control Switch
- ON-OFF Switch
- Multi-step Switch
- Instrument Switch
- Changeover Switch
- Motor Switch

Setup of order code number: Type - Switching programme - Mounting form

Ordering example:

4 pole Changeover Switch with centre OFF 60°, 10 A, M-handle silver/black →

Type	Switching programme	Mtg. form
P110	61028	219M1
Order code no.	P110-61028-219M1	

Type	Rated data (IEC 60947)			Degree of Protection	Terminal accessibility
	Operational current I_e AC-21A (A)	Operational power (at 380–440 V) AC-23A (kW) AC-3A (kW)			
P110	10	3	2.2	IP20	Terminals accessible from mounting direction

Switching programme	Stages	Contacts	Description
61191	1	1	ON-OFF Switch 90°, 1 pole
61192	1	2	ON-OFF Switch 90°, 2 pole
61001	1	1	ON-OFF Switch 60°, 1 pole
61002	1	2	ON-OFF Switch 60°, 2 pole
61351	1	1	ON-OFF Switch with spring return, 1 pole
61025	1	2	Changeover Switch with centre OFF 60°, 1 pole
61026	2	4	Changeover Switch with centre OFF 60°, 2 pole
61028	4	8	Changeover Switch with centre OFF 60°, 4 pole
61037	1	2	Changeover Switch without OFF 60°, 1 pole
61049	2	3	Multi-step Switch without OFF, 3 steps, 1 pole
61050	2	4	Multi-step Switch without OFF, 4 steps, 1 pole
61109	1	2	Gang Switch, 2 gangs, 1 pole
61111	3	6	Gang Switch, 2 gangs, 3 pole

Switching diagrams and further switching programmes from page 56.

Mounting form	Operator
219M1	M-handle silver/black

Dimensions in mm:

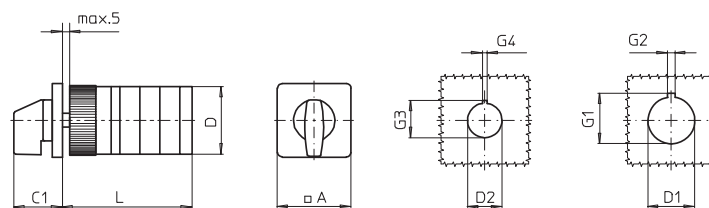

Type	A	C1	D	D1	D2	G1	G2	G3	G4	L with ... stages (max. 8)				each additional
										1	2	3	4	
P110	30	26	29	22.5	16.2	20	3.2	17.9	1.7	57	69	81	93	12

Rotary Cam Switches

Front mounting Single hole mounting Ø 16 mm/22.5 mm

Front mounting switches with single hole mounting Ø 16 mm/22.5 mm

- with front ring
- 10 A
- 1 up to 16 contacts
- IP66 (front)



- Control Switch
- ON-OFF Switch
- Multi-step Switch
- Instrument Switch
- Changeover Switch
- Motor Switch

Setup of order code number: Type - Switching programme - Mounting form Ordering example: 4 pole Changeover Switch with centre OFF 60°, 10 A, M-handle with front ring black/black →	Type	Switching programme	Mtg. form
	P110	61028	218M1
	Order code no. P110-61028-218M1		

Type	Rated data (IEC 60947)			Degree of Protection Terminals	Terminal accessibility
	Operational current I _e AC-21A (A)	Operational power (at 380–440 V) AC-23A (kW) AC-3A (kW)			
P110	10	3	2.2	IP20	Terminals accessible from mounting direction

Switching programme	Stages	Contacts	Description
61191	1	1	ON-OFF Switch 90°, 1 pole
61192	1	2	ON-OFF Switch 90°, 2 pole
61001	1	1	ON-OFF Switch 60°, 1 pole
61002	1	2	ON-OFF Switch 60°, 2 pole
61351	1	1	ON-OFF Switch with spring return, 1 pole
61025	1	2	Changeover Switch with centre OFF 60°, 1 pole
61026	2	4	Changeover Switch with centre OFF 60°, 2 pole
61028	4	8	Changeover Switch with centre OFF 60°, 4 pole
61037	1	2	Changeover Switch without OFF 60°, 1 pole
61049	2	3	Multi-step Switch without OFF, 3 steps, 1 pole
61050	2	4	Multi-step Switch without OFF, 4 steps, 1 pole
61109	1	2	Gang Switch, 2 gangs, 1 pole
61111	3	6	Gang Switch, 2 gangs, 3 pole

Switching diagrams and further switching programmes from page 56.

Mounting form	Operator
218M1	M-handle with front ring black/black

Dimensions in mm:

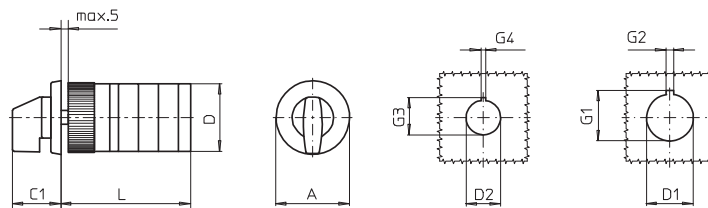

Type	A	C1	D	D1	D2	G1	G2	G3	G4	L with ... stages (max. 8)				each additional
										1	2	3	4	
P110	30	26	29	22.5	16.2	24.2	3.2	17.9	1.7	57	69	81	93	12

Rotary Cam Switches

Front mounting Single hole mounting Ø 16 mm/22.5 mm

Front mounting switches with single hole mounting Ø 16 mm/22.5 mm

- key operated
- 10 A
- 1 up to 16 contacts
- IP40 (front)



- Control Switch
- ON-OFF Switch
- Multi-step Switch
- Instrument Switch
- Changeover Switch
- Motor Switch

Setup of order code number: Type - Switching programme - Mounting form Ordering example: 1 pole Multi-step Switch without OFF, 10 A, key operated, key removable at 9h →	Type	Switching programme	Mtg. form
	P110	61050	S001A
	Order code no.	P110-61050-S001A	

Type	Rated data (IEC 60947)			Degree of Protection Terminals	Terminal accessibility
	Operational current I _e AC-21A (A)	Operational power (at 380–440 V) AC-23A (kW) AC-3A (kW)			
P110	10	3	2.2	IP20	Terminals accessible from mounting direction

Switching programme	Stages	Contacts	Description
61191	1	1	ON-OFF Switch 90°, 1 pole
61192	1	2	ON-OFF Switch 90°, 2 pole
61001	1	1	ON-OFF Switch 60°, 1 pole
61002	1	2	ON-OFF Switch 60°, 2 pole
61351	1	1	ON-OFF Switch with spring return, 1 pole
61025	1	2	Changeover Switch with centre OFF 60°, 1 pole
61026	2	4	Changeover Switch with centre OFF 60°, 2 pole
61037	1	2	Changeover Switch without OFF 60°, 1 pole
61049	2	3	Multi-step Switch without OFF, 3 steps, 1 pole
61050	2	4	Multi-step Switch without OFF, 4 steps, 1 pole
61109	1	2	Gang Switch, 2 gangs, 1 pole
61111	3	6	Gang Switch, 2 gangs, 3 pole

Switching diagrams and further switching programmes from page 56.

Mounting form	Operator
S001.*	Key operated, silver/metal key Ronis cylinder lock L001, 2 keys (other lock types on request)

* The dot in the order code number must be replaced by the classification letter which identifies the key removable positions, see page 85.

Dimensions in mm:

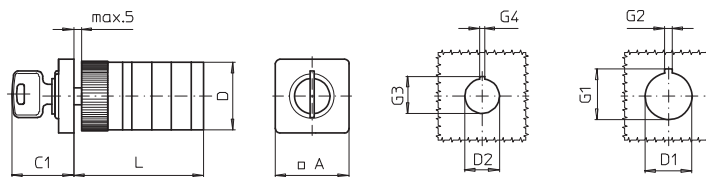

Type	A	C1	D	D1	D2	G1	G2	G3	G4	L with ... stages (max. 8)				each additional
										1	2	3	4	
P110	30	26	29	22.5	16.2	24.2	3.2	17.9	1.7	57	69	81	93	12

Rotary Cam Switches

Front mounting Single hole mounting \varnothing 16 mm/22.5 mm

Front mounting switches with single hole mounting \varnothing 16 mm/22.5 mm

- key operated with front ring
- 10 A
- 1 up to 16 contacts
- IP40 (front)



- Control Switch
- ON-OFF Switch
- Multi-step Switch
- Instrument Switch
- Changeover Switch
- Motor Switch

Setup of order code number: Type - Switching programme - Mounting form

Ordering example:

3 pole Changeover Switch without OFF, 10 A, front ring, key operated, key removable at 11h/01h/05h/07h →

Type	Switching programme	Mtg. form
P110	61039	R001A
Order code no.	P110-61039-R001O	

Type	Rated data (IEC 60947)			Degree of Protection Terminals	Terminal accessibility
	Operational current I_e AC-21A (A)	Operational power (at 380–440 V) AC-23A (kW) AC-3A (kW)			
P110	10	3	2.2	IP20	Terminals accessible from mounting direction

Switching programme	Stages	Contacts	Description
61191	1	1	ON-OFF Switch 90°, 1 pole
61192	1	2	ON-OFF Switch 90°, 2 pole
61001	1	1	ON-OFF Switch 60°, 1 pole
61002	1	2	ON-OFF Switch 60°, 2 pole
61351	1	1	ON-OFF Switch with spring return, 1 pole
61025	1	2	Changeover Switch with centre OFF 60°, 1 pole
61026	2	4	Changeover Switch with centre OFF 60°, 2 pole
61037	1	2	Changeover Switch without OFF 60°, 1 pole
61039	3	6	Changeover Switch without OFF 60°, 3 pole
61049	2	3	Multi-step Switch without OFF, 3 steps, 1 pole
61050	2	4	Multi-step Switch without OFF, 4 steps, 1 pole
61109	1	2	Gang Switch, 2 gangs, 1 pole
61111	3	6	Gang Switch, 2 gangs, 3 pole

Switching diagrams and further switching programmes from page 56.

Mounting form	Operator
R001.*	key operated, with front ring black/metal key Ronis cylinder lock L001, 2 keys (other lock types on request)

* The dot in the order code number must be replaced by the classification letter which identifies the key removable positions, see page 85.

Dimensions in mm:

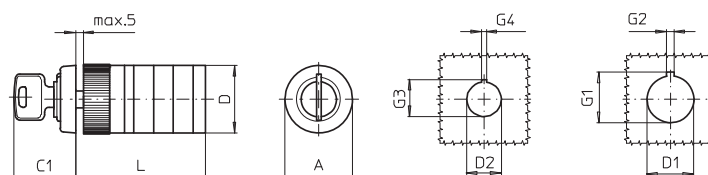

Type	A	C1	D	D1	D2	G1	G2	G3	G4	L with ... stages (max. 8)				each additional
										1	2	3	4	
P110	30	26	29	22.5	16.2	24.2	3.2	17.9	1.7	57	69	81	93	12

Rotary Cam Switches

Front mounting Single hole mounting \varnothing 22.5 mm

Front mounting switches with single hole mounting \varnothing 22.5 mm

- 20 A / 25 A / 32 A
- 1 up to 24 contacts
- IP66 (front)



- Control Switch
- ON-OFF Switch
- Multi-step Switch
- Instrument Switch
- Changeover Switch
- Motor Switch

Setup of order code number: Type - Switching programme - Mounting form Ordering example: 4 pole ON-OFF Switch 60°, 20 A, M-handle silver/black →	Type	Switching programme	Mtg. form
	M220	61004	219M1
	Order code no.	M220-61004-219M1	

Type	Rated data (IEC 60947)			Degree of Protection Terminals	Terminal accessibility
	Operational current I _e AC-21A (A)	Operational power (at 380–440 V) AC-23A (kW) AC-3A (kW)			
P220 P225	20 25	7.5 11	5.5 7.5	IP1B IP1B	Terminals accessible from mounting direction
M220 M225	20 25	7.5 11	5.5 7.5	IP20 IP20	Terminals accessible laterally
T225	32	15	11	IP20	Terminals accessible laterally

Switching programme	Stages	Contacts	Description
61191	1	1	ON-OFF Switch 90°, 1 pole
61192	1	2	ON-OFF Switch 90°, 2 pole
61001	1	1	ON-OFF Switch 60°, 1 pole
61002	1	2	ON-OFF Switch 60°, 2 pole
61004	2	4	ON-OFF Switch 60°, 4 pole
61025	1	2	Changeover Switch with centre OFF 60°, 1 pole
61026	2	4	Changeover Switch with centre OFF 60°, 2 pole
61027	3	6	Changeover Switch with centre OFF 60°, 3 pole
61037	1	2	Changeover Switch without OFF 60°, 1 pole
61050	2	4	Multi-step Switch without OFF, 4 steps, 1 pole
61313	3	6	Voltmeter Selector Switch with centre OFF, 3 phase line to line + 3 phase line to N
61325	3	6	Ammeter Selector Switch with centre OFF, 3 transformers, 1 pole
61211	3	5	Motor Reversing Switch, 3 pole

Switching diagrams and further switching programmes from page 56.

Mounting form	Operator
219M1	M-handle silver/black

Dimensions in mm:

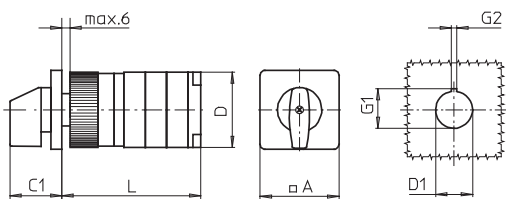

Type	L with ... stages (max. 12)											each additional
	A	C1	D	D1	G1	G2	1	2	3	4	5	
P220	48	32	44	22.5	24.2	3.2	66	79	92	105	118	13
P225	48	32	46	22.5	24.2	3.2	70	85	100	115	130	15
M220	48	32	46	22.5	24.2	3.2	59	69	79	89	99	10
M225	48	32	48	22.5	24.2	3.2	62	75	88	101	114	13
T225	48	32	50	22.5	24.2	3.2	64	79	94	109	124	15

Rotary Cam Switches



Front mounting Single hole mounting Ø 22.5 mm

Front mounting switches with single hole mounting Ø 22.5 mm

- with front ring
- 20 A / 25 A / 32 A
- 1 up to 24 contacts
- IP66 (front)



- Control Switch
- ON-OFF Switch
- Multi-step Switch
- Instrument Switch
- Changeover Switch
- Motor Switch

Setup of order code number: Type - Switching programme - Mounting form

Ordering example:

4 pole Changeover Switch with centre OFF 60°, 20 A, M-handle black/black →

Type	Switching programme	Mtg. form
P220	61028	218M1
Order code no.	P220-61028-218M1	

Type	Rated data (IEC 60947)			Degree of Protection Terminals	Terminal accessibility
	Operational current I _e AC-21A (A)	Operational power (at 380–440 V) AC-23A (kW) AC-3A (kW)			
P220 P225	20 25	7.5 11	5.5 7.5	IP1B IP1B	Terminals accessible from mounting direction
M220 M225	20 25	7.5 11	5.5 7.5	IP20 IP20	Terminals accessible laterally
T225	32	15	11	IP20	Terminals accessible laterally

Switching programme	Stages	Contacts	Description
61191	1	1	ON-OFF Switch 90°, 1 pole
61192	1	2	ON-OFF Switch 90°, 2 pole
61001	1	1	ON-OFF Switch 60°, 1 pole
61002	1	2	ON-OFF Switch 60°, 2 pole
61025	1	2	Changeover Switch with centre OFF 60°, 1 pole
61026	2	4	Changeover Switch with centre OFF 60°, 2 pole
61027	3	6	Changeover Switch with centre OFF 60°, 3 pole
61028	4	8	Changeover Switch with centre OFF 60°, 4 pole
61037	1	2	Changeover Switch without OFF 60°, 1 pole
61050	2	4	Multi-step Switch without OFF, 4 steps, 1 pole
61313	3	6	Voltmeter Selector Switch with centre OFF, 3 phase line to line + 3 phase line to N
61325	3	6	Ammeter Selector Switch with centre OFF, 3 transformers, 1 pole
61211	3	5	Motor Reversing Switch, 3 pole

Switching diagrams and further switching programmes from page 56.

Mounting form	Operator
218M1	M-handle with front ring black/black

Dimensions in mm:

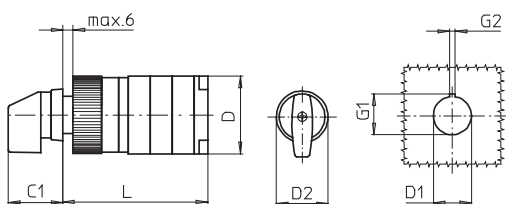

Type	L with ... stages (max. 12)											each additional
	C1	D	D1	D2	G1	G2	1	2	3	4	5	
P220	32	44	22.5	30.5	24.2	3.2	66	79	92	105	118	13
P225	32	46	22.5	30.5	24.2	3.2	70	85	100	115	130	15
M220	32	46	22.5	30.5	24.2	3.2	59	69	79	89	99	10
M225	32	48	22.5	30.5	24.2	3.2	62	75	88	101	114	13
T225	32	50	22.5	30.5	24.2	3.2	64	79	94	109	124	15

Rotary Cam Switches

Front mounting Single hole mounting Ø 22.5 mm

Front mounting switches with single hole mounting Ø 22.5 mm

- key operated
- 20 A / 25 A / 32 A
- 1 up to 16 contacts
- IP40 (front)



- Control Switch
- Instrument Switch
- ON-OFF Switch
- Changeover Switch
- Multi-step Switch
- Motor Switch

Setup of order code number: Type - Switching programme - Mounting form Ordering example: 3 pole Changeover Switch without OFF, 20 A, key operated, key removable at 11h/01h/05h/07h →	Type	Switching programme	Mtg. form
	M220	61039	S001A
	Order code no. M220-61039-S0010		

Type	Contacts	Rated data (IEC 60947)			Degree of Protection Terminals	Terminal accessibility
		Operational current I _e AC-21A (A)	Operational power (at 380–440 V)			
			AC-23A (kW)	AC-3A (kW)		
P220	1 to 16	20	7.5	5.5	IP1B	Terminals accessible from mounting direction
P225	1 to 16	25	11	7.5	IP1B	
M220	1 to 16	20	7.5	5.5	IP20	Terminals accessible laterally
M225	1 to 16	25	11	7.5	IP20	
T225	1 to 12	32	15	11	IP20	Terminals accessible laterally

Switching programme	Stages	Contacts	Description
61191	1	1	ON-OFF Switch 90°, 1 pole
61192	1	2	ON-OFF Switch 90°, 2 pole
61001	1	1	ON-OFF Switch 60°, 1 pole
61002	1	2	ON-OFF Switch 60°, 2 pole
61025	1	2	Changeover Switch with centre OFF 60°, 1 pole
61026	2	4	Changeover Switch with centre OFF 60°, 2 pole
61027	3	6	Changeover Switch with centre OFF 60°, 3 pole
61037	1	2	Changeover Switch without OFF 60°, 1 pole
61039	3	6	Changeover Switch without OFF 60°, 3 pole
61050	2	4	Multi-step Switch without OFF, 4 steps, 1 pole
61313	3	6	Voltmeter Selector Switch with centre OFF, 3 phase line to line + 3 phase line to N
61325	3	6	Ammeter Selector Switch with centre OFF, 3 transformers, 1 pole
61211	3	5	Motor Reversing Switch, 3 pole

Switching diagrams and further switching programmes from page 56.

Mounting form	Operator
S001.*	Key operated, silver/metal key Ronis cylinder lock C001, 2 keys (other lock types on request)

* The dot in the order code number must be replaced by the classification letter which identifies the key removable positions, see page 85.

Dimensions in mm:

Type	L with ... stages (max. 8)											each additional
	A	C1	D	D1	G1	G2	1	2	3	4	5	
P220	48	33	44	22.5	24.2	3.2	66	79	92	105	118	13
P225	48	33	46	22.5	24.2	3.2	70	85	100	115	130	15
M220	48	33	46	22.5	24.2	3.2	59	69	79	89	99	10
M225	48	33	48	22.5	24.2	3.2	62	75	88	101	114	13
T225	48	33	50	22.5	24.2	3.2	64	79	94	109	124	15

Rotary Cam Switches

Front mounting Single hole mounting \varnothing 22.5 mm

Front mounting switches with single hole mounting \varnothing 22.5 mm

- key operated with front ring
- 20 A / 25 A / 32 A
- 1 up to 16 contacts
- IP40 (front)



- Control Switch
- ON-OFF Switch
- Multi-step Switch
- Instrument Switch
- Changeover Switch
- Motor Switch

Setup of order code number: Type - Switching programme - Mounting form

Ordering example:

3 pole Changeover Switch without OFF, 20 A, key operated, key removable at 11h/01h/05h/07h →

Type	Switching programme	Mtg. form
M220	61039	R001A
Order code no.	M220-61039-R001O	

Type	Contacts	Rated data (IEC 60947)			Degree of Protection Terminals	Terminal accessibility
		Operational current I_e AC-21A (A)	Operational power (at 380–440 V) AC-23A (kW) AC-3A (kW)			
P220	1 to 16	20	7.5	5.5	IP1B	 Terminals accessible from mounting direction
P225	1 to 16	25	11	7.5	IP1B	
M220	1 to 16	20	7.5	5.5	IP20	 Terminals accessible laterally
M225	1 to 16	25	11	7.5	IP20	
T225	1 to 12	32	15	11	IP20	 Terminals accessible laterally

Switching programme	Stages	Contacts	Description
61191	1	1	ON-OFF Switch 90°, 1 pole
61192	1	2	ON-OFF Switch 90°, 2 pole
61001	1	1	ON-OFF Switch 60°, 1 pole
61002	1	2	ON-OFF Switch 60°, 2 pole
61025	1	2	Changeover Switch with centre OFF 60°, 1 pole
61026	2	4	Changeover Switch with centre OFF 60°, 2 pole
61027	3	6	Changeover Switch with centre OFF 60°, 3 pole
61037	1	2	Changeover Switch without OFF 60°, 1 pole
61039	3	6	Changeover Switch without OFF 60°, 3 pole
61050	2	4	Multi-step Switch without OFF, 4 steps, 1 pole
61313	3	6	Voltmeter Selector Switch with centre OFF, 3 phase line to line + 3 phase line to N
61325	3	6	Ammeter Selector Switch with centre OFF, 3 transformers, 1 pole
61211	3	5	Motor Reversing Switch, 3 pole

Switching diagrams and further switching programmes from page 56.

Mounting form	Operator
R001.*	key operated, with front ring black/metal key Ronis cylinder lock C001, 2 keys (other lock types on request)

* The dot in the order code number must be replaced by the classification letter which identifies the key removable positions, see page 85.

Dimensions in mm:

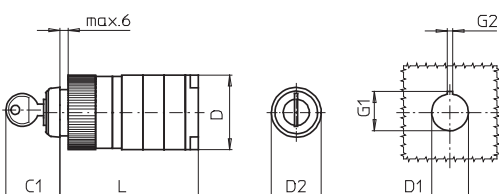

Type	L with ... stages (max. 8)					each additional						
	C1	D	D1	D2	G1							
P220	33	44	22.5	30.5	24.2	3.2	66	79	92	105	118	13
P225	33	46	22.5	30.5	24.2	3.2	70	85	100	115	130	15
M220	33	46	22.5	30.5	24.2	3.2	59	69	79	89	99	10
M225	33	48	22.5	30.5	24.2	3.2	62	75	88	101	114	13
T225	33	50	22.5	30.5	24.2	3.2	64	79	94	109	124	15

Rotary Cam Switches

Front mounting Single hole mounting Ø 22.5 mm

Front mounting switches with single hole mounting Ø 22.5 mm

- 20 A / 25 A / 32 A
- 1 up to 24 contacts
- IP66 (front)



- Main/Emergency-Off Switch
- Main Switch

Setup of order code number: Type - Switching programme - Mounting form Ordering example: 3 pole Main/Emergency-Off Switch 90°, 20 A, padlock device with M-handle yellow/red →	Type	Switching programme	Mtg. form
	M220	61199	206M4
	Order code no. M220-61199-206M4		

Type	Rated data (IEC 60947)			Degree of Protection	Terminal accessibility
	Operational current I _e AC-21A (A)	Operational power (at 380–440 V)			
		AC-23A (kW)	AC-3A (kW)	Terminals	
P220	20	7.5	5.5	IP1B	Terminals accessible from mounting direction
P225	25	11	7.5	IP1B	
M220	20	7.5	5.5	IP20	Terminals accessible laterally
M225	25	11	7.5	IP20	
T225	32	15	11	IP20	Terminals accessible laterally

Switching programme	Stages	Contacts	Description
61191	1	1	ON-OFF Switch 90°, 1 pole
61192	1	2	ON-OFF Switch 90°, 2 pole
61199	2	3	ON-OFF Switch 90°, 3 pole
61194	2	4	ON-OFF Switch 90°, 4 pole, 1 pole early make/late break
61906	3	6	ON-OFF Switch 90°, 6 pole
61919	4	8	ON-OFF Switch 90°, 8 pole, 2 pole early make/late break

Switching diagrams and further switching programmes from page 56.

Mounting form	Operator	Main/Emergency-Off Switch	Mounting form	Operator	Main Switch
206N4		padlock device with N-handle yellow/red	206N1		padlock device with N-handle black
206M4		padlock device with M-handle yellow/red	206M1		padlock device with M-handle black
206V4		padlockable with V-handle yellow/red	206V1		padlockable with V-handle silver/black

Dimensions in mm:

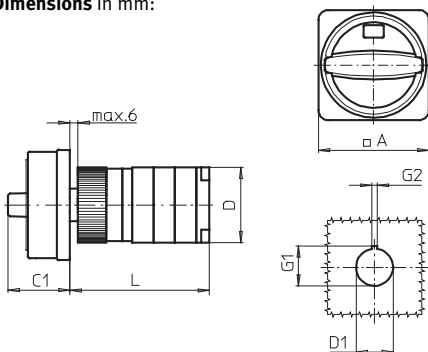

Type	Mounting form	A	C1	D	D1	G1	G2	L with ... stages (max. 12)					each additional
								1	2	3	4	5	
P220	206N4/206N1	67	33	44	22.5	24.2	3.2	66	79	92	105	118	13
	206M4/206M1	67	38	44	22.5	24.2	3.2	66	79	92	105	118	13
	206V4/206V1	48	32	44	22.5	24.2	3.2	66	79	92	105	118	13
P225	206N4/206N1	67	33	46	22.5	24.2	3.2	70	85	100	115	130	15
	206M4/206M1	67	38	46	22.5	24.2	3.2	70	85	100	115	130	15
	206V4/206V1	48	32	46	22.5	24.2	3.2	70	85	100	115	130	15
M220	206N4/206N1	67	33	46	22.5	24.2	3.2	59	69	79	89	99	10
	206M4/206M1	67	38	46	22.5	24.2	3.2	59	69	79	89	99	10
	206V4/206V1	48	32	46	22.5	24.2	3.2	59	69	79	89	99	10
M225	206N4/206N1	67	33	48	22.5	24.2	3.2	62	75	88	101	114	13
	206M4/206M1	67	38	48	22.5	24.2	3.2	62	75	88	101	114	13
	206V4/206V1	48	32	48	22.5	24.2	3.2	62	75	88	101	114	13
T225	206N4/206N1	67	33	50	22.5	24.2	3.2	64	79	94	109	124	15
	206M4/206M1	67	38	50	22.5	24.2	3.2	64	79	94	109	124	15
	206V4/206V1	48	32	50	22.5	24.2	3.2	64	79	94	109	124	15

Front mounting Flush wall mounting

Front mounting switches for flush wall mounting

- 20 A / 25 A
- 1 up to max. 6 contacts
- IP30 (front)
- for plaster depth box



- Control Switch
- Instrument Switch
- ON-OFF Switch
- Changeover Switch
- Multi-step Switch
- Motor Switch

Setup of order code number: Type - Switching programme - Mounting form Ordering example: 1 pole ON-OFF Switch 90°, 20 A, N-handle silver/white →	Type	Switching programme	Mtg. form
	P220	61191	025N3
	Order code no. P220-61191-025N3		

Type	Contacts	Rated data (IEC 60947)			Degree of Protection Terminals	Terminal accessibility
		Operational current I _o AC-21A (A)	Operational power (at 380–440 V) AC-23A (kW) AC-3A (kW)			
P220	1 to 4	20	7.5	5.5	IP1B	Terminals accessible from mounting direction
P225	1 to 2	25	11	7.5	IP1B	
M220	1 to 6	20	7.5	5.5	IP20	Terminals accessible laterally
M225	1 to 2	25	11	7.5	IP20	

Switching programme	Stages	Contacts	Description
61191	1	1	ON-OFF Switch 90°, 1 pole
61192	1	2	ON-OFF Switch 90°, 2 pole
61199	2	3	ON-OFF Switch 90°, 3 pole
61001	1	1	ON-OFF Switch 60°, 1 pole
61002	1	2	ON-OFF Switch 60°, 2 pole
61003	2	3	ON-OFF Switch 60°, 3 pole
61025	1	2	Changeover Switch with centre OFF 60°, 1 pole
61026	2	4	Changeover Switch with centre OFF 60°, 2 pole
61037	1	2	Changeover Switch without OFF 60°, 1 pole
61038	2	4	Changeover Switch without OFF 60°, 2 pole
61049	2	3	Multi-step Switch without OFF, 3 steps, 1 pole
61050	2	4	Multi-step Switch without OFF, 4 steps, 1 pole

Switching diagrams and further switching programmes from page 56.

Mounting form	Operator
025N3	N-handle silver/white

Dimensions in mm:

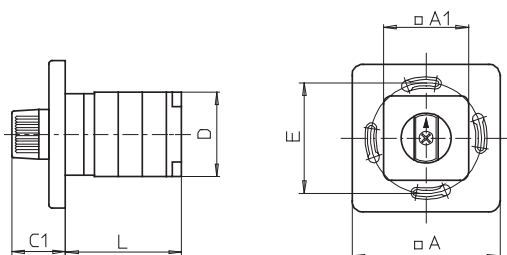

Type	A	A1	C1	D	E	L with ... stages		
						1	2	3
P220	80	46	31	44	60	43	56	-
P225	80	46	31	46	60	47	-	-
M220	80	46	31	46	60	36	46	56
M225	80	46	31	48	60	39	-	-

Rotary Cam Switches

Base mounting Snap on mounting

Base mounting switches with snap on mounting

- 20 A / 25 A / 32 A
- 1 up to 24 contacts
- IP66 (front)
- Four hole front mounting 36 × 36 mm

- Control Switch
- Instrument Switch
- ON-OFF Switch
- Changeover Switch
- Multi-step Switch
- Motor Switch



Setup of order code number: Type - Switching programme - Mounting form Ordering example: 2 pole Changeover Switch with centre OFF 60°, 20 A, M-handle silver/black →	Type	Switching programme	Mtg. form
	P220	61026	021M1
	Order code no.	P220-61026-021M1	

Type	Rated data (IEC 60947)			Degree of Protection Terminals	Terminal accessibility
	Operational current I _o AC-21A (A)	Operational power (at 380–440 V) AC-23A (kW) AC-3A (kW)			
P220 P225	20 25	7.5 11	5.5 7.5	IP1B IP1B	Terminals accessible from mounting direction
M220 M225	20 25	7.5 11	5.5 7.5	IP20 IP20	Terminals accessible laterally
T225	32	15	11	IP20	Terminals accessible laterally

Switching programme	Stages	Contacts	Description
61191	1	1	ON-OFF Switch 90°, 1 pole
61192	1	2	ON-OFF Switch 90°, 2 pole
61001	1	1	ON-OFF Switch 60°, 1 pole
61002	1	2	ON-OFF Switch 60°, 2 pole
61025	1	2	Changeover Switch with centre OFF 60°, 1 pole
61026	2	4	Changeover Switch with centre OFF 60°, 2 pole
61027	3	6	Changeover Switch with centre OFF 60°, 3 pole
61037	1	2	Changeover Switch without OFF 60°, 1 pole
61038	2	4	Changeover Switch without OFF 60°, 2 pole
61049	2	3	Multi-step Switch without OFF, 3 steps, 1 pole
61050	2	4	Multi-step Switch without OFF, 4 steps, 1 pole
61211	3	5	Motor Reversing Switch, 3 pole

Switching diagrams and further switching programmes from page 56.

Mounting form	Operator
021M1	M-handle silver/black

Dimensions in mm:

Type	A	C1	D	D1	D2	E	L with ... stages (max. 12)					each additional
							1	2	3	4	5	
P220	48	32	44	12	4.5	36	46	59	72	85	98	13
P225	48	32	46	12	4.5	36	48	63	78	93	108	15
M220	48	32	46	12	4.5	36	43	53	63	73	83	10
M225	48	32	48	12	4.5	36	46	59	72	85	98	13
T225	48	32	50	12	4.5	36	48	63	78	93	108	15

Base mounting switches with snap on mounting for DIN Rail

- 20 A / 25 A / 32 A
- 1 up to 24 contacts
- IP40 (front)
- Installation mounting for 45 mm aperture in Panel/Distribution boards



- Control Switch
- ON-OFF Switch
- Multi-step Switch
- Instrument Switch
- Changeover Switch
- Motor Switch

Setup of order code number: Type - Switching programme - Mounting form Ordering example: 1 pole Multi-step Switch with OFF, 20 A, N-handle silver/grey →	Type	Switching programme	Mtg. form
	P220	61060	026N2
	Order code no. P220-61060-026N2		

Type	Rated data (IEC 60947)			Degree of Protection Terminals	Terminal accessibility
	Operational current I _e AC-21A (A)	Operational power (at 380–440 V) AC-23A (kW) AC-3A (kW)			
P220 P225	20 25	7.5 11	5.5 7.5	IP1B IP1B	Terminals accessible from mounting direction
M220 M225	20 25	7.5 11	5.5 7.5	IP20 IP20	Terminals accessible laterally
T225	32	15	11	IP20	Terminals accessible laterally

Switching programme	Stages	Contacts	Description
61191	1	1	ON-OFF Switch 90°, 1 pole
61192	1	2	ON-OFF Switch 90°, 2 pole
61001	1	1	ON-OFF Switch 60°, 1 pole
61002	1	2	ON-OFF Switch 60°, 2 pole
61025	1	2	Changeover Switch with centre OFF 60°, 1 pole
61026	2	4	Changeover Switch with centre OFF 60°, 2 pole
61027	3	6	Changeover Switch with centre OFF 60°, 3 pole
61037	1	2	Changeover Switch without OFF 60°, 1 pole
61060	2	3	Multi-step Switch with OFF, 3 steps, 1 pole
61050	2	4	Multi-step Switch without OFF, 4 steps, 1 pole
61313	3	6	Voltmeter Selector Switch with centre OFF, 3 phase line to line + 3 phase line to N
61325	3	6	Ammeter Selector Switch with centre OFF, 3 transformers, 1 pole
61211	3	5	Motor Reversing Switch, 3 pole

Switching diagrams and further switching programmes from page 56.

Mounting form	Operator
026N2	N-handle silver/grey

Dimensions in mm:

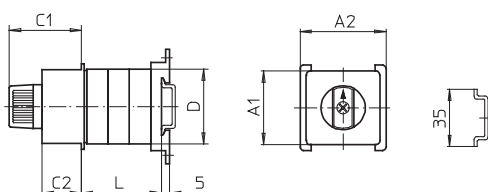

Type	L with ... stages (max. 12)					each additional
	A1	A2	C1	C2	D	
P220	45	52.2	45	24	44	28 41 54 67 80 13
P225	45	52.2	45	24	46	30 45 60 75 90 15
M220	45	52.2	45	24	46	25 35 45 55 65 10
M225	45	52.2	45	24	48	28 41 54 67 80 13
T225	45	52.2	45	24	50	30 45 60 75 90 15

Rotary Cam Switches

Base mounting Snap on mounting / Door clutch with modular shaft extension

Base mounting switches with snap on mounting / Door clutch with modular shaft extension

- 20 A / 25 A / 32 A ■ 1 up to 24 contacts
- IP66 (front)
- Four hole front mounting 36 × 36 mm



- Control Switch
- ON-OFF Switch
- Multi-step Switch
- Instrument Switch
- Changeover Switch
- Motor Switch

Setup of order code number: Type - Switching programme - Mounting form Ordering example: 1 pole Multi-step Switch with OFF, 20 A, M-handle silver/black →	Type	Switching programme	Mtg. form
	M220	61061	241M1
	Order code no.	M220-61061-241M1	

Type	Rated data (IEC 60947)			Degree of Protection	Terminal accessibility
	Operational current I _e AC-21A (A)	Operational power (at 380–440 V)			
		AC-23A (kW)	AC-3A (kW)	Terminals	
P220 P225	20 25	7.5 11	5.5 7.5	IP1B IP1B	Terminals accessible from mounting direction
M220 M225	20 25	7.5 11	5.5 7.5	IP20 IP20	Terminals accessible laterally
T225	32	15	11	IP20	Terminals accessible laterally

Switching programme	Stages	Contacts	Description
61191	1	1	ON-OFF Switch 90°, 1 pole
61192	1	2	ON-OFF Switch 90°, 2 pole
61001	1	1	ON-OFF Switch 60°, 1 pole
61002	1	2	ON-OFF Switch 60°, 2 pole
61025	1	2	Changeover Switch with centre OFF 60°, 1 pole
61026	2	4	Changeover Switch with centre OFF 60°, 2 pole
61027	3	6	Changeover Switch with centre OFF 60°, 3 pole
61037	1	2	Changeover Switch without OFF 60°, 1 pole
61038	2	4	Changeover Switch without OFF 60°, 2 pole
61061	2	4	Multi-step Switch with OFF, 4 steps, 1 pole
61049	2	3	Multi-step Switch without OFF, 3 steps, 1 pole
61050	2	4	Multi-step Switch without OFF, 4 steps, 1 pole
61211	3	5	Motor Reversing Switch, 3 pole

Switching diagrams and further switching programmes from page 56.

Mounting form	Operator
241M1	M-handle silver/black

Dimensions in mm:

Modular shaft extensions see page 84.

Type	A	C _{min}	C _{max}	C1	D	D1	D2	E	L with ... stages (max. 12) each				
									1	2	3	4	additional
P220	48	42	59	32	44	12	4.5	36	40	53	66	79	13
P225	48	42	59	32	46	12	4.5	36	42	57	72	87	15
M220	48	42	59	32	46	12	4.5	36	37	47	57	67	10
M225	48	42	59	32	48	12	4.5	36	40	53	66	79	13
T225	48	42	59	32	50	12	4.5	36	42	57	72	87	15

Rotary Cam Switches



Base mounting Snap on mounting / Door clutch with modular shaft extension

Base mounting switches with snap on mounting / Door clutch with modular shaft extension



- 20 A / 25 A / 32 A ■ 1 up to 24 contacts
- IP66 (front)
- Four hole front mounting 36 × 36 mm

- Main/Emergency-Off Switch
- Main Switch

Setup of order code number: Type - Switching programme - Mounting form Ordering example: 4 pole Main/Emergency-Off Switch 90°, 20 A, padlock device with N-handle yellow/red →	Type	Switching programme	Mtg. form
	M220	61194	232N4
	Order code no.	M220-61194-232N4	

Type	Rated data (IEC 60947)			Degree of Protection	Terminal accessibility
	Operational current I _o AC-21A (A)	Operational power (at 380–440 V) AC-23A (kW) AC-3A (kW)			
P220 P225	20 25	7.5 11	5.5 7.5	IP1B IP1B	Terminals accessible from mounting direction
M220 M225	20 25	7.5 11	5.5 7.5	IP20 IP20	Terminals accessible laterally
T225	32	15	11	IP20	Terminals accessible laterally

Switching programme	Stages	Contacts	Description
61191	1	1	ON-OFF Switch 90°, 1 pole
61192	1	2	ON-OFF Switch 90°, 2 pole
61199	2	3	ON-OFF Switch 90°, 3 pole
61194	2	4	ON-OFF Switch 90°, 4 pole, 1 pole early make/late break
61906	3	6	ON-OFF Switch 90°, 6 pole
61919	4	8	ON-OFF Switch 90°, 8 pole, 2 pole early make/late break

Switching diagrams and further switching programmes from page 56.

Mounting form	Operator	Main/Emergency-Off Switch	Mounting form	Operator	Main Switch
232N4		padlock device with N-handle yellow/red	232N1		padlock device with N-handle black
232M4		padlock device with M-handle yellow/red	232M1		padlock device with M-handle black
232V4		padlockable with V-handle yellow/red	232V1		padlockable with V-handle silver/black

Dimensions in mm:

Modular shaft extensions see page 84.

Type	Mounting form	A	C _{min}	C _{max}	C1	D	D1	D2	E	L with ... stages (max. 12) each additional				
											1	2	3	4
P220	232N4/232N1	67	42	59	33	44	15	4.5	36	40	53	66	79	13
	232M4/232M1	67	42	59	38	44	15	4.5	36	40	53	66	79	13
	232V4/232V1	48	42	59	32	44	12	4.5	36	40	53	66	79	13
P225	232N4/232N1	67	42	59	33	46	15	4.5	36	42	57	72	87	15
	232M4/232M1	67	42	59	38	46	15	4.5	36	42	57	72	87	15
	232V4/232V1	48	42	59	32	46	12	4.5	36	42	57	72	87	15
M220	232N4/232N1	67	42	59	33	46	15	4.5	36	37	47	57	67	10
	232M4/232M1	67	42	59	38	46	15	4.5	36	37	47	57	67	10
	232V4/232V1	48	42	59	32	46	12	4.5	36	37	47	57	67	10
M225	232N4/232N1	67	42	59	33	48	15	4.5	36	40	53	66	79	13
	232M4/232M1	67	42	59	38	48	15	4.5	36	40	53	66	79	13
	232V4/232V1	48	42	59	32	48	12	4.5	36	40	53	66	79	13
T225	232N4/232N1	67	42	59	33	50	15	4.5	36	42	57	72	87	15
	232M4/232M1	67	42	59	38	50	15	4.5	36	42	57	72	87	15
	232V4/232V1	48	42	59	32	50	12	4.5	36	42	57	72	87	15

Rotary Cam Switches

Base mounting Snap on mounting / Door interlock with modular shaft extension

Base mounting switches with snap on mounting / Door interlock with modular shaft extension

- with N/PE connection link
- 20 A / 25 A / 32 A
- IP66 (front)
- 1 up to 24 contacts
- Four hole front mounting 36 × 36 mm

- Control Switch
- ON-OFF Switch
- Multi-step Switch
- Instrument Switch
- Changeover Switch
- Motor Switch



Setup of order code number: Type - Switching programme - Mounting form Ordering example: 3 pole ON-OFF Switch 90°, 20 A, M-handle silver/black →	Type	Switching programme	Mtg. form
	M220	61199	242M1
	Order code no. M220-61199-242M1		

Type	Rated data (IEC 60947)			Degree of Protection Terminals	Terminal accessibility
	Operational current I _e AC-21A (A)	Operational power (at 380–440 V) AC-23A (kW) AC-3A (kW)			
P220 P225	20 25	7.5 11	5.5 7.5	IP1B IP1B	Terminals accessible from mounting direction
M220 M225	20 25	7.5 11	5.5 7.5	IP20 IP20	Terminals accessible laterally
T225	32	15	11	IP20	Terminals accessible laterally

Switching programme	Stages	Contacts	Description
61191	1	1	ON-OFF Switch 90°, 1 pole
61192	1	2	ON-OFF Switch 90°, 2 pole
61199	2	3	ON-OFF Switch 90°, 3 pole
61001	1	1	ON-OFF Switch 60°, 1 pole
61002	1	2	ON-OFF Switch 60°, 2 pole
61025	1	2	Changeover Switch with centre OFF 60°, 1 pole
61026	2	4	Changeover Switch with centre OFF 60°, 2 pole
61027	3	6	Changeover Switch with centre OFF 60°, 3 pole
61037	1	2	Changeover Switch without OFF 60°, 1 pole
61038	2	4	Changeover Switch without OFF 60°, 2 pole
61049	2	3	Multi-step Switch without OFF, 3 steps, 1 pole
61050	2	4	Multi-step Switch without OFF, 4 steps, 1 pole
61211	3	5	Motor Reversing Switch, 3 pole

Switching diagrams and further switching programmes from page 56.

Mounting form	Operator
242M1	M-handle silver/black

Dimensions in mm:

Modular shaft extensions see page 84.

Type	A	C _{min}	C _{max}	C1	D	D1	D2	E	L with ... stages (max. 12) each				
									1	2	3	4	additional
P220	48	42	57	32	44	12	4.5	36	40	53	66	79	13
P225	48	42	57	32	46	12	4.5	36	42	57	72	87	15
M220	48	42	57	32	46	12	4.5	36	37	47	57	67	10
M225	48	42	57	32	48	12	4.5	36	40	53	66	79	13
T225	48	42	57	32	50	12	4.5	36	42	57	72	87	15

Rotary Cam Switches

Base mounting Four hole mounting 68 × 68 mm

Base mounting switches with four hole mounting 68 × 68 mm

- 50 A / 63 A
- 1 up to 24 contacts
- IP55 (front)
- Four hole front mounting 48 × 48 mm



- ON-OFF Switch
- Multi-step Switch
- Changeover Switch
- Motor Switch

Setup of order code number: Type - Switching programme - Mounting form Ordering example: 3 pole Changeover Switch with centre OFF 60°, 50 A, M-handle silver/black →	Type	Switching programme	Mtg. form
	S432	61027	002M1
	Order code no. S432-61027-002M1		

Type	Rated data (IEC 60947)			Terminal accessibility
	Operational current I _e AC-21A (A)	Operational power (at 380–440 V) AC-23A (kW) AC-3A (kW)		
S432	50	22	22	Terminals accessible laterally
S440	63	30	30	

Switching programme	Stages	Contacts	Description
61191	1	1	ON-OFF Switch 90°, 1 pole
61192	1	2	ON-OFF Switch 90°, 2 pole
61001	1	1	ON-OFF Switch 60°, 1 pole
61002	1	2	ON-OFF Switch 60°, 2 pole
61003	2	3	ON-OFF Switch 60°, 3 pole
61025	1	2	Changeover Switch with centre OFF 60°, 1 pole
61026	2	4	Changeover Switch with centre OFF 60°, 2 pole
61027	3	6	Changeover Switch with centre OFF 60°, 3 pole
61037	1	2	Changeover Switch without OFF 60°, 1 pole
61038	2	4	Changeover Switch without OFF 60°, 2 pole
61050	2	4	Multi-step Switch without OFF, 4 steps, 1 pole
61211	3	5	Motor Reversing Switch, 3 pole

Switching diagrams and further switching programmes from page 56.

Mounting form	Operator
002M1	M-handle silver/black

Dimensions in mm:

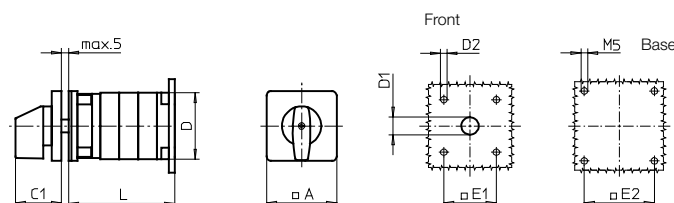

Type	A	C1	D	D1	D2	E1	E2	L with ... stages (max. 12)						each additional
								1	2	3	4	5	6	
S432	64	39	65	12	5	48	68	56	74	92	110	128	146	18
S440	64	39	70	12	5	48	68	61	82	103	124	145	166	21

Rotary Cam Switches

Base mounting Four hole mounting 68 × 68 mm

Base mounting switches with four hole mounting 68 × 68 mm

- 80 A / 100 A / 160 A
- 1 up to 24 contacts
- IP55 (front)
- Four hole front mounting 68 × 68 mm



- ON-OFF Switch
- Changeover Switch
- Multi-step Switch
- Motor Switch

Setup of order code number: Type - Switching programme - Mounting form Ordering example: 3 pole Changeover Switch with centre OFF 60°, 80 A, M-handle silver/black →	Type	Switching programme	Mtg. form
	S606	61027	002M1
	Order code no. S606-61027-002M1		

Type	Rated data (IEC 60947)			Terminal accessibility
	Operational current I _e AC-21A (A)	Operational power (at 380–440 V)		
		AC-23A (kW)	AC-3A (kW)	
S606	80	45	30	Terminals accessible laterally
S608	100	55	37	
S612	160	75	45	

Switching programme	Stages	Contacts	Description
61191	1	1	ON-OFF Switch 90°, 1 pole
61192	1	2	ON-OFF Switch 90°, 2 pole
61001	1	1	ON-OFF Switch 60°, 1 pole
61002	1	2	ON-OFF Switch 60°, 2 pole
61003	2	3	ON-OFF Switch 60°, 3 pole
61025	1	2	Changeover Switch with centre OFF 60°, 1 pole
61026	2	4	Changeover Switch with centre OFF 60°, 2 pole
61027	3	6	Changeover Switch with centre OFF 60°, 3 pole
61037	1	2	Changeover Switch without OFF 60°, 1 pole
61038	2	4	Changeover Switch without OFF 60°, 2 pole
61050	2	4	Multi-step Switch without OFF, 4 steps, 1 pole
61211	3	5	Motor Reversing Switch, 3 pole

Switching diagrams and further switching programmes from page 56.

Mounting form	Operator	Mounting form	Operator
002M1	M-handle silver/black	002G1	G-handle silver/black

Dimensions in mm:

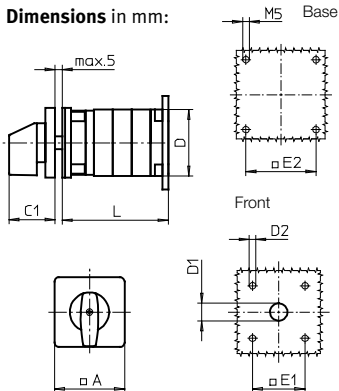

Type	Mtg. form	A	C1	D	D1	D2	E1	E2	L with ... stages (max. 12)				each additional
									1	2	3	4	
S606	002M1	88	52	84	15	5.5	68	68	64	86	108	130	22
	002G1	88	66	84	15	5.5	68	68	64	86	108	130	22
S608	002M1	88	52	88	15	5.5	68	68	71	97	123	149	26
	002G1	88	66	88	15	5.5	68	68	71	97	123	149	26
S612	002M1	88	52	88	15	5.5	68	68	77	109	141	173	32
	002G1	88	66	88	15	5.5	68	68	77	109	141	173	32

Rotary Cam Switches

Base mounting Four hole mounting 68 × 68 mm / Door clutch

Base mounting switches with four hole mounting 68 × 68 mm / Door clutch

- 50 A / 63 A
- IP55 (front)
- Four hole front mounting 48 × 48 mm
- 1 up to 24 contacts

- ON-OFF Switch
- Changeover Switch
- Multi-step Switch
- Motor Switch



Setup of order code number: Type - Switching programme - Mounting form	Type	Switching programme	Mtg. form
Ordering example: 3 pole ON-OFF Switch 60°, 50 A, M-handle silver/black →	S432	61006	041M1
	Order code no. S432-61006-041M1		

Type	Rated data (IEC 60947)			Terminal accessibility
	Operational current I _e AC-21A (A)	Operational power (at 380–440 V)		
		AC-23A (kW)	AC-3A (kW)	
S432	50	22	22	 Terminals accessible laterally
S440	63	30	30	

Switching programme	Stages	Contacts	Description
61191	1	1	ON-OFF Switch 90°, 1 pole
61192	1	2	ON-OFF Switch 90°, 2 pole
61001	1	1	ON-OFF Switch 60°, 1 pole
61002	1	2	ON-OFF Switch 60°, 2 pole
61003	2	3	ON-OFF Switch 60°, 3 pole
61006	3	6	ON-OFF Switch 60°, 6 pole
61025	1	2	Changeover Switch with centre OFF 60°, 1 pole
61026	2	4	Changeover Switch with centre OFF 60°, 2 pole
61027	3	6	Changeover Switch with centre OFF 60°, 3 pole
61037	1	2	Changeover Switch without OFF 60°, 1 pole
61038	2	4	Changeover Switch without OFF 60°, 2 pole
61050	2	4	Multi-step Switch without OFF, 4 steps, 1 pole
61211	3	5	Motor Reversing Switch, 3 pole

Switching diagrams and further switching programmes from page 56.

Mounting form	Operator
041M1	M-handle silver/black

Dimensions in mm:

Type	A	C _{min}	C _{max}	C1	D	D1	D2	E1	E2	L with ... stages (max. 12)				each additional
										1	2	3	4	
S432	64	42	56	39	65	12	5	48	68	51	69	87	105	18
S440	64	42	56	39	70	12	5	48	68	56	77	98	119	21

Rotary Cam Switches

Base mounting Four hole mounting 68 × 68 mm / Door clutch

Base mounting switches with four hole mounting 68 × 68 mm / Door clutch

- **80 A / 100 A / 160 A** ■ 1 up to 24 contacts
- IP55 (front)
- Four hole front mounting 68 × 68 mm



- ON-OFF Switch
- Changeover Switch
- Multi-step Switch
- Motor Switch

Setup of order code number: Type - Switching programme - Mounting form	Type	Switching programme	Mtg. form
Ordering example: 3 pole ON-OFF Switch 90°, 80 A, M-handle silver/black →	S606	61199	041M1
	Order code no. S606-61199-041M1		

Type	Rated data (IEC 60947)			Terminal accessibility
	Operational current I _e AC-21A (A)	Operational power (at 380–440 V)		
		AC-23A (kW)	AC-3A (kW)	
S606	80	45	30	 Terminals accessible laterally
S608	100	55	37	
S612	160	75	45	

Switching programme	Stages	Contacts	Description
61192	1	2	ON-OFF Switch 90°, 2 pole
61199	2	3	ON-OFF Switch 90°, 3 pole
61001	1	1	ON-OFF Switch 60°, 1 pole
61002	1	2	ON-OFF Switch 60°, 2 pole
61003	2	3	ON-OFF Switch 60°, 3 pole
61025	1	2	Changeover Switch with centre OFF 60°, 1 pole
61026	2	4	Changeover Switch with centre OFF 60°, 2 pole
61027	3	6	Changeover Switch with centre OFF 60°, 3 pole
61037	1	2	Changeover Switch without OFF 60°, 1 pole
61038	2	4	Changeover Switch without OFF 60°, 2 pole
61050	2	4	Multi-step Switch without OFF, 4 steps, 1 pole
61211	3	5	Motor Reversing Switch, 3 pole

Switching diagrams and further switching programmes from page 56.

Mounting form	Operator	Mounting form	Operator
041M1	M-handle silver/black	041G1	G-handle silver/black

Dimensions in mm:

Type	Mtg. form	A	C _{min}	C _{max}	C1	D	D1	D2	E1	E2	L with ... stages (max. 12) each additional				
											1	2	3	4	
S606	041M1	88	48	60	52	84	18	5.5	68	68	58	80	107	129	22
	041G1	88	48	60	66	84	18	5.5	68	68	58	80	107	129	22
S608	041M1	88	48	60	52	88	18	5.5	68	68	65	91	117	143	26
	041G1	88	48	60	66	88	18	5.5	68	68	65	91	117	143	26
S612	041M1	88	48	60	52	88	18	5.5	68	68	71	103	135	167	32
	041G1	88	48	60	66	88	18	5.5	68	68	71	103	135	167	32

Rotary Cam Switches

Base mounting Four hole mounting 68 × 68 mm / Door interlock

Base mounting switches with four hole mounting 68 × 68 mm / Door interlock

- 50 A / 63 A
- IP55 (front)
- Four hole front mounting 48 × 48 mm
- 1 up to 24 contacts



- ON-OFF Switch
- Multi-step Switch
- Changeover Switch
- Motor Switch

Setup of order code number: Type - Switching programme - Mounting form Ordering example: 3 pole ON-OFF Switch 90°, 50 A, M-handle silver/black →	Type	Switching programme	Mtg. form
	S432	61199	042M1
	Order code no. S432-61199-042M1		

Type	Rated data (IEC 60947)			Terminal accessibility
	Operational current I_e AC-21A (A)	Operational power (at 380–440 V) AC-23A (kW) AC-3A (kW)		
S432	50	22	22	Terminals accessible laterally
S440	63	30	30	

Switching programme	Stages	Contacts	Description
61191	1	1	ON-OFF Switch 90°, 1 pole
61192	1	2	ON-OFF Switch 90°, 2 pole
61199	2	3	ON-OFF Switch 90°, 3 pole
61001	1	1	ON-OFF Switch 60°, 1 pole
61002	1	2	ON-OFF Switch 60°, 2 pole
61003	2	3	ON-OFF Switch 60°, 3 pole
61025	1	2	Changeover Switch with centre OFF 60°, 1 pole
61026	2	4	Changeover Switch with centre OFF 60°, 2 pole
61027	3	6	Changeover Switch with centre OFF 60°, 3 pole
61037	1	2	Changeover Switch without OFF 60°, 1 pole
61038	2	4	Changeover Switch without OFF 60°, 2 pole
61050	2	4	Multi-step Switch without OFF, 4 steps, 1 pole
61211	3	5	Motor Reversing Switch, 3 pole

Switching diagrams and further switching programmes from page 56.

Mounting form	Operator
042M1	M-handle silver/black

Dimensions in mm:

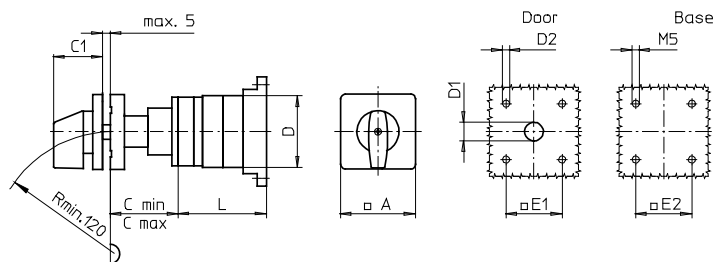

Type	A	C _{min}	C _{max}	C1	D	D1	D2	E1	E2	L with ... stages (max. 12)				each additional
										1	2	3	4	
S432	64	42	56	39	65	15	5	48	68	51	69	87	105	18
S440	64	42	56	39	70	15	5	48	68	56	77	98	119	21

Rotary Cam Switches

Base mounting Four hole mounting 68 × 68 mm / Door interlock

Base mounting switches with four hole mounting 68 × 68 mm / Door interlock

- **80 A / 100 A / 160 A** ■ 1 up to 24 contacts
- IP55 (front)
- Four hole front mounting 68 × 68 mm



- ON-OFF Switch
- Changeover Switch
- Multi-step Switch
- Motor Switch

Setup of order code number: Type - Switching programme - Mounting form Ordering example: 3 pole ON-OFF Switch 90°, 80 A, M-handle silver/black →	Type	Switching programme	Mtg. form
	S606	61199	042M1
	Order code no. S606-61199-042M1		

Type	Rated data (IEC 60947)			Terminal accessibility
	Operational current I _e AC-21A (A)	Operational power (at 380–440 V)		
		AC-23A (kW)	AC-3A (kW)	
S606	80	45	30	 Terminals accessible laterally
S608	100	55	37	
S612	160	75	45	

Switching programme	Stages	Contacts	Description
61192	1	2	ON-OFF Switch 90°, 2 pole
61199	2	3	ON-OFF Switch 90°, 3 pole
61001	1	1	ON-OFF Switch 60°, 1 pole
61002	1	2	ON-OFF Switch 60°, 2 pole
61003	2	3	ON-OFF Switch 60°, 3 pole
61025	1	2	Changeover Switch with centre OFF 60°, 1 pole
61026	2	4	Changeover Switch with centre OFF 60°, 2 pole
61027	3	6	Changeover Switch with centre OFF 60°, 3 pole
61037	1	2	Changeover Switch without OFF 60°, 1 pole
61038	2	4	Changeover Switch without OFF 60°, 2 pole
61050	2	4	Multi-step Switch without OFF, 4 steps, 1 pole
61211	3	5	Motor Reversing Switch, 3 pole

Switching diagrams and further switching programmes from page 56.

Mounting form	Operator	Mounting form	Operator
042M1	M-handle silver/black	042G1	G-handle silver/black

Dimensions in mm:

Type	Mtg. form	A	C _{min}	C _{max}	C1	D	D1	D2	E1	E2	L with ... stages (max. 12)				each additional
											1	2	3	4	
S606	042M1	88	48	60	52	84	18	5.5	68	68	58	80	107	129	22
	042G1	88	48	60	66	84	18	5.5	68	68	58	80	107	129	22
S608	042M1	88	48	60	52	88	18	5.5	68	68	65	91	117	143	26
	042G1	88	48	60	66	88	18	5.5	68	68	65	91	117	143	26
S612	042M1	88	48	60	52	88	18	5.5	68	68	71	103	135	167	32
	042G1	88	48	60	66	88	18	5.5	68	68	71	103	135	167	32

Rotary Cam Switches

Base mounting Four hole mounting 104 × 104 mm

Base mounting switches with four hole mounting 104 × 104 mm

- **315 A**
- 1 up to 24 contacts
- IP55 (front)
- Four hole front mounting 104 × 104 mm



- ON-OFF Switch
- Multi-step Switch
- Changeover Switch
- Motor Switch

Setup of order code number: Type - Switching programme - Mounting form Ordering example: 2 pole Changeover Switch with centre OFF 60°, 315 A, G-handle silver/black →	Type	Switching programme	Mtg. form
	S825	61026	002G1
	Order code no. S825-61026-002G1		

Type	Rated data (IEC 60947)			Terminal accessibility
	Operational current I _e AC-21A (A)	Operational power (at 380–440 V) AC-23A (kW) AC-3A (kW)		
S825	315	132	55	Terminals accessible laterally

Switching programme	Stages	Contacts	Description
61191	1	1	ON-OFF Switch 90°, 1 pole
61192	1	2	ON-OFF Switch 90°, 2 pole
61001	1	1	ON-OFF Switch 60°, 1 pole
61002	1	2	ON-OFF Switch 60°, 2 pole
61003	2	3	ON-OFF Switch 60°, 3 pole
61025	1	2	Changeover Switch with centre OFF 60°, 1 pole
61026	2	4	Changeover Switch with centre OFF 60°, 2 pole
61027	3	6	Changeover Switch with centre OFF 60°, 3 pole
61037	1	2	Changeover Switch without OFF 60°, 1 pole
61038	2	4	Changeover Switch without OFF 60°, 2 pole
61050	2	4	Multi-step Switch without OFF, 4 steps, 1 pole

Switching diagrams and further switching programmes from page 56.

Mounting form	Operator
002G1	G-handle silver/black

Dimensions in mm:

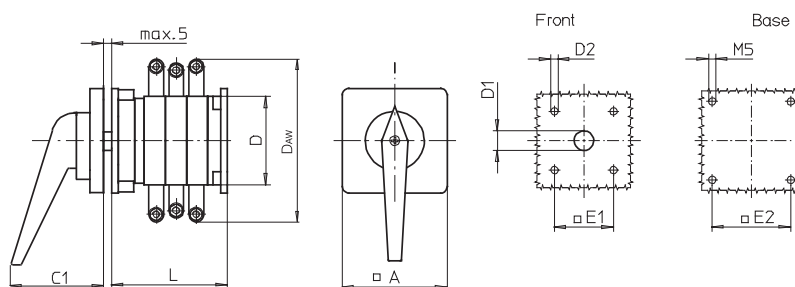

Type	A	C1	D	D _{AW}	D1	D2	E1	E2	L with ... stages (max. 12)						each additional
									1	2	3	4	5	6	
S825	130	74	120	210	20	5,5	104	104	96	132	168	204	240	276	36

Rotary Cam Switches

Base mounting Four hole mounting 104 × 104 mm / Door clutch

Base mounting switches with four hole mounting 104 × 104 mm / Door clutch

- **315 A** ■ 1 up to 24 contacts
- IP55 (front)
- Four hole front mounting 104 × 104 mm



- ON-OFF Switch
- Changeover Switch
- Multi-step Switch
- Motor Switch

Setup of order code number: Type - Switching programme - Mounting form Ordering example: 3 pole Changeover Switch with centre OFF 60°, 315 A, G-handle silver/black →	Type	Switching programme	Mtg. form
	S825	61027	041G1
	Order code no. S825-61027-041G1		

Type	Rated data (IEC 60947)			Terminal accessibility
	Operational current I_e AC-21A (A)	Operational power (at 380–440 V) AC-23A (kW) AC-3A (kW)		
S825	315	132	55	Terminals accessible laterally

Switching programme	Stages	Contacts	Description
61191	1	1	ON-OFF Switch 90°, 1 pole
61192	1	2	ON-OFF Switch 90°, 2 pole
61001	1	1	ON-OFF Switch 60°, 1 pole
61002	1	2	ON-OFF Switch 60°, 2 pole
61003	2	3	ON-OFF Switch 60°, 3 pole
61025	1	2	Changeover Switch with centre OFF 60°, 1 pole
61026	2	4	Changeover Switch with centre OFF 60°, 2 pole
61027	3	6	Changeover Switch with centre OFF 60°, 3 pole
61037	1	2	Changeover Switch without OFF 60°, 1 pole
61038	2	4	Changeover Switch without OFF 60°, 2 pole
61050	2	4	Multi-step Switch without OFF, 4 steps, 1 pole

Switching diagrams and further switching programmes from page 56.

Mounting form	Operator
041G1	G-handle silver/black

Dimensions in mm:

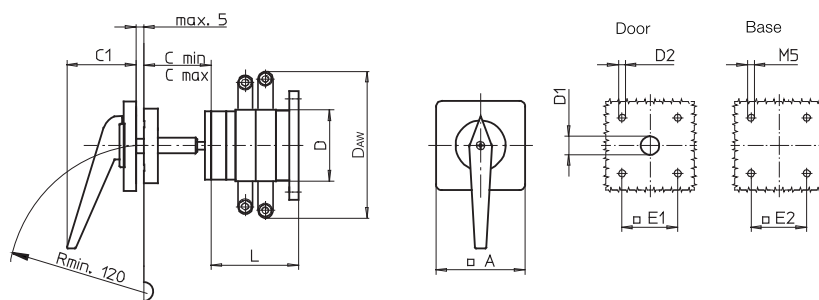

Type	A	C_{min}	C_{max}	C1	D	D_{AW}	D1	D2	E1	E2	L with ... stages (max. 12)				each additional
											1	2	3	4	
S825	130	75	102	74	120	210	20	5.5	104	104	90	126	162	198	36

Rotary Cam Switches

Base mounting Four hole mounting 104 × 104 mm / Door interlock

Base mounting switches with four hole mounting 104 × 104 mm / Door interlock

- 315 A
- IP55 (front)
- Four hole front mounting 104 × 104 mm
- 1 up to 24 contacts

- ON-OFF Switch
- Multi-step Switch
- Changeover Switch
- Motor Switch



Setup of order code number: Type - Switching programme - Mounting form Ordering example: 3 pole ON-OFF Switch 90°, 315 A, G-handle silver/black →	Type	Switching programme	Mtg. form
	S825	61199	042G1
	Order code no. S825-61199-042G1		

Type	Rated data (IEC 60947)			Terminal accessibility
	Operational current I_e AC-21A (A)	Operational power (at 380–440 V) AC-23A (kW) AC-3A (kW)		
S825	315	132	55	Terminals accessible laterally

Switching programme	Stages	Contacts	Description
61191	1	1	ON-OFF Switch 90°, 1 pole
61192	1	2	ON-OFF Switch 90°, 2 pole
61199	2	3	ON-OFF Switch 90°, 3 pole
61001	1	1	ON-OFF Switch 60°, 1 pole
61002	1	2	ON-OFF Switch 60°, 2 pole
61003	2	3	ON-OFF Switch 60°, 3 pole
61025	1	2	Changeover Switch with centre OFF 60°, 1 pole
61026	2	4	Changeover Switch with centre OFF 60°, 2 pole
61027	3	6	Changeover Switch with centre OFF 60°, 3 pole
61037	1	2	Changeover Switch without OFF 60°, 1 pole
61038	2	4	Changeover Switch without OFF 60°, 2 pole
61050	2	4	Multi-step Switch without OFF, 4 steps, 1 pole

Switching diagrams and further switching programmes from page 56.

Mounting form	Operator
042G1	G-handle silver/black

Dimensions in mm:

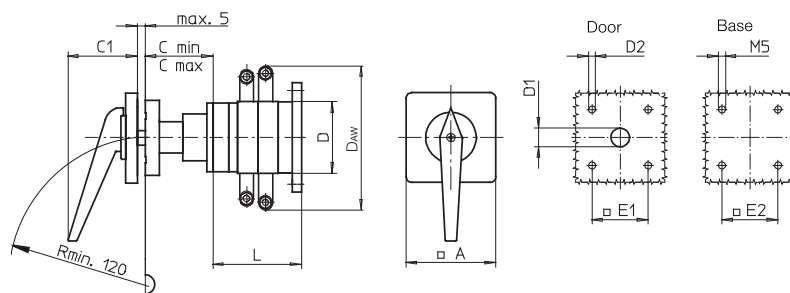

Type	A	C _{min}	C _{max}	C1	D	D _{AW}	D1	D2	E1	E2	L with ... stages (max. 12)				each additional
											1	2	3	4	
S825	130	75	102	74	120	210	20	5.5	104	104	90	126	162	198	36

Rotary Cam Switches



Enclosed Switches with insulated enclosure 68 × 68 × 53 mm

Enclosed Switches with insulated enclosure 68 × 68 × 53 mm

- 20 A
- 1 up to 4 contacts
- IP65
- Insulated polycarbonate enclosure



- Control Switch
- ON-OFF Switch
- Multi-step Switch
- Instrument Switch
- Changeover Switch
- Motor Switch

Setup of order code number: Type - Switching programme - Mounting form Ordering example: 1 pole Multi-step Switch without OFF, 20 A, N-handle silver/black →	Type	Switching programme	Mtg. form
	M220	61049	107M1
	Order code no. M220-61049-107M1		

Type	Rated data (IEC 60947)			Terminal accessibility
	Operational current I _e AC-21A (A)	Operational power (at 380–440 V)		
		AC-23A (kW)	AC-3A (kW)	
M220	20	7.5	5.5	 Terminals accessible laterally

Switching programme	Stages	Contacts	Description
61191	1	1	ON-OFF Switch 90°, 1 pole
61192	1	2	ON-OFF Switch 90°, 2 pole
61199	2	3	ON-OFF Switch 90°, 3 pole
61194	2	4	ON-OFF Switch 90°, 4 pole, 1 pole early make/late break
61001	1	1	ON-OFF Switch 60°, 1 pole
61002	1	2	ON-OFF Switch 60°, 2 pole
61003	2	3	ON-OFF Switch 60°, 3 pole
61025	1	2	Changeover Switch with centre OFF 60°, 1 pole
61026	2	4	Changeover Switch with centre OFF 60°, 2 pole
61037	1	2	Changeover Switch without OFF 60°, 1 pole
61049	2	3	Multi-step Switch without OFF, 3 steps, 1 pole
61050	2	4	Multi-step Switch without OFF, 4 steps, 1 pole
61210	2	4	Motor Reversing Switch, 2 pole

Switching diagrams and further switching programmes from page 56.

Mounting form	Operator
107M1	 M-handle silver/black

Dimensions in mm:

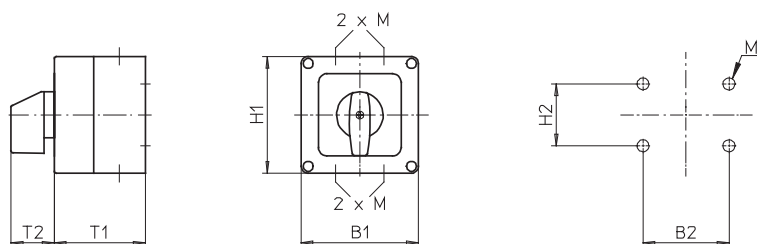

Type	H1	B1	T1	T2	2 × M	H2	B2
M220	68	68	53	25	16	36	50

Rotary Cam Switches

Enclosed Switches with insulated enclosure 68 × 68 × 53 mm

Enclosed Switches with insulated enclosure 68 × 68 × 53 mm

- 20 A
- 1 up to 4 contacts
- IP65
- Insulated polycarbonate enclosure









- Main/Emergency-Off Switch
- Main Switch

Setup of order code number: Type - Switching programme - Mounting form Ordering example: 2 pole Main/Emergency-Off Switch 90°, 20 A, padlock device with M-handle yellow/red →	Type	Switching programme	Mtg. form
	M220	61192	117M4
	Order code no. M220-61192-117M4		

Type	Rated data (IEC 60947)			Terminal accessibility
	Operational current I _e AC-21A (A)	Operational power (at 380–440 V) AC-23A (kW) AC-3A (kW)		
M220	20	7.5	5.5	 Terminals accessible laterally

Switching programme	Stages	Contacts	Description
61191	1	1	ON-OFF Switch 90°, 1 pole
61192	1	2	ON-OFF Switch 90°, 2 pole
61199	2	3	ON-OFF Switch 90°, 3 pole
61194	2	4	ON-OFF Switch 90°, 4 pole, 1 pole early make/late break

Switching diagrams and further switching programmes from page 56.

Mounting form	Operator	Main/Emergency-Off Switch	Mounting form	Operator	Main Switch
117M4	  	padlock device with M-handle yellow/red	117M1	  	padlock device with M-handle black

Dimensions in mm:

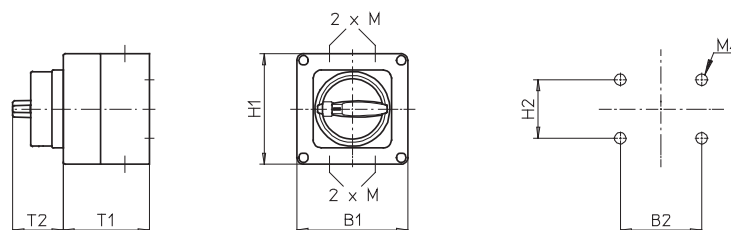

Type	H1	B1	T1	T2	2 × M	H2	B2
M220	68	68	53	31	16	36	50

Rotary Cam Switches

Enclosed Switches with insulated enclosure 100 × 80 × 65 mm

Enclosed Switches with insulated enclosure 100 × 80 × 65 mm

- 20 A
- 1 up to max. 4 contacts
- IP66
- Insulated polycarbonate enclosure



- Control Switch
- ON-OFF Switch
- Multi-step Switch
- Instrument Switch
- Changeover Switch
- Motor Switch

Setup of order code number: Type - Switching programme - Mounting form Ordering example: 2 pole Changeover Switch without OFF 60°, 20 A, M-handle silver/black →	Type	Switching programme	Mtg. form
	M220	61038	076M1
	Order code no. M220-61038-076M1		

Type	Contacts	Rated data (IEC 60947)			Terminal accessibility
		Operational current I _o AC-21A (A)	Operational power (at 380–440 V)		
			AC-23A (kW)	AC-3A (kW)	
P220	1 to 2	20	7.5	5.5	Terminals accessible from mounting direction
M220	1 to 4	20	7.5	5.5	Terminals accessible laterally

Switching programme	Stages	Contacts	Description
61191 for type P220	1	1	ON-OFF Switch 90°, 1 pole
61192 for type P220	1	2	ON-OFF Switch 90°, 2 pole
61001 for type P220	1	1	ON-OFF Switch 60°, 1 pole
61002 for type P220	1	2	ON-OFF Switch 60°, 2 pole
61025 for type P220	1	2	Changeover Switch with centre OFF 60°, 1 pole
61037 for type P220	1	2	Changeover Switch without OFF 60°, 1 pole
61003 for type M220	2	3	ON-OFF Switch 60°, 3 pole
61026 for type M220	2	4	Changeover Switch with centre OFF 60°, 2 pole
61038 for type M220	2	4	Changeover Switch without OFF 60°, 2 pole
61049 for type M220	2	3	Multi-step Switch without OFF, 3 steps, 1 pole
61050 for type M220	2	4	Multi-step Switch without OFF, 4 steps, 1 pole
61210 for type M220	2	4	Motor Reversing Switch, 2 pole

Switching diagrams and further switching programmes from page 56.

Mounting form	Operator
076M1	M-handle silver/black

Dimensions in mm:

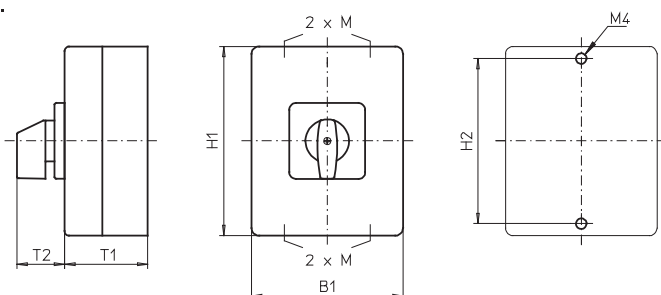

Type	H1	B1	T1	T2	2 × M	H2
P220	100	80	65	32	20	90
M220	100	80	65	32	20	90

Rotary Cam Switches

Enclosed Switches with insulated enclosure 100 × 80 × 65 mm

Enclosed Switches with insulated enclosure 100 × 80 × 65 mm

- 20 A
- 1 up to max. 4 contacts
- IP66
- Insulated polycarbonate enclosure



- Control Switch
- ON-OFF Switch
- Multi-step Switch
- Instrument Switch
- Changeover Switch
- Motor Switch

Setup of order code number: Type - Switching programme - Mounting form Ordering example: 2 pole Changeover Switch 90°, 20 A, padlockable with V-handle silver/black →	Type	Switching programme	Mtg. form
	M220	61152	076V1
	Order code no. M220-61152-076V1		

Type	Contacts	Rated data (IEC 60947)			Terminal accessibility
		Operational current I _e AC-21A (A)	Operational power (at 380–440 V)		
			AC-23A (kW)	AC-3A (kW)	
P220	1 to 2	20	7.5	5.5	Terminals accessible from mounting direction
M220	1 to 4	20	7.5	5.5	Terminals accessible laterally

Switching programme	Stages	Contacts	Description
61001 for type P220	1	1	ON-OFF Switch 60°, 1 pole
61002 for type P220	1	2	ON-OFF Switch 60°, 2 pole
61025 for type P220	1	2	Changeover Switch with centre OFF 60°, 1 pole
61151 for type P220	1	2	Changeover Switch with centre OFF 90°, 1 pole
61003 for type M220	2	3	ON-OFF Switch 60°, 3 pole
61026 for type M220	2	4	Changeover Switch with centre OFF 60°, 2 pole
61151 for type M220	1	2	Changeover Switch with centre OFF 90°, 1 pole
61152 for type M220	2	4	Changeover Switch with centre OFF 90°, 2 pole
61210 for type M220	2	4	Motor Reversing Switch, 2 pole

Switching diagrams and further switching programmes from page 56.

Mounting form	Operator	Padlockable options
076V1	padlockable with V-handle silver/black	padlockable 12h
078V1	padlockable with V-handle silver/black	3 positions padlockable (9h/12h/03h) (only for Changeover Switches with 90° switching angle)

Dimensions in mm:

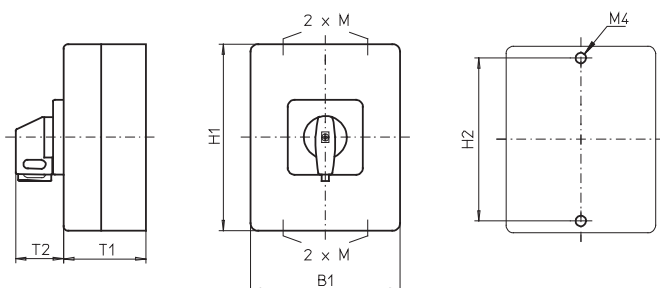

Type	H1	B1	T1	T2	2 × M	H2
P220	100	80	65	32	20	90
M220	100	80	65	32	20	90

Rotary Cam Switches

Enclosed Switches with insulated enclosure 100 × 80 × 65 mm

Enclosed Switches with insulated enclosure 100 × 80 × 65 mm

- 20 A
- 1 up to max. 4 contacts
- IP66
- Insulated polycarbonate enclosure



- Main/Emergency-Off Switch
- Main Switch

Setup of order code number: Type - Switching programme - Mounting form Ordering example: 2 pole Main Switch 90°, 20 A, padlock device with N-handle yellow/red →	Type	Switching programme	Mtg. form
	P220	61192	077N4
	Order code no. P220-61192-077N4		

Type	Contacts	Rated data (IEC 60947)			Terminal accessibility
		Operational current I _e AC-21A (A)	Operational power (at 380–440 V)		
			AC-23A (kW)	AC-3A (kW)	
P220	1 to 2	20	7.5	5.5	Terminals accessible from mounting direction
M220	1 to 4	20	7.5	5.5	Terminals accessible laterally

Switching programme	Stages	Contacts	Description
61191 for type P220	1	1	ON-OFF Switch 90°, 1 pole
61192 for type P220	1	2	ON-OFF Switch 90°, 2 pole
61191 for type M220	1	1	ON-OFF Switch 90°, 1 pole
61192 for type M220	1	2	ON-OFF Switch 90°, 2 pole
61199 for type M220	2	3	ON-OFF Switch 90°, 3 pole
61194 for type M220	2	4	ON-OFF Switch 90°, 4 pole, 1 pole early make/late break

Switching diagrams and further switching programmes from page 56.

Mounting form	Operator	Main/Emergency-Off Switch	Mounting form	Operator	Main Switch
077N4		padlock device with N-handle yellow/red	077N1		padlock device with N-handle black
077M4		padlock device with M-handle yellow/red	077M1		padlock device with M-handle black
077V4		padlockable with V-handle yellow/red	077V1		padlockable with V-handle silver/black

Dimensions in mm:

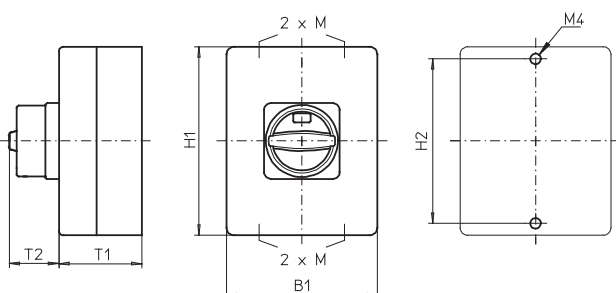

Mounting form	H1	B1	T1	T2	2 × M	H2
077N4/077N1	100	80	65	33	20	90
077M4/077M1	100	80	65	38	20	90
077V4/077V1	100	80	65	32	20	90

Rotary Cam Switches

Enclosed Switches with insulated enclosure 100 × 80 × 85 mm

Enclosed Switches with insulated enclosure 100 × 80 × 85 mm

- 20 A
- 3 up to max. 8 contacts
- IP66
- Insulated polycarbonate enclosure



- Control Switch
- ON-OFF Switch
- Multi-step Switch
- Instrument Switch
- Changeover Switch
- Motor Switch

Setup of order code number: Type - Switching programme - Mounting form Ordering example: 4 pole Changeover Switch without OFF 60°, 20 A, M-handle silver/black →	Type	Switching programme	Mtg. form
	M220	61040	176M1
	Order code no. M220-61040-176M1		

Type	Contacts	Rated data (IEC 60947)			Terminal accessibility
		Operational current I _e AC-21A (A)	Operational power (at 380–440 V)		
			AC-23A (kW)	AC-3A (kW)	
P220	3 to 6	20	7.5	5.5	Terminals accessible from mounting direction
M220	5 to 8	20	7.5	5.5	Terminals accessible laterally

Switching programme	Stages	Contacts	Description
61199 for type P220	2	3	ON-OFF Switch 90°, 3 pole
61194 for type P220	2	4	ON-OFF Switch 90°, 4 pole, 1 pole early make/late break
61026 for type P220	2	4	Changeover Switch with centre OFF 60°, 2 pole
61038 for type P220	2	4	Changeover Switch without OFF 60°, 2 pole
61049 for type P220	2	3	Multi-step Switch without OFF, 3 steps, 1 pole
61211 for type P220	3	5	Motor Reversing Switch, 3 pole
61906 for type M220	3	6	ON-OFF Switch 90°, 6 pole
61919 for type M220	4	8	ON-OFF Switch 90°, 8 pole, 2 pole early make/late break
61028 for type M220	4	8	Changeover Switch with centre OFF 60°, 4 pole
61039 for type M220	3	6	Changeover Switch without OFF 60°, 3 pole
61040 for type M220	4	8	Changeover Switch without OFF 60°, 4 pole
61211 for type M220	3	5	Motor Reversing Switch, 3 pole

Switching diagrams and further switching programmes from page 56.

Mounting form	Operator
176M1	M-handle silver/black

Dimensions in mm:

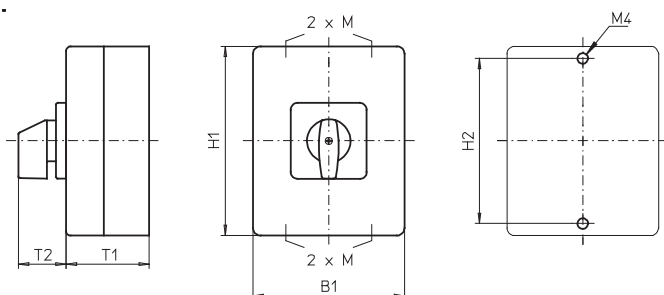

Type	H1	B1	T1	T2	2 × M	H2
P220	100	80	85	32	20	90
M220	100	80	85	32	20	90

Rotary Cam Switches

Enclosed Switches with insulated enclosure 100 × 80 × 85 mm

Enclosed Switches with insulated enclosure 100 × 80 × 85 mm

- 20 A
- 3 up to max. 8 contacts
- IP66
- Insulated polycarbonate enclosure



- Control Switch
- ON-OFF Switch
- Multi-step Switch
- Instrument Switch
- Changeover Switch
- Motor Switch

Setup of order code number: Type - Switching programme - Mounting form Ordering example: 2 pole Changeover Switch 90°, 20 A, padlockable with V-handle silver/black →	Type	Switching programme	Mtg. form
	P220	61152	178V1
	Order code no. P220-61152-178V1		

Type	Contacts	Rated data (IEC 60947)			Terminal accessibility
		Operational current I _o AC-21A (A)	Operational power (at 380–440 V) AC-23A (kW) AC-3A (kW)		
P220	1 to 2	20	7.5	5.5	Terminals accessible from mounting direction
M220	1 to 4	20	7.5	5.5	Terminals accessible laterally

Switching programme	Stages	Contacts	Description
61003 for type P220	2	3	ON-OFF Switch 60°, 3 pole
61027 for type P220	3	6	Changeover Switch with centre OFF 60°, 3 pole
61152 for type P220	2	4	Changeover Switch with centre OFF 90°, 2 pole
61153 for type P220	3	6	Changeover Switch with centre OFF 90°, 3 pole
61211 for type P220	3	5	Motor Reversing Switch, 3 pole
61027 for type M220	3	6	Changeover Switch with centre OFF 60°, 3 pole
61028 for type M220	4	8	Changeover Switch with centre OFF 60°, 4 pole
61153 for type M220	3	6	Changeover Switch with centre OFF 90°, 3 pole
61211 for type M220	3	5	Motor Reversing Switch, 3 pole

Switching diagrams and further switching programmes from page 56.

Mounting form	Operator	Padlockable options
176V1	padlockable with V-handle silver/black	padlockable 12h
178V1	padlockable with V-handle silver/black	3 positions padlockable (9h/12h/03h) (only for Changeover Switches with 90° switching angle)

Dimensions in mm:

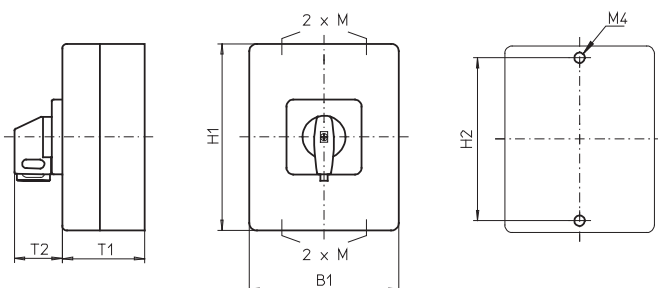

Type	H1	B1	T1	T2	2 × M	H2
P220	100	80	85	32	20	90
M220	100	80	85	32	20	90

Rotary Cam Switches

Enclosed Switches with insulated enclosure 100 × 80 × 85 mm

Enclosed Switches with insulated enclosure 100 × 80 × 85 mm

- key operated
- 20 A ■ 1 up to 6 contacts
- IP40
- Insulated polycarbonate enclosure



- Control Switch
- Instrument Switch
- ON-OFF Switch
- Changeover Switch
- Multi-step Switch
- Motor Switch

Setup of order code number: Type - Switching programme - Mounting form Ordering example: 3 pole Changeover Switch with centre OFF 60°, 20 A, key operated, key removable at 12h →	Type	Switching programme	Mtg. form
	M220	61027	E001B
	Order code no. M220-61027CE001B		

Type	Rated data (IEC 60947)			Terminal accessibility
	Operational current I _e AC-21A (A)	Operational power (at 380–440 V) AC-23A (kW) AC-3A (kW)		
M220	20	7.5	5.5	Terminals accessible laterally

Switching programme	Stages	Contacts	Description
61191	1	1	ON-OFF Switch 90°, 1 pole
61192	1	2	ON-OFF Switch 90°, 2 pole
61001	1	1	ON-OFF Switch 60°, 1 pole
61002	1	2	ON-OFF Switch 60°, 2 pole
61025	1	2	Changeover Switch with centre OFF 60°, 1 pole
61026	2	4	Changeover Switch with centre OFF 60°, 2 pole
61027	3	6	Changeover Switch with centre OFF 60°, 3 pole
61037	1	2	Changeover Switch without OFF 60°, 1 pole
61038	2	4	Changeover Switch without OFF 60°, 2 pole
61049	2	3	Multi-step Switch without OFF, 3 steps, 1 pole
61050	2	4	Multi-step Switch without OFF, 4 steps, 1 pole
61211	3	5	Motor Reversing Switch, 3 pole

Switching diagrams and further switching programmes from page 56.

Mounting form	Operator
E001.*	Key operated, silver/metal key Ronis cylinder lock C001, 2 keys (other lock types on request)

* The dot in the order code number must be replaced by the classification letter which identifies the key removable positions, see page 85.

Dimensions in mm:

Type	H1	B1	T1	T2	2 × M	H2
M220	100	80	85	33	20	90

Rotary Cam Switches

Enclosed Switches with insulated enclosure 100 × 80 × 85 mm

Enclosed Switches with insulated enclosure 100 × 80 × 85 mm

- 20 A
- 3 up to max. 8 contacts
- IP66
- Insulated polycarbonate enclosure



- Main/Emergency-Off Switch
- Main Switch

Setup of order code number: Type - Switching programme - Mounting form Ordering example: 6 pole ON-OFF Switch 90°, 20 A, padlock device with N-handle yellow/red →	Type	Switching programme	Mtg. form
	M220	61906	177N4
	Order code no. M220-61906-177N4		

Type	Contacts	Rated data (IEC 60947)			Terminal accessibility
		Operational current I _e AC-21A (A)	Operational power (at 380–440 V)		
			AC-23A (kW)	AC-3A (kW)	
P220	3 to 6	20	7.5	5.5	Terminals accessible from mounting direction
M220	5 to 8	20	7.5	5.5	Terminals accessible laterally

Switching programme	Stages	Contacts	Description	
61199	for type P220	2	3	ON-OFF Switch 90°, 3 pole
61194	for type P220	2	4	ON-OFF Switch 90°, 4 pole, 1 pole early make/late break
61906	for type P220	3	6	ON-OFF Switch 90°, 6 pole
61906	for type M220	3	6	ON-OFF Switch 90°, 6 pole
61919	for type M220	4	8	ON-OFF Switch 90°, 8 pole, 2 pole early make/late break

Switching diagrams and further switching programmes from page 56.

Mounting form	Operator	Main/Emergency-Off Switch	Mounting form	Operator	Main Switch
177N4		padlock device with N-handle yellow/red	177N1		padlock device with N-handle black
177M4		padlock device with M-handle yellow/red	177M1		padlock device with M-handle black
177V4		padlockable with V-handle yellow/red	177V1		padlockable with V-handle silver/black

Dimensions in mm:

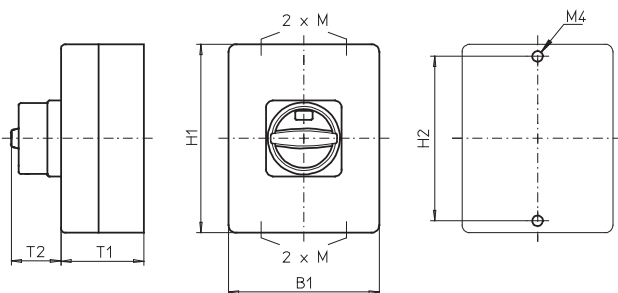

Mounting form	H1	B1	T1	T2	2 × M	H2
177N4/177N1	100	80	85	33	20	90
177M4/177M1	100	80	85	38	20	90
177V4/177V1	100	80	85	32	20	90

Rotary Cam Switches

Enclosed Switches with insulated enclosure 125 × 100 × 133 mm



Enclosed Switches with insulated enclosure 125 × 100 × 133 mm

- without cover interlock
- 20 A / 25 A / 32 A ■ 1 up to max. 16 contacts
- IP66
- Insulated polycarbonate enclosure



- Control Switch
- ON-OFF Switch
- Multi-step Switch
- Instrument Switch
- Changeover Switch
- Motor Switch

Setup of order code number: Type - Switching programme - Mounting form Ordering example: Reversing Star-Delta Switch, 25 A, M-handle silver/black →	Type	Switching programme	Mtg. form
	M225	61203	276M1
	Order code no. M225-61203-276M1		

Type	Contacts	Rated data (IEC 60947)			Degree of Protection Terminals	Terminal accessibility
		Operational current I_e AC-21A (A)	Operational power (at 380–440 V)			
			AC-23A (kW)	AC-3A (kW)		
P220	1 to 12	20	7.5	5.5	IP66	 Terminals accessible from mounting direction
P225	1 to 10	25	11	7.5	IP66	
M220	1 to 16	20	7.5	5.5	IP66	 Terminals accessible laterally
M225	1 to 12	25	11	7.5	IP66	
T225	1 to 10	32	15	11	IP66	 Terminals accessible laterally

Switching programme	Stages	Contacts	Description
61906 for types P220/P225	3	6	ON-OFF Switch 90°, 6 pole
61905 for types P220/P225	3	5	ON-OFF Switch 90°, 5 pole, 3 pole early make/late break
61029 for types P220/P225	5	10	Changeover Switch with centre OFF 60°, 5 pole
61089 for types P220/P225	5	9	Multi-step Switch without OFF, 3 steps, 3 pole
61211 for types P220/P225	3	5	Motor Reversing Switch, 3 pole
61203 for types P220/P225	5	10	Reversing Star-Delta Switch
61906 for types M220/M225/T225	3	6	ON-OFF Switch 90°, 6 pole
61919 for types M220/M225/T225	4	8	ON-OFF Switch 90°, 8 pole, 2 pole early make/late break
61030 for types M220/M225	6	12	Changeover Switch with centre OFF 60°, 6 pole
61041 for types M220/M225/T225	5	10	Changeover Switch without OFF 60°, 5 pole
61040 for types M220/M225/T225	4	8	Changeover Switch without OFF 60°, 4 pole
61211 for types M220/M225/T225	3	5	Motor Reversing Switch, 3 pole
61203 for types M220/M225/T225	5	10	Reversing Star-Delta Switch

Switching diagrams and further switching programmes from page 56.

Mounting form	Operator
276M1	 M-handle silver/black

Dimensions in mm:

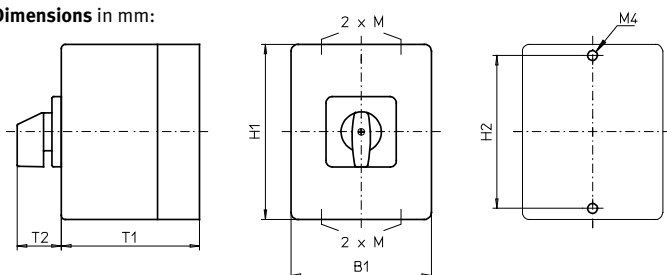

Type	H1	B1	T1	T2	2 × M	H2
P220	125	100	133	32	20/25	115
P225	125	100	133	32	20/25	115
M220	125	100	133	32	20/25	115
M225	125	100	133	32	20/25	115
T225	125	100	133	32	20/25	115

Rotary Cam Switches



Enclosed Switches with insulated enclosure 125 × 100 × 133 mm

Enclosed Switches with insulated enclosure 125 × 100 × 133 mm

- without cover interlock
- 20 A / 25 A / 32 A ■ 1 up to max. 16 contacts
- IP66
- Insulated polycarbonate enclosure



- Control Switch
- ON-OFF Switch
- Multi-step Switch
- Instrument Switch
- Changeover Switch
- Motor Switch

Setup of order code number: Type - Switching programme - Mounting form Ordering example: 4 pole Changeover Switch 90°, 25 A, padlockable with V-handle silver/black →	Type	Switching programme	Mtg. form
	P220	61154	276V1
	Order code no. P220-61154-276V1		

Type	Contacts	Rated data (IEC 60947)			Degree of Protection Terminals	Terminal accessibility
		Operational current I _e AC-21A (A)	Operational power (at 380–440 V)			
			AC-23A (kW)	AC-3A (kW)		
P220	1 to 12	20	7.5	5.5	IP66	Terminals accessible from mounting direction
P225	1 to 10	25	11	7.5	IP66	
M220	1 to 16	20	7.5	5.5	IP66	Terminals accessible laterally
M225	1 to 12	25	11	7.5	IP66	
T225	1 to 10	32	15	11	IP66	Terminals accessible laterally

Switching programme	Stages	Contacts	Description
61027 for types P220/P225	3	6	Changeover Switch with centre OFF 60°, 3 pole
61154 for types P220/P225	4	8	Changeover Switch with centre OFF 90°, 4 pole
61363 for types P220/P225	3	6	Changeover Switch with centre OFF 60°, 3 pole with spring return
61211 for types P220/P225	3	5	Motor Reversing Switch, 3 pole
61029 for types M220/M225/T225	5	10	Changeover Switch with centre OFF 60°, 5 pole
61032 for types M220/M225	8	16	Changeover Switch with centre OFF 60°, 8 pole
61008 for types M220/M225/T225	4	8	ON-OFF Switch 60°, 8 pole
61217 for types M220/M225	6	12	Reversing Multi-Speed Switch, single winding, 2 speeds

Switching diagrams and further switching programmes from page 56.

Mounting form	Operator	Padlockable options
276V1	padlockable with V-handle silver/black	padlockable 12h

Dimensions in mm:

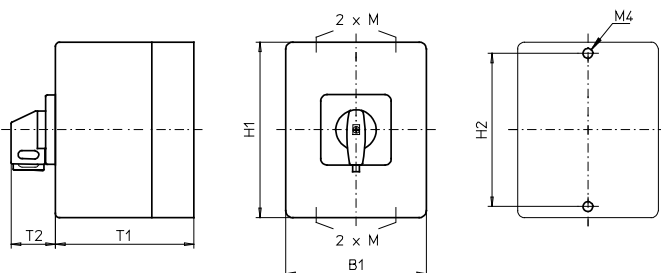

Type	H1	B1	T1	T2	2 × M	H2
P220	125	100	133	32	20/25	115
P225	125	100	133	32	20/25	115
M220	125	100	133	32	20/25	115
M225	125	100	133	32	20/25	115
T225	125	100	133	32	20/25	115

Rotary Cam Switches

Enclosed Switches with insulated enclosure 125 × 100 × 133 mm

Enclosed Switches with insulated enclosure 125 × 100 × 133 mm

- with cover interlock, interlocked in ON positions
- 20 A / 25 A / 32 A ■ 1 up to max. 12 contacts
- IP66
- Insulated polycarbonate enclosure



- Control Switch
- ON-OFF Switch
- Multi-step Switch
- Instrument Switch
- Changeover Switch
- Motor Switch

Setup of order code number: Type - Switching programme - Mounting form Ordering example: 3 pole Motor Reversing Switch, 32 A, padlockable with V-handle silver/black →	Type	Switching programme	Mtg. form
	T225	61154	273V1
	Order code no. T225-61154-273V1		

Type	Contacts	Rated data (IEC 60947)			Degree of Protection Terminals	Terminal accessibility
		Operational current I _e AC-21A (A)	Operational power (at 380–440 V)			
			AC-23A (kW)	AC-3A (kW)		
P220	1 to 10	20	7.5	5.5	IP66	Terminals accessible from mounting direction
P225	1 to 8	25	11	7.5	IP66	
M220	1 to 12	20	7.5	5.5	IP66	Terminals accessible laterally
M225	1 to 10	25	11	7.5	IP66	
T225	1 to 8	32	15	11	IP66	Terminals accessible laterally

Switching programme	Stages	Contacts	Description
61008 for types P220/P225	4	8	ON-OFF Switch 60°, 8 pole
61027 for types P220/P225	3	6	Changeover Switch with centre OFF 60°, 3 pole
61028 for types P220/P225	4	8	Changeover Switch with centre OFF 60°, 4 pole
61363 for types P220/P225	3	6	Changeover Switch with centre OFF 60°, 3 pole with spring return
61211 for types P220/P225	3	5	Motor Reversing Switch, 3 pole
61010 for types M220/M225	5	10	ON-OFF Switch 60°, 10 pole
61028 for types M220/M225/T225	4	8	Changeover Switch with centre OFF 60°, 4 pole
61029 for types M220/M225/T225	5	10	Changeover Switch with centre OFF 60°, 5 pole
61154 for types M220/M225/T225	4	8	Changeover Switch with centre OFF 90°, 4 pole
61211 for types M220/M225/T225	3	5	Motor Reversing Switch, 3 pole

Switching diagrams and further switching programmes from page 56.

Mounting form	Operator	Padlockable options
273V1	padlockable with V-handle silver/black	padlockable 12h
273M1	M-handle silver/black	

Dimensions in mm:

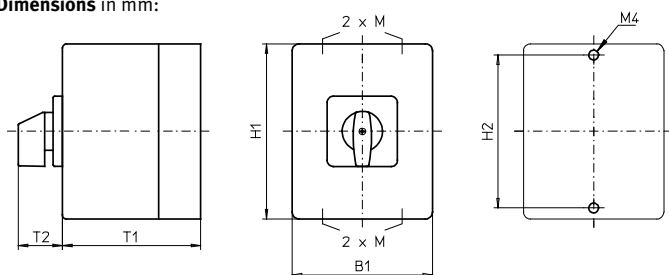

Type	H1	B1	T1	T2	2 × M	H2
P220	125	100	133	32	20/25	115
P225	125	100	133	32	20/25	115
M220	125	100	133	32	20/25	115
M225	125	100	133	32	20/25	115
T225	125	100	133	32	20/25	115

Rotary Cam Switches

Enclosed Switches with insulated enclosure 125 × 100 × 133 mm

Enclosed Switches with insulated enclosure 125 × 100 × 133 mm

- with cover interlock, interlocked in ON position
- 20 A / 25 A / 32 A ■ 1 up to max. 12 contacts
- IP66
- Insulated polycarbonate enclosure



- Main/Emergency-Off Switch
- Main Switch

Setup of order code number: Type - Switching programme - Mounting form Ordering example: 6 pole ON-OFF Switch 90°, 20 A, padlock device with N-handle yellow/red →	Type	Switching programme	Mtg. form
	M220	61907	275N4
	Order code no. M220-61907-275N4		

Type	Contacts	Rated data (IEC 60947)			Degree of Protection	Terminal accessibility
		Operational current I _e AC-21A (A)	Operational power (at 380–440 V)			
			AC-23A (kW)	AC-3A (kW)		
P220	1 to 10	20	7.5	5.5	IP66	Terminals accessible from mounting direction
P225	1 to 8	25	11	7.5	IP66	
M220	1 to 12	20	7.5	5.5	IP66	Terminals accessible laterally
M225	1 to 10	25	11	7.5	IP66	
T225	1 to 8	32	15	11	IP66	Terminals accessible laterally

Switching programme	Stages	Contacts	Description
61919 for types P220/P225	4	8	ON-OFF Switch 90°, 8 pole, 2 pole early make/late break
61918 for types P220/P225	4	8	ON-OFF Switch 90°, 8 pole
61910 for types P220	5	10	ON-OFF Switch 90°, 10 pole
61907 for types M220/M225/T225	4	8	ON-OFF Switch 90°, 6 pole, 2 auxiliary contacts
61910 for types M220/M225	5	10	ON-OFF Switch 90°, 10 pole

Switching diagrams and further switching programmes from page 56.

Mounting form	Operator	Main/Emergency-Off Switch	Mounting form	Operator	Main Switch
275N4		padlock device with N-handle yellow/red	275N1		padlock device with N-handle black
275M4		padlock device with M-handle yellow/red	275M1		padlock device with M-handle black
275V4		padlockable with V-handle yellow/red	275V1		padlockable with V-handle silver/black

Dimensions in mm:

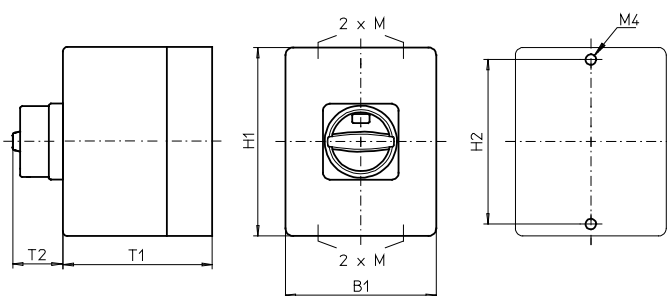













Mounting form	H1	B1	T1	T2	2 × M	H2
275N4/275N1	125	100	133	33	20/25	115
275M4/275M1	125	100	133	38	20/25	115
275V4/275V1	125	100	133	32	20/25	115











Rotary Cam Switches

Technical Information Switching programmes





ON-OFF Switches 90°

Description	Stages	Contacts	Ident No.	Ident No. with inscription
1 pole	1	1	61191.	
2 pole	1	2	61192.	
3 pole	2	3	61199.	
3 pole with N/PE terminals	2	4	61178.	
3 pole with N terminals	2	4	61908.	
4 pole	2	4	61914.	
4 pole, 1 pole early make/late break	2	4	61194.	
4 pole, 3 pole early make/late break	2	4	61904.	
5 pole, 3 pole early make/late break	3	5	61905.	
6 pole	3	6	61906.	
6 pole, 2 auxiliary contacts	4	8	61907.	61...F
7 pole	4	7	61917.	61...H
8 pole	4	8	61918.	61...K
8 pole, 2 pole early make/late break	4	8	61919.	
9 pole	5	9	61909.	
10 pole	5	10	61910.	
12 pole	6	12	61912.	
Complete rotation				
2 pole	1	2	61198.	
3 pole	2	3	61197.	
				

ON-OFF Switches 60°

Description	Stages	Contacts	Ident No.	Ident No. with inscription
1 pole	1	1	61001.	
2 pole	1	2	61002.	
3 pole	2	3	61003.	
4 pole	2	4	61004.	
5 pole	3	5	61005.	
6 pole	3	6	61006.	
7 pole	4	7	61007.	
8 pole	4	8	61008.	
9 pole	5	9	61009.	
10 pole	5	10	61010.	
11 pole	6	11	61011.	
12 pole	6	12	61012.	

ON-OFF Switches with spring return

Description	Stages	Contacts	Ident No.	Ident No. with inscription
Spring return to OFF				
1 pole	1	1	61351.	
2 pole	1	2	61352.	
3 pole	2	3	61353.	
4 pole	2	4	61354.	61...- 61...A
Spring return to ON				
1 pole	1	1	61302.	
				
				61302- 61302A

Changeover Switches with centre OFF, 60°

Description	Stages	Contacts	Ident No.	Ident No. with inscription
1 pole	1	2	61025.	
2 pole	2	4	61026.	
3 pole	3	6	61027.	
4 pole	4	8	61028.	
5 pole	5	10	61029.	
6 pole	6	12	61030.	
7 pole	7	14	61031.	
8 pole	8	16	61032.	
without jumpers				
1 pole	1	2	61625.	
2 pole	2	4	61626.	
3 pole	3	6	61627.	
				61...A
				61...B
				61...C
				61...D
				61...E
				61...G
				61...H
				61...I
				61...J
				61...K
				61...L
				61...M
				61...N
				61...O
				61...P
				61...Q
				61...R
				61...S
				61...T
				61...U
				61...V
				61...W

Changeover Switches with centre OFF, 90°

Description	Stages	Contacts	Ident No.	Ident No. with inscription
1 pole	1	2	61151.	
2 pole	2	4	61152.	
3 pole	3	6	61153.	
4 pole	4	8	61154.	
				61...A
				61...B
				61...C
				61...D
				61...E

Changeover Switches with centre OFF and spring return

Description	Stages	Contacts	Ident No.	Ident No. with inscription
Spring return to centre				
1 pole	1	2	61361.	
2 pole	2	4	61362.	
3 pole	3	6	61363.	
without jumpers				
1 pole	1	2	61761.	
2 pole	2	4	61762.	
				61...A
				61...B
				61...C
				61...D
				61...E
				61...F
				61...G
				61...H
				61...I
				61...J
				61...K
				61...L
				61...M
				61...N
				61...P
				61...Q
				61...R
				61...S
				61...T







Rotary Cam Switches

Technical Information Switching programmes







Changeover Switches with centre OFF and spring return

Description	Stages	Contacts	Ident No.	Ident No. with inscription
Spring return from left to centre				
1 pole	1	2	61364.	
2 pole	2	4	61365.	
3 pole	3	6	61369.	
				61...-

Changeover Switches without OFF

Description	Stages	Contacts	Ident No.	Ident No. with inscription
1 pole	1	2	61037.	
2 pole	2	4	61038.	
3 pole	3	6	61039.	
4 pole	4	8	61040.	
5 pole	5	10	61041.	
6 pole	6	12	61042.	
7 pole	7	14	61043.	
8 pole	8	16	61044.	
9 pole	9	18	61045.	
10 pole	10	20	61046.	
11 pole	11	22	61047.	
12 pole	12	24	61048.	
without jumpers				
1 pole	1	2	61637.	
2 pole	2	4	61638.	
3 pole	3	6	61639.	
4 pole	4	8	61640.	
overlapping contacts				
1 pole	1	2	61737.	
2 pole	2	4	61738.	
3 pole	3	6	61739.	
4 pole	4	8	61740.	

Changeover Switches without OFF with spring return

Description	Stages	Contacts	Ident No.	Ident No. with inscription	
Spring return to left					
1 pole	1	2	61371.		
2 pole	2	4	61372.		
3 pole	3	6	61373.		
without jumpers					
1 pole	1	2	61771.		
					
					
					
					















Multi-step Switches with OFF

Description	Stages	Contacts	Ident No.	Ident No. with inscription
2 steps				
1 pole	1	2	61059.	
2 pole	2	4	61079.	
3 pole	3	6	61099.	
4 pole	4	8	61130.	61...- 61...A 61...B
5 pole	5	10	61134.	
6 pole	6	12	61137.	
3 steps				
1 pole	2	3	61060.	
2 pole	3	6	61080.	
3 pole	5	9	61100.	
4 pole	6	12	61131.	61...- 61...A 61...B 61...C 61...D
5 pole	8	15	61135.	
4 steps				
1 pole	2	4	61061.	
2 pole	4	8	61081.	
3 pole	6	12	61101.	
4 pole	8	16	61132.	61...- 61...A
5 steps				
1 pole	3	5	61062.	
2 pole	5	10	61082.	
3 pole	8	15	61102.	61...- 61...A
6 steps				
1 pole	3	6	61063.	
2 pole	6	12	61083.	
3 pole	9	18	61103.	61...- 61...A
7 steps				
1 pole	4	7	61064.	
2 pole	7	14	61084.	
8 steps				
1 pole	4	8	61065.	
9 steps				
1 pole	5	9	61066.	
10 steps				
1 pole	5	10	61067.	
11 steps				
1 pole	6	11	61068.	

Rotary Cam Switches

Technical Information Switching programmes

Multi-step Switches without OFF

Description	Stages	Contacts	Ident No.	Ident No. with inscription
3 steps				
1 pole	2	3	61049.	 
2 pole	3	6	61069.	
3 pole	5	9	61089.	
4 pole	6	12	61120.	
5 pole	8	15	61124.	
6 pole	9	18	61126.	
without jumpers				
1 pole	2	3	61649.	
2 pole	3	6	61669.	
4 steps				
1 pole	2	4	61050.	 
2 pole	4	8	61070.	
3 pole	6	12	61090.	
4 pole	8	16	61121.	
5 pole	10	20	61125.	
6 pole	12	24	61127.	
without jumpers				
1 pole	2	4	61650.	
2 pole	4	8	61670.	
5 steps				
1 pole	3	5	61051.	 
2 pole	5	10	61071.	
3 pole	8	15	61091.	
4 pole	10	20	61122.	
6 steps				
1 pole	3	6	61052.	 
2 pole	6	12	61072.	
3 pole	9	18	61092.	
7 steps				
1 pole	4	7	61053.	
2 pole	7	14	61073.	
3 pole	11	21	61093.	
8 steps				
1 pole	4	8	61054.	
2 pole	8	16	61074.	
3 pole	12	24	61094.	
9 steps				
1 pole	5	9	61055.	 61055-
10 steps				
1 pole	5	10	61056.	 61056-
11 steps				
1 pole	6	11	61057.	 61057-
12 steps				
1 pole	6	12	61058.	 61058-

Code Switches

Description	Stages	Contacts	Ident No.	Ident No. with inscription
Binary code				
0 - 7	2	3	61920.	 61...-
0 - 7 complement	2	3	61921.	
0 - 7 + complement	3	6	61922.	
0 - 11	2	4	61923.	 61...-
0 - 11 + complement	4	8	61924.	
BCD Code				
0 - 9	2	4	61930.	 61...-
0 - 9 complement	2	4	61931.	
0 - 9 + complement	4	8	61932.	

Gang Switches

Description	Stages	Contacts	Ident No.	Ident No. with inscription
2 gangs				
1 pole	1	2	61109.	 61...-
2 pole	2	4	61117.	
3 pole	3	6	61111.	
				 61...A
				 61...B
3 gangs				
1 pole	2	3	61110.	 61...-
2 pole	3	6	61118.	
3 pole	5	9	61112.	
				 61...A
Series-gang Switches				
2 gangs				
1 pole	1	2	61113.	
2 pole	2	4	61115.	
3 pole	3	6	61114.	
Series-parallel Switches				
2 gangs				
2 pole	2	4	61116.	

Voltmeter Selector Switches with OFF

Description	Stages	Contacts	Ident No.	Ident No. with inscription
3 phase line to line, 30°	2	4	61312.	
				 61312-
				 61312A
				 61312B
				 61312C
				 61312D
				 61312E
				 61312F
3 phase line to line, 60°	2	4	61485.	
				 61485-
				 61485A
				 6485B

Rotary Cam Switches

Technical Information Switching programmes

Voltmeter Selector Switches with OFF

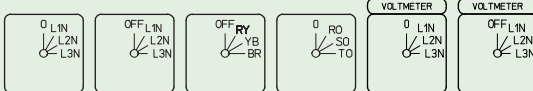
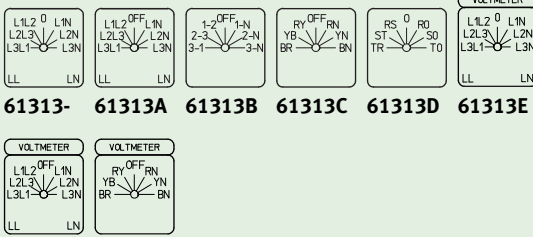
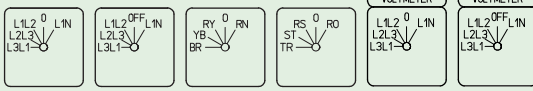
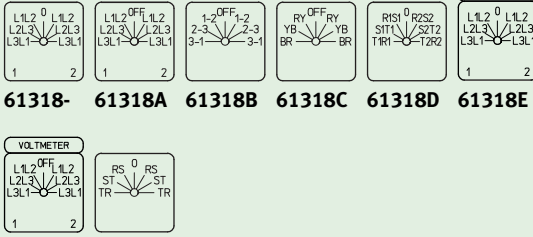
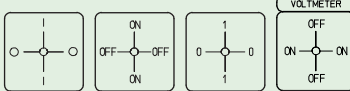
Description	Stages	Contacts	Ident No.	Ident No. with inscription
3 phase line to N	2	4	61311.	 61311- 61311A 61311B 61311C 61311D 61311E
3 phase line to line + 3 phase line to N	3	6	61313.	 61313- 61313A 61313B 61313C 61313D 61313E 61313F 61313G
3 phase line to line + 1 phase line to N	3	5	61317.	 61317- 61317A 61317B 61317C 61317D 61317E
3 phase line to line for 2 sources	4	8	61318.	 61318- 61318A 61318B 61318C 61318D 61318E 61318F 61318G
2 pole, 1 phase	1	2	61198.	 61198- 61198A 61198B 61198C

Voltmeter Selector Switches without OFF

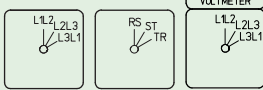
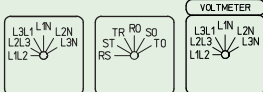
Description	Stages	Contacts	Ident No.	Ident No. with inscription
3 phase line to line	2	4	61319.	 61319- 61319A 61319B
3 phase line to line + 3 phase line to N	3	6	61314.	 61314- 61314A 61314B

Ammeter Selector Switches with OFF

Description	Stages	Contacts	Ident No.	Ident No. with inscription
1 transformer, 1 pole	1	2	61321.	 61321- 61321A 61321B 61321C 61321G
2 transformers, 1 pole (3 phase)	2	4	61331.	 61...- 61...A 61...B 61...C 61...D 61...E
3 transformers, 1 pole	3	6	61325.	
3 transformers, 2 pole	5	9	61328.	
				 61...F
2 transformers, 2 pole	3	6	61327.	 61327- 61327A 61327E

Ammeter Selector Switches without OFF

Description	Stages	Contacts	Ident No.	Ident No. with inscription
3 transformers, 1 pole	3	6	61384.	 61...- 61...A
3 transformers, 2 pole	5	9	61329.	
4 transformers, 1 pole	4	8	61326.	 61...- 61...A
4 transformers, 2 pole	6	12	61330.	

Volt-Ammeter Selector Switches

Description	Stages	Contacts	Ident No.	Ident No. with inscription
1 phase line to line, 2 phase voltages L–N, 2 currents	4	8	61334.	 61334- 61334A 61334B
3 voltages L–L, 3 currents	5	10	61336.	 61...- 61...A 61...B 61...C
3 phase voltages L–N, 3 currents	5	9	61338.	
4 voltages, 3 currents	6	11	61337.	 61337- 61337A 61337B

Rotary Cam Switches

Technical Information Switching programmes

Control Switches with spring return

Description	Stages	Contacts	Ident No.	Ident No. with inscription
Control Switches				
1 pole	1	2	61300.	
2 pole	2	4	61388.	
without jumpers				
1 pole	1	2	61700.	
Control Switches with position indication				
1 pole	1	2	61301.	
without jumpers				
1 pole	1	2	61701.	
Controlling two contactors				
Standard	2	3	61307.	
without jumpers	2	3	61707.	
				61...- 61...A 61...B
With spring return				
4 auxiliary contacts	2	4	61366.	
Motor voltage control switch	2	3	61271.	
single winding contactor	4	8	61272.	
				61...- 61...T

Motor Reversing Switches

Description	Stages	Contacts	Ident No.	Ident No. with inscription
2 pole	2	4	61210.	
3 pole	3	5	61211.	
				61...- 61...A 61...B
3 pole with spring return	3	5	61253.	
				61253- 61253T
3 pole, complete rotation	3	5	61214.	
				61214- 61214A

Star-Delta Switches

Description	Stages	Contacts	Ident No.	Ident No. with inscription
Standard	4	8	61200.	
Contact closed in "OFF"/"STOP"	5	9	61239.	
				61...- 61...A 61...B 61...C
Spring return from START to "OFF"	4	8	61201.	
				61201- 61201A

Star-Delta Switches

Description	Stages	Contacts	Ident No.	Ident No. with inscription
for use with contactor	4	7	61240.	 61240- 61240A 61240B
Reversing Star-Delta Switches Standard	5	10	61203.	 61203- 61203A

Multi-Speed Switches

Description	Stages	Contacts	Ident No.	Ident No. with inscription
2 speeds single winding	4	8	61212.	
single winding – contactor control	5	10	61215.	61...- 61...A
2 separate windings	3	6	61219.	
2 speeds single winding	4	8	61213.	 61213- 61213A
3 speeds speed 1+3 Dahlander	6	11	61226.	 61...- 61...A
speed 2+3 Dahlander	6	11	61243.	
Reversing Multi-Speed Switches 2 speeds, single winding	6	12	61217.	 61217- 61217A 61217B

Auxiliary Phase Switches

Description	Stages	Contacts	Ident No.	Ident No. with inscription
Standard	2	3	61208.	 61208- 61208A 61208B 61208C
2 directions	3	6	61209.	 61209- 61209A 61209B
2 directions phase continuously under load	3	6	61270.	 61270- 61270A

Rotary Cam Switches

Technical Information Switching diagrams

Switching diagrams 61001–61044

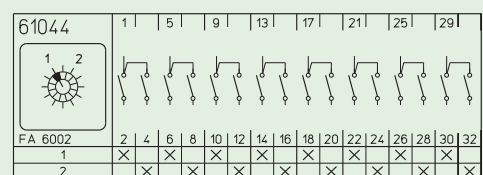
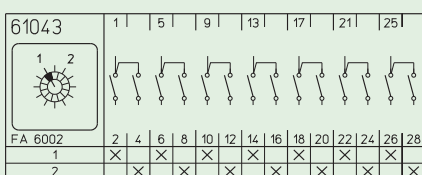
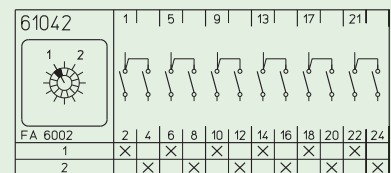
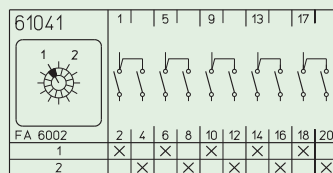
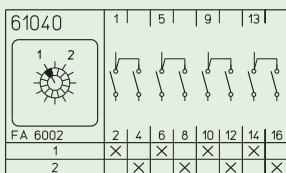
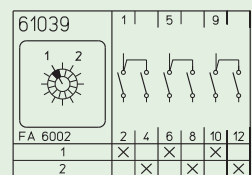
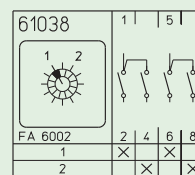
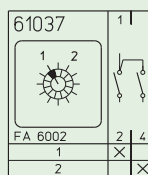
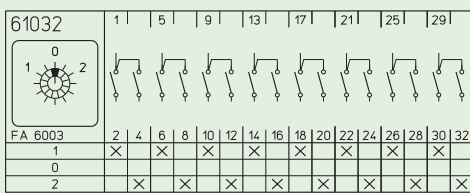
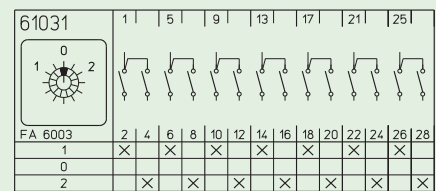
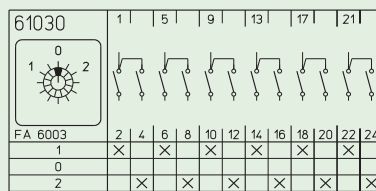
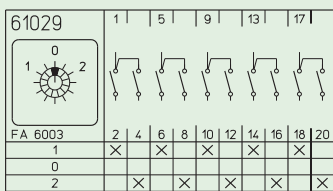
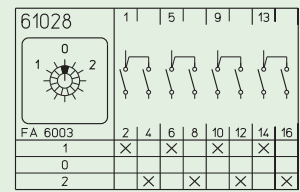
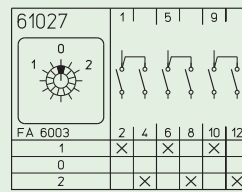
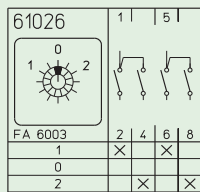
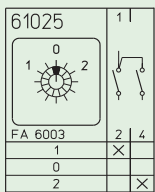
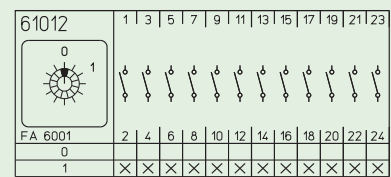
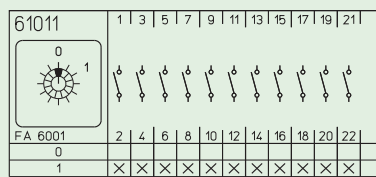
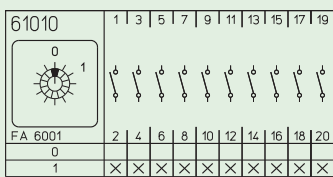
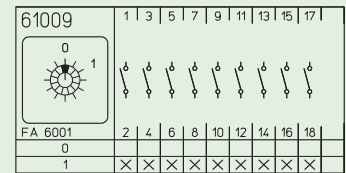
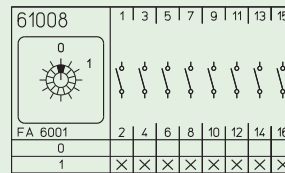
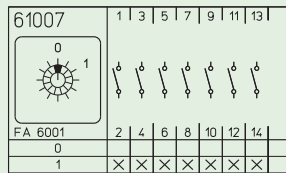
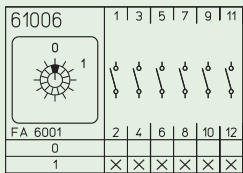
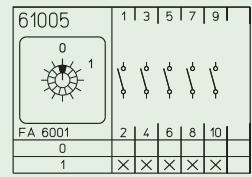
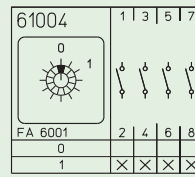
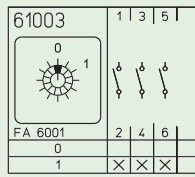
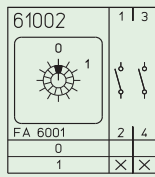
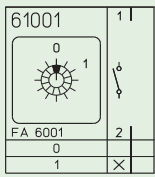

Switching diagrams 61045–61062

61045

FA 6002	2	4	6	8	10	12	14	16	18	20	22	24	26	28	30	32	34	36
1	X	X	X	X	X	X	X	X	X	X	X	X	X	X	X	X	X	X
2	X	X	X	X	X	X	X	X	X	X	X	X	X	X	X	X	X	X

61046

FA 6002	2	4	6	8	10	12	14	16	18	20	22	24	26	28	30	32	34	36	38	40
1	X	X	X	X	X	X	X	X	X	X	X	X	X	X	X	X	X	X	X	X
2	X	X	X	X	X	X	X	X	X	X	X	X	X	X	X	X	X	X	X	X

61047

FA 6002	2	4	6	8	10	12	14	16	18	20	22	24	26	28	30	32	34	36	38	40	42	44
1	X	X	X	X	X	X	X	X	X	X	X	X	X	X	X	X	X	X	X	X	X	X
2	X	X	X	X	X	X	X	X	X	X	X	X	X	X	X	X	X	X	X	X	X	X

61048

FA 6002	2	4	6	8	10	12	14	16	18	20	22	24	26	28	30	32	34	36	38	40	42	44	46	48
1	X	X	X	X	X	X	X	X	X	X	X	X	X	X	X	X	X	X	X	X	X	X	X	X
2	X	X	X	X	X	X	X	X	X	X	X	X	X	X	X	X	X	X	X	X	X	X	X	X

61049

FA 6005	2	4	6
1	X		
2		X	
3			X

61050

FA 6006	2	4	6	8
1	X			
2		X		
3			X	
4				X

61051

FA 6007	2	4	6	8	10
1	X				
2		X			
3			X		
4				X	
5					X

61052

FA 6008	2	4	6	8	10	12
1	X					
2		X				
3			X			
4				X		
5					X	
6						X

61053

FA 3015	2	4	6	8	10	12	14
1	X						
2		X					
3			X				
4				X			
5					X		
6						X	
7							X

61054

FA 3016	2	4	6	8	10	12	14	16
1	X							
2		X						
3			X					
4				X				
5					X			
6						X		
7							X	
8								X

61055

FA 3017	2	4	6	8	10	12	14	16	18
1	X								
2		X							
3			X						
4				X					
5					X				
6						X			
7							X		
8								X	
9									X

61056

FA 3018	2	4	6	8	10	12	14	16	18	20
1	X									
2		X								
3			X							
4				X						
5					X					
6						X				
7							X			
8								X		
9									X	
10										X

61057

FA 3019	2	4	6	8	10	12	14	16	18	20	22
1	X										
2		X									
3			X								
4				X							
5					X						
6						X					
7							X				
8								X			
9									X		
10										X	
11											X

61058

FA 3020	2	4	6	8	10	12	14	16	18	20	22	24
1	X											
2		X										
3			X									
4				X								
5					X							
6						X						
7							X					
8								X				
9									X			
10										X		
11											X	
12												X

61059

FA 6020	2	4
0		
1	X	
2		X

61060

FA 6021	2	4	6
0			
1	X		
2		X	
3			X

61061

FA 6022	2	4	6	8
0				
1	X			
2		X		
3			X	
4				X

61062

FA 6023	2	4	6	8	10
0					
1	X				
2		X			
3			X		
4				X	
5					X

Rotary Cam Switches

Technical Information Switching diagrams

Switching diagrams 61063–61082

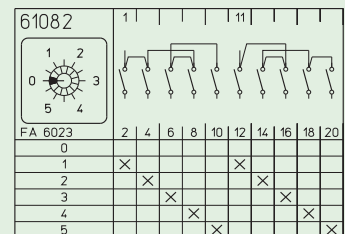
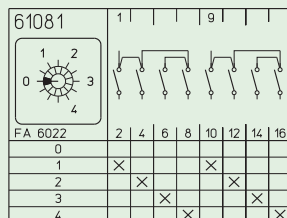
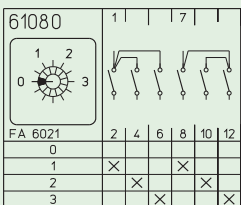
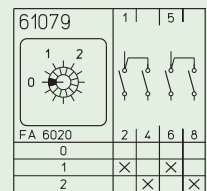
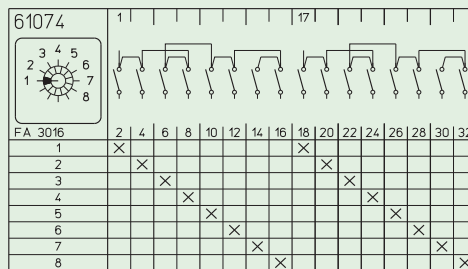
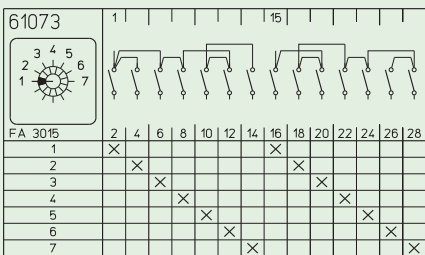
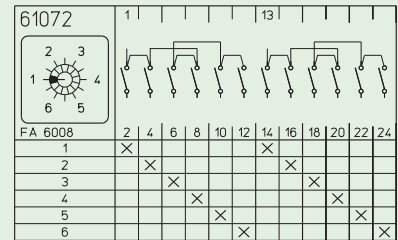
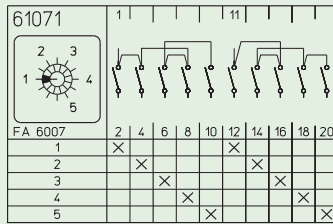
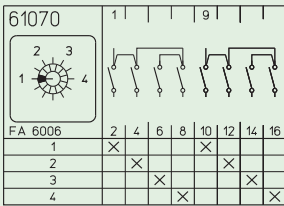
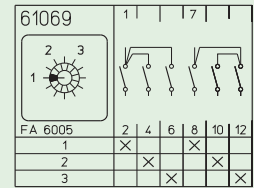
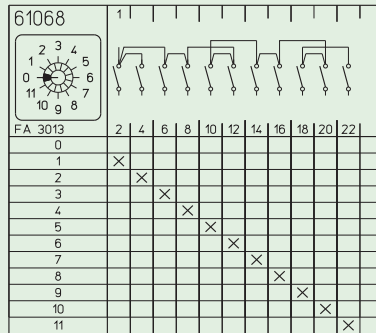
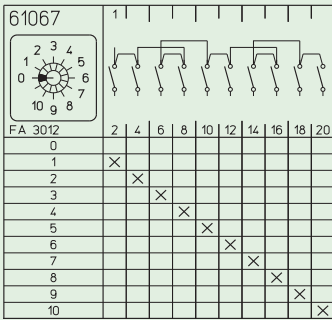
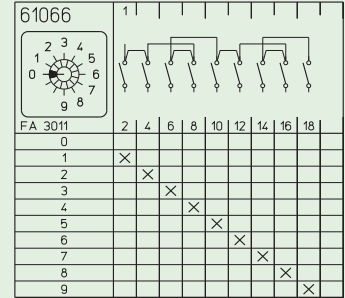
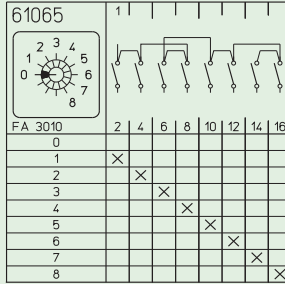
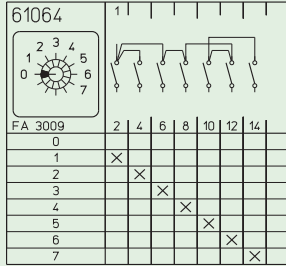
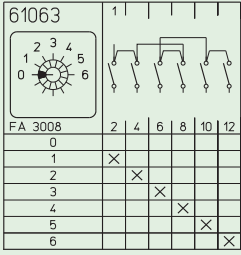

Switching diagrams 61083–61111

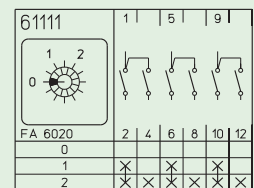
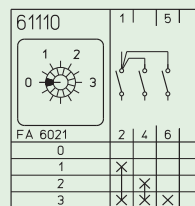
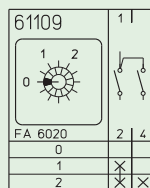
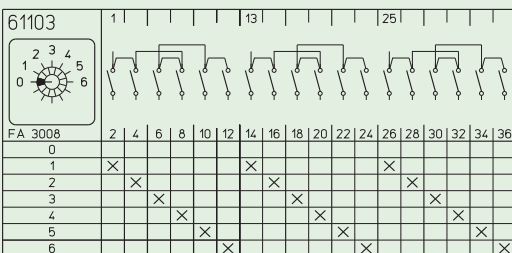
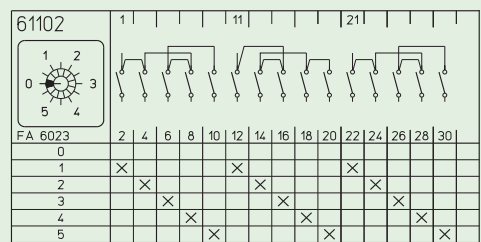
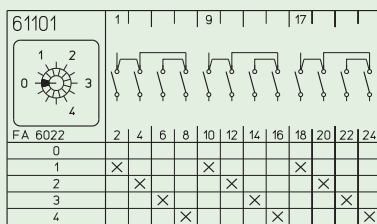
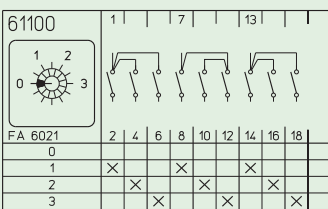
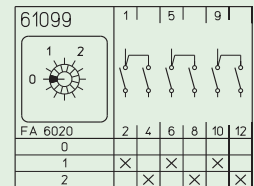
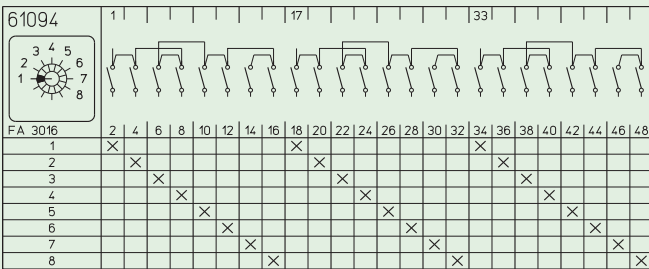
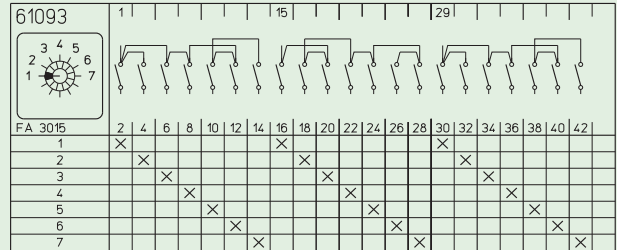
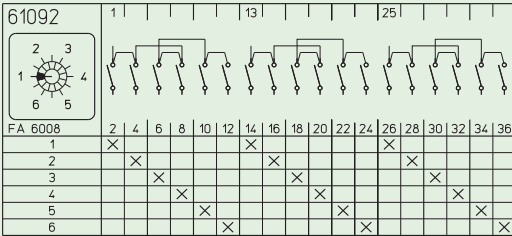
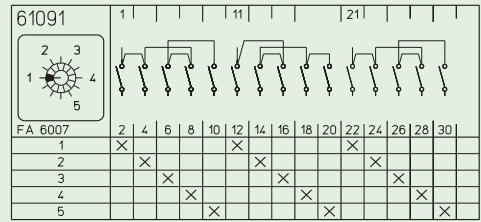
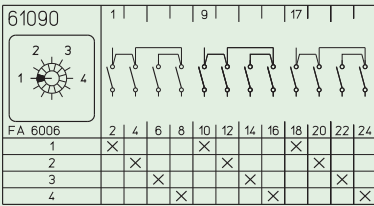
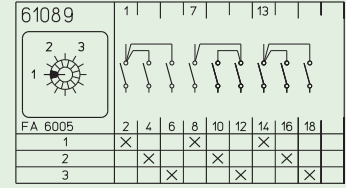
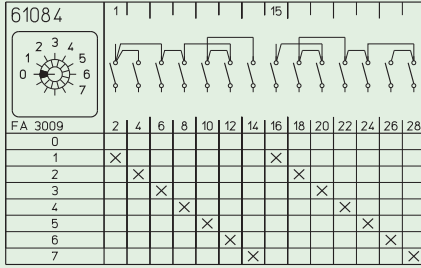
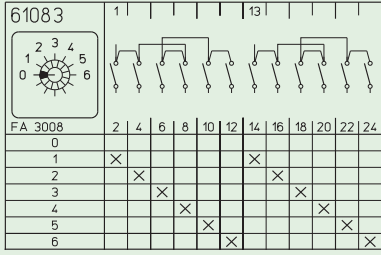

Switching diagrams 61151–61215

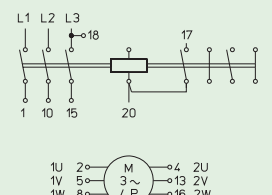
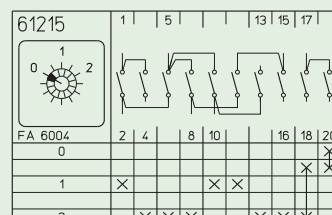
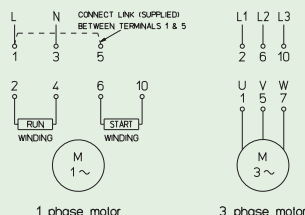
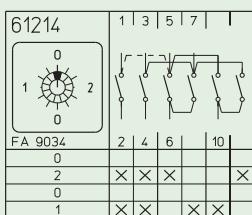
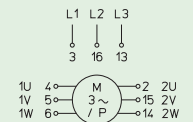
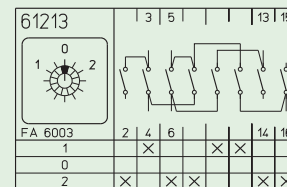
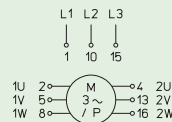
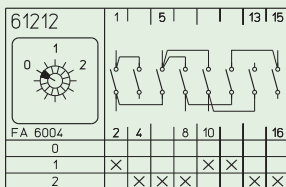
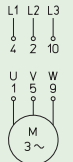
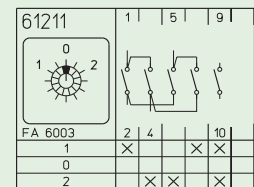
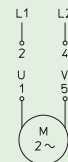
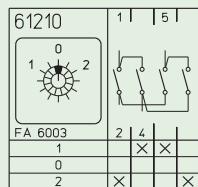
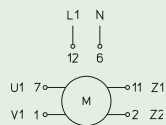
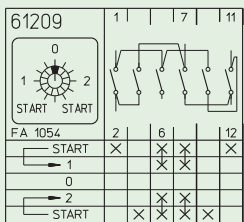
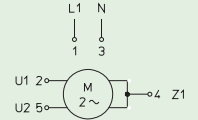
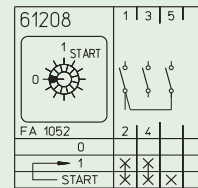
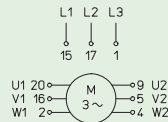
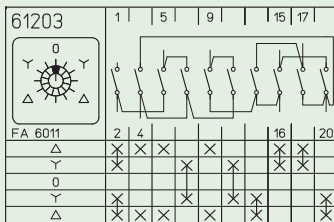
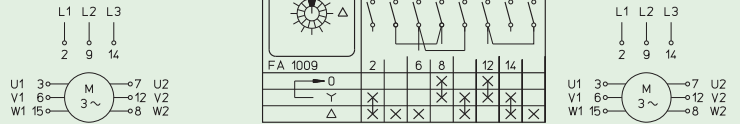
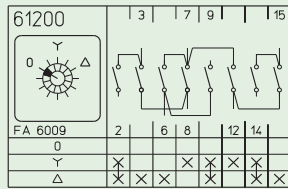
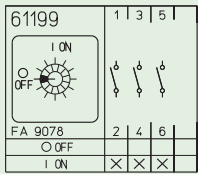
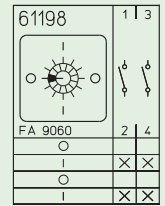
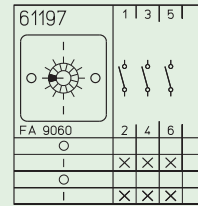
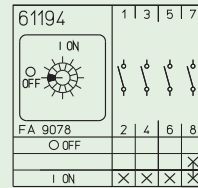
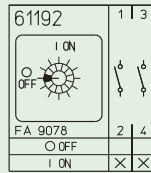
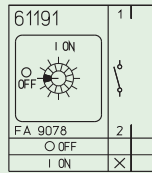
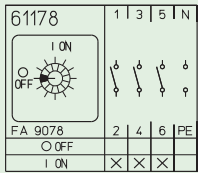
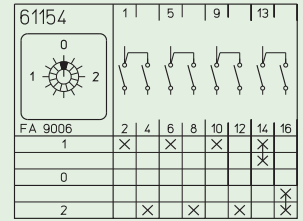
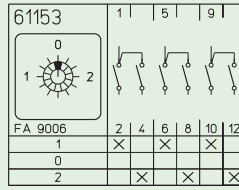
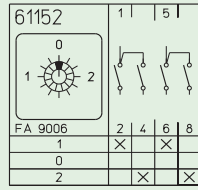
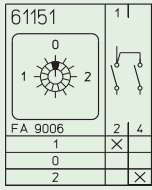

Rotary Cam Switches

Technical Information Switching diagrams

Switching diagrams 61217–61313

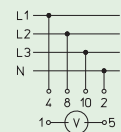
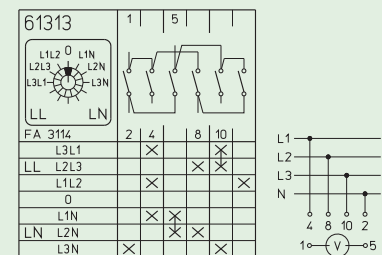
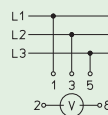
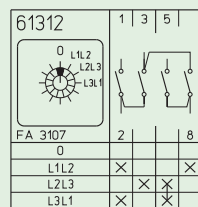
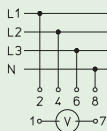
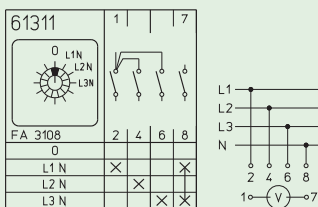
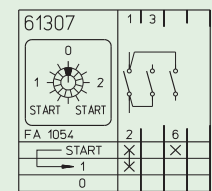
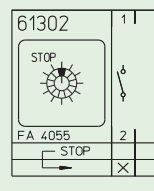
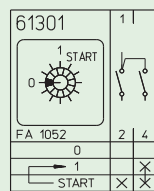
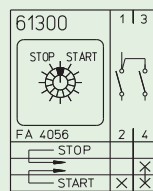
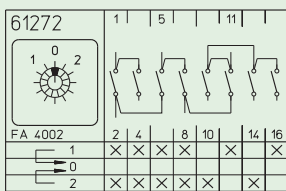
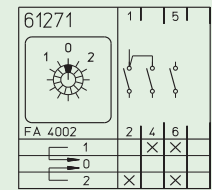
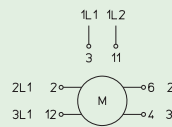
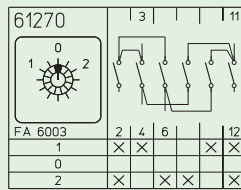
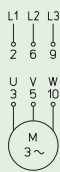
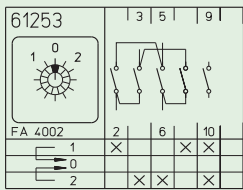
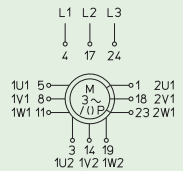
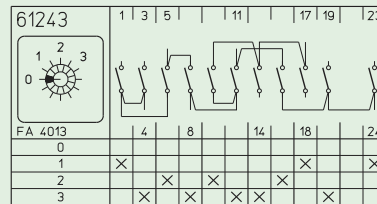
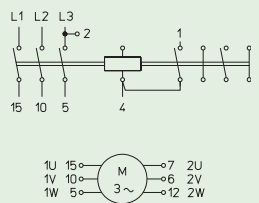
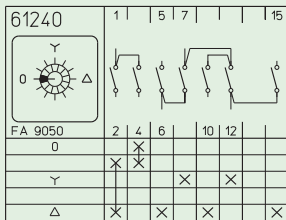
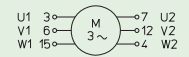
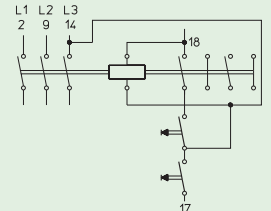
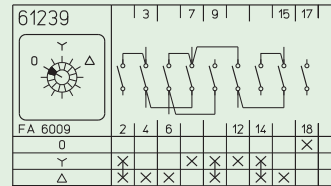
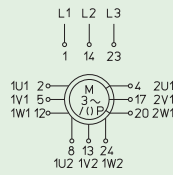
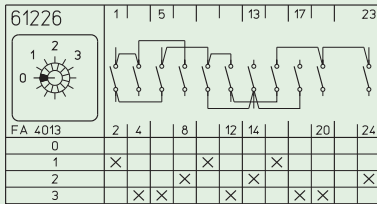
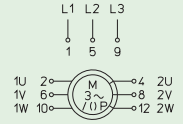
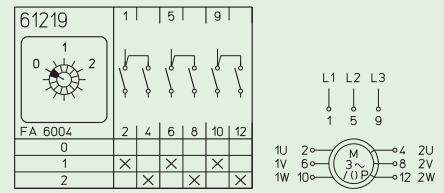
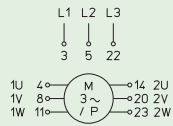
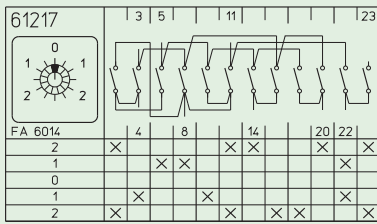

Switching diagrams 61314–61336

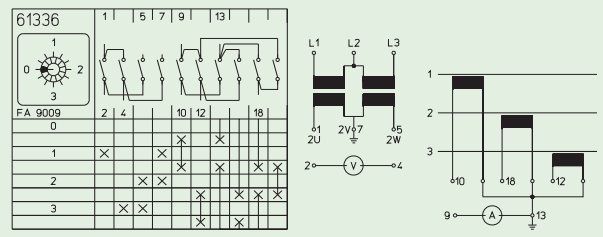
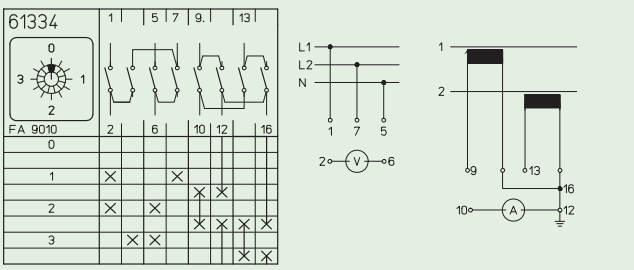
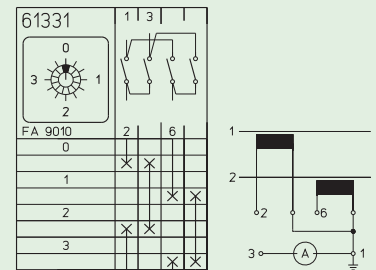
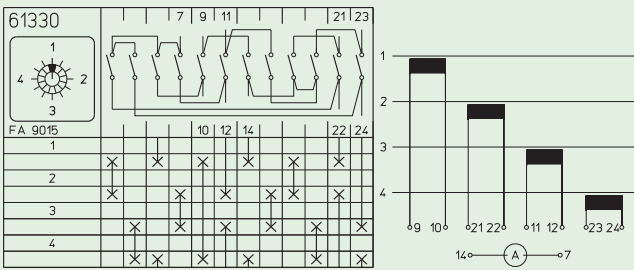
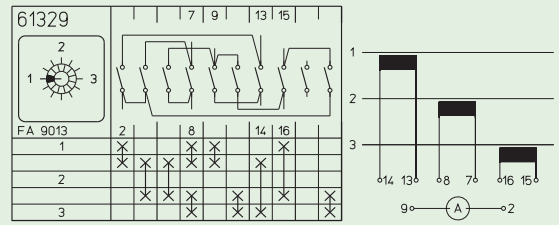
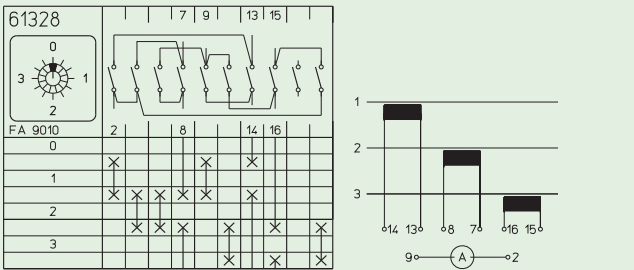
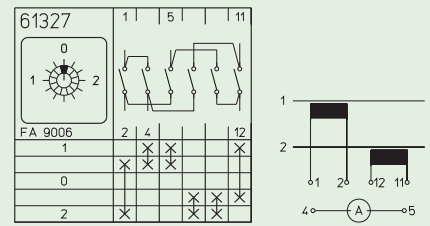
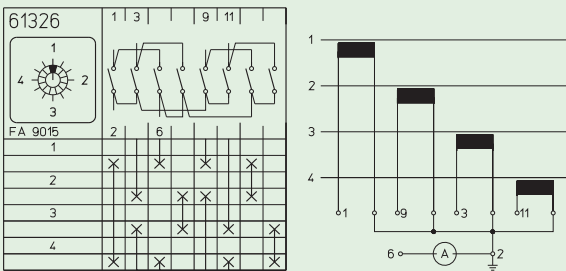
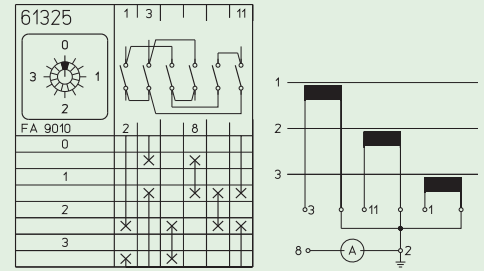
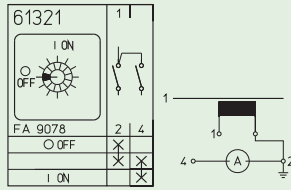
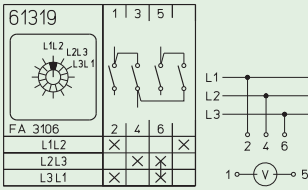
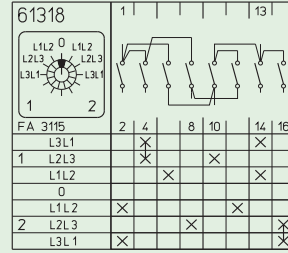
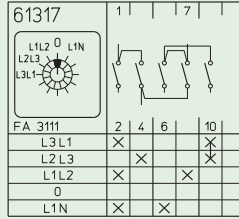
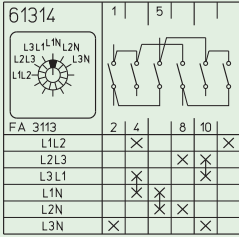

Switching diagrams 61737–61932

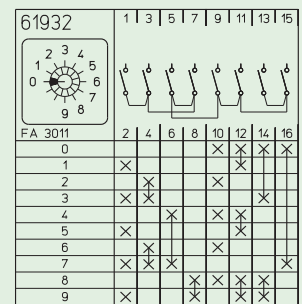
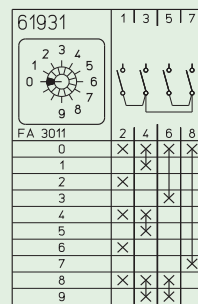
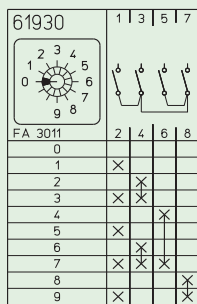
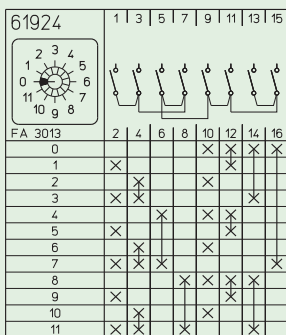
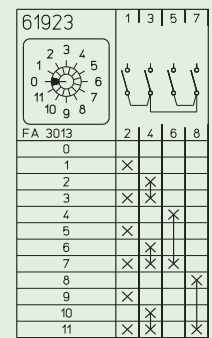
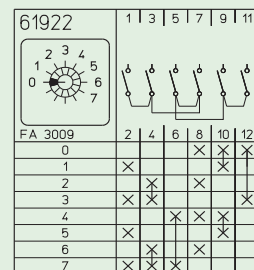
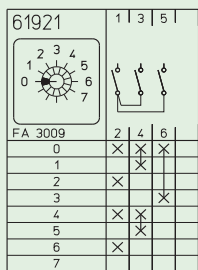
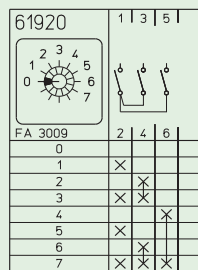
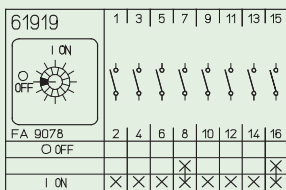
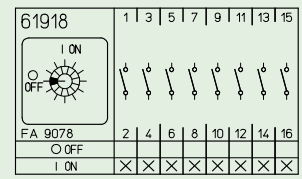
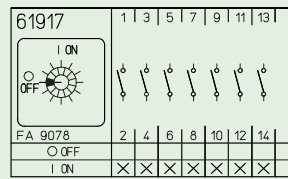
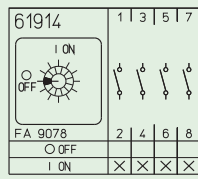
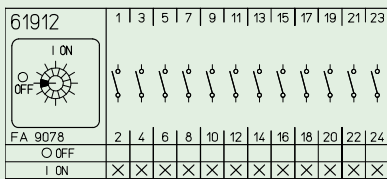
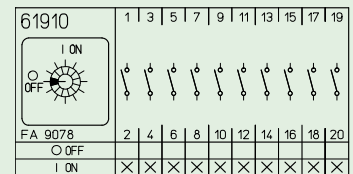
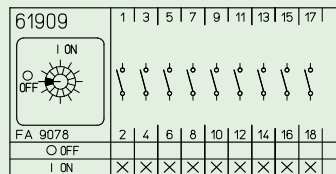
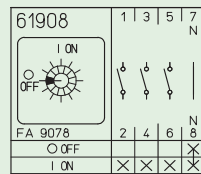
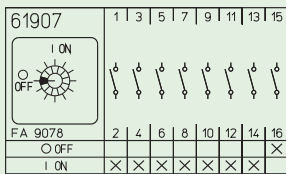
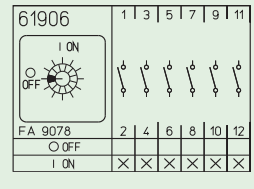
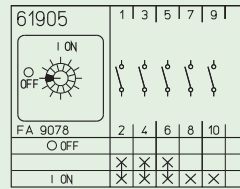
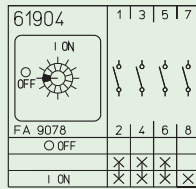
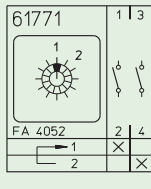
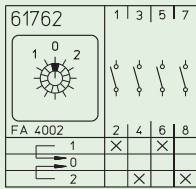
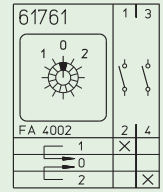
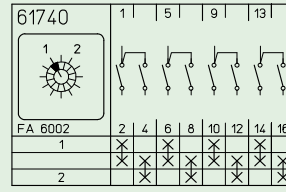
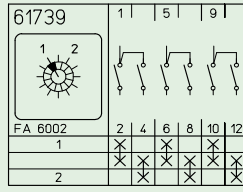
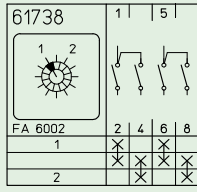
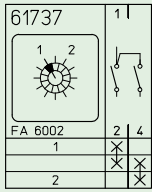

Order form for rotary cam switches with special switching programmes page 88.

Rotary Cam Switches

Technical Information Legend plates

2 switch positions

45° switching angle



FA 4018



FA 4020



FA 4022



FA 4047



FA 4048



FA 4052



FA 4054



FA 4055



FA 4056



FA 4066



FA 4073



FA 4077



FA 4078



FA 4080

60° switching angle



FA 6001



FA 6002



FA 6018



FA 6025



FA 6026



FA 6027



FA 6028



FA 6029



FA 6030



FA 6033



FA 6051



FA 6053



FA 6055



FA 6056



FA 6057



FA 6058



FA 6129



FA 6134



FA 6135



FA 6140



FA 6149

90° switching angle



FA 9011



FA 9016



FA 9017



FA 9018



FA 9021



FA 9026



FA 9031



FA 9032



FA 9033



FA 9057



FA 9058



FA 9078



FA 9079



FA 9080

3 switch positions

30° switching angle



FA 3028



FA 3030



FA 3046



FA 3103



FA 3104



FA 3105



FA 3106



FA 3116



FA 3117



FA 3118



FA 3119



FA 3120



FA 3121

3 switch positions

45° switching angle

FA 4001	FA 4002	FA 4006	FA 4012	FA 4024	FA 4025	FA 4026	FA 4027	FA 4028	FA 4029	FA 4030
FA 4031	FA 4032	FA 4033	FA 4034	FA 4035	FA 4036	FA 4037	FA 4038	FA 4045	FA 4067	FA 4068
FA 4069	FA 4070	FA 4071	FA 4072	FA 4074	FA 4076	FA 4079	FA 4081	FA 4082		

60° switching angle

FA 6003	FA 6004	FA 6005	FA 6009	FA 6010	FA 6017	FA 6019	FA 6020	FA 6034	FA 6035	FA 6036
FA 6038	FA 6039	FA 6044	FA 6045	FA 6060	FA 6061	FA 6062	FA 6063	FA 6064	FA 6065	FA 6067
FA 6068	FA 6069	FA 6070	FA 6071	FA 6072	FA 6073	FA 6074	FA 6075	FA 6076	FA 6077	FA 6091
FA 6103	FA 6105	FA 6116	FA 6117	FA 6126	FA 6131	FA 6132	FA 6133	FA 6136	FA 6141	FA 6142
FA 6143	FA 6144	FA 6146	FA 6147	FA 6148	FA 6150	FA 6151	FA 6152			

90° switching angle

FA 9006	FA 9008	FA 9013	FA 9023	FA 9024	FA 9027	FA 9037	FA 9038	FA 9050	FA 9081	FA 9083

Miscellaneous switching angles

FA 1009	FA 1015	FA 1020	FA 1052	FA 1053	FA 1055	FA 1059	FA 1061	FA 1063

Rotary Cam Switches

Technical Information Legend plates

4 switch positions

30° switching angle



FA 3014



FA 3021



FA 3022



FA 3029



FA 3047



FA 3056



FA 3058



FA 3087



FA 3088



FA 3089



FA 3090



FA 3107



FA 3108



FA 3109



FA 3110

45° switching angle



FA 4007



FA 4013



FA 4075



FA 4083



FA 4084



FA 4085

60° switching angle



FA 6006



FA 6013



FA 6021



FA 6041



FA 6049



FA 6104



FA 6113



FA 6114



FA 6119



FA 6127



FA 6137



FA 6138



FA 6145



FA 6153

90° switching angle



FA 9004



FA 9005



FA 9007



FA 9009



FA 9010



FA 9014



FA 9015



FA 9019



FA 9020



FA 9025



FA 9028



FA 9029



FA 9034



FA 9035



FA 9039



FA 9046



FA 9047



FA 9048



FA 9049



FA 9052



FA 9060



FA 9082



FA 9084

Miscellaneous switching angles



FA 1017



FA 1022



FA 1056



FA 1057

5 switch positions

30° switching angle



FA 3006



FA 3031



FA 3033



FA 3034



FA 3048



FA 3063



FA 3064



FA 3092



FA 3093



FA 3111



FA 3112

45° switching angle



FA 4003



FA 4008



FA 4014



FA 4039



FA 4040



FA 4041



FA 4059



FA 4060

60° switching angle



FA 6007



FA 6011



FA 6014



FA 6022



FA 6037



FA 6042



FA 6046



FA 6078



FA 6139

Miscellaneous switching angles



FA 1007



FA 1008



FA 1011



FA 1014



FA 1018



FA 1019



FA 1054



FA 1058



FA 1060



FA 1062

6 switch positions

30° switching angle



FA 3007



FA 3032



FA 3049



FA 3100



FA 3113



FA 3122

45° switching angle



FA 4009



FA 4015



FA 4091

Rotary Cam Switches

Technical Information Legend plates

6 switch positions

60° switching angle



FA 6008



FA 6012



FA 6015



FA 6023



FA 6024



FA 6040



FA 6043



FA 6047



FA 6081



FA 6083



FA 6085



FA 6098



FA 6118

7 switch positions

30° switching angle



FA 3004



FA 3008



FA 3015



FA 3023



FA 3035



FA 3043



FA 3050



FA 3060



FA 3062



FA 3065



FA 3067



FA 3082



FA 3083



FA 3084



FA 3114



FA 3115

45° switching angle



FA 4004



FA 4010



FA 4016



FA 4086



FA 4087



FA 4088



FA 4089



FA 4090

8 switch positions

30° switching angle



FA 3009



FA 3016



FA 3051

45° switching angle



FA 4011



FA 4017



FA 4046



FA 4058



FA 4061



FA 4092

9 switch positions

30° switching angle



FA 3010



FA 3017



FA 3025



FA 3044



FA 3052

10 switch positions

30° switching angle



FA 3011



FA 3018



FA 3053

11 switch positions

30° switching angle



FA 3012



FA 3019



FA 3054

12 switch positions

30° switching angle



FA 3013



FA 3020



FA 3055



FA 3123

Other



FA 1001

Rotary Cam Switches

Technical Information Legend plates

Additional top escutcheon plates

FA 8000	FA 8001	FA 8002	FA 8003	FA 8004	FA 8005
FA 8006	FA 8007	FA 8008	FA 8009	FA 8010	FA 8011
FA 8012	FA 8013	FA 8014	FA 8015	FA 8016	FA 8017
FA 8018	FA 8019	FA 8021	FA 8023	FA 8024	FA 8025
FA 8026	FA 8027	FA 8028	FA 8029	FA 8030	FA 8031
FA 8032	FA 8033	FA 8034	FA 8035	FA 8036	FA 8037
FA 8038	FA 8039	FA 8040	FA 8041	FA 8042	FA 8044
FA 8045	FA 8046	FA 8047			

How to order legend plates

Standard escutcheon 30 × 30 mm

Legend plate silver, inscription black
 Legend plate yellow, inscription black
 Legend plate black, inscription silver
 Legend plate white, inscription black
 Legend plate black, inscription white

Standard escutcheon 48 × 48 mm

Legend plate silver, inscription black
 Legend plate yellow, inscription black
 Legend plate black, inscription silver
 Legend plate white, inscription black
 Legend plate black, inscription white

Standard escutcheon 64 × 64 mm

Legend plate silver, inscription black
 Legend plate yellow, inscription black
 Legend plate black, inscription silver
 Legend plate white, inscription black
 Legend plate black, inscription white

Standard escutcheon 88 × 88 mm

Legend plate silver, inscription black
 Legend plate yellow, inscription black
 Legend plate black, inscription silver
 Legend plate white, inscription black
 Legend plate black, inscription white

Standard escutcheon 130 × 130 mm

Legend plate silver, inscription black
 Legend plate yellow, inscription black
 Legend plate black, inscription silver
 Legend plate white, inscription black
 Legend plate black, inscription white

Additional top escutcheon plates

Legend plate silver, inscription black
 Legend plate yellow, inscription black
 Legend plate black, inscription silver
 Legend plate white, inscription black
 Legend plate black, inscription white

Order code number

FAS1-.... (+FA number)
 FBS1-.... (+FA number)
 FCS1-.... (+FA number)
 FDS1-.... (+FA number)
 FES1-.... (+FA number)

Order code number

FAS2-.... (+FA number)
 FBS2-.... (+FA number)
 FCS2-.... (+FA number)
 FDS2-.... (+FA number)
 FES2-.... (+FA number)

Order code number

FAS4-.... (+FA number)
 FBS4-.... (+FA number)
 FCS4-.... (+FA number)
 FDS4-.... (+FA number)
 FES4-.... (+FA number)

Order code number

FAS6-.... (+FA number)
 FBS6-.... (+FA number)
 FCS6-.... (+FA number)
 FDS6-.... (+FA number)
 FES6-.... (+FA number)

Order code number

FAS8-.... (+FA number)
 FBS8-.... (+FA number)
 FCS8-.... (+FA number)
 FDS8-.... (+FA number)
 FES8-.... (+FA number)

Order code number

FAS2-8... (+FA number)
 FBS2-8... (+FA number)
 FCS2-8... (+FA number)
 FDS2-8... (+FA number)
 FES2-8... (+FA number)

Order form for Rotary cam switches
 with special inscriptions page 90.

Additional top escutcheon plates/Assembly tool

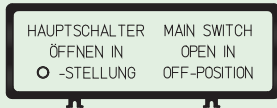

FAZ2-8041

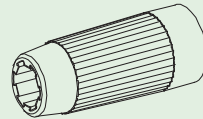

218098

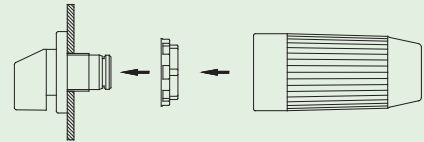

Additional top escutcheon plates

with additional inscription to be clipped on the escutcheons and padlock devices

Order code number

Escutcheon frame plate black, legend plate silver, without inscription (can be engraved)	FAZ2 - 8000
Escutcheon frame plate black, legend plate silver, inscription black, inscription FA 8... (see page 82)	FAZ2 - 8...
Escutcheon frame plate black, legend plate silver, inscription black, special engraving	FAZ2 - (special no.)
Escutcheon frame plate black, legend plate yellow, without inscription (can be engraved)	FBZ2 - 8000
Escutcheon frame plate black, legend plate yellow, inscription black, inscription FA 8... (see page 82)	FBZ2 - 8
Escutcheon frame plate black, legend plate yellow, inscription black, special engraving	FBZ2 - (special no.)
Escutcheon frame plate black, legend plate black, without inscription (can be engraved)	FCZ2 - 8000
Escutcheon frame plate black, legend plate black, inscription silver, inscription FA 8... (see page 82)	FCZ2 - 8...
Escutcheon frame plate black, legend plate black, inscription silver, special engraving	FCZ2 - (special no.)
Escutcheon frame plate black, legend plate white, without inscription (can be engraved)	FDZ2 - 8000
Escutcheon frame plate black, legend plate white, inscription black, inscription FA 8... (see page 82)	FDZ2 - 8...
Escutcheon frame plate black, legend plate white, inscription black, special engraving	FDZ2 - (special no.)
Escutcheon frame plate black, legend plate black, without inscription (can be engraved)	FEZ2 - 8000
Escutcheon frame plate black, legend plate black, inscription white, inscription FA 8... (see page 82)	FEZ2 - 8...
Escutcheon frame plate black, legend plate black, inscription white, special engraving	FEZ2 - (special no.)
Escutcheon frame plate black (without legend plate)	FAZ2

Legend plates for additional top escutcheon plates

Legend plate silver, without inscription (can be engraved)	FAS2 - 8000
Legend plate silver, inscription black, inscription FA 8... (see page 82)	FAS2 - 8...
Legend plate silver, inscription black, special engraving	FAS2 - (special no.)
Legend plate yellow, without inscription (can be engraved)	FBS2 - 8000
Legend plate yellow, inscription black, inscription FA 8... (see page 82)	FBS2 - 8...
Legend plate yellow, inscription black, special engraving	FBS2 - (special no.)
Legend plate black, without inscription (can be engraved)	FCS2 - 8000
Legend plate black, inscription silver, inscription FA 8... (see page 82)	FCS2 - 8...
Legend plate black, inscription silver, special engraving	FCS2 - (special no.)
Legend plate white, without inscription (can be engraved)	FDS2 - 8000
Legend plate white, inscription black, inscription FA 8... (see page 82)	FDS2 - 8...
Legend plate white, inscription black, special engraving	FDS2 - (special no.)
Legend plate black, inscription white, inscription FA 8... (see page 82)	FES2 - 8...
Legend plate black, inscription white, special engraving	FES2 - (special no.)

Assembly tool for single hole mounting

suitable for the fast assembly of escutcheons and padlock devices

Types	Order code number
P110 / P220 / P225 / M220 / M225 / T225	218098

Rotary Cam Switches

Technical Information Accessories

Shaft extensions

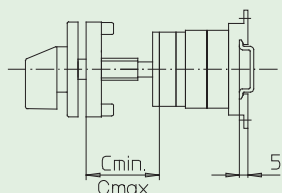
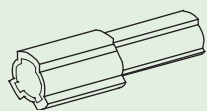

AVD2

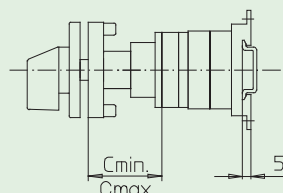
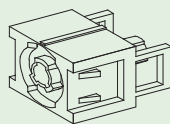

AVC2-

Modular shaft extensions for mounting forms with door clutch or door interlock

C_{min}	C_{max}	number	Order code number
-----------	-----------	--------	-------------------

Door clutch

42 mm	59 mm	–	–
60 mm	84 mm	1	AVD2
85 mm	109 mm	2	AVD2
110 mm	134 mm	3	AVD2
135 mm	159 mm	4	AVD2
160 mm	184 mm	5	AVD2
185 mm	209 mm	6	AVD2

Door interlock













42 mm	57 mm	–	–
64 mm	82 mm	1	AVC2 - 1
89 mm	107 mm	1	AVC2 - 2
114 mm	132 mm	1	AVC2 - 3
139 mm	157 mm	1	AVC2 - 4
164 mm	182 mm	1	AVC2 - 5
189 mm	207 mm	1	AVC2 - 6

Please note: AVC-2 to AVC2-6 have additional parts to aid the stability of the extended shaft modules

The dot in the order code number must be replaced by the classification letter which identifies the key removable positions. Due to the construction of the locking cylinder the key can also be removed at 180 degrees of the designated position.



















Type P110

Standard cylinder lock L001. Other lock types on request.

 A	key removable at 09 h / 03 h	 M	key removable at 01 h / 07 h
 B	key removable at 12 h / 06 h	 N	key removable at 10 h / 12 h / 02 h / 04 h / 06 h / 08 h
 C	key removable at 09 h / 12 h / 03 h / 06 h	 O	key removable at 11 h / 01 h / 05 h / 07 h
 D	key removable at 09 h / 11 h / 01 h / 03 h / 05 h / 07 h	 P	key removable at 10 h / 12 h / 04 h / 06 h
 E	key removable at 10 h / 04 h	 R	key removable at 12 h / 02 h / 06 h / 08 h
 F	key removable at 02 h / 08 h	 S	key removable at 10 h / 02 h / 04 h / 08 h
 L	key removable at 11 h / 05 h		

Types P220 / P225 / M220 / M225 / T225







Standard cylinder lock C001. Other lock types on request.

 A	key removable at 09 h / 03 h	 L	key removable at 11 h / 05 h
 B	key removable at 12 h / 06 h	 M	key removable at 01 h / 07 h
 C	key removable at 09 h / 12 h / 03 h / 06 h	 N	key removable at 10 h / 12 h / 02 h / 04 h / 06 h / 08 h
 D	key removable at 09 h / 11 h / 01 h / 03 h / 05 h / 07 h	 O	key removable at 11 h / 01 h / 05 h / 07 h
 E	key removable at 10 h / 04 h	 P	key removable at 10 h / 12 h / 04 h / 06 h
 F	key removable at 02 h / 08 h	 R	key removable at 12 h / 02 h / 06 h / 08 h
 G	key removable at 09 h / 10.30 h / 12 h / 01.30 h / 03 h / 04.30 h / 06 h / 07.30 h	 S	key removable at 10 h / 02 h / 04 h / 08 h
 H	key removable at 10.30 h / 04.30 h	 T	key removable at 09 h / 10.30 h / 03 h / 04.30 h
 J	key removable at 01.30 h / 07.30 h	 U	key removable at 10.30 h / 12 h / 04.30 h / 06 h
 K	key removable at 09 h / 10 h / 11 h / 12 h / 01 h / 02 h / 03 h / 04 h / 05 h / 06 h / 07 h / 08 h		

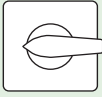
Rotary Cam Switches

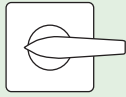
Technical Information Operators

Operator variants for mounting forms with escutcheon and handle

Operator Suitable for Types		Colour escutcheon	Colour legend plate	Colour operator	Change of order code number
M-handle P110, P220, P225, M220, M225, T225, S432, S440, S606, S608, S612		black	silver	black - - ...M1
		grey	silver	grey - - ...M2
		white	silver	white - - ...M3
		black	yellow	red - - ...M4
		black	silver	red - - ...M5
		black	black	black - - ...M8
F-handle P220, P225, M220, M225, T225		black	silver	black - - ...F1
		grey	silver	grey - - ...F2
		white	silver	white - - ...F3
		black	yellow	red - - ...F4
		black	silver	red - - ...F5
		black	black	black - - ...F8
B-handle P220, P225, M220, M225, T225, S432, S440, S606, S608, S612, S825		black	silver	black - - ...B1
		grey	silver	grey - - ...B2
		white	silver	white - - ...B3
		black	yellow	red - - ...B4
		black	silver	red - - ...B5
		black	black	black - - ...B8
N-handle P220, P225, M220, M225, T225, S432, S440		black	silver	black - - ...N1
		grey	silver	grey - - ...N2
		white	silver	white - - ...N3
		black	yellow	red - - ...N4
		black	silver	red - - ...N5
		black	black	black - - ...N8
G-handle S432, S440, S606, S608, S612, S825		black	silver	black - - ...G1
		black	yellow	red - - ...G4
		black	silver	red - - ...G5
		black	black	black - - ...G8
R-handle P220, P225, M220, M225, T225, S432, S440		black	silver	black - - ...R1
		grey	silver	grey - - ...R2
		white	silver	white - - ...R3
		black	yellow	red - - ...R4
		black	silver	red - - ...R5
Installation mounting for 45 mm aperture in Panel/Distribution boards:					
M-handle P220, P225, M220, M225, T225		grey	silver	black - - ...M1
		grey	silver	grey - - ...M2
		grey	yellow	red - - ...M4
N-handle P220, P225, M220, M225, T225		grey	silver	black - - ...N1
		grey	silver	grey - - ...N2
		grey	yellow	red - - ...N4

Operator variants for mounting forms with padlock device

Operator Suitable for Types		Colour escutcheon	Colour legend plate	Colour operator	Change of order code number
N-padlock device P220, P225, M220, M225, T225, S432, S440, S606, S608, S612		black	white	black	... - ... - ... N1
		grey	white	grey	... - ... - ... N2
		yellow	white	red	... - ... - ... N4
		grey	white	black	... - ... - ... N6
		yellow	white	black	... - ... - ... N7
		operator external dimension 67 x 67 mm 88 x 88 mm	max. number of padlocks 3 4	hasp diameter of padlock 4 mm (min) / 8 mm (max) 5 mm (min) / 9 mm (max)	
M-padlock device P110, P220, P225, M220, M225, T225, S432, S440, S606, S608, S612		black	white	black	... - ... - ... M1
		grey	white	grey	... - ... - ... M2
		yellow	white	red	... - ... - ... M4
		grey	white	black	... - ... - ... M6
		yellow	white	black	... - ... - ... M7
		operator external dimension 48 x 48 mm 67 x 67 mm 88 x 88 mm	max. number of padlocks 3 3 4	hasp diameter of padlock 3 mm (min) / 5 mm (max) 4 mm (min) / 8 mm (max) 5 mm (min) / 9 mm (max)	
B-padlock device S432, S440, S606, S608, S612, S825		black	silver	black	... - ... - ... B1
		black	yellow	red	... - ... - ... B4
		black	black	black	... - ... - ... B8
		operator external dimension 75 x 114 mm 98 x 142 130 x 178 mm	max. number of padlocks 4 4 4	hasp diameter of padlock 5 mm (min) / 8 mm (max) 5 mm (min) / 8 mm (max) 5 mm (min) / 8 mm (max)	
H-padlock device S432, S440, S606, S608, S612, S825		black	silver	black	... - ... - ... H1
		black	yellow	red	... - ... - ... H4
		black	black	black	... - ... - ... H8
		operator external dimension 75 x 114 mm 98 x 142 130 x 178 mm	max. number of padlocks 4 4 4	hasp diameter of padlock 5 mm (min) / 8 mm (max) 5 mm (min) / 8 mm (max) 5 mm (min) / 8 mm (max)	
Padlockable with V-handle P110, P220, P225, M220, M225, T225, S432, S440		black	silver	black	... - ... - ... V1
		black	yellow	red	... - ... - ... V4
		operator external dimension 48 x 48 mm 64 x 64 mm	max. number of padlocks 2 3	hasp diameter of padlock 3 mm (min) / 5 mm (max) 4 mm (min) / 6 mm (max)	
Padlockable with L-handle P110, P220, P225, M220, M225, T225		black	silver	black	... - ... - ... L1
		black	yellow	red	... - ... - ... L4
		operator external dimension 48 x 48 mm	max. number of padlocks 2	hasp diameter of padlock 3 mm (min) / 5 mm (max)	
Installation mounting for 45 mm aperture in Panel/Distribution boards:					
Padlockable with V-handle P220, P225, M220, M225 T225		grey	silver	black	... - ... - ... V1
		grey	yellow	red	... - ... - ... V4
		operator external dimension 45 x 52.5 mm	max. number of padlocks 2	hasp diameter of padlock 3 mm (min) / 5 mm (max)	
Padlockable with L-handle P220, P225, M220, M225, T225		grey	silver	black	... - ... - ... L1
		grey	yellow	red	... - ... - ... L4
		operator external dimension 45 x 52.5 mm	max. number of padlocks 2	hasp diameter of padlock 3 mm (min) / 5 mm (max)	

Copy form for special switches

<input type="checkbox"/> Bestell-Nr./Order no.																																																																																																																																																																																																																																																																																																																																																																																																																																																
Frontschild/Escutcheon plate 	<table border="1" style="width: 100%; text-align: center; border-collapse: collapse;"> <tr> <td style="width: 20px;">1</td><td style="width: 20px;">3</td><td style="width: 20px;">5</td><td style="width: 20px;">7</td><td style="width: 20px;">9</td><td style="width: 20px;">11</td><td style="width: 20px;">13</td><td style="width: 20px;">15</td><td style="width: 20px;">17</td><td style="width: 20px;">19</td><td style="width: 20px;">21</td><td style="width: 20px;">23</td><td style="width: 20px;">25</td><td style="width: 20px;">27</td><td style="width: 20px;">29</td><td style="width: 20px;">31</td><td style="width: 20px;">33</td><td style="width: 20px;">35</td> </tr> <tr> <td colspan="19" style="text-align: center;"> </td> </tr> <tr> <td style="width: 20px;">2</td><td style="width: 20px;">4</td><td style="width: 20px;">6</td><td style="width: 20px;">8</td><td style="width: 20px;">10</td><td style="width: 20px;">12</td><td style="width: 20px;">14</td><td style="width: 20px;">16</td><td style="width: 20px;">18</td><td style="width: 20px;">20</td><td style="width: 20px;">22</td><td style="width: 20px;">24</td><td style="width: 20px;">26</td><td style="width: 20px;">28</td><td style="width: 20px;">30</td><td style="width: 20px;">32</td><td style="width: 20px;">34</td><td style="width: 20px;">36</td> </tr> </table>			1	3	5	7	9	11	13	15	17	19	21	23	25	27	29	31	33	35																				2	4	6	8	10	12	14	16	18	20	22	24	26	28	30	32	34	36																																																																																																																																																																																																																																																																																																																																																																																						
1	3	5	7	9	11	13	15	17	19	21	23	25	27	29	31	33	35																																																																																																																																																																																																																																																																																																																																																																																																																															
2	4	6	8	10	12	14	16	18	20	22	24	26	28	30	32	34	36																																																																																																																																																																																																																																																																																																																																																																																																																															
Schaltwinkel Switching angle	<table border="1" style="width: 100%; text-align: center; border-collapse: collapse;"> <tr> <td style="width: 20px;">o</td><td style="width: 20px;"></td><td style="width: 20px;"></td><td style="width: 20px;"></td><td style="width: 20px;"></td><td style="width: 20px;"></td><td style="width: 20px;"></td><td style="width: 20px;"></td><td style="width: 20px;"></td><td style="width: 20px;"></td><td style="width: 20px;"></td><td style="width: 20px;"></td><td style="width: 20px;"></td><td style="width: 20px;"></td><td style="width: 20px;"></td><td style="width: 20px;"></td><td style="width: 20px;"></td><td style="width: 20px;"></td> </tr> </table>			o																																																																																																																																																																																																																																																																																																																																																																																																																																												
o																																																																																																																																																																																																																																																																																																																																																																																																																																																
Schaltstellungen Switch positions	<table border="1" style="width: 100%; text-align: center; border-collapse: collapse;"> <tr> <td style="width: 20px;">↓</td><td style="width: 20px;"></td><td style="width: 20px;"></td><td style="width: 20px;"></td><td style="width: 20px;"></td><td style="width: 20px;"></td><td style="width: 20px;"></td><td style="width: 20px;"></td><td style="width: 20px;"></td><td style="width: 20px;"></td><td style="width: 20px;"></td><td style="width: 20px;"></td><td style="width: 20px;"></td><td style="width: 20px;"></td><td style="width: 20px;"></td><td style="width: 20px;"></td><td style="width: 20px;"></td><td style="width: 20px;"></td> </tr> </table>			↓																																																																																																																																																																																																																																																																																																																																																																																																																																												
↓																																																																																																																																																																																																																																																																																																																																																																																																																																																
<table border="1" style="width: 100%; text-align: center; border-collapse: collapse;"> <tr><td style="width: 20px;">1</td><td style="width: 20px;"></td><td style="width: 20px;"></td><td style="width: 20px;"></td><td style="width: 20px;"></td><td style="width: 20px;"></td><td style="width: 20px;"></td><td style="width: 20px;"></td><td style="width: 20px;"></td><td style="width: 20px;"></td><td style="width: 20px;"></td><td style="width: 20px;"></td><td style="width: 20px;"></td><td style="width: 20px;"></td><td style="width: 20px;"></td><td style="width: 20px;"></td><td style="width: 20px;"></td><td style="width: 20px;"></td></tr> <tr><td>2</td><td></td><td></td><td></td><td></td><td></td><td></td><td></td><td></td><td></td><td></td><td></td><td></td><td></td><td></td><td></td><td></td><td></td></tr> <tr><td>3</td><td></td><td></td><td></td><td></td><td></td><td></td><td></td><td></td><td></td><td></td><td></td><td></td><td></td><td></td><td></td><td></td><td></td></tr> <tr><td>4</td><td></td><td></td><td></td><td></td><td></td><td></td><td></td><td></td><td></td><td></td><td></td><td></td><td></td><td></td><td></td><td></td><td></td></tr> <tr><td>5</td><td></td><td></td><td></td><td></td><td></td><td></td><td></td><td></td><td></td><td></td><td></td><td></td><td></td><td></td><td></td><td></td><td></td></tr> <tr><td>6</td><td></td><td></td><td></td><td></td><td></td><td></td><td></td><td></td><td></td><td></td><td></td><td></td><td></td><td></td><td></td><td></td><td></td></tr> <tr><td>7</td><td></td><td></td><td></td><td></td><td></td><td></td><td></td><td></td><td></td><td></td><td></td><td></td><td></td><td></td><td></td><td></td><td></td></tr> <tr><td>8</td><td></td><td></td><td></td><td></td><td></td><td></td><td></td><td></td><td></td><td></td><td></td><td></td><td></td><td></td><td></td><td></td><td></td></tr> <tr><td>9</td><td></td><td></td><td></td><td></td><td></td><td></td><td></td><td></td><td></td><td></td><td></td><td></td><td></td><td></td><td></td><td></td><td></td></tr> <tr><td>10</td><td></td><td></td><td></td><td></td><td></td><td></td><td></td><td></td><td></td><td></td><td></td><td></td><td></td><td></td><td></td><td></td><td></td></tr> <tr><td>11</td><td></td><td></td><td></td><td></td><td></td><td></td><td></td><td></td><td></td><td></td><td></td><td></td><td></td><td></td><td></td><td></td><td></td></tr> <tr><td>12</td><td></td><td></td><td></td><td></td><td></td><td></td><td></td><td></td><td></td><td></td><td></td><td></td><td></td><td></td><td></td><td></td><td></td></tr> <tr><td>13</td><td></td><td></td><td></td><td></td><td></td><td></td><td></td><td></td><td></td><td></td><td></td><td></td><td></td><td></td><td></td><td></td><td></td></tr> <tr><td>14</td><td></td><td></td><td></td><td></td><td></td><td></td><td></td><td></td><td></td><td></td><td></td><td></td><td></td><td></td><td></td><td></td><td></td></tr> <tr><td>15</td><td></td><td></td><td></td><td></td><td></td><td></td><td></td><td></td><td></td><td></td><td></td><td></td><td></td><td></td><td></td><td></td><td></td></tr> <tr><td>16</td><td></td><td></td><td></td><td></td><td></td><td></td><td></td><td></td><td></td><td></td><td></td><td></td><td></td><td></td><td></td><td></td><td></td></tr> <tr><td>17</td><td></td><td></td><td></td><td></td><td></td><td></td><td></td><td></td><td></td><td></td><td></td><td></td><td></td><td></td><td></td><td></td><td></td></tr> <tr><td>18</td><td></td><td></td><td></td><td></td><td></td><td></td><td></td><td></td><td></td><td></td><td></td><td></td><td></td><td></td><td></td><td></td><td></td></tr> <tr><td>19</td><td></td><td></td><td></td><td></td><td></td><td></td><td></td><td></td><td></td><td></td><td></td><td></td><td></td><td></td><td></td><td></td><td></td></tr> <tr><td>20</td><td></td><td></td><td></td><td></td><td></td><td></td><td></td><td></td><td></td><td></td><td></td><td></td><td></td><td></td><td></td><td></td><td></td></tr> <tr><td>21</td><td></td><td></td><td></td><td></td><td></td><td></td><td></td><td></td><td></td><td></td><td></td><td></td><td></td><td></td><td></td><td></td><td></td></tr> <tr><td>22</td><td></td><td></td><td></td><td></td><td></td><td></td><td></td><td></td><td></td><td></td><td></td><td></td><td></td><td></td><td></td><td></td><td></td></tr> <tr><td>23</td><td></td><td></td><td></td><td></td><td></td><td></td><td></td><td></td><td></td><td></td><td></td><td></td><td></td><td></td><td></td><td></td><td></td></tr> <tr><td>24</td><td></td><td></td><td></td><td></td><td></td><td></td><td></td><td></td><td></td><td></td><td></td><td></td><td></td><td></td><td></td><td></td><td></td></tr> </table>	1																		2																		3																		4																		5																		6																		7																		8																		9																		10																		11																		12																		13																		14																		15																		16																		17																		18																		19																		20																		21																		22																		23																		24																	
1																																																																																																																																																																																																																																																																																																																																																																																																																																																
2																																																																																																																																																																																																																																																																																																																																																																																																																																																
3																																																																																																																																																																																																																																																																																																																																																																																																																																																
4																																																																																																																																																																																																																																																																																																																																																																																																																																																
5																																																																																																																																																																																																																																																																																																																																																																																																																																																
6																																																																																																																																																																																																																																																																																																																																																																																																																																																
7																																																																																																																																																																																																																																																																																																																																																																																																																																																
8																																																																																																																																																																																																																																																																																																																																																																																																																																																
9																																																																																																																																																																																																																																																																																																																																																																																																																																																
10																																																																																																																																																																																																																																																																																																																																																																																																																																																
11																																																																																																																																																																																																																																																																																																																																																																																																																																																
12																																																																																																																																																																																																																																																																																																																																																																																																																																																
13																																																																																																																																																																																																																																																																																																																																																																																																																																																
14																																																																																																																																																																																																																																																																																																																																																																																																																																																
15																																																																																																																																																																																																																																																																																																																																																																																																																																																
16																																																																																																																																																																																																																																																																																																																																																																																																																																																
17																																																																																																																																																																																																																																																																																																																																																																																																																																																
18																																																																																																																																																																																																																																																																																																																																																																																																																																																
19																																																																																																																																																																																																																																																																																																																																																																																																																																																
20																																																																																																																																																																																																																																																																																																																																																																																																																																																
21																																																																																																																																																																																																																																																																																																																																																																																																																																																
22																																																																																																																																																																																																																																																																																																																																																																																																																																																
23																																																																																																																																																																																																																																																																																																																																																																																																																																																
24																																																																																																																																																																																																																																																																																																																																																																																																																																																
<input type="checkbox"/> Gesperrte Stellung Locked position	<input type="checkbox"/> Kontakt geschlossen Contact closed	<input type="checkbox"/> Kontakt über mehrere Stellungen geschlossen Contact closed without interruption	<input type="checkbox"/> Rückzug Spring return																																																																																																																																																																																																																																																																																																																																																																																																																																													
<input type="checkbox"/> Typ Type	<input type="checkbox"/> Bauform Mounting form	<input type="checkbox"/> Anschlag Stop																																																																																																																																																																																																																																																																																																																																																																																																																																														
<input type="checkbox"/> Bedienelemente Operator	<input type="checkbox"/> Zusatzeinrichtungen Optional extras																																																																																																																																																																																																																																																																																																																																																																																																																																															
<input type="checkbox"/> Aufschrift Marking	<input type="checkbox"/> mit <input type="checkbox"/> ohne with without																																																																																																																																																																																																																																																																																																																																																																																																																																															
Firma/Company		Datum/Date	Name/Signum																																																																																																																																																																																																																																																																																																																																																																																																																																													

Rotary Cam Switches

Technical Information Special engravings

How to order special engravings

For descriptions of the desired special engraving please use our order forms. On page 191 you will find order forms for switches with switching angle 30°/60° and 45°/90°.

When determining the desired engraving the following has to be considered:

- For standard engraving capital letters or figures type Helvetica in black are used.
- Engravings deviating from the standard design like small size text, symbols or graphical symbols please enclose a drawing or a file.
- The max. quantity of letters (symbols) is specified in the order form.
- The max. letter height is for

escutcheon	□	30 mm	=	3.5 mm
escutcheon	□	48 mm	=	4.0 mm
escutcheon	□	64 mm	=	4.5 mm
escutcheon	□	88 mm	=	6.5 mm
escutcheon	□	130 mm	=	8.0 mm

When utilizing the max. letter (symbol) quantity the letter height might be reduced.

- With the first order a FAX no. for the legend plate and a FAZ no. for the additional legend plate is fixed for every special engraving that will remain valid for all subsequent orders.

Copy form for special engravings

FAX FAZ	Sälzer	<div style="display: flex; justify-content: space-around; align-items: center;"> <div style="text-align: center;"> <p>24</p> </div> <div style="text-align: center;"> <p>30°/60°</p> </div> </div>	Datum/Date	Name/Signum
FAX FAZ	Sälzer	<div style="display: flex; justify-content: space-around; align-items: center;"> <div style="text-align: center;"> <p>24</p> </div> <div style="text-align: center;"> <p>45°/90°</p> </div> </div>	Datum/Date	Name/Signum
		Firma/Company		

Rotary Cam Switches

Technical Information Utilization Categories

Utilization Categories

Utilization categories for Switches, Disconnectors, Switch-Disconnectors and Fuse-Combination Units according to IEC/EN 60947-3

Type of Current	Utilization Category		Typical applications
	Frequent operation	Occasional operation	
AC	AC-15A	AC-15B	Controlling electromagnetic load
	AC-20A *	AC-20B *	Making and breaking without load
	AC-21A	AC-21B	Switching resistive loads including low overloads
	AC-22A	AC-22B	Switching mixed resistive and inductive loads, including low overloads
	AC-23A	AC-23B	Switching motors and other highly inductive loads
DC	DC-20A *	DC-20B *	Making and breaking without load
	DC-21A	DC-21B	Switching resistive loads including low overloads
	DC-22A	DC-22B	Switching mixed resistive and inductive loads, including low overloads (e. g. shunt motors)
	DC-23A	DC-23B	Switching highly inductive loads (e. g. series motors)

* The application of these utilization categories isn't permitted in the USA.

Category AC-23 includes occasional switching of individual motors. The utilization categories in the above table do not apply to an equipment normally used to start, accelerate and/or stop individual motors. The utilization categories for such an equipment are dealt with the following table:

Type of Current	Utilization Category	Typical applications
AC	AC-2	Slip-ring motors: starting, plugging ¹⁾ , switching off
	AC-3	Squirrel-cage motors: starting, switching off running motors
	AC-4	Squirrel-cage motors: starting, plugging ¹⁾ , inching ²⁾
DC	DC-3	Shunt motors: starting, plugging ¹⁾ , inching ²⁾ , dynamic breaking of d.c. motors
	DC-4	Series motors: starting, plugging ¹⁾ , inching ²⁾ , dynamic breaking of d.c. motors

¹⁾ Plugging is understood to mean stopping or reversing the motor rapidly by reversing motor primary connections while the motor is running.

²⁾ Inching (jogging) is understood to mean energizing a motor once or repeatedly for short periods to obtain small movements of the driven mechanism.

Note: The switching of rotor circuits, capacitors or tungsten filament/discharge lamps shall be subject to special agreements between manufacturer and user.

Rated currents of three-phase motors (approximate figures for squirrel-cage motors)

Motor rating			Motor full-load current A	Fuse starting		Motor full-load current A	Fuse starting	
kW	cos φ	Percent efficiency η %		D.O.L. A	Y/Δ A		D.O.L. A	Y/Δ A
			230 V			400 V		
0,06	0,7	58	0,37	2	—	0,21	2	—
0,09	0,7	60	0,54	2	—	0,31	2	—
0,12	0,7	60	0,72	4	2	0,41	2	—
0,18	0,7	62	1,04	4	2	0,6	2	—
0,25	0,7	62	1,4	4	2	0,8	4	2
0,37	0,72	66	2	6	4	1,1	4	2
0,55	0,75	69	2,7	10	4	1,5	4	2
0,75	0,79	74	3,2	10	4	1,9	6	4
1,1	0,81	74	4,6	10	6	2,6	6	4
1,5	0,81	74	6,3	16	10	3,6	6	4
2,2	0,81	78	8,7	20	10	5	10	6
3	0,82	80	11,5	25	16	6,6	16	10
4	0,82	83	14,8	32	16	8,5	20	10
5,5	0,82	86	19,6	32	25	11,3	25	16
7,5	0,82	87	26,4	50	32	15,2	32	16
11	0,84	87	38	80	40	21,7	40	25
15	0,84	88	51	100	63	29,3	63	32
18,5	0,84	88	63	125	80	36	63	40
22	0,84	92	71	125	80	41	80	50
30	0,85	92	96	200	100	55	100	63
37	0,86	92	117	200	125	68	125	80
45	0,86	93	141	250	160	81	160	100
55	0,86	93	173	250	200	99	200	125
75	0,86	94	233	315	250	134	200	160
90	0,86	94	279	400	315	161	250	200
110	0,86	94	342	500	400	196	315	200
132	0,87	95	401	630	500	231	400	250
160	0,87	95	486	630	630	279	400	315
200	0,87	95	607	800	630	349	500	400
250	0,87	95	—	—	—	437	630	500
315	0,87	96	—	—	—	544	800	630
400	0,88	96	—	—	—	683	1000	800
			500 V			690 V		
0,06	0,7	58	0,17	2	—	0,12	2	—
0,09	0,7	60	0,25	2	—	0,18	2	—
0,12	0,7	60	0,33	2	—	0,24	2	—
0,18	0,7	62	0,48	2	—	0,35	2	—
0,25	0,7	62	0,7	2	—	0,5	2	—
0,37	0,72	66	0,9	2	2	0,7	2	—
0,55	0,75	69	1,2	4	2	0,9	4	2
0,75	0,79	74	1,5	4	2	1,1	4	2
1,1	0,81	74	2,1	6	4	1,5	4	2
1,5	0,81	74	2,9	6	4	2,1	6	4
2,2	0,81	78	4	10	4	2,9	10	4
3	0,82	80	5,3	16	6	3,8	10	4
4	0,82	83	6,8	16	10	4,9	16	6
5,5	0,82	86	9	20	16	6,5	16	10
7,5	0,82	87	12,1	25	16	8,8	25	10
11	0,84	87	17,4	32	20	12,6	25	16
15	0,84	88	23,4	50	25	17	32	20
18,5	0,84	88	28,9	50	32	20,9	32	25
22	0,84	92	33	63	32	23,8	50	25
30	0,85	92	44	80	50	32	63	32
37	0,86	92	54	100	63	39	80	50
45	0,86	93	65	125	80	47	80	63
55	0,86	93	79	160	80	58	100	63
75	0,86	94	107	200	125	78	160	100
90	0,86	94	129	200	160	93	160	100
110	0,86	94	157	250	160	114	200	125
132	0,87	95	184	250	200	134	250	160
160	0,87	95	224	315	250	162	250	200
200	0,87	95	279	400	315	202	315	250
250	0,87	95	349	500	400	253	400	315
315	0,87	96	436	630	500	316	500	400
400	0,88	96	547	800	630	396	630	400

The rated motor currents are for standard 1500 r.p.m. motors with normal inner and outer surface cooling

Fuse: This table applies to "slow" or "gL"

D.O.L. starting: Maximum starting current: 6 × rated current. Maximum starting time: 5 sec.

Y/Δ starting: Maximum starting current: 2 × rated current. Maximum starting time: 15 sec.



Rotary Cam Switches

Technical Information Degree of Protection

IP Codes

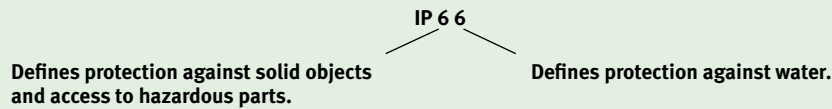
A coding system is defined by IEC/EN 60529 for the classification of degrees of protection provided by enclosures of electrical equipment against solid objects and water. This coding comprises the letters 'IP' followed by a two digit code as follows:

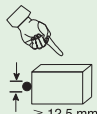
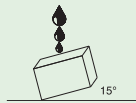
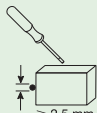
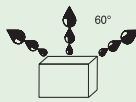
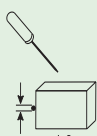
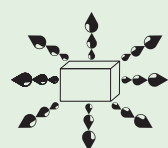
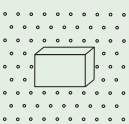
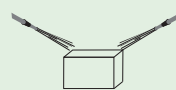
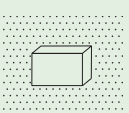
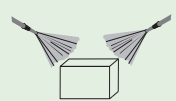
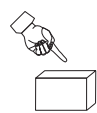
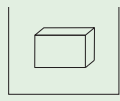
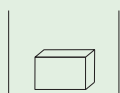

1 st digit	protection against solid objects and access to hazardous parts	2 nd digit	Protection against water
0	No protection.	0	No protection.
1	 No ingress by solid objects ≥ 50 mm dia nor access to hazardous parts with the back of the hand.	1	 Vertically falling drops of water shall have no harmful effect.
2	 No ingress by solid objects ≥ 12.5 mm dia nor access to hazardous parts with a finger.	2	 Vertically falling drops of water shall have no harmful effect when the enclosure is tilted at any angle up to 15° from vertical.
3	 No ingress by solid objects ≥ 2.5 mm dia nor access to hazardous parts with a tool.	3	 Water sprayed at up to 60° from the vertical shall have no harmful effect.
4	 No ingress by solid objects ≥ 1.0 mm dia nor access to hazardous parts with a wire.	4	 Water splashed from any direction shall have no harmful effect.
5	 Dust protected. Ingress of dust is not completely prevented, but there should be no harmful deposits. No access to hazardous parts with a wire.	5	 Jets of water projected from any direction shall have no harmful effect.
6	 Dust tight. No ingress of dust. No access to hazardous parts with a wire.	6	 Strong jets of water projected from any direction shall have no harmful effect.
1B	 Test finger penetration to a maximum of 80 mm must not contact hazardous parts.	7	 Temporary immersion in water shall not result in ingress of harmful quantities of water.
		8	 Continuous immersion in water shall not result in ingress of harmful quantities of water.

Mounting form table

Mtg. form	Type of mounting	page	Mtg. form	Type of mounting	page
002G1	base mounting/four hole mounting 68×68 mm	35	177M4	enclosed/insulated enclosure 100×80×85 mm	51
002G1	base mounting/four hole mounting 104×104 mm	40	177N1	enclosed/insulated enclosure 100×80×85 mm	51
002M1	base mounting/four hole mounting 68×68 mm	34	177N4	enclosed/insulated enclosure 100×80×85 mm	51
002M1	base mounting/four hole mounting 68×68 mm	35	177V1	enclosed/insulated enclosure 100×80×85 mm	51
003G1	front mounting/four hole mounting 104×104 mm	17	177V4	enclosed/insulated enclosure 100×80×85 mm	51
003G1	front mounting/four hole mounting 68×68 mm	16	178V1	enclosed/insulated enclosure 100×80×85 mm	49
003M1	front mounting/four hole mounting 36×36 mm	12	206M1	front mounting/single hole mounting ø 22.5 mm	26
003M1	front mounting/four hole mounting 48×48 mm	15	206M4	front mounting/single hole mounting ø 22.5 mm	26
003M1	front mounting/four hole mounting 68×68 mm	16	206N1	front mounting/single hole mounting ø 22.5 mm	26
003M1	front mounting/two hole mounting 20 mm	10	206N4	front mounting/single hole mounting ø 22.5 mm	26
005M1	front mounting/four hole mounting 36×36 mm	13	206V1	front mounting/single hole mounting ø 22.5 mm	26
021M1	base mounting/snap on mounting	28	206V4	front mounting/single hole mounting ø 22.5 mm	26
025N3	front mounting/flush wall mounting	27	218M1	front mounting/single hole mounting ø 16 mm/22.5 mm	19
026N2	base mounting/snap on mounting/DIN rail	29	218M1	front mounting/single hole mounting ø 22.5 mm	23
033M1	front mounting/four hole mounting 36×36 mm	14	219M1	front mounting/single hole mounting ø 16 mm/22.5 mm	18
033M1	front mounting/two hole mounting 20 mm	11	219M1	front mounting/single hole mounting ø 22.5 mm	22
033M4	front mounting/four hole mounting 36×36 mm	14	232M1	base mounting/snap on mounting/door clutch	31
033M4	front mounting/two hole mounting 20 mm	11	232M4	base mounting/snap on mounting/door clutch	31
033N1	front mounting/four hole mounting 36×36 mm	14	232N1	base mounting/snap on mounting/door clutch	31
033N4	front mounting/four hole mounting 36×36 mm	14	232N4	base mounting/snap on mounting/door clutch	31
033V1	front mounting/four hole mounting 36×36 mm	14	232V1	base mounting/snap on mounting/door clutch	31
033V4	front mounting/four hole mounting 36×36 mm	14	232V4	base mounting/snap on mounting/door clutch	31
041G1	base mtg./four hole mtg. 104×104 mm/door clutch	41	234M1	base mounting/snap on mounting/door interlock	33
041G1	base mtg./four hole mtg. 68×68 mm/door clutch	37	234M4	base mounting/snap on mounting/door interlock	33
041M1	base mtg./four hole mtg. 68×68 mm/door clutch	36	234N1	base mounting/snap on mounting/door interlock	33
041M1	base mtg./four hole mtg. 68×68 mm/door clutch	37	234N4	base mounting/snap on mounting/door interlock	33
042G1	base mtg./four hole mtg. 104×104 mm/door interlock	42	234V1	base mounting/snap on mounting/door interlock	33
042G1	base mtg./four hole mtg. 68×68 mm/door interlock	39	234V4	base mounting/snap on mounting/door interlock	33
042M1	base mtg./four hole mtg. 68×68 mm/door interlock	38	241M1	base mounting/snap on mounting/door clutch	30
042M1	base mtg./four hole mtg. 68×68 mm/door interlock	39	242M1	base mounting/snap on mounting/door interlock	32
076M1	enclosed/insulated enclosure 100×80×65 mm	45	273M1	enclosed/insulated enclosure 125×100×133 mm	54
076V1	enclosed/insulated enclosure 100×80×65 mm	46	273V1	enclosed/insulated enclosure 125×100×133 mm	54
077M1	enclosed/insulated enclosure 100×80×65 mm	47	275M1	enclosed/insulated enclosure 125×100×133 mm	55
077M4	enclosed/insulated enclosure 100×80×65 mm	47	275M4	enclosed/insulated enclosure 125×100×133 mm	55
077N1	enclosed/insulated enclosure 100×80×65 mm	47	275N1	enclosed/insulated enclosure 125×100×133 mm	55
077N4	enclosed/insulated enclosure 100×80×65 mm	47	275N4	enclosed/insulated enclosure 125×100×133 mm	55
077V1	enclosed/insulated enclosure 100×80×65 mm	47	275V1	enclosed/insulated enclosure 125×100×133 mm	55
077V4	enclosed/insulated enclosure 100×80×65 mm	47	275V4	enclosed/insulated enclosure 125×100×133 mm	55
078V1	enclosed/insulated enclosure 100×80×65 mm	46	276M1	enclosed/insulated enclosure 125×100×133 mm	52
107M1	enclosed/insulated enclosure 68×68×53 mm	43	276V1	enclosed/insulated enclosure 125×100×133 mm	53
117M1	enclosed/insulated enclosure 68×68×53 mm	44	E001.*	enclosed/insulated enclosure 100×80×85 mm	50
117M4	enclosed/insulated enclosure 68×68×53 mm	44	R001.*	front mounting/single hole mounting ø 16 mm/22.5 mm	21
176M1	enclosed/insulated enclosure 100×80×85 mm	48	R001.*	front mounting/single hole mounting ø 22.5 mm	25
176V1	enclosed/insulated enclosure 100×80×85 mm	49	S001.*	front mounting/single hole mounting ø 16 mm/22.5 mm	20
177M1	enclosed/insulated enclosure 100×80×85 mm	51	S001.*	front mounting/single hole mounting ø 22.5 mm	24

Rotary Cam Switches

Technical Information Technical Data

Rated data

Rated data			P110	M220 P220	M221* P221*	P225	M225 P226*	T225	S432	S440	S606	S608	S612	S825
Operational voltage U_e	(V AC)		440	690	690	690	690	690	690	690	690	690	690	690
Impulse withstand voltage U_{imp}	(kV)		4	6	6	6	6	6	6	6	6	6	6	6
Overvoltage category			III	III	III	III	III	III	III	III	III	III	III	III
Pollution degree			3	3	3	3	3	3	3	3	3	3	3	3
Uninterrupted current $I_u / I_{th} / I_{the}$	(A)		10	20	20	25	25	32	50	63	80	100	160	315
Load carrying capacity in intermittent operation (class 12)	(AB)		DF: 60% = $1.3 \times I_e / 40\%$ = $1.6 \times I_e / 25\%$ = $2 \times I_e$											
Breaking capacity	220–240V	(A)	90	180	180	255	255	370	520	550	600	700	900	1800
	380–440V	(A)	70	150	150	230	230	300	430	500	550	600	850	1650
	500–690V	(A)	—	90	90	270	270	210	280	380	420	450	340	350
short-circuit rating (max. fuse)	(gL)		10	20	20	25	25	32	50	63	80	100	160	315
Conditional short-circuit current	(kA_{eff})		3	10	10	10	10	15	20	20	25	25	25	25
Isolating characteristics (to EN 60947)	(up to ... V AC)		460	690	690	690	690	690	690	690	690	690	690	690
Switching angle			30° / 45° / 60° / 90°											
Contacts (Current paths) (max.)			16	24	24	24	24	24	24	24	24	24	24	24
Current heat loss per contact at I_u	(W)		0.3	0.65	0.65	0.75	0.75	1	3	3.5	4	5	11	28.5
Terminal capacity														
solid or stranded	min.	(mm ²)	0.75	1	1	1.5	1.5	2.5	2.5	4	6	10	10	185 ¹
	max.	(mm ²)	1.5	2.5	2.5	4	4	6	10	16	25	35	70	185 ¹
flexible or multiwire (including ferrule)	min.	(mm ²)	0.75	1	1	1.5	1.5	1.5	2.5	2.5	6	10	10	185 ¹
	max.	(mm ²)	1.5	2.5	2.5	2.5	2.5	4	6	10	16	25	50	185 ¹
American Wire Gauge	(AWG)		16	12	12	10	10	10	6	4	4	1/0	2/0	350MCM
Thread dimensions for terminal screw			M2.5	M3	M3	M3.5	M3.5	M4	M5	M5	2×M4	2×M5	2×M6	M12
Terminal tightening torque	min.	(Nm)	0.4	0.5	0.5	0.8	0.8	1.2	2	2	1.2	2	2.5	14
	max.	(Nm)	0.6	1	1	1.5	1.5	2.5	4	4	2.5	4	6	25
Operational current I_e														
AC-21A	220–500V	(A)	10	20	20	25	25	32	50	63	80	100	160	315
	660–690V	(A)	—	20	20	25	25	32	50	60	80	80	125	125
AC-22A	440V	(A)	6	16	16	22	22	30	44	50	65	80	120	285
cUL General Use	300V AC	(A)	10	20	20	25	25	35	55 ¹	70 ¹	95 ¹	110 ¹	175 ¹	240
	600V AC	(A)	—	—	20	—	25	35	55 ¹	70 ¹	95 ¹	110 ¹	175 ¹	240
Operational power 50–60 Hz (3 phase)														
AC-23A	220–240V	(kW)	1.8	4	4	5.5	5.5	7.5	11	15	30	30	37	75
	380–440V	(kW)	3	7.5	7.5	11	11	15	22	30	45	55	75	132
	500V	(kW)	—	7.5	7.5	11	11	15	30	45	55	55	90	132
	660–690V	(kW)	—	7.5	7.5	11	11	15	30	37	45	45	55	55
AC-3	220–240V	(kW)	1.5	3	3	4	4	5.5	11	15	15	22	22	37
	380–440V	(kW)	2.2	5.5	5.5	7.5	7.5	11	22	30	30	37	45	55
	500V	(kW)	—	5.5	5.5	7.5	7.5	11	22	30	30	37	45	55
	660–690V	(kW)	—	5.5	5.5	7.5	7.5	11	22	30	30	37	45	55
cUL	110–120VAC	(HP)	0.5	1	1	1.5	1.5	3	5	7.5	10	10	15	25
	208V AC	(HP)	0.5	2	2	5	5	7.5	7.5	7.5	10	15	15	30
	220–240VAC	(HP)	0.5	2	2	5	5	7.5	10	15	15	15	15	30
	440–480VAC	(HP)	—	—	5	—	10	10	20	30	30	30	40	50
550–600VAC	(HP)	—	—	5	—	10	10	25	40	50	50	50	50	

*use this version for 600V AC UL/CSA application

¹with terminal extensions for cable lug connection

Rated data

Rated data (auxiliary contacts)		P110	M220 P220	M221* P221*	P225	M225 P226*	T225	S432	S440	S606	S608	S612	S825
Operational voltage U_e	(V AC)	440	500	500	500	500	500	500	500	500	500	500	500
Uninterrupted current $I_u / I_{th} / I_{the}$	(A)	10	20	20	25	25	32	50	63	80	100	160	315
Operational current I_e													
AC-21A	(A)	10	20	20	25	25	32	50	63	80	100	160	315
	110–240V (A)	2.5	6	6	6	6	14	16	16	16	16	16	16
AC-15	380–440V (A)	1.5	4	4	5	5	6	7	7	7	7	7	7
	500V (A)	0.8	2	2	2.5	2.5	3	3.5	3.5	3.5	3.5	3.5	3.5
cUL General Use	600V AC (A)	—	—	20	—	25	35	55	70	70	110	175	240
Heavy Pilot Duty		B300	A300	A600	A300	A600	A600	A600	A600	A600	A600	A600	A600
Short-circuit rating (max. fuse)	(gL)	10	20	20	25	25	32	50	63	80	100	160	315
Conditional short-circuit current	(kA_{eff})	3	10	10	10	10	15	20	20	25	25	25	25
Terminal capacity													
flexible or multiwire (including ferrule)	min. (mm ²)	0.75	1	1	1.5	1.5	1.5	2.5	2.5	6	10	10	185 ¹
	max. (mm ²)	2.5	2.5	2.5	2.5	2.5	2.5	2.5	2.5	2.5	2.5	2.5	2.5
American Wire Gauge	(AWG)	16	12	12	10	10	10	6	4	4	1/0	2/0	350MCM

* use this version for 600V AC UL/CSA application ¹ with terminal extensions for cable lug connection

General

General		P110	M220 P220	M221* P221*	P225	M225 P226*	T225	S432	S440	S606	S608	S612	S825
Standards		IEC 60947 / EN 60947 / IEC 60204 / UL 508 / CSA 22.2, No. 14 / VDE 0660 Teil 107											
Mechanical lifespan		>10 ⁶	>10 ⁶	>10 ⁶	>10 ⁶	>10 ⁶	>10 ⁶	>10 ⁶	>10 ⁶	>10 ⁶	>10 ⁶	>10 ⁶	>10 ⁶
Max. operating frequency/h		50	50	50	50	50	50	50	50	50	50	50	50
Climatic resistance	constant	to DIN IEC 60068-2-78											
(damp heat)	cyclic	to DIN IEC 60068-2-30											
Ambient temperature	open (°C)	–25 / +50											
(min. / max.)	enclosed (°C)	–25 / +40											
Mounting position		as required											
Mechanical shock resistance	(g)	>10	>10	>10	>10	>10	>10	>10	>10	>10	>10	>10	>10
(shock duration 20 ms)													
Rated frequency	(Hz)	50 to 60 (other frequencies on request)											

* use this version for 600V AC UL/CSA application

Conformity

The Rotary Cam Switches conform to the regulations of the EC guideline 2006/95/EG “Electrical equipment for application within certain voltage limits”, specified as directive for low voltage devices.

The conformity is proved by the complete compliance of the harmonized european standards EN 60947-1, EN 60947-3, EN 60947-5-1, EN 60204-1.

Sälzer Electric products are developed, manufactured and tested according to these standards. The CE marking on all our products prove the conformity to the directives.

Rotary Cam Switches from Sälzer are approved according to cUL 508 und GOST R500 30.3-99.



Rotary Cam Switches

Contacts

Your contacts worldwide

 **GERMANY**

Sälzer Electric GmbH

Matthiasstraße 16
57482 Wenden

T +49 (0) 27 62 - 6 14-110

F +49 (0) 27 62 - 6 14-100

info@salzer.de

www.saelzer.com

 **GREAT BRITAIN**

Salzer UK Ltd.

44 Edison Road
Aylesbury Bucks.
HP19 8TE

T +44 (0) 12 96 - 39 99 92

F +44 (0) 12 96 - 39 22 29

info@salzeruk.co.uk

www.salzeruk.co.uk

 **U.S. A. / CANADA / MEXICO**

Salzer USA Corporation

3802 N. 54th Street
Mesa, AZ 85215

T +1 480-325-2690

F +1 480-985-9663

info@salzerusa.com

www.salzerusa.com

 **AUSTRIA**

Schmachtl GmbH
Pummererstraße 36
4020 Linz

T +43 (0) 7 32 - 76 46-0

F +43 (0) 7 32 - 78 50 36

office.linz@schmachtl.at

www.schmachtl.at

 **BELGIUM**

LUXEMBURG

Bintz technics N. V.
Brixtonlaan 23
Business Park
1930 Zaventem

T +32 (0) 2 - 720 49 16

F +32 (0) 2 - 720 37 50

info@bintz.be

www.bintz.be

 **CZECHIA**

SLOVAKIA

WAPRO spol. s r.o.
Rumunská 27
79601 Prostějov

T +420 582 334 676

F +420 582 334 677

info@wapro.cz

www.wapro.cz

 **DENMARK**

Gycom Danmark A/S
Theilgaards Torv 1
4600 Køge

T +45 - 56 26 66 35

F +45 - 56 26 77 78

admin@gycom.dk

www.gycom.com

 **FINLAND**

ESTONIA

LATVIA

UTU Oy

PL 20

29401 Ulvila

T +358 - 9 - 2746 411

F +358 - 9 - 2746 4141

powel@utu.eu

www.utupowel.fi

 **FRANCE**

AER – ERIS
22, rue Becquerel
ZI des Garennes
78130 Les Mureaux

T +33 (0) 1 30 22 39 60

F +33 (0) 1 30 99 80 63

www.eris-fr.com

 **IRELAND**

MCC Controls Ltd.
Robinhood Business Park
Robinhood Rd.
22 Dublin

T +353 (0) 1 - 4 50 64 50

F +353 (0) 1 - 4 50 61 04

sales@mcc-controls.com

www.mcc-controls.com

 **ITALY**

Telestar S. r. l.
Via C. Colombo, 13
22069 Rovellasca (CO)

T +39 (0) 02 96 74 02 68

F +39 (0) 02 96 74 02 73

telestar@telestar-automation.it

www.telestar-automation.it

 **KUWAIT**

The United Towers
Trading & Contracting Est.
Old Khaitan,
Block 45+46, Building 12
KWT 13157 Office No.1, Mezzanine

T +965 - 24745960

F +965 - 24727452

theunitedtowers@yahoo.com

 **NETHERLANDS**

Solar Nederland B.V.
Effect 5
6921 RG Duiven

T +31 (0) 26 - 365 29 11

F +31 (0) 26 - 365 23 46

industrie@solarnederland.nl

www.solarnederland.nl

 **NORWAY**

EFA ELEKTRO A. S.
Postboks 593
1411 Kolbotn

T +47 - 6681 2400

F +47 - 6680 0478

post@efa.no

www.efa.no

 **SINGAPORE**

Electrimec Asia Pacific Pte Ltd
17 Tuas Street (Off Pioneer Road)
Singapore 638454

T +65 - 6896 2979

F +65 - 6896 2925

elecmecc@singnet.com.sg

 **SOUTH AFRICA**

Waco Industries
11, Cleveland Road
Cleveland – Johannesburg

T +27 (0) 11 - 677 2500

F +27 (0) 11 - 677 2608

wacobuy@voltex.co.za

www.wacoelec.co.za

 **SPAIN**

Euromatel S. L.
Avenida Real de Pinto, 87
Nave II-A
28021 Madrid

T +34 - 91 - 3 58 92 70

F +34 - 91 - 3 58 92 95

info@euromatel.es

www.euromatel.es

 **SWEDEN**

Gycom Nordic AB
Box 1203
183 12 Täby

T +46 - 8 - 632 30 00

F +46 - 8 - 792 06 54

info@gycom.se

www.gycom.com

 **SWITZERLAND**

EHS Elektrotechnik AG
Industriestrasse 26
8604 Volketswil

T +41 (0) 44 - 908 40 50

F +41 (0) 44 - 908 40 55

info@ehs.ch

www.ehs.ch

Sälzer Electric GmbH
Matthiasstraße 16
57482 Wenden (Germany)
www.saelzer.com

Headquarters:
Tel. +49 (0) 27 62 / 6 14-110
Fax +49 (0) 27 62 / 6 14-100
sales@salzer.de

Technical Support:
Tel. +49 (0) 37 37 / 87-0
Fax +49 (0) 37 37 / 87-226
support@salzer.de

www.saelzer.com