

ITEM 084264 TP3-2131K024M

Description	Technical data	Accessories	Downloads
-------------	----------------	-------------	-----------



Features

- › Auxiliary release on the front
- › With door monitoring contact
- › Increased overtravel for horizontal and vertical approach direction.

Approach direction



› Figure

Horizontal and vertical

Can be adjusted in 90° steps

Increased overtravel for horizontal and vertical approach direction.

Solenoid operating voltage

- › AC/DC 24 V +10%, -15%

Guard locking type

TP3 Closed-circuit current principle, guard locking by spring force. Release by applying voltage to the guard locking solenoid.

Switching element

2131 Slow-action switching contact 2 NC \oplus + 1 NO + 1 NC (door monitoring contact)

Auxiliary release

Is used for releasing the guard locking with the aid of a tool. To protect against tampering, the auxiliary release is sealed with sealing lacquer.

Approvals



Mechanical figures and environment

Housing material	Reinforced thermoplastic
Ground	
	Net 0,5 kg
Ambient temperature	-20 ... 55 °C
Degree of protection	IP67
Mechanical life	1 x 10 ⁶
Contact material	Silver alloy, gold flashed
Switching principle	Slow-action switching contact
Installation position	Any
Number of door position positively driven contacts	2
Number of NC contacts	1
Number of NO contacts	1
Connection	
	3 x M20 x 1.5
Approach speed	
	max. 20 m/min
Actuation frequency	1200 1/h
Guard locking principle	Closed-circuit current principle
Locking force F _{max}	1300 N
Locking force F _{Zh}	1000 N
Retention force	10 N
Extraction force	20 N
Actuating force	10 N

Electrical connection ratings

Thermal rated current I_{th}	4 A
Utilization category acc. to EN 60947-5-1	AC-15 4A 230V DC-13 4A 24V
Solenoid operating voltage	AC/DC 24 V -15% ... +10%
Short circuit protection according to IEC 60269-1	(Fuse) 4A gG
Rated insulation voltage U_i	250 V
Rated impulse withstand voltage U_{imp}	2,5 kV
switching voltage	Min. at 10mA 12 V
Switching current	Min. at 24V 1 mA
Power consumption	8 W
Solenoid duty cycle	100 %
Connection cross-section	0,34 ... 1,5 mm ²

Reliability values according to EN ISO 13849-1

	Monitoring of guard locking and the safety guard position
B10 _D	3×10^6
	Control of the guard locking
Category	Depending on external control of guard locking
Performance Level	Depending on external control of guard locking
PFH _D	Depending on external control of guard locking

In combination with Actuator BETAETIGER-P-GT

Mechanical figures and environment

Overtravel A B C D E	2 mm
Overtravel K L M N	1,5 mm

In combination with Actuator BETAETIGER-P-GNT

Mechanical figures and environment

Overtravel A B C D E	7 mm
Overtravel K L M N	7 mm

Dimension drawing

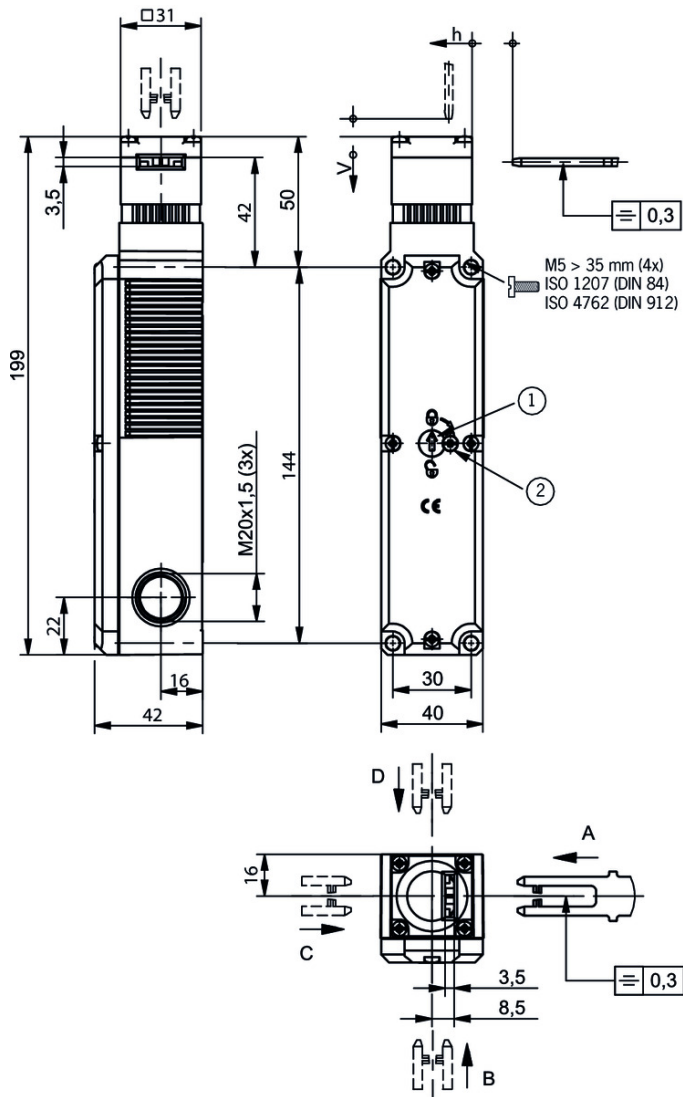

Legende

- 1 Auxiliary release
- 2 Locking screw

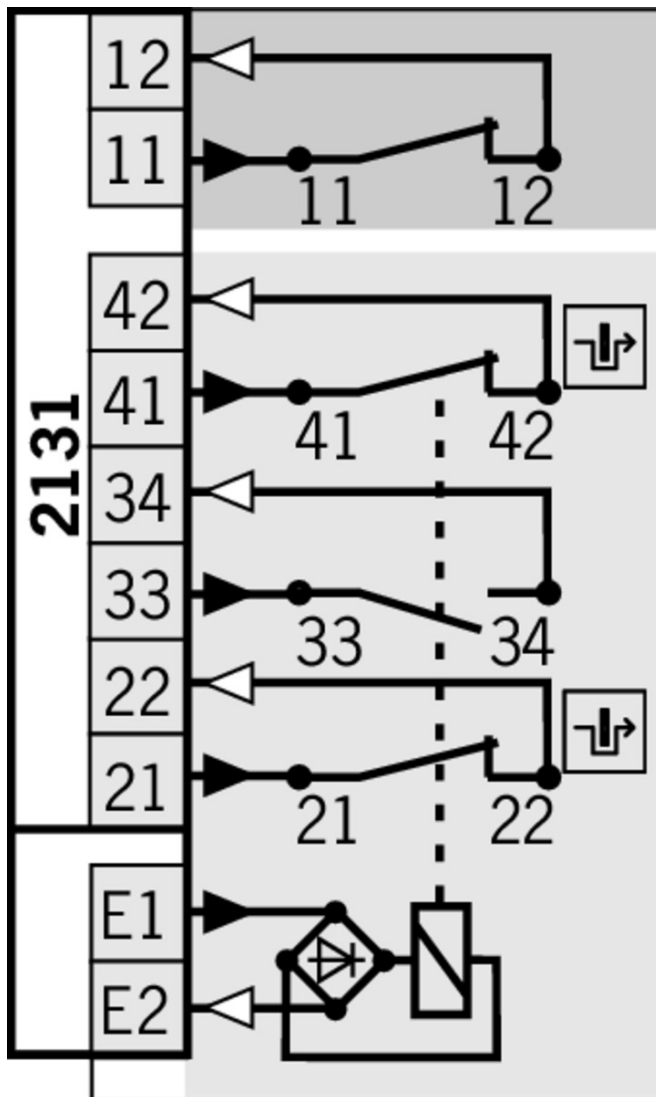

Legende

- Solenoid monitoring
- Door monitoring

Switching functions

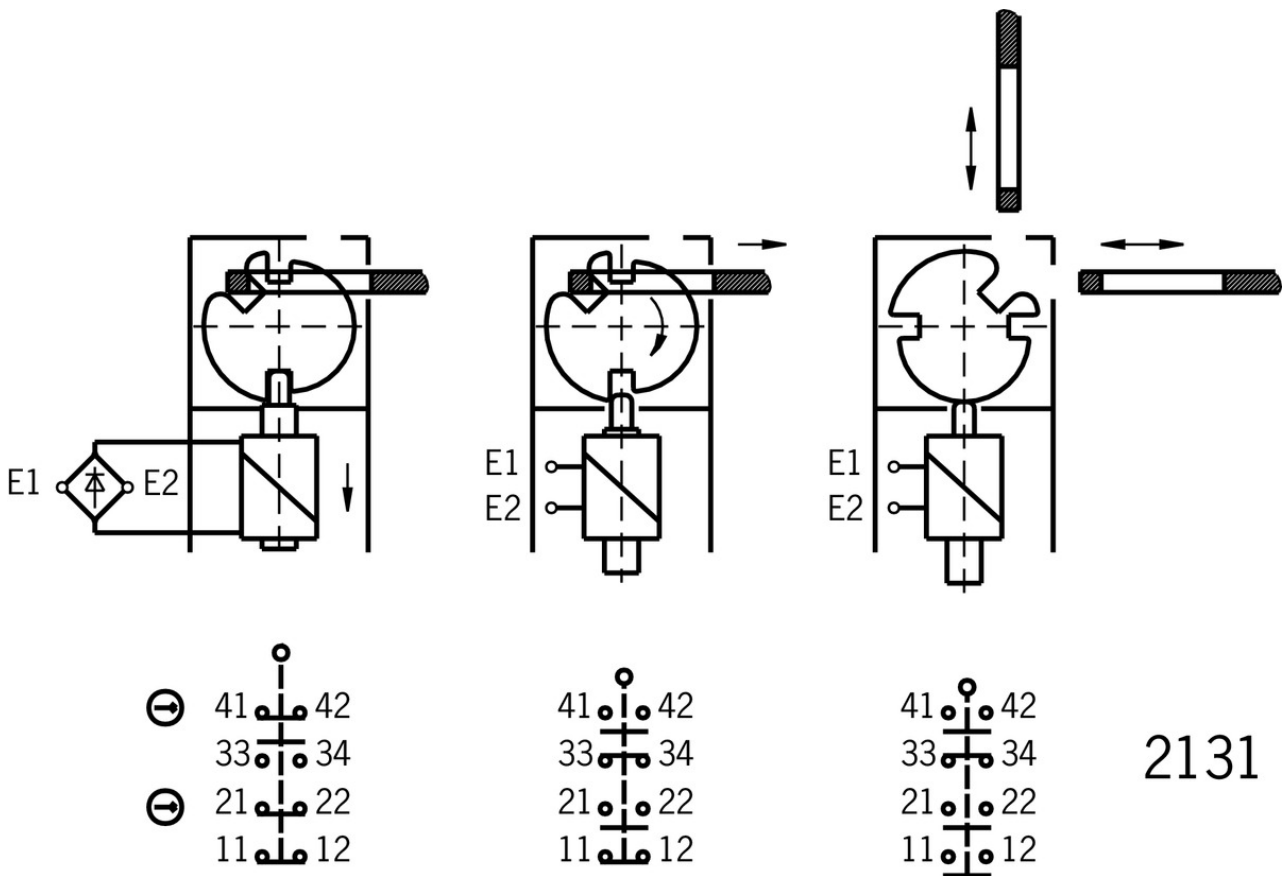

Function expansion

✓ Lock for auxiliary release for safety switches CTP/TP/STP



109212 SCHLOSS TP GLEICHSCHLIESSEND C2293

✓ Features

- › Identical locking
- › Key can be removed only in "locked" position



086236 SCHLOSS TP GLEICHSCHLIESSEND

✓ Features

- › Identical locking
- › Key removable in "unlocked" and "locked" positions



084177 SCHLOSS TP VERSCHIEDENSCHLIESSEND

✓ Features

- › Lock unique locking
- › Key removable in "unlocked" and "locked" positions

✓ Wire front release



098313 AE-B-A1-03,0-098313

✓ Features

- › Can be used as escape release or emergency unlocking

- › No automatic return
- › Sheath length 3 m (rope length 6 m)



096230 AE-B-A1-02,0-096230

✔ Features

- › Can be used as escape release or emergency unlocking
- › No automatic return
- › Sheath length 2 m (rope length 6 m)



098314 AE-B-A1-04,0-098314

✔ Features

- › Can be used as escape release or emergency unlocking
- › No automatic return
- › Sheath length 4 m (rope length 6 m)



097747 AE-B-A1-02,0-F-097747

✔ Features

- › Can be used as escape release or emergency unlocking
- › automatic return
- › Sheath length 2 m (rope length 6 m)



124770 AE-B-A1-06,0-F-124770

✔ Features

- › Can be used as escape release or emergency unlocking
- › automatic return
- › Rope length 6 m (without sheath)



111233 AE-B-A1-03,0-F-111233

✔ Features

- › Can be used as escape release or emergency unlocking
- › automatic return
- › Sheath length 3 m (rope length 6 m)



125582 AE-B-A1-06,0-125582

✔ Features

- › Can be used as escape release or emergency unlocking
- › No automatic return
- › Rope length 6 m (without sheath)

✔ Release with automatic reset for safety switches CTP/TP/STP



103110 ENTRIEGELUNG RUECKSTELLEND TP/STP

✔ Handle for wire front release



099795 AY-HDL-099795

✔ Features

- › Suitable for all wire front releases

- ▼ Emergency unlocking for safety switches CTP/TP/STP



099877 NOTENTSPERRUNG TP/STP

- ▼ Latch spring for increased retention force

076501 RASTFEDER NP/TP

- ▼ Built-in LED



087423 EINBAULEUCHTE LED M20X1,5



095510 EINBAULEUCHTE LED-F M20X1,5

- ▼ Lockout bar NP/GP/TP



096105 SPERREINSATZ TP

- ▼ Features

- › Prevents unintentional closing of the door
- › Can be secured with padlocks

- ▼ LED set



093752 TP LED SET

- ▼ Features

- › LED set

- ▼ Insertion funnel for safety switches NP..A/GP/TP..A



086237 EINFUEHRTRICHTER-P

- ▼ Handle for escape release for safety switches TP/STP/STA



105329 FE-GRIFF

Actuator

- ▼ Actuators for safety switches NP/GP/TP



059226 BETAETIGER-P-G

- ▼ Features

- › Actuators made of stainless steel

- › Two stainless safety screws per actuator



070046 BETAETIGER-P-GT

✓ Features

- › Actuators made of stainless steel
- › Two stainless safety screws per actuator
- › Actuators with rubber bushings

✓ Bent actuator for safety switches NP/GP/TP



059227 BETAETIGER-P-W

✓ Features

- › Actuators made of stainless steel
- › Two stainless safety screws per actuator



070038 BETAETIGER-P-WT

✓ Features

- › Actuators made of stainless steel
- › Two stainless safety screws per actuator
- › Actuators with rubber bushings

✓ Actuators for safety switches NP/GP/TP, increased overtravel



074570 BETAETIGER-P-GN

✓ Features

- › Actuators made of stainless steel
- › Two stainless safety screws per actuator



074576 BETAETIGER-P-GNT

✓ Features

- › Actuators made of stainless steel
- › Two stainless safety screws per actuator
- › Actuators with rubber bushings

✓ Bent actuator for safety switches NP/GP/TP, increased overtravel



074571 BETAETIGER-P-WN

✓ Features

- › Actuators made of stainless steel
- › Two stainless safety screws per actuator



074577 BETAETIGER-P-WNT

✓ Features

- › Actuators made of stainless steel
- › Two stainless safety screws per actuator
- › Actuators with rubber bushings

✓ Hinged actuator left/right for safety switches NP/GP/TP



059440 RADIUSBETAETIGER-P-LR

✓ Features

- › Actuators made of stainless steel
 - › Two stainless safety screws per actuator
 - › For doors hinged on right and left
-

- ✓ Hinged actuator top/bottom for safety switches NP/GP/TP



070050 RADIUSBETAETIGER-P-OU

✓ Features

- › Actuators made of stainless steel
 - › Two stainless safety screws per actuator
 - › For doors hinged at top and bottom
-

- ✓ Hinged actuator left/right for safety switches NP/GP/TP, increased overtravel



074573 RADIUSBETAETIGER-P-LRN

✓ Features

- › Actuators made of stainless steel
 - › Two stainless safety screws per actuator
 - › For doors hinged on right and left
-

- ✓ Hinged actuator top/bottom for safety switches NP/GP/TP, increased overtravel



074572 RADIUSBETAETIGER-P-OUN

✓ Features

- › Actuators made of stainless steel
 - › Two stainless safety screws per actuator
 - › For doors hinged at top and bottom
-

Mounting accessories

- ✓ Mounting plates EMP-SB for safety switches CTP, TP...A, STA, STP and TX



093456 EMP-SB

✓ Features

- › For vertical and horizontal mounting of safety switches TP...A, STA, STP and TX
-

- ✓ Mounting plates EMP-B1 for actuators for safety switches CTP, TP...A, STA, STP, TX and TZ



093457 EMP-B1

- ✓ Mounting plates EMP-B2 for actuators for safety switches CTP, TP...A, STA, STP, TX and TZ



093458 EMP-B2

▼ Safety screws for actuators, M5 x 10

073455 M5X10-NIRO/V100 NZ/TZ

▼ Features

- › Safety screws M5 x 10
 - › Packaging unit 100 pieces
-

▼ Safety screws for safety switches M4 x 14, large head

086232 M4X14-NIRO/V100

▼ Features

- › Safety screws M4 x 14 (large head)
 - › Packaging unit 100 pieces
-

▼ Switch bracket for bolt NP/TP



073539 SCHALTERAUFNAHME TP

▼ Features

- › Switch bracket made of steel
 - › For left or right hinged doors
-

▼ Switch bracket TP/STP GFK



096613 SCHALTERAUFNAHME TP/STP GFK

▼ Features

- › Switch bracket made of fiber glass reinforced plastic
 - › For left or right hinged doors
-

Connection material

▼ Cable glands M20x1.5



086233 EKPM20/06 086233

Bolt

▼ Bolt 0 NP/TP for safety switches NP, GP and TP



073535 RIEGEL 0 NP/TP OHNE RASTUNG

▼ Features

- › Steel bolt
 - › For left or right hinged doors
 - › Can be locked in open position with padlocks
 - › Actuator included
-

▼ Bolt 1 NP/TP for safety switches NP, GP and TP



073536 RIEGEL 1 NP/TP 1X RASTUNG ZU

▼ Features

- › Steel bolt
 - › For left or right hinged doors
 - › Can be locked in open position with padlocks
 - › Actuator included
 - › Detent mechanism closed position
-

▼ Bolt TP/GP... for safety switches GP and TP



084430 RIEGEL TP-A

▼ Features

- › Steel bolt
 - › For doors hinged on the right
 - › Can be locked in open position with padlocks
 - › Actuator included
-



084432 RIEGEL TP-C

▼ Features

- › Steel bolt
 - › For doors hinged on the left
 - › Can be locked in open position with padlocks
 - › Actuator included
-

▼ Bolt BTC-T/GP... without escape release for safety switches GP and TP



106301 BTC-T/GP-S-TH-00-X

▼ Features

- › Aluminum bolt
 - › For left or right hinged doors
 - › Can be locked in open position with padlocks
 - › Actuator included
-

▼ Bolt TP-GFK for safety switches TP and GP



096616 RIEGEL TP-GFK













▼ Features

- › Fiber glass reinforced plastic bolt
 - › For left or right hinged doors
 - › Can be locked in open position with padlocks
 - › Actuator included
-

Instructions

▼ Operating Instructions Safety Switches TP...

Doc. no. **Version** **Language** **Download**

Betriebsanleitung Sicherheitsschalter TP... Operating Instructions Safety Switches TP... Manual de instrucciones Interruptores de seguridad TP... Mode d'emploi pour les interrupteurs de sécurité TP... Istruzioni di impiego dei finecorsa di sicurezza TP...	084123	14-12/14	    	 7.1 MB
Návod k použití Bezpečnostní spínač TP...	084123	14-12/14		 2.1 MB
Driftsvejledning for sikkerhedsafbryder TP...	084123	14-12/14		 1.5 MB
Instruções de operação das chaves de segurança TP...	084123	14-12/14		 1.5 MB







Catalogs

▼ Safety Switches with Plastic Housing









	Doc. no.	Version	Language	Download
Sicherheitsschalter mit Kunststoffgehäuse	096955	10-10/12		 18.8 MB
Safety Switches with Plastic Housing	096956	10-10/12		 18.7 MB
Interrupteurs de sécurité avec boîtier plastique	100677	10-10/12		 19.2 MB
Interruptores de seguridad con carcasa plástica	104855	10-10/12		 18.7 MB
Bezpečnostní spínače s plastovým pouzdem	121649	10-10/12		 6.8 MB

Declaration of conformity

▼ EC-Declaration of Conformity

	Doc. no.	Version	Language	Download
EG-Konformitätserklärung EC-Declaration of Conformity CE-Declaración de Conformidad CE-Déclaration de Conformité CE-Dichiarazione di conformità	077153	24-01/16	    	 1.1 MB

▼ ES prohlášení o shodě

	Doc. no.	Version	Language	Download
ES prohlášení o shodě EF-overensstemmelseserklæring Δήλωση πιστότητας EK EY-vaatimuksenmukaisuusvakuutus EK-típusbizonyítvány EG-conformiteitsverklaring Deklaracja zgodności WE Declaração de Conformidade CE Declarație de conformitate CE ES vyhlásenie o zhode EF-overensstemmelseserklæring	111196	06-01/16	         	 2.7 MB

CAD data

CAD data for this item on TraceParts