



Page 16-2

MODULAR TIME RELAYS

- Suitable for consumer switchboards
- Selectable time ranges on front:
0.1 second - 100 days
- LED indication
- Mounting on 35mm DIN rail
- Screw terminals.



Page 16-5

PLUG-IN AND FLUSH-MOUNT TIME RELAYS, 48X48MM

- Flush and internal panel mounting
- Time ranges: 0.05 seconds - 10 hours
- LED indication
- 8 and 11-pin sockets for panel mounting.



- Modular version for consumer switchboards
- DIN mount version
- Plug-in or flush-mount version
- Vast range of functions and time scales
- Reliable time and repeat accuracy.

Modular version

SEC. - PAGE

On delay. Multiscale. Multivoltage	16 - 2
Multifunction. Multiscale. Multivoltage. 1 changeover contact	16 - 2
Multifunction. Multiscale. Multivoltage. 1 changeover contact and 1 normally open contact	16 - 2
Recycle, independent timings. Multiscale. Multivoltage	16 - 3
Off delay. Multiscale. Multivoltage	16 - 3
For starting. Multiscale. Multivoltage	16 - 4
For staircase	16 - 4

Plug-in and flush-mount version, 48x48mm

On delay. Single scale. Single voltage	16 - 5
On delay. Multiscale. Multivoltage	16 - 5
On delay. Multiscale. Single voltage	16 - 5
Multifunction. Multiscale. Multivoltage	16 - 5
Accessories	16 - 5

Dimensions	16 - 6
-------------------------	--------

Wiring diagrams	16 - 7
------------------------------	--------

Technical characteristics	16 - 13
--	---------

On delay time relay. Multiscale. Multivoltage



TM P

Order code	Time of scale range	Rated auxiliary supply voltage	Qty per pkg	Wt
		[V]	n°	[kg]
TM P	0.1-1s 1-10s 6-60s 1-10min 6min-1h 1-10h 0.1-1 day 1-10 days ON only OFF only	24-48VDC 24-240VAC	1	0.048

General characteristics

- Electronic time relay, multiscale, multivoltage.
- On delay, delay on make, with start at relay energising
- 1 relay output with 1 changeover contact (SPDT)
- Delay time adjustable on front by rotary switch: 10-100%
- Green LED indicator for power on
- Red LED indicator for relay state; flashing for delay and steady when relay energised
- Modular DIN 43880 housing, 1 module
- IEC degree of protection: IP40 on front (only when mounted in housing or electric board with IP40); IP20 on terminals.

Certifications and compliance

Certifications obtained: GOST; UL Listed, for USA and Canada (File E93601) as Auxiliary Devices - Tmers. Compliant with standards: IEC/EN 61812-1, UL508, CSA C22.2 n° 14.

Operational diagram

See page 16-7.

Multifunction time relay. Multiscale. Multivoltage. 1 relay output



TM M1

Order code	Time of scale range	Rated auxiliary supply voltage	Qty per pkg	Wt
		[V]	n°	[kg]
TM M1	0.1-1s 1-10s 6-60s 1-10min 6min-1h 1-10h 0.1-1 day 1-10 days ON only OFF only	12-240V AC/DC	1	0.086

General characteristics

- Electronic time relay, multifunction, multiscale, multivoltage
- Enabling input
- 1 relay output with 1 changeover contact (SPDT)
- Selectable functions: (a) On delay; delay on make with start at relay energising. (b) Pulse on relay energising with start when energised. (c) Flasher starting with OFF interval. Equal timing recycle. (d) Flasher starting with ON interval. Equal timing recycle. (e) Off delay; relay energising at external contact closing with start on break. (f) Pulse on relay energising with start on external contact closing. (g) Pulse on relay energising with start on external contact opening. (h) On-off delay. Delay on make, with start at external contact closing, and delay at break, with start at external contact opening. (i) Internal ON/OFF trigger with relay contact closing or operating at each closing of an external contact. (j) Pulse generator, unequal timing recycle; starting with OFF pulse time and 0.5s ON pulse.
- Delay time adjustable on front by rotary switch: 10-100%
- Green LED indicator for power on
- Red LED indicator for relay state; flashing for delay and steady when relay energised
- Modular DIN 43880 housing, 1 module suitable for fixing on 35mm DIN rail (IEC/EN 60715)
- IEC degree of protection: IP40 on front (only when mounted in housing or electric board with IP40); IP20 on terminals.

Certifications and compliance

Certifications obtained: GOST; UL Listed, for USA and Canada (File E93601) as Auxiliary Devices - Tmers. Compliant with standards: IEC/EN 61812-1, UL508, CSA C22.2 n° 14.

Operational diagram

See page 16-7.

Multifunction time relay. Multiscale. Multivoltage. 2 relay outputs.



TM M2

Order code	Time of scale range	Rated auxiliary supply voltage	Qty per pkg	Wt
		[V]	n°	[kg]
TM M2	0.1-1s 1-10s 6-60s 1-10min 6min-1h 1-10h 0.1-1 day 1-10 days ON only OFF only	12-240V AC/DC	1	0.094

General characteristics

- Electronic time relay, multifunction, multiscale, multivoltage
- Enabling input
- 2 relay outputs, one with 1 delayed changeover (C/O-SPDT) contact and the other with 1 normally open (N/O-SPST) contact, programmable as instantaneous or delayed
- Selectable functions: (a) On delay; delay on make with start at relay energising. (b) Pulse on relay energising with start when energised. (c) Flasher starting with OFF interval. Equal timing recycle. (d) Flasher starting with ON interval. Equal timing recycle. (e) Off delay; relay energising at external contact closing with start on break. (f) Pulse on relay energising with start on external contact closing. (g) Pulse on relay energising with start on external contact opening. (h) On-off delay. Delay on make, with start at external contact closing, and delay at break, with start at external contact opening. (i) Internal ON/OFF trigger with relay contact closing or operating at each closing of an external contact. (j) Pulse generator, unequal timing recycle; starting with OFF pulse time and 0.5s ON pulse.
- Delay time adjustable on front by rotary switch: 10-100%
- Green LED indicator for power on
- Red LED indicator for relay state; flashing for delay and steady when relay energised
- Modular DIN 43880 housing, 1 module suitable for fixing on 35mm DIN rail (IEC/EN 60715)
- IEC degree of protection: IP40 on front (only when mounted in housing or electric board with IP40); IP20 on terminals.

Certifications and compliance

Certifications obtained: GOST; UL Listed, for USA and Canada (File E93601) as Auxiliary Devices - Tmers. Compliant with standards: IEC/EN 61812-1, UL508, CSA C22.2 n° 14.

Operational diagram

See page 16-8.

Recycle time relay, independent timings. Multiscale. Multivoltage



TM PL

Order code	Time of scale range	Rated auxiliary supply voltage	Qty per pkg	Wt
		[V]	n°	[kg]
TM PL	0.1-1s 1-10s 6-60s 1-10min 6min-1h 1h-10h 0.1-1 day 1-10 days 3-30 days 10-100 days	12-240V AC/DC	1	0.082

General characteristics

- Programmable asymmetrical recycle time relay, multiscale, multivoltage. Flasher with independent timing for ON and OFF intervals
- Enabling input of ON or OFF interval
- 1 relay output with 1 changeover contact (SPDT)
- Delay time for OFF (pause) interval, adjustable on front by rotary switch: 10-100%
- Delay time for ON (work) interval, adjustable on front by rotary switch: 10-100%
- Green LED indicator for power on
- Red LED indicator for relay state; flashing for delay
- Modular DIN 43880 housing, 1 module; suitable for fixing on 35mm DIN rail (IEC/EN 60715)
- IEC degree of protection: IP40 on front (only when mounted in housing or electric board with IP40); IP20 on terminals.

Certifications and compliance

Certifications obtained: GOST; UL Listed, for USA and Canada (File E93601) as Auxiliary Devices - Tmers. Compliant with standards: IEC/EN 61812-1, UL508, CSA C22.2 n° 14.

Operational diagram

See page 16-9.

Off delay time relay. Multiscale. Multivoltage



TM D

Order code	Time of scale range	Rated auxiliary supply voltage	Qty per pkg	Wt
		[V]	n°	[kg]
TM D	0.06-0.6s 0.6-6s 6-60s 18-180s	24-240V AC/DC	1	0.080

General characteristics

- Electronic time relay, multiscale, multivoltage. True off delay; delay on break with start at relay de-energising
- 1 relay output with 1 changeover contact
- Delay time adjustable on front by rotary switch: 10-100%
- Green LED indicator for power on
- Modular DIN 43880 housing, 1 module; suitable for fixing on 35mm DIN rail (IEC/EN 60715)
- IEC degree of protection: IP40 on front (only when mounted in housing or electric board with IP40); IP20 on terminals.

Certifications and compliance

Certifications obtained: GOST; UL Listed, for USA and Canada (File E93601) as Auxiliary Devices - Tmers. Compliant with standards: IEC/EN 61812-1, UL508, CSA C22.2 n° 14.

Operational diagram

See page 16-9.

Time relay for starting. Multiscale. Multivoltage



TM ST

Order code	Time of scale range	Rated auxiliary supply voltage	Qty per pkg	Wt
		[V]	n°	[kg]
TM ST	0.1-1s	24-48VDC 24-240VAC	1	0.090
	1-10s			
	6-60s			
	1-10min			
TM ST A440	0.1-1s	380-440VAC	1	0.090
	1-10s			
	6-60s			
	1-10min			

General characteristics

- Electronic time relay, multiscale, multivoltage for starting (star-delta, impedance, autotransformer, etc) of induction motors (squirrel cage), 2 separate timings
- 1 relay output with 2 normally open (N/O-SPST) contacts with common pole
- Delay time adjustable on front by rotary switch: 10-100% for star connection
- Starting and transition (20-300ms time scale - from star to delta), time adjustable on front by rotary switch
- Green LED indicator for power on
- Red LED indicator for relay state; flashing during delay and steady at delay lapsing
- Modular DIN 43880 housing, 1 module; suitable for fixing on 35mm DIN rail (IEC/EN 60715)
- IEC degree of protection: IP40 on front (only when mounted in housing or electric board with IP40); IP20 on terminals.

Certifications and compliance

Certifications obtained: GOST; UL Listed, for USA and Canada (File E93601) as Auxiliary Devices - Tmers. Compliant with standards: IEC/EN 61812-1, UL508, CSA C22.2 n° 14.

Operational diagram

See page 16-9.

Staircase time relay



TM LS

Order code	Time of scale range	Rated auxiliary supply voltage	Qty per pkg	Wt
		[V]	n°	[kg]
TM LS	0.5-20min	220-240VAC	1	0.080

General characteristics

- Electronic time relay single scale and voltage for staircase illumination
- 1 relay output with 1 powered normally open (N/O-SPST) contact
- Delay time adjustable on front by rotary switch
- Suitable for 3 or 4-wire systems
- 1 slide switch for timed or constant lighting operation
- Function for one hour lighting and fast switch off
- Green LED indicator for power on
- Connection with up to 50 light-up switches maximum; ≤ 1mA each
- Modular DIN 43880 housing, 1 module suitable for fixing on 35mm DIN rail (IEC/EN 60715)
- IEC degree of protection: IP40 on front (only when mounted in housing or electric board with IP40); IP20 on terminals.

Certifications and compliance

Certifications obtained: GOST; UL Listed, for USA and Canada (File E93601) as Auxiliary Devices - Tmers. Compliant with standards: IEC/EN 61812-1, UL508, CSA C22.2 n° 14.

Operational diagram

See page 16-9.

48x48mm/1.9x1.9in time relay



31 L48T...



31 L48TP...



31 L48TPB...



31 L48M...

Order code	Time scale range	Rated auxiliary supply voltage	Qty per pkg	Wt
		[V]	n°	[kg]

Time relay on delay.
Single scale and single voltage.

31 L48T 3S 24	0.1-3s	24VAC/DC	1	0.115
31 L48T 6S 24	0.1-6s		1	0.115
31 L48T 30S 24	0.5-30s		1	0.115
31 L48T 60S 24	0.5-60s		1	0.115
31 L48T 3M 24	1s-3min		1	0.115
31 L48T 6M 24	3s-6min		1	0.115
31 L48T 30M 24	30s-30min		1	0.115
31 L48T 60M 24	30s-60min		1	0.115
31 L48T 3H 24	3min-3h		1	0.115
31 L48T 3S 240	0.1-3s	220-240VAC	1	0.120
31 L48T 6S 240	0.1-6s		1	0.120
31 L48T 30S 240	0.5-30s		1	0.120
31 L48T 60S 240	0.5-60s		1	0.120
31 L48T 3M 240	1s-3min		1	0.120
31 L48T 6M 240	3s-6min		1	0.120
31 L48T 30M 240	30s-30min		1	0.120
31 L48T 60M 240	30s-60min		1	0.120
31 L48T 3H 240	3min-3h		1	0.120

Time relay on delay.
Multiscale and multivoltage.

31 L48TP S 240	0.3-780s	24VAC/DC 110VAC	1	0.124
31 L48TP M 240	18s-780min	220-240VAC	1	0.124

Time relay on delay.
Multiscale and single voltage.

31 L48TPB M24	0.05s-10min	24VAC/DC	1	0.124
31 L48TPB M240		220-240VAC	1	0.124

Time relay, multifunction, multivoltage and multiscale.

31 L48M M 240	0.05s-10min	24-240V	1	0.135
31 L48M H 240	0.05min-10h	AC/DC	1	0.135

General characteristics

TIME RELAY L48T

- Electronic time relay, single scale, single voltage.
- On delay, delay on make with start at relay energising
- 1 relay output with 1 changeover contact (SPDT)
- Delay time adjustable on front by rotary knob
- LED indicators for power on and relay state
- Plug-in housing with 8-pin socket, 31 S8 or 31 L48 P8
- Flush mount bracket 31 L48AP available
- IEC protection degree: IP40 on front and IP20 at terminals.

TIME RELAY L48TP

- Electronic time relay, multiscale, multivoltage.
- On delay, delay on make with start at relay energising
- 1 relay output with 1 changeover contact (SPDT)
- Delay time adjustable on front by rotary knob
- Time range selected by dip switches:
L48TP S: 0.3-3s; 1.2-12s; 10-100s; 7.8-780s
L48TP M: 18s-3min; 72s-12min; 10-100min; 78-780min
- LED indicators for power on and relay state
- Plug-in housing with 8-pin socket, 31 S8 or 31 L48 P8
- Flush mount bracket 31 L48AP available
- IEC protection degree: IP40 on front and IP20 at terminals.

Time range setting

	A B	A B	A B	A B
	1 0	1 0	1 0	1 0
L48TP S	0.3-3s	1.2-12s	10-100s	7.8-780s
L48TP M	18s-3min	72s-12min	10-100min	78-780min

TIME RELAY T48TPB

- Electronic time relay, multiscale, single voltage, multifunction
- 2 relay outputs, each with 1 changeover contact (SPDT), configurable either delay on make or instantaneous
- Delay time adjustable on front by rotary knob
- Time range selected by dip switches: 0.05-1s; 0.1-10s; 0.6s-1min; 6s-10min
- LED indicators for power on and relay state
- Plug-in housing with 8-pin socket, 31 S8 or 31 L48 P8
- Flush mount bracket 31 L48AP available
- IEC protection degree: IP40 on front and IP20 at terminals.

Time range setting

	A B	A B	A B	A B
	1 0	1 0	1 0	1 0
L48TPB	0.05-1s	0.1-10s	0.6s-1min	6s-10min

TIME RELAY L48M

- Electronic time relay, multiscale, multivoltage, multifunction
- Selectable functions: On delay, delay on make with start at relay energising. On delay, delay on break with start at relay de-energising. Flasher, starting with OFF interval. Flasher, starting with ON interval. Time relay resetting is possible on closing of external contact (R) connected to terminals 7-6. Possible time relay stopping storing elapsed time on closing of external contact (M) connected to terminals 7-5 and then restarting time on its opening. See diagrams on page 16-11
- 2 relay outputs, each with 1 changeover contact; both delayed
- Delay time adjustable on front by rotary knob SPDT,
- Time range selected by dip switches:
L48M M: 0.05-1s; 0.1-10s; 0.6s-1min; 6s-10min
L48M H: 0.05-1min; 0.1-10min; 0.6min-1h; 1min-10h
- LED indicators for power on and relay state
- Plug-in housing with 11-pin socket, 31 S11 or 31 L48 P11
- Flush mount bracket 31 L48AP available
- IEC protection degree: IP40 on front and IP20 at terminals.

Time range setting

	A B	A B	A B	A B
	1 0	1 0	1 0	1 0
L48M M	0.05-1s	0.1-10s	0.6s-1min	6s-10min
L48M H	0.05-1min	0.1-10min	0.6min-1h	1min-10h

Certifications and compliance

Certifications obtained: GOST; UL Recognized, for USA and Canada (File E172189) as Industrial Switches - Timer.
Compliant with standards: IEC/EN 61812-1, UL508, CSA C22.2 n° 14.

Operational diagram

See page 16-10 and 16-11.

Accessories for 48x48mm time relay



31 S8



31 S11

Order code	Description	Qty per pkg	Wt
		n°	[kg]
31 S8	8-pin socket for screw fixing or on 35mm DIN rail (IEC/EN 60715). Screw terminals	10	0.061
31 L48 P8	8-pin loose socket. Screw terminals	10	0.040
31 S11	11-pin socket for screw fixing or on 35mm DIN rail (IEC/EN 60715). Screw terminals	10	0.064
31 L48 P11	11-pin loose socket. Screw terminals	10	0.048
31 L48AP	Flush mount bracket	10	0.012

N.B. Max. conductor section for sockets: 2x2.5mm²/2x14AWG.
Tightening torque: 0.8Nm/7.1lbin.

TIME RELAYS TM...

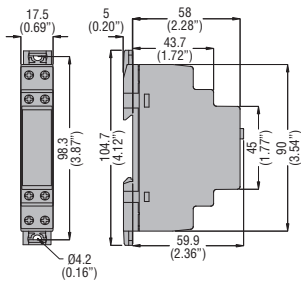

L48...

Cutout

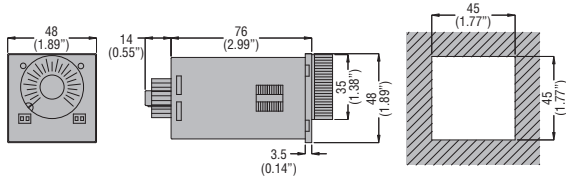

L48... with S8 - S11 sockets

Cutout

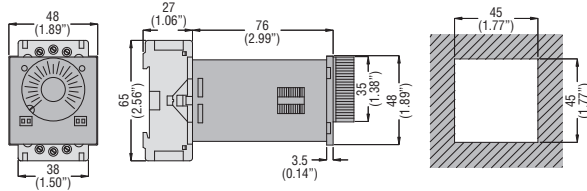

Accessories - Plug-in sockets

S8 - S11

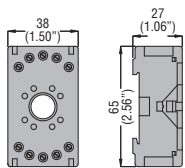

L48 P8

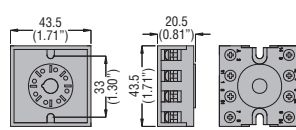

L48 P11

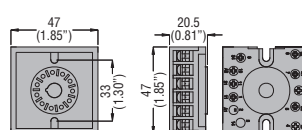

TM P

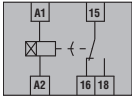

On delay. Delay on make, with start at relay energising.

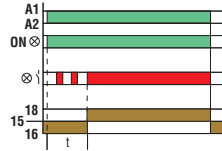

TM M1

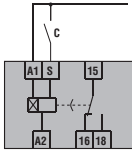

On delay. Delay on make, with start at relay energising

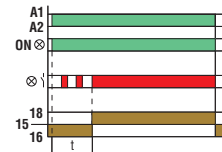

Pulse on relay energising with start at external contact closing

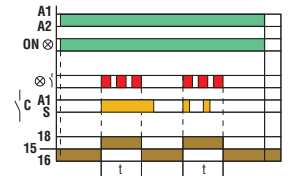

Pulse on relay energising with start on energising

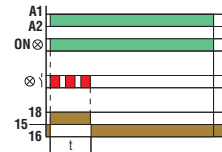

Pulse on relay energising with start at external contact opening

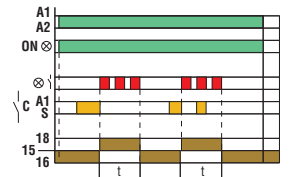

Flasher, starting with OFF (pause) interval. Equal timing recycle.

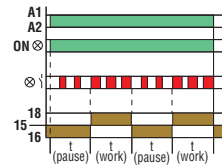

On-Off delay. Delay on make, with start at external contact closing, and delay at break, with start at external contact opening.

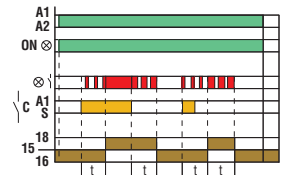

Flasher, starting with ON (work) interval. Equal timing recycle.

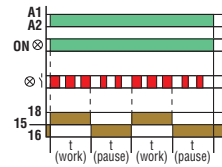

Internal ON/OFF trigger. Relay contact either closes or opens at each external contact closing.

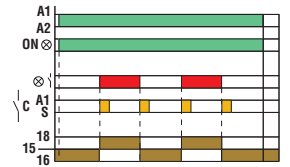

Off delay. Relay energising at external contact closing with start on break

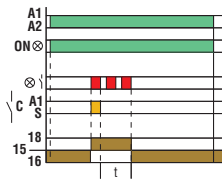

Pulse generator. Unequal timing recycle, starting with OFF pulse time and 0.5sec ON time.

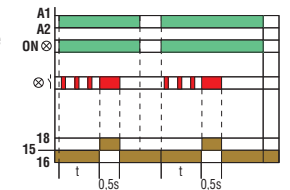

TM M2

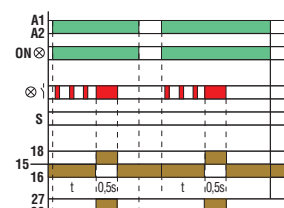
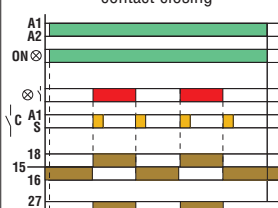
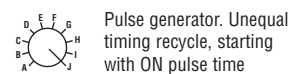
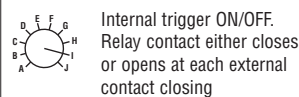
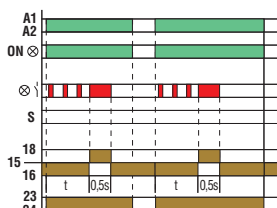
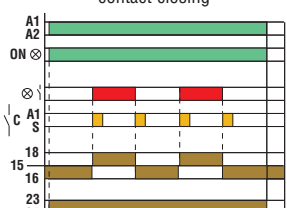
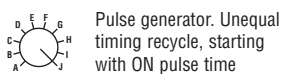
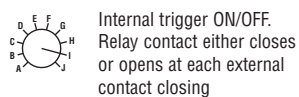
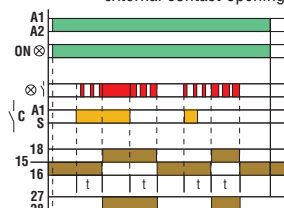
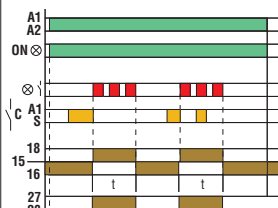
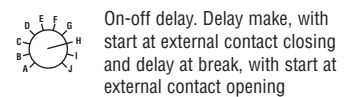
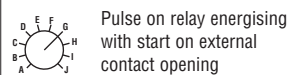
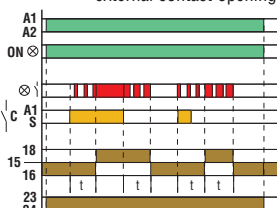
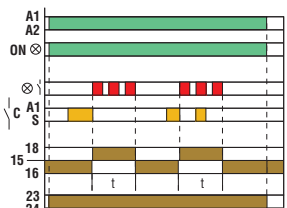
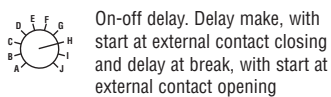
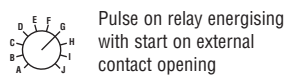
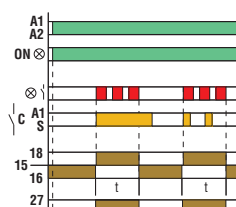
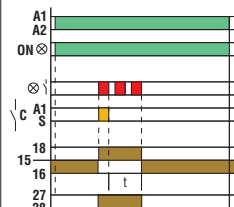
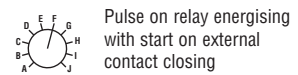
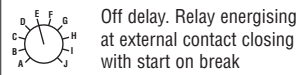
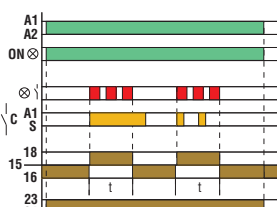
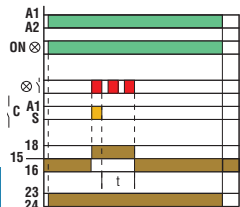
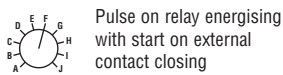
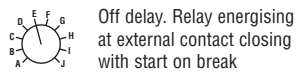
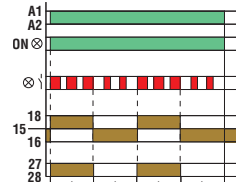
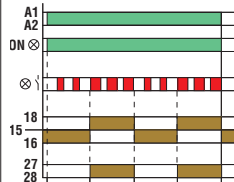
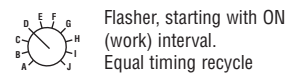
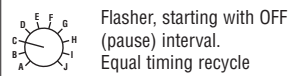
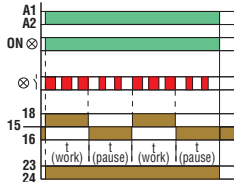
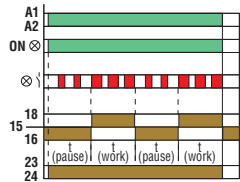
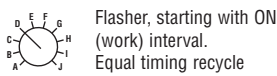
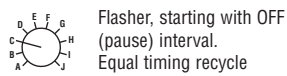
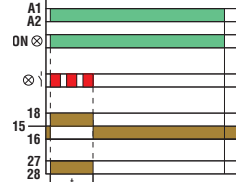
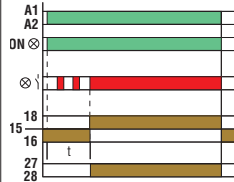
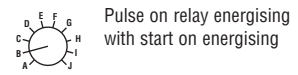
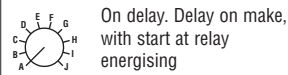
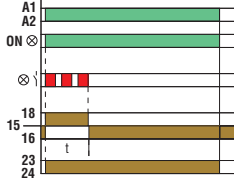
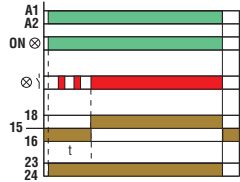
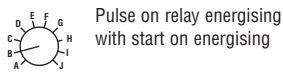
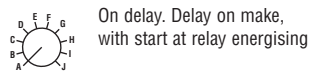
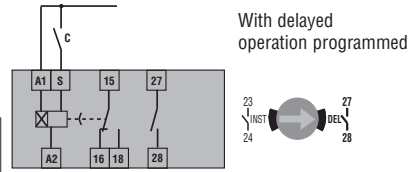
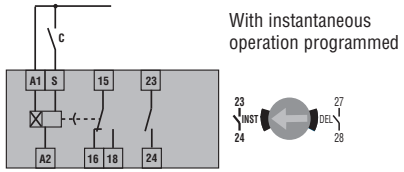

TM PL

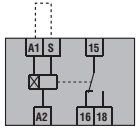

Flasher, starting with ON interval.
Equal timing recycle, ON first

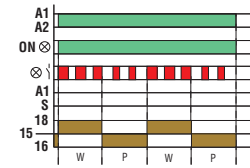

W = Work (ON)
P = Pause (OFF)

Flasher, starting with OFF interval.
Equal timing recycle, OFF first

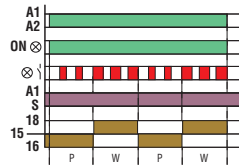

W = Work (ON)
P = Pause (OFF)

TM D

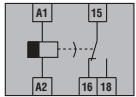

True off delay. Delay on break, starting at
relay de-energising

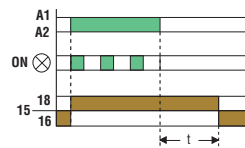

TM ST

For starting

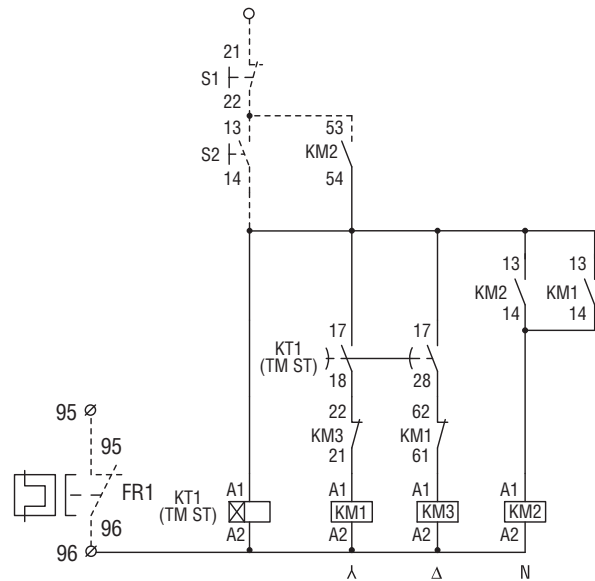
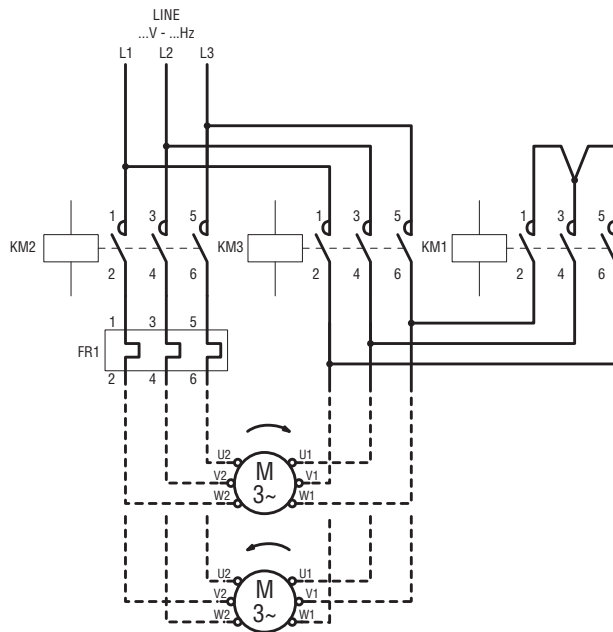
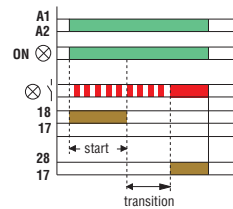
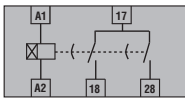

TM LS

Staircase lighting

4-wire connection

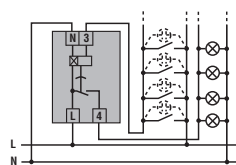

3-wire connection

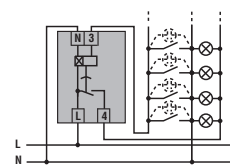

Timed lighting

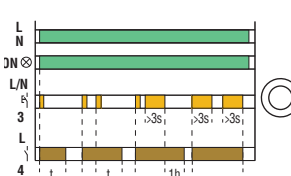

Constant lighting

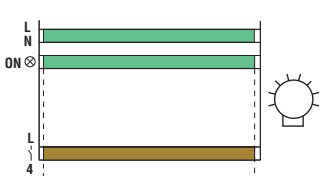

L48T...

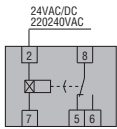

On delay

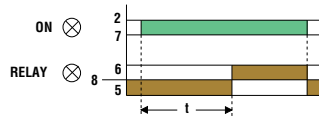

L48TP...

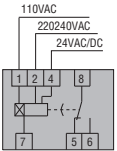

On delay

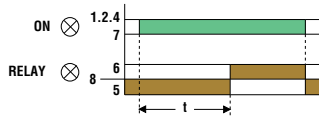

L48TPB...

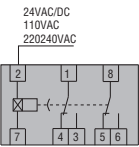

On delay

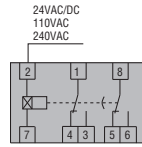
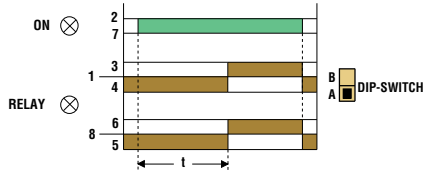

On delay with one instantaneous c/o contact and one late-break c/o contact

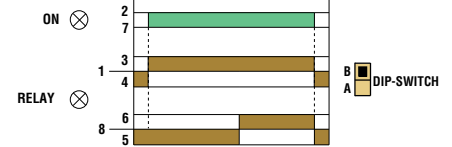

L48M...

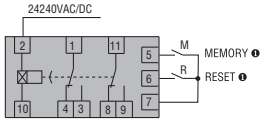

T (preset time) = $T1+T2$

● Contacts "M" and "R" are to be volt free (dry).

On delay

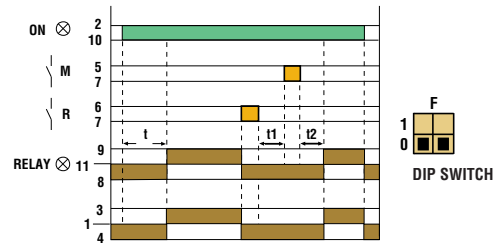

Pulse on relay energising with start on energising

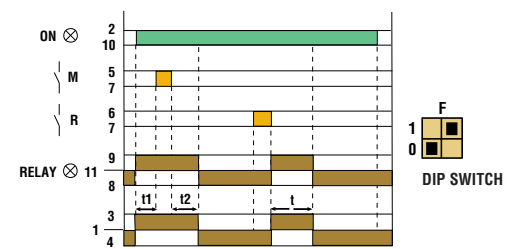

Flasher starting with OFF

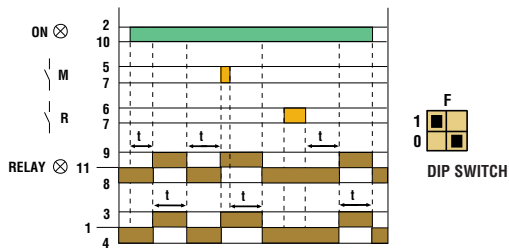

Flasher starting with ON

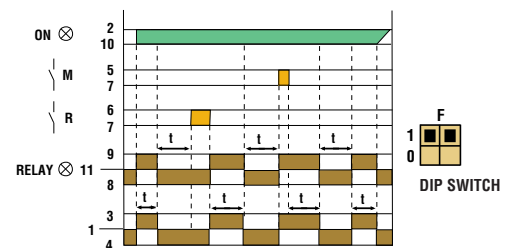

TYPE	TM P	TM M1	TM M2	TM PL	TM D	TM ST	TM LS
DESCRIPTION							
	On delay	Programmable multifunction	Programmable multifunction timing	Asymmetrical recycle	True off delay	For starting	Staircase illumination
	Multiscale	Multiscale	Multiscale	Multiscale	Multiscale	Multiscale	Single scale
	Multivoltage	Multivoltage	Multivoltage	Multivoltage	Multivoltage	Multivoltage	Single voltage
CONTROL CIRCUIT							
Rated auxiliary supply voltage U_s	24-48VDC 24-240VAC	12-240VAC/DC			24-240VAC/DC	24-48VDC 24-240VAC 380-440VAC	220-240VAC
Rated frequency	50/60Hz						
Operating voltage range	0.85-1.1 U_s						
Power consumption (maximum)	1.2VA/0.8W max (24...48VAC/DC) 16VA/0.9W max (110...240VAC/DC)	0.6VA/0.3W max (12...48VAC/DC) 1.6VA/1.2W max (110...240VAC/DC)	1.1VA/0.8W max (12...48VAC/DC) 1.8VA/1.2W max (110...240VAC/DC)	0.6VA/0.3W max (12...48VAC/DC) 1.6VA/1.2W max (110...240VAC/DC)	0.1VA/0.1W (24...48VAC/DC) 1.1VA/0.8W (110...240VAC/DC)	1.2VA/0.8W max (24...48VAC/DC) 1.6VA/0.9W max (110...240VAC)	De-energised 5VA/0.5W max Energised 12VA/0.8W max
TIMING CIRCUIT							
Time setting range	Multiscale 0.1-1s 1-10s 6s-60s 1-10min 6min-1h 1-10h 0.1-1day 1-10days ON only OFF only		Multiscale 0.1-1s 1-10s 6s-60s 1-10min 6min-1h 1h-10h 0.1-1day 1-10days 3-30days 10-100days		Multiscale 0.06-0.6s 0.6-6s 6s-60s 18s-180s	Multiscale 0.1-1s 1-10s 6s-60s 1-10min	Multiscale 0.5-20min
Setting accuracy	< $\pm 9\%$						
Repeat accuracy	< $\pm 0.1\%$	< $\pm 0.5\%$	< $\pm 0.2\%$		< $\pm 0.5\%$		
Influence of voltage variation	< $\pm 0.01\%$						< $\pm 0.5\%$
Average variation of set delays related to $+20^\circ\text{C}$ condition at -20°C	< $\pm 0.2\%$						< $\pm 0.25\%$
Minimum power time	—	—	—	—	$\geq 200\text{ms}$	—	—
Minimum ON time	—	25ms (no maximum limit)			—	—	$\geq 60\text{ms}$ (no max lim.)
Resetting during timing time	$\geq 100\text{ms}$		$\geq 100\text{ms}$		—	$\geq 100\text{ms}$	$\geq 100\text{ms}$
Resetting elapsed time	$\geq 50\text{ms}$		$\geq 50\text{ms}$		—	$\geq 50\text{ms}$	—
Immunity time for microbreakings	$\leq 50\text{ms}$	$\leq 25\text{ms}$	$\leq 15\text{ms}$	$\leq 25\text{ms}$	—	$\leq 40\text{ms}$ ①	$\leq 20\text{ms}$
RELAY OUTPUTS							
Contact arrangement	1 delayed changeover		1 inst./delayed N/O + 1 delayed c/o	1 delayed changeover		2 delayed N/O	1 delayed N/O
Maximum switching voltage	250VAC						
IEC conventional free air thermal current (I _{th})	8A			5A		8A	16A
UL/GSA and IEC/EN 60947-5-1 designation	B300						—
Electrical life (with rated load)	10^5 cycles						
Mechanical life	30×10^6 cycles						
Tightening torque maximum	0.8Nm (7lbin)						
Conductor section min-max	0.2-4mm ² (24-12 AWG)						
INSULATION (input-output)							
IEC rated insulation voltage	250V						
IEC rated impulse withstand voltage	4kV						
IEC power frequency withstand voltage	2kV (50Hz - 60sec)						
AMBIENT CONDITIONS							
Operating temperature	$-20...+60^\circ\text{C}$						
Storage temperature	$-30...+80^\circ\text{C}$						
Housing material	Self-extinguishing polyamide						

Note: N/O = normally open / SPST
c/o = changeover / SPDT; inst. = instantaneous.

① Used at 24-48VDC or 24-240VAC; $\leq 30\text{ms}$ at 380-440VAC.

Time relays

Technical characteristics

Plug-in and flush mount version 48x48mm

TYPE	L48T...	L48TP...	L48TPB...	L48M...
DESCRIPTION				
	On delay	On delay	On delay	Programmable multifunction
	Single scale	Multiscale	Multiscale	Multiscale
	Single voltage	Multivoltage	Single voltage	Multivoltage
CONTROL CIRCUIT				
Rated supply voltage U_s	24VAC/DC①	24VAC/DC①	24VAC/DC①	24-240VAC/DC①
	220-240VAC①	110VAC① 220-240VAC①	220-240VAC①	
Rated frequency	50-60Hz			
Operating voltage range	0.85-1.1 U_s			
Power consumption (maximum)	6VA			
Power dissipation (maximum)	②			
TIMING CIRCUIT				
Time setting range	Single scale	Multiscale	Multiscale	Multiscale
	0.1-3s	0.3-3s	0.05-1s	0.05-1s
	0.1-6s	0.12-12s	0.10-10s	0.1-10s
	0.5-30s	10-100s	0.6s-1min	0.6s-1min
	0.5-60s	78-780s	6s-10min	6s-10min
	1s-3min	18s-3min		0.05-1min
	3s-6min	72s-12min		0.1-10min
	30s-30min	10-100min		0.6min-1h
	30s-60min	78-780min		1min-10h
3min-3h				
Setting accuracy	±9%		±5%	
Repeat accuracy	≤±0.5%		±0.5%	
Influence of voltage variation	±0.3%		±0.1%	
Average variation of set delays in related to 20°C condition	at -20°C	+2%	+2%	
	at +60°C	-3%	-3%	
Minimum ON time	—			
Resetting time	during operation	≥ 0.1s	≥ 0.1s	≥ 0.1s
	elapsed time	≥ 65ms	≥ 65ms	≥ 65ms
Immunity time for microbreakings	≤ 40ms	≤ 40ms	≤ 40ms	≤ 40ms
RELAY OUTPUTS				
Number of relays	1	1	2	2
Contact arrangement	1 delayed c/o	1 delayed c/o	2 del. or 1 inst. + 1 del. c/o	2 delayed c/o
Maximum switching voltage	250V			
IEC conventional free air thermal current (I _{th})	5A			
UL/CSA and IEC/EN 60947-5-1 designation	B300			
Electrical life (with rated load)	10 ⁵ cycles			
Mechanical life	30x10 ⁶ cycles			
CONNECTIONS				
Tightening torque maximum	—			
Conductor section (min-max)	—			
INSULATION (input-output)				
IEC rated insulation voltage U_i	250V			
IEC power frequency withstand voltage U_{imp}	—			
IEC power frequency withstand voltage	2kV			
AMBIENT CONDITIONS				
Operating temperature	-10...+60°C			
Storage temperature	-30...+80°C			
Housing material	Self-extinguishing polyamide			

① Other voltages on request.

② Consult Customer Service for information; see contact details on inside front cover.

NOTE:

del. = delayed inst. = instantaneous c/o = changeover/SPDT