



Low Voltage Switches

Switches

Switch fuses

OS32...160 A Gamma series

# Switch fuses for extreme conditions

## - OS 32...160 Gamma series

Numerous applications require switch fuses that can withstand extreme conditions. High voltages and high short circuit currents create a demand for superior performance without neglecting safety.

### Superior performance

- High  $U_i$  ratings
  - High CTI in supporting parts
  - The contact constructions are optimal, regardless of fuse type, DIN, BS, NFC or UL-type
  - Meets the requirements for installation close to the main transformer up to 100 kA in heavy industry and in ships
- High performance level and smart design makes OS Gamma switch fuses suitable for all applications in low voltage networks.



Our new series comprises of two frame sizes OS32G...63G\_ and OS100G...160G\_.



### Compact construction

- Intelligent construction in combination with a small number of components results in a very compact mechanism design
  - Very small footprint area
- Space savings mean cost reduction!

### Designed for safety

- The frame is made of robust plastic with excellent mechanical and thermal properties.
  - Voltage output pins (as standard)
  - Pole markings as standard
  - The fuse covers cannot be opened while the switch fuse is in the ON-position and can be sealed in the closed position.
- You take no risks with OS32...160 Gamma switch fuses



# Switch fuses OS32G...160G\_

## Technical data

### Technical data according to IEC 60947-3

		Switch size	A	OS 32	OS 50	OS 63	OS 100	OS 125	OS 160
Rated insulation voltage	Pollution degree 3	V	1 000	1 000	1 000	1 000	1 000	1 000	1 000
Dielectric strength	50 Hz 1min.	kV	10	10	10	10	10	10	10
Rated thermal current in ambient 40 °C <sup>2)</sup> / max. fuse power dissipation <sup>1)</sup>	In open air	A/W	32/7.5	50/7.5	63/7.5	100/12	125/12	160/12	
	In enclosure	A/W	32/7.5	50/7.5	63/7.5	100/12	125/12	160/12	
...with minimum cable cross section	Cu	mm <sup>2</sup>	6	10	16	50	50	70	
Rated operational voltage AC-20 and DC-20		V	1 000	1 000	1 000	1 000	1 000	1 000	1 000
Rated operational current, AC-21, AC-22 and AC 23		A	32	50	63	100	125	160	
Rated operational current / poles in series DC-21A	48 V	A	32/2	50/2	63/2	100/2	125/2	160/2	
	110-220 V	A	32/2*	50/2*	63/2*	100/2*	125/2*	125/2*	
	440 V	A	32/4*	50/4*	50/4*	100/4*	125/4*	125/4*	
Rated operational current / poles in series DC-22A	48 V	A	32/2	50/2	63/2	100/2	125/2	160/2	
	110-220 V	A	32/2*	50/2*	63/2*	100/2*	125/2*	125/2*	
Rated operational current / poles in series DC-23A	48 V	A	32/2	50/2	63/2	100/2	125/2	160/2	
	110-220 V	A	32/2*	50/2*	63/2*	100/2*	125/2*	125/2*	
Rated operational power, AC-23 <sup>4)</sup>	230 V	kW	7.5	11	18.5	30	37	45	
The kW-ratings are accurate for three-phase 1500 R.P.M. standard asynchronous motors.	400 V	kW	15	22	30	55	55	75	
	415 V	kW	15	22	30	55	55	75	
	500 V	kW	18.5	30	37	55	75	90	
	690 V	kW	22	37	55	90	110	132	
Rated breaking capacity in category AC-23	up to 690 V	A	504	504	504	1 280	1 280	1 280	
Rated breaking capacity / poles in series in category DC-23	up to 220 V	A	252/2	252/2	252/2	640/2	640/2	640/2	
Rated conditional short-circuit current I <sub>p</sub> (r.m.s.)	80 kA, 415 V	kA	13.5	13.5	13.5	23.5	23.5	23.5	
I <sub>p</sub> (r.m.s.) and corresponding max. allowed cut-off current $\hat{i}_c$	Fuse size	gG/aM	A	80/63	80/63	80/63	160/160	160/160	160/160
	I <sub>p</sub> (r.m.s.)	kA	12.5	12.5	12.5	25.5	25.5	25.5	
	Fuse size	gG/aM	A	63/63	63/63	63/63	160/160	160/160	160/160
	I <sub>p</sub> (r.m.s.)	kA	11.5	11.5	11.5	20.5	20.5	20.5	
	Fuse size	gG/aM	A	63/63	63/63	63/63	125/160	125/160	125/160
Rated short-time withstand current, 1s	r.m.s. -value	kA	2.5	2.5	2.5	5	5	5	
Rated capacitor power <sup>5)</sup>	400/415/690 V	A	15/15/25	20/25/42	25/32/50	40/42/75	50/55/90	60/65/100	
Power loss / pole	With rated current, without fuse	W	1	2.5	4	4	5	9	
Mechanical endurance	Divide by two for oper. cycles	Oper.	20 000	20 000	20 000	20 000	20 000	20 000	
Fuse types, IEC 60269-2-1	DIN 43620		000		000		000, 00	000, 00	
	NFC 63210, 63211			14x51			22x58		
	BS 88-2, -6 -size / distance of fuse-link bolts	mm	A2-A3		A2-A3	A2-A4 <sup>3)</sup>	A2-A4 <sup>3)</sup>	A2-A4 <sup>3)</sup>	
			M5/73		M5/73	M5/73, M8/94	M5/73, M8/94	M5/73, M8/94	
Weight without accessories	3-pole switch fuses	kg	1.3	1.3	1.3	1.5	1.5	1.5	
	4-pole switch fuses	kg	1.6	1.6	1.6	1.8	1.8	1.8	
Built-in terminal size	Cu	mm <sup>2</sup>	2.5...25	2.5...25	2.5...25				
Terminal bolt size (included)	Metric thread diameter x length	mm				M8x25	M8x25	M8x25	
Terminal tightening torque	Counter torque required	Nm	4	4	4	15-22	15-22	15-22	
Fuse-links bolts tightening torque		Nm	3.5		3.5	M5:3.5	M5:3.5	M5:3.5	
						M8:5	M8:5	M8:5	
Operating torque	Typical for 3-pole switch fuses	Nm	5	5	5	7	7	7	

### Placing options of the operating mechanism

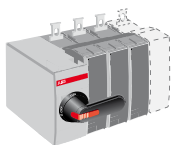

At the end of the switch fuse OS\_03 or 04

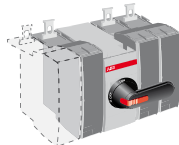

Between the poles OS\_12 or 22

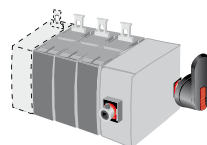

Side operated types OS\_30 or 40

<sup>1)</sup> Utilization category B

<sup>2)</sup> Ambient temperature 60 °C: derating 20%.

<sup>3)</sup> Acc. to IEC 60947-1, § 6.1.1.

<sup>4)</sup> Max. fuse body diam. 32 mm.

<sup>5)</sup> Some fuse links limit these figures further. Starting current characteristics must be considered separately.

<sup>6)</sup> The capacitor rating of the switch-fuse is limited by the fuse link.

The technical data is valid at the time of printing. We reserve the right to subsequent alterations.

# Switch fuses OS32G...160G\_, DIN-types

## Ordering information

### Front operated switch fuses

Including a black ON-OFF plastic handle and shaft as standard. OS32G...63G\_ include protected tunnel terminals (IP20) and OS125G...160G include a terminal bolt kit. The handle is IP65 protected, padlockable in the OFF-position and with door interlock in the ON-position and when padlocked. The shaft is adjustable for a range of installation depths.

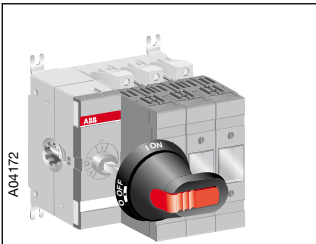

OS32G...63G\_03P

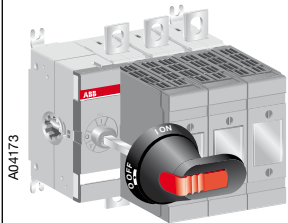

OS125G...160G\_03P

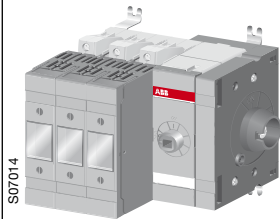

OS32G...63GDS30

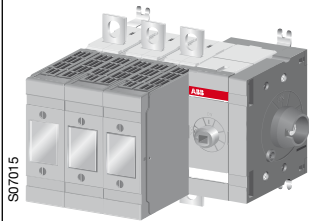

OS125G...160GDS30

Rated op. current AC-20...23 ≤ 690V [A]	Rated op. power AC-23 400/500/690V [kW]	Fuse size	Number of poles	Type	Order number	Units/ type [pcs]	Weight/ unit [kg]
---	---	-----------	-----------------	------	--------------	-------------------	-------------------

#### Mechanism between the poles

32	15/18.5/22	000	3	OS32GD12P	1SCA114581R1001	1	1.3
32	15/18.5/22	000	4	OS32GD22N2P	1SCA115202R1001	1	1.6
63	30/37/55	000	3	OS63GD12P	1SCA115227R1001	1	1.3
63	30/37/55	000	4	OS63GD22N2P	1SCA115230R1001	1	1.6
125	55/75/110	000, 00	3	OS125GD12P	1SCA115641R1001	1	1.5
125	55/75/110	000, 00	4	OS125GD22N2P	1SCA115880R1001	1	1.8
160	75/90/132	000, 00	3	OS160GD12P	1SCA115643R1001	1	1.5
160	75/90/132	000, 00	4	OS160GD22N2P	1SCA115884R1001	1	1.8

#### Mechanism at the end of the switch fuse

32	15/18.5/22	000	3	OS32GD03P	1SCA115189R1001	1	1.3
32	15/18.5/22	000	4	OS32GD04N2P	1SCA115193R1001	1	1.6
63	30/37/55	000	3	OS63GD03P	1SCA115207R1001	1	1.3
63	30/37/55	000	4	OS63GD04N2P	1SCA115209R1001	1	1.6
125	55/75/110	000, 00	3	OS125GD03P	1SCA115639R1001	1	1.5
125	55/75/110	000, 00	4	OS125GD04N2P	1SCA115877R1001	1	1.8
160	75/90/132	000, 00	3	OS160GD03P	1SCA115399R1001	1	1.5
160	75/90/132	000, 00	4	OS160GD04N2P	1SCA115882R1001	1	1.8

### Side operated switch fuses without handle and shaft

OS32G...63G\_ include protected tunnel terminals (IP20) and OS125G...160G include a terminal bolt kit.

Rated op. current AC-20...23 ≤ 690V [A]	Rated op. power AC-23 400/500/690V [kW]	Fuse size	Number of poles	Type	Order number	Units/ type [pcs]	Weight/ unit [kg]
32	15/18.5/22	000	3	OS32GDS30	1SCA115963R1001	1	1.3
32	15/18.5/22	000	4	OS32GDS40N2	1SCA116046R1001	1	1.6
63	30/37/55	000	3	OS63GDS30	1SCA116007R1001	1	1.3
63	30/37/55	000	4	OS63GDS40N2	1SCA116047R1001	1	1.6
125	55/75/110	000, 00	3	OS125GDS30	1SCA115966R1001	1	1.5
125	55/75/110	000, 00	4	OS125GDS40N2	1SCA115967R1001	1	1.8
160	75/90/132	000, 00	3	OS160GDS30	1SCA115968R1001	1	1.5
160	75/90/132	000, 00	4	OS160GDS40N2	1SCA115969R1001	1	1.8

### Shafts and handles included as standard / Front operated switch fuses

Suitable for switches	Included shaft	Included handle	Included terminal bolts
OS32G...63G_	OXF6X161	OHB45J6	
OS125G...160G_	OXF6X161	OHB65J6	M8x25

OS\_N2\_ = Non-fused neutral on the right side

# Switch fuses OS32G...160G\_, BS-types

## Ordering information

### Front operated switch fuses

Including a black ON-OFF plastic handle and shaft as standard. OS32G...63G\_ include protected tunnel terminals (IP20) and OS100G...160G include a terminal bolt kit. The handle is IP65 protected, padlockable in the OFF-position and with door interlock in the ON-position and when padlocked. The shaft is adjustable for a range of installation depths.

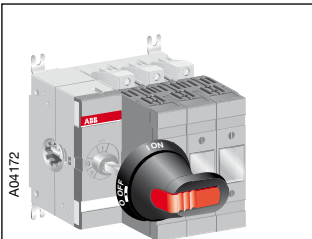

OS32G...63G\_03P

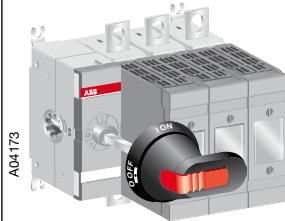

OS100G...160G\_03P

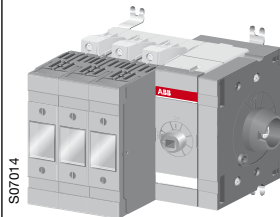

OS32G...63GBS30

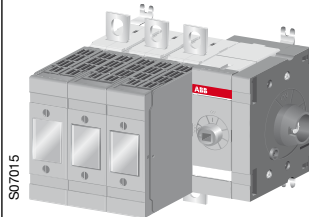

OS100G...160GBS30

Rated op. current AC-20...23 ≤ 690V [A]	Rated op. power AC-23 400/500/690V [kW]	Fuse size	Number of poles	Type	Order number	Units/type [pcs]	Weight/unit [kg]
---	---	-----------	-----------------	------	--------------	------------------	------------------

#### Mechanism between the poles

32	15/18.5/22	A2, A3	3	OS32GB12P	1SCA115331R1001	1	1.3
32	15/18.5/22	A2, A3	4	OS32GB22N1P	1SCA115345R1001	1	1.6
63	30/37/55	A2, A3	3	OS63GB12P	1SCA115325R1001	1	1.3
63	30/37/55	A2, A3	4	OS63GB22N1P	1SCA114601R1001	1	1.6
100	55/55/90	A2, A3, A4 <sup>1)</sup>	3	OS100GB12P	1SCA114586R1001	1	1.5
100	55/55/90	A2, A3, A4 <sup>1)</sup>	4	OS100GB22N1P	1SCA114602R1001	1	1.8
125	55/75/110	A2, A3, A4 <sup>1)</sup>	3	OS125GB12P	1SCA114603R1001	1	1.5
125	55/75/110	A2, A3, A4 <sup>1)</sup>	4	OS125GB22N1P	1SCA115903R1001	1	1.8
160	75/90/132	A2, A3, A4 <sup>1)</sup>	3	OS160GB12P	1SCA115637R1001	1	1.5
160	75/90/132	A2, A3, A4 <sup>1)</sup>	4	OS160GB22N1P	1SCA115899R1001	1	1.8

#### Mechanism at the end of the switch fuse

32	15/18.5/22	A2, A3	3	OS32GB03P	1SCA115259R1001	1	1.3
32	15/18.5/22	A2, A3	4	OS32GB04N1P	1SCA114610R1001	1	1.6
63	30/37/55	A2, A3	3	OS63GB03P	1SCA115235R1001	1	1.3
63	30/37/55	A2, A3	4	OS63GB04N1P	1SCA115238R1001	1	1.6
100	55/55/90	A2, A3, A4 <sup>1)</sup>	3	OS100GB03P	1SCA114613R1001	1	1.5
100	55/55/90	A2, A3, A4 <sup>1)</sup>	4	OS100GB04N1P	1SCA114614R1001	1	1.8
125	55/75/110	A2, A3, A4 <sup>1)</sup>	3	OS125GB03P	1SCA115634R1001	1	1.5
125	55/75/110	A2, A3, A4 <sup>1)</sup>	4	OS125GB04N1P	1SCA115901R1001	1	1.8
160	75/90/132	A2, A3, A4 <sup>1)</sup>	3	OS160GB03P	1SCA115413R1001	1	1.5
160	75/90/132	A2, A3, A4 <sup>1)</sup>	4	OS160GB04N1P	1SCA115896R1001	1	1.8

### Side operated switch fuses without handle and shaft

OS32G...63G\_ include protected tunnel terminals (IP20) and OS100G...160G include a terminal bolt kit.

Rated op. current AC-20...23 ≤ 690V [A]	Rated op. power AC-23 400/500/690V [kW]	Fuse size	Number of poles	Type	Order number	Units/type [pcs]	Weight/unit [kg]
32	15/18.5/22	A2, A3	3	OS32GBS30	1SCA115955R1001	1	1.3
32	15/18.5/22	A2, A3	4	OS32GBS40N1	1SCA115956R1001	1	1.6
63	30/37/55	A2, A3	3	OS63GBS30	1SCA115957R1001	1	1.3
63	30/37/55	A2, A3	4	OS63GBS40N1	1SCA115978R1001	1	1.6
100	55/55/90	A2, A3, A4 <sup>1)</sup>	3	OS100GBS30	1SCA116758R1001	1	1.5
100	55/55/90	A2, A3, A4 <sup>1)</sup>	4	OS100GBS40N1	1SCA116759R1001	1	1.8
100	55/55/90	A2, A3, A4 <sup>1)</sup>	4	OS100GBS40N2	1SCA116760R1001	1	1.8
125	55/75/110	A2, A3, A4 <sup>1)</sup>	3	OS125GBS30	1SCA116048R1001	1	1.5
125	55/75/110	A2, A3, A4 <sup>1)</sup>	4	OS125GBS40N1	1SCA115959R1001	1	1.8
160	75/90/132	A2, A3, A4 <sup>1)</sup>	3	OS160GBS30	1SCA115960R1001	1	1.5
160	75/90/132	A2, A3, A4 <sup>1)</sup>	4	OS160GBS40N1	1SCA115961R1001	1	1.8

### Shafts and handles included as standard / Front operated switch fuses

Suitable for switches	Included shaft	Included handle	Included terminal bolts
OS32G...63G_	OXF6X161	OHB45J6	
OS100G...160G_	OXF6X161	OHB65J6	M8x25

1) Max. fuse diameter 32 mm  
 OS\_N1\_ = Non-fused neutral on the left side  
 OS\_N2\_ = Non-fused neutral on the right side

# Switch fuses OS32G...160G\_, NFC-types

## Ordering information

### Front operated switch fuses

Including a black ON-OFF plastic handle and shaft as standard. OS50G\_ include protected tunnel terminals (IP20) and OS125G include a terminal bolt kit. The handle is IP65 protected, padlockable in the OFF-position and with door interlock in the ON-position and when padlocked. The shaft is adjustable for a range of installation depths.

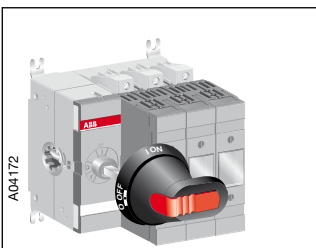

OS50G\_03P

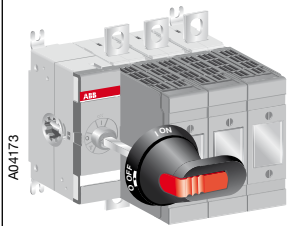

OS125G\_03P

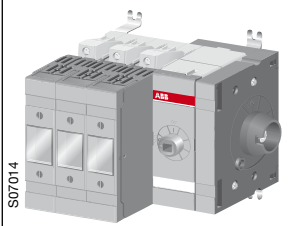

OS50GFS30

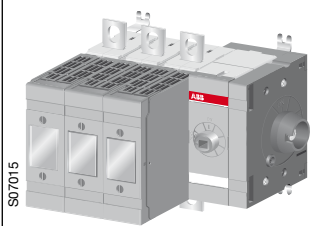

OS125GFS30

Rated op. current AC-20...23 ≤ 690V [A]	Rated op. power AC-23 400/500/690V [kW]	Fuse size	Number of poles	Type	Order number	Units/type [pcs]	Weight/unit [kg]
--	--	-----------	-----------------	------	--------------	------------------	------------------

#### Mechanism between the poles

50	22/30/37	14x51	3	OS50GF12P	1SCA115553R1001	1	1.3
50	22/30/37	14x51	4	OS50GF22N1P	1SCA114622R1001	1	1.6
50	22/30/37	14x51	4	OS50GF22FP	1SCA114623R1001	1	1.6
125	55/75/110	22x58	3	OS125GF12P	1SCA114624R1001	1	1.5
125	55/75/110	22x58	4	OS125GF22N1P	1SCA115893R1001	1	1.8
125	55/75/110	22x58	4	OS125GF22FP	1SCA115614R1001	1	1.8

#### Mechanism at the end of the switch fuse

50	22/30/37	14x51	3	OS50GF03P	1SCA115492R1001	1	1.3
50	22/30/37	14x51	4	OS50GF04N1P	1SCA115495R1001	1	1.6
50	22/30/37	14x51	4	OS50GF04FP	1SCA115498R1001	1	1.6
125	55/75/110	22x58	3	OS125GF03P	1SCA115602R1001	1	1.5
125	55/75/110	22x58	4	OS125GF04N1P	1SCA115888R1001	1	1.8
125	55/75/110	22x58	4	OS125GF04FP	1SCA115606R1001	1	1.8

### Side operated switch fuses without handle and shaft

OS50G\_ include protected tunnel terminals (IP20) and OS125G include a terminal bolt kit.

Rated op. current AC-20...23 ≤ 690V [A]	Rated op. power AC-23 400/500/690V [kW]	Fuse size	Number of poles	Type	Order number	Units/type [pcs]	Weight/unit [kg]
50	22/30/37	14x51	3	OS50GFS30	1SCA116050R1001	1	1.3
50	22/30/37	14x51	4	OS50GFS40N1	1SCA116058R1001	1	1.6
50	22/30/37	14x51	4	OS50GFS40F	1SCA116014R1001	1	1.6
125	55/75/110	22x58	3	OS125GFS30	1SCA115973R1001	1	1.5
125	55/75/110	22x58	4	OS125GFS40N1	1SCA115974R1001	1	1.8
125	55/75/110	22x58	4	OS125GFS40F	1SCA115975R1001	1	1.8

### Shafts and handles included as standard / Front operated switch fuses

Suitable for switches	Included shaft	Included handle	Included terminal bolts
OS50G_	OSP6X161	OHB45J6	
OS125G_	OSP6X161	OHB65J6	M8x25

OS\_N1\_ = Non-fused neutral on the left side  
OS\_F\_ = Fused neutral

# Switch fuses OS32G...160G\_, UL-types

## Ordering information

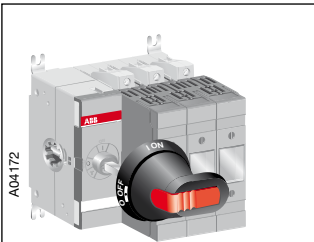

A04172

OS60G\_03P

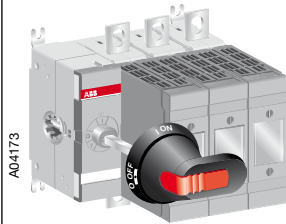

A04173

OS100G\_03P

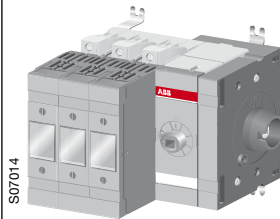

S07014

OS60GJS30

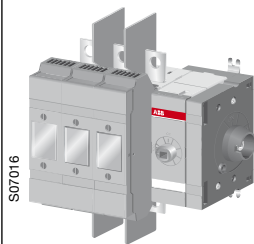

S07016

OS100GJS30

### Front operated switch fuses

Including a black ON-OFF plastic handle and shaft as standard. OS60G\_ include protected tunnel terminals (IP20) and OS100G\_ include a terminal bolt kit. The handle is IP65 protected, Nema type 1, 3R, 12, padlockable in the OFF-position and with door interlock in the ON-position and when padlocked. The shaft is adjustable for a range of installation depths.

Ampere rating [A]	Horse power ratings 3-phase 240/480/600V [HP]	Fuse size	Number of poles	Type	Order number	Units/type [pcs]	Weight/unit [kg]
-------------------	---	-----------	-----------------	------	--------------	------------------	------------------

#### Mechanism between the poles

60	15/30/50	J, 60A	3	OS60GJ12P	1SCA115449R1001	1	1.3
60	15/30/50	J, 60A	4	OS60GJ22FP	1SCA115469R1001	1	1.6
100	30/60/75	J, 100A	3	OS100GJ12P	1SCA115666R1001	1	1.5
100	30/60/75	J, 100A	4	OS100GJ22FP	1SCA114636R1001	1	1.8

#### Mechanism at the end of the switch fuse

60	15/30/50	J, 60A	3	OS60GJ03P	1SCA115443R1001	1	1.3
60	15/30/50	J, 60A	4	OS60GJ04FP	1SCA115446R1001	1	1.6
100	30/60/75	J, 100A	3	OS100GJ03P	1SCA114639R1001	1	1.5
100	30/60/75	J, 100A	4	OS100GJ04FP	1SCA115439R1001	1	1.8

### Side operated switch fuses without handle and shaft

OS60G\_ include protected tunnel terminals (IP20) and OS100G include a terminal bolt kit.

Ampere rating [A]	Horse power ratings 3-phase 240/480/600V [HP]	Fuse size	Number of poles	Type	Order number	Units/type [pcs]	Weight/unit [kg]
-------------------	---	-----------	-----------------	------	--------------	------------------	------------------

### Shafts and handles included as standard / Front operated switch fuses

Suitable for switches	Included shaft	Included handle	Included terminal bolts
OS60G_	OXp6X161	OHB45J6	
OS100G_	OXp6X161	OHB65J6	M8x25

# Accessories

## Ordering information

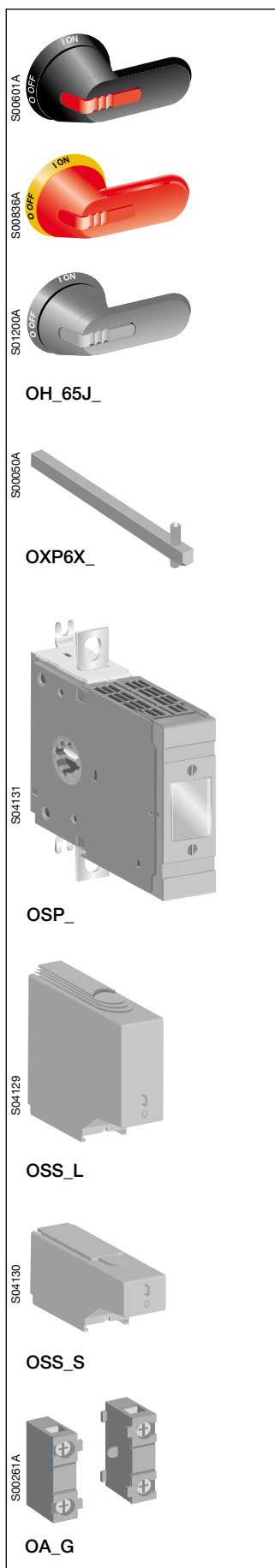

### Optional handles, IP 65

For front operated switch fuses

Padlockable with 3 padlocks in the OFF-position, door interlock in the ON-position. Units/type = 1 pcs. Screw fixing from the back side of the handle, no screws on the front, ensures double insulation.

Colour	Handle length [mm]	Type	Order number	Delivery batch [pcs]	Weight /unit [kg]
--------	--------------------	------	--------------	----------------------	-------------------

For shaft diameter 6 mm

Plastic handles, black and red-yellow: I-O/ON-OFF, grey: I-O.

Black	45	OHB45J6	1SCA022380R8770	100	0.12
Red-Yellow	45	OHY45J6	1SCA022380R8930	100	0.12
Black	65	OHB65J6	1SCA022380R9660	100	0.12
Red-Yellow	65	OHY65J6	1SCA022380R9820	100	0.12
Grey	65	OHG65J6	1SCA022380R9740	100	0.12

Plastic handles, black and red-yellow: Test/I-O/ON-OFF, grey: Test/I-O.

Black	45	OHB45J6T	1SCA109870R1001	100	0.12
Black	65	OHB65J6T	1SCA022399R8110	100	0.12
Red-Yellow	65	OHY65J6T	1SCA022456R9540	100	0.12
Grey	65	OHG65J6T	1SCA022456R9620	100	0.12

### Extended shafts

Units/type = 1 piece

Shaft length [mm]	Front operated H / [mm]	Side operated H / [mm]	Type	Order number	Delivery batch [pcs]	Weight /unit [kg]
-------------------	-------------------------	------------------------	------	--------------	----------------------	-------------------

For OS 32...63<sup>2)</sup>, shaft diameter 6 mm

63		161...167	OXP6X63	1SCA111010R1001	10	0.02
90		188...194	OXP6X90	1SCA022064R1180	10	0.03
130	127...174 <sup>3)</sup>	228...234	OXP6X130	1SCA022057R0570	10	0.04
161	138...205		OXP6X161 <sup>1)</sup>	1SCA022067R1760	10	0.05
210	187...254		OXP6X210	1SCA022295R6080	10	0.06
290	267...334		OXP6X290	1SCA022042R6370	10	0.08
360	337...404		OXP6X360	1SCA022042R6530	10	0.10
430	407...474		OXP6X430	1SCA022056R6030	10	0.12

For OS 100...160<sup>2)</sup>, shaft diameter 6 mm

63		196...202	OXP6X63	1SCA111010R1001	10	0.02
90		223...229	OXP6X90	1SCA022064R1180	10	0.03
130	137...174 <sup>4)</sup>	263...269	OXP6X130	1SCA022057R0570	10	0.04
161	138...205		OXP6X161 <sup>1)</sup>	1SCA022067R1760	10	0.05
210	187...254		OXP6X210	1SCA022295R6080	10	0.06
290	267...334		OXP6X290	1SCA022042R6370	10	0.08
360	337...404		OXP6X360	1SCA022042R6530	10	0.10
430	407...474		OXP6X430	1SCA022056R6030	10	0.12

### Fourth poles

Snap-on mounting to the left or right side of the switch.

Suitable for 3-pole switches	Number of poles	Description	Type	Order number	Units/type [pcs]	Weight [kg]
------------------------------	-----------------	-------------	------	--------------	------------------	-------------

Fusible 4. poles

OS125G...160G_	DIN-type	Fusible	OSP160GD	1SCA114768R1001	1	0.40
OS125G...160G_	BS-type	Fusible	OSP160GB	1SCA114769R1001	1	0.40
OS100G...160G_	N-type	Switched	OSP160GN	1SCA114770R1001	1	0.40

### Terminal shrouds

Pack of single pole terminal shrouds, snap-on mounting, grey plastic, IP 3X. Transparent shrouds available on request.

OS100G...160G_	3	Long type	OSS160GG1L/3	1SCA114764R1001	3	0.10
OS100G...160G_	3	Short type	OSS160GG1S/3	1SCA114766R1001	3	0.07
OS100G...160G_	4	Long type	OSS160GG1L/4	1SCA114765R1001	4	0.12
OS100G...160G_	4	Short type	OSS160GG1S/4	1SCA114767R1001	4	0.08

### Auxiliary contacts

Protection degree IP20. Mounting under the mechanism cover, max. 4 contact blocks. All four contacts can be used as "Aux./Test"-contacts and 2 contacts can be used as "Test indication" contacts.

Auxiliary contact blocks can be mounted also on the left side of the switch fuse with the OEA28 module, max. 8 contact blocks.

OS32G...160G_	1NO	OA1G10	1SCA022353R4970	10	0.03
OS32G...160G_	1NC	OA3G01	1SCA022456R7410	10	0.03

<sup>1)</sup> Included as standard

<sup>2)</sup> Side operated, 4-pole: OS 32...63: add 45 mm, OS 100...160: add 35 mm

<sup>3)</sup> OS32...63GB/GF: 115...174

<sup>4)</sup> OS100GJ: 113...174, OS100GB...160GB: 121...174



# Switch fuses OS32G...160G\_

## Dimension drawings

### OS32...63G\_

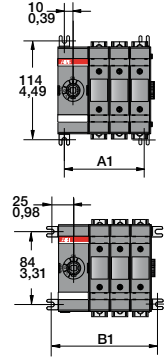
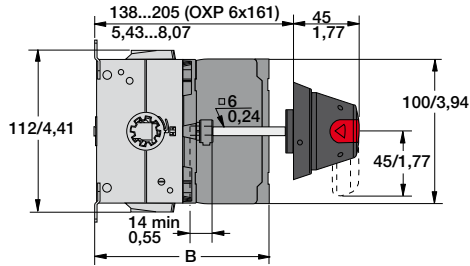
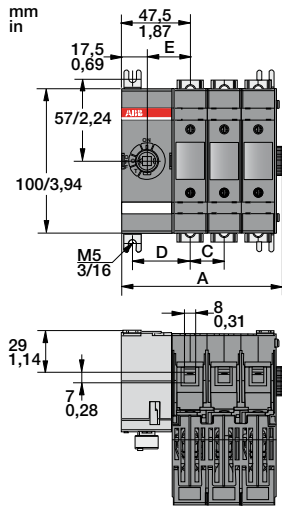

	OS32-63GD				OS32-63GB/F				OS60GJ						
	mm								mm / in						
	D01	D02	D03	D04	B/F01	B/F02	B/F03	B/F04	J01	J02	J03	J04			
A	64,5	88	111,5	135,5	64,5	88	111,5	135,5	74,5/2,93	109,5/4,31	144,5/5,69	179,5/7,07			
B	120,5	120,5	120,5	108,5	108,5	108,5	108,5	108,5	118/4,65	118/4,65	118/4,65	118/4,65			
C	-	23,5	23,5	23,5	-	23,5	23,5	23,5	-	35/1,38	35/1,38	35/1,38			
D	40	40	40	40	40	40	40	40	45,5/1,79	45,5/1,79	45,5/1,79	45,5/1,79			
E	30	30	30	30	30	30	30	30	36/1,41	36/1,41	36/1,41	36/1,41			
A1	45	68,5	92	111,5	45	68,5	92	111,5	51/2,01	86/3,39	121/4,76	156/6,14			
B1	75	98,5	122	145,5	75	98,5	122	145,5	81/3,19	116/4,57	151/5,94	186/7,32			

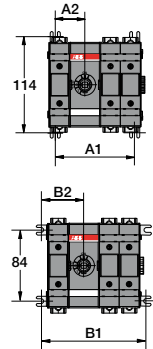
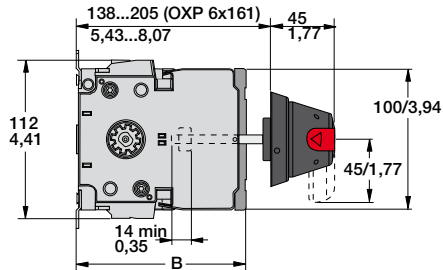
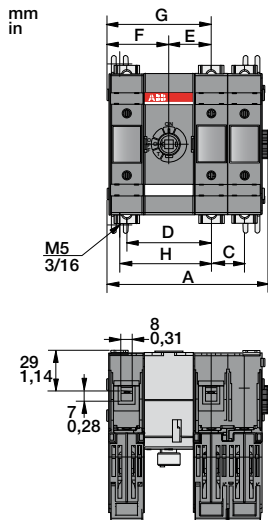

	OS32-63GD				OS32-63GB/F				OS60GJ						
	mm								mm / in						
	D11	D12	D13	D22	B/F11	B/F12	B/F13	B/F22	J11	J12	J13	J22			
A	91	114,5	138	138	91	114,5	138	138	74,5/2,93	148/5,82	193,5/7,20	179,5/8,58			
B	120,5	120,5	120,5	108,5	108,5	108,5	108,5	108,5	118/4,65	118/4,65	118/4,65	118/4,65			
C	-	23,5	23,5	23,5	-	23,5	23,5	23,5	-	35/1,38	35/1,38	35/1,38			
D	60	60	60	60	60	60	60	60	71,5/2,81	71,5/2,81	71,5/2,81	71,5/2,81			
E	30	30	30	30	30	30	30	30	36/1,41	36/1,41	36/1,41	36/1,41			
F	44	44	44	67,5	44	44	44	67,5	55,5/2,19	55,5/2,19	55,5/2,19	90,5/3,56			
G	74	74	74	97,5	74	74	74	97,5	91,5/3,6	91,5/3,6	91,5/3,6	126,5/4,98			
A1	70	93,5	117	117	70	93,5	117	117	81,5/3,21	116,5/4,59	151,5/5,96	151,5/5,96			
A2	35	35	35	58,5	35	35	35	58,5	40,5/1,59	40,5/1,59	40,5/1,59	75,5/2,97			
B1	75	123,5	147	147	75	123,5	147	147	111,5/4,39	146,5/5,77	181,5/7,15	181,5/7,15			
B2	50	50	50	73,5	50	50	50	73,5	70,5/2,78	70,5/2,78	70,5/2,78	105,5/4,15			

### OS32...63G\_S

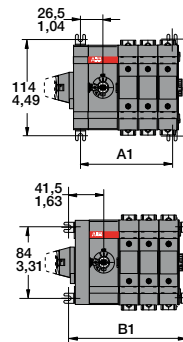
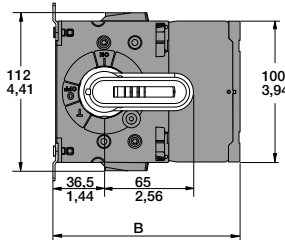
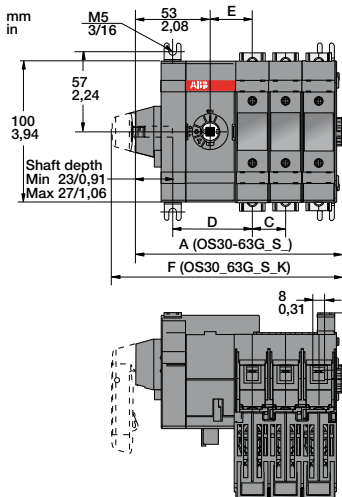

	OS32-63G mm								OS60G mm / in			
	DS01	DS02	DS03	DS04	B/FS01	B/FS02	B/FS03	B/FS04	JS01	JS02	JS03	JS04
A	99,5	123	146,5	170	99,5	123	146,5	170	109,5/4,31	144,5/5,69	179,5/7,07	214,5/8,44
B	132,5	132,5	132,5	120,5	120,5	120,5	120,5	120,5	130/5,12	130/5,12	130/5,12	130/5,12
C	-	23,5	23,5	23,5	-	23,5	23,5	23,5	-	35/1,38	35/1,38	35/1,38
D	56,5	56,5	56,5	56,5	56,5	56,5	56,5	56,5	62/2,44	62/2,44	62/2,44	62/2,44
E	30	30	30	30	30	30	30	30	36/1,41	36/1,41	36/1,41	36/1,41
F	116,5	140	163,5	187	116,5	140	163,5	187	126,5/4,98	161,5/6,36	196,5/7,74	231,5/9,11
A1	61,5	85	108,5	132	61,5	85	108,5	132	67,5/2,66	102,5/4,04	137,5/5,41	172,5/6,79
B1	91,5	115	138,5	162,5	91,5	115	138,5	162,5	37,5/1,48	72,5/2,85	107,5/4,23	142,5/5,61

# Switch fuses OS32G...160G\_

## Dimension drawings

### OS100...160G\_

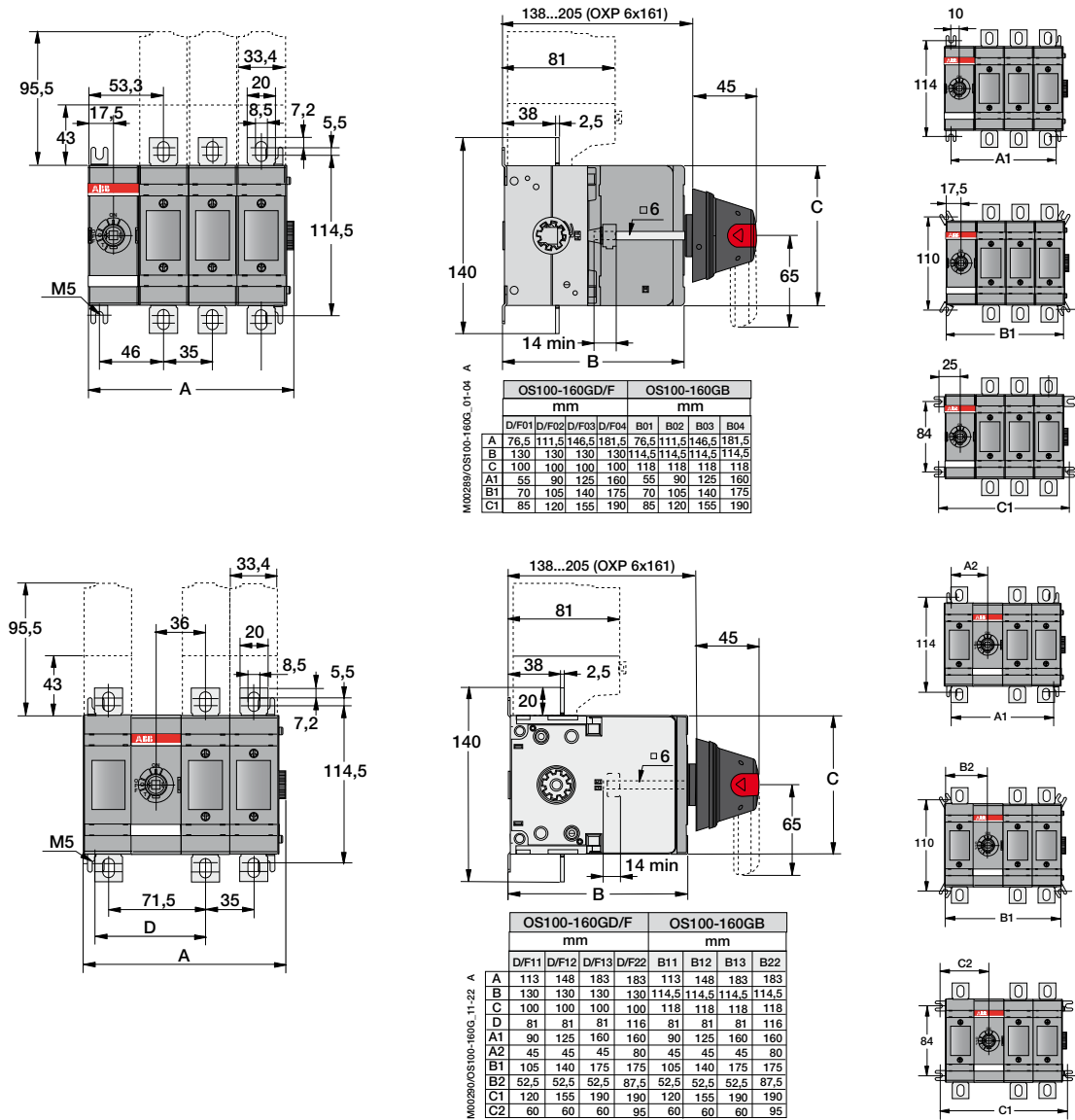

### OS100...160G\_S

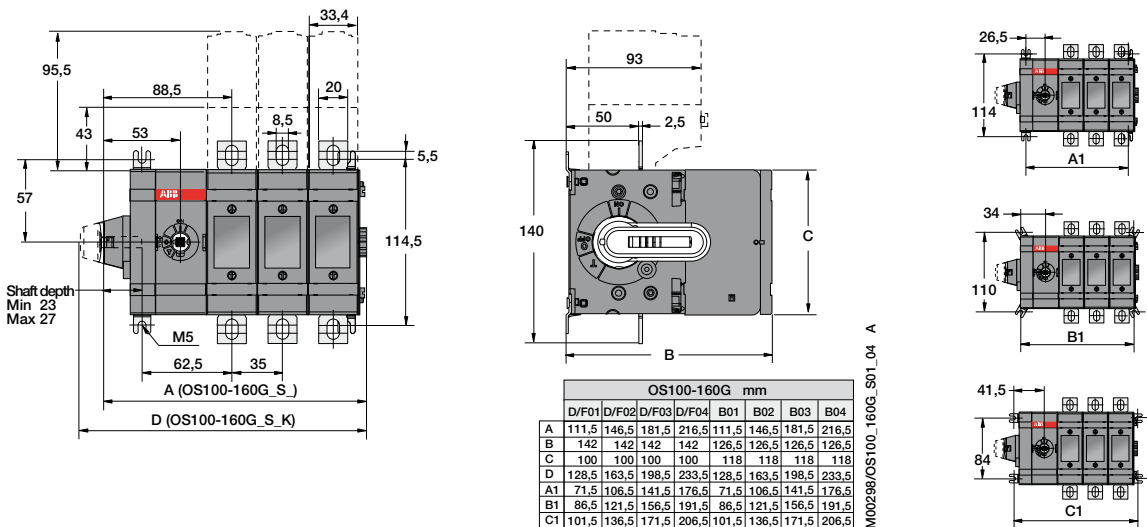

# Switch fuses OS32G...160G\_

## Dimension drawings

### OS100GJ\_

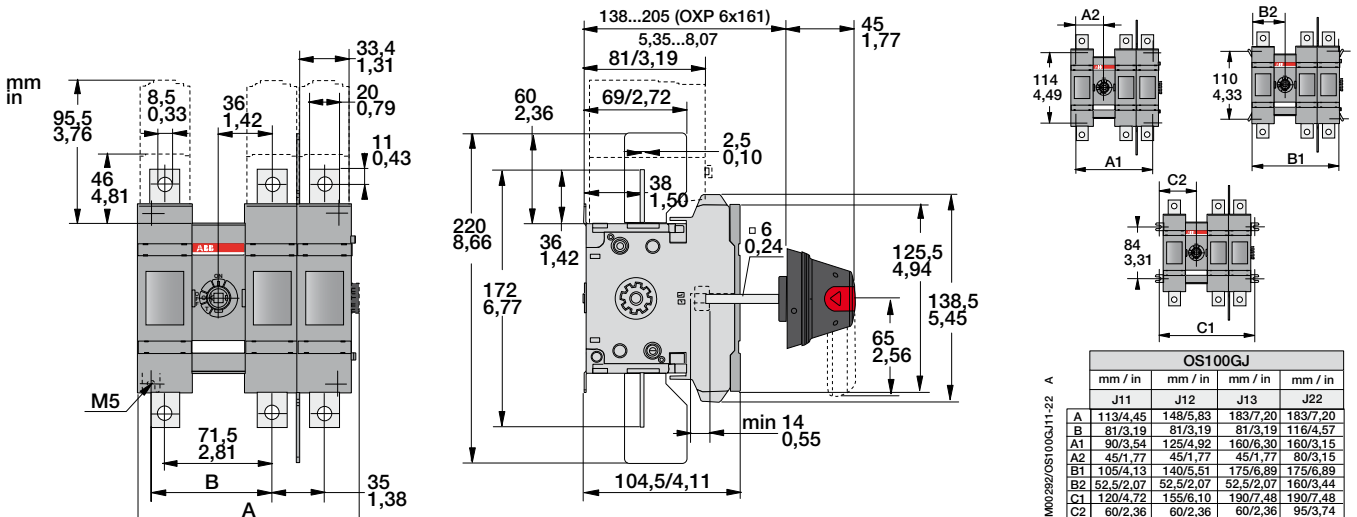
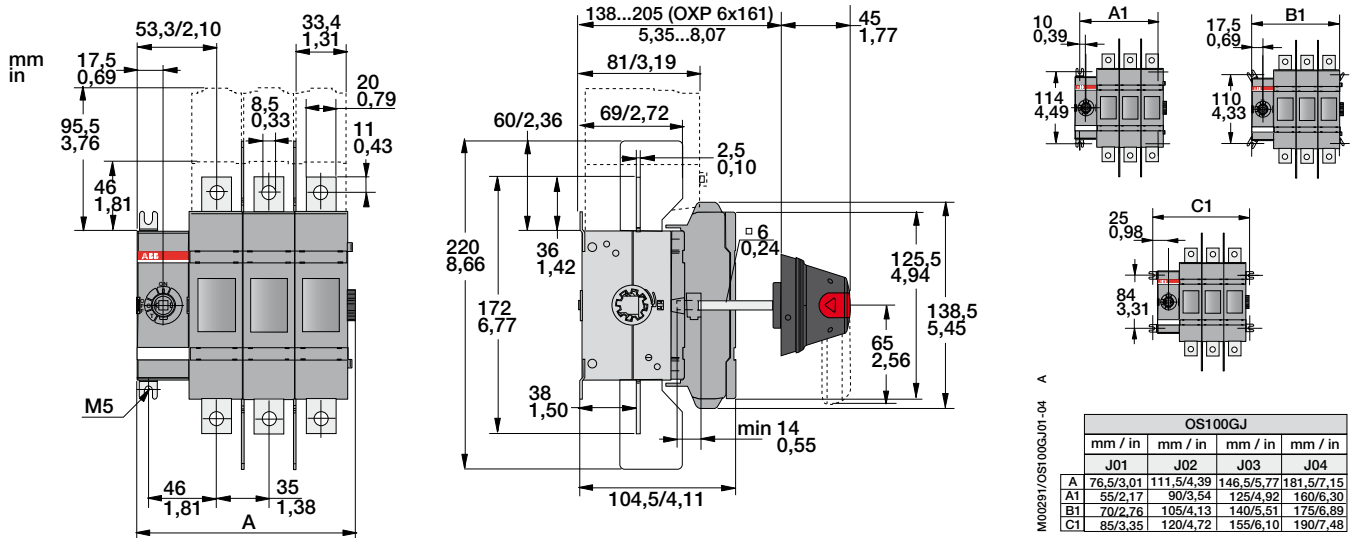

The measurements in the dimension drawings are preliminary and may be altered.

### OS100GJ\_S

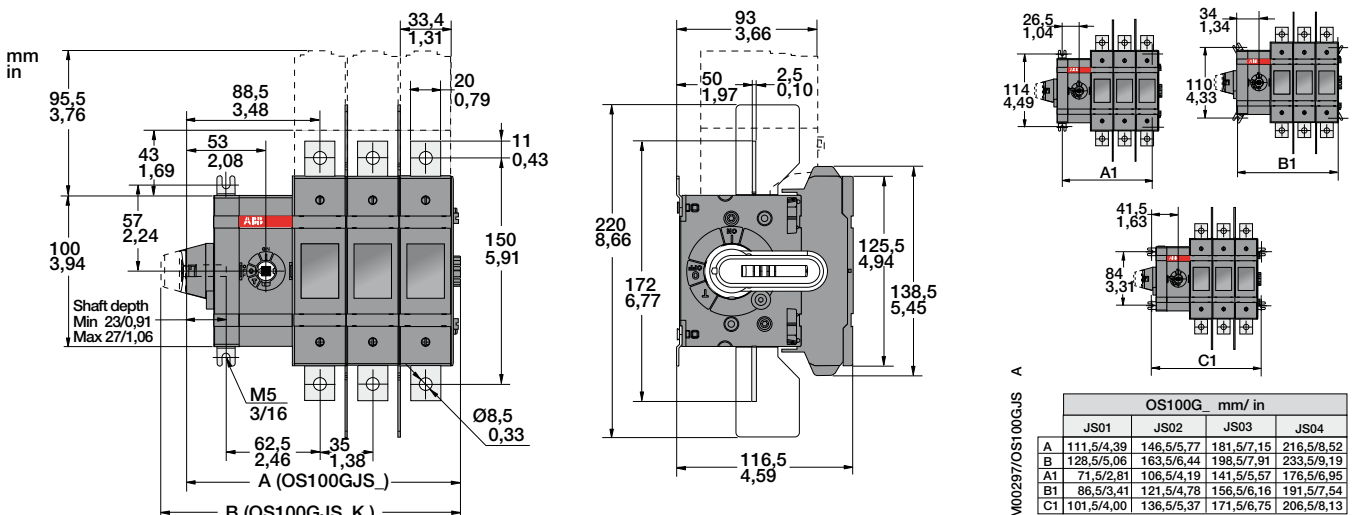

# Contact us

## ABB Oy

### Low Voltage Switches

P.O. Box 622

FI-65101 Vaasa, Finland

Phone: +358 10 22 11

Fax: +358 22 45708

E-Mail: [firstname.surname@fi.abb.com](mailto:firstname.surname@fi.abb.com)

[www.abb.com](http://www.abb.com)

The technical data and dimensions are valid at the time of printing. We reserve the right to subsequent alterations.

