

Photoelectrics Through-beam Type PD30CNT15....MU/RT

CARLO GAVAZZI



- Miniature sensor range
- Range: 15 m
- Sensitivity adjustment by Teach-In programming
- Modulated, Infrared light 880 nm
- Supply voltage: 10 to 30 VDC
- Output: 100 mA, NPN or PNP preset
- Make and break switching function programmable
- LED indication for output, stability and power ON
- Protection: reverse polarity, short circuit and transients
- Cable and plug versions
- Excellent EMC performance
- Mute function (Sensor blanking) Emitter
- Remote teach - Receiver



Product Description

The PD30CNT15 sensor family comes in a compact 10 x 30 x 20 mm reinforced PMMA/ABS housing. The sensors are useful in applications where high-accuracy detection as well as small size is required. Compact housing and high power LED for excellent performance-size ratio.

The Teach-In function for adjustment of the sensitivity makes the sensors highly flexible. The output type is preset (NPN or PNP), and the output switching function is programmable (NO or NC). The mute function can be used for testing the sensor for: Malfunctioning, disconnection, optical axis adjustment, dusty and dirty lenses.

Ordering Key

PD30CNT15NPM5RT

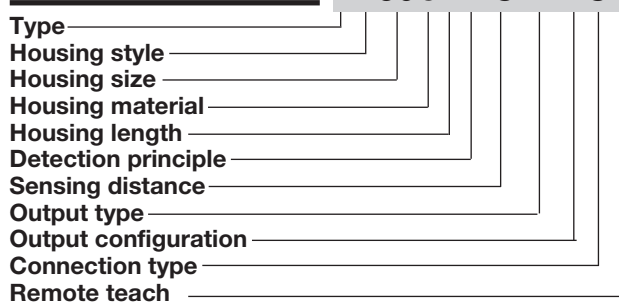

Type Selection

Housing W x H x D	Range S _n	Connection	Ordering no. NPN Emitter	Ordering no. NPN Make or break switching	Ordering no. PNP Emitter	Ordering no. PNP Make or break switching
10 x 30 x 20 mm	15 m	Cable	PD 30 CNT 15 NMU	PD 30 CNT 15 NPRT	PD 30 CNT 15 PMU	PD 30 CNT 15 PPRT
10 x 30 x 20 mm	15 m	Plug	PD 30 CNT 15 NM5MU	PD 30 CNT 15 NPM5RT	PD 30 CNT 15 PM5MU	PD 30 CNT 15 PPM5RT

Note: Emitter, Receiver and Connector to be ordered separately.

Specifications Emitter EN 60947-5-2

Rated operational volt. (U _B)	10 to 30 VDC	Protection	Reverse polarity, transients
Ripple (U _{rpp})	≤ 10%	Indication function	LED, green
Supply current	≤ 25 mA	Power supply ON	
Light Source	GaAlAs, LED, 880 nm	Mute function	
Optical angle	± 2° at ½ range	Emitter off	0 to 3 sec
Light type	Infrared, modulated	Emitter half power	> 3 sec
Light spot	110 mm @ 1.5 m		0 to 2.5 VDC (NPN) 5 to 30 VDC (PNP) 0 to 2.5 VDC (NPN) 5 to 30 VDC (PNP)

Specifications Receiver EN 60947-5-2

Rated operating distance (S _n)	15 m, with PD30CNT15 Emitter	Adjustable range resolution	1.5 m to 15 m 3% on distance
Blind zone	None	Output current	
Sensitivity	Adjustable by Teach-In (push button or wire)	Continuous (I _e)	≤ 100 mA
		Short-time (I)	≤ 100 mA (max. load capacity 100 nF)
Temperature drift	≤ 0.3%/°C	No load supply current (I _o)	≤ 30 mA
Hysteresis (H) (differential travel)	≤ 10%	Minimum operational current (I _m)	0.5 mA
Rated operational volt. (U _B)	10 to 30 VDC	OFF-state current (I _r)	≤ 100 μA
Ripple (U _{rpp})	≤ 10%	Voltage drop (U _d)	≤ 2.5 VDC @ 100 mA



Specifications Receiver (cont.) EN 60947-5-2

Protection	Short-circuit, reverse polarity and transients
Sensing angle	± 4°
Ambient light	10,000 lux
Operating frequency	1000 Hz
Response time	
OFF-ON (t _{ON})	≤ 0.5 ms
ON-OFF (t _{OFF})	≤ 0.5 ms
Power ON delay (t_v)	≤ 300 ms
Output function	
NPN and PNP	Preset
NO/NC switching function	Set up by button
Remote teach	
"Push button active"	0 to 2.5 VDC (NPN) 5 to 30 VDC (PNP)
Tamper proof	When activated more than 20 sec. the sensor goes into a Tamper proof mode.
Indication	
Output ON	LED, yellow
Signal stability ON and power ON	LED, green

General Specifications EN 60947-5-2

Environment	
Installation category	III (IEC 60664/60664A; 60947-1)
Pollution degree	3 (IEC 60664/60664A; 60947-1)
Degree of protection	IP 67 (IEC 60529; 60947-1)
Ambient temperature	
Operating	-25° to +55°C (-13° to +131°F)
Storage	-40° to +70°C (-40° to +158°F)
Vibration	10 to 55 Hz, 0.5 mm/7.5 g (IEC 60068-2-6)
Shock	30 g / 11ms, 3 pos, 3 neg per axis (IEC 60068-2-6, 60068-2-32)
Rated insulation voltage	500 VAC (rms)
Housing material	
Body	ABS
Front material	PMMA, red
Connection	
Cable Emitter/receiver	PVC, black, 2 m, Ø = 3.3 mm 4 x 0.14 mm ²
Plug	M8, 4-pin (CON, 54-series)
Weight (each sensor)	With cable: 40 g With plug: 10 g
CE-marking	Yes
Approvals	cULus (UL508)

Operation Diagram

t_v = Power ON delay

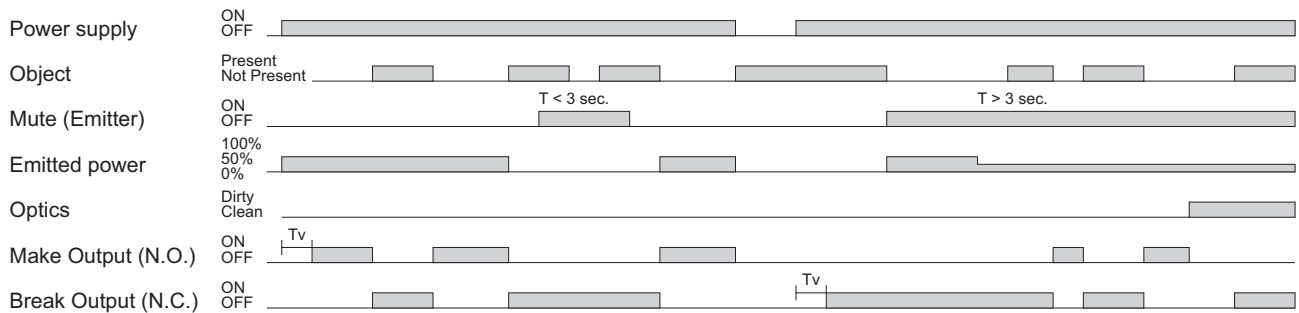

Wiring Diagrams

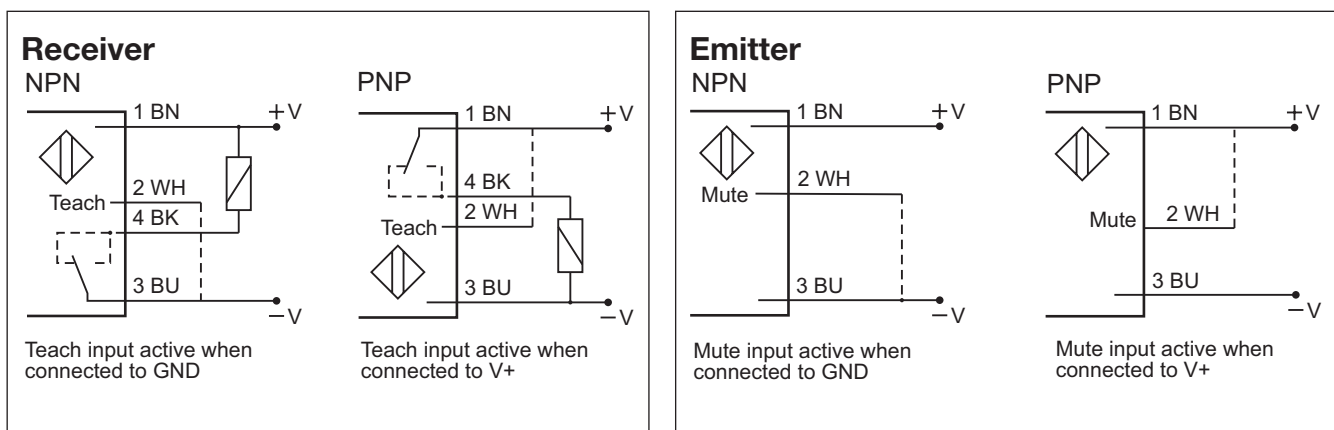

Detection Diagram

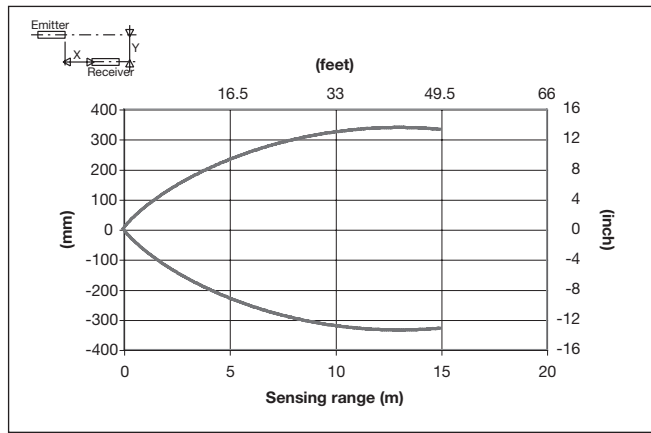

Excess Gain

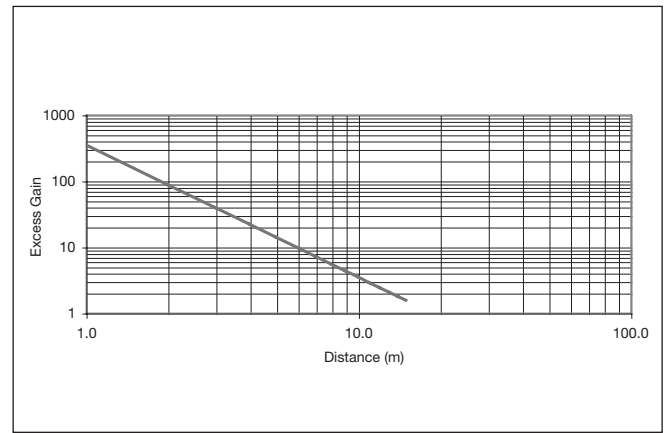

Signal Stability Indication

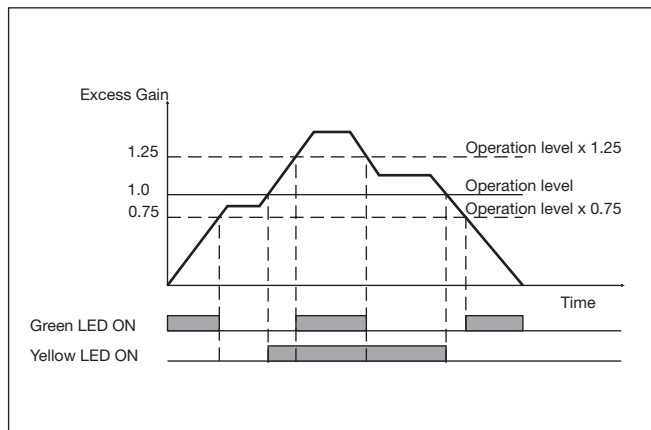

Accessories

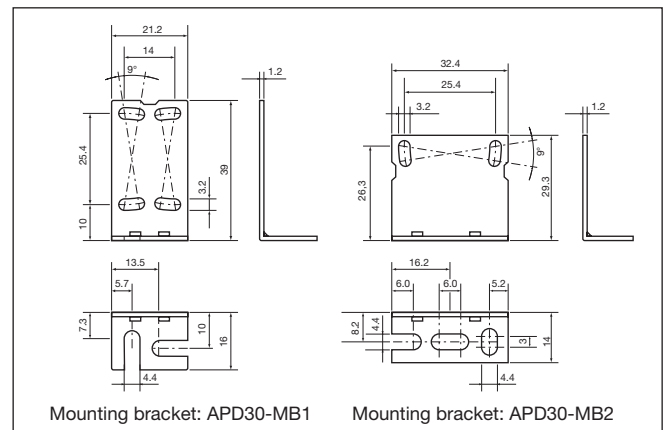

Dimensions

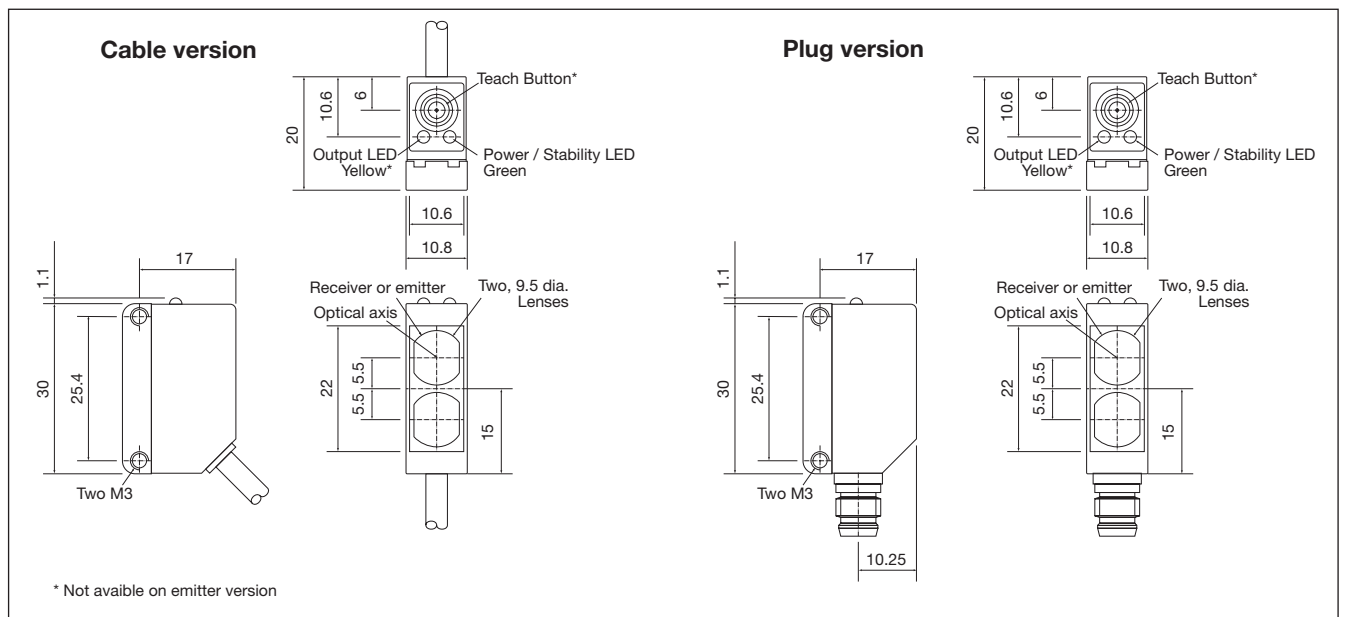

* Not available on emitter version

Installation Hints

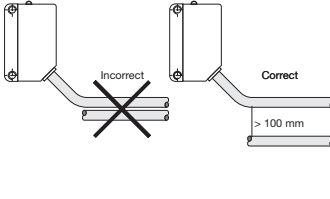
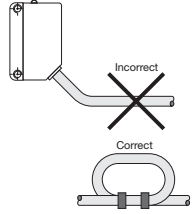
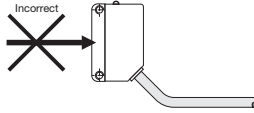
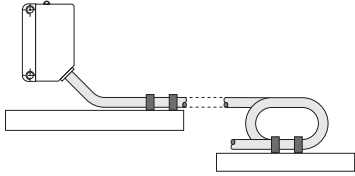
<p><i>To avoid interference from inductive voltage / current peaks, separate the proximity switch cables from any other power cables. E.g. Engine, contactor or solenoid cables</i></p>  <p>Incorrect Correct > 100 mm</p>	<p><i>Relief of the cable strain</i></p>  <p>Incorrect Correct</p> <p><i>The cable should not be pulled</i></p>	<p><i>Protection of the sensing face</i></p>  <p>Incorrect</p> <p><i>A proximity switch should not serve as mechanical stop</i></p>	<p><i>Sensor mounted on a mobile carrier</i></p>  <p><i>Any repetitive flexing of the cable should be avoided</i></p>
---	--	--	--

Delivery Contents

- Photoelectric switch: PD 30 CNT 15 ...
- Installation instruction
- Mounting bracket APD30-1
- **Packaging:** Cardboard box

Accessories

- Mounting bracket APD30-2 to be purchased separately
- Connector type CONG 5A../CON. 54NF.. series.

Teach functions

Normal operation, optimized switching point

1. Line up the emitter and receiver. Yellow LED and Green LED are ON.
2. Press the button for 3 seconds until both LEDs flashes simultaneously.
(The first switch point is stored)
3. Place the object between the emitter and receiver in the detection zone.
4. Press the button once and the sensor is ready to operate (Green LED ON, Yellow LED ON)
(The second switch point is stored)

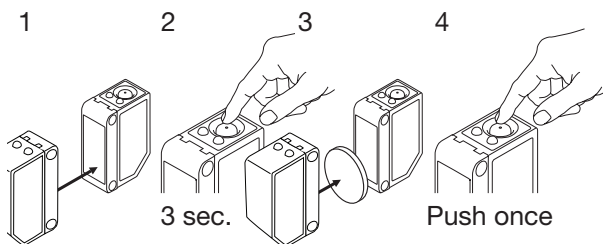

For dynamic set-up (running process)

1. Line up the emitter and receiver. Green LED is ON, status on the yellow LED is not important.
2. Press the button for 3 second until both LEDs flashes simultaneously.
(The first switch point is stored)
3. Press the button a second time and keep the button pressed for at least one process cycle, release the button and the sensor is ready to operate (The second switch point is stored)

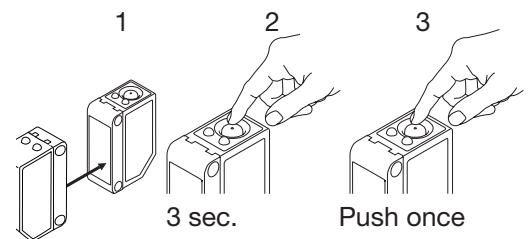

For maximum sensing distance (default setting)

1. Line up the emitter and receiver, place the object between the emitter and receiver in the detection zone. Yellow LED is OFF and Green LED is ON.
2. Press the button for 3 seconds until both LEDs flashes simultaneously.
(The first switch point is stored)
3. Press the button a second time and the sensor is ready to operate (Green LED ON, Yellow LED ON)
(The second switch point is stored)

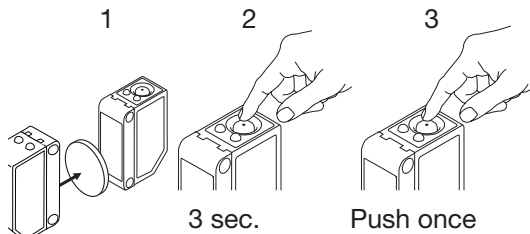

For make or break set-up

1. Press the button for 10 seconds, until the green LEDs flashes.
2. While the green LED flashes, the output is inverted each time the button is pressed. Yellow LED indicates N.O. function selected.
If the button is not pressed within the next 10 seconds, the current output is stored.

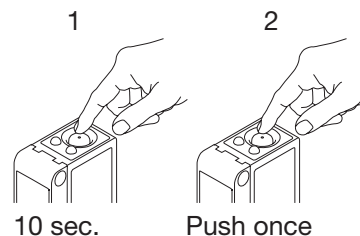

For minimum sensing distance (Transparent or semi-transparent objects)

1. Line up the emitter and receiver. Yellow LED and Green LED are ON.
2. Press the button for 3 seconds until both LEDs flashes simultaneously.
(The first switch point is stored)
3. Press the button a second time and the sensor is ready to operate (Green LED ON, Yellow LED ON)
(The second switch point is stored)

