



# TR4-SBM01C

TR4 Direct

NON-CONTACT SAFETY SWITCHES

**SICK**  
Sensor Intelligence.



### Ordering information

Type	Part no.
TR4-SBM01C	6035190

Other models and accessories → [www.sick.com/TR4\\_Direct](http://www.sick.com/TR4_Direct)



### Detailed technical data

#### Features

<b>System part</b>	Sensor and actuator
<b>Sensor principle</b>	Transponder
<b>Number of safe outputs</b>	2
<b>Safe switch on distance <math>S_{ao}</math></b>	25 mm
<b>Safe switch off distance <math>S_{ar}</math></b>	35 mm
<b>Active sensor surfaces</b>	2
<b>Actuation directions</b>	5
<b>Coding</b>	Universally coded

#### Safety-related parameters

<b>Safety integrity level</b>	SIL3 (IEC 61508), SILCL3 (EN 62061)
<b>Category</b>	Category 4 (EN ISO 13849)
<b>Performance level</b>	PL e (EN ISO 13849)
<b>PFH<sub>D</sub> (mean probability of a dangerous failure per hour)</b>	$1.119 \times 10^{-9}$ (EN ISO 13849)
<b>T<sub>M</sub> (mission time)</b>	20 years (EN ISO 13849)
<b>Type</b>	Type 4 (EN ISO 14119)
<b>Actuator coding level</b>	Low coding level (EN ISO 14119)
<b>Classification in compliance with IEC/EN 60947-5-3</b>	PDF-M
<b>Safe state in the event of a fault</b>	At least one safety-related semiconductor output (OSSD) is in the OFF state.

#### Functions

<b>Cascading</b>	✓
------------------	---

#### Interfaces

<b>Connection type</b>	Cable with plug M12, 8-pin
Length of cable	0.2 m
Cable material	PVC
Long connecting cable	≤ 200 m
<b>Status display</b>	✓

## Electrical data

<b>Protection class</b>	III (EN 50178)
<b>Classification according to cULus</b>	Class 2
<b>Supply voltage <math>V_s</math></b>	24 V DC (20.4 V DC ... 26.4 V DC)
<b>Power consumption</b>	50 mA
<b>Type of output</b>	Semiconductor (OSSD)
<b>Output current</b>	≤ 200 mA
<b>Response time</b>	60 ms <sup>1)</sup>
<b>Enable time</b>	360 ms <sup>2)</sup>
<b>Risk time</b>	60 s <sup>3)</sup>
<b>Switch-on time</b>	2.5 s <sup>4)</sup>
<b>Electrical life</b>	10 x 10 <sup>6</sup> switching cycles

<sup>1)</sup> In a cascade, each downstream safety switch increases the system response time. More response times can be found in the operating instructions.

<sup>2)</sup> Response time on approach to the enable zone.

<sup>3)</sup> Detection time for external faults (e.g., short-circuit or cross-circuit of output signal switching devices). Follow the detailed information in the operating instructions.

<sup>4)</sup> After application of the supply voltage to the safety switch.

## Mechanical data

<b>Design</b>	Cylindrical
<b>Housing diameter (sensor/actuator)</b>	M18 / M30
<b>Weight</b>	79 g
<b>Housing material</b>	Valox® DR48

## Ambient data

<b>Enclosure rating</b>	IP69K (IEC 60529) NEMA 3 (NEMA 250) NEMA 4X (NEMA 250) NEMA 12 (NEMA 250) NEMA 13 (NEMA 250)
<b>Ambient operating temperature</b>	-10 °C ... +55 °C
<b>Vibration resistance</b>	10 Hz ... 55 Hz, 3.5 mm (IEC 60068-2-6)
<b>Shock resistance</b>	30 g, 11 ms (EN 60068-2-27)

## Classifications

<b>ECl@ss 5.0</b>	27272403
<b>ECl@ss 5.1.4</b>	27272403
<b>ECl@ss 6.0</b>	27272403
<b>ECl@ss 6.2</b>	27272403
<b>ECl@ss 7.0</b>	27272403
<b>ECl@ss 8.0</b>	27272403
<b>ECl@ss 8.1</b>	27272403
<b>ECl@ss 9.0</b>	27272403
<b>ETIM 5.0</b>	EC001829
<b>ETIM 6.0</b>	EC001829
<b>UNSPSC 16.0901</b>	39122205

**Dimensional drawing** (Dimensions in mm (inch))

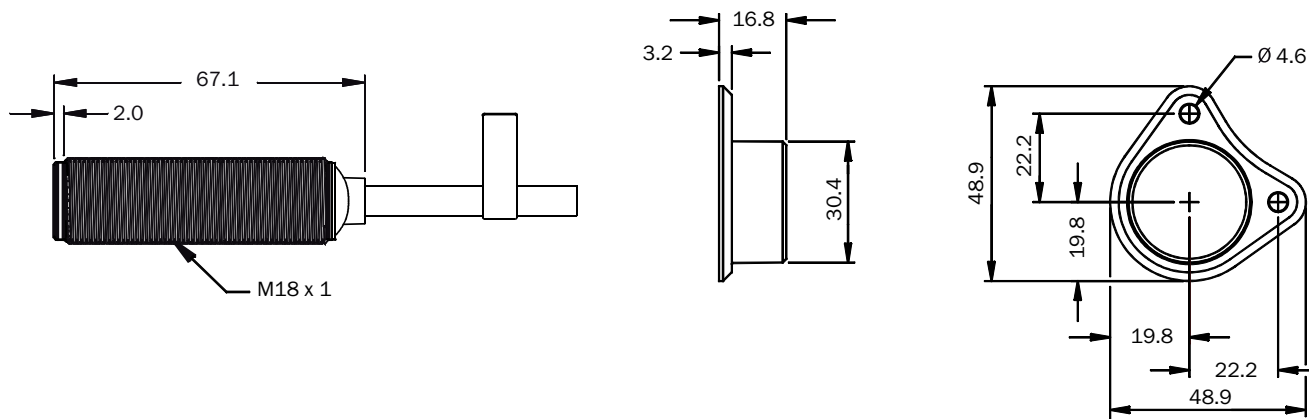

**Response range**

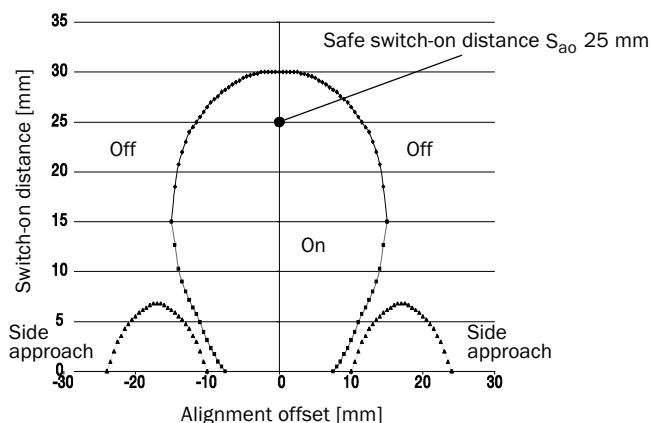

If the actuator moves laterally in relation to the surface of the sensor, a minimum distance of 7 mm must be maintained. This distance will prevent premature triggering due to the side approach areas.

**Connection diagram**

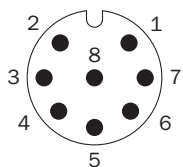

1	Aux output (not safe)
2	Voltage supply 24 V DC
3	Not connected
4	Enable input for OSSD 2
5	OSSD 1
6	OSSD 2
7	Voltage supply 0 V DC
8	Enable input for OSSD 1

## Connection single sensor

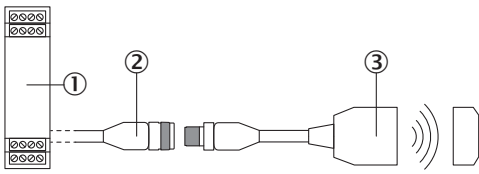

- ① Safe evaluation unit
- ② Connecting cable with 8-pin, M12 female connector and flying leads (e.g., YF2A18-xxxUA5LEAX)
- ③ TR4 Direct transponder safety switch (e.g., TR4-Sxx01C)

## Series connection

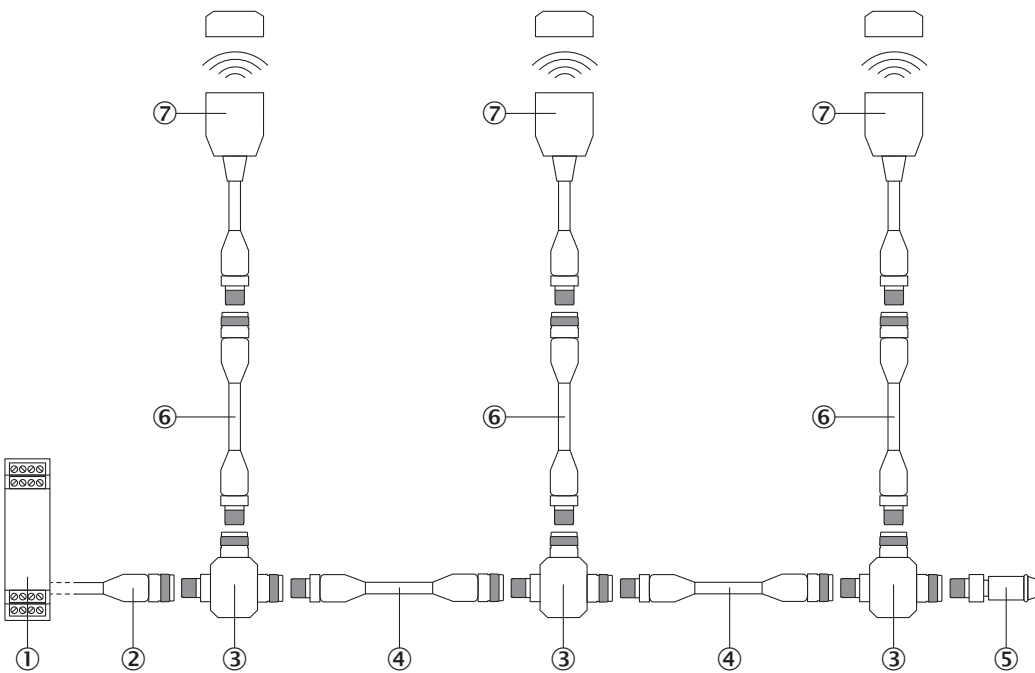

Series connection with T-piece (without diagnostics)



- ① Safe evaluation unit
- ② Connecting cable with 4-pin, M12 female connector and flying leads (e.g., YF2A14-xxxVB3XLEAX)
- ③ TR4-AK004C T-connector
- ④ Connection cable with 4-pin, M12 male connector and 4-pin, M12 female connector (e.g., YF2A14-xxxVB3M2A14)
- ⑤ MLP1-XT end connector
- ⑥ Connection cable with 8-pin, M12 male connector and 8-pin, M12 female connector (e.g., YF2A18-xxxUA5M2A18)
- ⑦ TR4 Direct transponder safety switch (e.g., TR4-Sxx01C)

## Recommended accessories

Other models and accessories → [www.sick.com/TR4\\_Direct](http://www.sick.com/TR4_Direct)

	Brief description	Type	Part no.
<b>Mounting brackets and plates</b>			
	Mounting bracket for M18 sensors, steel, zinc coated, without mounting hardware	BEF-WN-M18	5308446
<b>Terminal and alignment brackets</b>			
	Clamping block for round sensors M18, without fixed stop, plastic (PA12), glass-fiber reinforced, mounting hardware included	BEF-KH-M18	2051481
<b>Plug connectors and cables</b>			
	Head A: female connector, M12, 8-pin, straight, A-coded Head B: Flying leads Cable: Sensor/actuator cable, PUR, halogen-free, unshielded, 2 m	YF2A18-020UA5XLEAX	2095652
	Head A: female connector, M12, 8-pin, straight, A-coded Head B: Flying leads Cable: Sensor/actuator cable, PUR, halogen-free, unshielded, 5 m	YF2A18-050UA5XLEAX	2095653
	Head A: female connector, M12, 8-pin, straight, A-coded Head B: Flying leads Cable: Sensor/actuator cable, PUR, halogen-free, unshielded, 10 m	YF2A18-100UA5XLEAX	2095654

## SICK AT A GLANCE

SICK is one of the leading manufacturers of intelligent sensors and sensor solutions for industrial applications. A unique range of products and services creates the perfect basis for controlling processes securely and efficiently, protecting individuals from accidents and preventing damage to the environment.

We have extensive experience in a wide range of industries and understand their processes and requirements. With intelligent sensors, we can deliver exactly what our customers need. In application centers in Europe, Asia and North America, system solutions are tested and optimized in accordance with customer specifications. All this makes us a reliable supplier and development partner.

Comprehensive services complete our offering: SICK LifeTime Services provide support throughout the machine life cycle and ensure safety and productivity.

For us, that is “Sensor Intelligence.”

## WORLDWIDE PRESENCE:

Contacts and other locations –[www.sick.com](http://www.sick.com)