

Miniature circuit-breakers S 200/S 200 M
Residual-current-operated
circuit-breakers F 200
Cross wiring/accessories

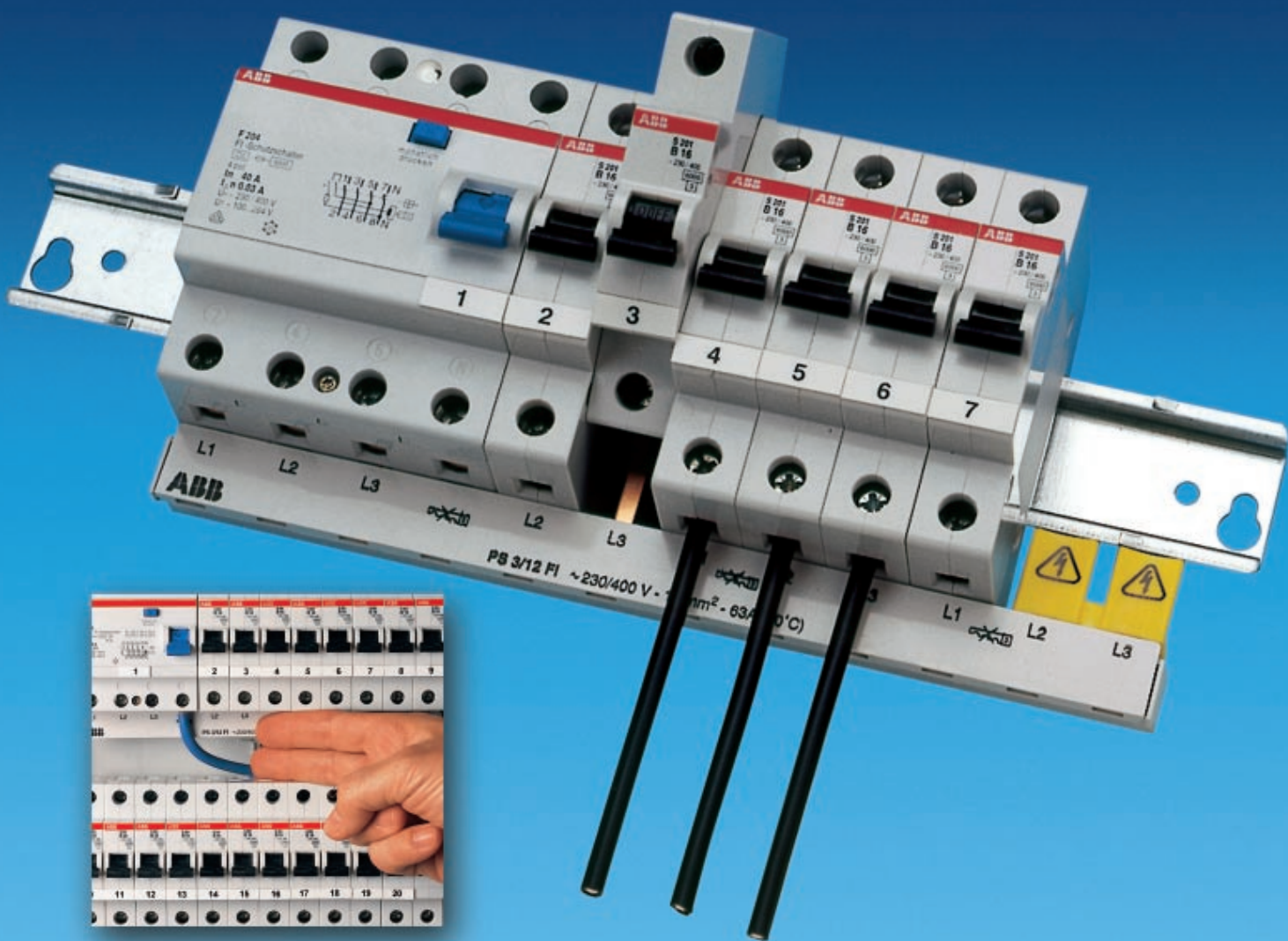

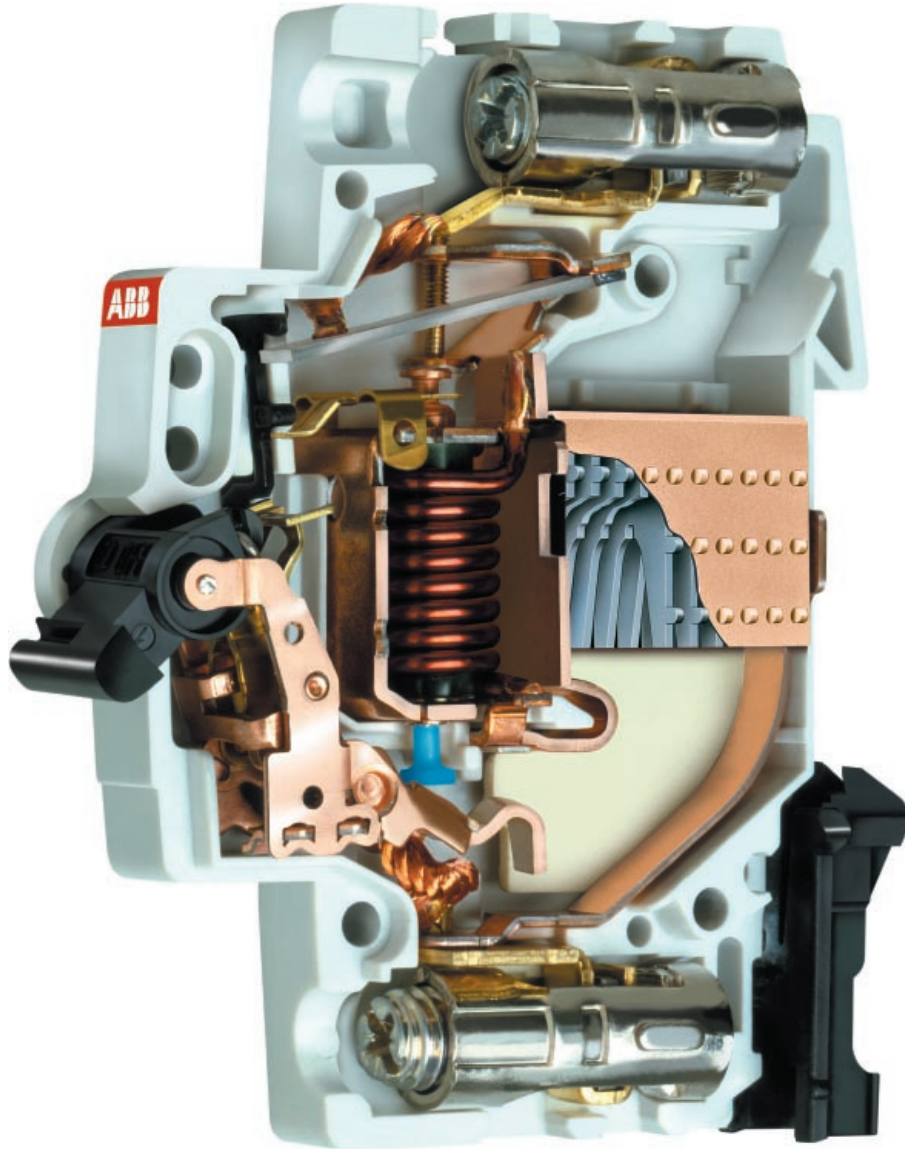

Standard Terms for Delivery and Sale

For domestic business, the Standard Terms for Delivery of Products and Services of the Electrical Industry (ABB Form 2292) shall apply in connection with the Standard Sales Terms (ABB Form 2327) in their then applicable version. For foreign business, the Standard Terms for Delivery of Products and Services of the Electrical Industry (ABB Form 2293 German-English, or ABB Form 2294 German- French) shall apply in connection with the Standard Sales Terms (ABB-Form 2381 English) in their then applicable version.

Warranty

We assume warranty in accordance with the standard sales and delivery terms. Complaints shall be made in writing within eight days following receipt of the goods.

Technical information and illustrations are not binding and subject to change without notice.

Contents

page

The technology of S 200

Notes for use, special features	4
The offer at a glance	6
Overview of technical data	7
Internal resistance and power loss	8
Max. permissible impedances of fault loops	8
Tripping characteristics	9
Short circuit capacity	9
Short circuit selectivity	10
Tripping diagrams	11
Let-through value diagrams	13
Current-carrying capacity, thermal influence	14
Applications S 200	15
Installation and operation instructions S 200	16
Supplementary devices	17
Dimensions	25
Dimension drawings accessories	26

The technology of F 200

Supplementary devices	17
Description, Application examples	20
Technical data	21
Installation and operation instructions F 200	22
Use in different types of circuit	23
Dimension drawings	26
Dimension drawings accessories	27

The technology of busbars

Description	24
Technical data	24
Dimensions	27

The program

Selection table S 200-B	29
Selection table S 200-C	31
Selection table S 200-D	33
Selection table S 200-K	35
Selection table S 200-Z	37
Selection table S 200-K H	39
Selection table S 200 M-B	41
Selection table S 200 M-C	43
Supplementary devices	44
Selection table F 200	45
Selection table busbars, rail connectors	47
Selection table accessories	49

Prior to connection of aluminium conductors ($\geq 4 \text{ mm}^2$) ensure that their contact points are cleaned, brushed and coated with grease.

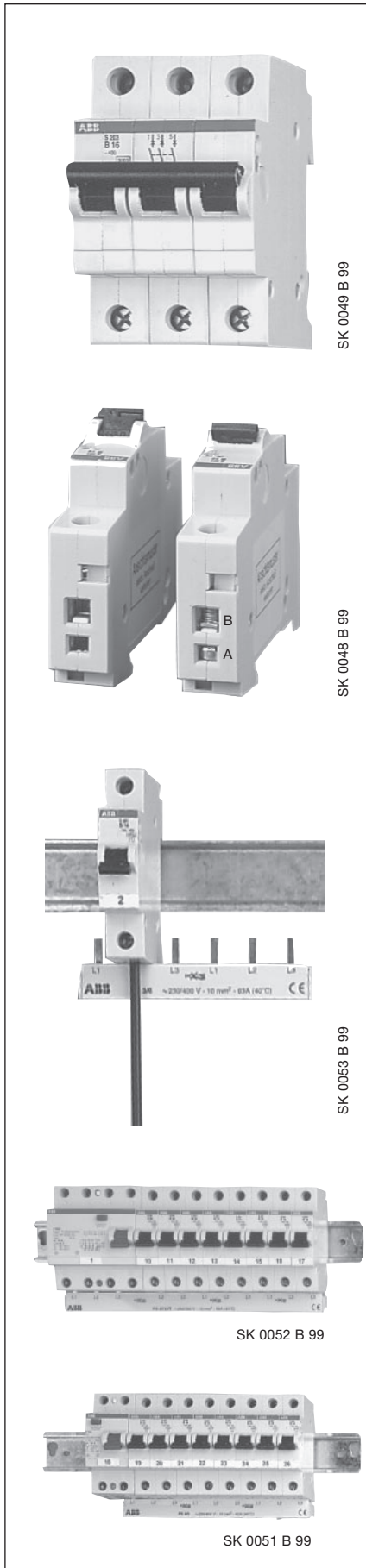

- All round protection against contact with live parts in accordance with DIN VDE 106 part 100.
- Due to new design: Upper and lower shoulders reduced. More working space between component rows. Outgoing and incoming connection points easily accessible.
- New, failsafe, bi-directional cylinder lift terminal, ensuring a faster, totally error-free connection. As you tighten the screw, the terminal draws together to simultaneously close the front and rear wiring inputs. This creates a strong, contactassured connection between the wires and the device, in a single operation. Busbar is installed at the back terminals (A). Connection of conductors on the front terminals (B). Result: a clear view on all connection points. Never fumble for the right connection point again. Substantially improved cross-wiring safety. Tangible time-savings.
- Connection possible for single, multi and finely stranded conductors of 0.75 to 25 mm². It is also possible to connect conductors with different cross section at the same time.
- New cross wiring busbars. Standard length sizes or meter length cutable.



- New quick-fastening technique for easy disconnection of the device from the assembly.
No time-consuming extra work:
Cross-wiring remains with the assembly.
To remove the device, just loosen the screw, lift the device and pull it out.
If necessary, all devices of the series connected to the new pro M compact cross-wiring rails may be exchanged easily and quickly, e.g. to implement the adaptation to the VDE standard 0100 part 410.
Easy to add on MCB for extensions.

- New, integrated auxiliary contact, factory fitted, reduces space by 50 %.
Cross wiring to customary compact busbar possible.

- Self-adhesive identification labels are provided for all devices, ensuring clear and accurate identification.
Every detail of System pro M compact has now been optimised to meet the user's requirements.
Furthermore, System pro M compact offers you many different ways to label the switchgear cabinet and built-in consumer unit in a professional manner.
Individual, efficient labeling of devices.

- Pad lock prevents unauthorized switching to ON or OFF.

- Complete range of tripping characteristics in B, C, D, K, Z.
- High rated switching capacity of 6 000 A (S 200) or 10 000 A (S 200 M).
- Current limitation is below the values prescribed by the VDE, therefore higher selectivity rating than energy limitation class 3.
- Disconnecter abilities according to DIN VDE 0660 part 107, surge withstand capability 6 kV (1.2/50).

Trip characteristics

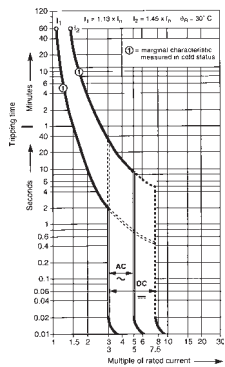

SK 0126 Z 00

B

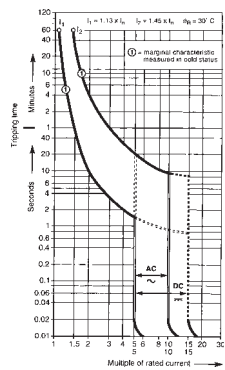

SK 0128 Z 00

C

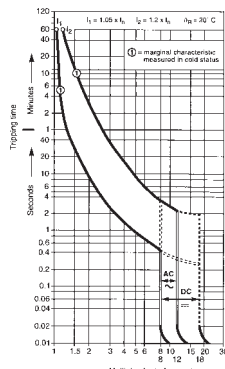

SK 0142 Z 00

D

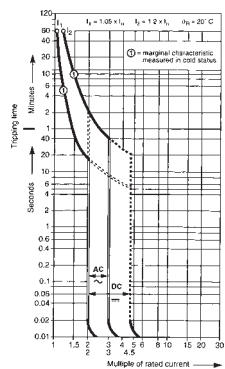

SK 0146 Z 00

Z

Description

The MCBs of the S 200/S 200 M series have a current-limiting effect. They have two different trip releases acting on the contact mechanism

1. the delayed thermal release providing overload protection
2. the electromagnetic instantaneous release with "hammer trip" solenoid providing fault current protection.

They offer:

- high short-circuit capacity
- high selectivity for back-up fuse
- In case of short-circuit, low stress on the cable in the point of fault due to the high limitation of the let-through $\int i^2 dt$ (current heating value).

Oscillogram of rupturing process

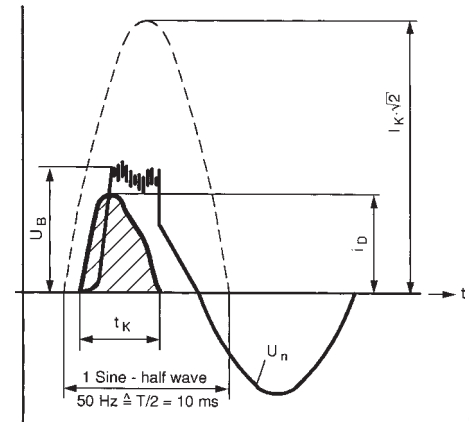

SK 0130 Z 98

Task

To protect against excessive temperature rises of electric items in the case of overcurrents caused by overload, short circuit of earth-fault current if assigned according to DIN VDE 0100 Part 430. Protection against electric shock in the case of excessive touch voltage caused by insulation fault if assigned according to DIN VDE 0100 Part 410.

Trip characteristics and rated current

Independent of the type of characteristic, national codes of practice provide what highest rated current and/or performance characteristic can be assigned to the conductor cross section to be protected (e.g. DIN VDE 0100 Part 430).

The following assignment rules apply: $I_b \leq I_n \leq I_z$; $I_2 \leq 1,45 \cdot I_z$

- I_b = operating current of the circuit to be expected
- I_n = rated current of the MCB of characteristics type B, C, D, K and Z
- I_z = permissible current loading of lines
- I_2 = conventional tripping current

B-, C- and D-type trip characteristics for line protection

Tripping behaviour according to DIN VDE 0641 Part 11. Rated current 6 ... 63 A, (C 0,5 ... 63 A). The introduction of these trip characteristics enables direct assignments of MCBs to the permissible load of lines I_z according to DIN VDE 0298 Part 4/11.98, as the second condition is already fulfilled ($I_2 = 1.45 \cdot I_n$).

K-type trip characteristics

Tripping behaviour according to DIN VDE 0660 Part 101 and IEC 947-2, rated current 0.5 ... 63 A, for circuits where current-consuming apparatus cause functional current peaks and for the overcurrent protection of lines.

Z-type trip characteristics

Tripping behaviour according to DIN VDE 0660 Part 101 and IEC 947-2. Rated current 0.5 ... 63 A in 17 grades. For the protection of semiconductors and measuring circuits with transformers.

Technical data

Specifications:	DIN VDE 0641 Part 11, IEC 60898, EN 60898, IEC 60947-2, UL 1077
No. of poles:	1, 2, 3, 4, 1 + NA, 3 + NA
tripping characteristics:	B, C, D, K, Z
rated current I_n :	B 6 ... 63 A, C, D, K and Z 0,5 ... 63 A
rated voltage U_n :	1-pole 230 V ~ multipole 400 V ~
max. operating voltage U_{Bmax} :	AC $U_n + 10\%$ DC 1-pole 60 V ~ 2-pole 125 V ~
min. operating voltage U_{Bmin} :	12 V~, 12 V-
energy limitation class:	S 3
short circuit rupturing capacity:	see page 9
frequency:	50 ... 60 Hz
insulation coordination:	according to DIN VDE 0110 Part 1 and 2
- overvoltage category:	III
- pollution degree:	2
- surge voltage:	5 kV (1.2/50 μ s)
- impulse alternating voltage:	3 kV (50/60 Hz)
housing:	Insulating material rating I (CTI \geq 600) according to DIN IEC 112/VDE 0303 Part 1, RAL 7035
operating lever:	Insulating material rating II ($400 \leq$ CTI < 600) black, sealable
degree of protection acc. to DIN VDE 0100:	IP 20, in the consumer unit IP 40
dimensions:	according to DIN 43880, size code 1
depth of device:	68 mm
overall dimensions:	see page 25
mounting position:	optional
fixing:	snap-on to DIN rails EN 60 715, 35 mm or screw fixing by means of mounting plate (see accessories)
connection:	failsafe bi-directional cylinder-lift terminal at top and bottom, shock-protected according to
to	DIN VDE 0106 Part 100. Suitable for connection of single, multi or finely stranded conductors up to 25 mm ² (if also connected to rails)
tightening torque:	2.8 Nm
mechanical service life:	20,000 operations
service life at rated load	
$I_n < 32$ A:	20,000 operations
$I_n \geq 32$ A:	10,000 operations
climatic resistance acc. to DIN IEC 68 Part 2-30:	constant climate 23/83, 40/93, 55/20 [°C/RH] alternating climate 25/95 - 40/93 [°C/RH]
storage temperature:	T_{max} +70 °C/15 _g .F, T_{min} -40 °C/-13 °F
ambient temperature:	T_{max} +55 °C/15 _g .F, T_{min} -25 °C/-13 °F
shock resistance:	30 g, at least 2 impacts shock duration 13 ms
resistance to vibration acc. to DIN IEC 68-2-6:	5 g, 20 frequency cycles 5 ... 150 ... 5 Hz at 0.8 I_n
weight:	see selection tables

Technical data of the integrated auxiliary contact

contact:	1NO (1 make contact) 1NC (1 normally closed contact)
contact load:	AC 14 230 V 2 A DC 12 identical DC 13 DC 13 50 V 1 A
min. operating voltage:	12 VAC/DC at 0.1 VA
short-circuit withstand capacity:	230 V~ 1,000 A
electrical service life:	> 4,000 operations
safe disconnection of auxiliary circuit and main circuit according to VDE 0106 Part 101	
connection capacity:	0.75 to 2.5 mm ² (finely-stranded conductors to be fitted with a connector sleeve)

Internal resistance and power loss of the miniature circuit-breakers

Internal resistance per pole in mΩ, power loss per pole in W

type	rated current I_n A	device series B, C, D Ⓣ		K		Z	
		mΩ	W	mΩ	W	mΩ	W
S 200 and S 200 M	0.5	5500	1.4	6340	1.6	10100	2.5
	1	1440	1.4	1550	1.6	2270	2.3
	1.6	630	1.6	695	1.8	1100	2.8
	2	460	1.8	460	1.9	619	2.5
	3	150	1.3	165	1.5	202	1.8
	4	110	1.8	120	2.0	149	2.4
	6	55	2.0	52	1.9	104	3.7
	8	15	1.0	38	2.5	53.9	3.45
	10	13.3	1.3	12.6	1.26	17.5	1.7
	13	13.3	2.3	12.6	1.26	–	–
	16	7.0	1.8	7.7	2.0	10.9	2.8
	20	6.25	2.5	6.7	2.7	6.0	2.4
	25	5.0	3.2	4.6	2.9	4.1	2.6
	32	3.6	3.7	3.5	3.6	2.8	2.9
	40	3.0	4.8	2.8	4.5	2.5	4.1
	50	1.3	3.25	1.25	2.9	1.8	4.4
	63	1.2	4.8	0.7	5.2	1.3	5.2

Ⓣ Current intensities 0.5 – 4 apply exclusively to C-type trip characteristics.

Maximum permissible fault loop impedance Z_s at $U_0 = 230 V \sim$ Ⓣ
to ensure compliance with the rupturing conditions prescribed in DIN VDE 0100 Part 410.

The internal resistance of MCB is included.

Note: Attention should be paid to the maximum voltage drop

S 200 and S 200 M

Bemessungs- strom I_n A	B max. Z_s Ω	C max. Z_s Ω	D max. Z_s Ω	K max. Z_s Ω	Z max. Z_s Ω
0,5		46.0	33.0	38.3	153.3
1		23.0	16.5	19.2	76.7
1.6		14.4	10.3	12.0	47.9
2		11.5	8.2	9.6	38.3
3		7.7	5.5	6.4	25.6
4		5.8	4.1	4.8	19.2
6	7.7	3.8	2.7	3.2	12.8
8	–	2.8	2.1	2.4	9.5
10	4.6	2.3	1.6	1.9	7.7
13	3.5	1.7	1.2	–	–
16	2.9	1.4	1.0	1.2	4.8
20	2.3	1.2	0.8	1.0	3.8
25	1.8	0.9	0.7	0.8	3.1
32	1.4	0.7	0.5	0.6	2.4
40	1.2	0.6	0.4	0.5	1.9
50	0.9	0.5	0.3	0.4	1.5
63	0.7	0.4	0.3	0.3	1.2

Ⓣ U_0 = rated voltage against earthed conductor; for $U_0 = 240 V \sim$: $Z_s \cdot 1.04$; for $U_0 = 127 V \sim$: $Z_s \cdot 0.55$
The max. permissible length of cable at different voltage and cross sections on request.

Tripping characteristics

acc. to	tripping characteristic and rated current		thermal release ^②		tripping time	electromagnetic release ^③		tripping time
			current: conventional non-tripping c.	conventional tripping c.		currents: hold current surges	trip at least at	
DIN VDE 0641/T 11	B	6 to 63 A	$1.13 \cdot I_n$	$1.45 \cdot I_n$	> 1 h < 1 h	$3 \cdot I_n$	$5 \cdot I_n$	> 0.1 s < 0.1 s
	C	0.5 to 63 A	$1.13 \cdot I_n$	$1.45 \cdot I_n$	> 1 h < 1 h	$5 \cdot I_n$	$10 \cdot I_n$	> 0.1 s < 0.1 s
	D	0.5 to 63 A	$1.13 \cdot I_n$	$1.45 \cdot I_n$	> 1 h < 1 h	$10 \cdot I_n$	$20 \cdot I_n$	> 0.1 s < 0.1 s
DIN VDE 0660/9.82	K	0.5 to 63 A	$1.05 \cdot I_n$	$1.2 \cdot I_n$	> 1 h < 1 h	not applicable		
DIN VDE 0660 8/69 Part 1 ^④			$1.05 \cdot I_n$	$1.2 \cdot I_n$ $1.5 \cdot I_n$ $6.0 \cdot I_n$	> 2 h < 2 h ^③ < 2 min. ^③ > 2 s (T1)	$8 \cdot I_n$	$12 \cdot I_n$	> 0.2 s < 0.2 s
DIN VDE 0660/9.82	Z	0.5 to 63 A	$1.05 \cdot I_n$	$1.2 \cdot I_n$	> 1 h < 1 h	not applicable		
DIN VDE 0660 8/69 Part 1 ^④			$1.05 \cdot I_n$	$1.2 \cdot I_n$ $1.5 \cdot I_n$ $6.0 \cdot I_n$	> 2 h < 2 h ^③ < 2 min. ^③ > 2 s (T1)	$2 \cdot I_n$	$3 \cdot I_n$	> 0.2 s < 0.2 s

① The indicated tripping values of electromagnetic tripping devices apply to a frequency range of 16 2/3 ... 60 Hz. In the case of diverging frequencies or direct current, the values change by the factor indicated below

factor ca.	alternating current			direct current
	100 Hz	200 Hz	400 Hz	
	1.1	1.2	1.5	1.5

The thermal release operates independently of voltages.

② The thermal releases are calibrated to a nominal reference ambient temperature; for Z and K, the value is 20 °C, for B and C = 30 °C. In the case of higher ambient temperatures, the current values fall by ca. 6% for each 10 K temperature rise.

③ as from operating temperature (after $I_1 > 1$ h or, as applicable, 2 h).

④ The standard DIN VDE 0660/9.69 has expired in 1986, but is still referred to due to its complete statement of the tripping characteristics.

Short circuit rupturing capacity and back-up

operating sequence: **B and C according to DIN VDE 0641, DIN VDE 0660 Part 101 I_{cs} K and Z according to IEC 947**

series	trip characteristic	1phase 133 V ~	alternating current				direct current	Max. back-up	
			230 V ~	2/3phase 230 V ~	400 V ~ 133/230 V ~	1pole ^① 60 V ... 230/400 V ~		kA/T ≤ ms	fuse gL ^②
S 200-B	A	6	10/0.5	6/0.7	10/0.5	6/0.7	10/4.0	63 A	100 A
S 200 M-B	10 ... 20	100 A						100 A	
	25 ... 32	100 A						100 A	
	40	125 A						100 A	
	50 ... 63	160 A						100 A	
S 200-C	A	0.5 ... 2	unlimited				not required		
S 200 M-C	A	3 ... 4	10/0.5	6/0.7	10/0.5	6/0.7	10/4.0	20 A	-
S 200-D	6	40 A						100 A	
	8	63 A						100 A	
	10 ... 20	100 A						100 A	
	25 ... 32	100 A						100 A	
	40	125 A						100 A	
50 ... 63	160 A	100 A							
S 200-K	A	0.5 ... 2	unlimited				not required		
S 200-Z	3	20 A	-						
	4	25 A	-						
	6 ... 10	63 A	100 A						
	16 ... 20	80 A	100 A						
	25 ... 32	100 A	100 A						
	40	125 A	100 A						
50 ... 63	160 A	100 A							
S 200-Z	A	0.5 ... 2	unlimited				not required		
S 200-Z	3 ... 4	20 A	-						
	6	35 A	100 A						
	8	40 A	100 A						
	10 ... 16	63 A	100 A						
	20 ... 25	80 A	100 A						
	32 ... 40	100 A	100 A						
	50 ... 63	125 A	100 A						

① In symmetrically earthed direct current circuits, 2-pole devices (two poles connected in series) can be used up to 110 VDC. Any connection is possible, polarity does not need to be taken into account.

② Back-up protection is necessary only if the solid short-circuit current to be expected at the place of installation may exceed the switching capacity indicated.

Short circuit selectivity: In the case of a short circuit, selectivity exists up to the values indicated.

series	I_n A	short circuit discrimination in kA									to fuse gL/gG (DIN VDE 0636; IEC 269/3)													
		16	20	25	35	40	50	63	80	100	16	20	25	35	50	63	80	100	125	160				
S 200-B, C, D Current values smaller than 6 A and 8 A, apply only to C and D characteristics.	≤ 2	>15	>15	>15	>15	>15	>15	>15	>15	>15	1	1.2	4	>15	>15	>15	>15	>15	>15	>15	>15	>15		
	3	10	10	10	10	10	10	10	8	8	0.3	0.7	1.2	4.6	6	6	6	6	6	6	6	6	6	
	4	10	10	10	10	10	10	10	8	8	0.3	0.6	0.9	2.8	6	6	6	6	6	6	6	6	6	
	6	10	10	10	10	10	10	10	8	8	0.2	0.5	0.8	2	3.3	5.5	6	6	6	6	6	6	6	
	8	10	10	10	10	10	10	10	8	8	0.2	0.4	0.7	1.7	2.8	4.5	6	6	6	6	6	6	6	
	10	10	10	10	10	10	10	10	8	8	0.2	0.4	0.7	1.5	2.5	3.5	5	6	6	6	6	6	6	
	13	10	10	10	10	10	10	10	8	8			0.7	1.5	2.5	3.5	5	6	6	6	6	6	6	
	16	10	10	10	10	10	10	10	8	8				1.3	2	2.9	4.1	6	6	6	6	6	6	
	20		10	10	10	10	10	10	8	8					1.8	2.6	3.5	5	6	6	6	6	6	
	25			10	10	10	10	10	8	8					1.8	2.6	3.5	5	6	6	6	6	6	
	32				10	10	10	10	8	8						2.2	3	4	6	6	6	6	6	
	40			**		10	10	10	8	8						2.5	4	6	6	6	6	6	6	
	50/63						10	10	8	8								3.5	5	6	6	6	6	
S 200 M-B, C Current values smaller than 6 A and 8 A, apply only to C characteristics.	≤ 2	>15	>15	>15	>15	>15	>15	>15	>15	>15	1	1.2	4	>15	>15	>15	>15	>15	>15	>15	>15	>15		
	3	15	15	15	15	15	15	15	10	10	0.3	0.7	1.2	4.6	6	6	6	6	6	6	6	6	6	
	4	15	15	15	15	15	15	15	10	10	0.3	0.6	0.9	2.8	6	6	6	6	6	6	6	6	6	
	6	15	15	15	15	15	15	15	10	10	0.2	0.5	0.8	2	3.3	5.5	6	6	6	6	6	6	6	
	8	15	15	15	15	15	15	15	10	10	0.2	0.4	0.7	1.7	2.8	4.5	6	6	6	6	6	6	6	
	10	15	15	15	15	15	15	15	10	10	0.2	0.4	0.7	1.5	2.5	3.5	5	6	6	6	6	6	6	
	13	15	15	15	15	15	15	15	10	10			0.7	1.5	2.5	3.5	5	6	6	6	6	6	6	
	16	15	15	15	15	15	15	15	10	10				1.3	2	2.9	4.1	6	6	6	6	6	6	
	20		15	15	15	15	15	15	10	10					1.8	2.6	3.5	5	6	6	6	6	6	
	25			15	15	15	15	15	10	10					1.8	2.6	3.5	5	6	6	6	6	6	
	32				15	15	15	15	10	10						2.2	3	4	6	6	6	6	6	
	40			**		15	15	15	10	10						2.5	4	6	6	6	6	6	6	
	50/63					15	15	10	10	10							3.5	5	6	6	6	6	6	
S 200-K Selectivity values apply to I_{cu} according to IEC 947-2.	≤ 2	>15	>15	>15	>15	>15	>15	>15	>15	>15	0.3	1.2	4	>15	>15	>15	>15	>15	>15	>15	>15	>15		
	3	10	10	10	10	10	10	10	10	10	0.3	0.7	1.2	4.6	6	6	6	6	6	6	6	6	6	
	4	10	10	10	10	10	10	10	10	10	0.3	0.6	0.9	2.8	6	6	6	6	6	6	6	6	6	
	6	10	10	10	10	10	10	10	10	10			0.7	1.7	3	5.9	6	6	6	6	6	6	6	
	8	10	10	10	10	10	10	10	10	10				1.3	2.2	3.6	6	6	6	6	6	6	6	
	10	10	10	10	10	10	10	10	10	10					1.7	2.5	4	6	6	6	6	6	6	
	16	10	10	10	10	10	10	10	10	10						2.2	3.1	4.6	6	6	6	6	6	
	20		10	10	10	10	10	10	10	10							3.1	4.6	6	6	6	6	6	
	25			10	10	10	15	10	10	10							2.6	3.5	6	6	6	6	6	
	32				10	10	10	10	10	10								3.5	6	6	6	6	6	
	40			**		10	10	10	10	10									5.5	6	6	6	6	
	50/63					10	10	10	10	10													6	6
	S 200 Z Selectivity values apply to I_{cu} according to IEC 947-2.	≤ 2	>15	>15	>15	>15	>15	>15	>15	>15	>15	0.5	2	>15	>15	>15	>15	>15	>15	>15	>15	>15	>15	
3		10	10	10	10	10	10	10	10	10	0.3	0.7	1.2	6	6	6	6	6	6	6	6	6	6	
4		10	10	10	10	10	10	10	10	10	0.3	0.6	1.3	7	6	6	6	6	6	6	6	6	6	
6		10	10	10	10	10	10	10	10	10	0.2	0.5	0.9	2.7	6	6	6	6	6	6	6	6	6	
8		10	10	10	10	10	10	10	10	10	0.2	0.5	0.6	1.7	3.8	6	6	6	6	6	6	6	6	
10		10	10	10	10	10	10	10	10	10			0.4	0.6	1.3	2.4	4	6	6	6	6	6	6	
16		10	10	10	10	10	10	10	10	10				0.5	1.1	1.7	3	4.5	6	6	6	6	6	
20			10	10	10	10	10	10	10	10					0.9	1.5	2.3	3.5	5.2	6	6	6	6	
25				10	10	10	15	10	10	10						1.4	2	3	4	6	6	6	6	
32					10	10	10	10	10	10						1.4	2	3	4	6	6	6	6	
40				**		10	10	10	10	10							2	3	4	6	6	6	6	
50/63						10	10	10	10	10							2.2	3.5	5.8	6	6	6	6	

** Limited or no selectivity at all possible in the overload range (thermal tripping)

The above values require that, in the case of multi-phase installations, that the last cb be feed from above.

Tripping diagrams

Reading example for tripping characteristic of the B-type trip characteristics (in connection with the table **tripping characteristics** on page 9, line **B**)

a Thermal tripping characteristic:

Conventional non-tripping current I_1 = selected non-tripping current
The MCB maintains the 1.13 times of the rated current for at least 60 minutes.
Conventional tripping current I_2 = selected tripping current.
The MCB switches off within 60 minutes when the 1.45 times of the rated current is reached.

b Electromagnetic trip characteristic AC:

The MCB maintains current rushes of the 3-fold of the rated current for more than 0.1 sec. (in this example up to ca. 4 sec.).

The MCB switches off within less than 0.1 sec when the 5-times of the rated current is reached.

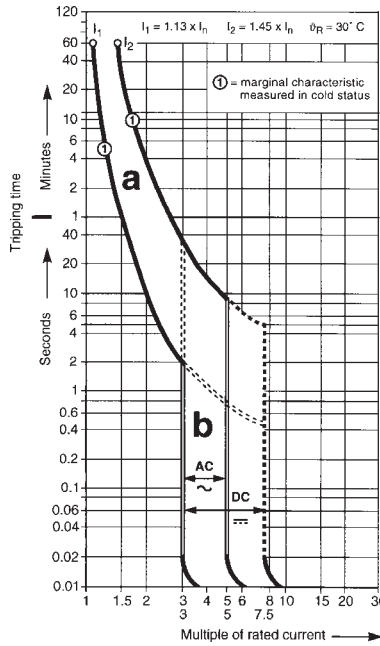

SK 0038 Z 01

trip characteristic: B
 $I_n = 6 \dots 63 \text{ A}$
S 200/S 200 M MCBs

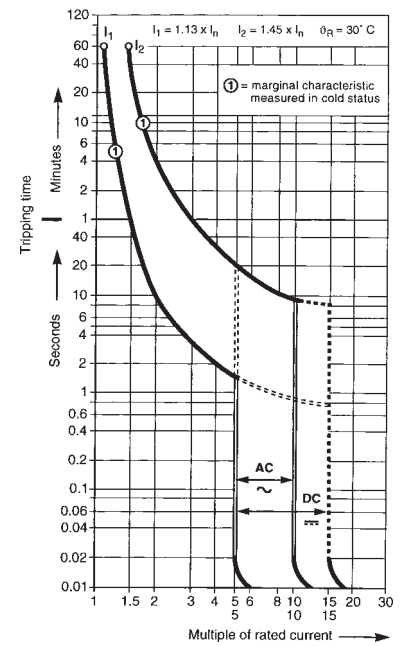

SK 0128 Z 00

trip characteristic: C
 $I_n = 0.5 \dots 63 \text{ A}$
S 200/S 200 M MCBs

Note: Deviating ambient temperature values and interdependencies need to be taken into account

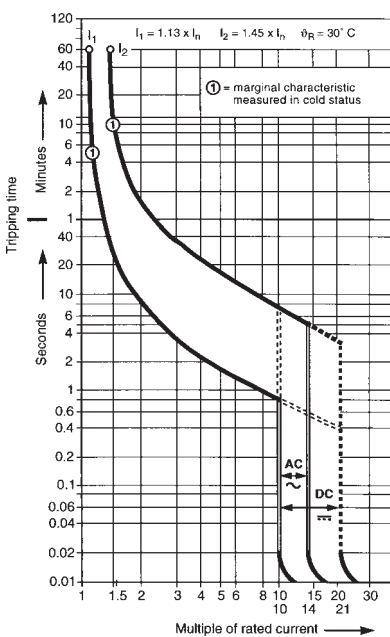

2CDC 022 377 F0203

trip characteristic: D
 $I_n = 0.5 \dots 63 \text{ A}$
S 200 MCBs

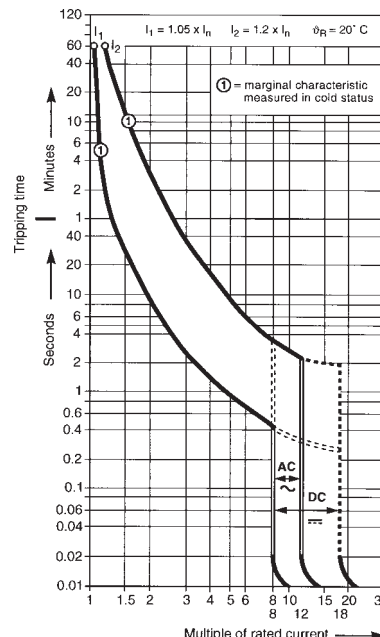

SK 0142 Z 00

trip characteristic: K
 $I_n = 0.5 \dots 63 \text{ A}$
S 200 MCBs

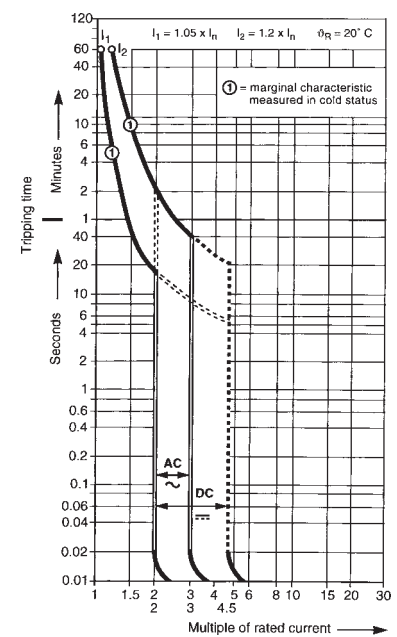

SK 0146 Z 00

trip characteristic: Z
 $I_n = 0.5 \dots 63 \text{ A}$
S 200 MCBs

Pulse tripping of the MCBs S 200/S 200 M made by ABB-STOTZ-KONTAKT

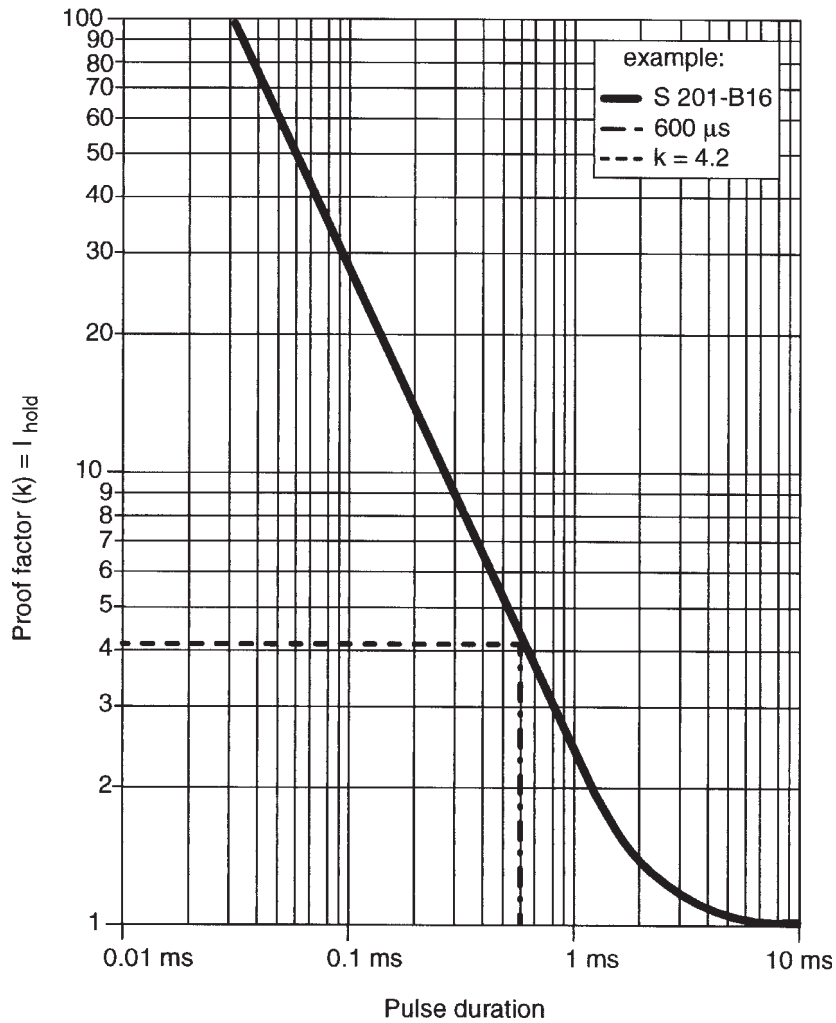

2CDC 022 131 F0203

Example:

S 201-B16

$I_{hold} = K \times \text{non-tripping current}$
 $I_{hold} = 4.2 \times 3 \times 16$
 $I_{hold} = 201.6 \text{ A}$

non-tripping current (electromagnetic release)

B-type characteristic = $3 \times I_n$
 C-type characteristic = $5 \times I_n$
 D-type characteristic = $10 \times I_n$
 K-type characteristic = $10 \times I_n$
 Z-type characteristic = $2 \times I_n$

In the case of an impulse of 600 μ s, S 201-B16 maintains up to a current of 201.6 A.

Diagrams of let-through values $I^2 t$ at 230/400 VAC

Miniature circuit-breakers S 200 B/C, D on request

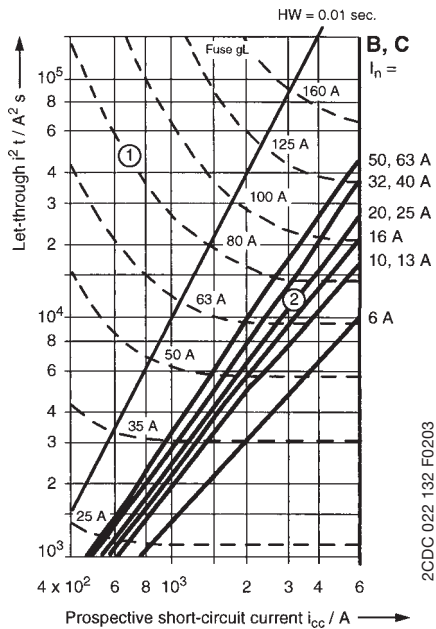

Miniature circuit-breakers S 200 K

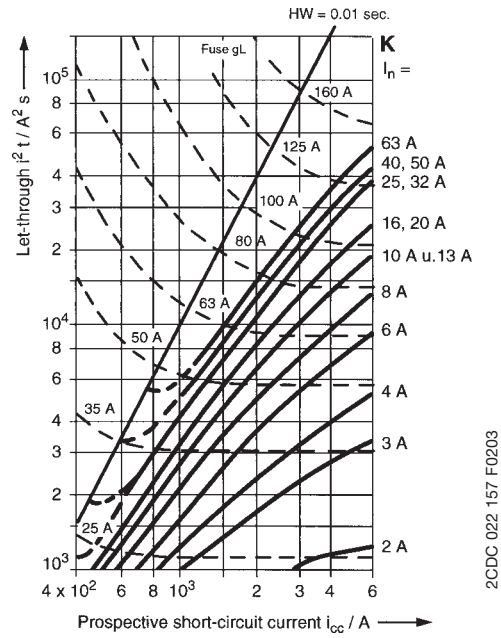

- ① min. pre-arcing I^2t , e.g. $I_n = 80$ A gL
- ② max. let-through I^2t MCB e.g. B20 A

- Fuse-MCB, selectivity with respect to the upstream fuse to the point of intersection of both curves ① and ②.
e.g. S 200-B20 to fuse 80 A: selectivity up to 3.5 kA min.
- Let-through value I^2t reduced:
127 V~ by factor 2.5
110 V~ by factor 3

Miniature circuit-breakers S 200 Z

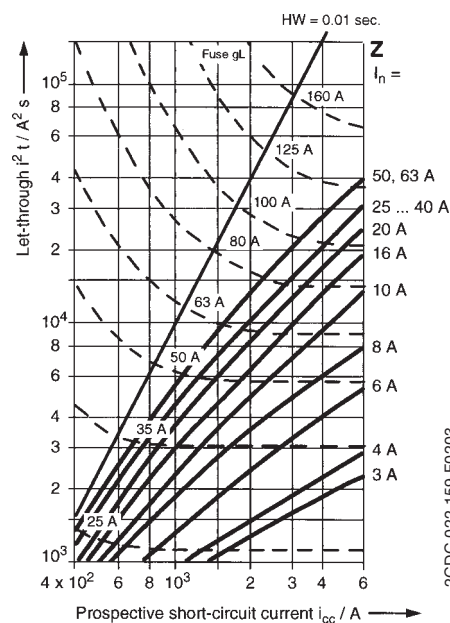

Miniature circuit-breakers S 200 M B/C

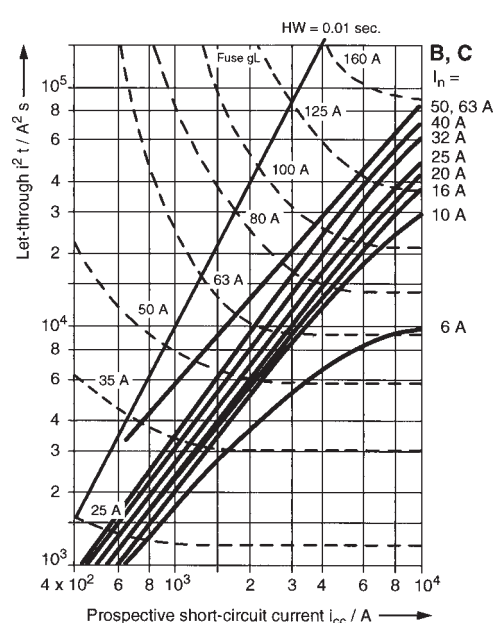

The influence of ambient temperature and interdependencies in the case of even loads on the load capability of MCBs

Practical Note: This practical deduction, that is applicable for all types of characteristics, can be recommended for standard environments. Selection criteria for rated current of circuit-breakers according to EN 60898 and EN 60947-2.

Choose the circuit-breaker that is appropriate for the lower of the rated value of the device or the permissible current loading. Now, the major factors having an influence on the circuit-breaker, must be taken into account:

1. ambient temperature with $I_b \leq 0.9 \times I_n$ at 40 °C ambient temperature
2. mutual influence with $I_b \leq 0.75 \times I_n$ in the case of more than one circuit-breaker being loaded evenly in parallel.

The ensuing rated current of the circuit breaker is thus: $I_n = 1.5 \times \text{rated current}$

Example: operating current 4 A, then the rated current of the circuit-breaker is: $I_n = 1.5 \times 4 \text{ A} = 6 \text{ A}$

The above takes into account all relevant factors and the circuit is protected at the lowest possible level.

This practical note is based on the following:

1. Deviating ambient temperature: The thermal releases are adapted to a given reference ambient temperature. For the K- and Z-type characteristics, it is 20 °C, for B-, C- and D-type, it is 30 °C.

For all other ambient temperatures, the current values indicated vary by **ca. 6 % per 10 K temperature de/increase**.

For more precise calculations and very high/low ambient temperatures, the following tables apply:

Max. operating current depending on the ambient temperature circuit-breaker in load circuit of characteristics type B, C and D

B, C and D	Ambient temperature T (°C)											
	-40	-30	-20	-10	0	10	20	30	40	50	60	70
I_n (A)												
0.5	0.67	0.65	0.62	0.60	0.58	0.55	0.53	0.50	0.47	0.44	0.41	0.37
1.0	1.33	1.29	1.25	1.20	1.15	1.11	1.05	1.00	0.94	0.88	0.82	0.75
1,6	2.13	2.07	2.00	1.92	1.85	1.77	1.69	1.60	1.51	1.41	1.31	1.19
2,0	2.67	2.58	2.49	2.40	2.31	2.21	2.11	2.00	1.89	1.76	1.63	1.49
3,0	4.0	3.9	3.7	3.6	3.5	3.3	3.2	3.0	2.8	2.6	2.4	2.2
4,0	5.3	5.2	5.0	4.8	4.6	4.4	4.2	4.0	3.8	3.5	3.3	3.0
6,0	8.0	7.7	7.5	7.2	6.9	6.6	6.3	6.0	5.7	5.3	4.9	4.5
8,0	10.7	10.3	10.0	9.6	9.2	8.8	8.4	8.0	7.5	7.1	6.5	6.0
10,0	13.3	12.9	12.5	12.0	11.5	11.1	10.5	10.0	9.4	8.8	8.2	7.5
13,0	17.3	16.8	16.2	15.6	15.0	14.4	13.7	13.0	12.3	11.5	10.6	9.7
16,0	21.3	20.7	20.0	19.2	18.5	17.7	16.9	16.0	15.1	14.1	13.1	11.9
20,0	26.7	25.8	24.9	24.0	23.1	22.1	21.1	20.0	18.9	17.6	16.3	14.9
25,0	33.3	32.3	31.2	30.0	28.9	27.6	26.4	25.0	23.6	22.0	20.4	18.6
32,0	42.7	41.3	39.9	38.5	37.0	35.4	33.7	32.0	30.2	28.2	26.1	23.9
40,0	53.3	51.6	49.9	48.1	46.2	44.2	42.2	40.0	37.7	35.3	32.7	29.8
50,0	66.7	64.5	62.4	60.1	57.7	55.3	52.7	50.0	47.1	44.1	40.8	37.3
63,0	84.0	81.3	78.6	75.7	72.7	69.6	66.4	63.0	59.4	55.6	51.4	47.0

Max. operating current depending on the ambient temperature circuit-breaker in load circuit of characteristics type K and Z

K and Z	Ambient temperature T (°C)											
	-40	-30	-20	-10	0	10	20	30	40	50	60	70
I_n (A)												
0.5	0.66	0.64	0.61	0.59	0.56	0.53	0.50	0.47	0.43	0.40	0.35	0.31
1.0	1.32	1.27	1.22	1.17	1.12	1.06	1.00	0.94	0.87	0.79	0.71	0.61
1.6	2.12	2.04	1.96	1.88	1.79	1.70	1.60	1.50	1.39	1.26	1.13	0.98
2.0	2.65	2.55	2.45	2.35	2.24	2.12	2.00	1.87	1.73	1.58	1.41	1.22
3.0	4.0	3.8	3.7	3.5	3.4	3.2	3.0	2.8	2.6	2.4	2.1	1.8
4.0	5.3	5.1	4.9	4.7	4.5	4.2	4.0	3.7	3.5	3.2	2.8	2.4
6.0	7.9	7.6	7.3	7.0	6.7	6.4	6.0	5.6	5.2	4.7	4.2	3.7
8.0	10.8	10.2	9.8	9.4	8.9	8.5	8.0	7.5	6.9	6.3	5.7	4.9
10.0	13.2	12.7	12.2	11.7	11.2	10.6	10.0	9.4	8.7	7.9	7.1	6.1
13.0	17.2	16.6	15.9	15.2	14.5	13.8	13.0	12.2	11.3	10.3	9.2	8.0
16.0	21.2	20.4	19.6	18.8	17.9	17.0	16.0	15.0	13.9	12.6	11.3	9.8
20.0	26.5	25.5	24.5	23.5	22.4	21.2	20.0	18.7	17.3	15.8	14.1	12.2
25.0	33.1	31.9	30.6	29.3	28.0	26.5	25.0	23.4	21.7	19.8	17.7	15.3
32.0	42.3	40.8	39.2	37.5	35.8	33.9	32.0	29.9	27.7	25.3	22.6	19.6
40.0	52.9	51.0	49.0	46.9	44.7	42.4	40.0	37.4	34.6	31.6	28.3	24.5
50.0	66.1	63.7	61.2	58.6	55.9	53.0	50.0	46.8	43.3	39.5	35.4	30.6
63.0	83.3	80.3	77.2	73.9	70.4	66.8	63.0	58.9	54.6	49.8	44.5	38.6

2. Interdependencies in the case of even loads

A correction factor must be taken into account in the case butt-mounted devices and an evenly applied, high load:

2 and 3 circuit-breakers with factor 0.9

4 and 5 circuit-breakers with factor 0.8

6 and more circuit-breakers with factor 0.75

The interdependency becomes irrelevant if FST ... spacers or packing blocks (9mm width) are used.

Use of S 200/S 200 M miniature circuit-breakers in direct current circuits 60 VDC/125 VDC

In DC systems up to 60 VDC or, as the case may be, series connection up to 125 VDC, customary S 200/S 200 M series MCBs can be used. Polarity does not need to be taken into consideration, the outgoing circuit may be implemented from above or below the device.

For higher direct voltage up to 440 VDC devices of the S 280 UC series must be used.

Example for max. permissible voltages between conductors depending on the number of poles and type of connection.

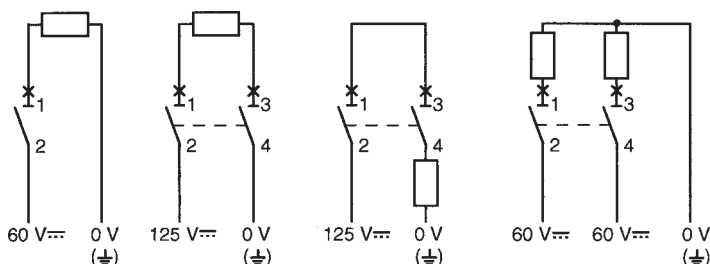

Examples for different voltages between a conductor and earth where voltages between conductors are identical:

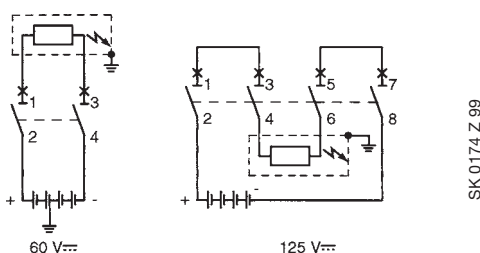

Fusing of lighting currents

1. Filament lamps and fluorescent lamps

The following table indicates the maximum number of fluorescent lamps that can be protected with a single-pole miniature circuit-breaker. In the case of multipole MCBs, the value is reduced by 20 %. Tripping characteristic type C allows for light currents up to the rated current of the MCB, for fusing of:

- filament lamps
- fluorescent lamps
 - a) non-compensated
 - b) shunt compensated ($\cos \varphi = 0.95$)
 - c) electronic load

Characteristic/ rated current	non-compensated conventional ballast			shunt compensated conventional ballast			electronic ballast ^①		
	18/20 W	36/40 W	58/65 W	18/20 W	36/40 W	58/65 W	18/20 W	36/40 W	58/65 W
10	27	23	15	32	32	20	18	18	8
16	43	37	24	51	51	33	26	26	12
20	53	46	30	64	64	41	33	33	15
25	66	58	37	82	82	53	42	42	19

① electronic ballast: twin-lamp style, jointly switched number of lamps

2. High-pressure discharge lamps

Starting current: ca. 1.7 x lamp current
Recovery time: ca. 3 ... 5 min.

According to the type of lamp, line impedance and start-stop torque, the so-called rectifier effect may occur which superimposes the starting current of the lamp for some half-waves.

In the most unfavorable circumstances, inrush currents of 15 times of the lamp nominal current may ensue.

To avoid nuisance tripping, MCBs with K-type characteristic should not carry loads higher than 0.6-fold of the lamp current. The load factor indicated refers to the least favorable case (proximity to transformer, low line impedances).

Installation and operation instructions

Installation

Can be installed in any mounting position due to snap-on fixing to DIN rails EN 60 715, 35 mm width.

- A** If MCB S 200/S 200 M is installed without cross wiring, hinge the upper part into the DIN rail and push to let the lower part of the device snap into place **(1)**. The device is released in the reverse order, after the quick fastener has been removed with a screw driver **(2)**.
- B** To release S 200 /S 200 M that are cross-wired with **System pro M compact** busbars, first remove the clamping screws. Then, pull the lower part of the S 200/S 200 M forwards **(1)** and lift it straight up **(1a)**, then, the quick fastener **(1b)** will recede.
- C** The busbar is deallocated and the S 200/S 200 M can be pulled out by lifting the device forwards **(2)**.
- D** The cross-wiring is re-inserted in the reverse order. First, open the clamping screws and pull out the quick fastener **until it locks into place for the first time (3)**. Then, take the S 200 /S 200 M and insert it with rear terminal side onto the pins of the **System pro M compact** busbar **(4)**, turn it into the direction of the DIN rail **(4a)** and shift it vertically downwards **(4b)**, this way, the quick fastener snaps back into place **(4c)**.

Attention: Do not forget to re-tighten the clamping screws.

A Assembly, disassembly without pro M compact cross wiring

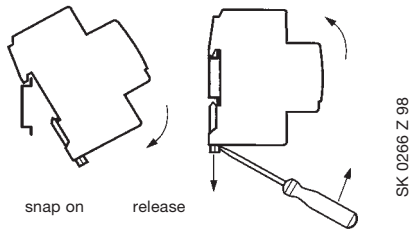

B Detaching when pro M compact cross wiring remains in place

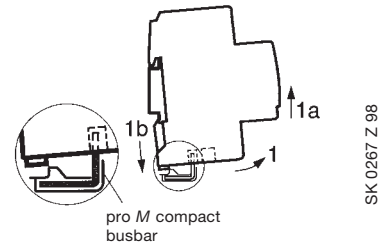

C Removal when pro M compact cross wiring remains in place

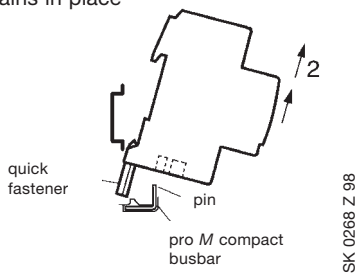

D Insertion when pro M compact cross wiring remains in place

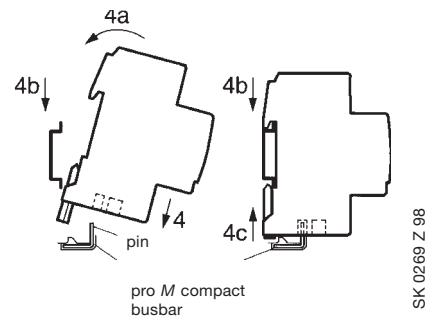
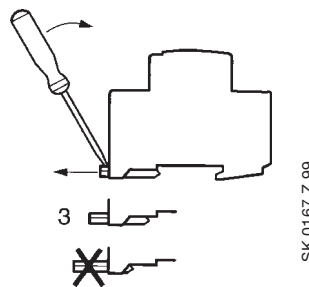

Operation

MCBs are switched on by switching the operating lever into the upper position (with respect to the text block of the nameplate). If an MCB, after it has triggered, cannot be switched on again off-handedly, the triggering is probably caused by overload.

If the MCB trips again immediately when trying to reclose (let a short period of time elapse), a complete short-circuit, or as the case may be, earth connection can be assumed.

Do not try and continuously re-close an existing short circuit or earth fault. The MCB even trips under overload, or short-circuit or earth fault conditions, even if the operating lever is maintained in the ON position by force (trip-free mechanism).

Cleaning the device

MCBs soiled by installation work should be cleaned with a dry, or, if necessary, a damp and soapy cloth. Never use caustic agents or dissolvents.

Maintenance

STOTZ MCBs are maintenance-free.

Opening the device will lead to a loss of warranty.

Connection:

For connection cross sections, see page 7.

Feeder optional, top or bottom, terminal designation according to EN 50 005.

For wiring diagrams, see picture to the right.

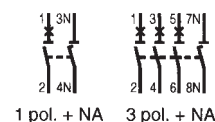
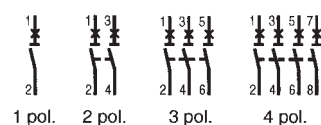

2CDC 022 153 F0003

Additional devices

Mounting additional devices

Additional devices are always fitted from the right hand side:

- signal contact/auxiliary switch S2C-S/H6R for MCBs and RCCBs
- auxiliary switch S2C-H6R for MCBs
- shunt release S2C-A for MCB

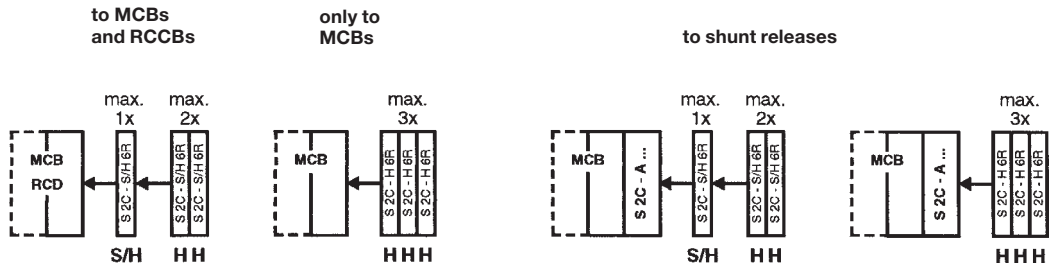

S function signal contact
H function auxiliary switch

2CDC 092 154 F0003

1. Signal contact and auxiliary switches

Retrofittable to the right side of circuit-breakers or shunt releases without extra installation devices.

1.1 Universal signal contact/ auxiliary switch type S2C-S/H6R

Description

S2 – serial code:

S 2 C - S / H 6 R

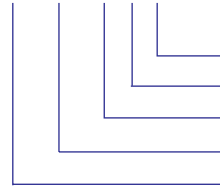

- R** = right side-mounted
- 6** = change over
- H** = auxiliary switch
- S** = signal contact
- C** = compatible to pro M compact

S2C-S/H6R is a universal device complementing the range of pro M compact, which is supplied to offer signal contact functionality, or the auxiliary switch can be activated, all you need is a screwdriver. The universal switch can be with MCBs and RCCBs. Up to three S2C-H6R can be mounted (one signal contact max. fitted to MCB or RCCB). Both the switchgear and the S2C-S/H6R must be in the ON end position to ensure that the coupling is correct.

Function of the signal contact S

Signal is transmitted only if caused by fault-tripping of the circuit-breaker, but not if the switch has been switched on or off manually. Press the orange reset button to acknowledge the has-tripped signal.

Function of the auxiliary switch H

The switch always indicates the switching position of the MCB, irrespective of whether the switching position is attributable to manual operation or fault tripping.

Functionality selection

To select either the signal contact function S or the auxiliary switch H, use a screwdriver and adjust to position S, or as the case may be, H at the side of the device.

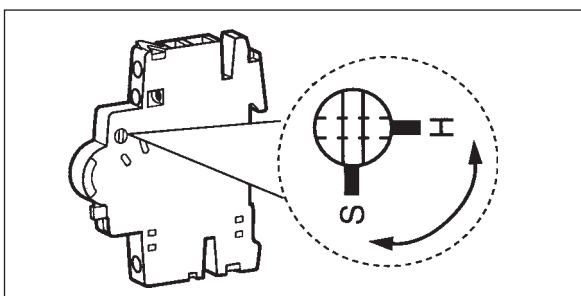

SK 0170 Z 02

Installation:

1. Mounting one S2C-S/H6R

→ RCCB or MCB must be in the ON position → remove coupling cover on the right side of the MCB/RCCB → signal contact/auxiliary switch in ON position → if fitted to MCB, remove bottom (RCD), if fitted to RCCB middle (MCB) coupling pin → plug devices together.

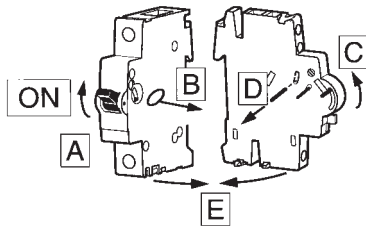

SK 0287 Z 02

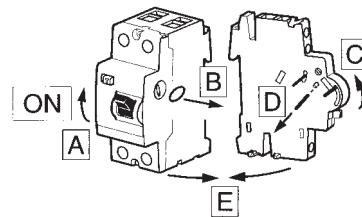

SK 0288 Z 02

2. Mounting more than one S2C-S/H6R

Up to three S2C-H6R can be mounted.

Note: one signal contact max. fitted at first to MCB or RCCB

If fitted to an MCB, remove the bottom coupling pin (RCD), if fitted to an RCCB, remove the middle coupling pin (MCB), switch all signal contact/ auxiliary switches to the end position ON, plug them together and carry through a function control test.

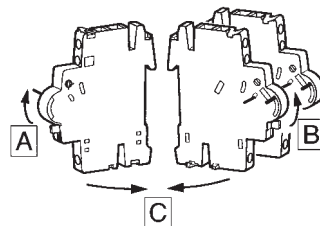

SK 0285 Z 02

Function control test:

After all signal contacts/auxiliary switches or auxiliary switches have been mounted, use the upper coupling pin to switch on the devices (ON position). If the lower (for RCD) or, as the case may be, the middle (for MCB) coupling pin is operated, all devices must trip.

Now combination with MCB/RCCB:

RCCB or MCB must be in the ON position → remove coupling cover on the right side of the MCB/RCCB → signal contact/auxiliary switch in ON position → if fitted to MCB, remove bottom (RCD), if fitted to RCCB middle (MCB) coupling pin → plug devices together.

Test functions of the signal contact

in ON and OFF position after hand operation

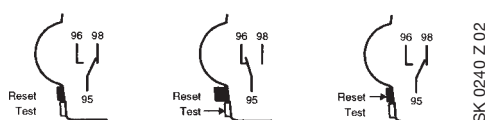

SK 0240 Z 02

Test functions of the auxiliary switch

in ON position

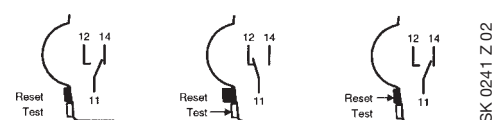

SK 0241 Z 02

in ON position after tripping

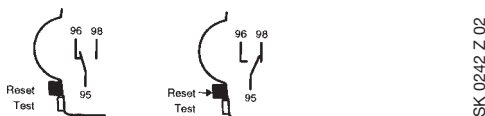

SK 0242 Z 02

in OFF position

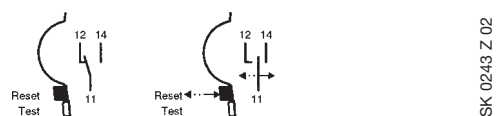

SK 0243 Z 02

Technical Data

Signal contact/auxiliary switch S2C-S/H6R and auxiliary switch S2C – H6R according to EN 62019

AC 14	U _e	400 V	230 V
	I _e	1 A	2 A
DC 12	U _e	220 V	110 V
	I _e	1 A	1.5 A
DC 13	U _e	60 V	24 V
	I _e	1.5 A	4 A

rated current I _{th} :	10 A
min. rated voltage U _{Bmin} :	24 V ~, 24 V...
min. rated operational current:	5 VA ①
short-circuit withstand capacity:	230 V~ 1000 A with S 201 K 4
insulation coordination:	according to DIN VDE 0110 Parts 1 and 2
– overvoltage category:	III
– surge voltage:	4 kV (1.2/50 μs)
– pollution degree:	2
connection cross section:	0.75 ... 2.5 mm ² (up to 2 x 1.5 mm ²)
tightening torque:	1.2 Nm max.
contact stability in vibration test according to DIN IEC 68-2-6-:	5 g, 20 sweep cycles 5 ... 150 ... 5 Hz at 24 VAC/DC, 5 mA automatic reclosing < 10 ms
mech. service life:	10 000 operations

① The minimum rated operational current value applies in the case of operation and environmental conditions according to EN 60 204-1/1998 and EN 60 439-1/2000 if installed indoors and in clean ambient air: 24 VAC/DC, 5 mA (AC-12, DC-12)

1.2 Auxiliary switch type S2C-H6R

Description

The simple auxiliary switch without test functionality is appropriate for applications where it is only necessary to indicate the contact position of the circuit-breaker.

Up to three S2C-H6R can be butt-mounted, including combinations with the signal contact/auxiliary switch SC2-S/H6R.

Installation and technical data

the same as for signal contact/auxiliary switch SC2-S/H6R, see preceding page and above.

Installation and technical data

the same as for signal contact/auxiliary switch SC2-S/H6R, see preceding page and above.

2. Shunt trip S2C-A

Description

For distance tripping of the MCB. The shunt release has a relay coil with an integrated contact which disconnects the coil and the coil voltage if the MCB trips, this prevents the flow of current in the case of sustained coil voltage.

Technical data

type:	S2C - A1	S2C - A2
service voltage:	12 ... 60 V	110 ... 415 VAC and 110 ... 250 VDC

STOTZ-Shunt trip with automatic disconnecting within 10 milliseconds U_B = U_n + 10 – 30 %

	U _B	I _{Bmax}		U _B	I _{Bmax}
S2C-A1	12 VDC	2.2 A	S2C-A2	110 VDC	0.35 A
	12 VAC	2.5 A		110 VAC	0.5 A
	24 VDC	4.5 A		220 VDC	1.1 A
	24 VAC	5 A		230 VAC	1.0 A
	60 VDC	14 A		415 VAC	2.7 A
	60 VAC	8.8 A			

U_B = operating voltage



I_{Bmax} = operating current

Description

Residual-current protective devices have a balance or, as the case may be, differential current transformer as measuring device that is connected with permanent magnet trip via the secondary winding. Residual-current protective devices cover a.c. fault current and pulsating d.c. fault current and are insensitive to current rushes up to 250 A, selective and short-time delayed tripping types up to 3,000 A). Pulse shape 8/20 according to DIN VDE 0432 Part 2.

STOTZ residual-current protective devices are surge-proof and thus insensitive to transient leakage current to earth, as may occur e.g. when switching fluorescent lamps, X-ray apparatus, IT systems and also thyristor control. (The value of the surge strength is indicated in the technical data information regarding the switching variants).

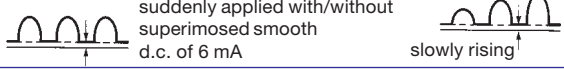
Protection through RCD of types AC, A and B according to IEC 755

form of residual current		correct functioning of RCD ●		
		a.c.- sensitive type AC	pulsating current-sensitive type A	d.c.-sensitive type B
sinusoidal a.c.		● F 200 AC	● F 200	●
pulsating d.c.			●	●
smooth d.c.				●

Selective RCCB F 200S

Is installed centrally and operates on a time-selective basis with respect to more sensitive downstream residual-current devices. The result is a high degree of service security, as in the case of a fault, only the circuit affected will be switched off. Due to their surge strength of up to 5,000 A/3,000 A, nuisance tripping of STOTZ main RCCBs caused by remote strike is ruled out. They are therefore the perfect choice for the connection of freezers and agricultural applications (e.g. fans in intensive livestock husbandry) according to DIN VDE 0100 Part 705.

Short-time delayed RCCBs F 200 R

are RCCBs with high surge strength needed where apparatus causes high leakage currents when switched on or off (e.g. lighting circuits with ballast, long lines).

Application





To obtain a better level of security in all wiring systems, as well as in supply areas with respect to which codes of practice recommend or require the use of residual-current protective devices.

Tasks

Protection against electric shock

Measures for the protection against electric shock as provided for in DIN VDE 0100 Part 410. These measures are:

- Protection from indirect touch – as fault protection through disconnection of circuit in the case of excessive touch voltage caused by short circuit to exposed conductive part.
- Protection from direct touch – as additional protection through disconnection when conductive parts are touched. Dangerous leakage current is switched off within the shortest possible time if the rated residual current of the circuit-breakers is $I_{\Delta n} \leq 30 \text{ mA}$, in the case of people protector FS 201 $I_{\Delta n} \leq 10 \text{ mA}$.
- Protection against fire – protection against fire ignited by electricity if the nominal residual current of the circuit-breaker is $I_{\Delta n} \leq 300 \text{ mA}$.

Technical data	F 200	F 200 AC	F 200 R short time delayed	F 204 S selective	FS 201 RCBO
specifications:	DIN VDE 0664 Part 11, EN 61008-2-1				DIN VDE 0664 Part 21 and EN 61009/IEC 61009
No. of poles:	2-pole 4-pole	2-pole 4-pole	2-pole 4-pole	4-pole	
tripping characteristics:	-				B and C acc. to DIN VDE 0641 and EN 60898; K acc. to DIN VDE 0660 and EN 60947
rated current I_n :	16, 25, 40, 63 A	25, 40, 63 A		25, 40, 63 A	40 A, 63 A 6 to 32 (40) A
rated residual current $I_{\Delta n}$:	10, 30, 300 and 500 mA	30, 100 and 300 mA	30 mA	300 mA	10 mA, 30 mA, 300 mA
tripping range at  at 	0.50 ... 1.0 · $I_{\Delta n}$ 0.11 ... 1.4 · $I_{\Delta n}$				
tripping time  at 1 · $I_{\Delta n}$: at 2 · $I_{\Delta n}$: at 5 · $I_{\Delta n}$: at 500 A:	≤ 300 ms ≤ 40 ms	≤ 300 ms ≤ 40 ms	120 ... 300 ms 50 ... 150 ms 20 ... 40 ms	150 ... 500 ms 60 ... 200 ms 40 ... 150 ms 40 ... 150 ms	≤ 300 ms ≤ 40 ms
tripping time  at 1 · 1,4 $I_{\Delta n}$: at 5 · 1,4 $I_{\Delta n}$:	≤ 300 ms ≤ 40 ms	- -	≤ 300 ms ≤ 40 ms	≤ 300 ms ≤ 50 ... 150 ms	≤ 300 ms ≤ 40 ms
rated switching capacity:	-			-	6 kA, φ 0,7
surge strength (impulse waveshape 8/20):	250 A		3000 A	5000 A	250 A
short-circuit withstand capacity:	10.000 A, in connection with an upstream fuse gL 100 A or the STOTZ selective main circuit-breaker S 700-E 100 A		10.000 A, in connection with an upstream fuse gL 100 A or the selective main circuit-breaker S 700-E 100 A		
rated voltage U_n :	2-pole: 230 V ~ 4-pole: 230/400 V ~		230/400 V ~		2-pole: 230 V ~
max. operating voltage U_{Bmax} :	$U_n + 10\%$				
operative range of test equipment U_T :	100 V ~ to 264 V ~				100 V ~ to 264 V ~ 100 V ~ to 264 V ~
insulation coordination according to DIN VDE 0110 Part 1 and 2 - overvoltage category: - pollution degree: - surge voltage U_{imp} (1,2/50): - power-frequency withstand voltage (50/60 Hz):	III, disconnector abilities 2 4 kV 2.5 kV				
frequency:	50/60 Hz				50/60 Hz
housing:	moulding grey				moulding grey
operating lever/test button:	blue				black/blue
degree of protection:	IP 20; in the distribution board IP 40; in moulded-plastic casing IP 55 (see accessories)				
dimensions:	see dimension drawings				
connection cross section:	1 to 16 mm ² for finely-stranded to massive conductors for I_n to 40 A, 1 to 25 mm ² for I_n 63 A				1 to 16 mm ²
service life:	> 5.000 switches				
climatic resistance according to DIN IEC 68 Part 2-30: (RH = rel. humidity)	damp heat, cyclic (55 °C/28 cycles)				damp heat: 28 cycl. 55/95 ... 100 (°C/RH) alternating climate: 25/95 - 40/93 (°C/RH) constant climate: 23/83, 40/93, 55/95 ... 100 (°C/RH)
ambient temperature:	$T_{max.} + 55\text{ °C}$ $T_{min.} - 25\text{ °C}$				
vibration resistance according to:	DIN VDE 0664 Part 1/10.85 and EN 61008				DIN VDE 0664 Part 2/10.85 and EN 61009
terminals:	bi-directional cylinder-lift terminal				
trip-free mechanism:	yes				
connection:	individually or collectively via a busbar				
supplementary devices:	type S2C-S/HR s. pagee 17				in preparation

Installation and operation instructions

Installation

Can be installed in any mounting position due to snap-on fixing to DIN rails EN 50 022, 35 mm width.

- A** If RCD F 200/FS 201 is installed without cross-wiring, hinge the upper part into the DIN rail and push to let the lower part of the device snap into place (1). The device is released in the reverse order, after the quick fastener has been removed with a screw driver (2).
- B** To release RCD F 200/FS 201 that are cross-wired with **System pro M compact** busbars, first remove the clamping screws. Then, pull the lower part of the F 200/FS 201 forwards (1) and lift it straight up (1a), then, the quick fastener will recede (1b).
- C** The busbar is deallocated and the RCD F 200/FS 201 can be pulled out by lifting the device forwards (2).
- D** The cross-wiring is re-inserted in the reverse order. First, open the clamping screws and pull out the quick fastener **until it locks into place for the first time** (3). Then, take the RCD F 200/FS 201 and insert it with the rear terminal side onto the pins of the **System pro M compact** busbar (4), turn it into the direction of the DIN rail (4a) and shift it vertically downwards (4b), to let the quick fastener snap back into place (4c).

Attention: Do not forget to re-tighten the clamping screws.

A Assembly,
disassembly
without
pro M compact
cross wiring

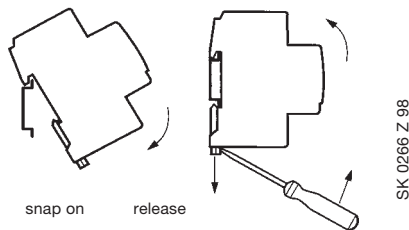

SK 0266 Z 98

B Detaching when
pro M compact
cross wiring
remains in place

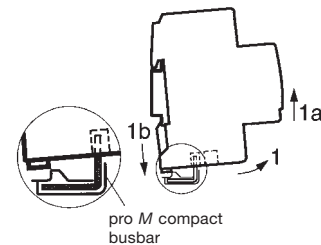

SK 0267 Z 98

C Removal when
pro M compact
cross wiring
remains in place

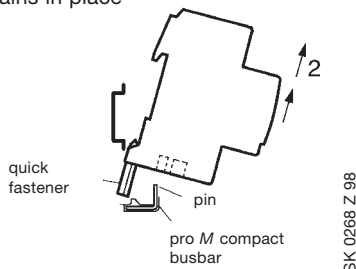

SK 0268 Z 98

D Insertion when
pro M compact
cross wiring
remains in place

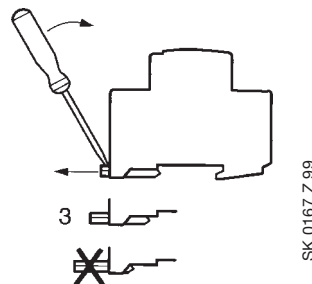

SK 0167 Z 99

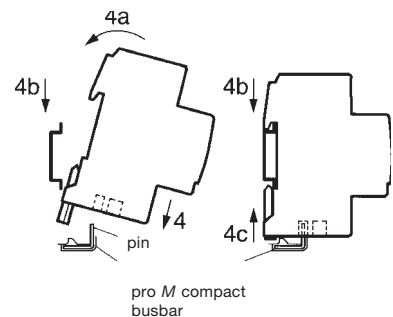

SK 0269 Z 98

Connection

Feeder optional, top or bottom. Ensure that conductors are connected correctly and firmly.

If the 4-pole RCCB is operated as a 2-pole RCCB, use terminals 5 and 7 or, as the case may be, 6 and 8 to make sure that the test button function of the RCCB is working. In the case of a three-phase system with $U_n = 127/230$ V (without neutral N), terminals 4 and 8 must be bridged.

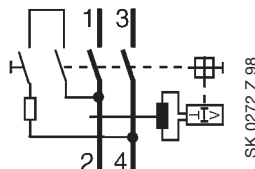

SK 0272 Z 98

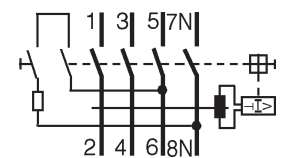

SK 0012 Z 96

Operation

F 200/FS 201 is switched ON or OFF with the blue operating lever.

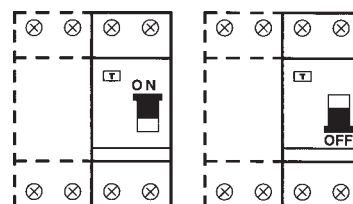

2CDC 032 138
F0203

Operating test

To test proper functioning, press the blue test button when the device is switched ON, the RCCB must trip immediately (the knob jumps into the „0“ switching position).

It is necessary to test the RCD half-yearly, if no other regional or user specified additional test are required.

Test of protective measure

Except for the operating test, the effectiveness of the protection provided within the installation must be tested according to the applicable codes of practice. For RCD protection, the maximum permissible earthing resistance values are as follows:

max. touch voltage U_L	max. earthing resistance at nominal residual current				
	10 mA	30 mA	100 mA	300 mA	500 mA
25 V	2500 Ω	833 Ω	250 Ω	83 Ω	50 Ω
50 V	5000 Ω	1666 Ω	500 Ω	166 Ω	100 Ω

Malfunctioning

The high-quality STOTZ residual-current-operated circuit-breakers are thoroughly adjusted and tested in our works. Where damage occurs (caused e.g. by transport, storage, etc.) no repair work must be undertaken. If the device responds immediately after putting the RCCB into operation, check the downstream active circuit and any connected current-consuming apparatus for earth fault current. Remove insulation faults or connections between the neutral conductor and the protective conductor existing in load circuit. Where the RCCB does not trip in the first operating test after pressing the test button, check first whether the test circuit is connected correctly.

Where none of the above causes apply, or should the operating test be completed unsuccessfully, the RCCB must be replaced.

Opening the device will lead to a loss of warranty.

Examples for the protection against electric shock

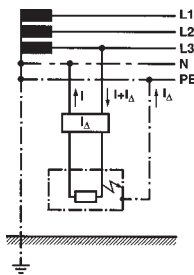

SK 0038 Z 94

TN-S system (protective multiple earthing)
separate neutral and protective conductors throughout the network

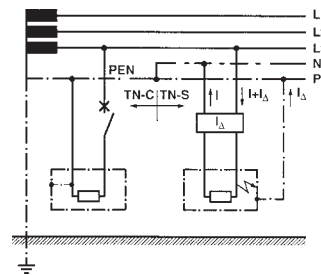

SK 0005 Z 97

TN-C-S system
neutral and protective conductor (PEN) combined in one part of the network.

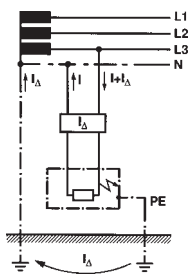

SK 0040 Z 94

TT system

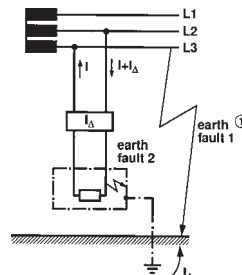

① only indicated by line isolation monitor

SK 0017 Z 95

IT system
The residual-current-operated circuit-breaker trips if a double fault occurs, as e.g. is indicated as fault 1 and fault 2 above.

Explanation of type codes

- L1, L2, L3 „line“ phase conductor
- PE „protection earth“
- N „neutral“
- PEN PE and N combined
- T „terre“ direct bond to earth

- I „insulation“
- C „combined“ PE and N (PEN)
- S „separated“ PE and N
- „...“ terms used in international IEC standard

Description

The newly developed **pro M compact** cross wiring busbar system includes everything that is needed for secure and economic connections of distribution build-in devices of the series S 200 and F 200.

The optimised quick fastener of the S 200 series, F 200, when used together with the **System pro M compact** cross wiring busbars, makes removing and inserting devices a quick and easy job, and the cross wiring of other devices remains in place, at that.

Busbars are supplied ready-to-use and in standard lengths, time-consuming cutting to length or end caps are no longer required.

MCBs and RCCBs of the customary **System pro M** technology can also be easily cross-wired with the new **System pro M compact** busbars.

Technical data

specifications:	VDE 0660 Part 500, DIN EN 60439-1: 1994	test surge voltage: (1,2/50)	6,2 kV
busbar material:	SF-Cu F 24	short-circuit withstand capacity:	25 kA
insulating profile material:	plastic, temperature resistant ≥ 90 °C flame-retardant, self-extinguishing dioxine- and halogene-free	climatic resistance:	constant climate L23/83; 40/92 55/20 according to DIN 50 015 humid heat, 28 cycles (\geq IEC 68 Part 2 - 30)
busbar cross section:	10 mm ²	insulation coordination:	acc. to VDE 0110 Part 1 April 1997 (IEC 664)
max. operating voltage:	440 V	- overvoltage category:	III
rated surge voltage:	4 kV	- pollution degree:	2

Load capability depending on the feed point

bar cross section	10 mm ²	16 mm ²
① max. busbar current I_S /phase	63 A	80 A
② max. current in branch I_E /phase	100 A	130 A*

* If the device is fed via the device terminal, ensure that - irrespective of the current carrying capacity (I_S) of the busbar - the following values are not exceeded:

For devices up to and including 40 A I_n max. 110 A and for 50/63 A I_n max. 140 A.

① incoming supply at the beginning of the busbar

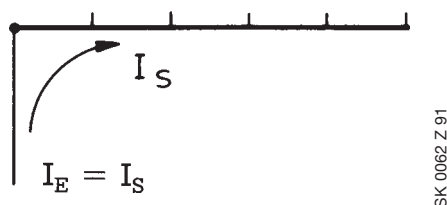

② incoming supply within the busbar or centre-fed

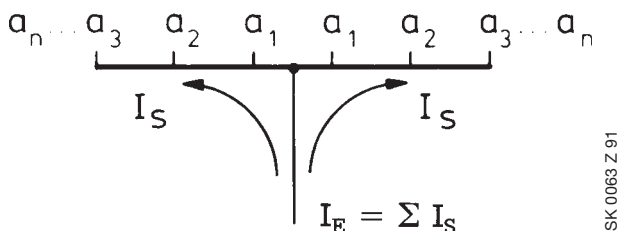

If the device is centre-fed (see picture to the right), ensure that the combined outgoing currents $a_1 \dots a_n$ per branch do not exceed the max. busbar current I_S /phase referred to above.

Dimensions

measurements in mm

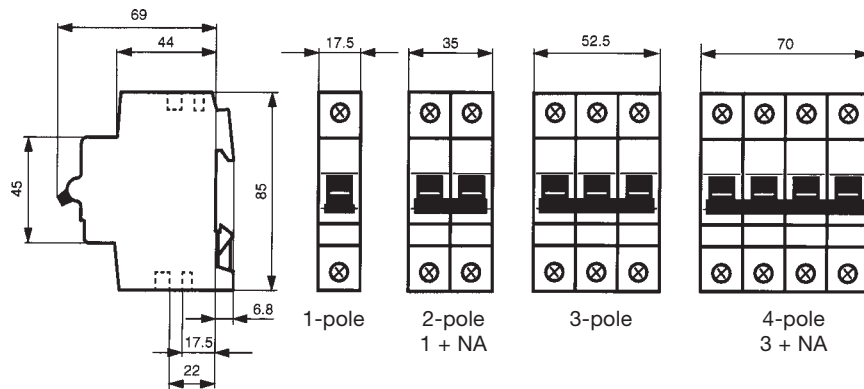

SK 0136 Z 01

S 201, S 202, S 203, S 204

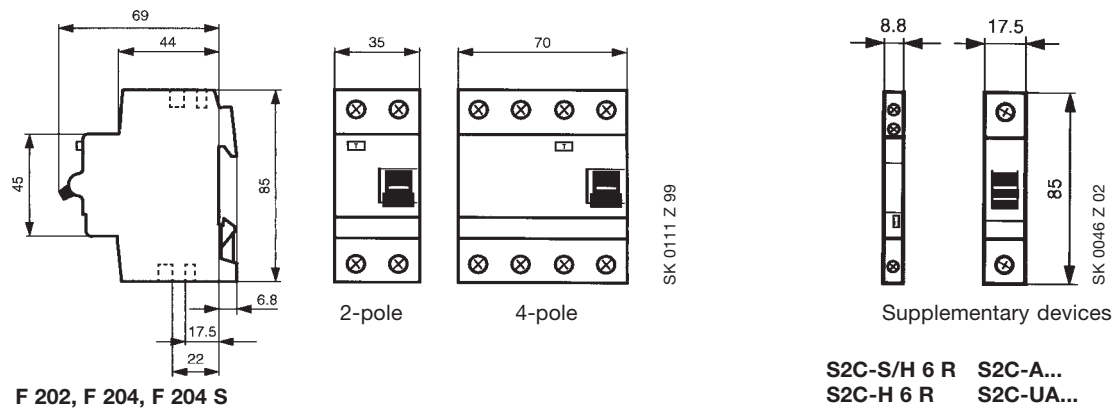

SK 0111 Z 99

SK 0046 Z 02

F 202, F 204, F 204 S

**S2C-S/H 6 R S2C-A...
S2C-H 6 R S2C-UA...**

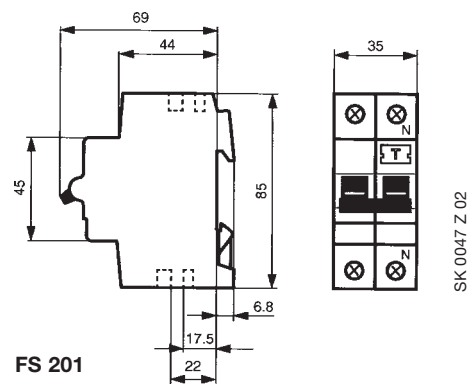

SK 0047 Z 02

FS 201

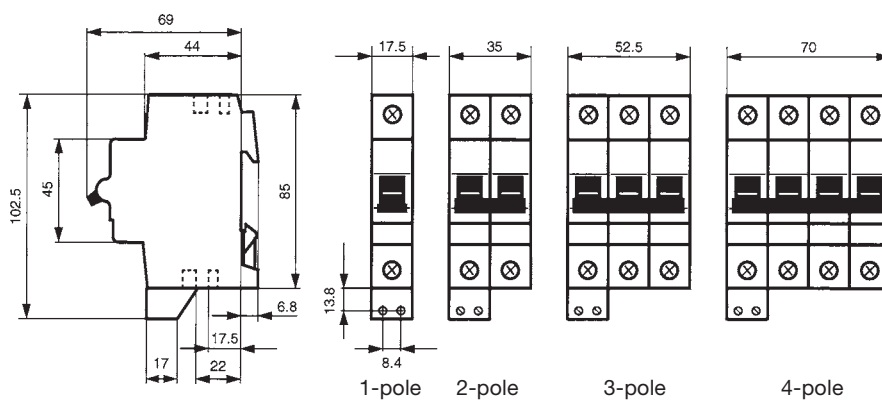

SK 0058 Z 01

S 201 H, S 202 H, S 203 H, S 204 H

Accessories Dimensions

Terminal covers

measurements in mm

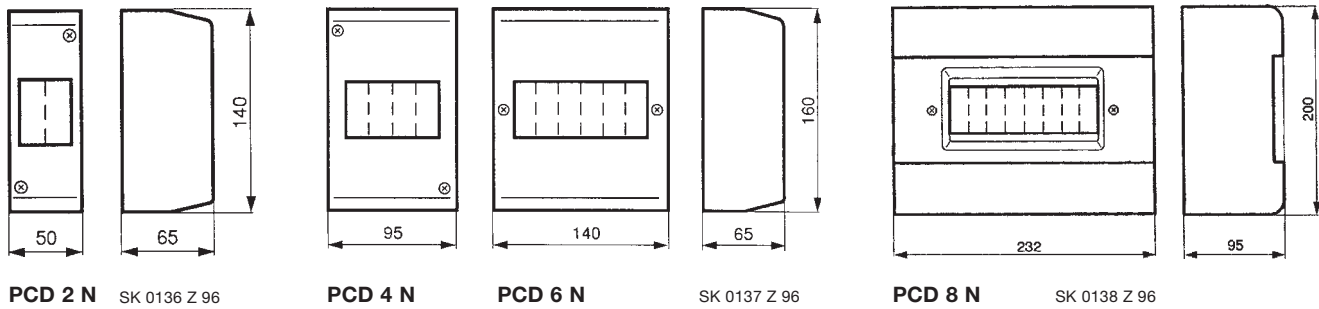

Enclosure of moulded-plastic

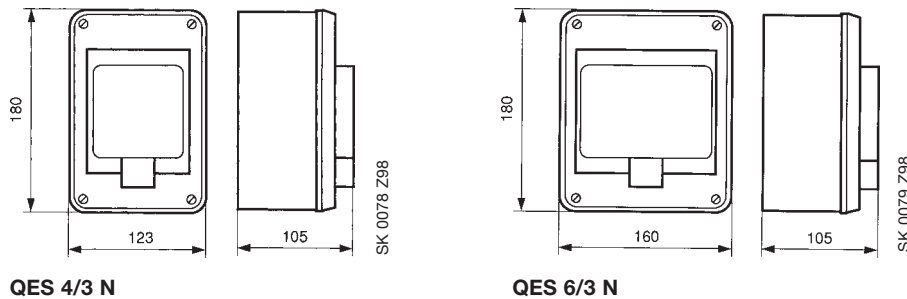

Flush frame

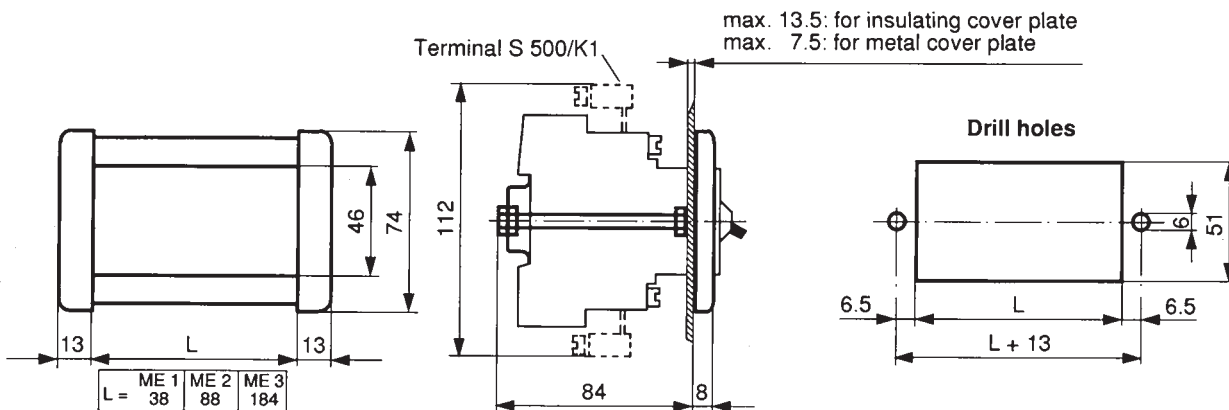

type	dim. L	max. No. of modules (1 module = 17.5 mm)
S 500 - ME 1	38 mm	for 2 Module
S 500 - ME 2	88 mm	for 5 Module
S 500 - ME 3	184 mm	for 10 Module

Mounting rails

① In the case of DSW 1, the drill holes are vertical

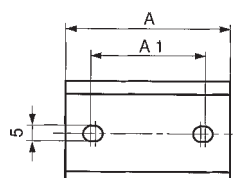

name	A	A1
DSW	17.5	15
DSW 2	35	20
DSW 3	52.5	37.5
DSW 4	70	55
DSW 6	105	90

SK 0131 Z 94

Dimensions

measurements in mm

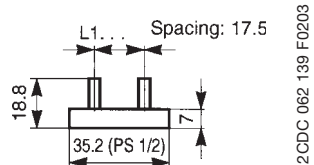

PS 1/2

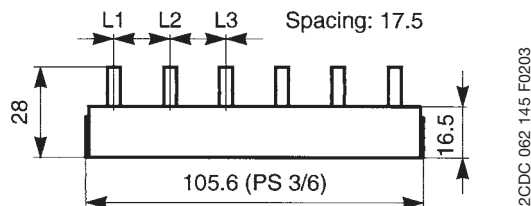

PS 3/6

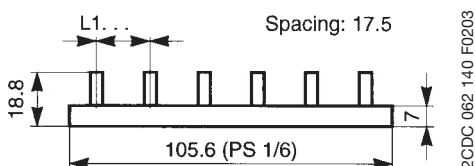

PS 1/6

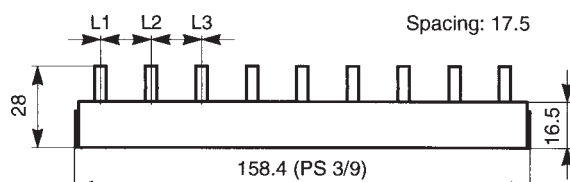

PS 3/9

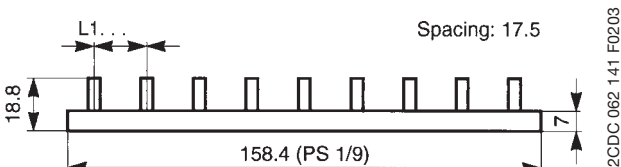

PS 1/9

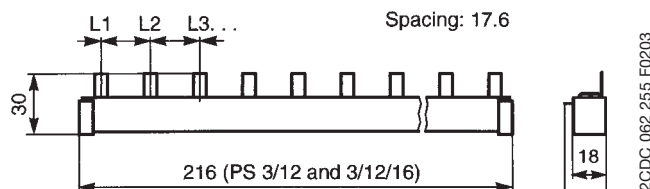

PS 3/12

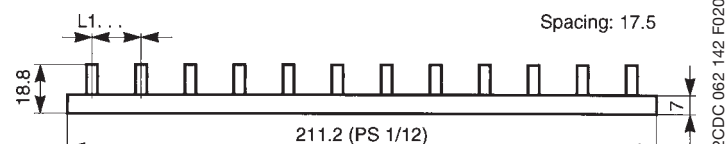

PS 1/12

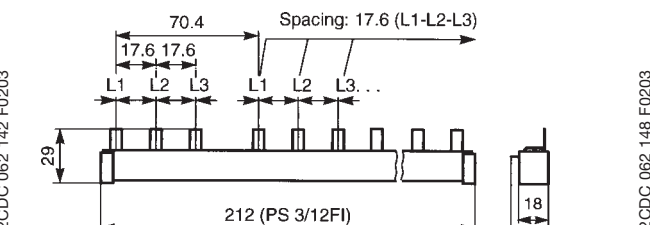

PS 3/12 FI

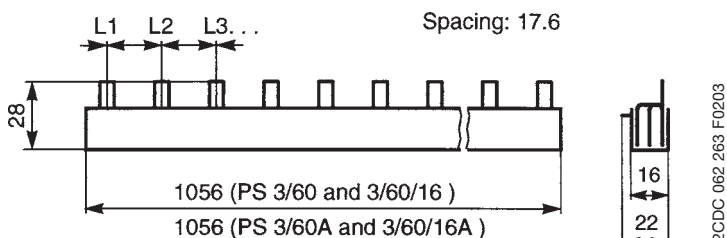

PS 3/60

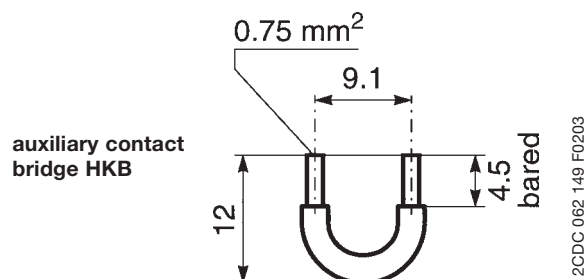

**auxiliary contact
bridge HKB**

Dimensions

measurements in mm

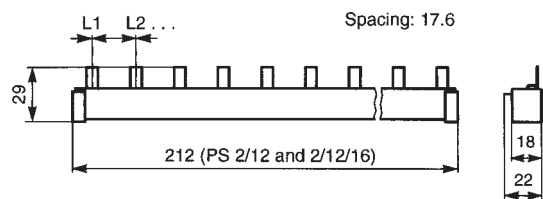

2CDC 062 251 F0203

PS 2/12

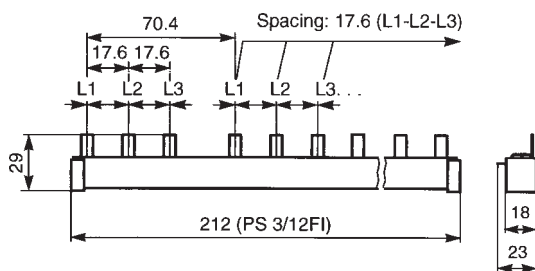

2CDC 062 148 F0203

PS 3/12 FI H

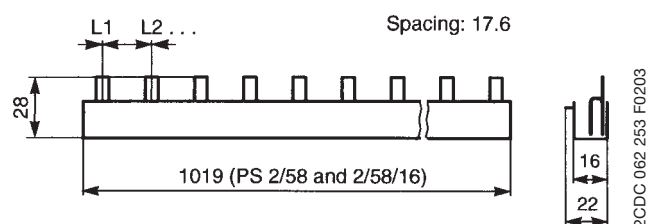

2CDC 062 253 F0203

PS 2/58

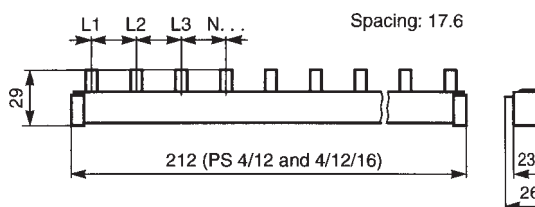

2CDC 062 265 F0203

PS 4/12

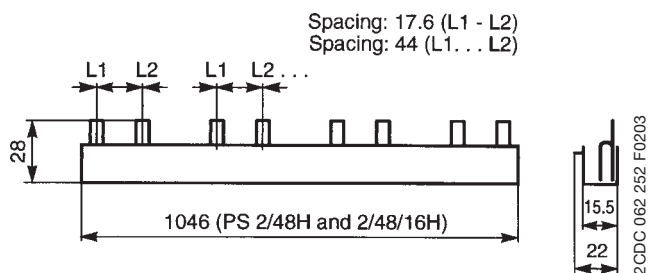

2CDC 062 252 F0203

PS 2/48

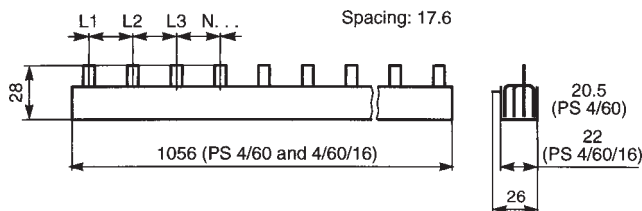

2CDC 062 269 F0203

PS 4/60

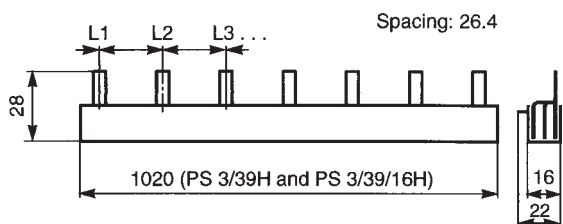

2CDC 062 260 F0203

PS 3/39 H

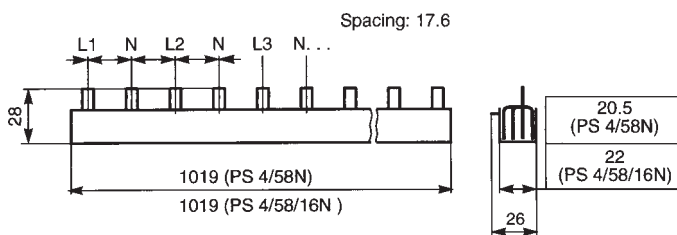

2CDC 062 267 F0203

PS 4/58 N

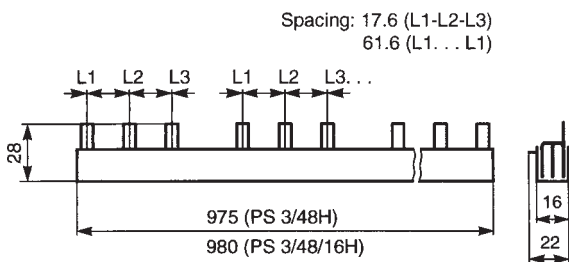

2CDC 062 261 F0203

PS 3/48 H

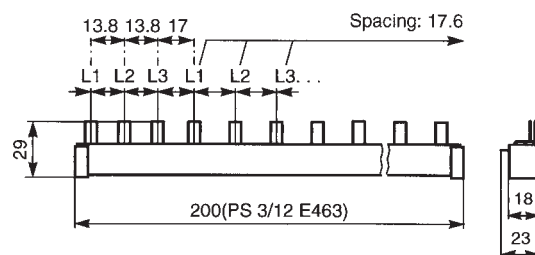

2CDC 062 143 F0203

PS 3/12 E 463

B

6000
S



SK 019 B 99



SK 020 B 99



SK 021 B 99



SK 087 B 01

Selection table

No. of poles	rated current I _n A	order details		bbn 40 16779 EAN	price 1 piece €	price group	w'ght 1 pc. kg	pack. unit pc.
		type code	order code					
1	6	S 201-B 6	2CDS 251 001 R0065	46490 1			0.125	10/40
	10	S 201-B 10	2CDS 251 001 R0105	46380 5				
	13	S 201-B 13	2CDS 251 001 R0135	46500 7				
	16	S 201-B 16	2CDS 251 001 R0165	57863 9				
	20 ①	S 201-B 20	2CDS 251 001 R0205	46510 6				
	25	S 201-B 25	2CDS 251 001 R0255	46520 5				
	32 ②	S 201-B 32	2CDS 251 001 R0325	46530 4				
	40 ③	S 201-B 40	2CDS 251 001 R0405	46540 3				
	50	S 201-B 50	2CDS 251 001 R0505	55092 5				
	63	S 201-B 63	2CDS 251 001 R0635	55093 2				
2	6	S 202-B 6	2CDS 252 001 R0065	46640 0			0.250	5/20
	10	S 202-B 10	2CDS 252 001 R0105	46660 8				
	13	S 202-B 13	2CDS 252 001 R0135	46670 7				
	16	S 202-B 16	2CDS 252 001 R0165	46690 5				
	20	S 202-B 20	2CDS 252 001 R0205	46700 1				
	25	S 202-B 25	2CDS 252 001 R0255	46710 0				
	32	S 202-B 32	2CDS 252 001 R0325	46720 9				
	40	S 202-B 40	2CDS 252 001 R0405	46740 7				
	50	S 202-B 50	2CDS 252 001 R0505	55094 9				
	63	S 202-B 63	2CDS 252 001 R0635	55095 6				
3	6	S 203-B 6	2CDS 253 001 R0065	46860 2			0.375	3/12
	10	S 203-B 10	2CDS 253 001 R0105	46870 1				
	13	S 203-B 13	2CDS 253 001 R0135	46890 9				
	16	S 203-B 16	2CDS 253 001 R0165	46900 5				
	20 ①	S 203-B 20	2CDS 253 001 R0205	46910 4				
	25	S 203-B 25	2CDS 253 001 R0255	46920 3				
	32 ②	S 203-B 32	2CDS 253 001 R0325	46930 2				
	40 ③	S 203-B 40	2CDS 253 001 R0405	46940 1				
	50	S 203-B 50	2CDS 253 001 R0505	55096 3				
	63	S 203-B 63	2CDS 253 001 R0635	55097 0				
4	6	S 204-B 6	2CDS 254 001 R0065	52895 5			0.500	2
	10	S 204-B 10	2CDS 254 001 R0105	52896 2				
	13	S 204-B 13	2CDS 254 001 R0135	52897 9				
	16	S 204-B 16	2CDS 254 001 R0165	52898 6				
	20	S 204-B 20	2CDS 254 001 R0205	52899 3				
	25	S 204-B 25	2CDS 254 001 R0255	52900 6				
	32	S 204-B 32	2CDS 254 001 R0325	52901 3				
	40	S 204-B 40	2CDS 254 001 R0405	52902 0				
	50	S 204-B 50	2CDS 254 001 R0505	55098 7				
	63	S 204-B 63	2CDS 254 001 R0635	55099 4				

① suitable for flow-type heaters 12 kW
② suitable for flow-type heaters 18 kW

③ suitable for flow-type heaters 21, 24 and 27 kW
④ U_{Bmax} 125 V ... with 2 poles connected in series

B

6000
3



SK 033 B 02

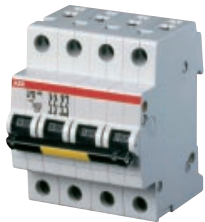

SK 029 B 02

Selection table

No. of poles	rated current I _n A	order details		bbn 40 16779 EAN	price 1 piece €	price group	w'ght 1 pc. kg	pack. unit pc.
		type code	order code					

With disconnecting neutral NA

1 + NA	6	S 201-B 6 NA	2CDS 251 103 R0065	53158 0			0.250	50/40
	10	S 201-B 10 NA	2CDS 251 103 R0105	53159 7				
	13	S 201-B 13 NA	2CDS 251 103 R0135	53160 3				
	U _{Bmax} 440 V ~ 60 V ∴	16	S 201-B 16 NA	2CDS 251 103 R0165	53161 0			
		20 ①	S 201-B 20 NA	2CDS 251 103 R0205	53162 7			
		25	S 201-B 25 NA	2CDS 251 103 R0255	53163 4			
		32 ②	S 201-B 32 NA	2CDS 251 103 R0325	53164 1			
		40 ③	S 201-B 40 NA	2CDS 251 103 R0405	53165 8			
	50	S 201-B 50 NA	2CDS 251 103 R0505	53615 8				
	63	S 201-B 63 NA	2CDS 251 103 R0635	53614 1				
3 + NA	6	S 203-B 6 NA	2CDS 253 103 R0065	53228 0			0.500	2/20
	10	S 203-B 10 NA	2CDS 253 103 R0105	53229 7				
	13	S 203-B 13 NA	2CDS 253 103 R0135	53230 3				
	U _{Bmax} 440 V ~	16	S 203-B 16 NA	2CDS 253 103 R0165	53231 0			
		20 ①	S 203-B 20 NA	2CDS 253 103 R0205	53232 7			
		25	S 203-B 25 NA	2CDS 253 103 R0255	53233 4			
		32 ②	S 203-B 32 NA	2CDS 253 103 R0325	53234 1			
		40 ③	S 203-B 40 NA	2CDS 253 103 R0405	53235 8			
	50	S 203-B 50 NA	2CDS 253 103 R0505	53616 5			0.580	
	63	S 203-B 63 NA	2CDS 253 103 R0635	53617 2				

① suitable for flow-type heaters 12 kW
② suitable for flow-type heaters 18 kW

③ suitable for flow-type heaters 21, 24 and 27 kW

C

6000
3



SK 018 B 01



SK 019 B 01



SK 020 B 019



SK 030 B 01

Selection table

No. of poles	rated current I_n , A	order details		bbn 40 16779 EAN	price 1 piece €	price group	w'ght 1 pc. kg	pack. unit pc.
		type code	order code					
1	0.5	S 201-C 0.5	2CDS 251 001 R0984	52329 5			0.125	10/40
	1	S 201-C 1	2CDS 251 001 R0014	52331 8				
	1.6	S 201-C 1.6	2CDS 251 001 R0974	52330 1				
	2	S 201-C 2	2CDS 251 001 R0024	52332 5				
	3	S 201-C 3	2CDS 251 001 R0034	52333 2				
	4	S 201-C 4	2CDS 251 001 R0044	52334 9				
	6	S 201-C 6	2CDS 251 001 R0064	46400 0				
	8	S 201-C 8	2CDS 251 001 R0084	46410 9				
	10	S 201-C 10	2CDS 251 001 R0104	46420 8				
	13	S 201-C 13	2CDS 251 001 R0134	46430 7				
	16	S 201-C 16	2CDS 251 001 R0164	46440 6				
	20 ①	S 201-C 20	2CDS 251 001 R0204	46450 5				
	25	S 201-C 25	2CDS 251 001 R0254	46460 4				
	32 ②	S 201-C 32	2CDS 251 001 R0324	46470 3				
	40 ③	S 201-C 40	2CDS 251 001 R0404	46480 2				
	50	S 201-C 50	2CDS 251 001 R0504	55100 7				
	63	S 201-C 63	2CDS 251 001 R0634	55101 4				
2	0.5	S 202-C 0.5	2CDS 252 001 R0984	52335 6			0.250	5/20
	1	S 202-C 1	2CDS 252 001 R0014	52336 3				
	1.6	S 202-C 1.6	2CDS 252 001 R0974	52337 0				
	2	S 202-C 2	2CDS 252 001 R0024	52338 7				
	3	S 202-C 3	2CDS 252 001 R0034	52339 4				
	4	S 202-C 4	2CDS 252 001 R0044	52340 0				
	6	S 202-C 6	2CDS 252 001 R0064	46550 2				
	8	S 202-C 8	2CDS 252 001 R0084	46560 1				
	10	S 202-C 10	2CDS 252 001 R0104	46570 0				
	13	S 202-C 13	2CDS 252 001 R0134	46580 9				
	16	S 202-C 16	2CDS 252 001 R0164	46590 8				
	20	S 202-C 20	2CDS 252 001 R0204	46600 4				
	25	S 202-C 25	2CDS 252 001 R0254	46610 3				
	32	S 202-C 32	2CDS 252 001 R0324	46620 2				
	40	S 202-C 40	2CDS 252 001 R0404	46630 1				
	50	S 202-C 50	2CDS 252 001 R0504	55104 5				
	63	S 202-C 63	2CDS 252 001 R0634	55105 2				
3	0.5	S 203-C 0.5	2CDS 253 001 R0984	52341 7			0.375	3/12
	1	S 203-C 1	2CDS 253 001 R0014	52342 4				
	1.6	S 203-C 1.6	2CDS 253 001 R0974	52343 1				
	2	S 203-C 2	2CDS 253 001 R0024	52344 8				
	3	S 203-C 3	2CDS 253 001 R0034	52345 5				
	4	S 203-C 4	2CDS 253 001 R0044	52346 2				
	6	S 203-C 6	2CDS 253 001 R0064	46750 6				
	8	S 203-C 8	2CDS 253 001 R0084	46760 5				
	10	S 203-C 10	2CDS 253 001 R0104	46780 3				
	13	S 203-C 13	2CDS 253 001 R0134	46790 2				
	16	S 203-C 16	2CDS 253 001 R0164	46800 8				
	20 ①	S 203-C 20	2CDS 253 001 R0204	46810 7				
	25	S 203-C 25	2CDS 253 001 R0254	46820 6				
	32 ②	S 203-C 32	2CDS 253 001 R0324	46830 5				
	40 ③	S 203-C 40	2CDS 253 001 R0404	46840 4				
	50	S 203-C 50	2CDS 253 001 R0504	55106 9				
	63	S 203-C 63	2CDS 253 001 R0634	55107 6				
4	0.5	S 204-C 0.5	2CDS 254 001 R0984	52911 2			0.500	2
	1	S 204-C 1	2CDS 254 001 R0014	52912 9				
	1.6	S 204-C 1.6	2CDS 254 001 R0974	52913 6				
	2	S 204-C 2	2CDS 254 001 R0024	52914 3				
	3	S 204-C 3	2CDS 254 001 R0034	52915 0				
	4	S 204-C 4	2CDS 254 001 R0044	52916 7				
	6	S 204-C 6	2CDS 254 001 R0064	52917 4				
	8	S 204-C 8	2CDS 254 001 R0084	52918 1				
	10	S 204-C 10	2CDS 254 001 R0104	52919 8				
	13	S 204-C 13	2CDS 254 001 R0134	52920 4				
	16	S 204-C 16	2CDS 254 001 R0164	52921 1				
	20	S 204-C 20	2CDS 254 001 R0204	52922 8				
	25	S 204-C 25	2CDS 254 001 R0254	52923 5				
	32	S 204-C 32	2CDS 254 001 R0324	52924 2				
	40	S 204-C 40	2CDS 254 001 R0404	52925 9				
	50	S 204-C 50	2CDS 254 001 R0504	55110 6				
	63	S 204-C 63	2CDS 254 001 R0634	55111 3				

① suitable for flow-type heaters 12 kW
② suitable for flow-type heaters 18 kW

③ suitable for flow-type heaters 21, 24 and 27 kW
④ U_{Bmax} 125 V ∴ with 2 poles connected in series

C

6000
3



SK 033 B 02

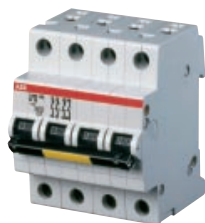

SK 029 B 02

Selection table

No. of poles	rated current I _n A	order details		bbn 40 16779 EAN	price 1 piece €	price group	w'ght 1 pc. kg	pack. unit pc.
		type code	order code					

With disconnecting neutral NA

1 + NA	0.5	S 201-C 0.5 NA	2CDS 251 103 R0984	53166 5			0.250	5
	1	S 201-C 1 NA	2CDS 251 103 R0014	53167 2				
	1.6	S 201-C 1.6 NA	2CDS 251 103 R0974	53168 9				
	2	S 201-C 2 NA	2CDS 251 103 R0024	53169 6				
	3	S 201-C 3 NA	2CDS 251 103 R0034	53170 2				
	4	S 201-C 4 NA	2CDS 251 103 R0044	53172 6				
	6	S 201-C 6 NA	2CDS 251 103 R0064	53173 3				
	8	S 201-C 8 NA	2CDS 251 103 R0084	53174 0				
	10	S 201-C 10 NA	2CDS 251 103 R0104	53175 7				
	13	S 201-C 13 NA	2CDS 251 103 R0134	53176 4				
	16	S 201-C 16 NA	2CDS 251 103 R0164	53177 1				
	20 ①	S 201-C 20 NA	2CDS 251 103 R0204	53178 8				
	25	S 201-C 25 NA	2CDS 251 103 R0254	53179 5				
	32 ②	S 201-C 32 NA	2CDS 251 103 R0324	53180 1				
	40 ③	S 201-C 40 NA	2CDS 251 103 R0404	53181 8				
50	S 201-C 50 NA	2CDS 251 103 R0504	55102 1			0.290		
63	S 201-C 63 NA	2CDS 251 103 R0634	55103 8					
3 + NA	0.5	S 203-C 0.5 NA	2CDS 253 103 R0984	53236 5			0.500	2
	1	S 203-C 1 NA	2CDS 253 103 R0014	53237 2				
	1.6	S 203-C 1.6 NA	2CDS 253 103 R0974	53238 9				
	2	S 203-C 2 NA	2CDS 253 103 R0024	53240 2				
	3	S 203-C 3 NA	2CDS 253 103 R0034	53241 9				
	4	S 203-C 4 NA	2CDS 253 103 R0044	53242 6				
	6	S 203-C 6 NA	2CDS 253 103 R0064	53243 3				
	8	S 203-C 8 NA	2CDS 253 103 R0084	53244 0				
	10	S 203-C 10 NA	2CDS 253 103 R0104	53245 7				
	13	S 203-C 13 NA	2CDS 253 103 R0134	53246 4				
	16	S 203-C 16 NA	2CDS 253 103 R0164	53247 1				
	20 ①	S 203-C 20 NA	2CDS 253 103 R0204	53248 8				
	25	S 203-C 25 NA	2CDS 253 103 R0254	53249 5				
	32 ②	S 203-C 32 NA	2CDS 253 103 R0324	53250 1				
	40 ③	S 203-C 40 NA	2CDS 253 103 R0404	53251 8				
50	S 203-C 50 NA	2CDS 253 103 R0504	55108 3			0.580		
63	S 203-C 63 NA	2CDS 253 103 R0634	55109 0					

① suitable for flow-type heaters 12 kW
② suitable for flow-type heaters 18 kW

③ suitable for flow-type heaters 21, 24 and 27 kW

D

6000
3



SK 018 B 01



SK 019 B 01



SK 020 B 019



SK 030 B 01

Selection table

No. of poles	rated current I_n , A	order details		bbn 40 16779 EAN	price 1 piece €	price group	w'ght 1 pc. kg	pack. unit pc.
		type code	order code					
1	0.5	S 201-D 0.5	2CDS 251 001 R0981	52993 8			0.125	10/40
	1	S 201-D 1	2CDS 251 001 R0011	52994 5				
	1.6	S 201-D 1.6	2CDS 251 001 R0971	52995 2				
	2	S 201-D 2	2CDS 251 001 R0021	52996 9				
	3	S 201-D 3	2CDS 251 001 R0031	52997 6				
	4	S 201-D 4	2CDS 251 001 R0041	52998 3				
	6	S 201-D 6	2CDS 251 001 R0061	52999 0				
	8	S 201-D 8	2CDS 251 001 R0081	53000 2				
	10	S 201-D 10	2CDS 251 001 R0101	53001 9				
	13	S 201-D 13	2CDS 251 001 R0131	53002 6				
	16	S 201-D 16	2CDS 251 001 R0161	53003 3				
	20 ①	S 201-D 20	2CDS 251 001 R0201	53004 0				
	25	S 201-D 25	2CDS 251 001 R0251	53005 7				
	32 ②	S 201-D 32	2CDS 251 001 R0321	53006 4				
	40 ③	S 201-D 40	2CDS 251 001 R0401	53007 1				
	50	S 201-D 50	2CDS 251 001 R0501	55199 1				
	63	S 201-D 63	2CDS 251 001 R0631	55200 4				
2	0.5	S 202-D 0.5	2CDS 252 001 R0981	53048 4			0.250	5/20
	1	S 202-D 1	2CDS 252 001 R0011	53049 1				
	1.6	S 202-D 1.6	2CDS 252 001 R0971	53050 7				
	2	S 202-D 2	2CDS 252 001 R0021	53051 4				
	3	S 202-D 3	2CDS 252 001 R0031	53052 1				
	4	S 202-D 4	2CDS 252 001 R0041	53053 8				
	6	S 202-D 6	2CDS 252 001 R0061	53054 5				
	8	S 202-D 8	2CDS 252 001 R0081	53055 2				
	10	S 202-D 10	2CDS 252 001 R0101	53058 3				
	13	S 202-D 13	2CDS 252 001 R0131	53060 6				
	16	S 202-D 16	2CDS 252 001 R0161	53061 3				
	20	S 202-D 20	2CDS 252 001 R0201	53063 7				
	25	S 202-D 25	2CDS 252 001 R0251	53064 4				
	32	S 202-D 32	2CDS 252 001 R0321	53065 1				
	40	S 202-D 40	2CDS 252 001 R0401	53066 8				
	④	S 202-D 50	2CDS 252 001 R0501	55203 5				
	63	S 202-D 63	2CDS 252 001 R0631	55204 2				
3	0.5	S 203-D 0.5	2CDS 253 001 R0981	53081 1			0.375	3/12
	1	S 203-D 1	2CDS 253 001 R0011	53082 8				
	1.6	S 203-D 1.6	2CDS 253 001 R0971	53083 5				
	2	S 203-D 2	2CDS 253 001 R0021	53084 2				
	3	S 203-D 3	2CDS 253 001 R0031	53085 9				
	4	S 203-D 4	2CDS 253 001 R0041	53086 6				
	6	S 203-D 6	2CDS 253 001 R0061	53088 0				
	8	S 203-D 8	2CDS 253 001 R0081	53089 7				
	10	S 203-D 10	2CDS 253 001 R0101	53090 3				
	13	S 203-D 13	2CDS 253 001 R0131	53091 0				
	16	S 203-D 16	2CDS 253 001 R0161	53092 7				
	20 ①	S 203-D 20	2CDS 253 001 R0201	53093 4				
	25	S 203-D 25	2CDS 253 001 R0251	53094 1				
	32 ②	S 203-D 32	2CDS 253 001 R0321	53095 8				
	40 ③	S 203-D 40	2CDS 253 001 R0401	53096 5				
	50	S 203-D 50	2CDS 253 001 R0501	55205 9				
	63	S 203-D 63	2CDS 253 001 R0631	55206 6				
4	0.5	S 204-D 0.5	2CDS 254 001 R0981	53112 2			0.500	2
	1	S 204-D 1	2CDS 254 001 R0011	53113 9				
	1.6	S 204-D 1.6	2CDS 254 001 R0971	53114 6				
	2	S 204-D 2	2CDS 254 001 R0021	53115 3				
	3	S 204-D 3	2CDS 254 001 R0031	53116 0				
	4	S 204-D 4	2CDS 254 001 R0041	53117 7				
	6	S 204-D 6	2CDS 254 001 R0061	53118 4				
	8	S 204-D 8	2CDS 254 001 R0081	53119 1				
	10	S 204-D 10	2CDS 254 001 R0101	53120 7				
	13	S 204-D 13	2CDS 254 001 R0131	53121 4				
	16	S 204-D 16	2CDS 254 001 R0161	53122 1				
	20	S 204-D 20	2CDS 254 001 R0201	53123 8				
	25	S 204-D 25	2CDS 254 001 R0251	53129 0				
	32	S 204-D 32	2CDS 254 001 R0321	53130 6				
	40	S 204-D 40	2CDS 254 001 R0401	53131 3				
	50	S 204-D 50	2CDS 254 001 R0501	55209 7				
	63	S 204-D 63	2CDS 254 001 R0631	55210 3				

① suitable for flow-type heaters 12 kW
② suitable for flow-type heaters 18 kW

③ suitable for flow-type heaters 21, 24 and 27 kW
④ U_{Bmax} 125 V ∴ with 2 poles connected in series

D

6000
3



SK 033 B 02



SK 029 B 02

Selection table

No. of poles	rated current I_n A	order details		bbn 40 16779 EAN	price 1 piece €	price group	w'ght 1 pc. kg	pack. unit pc.
		type code	order code					

With disconnecting neutral NA

1 + NA	0.5	S 201-D 0.5 NA	2CDS 251 103 R0981	53197 9			0.250	5
	1	S 201-D 1 NA	2CDS 251 103 R0011	53199 3				
	1.6	S 201-D 1.6 NA	2CDS 251 103 R0971	53198 6				
	2	S 201-D 2 NA	2CDS 251 103 R0021	53200 6				
	3	S 201-D 3 NA	2CDS 251 103 R0031	53201 3				
	4	S 201-D 4 NA	2CDS 251 103 R0041	53202 0				
	6	S 201-D 6 NA	2CDS 251 103 R0061	53203 7				
	8	S 201-D 8 NA	2CDS 251 103 R0081	53204 4				
	10	S 201-D 10 NA	2CDS 251 103 R0101	53205 1				
	13	S 201-D 13 NA	2CDS 251 103 R0131	53206 8				
	16	S 201-D 16 NA	2CDS 251 103 R0161	53209 9				
	20 ①	S 201-D 20 NA	2CDS 251 103 R0201	53210 5				
	25	S 201-D 25 NA	2CDS 251 103 R0251	53211 2				
	32 ②	S 201-D 32 NA	2CDS 251 103 R0321	53212 9				
	40 ③	S 201-D 40 NA	2CDS 251 103 R0401	53213 6				
3 + NA	0.5	S 203-D 0.5 NA	2CDS 253 103 R0981	53276 1			0.500	2
	1	S 203-D 1 NA	2CDS 253 103 R0011	53278 5				
	1.6	S 203-D 1.6 NA	2CDS 253 103 R0971	53277 8				
	2	S 203-D 2 NA	2CDS 253 103 R0021	53279 2				
	3	S 203-D 3 NA	2CDS 253 103 R0031	53280 8				
	4	S 203-D 4 NA	2CDS 253 103 R0041	53281 5				
	6	S 203-D 6 NA	2CDS 253 103 R0061	53282 2				
	8	S 203-D 8 NA	2CDS 253 103 R0081	53283 9				
	10	S 203-D 10 NA	2CDS 253 103 R0101	53284 6				
	13	S 203-D 13 NA	2CDS 253 103 R0131	53286 0				
	16	S 203-D 16 NA	2CDS 253 103 R0161	53287 7				
	20 ①	S 203-D 20 NA	2CDS 253 103 R0201	53288 4				
	25	S 203-D 25 NA	2CDS 253 103 R0251	53289 1				
	32 ②	S 203-D 32 NA	2CDS 253 103 R0321	53290 7				
	40 ③	S 203-D 40 NA	2CDS 253 103 R0401	53291 4				
U_{Bmax} 440 V ~ 60 V ∴	50	S 201-D 50 NA	2CDS 251 103 R0501	55201 1			0.290	
	63	S 201-D 63 NA	2CDS 251 103 R0631	55202 8				
U_{Bmax} 440 V ~	50	S 203-D 50 NA	2CDS 253 103 R0501	55207 3			0.580	
	63	S 203-D 63 NA	2CDS 253 103 R0631	55208 0				

① suitable for flow-type heaters 12 kW
② suitable for flow-type heaters 18 kW

③ suitable for flow-type heaters 21, 24 and 27 kW

K

6000



SK 021 B 01



SK 022 B 01



SK 023 B 01

Our recommendation:

K-type characteristic, tried and proven for more than 70 years.

K (= power)-type characteristic according to DIN VDE 0660 Part 101 (power circuit-breaker)

1. No nuisance tripping in the case of functional peak currents up to $8xI_n$, depending on the series.
2. Through its highly sensitive thermostatic bimetal trip, the K-type characteristic offers protection to damageable elements in the overcurrent range. It also provides the best protection to cables and lines.

No. of poles	rated current I_n A	order details		bbn 40 16779 EAN	price 1 piece €	price group	w'ght 1 pc. kg	pack. unit pc.
		type code	order code					
1	0.5	S 201-K 0.5	2CDS 251 001 R0157	50719 6			0.125	10/40
	1	S 201-K 1	2CDS 251 001 R0217	50720 2				
	1.6	S 201-K 1.6	2CDS 251 001 R0257	50721 9				
	2	S 201-K 2	2CDS 251 001 R0277	50722 6				
	3	S 201-K 3	2CDS 251 001 R0317	50723 3				
	4	S 201-K 4	2CDS 251 001 R0337	50724 0				
	6	S 201-K 6	2CDS 251 001 R0377	50725 7				
	8	S 201-K 8	2CDS 251 001 R0407	50726 4				
	10	S 201-K 10	2CDS 251 001 R0427	49611 7				
	13	S 201-K 13	2CDS 251 001 R0447	50727 1				
	16	S 201-K 16	2CDS 251 001 R0467	49612 4				
	20	S 201-K 20	2CDS 251 001 R0487	50728 8				
	25	S 201-K 25	2CDS 251 001 R0517	50729 5				
	32	S 201-K 32	2CDS 251 001 R0537	49613 1				
	40	S 201-K 40	2CDS 251 001 R0557	50730 1				
	50	S 201-K 50	2CDS 251 001 R0577	55112 0				
	63	S 201-K 63	2CDS 251 001 R0607	55113 7				
2	0.5	S 202-K 0.5	2CDS 252 001 R0157	50731 8			0.250	5/20
	1	S 202-K 1	2CDS 252 001 R0217	50732 5				
	1.6	S 202-K 1.6	2CDS 252 001 R0257	50733 2				
	2	S 202-K 2	2CDS 252 001 R0277	50734 9				
	3	S 202-K 3	2CDS 252 001 R0317	50735 6				
	4	S 202-K 4	2CDS 252 001 R0337	50736 3				
	6	S 202-K 6	2CDS 252 001 R0377	50737 0				
	8	S 202-K 8	2CDS 252 001 R0407	50738 7				
	10	S 202-K 10	2CDS 252 001 R0427	50739 4				
	13	S 202-K 13	2CDS 252 001 R0447	50740 0				
	16	S 202-K 16	2CDS 252 001 R0467	50741 7				
	20	S 202-K 20	2CDS 252 001 R0487	50742 4				
	25	S 202-K 25	2CDS 252 001 R0517	50743 1				
	32	S 202-K 32	2CDS 252 001 R0537	50744 8				
	40	S 202-K 40	2CDS 252 001 R0557	50745 5				
	50	S 202-K 50	2CDS 252 001 R0577	55116 8				
	63	S 202-K 63	2CDS 252 001 R0607	55117 5				
3	0.5	S 203-K 0.5	2CDS 253 001 R0157	50746 2			0.375	3/12
	1	S 203-K 1	2CDS 253 001 R0217	50747 9				
	1.6	S 203-K 1.6	2CDS 253 001 R0257	50748 6				
	2	S 203-K 2	2CDS 253 001 R0277	50749 3				
	3	S 203-K 3	2CDS 253 001 R0317	50750 9				
	4	S 203-K 4	2CDS 253 001 R0337	50751 6				
	6	S 203-K 6	2CDS 253 001 R0377	50752 3				
	8	S 203-K 8	2CDS 253 001 R0407	50753 0				
	10	S 203-K 10	2CDS 253 001 R0427	49614 8				
	13	S 203-K 13	2CDS 253 001 R0447	50754 7				
	16	S 203-K 16	2CDS 253 001 R0467	49615 5				
	20	S 203-K 20	2CDS 253 001 R0487	50755 4				
	25	S 203-K 25	2CDS 253 001 R0517	50756 1				
	32	S 203-K 32	2CDS 253 001 R0537	49616 2				
	40	S 203-K 40	2CDS 253 001 R0557	50757 8				
	50	S 203-K 50	2CDS 253 001 R0577	55118 2				
	63	S 203-K 63	2CDS 253 001 R0607	55119 9				

① U_{Bmax} 125 V ∴ with 2 poles connected in series

K

6000

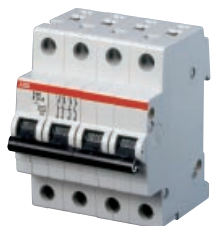

SK 030 B 01

Selection table

No. of poles	rated current I _n A	order details		bbn 40 16779 EAN	price 1 piece €	price group	w'ght 1 pc. kg	pack. unit pc.
		type code	order code					
4	0.5	S 204-K 0.5	2CDS 254 001 R0157	52926 6			0.500	2
	1	S 204-K 1	2CDS 254 001 R0217	52927 3				
	1.6	S 204-K 1.6	2CDS 254 001 R0257	52928 0				
	2	S 204-K 2	2CDS 254 001 R0277	52929 7				
	3	S 204-K 3	2CDS 254 001 R0317	52930 3				
	4	S 204-K 4	2CDS 254 001 R0337	52931 0				
	6	S 204-K 6	2CDS 254 001 R0377	52932 7				
	8	S 204-K 8	2CDS 254 001 R0407	52933 4				
	10	S 204-K 10	2CDS 254 001 R0427	52934 1				
	13	S 204-K 13	2CDS 254 001 R0447	52935 8				
	16	S 204-K 16	2CDS 254 001 R0467	52936 5				
	20	S 204-K 20	2CDS 254 001 R0487	52937 2				
	25	S 204-K 25	2CDS 254 001 R0517	52938 9				
	32	S 204-K 32	2CDS 254 001 R0537	52939 6				
	40	S 204-K 40	2CDS 254 001 R0557	52940 2				
	50	S 204-K 50	2CDS 254 001 R0577	55122 9				
63	S 204-K 63	2CDS 254 001 R0607	55123 6					

U_{Bmax}
440 V ~
60 V ∴

With disconnecting neutral NA

1 + NA	0.5	S 201-K 0.5 NA	2CDS 251 103 R0157	53182 5			0.25	5
	1	S 201-K 1 NA	2CDS 251 103 R0217	53183 2				
	1.6	S 201-K 1.6 NA	2CDS 251 103 R0257	53184 9				
	2	S 201-K 2 NA	2CDS 251 103 R0277	53185 6				
	3	S 201-K 3 NA	2CDS 251 103 R0317	53186 3				
	4	S 201-K 4 NA	2CDS 251 103 R0337	53187 0				
	6	S 201-K 6 NA	2CDS 251 103 R0377	53188 7				
	8	S 201-K 8 NA	2CDS 251 103 R0407	53189 4				
	10	S 201-K 10 NA	2CDS 251 103 R0427	53190 0				
	13	S 201-K 13 NA	2CDS 251 103 R0447	53191 7				
	16	S 201-K 16 NA	2CDS 251 103 R0467	53192 4				
	20	S 201-K 20 NA	2CDS 251 103 R0487	53193 1				
	25	S 201-K 25 NA	2CDS 251 103 R0517	53194 8				
	32	S 201-K 32 NA	2CDS 251 103 R0537	53195 5				
	40	S 201-K 40 NA	2CDS 251 103 R0557	53196 2				
	50	S 201-K 50 NA	2CDS 251 103 R0577	55114 4				
63	S 201-K 63 NA	2CDS 251 103 R0607	55115 1					
3 + NA	0.5	S 203-K 0.5 NA	2CDS 253 103 R0157	53261 7			0.50	2
	1	S 203-K 1 NA	2CDS 253 103 R0217	53262 4				
	1.6	S 203-K 1.6 NA	2CDS 253 103 R0257	53263 1				
	2	S 203-K 2 NA	2CDS 253 103 R0277	53264 8				
	3	S 203-K 3 NA	2CDS 253 103 R0317	53265 5				
	4	S 203-K 4 NA	2CDS 253 103 R0337	53266 2				
	6	S 203-K 6 NA	2CDS 253 103 R0377	53267 9				
	8	S 203-K 8 NA	2CDS 253 103 R0407	53268 6				
	10	S 203-K 10 NA	2CDS 253 103 R0427	53269 3				
	13	S 203-K 13 NA	2CDS 253 103 R0447	53270 9				
	16	S 203-K 16 NA	2CDS 253 103 R0467	53271 6				
	20	S 203-K 20 NA	2CDS 253 103 R0487	53272 3				
	25	S 203-K 25 NA	2CDS 253 103 R0517	53273 0				
	32	S 203-K 32 NA	2CDS 253 103 R0537	53274 7				
	40	S 203-K 40 NA	2CDS 253 103 R0557	53275 4				
	50	S 203-K 50 NA	2CDS 253 103 R0577	55120 5				
63	S 203-K 63 NA	2CDS 253 103 R0607	55121 2					

U_{Bmax}
440 V ~
60 V ∴

U_{Bmax}
440 V ~



SK 033 B 02



SK 029 B 02

Z

6000



SK 043 B 02



SK 022 B 01



SK 023 B 01

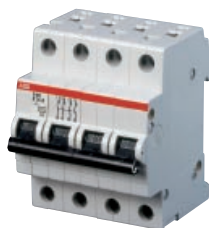

SK 030 B 01

Selection table

No. of poles	rated current I _n A	order details		bbn 40 16779 EAN	price 1 piece €	price group	w'ght 1 pc. kg	pack. unit pc.	
		type code	order code						
1	0.5	S 201-Z 0.5	2CDS 251 001 R0158	53030 9			0.125	10/40	
	1	S 201-Z 1	2CDS 251 001 R0218	53033 0					
	1.6	S 201-Z 1.6	2CDS 251 001 R0258	53034 7					
	2	S 201-Z 2	2CDS 251 001 R0278	53035 4					
	3	S 201-Z 3	2CDS 251 001 R0318	53036 1					
	4	S 201-Z 4	2CDS 251 001 R0338	53037 8					
	6	S 201-Z 6	2CDS 251 001 R0378	53040 8					
	8	S 201-Z 8	2CDS 251 001 R0408	53041 5					
	10	S 201-Z 10	2CDS 251 001 R0428	53042 2					
	16	S 201-Z 16	2CDS 251 001 R0468	53043 9					
	20	S 201-Z 20	2CDS 251 001 R0488	53044 6					
	25	S 201-Z 25	2CDS 251 001 R0518	53045 3					
	U _{Bmax} 440 V ~ 60 V ∴	32	S 201-Z 32	2CDS 251 001 R0538					53046 0
		40	S 201-Z 40	2CDS 251 001 R0558					53047 7
		50	S 201-Z 50	2CDS 251 001 R0578					55191 5
		63	S 201-Z 63	2CDS 251 001 R0608					55192 2
2	0.5	S 202-Z 0.5	2CDS 252 001 R0158	53068 2			0.250	5/20	
	1	S 202-Z 1	2CDS 252 001 R0218	53067 5					
	1.6	S 202-Z 1.6	2CDS 252 001 R0258	53069 9					
	2	S 202-Z 2	2CDS 252 001 R0278	53070 5					
	3	S 202-Z 3	2CDS 252 001 R0318	53071 2					
	4	S 202-Z 4	2CDS 252 001 R0338	53072 9					
	6	S 202-Z 6	2CDS 252 001 R0378	53073 6					
	8	S 202-Z 8	2CDS 252 001 R0408	53074 3					
	10	S 202-Z 10	2CDS 252 001 R0428	53075 0					
	16	S 202-Z 16	2CDS 252 001 R0468	53076 7					
	20	S 202-Z 20	2CDS 252 001 R0488	53077 4					
	25	S 202-Z 25	2CDS 252 001 R0518	53078 1					
	U _{Bmax} 440 V ~ 125 V ∴	32	S 202-Z 32	2CDS 252 001 R0538					53079 8
		40	S 202-Z 40	2CDS 252 001 R0558					53080 4
		50	S 202-Z 50	2CDS 252 001 R0578					55193 9
		63	S 202-Z 63	2CDS 252 001 R0608					55194 6
3	0.5	S 203-Z 0.5	2CDS 253 001 R0158	53097 2			0.375	3/12	
	1	S 203-Z 1	2CDS 253 001 R0218	53098 9					
	1.6	S 203-Z 1.6	2CDS 253 001 R0258	53099 6					
	2	S 203-Z 2	2CDS 253 001 R0278	53100 9					
	3	S 203-Z 3	2CDS 253 001 R0318	53101 6					
	4	S 203-Z 4	2CDS 253 001 R0338	53102 3					
	6	S 203-Z 6	2CDS 253 001 R0378	53103 0					
	8	S 203-Z 8	2CDS 253 001 R0408	53104 7					
	10	S 203-Z 10	2CDS 253 001 R0428	53105 4					
	16	S 203-Z 16	2CDS 253 001 R0468	53106 1					
	20	S 203-Z 20	2CDS 253 001 R0488	53107 8					
	25	S 203-Z 25	2CDS 253 001 R0518	53108 5					
	U _{Bmax} 440 V ~	32	S 203-Z 32	2CDS 253 001 R0538					53109 2
		40	S 203-Z 40	2CDS 253 001 R0558					53110 8
		50	S 203-Z 50	2CDS 253 001 R0578					55195 3
		63	S 203-Z 63	2CDS 253 001 R0608					55196 0
4	0.5	S 204-Z 0.5	2CDS 254 001 R0158	53024 8			0.500	2	
	1	S 204-Z 1	2CDS 254 001 R0218	53132 0					
	1.6	S 204-Z 1.6	2CDS 254 001 R0258	53144 3					
	2	S 204-Z 2	2CDS 254 001 R0278	53143 6					
	3	S 204-Z 3	2CDS 254 001 R0318	53133 7					
	4	S 204-Z 4	2CDS 254 001 R0338	53134 4					
	6	S 204-Z 6	2CDS 254 001 R0378	53135 1					
	8	S 204-Z 8	2CDS 254 001 R0408	53136 8					
	10	S 204-Z 10	2CDS 254 001 R0428	53137 5					
	16	S 204-Z 16	2CDS 254 001 R0468	53138 2					
	20	S 204-Z 20	2CDS 254 001 R0488	53139 9					
	25	S 204-Z 25	2CDS 254 001 R0518	53140 5					
	U _{Bmax} 440 V ~ 125 V ∴	32	S 204-Z 32	2CDS 254 001 R0538					53141 2
		40	S 204-Z 40	2CDS 254 001 R0558					53142 9
		50	S 204-Z 50	2CDS 254 001 R0578					55197 7
		63	S 204-Z 63	2CDS 254 001 R0608					55198 4

① U_{Bmax} 125 V ∴ with 2 poles connected in series

Z

6000



SK 033 B 02



SK 029 B 02

Selection table

No. of poles	rated current I_n A	order details		bbn 40 16779 EAN	price 1 piece €	price group	w'ght 1 pc. kg	pack. unit pc.
		type code	order code					

With disconnecting neutral NA

1 + NA	0.5	S 201-Z 0.5 NA	2CDS 251 103 R0158	53214 3			0.260	5	
	1	S 201-Z 1 NA	2CDS 251 103 R0218	53215 0					
	1.6	S 201-Z 1.6 NA	2CDS 251 103 R0258	53216 7					
	2 3 4	2	S 201-Z 2 NA	2CDS 251 103 R0278	53217 4			0.320	
		3	S 201-Z 3 NA	2CDS 251 103 R0318	53218 1				
		4	S 201-Z 4 NA	2CDS 251 103 R0338	53219 8				
		6	S 201-Z 6 NA	2CDS 251 103 R0378	53220 4				
		8	S 201-Z 8 NA	2CDS 251 103 R0408	53221 1				
		10	S 201-Z 10 NA	2CDS 251 103 R0428	53222 8				
	16 20 25	16	S 201-Z 16 NA	2CDS 251 103 R0468	53223 5			0.320	
		20	S 201-Z 20 NA	2CDS 251 103 R0488	53224 2				
		25	S 201-Z 25 NA	2CDS 251 103 R0518	53225 9				
		32	S 201-Z 32 NA	2CDS 251 103 R0538	53226 6				
		40	S 201-Z 40 NA	2CDS 251 103 R0558	53227 3				
		50	S 201-Z 50 NA	2CDS 251 103 R0578	55212 7				
63	S 201-Z 63 NA	2CDS 251 103 R0608	55213 4						
3 + NA	0.5	S 203-Z 0.5 NA	2CDS 253 103 R0158	53292 1			0.520	2	
	1	S 203-Z 1 NA	2CDS 253 103 R0218	53293 8					
	1.6	S 203-Z 1.6 NA	2CDS 253 103 R0258	53294 5					
	2 3 4	2	S 203-Z 2 NA	2CDS 253 103 R0278	53295 2			0.640	
		3	S 203-Z 3 NA	2CDS 253 103 R0318	53297 6				
		4	S 203-Z 4 NA	2CDS 253 103 R0338	53298 3				
		6	S 203-Z 6 NA	2CDS 253 103 R0378	53299 0				
	8 10	8	S 203-Z 8 NA	2CDS 253 103 R0408	53300 3			0.640	
		10	S 203-Z 10 NA	2CDS 253 103 R0428	53301 0				
		16	S 203-Z 16 NA	2CDS 253 103 R0468	53302 7				
	20 25	20	S 203-Z 20 NA	2CDS 253 103 R0488	53305 8			0.640	
		25	S 203-Z 25 NA	2CDS 253 103 R0518	53306 5				
		32	S 203-Z 32 NA	2CDS 253 103 R0538	53307 2				
	40 50	40	S 203-Z 40 NA	2CDS 253 103 R0558	53308 9			0.640	
		50	S 203-Z 50 NA	2CDS 253 103 R0578	55214 1				
63		S 203-Z 63 NA	2CDS 253 103 R0608	55216 5					

K

6000



SK 027 B 01



SK 028 B 01



SK 029 B 01



SK 031 B 01

Selection table

No. of poles	rated current I _n A	order details		bbn 40 16779 EAN	price 1 piece €	price group	w'ght 1 pc. kg	pack. unit pc.
		type code	order code					
1	0.5	S 201-K 0.5 H	2CD□251001R0157				0.125	10/40
	1	S 201-K 1 H	2CD□251001R0217					
	1.6	S 201-K 1.6 H	2CD□251001R0257					
	2	S 201-K 2 H	2CD□251001R0277					
	3	S 201-K 3 H	2CD□251001R0317					
	4	S 201-K 4 H	2CD□251001R0337					
	6	S 201-K 6 H	2CD□251001R0377					
	8	S 201-K 8 H	2CD□251001R0407					
	10	S 201-K 10 H	2CD□251001R0427					
	13	S 201-K 13 H	2CD□251001R0447					
	16	S 201-K 16 H	2CD□251001R0467					
	20	S 201-K 20 H	2CD□251001R0487					
	25	S 201-K 25 H	2CD□251001R0517					
	32	S 201-K 32 H	2CD□251001R0537					
	40	S 201-K 40 H	2CD□251001R0557					
	50	S 201-K 50 H	2CD□251001R0577					
	63	S 201-K 63 H	2CD□251001R0607					
2	0.5	S 202-K 0.5 H	2CD□252001R0157				0.250	5/20
	1	S 202-K 1 H	2CD□252001R0217					
	1.6	S 202-K 1.6 H	2CD□252001R0257					
	2	S 202-K 2 H	2CD□252001R0277					
	3	S 202-K 3 H	2CD□252001R0317					
	4	S 202-K 4 H	2CD□252001R0337					
	6	S 202-K 6 H	2CD□252001R0377					
	8	S 202-K 8 H	2CD□252001R0407					
	10	S 202-K 10 H	2CD□252001R0427					
	13	S 202-K 13 H	2CD□252001R0447					
	16	S 202-K 16 H	2CD□252001R0467					
	20	S 202-K 20 H	2CD□252001R0487					
	25	S 202-K 25 H	2CD□252001R0517					
	32	S 202-K 32 H	2CD□252001R0537					
	40	S 202-K 40 H	2CD□252001R0557					
	50	S 202-K 50 H	2CD□252001R0577					
	63	S 202-K 63 H	2CD□252001R0607					
3	0.5	S 203-K 0.5 H	2CD□253001R0157				0.375	3/12
	1	S 203-K 1 H	2CD□253001R0217					
	1.6	S 203-K 1.6 H	2CD□253001R0257					
	2	S 203-K 2 H	2CD□253001R0277					
	3	S 203-K 3 H	2CD□253001R0317					
	4	S 203-K 4 H	2CD□253001R0337					
	6	S 203-K 6 H	2CD□253001R0377					
	8	S 203-K 8 H	2CD□253001R0407					
	10	S 203-K 10 H	2CD□253001R0427					
	13	S 203-K 13 H	2CD□253001R0447					
	16	S 203-K 16 H	2CD□253001R0467					
	20	S 203-K 20 H	2CD□253001R0487					
	25	S 203-K 25 H	2CD□253001R0517					
	32	S 203-K 32 H	2CD□253001R0537					
	40	S 203-K 40 H	2CD□253001R0557					
	50	S 203-K 50 H	2CD□253001R0577					
	63	S 203-K 63 H	2CD□253001R0607					
4	0.5	S 204-K 0.5 H	2CD□254001R0157				0.500	2
	1	S 204-K 1 H	2CD□254001R0217					
	1.6	S 204-K 1.6 H	2CD□254001R0257					
	2	S 204-K 2 H	2CD□254001R0277					
	3	S 204-K 3 H	2CD□254001R0317					
	4	S 204-K 4 H	2CD□254001R0337					
	6	S 204-K 6 H	2CD□254001R0377					
	8	S 204-K 8 H	2CD□254001R0407					
	10	S 204-K 10 H	2CD□254001R0427					
	13	S 204-K 13 H	2CD□254001R0447					
	16	S 204-K 16 H	2CD□254001R0467					
	20	S 204-K 20 H	2CD□254001R0487					
	25	S 204-K 25 H	2CD□254001R0517					
	32	S 204-K 32 H	2CD□254001R0537					
	40	S 204-K 40 H	2CD□254001R0557					
	50	S 204-K 50 H	2CD□254001R0577					
	63	S 204-K 63 H	2CD□254001R0607					

Order code

MCB with NC contact



MCB with NO contact



① U_{Bmax} 125 V ∴ with 2 contact decks connected in series

K

6000



SK 031 B 02



SK 028 B 02

Selection table

No. of poles	rated current I _n A	order details	bbn 40 16779 EAN	price 1 piece €	price group	w'ght 1 pc. kg	pack. unit pc.
		type code	order code				

Model with disconnecting neutral NA

1 + NA	0.5	S 201-K 0.5 NA H□□	2CD□ 251 103 R0157			0.260	10/40			
	1	S 201-K 1 NA H□□	2CD□ 251 103 R0217							
	1.6	S 201-K 1.6 NA H□□	2CD□ 251 103 R0257							
	2	S 201-K 2 NA H□□	2CD□ 251 103 R0277							
	3	S 201-K 3 NA H□□	2CD□ 251 103 R0317							
	4	S 201-K 4 NA H□□	2CD□ 251 103 R0337							
	6	S 201-K 6 NA H□□	2CD□ 251 103 R0377							
	8	S 201-K 8 NA H□□	2CD□ 251 103 R0407							
	10	S 201-K 10 NA H□□	2CD□ 251 103 R0427							
	13	S 201-K 13 NA H□□	2CD□ 251 103 R0447							
	16	S 201-K 16 NA H□□	2CD□ 251 103 R0467							
	20	S 201-K 20 NA H□□	2CD□ 251 103 R0487							
	U _{Bmax} 440 V ~ 60 V ∴	25	S 201-K 25 NA H□□	2CD□ 251 103 R0517						
		32	S 201-K 32 NA H□□	2CD□ 251 103 R0537						
		40	S 201-K 40 NA H□□	2CD□ 251 103 R0557						
	3 + NA	0.5	S 203-K 0.5 NA H□□	2CD□ 253 103 R0157					0.520	3/12
		1	S 203-K 1 NA H□□	2CD□ 253 103 R0217						
1.6		S 203-K 1.6 NA H□□	2CD□ 253 103 R0257							
2		S 203-K 2 NA H□□	2CD□ 253 103 R0277							
3		S 203-K 3 NA H□□	2CD□ 253 103 R0317							
4		S 203-K 4 NA H□□	2CD□ 253 103 R0337							
6		S 203-K 6 NA H□□	2CD□ 253 103 R0377							
8		S 203-K 8 NA H□□	2CD□ 253 103 R0407							
10		S 203-K 10 NA H□□	2CD□ 253 103 R0427							
13		S 203-K 13 NA H□□	2CD□ 253 103 R0447							
16		S 203-K 16 NA H□□	2CD□ 253 103 R0467							
20		S 203-K 20 NA H□□	2CD□ 253 103 R0487							
U _{Bmax} 440 V ~		25	S 203-K 25 NA H□□	2CD□ 253 103 R0517						
		32	S 203-K 32 NA H□□	2CD□ 253 103 R0537						
		40	S 203-K 40 NA H□□	2CD□ 253 103 R0557						
50		S 203-K 50 NA H□□	2CD□ 253 103 R0577							
		63	S 203-K 63 NA H□□	2CD□ 253 103 R0607						

Order code

MCB with NC contact

MCB with NO contact

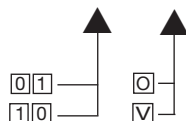

Attention:

Other characteristics with integrated auxiliary contact on request.

B

10000
3



SK 032 B 02

Selection table

No. of poles	rated current I _n A	order details		bbn 40 16779 EAN	price 1 piece €	price group	w'ght 1 pc. kg	pack. unit pc.	
		type code	order code						
1	6	S 201 M-B 6	2CDS 271 001 R0065	54942 4			0.125	10/40	
	10	S 201 M-B 10	2CDS 271 001 R0105	54943 1					
	13	S 201 M-B 13	2CDS 271 001 R0135	54944 8					
	16	S 201 M-B 16	2CDS 271 001 R0165	54945 5					
	20 ①	S 201 M-B 20	2CDS 271 001 R0205	54946 2					
	25	S 201 M-B 25	2CDS 271 001 R0255	54947 9					
	U _{Bmax} 440 V ~	32 ②	S 201 M-B 32	2CDS 271 001 R0325					54948 6
	60 V ∴	40 ③	S 201 M-B 40	2CDS 271 001 R0405					54949 3
		50	S 201 M-B 50	2CDS 271 001 R0505					54381 1
		63	S 201 M-B 63	2CDS 271 001 R0635					54382 8
2	6	S 202 M-B 6	2CDS 272 001 R0065	54958 5			0.250	5/20	
	10	S 202 M-B 10	2CDS 272 001 R0105	54959 2					
	13	S 202 M-B 13	2CDS 272 001 R0135	54960 8					
	16	S 202 M-B 16	2CDS 272 001 R0165	54961 5					
	20	S 202 M-B 20	2CDS 272 001 R0205	54962 2					
	25	S 202 M-B 25	2CDS 272 001 R0255	54963 9					
	U _{Bmax} 440 V ~	32	S 202 M-B 32	2CDS 272 001 R0325					54964 6
	125 V ∴	40	S 202 M-B 40	2CDS 272 001 R0405					54965 3
		50	S 202 M-B 50	2CDS 272 001 R0505					54385 9
		63 ④	S 202 M-B 63	2CDS 272 001 R0635					54386 6
3	6	S 203 M-B 6	2CDS 273 001 R0065	54966 0			0.375	3/12	
	10	S 203 M-B 10	2CDS 273 001 R0105	54967 7					
	13	S 203 M-B 13	2CDS 273 001 R0135	54968 4					
	16	S 203 M-B 16	2CDS 273 001 R0165	54969 1					
	20 ①	S 203 M-B 20	2CDS 273 001 R0205	54970 7					
	25	S 203 M-B 25	2CDS 273 001 R0255	54971 4					
	U _{Bmax} 440 V ~	32 ②	S 203 M-B 32	2CDS 273 001 R0325					54972 1
		40 ③	S 203 M-B 40	2CDS 273 001 R0405					54973 8
		50	S 203 M-B 50	2CDS 273 001 R0505					54387 3
		63	S 203 M-B 63	2CDS 273 001 R0635					54388 0
4	6	S 204 M-B 6	2CDS 274 001 R0065	54982 0			0.500	2	
	10	S 204 M-B 10	2CDS 274 001 R0105	54983 7					
	13	S 204 M-B 13	2CDS 274 001 R0135	54984 4					
	16	S 204 M-B 16	2CDS 274 001 R0165	54985 1					
	20	S 204 M-B 20	2CDS 274 001 R0205	54986 8					
	25	S 204 M-B 25	2CDS 274 001 R0255	54987 5					
	U _{Bmax} 440 V ~	32	S 204 M-B 32	2CDS 274 001 R0325					54988 2
	125 V ∴	40	S 204 M-B 40	2CDS 274 001 R0405					54989 9
		50	S 204 M-B 50	2CDS 274 001 R0505					54391 0
		63 ④	S 204 M-B 63	2CDS 274 001 R0635					54392 7

① suitable for flow-type heaters 12 kW
② suitable for flow-type heaters 18 kW

③ suitable for flow-type heaters 21, 24 and 27 kW
④ U_{Bmax} 125 V ∴ with 2 poles connected in series

B

10000
3



SK 032 B 02

Selection table

No. of poles	rated current I_n A	order details	bbn 40 16779 EAN	price 1 piece €	price group	w'ght 1 pc. kg	pack. unit pc.
		type code	order code				

With disconnecting neutral NA

1 + NA	6	S 201 M-B 6 NA	2CDS 271 103 R0065	54950 9		0.250	50/40
	10	S 201 M-B 10 NA	2CDS 271 103 R0105	54951 6			
	13	S 201 M-B 13 NA	2CDS 271 103 R0135	54952 3			
	16	S 201 M-B 16 NA	2CDS 271 103 R0165	54953 0			
	20 ①	S 201 M-B 20 NA	2CDS 271 103 R0205	54954 7			
	25	S 201 M-B 25 NA	2CDS 271 103 R0255	54955 4			
	32 ②	S 201 M-B 32 NA	2CDS 271 103 R0325	54956 1			
	40 ③	S 201 M-B 40 NA	2CDS 271 103 R0405	54957 8			
	50	S 201 M-B 50 NA	2CDS 271 103 R0505	54383 5			
	63	S 201 M-B 63 NA	2CDS 271 103 R0635	54384 2			
3 + NA	6	S 203 M-B 6 NA	2CDS 273 103 R0065	54974 5		0.500	2/20
	10	S 203 M-B 10 NA	2CDS 273 103 R0105	54975 2			
	13	S 203 M-B 13 NA	2CDS 273 103 R0135	54976 9			
	16	S 203 M-B 16 NA	2CDS 273 103 R0165	54977 6			
	20 ①	S 203 M-B 20 NA	2CDS 273 103 R0205	54978 3			
	25	S 203 M-B 25 NA	2CDS 273 103 R0255	54979 0			
	32 ②	S 203 M-B 32 NA	2CDS 273 103 R0325	54980 6			
	40 ③	S 203 M-B 40 NA	2CDS 273 103 R0405	54981 3			
	50	S 203 M-B 50 NA	2CDS 273 103 R0505	54389 7			
	63	S 203 M-B 63 NA	2CDS 273 103 R0635	54390 3			

① suitable for flow-type heaters 12 kW
② suitable for flow-type heaters 18 kW

③ suitable for flow-type heaters 21, 24 and 27 kW

C

10000
3



SK 044 B 02



SK 045 B 02



SK 046 B 02

Selection table

No. of poles	rated current I _n A	order details		bbn 40 16779 EAN	price 1 piece €	price group	w'ght 1 pc. kg	pack. unit pc.
		type code	order code					
1	0.5	S 201 M-C 0.5	2CDS 271 001 R0984	54990 5			0.125	10/40
	1	S 201 M-C 1	2CDS 271 001 R0014	54992 9				
	1.6	S 201 M-C 1.6	2CDS 271 001 R0974	54991 2				
	2	S 201 M-C 2	2CDS 271 001 R0024	54993 6				
	3	S 201 M-C 3	2CDS 271 001 R0034	54994 3				
	4	S 201 M-C 4	2CDS 271 001 R0044	54995 0				
	6	S 201 M-C 6	2CDS 271 001 R0064	54996 7				
	8	S 201 M-C 8	2CDS 271 001 R0084	54997 4				
	10	S 201 M-C 10	2CDS 271 001 R0104	54998 1				
	13	S 201 M-C 13	2CDS 271 001 R0134	54999 8				
	16	S 201 M-C 16	2CDS 271 001 R0164	55000 0				
	20 ①	S 201 M-C 20	2CDS 271 001 R0204	55001 7				
	25	S 201 M-C 25	2CDS 271 001 R0254	55002 4				
	32 ②	S 201 M-C 32	2CDS 271 001 R0324	55003 1				
	40 ③	S 201 M-C 40	2CDS 271 001 R0404	55004 8				
	50	S 201 M-C 50	2CDS 271 001 R0504	54393 4				
	63	S 201 M-C 63	2CDS 271 001 R0634	54394 1				
U _{Bmax} 440 V ~ 60 V ∴								
2	0.5	S 202 M-C 0.5	2CDS 272 001 R0984	55020 8			0.250	5/20
	1	S 202 M-C 1	2CDS 272 001 R0014	55022 2				
	1.6	S 202 M-C 1.6	2CDS 272 001 R0974	55021 5				
	2	S 202 M-C 2	2CDS 272 001 R0024	55023 9				
	3	S 202 M-C 3	2CDS 272 001 R0034	55024 6				
	4	S 202 M-C 4	2CDS 272 001 R0044	55025 3				
	6	S 202 M-C 6	2CDS 272 001 R0064	55026 0				
	8	S 202 M-C 8	2CDS 272 001 R0084	55027 7				
	10	S 202 M-C 10	2CDS 272 001 R0104	55028 4				
	13	S 202 M-C 13	2CDS 272 001 R0134	55029 1				
	16	S 202 M-C 16	2CDS 272 001 R0164	55030 7				
	20	S 202 M-C 20	2CDS 272 001 R0204	55031 4				
	25	S 202 M-C 25	2CDS 272 001 R0254	55032 1				
	32	S 202 M-C 32	2CDS 272 001 R0324	55033 8				
	40	S 202 M-C 40	2CDS 272 001 R0404	55034 5				
	50	S 202 M-C 50	2CDS 272 001 R0504	54397 2				
	63	S 202 M-C 63	2CDS 272 001 R0634	54398 9				
U _{Bmax} 440 V ~ 125 V ∴ ④								
3	0.5	S 203 M-C 0.5	2CDS 273 001 R0984	55035 2			0.375	3/12
	1	S 203 M-C 1	2CDS 273 001 R0014	55037 6				
	1.6	S 203 M-C 1.6	2CDS 273 001 R0974	55036 9				
	2	S 203 M-C 2	2CDS 273 001 R0024	55038 3				
	3	S 203 M-C 3	2CDS 273 001 R0034	55039 0				
	4	S 203 M-C 4	2CDS 273 001 R0044	55040 6				
	6	S 203 M-C 6	2CDS 273 001 R0064	55041 3				
	8	S 203 M-C 8	2CDS 273 001 R0084	55042 0				
	10	S 203 M-C 10	2CDS 273 001 R0104	55043 7				
	13	S 203 M-C 13	2CDS 273 001 R0134	55044 4				
	16	S 203 M-C 16	2CDS 273 001 R0164	55045 1				
	20 ①	S 203 M-C 20	2CDS 273 001 R0204	55046 8				
	25	S 203 M-C 25	2CDS 273 001 R0254	55047 5				
	32 ②	S 203 M-C 32	2CDS 273 001 R0324	55048 2				
	40 ③	S 203 M-C 40	2CDS 273 001 R0404	55049 9				
	50	S 203 M-C 50	2CDS 273 001 R0504	54399 6				
	63	S 203 M-C 63	2CDS 273 001 R0634	54400 9				
U _{Bmax} 440 V ~								
4	0.5	S 204 M-C 0.5	2CDS 274 001 R0984	55065 9			0.500	2
	1	S 204 M-C 1	2CDS 274 001 R0014	55067 3				
	1.6	S 204 M-C 1.6	2CDS 274 001 R0974	55066 6				
	2	S 204 M-C 2	2CDS 274 001 R0024	55068 0				
	3	S 204 M-C 3	2CDS 274 001 R0034	55069 7				
	4	S 204 M-C 4	2CDS 274 001 R0044	55070 3				
	6	S 204 M-C 6	2CDS 274 001 R0064	55071 0				
	8	S 204 M-C 8	2CDS 274 001 R0084	55072 7				
	10	S 204 M-C 10	2CDS 274 001 R0104	55073 4				
	13	S 204 M-C 13	2CDS 274 001 R0134	55074 1				
	16	S 204 M-C 16	2CDS 274 001 R0164	55075 8				
	20	S 204 M-C 20	2CDS 274 001 R0204	55076 5				
	25	S 204 M-C 25	2CDS 274 001 R0254	55077 2				
	32	S 204 M-C 32	2CDS 274 001 R0324	55078 9				
	40	S 204 M-C 40	2CDS 274 001 R0404	55079 6				
	50	S 204 M-C 50	2CDS 274 001 R0504	54403 0				
	63	S 204 M-C 63	2CDS 274 001 R0634	54404 7				
U _{Bmax} 440 V ~ 125 V ∴ ④								

① suitable for flow-type heaters 12 kW
② suitable for flow-type heaters 18 kW

③ suitable for flow-type heaters 21, 24 and 27 kW
④ U_{Bmax} 125 V ∴ with 2 poles connected in series

C

10000

3



SK 032 B 02

Attention:
S 200 M, B and C
with integrated auxiliary contact
on request.

Selection table

No. of poles	rated current I _n A	order details		bbn 40 16779 EAN	price 1 piece €	price group	w'ght 1 pc. kg	pack. unit pc.
		type code	order code					
With disconnecting neutral NA								
1 + NA	0.5	S 201 M-C 0.5 NA	2CDS 271 103 R0984	55005 5			0.250	5
	1	S 201 M-C 1 NA	2CDS 271 103 R0014	55007 9				
	1.6	S 201 M-C 1.6 NA	2CDS 271 103 R0974	55006 2				
	2	S 201 M-C 2 NA	2CDS 271 103 R0024	55008 6				
	3	S 201 M-C 3 NA	2CDS 271 103 R0034	55009 3				
	4	S 201 M-C 4 NA	2CDS 271 103 R0044	55010 9				
	6	S 201 M-C 6 NA	2CDS 271 103 R0064	55011 6				
	8	S 201 M-C 8 NA	2CDS 271 103 R0084	55012 3				
	10	S 201 M-C 10 NA	2CDS 271 103 R0104	55013 0				
	13	S 201 M-C 13 NA	2CDS 271 103 R0134	55014 7				
	16	S 201 M-C 16 NA	2CDS 271 103 R0164	55015 4				
	20 ①	S 201 M-C 20 NA	2CDS 271 103 R0204	55016 1				
	25	S 201 M-C 25 NA	2CDS 271 103 R0254	55017 8				
	32 ②	S 201 M-C 32 NA	2CDS 271 103 R0324	55018 5				
40 ③	S 201 M-C 40 NA	2CDS 271 103 R0404	55019 2					
3 + NA	0.5	S 203 M-C 0.5 NA	2CDS 273 103 R0984	55051 2			0.500	2
	1	S 203 M-C 1 NA	2CDS 273 103 R0014	55052 9				
	1.6	S 203 M-C 1.6 NA	2CDS 273 103 R0974	55050 5				
	2	S 203 M-C 2 NA	2CDS 273 103 R0024	55053 6				
	3	S 203 M-C 3 NA	2CDS 273 103 R0034	55054 3				
	4	S 203 M-C 4 NA	2CDS 273 103 R0044	55055 0				
	6	S 203 M-C 6 NA	2CDS 273 103 R0064	55056 7				
	8	S 203 M-C 8 NA	2CDS 273 103 R0084	55057 4				
	10	S 203 M-C 10 NA	2CDS 273 103 R0104	55058 1				
	13	S 203 M-C 13 NA	2CDS 273 103 R0134	55059 8				
	16	S 203 M-C 16 NA	2CDS 273 103 R0164	55060 4				
	20 ①	S 203 M-C 20 NA	2CDS 273 103 R0204	55061 1				
	25	S 203 M-C 25 NA	2CDS 273 103 R0254	55062 8				
	32 ②	S 203 M-C 32 NA	2CDS 273 103 R0324	55063 5				
40 ③	S 203 M-C 40 NA	2CDS 273 103 R0404	55064 2					
50	S 203 M-C 50 NA	2CDS 273 103 R0504	54401 6			0.580		
63	S 203 M-C 63 NA	2CDS 273 103 R0634	54402 3					

① suitable for flow-type heaters 12 kW
② suitable for flow-type heaters 18 kW

③ suitable for flow-type heaters 21, 24 and 27 kW

Supplementary devices MCB's Range S 200/S 200 M



SK 011 B 02



SK 209 B 02

SC-S/H6R

S 2C-A

Description	order details		bbn 40 16779 EAN	price 1 piece €	price group	w'ght 1 pc. kg	pack. unit pc.
	type code	order code					
Signalcontact/Auxiliary switch (universal) Retrofittable to the right side of MCB's, RCB's and Shunt trip's							
1 change over	S 2C-S/H6R	2CDS 200 922 R0001	56381 9			0.04	1
Auxiliary contact Retrofittable to the right side of MCB's							
1 change over	S 2C-H6R	2CDS 200 912 R0001	56382 6			0.04	1
Shunt trip							
AC/DC 12 ... 60 V	S 2C-A1	2CDS 200 909 R0001	57099 2			0.15	1
AC 110 ... 415 V und DC 110 ... 250 V	S 2C-A2	2CDS 200 909 R0002	57100 5				
Undervoltage release (in preparation)							
DC 12 V	S 2C-UA 12	2CDS 200 911 R0001	57101 2			0.09	1
AC/DC 24 V	S 2C-UA 24	2CDS 200 911 R0002	57102 9				
AC/DC 48 V	S 2C-UA 48	2CDS 200 911 R0003	57103 6				
AC/DC 110 V	S 2C-UA 110	2CDS 200 911 R0004	57104 3				
AC/DC 220 V	S 2C-UA 220	2CDS 200 911 R0005	57105 0				
AC 380 V	S 2C-UA 380	2CDS 200 911 R0006	57106 7				

Selection table residual-current-operated circuit breaker

nominal fault current $I_{\Delta n}$ mA	nominal current I_n A	order details		bbn 40 16779 EAN	price 1 piece €	price group	w'ght 1 pc. kg	pack. unit pc.
		type code	order code					

Residual-current-operated circuit breaker F 202, 2-pole, type A (sensitive to AC and pulsating DC current)

10	16	F 202 A-16/0.01	2CSF 202 101 R0160	47570 9			0.345	1
30	25	F 202 A-25/0.03	2CSF 202 101 R1250	47580 8			0.345	1
	40	F 202 A-40/0.03	2CSF 202 101 R1400	47600 3			0.345	1
	63	F 202 A-63/0.03	2CSF 202 101 R1630	55323 0			0.345	1
300	25	F 202 A-25/0.3	2CSF 202 101 R3250	47590 7			0.345	1
	40	F 202 A-40/0.3	2CSF 202 101 R3400	47610 2			0.345	1
	63	F 202 A-63/0.3	2CSF 202 101 R3630	55234 9			0.345	1
500	25	F 202 A-25/0.5	2CSF 202 101 R4250	55325 4			0.345	1
	40	F 202 A-40/0.5	2CSF 202 101 R4400	55324 7			0.345	1
	63	F 202 A-63/0.5	2CSF 202 101 R4630	55235 6			0.345	1

Residual-current-operated circuit-breaker F 204, 4-pole, type A (sensitive to AC and pulsating DC current)

30	25	F 204 A-25/0.03	2CSF 204 101 R1250	47620 1			0.405	1
	40	F 204 A-40/0.03	2CSF 204 101 R1400	47650 8			0.430	1
	63	F 204 A-63/0.03	2CSF 204 101 R1630	53996 8			0.430	1
300	25	F 204 A-25/0.3	2CSF 204 101 R3250	47630 0			0.415	1
	40	F 204 A-40/0.3	2CSF 204 101 R3400	47660 7			0.430	1
	63	F 204 A-63/0.3	2CSF 204 101 R3630	53999 9			0.430	1
500	25	F 204 A-25/0.5	2CSF 204 101 R4250	47640 9			0.415	1
	40	F 204 A-40/0.5	2CSF 204 101 R4400	47670 6			0.430	1
	63	F 204 A-63/0.5	2CSF 204 101 R4630	54000 1			0.430	1

Residual-current-operated circuit-breaker F 204 S, 4-pole selective, type A (sensitive to AC and pulsating DC current)

300	40	F 204 S-40/0.3	2CSF 204 201 R3400	47680 5			0.405	1
	63	F 204 S-63/0.3	2CSF 204 201 R3630	54016 2			0.405	1

Residual-current-operated circuit-breaker F 202 AC, 2-pole, type AC (sensitive to AC)

30	25	F 202 AC-25/0.03	2CSF 202 001 R1250	53499 4			0.345	1
	40	F 202 AC-40/0.03	2CSF 202 001 R1400	53503 8			0.345	1
	63	F 202 AC-63/0.03	2CSF 202 001 R1630	55269 1			0.345	1
100	25	F 202 AC-25/0.1	2CSF 202 001 R2250	53501 4			0.345	1
	40	F 202 AC-40/0.1	2CSF 202 001 R2400	53504 5			0.345	1
	63	F 202 AC-63/0.1	2CSF 202 001 R2630	55270 7			0.345	1
300	25	F 202 AC-25/0.3	2CSF 202 001 R3250	53502 1			0.345	1
	40	F 202 AC-40/0.3	2CSF 202 001 R3400	53505 2			0.345	1
	63	F 202 AC-63/0.3	2CSF 202 001 R3630	55271 4			0.345	1

Residual-current-operated circuit-breaker F 204 AC, 4-pole, type AC (sensitive to AC)

30	25	F 204 AC-25/0.03	2CSF 204 001 R1250	53506 9			0.405	1
	40	F 204 AC-40/0.03	2CSF 204 001 R1400	53509 0			0.430	1
	63	F 204 AC-63/0.03	2CSF 204 001 R1630	53993 7			0.430	1
100	25	F 204 AC-25/0.1	2CSF 204 001 R2250	53507 6			0.415	1
	40	F 204 AC-40/0.1	2CSF 204 001 R2400	53510 6			0.430	1
	63	F 204 AC-63/0.1	2CSF 204 001 R2630	53994 4			0.430	1
300	25	F 204 AC-25/0.3	2CSF 204 001 R3250	53508 3			0.415	1
	40	F 204 AC-40/0.3	2CSF 204 001 R3400	53511 3			0.430	1
	63	F 204 AC-63/0.3	2CSF 204 001 R3630	55995 1			0.430	1

Residual-current-operated circuit-breaker F 204 R, 4-pole short time delayed, type A

30	25	F 204 AP-R-25/0.03	2CSF 204 401 R1250	57826 4			0.405	1
	40	F 204 AP-R-40/0.03	2CSF 204 401 R1400	57827 1			0.430	1
	63	F 204 AP-R-63/0.03	2CSF 204 401 R1630	57828 8			0.430	1

Signalcontact/Auxiliary switch (universal)
Retrofittable to the right side of MCB's and RCD's

1 change over	S 2C-S/H6R	2CDS 200 922 R0001	56381 9				0.04	1
---------------	-------------------	--------------------	----------------	--	--	--	------	---



F 202

SK 047 B 02



F 204

SK 048 B 02



F 204 S

SK 0026 B 99



S2C-S/H6R

SK 011 B 02

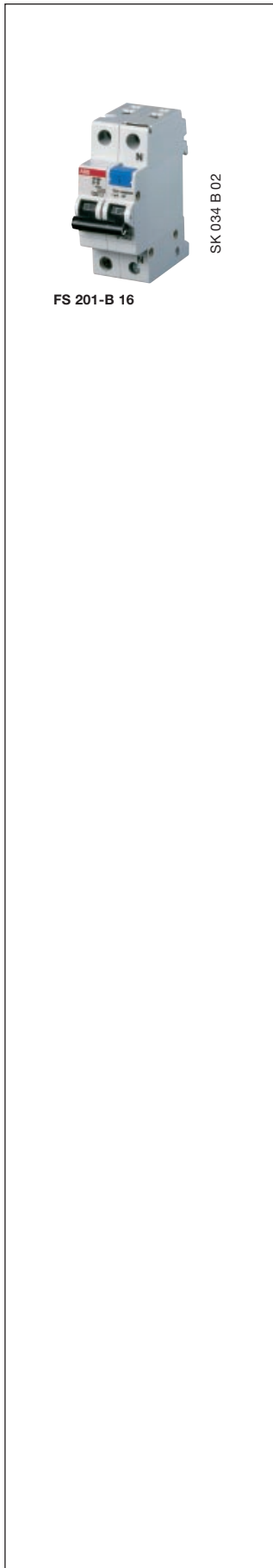

FS 201-B 16

nominal fault current $I_{\Delta n}$ mA	nominal current I_n A	order details type code	order code	bbn 40 16779 EAN	price 1 piece €	price group	w/ght 1 pc. kg	pack. unit pc.
Residual-current-operated circuit breaker with overload protection and people protector device								
10 People protector	10	FS 201-B 10/0.01	2CSR255101R0105	56473 1			0.25	1
	13	FS 201-B 13/0.01	2CSR255101R0135	56474 8			0.25	1
	16	FS 201-B 16/0.01	2CSR255101R0165	56475 5			0.25	1
	16	FS 201-K 16/0.01	2CSR255101R0167	56476 2			0.25	1
30	6	FS 201-B 6/0.03	2CSR255101R1065	51699 0			0.25	1
	10	FS 201-B 10/0.03	2CSR255101R1105	51703 4			0.25	1
	13	FS 201-B 13/0.03	2CSR255101R1135	51704 1			0.25	1
	16	FS 201-B 16/0.03	2CSR255101R1165	51707 2			0.25	1
	20	FS 201-B 20/0.03	2CSR255101R1205	51708 9			0.25	1
	25	FS 201-B 25/0.03	2CSR255101R1255	51711 9			0.25	1
	32	FS 201-B 32/0.03	2CSR255101R1325	51712 6			0.25	1
30	40	FS 201-B 40/0.03	2CSR255101R1405	51713 3			0.25	1
	1	FS 201-K 1/0.03	2CSR255101R1017	56957 6			0.25	1
	2	FS 201-K 2/0.03	2CSR255101R1027	56958 3			0.25	1
	4	FS 201-K 4/0.03	2CSR255101R1047	56999 6			0.25	1
	6	FS 201-K 6/0.03	2CSR255101R1067	51714 0			0.25	1
	10	FS 201-K 10/0.03	2CSR255101R1107	51715 7			0.25	1
	13	FS 201-K 13/0.03	2CSR255101R1137	56959 0			0.25	1
	16	FS 201-K 16/0.03	2CSR255101R1167	51716 4			0.25	1
	20	FS 201-K 20/0.03	2CSR255101R1207	51717 1			0.25	1
	25	FS 201-K 25/0.03	2CSR255101R1257	51718 8			0.25	1
300	32	FS 201-K 32/0.03	2CSR255101R1327	51719 5			0.25	1
	1	FS 201-K 1/0.3	2CSR255101R3017	56961 3			0.25	1
	2	FS 201-K 2/0.3	2CSR255101R3027	56962 0			0.25	1
	4	FS 201-K 4/0.3	2CSR255101R3047	56963 7			0.25	1
	6	FS 201-K 6/0.3	2CSR255101R3067	56964 4			0.25	1
	10	FS 201-K 10/0.3	2CSR255101R3107	56965 1			0.25	1
	13	FS 201-K 13/0.3	2CSR255101R3137	56966 8			0.25	1
	16	FS 201-K 16/0.3	2CSR255101R3167	56967 5			0.25	1
	20	FS 201-K 20/0.3	2CSR255101R3207	56968 2			0.25	1
	25	FS 201-K 25/0.3	2CSR255101R3257	56969 9			0.25	1
	32	FS 201-K 32/0.3	2CSR255101R3327	56970 5			0.25	1
30	6	FS 201-C 0.03	2CSR255101R1064	552882			0.25	1
	10	FS 201-C 0.03	2CSR255101R1104	552899			0.25	1
	13	FS 201-C 0.03	2CSR255101R1134	552905			0.25	1
	16	FS 201-C 0.03	2CSR255101R1164	552912			0.25	1
	20	FS 201-C 0.03	2CSR255101R1204	552929			0.25	1
	25	FS 201-C 0.03	2CSR255101R1254	552936			0.25	1
	32	FS 201-C 0.03	2CSR255101R1324	552936			0.25	1
300	40	FS 201-C 0.03	2CSR255101R1404	552950			0.25	1
	6	FS 201-C 6/0.3	2CSR255101R3064	53983 8			0.25	1
	10	FS 201-C 10/0.3	2CSR255101R3104	53984 5			0.25	1
	13	FS 201-C 13/0.3	2CSR255101R3134	53985 2			0.25	1
	16	FS 201-C 16/0.3	2CSR255101R3164	53986 9			0.25	1
	20	FS 201-C 20/0.3	2CSR255101R3204	53987 6			0.25	1
	25	FS 201-C 25/0.3	2CSR255101R3254	53988 3			0.25	1
	32	FS 201-C 32/0.3	2CSR255101R3324	53989 0			0.25	1
	40	FS 201-C 40/0.3	2CSR255101R3404	53990 6			0.25	1

Selection table busbars (to be used exclusive with compact series)

cross section mm ²	module	phases	order details type code	order code	bbn 40 16779 EAN	price 1 piece €	price group	w'ght 1 pc. kg	pack. unit pc.
----------------------------------	--------	--------	----------------------------	------------	------------------------	-----------------------	----------------	----------------------	----------------------

busbars cannot be cut to length (standard style)

10	2	1	PS 1/2	2CDL 210 001 R1002	46300 3			0.008	180
10	3	1	PS 1/3	2CDL 210 001 R1003	51465 1			0.025	60
10	6	1	PS 1/6	2CDL 210 001 R1006	46310 2			0.025	60
10	9	1	PS 1/9	2CDL 210 001 R1009	46320 1			0.039	30
10	12	1	PS 1/12	2CDL 210 001 R1012	46330 0			0.052	30
10	6	3	PS 3/6	2CDL 231 001 R1006	46340 9			0.042	60
10	9	3	PS 3/9	2CDL 231 001 R1009	46350 8			0.069	30
10	12	3	PS 3/12	2CDL 231 001 R1012	46360 7			0.096	30
10	12 (no NA)	3	PS 3/12 FI	2CDL 231 002 R1012	46370 6			0.094	30

1, 2, 3 and 4-pole busbars to be cut to length

10	57	1	PS 1/57 N A*	2CDL 210 011 R1057	57972 8			0.145	30
16	57	1	PS 1/57/16 N A*	2CDL 210 011 R1657	57973 5			0.205	30
10	60	1	PS 1/60	2CDL 210 001 R1060	51466 8			0.260	30
16	60	1	PS 1/60/16	2CDL 210 001 R1660	51665 5			0.365	30
10	12	2	PS 2/12	2CDL 220 001 R1012	55652 1			0.070	50
10	58	2	PS 2/58	2CDL 220 001 R1058	55655 2			0.320	10
16	58	2	PS 2/58/16	2CDL 220 001 R1658	55656 9			0.545	10
16	48	2	PS 2/48/16 H**	2CDL 220 001 R1648	55654 5			0.680	10
10	12	3	PS 3/12	2CDL 230 001 R1012	57611 6			0.110	50
10	60	3	PS 3/60	2CDL 230 001 R1060	51469 9			0.505	10
10	60	3	PS 3/60 A	2CDL 230 010 R1060	56375 8			0.510	10
16	60	3	PS 3/60/16	2CDL 230 001 R1660	51470 5			0.760	10
16	60	3	PS 3/60/16 A	2CDL 230 010 R1660	56376 5			0.640	10
10	39	3	PS 3/39 H**	2CDL 230 001 R1039	55659 0			0.505	10
16	39	3	PS 3/39/16 H**	2CDL 230 001 R1639	55660 6			0.760	10
10	48	3	PS 3/48 H**	2CDL 230 001 R1048	55661 3			0.505	10
16	48	3	PS 3/48/16 H**	2CDL 230 001 R1648	55664 4			0.760	10
10	12	3	PS 3/12 FI	2CDL 230 002 R1012	57107 4			0.110	50
10	12	3	PS 3/12 FI H	2CDL 230 003 R1012	57108 1			0.110	50
10	57	3	PS 3/57 FI	2CDL 230 002 R1057	55665 1			0.550	10
10	12	4	PS 4/12	2CDL 240 001 R1012	55666 8			0.120	50
10	60	4	PS 4/60	2CDL 240 001 R1060	55668 2			0.800	10
16	12	4	PS 4/12/16	2CDL 240 001 R1612	55667 5			0.240	50
16	60	4	PS 4/60/16	2CDL 240 001 R1660	55674 3			1.205	10
10	58	4	PS 4/58 N	2CDL 240 001 R1058	55670 5			0.800	10
10	58	4	PS 4/58 N A	2CDL 240 010 R1058	56373 4			0.540	10
16	58	4	PS 4/58/16 N	2CDL 240 001 R1658	55673 6			1.205	10
16	58	4	PS 4/58/16 N A	2CDL 240 010 R1658	56374 1			0.750	10
16	52	4	PS 4/52/16 H*	2CDL 240 001 R1652	55669 9			1.300	10

* blue isolation ** bar with auxiliary switch cut-out A = with knockout pins

Note: busbars up to 12-module with end caps (standard style)
 PS 1/60 no end caps required
 PS 2/.. and PS 3/.. use PS END
 PS 4/.. use PS END 1

End caps

			PS-END	2CDL 200 001 R0001	51472 9			0.001	50
			PS-END 1	2CDL 200 001 R0002	57011 4			0.001	

Main circuit-breaker busbar

3-phase busbar (10mm²) for connecting the main circuit-breaker E 463/3-KB to pro M compact devices incl. end caps. No. of poles: 12 (1xE 463/3-KB + 9xS 201)

	12	3	PS 3/12 E463	2CDL 230 004 R1012	51741 6			0.081	30
--	----	---	--------------	--------------------	---------	--	--	-------	----

Rail connectors

for wiring component rows in the consumer unit with a rail-to-rail clearance of 125 mm. The insulation material of the N is blue in the case of 4-pole connectors.

10	3-pole		RV 3	GH V036 0504 R0023	51238 1			0.080	25
10	4-pole		RV 4	GH V036 0504 R0024	51224 4			0.114	25

Auxiliary contact bridge

wire jumper for integrated auxiliary contact S 200 H for series connection

	1/2 mod.		HKB	GH V036 0504 R0100	52313 4			0.001	1000
--	----------	--	-----	--------------------	---------	--	--	-------	------

Shock-protection caps for PS... busbar

		5 parts	SZ-BSK	2CDL 200 001 R0011	42000 6			0.003	10
--	--	---------	--------	--------------------	---------	--	--	-------	----

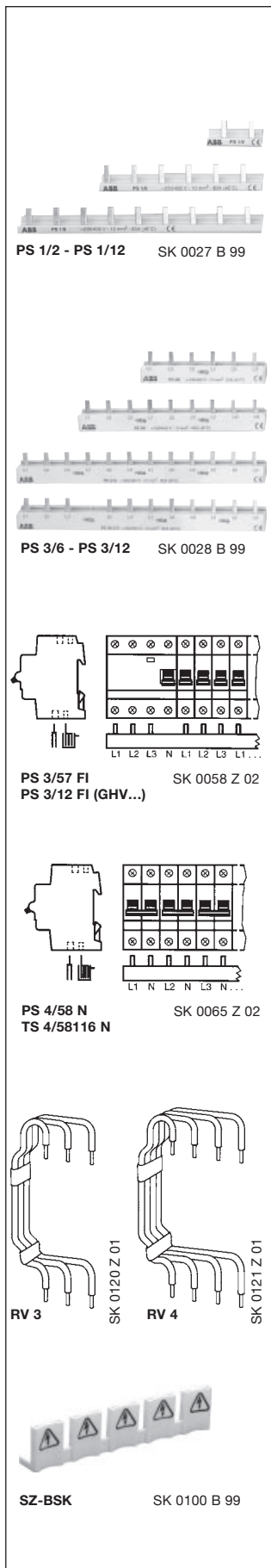

Wiring examples

PS 3/12
PS 3/60
PS 3/60/16

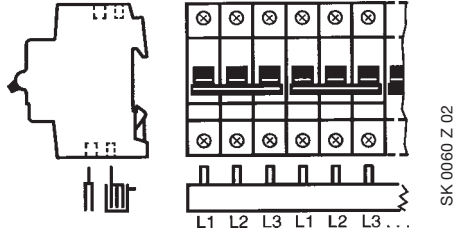

PS 4/12
PS 4/12/16
PS 4/60
PS 4/60/16

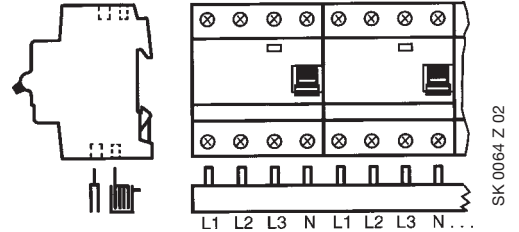

PS 4/12
PS 4/12/16
PS 4/60
PS 4/60/16

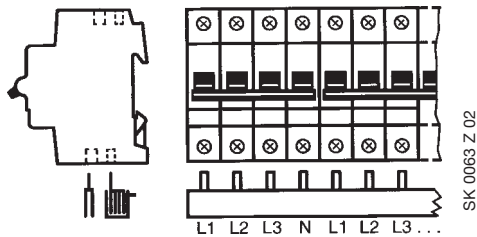

PS 3/48 H
PS 3/48/16 H

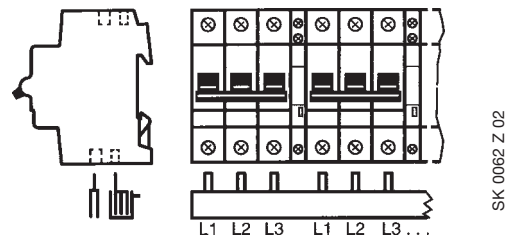

PS 3/39 H
PS 3/39/16 H

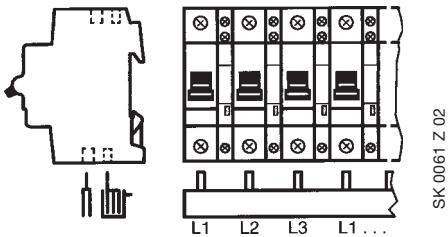

PS 2/12
PS 2/12/16
PS 2/58
PS 2/58/16

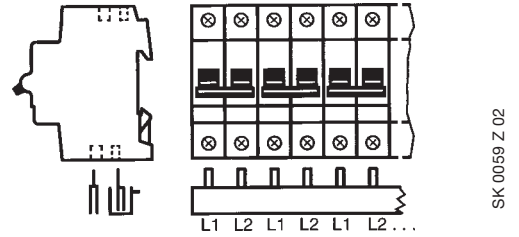

PS 2/48/16 H

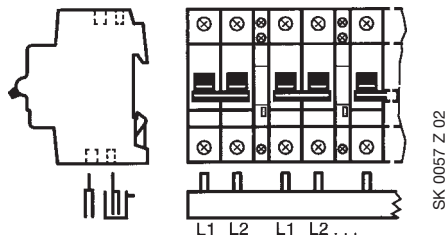

PS 4/52/16 H

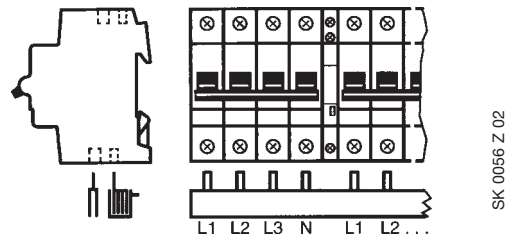

PS 3/12 FI H

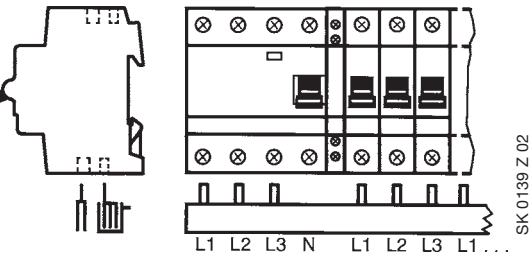

PS 3/12 E 463

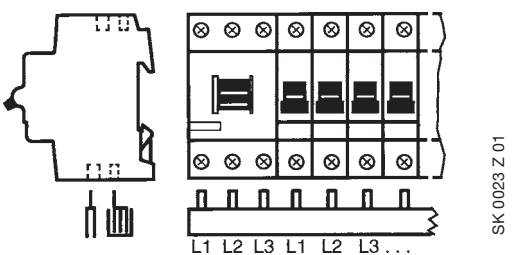

**Example for
overlapping**

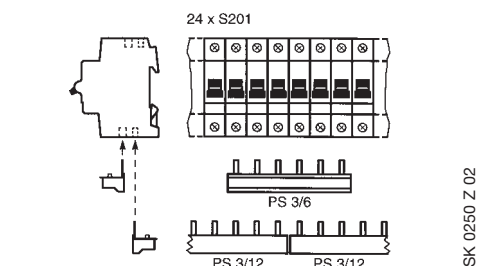

**Example for
overlapping**

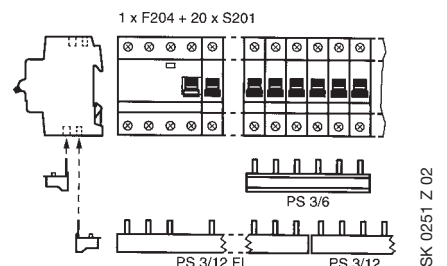

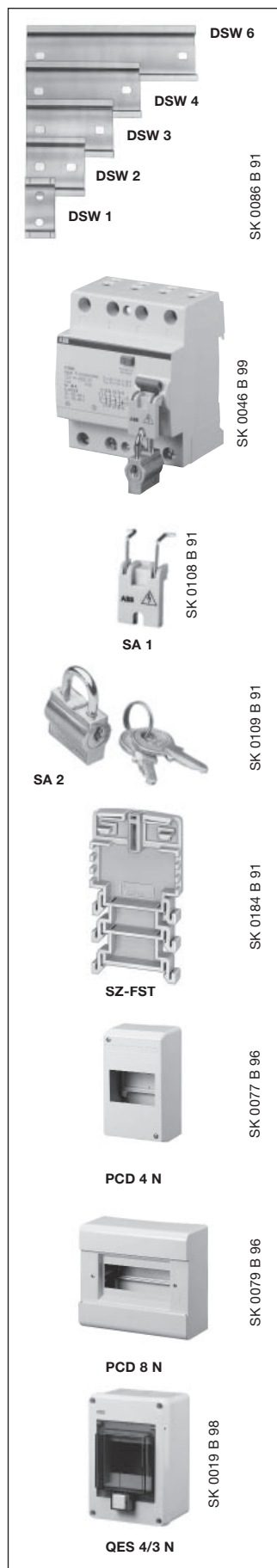

description	type code	order code	bbn 40 12233 EAN	price 1 piece €	price group	w'ght 1 pc. kg	pack. unit pc
-------------	-----------	------------	------------------------	-----------------------	----------------	----------------------	---------------------

Mounting rails (EN 60 715 - 35 x 7.5)

For individual installation with 2 screws onto an even surface (1 module = 17.5 mm)

for 1 module	DSW 1	GH S210 1926 R0001	13580 6			0.006	10
for 2 modules	DSW 2	GH S210 1926 R0002	13590 5			0.012	10
for 3 modules	DSW 3	GH S210 1926 R0003	13600 1			0.018	10
for 4 modules	DSW 4	GH S210 1926 R0004	13610 1			0.024	10
for 6 modules	DSW 6	GH S210 1926 R0006	13620 9			0.030	10

Locking devices for miniature circuit-breakers and switches

for the protection against unauthorised or unsafe operation of the operating lever. An adaptor makes it possible to block the operating lever whether switched ON or OFF. The lever is blocked with a padlock having a bar cross section of 3 or 6 mm max. For multipole devices, one lock may be fitted per pole.

application

- block against closing**
 - block to prevent unwanted closing during maintenance work
 - block and initialisation notice
 - block in the case of power cut-offs
- block against opening**
 - to prevent unwanted manual opening e.g. in alarm devices, air-condition systems, IT equipment, etc.
 - re-initialisation after tripping only possible by authorised personnel

The lock adapter can be used for all MCBs of series S 200, S 440, S 280, switches of series E 220 and 270 as well as residual-current-operated circuit-breaker F 200, F 440.

lock-out latch for } padlock bar	3 mm	SA 1	GJ F110 1903 R0001	58760 5		0.004	10
	6 mm	SA 1E	GJ F110 1903 R0004	58790 2		0.004	10
padlock with 2 keys		SA 2	GJ F110 1903 R0002	58770 4		0.02	10
padlock, identical locking with 2 keys		SA 2 i	GJ F110 9999 R0001	96940 1		0.02	10
lock adapter incl. padlock with three keys in transparent box		SA 3	GJ F110 1903 R0003	58780 3		0.05	10

Filler piece

Width 8.75 mm as heat conductor for M.C.B.'s mounted in a row. Three different heights, with break-off sections.

	SZ-FST	GJ I148 0003 R0001	59410 8			0.01	25
--	---------------	--------------------	----------------	--	--	------	----

Terminal cover with base plate, degree of protection IP 20

The terminal cover is snapped into place onto the base plate and is sealable. The base plate is fitted with an integrated DIN mounting rail.

for 2 modules	PCD 2 N	GH S270 1921 R0002	11869 8 ②			0.08	1
for 4 modules	PCD 4 N	GH S270 1921 R0004	11872 8 ②			0.14	1
for 6 modules	PCD 6 N	GH S270 1921 R0006	11877 3 ②			0.175	1
for 8 modules	PCD 8 N	GH S270 1921 R0008	14222 8 ②			0.63	1

blanking plate 1 module = 17.5 mm with half module width	BP	GH S270 1913 R0001	12857 4 ②			0.005	10
--	-----------	--------------------	------------------	--	--	-------	----

② to be retrofitted in terminal system PCD...

Enclosure of moulded-plastic, degree of protection IP 55

complete with device DIN rails EN 60 715 and 3, bzw. 5 cable entry grommets Pg 21 for 4 modules, knockouts: top 1 x Pg 21, bottom 2 x Pg 21

with 2 grommets	QES 4/3 N	GH L111 2304 R0013	12644 0 ②			0.330	1
-----------------	------------------	--------------------	------------------	--	--	-------	---

for 6 modules, knockouts: top and bottom, each 3 x Pg 21

for 2 grommets	QES 6/3 N	GH L111 2306 R0013	12646 4 ②			0.420	1
----------------	------------------	--------------------	------------------	--	--	-------	---

casing for 10 modules (QES 10/3 N) please inquire

② bbn-Nr. 80 00126

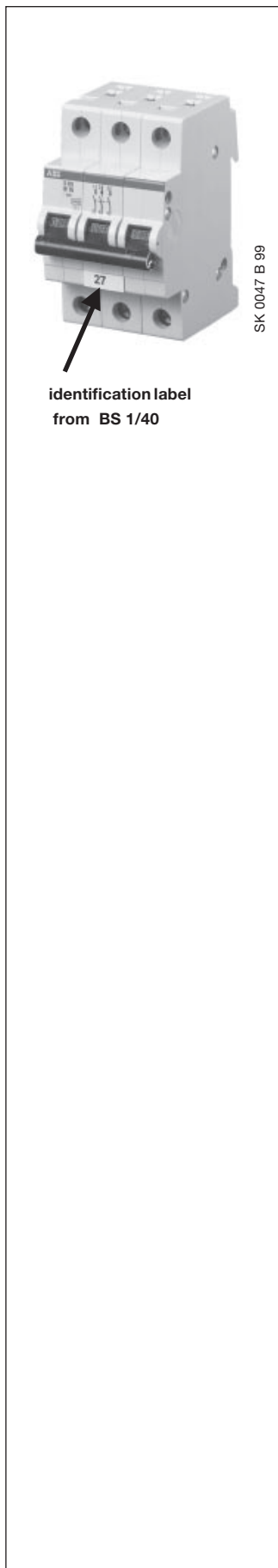

SK 0047 B 99

identification label from BS 1/40

description	order details		bbn	price	price	w'ght	pack.
	type code	order code	40 16779 EAN	1 piece €	group	1 pc. kg	unit pc.

Labelling system

Self-adhesive identification labels are available for all devices of the **System pro M compact** range. An integrated positioning aid ensures the exact arrangement of labels.

Selection table

Each package contains 40 labels, marked or blank. Blank label mats can be labeled by hand with an indelible, waterproof pen or with computerised labelling systems (plotter).

identification labels blank	BS	GH S200 1946 R0001	47810 6				30
identification labels with pictograms	BS Pikto	GH S200 1946 R0002	47820 5				30
identification labels labeled 4 x 1-10	BS 1/10	GH S200 1946 R0003	47830 4				30
identification labels labeled 2 x 1-20	BS 1/20	GH S200 1946 R0004	47840 3				30
identification labels labeled 1-40	BS 1/40	GH S200 1946 R0005	47850 2				30

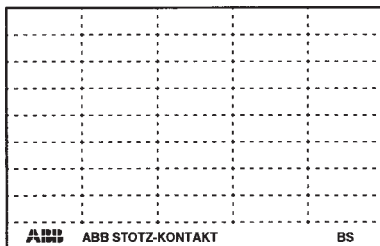

SK 0101 Z 99

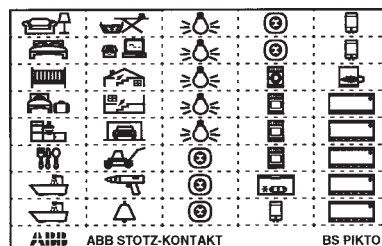

SK 0102 Z 99

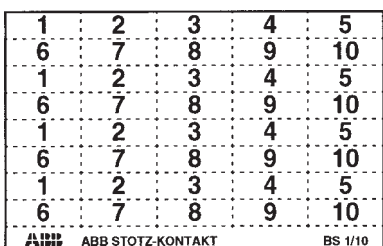

SK 0103 Z 99

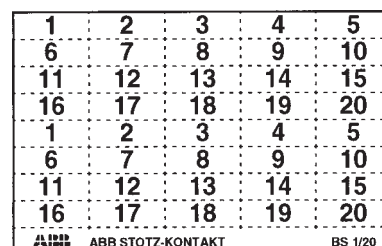

SK 0104 Z 99



SK 0105 Z 99

Areas of application	DIN VDE...	Required sensitivity I _n mA	F 200 F 660 F 670	F 200 F 690 S	F 172 FS 200	F220 F 804
In apartments ≤32 A Socket-outlets up to 20 A Outdoor lightning installations	0100 – 739 0100 – 470 0100 – 714	10...30 10...30 10...30	F 200 F 660 F 670		F 172 FS 200	
Fire protection in high-risk or high-danger areas	0100 – 482	10 u. 30	F 200 F 660 F 670	F 200 F 690	F 172 FS 200	
Rooms with bath tub or shower Swimming pools	0100 – 701 0100 – 702	10...30 10...30	F 200 F 660 F 670		F 172 FS 200	
Construction sites Socket-outlet circuits up to 32 A and other socket-outlet circuits	0100 – 704 BG F&E	10...30 ≤300...500 ^①	F 200 F 660 F 670	F 200 F 690	F 172 FS 200	F 220 F 804 Type B
Agricultural and horticultural properties, General socket-outlet circuits	0100 – 705	≤300...500 ^① 10...30	F 200 F 660 F 670	F 200 F 690	F 172 FS 200 F 270 P 270	
Feed points for caravans Camp sites	0100 – 708	10...30	F 200 F 660 F 670		F 172 FS 200	
Berths Socket-outlets	0100 – 721	10...30	F 200 F 660 F 670		F 172 FS 200	
Temporary buildings, carny carriages and caravans, Feed points	0100 – 722	30 and 300	F 200 F 660 F 670	F 200 F 690	F 172 FS 200	
Medical rooms Group 1 Group 2 a Group 2 b	0100 – 710	at I _n ≤ 32 A 10...30 10...30 ≤ 300	F 200 F 660 F 670	F 200 F 690	F 172 FS 200	F 220 F 804 Type B
Equipment of power installations with electronic items I _{ab} type A, test for type B	0160 DIN EN 50 178	≤ 4kVA 10...30 > 4kVA 300	F 200 F 660 F 670	F 200 F 690	F 172 FS 200	F 220 F 804 Type B
Photovoltaics	0100 – 712 E EnBW	≤ 30				F 220 F 802 Type B

① Operating areas subject to fire hazards... VdS 2033: 2002 – 02 ≤ 300 mA

MCB's and RCB's

Type	Approvals												Ship classification associations			
Sign of conformity																
Code	SEV	BD 6 DEMKO	NEMKO	SEMKO	EL.	① CSA Inspect. CDN	① USA	KEMA	ÖVE	CEBEC	UTE	VDE	BV	GL	LRS	DNV
Valid for	CH	DK	N	S	SF	277/480 V~		NL	A	B	F	D	F	D	GB	N
S 200, B, C 1 – 4 pole	<input type="checkbox"/>	<input type="checkbox"/>	<input type="checkbox"/>	<input type="checkbox"/>	<input type="checkbox"/>		<input checked="" type="checkbox"/>	<input type="checkbox"/>	<input type="checkbox"/>	<input type="checkbox"/>	<input type="checkbox"/>	<input checked="" type="checkbox"/>	<input type="checkbox"/>	<input type="checkbox"/>	<input type="checkbox"/>	<input type="checkbox"/>
S 200 M 1 – 4 pole	<input type="checkbox"/>	<input type="checkbox"/>	<input type="checkbox"/>	<input type="checkbox"/>	<input checked="" type="checkbox"/>			<input type="checkbox"/>	<input type="checkbox"/>	<input type="checkbox"/>	<input type="checkbox"/>	<input checked="" type="checkbox"/>	<input type="checkbox"/>	<input type="checkbox"/>	<input type="checkbox"/>	<input type="checkbox"/>
F 200 - 16/25/ 40 – 0.01/ 0.03/0.1/ 0.3/0.5							<input checked="" type="checkbox"/>									
F 200 A, AC, S 2/4 pole 16...63 A 0.01...0.5 A	<input checked="" type="checkbox"/>	<input checked="" type="checkbox"/>	<input checked="" type="checkbox"/>	<input checked="" type="checkbox"/>	<input checked="" type="checkbox"/>			<input type="checkbox"/>	<input checked="" type="checkbox"/>	<input type="checkbox"/>	<input type="checkbox"/>	<input checked="" type="checkbox"/>				
FS 201 B 6...40/0,03 A C 16/0,03	<input checked="" type="checkbox"/>	<input checked="" type="checkbox"/>	<input checked="" type="checkbox"/>	<input checked="" type="checkbox"/>	<input checked="" type="checkbox"/>			<input type="checkbox"/>	<input checked="" type="checkbox"/>	<input type="checkbox"/>	<input type="checkbox"/>	<input checked="" type="checkbox"/>				

- approved
- submitted for aproval/planed to be submitted
- Approved variants on request
- Approval not required

① Back-up protection usually required.
For details contact your importer and/or inspector.



ABB STOTZ-KONTAKT GmbH
P.O. Box 10 16 80, 69006 Heidelberg, Germany
Eppelheimer Straße 82, 69123 Heidelberg, Germany
Telephone: +49 (0) 62 21 701- 0
Fax: +49 (0) 62 21 701-723
www.abb.de/stotz-kontakt