

Marina wall mounting enclosures

Polyester (GRP) IP 66 - IK 10 (continued)

Wall mounting brackets

Cat. No. 0364 08
for enclosures height 300 mm

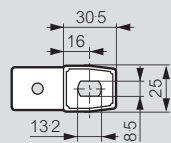

Cat. No. 0364 09
for enclosures height ≥ 400 mm

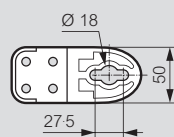

Wall fixing by threaded rods

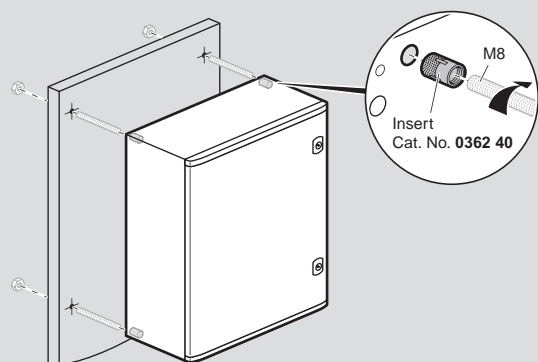

Floor fixing on plinth

H 170 mm (polyester RAL 7035)

Roof RAL 7035
Cat. Nos. 0362 93/94/95

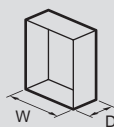

W (mm)	D (mm)
500	250
600	300
800	300

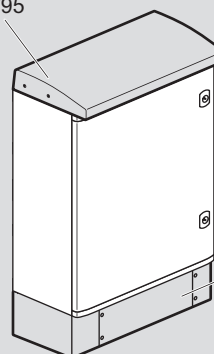

Plinth
Cat. Nos. 0362 91/92

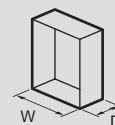

W (mm)	D (mm)
600	300
800	300

Marina free standing enclosures and equipment

Polyester (GRP) IP 66 - IK 10



Technical information and dimensions **p. 22**
 Locking accessories **p. 28**
 Ventilation and heating **p. 29-31**

Grey RAL 7035
 IP 66 according to IEC EN 60529
 IK 10 according to IEC EN 62262 (EN 50102)
 Class II insulation for final assembly according to IEC EN 60439-1
 Glass fibre reinforced polyester (GRP) enclosures
 Self extinguishing at 960 °C according to IEC EN 60695-2-11
 Designed for corrosive environments
 Stainless steel hinges and hinge pins
 Reversible door equipped with equipment mounting bosses
 Supplied with two part gland plate and fixing kit for plain plate or sectioned uprights
 Three point locking handle with European lock and 2433 A key¹
 Depth adjustment of equipment

Pack	Cat. Nos.	GRP enclosures			
		External dimensions (mm)			Weight (kg)
		Height	Width	Depth	
1	0362 85	1460	800	463 ²	49
1	0362 86	1660	800	463 ²	53
1	0362 87	1860	800	463 ²	57

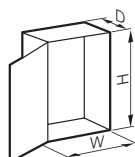

Pack	Cat. Nos.	Roof	
		For enclosures (mm)	
		Width	Depth
1	0362 97	800	463

Pack	Cat. Nos.	Plinth	
		For enclosures (mm)	
		Width	Depth
1	0362 96	800	463

Height 170 mm
 Front and rear access plates
 Stackable for extra height (2 max)

Pack	Cat. Nos.	Equipment		
		Plain plates		
		Galvanised steel. Premarked at 100 mm intervals Permissible load : 200 kg/m ²		
		For enclosures (mm)		Net weight (kg)
		Height	Width	
1	0349 59	1460	800	27
1	0349 50	1660	800	30.5
1	0344 18	1860	800	34

Pack	Cat. Nos.	Sectioned uprights	
		For enclosures	
		Height (mm)	Length (mm)
1	0363 90	1460	1284
1	0363 91	1660	1484
1	0363 92	1860	1684

For Lina 25 rail, Lina rail and Lina 12.5 or Lina 25 plates
 Set of 2 uprights galvanised steel

1 : Other barrels **p. 28**
 2 : 487 mm when handle in use

Download the full file at

<http://assets.kempstoncontrols.com/doc/Legrand%20Industrial%20and%20power%20protection%20catalogue.pdf>



KEMPSTON
CONTROLS