

CE	VDE	ESC	UKRTEST	PCT	RCC	eUL US LISTED
EU	Germany	Czech	Ukraine	Russia	South Africa	USA

NC1 Contactor, 9~95A

1. General

- 1.1 Certificates: CE, UL, PCT, RCC, VDE, UKRTEST, ESC;
- 1.2 Electric ratings: AC50/60Hz, 690V, up to 95A;
- 1.3 Application: remote making & breaking circuits; protect circuit from over-load when assembling with thermal over-load relay; frequent start-up and control of AC contactor;
- 1.4 Utilization category: AC-3, AC-4;
- 1.5 Altitude: ≤2000m;
- 1.6 Ambient temperature: -5°C ~ +40°C;
- 1.7 Mounting category: III;
- 1.8 Mounting conditions: inclination between the mounting plane and the vertical plane should not exceed ±5° ;
- 1.9 Standard: IEC/EN 60947-4-1.

2. Type Designation

NC1-□□□□-□

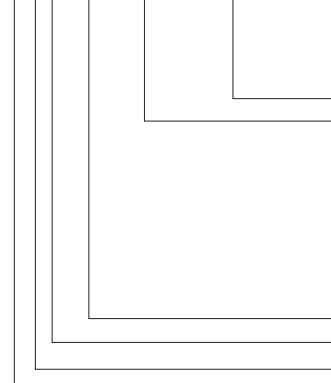



- Z: DC operation Blank: AC operation
- Number of contacts
- 10: 3 N/O main contacts+1 N/O auxiliary contact (9A,12A,18A,25A,32A)
- 01: 3 N/O main contacts+1 N/C auxiliary contact (9A,12A,18A,25A,32A)
- 11: 3 N/O main contacts+1 N/O and 1N/C auxiliary contact (40A,50A,65A,80A,95A)
- 04: 4 N/O main contacts(9A,12A,25A,40A,50A,65A,80A,95A)
- 08: 2 N/O and 2N/C main contacts (9A,12A,25A,40A,50A,65A,80A,95A)
- Basic specification, expressed with the rated operational current (380V/400V, AC3)
- Design sequence NO.
- Contactor
- Company code





3. Technical Data

3.1 AC operation

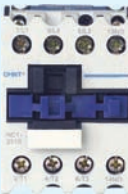

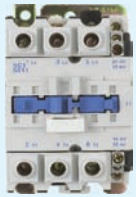
★ AC coil operation



Items	Model	NC1-09	NC1-12	NC1-18	NC1-25	
	Frame	Frame 1 (3P, 4P)		Frame 2 (3P)	Frame 3 (3P, 4P)	
						
Rated conventional heating current (A) AC-1		20	20	32	40	
Rated operational current (A)	380/400V	AC-3	9	12	18	25
		AC-4	3.5	5	7.7	8.5
	660/690V	AC-3	6.6	8.9	12	18
		AC-4	1.5	2	3.8	4.4
Rated insulation voltage (V AC)		690	690	690	690	
Power of controlled 3-phase cage motor (AC-3)	kW	220/230V AC	2.2	3	4	5.5
		380/400V AC	4	5.5	7.5	11
		660/690V AC	5.5	7.5	10	15
	hp	200V AC	3	5	7.5	7.5
		240V AC	3	5	7.5	10
		460V AC	5	7.5	10	15
		600V AC	5	7.5	10	15
Operating frequency (operations/h)	Electrical	AC-3	1,200	1,200	1,200	1,200
		AC-4	300	300	300	300
	Mechanical	3,600	3,600	3,600	3,600	
Electrical life ($\times 10^3$ operations)	AC-3	1,000	1,000	1,000	1,000	
	AC-4	200	200	200	200	
Mechanical life ($\times 10^6$ operations)		10	10	10	10	
Matched fuse type		RT16-20	RT16-20	RT16-32	RT16-40	

NC1-32	NC1-40	NC1-50	NC1-65	NC1-80	NC1-95
Frame 4 (3P)	Frame 5 (3P, 4P)			Frame 6 (3P, 4P)	
					
50	60	80	80	95	95
32	40	50	65	80	95
12	18.5	24	28	37	44
21	34	39	42	49	49
7.5	9	12	14	17.3	21.3
690	690	690	690	690	690
7.5	11	15	18.5	22	25
15	18.5	22	30	37	45
18.5	30	37	37	45	45
10	15	15	20	25	30
15	20	20	25	30	30
20	25	30	40	40	50
20	25	30	40	40	50
600	600	600	600	600	600
300	300	300	300	300	300
3,600	3,600	3,600	3,600	3,600	3,600
800	800	600	600	600	600
200	150	150	150	100	100
8	8	8	8	6	6
RT16-50	RT16-63	RT16-80	RT16-80	RT16-100	RT16-125

3.2 DC operation

★ DC coil operation

Items		Model	NC1-09Z	NC1-12Z	NC1-18Z	NC1-25Z
		Frame	Frame 1 (3P, 4P)		Frame 2 (3P)	Frame 3 (3P, 4P)
						
Rated conventional heating current (A) AC-1			20	20	32	40
Rated operational current (A)	380/400V	AC-3	9	12	18	25
		AC-4	3.5	5	7.7	8.5
	660/690V	AC-3	6.6	8.9	12	18
		AC-4	1.5	2	3.8	4.4
Conventional heating current (A)			20	20	32	40
Rated insulation voltage (V AC)			690	690	690	690
Power of controlled 3-phase cage motor (AC-3)	kW	220/230V AC	2.2	3	4	5.5
		380/400V AC	4	5.5	7.5	11
		660/690V AC	5.5	7.5	10	15
Operating frequency (operations/h)	Electrical	AC-3	1,200	1,200	1,200	1,200
		AC-4	300	300	300	300
		Mechanical	3,600	3,600	3,600	3,600
Electrical life ($\times 10^3$ operations)	AC-3		1,000	1,000	1,000	1,000
	AC-4		200	200	200	200
Mechanical life ($\times 10^6$ operations)			10	10	10	10
Matched fuse type			RT16-20	RT16-20	RT16-32	RT16-40

NC1-32Z	NC1-40Z	NC1-50Z	NC1-65Z	NC1-80Z	NC1-95Z
Frame 4 (3P)	Frame 5 (3P, 4P)			Frame 6 (3P, 4P)	
					
50	60	80	80	95	95
32	40	50	65	80	95
12	18.5	24	28	37	44
21	34	39	42	49	49
7.5	9	12	14	17.3	21.3
50	60	80	80	95	95
690	690	690	690	690	690
7.5	11	15	18.5	22	25
15	18.5	22	30	37	45
18.5	30	37	37	45	45
600	600	600	600	600	600
300	300	300	300	300	300
3,600	3,600	3,600	3,600	3,600	3,600
800	800	600	600	600	600
200	150	150	150	100	100
8	8	6	6	6	6
RT16-50	RT16-63	RT16-80	RT16-80	RT16-100	RT16-125

4. Accessories

4.1 Accessories

Items		Model	NC1-09(Z)	NC1-12(Z)	NC1-18(Z)	NC1-25(Z)
AC coil	Coil power	Start-up (VA)	70	70	70	110
		Holding (VA)	8	8	8	11
		Power (W)	1.8~2.7	1.8~2.7	1.8~2.7	3~4
	Operation range	Pick-up voltage	(85%~110%) Us			
		Drop-out voltage	(20%~75%) Us			
Coil voltage(50Hz,60Hz, 50/60Hz)(V)		24,36,48,110,127,220,240,380,415,440,480,500,600,660				
DC coil	Coil power(W)		9	9	11	11
	Operation range	Pick-up voltage	(85%~110%) Us			
		drop-out voltage	(10%~75%) Us			
	Coil voltage (V)		24,36,48,110,220			

F4 auxiliary contact

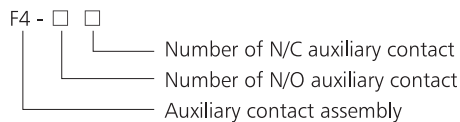

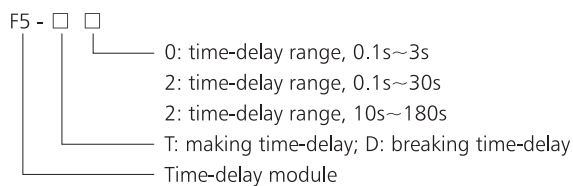

F5 auxiliary contact



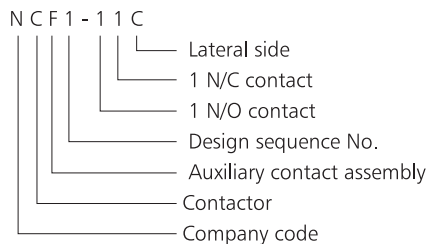















NCF1-11C lateral side auxiliary contact



NC1-32(Z)	NC1-40(Z)	NC1-50(Z)	NC1-65(Z)	NC1-80(Z)	NC1-95(Z)
110	200	200	200	200	200
11	20	20	20	20	20
3~4	6~10	6~10	6~10	6~10	6~10
(85%~110%) Us					
(20%~75%) Us					
24,36,48,110,127,220,240,380,415,440,480,500,600					
11	20	20	20	20	20
(85%~110%) Us					
(10%~75%) Us					

Model	Configuration of contacts		Picture
	Number of N/O contact	Number of N/C contact	
F4-20	2	0	
F4-11	1	1	
F4-02	0	2	
F4-40	4	0	
F4-31	3	1	
F4-22	2	2	
F4-13	1	3	
F4-04	0	4	
Model	Time-delay range	Number of time-delay contacts	Picture
F5-T0	0.1s~3s	N/O+N/C	
F5-T2	0.1s~30s	N/O+N/C	
F5-T4	10s~180s	N/O+N/C	
F5-D0	0.1s~3s	N/O+N/C	
F5-D2	0.1s~30s	N/O+N/C	
F5-D4	10s~180s	N/O+N/C	



4.2 Derived products when the contactor is assembled with following accessory module

Derived products	Contactor	Accessorial modular	Picture
Time-delay contactor		+  Time-delay block	
Reversing contactor		+  Mechanical interlock	
Magnetic starter		+  Thermal relay	
AC contactor for capacitor switching		+  Current-limiting contact assembly	
Star-delta starter		+  +  Time-delay block Auxiliary contact assembly	

4.3 Assembly with thermal over-load relay

Model of contactor	Assembled thermal over-load relay			
	Model	Rated current (A)	Recommended fuse type	
			aM	gG
NC1-09 NC1-12 NC1-18	 NR2-11.5	0.1~0.16	0.25	2
		0.16~0.25	0.5	2
		0.25~0.4	1	2
		0.4~0.63	1	2
		0.63~1	2	4
		1~1.6	2	4
NC1-09 NC1-12 NC1-18	 NR2-11.5	1.25~2	4	6
		1.6~2.5	4	6
		2.5~4	6	10
		4~6	8	16
		5.5~8	12	20
		7~10	12	20
NC1-09 NC1-12 NC1-18 NC1-25 NC1-32	 NR2-25	0.1~0.16	0.25	2
		0.16~0.25	0.5	2
		0.25~0.4	1	2
		0.4~0.63	1	2
		0.63~1	2	4
		1~1.6	2	4
		1.25~2	4	6
		1.6~2.5	4	6
		2.5~4	6	10
		4~6	8	16
		5.5~8	12	20
		7~10	12	20
NC1-32	 NR2-36	23~32	40	63
		28~36	40	80
NC1-40 NC1-50 NC1-65 NC1-80 NC1-95	 NR2-93	23~32	40	63
		30~40	40	100
		37~50	63	100
		48~65	63	100
		55~70	80	125
		63~80	80	125
		80~93	100	160

4.4 Assembly with electronic overload relay

Model of contactor	Model	Rated	Range of setting	Recommended	
		Assembled thermal current (A)	over-load relay current (A)	fuse type	
NC1-09		1.2	0.6~1.2	RT36-4 (NT00-4)	
		2.4	1.2~2.4	RT36-6 (NT00-6)	
		4	2~4	RT36-10 (NT00-10)	
		8	4~8	RT36-16 (NT00-16)	
		10	5~10	RT36-20 (NT00-20)	
		12	7~12	RT36-25 (NT00-25)	
NC1-12	NRE8-25	20	10~20	RT36-40 (NT00-40)	
NC1-18		25	20~25	RT36-50 (NT00-50)	
NC1-25		32	22~32	RT36-80 (NT00-80)	
NC1-40			4	2~4	RT36-10 (NT00-10)
			8	4~8	RT36-16 (NT00-16)
			10	5~10	RT36-20 (NT00-20)
	20		10~20	RT36-40 (NT00-40)	
	40		20~40	RT36-80 (NT00-80)	
NC1-40	NRE8-40	65	30~65	RT36-160 (NT00-160)	
NC1-50					
NC1-65					
NC1-80					
NC1-95					
NC1-80		100	50~100	RT36-200 (NT1-200)	
					NC1-95

5. Technical Information

5.1 Terminal connection

Model	Cabling cross section(Cu)				Screw size	Tightening torque (N · m)
	Number of piece	Flexible cable with cold-pressed socket(mm ²)	Flexible cable without cold-pressed socket(mm ²)	Inflexible cable(mm ²)		
NC1-09	1~2	2.5	4	4	M3.5	0.8
NC1-12	1~2	2.5	4	4	M3.5	0.8
NC1-18	1~2	4	6	6	M3.5	0.8
NC1-25	1	4	10	6	M4	1.2
	2	4	6	6	M4	1.2
NC1-32	1	4	10	6	M4	1.2
	2	4	6	6	M4	1.2
NC1-40	1	10	16	10	M4	1.2
	2	10	10	10	M8	3.5
NC1-50	1	16	25	25	M8	3.5
	2	16	16	-	M8	3.5
NC1-65	1	16	25	25	M8	3.5
	2	16	16	-	M8	3.5
NC1-80	1	50	50	50	M8	3.5
	2	25	35	-	M10	4.0
NC1-95	1	50	50	50	M10	4.0
	2	25	35	-	M10	4.0

5.2 Curves

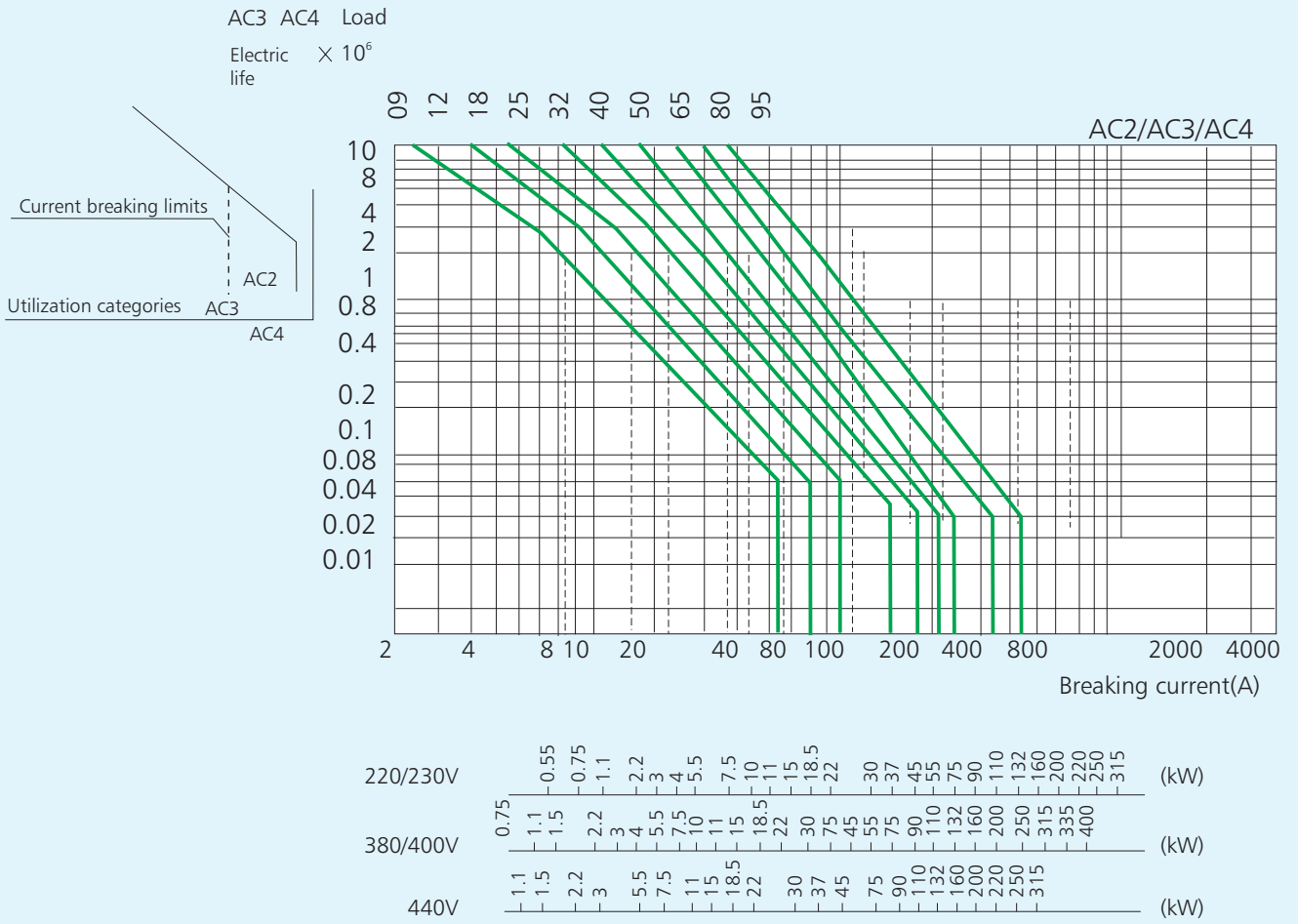

6. Overall and Mounting Dimensions (mm)

NC1-09~32

NC1-40~95

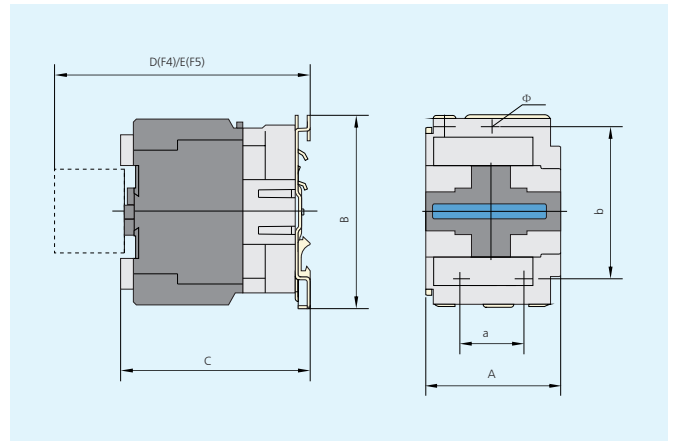
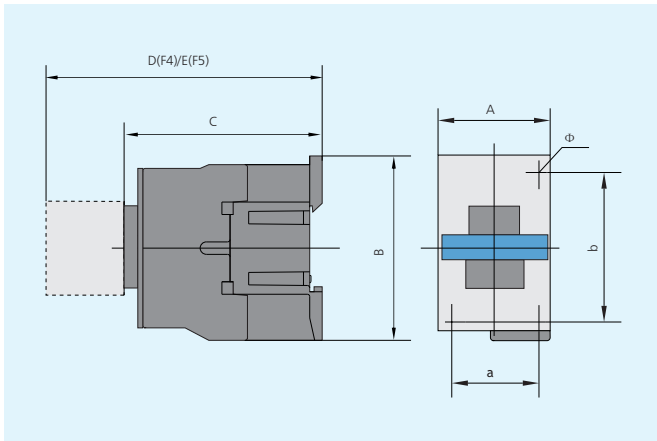

NC1-09Z~32Z

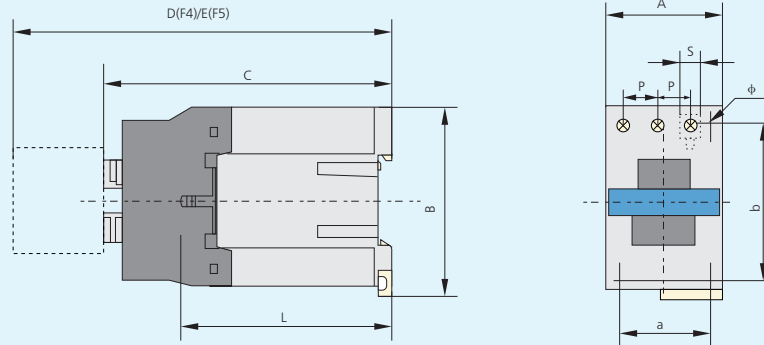

NC1-40Z~95Z

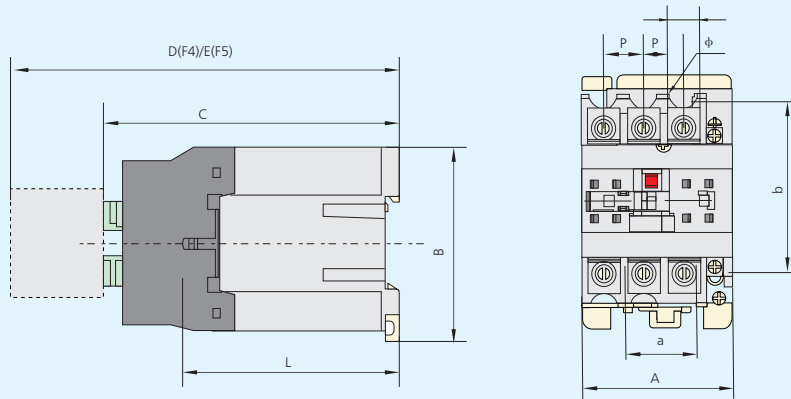

Note:

1. L: in main circuit, the distance between terminals and plate;
2. P: in main circuit, the distance between two phases;
3. S: in main circuit, the width of contacting plate.

Model	A max	B max	C max	D max	E max	a	b	Φ	L	P	S
NC1-09(Z)~12(Z)	47	76	82(116)	120.5(154.5)	140.5(174.5)	34/35	50/60	4.5	60(95)	10.5	8.6
NC1-18(Z)	47	76	87(122)	125.5(160.5)	145.5(180.5)	34/35	50/60	4.5	61(96)	11.3	10.4
NC1-25(Z)	57	86	95(131)	133.5(169.5)	153.5(189.5)	40	48	4.5	70(107)	13.2	11.7
NC1-32(Z)	57	86	100(138)	138.5(176.5)	158.5(196.5)	40	48	4.5	71.6(120)	14.5	13
NC1-4011(Z)~6511(Z)	77	129	116(173)	154.5(211.5)	174.5(231.5)	40	100/110	6.5	78(135)	20	8.6
NC1-4004/4008(Z)~6504/6508(Z)	84	129	116(173)	154.5(211.5)	174.5(231.5)	40	100/110	6.5	78(135)	20	8.6
NC1-8011(Z)~9511(Z)	87	129	127(188)	165.5(226.5)	185.5(246.5)	40	100/110	6.5	83(140)	23.5	12
NC1-8004/8008(Z)~9504/9508(Z)	96	129	127(183)	160.5(221.5)	180.5(241.5)	40	100/110	6.5	83(140)	23.5	12