



## IEC Contactors and Overload Relays

Technical Solutions

Mini Series Contactors and Overload Relays  
Freedom Series Contactors and Overload Relays  
Modular Series Contactors and Overload Relays



### Mini Series Contactors and Overload Relays

Contactors	2
Contactors – reversing	2
Accessories	3
Technical data	4
Lighting circuit switching	6
Overload relay	7
Technical data	7
Dimensions	8



### Freedom Series Contactors and Overload Relays

Contactors	10
Accessories	11
Thermal overload relays	14
Type 2 Co-ordination Selection procedure	16
Technical data	18
Dimensions	33



### Modular Series Contactors and Overload Relays

Contactors	38
Accessories	40
Technical data	42
Dimensions	47
Thermal overload relays	49
Technical data	50
Dimensions	54

## Mini Series - 4 and 5.5kW

## Catalogue numbers

## Contactors

	AC3 rating 3ph 400/440V	Number of contacts		Catalogue numbers
		Main	Auxiliary	
	4kW	3 N.O.	1 N.O.	CE12BNC310*
		3 N.O.	1 N.C.	CE12BNC301*
		4 N.O.		CE12BNC400*
	5.5kW	3 N.O.	1 N.O.	CE12CNC310*
		3 N.O.	1 N.C.	CE12CNC301*
		4 N.O.		CE12CNC400*

## Contactors - Reversing

	AC3 rating 3ph 400/440V	Number of contacts		Catalogue numbers
		Main	Auxiliary	
	4kW	3 N.O.	1 N.O.	CE52BNC310*
		3 N.O.	1 N.C.	CE52BNC301*
		3 N.O.	1 N.O.	CE52CNC310*
	5.5kW	3 N.O.	1 N.C.	CE52CNC301*
		3 N.O.	1 N.C.	
		3 N.O.	1 N.C.	

\* Add suffix for coil voltage from the tables below

## A.C. operating coils - 3.5VA

Coil voltage 40 to 450Hz	Suffix
24	T
48	W
110 - 127	A
220 - 240	B
277	H
380 - 415	L

## D.C. low power consumption operating coils for non-reversing contactors

Coil voltage	Suffix
24 (1.4 watts)	T2
24 (1.7 watts with surge suppressor)	T3
17 - 32 (2.4 watts)	V2
17 - 32 (2.8 watts with surge suppressor)	V3



*Can not be used when auxiliary contacts are fitted.*

## D.C. operating coils - 3.5 watts

Coil voltage	Suffix
12	R1
24	T1
48	W1
110 - 125	A1
220 - 240	B1

**Catalogue numbers - Accessories**

**Auxiliary Contacts <sup>①</sup>**

	Description	Contact configuration	Catalogue numbers
	Side mounting	1 N.O. 1 N.C.	C320MCS11
	Top mounting	1 N.O. 1 N.C. 2 N.O. 2 N.C.	C320MCF11 C320MCF20 C320MCF02

<sup>①</sup> Top and side mounted auxiliary contact blocks can not be used together.

**Accessories**

	Description	Voltage	Catalogue numbers
	Supressors	24 - 60Vdc 50 - 250Vdc 200 - 420Vdc	C320MSS1 C320MSS2 C320MSS3
	Identification markers		C320MCM1

## Mini Series - 4 and 5.5kW

## Technical data - Contactors

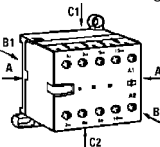
Contactor	CE12BN & CE52BN				CE12CN & CE52CN							
Specifications	IEC 947-4-1, IEC947-5-1				IEC947-4-1							
Rated insulation voltage $U_i$	690V				500V							
Air temperature (close to contactor)												
Fitted with a thermal O/L relay	25 to +50j C				25 to +50j C							
Without thermal O/L relay	25 to +55j				25 to +55j C							
For storage	40 to +80j C				40 to +80j C							
Climatic withstand												
Acc. to DIN 50 017	Humidity in alternative climate				Humidity in alternative climate KFW							
Acc. to UTE C 63-100	30 cycles, specification 1				30 cycles, specification 1							
Mounting positions	All positions				All positions							
Mechanical durability												
Operating cycles	10 million				10 million							
Maximum switching frequency												
AC-1	300 cycles/h				300 cycles/h							
DC-1, DC-3, DC-5, AC-2, AC-3, AC-15, DC-13	600 cycles/h											
Rated operational voltage $U_e$	12 - 500V ac				12 - 500V ac							
Rated operational current $I_e$ /AC-1, AC-3	AC-1/ $I_e$ (A)		AC-2, AC-3		AC-1/ $I_e$ (A)		AC-2, AC-3					
Rated operational power at:	55j C	40j C	$I_e$ (A)	P (kW)	55j C	40j C	$I_e$ (A)	P (kW)				
220/240V	16	20	9	2.2	16	20	12/11	3				
380/440V	16	20	9/8	4.0	16	20	12/11	5.5				
500V	12	12	5.5	3.0	12	12	7.0	4				
Shock withstand	$1/2$ sinusoidal shock for 10ms: no change in contact position				$1/2$ sinusoidal shock for 10ms: no change in contact position							
Standard mounting position: position 1												
	Shock directions				Shock directions							
	A	B1	B2	C1	C2	A	B1	B2	C1	C2		
Making position	20g	20g	20g	20g	20g	20g	20g	20g	20g	20g		
Breaking position	10g	20g	20g	20g	20g	10g	20g	20g	20g	20g		
Operating time	<b>B6</b>		<b>BC6</b>		<b>K6</b>		<b>KC6</b>		<b>B7</b>		<b>BC7</b>	
Between coil energisation and:			(ms)		(ms)		(ms)		(ms)		(ms)	
N.O. contact closing/N.C. contact opening	14 - 26		14 - 26		14 - 26		14 - 26		14 - 26		14 - 26	
Between coil de-energisation and:												
N.O. contact opening/N.C. contact closing	16 - 40		4 - 10		16 - 40		4 - 10		16 - 40		4 - 10	
Heat dissipation per pole	2W at 20A				2W at 20A							
Short-circuit protection (for contactors without add-on thermal O/L relay)												
Type fuses gG (gl) - co-ordination:												
Type 1	20A				25A							
Type 2	20A				20A							
Coil consumption (average value)												
ac pull-in/holding	3.5VA				3.5VA							
dc pull-in/holding	3.5W				3.5W							

## Technical data - Built-in or add-on auxiliary contact blocks

Rated operational voltage $U_e$	12 - 240V dc 12 - 500V ac	Rated operational current $I_e$ / DC-13	24V 60V 110V 220/240V	1.5A 0.5A 0.4A 0.04
Conventional free air thermal current $I_{th}$	6A	Min. switching capacity of auxiliary contacts	⊕ 17V and ⊕ 5mA	
Short-circuit protection, type fuses gG (gl)	10A			
Rated operational current $I_e$ / AC-15				
220/240V	4A			
380/440V	3A			
500V	2A			

April 2005

Mini Series - 4 and 5.5kW

Technical data

AC Electrical endurance curves

4kW contactors - AC1 & AC3 duty

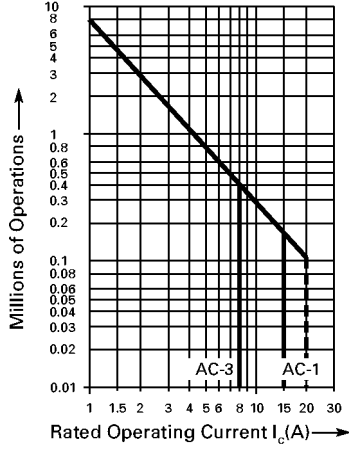

4kW contactors - AC4 duty

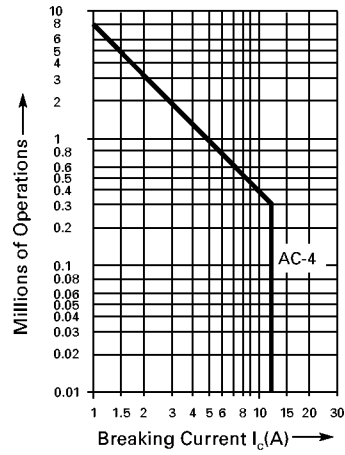

5.5kW contactors - AC1 & AC3 duty

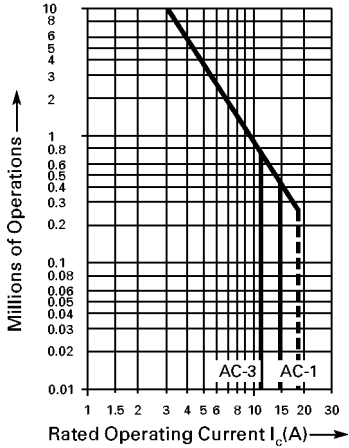

5.5kW contactors - AC4 duty

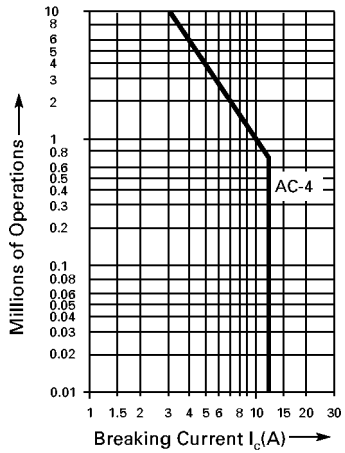

Electrical durability curves for DC-1, DC-3 & DC-5

The curves below take into account the time constant L/R for each utilisation category and show the electrical durability of the contactors during DC-1, DC-3 and DC-5 use for three poles connected in series.

If one single pole is used, the corresponding breaking capacity (W) is reduced to 1/3 and for two poles connected in series it is reduced to 2/3.

- A = DC-1 3 poles in series      C = DC-5 3 poles in series
- B = DC-3 3 poles in series

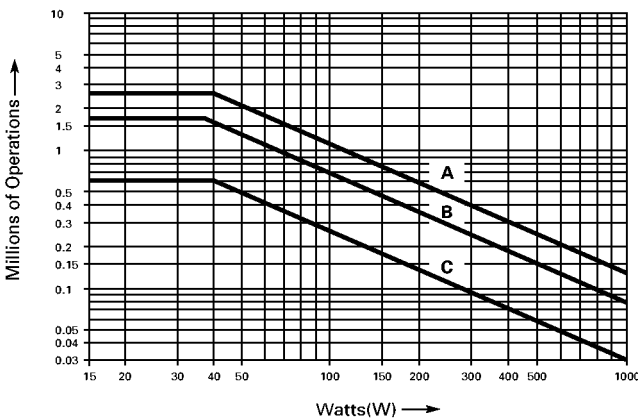

DC power circuit switching

Utilisation category	DC-1			DC-3			DC-5		
	L/R ⊕ 1ms			L/R ⊕ 2ms			L/R ⊕ 7.5ms		
	24V	16A	16A	16A	16A	16A	24V	16A	16A
	48V	16A	8.0A	8.0A	8.0A	2.0A	48V	16A	2.0A
	60V	16A	4.0A	4.0A	4.0A	1.25A	60V	16A	1.25A
	110V	7.0A	1.5A	1.5A	1.5A	0.4A	110V	7.0A	0.4A
	220V	0.8A	0.25A	0.25A	0.25A	0.2A	220V	0.8A	0.2A
	24V	16A	16A	16A	16A	16A	24V	16A	16A
	48V	16A	16A	16A	16A	16A	48V	16A	16A
	60V	16A	15A	15A	15A	12A	60V	16A	12A
	110V	16A	7.0A	7.0A	7.0A	2.0A	110V	16A	2.0A
	220V	5.0A	1.5A	1.5A	1.5A	0.5A	220V	5.0A	0.5A
	24V	16A	16A	16A	16A	16A	24V	16A	16A
	48V	16A	16A	16A	16A	16A	48V	16A	16A
	60V	16A	16A	16A	16A	16A	60V	16A	16A
	110V	16A	15A	15A	15A	8.0A	110V	16A	8.0A
	220V	14A	4.0A	4.0A	4.0A	2.0A	220V	14A	2.0A

## Mini Series - 4 and 5.5kW

## Lighting circuit switching

The table below shows the *number of lamps per phase in 230V 50Hz* for the main poles (terminals marked 1 to 8):  
Note that overshooting of the announced capacitive loads may generate on energisation unacceptable current peaks.

Other factors may influence peak amplitude on energisation.

- Lengths and cross sections of installation conductors
- Electronic arcing devices
- Lamp manufacture

For these reasons, the values in the following tables are given for information only.

Type of lamps	Characteristics In (W) (A)	Number of lamps per phase (230V, 50Hz)	Capacitive load in $\mu\text{F}$	Type of lamps	Characteristics In (W) (A)	Number of lamps per phase (230V, 50Hz)	Capacitive load in $\mu\text{F}$
Incandescent lamps	60	0.26	20	Metal iodide lamps eg HGI, HPI	Without compensation		
	10	0.43	12		35	0.53	10
	200	0.87	6		70	1.0	5
	300	1.30	4		150	1.8	3
	500	2.17	2		250	3.0	2
	1000	4.35	1		400	3.5	1
Flourescent lamps	Without compensation and series compensation			Parallel compensation			
	15	0.35	25	35	0.25	6	6
	20	0.37	23	70	0.45	3	12
	40	0.43	20	150	0.75	1	20
	58	0.67	16	250	1.5	1	33
	65	0.67	12	400	2.5	1	35
	115	1.5	5	low pressure sodium lamps			
	140	1.5	5	Without compensation			
	Two lamp circuit			35	1.5	4	
	2 x 20	1 x 0.13	2 x 26	55	1.5	4	
	2 x 40	1 x 0.22	2 x 20	90	2.4	2	
	2 x 58	1 x 0.32	2 x 16	135	3.5	2	
	2 x 65	1 x 0.34	2 x 12	150	1.0	2	
2 x 115	1 x 0.65	2 x 5	180	3.3	2		
2 x 140	1 x 0.75	2 x 5	200	2.3	2		
Parallel compensation			Parallel compensation				
15	0.11	7	35	0.31		20	
20	0.13	6	55	0.42		20	
40	0.22	7	90	0.63		30	
58	0.32	5	135	0.94		45	
65	0.34	4	150	1.0		40	
115	1.65	1	180	1.16		40	
140	1.75	1	200	1.32		25	
High pressure mercury vapour lamps eg HQL, HPL	Without compensation			High pressure sodium lamps			
	50	0.61	10	150	1.8	3	
	80	0.8	7	250	3.0	2	
	125	1.15	5	330	3.7	2	
	250	2.15	3	400	4.7	1	
	400	3.25	2	Parallel compensation			
	700	5.40	1	150	0.83		20
	Parallel compensation			250	1.5		33
	50	0.28	10	330	2.0		40
	80	0.41	7	400	2.4		48
125	0.65	5	1000	6.3		106	
250	1.22	3	Transformers for low voltage halogen lamps				
400	1.95	2	Transformer power (W)	Number of transformers per phase (230V, 50Hz)			
700	3.45		20	40			
1000	4.8		50	20			
Lamps with electronic ignition device			75	13			
1 x 18		17	100	10			
2 x 18		8	150	7			
1 x 36		11	200	5			
2 x 36		6	300	3			
1 x 56		11					
2 x 58		6					

Catalogue numbers



Motor FLA in Amperes	Catalogue Number
.10 – .16	C312AN3A
.16 – .24	C312AN3B
.24 – .40	C312AN3C
.40 – .60	C312AN3D
.60 – 1.00	C312AN3E
1.00 – 1.60	C312AN3F
1.60 – 2.40	C312AN3G
2.40 – 4.0	C312AN3H
4.0 – 6.0	C312AN3J
6.0 – 9.0	C312AN3K
9.0 – 12.0	C312AN3L

Overload relays to be used with Pressure Plate Terminal type Mini Contactors only.

Technical data

Thermal Overload Relay C312 –

Conformity to Standards  
 ¥ IEC 947-4-1, 947-5-1, CE  
 ¥ UL 508, CSA 22.2

Thermal (Bimetallic) Overload Relay, C312 OL Relay  
 ¥ Insulation Voltage (Ui): 690V AC  
 ¥ Rated Operational Voltage (Ue): 690V AC  
 ¥ Ambient Temperature: -13° to 122°F (-25° to +50°C) temperature compensated  
 ¥ Storage: -40° to 158°F (-40° to +70°C)

¥ Impulse Withstand Voltage (Uimp): 6 kV  
 ¥ Climatic Resistance —  
 ¥ Acc. to DIN 50 017  
 ¥ Acc. to UTE C 63 – 100: IEC 68-2-3, IEC 68-2-30  
 ¥ Mounting Position: ± 30 from vertical position, not horizontal, not upside down, 5 mm side by side mounting distance  
 ¥ Switching Frequency with Avoidance of Nuisance Trippings — max. ops./h: 15  
 ¥ 40% ED — max. ops./h: 60 (if 6X in startup time 1 s)  
 ¥ Overvoltage Category/Pollution Degree: III/3  
 ¥ Safe Isolation to IEC 536: 300V AC  
 ¥ Conventional Free Air Thermal Current (Ith): 6.0A

Terminal Capacities

Description	Specification
Solid	mm 2X (.75X – 2.5) mm
Flexible with Ferrule	mm 2X (.5X – 1.5) mm
Solid or Stranded	AWG 2X (18X –12)

Trip Contact Ratings AC-15

Operating Voltage (Ue)	120V	220/240V	380/415V	500V
Rated Operational Current (Ie)				
Contacts 95 – 96 — NC (Break)	—	1.5A	.7A	.5A
Contacts 97 – 98 — NO (Make)	—	1.5A	.5A	.3A

Trip Contact Ratings DC-13

Operating Voltage (Ue)	24V DC	60V DC	110V DC	220V DC
Rated Operational Current (Ie)				
Contacts 95 – 96 — NC (Break)	.9A	.5A	.3A	.1A
Contacts 97 – 98 — NO (Make)	.9A	.5A	.3A	.1A

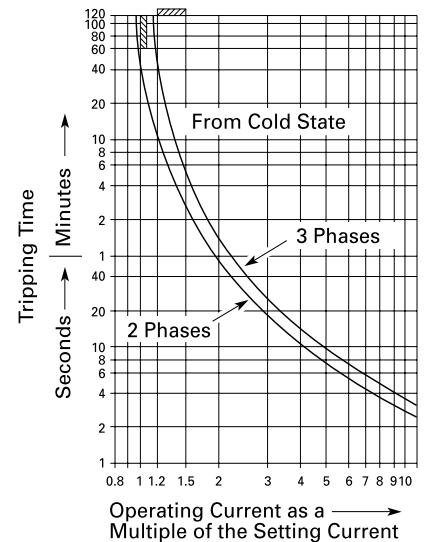

Setting Variances

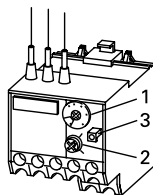

- Setting Variances
- Adjust knob for setting to rated current of the motor
  - Reset: Hand — manual reset  
 Position A: Auto — without manual reset  
 Position H: Reset OFF

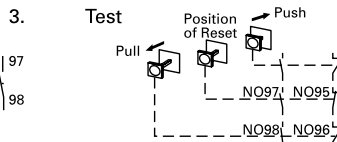
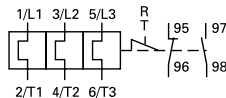

Mini Series - 4 and 5.5kW

Dimensions (mm)

Contactor

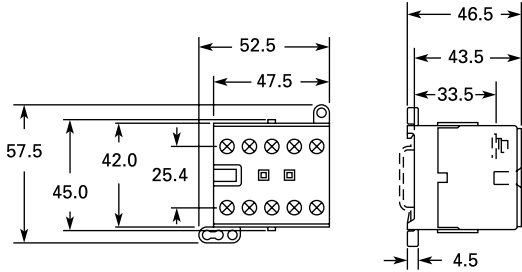

Mini Contactor CE12(B or C) (AC and DC Operated) for Pressure Plate Terminals

Reversing contactors

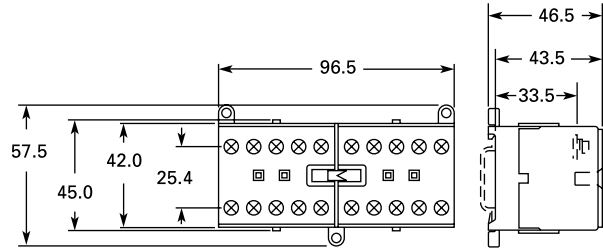

Mechanically Interlocked Contactors CE52BNC with Screw Pressure Plate and Quick Connect Terminals

Contactor with side mounted auxiliary

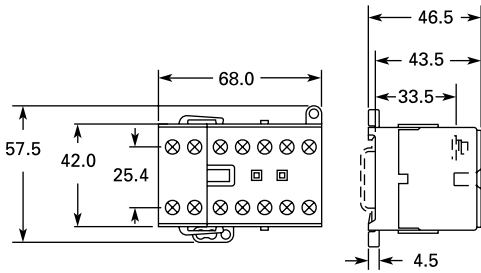

Mini Contactor CE12(B or C) (AC and DC Operated) with Auxiliary Contact Block C320 (Side Mounted) for Screw Pressure Plate and Quick Connect Terminals

Contactor with top mounted auxiliary

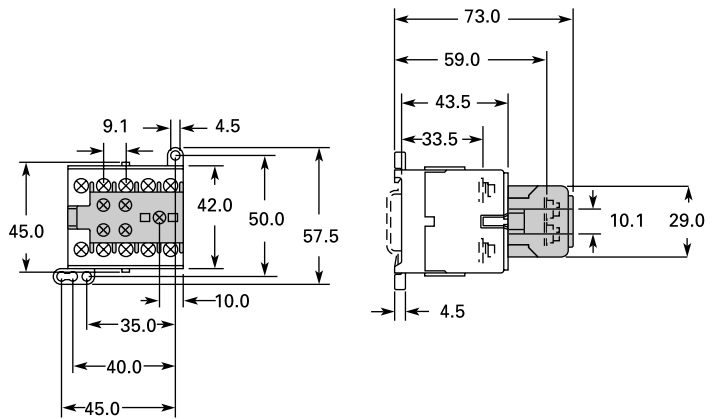

Mini Contactor with Screw Pressure Plate Terminals CE12(B or C)NC with Screwed-On Auxiliary Contact C320MCF (Front Mounted Auxiliary Contact)

Mounting dimensions

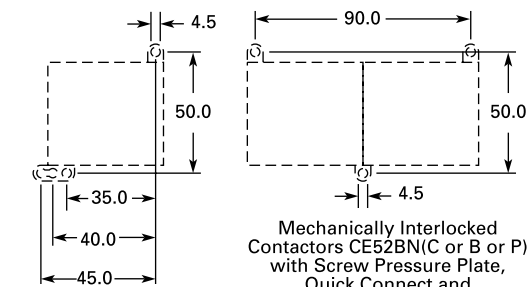

CE12(B or C) Mini Contactor with Screw Pressure Plate, Quick Connect and Solder Pin Terminals

Mechanically Interlocked Contactors CE52BN(C or B or P) with Screw Pressure Plate, Quick Connect and Solder Pin Terminals



April 2005

Mini Series - 4 and 5.5kW

Dimensions (mm)

Mini contactor and overload relay

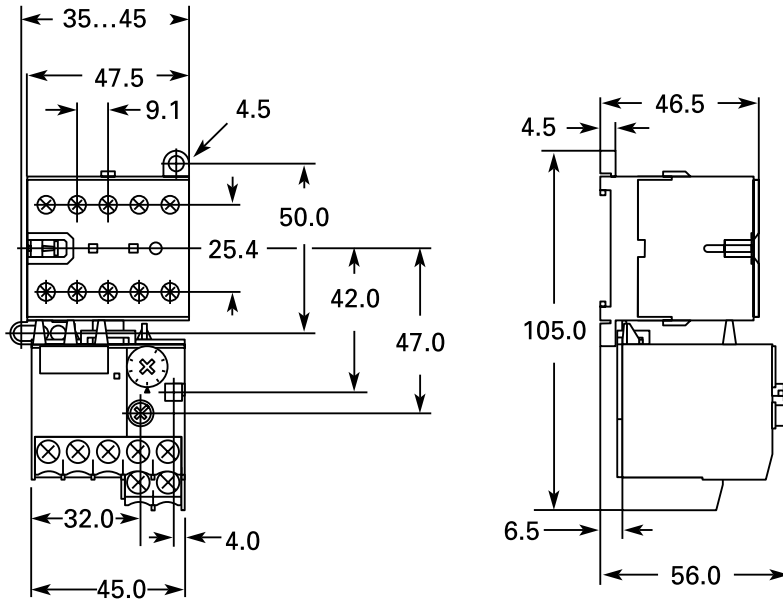

Mini Contactor with Screw Pressure Plate Terminals and Overload Relay  
CE12(B or C)NC + C312AN3

Side mounted auxiliary contact

Top mounted auxiliary contact

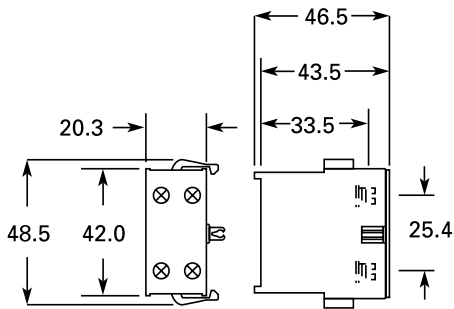



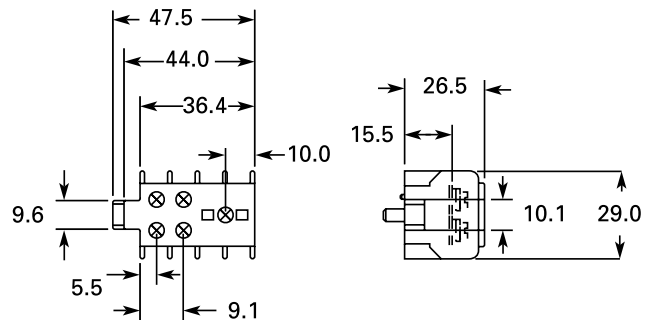

Side Mounted to Use with Screw Pressure Plate Terminal Contactor  
C320MCS11



C320MCF Front Mounted Auxiliary Contact to Be Used with Contactor or Control Relay with Pressure Plate Terminals

Freedom Series - 2.2 to 160kW

## Catalogue numbers - Contactors

	AC3 rating 3 ph 380/440V (kW)	Number of contacts		Catalogue numbers	
		Main	Auxiliary	AC operated	DC operated
	2.2	3 N.O.	1 N.O.	CE15ANS3*	-
		3 N.O.	1 N.C.	CE15ANC3*	-
		4 N.O.		CE15AN4*	-
	4	3 N.O.	1 N.O.	CE15BNS3*	CE15BNS3*
		3 N.O.	1 N.C.	CE15BNC3*	-
		4 N.O.		CE15BN4*	-
5.5	3 N.O.	1 N.O.	CE15CNS3*	CE15CNS3*	
	3 N.O.	1 N.C.	CE15CNC3*	-	
	4 N.O.		CE15CN4*	-	
	7.5	3 N.O.		CE15DN3*	CE15DNS3*
	11	3 N.O.		CE15EN3*	CE15ENS3*
	15	3 N.O.		CE15FN3*	CE15FNS3*
	18.5	3 N.O.		CE15GN3*	CE15GNS3*
	22	3 N.O.		CE15HN3*	CE15HNS3*
	30	3 N.O.		CE15JN3*	CE15JNS3*
	37	3 N.O.		CE15KN3*	CE15KNS3*
	45	3 N.O.	1 N.O.	CE15LN3*	CE15LNS3*
	55	3 N.O.	1 N.O.	CE15MN3*	CE15MNS3*
	75	3 N.O.	1 N.O.	CE15NN3*	CE15NNS3*
	90	3 N.O.	1 N.O. 1 N.C.	MCE15PN3*	MCE15PNS3*
	110	3 N.O.	1 N.O. 1 N.C.	MCE15RN3*	MCE15RNS3*
	160	3 N.O.	1 N.O. 1 N.C.	MCE15SN3*	MCE15SNS3*

\* Add suffix from tables on page 11 to select coil voltage required. For voltages not shown contact Head Office.

## Mounting positions of auxiliary contacts

Contactors CE15LN to NN are supplied with R1 fitted.  
Contactors CE15PN to SN with ac coils are supplied with L1 fitted. With dc coils L1 and L2 are fitted.

By attaching combinations of top and side mounted auxiliary contact blocks up to 8 additional circuits may be added.

CE15AN to CE15KN up to 8 N.O. or 4 N.O. - 4 N.C.

CE15LN to CE15SN maximum 6 N.O. or 6 N.C. in any one configuration

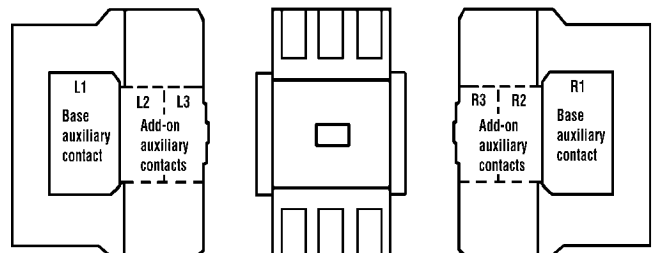

**Catalogue numbers - Accessories**

**Auxiliary contact blocks - top mounting (maximum 1 per contactor)**



Contact configuration	Contactor type	Catalogue numbers
1 N.O.	CE15A to CE15K	C320KGT1
1 N.O. 1 N.C.		C320KGT2
1 N.O. 1 N.C.		C320KGT3
2 N.O.		C320KGT4
2 N.O. 2 N.C.		C320KGT5
2 N.O. 2 N.C.		C320KGT15
3 N.O. 1 N.C.		C320KGT14
4 N.O.		C320KGT13

**Auxiliary contact blocks - side mounting (maximum 2 per contactor)**



Contact configuration	Mounting position †	Contactor type	Catalogue numbers
1 N.O.	L1, R1	CE15AN to KN	C320KGS1
1 N.O. 1 N.C.	L1, R1		C320KGS2
1 N.O. 1 N.C.	L1, R1		C320KGS3
2 N.O.	L1, R1		C320KGS4

**Auxiliary contact blocks - base mounting**



Contact configuration	Mounting position †	Contactor type	Catalogue numbers
1 N.O.	L1, R1	CE15LN to NN	C320KGS31
1 N.O. 1 N.C.	L1, R1	CE15LN to NN	C320KGS32
1 N.O.	L1, R1	CE15PN to SN	C320KGS41
1 N.O. 1 N.C.	L1, R1	CE15PN to SN	C320KGS42

**Auxiliary contact blocks - add-on**



Contact configuration	Mounting position †	Contactor type	Catalogue numbers
1 N.O.	L2, L3, R2, R3	CE15LN to SN	C320KGS20
1 N.O. 1 N.C.	L2, L3, R2, R3		C320KGS21
1 N.O. 1 N.C.	L2, L3, R2, R3		C320KGS22

† Mounting positions of auxiliary contacts (See page 33)

**A.C. Operating coils**

Coil voltage	50Hz	24	48	110	220	240	380	415	440	550
Coil voltage	60Hz	-	-	120	240	-	-	-	480	600
Suffix code	CE15AN to FN	T	Y	A	B	K	L	M	C	D
Suffix code	CE15GN to SN	U	Y	A	B	K	L	M	C	D

**D.C. operating coils for contactors 4 to 15 & 45kW to 75kW only**

Coil voltage	12	24	48	120
Suffix code	R1B	T1B	W1B	A1B

**D.C. Operating coils for contactors 18.5 to 37kW only**

Coil voltage	12	24	48	120
Suffix code	R4B	T4B	W4B	A4B

**Note**

DC operating coils come complete with encapsulated coil, 1N.C. early opening side auxiliary and connection wiring.

**D.C. Operating coils for contactors 90 to 160kW only**



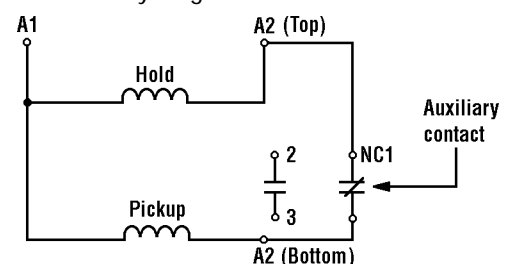

Coil voltage	24	48	120	240
Suffix code	T1B	W1B	A1B	B1B

**D.C. Coil elementary diagram for contactors 4 to 15kW**



Freedom Series - 2.2 to 160kW

## Catalogue numbers - Accessories (continued)

Description	For contactor type	Catalogue numbers
 Pneumatic timer - top mounting Adjustable range (On or off delay) 0.3 to 30 secs. 10 to 180 secs.	CE15AN to KN	C320TP1 C320TP2
Note: When timer is used, other top mounting auxiliaries cannot be added.		
 Mechanical interlock When fitted, auxiliary contacts can be added to one side of the contactor only.	CE15AN to KN CE15LN to NN MCE15PN to SN	C321KM60B C321KM30 C321KM40
<small>C321M60B    C321KM30</small>		
 Coil surge suppressor To suppress operating coil switch-off surge. Control supply 50-60Hz 24 48V 110 240V 110 240V 110 240V	CE15AN to KN CE15AN to KN CE15LN to NN MCE15PN to SN	MC320LRC5 MC320LRC2 MC320LRC3 MC320LRC3
 35mm DIN mounting rail 1 metre length	CE15AN to GN	MC382MA1
Identification marker Pack of 100	CE15AN to KN	C320DL2
 Reversing connections kit Comprises mechanical interlock and a pre-cut trimmed and formed wire set.	CE15AN to CN CE15DN to FN CE15GN to KN CE15LN to NN MCE15PN to SN	C321KM60K14B C321KM60K13B C321KM60K16B C321KM60K21 † C321KM60K19 †
Termination kits for main contacts For crimp terminal lugs to allow connection of up to 2 additional cables for reversing or star/delta duty.	CE15LN to NN	C325MTK
Extension plates for reversing connections.	MCE15PN to SN	MC321TE3
Finger protection shields Shields to prevent accidental contact with line/load terminals.	CE15LN to NN	MC321FK1 MC321FK2 MC321FK3
Standard mounting Side mounting Side mounting with overload relay fitted Standard or side mounting with or without overload relay fitted	MCE15PN to SN	MC321FK4

† Kit includes 2 off N.C. auxiliary contact blocks.

April 2005

Freedom Series - 2.2 to 160kW

**Catalogue numbers - Accessories (continued)**

Description	For contactor type	Catalogue numbers
Main contact renewal kit 	CE15GN3	6-65-4
	CE15HN3	6-65-6
	CE15JN3	6-65-8
	CE15KN3	6-65-17
	CE15LN3	6-43-4
	CE15MN3	6-43-2
	CE15NN3	6-43-6
	CE15NN	6-293
	MCE15PN	6-294
	MCE15RN	6-288
	MCE15SN	6-286

**Replacement operating coils - AC (See note below)**

Coil voltage		Catalogue numbers				
50Hz	60Hz	CE15AN to CN	CE15DN to FN	CE15GN to KN	CE15LN to NN	MCE15PN to SN
24		MC15CWU	MC15FWU	MC15KWU	MC15WU	9-2412-5A
48		MC15CWY	MC15FWY	MC15KWY	MC15WY	9-2412-8A
110	120	MC15CWA	MC15FWA	MC15KWA	MC15WA	9-2412-1A
220	240	MC15CWB	MC15FWB	MC15KWB	MC15WB	9-2412-2A
240		MC15CWK	MC15FWK	MC15KWK	MC15WK	9-2412-13A
380		MC15CWL	MC15FWL	MC15KWL	MC15WL	9-2412-14A
415		MC15CWM	MC15FWM	MC15KWM	MC15WM	9-2412-16A
440	480	MC15CWC	MC15FWC	MC15KWC	MC15WC	9-2412-3A
550	600	MC15CWD	MC15FWD	MC15KWD	MC15WD	9-2412-4A

Note:  
 Replacement operating coils are for use with current series 'B' contactors.  
 For replacement coils for previous series 'A' contactors please contact Eaton.

Freedom Series - 2.2 to 160kW

## Catalogue numbers - Thermal overload relays

For direct connection with CE15AN to FN contactors or independent mounting

Description	Motor FLC range A	Catalogue numbers
Relay with 1 N.O. 1 N.C. electrically separate contacts, selectable hand or auto reset with reset or stop-reset option, phase loss protection and trip indicator.	0.25 0.4	C316FNA3C
	0.4 0.63	C316FNA3D
	0.63 1.0	C316FNA3E
	1.0 1.4	C316FNA3F
	1.3 1.8	C316FNA3G
	1.7 2.4	C316FNA3H
	2.2 3.1	C316FNA3J
	2.8 4.0	C316FNA3K
	3.5 5.0	C316FNA3L
	4.5 6.5	C316FNA3M
	6.0 8.5	C316FNA3N
	7.5 11.0	C316FNA3P
	10 14.0	C316FNA3Q
	13 19.0	C316FNA3R
18 24.0	C316FNA3S	
24 32.0	C316FNA3T	



Separate base for independent connection and DIN rail or panel mounting

C306TB1



For direct connection with CE15GN to KN contactors or independent mounting

Relay with 1 N.O. 1 N.C. electrically separate contacts, selectable hand or auto reset with reset or stop-reset option, phase loss protection and trip indicator.	18 25	C316KNA3A
	22 32	C316KNA3B
	29 42	C316KNA3C
	36 52	C316KNA3D
	45 63	C316KNA3E
	60 80	C316KNA3F



Separate base for independent connection and panel mounting

C316TB1



Note: For star-delta applications multiply motor FLC by 0.58

April 2005

Freedom Series - 2.2 to 160kW

**Catalogue numbers - Thermal overload relays (continued)**

For independent mounting and connection with CE15LN to PN contactors

Description	Motor FLC range A	Catalogue numbers
Relay with 1 N.O. 1 N.C. electrically separate contacts, selectable hand or auto reset with reset or stop-reset option, phase loss protection and trip indicator.	65 90	C316PNA3A
	80 110	C316PNA3B
	100 135	C316PNA3C
	110 150	C316PNA3D
	130 175	C316PNA3E
	150 200	C316PNA3F



Set of connecting links	To contactors CE15LN to NN3	C316MCL
	To contactors CE15PN	C316PCL

Current transformer operated for independent connection with CE15RN to SN contactors

Relay with 1N.O. 1N.C. electrically separate contacts, selectable hand or auto reset with reset or stop-reset option, phase loss protection and trip indicator.	130 185	C316SNA3A
	165 235	C316SNA3B
	220 310	C316SNA3C
	285 400	C316SNA3D



Identification marker (pack of 50)	C316MT1
------------------------------------	---------

**Remote reset module**

Description	Operating voltage 50/60HZ	Catalogue numbers
For use with thermal overload relays C316FNA3, and C316SNA3	220/440	C316RR1N



Operating time	
Minimum:	0.2 secs
Maximum:	0.3 secs
Inrush VA	
Operating voltage	Inrush VA
220/440	412

Note: For star-delta applications multiply motor FLC by 0.58

## Type 2 co-ordination selection procedure

### Step 1.

Determine the motor Full Load Current (FLC) from Table 1.

kW	HP	220V	380V	415V
1.1	1.0	4.9	2.9	2.6
1.5	2.0	6.3	3.6	3.3
2.2	3.0	9.0	5.2	4.8
3.0	4.0	11.0	6.3	5.8
4.0	5.5	14.0	8.0	7.5
5.5	7.5	18.0	10.5	9.8
7.5	10.0	23.0	13.5	12.5
10.0	13.5	29.0	17.0	15.8

### Step 4.

Select overload relay and note it's fuse link rating from table 4.

Full load current range (A)	Catalogue number	Fuse (A)
0.25 - 0.4	C316FNA3C	2
0.7 - 0.63	FNA3D	2
2.8 - 3.1	FNA3K	16
3.5 - 5.0	FNA3L	20
4.5 - 6.5	FNA3M	20
6.0 - 8.5	FNA3N	25
	FNA3P	32

### Step 2.

Decide method of starting and then note the fuse link rating which corresponds to the Motor FLC from table 2a (Direct on Line) or 2b (Star Delta starting).

Motor FLC (A)	Fuse (A)
0 - 0.7	2
1.0 - 2.0	10
2.1 - 3.0	16
3.1 - 6.1	20
6.2 - 9.0	25
9.1 - 11	32

### Step 5.

Compare the fuse link rating noted in step 2 with the lowest of the ratings noted in steps 3 and 4.

#### Example

- Step 2 - Motor = 16A
- Step 3 - Contactor = 16A
- Step 4 - Overload relay = 20A

If this lowest value is less than the fuse link rating noted in step 2, then Type 2 co-ordination is not achieved.

**NO**  
Type 2 Co-ordination is not achieved.

### Step 3.

Select contactor and note it's fuse link rating from table 3.

kW	Ie (AC3)	Contactors 380/415V cat. no.	Fuse (A)
2.2	5.2	CE15A	16
4	9.1	CE15B	25
5.5	12	CE15C	32
7.5	16	CE15D	35
		CE15E	40

If this lowest value is equal to or greater than the fuse link rating noted in step 2, then Type 2 co-ordination is achieved.

**YES**  
Type 2 Co-ordination is achieved.



**Selection procedure (continued)**

**Table 1. Motor full load current**

kW	HP	220V	380V	415V
1.1	1.0	4.9	2.9	2.6
1.5	2.0	6.3	3.6	3.3
2.2	3.0	9.0	5.2	4.8
3.0	4.0	12	6.8	6.2
4.0	5.5	16	9.1	8.3
5.5	7.5	21	12	11
7.5	10	27	16	14
10	13.5	36	21	19
11	15	40	23	21
15	20	52	30	28
18.5	25	64	37	34
22	30	77	44	41
30	40	100	59	54
37	50	125	73	67
45	60	150	86	79
55	75	180	106	98
75	100	240	140	130
90	125	300	170	160
110	150	350	200	190
132	175	410	240	220
160	220	510	300	270

**Table 2a. D.O.L. fuse link rating**

Motor FLC (A)	Fuse (A)
0 - 0.7	2
0.8 - 1.4	4
1.5 - 2.0	6
2.1 - 3.0	10
3.1 - 6.1	16
6.2 - 9.0	20
9.1 - 11	25
11.1 - 14.4	32
14.5 - 15.4	35
15.5 - 18	40
18.1 - 22	50
22.1 - 28	63
28.1 - 45	80
45.1 - 58	100
58.1 - 80	125
80.1 - 99	160
99.1 - 128	200
128 - 180	250
180 - 216	315
216 - 270	355

**Table 2b. Star/delta fuse link rating**

Motor FLC (A)	Fuse (A)
0 - 1.4	2
1.5 - 2.1	4
2.2 - 3.1	6
3.2 - 5.5	10
5.6 - 10	16
10.1 - 14	20
14.1 - 18	25
18.1 - 22	32
22.1 - 28	35
28.1 - 32	40
32.1 - 40	50
40.1 - 51	63
51.1 - 80	80
80.1 - 100	100
100 - 125	125
125 - 160	160
160 - 200	200
200 - 250	250
250 - 315	315
315 - 355	355

**Table 3. Freedom contactors**

kW	Ie (AC3) 380/415V	Contactors cat. no.	Fuse (A)
2.2	5.2	CE15A	16
4	9.1	CE15B	25
5.5	12	CE15C	32
7.5	16	CE15D	35
11	23	CE15E	50
15	30	CE15F	63
18.5	37	CE15G	100
22	44	CE15H	100
30	59	CE15J	125
37	73	CE15K	125
45	86	CE15L	160
55	106	CE15M	200
75	140	CE15N	250
90	170	MCE15P	250
110	200	MCE15R	315
160	300	MCE15S	355

**Table 4. Freedom overload relays**

Full load current range (A)	Catalogue number	Fuse (A)	Full load current range (A)	Catalogue number	Fuse (A)
0.25 - 0.4	C316 FNA3C	2	18 - 25	C316 KNA3A	50
0.4 - 0.63	FNA3D	2	22 - 32	KNA3B	63
0.43 - 1.1	FNA3E	4	29 - 42	KNA3C	80
1.0 - 1.4	FNA3F	4	36 - 52	KNA3D	125
1.3 - 1.8	FNA3G	6	45 - 63	KNA3E	160
1.7 - 2.4	FNA3H	10	60 - 80	KNA3F	200
2.2 - 3.1	FNA3J	10	65 - 90	C316 PNA3A	200
2.8 - 3.1	FNA3K	16	80 - 110	PNA3B	200
3.5 - 5.0	FNA3L	20	100 - 135	PNA3C	200
4.5 - 6.5	FNA3M	20	110 - 150	PNA3D	250
6.0 - 8.5	FNA3N	25	130 - 175	PNA3E	315
7.5 - 11	FNA3P	32	150 - 200	PNA3F	315
10 - 14	FNA3Q	35	130 - 185	C316 SNA3A	C/T overload relays No limit
13 - 19	FNA3R	50	165 - 235	SNA3B	
18 - 24	FNA3S	50	220 - 310	SNA3C	
24 - 32	FNA3T	80	285 - 400	SNA3D	
			355 - 500	C316 UNA3A	C/T overload relays No limit
			465 - 650	UNA3B	
			610 - 850	UNA3C	

**Notes:**

- Account of the crossover current (Ic) of the fuse and the overload relay characteristic has already been made in the formation of table 4.
- A thermal or electronic overload relay which uses current transformers to sense primary current, has no restriction on the size of fuse required to afford Type 2 co-ordination. Determination of the maximum fuse size should be based on co-ordination of the contactor as shown in table 3.
- Remember all testing has been conducted at 415 Volts. Co-ordination details are therefore applicable at this voltage or lower.
- Reference should be made to the Contactor Safety Perimeter Zone dimensions (page 38) to ensure that within the enclosure used, no part of the metal work infringes this zone.

## Freedom Series - 2.2 to 160kW

## Technical data

Contactor		CE15AN	CE15BN	CE15CN	CE15DN					
<b>General</b>										
kW AC3 rating 380/415V		2.2	4.0	5.5	7.5					
Standards and approvals		IEC947-4-1, UL508, CSA22.14								
Width mm		45	45	45	45					
Number of poles (maximum)		4	4	4	3					
Protection against direct contact (with terminal cover fitted)		IP20 to IEC529 (removable terminal cover)								
Mechanical lifespan		20,000,000	20,000,000	20,000,000	20,000,000					
Weight kg		0.41	0.41	0.41	0.44					
<b>Environment</b>										
Pollution degree IEC947-1		3	3	3	3					
Impulse withstand voltage IEC947-4-1		6kV	6kV	6kV	6kV					
Operating temperature, open		20 to +65 <sub>i</sub> C	20 to +65 <sub>i</sub> C	20 to +65 <sub>i</sub> C	20 to +65 <sub>i</sub> C					
Relative humidity at 40 <sub>i</sub> C		95%	95%	95%	95%					
Operating altitude		2,000m	2,000m	2,000m	2,000m					
Operating position (relative to normal mounting position)		±30 <sub>i</sub>	±30 <sub>i</sub>	±30 <sub>i</sub>	±30 <sub>i</sub>					
<b>Main contact ratings</b>										
Insulating voltage U <sub>i</sub>		690V	690V	690V	690V					
Operating frequency limits		50 to 60Hz	50 to 60Hz	50 to 60Hz	50 to 60Hz					
Rated thermal current I <sub>th</sub> @ 600V		20	20	20	32					
AC1 duty	Rated operational current I <sub>e</sub> (A)	P	I <sub>e</sub>	P	I <sub>e</sub>	P	I <sub>e</sub>	P	I <sub>e</sub>	
	Maximum power rating P (kW)	220/240V	6.1	6.1	6.1	9.7				
		380/415V	10.5	10.5	10.5	16.8				
	(p.f.) = 0.8	440/460V	12.1	12.1	12.1	19.5				
	Non-inductive or slightly inductive loads	500/575V	13.8	13.8	13.8	22				
	660V	18.2	18.2	18.2	29					
AC2 & AC3 duty	Rated operational current I <sub>e</sub> (A)	P	I <sub>e</sub>	P	I <sub>e</sub>	P	I <sub>e</sub>	P	I <sub>e</sub>	
	Maximum power rating P (kW)	220/240V	1.1	5.2	1.5	6.8	2.2	9.6	4.0	16.0
		380/415V	2.2	5.2	4.0	9.1	5.5	12.0	7.5	16.0
	Slipping motors: Starting, switching off	440/460V	2.2	4.8	4.0	7.8	5.5	11.0	7.5	14.0
	Squirrel cage motors: Starting, plugging & inching	500/575V	4.0	6.9	5.5	9.4	7.5	12.0	11.0	17.0
		660V	2.2	3.0	4.0	5.2	5.5	7.1	7.5	9.1
	Maximum operations per hour		600		600		600		600	
	AC3 electrical life at 380/415V		2,800,000		2,300,000		2,100,000		1,500,000	
	AC2 electrical life at 380/415V		260,000		239,000		175,000		272,000	
	AC4 duty	Rated operational current I <sub>e</sub> (A)	P	I <sub>e</sub>	P	I <sub>e</sub>	P	I <sub>e</sub>	P	I <sub>e</sub>
Maximum power rating P (kW)		220/240V	1.1	5.2	1.5	6.8	2.2	9.6	4.0	16.0
		380/415V	2.2	5.2	4.0	9.1	5.5	12.0	7.5	16.0
Squirrel cage motors: Starting, plugging & inching		440/460V	2.2	4.8	4.0	7.8	5.5	11.0	7.5	14.0
		500/575V	4.0	6.9	5.5	9.4	5.5	9.4	7.5	12.0
		660V	2.2	3.0	4.0	5.2	5.5	7.1	7.5	9.1
Maximum operations per hour			300		300		300		300	
AC4 electrical life at 380/415V		64,000		59,000		43,000		67,000		
Other ratings	Rated operational current I <sub>e</sub> (A)	P	IL	P	IL	P	IL	P	IL	
	Star delta starter duty	220/240V	2.2	9.6	4.0	16.0	4.0	16.0	7.5	28.0
		380/415V	5.5	12.0	7.5	16.0	11.0	23.0	15.0	30.0
	Ratings for contactors delta connected	440/460V	5.5	11.0	7.5	14.0	11.0	21.0	15.0	27.0
		500/575V	7.5	12.0	7.5	12.0	11.0	17.0	18.5	28.0
		660V	4.0	4.0	5.5	5.5	7.5	7.5	11.0	11.0
	Rated rotor insulation voltage U <sub>ir</sub>		690V		690V		690V		690V	
	Rated rotor operational voltage U <sub>er</sub>		1320V		1320V		1320V		1320V	
	AC2 duty, slipping motors starting and switching off	100% DF	12A		16A		21A		29A	
	Electrical life span > = 1,000,000 operations	60% DF	15A		21A		27A		38A	
Ratings for contactors delta connected	40% DF	19A		26A		33A		47A		
	20% DF	27A		36A		46A		66A		

April 2005

Freedom Series - 2.2 to 160kW

CE15EN		CE15FN		CE15GN		CE15HN		CE15JN		CE15KN	
11.0		15.0		18.5		22.0		30.0		37.0	
IEC947-4-1, UL508, CSA22.14											
45		45		65		65		65		65	
3		3		3		3		3		3	
Finger and back of hand protection to VDE0106 part 100.											
20,000,000		20,000,000		10,000,000		10,000,000		10,000,000		10,000,000	
0.44		0.44		1.25		1.25		1.25		1.25	
3		3		3		3		3		3	
6kV		6kV		6kV		6kV		6kV		6kV	
20 to +65jC		20 to +65jC		20 to +65jC		20 to +65jC		20 to +65jC		20 to +65jC	
95%		95%		95%		95%		95%		95%	
2,000m		2,000m		2,000m		2,000m		2,000m		2,000m	
±30j		±30j		±30j		±30j		±30j		±30j	
690V		690V		690V		690V		690V		690V	
50 to 60Hz		50 to 60Hz		50 to 60Hz		50 to 60Hz		50 to 60Hz		50 to 60Hz	
32		32		50		60		75		80	
P	le	P	le	P	le	P	le	P	le	P	le
9.7		9.7		15.2		18.3		22.9		24.4	
16.8		16.8		26.3		31.6		39.5		42.1	
19.5		19.5		30.5		36.6		45.7		48.8	
22.0		22.0		38.1		45.7		57.2		61.0	
29.0		29.0		45.7		54.9		68.6		73.2	
P	le	P	le	P	le	P	le	P	le	P	le
5.5	22.0	7.5	28.0	10.0	36.0	11.0	42.0	15.0	54.0	18.5	68.0
11.0	23.0	15.0	30.0	18.5	37.0	22.0	44.0	30.0	59.0	37.0	73.0
11.0	21.0	15.0	27.0	18.5	34.0	22.0	40.0	30.0	52.0	37.0	65.0
15.0	23.0	18.5	28.0	22.0	34.0	30.0	45.0	30.0	45.0	37.0	55.0
11.0	13.0	15.0	17.0	11.0	13.0	15.0	17.0	18.5	21.0	22.0	26.0
600		600		600		600		600		600	
1,500,000		1,700,000		1,100,000		1,300,000		1,500,000		1,300,000	
211,000		199,000		235,000		252,000		138,000		98,000	
P	le	P	le	P	le	P	le	P	le	P	le
5.5	22.0	5.5	22.0	10.0	36.0	11.0	42.0	15.0	54.0	15.0	54.0
11.0	23.0	11.0	23.0	18.5	37.0	22.0	44.0	30.0	59.0	30.0	59.0
11.0	21.0	11.0	21.0	18.5	34.0	22.0	40.0	30.0	52.0	30.0	52.0
11.0	17.0	11.0	17.0	22.0	34.0	30.0	45.0	30.0	45.0	30.0	45.0
7.5	9.1	7.5	9.1	11.0	13.0	15.0	17.0	18.5	21.0	18.5	21.0
600		600		600		600		600		600	
52,000		75,000		58,000		62,000		34,000		34,000	
P	IL	P	IL	P	IL	P	IL	P	IL	P	IL
7.5	28.0	11.0	42.0	15.0	54.0	18.5	68.0	22.0	80.0	30.0	104.0
18.5	37.0	22.0	44.0	30.0	59.0	37.0	73.0	45.0	86.0	55.0	106.0
18.5	34.0	22.0	40.0	30.0	52.0	37.0	65.0	45.0	77.0	55.0	96.0
22.0	34.0	30.0	45.0	37.0	55.0	45.0	66.0	45.0	66.0	55.0	81.0
18.5	13.5	22.0	22.0	18.5	18.5	22.0	22.0	30.0	30.0	37.0	37.0
690V		690V		690V		690V		690V		690V	
1320V		1320V		1320V		1320V		1320V		1320V	
40A		52A		64A		76A		104A		126A	
51A		67A		83A		98A		134A		163A	
63A		82A		101A		120A		164A		200A	
89A		116A		143A		170A		232A		283A	

## Freedom Series - 2.2 to 160kW

## Technical data (continued)

Contactor		CE15LN	CE15MN	CE15NN					
<b>General</b>									
kW AC3 rating 380/415V		45	55	75					
Standards and approvals		IEC947-4-1, UL508, CSA 22.14							
Width mm		90	90	93					
Number of poles		3	3	3					
Mechanical lifespan		6,000,000	6,000,000	6,000,000					
Weight kg		3.8	3.8	3.8					
<b>Environment</b>									
Pollution degree IEC 947-1		3	3	3					
Impulse withstand voltage IEC 947-4-1		6kV	6kV	6kV					
Operating temperature, open		20 to +65 <sub>i</sub> C	20 to +65 <sub>i</sub> C	20 to +65 <sub>i</sub> C					
Relative humidity		95%	95%	95%					
Operating altitude		2,000m	2,000m	2,000m					
Operating position (relative to normal mounting position)		±30 <sub>i</sub>	±30 <sub>i</sub>	±30 <sub>i</sub>					
<b>Main contact ratings</b>									
Insulation voltage Ui		690V	690V	690V					
Operating frequency limits		50 to 60Hz	50 to 60Hz	50 to 60Hz					
Rated thermal current I <sub>th</sub> @ 600V		100	135	175					
AC1 duty	Rated operational current I <sub>e</sub> (A)	P	I <sub>e</sub>	P	I <sub>e</sub>	P	I <sub>e</sub>		
		220/240V		30	41	45			
	380/415V		52	71	79				
	(p.f.)=0.8	440/460V		60	82	91			
		500/575V		69	93	104			
Non-inductive or slightly inductive loads		660V	91	123	137				
AC2 & AC3 duty	Rated operational current I <sub>e</sub> (A)	P	I <sub>e</sub>	P	I <sub>e</sub>	P	I <sub>e</sub>		
		220/240V		22	86	30	106	37	140
	380/415V		45	86	55	106	75	140	
	Slipping motors: Starting, switching off		440/460V	45	86	55	106	75	140
	Squirrel cage motors: Starting, plugging & inching		500/575V	55	81	75	106	75	105
	660V		37	42	45	50	45	50	
	Maximum operations per hour		600	600	600				
	AC3 electrical life at 380/415V		500,000	576,000	620,000				
	AC2 electrical life at 380/415V		121,000	125,000	160,000				
	AC4 duty	Rated operational current I <sub>e</sub> (A)	P	I <sub>e</sub>	P	I <sub>e</sub>	P	I <sub>e</sub>	
220/240V			18.5	68	22	86	30	106	
380/415V		37	73	45	86	55	106		
Squirrel cage motors: Starting, plugging & inching		440/460V		37	65	45	86	55	106
		500/575V		37	55	45	66	55	81
660V		30	30	37	42	40	46		
Maximum operations per hour		300	300	300					
AC4 electrical life at 380/415V		39,000	43,000	61,000					
Other ratings	Rated operational current I <sub>e</sub> (A)	P	IL	P	IL	P	IL		
		Star delta starter duty		45	150	55	180	75	240
	380/415V		75	140	90	170	132	240	
	Ratings for contactors delta connected		440/460V	75	130	90	160	132	220
	500/575V		90	130	132	180	132	180	
	660V		55	55	75	75	75	75	
Rotor circuit contactors	Rated rotor insulation voltage U <sub>ir</sub>	690V		690V		690V			
	Rated rotor operational voltage U <sub>er</sub>	1320V		1320V		1320V			
Slipping motors starting and switching off		100% DF	165A	225A	330A				
Electrical life span >=500.000 operations at 100% DF		60% DF	213A	290A	426A				
Ratings for contactors delta connected		40% DF	261A	356A	522A				
		20% DF	369A	503A	738A				

April 2005

Freedom Series - 2.2 to 160kW

MCE15PN		MCE15RN		MCE15SN	
90		110		160	
IEC947-4-1, UL508, CSA22.14					
178		178		178	
3		3		3	
5,000,000		5,000,000		5,000,000	
8.25		8.3		8.3	
3		3		3	
6kV		6kV		6kV	
-20 to +65°C		-20 to +65°C		-20 to +65°C	
95%		95%		95%	
2,000m		2,000m		2,000m	
±30°		±30°		±30°	
690V		690V		690V	
50 to 60Hz		50 to 60Hz		50 to 60Hz	
185		220		315	
P	le	P	le	P	le
56		67		96	
97		115		165	
112		134		192	
128		152		218	
169		200		288	
P	le	P	le	P	le
45	170	55	200	90	300
90	170	110	200	160	300
90	170	110	200	160	300
90	130	110	160	160	210
45	50	55	61	75	80
600		600		300	
582,000		520,000		351,000	
173,000		166,000		100,000	
P	le	P	le	P	le
37	128	45	150	50	170
65	128	75	140	90	170
65	128	75	140	90	170
65	98	75	105	90	160
45	50	55	61	75	80
300		200		150	
67,000		65,000		60,000	
P	IL	P	IL	P	IL
75	240	110	380	160	520
132	240	200	380	250	520
160	220	220	380	300	485
132	180	160	225	220	320
75	75	90	90	110	110
690V		690V		690V	
1320V		1320V		1320V	
357A		393A		465A	
461A		507A		600A	
564A		621A		735A	
798A		879A		1040A	

## Freedom Series - 2.2 to 160kW

Contactor	CE15AN	CE15BN	CE15CN	CE15DN					
Non motor utilisation categories	le	le	le	le					
AC-5a Switching of electrical discharge lamps. Ue<=440V, rated current le	18A	25A	25A	32A					
AC-5b Switching of incandescent loads. Ue<=575V, rated current le	3A	4A	5.2A	7.3A					
AC-6a Switching of transformers. Having inrush current peaks not more than 30 times peak of the rated current. Ue<=575V, rated current le	3.1A	4.2A	5.4A	7.6A					
AC-6b Switching of single capacitor banks.	Ue	kVAr	le	kVAr	le	kVAr	le	kVAr	le
Having prospective short circuit current Ik at the location of the capacitor bank.	220V	2.6	6.1	3.5	8.3	4.6	10.6	6.5	15.1
	380V	4.5	6.1	6.1	8.3	7.9	10.6	11.0	15.1
Ue<=575V Ik<=15kA	415V	4.9	6.1	6.7	8.3	8.6	10.6	12.0	15.1
Where Ik is between 15kA and 25kA, derate to 60% of the ratings.	440V	5.2	6.1	7.1	8.3	9.1	10.6	13.0	15.1
	500V	5.9	6.1	8.1	8.3	10.0	10.6	14.0	15.1
Where Ik is between 25kA and 50kA, derate to 30% of the ratings.	550V	6.5	6.1	8.9	8.3	11.0	10.6	16.0	15.1
	575V	6.1	6.1	8.3	8.3	10.6	10.6	15.0	15.1
Average contact resistance per pole (milli-ohms)	2	2	2	1.3					
Power dissipated per pole at Ith, W	0.8	0.8	0.8	1.3					
Power dissipated per pole at le max, W	0.1	0.18	0.29	0.38					
Short circuit co-ordination; IEC947-4	Type 2	Type 2	Type 2	Type 2					
Circuit breaker type A305	6.3 – 9	9 – 12.5	9 – 12.5	16 – 20					
Fuse type: BS88 class gG & gM	16A	25A	32A	35A					
Rated conditional short circuit current (Iq)	50kA	50kA	50kA	50kA					
<b>Magnet system - AC operated</b>									
Pickup	>=0.85 <=1.1Uc	>=0.85 <=1.1Uc	>=0.85 <=1.1Uc	>=0.85 <=1.1Uc					
Drop out	>=0.2 <=0.75Uc	>=0.2 <=0.75Uc	>=0.2 <=0.75Uc	>=0.2 <=0.75Uc					
Pick up VA	70	70	70	92					
Sealed VA	6.4	6.4	6.4	8					
Sealed W	1.9	1.9	1.9	2.7					
Duty (continuous rated) maximum rate of operation	12,000	12,000	12,000	12,000					
Insulation class of coil to IEC85 (BS2757)	B	B	B	B					
Pick up time	16	16	16	16					
Drop out time	12	12	12	12					
<b>Magnet system - DC operated</b>									
	Coil voltage								
Pickup VA/W	12V	–	6.4/76.8	6.4/76.8	6.4/76.8				
	24V	–	3.2/76.8	3.2/76.8	3.2/76.8				
	48V	–	1.6/76.8	1.6/76.8	1.6/76.8				
	120V	–	0.64/76.8	0.64/76.8	0.64/76.8				
Sealed VA/W	12V	–	0.28/3.36	0.28/3.36	0.28/3.36				
	24V	–	0.14/3.36	0.14/3.36	0.14/3.36				
	48V	–	0.07/3.36	0.07/3.36	0.07/3.36				
	120V	–	0.028/3.36	0.028/3.36	0.028/3.36				
<b>Cabling capacity in accordance with the requirements of EN 60 947</b>									
Number of conductors	2	2	2	2					
Solid or stranded – Max. wire size (mm <sup>2</sup> )	2.5	2.5	2.5	6					
– Min. wire size (mm <sup>2</sup> )	0.75	0.75	0.75	1					
Flexible – Max. wire size (mm <sup>2</sup> )	2.5	2.5	2.5	4					
– Min. wire size (mm <sup>2</sup> )	0.75	0.75	0.75	1					
<b>Cabling maximum terminal capacity</b>									
Number of conductors	2	2	2	2					
Solid, stranded or flexible. Max. size (mm <sup>2</sup> )	4	4	4	10					

April 2005

Freedom Series - 2.2 to 160kW

CE15EN		CE15FN		CE15GN		CE15HN		CE15JN		CE15KN	
le	le	le	le	le	le	le	le	le	le	le	le
32A	32A	50A	60A	75A	80A						
10A	12A	14.6A	19A	19A	24A						
10A	13A	15A	20A	20A	24A						
kVAr	le	kVAr	le	kVAr	le	kVAr	le	kVAr	le	kVAr	le
8.4	20.4	8.4	26.6	13.0	32.8	16.0	39.9	19.0	53.2	21.0	64.7
14.0	20.4	14.0	26.6	23.0	32.8	27.0	39.9	34.0	53.2	36.0	64.7
<b>15.0</b>	<b>20.4</b>	<b>15.0</b>	<b>26.6</b>	<b>25.0</b>	<b>32.8</b>	<b>30.0</b>	<b>39.9</b>	<b>37.0</b>	<b>53.2</b>	<b>40.0</b>	<b>64.7</b>
16.0	20.4	16.0	26.6	26.0	32.8	32.0	39.9	39.0	53.2	42.0	64.7
19.0	20.4	19.0	26.6	30.0	32.8	36.0	39.9	45.0	53.2	48.0	64.7
21.0	20.4	21.0	26.6	33.0	32.8	40.0	39.9	49.0	53.2	53.0	64.7
20.3	20.4	26.5	26.6	32.7	32.8	39.7	39.9	53.0	53.2	64.5	64.7
1.3	1.3	1.75	1.75	1.75	1.75	1.75	1.75	1.75	1.75	1.75	1.75
1.3	1.3	4.4	6.3	6.3	9.8	9.8	11.2	11.2	11.2	11.2	11.2
0.69	1.2	2.4	3.5	3.5	6.1	6.1	9.3	9.3	9.3	9.3	9.3
Type 2	Type 2	Type 2	Type 2	Type 2	Type 2	Type 2	Type 2	Type 2	Type 2	Type 2	Type 2
20 – 25	–	–	–	–	–	–	–	–	–	–	–
50A	63A	80A	100A	100A	125A						
50kA	50kA	50kA	50kA	50kA	50kA						
>=0.85 <=1.1Uc	>=0.85 <=1.1Uc	>=0.85 <=1.1Uc	>=0.85 <=1.1Uc	>=0.85 <=1.1Uc	>=0.85 <=1.1Uc	>=0.85 <=1.1Uc	>=0.85 <=1.1Uc	>=0.85 <=1.1Uc	>=0.85 <=1.1Uc	>=0.85 <=1.1Uc	>=0.85 <=1.1Uc
>=0.2 <=0.75Uc	>=0.2 <=0.75Uc	>=0.2 <=0.75Uc	>=0.2 <=0.75Uc	>=0.2 <=0.75Uc	>=0.2 <=0.75Uc	>=0.2 <=0.75Uc	>=0.2 <=0.75Uc	>=0.2 <=0.75Uc	>=0.2 <=0.75Uc	>=0.2 <=0.75Uc	>=0.2 <=0.75Uc
92	92	230	230	230	230						
8	8	28	28	28	28						
2.7	2.7	8.0	8.0	8.0	8.0						
12,000	12,000	12,000	12,000	12,000	12,000						
B	B	B	B	B	B						
16	16	24	24	24	24						
12	12	19	19	19	19						
6.4/76.8	6.4/76.8	15.4/126	15.4/126	15.4/126	15.4/126						
3.2/76.8	3.2/76.8	6.2/88.4	6.2/88.4	6.2/88.4	6.2/88.4						
1.6/76.8	1.6/76.8	2.9/76.2	2.9/76.2	2.9/76.2	2.9/76.2						
0.64/76.8	0.64/76.8	1.1/67.3	1.1/67.3	1.1/67.3	1.1/67.3						
0.28/3.36	0.28/3.36	0.42/4.98	0.42/4.98	0.42/4.98	0.42/4.98						
0.14/3.36	0.14/3.36	0.21/4.96	0.21/4.96	0.21/4.96	0.21/4.96						
0.07/3.36	0.07/3.36	0.11/5.04	0.11/5.04	0.11/5.04	0.11/5.04						
0.028/3.36	0.028/3.36	0.041/4.87	0.041/4.87	0.041/4.87	0.041/4.87						
2	2	2*	2*	2*	2*						
6	6	25 (10)	25 (10)	25 (10)	25 (10)						
1	1	2.5 (2.5)	2.5 (2.5)	2.5 (2.5)	2.5 (2.5)						
4	4	16 (6)	16 (6)	16 (6)	16 (6)						
1	1	2.5 (2.5)	2.5 (2.5)	2.5 (2.5)	2.5 (2.5)						
2	2	2*	2*	2*	2*						
10	10	35 (16)	35 (16)	35 (16)	35 (16)						

\* 2 Terminal compartments (upper and lower), the upper having the greater capacity. Lower capacities in brackets.

## Freedom Series - 2.2 to 160kW

Contactor	CE15LN	CE15MN	CE15NN
<b>Non motor utilisation categories</b>	le	le	le
AC-5a Switching of electrical discharge lamps. $U_e \leq 440V$ , rated current le	100A	135A	150A
AC-5b Switching of incandescent loads. $U_e \leq 575V$ , rated current le	37A	46A	60A
AC-6a Switching of transformers. Having inrush current peaks not more than 30 times peak of the rated current. $U_e \leq 575V$ , rated current le	39A	48A	63A
AC-6b Switching of single capacitor banks.	$U_e$	kVAr	le
Having prospective short circuit current $I_k$ at the location of the capacitor bank.	220V	26	23
	380V	46	23
$U_e \leq 575V$ $I_k \leq 15kA$	415V	50	23
Where $I_k$ is between 15kA and 25kA, derate to 60% of the ratings.	440V	53	23
	500V	60	23
Where $I_k$ is between 25kA and 50kA, derate to 30% of the ratings.	550V	66	23
	575V	23	23
		28	28
		35	28
		61	28
		67	28
		71	28
		81	28
		89	28
		28	28
		37	37
Average contact resistance per pole (milli-ohms)	0.45	0.45	0.25
Power dissipated at $I_{th}$ , W	4.5	8.2	5.6
Power dissipated at $I_{le}$ max, W	3.3	5	5
Short circuit co-ordination, IEC947-4	Type 2	Type 2	Type 2
Fuse type, BS88 class gG & gM	160A	200A	250A
Rated conditional short circuit current ( $I_q$ )	50kA	50kA	50kA
<b>Magnet system</b>			
Pick up	$\geq 0.85 \leq 1.1 U_c$	$\geq 0.85 \leq 1.1 U_c$	$\geq 0.85 \leq 1.1 U_c$
Drop out	$\geq 0.2 \leq 0.75 U_c$	$\geq 0.2 \leq 0.75 U_c$	$\geq 0.2 \leq 0.75 U_c$
Pick up VA	390	390	393
Sealed VA	50	50	57
Sealed W	14	14	14
Duty (continuous rated) maximum rate of operation per hour	7,200	7,200	7,200
Insulation class of coil to IEC85 (BS2757)	B	B	B
Pick up time (milli-seconds)	20	20	20
Drop out time (milli-seconds)	11	11	11
<b>Magnet system - DC operated</b>	Coil voltage		
Pickup VA/W	12V	24/293	24/293
	24V	12/288	12/288
	48V	6.1/295	6.1/295
	120V	2.5/298	2.5/298
	240V	—	—
Sealed VA/W	12V	0.4/4.84	0.4/4.84
	24V	0.2/4.75	0.2/4.75
	48V	0.097/4.67	0.097/4.67
	120V	0.038/4.57	0.038/4.57
	240V	—	—
<b>Cabling capacity</b>			
Number of conductors	2	2	2
Number of conductors when using terminal extension kit	3	3	3
Terminal capacity using compression lugs (mm <sup>2</sup> )	6 to 35	6 to 35	6 to 35
Terminal bolt/stud size	¼ UNC	¼ UNC	¼ UNC
<b>Cabling using box lug (supplied)</b>			
Number of conductors	1	1	—
Solid or stranded – Max. size (mm <sup>2</sup> )	50	70	—
Flexible – Max. size (mm <sup>2</sup> )	35	50	—



April 2005

Freedom Series - 2.2 to 160kW

MCE15PN		MCE15RN		MCE15SN	
le		le		le	
185A		220A		315A	
73A		86A		129A	
77A		90A		135A	
kV Ar	le	kV Ar	le	kV Ar	le
49	45	58	53	83	61
84	45	101	53	144	61
92	45	110	53	158	61
98	45	117	53	167	61
111	45	133	53	190	61
122	45	146	53	209	61
45	45	53	53	61	61
0.25		0.25		0.25	
8.5		12		25	
7.5		10		22	
Type 2		Type 2		Type 2	
250A		315A		355A	
50kA		50kA		50kA	
$\geq 0.85 \leq 1.1 U_c$		$\geq 0.85 \leq 1.1 U_c$		$\geq 0.85 \leq 1.1 U_c$	
$\geq 0.2 \leq 0.75 u_c$		$\geq 0.2 \leq 0.75 U_c$		$\geq 0.2 \leq 0.75 U_c$	
1040		1040		1040	
116		116		116	
17		17		17	
2,400		2,400		2,400	
B		B		B	
23		23		23	
15		15		15	
–		–		–	
18/400		18/400		18/400	
9/400		9/400		9/400	
3.3/450		3.3/450		3.3/450	
1.7/440		1.7/440		1.7/440	
–		–		–	
0.22/5.3		0.22/5.3		0.22/5.3	
0.11/5.2		0.11/5.2		0.11/5.2	
0.05/5.4		0.05/5.4		0.05/5.4	
0.02/4.9		0.02/4.9		0.02/4.9	
2		2		2	
4		4		4	
16 to 95		25 to 120		25 to 120	
M8		M10		M10	
–		–		–	
–		–		–	
–		–		–	

## Freedom Series - 2.2 to 160kW

Auxiliary contacts	Integral contacts			Add-on contact blocks			
				Top mounted		Side mounted	
<b>General</b>							
Standards and approvals	IEC947-5-1, UL508, CSA22.14						
Protection against direct contact	IP20 to IEC529		IP20 to IEC529		IP20 to IEC529		
Mechanical life span	20,000,000		10,000,000		10,000,000		
Terminal marking	EN50012 (BS5582)		EN50012 (BS5582)		EN50012 (BS5582)		
<b>Environment</b>							
Pollution degree IEC947-1	3		3		3		
Impulse withstand voltage IEC947-1	6kV		6kV		6kV		
Operating temperature, open	-20 to +65°C		-20 to +65°C		-20 to +65°C		
Relative humidity							
Operating altitude	2,000m		2,000m		2,000m		
Weight	-		58g		46g		
<b>Contact ratings</b>							
Rated thermal current. Open Ith	10A		10A		10A		
Rated insulation voltage Ui	690V		690V		690V		
Operating frequency limits	50 to 60Hz		50 to 60Hz		50 to 60Hz		
Adjacent contacts 'electrically separate'	Yes		Yes		Yes		
<b>AC15 duty</b>	Ue	VA	Ie	VA	Ie	VA	Ie
Control of A.C. electromagnetic loads (Greater than 72VA)	48	480	10	480	10	480	10
	120	720	6	720	6	720	6
	240	960	4	960	4	960	4
	440	880	2	880	2	880	2
	660	990	1.5	990	1.5	990	1.5
<b>DC13 duty</b>	Ue	W	Ie	W	Ie	W	Ie
Control of D.C. electromagnets	24	19.2	8	19.2	8	19.2	8
	48	288	6	288	6	288	6
	120	120	1	120	1	120	1
	220	110	0.5	110	0.5	110	0.5
	440	110	0.25	110	0.25	110	0.25
	660	66	0.1	66	0.1	66	0.1
<b>Short circuit co-ordination</b>							
Conditional short circuit current I <sub>k</sub>	1kA		1kA		1kA		
Fuse type BS88 type gG	10A		10A		10A		
Average contact resistance per pole (milli-ohms)	N.O.		N.C.		N.O.		N.C.
	3.5		4.5		3.5		5
Power dissipated at I <sub>th</sub> (W)	0.35		0.45		0.35		0.5
	at I <sub>e</sub> 6A (W)		0.13		0.16		0.18
<b>Cabling capacity in accordance with the requirements of IEC947</b>							
Number of conductors	2		2		2		
Solid, stranded or flexible – Max. wire size (mm <sup>2</sup> )	2.5		2.5		2.5		
	– Min. wire size (mm <sup>2</sup> )		0.75		0.75		
<b>Cabling maximum terminal capacity</b>							
Number of conductors	2		2		2		
Solid, stranded or flexible – max. wire size (mm <sup>2</sup> )	4		4		4		

April 2005

Freedom Series - 2.2 to 160kW

Pneumatic timer		Base auxiliary contact block		Add-on contact blocks	
IEC947-5-1, UL508, CSA22.14					
IP20 to IEC529		IP20 to IEC529		IP20 to IEC529	
20,000,000		5,000,000		5,000,000	
		EN50012 (BS5582)		EN50012 (BS5582)	
3		3		3	
6kV		6kV		6kV	
-20 to +65°C		-20 to +65°C		-20 to +65°C	
2,000m		2,000m		2,000m	
410g		120g		35g	
10A		10A		10A	
690V		690V		690V	
50-60Hz		50-60Hz		50-60Hz	
Yes		No		Yes	
VA	le	VA	le	VA	le
-	-	480	10	480	10
480	4	720	6	720	6
600	2.5	960	4	960	4
880	2	880	2	880	2
660	1	990	1.5	990	1.5
W	le	W	le	W	le
-	-	192	8	192	8
-	-	288	6	288	6
72	0.6	120	1	120	1
66	0.3	110	0.5	110	0.5
66	0.15	110	0.25	110	0.25
66	0.1	66	0.1	66	0.1
1kA		1kA		1kA	
10A		10A		10A	
12					
1.2					
0.19					
2		2		2	
2.5		2.5		2.5	
0.75		0.75		0.75	
2		2		2	
4					

Freedom Series - 2.2 to 160kW

Technical data

Contactors 2.2 to 37kW

AC3 electrical durability

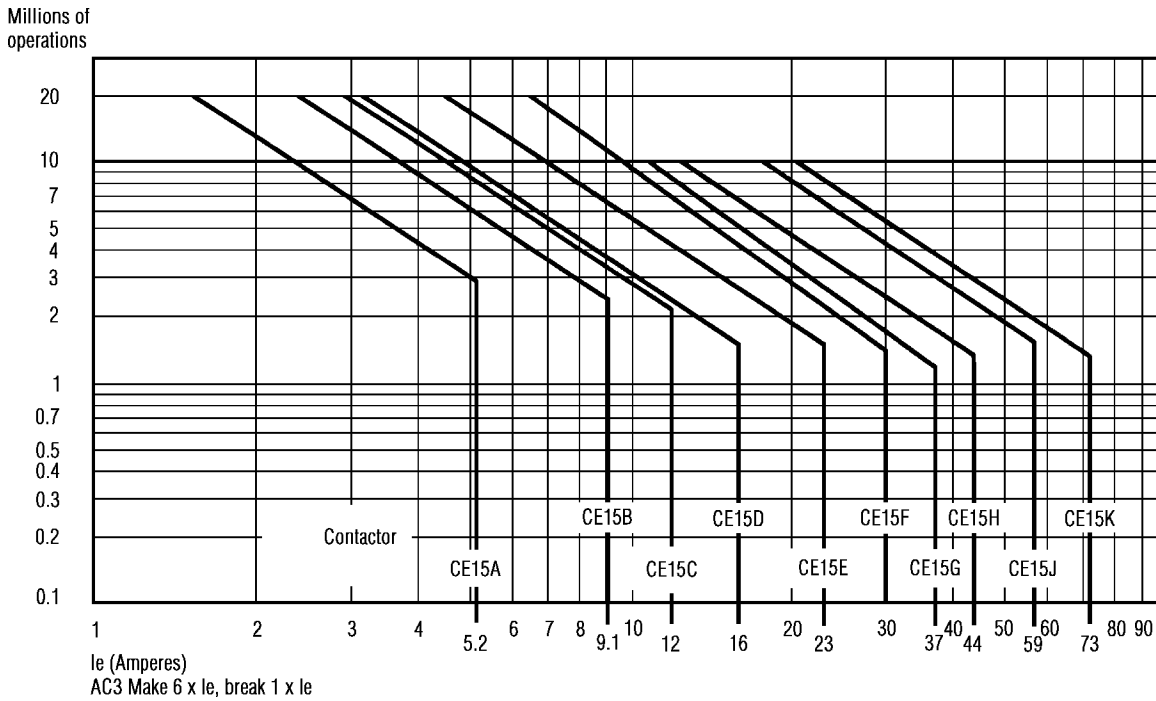

AC4 electrical durability

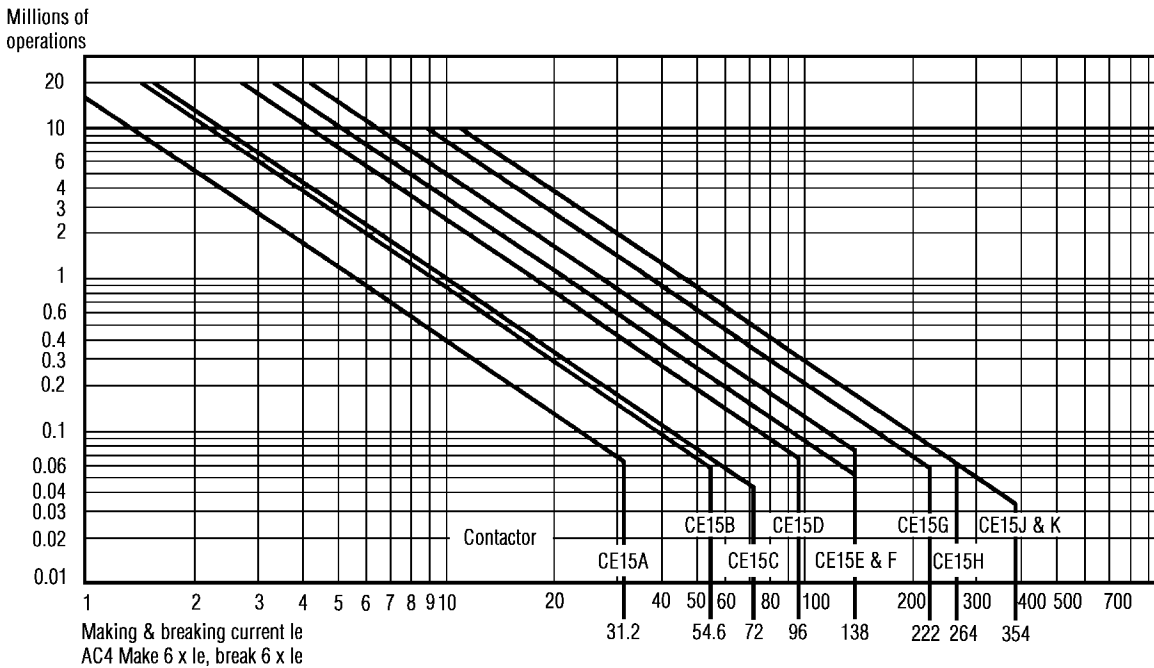

April 2005

Freedom Series - 2.2 to 160kW

Contactors 45 to 160kW

AC3 electrical durability

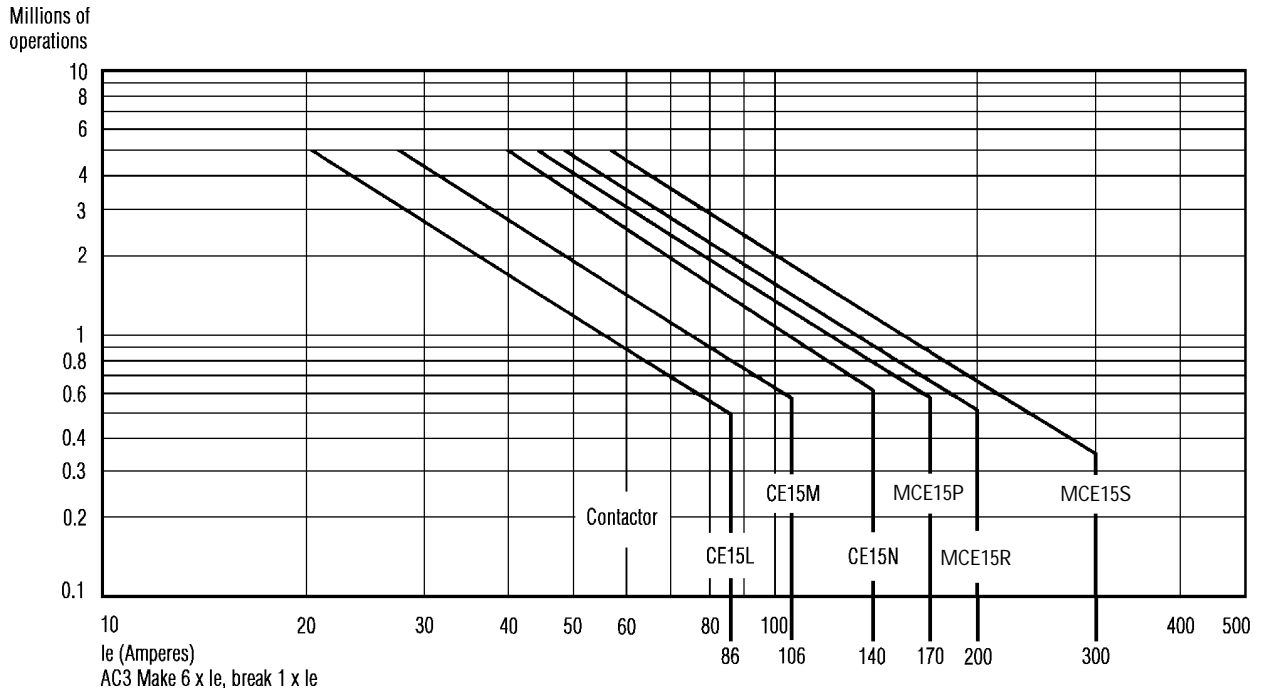

AC4 electrical durability

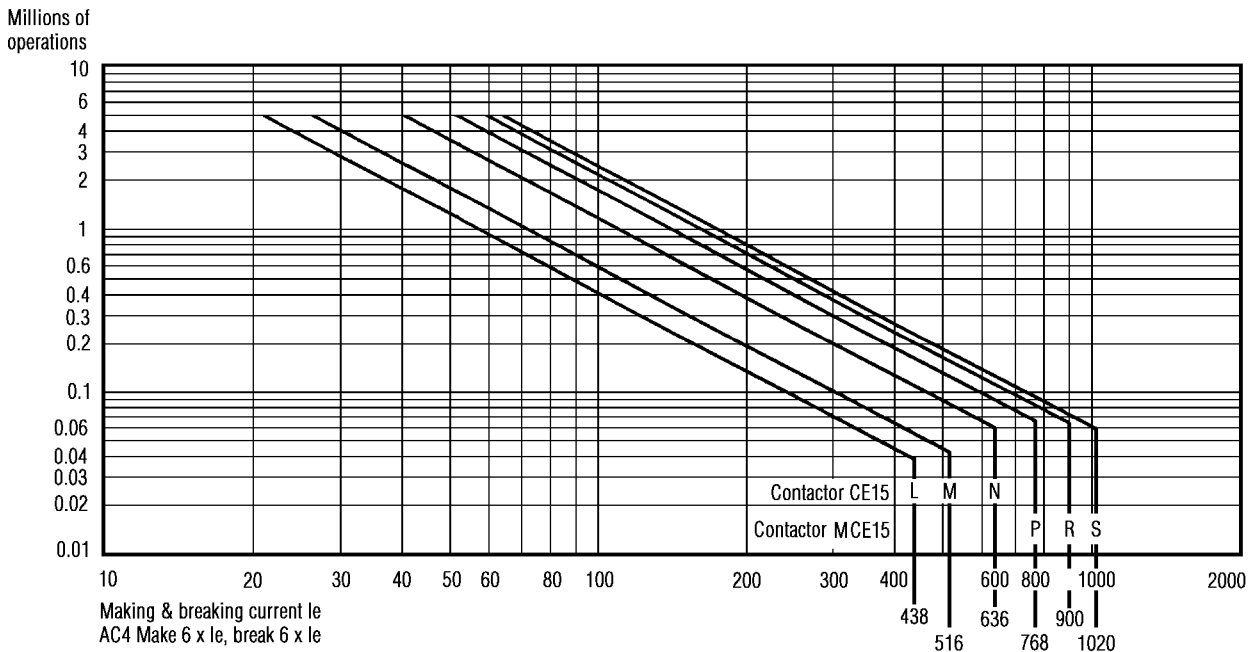

## Freedom Series - 2.2 to 160kW

## Technical data

Overload relays	C316FNA3	C316KNA3	C316PNA3	C316SNA3	C316UNA3
<b>General</b>					
Thermal current I <sub>th</sub>	Up to 32A	Up to 80A	Up to 200A	Up to 400A CT operated	Up to 850A CT operated
Standards and approvals	IEC 947-4-1, IEC 292-1, BS4941, VDE0660, UL 508, CSA C22-14, NFC 63-650				
Trip class IEC947-4-1	10A	10A	10A	30	30
Terminal marking	EN50005 (BS5472)				
Width (mm)	45	55	80*	193	246
	* Width across terminals is greater, <100A = 85mm, >100A = 105mm				
Protection against direct contact	Protected against unintentional contact in accordance with VDE0106 pt 100				
Weight (kg)	0.17	0.32	0.91	1.5	3
<b>Environment</b>					
Pollution degree IEC947-1	3	3	3	3	3
Impulse withstand voltage IEC947-4-1	6kV	6kV	6kV	6kV	6kV
Operating temperature, open	-25 to +50°C	-25 to +55°C	-25 to +55°C	-25 to +55°C	-25 to +55°C
Temperature compensation range	-25 to +50°C	-25 to +50°C	-25 to +50°C	-25 to +50°C	-25 to +50°C
Maximum altitude	2000m	2000m	2000m	2000m	2000m
Operating position (relative to normal position)	±30°	±30°	±30°	±30°	±30°
Climatic conditions	Damp heat constant to IEC68-2-3. Damp heat, cyclic to IEC68-2-30				
Mechanical shock resistance	12g for 15ms	12g for 15ms	12g for 15ms	12g for 15ms	12g for 15ms
Vibration	@ 45Hz 8g (1mm displacement with N.C. contacts maintained)				
Storage temperature	-40 to +70°C	-40 to +70°C	-40 to +70°C	-40 to +70°C	-40 to +70°C
<b>Main contacts</b>					
Insulation voltage U <sub>i</sub>	690V	690V	690V	690V	690V
Current range	0.25 – 32A	18 – 80A	100 – 200A	130 – 400A	265 – 850A
Power dissipated at minimum setting	2.2W	3.4W	5.8W	2.2W	2.2W
at maximum setting	3.3W	4.9W	7.3W	3.3W	3.3W
Max operating frequency of motor (starts per hour)	15 (dependent upon starting time and current)				
Short circuit co-ordination	Type 2 to IEC947-4-1				
Rated conditional short circuit current	50kA	50kA	50kA	50kA	50kA
Fuse type	See table on page 19				
<b>Cabling capacity in accordance with the requirements of IEC947-1</b>					
Number of conductors	1	2	1	2	–
Solid or stranded - Max. wire size (mm <sup>2</sup> )	10	6	35	15	–
- Min. wire size (mm <sup>2</sup> )	1.5	1.5	2.5	2.5	–
Flexible - Max. wire size (mm <sup>2</sup> )	6	4	25	10	–
- Min. wire size (mm <sup>2</sup> )	1.5	1.5	2.5	2.5	–
Cabling capacity using compression lugs (mm <sup>2</sup> )	–	–	–	25 to 120	–
Terminal flag bolt size - <100A	–	–	–	M6	–
- >100A	–	–	–	M10	–
CT aperture size (mm)	–	–	–	22 x 28	45 x 22

**Technical data**

	Auxiliary contacts				
	N.C. (95 - 96)	N.O. (97 - 98)			
<b>General</b>					
Protection against direct contact	IP20 to IEC529	IP20 to IEC529			
Mechanical life span	50,000	50,000			
<b>Contact ratings</b>					
Thermal current I <sub>th</sub>	10A	6A			
Insulation voltage U <sub>i</sub>	500V	500V			
Operating frequency limits	50/60Hz	50/60Hz			
Adjacent contacts 'electrically separate'	Yes	Yes			
<b>AC15 duty</b>					
Control of A.C. electromagnetic loads (Greater than 72VA)	U <sub>e</sub>	VA	I <sub>e</sub>	VA	I <sub>e</sub>
	120	360	3	204	1.7
	240	720	3	408	1.7
	415	830	2	539	1.3
	500	750	1.5	500	1
<b>DC13 duty</b>					
Control of D.C. electromagnets	U <sub>e</sub>	W	I <sub>e</sub>	W	I <sub>e</sub>
	220	110	0.5	110	0.5
<b>Short circuit co-ordination</b>					
Conditional short circuit current I <sub>q</sub>	1kA	1kA			
Fuse type BS88 type gG	10A	6A			
<b>Cabling capacity in accordance with the requirements of IEC947-1</b>					
Number of conductors	2	2			
Solid or stranded - Max. wire size (mm <sup>2</sup> )	4	4			
- Min. wire size (mm <sup>2</sup> )	0.75	0.75			
Flexible - Max. wire size (mm <sup>2</sup> )	2.5	2.5			
- Min. wire size (mm <sup>2</sup> )	0.75	0.75			

**Standard features**

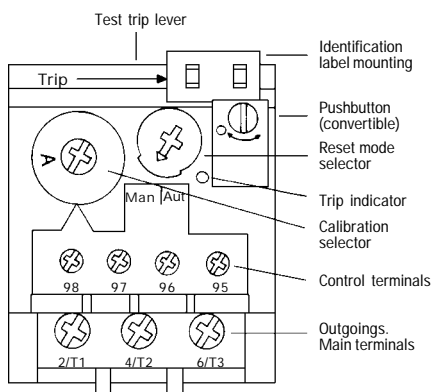

**Remote reset module**

**Circuit diagram**

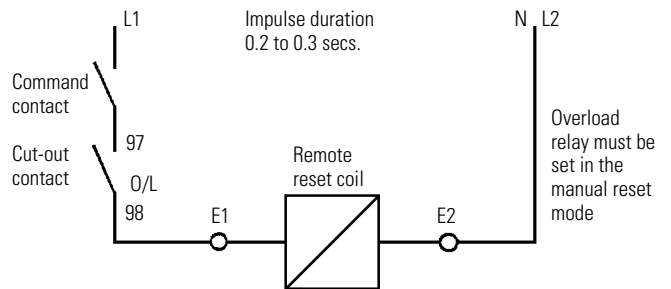

Freedom Series - 2.2 to 160kW

Technical data

Overload time/current characteristics

C316FNA3 thermal overload relay

FLC current ranges 0.25 to 32A

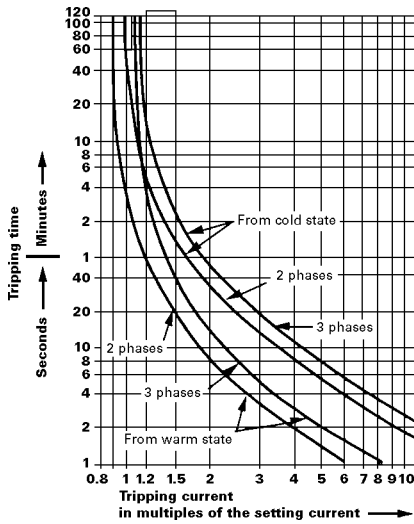

C316KNA3 thermal overload relay

FLC current ranges 18 to 80A

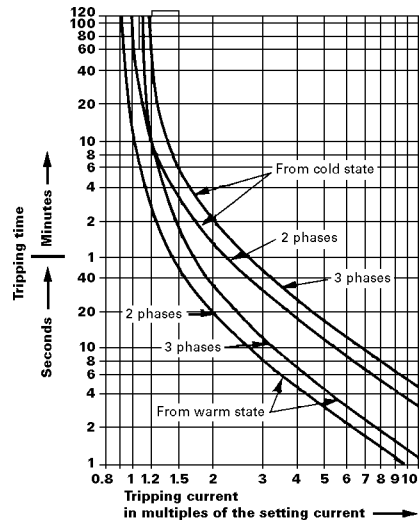

C316PNA3 thermal overload relay

FLC current ranges 100 to 200A

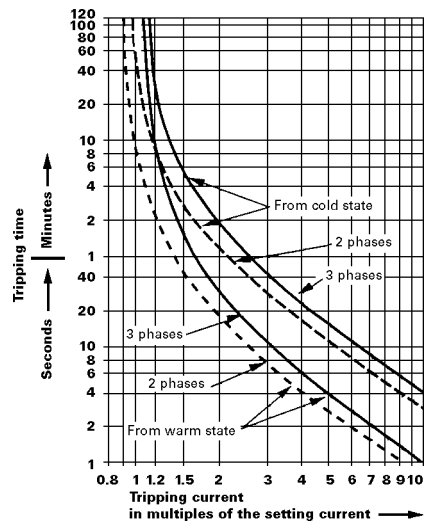

C316SNA3 thermal overload relay

FLC current ranges 130 to 400A

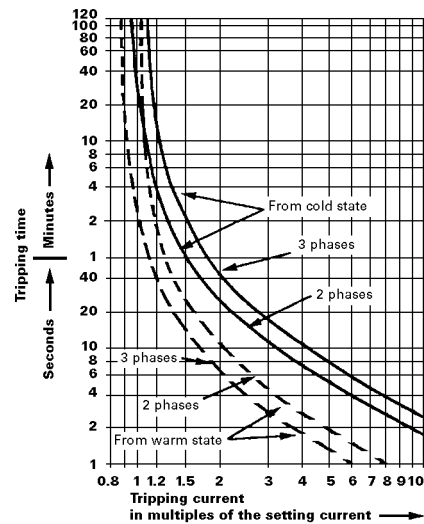



Dimensions (mm)

Contactors  
CE15AN to FN

Mechanically interlocked contactors

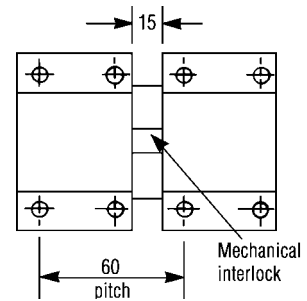
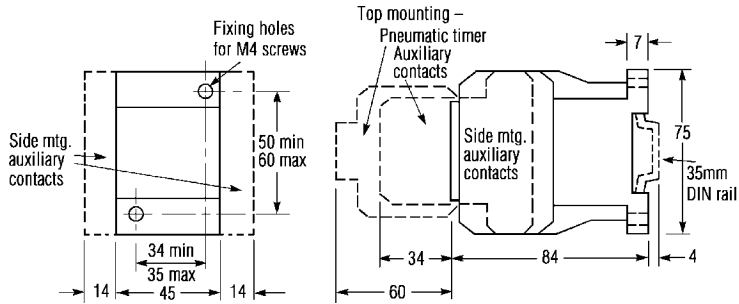

CE15AN to FN contactor + C316FNA3 thermal

C316FNA3 thermal overload relay and C306TB1 overload relay mounting adaptor

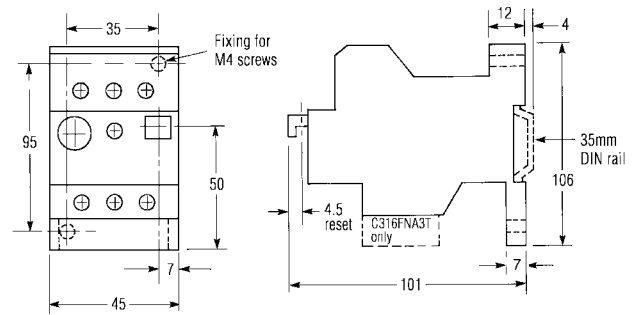
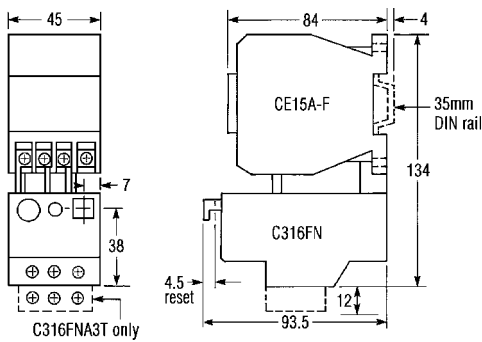

C316FNA3 thermal overload relay + C316RR1 remote reset module

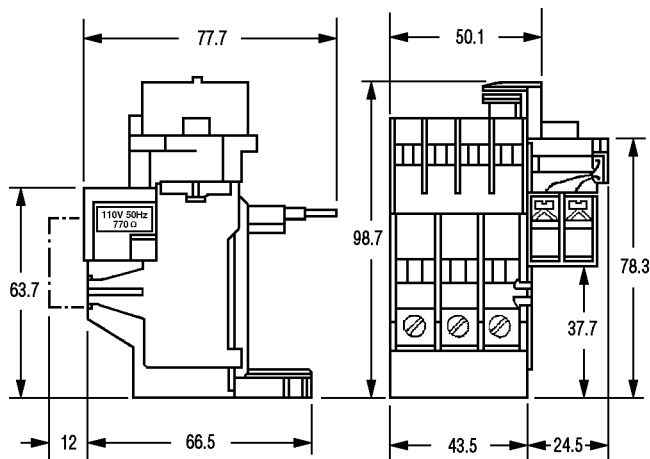

Freedom Series - 2.2 to 160kW

Dimensions mm (continued)

Contactors  
CE15GN to KN

Mechanically interlocked contactors

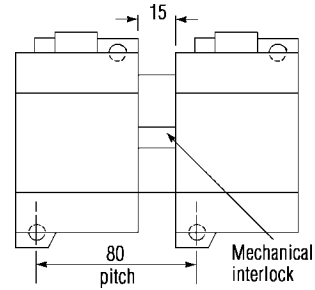
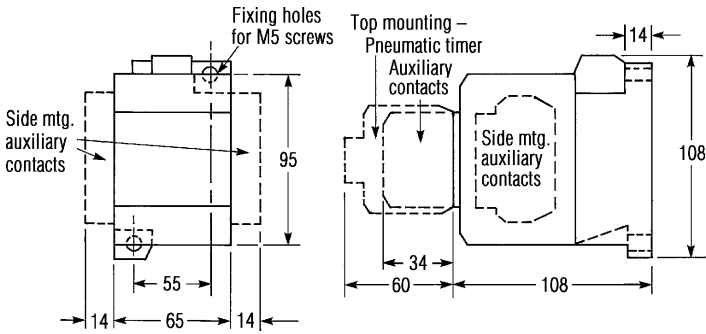

CE15GN to KN contactor + C316KNA3 thermal overload relay

C316KNA3 thermal overload relay and C316TB1 overload relay mounting adaptor

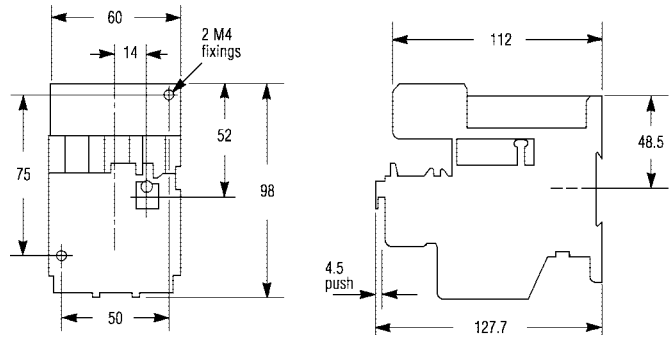
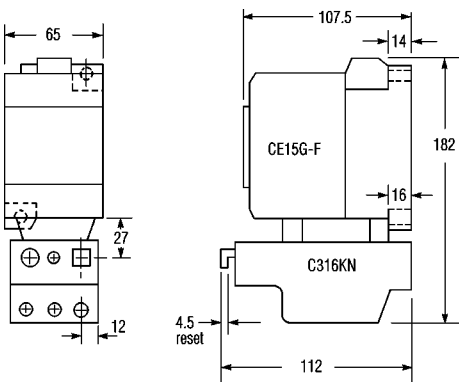

Contactors  
CE15LN to NN

Mechanically interlocked contactors

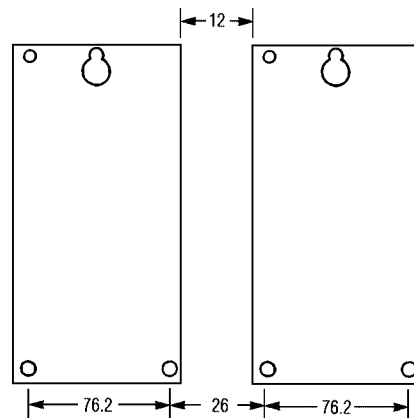
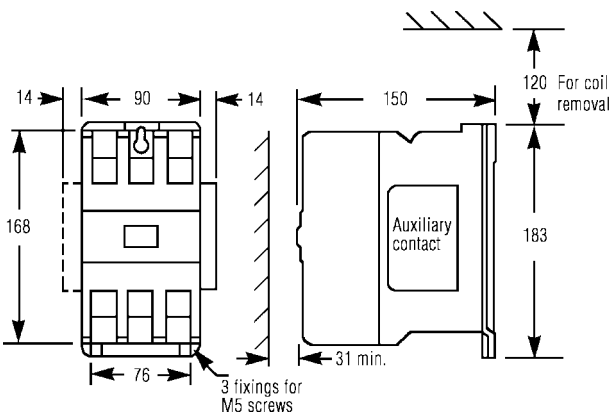

April 2005

Freedom Series - 2.2 to 160kW

Contactors  
MCE15PN to SN

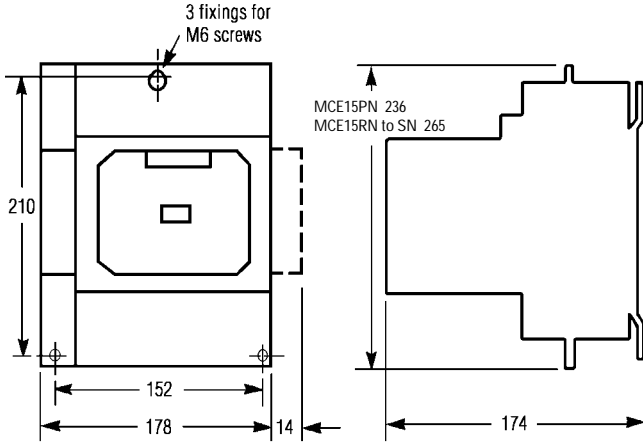

Mechanically interlocked contactors

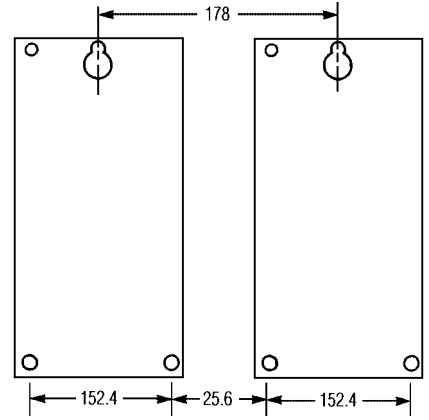

C316PNA3 thermal overload relay

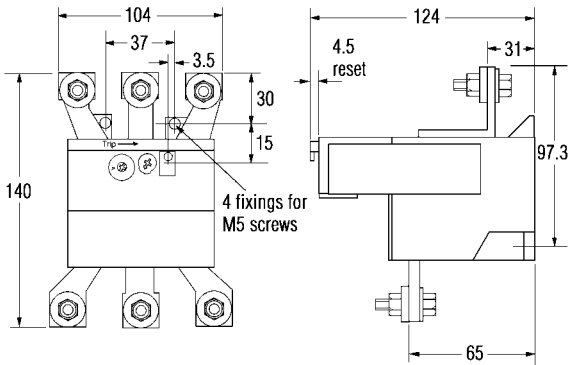

CE15LN to NN contactor + CE16PNA3 thermal overload relay  
(with links C316MCL)

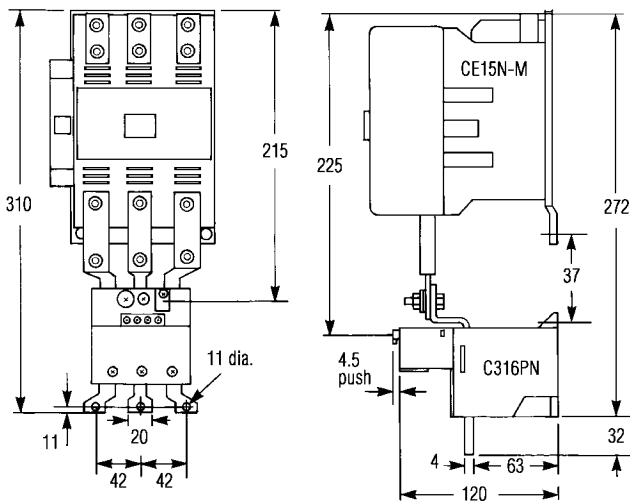

MCE15PN to SN contactor + C316PNA3 thermal overload relay  
(with links C316PCL)

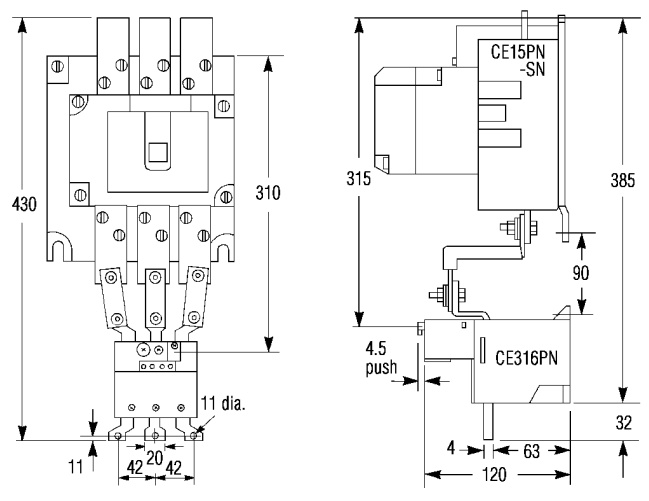

Freedom Series - 2.2 to 160kW

Dimensions mm (continued)

C316SNA3 CT operated thermal overload relay

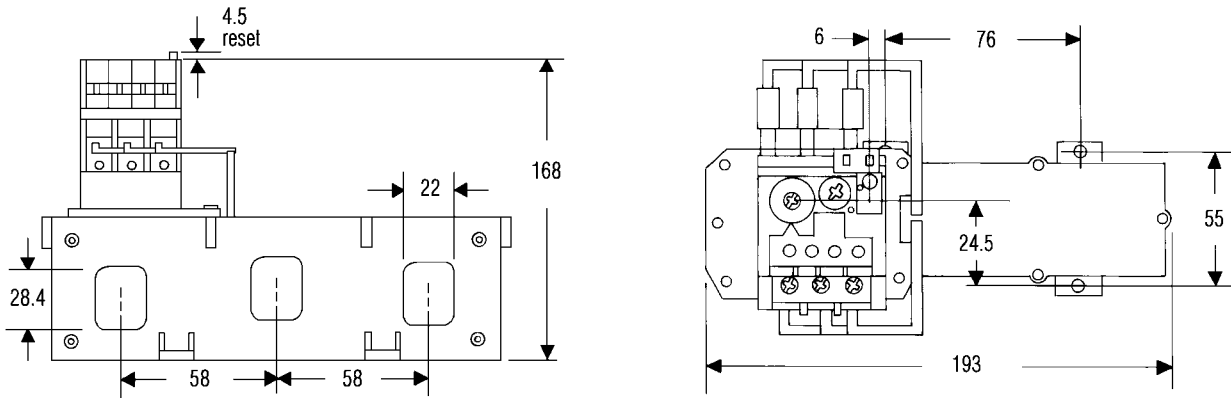

Contactor safety perimeter zones (mm)

Contactors CE15AN to FN

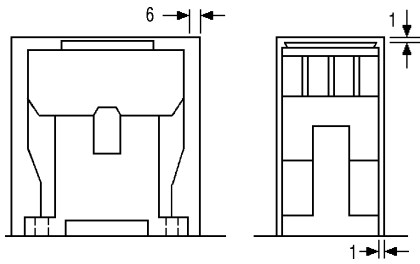

Contactors CE15LN to NN

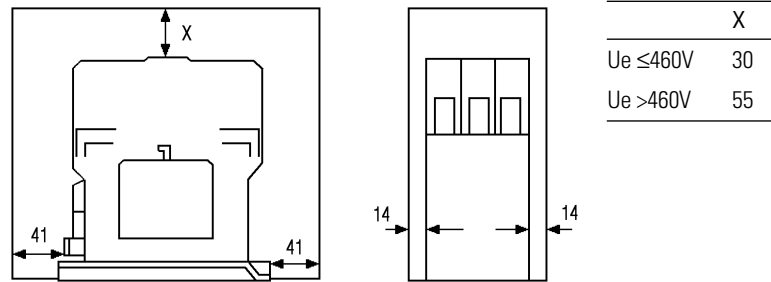

Contactors CE15GN to KN

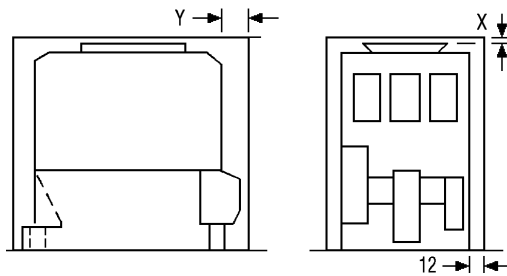

Contactors MCE15PN to SN

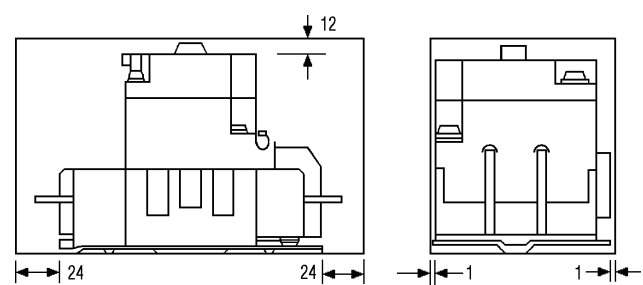

	X	Y
$U_e \leq 460V$	1.5	14
$U_e > 460V$	12	29

**Three phase 50Hz motors approx. FLC at line voltage**

This table is based on motors of approximately 1450 r.p.m. of average efficiency and power factor. Motors of higher speed than 1450 r.p.m. usually take a lower current than that shown in the table; while motors of lower speed usually take higher current.

Wide variations from these figures can arise and engineers should, whenever possible, determine the actual FLC from the motor rating plate in each case.

Motor rating		Voltage					
kW	hp	220	380	415	500	550	660
0.37	0.5	2.1	1.2	1.1	0.9	0.8	0.7
0.55	0.75	2.8	1.6	1.5	1.2	1.1	0.9
0.75	1.0	3.5	2.0	1.9	1.5	1.4	1.2
1.1	1.5	4.9	2.9	2.6	2.2	2.0	1.6
1.5	2.0	6.3	3.6	3.3	2.8	2.5	2.1
2.2	3.0	9.0	5.2	4.8	4.0	3.6	3.0
3.0	4.0	12	6.8	6.2	5.1	4.7	3.9
4.0	5.5	16	9.1	8.3	6.9	6.3	5.2
5.5	7.5	21	12	11	9.4	8.5	7.1
7.5	10	27	16	14	12	11	9.1
10	13.5	36	21	19	16	14	12
11	15	40	23	21	17	16	13
15	20	52	30	28	23	21	17
18.5	25	64	37	34	28	26	21
22	30	77	44	41	34	31	26

Motor rating		Voltage					
kW	hp	220	380	415	500	550	660
30	40	100	59	54	45	41	34
37	50	125	73	67	55	50	42
45	60	150	86	79	66	60	50
55	75	180	106	98	81	74	61
75	100	240	140	130	105	96	80
90	125	300	170	160	130	120	99
110	150	350	200	190	160	140	120
132	175	410	240	220	180	160	140
160	220	510	300	270	230	210	170
200	270	630	360	330	280	250	210
220	300	730	420	380	320	290	240
250	350	810	470	430	360	320	270

*It is important to note that these figures are average values and that actual values can vary by +20% -10% for motors up to 7.5kW and by ±10% for motors above 7.5kW.*

**Star-delta starters utilising smaller star contactor size**

Ue = 380/415V Star delta starters

Starter (kW)	Main/Delta contactor	Starter Ie line current (A)	Star contactor size	
			Without mech interlock	With mech interlock
5.5	CE15A	12	CE15A	CE15A
7.5	CE15B	16	CE15A	CE15A
11	CE15C	23	CE15B	CE15B
15	CE15D	30	CE15C	CE15C
18.5	CE15E	37	CE15D	CE15D
22	CE15F	44	CE15D	CE15D
30	CE15G	59	CE15E	CE15G
37	CE15H	73	CE15F	CE15G
45	CE15J	86	CE15G	CE15G
55	CE15K	100	CE15G	CE15G
75	CE15L	140	CE15H	CE15L
90	CE15M	170	CE15K	CE15L
110	CE15N	190	CE15L	CE15N
132	CE15N	240	CE15M	CE15N
160	MCE15R	300	CE15N	CE15N
200	MCE15R	360	CE15N	CE15N
250	MCE15S	470	MCE15P	MCE15P

Notes:

1. Main and delta contactors delta connected.
2. Star contactor life 100,00 operations or greater at normal starting duty (make 2 x Ie, break 1 x Ie).
3. Maximum starting time in the star connection 25 seconds.
4. For heavy duty starting where the star contactor breaks >1 x Ie, or where the starting time in the star connection is greater than 25 seconds, or where contactor life is insufficient, use the same size of contactor as for main and delta.

## Catalogue numbers









## Contactors

	AC1 rating (A)	Number of poles		Width (mm)	Catalogue number
		N.O.	N.C.		
	30	4	–	45	GH15BN40*
	30	2	2	45	GH15BN22*
	30	–	4	45	GH15BN04*
	40	4	–	45	GH15DN40*
	50	4	–	60	GH15FN40*
	63	4	–	60	GH15GN40*
	63	2	2	60	GH15GN22*
	63	–	4	60	GH15GN04*
	80	4	–	70	GH15HN40*
	100	4	–	70	GH15JN40*
	125	4	–	105	GH15LN40*
	125	2	2	105	GH15LN22*
	125	–	4	105	GH15LN04*
	160	3	–	150	GH33B-3-22*
	200	3	–	150	GH35B-3-22*
	250	3	–	150	GH37B-3-22*

\* Add suffix from the table to select coil operating voltage. For voltages not shown please contact Head Office.

April 2005

Contactors

	AC1 rating (A)	Number of poles*		Width (mm)	Catalogue number
		N.O.	N.C.		
	350	3	–	177	GH44-3-22*
	450	3	–	214	GH52-3-22*
	240	3	–	220	GH55-3-22*
	280	3	–	220	GH57-3-22*
	375	3	–	280	GH62-3-22*
	475	3	–	280	GH64-3-22*
	550	3	–	334	GH76-3-12*
	650	3	–	334	GH78-3-12*

\* Select add-on neutral switching pole, see page 41

## Operating coils

Contactors GH15 to GH55

Combined dual frequency AC and DC coils

Coil voltage 50/60Hz	D.C.	Suffix code
110/120	110	A
220/240	200/220	K
380/415	345/380	M
440/480	400/440	C

Contactors GH76 to 78

Dual frequency AC coils

Coil voltage 50/60Hz	Suffix code
110/120	A
220/240	K
380/415	M
440/480	C

DC coils

48	W1
120	A1
220	B1

## Accessories

Standard available control voltages

Contactor type	GH15BN GH15DN	GH15FN GH15HN GH15HN				GH15LN	GH33B GH35B GH37B			GH44		GH52		GH55 GH57	GH62 GH64	GH76 GH78	
Coil type	B01-	B02-				B021-	B31-			B9-		B7-		B51-	B61-	B8-	
Feeder group type	/	/				/	/			/		/		FG51	FG61	FG78	
	Hz	50-60	50	60	50-60(1)	50-60	50	60	50	60	50	60	50	60	50-60	50-60	50-60
AC voltage	V	24	24		24	24	24		24		24		24		24	24	
	V	48	48		48	48	48		48		48		48		48	48	
	V	110-120	110		110	110-120	110	110	110	110	110	110	110	110	110-120	110-120	110-115
	V			115				115		115		115		115			
	V	220-240	22-230		220	220-240	220-230	220	220-230	220	220-230	220	220-230	220	220-240	220-240	220-230
	V		240	240			240	240		240		240		240			240
	V	380-415	380-400		380-415	380-400	380-400	380-400	380-400	380-400	380-400	380-400	380-400	380-400	380-415	380-415	380-400
	V		415			415	415		415		415		415				
	V			440				440		440		440		440			440
	V	440-480		460				460		460		460		460	440-480	440-480	
V			480				480		480		480		480				
DC voltage	V	24	24				24	24			24		24	24	24		
	V	48	48				48	48			48		48	48	48		
	V	110	110				110	110			110		100-110	100-110	110		
	V	220	220				220	220			220		200-220	200-220	220		

EG B01-240 is a 240V coil for a GH15DN contactor

With these coils at 50Hz the consumption is increased by 25% and the mechanical durability is reduced by 50%



April 2005

Accessories Table

Description	GH15BN, GH15DN, GH15FN, GH15HN, GH15JN, GH15LN	GH33B, GH35B, GH37B	GH44	GH52	GH55	GH57	GH62 & 64	GH76 & 78
<b>Add on Aux control blocks</b>								
1no	GH15T01	-	-	-	-	-	-	-
1nc	GH15T10	-	-	-	-	-	-	-
1no-1nc	GH15T11	GH15T11-3	-	-	-	-	-	EB11
1no-1nc Add on*	-	GH15T11-3A	-	-	-	-	-	-
2no-2nc	GH15T22	-	EF22	EF22	EF22	EF22	EF22	-
3no-1nc	GH15T31	-	-	-	-	-	-	-
4no	GH15T40	-	-	-	-	-	-	-
<b>Add on neutral Switching Pole</b>								
125 (lth)	-	NP125-3	-	-	-	-	-	-
175 (lth)	-	-	NP175-4	-	-	-	-	-
250 (lth)	-	NP250-3	-	-	-	-	-	-
325 (lth)	-	-	-	NP325-5	NP325-5	NP325-5	-	-
350 (lth)	-	-	NP350-3	-	-	-	-	-
500 (lth)	-	-	-	NP500-3	NP500-5	NP500-5	NP500-6	-
760 (lth)	-	-	-	-	NP760-5	NP760-5	-	-
1000 (lth)	-	-	-	-	-	-	NP1000-6	NP1000-7
<b>Mechanical interlock</b>								
Horizontal	BMOH	BM07	BM08	BM5H	BM5H	BM5H	BM6H	BM6H
Vertical	-	-	BM09	BM5V	BM5V	BM5V	BM6V	BM7V
<b>Mechanical Latch Kit</b>								
Kit complete	-	-	AM44	AM5-52	AM5	AM5	AM6	-
<b>Three pole shrouds</b>								
shrouds	-	PR37	PR44	PR55	PR55	PR57	PR62	PR64

**Catalogue numbers - Accessories**

**Auxiliary contact blocks - top mounting (max 1 per contactor)**

Contact configuration	Catalogue numbers
1 N.O. -	C320KGT1
- 1 N.C.	C320KGT2
1 N.O. 1 N.C.	C320KGT3
2 N.O. -	C320KGT4
- 2 N.C.	C320KGT5
2 N.O. 2 N.C.	C320KGT15
3 N.O. 1 N.C.	C320KGT14
4 N.O. -	C320KGT13



**Pneumatic timer - top mounting**

Description	Catalogue numbers
Adjustable range (On or off delay)	
0.3 to 30 secs.	C320TP1
10 to 180 secs.	C320TP2



Note: When timer is used, other top mounting auxiliaries cannot be added.

**A.C. Operating coil**

Coil voltage	50Hz	24	48	110	220	240	380	415	440	550
	60Hz	-	-	120	240	-	-	-	480	600
Suffix code	U	Y	A	B	K	L	M	C	D	

## Technical data

Contactor	GH15BN	GH15DN	GH15FN	GH15HN	GH15JN
<b>General</b>					
kW AC3 rating 400V	4	7.5	15	22	30
Standards and approvals	IEC 60947-4-1	IEC 60947-4-1	IEC 60947-4-1	IEC 60947-4-1	IEC 60947-4-1
Width mm	45	45	60	79	
Number of poles (maximum)	4	4	4	4	4
Add on 4th pole	N/A	N/A	N/A	N/A	N/A
Protection against direct contact	IP20-IP10*	IP20-IP10*	IP20-IP10*	IP20-IP10*	IP20-IP10*
Mechanical lifespan	1,000,000	1,000,000	1,000,000	1,000,000	1,000,000
Weight kg	0.4	0.4	0.9	1.28	1.28
<b>Environment</b>					
Pollution degree	3	3	3	3	3
Operating temperature	-25 to +55°C	-25 to +55°C	-25 to +55°C	-25 to +55°C	-25 to +55°C
Relative humidity at 40°C	92%	92%	92%	92%	92%
Operating altitude	2000m	2000m	2000m	2000m	2000m
Operating position (relative to normal mounting position)	90°	90°	90°	90°	90°
<b>Main contact ratings</b>					
Insulating voltage	690V	690V	690V	690V	690V
Operating frequency limits Per Hour	3000	3000	3000	3000	3000
Rated thermal current Ith	30	40	50	80	100
<b>AC1 Watts</b>					
230V	12	15	20	31	39
240V	12	16	20	33	41
400V	20	27	34	55	69
415V	21	28	235	57	71
440V	22	30	38	60	76
500V	25	34	43	69	86
690V	35	47	59	95	119
<b>AC2/3 Watts</b>					
230V	2.2	4	7.5	12.5	18.5
240V	2.2	4	7.5	15	18.5
400V	4	7.5	15	22	30
415V	4.3	8	15	22	30
440V	4.7	9	16.5	25	33
500V	5.5	10	15	22	30
690V	5.5	7.5	15	22	30
<b>AC2/3 IE</b>					
440V	9	16	32	50	63
500V	9	16	24	38	45
690V	7	9	18	26	34
<b>AC4 Watts</b>					
230V	0.9	1.6	3	5.5	7.5
240V	1.5	3	5.5	11	15
400V	1.5	3	5.5	11	15
415V	1.5	3	5.5	11	15
440V	1.5	3	5.5	11	15
500V	1.5	3	5.5	11	15
<b>AC4 IE</b>					
440V	4	7	12	23	30

April 2005

**Technical data**

Contactor	GH15LN	GH33B	GH35B	GH37B	GH44	GH52
<b>General</b>						
kW AC3 rating 400V	45	55	75	90	110	160
Standards and approvals	IEC 60947-4-1	IEC 60947-4-1	IEC 60947-4-1	IEC 60947-4-1	IEC 60947-4-1	IEC 60947-4-1
Width mm	105	168	168	168	223	223
Number of poles (maximum)	4	3*	3*	3*	3*	3*
Add on 4th pole	N/A	NP125-3/NP250-3	NP125-3/NP250-3	NP125-3/NP250-3	NP175-4/NP350-4	NP325-5/NP500-5
Protection against direct contact	IP20-IP10*	IP00	IP00	IP00	IP00	IP00
Mechanical lifespan	1,000,000	1,000,000	1,000,000	1,000,000	800,000	500,000
Weight kg	2.2	5	5	5	7.3	12.8
<b>Environment</b>						
Pollution degree	3	3	3	3	3	3
Operating temperature	-25 to +55°C	-25 to +55°C	-25 to +55°C	-25 to +55°C	-25 to +55°C	-25 to +55°C
Relative humidity at 40°C	92%	92%	92%	92%	92%	92%
Operating altitude	2000m	2000m	2000m	2000m	2000m	2000m
Operating position (relative to normal mounting position)	90°	90°	90°	25°	25°	25°
<b>Main contact ratings</b>						
Insulating voltage	690V	690V	690V	690V	690V	690V
Operating frequency limits Per Hour	3000	3000	3000	3000	3000	3000
Rated thermal current Ith	125	160	200	250	350	400
<b>AC1 Watts</b>						
230V	49	63	79	99	139	179
240V	51	66	83	103	145	187
400V	86	110	138	173	242	311
415V	89	115	143	179	251	323
440V	95	121	152	190	266	342
500V	108	138	173	216	303	389
690V	149	191	239	298	418	537
<b>AC2/3 Watts</b>						
230V	25	33	40	50	60	90
240V	25	33	45	55	65	100
400V	45	55	75	90	110	160
415V	47	59	80	95	115	180
440V	51	63	85	100	125	190
500V	51	55	75	100	132	210
690V	51	55	75	110	132	210
<b>AC2/3 IE</b>						
440V	95	115	150	175	210	315
500V	80	85	110	145	210	315
690V	60	70	85	120	150	240
<b>AC4 Watts</b>						
230V	11	12	15	18.5	25	37
240V	18.5	22	25	30	45	63
400V	18.5	22	25	33	45	65
415V	22	25	30	34	48	67
440V	22	22	25	30	55	75
500V	22	22	25	30	55	75
<b>AC4 IE</b>						
440V	40	45	55	63		120

## Technical data (continued)

## Electrical and Mechanical Ratings for Contactors to IEC 60947-1

Operating conditions:

Cooling air temperature surrounding contactor = -20°C to +55°C

Maximum altitude = 2000m.

A.C. ratings are 3 phase 50–60Hz for main contacts.

Contactor			GH55		GH57		GH62	
Insulation voltage $U_i$			1000		1000		1000	
Thermal current (I <sub>th</sub> open)			600		760		1000	
			kW		kW		kW	
AC1 (2)	Non-inductive or slightly inductive loads P.F. = 0.95	220/240V	185		230		306	
		380V	315		400		527	
	Ratings are for open contactors at ambient temperatures ≤ 55°C	415/440V	365		465		612	
		500/550V	420		530		697	
		660V	550		730		918	
		1000V	835		1060		1360	
			kW	leA	kW	leA	kW	leA
AC2	Slipping motors starting and plugging	220/240V	129	450	160	550	220	700
		380V	220	450	280	550	375	700
AC3	Squirrel cage motors starting and F.L.C. breaking	415/440V	240	450	315	550	400	700
		500/550V	300	420	375	520	500	630
		660V	335	350	450	450	600	630
		1000V	280	170	355	260	500	350
AC4	Squirrel cage motor starting, inching, plugging. Stopping during run up	220/240V	45	180	51	200	68	220
		380V	75	180	90	200	120	220
		415/440V	80	180	100	200	132	220
		500/550V	100	140	110	145	150	150
		660V	100	140	110	145	150	150
Maximum number of operations per hour at above ratings AC2/AC3 – AC4 duty			300 – 100		300 – 100		300 – 100	
Other ratings			kW	IL	kW	IL	kW	IL
Star delta starter (Delta loop connected)	220V		220	700	270	900	300	1100
	380V		335	700	450	900	600	1100
	415/440V		400	700	500	900	650	1100
	500/550V		400	650	500	800	700	900
	660V		450	550	600	650	800	850
Rotor contactors (Delta connected)	Intermediate (1)	A	1000		1300		1600	
	Final	A	700		900		1100	
Transformer primary switching	440V	A	180		220		300	
Tungsten or infra-red lamps	250V	A	260		315		440	
Mercury vapour lamps	440V	A	400		500		650	
Non-compensated fluorescent lamps 440V		A	360		450		570	
Compensated fluorescent and sodium vapour lamps 440V		A	300		360		460	
Capacitor switching (Single bank only)	380V 3ph	kVAr	200		250		350	
General data	Average operating times (AC coil)	Pick up	ms	100		100		105
		Drop out	ms	170		170		200
	AC coil consumption	Pick up – Seal	VA	950 – 11		950 - 11		1600 - 25
Seal		Watts	10		10		22	
Mechanical endurance	Millions of operations		5		5		5	

(1) Ratings apply when intermediate contactors are shorted out by final contactor and have an on-load time ≤ 15 secs.

(2) When contactors are operated continuously at maximum AC1 ratings excessive terminal temperature rises can occur due to oxidation of terminals and/or contamination of contacts. It is recommended that plated or oxidation protected external connections are used.

Note: leA figures given are contactor maximum amperes.

April 2005

GH64		GH76		GH78	
1000		660		660	
1100		1200		1350	
kW		kW		kW	
335		365		415	
580		635		715	
670		735		830	
765		835		945	
1000		1100		1245	
1525		-		-	
kW	leA	kW	leA	kW	leA
270	860	320	1000	380	1200
475	860	550	1000	650	1200
500	860	600	1000	700	1200
600	760	720	1000	840	1200
650	680	930	1000	1120	1200
550	380	-	-	-	-
80	240	110	370	132	400
150	240	185	370	220	400
160	240	200	370	230	400
180	160	240	300	250	350
180	160	240	250	275	285
300 – 100		120 – 30		120 – 30	
kW	IL	kW	IL	kW	IL
400	1300	450	1500	-	-
700	1300	850	1500	950	-
750	1300	900	1500	-	-
850	1000	1000	1100	1100	-
900	1000	1200	1100	1400	-
2000		2500		3000	
1300		1500		1700	
350		400		500	
500		560		630	
800		950		1100	
700		850		1000	
500		660		800	
400		450		500	
105		70		70	
200		50		50	
1600 – 25		2450 – 75		2450 – 75	
22		60		60	
5		1		1	

## Technical data (continued)

Auxiliary	GH15T01	GH15T10	GH15T11	GH15T22	GH15T31	GH15T40	C320TP1
Type	Top mount Aux	Top mount Aux	Top mount Aux	Top mount Aux	Top mount Aux	Top mount Aux	Top mount Aux
Contacts	1 N/C	1 N/O	1 N/O – 1 N/C	2 N/O – 2 N/C	3 N/O – 1 N/C	4 N/O	1 N/O – 1 N/C
Time delay	-	-	-	-	-	-	0.3 – 30SEC
Weight kg	0.011	0.011	0.05	0.05	0.05	0.05	0.08
Ui	690	690	690	690	690	690	690
ith A	10	10	10	10	10	10	10
Short time withstand	500ms 60A	500ms 60A	500ms 60A	500ms 60A	500ms 60A	500ms 60A	500ms 60A
Protection fuse	10 A gG	10 A gG	10 A gG	10 A gG	10 A gG	10 A gG	10 A gG
AC15							
120V	6	6	6	6	6	6	4
240V	3	3	3	3	3	3	2.5
400V	2	2	2	2	2	2	2
500V	1.5	1.5	1.5	1.5	1.5	1.5	1.5
690V	1	1	1	1	1	1	1
DC13							
24V	5	5	5	5	5	5	-
48V	2	2	2	2	2	2	-
110V	0.8	0.8	0.8	0.8	0.8	0.8	0.6
220V	0.4	0.4	0.4	0.4	0.4	0.4	0.3
Auxiliary	C320TP2	GH15S11	GH15S11-3	GH15S11-3A*	EF22	EB11	
Type	Side mount Aux	Side mount Aux	Side mount Aux	Side mount Aux	Side mount Aux		
Contacts	1 N/O – 1 N/C	1 N/O – 1 N/C	1 N/O – 1 N/C	1 N/O – 1 N/C	2 N/O – 2 N/C	1 N/O – 1 N/C	
Time delay	10-180 SEC	-	-	-	-	-	
Weight kg	0.08	0.05	0.08	0.08	0.12	0.17	
Ui	690	690	690	690	690	690	
ith A	10	10	10	10	16	16	
Short time withstand	500ms 60A	500ms 60A	500ms 60A	500ms 60A	500ms 60A	500ms 60A	
Protection fuse	10 A gG	10 A gG	10 A gG	10 A gG	10 A gG	10 A gG	
AC15							
120V	4	6	6	6	6	6	
240V	2.5	3	3	3	3	3	
400V	2	2	2	2	2	2	
500V	1.5	1.5	1.5	1.5	1.5	1.5	
690V	1	1	1	1	1	1	
DC13							
24V	-	4	4	4	6	6	
48V	1	1.5	1.5	1.5	3	3	
110V	0.6	0.5	0.5	0.5	1	1	
220V	0.3	0.2	0.2	0.2	0.5	0.5	

April 2005

**Dimensions (mm)**

Sizes GH15BN & DN

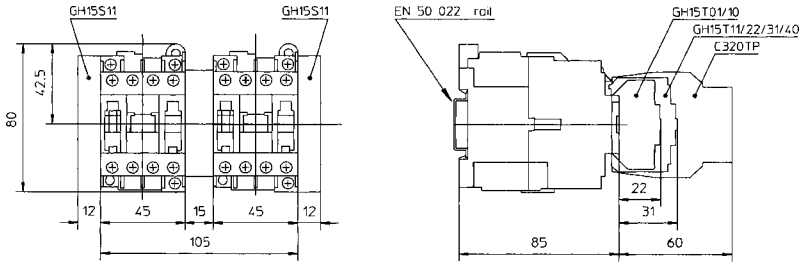

Sizes GH15GN, HN & JN

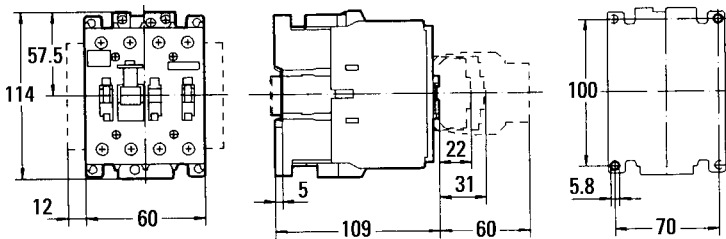

Four-pole contactors - AC coil

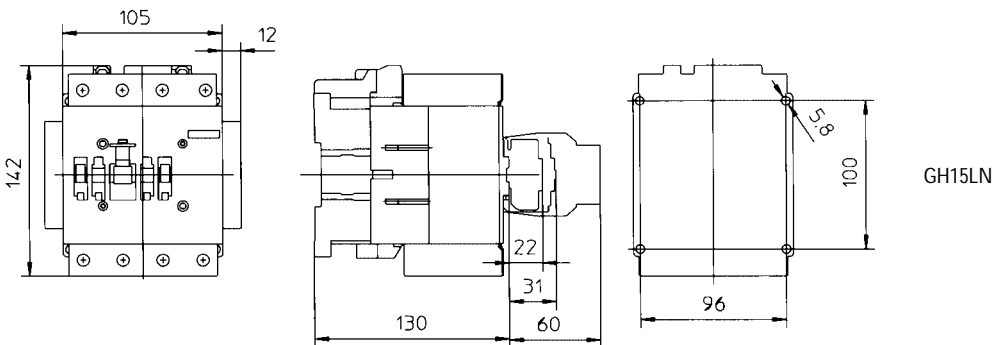
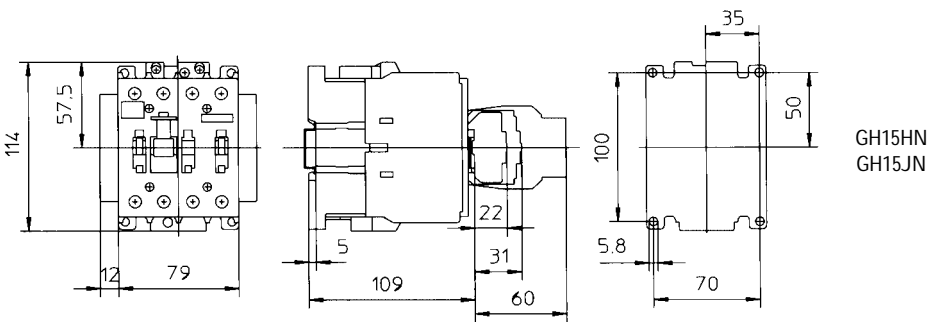
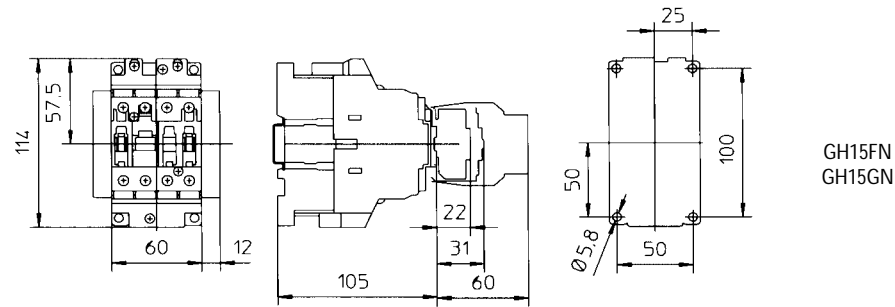

Three-pole contactors - AC coil

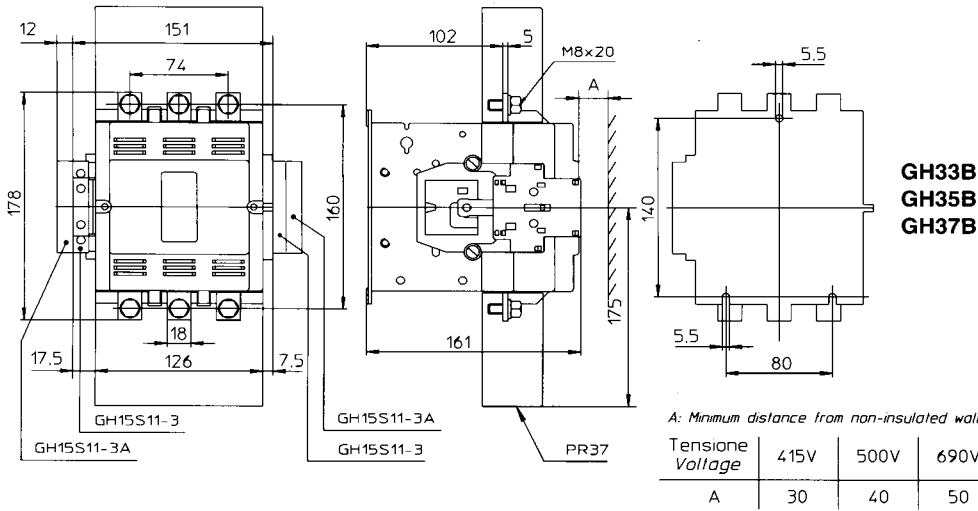

DC coil

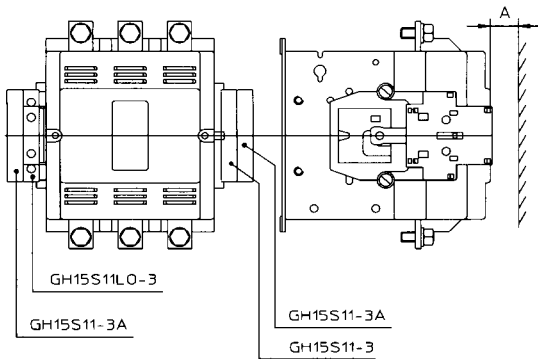

Three/Four-pole Contactors - AC coil

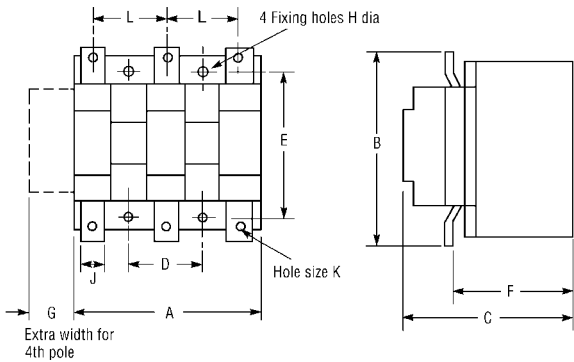

Contactor	Dimension											Mechanical intlk. mounting matrix		Weight (kg)
	A	B	C	D	E	F	G	H	J	K	L	Horiz	Vert	
GH55	220	233	225	110	220	160	72	8	30	10.5	80	262	314	13
GH57	220	258	225	110	220	160	72	8	40	12.5	80	262	314	13.5
GH62	280	307	291	175	280	200	90	10	50	13	100	312	380	26
GH64	280	361	291	175	280	200	90	10	50	15	100	312	380	28
GH76	334	490	345	120	380	220	111	12	50	17 x 2	100	380	580	49
GH78	334	490	345	120	380	220	111	12	60	17 x 2	100	380	580	53



April 2005

Overload Relays

**Catalogue numbers**

For direct connection with CE15AN to FN contactors or independent mounting

Description	Motor FLC range A	Catalogue numbers
Relay with 1 N.O. – 1 N.C. electrically separate contacts, selectable hand or auto reset with reset or stop-reset option, phase loss protection and trip indicator.	0.25 – 0.4	C316FNA3C
	0.4 – 0.63	C316FNA3D
	0.63 – 1.0	C316FNA3E
	1.0 – 1.4	C316FNA3F
	1.3 – 1.8	C316FNA3G
	1.7 – 2.4	C316FNA3H
	2.2 – 3.1	C316FNA3J
	2.8 – 4.0	C316FNA3K
	3.5 – 5.0	C316FNA3L
	4.5 – 6.5	C316FNA3M
	6.0 – 8.5	C316FNA3N
	7.5 – 11.0	C316FNA3P
	10 – 14.0	C316FNA3Q
	13 – 19.0	C316FNA3R
	18 – 24.0	C316FNA3S
24 – 32.0	C316FNA3T	



Separate base for independent connection and DIN rail or panel mounting



C306TB1

Thermal overload relays for independent mounting and connection with GH33 & GH37 contactors.<sup>①</sup>



65 – 90	C316PNA3A
80 – 110	C316PNA3B
100 – 135	C316PNA3C
110 – 150	C316PNA3D
130 – 175	C316PNA3E
150 – 200	C316PNA3F

Thermal overload relays, current transformer operated, for independent connection with GH44 contactors.<sup>①</sup>



130 – 185	C316SNA3A
165 – 235	C316SNA3B
220 – 310	C316SNA3C
285 – 400	C316SNA3D

Identification marker (pack of 50)

C316MT1

Thermal overload relays, current transformer operated, for independent connection to GH55 to 78 contactors.<sup>①</sup>



355 – 500	C316UNA3A
465 – 650	C316UNA3B
610 – 850	C316UNA3C

**Remote reset module**

Description	Operating voltage 50/60HZ	Catalogue number
For use with thermal overload relays C316SNA3 and C316UNA3	220/440	C316RR1N



<sup>①</sup> Relay with 1N.O. – 1N.C. electrically separate contacts, selectable hand or auto reset with reset or stop-reset option, phase loss protection and trip indicator.

Overload Relays

Technical data

Electrical life

The two graphs below show average contact life for AC3 and AC4 duties respectively.

To obtain the contact life for duties which include a proportion of both AC3 and AC4 operations the following may be used.

$$\text{Contact life} = \frac{N.P}{Z.N. + S.P}$$

where N = AC3 life Z = % AC4 operations  
P = AC4 life S = % AC3 operations

Select AC3 and AC4 life for operational current required from graphs below. Estimate number of AC4 operations in percent and calculate from above equation.

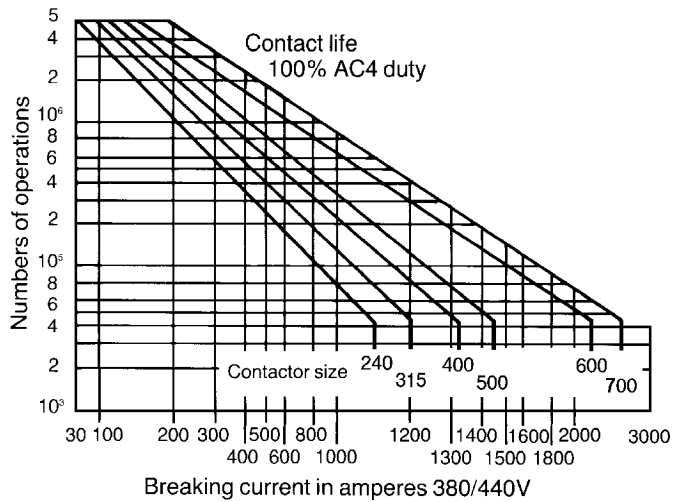
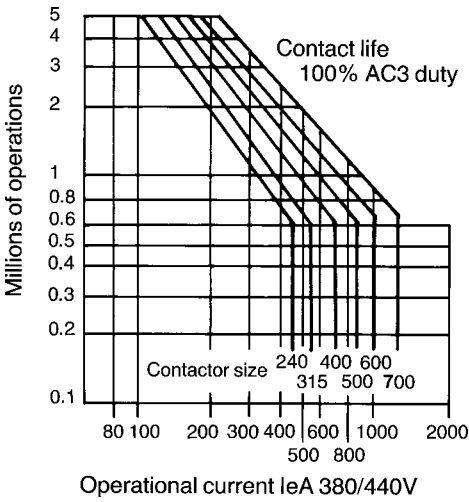

Auxiliary contacts

Specifications

IEC337-1, BS4774-1

Maximum number

4 N.O. - 4 N.C.

Thermal rating

25A

Contact ratings AC11

Rated operational voltage UeV	Rated operational current IeA
120	14
240	7
440	4
600	2

Contact rating DC11

Rated operational voltage dc	Rated operational current IeA
24	18
48	15
110	7
220	4

Terminal capacity

Solid or stranded: 2 x 4mm<sup>2</sup>

Terminal markings



April 2005

## Overload Relays

## Technical data

Overload relays	C316PNA3	C316SNA3	C316UNA3
<b>General</b>			
Thermal current I <sub>th</sub>	Up to 200A CT operated	Up to 400A CT operated	Up to 850A
Standards and approvals	IEC 947-4-1, IEC 292-1, BS4941, VDE0660, UL 508, CSA C22-14, NFC 63-650		
Trip class IEC947-4-1	10A	30	30
Terminal marking	EN50005 (BS5472)		
Width (mm)	80*	193	246
	* Width across terminals is greater, <100A = 85mm, >100A = 105mm		
Protection against direct contact	Protected against unintentional contact in accordance with VDE0106 pt 100		
Weight (kg)	0.91	1.5	3
<b>Environment</b>			
Pollution degree IEC947-1	3	3	3
Impulse withstand voltage IEC947-4-1	6kV	6kV	6kV
Operating temperature, open	-25 to +55°C	-25 to +55°C	-25 to +55°C
Temperature compensation range	-25 to +50°C	-25 to +50°C	-25 to +50°C
Maximum altitude	2000m	2000m	2000m
Operating position (relative to normal position)	±30°	±30°	±30°
Climatic conditions	Damp heat constant to IEC68-2-3. Damp heat, cyclic to IEC68-2-30		
Mechanical shock resistance	12g for 15ms	12g for 15ms	12g for 15ms
Vibration	@ 45Hz 8g (1mm displacement with N.C. contacts maintained)		
Storage temperature	-40 to +70°C	-40 to +70°C	-40 to +70°C
<b>Main contacts</b>			
Insulation voltage U <sub>i</sub>	690V	690V	690V
Current range	100 – 200A	130 – 400A	265 – 850A
Power dissipated at minimum setting	5.8W	2.2W	2.2W
at maximum setting	7.3W	3.3W	3.3W
Max operating frequency of motor (starts per hour)	15 (dependent upon starting time and current)		
Short circuit co-ordination	Type 2 to IEC947-4-1		
Rated conditional short circuit current	50kA	50kA	50kA
Fuse type	See table on page 46		
<b>Cabling capacity in accordance with the requirements of IEC947-1</b>			
Cabling capacity using compression lugs (mm <sup>2</sup> )	25 to 120	–	–
Terminal flag bolt size - <100A	M6	–	–
- >100A	M10	–	–
CT aperture size (mm)	–	22 x 28	45 x 22

## Overload Relays

## Technical data (continued)

	Auxiliary contacts N.C. (95 - 96)		N.O. (97 - 98)		Remote reset module
<b>General</b>					
Protection against direct contact	IP20 to IEC529		IP20 to IEC529		
Mechanical life span	50,000		50,000		
<b>Contact ratings</b>					
Thermal current I <sub>th</sub>	10A		6A		
Insulation voltage U <sub>i</sub>	500V		500V		
Operating frequency limits	50/60Hz		50/60Hz		
Adjacent contacts 'electrically separate'	Yes		Yes		
<b>AC15 duty</b>					
Control of A.C. electromagnetic loads (Greater than 72VA)	U <sub>e</sub>	VA	I <sub>e</sub>	VA	I <sub>e</sub>
	120	360	3	204	1.7
	240	720	3	408	1.7
	415	830	2	539	1.3
	500	750	1.5	500	1
<b>DC13 duty</b>					
Control of D.C. electromagnets	U <sub>e</sub>	W	I <sub>e</sub>	W	I <sub>e</sub>
	220	110	0.5	110	0.5
<b>Short circuit coordination</b>					
Conditional short circuit current I <sub>q</sub>	1kA		1kA		
Fuse type BS88 type gG	10A		6A		
Circuit breaker type	To be announced		To be announced		
<b>Cabling capacity in accordance with the requirements of IEC947-1</b>					
Number of conductors	2		2		
Solid or stranded - Max. wire size (mm <sup>2</sup> )	4		4		
- Min. wire size (mm <sup>2</sup> )	0.75		0.75		
Flexible - Max. wire size (mm <sup>2</sup> )	2.5		2.5		
- Min. wire size (mm <sup>2</sup> )	0.75		0.75		

## Standard features

3 pole adjustable overload relay or current transformer operated relay for heavy starting duty.

Auxiliary contacts make & break (separate).

For fitting directly on to contactor, or for separate mounting.

Temperature compensated.

Clearly marked setting scale

Facilitates accurate setting, even for intermediate values.

Setting lever for hand or auto reset  
Supplied set to "Man" (with hand reset)

**Manual**

After tripping, reset button must be operated.  
Normally associated with two-wire controls for safety reasons and to prevent "pumping".

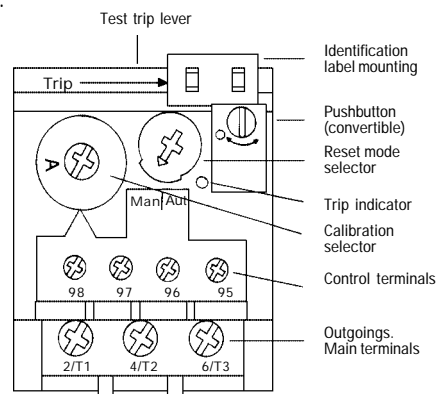
**Auto**

Automatic reset after tripping. Normally associated with three-wire controls.

**Reset button (internal reset)**

To reset after tripping when reset is set to "Man".  
If fault still exists, trips free even if reset button is held down.

**Test lever**

To simulate tripping of overload relay.

**Off button**

To de-energise self maintaining contactors.

**Current transformer operated overload relay**  
The specified primary rated current applies to one cable loop (C316UNA3\*). For lower rated motor currents loop cable several times.

**Technical data (continued)**

**Recommended fuse sizes for type 2 co-ordination**

Catalogue	Motor full load current number range (A)	BS88 gG/gM (A)	DIN type gL/gI (A)	DIN type aM (A)
C316PNA3A	65 – 90	200	200	160
C316PNA3B	80 – 100	200	224	200
C316PNA3C	100 – 135	200	224	200
C316PNA3D	110 – 150	250	250	224
C316PNA3E	130 – 175	315	315	250
C316PNA3F	150 – 200	315	315	250
C316SNA3A	130 – 185	355	355	–
C316SNA3B	165 – 235	450	400	–
C316SNA3C	220 – 310	630	500	–
C316SNA3D	285 – 400	750	630	–
C316UNA3A	265 – 375	500	800	–
C316UNA3B	355 – 500	750	1000	–
C316UNA3C	465 – 650	1000	1250	–
C316UNA3D	610 – 850	1250	1250	–

**Overload time/ Current characteristics**

**C316PNA3 thermal overload relay**  
FLC current ranges 100 to 200A

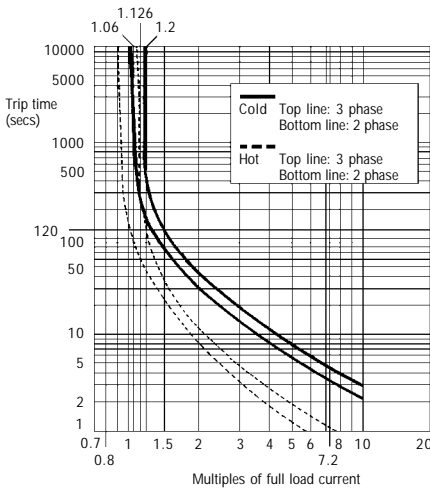

**C316SNA3 thermal overload relay**  
FLC current ranges 130 to 400A

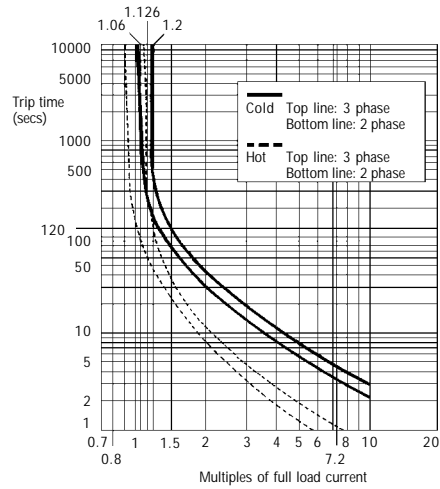

**C316UNA3 thermal overload relay**  
FLC current ranges 265 to 850A

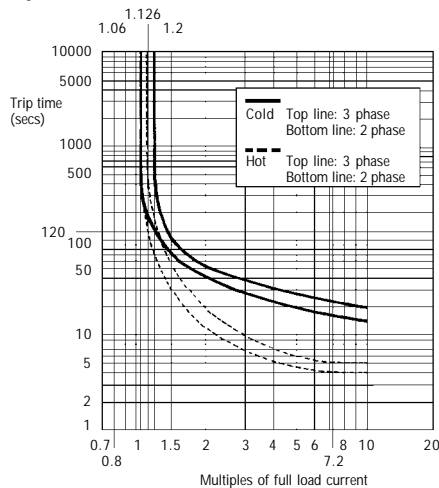

Overload Relays

Technical data (continued)

C316UNA3 thermal overload relays

Approvals and standards

IEC947-4 class 10A relay with single phase detection

IEC337, BS4941, VDE0660, CSA, UL

Electrical ratings

Insulation voltage  $U_i$ : 660 Volts AC

Climatic conditions

Maximum altitude: 2000 metres

Ambient temperature compensation range:  $-25^{\circ}\text{C}$  to  $+55^{\circ}\text{C}$

Storage temperature range:  $-40^{\circ}\text{C}$  to  $+70^{\circ}\text{C}$

Relative humidity: 95% RH at  $40^{\circ}\text{C}$  DIN50017

Control contact ratings

1N.O. – 1N.C. electrically separate

Rating	N.C. 95-96	N.O. 97-98
Thermal current $I_{th}$	10A	6A
Rated operational current $I_e$ at AC15	220V 3A	1.7A
	380V 2A	1.3A
	500V 1.5A	1A
Maximum fuse size	10A	6A

Co-ordination with short circuit protection devices

Catalogue number	Ratings of fuses for type 2 coordination	
	BS88 class Q1	VDE0660 gl
C316UNA3A	450A	500A
C316UNA3B	630A	800A
C316UNA3C	710A	1000A
C316UNA3A	1000A	1250A

Typical trip characteristics

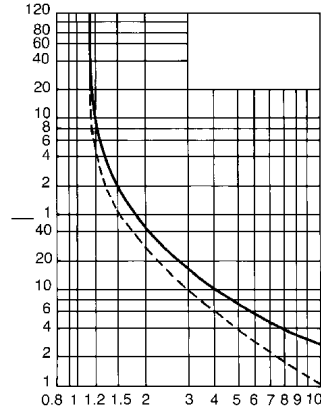

Reset function

Selectable: Automatic, manual or manual/stop

Reset time

<5 minutes

Terminal capacities

Terminals nos. 95 to 98: 2 x 2.5 or 2 x 4

Terminal markings

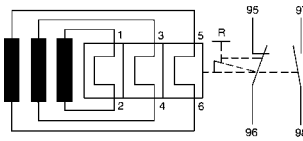

Dimensions (mm)

Thermal overload relay

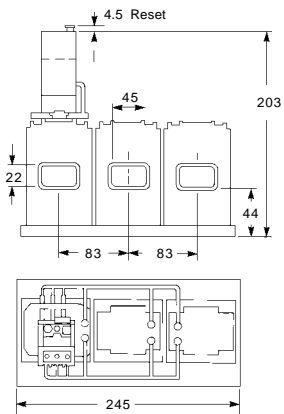

Eaton's Electrical business is a global leader in electrical control, power distribution, and industrial automation products and services. Through advanced product development, world-class manufacturing methods, and global engineering services and support, Eaton's Electrical business provides customer-driven solutions under brand names such as Cutler-Hammer®, Durant®, Heinemann®, Holec® and MEM®, which globally serve the changing needs of the industrial, utility, light commercial, residential, and OEM markets. For more information, visit [www.EatonElectrical.com](http://www.EatonElectrical.com).

Eaton Corporation is a diversified industrial manufacturer with 2004 sales of \$9.8 billion. Eaton is a global leader in fluid power systems and services for industrial, mobile and aircraft equipment; electrical systems and components for power quality, distribution and control; automotive engine air management systems and powertrain controls for fuel economy; and intelligent drivetrain systems for fuel economy and safety in trucks. Eaton has 55,000 employees and sells products to customers in more than 125 countries. For more information, visit [www.eaton.com](http://www.eaton.com).

Eaton Electric Limited  
Reddings Lane  
Birmingham B11 3EZ  
United Kingdom  
  
Customer Support Centre  
Tel: +44 (0)8700 545 333  
Fax: +44 (0)8700 540 333  
email: [ukcommorders@eaton.com](mailto:ukcommorders@eaton.com)

Eaton Electric NV  
PO Box 23  
7550 AA Hengelo  
The Netherlands  
  
Customer Support Centre  
Tel: +31 (0)74 246 7066  
Fax: +31 (0)74 246 7070  
email: [c-heuropesupport@eaton.com](mailto:c-heuropesupport@eaton.com)

