



**Pushbuttons, Indicating lights,  
Selector switches and Stacklights**

Product Guide

- E22 Series
- 9100T Series
- E26 Series



**Innovative  
Solutions  
for Control  
and Indication**

# Contents

---

## 22.5mm operators – E22 Series

<b>Description</b>	<b>Page</b>	<b>Description</b>	<b>Page</b>
Pushbutton operators non-illuminating	4	Double-headed pushbutton operators suitable for illuminating	10
Double-headed pushbutton operators	4	Press to test light source units	10
Contact blocks	4	Key selector switches	11
Mushroom operators - Latched	5	Knob & lever selector switches non illuminating	12
Mushroom operators - Spring return	5	Knob & lever selector switches suitable for illuminating	13
Mushroom operators - Trigger action	5	Cam & contact block selection charts for selector switches	14
Push-Pull operators non-illuminating	6	Complete rotary cam selector switches	16
Push-Pull operators suitable for illuminating	6	Ammeter & voltmeter rotary cam selector switches	19
Light source units - push-pull operators	7	Legend plates	20
Indicating lights	8	Accessories	21
Light source units for indicating lights and illuminated pushbuttons	8	Enclosures - Polycarbonate	24
Bulbs	8	Enclosures - die cast aluminium	25
Direct voltage indicating lights	9	Assembled stations	26
Pushbutton operators suitable for illuminating	10	Technical data	27

---

## 30.5mm operators – 9100T Series

<b>Description</b>	<b>Page</b>	<b>Description</b>	<b>Page</b>
Pushbutton operators	32	Roto-push pushbuttons	38
Mechanical push operators	32	Joystick controllers	39
Illuminated pushbuttons	33	Legend plates	40
Cylinder lock pushbuttons	33	Accessories	41
Contact blocks	33	Assembled pushbutton stations	43
Knob or lever operated selector switches	34	Emergency stop stations	43
Key operated selector switches	35	Aluminium alloy enclosures	44
Standard indicating lights	36	Technical data	45
Pretest Indicating lights	37		

---

## Stacklights – E26 Series

<b>Description</b>	<b>Page</b>	<b>Description</b>	<b>Page</b>
Product description	48	Technical data	54
Catalogue number selection guide	48	Application data	54
Light and xenon strobe modules	49	Mounting options and dimensions	55
Accessories	50	Dimensions	56
LEDs - Cluster or cylindrical	53		

---

**Contents**

**E22 Series – pages 3-30**

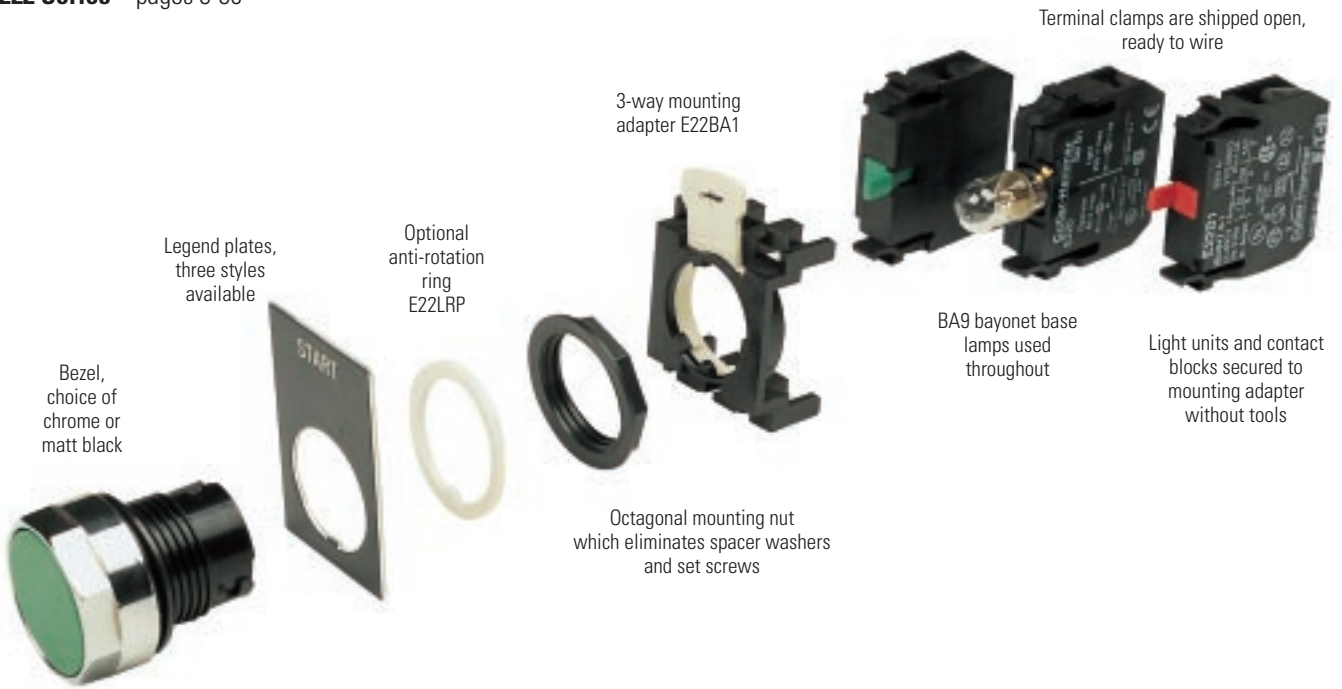

**91000T Series – pages 31-45**



**E26 Series – pages 47-56**

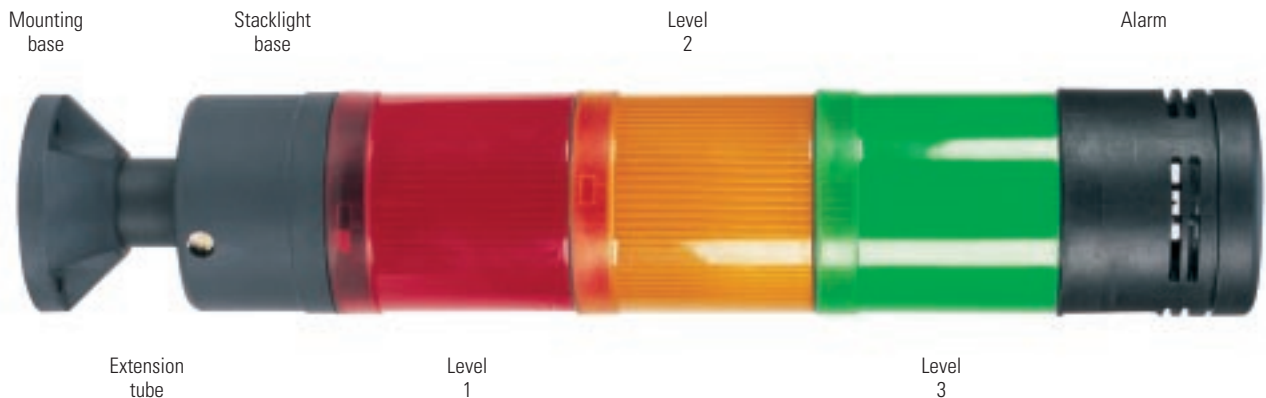



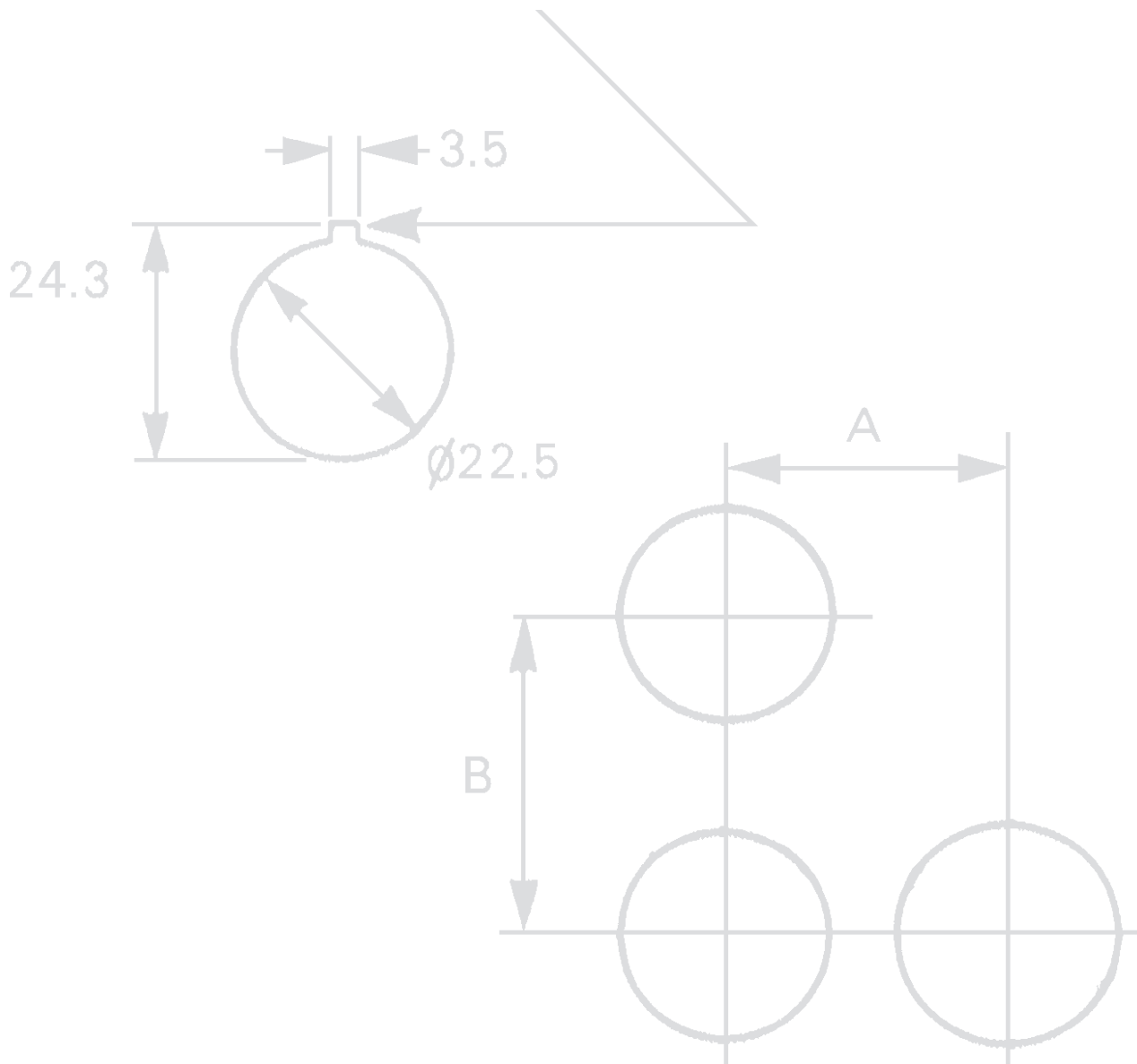

**22.5mm operators – E22 Series**

**Description**

Pushbutton operators non-illuminating	4
Double-headed pushbutton operators	4
Contact blocks	4
Mushroom operators - Latched	5
Mushroom operators - Spring return	5
Mushroom operators - Trigger action	5
Push-Pull operators non-illuminating	6
Push-Pull operators suitable for illuminating	6
Light source units - push-pull operators	7
Indicating lights	8
Light source units for indicating lights and illuminated pushbuttons	8
Bulbs	8
Direct voltage indicating lights	9
Pushbutton operators suitable for illuminating	10

**Page**





**Description**

Double-headed pushbutton operators suitable for illuminating	10
Press to test light source units	10
Key selector switches	11
Knob & lever selector switches non illuminating	12
Knob & lever selector switches suitable for illuminating	13
Cam & contact block selection charts for selector switches	14
Complete rotary cam selector switches	16
Ammeter & voltmeter rotary cam selector switches	19
Legend plates	20
Accessories	21
Enclosures - Polycarbonate	24
Enclosures - die cast aluminium	25
Assembled stations	26
Technical data	27

**Page**

## E22 Series - Non-illuminating operators, double-headed operators and contact blocks

### Pushbutton operators non-illuminating *See notes 3,4 & 5*

Chrome bezel	Black bezel	Button colour	Catalogue numbers Chrome bezel	Black bezel	Overall dimensions (mm)
<b>Flush</b>  25mm diameter push		Black Red Green Yellow White Blue Grey	<b>E22P1</b> <b>E22P2</b> <b>E22P3</b> <b>E22P4</b> <b>E22P5</b> <b>E22P6</b> <b>E22P7</b>	<b>E22PB1</b> <b>E22PB2</b> <b>E22PB3</b> <b>E22PB4</b> <b>E22PB5</b> <b>E22PB6</b> <b>E22PB7</b>	 Weight 0.043kg
<b>Extended</b>  25mm diameter push		Black Red Green Yellow White Blue Grey	<b>E22E1</b> <b>E22E2</b> <b>E22E3</b> <b>E22E4</b> <b>E22E5</b> <b>E22E6</b> <b>E22E7</b>	<b>E22EB1</b> <b>E22EB2</b> <b>E22EB3</b> <b>E22EB4</b> <b>E22EB5</b> <b>E22EB6</b> <b>E22EB7</b>	 Weight 0.043kg

**Full shroud bezel operator** Add the letter **F** to the flush button catalogue number eg **E22PF1**



### Double headed pushbutton operators *See note 6*

Description	Colour of operators	Marking	Ingress protection	Catalogue numbers Black bezel	Overall dimensions (mm)
<b>2 Flush buttons</b> 	Green - Red	Unmarked	IP40 IP65	<b>E22DB1A11</b> <b>E22DB1B11</b>	
	Green - Red	I O	IP40 IP65	<b>E22DB1A21</b> <b>E22DB1B21</b>	

### Assembled operators

Description	Colour of operators	Marking	Ingress protection	Contact block/ light unit	Operator black bezel	Circuit diagram	Catalogue numbers Black bezel
<b>2 Flush buttons</b>	Green	I	IP40	E22B2	E22DB1A21		<b>E22DB1A21C</b>
	Red	O	IP65	E22B1			<b>E22DB1B21C</b>

### Contact blocks

 Single pole	 Double pole	Description	Catalogue numbers		Weight (kg)
			Screw terminals	Push-on terminals	
		1N.C.	<b>E22B1</b>	<b>E22BF1</b>	0.013
		1N.O.	<b>E22B2</b>	<b>E22BF2</b>	0.013
		1N.O. - 1N.C.	<b>E22B11</b>	<b>E22BF11</b>	0.022
		2N.O.	<b>E22B20</b>	<b>E22BF20</b>	0.022
		1N.O. early make	<b>E22B3</b>	<b>E22BF3</b>	0.013
		1N.C. late break	<b>E22B4*</b>	<b>E22BF4*</b>	0.013
		1N.C. low power	<b>E22B1E</b>	—	0.013
		1N.O. low power	<b>E22B2E</b>	—	0.013

\* Cannot be used with 5 way adaptor

**Notes:** 3. Mounting adaptor for 3 contact blocks included.

4. Use operator plug E22BA2 to operate centre contact block.

5. For printed operators see page 9

6. Only 2 contact blocks can be fitted.

7. See page 30 for technical information

**E22 Series - Mushroom operators - latched, spring return and trigger action**

**Mushroom operators – latched** *See notes 5 & 6*

Chrome bezel	Black bezel	Button colour	Catalogue numbers Chrome bezel	Black bezel	Overall dimensions (mm)
<b>Push to latch-twist to release (6)</b>		Black Red Green Yellow Blue	<b>E22ML1</b> <b>E22ML2</b> <b>E22ML3</b> <b>E22ML4</b> <b>E22ML6</b>	<b>E22MLB1</b> <b>E22MLB2</b> <b>E22MLB3</b> <b>E22MLB4</b> <b>E22MLB6</b>	 Weight 0.039kg
<b>28mm diameter head</b>					
<b>40mm diameter head</b>		Black Red Green Yellow Blue	<b>E22LL1</b> <b>E22LL2</b> <b>E22LL3</b> <b>E22LL4</b> <b>E22LL6</b>	<b>E22LLB1</b> <b>E22LLB2</b> <b>E22LLB3</b> <b>E22LLB4</b> <b>E22LLB6</b>	 Weight 0.041kg
<b>Push to latch-pull to release</b>		Red (marked EMERGENCY STOP) Black Red Green Aluminium head Red	<b>E22JPL2N8</b> <b>E22JPL1</b> <b>E22JPL2</b> <b>E22JPL3</b> <b>E22JL2</b>	<b>E22JPLB2N8</b> <b>E22JPLB1</b> <b>E22JPLB2</b> <b>E22JPLB3</b> <b>E22JLB2</b>	 Weight 0.043kg
<b>50mm diameter head</b>					
<b>Push to latch-key release (6)</b>		Black Red Green	<b>E22G1</b> <b>E22G2</b> <b>E22G3</b>	<b>E22GB1</b> <b>E22GB2</b> <b>E22GB3</b>	 Weight 0.043kg

**Mushroom operators – spring return** *See notes 3, 4 & 5*

<b>28mm diameter head</b>		Black Red Green Yellow Blue	<b>E22M1</b> <b>E22M2</b> <b>E22M3</b> <b>E22M4</b> <b>E22M6</b>	<b>E22MB1</b> <b>E22MB2</b> <b>E22MB3</b> <b>E22MB4</b> <b>E22MB6</b>	 Weight 0.039kg
<b>40mm diameter head</b>		Black Red Green Yellow Blue	<b>E22L1</b> <b>E22L2</b> <b>E22L3</b> <b>E22L4</b> <b>E22L6</b>	<b>E22LB1</b> <b>E22LB2</b> <b>E22LB3</b> <b>E22LB4</b> <b>E22LB6</b>	 Weight 0.041kg
<b>50mm diameter head</b>		Black Red Green Aluminium head Red Red (marked EMERGENCY STOP)	<b>E22JP1</b> <b>E22JP2</b> <b>E22JP3</b> <b>E22J2</b> <b>E22J2N8</b>	<b>E22JPB1</b> <b>E22JPB2</b> <b>E22JPB3</b> <b>E22JB2</b> <b>E22JB2N8</b>	 Weight 0.043kg

**Trigger action operators – spring return** *See note 7*

<b>40mm red twist-to-release with red arrow legend</b>		1N.C 2N.C	<b>E22LTA2QB</b> <b>E22LTA2QE</b>	– –	
<b>40mm red twist-to-release with white Emergency Machine Off legend</b>		1N.C	<b>E22LTA2N123QB</b>	–	
<b>Rectangular safety emergency stop shroud</b>		Yellow	<b>E22MGTA</b>	–	

## E22 Series - Push-pull operators - non-illuminating and suitable for illuminating

### Push-Pull operators non-illuminating *See note 12*

Chrome bezel	Black bezel	Head diameter (mm)	Catalogue numbers		Overall dimensions (mm)
			Chrome bezel	Black bezel	
<b>2 position stayput</b>			Red push (marked EMERGENCY STOP)		
		40	<b>E22ED2N8</b>	<b>E22EDB2N8</b>	
		40	Operators without markings		
		29.5	<b>E22ED*</b>	<b>E22EDB*</b>	
			<b>E22EH*</b>	<b>E22EHB*</b>	
<b>3 position spring return to centre (13)</b>			Red push (marked EMERGENCY STOP)		
		40	<b>E22FD2N8</b>	<b>E22FDB2N8</b>	
		40	Operators without markings		
		29.5	<b>E22FD*</b>	<b>E22FDB*</b>	
			<b>E22FH*</b>	<b>E22FHB*</b>	

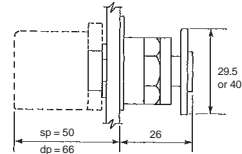

Weight 0.032kg

### Push-Pull operators suitable for illuminating *See note 12*

<b>2 position stayput</b>			Red push (marked EMERGENCY STOP)		
		40	<b>E22GD2N8</b>	<b>E22GDB2N8</b>	
		40	Operators without markings		
		29.5	<b>E22GD*</b>	<b>E22GDB*</b>	
			<b>E22GH*</b>	<b>E22GHB*</b>	
<b>3 position spring return to centre (13)</b>			Red push (marked EMERGENCY STOP)		
		40	<b>E22HD2N8</b>	<b>E22HDB2N8</b>	
		40	Operators without markings		
		29.5	<b>E22HD*</b>	<b>E22HDB*</b>	
			<b>E22HH*</b>	<b>E22HHB*</b>	

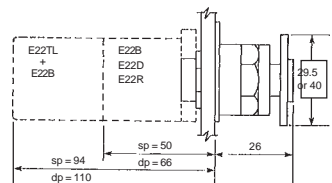

Weight 0.032kg

### Mushroom operators suitable for illuminating *See note 12*

Push to latch – Pull to release		Red	<b>E22JPT2</b>	<b>E22JPTB2</b>
		Green	<b>E22JPT3</b>	<b>E22JPTB3</b>
		Yellow	<b>E22JPT4</b>	<b>E22JPTB4</b>
		White	<b>E22JPT5</b>	<b>E22JPTB5</b>
		Blue	<b>E22JPT6</b>	<b>E22JPTB6</b>
		Amber	<b>E22JPT9</b>	<b>E22JPTB9</b>
		Clear	<b>E22JPT0</b>	<b>E22JPTB0</b>

50mm diameter head

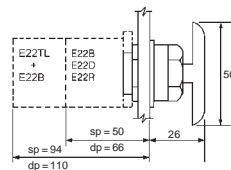

Weight 0.043kg

### Colour code selection for operator pushes 29.5 & 40 mm dia.

Colour	Code	Colour	Code	Colour	Code
Black	<b>1</b>	Yellow	<b>4</b>	Grey	<b>7</b>
Red	<b>2</b>	White	<b>5</b>	Amber	<b>9</b>
Green	<b>3</b>	Blue	<b>6</b>	Clear	<b>0</b>

\* Add push colour selection code from table above

#### Notes:

10 Transformers E22TL2 to 4 will accommodate 2 contact blocks.

Transformer E22TL1 will not accommodate contact blocks.



12 Operators will accommodate 2 contact blocks.

13 Contact block E22B2 can not be used on 3 position Push Pulls.

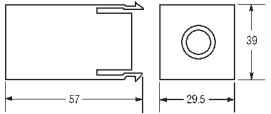

**E22 Series - Push-pull operators - light source units**

**Light source units – push-pull operators** *BA9s bayonet fitting. Bulb supplied with unit*

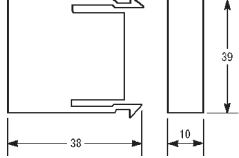

	Description	Supply voltage		Catalogue numbers	Overall dimensions (mm)	Weight (kg)
		50Hz	60Hz			
	<b>Transformer (10)</b> 6V secondary	110	120	<b>E22TL1</b>		0.08
		240	240	<b>E22TL2</b>		0.08
		380/415	–	<b>E22TL3</b>		0.08
		440	480	<b>E22TL4</b>		0.08
	<b>Resistor unit</b>	110/120V 60V bulb		<b>E22R2</b>		0.018
	<b>Direct voltage</b>	6.3V (1W)		<b>E22D6</b>		0.018
		12V (1.2W)		<b>E22D12</b>		0.018
		24V (1.2W)		<b>E22D24</b>		0.018
		50V (1W)		<b>E22D50</b>		0.018
		60V (1.2W)		<b>E22D60</b>		0.018
	Without bulb		<b>E22D</b>	0.018		

**Bulbs** For use with E22D above. See page 8 for LED type bulbs.

Description	Operating voltage	Catalogue numbers	Operating voltage	Catalogue numbers
Type BA9s	6 (1W) flasher	<b>28-2225-26</b>	24 (1.2W)	<b>28-2225-30</b>
bayonet	6.3 (1W)	<b>28-2225-72</b>	50 (1W)	<b>28-2225-31</b>
bulb	12 (1.2W)	<b>28-2225-29</b>	60 (1.2W)	<b>28-2225-32</b>

**Contact block selection chart** *See note 13*

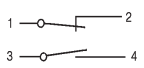
0 = circuit open X = circuit closed

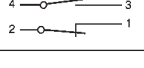
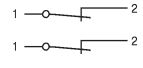
2 position push-pull		Circuit	Catalogue numbers	3 position push-pull			Circuit	Catalogue numbers
Pulled	Pushed			Pulled	Centre	Pushed		
X	0		<b>E22B1</b> <b>E22B2</b>	X	0	0		<b>E22B1</b> <b>E22B4</b>
0	X			X	X	0		
0	X		<b>E22B11</b> <b>E22B20</b>	X	0	0		<b>E22B1</b> <b>E22B5</b>
0	X			0	0	X		

**Typical push-pull applications** *BA9s bayonet fitting. Bulb supplied with unit*

**2 position push-pull with E22B1**

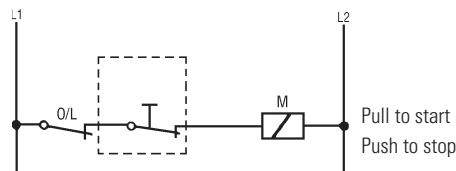

**3 position push-pull with E22B1 & E22B5**

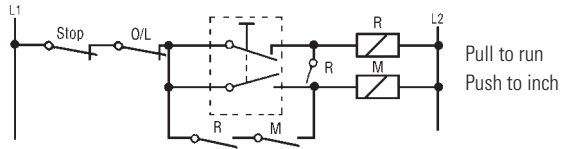

**3 position push-pull with E22B1 & E22B4**

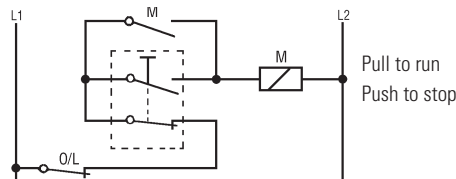

**3 position push-pull with E22B1 & E22B5**

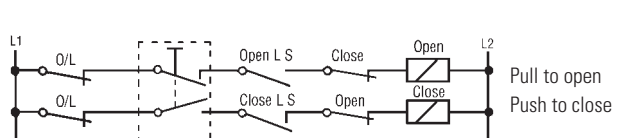

## E22 Series - Indicating lights, light sources and bulbs

### Indicating lights with plastic lens

Description		Lens colour	Catalogue numbers Standard lens	Lens suitable for printing (7)	Overall dimensions (mm)
<b>Standard</b>	<b>Printable</b>	Red	<b>E22H2</b>	<b>E22A2</b>	<p>Weight 0.023kg</p>
		Green	<b>E22H3</b>	<b>E22A3</b>	
		Yellow	<b>E22H4</b>	<b>E22A4</b>	
		White	<b>E22H5</b>	<b>E22A5</b>	
		Blue	<b>E22H6</b>	<b>E22A6</b>	
		Amber	<b>E22H9</b>	<b>E22A9</b>	
		Clear	<b>E22H0</b>	<b>E22A0</b>	

### Light source units *BA9s bayonet fitting. Bulb supplied with unit.*

Description Operator unit	Circuit diagram	Supply voltage 50Hz	60Hz	Catalogue numbers	Weight (kg)
<b>Transformer (10)</b>		110	120	<b>E22TL1</b>	0.08
		240	220	<b>E22TL2</b>	0.08
		380/415	–	<b>E22TL3</b>	0.08
		440	480	<b>E22TL4</b>	0.08
6V secondary					
<b>Resistor/Diode (110V bulb) (8)</b>		220/240ac		<b>E22R1</b>	0.018
<b>Resistor unit (60V bulb)</b>		110/120ac		<b>E22R2</b>	0.018
<b>Single diode unit</b>		6 – 120dc		<b>E22D1</b>	0.018
<b>Double diode unit</b>		6 – 120dc		<b>E22D2</b>	0.018
<b>Direct voltage</b>		6Vdc (1W)		<b>E22D6</b>	0.018
		12Vdc (1.2W)		<b>E22D12</b>	0.018
		24Vdc (1.2W)		<b>E22D24</b>	0.018
		50Vdc (1W)		<b>E22D50</b>	0.018
		110Vdc (2.2W) (8)		<b>E22D110</b>	0.018
		Without bulb		<b>E22D</b>	0.018

For operator light source units with push-on terminals add the letter **F** to the light source catalogue number eg **E22TLF1**

### Bulbs

**Filament and Neon type bulbs** For use with E22D and E22R above.

Description	Operating voltage	Catalogue numbers	Description	Operating voltage	Catalogue numbers
<b>Filament type</b>	6V (1W) flasher	<b>28-2225-26</b>	<b>Neon type</b>	50V (1W)	<b>28-2225-31</b>
	6.3V (1W)	<b>28-2225-72</b>		60V (1.2W)	<b>28-2225-32</b>
	12V (1.2W)	<b>28-2225-29</b>		110V (2.2W) (8)	<b>28-2225-24</b>
	24V (1.2W)	<b>28-2225-30</b>		110V (0.8mA)	<b>28-2225-48</b>
	28V (1.12W)	<b>28-2225-73</b>		240V (1.5mA)	<b>28-2225-49</b>



### LED bulbs

Colour	Catalogue numbers				Voltage code	
	Upto 60Vac/dc	120Vac	120Vdc	135Vac/dc	Voltage	Code
Blue	<b>E22LED*BN</b>	<b>E22LED120BA</b>	<b>E22LED120BD</b>	<b>E22LED135BD</b>	10Vac – 6Vdc	<b>006</b>
Green	<b>E22LED*GN</b>	<b>E22LED120GA</b>	<b>E22LED120GD</b>	<b>E22LED135GD</b>	12Vac – 12Vdc	<b>012</b>
Orange	<b>E22LED*ON</b>	<b>E22LED120OA</b>	<b>E22LED120OD</b>	<b>E22LED135OD</b>	24Vac – 24Vdc	<b>024</b>
Red	<b>E22LED*RN</b>	<b>E22LED120RA</b>	<b>E22LED120RD</b>	<b>E22LED135RD</b>	35Vac – 35Vdc	<b>035</b>
White	<b>E22LED*WN</b>	<b>E22LED120WA</b>	-	<b>E22LED135WD</b>	48Vac – 48Vdc	<b>048</b>
Yellow	<b>E22LED*YN</b>	<b>E22LED120YA</b>	<b>E22LED120YD</b>	<b>E22LED135YD</b>	60Vac – 60Vdc	<b>060</b>

\*Add voltage code alongside to complete catalogue number

**E22 Series - Direct voltage indicating lights**

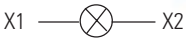
**Direct voltage type – bulb not included** (order bulb separately)

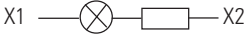
Description	Supply voltage/ wattage	Lens colour	Catalogue numbers		Lens with printable insert			
			Standard lens IP40	IP65	IP40	IP65		
<b>Direct voltage without resistor</b> (Excludes bulb)    	6 - 130V (2.6W max.) (Not suitable for 240V bulb.)	No lens (2)	<b>E22HVP</b>	<b>E22HV</b>	<b>E22HVP</b>	<b>E22HV</b>		
		Red	<b>E22HVP2</b>	<b>E22HV2</b>	<b>E22HVR2</b>	<b>E22HVA2</b>		
		Green	<b>E22HVP3</b>	<b>E22HV3</b>	<b>E22HVR3</b>	<b>E22HVA3</b>		
		Yellow	<b>E22HVP4</b>	<b>E22HV4</b>	<b>E22HVR4</b>	<b>E22HVA4</b>		
		White	<b>E22HVP5</b>	<b>E22HV5</b>	<b>E22HVR5</b>	<b>E22HVA5</b>		
		Blue	<b>E22HVP6</b>	<b>E22HV6</b>	<b>E22HVR6</b>	<b>E22HVA6</b>		
		Amber	<b>E22HVP9</b>	<b>E22HV9</b>	<b>E22HVR9</b>	<b>E22HVA9</b>		
		Clear	<b>E22HVP0</b>	<b>E22HV0</b>	<b>E22HVR0</b>	<b>E22HVA0</b>		
		<b>Direct voltage with built-in resistor</b> (Excludes bulb)    	220/240V input 110V output (2.6W max.) Use filament bulb only	No lens (2)	<b>E22HRP</b>	<b>E22HR</b>	<b>E22HRP</b>	<b>E22HR</b>
				Red	<b>E22HRP2</b>	<b>E22HR2</b>	<b>E22HRR2</b>	<b>E22HRA2</b>
Green	<b>E22HRP3</b>			<b>E22HR3</b>	<b>E22HRR3</b>	<b>E22HRA3</b>		
Yellow	<b>E22HRP4</b>			<b>E22HR4</b>	<b>E22HRR4</b>	<b>E22HRA4</b>		
White	<b>E22HRP5</b>			<b>E22HR5</b>	<b>E22HRR5</b>	<b>E22HRA5</b>		
Blue	<b>E22HRP6</b>			<b>E22HR6</b>	<b>E22HRR6</b>	<b>E22HRA6</b>		
Amber	<b>E22HRP9</b>			<b>E22HR9</b>	<b>E22HRR9</b>	<b>E22HRA9</b>		
Clear	<b>E22HRP0</b>			<b>E22HR0</b>	<b>E22HRR0</b>	<b>E22HRA0</b>		

**Printed legends for operators and indicating lights**

Add the following suffix code to the selected catalogue number. For legends not listed please refer to Eaton.

Legend	Suffix	Legend	Suffix	Legend	Suffix
Close	<b>N11</b>	Off	<b>N24</b>	Motor running	<b>N56</b>
Open	<b>N26</b>	On	<b>N25</b>	Motor stopped	<b>N57</b>
Power on	<b>N80</b>	Supply on	<b>N61</b>		

**Notes:**

- 2 Order lens and/or insert separately. See page 23
- 7 For printed inserts see page 23
- 8 For use with indicating lights only
- 10 Transformers E22TL2 to 4 will accommodate 2 contact blocks.  
Transformer E22TL1 does not accommodate contact blocks.

**Light source unit master test applications**

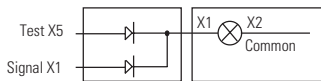

**E22D2      E22D**

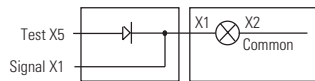

**E22D1      E22D**

**Mounting position for light source units**





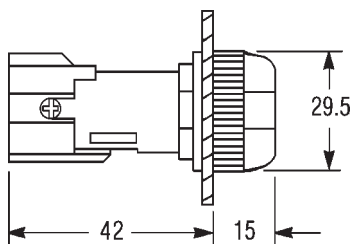



**Dimensions (mm)**

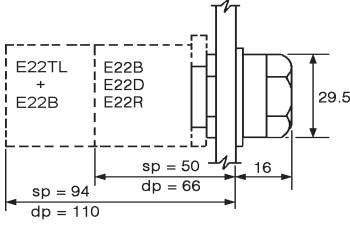

Weight: 0.022kg

E22 Series - Operators suitable for illuminating and press to test light source units

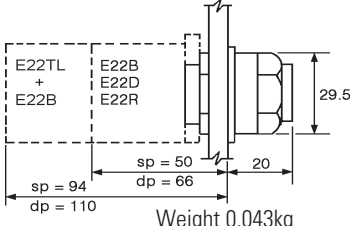
Pushbutton operators suitable for illuminating *See notes 7, 9 & 11*

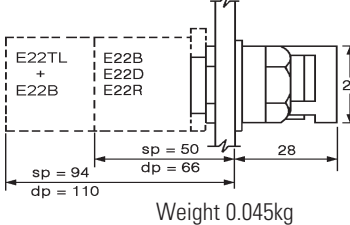
Chrome bezel	Black bezel	Lens colour	Catalogue numbers Chrome bezel	Black bezel	Overall dimensions (mm)
<b>Flush button</b> 		Red Green Yellow White Blue Amber Clear	<b>E22N2</b> <b>E22N3</b> <b>E22N4</b> <b>E22N5</b> <b>E22N6</b> <b>E22N9</b> <b>E22N0</b>	<b>E22NB2</b> <b>E22NB3</b> <b>E22NB4</b> <b>E22NB5</b> <b>E22NB6</b> <b>E22NB9</b> <b>E22NB0</b>	 Weight 0.043kg
<b>Extended button</b> 		Red Green Yellow White Blue Amber Clear	<b>E22T2</b> <b>E22T3</b> <b>E22T4</b> <b>E22T5</b> <b>E22T6</b> <b>E22T9</b> <b>E22T0</b>	<b>E22TB2</b> <b>E22TB3</b> <b>E22TB4</b> <b>E22TB5</b> <b>E22TB6</b> <b>E22TB9</b> <b>E22TB0</b>	 Weight 0.043kg
<b>Full shroud</b> 		Red Green Yellow White Blue Amber Clear	<b>E22TX2</b> <b>E22TX3</b> <b>E22TX4</b> <b>E22TX5</b> <b>E22TX6</b> <b>E22TX9</b> <b>E22TX0</b>	— — — — — — —	 Weight 0.045kg

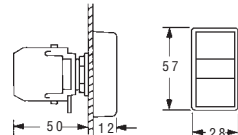

Double headed pushbutton operators *See note 6*

Description	Colour of operators	Marking	Ingress protection	Catalogue numbers Black bezel	Overall dimensions (mm)
<b>2 Flush buttons &amp; 1 pilot light with clear lens</b> 	Green - Red	Unmarked	IP40 IP65	<b>E22DB1A10</b> <b>E22DB1B10</b>	
	Green - Red	I O	IP40 IP65	<b>E22DB1A20</b> <b>E22DB1B20</b>	

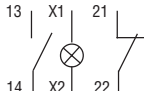
## Assembled operators

Description	Colour of operators	Marking	Ingress protection	Contact block/light unit	Operator black bezel	Circuit diagram	Catalogue numbers Black bezel
<b>2 Flush buttons &amp; 1 pilot light with clear lens</b>	Green	I	IP40	E22B2	E22DB1A20		<b>E22DB1A20X1C</b>
	Red	O	IP65	E22B1 E22D			<b>E22DB1B20X1C</b>

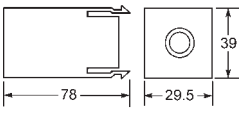
Press to test light source units *For use with illuminated operators*

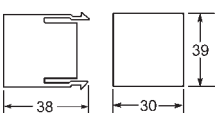
Description	Supply voltage 50Hz 60Hz	Catalogue numbers	Overall dimensions (mm)
<b>Transformer</b> 6V filament bulb supplied  6V secondary	110 240 120 220	<b>E22TL1C</b> <b>E22TL2C</b>	 Weight 0.106kg
<b>Resistor unit</b> 60V filament bulb supplied 	110/120V	<b>E22R2C</b>	 Weight 0.044kg
<b>Direct voltage</b> Filament bulb supplied	12V 24V 50V	<b>E22D12C</b> <b>E22D24C</b> <b>E22D50C</b>	

## Contact blocks

A light source unit ordered from the table alongside comes complete with 1N.O. & 1N.C. contact blocks.  
If the pushbutton is required to be used without a light source unit, select the contact blocks from page 4.

## Press to test circuit diagram

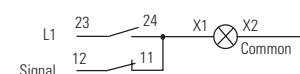



**Key selector switches** *See note 14*

Chrome bezel



Black bezel

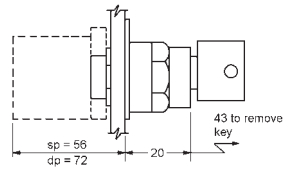

Description	Key removal position	Cam number	Catalogue numbers		Overall dimensions (mm)	
			Chrome bezel	Black bezel		
<b>2 Position</b>						
Stayput 	Right & left	2	<b>E22K53</b>	<b>E22KB53</b>	 <p>Weight 0.055kg</p>	
Spring return from right to left	Left only	2	<b>E22K62</b>	<b>E22KB62</b>		
<b>2 Position</b>						
Stayput 	Centre & right	2	<b>E22KF5</b>	<b>E22KBF5</b>		
Spring return from right to centre	Centre	2	<b>E22KE4</b>	<b>E22KBE4</b>		
<b>3 Position</b>						
Stayput & right 	Left, centre	1 2	<b>E22KG7</b> <b>E22KH7</b>	<b>E22KBG7</b> <b>E22KBH7</b>		
Spring return from left to centre	Centre & right	1 2	<b>E22KJ5</b> <b>E22KK5</b>	<b>E22KBJ5</b> <b>E22KBK5</b>		
Spring return from right and left to centre	Centre	1 2	<b>E22KL4</b> <b>E22KM4</b>	<b>E22KBL4</b> <b>E22KBM4</b>		
Spring return from right to centre	Left & centre	1 2	<b>E22KN6</b> <b>E22KP6</b>	<b>E22KBN6</b> <b>E22KBP6</b>		

**Alternative key removal position selection**

To select an alternative key removal position change the last digit of the listed catalogue number with a code from the table below. e.g. **E22KG6** is a 3 position switch with the key removable from left and centre. Key removal in a spring return position is not available.

Key removal position	Code	Key removal position	Code	Key removal position	Code	Key removal position	Code
Right only	<b>1</b>	Right & left	<b>3</b>	Right & centre	<b>5</b>	Right, left & centre	<b>7</b>
Left only	<b>2</b>	Centre only	<b>4</b>	Left & centre	<b>6</b>		

**Special lock selection**

Key operated devices listed above are supplied with a standard lock and key, ref. no. 92239. Different locks and keys are available on request.

**Notes:**

- 6 Only 2 contact blocks can be fitted.
- 7 For printed inserts see page 23
- 9 Operators will accommodate 2 contact blocks and 1 direct unit or 1 transformer
- 11 For printed operators see page 23
- 14 For contact block sequences see pages 14 & 15

**Selector switch switching angles**

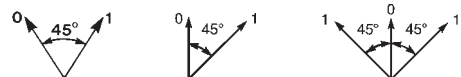

## E22 Series - Knob and lever selector switches non illuminating

Selector switches non-illuminating *See note 14*

Chrome bezel



Black bezel



Knob operator



Chrome bezel





Black bezel

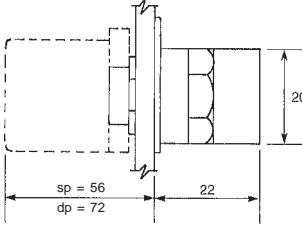

Lever operator

Description	Cam number	Catalogue numbers		Overall dimensions (mm)	
		Chrome bezel	Black bezel		
<b>Knob selector switch (black)</b>					
<b>2 Position</b> 					
Stayput	2	E22X51	E22XB51	 Weight 0.043kg	
Spring return from right to left	2	E22X61	E22XB61		
<b>2 Position</b> 					
Stayput	2	E22XF1	E22XBF1		
Spring return from right to centre	2	E22XE1	E22XBE1		
<b>3 Position</b> 					
Stayput	1	E22XG1	E22XBG1		
	2	E22XH1	E22XBH1		
Spring return from left to centre	1	E22XJ1	E22XBJ1		
	2	E22XK1	E22XBK1		
Spring return from right and left to centre	1	E22XL1	E22XBL1		
	2	E22XM1	E22XBM1		
Spring return from right to centre	1	E22XN1	E22XBN1		
	2	E22XP1	E22XBP1		

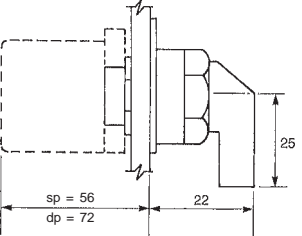
**Lever selector switch (black)**

<b>2 Position</b> 					
Stayput	2	E22V51	E22VB51	 Weight 0.043kg	
Spring return from right to left	2	E22V61	E22VB61		
<b>2 Position</b> 					
Stayput	2	E22VF1	E22VBF1		
Spring return from right to centre	2	E22VE1	E22VBE1		
<b>3 Position</b> 					
Stayput	1	E22VG1	E22VBG1		
	2	E22VH1	E22VBH1		
Spring return from left to centre	1	E22VJ1	E22VBJ1		
	2	E22VK1	E22VBK1		
Spring return from right and left to centre	1	E22VL1	E22VBL1		
	2	E22VM1	E22VBM1		
Spring return from right to centre	1	E22VN1	E22VBN1		
	2	E22VP1	E22VBP1		

**Note:***Different colour knobs and levers are available. Please contact Eaton.*

**Selector switches suitable for illuminating** *See note 14*

Chrome bezel



Black bezel



Knob operator

Chrome bezel



Black bezel



Lever operator

Description	Cam number	Catalogue numbers Chrome bezel	Black bezel	Overall dimensions (mm)
-------------	------------	-----------------------------------	-------------	-------------------------

**Knob selector switch (red) (15)**

**2 Position**



Stayput	2	<b>E22S52</b>	<b>E22SB52</b>
Spring return from right to left	2	<b>E22S62</b>	<b>E22SB62</b>

**2 Position**



Stayput	2	<b>E22SF2</b>	<b>E22SBF2</b>
Spring return from right to centre	2	<b>E22SE2</b>	<b>E22SBE2</b>

**3 Position**



Stayput	1	<b>E22SG2</b>	<b>E22SBG2</b>
	2	<b>E22SH2</b>	<b>E22SBH2</b>
Spring return from left to centre	1	<b>E22SJ2</b>	<b>E22SBJ2</b>
	2	<b>E22SK2</b>	<b>E22SBK2</b>
Spring return from right and left to centre	1	<b>E22SL2</b>	<b>E22SBL2</b>
	2	<b>E22SM2</b>	<b>E22SBM2</b>
Spring return from right to centre	1	<b>E22SN2</b>	<b>E22SBN2</b>
	2	<b>E22SP2</b>	<b>E22SBP2</b>

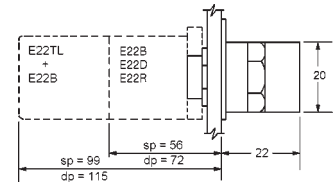

Weight 0.043kg

**Lever selector switch (red) (15)**

**2 Position**



Stayput	2	<b>E22W52</b>	<b>E22WB52</b>
Spring return from right to left	2	<b>E22W62</b>	<b>E22WB62</b>

**2 Position**



Stayput	2	<b>E22WF2</b>	<b>E22WBF2</b>
Spring return from right to centre	2	<b>E22WE2</b>	<b>E22WBE2</b>

**3 Position**



Stayput	1	<b>E22WG2</b>	<b>E22WBG2</b>
	2	<b>E22WH2</b>	<b>E22WBH2</b>
Spring return from left to centre	1	<b>E22WJ2</b>	<b>E22WBJ2</b>
	2	<b>E22WK2</b>	<b>E22WBK2</b>
Spring return from right and left to centre	1	<b>E22WL2</b>	<b>E22WBL2</b>
	2	<b>E22WM2</b>	<b>E22WBM2</b>
Spring return from right to centre	1	<b>E22WN2</b>	<b>E22WBN2</b>
	2	<b>E22WP2</b>	<b>E22WBP2</b>

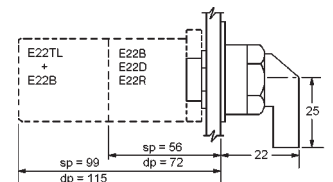

Weight 0.043kg

**Notes:**

14 For contact block sequences see pages 14 & 15

15 For light source units see page 8

E22 Series - Cam and contact block selection charts for selector switches

Cam and contact block selection chart – 3 way adaptor *See note 16*

Circuit configurations. Viewed from front of panel

2 position Cam II	3 position Cam I	Cam II	Contact block mounting position. Viewed from rear of panel			Contact arrangement	Catalogue number
			Left 1	Central 3	Right 2		
0 X or X 0	X 0 0	X 0 X	■	□	□	14 —○— 13	E22B2
X 0	0 X X	0 X 0	■	□	□	12 —○— 11	E22B1
0 X X 0	X 0 0 0 X X	X 0 X 0 X 0	■	□	□	14 —○— 13 12 —○— 11	E22B11
0 X 0 X	X 0 0 X 0 0	X 0 X X 0 X	■	□	□	14 —○— 13 14A —○— 13A	E22B20
0 X	0 0 X	0 0 X	□	□	■	24 —○— 23	E22B2
X 0	X X 0	X X 0	□	□	■	22 —○— 21	E22B1
0 X X 0	0 0 X X X 0	0 0 X X X 0	□	□	■	24 —○— 23 22 —○— 21	E22B11
0 X 0 X	0 0 X 0 0 X	0 0 X 0 0 X	□	□	■	24 —○— 23 24A —○— 23A	E22B20
0 X X 0	X 0 0 0 X 0	X 0 X 0 X 0	■	□	■	14 —○— 13 12 —○— 11 22 —○— 21	E22B11+B1
0 X X 0 0 X	X 0 0 0 X 0 0 0 X	X 0 X 0 X 0 0 0 X	■	□	■	14 —○— 13 12 —○— 11 22 —○— 21 24 —○— 23	E22B11+B11

Explanation of how to use selector switch contact block selection chart

1. Determine the "X O" sequence you require for your application.

Example:

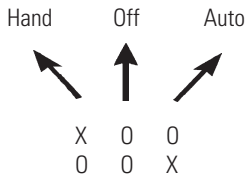

X = Circuit closed  
O = Circuit open

2. Locate the first sequence "X O O" under column marked Cam I or Cam II, then identify which Cam and contact is used and in what position it is assembled.

Example: "X O O" uses Cam I, E22B2, mounting position 1 (left)

3. Repeat for second sequence "O O X". Do not mix sequences from Cam I and Cam II.

Example: "O O X" uses Cam I, E22B2, mounting position 2 (right)

4. Assemble contact block(s) to adaptor in the mounting position selected (two contact blocks per switch), using the selector switch with the appropriate cam and switch positions. Cam I has 1 peak, Cam II has 2 peaks, viewed from the rear.

Terminal numbers

These identify the contact block position and contact function.

Example: 14 —○— 13.

The "1" indicates mounting position number 1 (left), "3 & 4" indicates the circuit is N.O.

Note: 16 Illuminated selector switches will accommodate 1 direct voltage or 1 transformer unit with 2 contact blocks.

5 Way adaptor mounting example

Requirement	Contact status	Mounting position					Contact arrangement	Contact block catalogue number
		5-	1-	3-	2-	4-		
Hand Off Auto X 0 0	X 0 0	□	■	□	□	□	14 —○— 13	E22B2
0 0 X	0 0 X	□	□	□	■	□	24 —○— 23	E22B2
X 0 0	X 0 0	■	□	□	□	□	34 —○— 33	E22B2
0 X X	X 0 0 0 X X	□	□	■	□	□	54 —○— 53 52 —○— 51	E22B11

With contact block printing facing position 2

The above example uses a 3 position selector switch cam 1 plus mounting adaptor E22BA12



Cam and contact block selection charts – 5 way adaptor

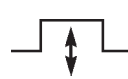

2 position selector switch operators and pushbuttons

Circuit configurations viewed from front of panel

2 position cam 2 	Pushbutton 	Contact block mounting position					Contact arrangement	Contact block catalogue number
		5-	1-	3-	2-	4-		
0 X		■	■	■	■	■	-4 ——— -3	E22B2
X 0		■	■	■	■	■	-2 ——— -1	E22B1
0 X X 0		■	■	■	■	■	-4 ——— -3 -2 ——— -1	E22B11
0 X 0 X		■	■	■	■	■	-4 ——— -3 -4A ——— -3A	E22B20

3 position selector switch operators

Circuit configurations viewed from front of panel

3 position cam 1 	3 position cam 2 	Contact block mounting position					Contact arrangement	Contact block catalogue number
		5-	1-	3-	2-	4-		
X 0 0	Not suitable	■	■	□ A	□	□	-4 ——— -3	E22B2
0 X X	"	■	■	□ A	□	□	-2 ——— -1	E22B1
X 0 0 0 X X	"	■	■	□ A	□	□	-4 ——— -3 -2 ——— -1	E22B11
X 0 0 X 0 0	"	■	■	□ A	□	□	-4 ——— -3 -4A ——— -3A	E22B20
0 0 X	"	□	□	□ B	■	■	-4 ——— -3	E22B2
X X 0	"	□	□	□ B	■	■	-2 ——— -1	E22B1
0 0 X X X 0	"	□	□	□ B	■	■	-4 ——— -3 -2 ——— -1	E22B11
0 0 X 0 0 X	"	□	□	□ B	■	■	-4 ——— -3 -4A ——— -3A	E22B20

□ A. Operated as positions 1 & 5 with contact block printing facing position 2. B. Operated as positions 2 & 4 with contact block printing facing position 1.

Applications

Use any combination of contact blocks/light source except where noted

Front of panel device	5 way adaptor/back of panel options				Front of panel device	5 way adaptor/back of panel options			
	Non ill operators		Ill operators			Non ill operators		Ill operators	
	E22BA11	BA12	E22BA11L	BA12L		E22BA11	BA12	E22BA11L	BA12L
Flush & extended pushbuttons	Yes	No	Yes	No	29.5 and 40mm 3 position push pull	No	No	No	No
28, 40, 50mm mushroom (momentary)	Yes	No	No	No	Double headed pushbutton	No	No	No	No
50mm mushroom latch (pull to release)	Yes	No	Yes	No	2 position selector switch cam 2	Yes	No	Yes	No
40mm mushroom latch (key release)	Yes †	No	No	No	3 position selector switch cam 1	No	Yes	No	Yes
28 & 40mm mushroom latch (twist to release)	Yes †	No	No	No	3 position selector switch cam 2	No	No	No	No
29.5 and 40mm 2 position push pull	Yes	No	Yes	No	† 4 single circuit contact blocks maximum				

Notes:

E22B4 & E22BF4 can not be used with 5 way adaptors.

5 way adaptors can only be used in single way double contact block depth enclosures.

E22 Series - Complete rotary cam selector switches

Complete rotary cam selector switches *See notes 17 & 18*



Lever operator

Knob operator

Key operator

Description, circuit and terminal numbers	Contact sequence	Switch position	Operator type	Catalogue numbers Chrome bezel	Black bezel
<b>4 Position</b> 2 —○— 1 6 —○— 5 4 —○— 3 8 —○— 7	1 2 3 4 X 0 0 0 0 X 0 0 0 0 X 0 0 0 0 X		Lever Knob Key	<b>E22JD4W1</b> <b>E22LD4W1</b> <b>E22KD4W8</b>	<b>E22JDB4W1</b> <b>E22LDB4W1</b> <b>E22KDB4W8</b>
<b>5 Position</b> 2 —○— 1 8 —○— 7 10 —○— 9 6 —○— 5 4 —○— 3	1 2 3 4 5 X 0 0 0 0 0 X 0 0 0 0 0 X 0 0 0 0 0 X 0 0 0 0 0 X		Lever Knob Key	<b>E22JD5W1</b> <b>E22LD5W1</b> <b>E22KD5W8</b>	<b>E22JDB5W1</b> <b>E22LDB5W1</b> <b>E22KDB5W8</b>
<b>6 Position</b> 2 —○— 1 6 —○— 5 10 —○— 9 12 —○— 11 4 —○— 3 8 —○— 7	1 2 3 4 5 6 X 0 0 0 0 0 0 X 0 0 0 0 0 0 X 0 0 0 0 0 0 X 0 0 0 0 0 0 X 0 0 0 0 0 0 X		Lever Knob Key	<b>E22JD6W1</b> <b>E22LD6W1</b> <b>E22KD6W8</b>	<b>E22JDB6W1</b> <b>E22LDB6W1</b> <b>E22KDB6W8</b>
<b>7 Position</b> 2 —○— 1 6 —○— 5 10 —○— 9 14 —○— 13 4 —○— 3 8 —○— 7 12 —○— 11	1 2 3 4 5 6 7 X 0 0 0 0 0 0 0 X 0 0 0 0 0 0 0 X 0 0 0 0 0 0 0 X 0 0 0 0 0 0 0 X 0 0 0 0 0 0 0 X 0 0 0 0 0 0 0 X		Lever Knob Key	<b>E22JD7W</b> <b>E22LD7W1</b> <b>E22KD7W8</b>	<b>E22JDB7W1</b> <b>E22LDB7W1</b> <b>E22KDB7W8</b>
<b>8 Position</b> 2 —○— 1 6 —○— 5 10 —○— 9 14 —○— 13 4 —○— 3 8 —○— 7 12 —○— 11 16 —○— 15	1 2 3 4 5 6 7 8 X 0 0 0 0 0 0 0 0 X 0 0 0 0 0 0 0 0 X 0 0 0 0 0 0 0 0 X 0 0 0 0 0 0 0 0 X 0 0 0 0 0 0 0 0 X 0 0 0 0 0 0 0 0 X 0 0 0 0 0 0 0 0 X		Lever Knob Key	<b>E22JD8W1</b> <b>E22LD8W1</b> <b>E22KD8W8</b>	<b>E22JDB8W1</b> <b>E22LDB8W1</b> <b>E22KDB8W8</b>

**Complete rotary cam selector switches** *See notes 17 & 18*

Description, circuit and terminal numbers	Contact sequence	Switch position	Operator type	Catalogue numbers Chrome bezel	Black bezel
<b>4 Position</b> 2 — 1 6 — 5 4 — 3	0 1 2 3 0 X 0 0 0 0 X 0 0 0 0 X		Lever Knob Key	<b>E22JD4Y1</b> <b>E22LD4Y1</b> <b>E22KD4Y8</b>	<b>E22JDB4Y1</b> <b>E22LDB4Y1</b> <b>E22KDB4Y8</b>
<b>5 Position</b> 2 — 1 6 — 5 4 — 3 8 — 7	0 1 2 3 4 0 X 0 0 0 0 0 X 0 0 0 0 0 X 0 0 0 0 0 X		Lever Knob Key	<b>E22JD5Y1</b> <b>E22LD5Y1</b> <b>E22KD5Y8</b>	<b>E22JDB5Y1</b> <b>E22LDB5Y1</b> <b>E22KDB5Y8</b>
<b>6 Position</b> 2 — 1 6 — 5 8 — 7 10 — 9 4 — 3	0 1 2 3 4 5 0 X 0 0 0 0 0 0 X 0 0 0 0 0 0 X 0 0 0 0 0 0 X 0 0 0 0 0 0 X		Lever Knob Key	<b>E22JD6Y1</b> <b>E22LD6Y1</b> <b>E22KD6Y8</b>	<b>E22JDB6Y1</b> <b>E22LDB6Y1</b> <b>E22KDB6Y8</b>
<b>7 Position</b> 2 — 1 6 — 5 10 — 9 12 — 11 4 — 3 8 — 7	0 1 2 3 4 5 6 0 X 0 0 0 0 0 0 0 X 0 0 0 0 0 0 0 X 0 0 0 0 0 0 0 X 0 0 0 0 0 0 0 X 0 0 0 0 0 0 0 X		Lever Knob Key	<b>E22JD7Y1</b> <b>E22LD7Y1</b> <b>E22KD7Y8</b>	<b>E22JDB7Y1</b> <b>E22LDB7Y1</b> <b>E22KDB7Y8</b>
<b>8 Position</b> 2 — 1 6 — 5 10 — 9 14 — 13 4 — 3 8 — 7 12 — 11	0 1 2 3 4 5 6 7 0 X 0 0 0 0 0 0 0 0 X 0 0 0 0 0 0 0 0 X 0 0 0 0 0 0 0 0 X 0 0 0 0 0 0 0 0 X 0 0 0 0 0 0 0 0 X 0 0 0 0 0 0 0 0 X		Lever Knob Key	<b>E22JD8Y1</b> <b>E22LD8Y1</b> <b>E22KD8Y8</b>	<b>E22JDB8Y1</b> <b>E22LDB8Y1</b> <b>E22KDB8Y8</b>

**Dimensions (mm)**

Lever operator

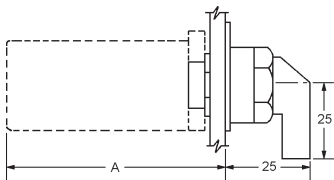

Knob operator

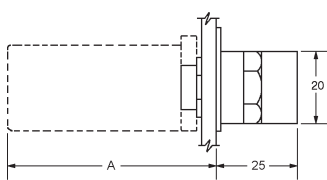

Key operator

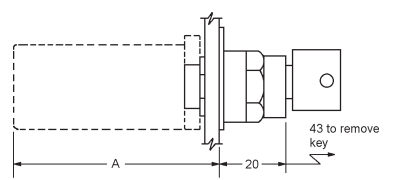

No. of circuits	Dim. A
1 - 2	72mm
3 - 4	84mm
5 - 6	96mm
7 - 8	108mm

**Notes:**

17 Lever and knob switches are fitted with black operators.

18 Key switches are fitted with standard lock key ref. 92239 with the key removable in all positions. For a non-standard lock refer to Eaton.

## E22 Series - Complete rotary cam selector switches

Complete rotary cam selector switches *See notes 17 & 18*















Lever operator



Knob operator



Key operator

Description terminal numbers	Circuit and sequence	Contact of poles	Number type	Operator Chrome bezel	Catalogue numbers	
					Black bezel	
2 Position changeover 	 Pole 1	XO OX	1	Lever Knob Key	<b>E22JDP1</b> <b>E22LDP1</b> <b>E22KDP5</b>	<b>E22JDBP1</b> <b>E22LDBP1</b> <b>E22KDBP5</b>
	 Pole 2	XO OX	2	Lever Knob Key	<b>E22JDR1</b> <b>E22LDR1</b> <b>E22KDR5</b>	<b>E22JDBR1</b> <b>E22LDBR1</b> <b>E22KDBR5</b>
	 Pole 3	XO OX	3	Lever Knob Key	<b>E22JDS1</b> <b>E22LDS1</b> <b>E22KDS5</b>	<b>E22JDBS1</b> <b>E22LDBS1</b> <b>E22KDBS5</b>
	 Pole 4	XO OX	4	Lever Knob Key	<b>E22JDT1</b> <b>E22LDT1</b> <b>E22KDT5</b>	<b>E22JDBT1</b> <b>E22LDBT1</b> <b>E22KDBT5</b>
2 Position changeover 	 Pole 1	XO OX	1	Lever Knob Key	<b>E22JDP51</b> <b>E22LDP51</b> <b>E22KDP53</b>	<b>E22JDBP51</b> <b>E22LDBP51</b> <b>E22KDBP53</b>
	 Pole 2	XO OX	2	Lever Knob Key	<b>E22JDR51</b> <b>E22LDR51</b> <b>E22KDR53</b>	<b>E22JDBR51</b> <b>E22LDBR51</b> <b>E22KDBR53</b>
	 Pole 3	XO OX	3	Lever Knob Key	<b>E22JDS51</b> <b>E22LDS51</b> <b>E22KDS53</b>	<b>E22JDBS51</b> <b>E22LDBS51</b> <b>E22KDBS53</b>
	 Pole 4	XO OX	4	Lever Knob Key	<b>E22JDT51</b> <b>E22LDT51</b> <b>E22KDT53</b>	<b>E22JDBT51</b> <b>E22LDBT51</b> <b>E22KDBT53</b>
3 Position without off	 Pole 1	XOO OXO OOX	2	Lever Knob Key	<b>E22JDV1</b> <b>E22LDV1</b> <b>E22KDV7</b>	<b>E22JDBV1</b> <b>E22LDBV1</b> <b>E22KDBV7</b>
	 Pole 2	XOO OXO OOX				
3 Position with centre position off	 Pole 1	XOO OOX	3	Lever Knob Key	<b>E22JDW1</b> <b>E22LDW1</b> <b>E22KDW7</b>	<b>E22JDBW1</b> <b>E22LDBW1</b> <b>E22KDBW7</b>
	 Pole 2	XOO OOX				
	 Pole 3	XOO OOX				

## Switching angles



Overall dimensions. See page 19

**Complete rotary cam selector switches** See notes 17 & 18

Description	Circuit and terminal numbers	Contact sequence	Number of poles	Operator type	Catalogue numbers Chrome bezel	Black bezel
<b>3 Position</b> with right hand position off	2 — 1 4 — 3	Pole 1 X00 OXO	2	Lever Knob Key	<b>E22JDL1</b> <b>E22LDL1</b> <b>E22KDL7</b>	<b>E22JDBL1</b> <b>E22LDBL1</b> <b>E22KDBL7</b>
	6 — 5 8 — 7					
<b>3 Position</b> with left hand position off	2 — 1 4 — 3	Pole 1 OXO OOX	2	Lever Knob Key	<b>E22JDM1</b> <b>E22LDM1</b> <b>E22KDM7</b>	<b>E22JDBM1</b> <b>E22LDBM1</b> <b>E22KDBM7</b>
	6 — 5 8 — 7					
<b>4 Position</b> without off	2 — 1 6 — 5 8 — 7 4 — 3	Pole 1 X000 OX00 00X0 000X	1	Lever Knob	<b>E22JDN1</b> <b>E22LDN1</b>	<b>E22JDBN1</b> <b>E22LDBN1</b>

**Ammeter and voltmeter rotary cam selector switches**

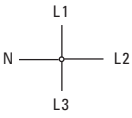
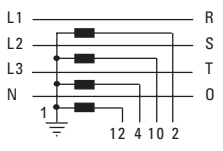
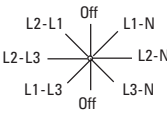
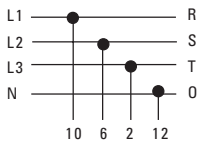
Description	Switch positions	Circuit and terminal numbers	Operator type	Catalogue numbers Chrome bezel	Black bezel
<b>Ammeter switch</b> (Single pole 4 current transformers)			1 — 5 Lever Knob	<b>E22JDAM1</b> <b>E22LDAM1</b>	<b>E22JDBAM1</b> <b>E22LDBAM1</b>
<b>Voltmeter switch</b> (3 Phase to phase and 3 phase to neutral)			1 — 3 Lever Knob	<b>E22JDVM1</b> <b>E22LDVM1</b>	<b>E22JDBVM1</b> <b>E22LDBVM1</b>

**Dimensions (mm)**

Lever operator

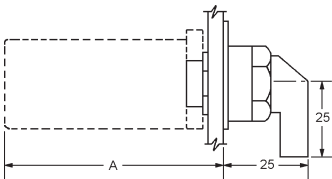

Knob operator

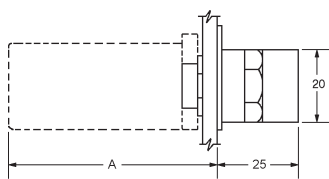

Key operator

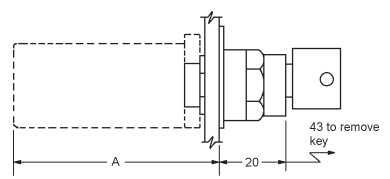

No. of circuits	Dim. A
1 — 2	72mm
3 — 4	84mm
5 — 6	96mm
7 — 8	108mm



**Notes:**

17 Lever and knob switches are fitted with black operators.

18 Key switches are fitted with standard lock key ref. 92239 with the key removable in all positions. For a non-standard lock refer to Eaton.

## E22 Series - Legend plates

## Legend plates

Description	Size (mm)	Catalogue numbers	Description	Size (mm)	Catalogue numbers
Aluminium (IP65)	30 x 45 40 x 45	E22NE* E22NF*	Clip-in legend (IP65)	30 x 45 40 x 45	Legend carrier Legend plate Legend carrier Legend plate
					E22ND E22ND* E22PD E22PD*
Enclosure legend plate (Adhesive backing)	19 x 19	E22NC*	Special engraving		
			Where non-standard engraving is required the maximum number of letters (including spaces) 3mm high that can be engraved per row is as follows:		
			E22ND	2 rows, 8 letters	
			E22NE	3 rows, 8 letters	
			E22NF	3 rows, 11 letters	
			E22PD	2 rows, 11 letters	

\* Add relevant suffix code from list below for required legend. Example E22NE11 = aluminium legend plate engraved "close".

Legend	Code number	Legend	Code number	Legend	Code number	Legend	Code number
(Blank)	36	Inch reverse	59	Off On (19)	42	Slow	32
(Blank†)	37	Inch Run (19)	60	Off On (20)	105	Slower	88
Auto Off Hand	49	Inch Run (20)	114	On	25	Start	33
Clamp	90	Jog	19	Open	26	Start Inch (19)	77
Close	11	Jog for	96	Open Close (19)	43	Start Inch (20)	119
Down	12	Jog rev	21	Open Close (20)	106	Start Stop (19)	47
Emerg stop†	13	Left	10	Open Off Close	53	Start Stop (20)	110
Fast	14	Left Right (19)	66	Out	27	Stop†	34
For	4	Left Right (20)	117	Overload tripped	98	Stop reset†	58
Forward	15	Loc Rem (19)	63	Overload reset	100	Supply on	61
For Off Rev	50	Loc Rem (20)	116	Power on	80	Test	83
For Rev (19)	38	Low	22	Raise	28	Trip	84
For Rev (20)	101	Lower	23	Ready	86	Unclamp	91
Hand Auto (19)	39	Man Auto (19)	67	Reset	29	Up Down (19)	48
Hand Auto (20)	102	Man Auto (20)	118	Rev	6	Up Down (20)	111
Hand Off Auto	51	Man Off Auto	68	Reverse	30	Up	35
High	16	Motor run	81	Right	79	Special legend	36x
High Low (19)	40	Motor running	56	Run	31	Special legend†	37x
High Low (20)	103	Motor stop	82	Seq. Test (19)	62	Quote legend required.	
I	65	Motor stopped	57	Seq. Test (20)	115		
I O II	121	O†	64				
In	17	O I (19)	122				
Inch	18	O I (20)	120				
Inch forward	76	Off†	24				

Notes: (19) For selector switches with left/right switch angle.  
(20) For selector switches with centre/right switch angle.

† The standard colour field is black except those marked with a dagger which are red.

## Push-Pull legend plates aluminium IP65 rated

Legend	Catalogue number
Pull on, Push off	E22NP73
Pull open, Push close	E22NP74
Pull start, Push stop	E22NP75
Pull up, Push down	E22NP76
Blank	E22NP77

## Visual aid plate

Description	Catalogue number
 70mm not printed	E22VA1
45mm not printed	E22VA2
70mm printed "EMERGENCY STOP"	E22VA8

**Legend plates for 4 – 8 position selector switches**

**Description**

**Catalogue numbers**

Legend plates with standard text  
 Size 45 x 45mm (E22NJP\*)  
 60 x 60mm (E22NGP\*)  
 Black background, white letters.

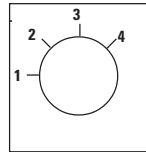

**E22NJP215**

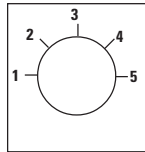

**E22NJP216**

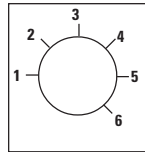

**E22NJP217**

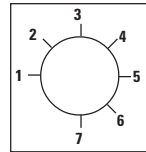

**E22NJP218**

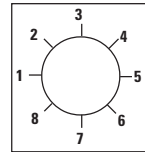

**E22NJP219**

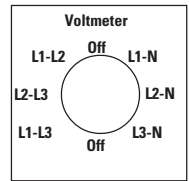

**E22NGP220**

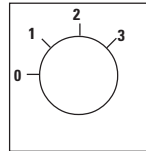

**E22NJP210**

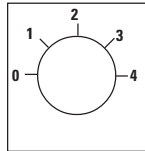

**E22NJP211**

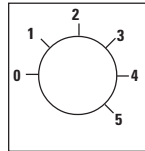

**E22NJP212**

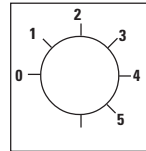

**E22NJP213**

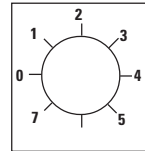

**E22NJP214**

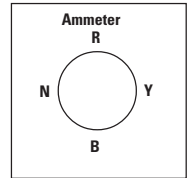

**E22NGP221**

**Description**

**Size (mm)**

**Catalogue numbers**

Legend plates without text  
 Black onside, red reverse.  
 White text





45 x 45  
 60 x 60

**E22NJP36**  
**E22NGP36**

**Non-standard legends**

If a legend is required that is not listed above, specify the blank catalogue number for the required size, add a suffix 'X' and detail engraving requirements. Use dashes to separate positions and quote background colour (black or red).  
 Example: E22NJP36X, OFF – PUMP 1 – PUMP 2 – PUMP 3 – PUMP 4, black background.

**Accessories**

	<b>Description</b>		<b>Catalogue number</b>
	<b>Locating rings</b> Gives additional anti-rotational feature. Panel notch required.	Pack of 10	<b>E22LRP</b>
	<b>Operator plug</b> To operate centre contact block on pushbuttons and momentary mushroom operators.		<b>E22BA2</b>
	<b>Moulded black bezels</b> For converting chrome type to moulded plastic.	For 25mm pushbuttons.	<b>E22AYB</b>
		For knob, lever, key selector switches	<b>E22AZB</b>
	<b>Push-on terminals</b> To convert screw type terminal devices. Rated 300V maximum.	Pack of 10	<b>E22AT</b>
	<b>Five way mounting adaptor</b> For use with:	Non-illuminating operators and mushroom operators	<b>E22BA11</b>
		Illuminated pushbuttons and mushroom operators	<b>E22BA11L</b>
		Non-illuminating key, lever and knob type selector switches	<b>E22BA12</b>
		Illuminated lever and knob type selector switches	<b>E22BA12L</b>







## E22 Series - Accessories







## Accessories



	Description numbers		Catalogue dimensions (mm)	Overall (kg)	Weight
	<b>Padlockable transparent cover.</b> For flush & extended 25mm pushbuttons.		<b>E22PCM</b>		
	For extended 25mm pushbuttons. Enables N.C. circuit to be held open when in padlocked position.		<b>E22PCPM</b>		0.025
	<b>Padlockable transparent cover.</b> For use with 28mm mushroom operators, knob and key selector switches.		<b>E22BA9</b>		0.025
	<b>Mechanical push.</b> For use with pushbuttons and push-pulls only. Cut to required length. Pushbutton stroke 5.8mm.		<b>E22MRL</b>		
	<b>Protective boot</b> Forms oil and watertight seal to IP66. For flush & extended pushbuttons only	Red Green Black Clear	<b>E22BRM</b> <b>E22BGM</b> <b>E22BBM</b> <b>E22BCM</b>		0.015 0.015 0.015 0.015
	<b>Mushroom shroud</b> Protects against inadvertent operation. Suitable for all operators up to 40mm dia.	Half shroud Full shroud	<b>E22MS</b> <b>E22MSF</b>		0.05 0.05
	<b>Hole plug</b> Forms oil and watertight seal (IP66) for unused panel hole.	Plastic Stainless steel	<b>E22BHP</b> <b>E22BA8</b>		0.015 0.03
	<b>Bulb removal tool.</b> To assist bulb removal on illuminated operators from front of panel		<b>E22BA3</b>		
	<b>Handtool</b> For cutting 22.5mm diameter hole Maximum sheet steel panel thickness 1.6mm		<b>E22BA5</b>		
	<b>Octagonal box spanner.</b> Ensures easy tightening of rear of panel mounting rigs on all operators.		<b>E22BA6</b>		
	<b>Bulb extender</b> For use with BA9s bayonet base bulbs. For use with illuminated selector and push-pull switches.		<b>E22BA4</b>		
	<b>Hole Reducer</b> Converts 30.5 mm hole in diecast enclosures to 22.5 mm		<b>E22BA14</b>		





**Accessories (continued)**

Description	Colour	Catalogue numbers		Selector switch Levers		Selector switch Knobs	
		Push-pull cap 29.5mm	40mm				
<b>Replacement caps, levers and knobs – Non-illuminated</b>   Caps  Levers   Knobs	Black	<b>E22AHS1</b>	<b>E22AH1</b>	<b>E22AV1</b>	<b>E22AV21</b>	<b>E22AX1</b>	<b>E22AX21</b>
	Red	<b>E22AHS2</b>	<b>E22AH2</b>	<b>E22AV2</b>	<b>E22AV22</b>	<b>E22AX2</b>	<b>E22AX22</b>
	Green	<b>E22AHS3</b>	<b>E22AH3</b>	<b>E22AV3</b>	<b>E22AV23</b>	<b>E22AX3</b>	<b>E22AX23</b>
	Yellow	<b>E22AHS4</b>	<b>E22AH4</b>	<b>E22AV4</b>	<b>E22AV24</b>	<b>E22AX4</b>	<b>E22AX24</b>
	White	<b>E22AHS5</b>	<b>E22AH5</b>	<b>E22AV5</b>	<b>E22AV25</b>	<b>E22AX5</b>	<b>E22AX25</b>
	Blue	<b>E22AHS6</b>	<b>E22AH6</b>	<b>E22AV6</b>	<b>E22AV26</b>	<b>E22AX6</b>	<b>E22AX26</b>
	Grey	<b>E22AHS7</b>	<b>E22AH7</b>	<b>E22AV7</b>	<b>E22AV27</b>	<b>E22AX7</b>	<b>E22AX27</b>
	Orange	<b>E22AHS8</b>	<b>E22AH8</b>	<b>E22AV8</b>	<b>E22AV28</b>	<b>E22AX8</b>	<b>E22AX28</b>
	Red marked EMERGENCY STOP	–	<b>E22AH2N8</b>	–	–	–	–

Description	Colour	Catalogue numbers		Selector switch Levers		Selector switch Knobs	
		Push-pull cap 29.5mm	40mm				
<b>Illuminated</b>   Caps  Levers   Knobs	Clear	<b>E22AFS0</b>	<b>E22AF0</b>	<b>E22AW0</b>	<b>E22AW20</b>	<b>E22AR0</b>	<b>E22AR20</b>
	Red	<b>E22AFS2</b>	<b>E22AF2</b>	<b>E22AW2</b>	<b>E22AW22</b>	<b>E22AR2</b>	<b>E22AR22</b>
	Green	<b>E22AFS3</b>	<b>E22AF3</b>	<b>E22AW3</b>	<b>E22AW23</b>	<b>E22AR3</b>	<b>E22AR23</b>
	Yellow	<b>E22AFS4</b>	<b>E22AF4</b>	<b>E22AW4</b>	<b>E22AW24</b>	<b>E22AR4</b>	<b>E22AR24</b>
	White	<b>E22AFS5</b>	<b>E22AF5</b>	<b>E22AW5</b>	<b>E22AW25</b>	<b>E22AR5</b>	<b>E22AR25</b>
	Blue	<b>E22AFS6</b>	<b>E22AF6</b>	<b>E22AW6</b>	<b>E22AW26</b>	<b>E22AR6</b>	<b>E22AR26</b>
	Amber	<b>E22AFS9</b>	<b>E22AF9</b>	<b>E22AW9</b>	<b>E22AW29</b>	<b>E22AR9</b>	<b>E22AR29</b>
	Red marked EMERGENCY STOP	–	<b>E22AF2N8</b>	–	–	–	–

Description	Colour	Catalogue numbers		Glass lens	Lens for double pushbutton
		Standard lens	Lens for printed insert*		
<b>Replacement lenses – indicating lights</b>   Standard lens  Glass lens	Clear	<b>E22AE0</b>	<b>E22AG0</b>	<b>E22AC0</b>	<b>E22AE20</b>
	Red	<b>E22AE2</b>	<b>E22AG2</b>	<b>E22AC2</b>	<b>E22AE22</b>
	Green	<b>E22AE3</b>	<b>E22AG3</b>	<b>E22AC3</b>	<b>E22AE23</b>
	Yellow	<b>E22AE4</b>	<b>E22AG4</b>	–	–
	White	<b>E22AE5</b>	<b>E22AG5</b>	<b>E22AC5</b>	<b>E22AE25</b>
	Blue	<b>E22AE6</b>	<b>E22AG6</b>	<b>E22AC6</b>	<b>E22AE26</b>
	Amber	<b>E22AE9</b>	<b>E22AG9</b>	<b>E22AC9</b>	<b>E22AE29</b>

Description	Colour	Catalogue numbers		Glass lens	Lens for double pushbutton
		Standard lens	Lens for printed insert*		
 Lens for printed insert  Printed insert	<b>* Printed insert</b>	<b>Catalogue no.</b>		<b>* Printed insert</b>	<b>Catalogue no.</b>
	Without marking	<b>E22AL5</b>		On	<b>E22AL5N25</b>
	Motor run	<b>E22AL5N81</b>		Power on	<b>E22AL5N80</b>
	Motor running	<b>E22AL5N56</b>		Supply on	<b>E22AL5N61</b>
	Motor stopped	<b>E22AL5N57</b>		Special legend	<b>E22AL5N36X</b>
	Off	<b>E22AL5N24</b>			

**Spare keys**

Description	Ref. no.	Catalogue numbers
2 Standard keys	92239	<b>E22KS2</b>
1 Master key (For all non-standard locks)	92	<b>E22KM92</b>







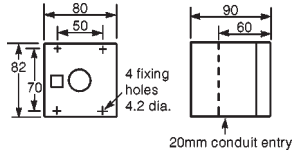

*For spare keys of locks not listed please contact Eaton*

## E22 Series - Enclosures - polycarbonate

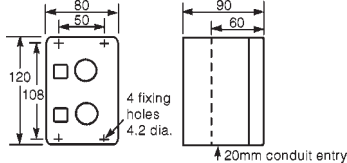
## Enclosures – polycarbonate

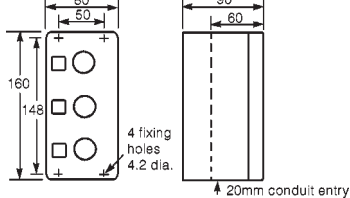
## Main features

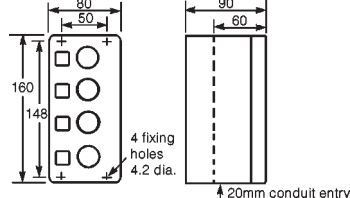

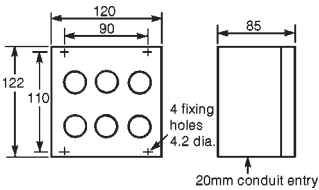

- Polycarbonate enclosures
- IP65 ingress protection
- Quick release stainless steel screws
- Double insulated
- Colour light grey

	Description	Usable depth	Catalogue numbers	Weight (kg)	Overall dimensions (mm)
	<b>Single way</b> Grey base and grey lid	56mm	<b>E22CSP1</b>	0.1	
	Grey base and yellow lid	86mm	<b>E22CDP1</b>	0.1	
	<b>Two way</b> Mounting matrix 36mm	56mm	<b>E22CSP2</b>	0.2	
		86mm	<b>E22CDP2</b>	0.4	
	<b>Three way</b> Mounting matrix 36mm	56mm	<b>E22CSP3</b>	0.2	
		86mm	<b>E22CDP3</b>	0.4	
	<b>Four way</b> Mounting matrix 30mm	56mm	<b>E22CSP4</b>	0.2	
		86mm	<b>E22CDP4</b>	0.4	
	<b>Six way</b> Mounting matrix 36mm x 47mm	81mm	<b>E22CDP6</b>	0.6	

**Enclosures – die cast aluminium**

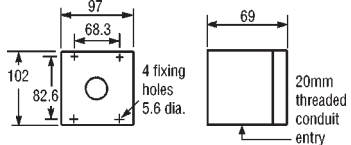

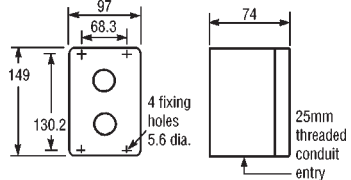

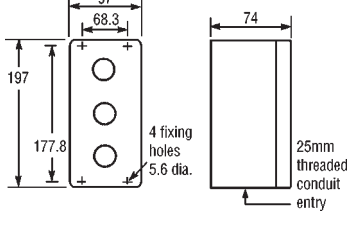









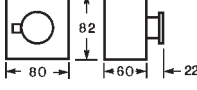
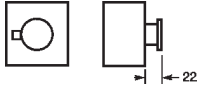
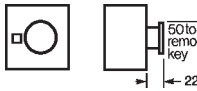
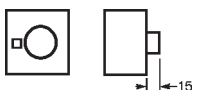
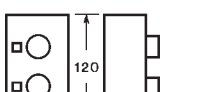

**Main features**

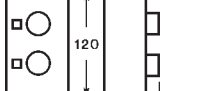
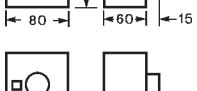
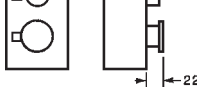
- Powder coated paint finish
- IP65 ingress protection
- Threaded conduit entry
- Colour light grey RAL 7032

	Description	Usable depth	Catalogue numbers	Weight (kg)	Overall dimensions (mm)
	<b>Single way</b> Grey base and grey lid	50mm	<b>E22CDD1</b>	0.05	
	Grey base and yellow lid	50mm	<b>E22CDD1Y</b>	0.05	
	<b>Two way</b> Mounting matrix 47mm	50mm	<b>E22CDD2</b>	0.65	
	<b>Three way</b> Mounting matrix 47mm	50mm	<b>E22CDD3</b>	0.76	

## E22 Series - Assembled stations

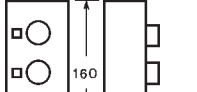
## Assembled stations

Description	Operator	Button colour	Contact arrangement	Catalogue numbers		Operator dimensions (mm)	Weight (kg)
				Chrome bezel	Black bezel		
<b>Single way</b>     	40 mm mushroom	Red (spring return)	N.C. Yellow background	<b>E22AS105</b>	<b>E22ASB105</b>		0.2
	40 mm mushroom	Red (latch-in twist to release)	N.C. Yellow background	<b>E22AS106</b>	<b>E22ASB106</b>		0.2
	40 mm mushroom (latch-in key release)	Red	N.C. Yellow background (IP54)	<b>E22AS107</b>	<b>E22ASB107</b>		0.23
	Start (flush)	Green with legend	N.O.	<b>E22AS108</b>	<b>E22ASB108</b>		0.2
	Stop (extended)	Red with legend	N.C.	<b>E22AS109</b>	<b>E22ASB109</b>		0.2
<b>Two way</b>   	Start (flush) Stop (extended)	Green Red	N.O. N.C.	<b>E22AS204</b>	<b>E22ASB204</b>		0.32
	▲ (flush) ▼ (flush)	Black Black	N.O. N.O.	<b>E22AS207</b>	<b>E22ASB207</b>		0.32
	Start (flush) Stop (40 mm mushroom spring return)	Green Red	N.O. N.C.	<b>E22AS205</b>	<b>E22ASB205</b>		0.32
	Start (flush) Stop (40 mm mushroom latch-in twist to release)	Green Red	N.O. N.C.	<b>E22AS206</b>	<b>E22ASB206</b>		0.37
	<b>Three way</b>    	Forward (flush) Stop (extended) Reverse (flush)	Black Red Black	N.O. N.C. N.O.	<b>E22AS304</b>	<b>E22ASB304</b>	
Open (flush) Stop (extended) Close (flush)		Black Red Black	N.O. N.C. N.O.	<b>E22AS305</b>	<b>E22ASB305</b>		0.5
Up (flush) Stop (extended) Down (flush)		Black Red Black	N.O. N.C. N.O.	<b>E22AS306</b>	<b>E22ASB306</b>		0.5
▲ (flush) ○ (extended) ▼ (flush)		Black Red Black	N.O. N.C. N.O.	<b>E22AS307</b>	<b>E22ASB307</b>		0.5

**Technical data**

**Operator forces**

Operation		Initial force (N)	Final force (N)
Pushbutton	25mm	2.25	5.6
	Mushroom	3	6.9
2 Position push/pull		16	0
3 Position push/pull	Push	0	22.3
	Pull	0	33.5
Single circuit contact block	E22B2 N.O. contact block	1	4.45
	E22B1 N.C. contact block	0.3	3.4
Dual circuit contact blocks	E22B20 2N.O. contact block	0.8	5.9
	E22B11 1N.O. + 1N.C contact block	0.6	5.4

**Operator torque**

Operation		Initial torque (Nm)	Final torque (Nm)
Key, lever & knob selectors	Spring return	0.1	0.15
	Maintained	0.2	0.3

**Mounting (mm)**

Description	Dimension	
Mounting panel thickness – minimum	1	
	– maximum	6.35*
* The accessories alongside reduce the maximum panel thickness by the following amount.	Legend plates	1.25
	Locating ring	1.5
	Padlockable cover	2.4
	Rubber boots	1.3

Optional panel notch to provide anti-rotation. Use E22LRP or E22LRM accessory

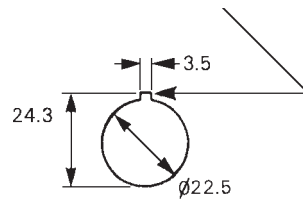

**Mounting matrix – minimum (mm)**

Description	3 Way mounting adaptor		5 Way mounting adaptor		
	Dim 'A'	Dim 'B'	Dim 'A' (1)	Dim 'A' (2)	Dim 'B'
All operators except those below	30	50	40	50	50
3 Position lever selector switches & 40mm operators	45	50	45	50	50
50mm operators	55	55	55	55	55
Pushbuttons assembled with boots or padlockable covers	35	50	40	50	50

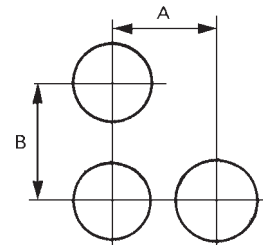

**A (1)** Horizontal spacing for one 3 way & one 5 way mounting adaptor.

**A (2)** Horizontal spacing for two 5 way mounting adaptors.

**AC15 Electrical durability**

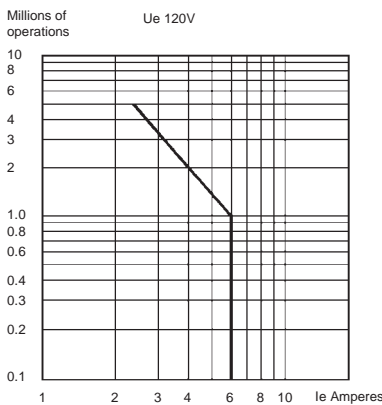

**DC13 Electrical durability**

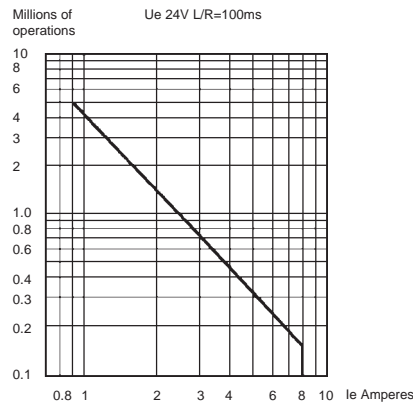

**DC13 Electrical durability**

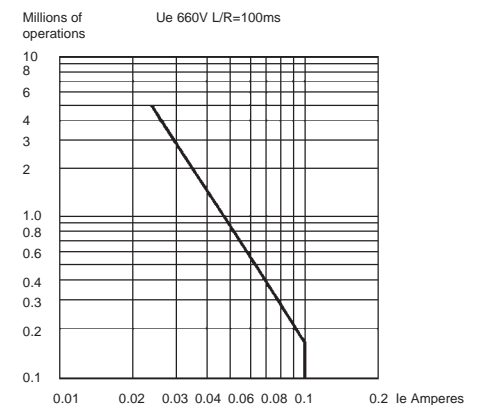

## E22 Series - Technical data

## Technical data

	Contact blocks	Pushbutton operators	Push/pull operators	Double headed operators
<b>General</b>				
Standards and approvals	IEC947-5-1, IEC337-1, BS4794, VDE0660, UL508, CSA22.2 no. 14, Lloyds			
Terminal markings	EN50013 (BS5581)	–	–	–
Ingress protection – IEC529*	–	IP65	1P65	–
– UL508 (NEMA)*	–	Type 4, 4x, 13	Type 4, 4x, 13	–
Protection against direct contact IEC529	IP20	–	–	–
Mechanical life span (no. of operations)	3,000,000	5,000,000	300,000	1,000,000
Operating frequency (operations per hour)	6,000	6,000	3,000	6,000
Weight	13g (single) 22g (double)	43g	32g	26g
<b>Environment</b>				
Pollution degree IEC947-1	3	3	3	3
Impulse withstand voltage IEC947-1	4kV	4kV	4kV	4kV
Operating ambient temperature – non-illuminated	–20 to +60°C	–20 to +60°C	–20 to +60°C	–20 to +60°C
– illuminated	–	–20 to +60°C	–20 to +60°C	–20 to +60°C
Vibration resistance 10 sweeps 10 - 500Hz		5g	5g	5g –
Shock resistance (shock duration 18ms)		30g	30g	30g –
Bump resistance 6ms 1000cycles	25g	25g	25g	–
Storage temperature	–40 to +80°C	–40 to +80°C	–40 to +80°C	–40 to +80°C
Mounting position	Any	Any	Any	Any
Operating altitude	2000m	2000m	2000m	2000m
<b>Cabling capacity</b>				
Number of conductors	2	–	–	–
Solid, stranded or flexible – Max wire size (mm <sup>2</sup> )	2.5	–	–	–
– Min wire size (mm <sup>2</sup> )	0.75	–	–	–

\* Ingress protection provided by E22 component fitted to a suitable enclosure.

## Contact ratings – Contact blocks

Thermal current I <sub>th</sub>	10A
Insulation voltage U <sub>i</sub>	690V
Operating frequency limits	50 to 60Hz
Adjacent contacts 'electrically separate'	Yes

AC15 duty (AC11 to IEC337)	U <sub>e</sub>	VA	I <sub>e</sub>
Control of A.C. electromagnetic loads	48V	480	10A
	120V	720	6A
	240V	960	4A
	440V	880	2A
	660V	990	1.5A

DC13 duty (DC11 to IEC337)	U <sub>e</sub>	W	I <sub>e</sub>
Control of D.C. electromagnets	24V	192	8A
	48V	288	6A
	120V	120	1A
	220V	110	0.5A
	440V	110	0.25A
	660V	66	0.1A

## Short circuit co-ordination

Conditional short circuit current I <sub>g</sub>	1kA
Fuse type BS88 type gG	10A

## UL and CSA ratings

Maximum rated voltage	600Vac
Switching capacity	
– Heavy pilot duty (A600)	6A ac
– Heavy pilot duty (Q600)	0.55A dc

## Contact operation

Normally open (N.O.)	Slow make, break
Normally closed (N.C.)	Slow make break, positive action

## Low power switching

(Operating under normal environmental conditions)	
Minimum operational voltage (ac/dc)	5V
Minimum operational current (ac/dc)	1mA

**E22 Series - Technical data**

Mushroom operators	Selector switch operators	Rotary cam selector switches	Transformer light source units	Non-transformer light source units	Indicating lights	Monoblock indicating lights
IEC947-5-1, IEC337-1, BS4794, VDE0660, UL508, CSA22.2 no 14, Lloyds						IEC337-1
–	–	EN50013 (BS5581)	EN50013 (BS5581)	EN50013 (BS5581)	EN50013 (BS5581)	EN50013 (BS5581)
IP65	IP65	IP65	–	–	IP65	–
Type 4, 4x, 13	Type 4, 4x, 13	Type 4, 4x, 13	–	–	Type 4, 4x, 13	–
–	–	–	IP20	IP20	–	IP10
300,000	500,000	2,000,000	–	–	–	–
1,200	3,000	3,000	–	–	–	–
70g	55g (key) 43g (lever)	106g (4 circuit) 115g (6 circuit) 125g (8 circuit)	80g	14g	23g	21g
3	3	3	3	3	3	3
4kV	4kV	4kV	4kV	4kV	4kV	4kV
–20 to +60°C	–20 to +60°C	–20 to +60°C	–	–	–	–
–20 to +60°C	–20 to +60°C	–	–20 to +60°C	–20 to +60°C	–20 to +60°C	–20 to +60°C
5g	5g	–	5g	5g	5g	–
30g	30g	30g†	30g	30g	30g	–
25g	25g	25g†	25g	25g	25g	–
–40 to +80°C	–40 to +80°C	–40 to +80°C	–40 to +80°C	–40 to +80°C	–40 to +80°C	–40 to +80°C
Any	Any	Any	Any	Any	Any	Any
2000m	2000m	2000m	2000m	2000m	2000m	2000m
–	–	2	2	2	–	2
–	–	1.5	2.5	2.5	–	2.5
–	–	0.75	0.75	0.75	–	0.75

† Rotary cam selector switches having no more than 4 circuits.

**Contact ratings – Rotary cam switches**

Thermal current I <sub>th</sub>	10A		
Insulation voltage U <sub>i</sub>	500V		
Operating frequency limits	50-60Hz		
Adjacent contacts 'electrically separate'	Yes		
<b>AC1 duty</b>	U <sub>e</sub>	VA	I <sub>e</sub>
Resistive or low inductive loads	380V	3,800	10A
<b>AC11 duty</b>			
Control of A.C. electromagnets	240V 440V	600 660	2.5A 1.5A
<b>AC21 duty</b>			
Switching of resistive loads, including moderate overloads	500V	5,000	10A
<b>AC22 duty</b>			
Switching of combined resistive or inductive loads, including moderate overloads	500V	5,000	10A
<b>Short circuit co-ordination</b>			
Conditional short circuit current I <sub>g</sub>	3kA		
Fuse type BS88 type gG	10A		
Circuit breaker type	To be announced		

**DC switching capacity**

Number of series contacts	Voltage (V)								Amperes
	1	2	3	4	5	6	8		
<b>DC1 resistive loads</b>	24	48	70	95	120	144	190	10	
	48	95	140	190	240	290	350	6	
L/R<=1ms	60	120	180	240	300	360	450	2.5	
	110	220	330	440	–	–	–	0.7	
	220	440	–	–	–	–	–	0.3	
	440	–	–	–	–	–	–	0.2	
<b>DC1 inductive loads</b>	24	48	72	96	120	144	190	6	
	30	60	90	120	150	180	240	3	
L/R<=50ms	48	95	140	190	240	290	350	1	
	60	120	180	240	300	360	450	0.7	
	110	220	330	440	–	–	–	0.3	

**UL & CSA ratings**

Maximum rated voltage	300V ac
Switching capacity, heavy pilot duty A300	3A ac
DOL motor load	3 phase 240V 1HP 1 phase 120V 0.33HP 240V 0.75HP

## E22 Series - Technical data

## Technical data – Trigger action actuators

## Description

The E22LTA2 is a latching, trigger-action, twist-to-release pushbutton actuator designed specifically for use as an Emergency Stop Switch.

The E22MGTA is a rectangular guard designed to prevent accidental or inadvertent actuation of the E22TLA actuator. It is also designed to permit easy knob rotation access for manually resetting the switch.

The E22CB1, E22CB11 & E22CB1E contact blocks are specially marked contact blocks indicating compliance with IEC 60947-5-1 Annex K.

## Application

The E22LTA2 actuator and E22CB\* contact blocks are intended to be the primary and/or one of several series-connected emergency stop switches in a control panel. The N.C. (normally closed), break electrical contacts are D.O.A. (direct opening action) which are designed to be forcibly opened by the movement of the actuator in the event that the contact should be tack welded etc.

## Key features

- ★ Mushroom head button (40mm diameter) for easy actuation (per EN418 Section 4.4).
- ★ Safety red coloured button per ANSI Z535.1 and EN418 Section 4.4.3.
- ★ Manually resettable actuator.
- ★ Rectangular guard is coloured safety yellow per ANSI Z535.1 and provides yellow background for the actuator per EN418 Section 4.4.3.
- ★ All external pushbutton and guard materials have a V-0 flammability rating per UL94.
- ★ Contact blocks are A600/Q600 rated per UL508 and AC15/DC13 rated per IEC 60947-5-1.
- N.C. (normally closed), break contact blocks are positive opening or D.O.A. (direct opening action) in accordance with EN418 Section 4.1.2.
- ★ Suitable for isolation per IEC 60947-5-1.

## Environmental ratings (actuator)

## Ingress protection

UL (NEMA) 1, 2, 3, 3R, 4, 4X, 12 & 13 and IEC IP 65 when mounted on a flat surface of a similarly rated enclosure. Above ratings do not apply to applications where devices are mounted directly unto a machine without the use of a separate console or enclosure. If not installed in a suitable panel or enclosure, precautions must be taken to safeguard contact blocks against electrical contact or shock and from contamination from environmental or working conditions of the machine.

## Operating temperature

-20° to +60°C

## Storage temperature

-40° to +80°C

## Altitude

2,000m

## Humidity

Max 95% RH @ 60°C

## Flammability

UL94 V-0 rated

## UV resistance

Shield actuator from excessive exposure to UV, and routinely perform a functional test of the emergency stop switch and inspect actuator for fading and cracking after every 500 hours of UV exposure.

## Mechanical endurance ratings (actuator)

## Life

100,000 cycles (actuation & release)

## Frequency of operation

6 per minute

## Vibration

5g, 0.7mm peak to peak, 10 sweeps, 10 to 500Hz

## Shock

30g, 12ms

## Bump

25g, 6ms for 1,000 cycles

## Electrical ratings (contact blocks)

- ★ A600 & Q600 per UL508
- ★ AC15 & DC13 per IEC 60947-5-1

## AC Life (AC15)

120Vac, 6A - 1,000k operations

## DC Life (DC13)

24Vdc, 4A - 400k operations

## N.C. Contacts

DOA (direct opening action) per IEC 60947-5-1

## Short circuit co-ordination rating

1kA

## Short circuit co-ordination fuse

GE Power Controls TIA 10, Red Spot type gG, 10A 660Vac 460Vdc, BS88-2, per IEC 60269-2-1

## Standards &amp; certifications

- ★ UL Listed E-Stop device per file # E217948
- ★ Certified to EN 60947-5-1 & EN 60947-5-5 per DEMKO certificate # 129648-01/A1
- ★ Certified to EN418 per DEMKO Certificate # 129648-02/A2
- ★ UL508 listed per file # E131568
- ★ CSA certified per file # LR68551



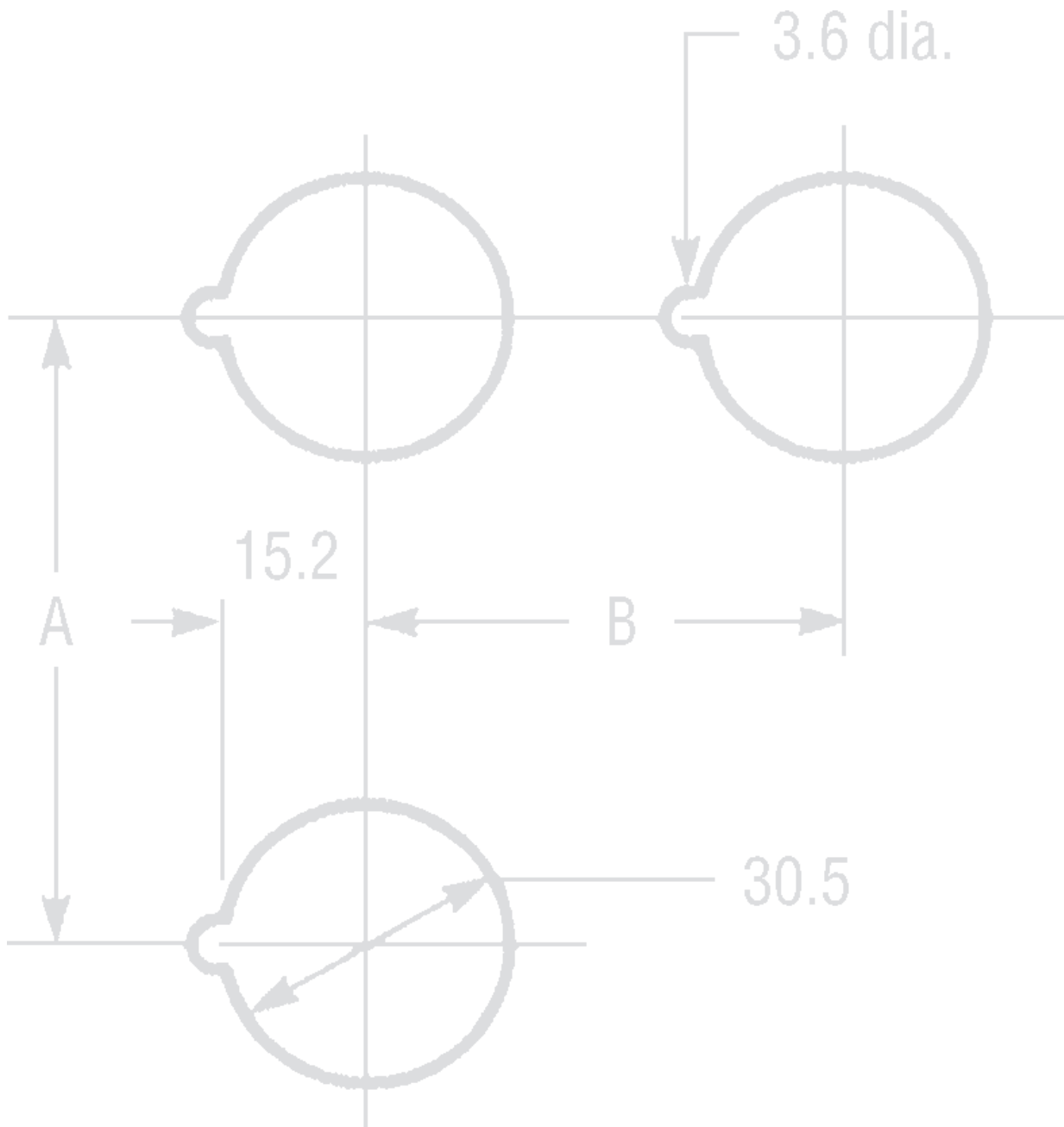







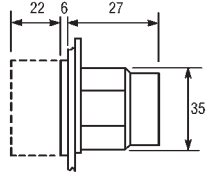

**30.5mm operators – 91000T Series**

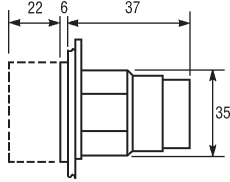
<b>Description</b>	<b>Page</b>	<b>Description</b>	<b>Page</b>
Pushbutton operators	32	Roto-push pushbuttons	38
Mechanical push operators	32	Joystick controllers	39
Illuminated pushbuttons	33	Legend plates	40
Cylinder lock pushbuttons	33	Accessories	41
Contact blocks	33	Assembled pushbutton stations	43
Knob or lever operated selector switches	34	Emergency stop stations	43
Key operated selector switches	35	Aluminium alloy enclosures	44
Standard indicating lights	36	Technical data	45
Prestest Indicating lights	37		

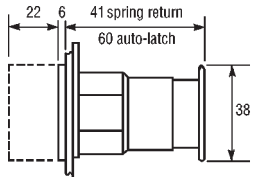
## 91000T Series - Pushbutton and mechanical push operators

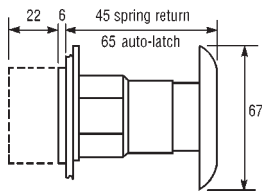
## Pushbutton operators

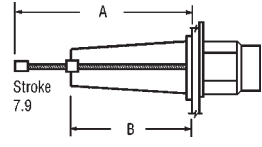

Description	Button colour	Catalogue numbers	Overall dimensions (mm)	Weight (kg)
<b>Flush button</b> 	Black	<b>91000T101</b>		0.093
	Red	<b>91000T102</b>		0.093
	Green	<b>91000T103</b>		0.093
	Yellow	<b>91000T104</b>		0.093
	White	<b>91000T106</b>		0.093
	Blue	<b>91000T108</b>		0.093
<b>Extended button</b> 	Black	<b>91000T111</b>		0.093
	Red	<b>91000T112</b>		0.093
	Green	<b>91000T113</b>		0.093
<b>Padlockable, lockdown</b> Fitted with 38mm mushroom push 	Red	<b>91000TA45</b>		0.95
<b>Complete flush operator</b> Auto-latch	Red	<b>91000T2821</b>		0.95
<b>Bare shaft operator</b> For mushroom or palm push 	Momentary, spring return	<b>91000T100</b>		0.095
	Auto-latch	<b>91000T140</b>		0.095
<b>Operating pushes for bare shaft operators</b>				
<b>Mushroom 38.1mm</b> 	Black	<b>91000T281</b>		
	Red	<b>91000T282</b>		
	Green	<b>91000T283</b>		
	Yellow	<b>91000T284</b>		
	Blue	<b>91000T288</b>		
<b>Palm 63.5mm</b> 	Black	<b>91000T291</b>		
	Red	<b>91000T292</b>		
	Green	<b>91000T293</b>		
<b>Extended pushbutton</b> 	Red	<b>91000T2820</b>		

## Mechanical push operators

Description	Colour	Catalogue numbers	Overall dimensions (mm)	Weight (kg)												
 Flush push, standard reach, 127mm	Black	<b>91000TA85</b>		0.015												
	Green	<b>91000TA86</b>		0.015												
	Red	<b>91000TA87</b>		0.015												
Flush push, long reach, 217mm	Black	<b>91000TA97</b>	<table border="1"> <thead> <tr> <th>Dimension</th> <th>A Min</th> <th>A Max</th> <th>B</th> </tr> </thead> <tbody> <tr> <td>Std. reach</td> <td>35</td> <td>127</td> <td>8</td> </tr> <tr> <td>Long reach</td> <td>118</td> <td>217</td> <td>85</td> </tr> </tbody> </table>	Dimension	A Min	A Max	B	Std. reach	35	127	8	Long reach	118	217	85	0.015
	Dimension	A Min		A Max	B											
	Std. reach	35		127	8											
Long reach	118	217	85													
Green	<b>91000TA98</b>	0.015														
	Red	<b>91000TA99</b>	0.015													

For base mounting contact block information see page 44

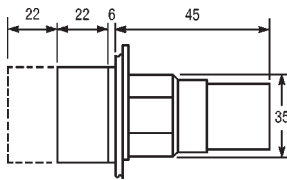
**Illuminated pushbuttons** BA9s bayonet fitting. For replacement bulbs see page 42.

	Description	Supply voltage 50/60Hz	Catalogue numbers	Overall dimensions (mm)	Weight (kg)	
 <p>Operator</p>	<b>Transformer type</b>	110/120	<b>91000T411</b>		0.19	
	6V 1W secondary.	220/240	<b>91000T412</b>		0.19	
	Bulb supplied	380/415	<b>91000T413</b>		0.19	
		440/480	<b>91000T414</b>		0.19	
	<b>Direct voltage</b>					
	Supplied without bulb	6 to 240	<b>91000T441</b>		0.093	
	<b>BA9s bayonet bulbs</b> (for use with 91000T441)					
 <p>Lens</p>	<b>Filament type</b>	6V (1W) flasher	<b>28-2225-26</b>			
		6.3V (1W)	<b>28-2225-72</b>			
		12V (1.2W)	<b>28-2225-29</b>			
		24V (1.2W)	<b>28-2225-30</b>			
		28V (1.12W)	<b>28-2225-73</b>			
		50V (1W)	<b>28-2225-31</b>			
		60V (1.2W)	<b>28-2225-32</b>			
		110V (2.2W)	<b>28-2225-24</b>			
		<b>Neon type</b>	110V (0.8mA)	<b>28-2225-48</b>		
			240V (1.5mA)	<b>28-2225-49</b>		

**LED Bulbs** see page 37

**Plastic lens** (for use with illuminated pushbuttons).

Colour	Catalogue numbers	Colour	Catalogue numbers	Colour	Catalogue numbers
Red	<b>91000TC21</b>	Amber	<b>91000TC43</b>	Clear	<b>91000TC25</b>
Green	<b>91000TC22</b>	Blue	<b>91000TC24</b>	White	<b>91000TC26</b>

**Cylinder lock pushbuttons**

**Operators** (Supplied with the standard lock and 2 keys, key ref. H661).

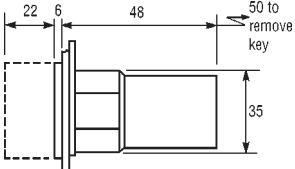
	Key position and pushbutton operation			Key removal positions	Catalogue numbers		Weight (kg)
	Left	Centre	Right				
	Lock-up	Free	Lock down	All	<b>91000T430</b>		0.185
	Blocked	Free	Push to lock	C & R	<b>91000T437</b>		0.185

**Special lock selection:** Add the appropriate suffix code from page 35. eg 91000T430H620.

**Contact blocks**

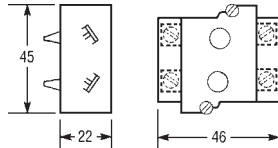
	Description	Catalogue numbers: One-hole mounting *	Overall dimensions (mm)	Weight (kg)
	1 N.O. 1 N.C.	<b>91000T1</b>		0.025
	2 N.O.	<b>91000T2</b>		0.025
	2 N.C.	<b>91000T3</b>		0.025
	1 N.C.	<b>91000T51</b>		0.025
	1 N.O.	<b>91000T53</b>		0.025
	2 N.O. 2 N.C.	<b>91000T44</b>		0.025
	1 N.O. 1 N.C. make before break	<b>91000T55</b>		0.025

**Note:**



A maximum of 6 blocks (12 circuits) may be fitted to each operator except for 91000T44 where a maximum of 4 blocks (16 circuits) may be fitted.

\* For base mounting contact blocks see page 44.

## 91000T Series - Knob or lever operated selector switches

## Knob or lever operated selector switches

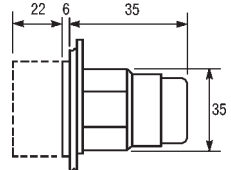
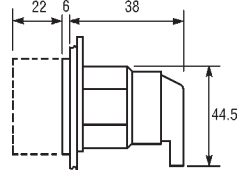
## Bare shaft operator

	Description	Cam code	Catalogue numbers	Overall dimensions (mm)	Weight (kg)	
	<b>2-position</b>					
	Stayput	1	<b>91000T4011</b>		0.115	
	Spring return right to left	1	<b>91000T4081</b>		0.115	
	<b>3-position</b>					
	Stayput	2	<b>91000T4022</b>		0.115	
		3	<b>91000T4023</b>		0.115	
		4	<b>91000T4024</b>		0.115	
		6*	<b>91000T4026</b>		0.115	
	Spring return from left, stayput centre and right	2	<b>91000T4032</b>	0.115		
		3	<b>91000T4033</b>	0.115		
Spring return to centre from left and right	2	<b>91000T4042</b>	0.115			
	3	<b>91000T4043</b>	0.115			
Stayput left and centre, spring return from right	2	<b>91000T4052</b>	0.115			
	3	<b>91000T4053</b>	0.115			
	<b>Knob</b> (for any operator)		<b>91000TKB</b>			
	<b>Lever</b> (for any operator)		<b>91000TLB</b>			

## Cam selection chart showing contact sequence

To determine the number of the cam you require and the right contact block select the contact sequence desired from table below. O = contacts open, X = contacts closed. The cam number is shown at top of column. The catalogue number of the appropriate contact block is shown at extreme left of table.

Catalogue numbers of contact block	Base mounting	Circuit (see note (1) at foot of table)	2-position selector switch		3-position selector switch			
			Cam code no. 1	Cam code no. 2	Cam code no. 3	Cam code no. 4	Cam code no. 6 †	
<b>91000T1</b>	<b>91000T6</b>	A N.C.	XO	OXO	OXX	XOO	XOO	
		B N.O.	OX	OOX	OOX	OXO	OXO	
<b>91000T1</b>	<b>91000T6</b>	A N.O.	OX	XOX	XOO	OXX	OOX	
		B N.C.	XO	XXO	XXO	XOX	OOX	
<b>91000T2</b>	<b>91000T7</b>	A N.O.	OX	XOX	XOO	OXX	OOX	
		B N.O.	OX	OOX	OOX	OXO	OXO	
<b>91000T3</b>	<b>91000T8</b>	A N.C.	XO	OXO	OXX	XOO	XOO	
		B N.C.	XO	XXO	XXO	XOX	OOX	

## Switching angle.

60° between each position.



## Note:

(1) Each contact block contains two contact circuits. The top set of contacts is identified as 'Circuit A' and the lower set as 'Circuit B' is indicated in the table. The chart shows the contact arrangements with the three contact blocks available and in each operator position. Additional contact combinations are obtainable by stacking contact blocks in tandem up to a maximum of 6 blocks (12 circuits).

† A maximum of 2 are to be used with cam 6. Rated fo A.C. only.

**Key operated selector switches**

**Operators** (Supplied with the standard lock and 2 keys, key ref. H661)

	Description code	Cam removal	Key Vertical position	Catalogue numbers Horizontal mounting *	dimensions mounting *	Overall (kg) (mm)	Weight
	<b>2-position</b>						
	Stayput	1	Right & left	<b>91000T15113</b>	<b>91000T16113</b>		0.185
	Spring return right to left	1	Left only	<b>91000T15712</b>	<b>91000T15812</b>		0.185
	<b>3-position</b>						
	Stayput	2	Left, right & centre	<b>91000T15227</b>	<b>91000T16227</b>		0.185
		3		<b>91000T15237</b>	<b>91000T16237</b>		0.185
		4		<b>91000T15247</b>	<b>91000T16247</b>		0.185
		6		<b>91000T15267</b>	<b>91000T16267</b>		0.185
	Spring return from left	2	Right & centre	<b>91000T15325</b>	<b>91000T16325</b>		0.185
		3		<b>91000T15335</b>	<b>91000T16335</b>		0.185
	Spring return to centre from left and right	2	Centre only	<b>91000T15424</b>	<b>91000T16424</b>		0.185
		3		<b>91000T15434</b>	<b>91000T16434</b>		0.185
	Spring return from right	2	Left & centre	<b>91000T16526</b>	<b>91000T16626</b>		0.185
3		<b>91000T16536</b>		<b>91000T16636</b>		0.185	

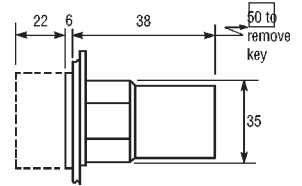

\* **Vertical mounting** means terminals are left & right of contact block.

**Horizontal mounting** means terminals are top & bottom of contact block. This allows close spacing of adjacent operators with easy access to terminals.

**Alternative key removal position selection**

To select an alternative key removal position change the last digit of the listed catalogue number with a code from the table below e.g. 91000T1522**6** is a 3 position stayput switch with key removal from left and centre.

Key removal position	Suffix
Right	<b>1</b>
Left	<b>2</b>
Right and Left	<b>3</b>
Centre	<b>4</b>
Right and Centre	<b>5</b>
Left and Centre	<b>6</b>
All Positions	<b>7</b>

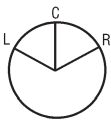

**Note:** Select one suffix number only. Key removal in a spring return position is not available.

**Special lock selection**

To select an alternative lock add the suffix code from the table below to the operator catalogue number e.g. 91000T15113**H621**



Special lock Suffix	Suffix
<b>H620</b>	<b>H654</b>
<b>H621</b>	<b>H663</b>
<b>H634</b>	<b>H675</b>
<b>H635</b>	<b>H683</b>
<b>H639</b>	<b>H688</b>
<b>H643</b>	—

Special locks are supplied with two keys. Extra keys may be ordered, refer to accessories page 42.

## 91000T Series - Standard indicating lights

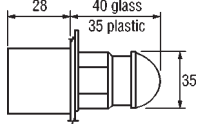
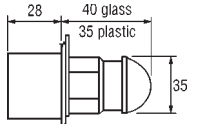

## Standard indicating lights

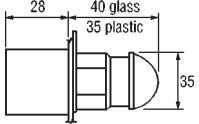
Lamp units Bulbs supplied with units unless otherwise stated. For replacement light bulbs see page 42

	Description	Supply volts 50/60Hz	Catalogue numbers	Overall dimensions (mm)	Weight (kg)	
	<b>Transformer type</b>	110/120	<b>91000T181N</b>		0.22	
	6V 1W secondary BA9s	220/240	<b>91000T182N</b>		0.22	
	bayonet bulb under rated by	380/415	<b>91000T183N</b>		0.22	
	10% for longer life.	550/600	<b>91000T185N</b>		0.22	
	<b>Resistor type</b>	110/120	<b>91000T201N</b>			0.112
	120V 2.2W	220/240	<b>91000T202N</b>	0.112		
		<b>Direct voltage unit (MCC/MBC)</b>				
		Supplied without bulb. Suitable for BA9s bayonet bulbs	6 to 240	<b>91000T197N</b>		0.11
		<b>BA9s bayonet bulbs</b> (for use with 91000T197N)				
		<b>Filament type</b>	6V (1W) flasher	<b>28-2225-26</b>		
		6.3V (1W)	<b>28-2225-72</b>			
		12V (1.2W)	<b>28-2225-29</b>			
		24V (1.2W)	<b>28-2225-30</b>			
		28V (1.12W)	<b>28-2225-73</b>			
		50V (1W)	<b>28-2225-31</b>			
		60V (1.2W)	<b>28-2225-32</b>			
		110V (2.2W)	<b>28-2225-24</b>			
	<b>Neon type</b>	110V (0.8mA)	<b>28-2225-48</b>			
		240V (1.5mA)	<b>28-2225-49</b>			
	<b>Direct voltage unit (SBC)</b>				0.11	
	Supplied without bulb. Suitable for BA15d bayonet bulb	6 to 240	<b>91000T200N</b>			
	<b>BA15d bulbs (filament type)</b>	6	<b>28-2225-18</b>			
	6 – 10 watt.	12	<b>28-2225-19</b>			
	For use with 91000T200N	24	<b>28-2225-20</b>			
		48	<b>28-2225-21</b>			
		130	<b>28-2225-22</b>			
	240	<b>28-2225-23</b>				

## LED Bulbs see page 37

## Lenses

	Colour	Catalogue numbers	
		Plastic	Glass
	Red	<b>91000TC1N</b>	<b>91000TC7N</b>
	Green	<b>91000TC2N</b>	<b>91000TC8N</b>
	Amber	<b>91000TC19N</b>	<b>91000TC9N</b>
	Blue	<b>91000TC4N</b>	<b>91000TC10N</b>
	Clear	<b>91000TC5N</b>	<b>91000TC11N</b>
	White	<b>91000TC6N</b>	<b>91000TC12N</b>
			

**91000T Series - Pretest indicating lights**

**Pretest indicating lights**

**Lamp units** For replacement light bulbs see page 42.

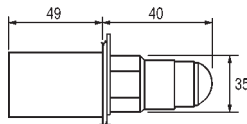
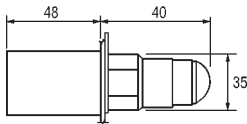
	Description	Supply volts 50/60Hz	Catalogue numbers	Overall dimensions (mm)	Weight (kg)	
	<b>Transformer type</b> 6V 1W secondary BA9s bayonet bulb underrated by 10% for longer life	110/120 220/240 380/415	<b>91000T221N</b> <b>91000T222N</b> <b>91000T223N</b>		0.29 0.29 0.29	
	<b>Resistor type</b> 120V 2.2W BA9s bayonet bulb	110/120 220/240	<b>91000T231N</b> <b>91000T240N</b>			0.185 0.185
	<b>Direct voltage unit (MCC/MBC)</b> Suitable for BA9s bayonet bulbs	6 to 240	<b>91000T230N</b>			0.175
	<b>BA9s bayonet bulbs</b> (for use with 91000T230N)					
	<b>Filament type</b>	6.3V (1W) 12V (1.2W) 24V (1.2W) 50V (1W) 60V (1.2W) 110V (2.2W)	<b>28-2225-72</b> <b>28-2225-29</b> <b>28-2225-30</b> <b>28-2225-31</b> <b>28-2225-32</b> <b>28-2225-24</b>			
	<b>Neon type</b>	110V (0.8mA) 240V (1.5mA)	<b>28-2225-48</b> <b>28-2225-49</b>			

**LED bulbs**



Colour	Catalogue numbers			
	Upto 60Vac/dc	120Vac	120Vdc	135Vac/dc
Blue	<b>E22LED*BN</b>	<b>E22LED120BA</b>	<b>E22LED120BD</b>	<b>E22LED135BD</b>
Green	<b>E22LED*GN</b>	<b>E22LED120GA</b>	<b>E22LED120GD</b>	<b>E22LED135GD</b>
Orange	<b>E22LED*ON</b>	<b>E22LED120OA</b>	<b>E22LED120OD</b>	<b>E22LED135OD</b>
Red	<b>E22LED*RN</b>	<b>E22LED120RA</b>	<b>E22LED120RD</b>	<b>E22LED135RD</b>
White	<b>E22LED*WN</b>	<b>E22LED120WA</b>	–	<b>E22LED135WD</b>
Yellow	<b>E22LED*YN</b>	<b>E22LED120YA</b>	<b>E22LED120YD</b>	<b>E22LED135YD</b>

**Voltage code**

Voltage	Code
10Vac – 6Vdc	<b>006</b>
12Vac – 12Vdc	<b>012</b>
24Vac – 24Vdc	<b>024</b>
35Vac – 35Vdc	<b>035</b>
48Vac – 48Vdc	<b>048</b>
60Vac – 60Vdc	<b>060</b>

\*Add voltage code alongside to complete catalogue number

**Lenses**

	Colour	Catalogue numbers	
		Plastic	Glass
 Plastic   Glass	Red	<b>91000TC21</b>	<b>91000TC13N</b>
	Green	<b>91000TC22</b>	<b>91000TC14N</b>
	Amber	<b>91000TC43</b>	<b>91000TC15N</b>
	Blue	<b>91000TC24</b>	<b>91000TC16N</b>
	Clear	<b>91000TC25</b>	<b>91000TC17N</b>
	White	<b>91000TC26</b>	<b>91000TC18N</b>

## 91000T Series - Roto-push pushbuttons

## Roto-push pushbutton (a combined selector switch and pushbutton)

Description  
colourButton  
VerticalCatalogue numbers  
Horizontal  
mounting dimensions  
mountingOverall  
(kg)  
(mm)

Weight

Black  
Green

91000T241\*

91000T251\*

91000T243\*

91000T253\*

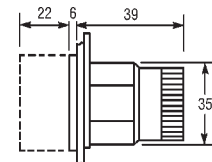

0.128

0.128

\* Complete the catalogue number by adding the respective cam code number from the table below. Example: 91000T24111 is a 2 position roto-push for use as shown below.

## Typical application run-inch, start-inch

2 position roto-push 91000T24111 + 91000T1

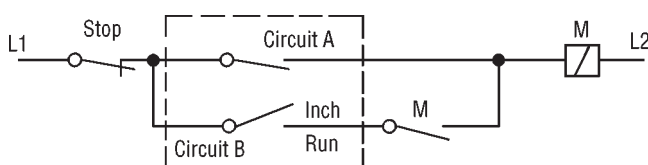

With the roto-push sleeve turned to Inch depression of the push energises coil M through circuit A only so long as the push is pressed i.e. the motor will inch. With the roto-push sleeve turned to Run, the roto-push contact connected to the maintaining contact of M through circuit B is permanently closed, thus when the push is pressed (circuit A) M will close and maintain itself and the motor will run.

## Cam selection chart showing contact sequence

O = contacts open, X = contacts closed. The catalogue number of the appropriate contact block is shown at extreme left of table.

Catalogue number of contact block	Button position	Circuit †	2 position operators										3 position operators		
			Cam code number										7	8	9
			1	2	3	4	5	6	10	11					
91000T1	91000T6	N	A	N.C.	XX	XX	XO	XX	XX	XO	XX	XX	XXX	XOX	XO0
		N	B	N.O.	OO	OO	OX	OX	OX	OX	OX	OX	OXX	OXO	OOX
	D	A	N.C.	XO	XO	OO	OO	XO	XO	OX	OO	OXO	OOX	XO0	
	D	B	N.O.	XO	XX	XX	XX	OX	XX	OX	OX	OXX	OXO	OOX	
91000T1§	91000T6§	N	A	N.O.	OO	OO	OX	OO	OO	OX	OO	OO	OOO	OXO	OOX
		N	B	N.C.	XX	XX	XO	XO	XO	XO	XO	XO	XOO	XOX	XXO
	D	A	N.O.	OX	OX	XX	XX	OX	OX	XO	XX	XOX	XXO	OXO	
	D	B	N.C.	OX	OO	OO	OO	XO	OO	XO	XO	XOO	XOO	XXO	
91000T2	91000T7	N	A	N.O.	OO	OO	OX	OO	OO	OX	OO	OO	OOO	OXO	OOX
		N	B	N.O.	OO	OO	OX	OX	OX	OX	OX	OX	OXX	OXO	OOX
	D	A	N.O.	OX	OX	XX	XX	OX	OX	XO	XX	XOX	XXO	OXO	
	D	B	N.O.	XO	XX	XX	XX	OX	XX	OX	OX	OXX	OXO	OOX	
91000T3	91000T8	N	A	N.C.	XX	XX	XO	XX	XX	XO	XX	XX	XXX	XOX	XO0
		N	B	N.C.	XX	XX	XO	XO	XO	XO	XO	XO	XOO	XOX	XXO
	D	A	N.C.	XO	XO	OO	OO	XO	XO	OX	OO	OXO	OOX	XO0	
	D	B	N.C.	OX	OO	OO	OO	XO	OO	XO	XO	XOO	XOO	XXO	

Note: Cam codes 6 & 7 are for ac use only.

† Each contact block contains two contact circuits. The top set of contacts is identified as 'circuit A' and the lower set as 'B'. The table shows contact arrangement of each contact block with the operating button in normal and depressed positions and in each rotary sleeve position.

Additional combinations are obtainable by stacking contact blocks in tandem.

§ These contact blocks are the same as the ones above except rotated 180° when assembled to the operator.

Switching angle: 60°

N = Button in free or normal position

D = Button depressed



**Joystick controllers**



Eight circuit  
Non-latched operator

- Supplied with 4 position gate fitted
- 3 additional gates supplied which allows conversion to 2, 3 or 8 positions. (T1030, T1050, T1020)
- Up to eight switching positions
- Up to twelve circuits.
- Each circuit N.O. or N.C. required a.c. or d.c.

Description	Catalogue numbers	
	Without latch:	With off position latch:
Spring return only	<b>91000T450</b>	<b>91000T460</b>
Field adjustable spring return to stayput	<b>91000T451</b>	<b>91000T461</b>

**Overall dimensions (mm)**

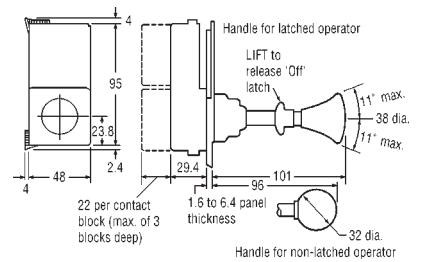

**Contact blocks**

Description	Catalogue numbers
1 N.O. – N.C.	<b>91000T1</b>
2 N.O.	<b>91000T2</b>
2 N.C.	<b>91000T3</b>
1 N.O. 1N.C. make before break	<b>91000T55</b>

**Panel drilling dimensions (mm)**

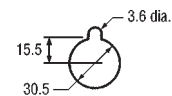

**Legend plates**

Description	Catalogue numbers
Blank	<b>91000TJS1</b>
Engraved	<b>91000TJS2</b>
Hole plug	<b>91000TA700</b>

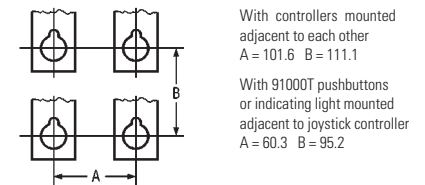

**Positioning gate 91000T1010 is fitted as standard to each operator**

The arrows shown in the 'Handle positions' column A indicates the handle positions and movements available when the indent mark on the gate is adjacent to the letter A on the handle assembly base casting. (No indent mark is provided on gates 91000T1010 and T1020).

Gate profile	Handle position				Catalogue numbers
	A	B	C	D	
					<b>91000T1010</b>
					<b>91000T1020</b>
					<b>91000T1030</b>
					<b>91000T1040</b>
					<b>91000T1050</b>
					<b>91000T1060</b>
					<b>91000T1070</b>
					<b>91000T1080</b>
					<b>91000T1090</b>

Gate profile	Handle position				Catalogue numbers
	A	B	C	D	
					<b>91000T1100</b>
					<b>91000T1110</b>
					<b>91000T1120</b>
					<b>91000T1130</b>
					<b>91000T1130*</b>
					<b>91000T1140</b>
					<b>91000T1150</b>
					<b>91000T1150*</b>
					<b>91000T1160</b>

\* These positioning gates are identical with the one immediately above them. The handle positions shown against these profiles are obtained when the positioning gate is fitted with the indent mark not visible i.e. in contact with the common gate.

## 91000T Series - Legend plates

## Legend plates



Medium



Large

Legend	Catalogue numbers		Legend	Catalogue numbers		Legend	Catalogue numbers	
	Medium	Large		Medium	Large		Medium	Large
	<b>91000T</b>	<b>91000T</b>		<b>91000T</b>	<b>91000T</b>		<b>91000T</b>	<b>91000T</b>
Auto off hand	<b>M49</b>	<b>J49</b>	Inch Run	<b>M41</b>	<b>J41</b>	Raise	<b>M28</b>	<b>J28</b>
(Blank)	<b>M36</b>	<b>J36</b>	Inch Safe Run	<b>M52</b>	<b>J52</b>	Raise Lower	<b>M76</b>	<b>J76</b>
(Blank)§	<b>M37</b>	<b>J37</b>	Jog	<b>M19</b>	<b>J19</b>	Ready	<b>M78</b>	<b>J78</b>
(Blank)	<b>M95†</b>	<b>J95†</b>	Left	<b>M73</b>	<b>J73</b>	Reset	<b>M29</b>	<b>J29</b>
(Blank)§	<b>M96†</b>	<b>J96†</b>	Left Right	<b>M74</b>	<b>J74</b>	Reverse	<b>M30</b>	<b>J30</b>
Close	<b>M11</b>	<b>J11</b>	Local Off			Right	<b>M79</b>	<b>J79</b>
Down	<b>M12</b>	<b>J12</b>	Remote	<b>M66</b>	<b>J66</b>	Run	<b>M31</b>	<b>J31</b>
Emerg Stop§	<b>M13</b>	–	Local Remote	<b>M63</b>	<b>J63</b>	Run Inch	<b>M44</b>	<b>J44</b>
Emergency			Low	<b>M22</b>	<b>J22</b>	Safe Run	<b>M45</b>	<b>J45</b>
Stop§	–	<b>J13</b>	Lower	<b>M23</b>	<b>J23</b>	Seq. Test	<b>M62</b>	<b>J62</b>
Fast	<b>M14</b>	<b>J14</b>	Man Auto	<b>M67</b>	<b>J67</b>	Slow	<b>M32</b>	<b>J32</b>
For Off Rev	<b>M50</b>	<b>J50</b>	Man Off Auto	<b>M68</b>	<b>J68</b>	Slow Fast	<b>M84</b>	<b>J84</b>
For Rev	<b>M38</b>	<b>J38</b>	Motor Run	<b>M58</b>	<b>J58</b>	Slow Off Fast	<b>M85</b>	<b>J85</b>
Forward	<b>M15</b>	<b>J15</b>	Motor Running	<b>M56</b>	<b>J56</b>	Start	<b>M33</b>	<b>J33</b>
Hand Auto	<b>M39</b>	<b>J39</b>	Motor Stop§	<b>M59</b>	<b>J59</b>	Start Inch	<b>M46</b>	<b>J46</b>
Hand Off Auto	<b>M51</b>	<b>J51</b>	Motor Stopped	<b>M57</b>	<b>J57</b>	Start Stop	<b>M47</b>	<b>J47</b>
High	<b>M16</b>	<b>J16</b>	Off§	<b>M64</b>	<b>J64</b>	Stop§	<b>M34</b>	<b>J34</b>
High Low	<b>M40</b>	<b>J40</b>	Off§	<b>M24</b>	<b>J24</b>	Stop Reset§	<b>M88</b>	<b>J88</b>
I	<b>M65</b>	<b>J65</b>	Off On	<b>M42</b>	<b>J42</b>	Stop (Turn barrel to release)§	<b>M90</b>	–
In	<b>M17</b>	<b>J17</b>	On	<b>M25</b>	<b>J25</b>	Supply On	<b>M61</b>	<b>J61</b>
Inch	<b>M18</b>	<b>J18</b>	Open	<b>M26</b>	<b>J26</b>	Test	<b>M60</b>	<b>J60</b>
Inch For	<b>M20</b>	–	Open Close	<b>M43</b>	<b>J43</b>	Up	<b>M35</b>	<b>J35</b>
Inch Forward	–	<b>J20</b>	Open Off Close	<b>M53</b>	<b>J53</b>	Up Down	<b>M48</b>	<b>J48</b>
Inch Rev	<b>M21</b>	–	Out	<b>M27</b>	<b>J27</b>	Up Off Down	<b>M54</b>	<b>J54</b>
Inch Reverse	–	<b>J21</b>	Power On	<b>M55</b>	<b>J55</b>			

The standard colour field is black, except for those legends marked § for which the standard colour is red. Legends marked thus † are of brass. All other legends are of aluminium.

## Non-standard legends

If a legend not quoted above is required, give the blank catalogue number for the size/colour and add the suffix 'X' to the code, indicating (e.g. by dashes not to be reproduced on the plate) the number of positions to be catered for, e.g. M36X JET-OFF-SPRAY (medium, black, 3-position).

The following table gives the maximum number of letters of a certain size which can be engraved on standard legend plates.

Type	Letter size (mm)		3.2		4.8		6.4		8		9.5		12.7	
	No. of lines	No. of letters	No. of lines	No. of letters	No. of lines	No. of letters	No. of lines	No. of letters	No. of lines	No. of letters	No. of lines	No. of letters	No. of lines	No. of letters
Medium	3	24	2	12	1	8	1	6	1	4	1	4	–	–
Large	6	30	4	15	3	10	2	7	2	5	1	5	1	3

## Dimensions (mm)

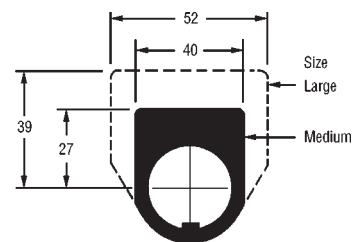

Note: Two large size legend plates cannot be mounted one above the other on standard enclosures.





**Accessories**

	<b>Description</b>	<b>Catalogue numbers</b>
<b>Padlock attachments</b>		
	Padlock attachment for stop button. Permits locking N.C. contacts in open position, prevents operation of button	<b>91000TA2</b>
	Padlock attachment with hinged transparent flap, for flush or extended pushbuttons, and knob-operated selector switches	<b>91000TA38</b>

**Boots**

	Protective boot for flush pushbutton operators	Blue	<b>91000TA46</b>
		Black	<b>91000TA47</b>
		Red	<b>91000TA48</b>
		Green	<b>91000TA49</b>
		Yellow	<b>91000TA50</b>
	Protective boot for mushroom and palm pushbutton operators. Not suitable for use with 91000T140	Black	<b>91000TA88</b>
	Protective boot for extended pushbutton operators	Black	<b>91000TA3</b>
		Red	<b>91000TA4</b>
		Green	<b>91000TA10</b>

**Guards and shrouds**

	Guard sleeve for flush pushbutton	<b>91000TA12</b>
	Guard sleeve for mushroom head operator. Chrome finish. Prevents accidental operation. Not suitable for use with 91000T140	<b>91000TA6</b>
	Guard sleeve for illuminated pushbutton. Prevents accidental operation	<b>91000TA15</b>

**Lever operator**

<b>Description</b>	<b>Catalogue number</b>
 Lever for release of a staydown pushbutton or roto-push operator.	<b>91000TA13</b>

## 91000T Series - Accessories

## Accessories

## Trip and reset attachment

Description	Catalogue number
Trip and reset attachment. Use with two pushbutton operators and one or more contact blocks. The contact blocks are mounted under the reset or stop push which latches in the depressed position until released by depression of the trip push.	<b>91000TA1</b>



## Replacement light bulbs \*

Type	Voltage	Used on	Catalogue numbers
BA9s flasher filament	6	91000T181N – 185N 91000T221N – 223N 91000T411 – 414	<b>28-2225-26</b>
BA9s filament	6.3	91000T181N – 185N 91000T221N – 223N 91000T411 – 414	<b>28-2225-72</b>
BA9s filament	110/120	91000T201N,T202N 91000T231N,T240N	<b>28-2225-24</b>

## Note:

\* Replacement bulbs are for use with current series 'B' operators. For replacement bulbs for series 'A' (round bezelled) operators contact Eaton Limited.

## Bulb removal tool

BA9s and BA15d type bulbs	<b>91000TA65</b>
---------------------------	------------------

## Other accessories





Description	Catalogue numbers
Wobble stick complete with locking ring for mounting on a flush pushbutton. Designed for emergency or hurried operation	<b>91000TA5</b>
 Plug for unused hole in cover Finish in light grey (RAL 7032)	<b>91000TA7</b>
 Protective washer, used as substitute when legend plate is not required. Prevents locking ring from scratching paint.	<b>91000TA8</b>
Double ended box spanner for easy installation of control units on panel. (Will not fit over selector switch levers).	<b>E22CW</b>
 Box spanner Notched to fit over selector switch levers.	<b>91000TA95</b>

Description	Catalogue numbers
Boot spanner. For easy installation of operators fitted with protective boots.	<b>91000TA96</b>
 2 spare keys for special locks, state key 'H' code as suffix e.g.91000TA151H620	<b>91000TA151H*</b>
2 spare keys for standard lock ref. no. H661	<b>91000TA152</b>
6-32 stacking screws for series B operators	<b>91000TA79</b> (pack of 10)
 Octagonal bezel with 26 T.P.I. to convert round style pushbutton operators to octagonal	<b>91000TA202</b>
 Terminal boots. Provides IP20 (fingerproof protection) for terminals	<b>91000TA81</b> (pack of 10)



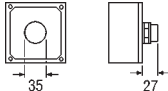

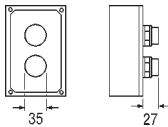
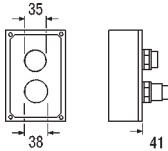
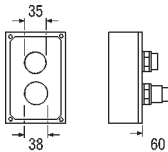
**Assembled pushbutton stations**

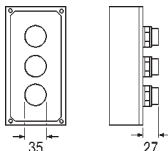
**Features and characteristics**

- Oiltight stations
- IP65 ingress protection
- Surface mounted die-cast aluminium enclosures
- Threaded conduit entry
- Powder coat painted light grey (RAL7032)

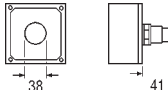
Description	Operator	Contact arrangement	Catalogue numbers	Weight (kg)	Operator dimensions (mm)
<b>Single way station</b> 	Start	N.O. – N.C.	<b>91000T3516</b>	0.68	
<b>Two way stations</b> 	Start Stop	N.O. – N.C. N.C.	<b>91000T3525</b>	0.98	
	Start Mushroom stop (spring return)	N.O. – N.C. N.C.	<b>91000T3526</b>	0.98	
	Start Mushroom stop (auto latch)	N.O. – N.C. N.C.	<b>91000T3630</b>	0.98	
<b>Three way stations</b> 	Forward Reverse Stop	N.O. – N.C. N.O. – N.C. N.C.	<b>91000T3532</b>	1.3	
	Open Close Stop	N.O. – N.C. N.O. – N.C. N.C.	<b>91000T3614</b>	1.3	
	Up Down Stop	N.O. – N.C. N.O. – N.C. N.C.	<b>91000T3615</b>	1.3	

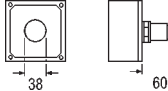
**Emergency stop stations**

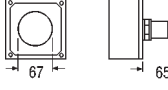
	38mm dia. red mushroom push. Momentary spring return. Yellow lid.	N.C.	<b>91000T3553</b>	
	38mm dia. red mushroom push. Stop-lock, twist barrel to release. Yellow lid.	N.C.	<b>91000T3554</b>	
	63mm dia. red palm push. Stop lock, twist barrel to release. Yellow lid.	N.C.	<b>91000T3555</b>	

**Note:** For enclosure dimensions see page 44.

## 91000T Series - Aluminium alloy enclosures

## Aluminium alloy enclosures

Description Painted light grey (RAL7032) textured finish	Operator capacity per enclosure	Catalogue numbers	
		One contact block deep:	Two contact blocks deep:
	1	<b>91000TN1</b>	<b>91000TN11</b>
	1†	<b>91000TN100</b>	—
	2	<b>91000TN2</b>	<b>91000TN12</b>
	3	<b>91000TN3</b>	<b>91000TN13</b>
	4	<b>91000TN4</b>	<b>91000TN14</b>

3 operator enclosure

† Enclosure has yellow lid

## Accessories

Description	Catalogue numbers		
<b>Spacers</b> 	Used for base mounting contact blocks. One required for each operator plus additional spacer may be required to make up enclosure depth.	One contact block deep Two contact blocks deep	<b>91000TA21</b> <b>91000TA22</b>

## Base mounting contact blocks

1 N.O. 1 N.C.	<b>91000T6</b>
2 N.O.	<b>91000T7</b>
2 N.C.	<b>91000T8</b>
1 N.C.	<b>91000T52</b>
1 N.O.	<b>91000T54</b>

## Dimensions (mm)

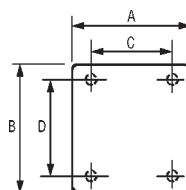
1,2,3 & 4 unit sizes  
single contact  
block depth1,2,3 & 4 unit sizes  
double contact  
block depth

Enclosure size	Dimensions					Conduit entry	Fixing holes	Weight (kg)
	A	B	C	D	E			
1 unit	97	102	68.3	82.6	69	20	5.6	0.050
2 unit	97	149	68.3	130.2	74	25	5.6	0.65
3 unit	97	197	68.3	177.8	74	32	5.6	0.775
4 unit	100	248	68.3	225	76	32	5.6	0.95

**Technical data**

**Standards and approvals**

IEC 947-5-1. MTTA\*  
 CSA C22-2 no. 14, UL508

**Ingress protection (IP ratings to IEC144 (BS5420))**

IP65  
 IP66, NEMA 4 on pushbuttons when fitted with a rubber boot  
 IP65 on enclosures

**Max. frequency of operations**

All pushbuttons: 6000 ops/hr.  
 Key and lever selector switch: 3000 ops/hr.  
 Auto-latch devices: 1200 ops/hr.

**Mechanical life**

Pushbuttons: 10 x 10<sup>6</sup> operations  
 Contact blocks: 10 x 10<sup>6</sup> operations  
 Pretest units: 1 x 10<sup>6</sup> operations  
 Lever & key sel. sw.: 0.25 x 10<sup>6</sup> operations  
 Twist to release p/btns: 0.3 x 10<sup>6</sup> operations

**Climatic conditions**

Operating: Max 60°C at 95% RH.  
 Temp. -17°C to +66°C  
 Altitude 2000 metres  
 Storage: Max. 60°C at 95% RH.  
 Temp. -40°C to +80°C

**Shock resistance**

Shock duration: 20 ms ± 5g

**Electrical ratings**

Rated insulation: U<sub>i</sub> = 660V ac or dc  
 Rated thermal: I<sub>th</sub> = 10A  
 Short circuit (IEC947-5-1): 1000A with a 6A (NIT) fuse (to BS88)  
 NEMA, UL rating: A600, P600  
 AC load life duty cycle 1200 ops/hr  
 10A 110V pf 0.4 - 1 x 10<sup>6</sup> operations  
 5A 250V pf 0.4 - 1 x 10<sup>6</sup> operations  
 2A 660V pf 0.4 - 1 x 10<sup>6</sup> operations

**Switching capacity**

AC15 rated make/break (11 x I<sub>e</sub> at 1.1 x U<sub>e</sub>)  
 6A 120V pf 0.7  
 4A 240V pf 0.7  
 2A 660V pf 0.7  
 DC13 rated make/break (1.1 x I<sub>e</sub> at 1.1 x U<sub>e</sub>)  
 1.0A 120V L/R ⊕ 0.95 at 300ms  
 0.5A 240V L/R ⊕ 0.95 at 300ms  
 0.1A 660V L/R ⊕ 0.95 at 300ms  
 10A 110V pure resistive

**Light units**

Transformers will withstand short circuit for 1 hour per IEC947-5-1.  
 Bulbs average life:  
 Transformer type = 20,000 hrs.  
 Resistor/direct voltage type = 2,500 hrs min. at rated voltage.

**Low voltage switching**

Conical shaped points or “reliability nibs” improve performance in dry circuit, corrosive, fine dust and other contaminated atmospheres. Under normal environmental conditions, the minimum operational voltage is 5V and the minimum operational current is 1mA, ac/dc.

**Contact operation**

Slow make and break. All normally closed contacts have positive opening operation. i.e. normally closed contacts are forced open in the event of contact weld or spring breakage.

**Terminal marking**

Dual marking system 1 – 2 for normally closed 3 – 4 normally open to meet BS5472 (Cenelec EN50 005) and N.C. – N.O. moulded in the contact block to meet the NEMA requirements.

**Terminal clamps**

Terminals are saddle clamp types for 1 x 0.5mm” to 2 x 3mm” conductors.

**Panel thickness**

Maximum = 8mm including legend plate.  
 Minimum = 1.6mm.

**\*M.T.T.A. (Machine Tool, Trades Association)**

A range of pushbutton operators to meet the requirements of M.T.T.A. standard “Electrical Equipment of Machine tools and other industrial machines and equipment for the automobile industry” are included in the 91000T range.

**Mounting matrix**

Legend plate	A	B	C	D
Medium	57	45	45	57
Large	57	57	57	57

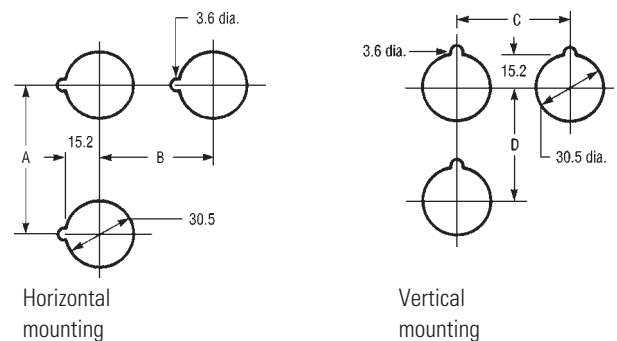

Vertical mounting means terminals are left & right of contact block. Horizontal mounting means terminals are top & bottom of contact block. This allows close spacing of adjacent operators with easy access to terminals.





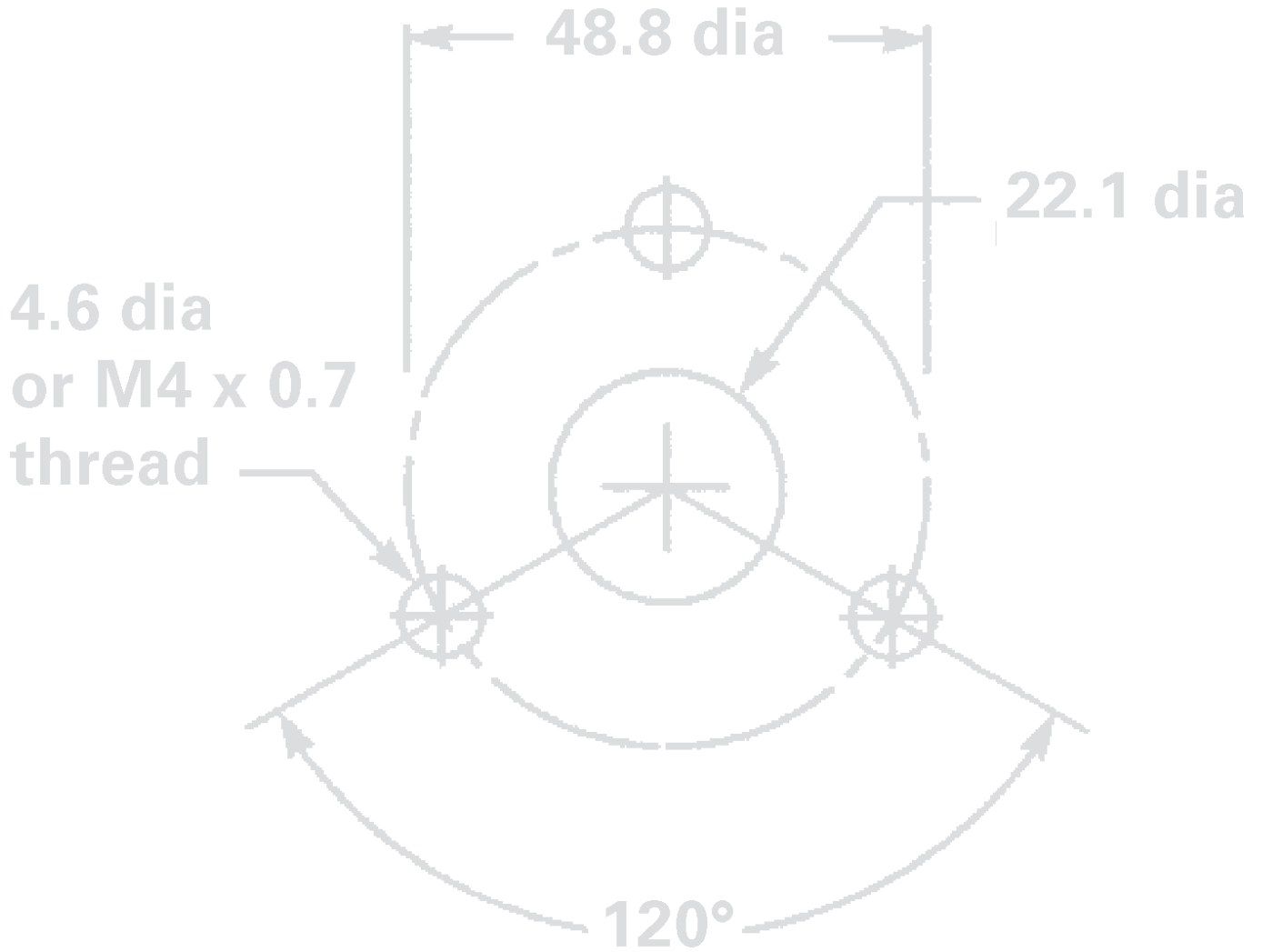

**Stacklights – E26 Series**

**Description**

- Product description
- Catalogue number selection guide
- Light and xenon strobe modules
- Accessories
- LEDs - Cluster or cylindrical

**Page**

- 48
- 48
- 49
- 50
- 53

**Description**

- Technical data
- Application data
- Mounting options and dimensions
- Dimensions

**Page**

- 54
- 54
- 55
- 56

## E26 Series - Product description

## Product description

The E26 Stacklight unit is a modular system that provides illuminated and audible status indication in all directions. Easily assembled plug-in modular units include constant, flashing and strobe light units, as well as mono-tonal, bitonal, intermittent alarm systems. Stacklights may be assembled in a variety of configurations, which are identified in the Maximum Configurations table below. Numerous lamp, colour and mounting options further enhance the Stacklight's versatility.



Light module

## Light modules

Available in a variety of colours for both incandescent lamps and LED lamps. To maximise illumination and light dispersion, incandescent units include an opal white diffuser while LED diffusers are clear. See page 49.

## Xenon strobe

Sets are similar to standard lens/diffuser units, except each set consists of two lens units. The lower unit includes the electronics and is permanently fused to the upper unit which contains the Xenon lamp. Xenon units may be placed in any position in a complete Stacklight unit. They will flash 60 times per minute when used with a standard or flashing base. See page 49.

## Catalogue number selection

## Complete Stacklight modules

- ★ Stacklights accept a maximum of 6 incandescent or LED light modules or 2 Xenon flasher modules and can be mounted in any position on the stack.
- ★ Alarm units are mounted in the top most position only.



Standard base and top cover

## Standard Stacklight base

For use with incandescent or standard LED for steady, non-flashing illumination or with flashing LEDs for flashing illumination. Bases include terminal block for wiring, stacklight cover and gasket. See page 50.



Flashing base and top cover

## Flashing Stacklight base

Allows configuration of each light in the stack for either steady or 60 times per minute flashing illumination. Flashing circuit for use with incandescent lamps only. (Maximum allowable number of light modules is 2 at 12V, 4 at 24V and 6 at 48V and above.) See page 50.

For flashing LEDs use standard base with flashing LED light module.



Alarm

## Alarms

May be fitted to the top of a complete Stacklight unit or directly to the Stacklight bases, if desired. Available in three versions, each with adjustable sound levels. See page 51.

## Features

- Modular construction
- Wide variety of lens colours
- Variety of lamp types and voltages
- Mono-tonal, bi-tonal and intermittent alarm systems

## Benefits

- Combination of visible and audible alarms
- Modular components reduce inventory requirements, increase flexibility
- Steady and flashing modes allow one light to signal multiple conditions
- No-tools assembly permits easy lamp replacement

## Maximum configurations

Incandescent or LED modules	Xenon modules	Alarm modules	Max. number of modules
6	–	–	6
5	–	1	6
4	1	–	5
3	1	1	5
2	2	–	4
1	2	1	4

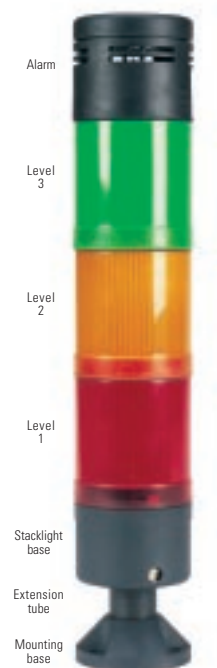

Complete Stacklight module

**Light and xenon strobe modules** (includes lens, diffusers and bulbs unless otherwise noted)

- Light modules include lens diffusers which provide even illumination and eliminate hot spots.
- Xenon strobes emit a bright attention-getting white flashing light. Flash rate = 60/min.
- Xenon strobe modules occupy two positions in the Stacklight assembly.





*Light/LED module*

LED/Lamp voltage	Lens colour	Incandescent Catalogue numbers Steady or Flashing	Cluster LED Catalogue numbers		Cylindrical LED Catalogue numbers Steady only	Xenon Catalogue numbers Flashing
			Steady	Flashing		
Without bulb or LED	Red	<b>E26B2</b>	<b>E26BR</b>	<b>E26BR</b>	<b>E26BR</b>	—
	Green	<b>E26B3</b>	<b>E26BG</b>	<b>E26BG</b>	<b>E26BG</b>	—
	Yellow	<b>E26B4</b>	<b>E26BY</b>	<b>E26BY</b>	<b>E26BY</b>	—
	Blue	<b>E26B6</b>	<b>E26BB</b>	<b>E26BB</b>	<b>E26BB</b>	—
	Amber	<b>E26B9</b>	<b>E26BA</b>	<b>E26BA</b>	<b>E26BA</b>	—
	Clear	<b>E26B0</b>	<b>E26BW</b>	<b>E26BW</b>	<b>E26BW</b>	—
12V ac/dc	Red	<b>E26B2V1</b>	<b>E26BRV1</b>	<b>E26BEV1</b>	<b>E26BR1V1</b>	<b>E26BX2V1</b>
	Green	<b>E26B3V1</b>	<b>E26BGV1</b>	<b>E26BUV1</b>	<b>E26BG1V1</b>	<b>E26BX3V1</b>
	Yellow	<b>E26B4V1</b>	<b>E26BYV1</b>	<b>E26BVV1</b>	<b>E26BY1V1</b>	<b>E26BX4V1</b>
	Blue	<b>E26B6V1</b>	<b>E26BBV1</b>	<b>E26BKV1</b>	<b>E26BB1V1</b>	<b>E26BX6V1</b>
	Amber	<b>E26B9V1</b>	<b>E26BAV1</b>	<b>E26BZV1</b>	<b>E26BA1V1</b>	<b>E26BX9V1</b>
	Clear	<b>E26B0V1</b>	<b>E26BWW1</b>	<b>E26BMV1</b>	<b>E26BW1V1</b>	<b>E26BX0V1</b>
24V ac/dc	Red	<b>E26B2V2</b>	<b>E26BRV2</b>	<b>E26BEV2</b>	<b>E26BR1V2</b>	<b>E26BX2V2</b>
	Green	<b>E26B3V2</b>	<b>E26BGV2</b>	<b>E26BUV2</b>	<b>E26BG1V2</b>	<b>E26BX3V2</b>
	Yellow	<b>E26B4V2</b>	<b>E26BYV2</b>	<b>E26BVV2</b>	<b>E26BY1V2</b>	<b>E26BX4V2</b>
	Blue	<b>E26B6V2</b>	<b>E26BBV2</b>	<b>E26BKV2</b>	<b>E26BB1V2</b>	<b>E26BX6V2</b>
	Amber	<b>E26B9V2</b>	<b>E26BAV2</b>	<b>E26BZV2</b>	<b>E26BA1V2</b>	<b>E26BX9V2</b>
	Clear	<b>E26B0V2</b>	<b>E26BWW2</b>	<b>E26BMV2</b>	<b>E26BW1V2</b>	<b>E26BX0V2</b>
48V ac/dc	Red	<b>E26B2V3</b>	<b>E26BRV3</b>	<b>E26BEV3</b>	<b>E26BR1V3</b>	<b>E26BX2V3</b>
	Green	<b>E26B3V3</b>	<b>E26BGV3</b>	<b>E26BUV3</b>	<b>E26BG1V3</b>	<b>E26BX3V3</b>
	Yellow	<b>E26B4V3</b>	<b>E26BYV3</b>	<b>E26BVV3</b>	<b>E26BY1V3</b>	<b>E26BX4V3</b>
	Blue	<b>E26B6V3</b>	<b>E26BBV3</b>	<b>E26BKV3</b>	<b>E26BB1V3</b>	<b>E26BX6V3</b>
	Amber	<b>E26B9V3</b>	<b>E26BAV3</b>	<b>E26BZV3</b>	<b>E26BA1V3</b>	<b>E26BX9V3</b>
	Clear	<b>E26B0V3</b>	<b>E26BWW3</b>	<b>E26BMV3</b>	<b>E26BW1V3</b>	<b>E26BX0V3</b>
120V ac *	Red	<b>E26B2V4</b>	<b>E26BRV4</b>	<b>E26BEV4</b>	<b>E26BR1V4</b>	<b>E26BX2V4</b>
	Green	<b>E26B3V4</b>	<b>E26BGV4</b>	<b>E26BUV4</b>	<b>E26BG1V4</b>	<b>E26BX3V4</b>
	Yellow	<b>E26B4V4</b>	<b>E26BYV4</b>	<b>E26BVV4</b>	<b>E26BY1V4</b>	<b>E26BX4V4</b>
	Blue	<b>E26B6V4</b>	<b>E26BBV4</b>	<b>E26BKV4</b>	<b>E26BB1V4</b>	<b>E26BX6V4</b>
	Amber	<b>E26B9V4</b>	<b>E26BAV4</b>	<b>E26BZV4</b>	<b>E26BA1V4</b>	<b>E26BX9V4</b>
	Clear	<b>E26B0V4</b>	<b>E26BWW4</b>	<b>E26BMV4</b>	—	<b>E26BX0V4</b>
240V ac *	Red	<b>E26B2V5</b>	<b>E26BRV5</b>	<b>E26BEV5</b>	—	<b>E26BX2V5</b>
	Green	<b>E26B3V5</b>	<b>E26BGV5</b>	<b>E26BUV5</b>	—	<b>E26BX3V5</b>
	Yellow	<b>E26B4V5</b>	<b>E26BYV5</b>	<b>E26BVV5</b>	—	<b>E26BX4V5</b>
	Blue	<b>E26B6V5</b>	<b>E26BBV5</b>	<b>E26BKV5</b>	—	<b>E26BX6V5</b>
	Amber	<b>E26B9V5</b>	<b>E26BAV5</b>	<b>E26BZV5</b>	—	<b>E26BX9V5</b>
	Clear	<b>E26B0V5</b>	<b>E26BWW5</b>	<b>E26BMV5</b>	—	<b>E26BX0V5</b>

\* Incandescent bulbs are ac/dc rated, LEDs are ac rated only.

E26 Series - Accessories

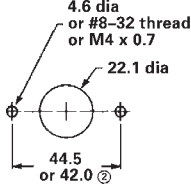
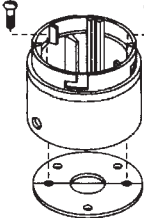
Accessories

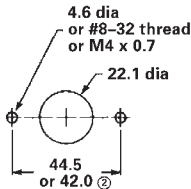
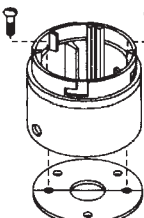
Description	Voltage	Catalogue numbers	Approximate dimensions (mm) ①
 <p><b>Standard base</b> For use with steady incandescent or steady/ flashing LED</p>	12V ac/dc to 240V ac/dc	<b>E26BL</b>	  <p>4.6 dia or #8-32 thread or M4 x 0.7 22.1 dia 44.5 or 42.0 ②</p> <p>Drill 2 holes in Stacklight base to 4.3 mm. Mount Stacklight with M4 screws. Tighten to torque of 0.79 Nm.</p>
 <p><b>Flashing base</b> Enables configuration of incandescent light modules for steady or flashing operation</p>	12V dc 24V ac/dc 48V ac/dc 240V ac/dc 120V ac/dc	<b>E26BFV1</b> <b>E26BFV2</b> <b>E26BFV3</b> <b>E26BFV4</b> <b>E26BFV5</b>	  <p>4.6 dia or #8-32 thread or M4 x 0.7 22.1 dia 44.5 or 42.0 ②</p> <p>Drill 2 holes in Stacklight base to 4.3 mm. Mount Stacklight with M4 screws. Tighten to torque of 0.79 Nm.</p>

Standard base

Flashing base

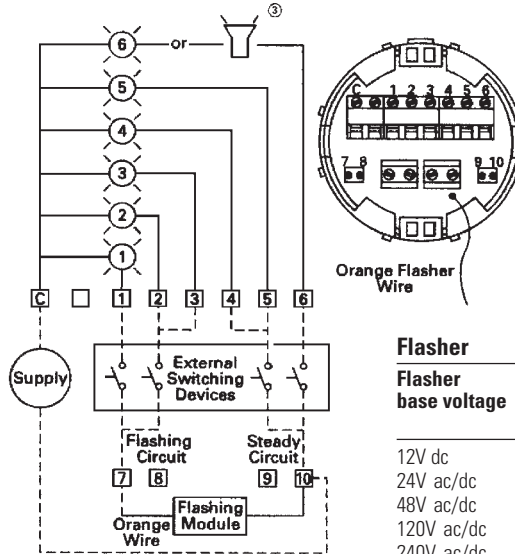
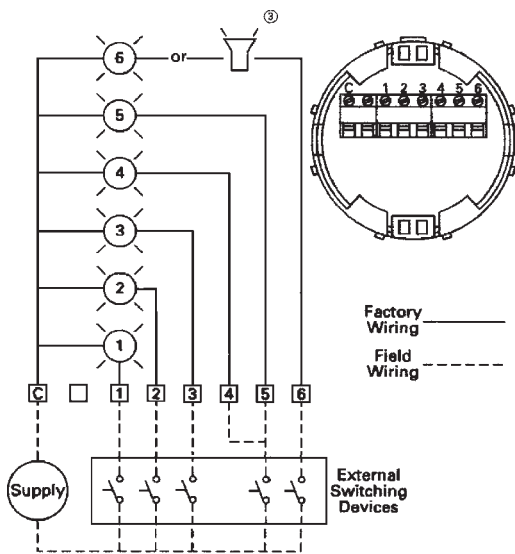





Flasher base voltage	Max. Allowable no. of light modules
12V dc	2
24V ac/dc	4
48V ac/dc	6
120V ac/dc	6
240V ac/dc	6

Notes

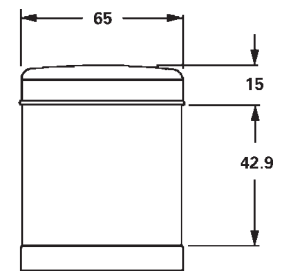
- ① Bases also suitable for mounting with extension tubes listed on page 51.
- ② Stacklight base and gasket are supplied as standard with two sets of base mount holes. One set with centre-to-centre spacing of 44.5 mm and another set with centre-to-centre spacing of 42 mm.
- ③ Audible alarm units must be wired via the steady circuit on flashing base units.
- √ Bases are supplied with top cover.

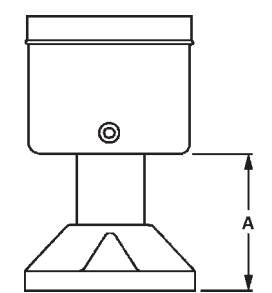
**Accessories (continued)**

Description	Voltage	Catalogue numbers	Approximate dimensions (mm)										
<b>Audible alarms – IP20</b> Volume adjustment range: 64 dB to 90 dB typical current draw (mA):													
	<b>Mono-tonal</b>												
	4.5 mA	12V ac/dc		<b>E26BQV1</b>									
	12.6 mA	24V ac/dc		<b>E26BQV2</b>									
	9.4 mA	48V ac/dc		<b>E26BQV3</b>									
	11.5 mA	120V ac/dc		<b>E26BQV4</b>									
	5.1 mA	240V ac/dc		<b>E26BQV5</b>									
	<b>Bi-Tonal</b>												
	4.5 mA	12V ac/dc		<b>E26BNV1</b>									
	12.6 mA	24V ac/dc		<b>E26BNV2</b>									
	9.4 mA	48V ac/dc		<b>E26BNV3</b>									
11.5 mA	120V ac/dc	<b>E26BNV4</b>											
5.1 mA	240V ac/dc	<b>E26BNV5</b>											
<b>Intermittent</b>													
4.5 mA	12V ac/dc	<b>E26BPV1</b>											
12.6 mA	24V ac/dc	<b>E26BPV2</b>											
9.4 mA	48V ac/dc	<b>E26BPV3</b>											
11.5 mA	120V ac/dc	<b>E26BPV4</b>											
5.1 mA	240V ac/dc	<b>E26BPV5</b>											
<b>Extension tubes – Black anodised aluminium</b> For use with standard mounting base or 3/4" NPT threaded hub –													
	<b>Extension "A":</b>												
	20 mm extension	–		<b>E26BHA</b>									
	160 mm extension	–		<b>E26BJA</b>									
	360 mm extension	–		<b>E26BKA</b>									
	760 mm extension	–		<b>E26BMA</b>									
<b>Mounting bases</b>													
	Standard 3-hole mounting base	–	<b>E26S108</b>										
	Standard 4-hole mounting base	–	<b>E26S109</b>										
			<b>Assembled dimensions (mm)</b>										
			<table border="1"> <thead> <tr> <th data-bbox="1230 1397 1378 1424">Tube extension</th> <th data-bbox="1422 1397 1513 1424">Height A</th> </tr> </thead> <tbody> <tr> <td data-bbox="1230 1442 1257 1469">20</td> <td data-bbox="1422 1442 1449 1469">45</td> </tr> <tr> <td data-bbox="1230 1471 1268 1498">160</td> <td data-bbox="1422 1471 1460 1498">185</td> </tr> <tr> <td data-bbox="1230 1500 1268 1527">360</td> <td data-bbox="1422 1500 1460 1527">385</td> </tr> <tr> <td data-bbox="1230 1529 1268 1556">760</td> <td data-bbox="1422 1529 1460 1556">785</td> </tr> </tbody> </table>	Tube extension	Height A	20	45	160	185	360	385	760	785
Tube extension	Height A												
20	45												
160	185												
360	385												
760	785												

## E26 Series - Accessories

## Accessories (continued)

Description	Notes	Diagram	Catalogue numbers
Replacement mounting gasket	Normally included with Stacklight base	9	<b>E26S105</b>
Replacement lens O-ring	Normally included with light modules	2	<b>E26S106</b>
Replacement extension tube O-rings	Normally included with extension tubes	6	<b>E26S107</b>
Replacement cover	Normally included with Stacklight base	1	<b>E26S68</b>
Replacement lamps	12V 24V 48V 120V 240V	5	<b>E26S8</b> <b>E26S9</b> <b>E26S10</b> <b>E26S11</b> <b>E26S12</b>
Replacement Xenon strobe dual high (Does not include lenses)	12V ac/dc 24V ac/dc 48V ac/dc 120V ac 240V ac	4	<b>E26S33</b> <b>E26S34</b> <b>E26S35</b> <b>E26S36</b> <b>E26S37</b>
Replacement lenses	Clear Red Green Yellow Blue Amber	3	<b>E26S38</b> <b>E26S39</b> <b>E26S40</b> <b>E26S41</b> <b>E26S42</b> <b>E26S43</b>
Replacement diffusers	White – normally supplied with incandescent light modules	4	<b>E26S31</b>
	Clear – normally supplied with LED light modules	4	<b>E26S32</b>
Lamp removal tool	For E26 and E22 incandescent lamps		<b>E22BA3</b>

## Typical Stacklight assemblies (exploded view)

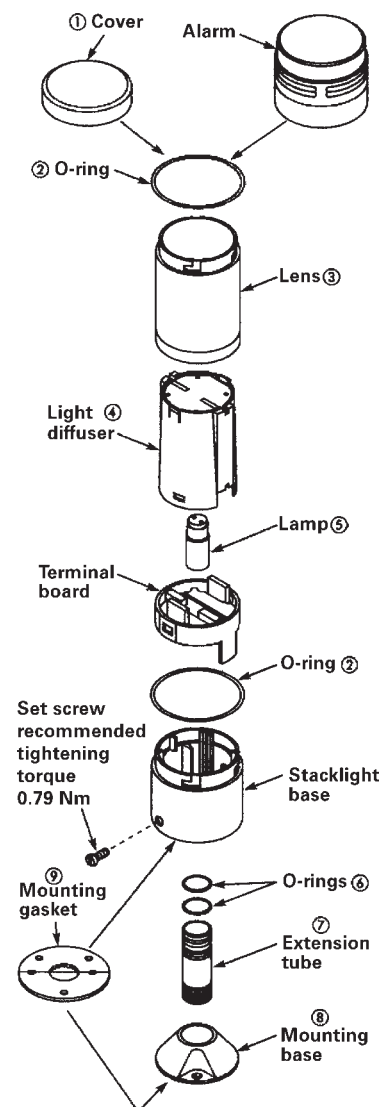

## LEDs – Cluster or cylindrical

Voltage	Colour	Catalogue numbers		Cylindrical LEDs Steady Only
		Cluster LEDs Steady	Flashing	
12V ac/dc	Red	<b>E26S15</b>	<b>E26S48</b>	<b>E26S110</b>
	Green	<b>E26S19</b>	<b>E26S53</b>	<b>E26S114</b>
	Yellow	<b>E26S23</b>	<b>E26S58</b>	<b>E26S112</b>
	Blue	<b>E26S27</b>	<b>E26S63</b>	<b>E26S115</b>
	White	<b>E26S71</b>	<b>E26S75</b>	<b>E26S116</b>
	Amber	<b>E26S79</b>	<b>E26S84</b>	<b>E26S111</b>
24V ac/dc	Red	<b>E26S16</b>	<b>E26S49</b>	<b>E26S117</b>
	Green	<b>E26S20</b>	<b>E26S54</b>	<b>E26S121</b>
	Yellow	<b>E26S24</b>	<b>E26S59</b>	<b>E26S119</b>
	Blue	<b>E26S28</b>	<b>E26S64</b>	<b>E26S122</b>
	White	<b>E26S72</b>	<b>E26S76</b>	<b>E26S123</b>
	Amber	<b>E26S80</b>	<b>E26S85</b>	<b>E26S118</b>
48V ac/dc	Red	<b>E26S17</b>	<b>E26S50</b>	<b>E26S124</b>
	Green	<b>E26S21</b>	<b>E26S55</b>	<b>E26S128</b>
	Yellow	<b>E26S25</b>	<b>E26S60</b>	<b>E26S126</b>
	Blue	<b>E26S29</b>	<b>E26S65</b>	<b>E26S129</b>
	White	<b>E26S73</b>	<b>E26S77</b>	<b>E26S130</b>
	Amber	<b>E26S81</b>	<b>E26S86</b>	<b>E26S125</b>
120V ac/dc	Red	<b>E26S18</b>	<b>E26S51</b>	<b>E26S138</b>
	Green	<b>E26S22</b>	<b>E26S56</b>	<b>E26S142</b>
	Yellow	<b>E26S26</b>	<b>E26S61</b>	<b>E26S140</b>
	Blue	<b>E26S30</b>	<b>E26S66</b>	<b>E26S143</b>
	White	<b>E26S74</b>	<b>E26S78</b>	–
	Amber	<b>E26S82</b>	<b>E26S87</b>	<b>E26S139</b>
240V ac/dc	Red	<b>E26S44</b>	<b>E26S52</b>	–
	Green	<b>E26S45</b>	<b>E26S57</b>	–
	Yellow	<b>E26S46</b>	<b>E26S62</b>	–
	Blue	<b>E26S47</b>	<b>E26S67</b>	–
	White	<b>E26S101</b>	<b>E26S102</b>	–
	Amber	<b>E26S83</b>	<b>E26S88</b>	–

## E26 Series - Technical and application data

## Technical data

### Standards and certifications

CE 60947-5-1  
UL 508 – file #E131568  
cUL C22.2 No. 14 – file #E131568

### Ingress protection

Stacklight base and light units: IP65, NEMA 4, 4X and 13  
Alarm units: IP20, NEMA 1

### Electrical shock protection

Stacklight base and light unit: IP2X  
Alarm units: IPOX

### Mechanical ratings

Shock (IEC 68-2-27): 11 mS, 15g  
Vibration (IEC 68-2-6): 10 sweeps 10 to 150 Hz, 2g  
Bump (IEC 68-2-29): 1000 pulses, 6 mS, 15g

### Climate conditions

Operating: maximum 40°C at 95% RH,  
temperature –20° to 60°C  
Storage: Temperature –40° to 80°C

### Materials

Cover: Polycarbonate  
Lenses: Polycarbonate  
Stacklight base: Nylon  
Extension tubes: Aluminium  
Mounting base: Zinc die cast

### Terminals

2.5 – 0.05 mm<sup>2</sup> for single conductors and 0.75 – 0.14 mm<sup>2</sup>  
for two conductors of the same size. Do not mix solid and  
stranded wire in the same terminal.  
Recommended tightening torque is 0.5 – 0.6 Nm.

### Electrical ratings

Insulation voltage (Ui): 690V  
Operational voltage (Ue): 250V  
Impulse withstand voltage (Uimp): 1.5 kV

### Bulb specifications

Incandescent lamp type: BA15d  
Maximum lamp wattage: 6W  
Bulbs – average life:  
Incandescent: 7,000 to 12,000 hrs.  
Xenon flasher: 20,000 hrs.  
LED: 60,000 to 100,000 hrs.

### LED/Incandescent comparison

#### Incandescent lamps

Average operating life of 7,000 hours  
Each lamp can be used with any colour lens  
Low cost results in short term savings

#### LED lamps

Average operating life of 100,000 hours  
Low power consumption  
Extended life results in long-term savings

## Application data

### E26 Stacklight incandescent lamps

Type of light	Lamp used	Approximate current, mA per light	Theoretical lamp life, hours as applied
12V	BA15d	417	7,000
24V	BA15d	208	7,000
48V	BA15d	104	7,000
110 – 140V	BA15d	36 – 50	7,000
220 – 260V	BA15d	23 – 27	12,000

### E26 Xenon flasher

Model	Voltage	Current (cont.)	Lamp life
12V	DC	460 mA	20,000
	AC	780 mA	20,000
24V Strobe	DC	190 mA	20,000
	AC	320 mA	20,000
48V	DC	100 mA	20,000
	AC	150 mA	20,000
120V	AC	60 mA ①	20,000
240V	AC	30 mA ①	20,000

① Represents average current draw, 1.6A peak for 120V and 0.8 peak at 240V.

### E26 Continuous/flashing Stacklight LED

Type of light	Colour	Cluster LED Approximate current, mA at rated volts	Cylindrical LED Approximate current, mA at rated volts	Theoretical lamp life, hours as applied
12V ac/dc	Red	92	92	100,000
	Amber	92	92	100,000
	Yellow	92	92	100,000
	Green	60	60	80,000
	Blue	60	60	60,000
	White	60	60	60,000
24V ac/dc	Red	47	47	100,000
	Amber	47	47	100,000
	Yellow	47	47	100,000
	Green	59	59	80,000
	Blue	59	59	60,000
	White	59	59	60,000
48V ac/dc	Red	25	25	100,000
	Amber	25	25	100,000
	Yellow	25	25	100,000
	Green	18	18	80,000
	Blue	31	31	60,000
	White	31	31	60,000
60V ac/dc	Red	25	25	100,000
	Amber	25	25	100,000
	Yellow	25	25	100,000
	Green	18	18	80,000
	Blue	17	17	60,000
	White	17	17	60,000
120V ac/dc	Red	24	24	100,000
	Amber	24	24	100,000
	Yellow	24	24	100,000
	Green	17	17	80,000
	Blue	16	16	60,000
	White	16	16	60,000

#### Note:

Published theoretical lamp lives are based on ideal laboratory conditions and should be used for comparison only. Actual life may be shorter due to various application conditions.



**Mounting options and dimensions (mm)**

Stacklight bases may be mounted without the use of extension tube or mounting base. If additional height is required, choose 20 to 760 mm extension tubes that fit between the mounting base and the

Stacklight base. The extension tubes are threaded with 3/4" NPT threads, allowing for direct connection to conduit fittings or threaded holes without the use of a mounting base.

**Base mounting**

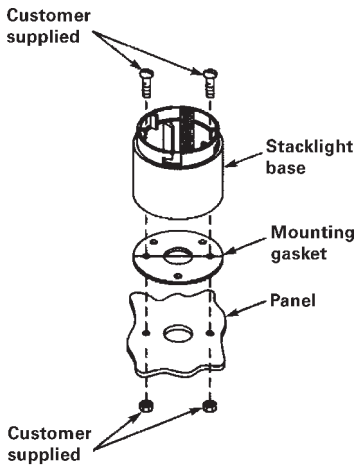

**Utilising extension tube and mounting base**

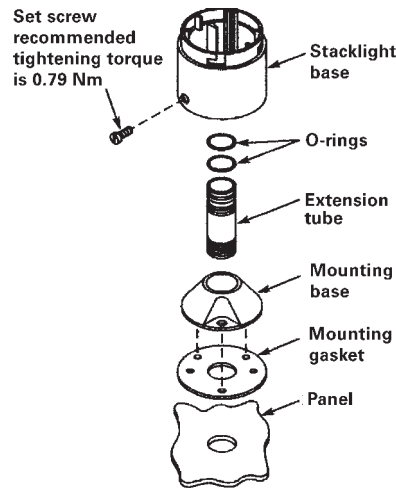

**Base mounting**

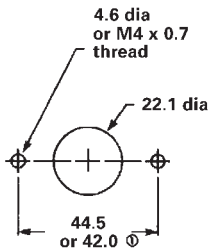

**3-hole mounting for E26S108**

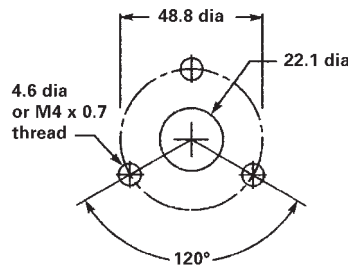

**4-hole mounting for E26S109**

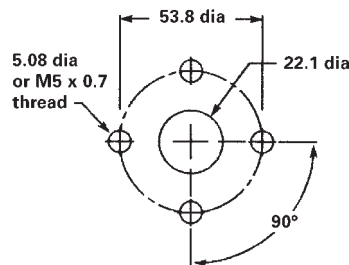

**Note**

- ① Stacklight base and gasket are supplied as standard with two sets of base mount holes. One set with centre-to-centre spacing of 44.5 mm and another set with centre-to-centre spacing of 42 mm.

E26 Series - Dimensions

Approximate dimensions (mm)

One-light unit Stacklight

Standard

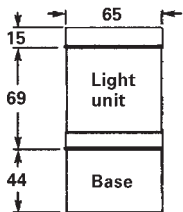

With alarm

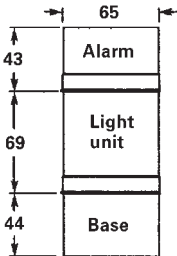

With Xenon flasher

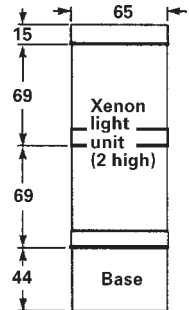

Light modules

Standard

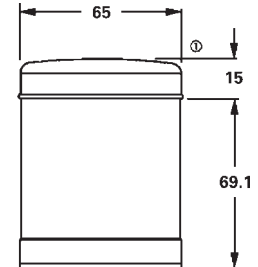

Xenon

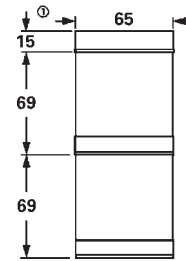

Note

① Cover included with Stacklight base.

Two-light unit Stacklight

Standard

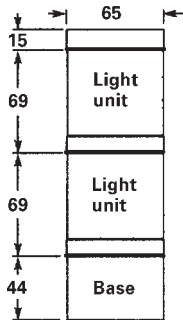

With alarm

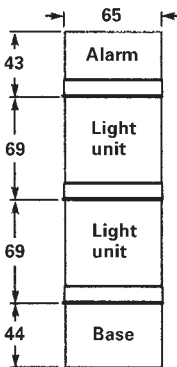

With Xenon flasher

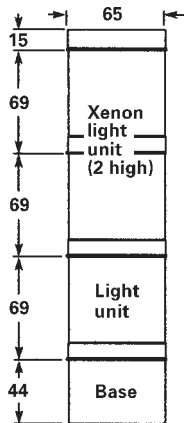

Three-light unit Stacklight

Standard

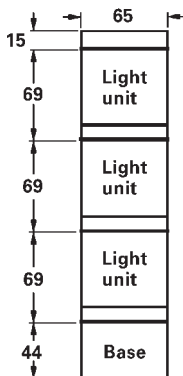

With alarm

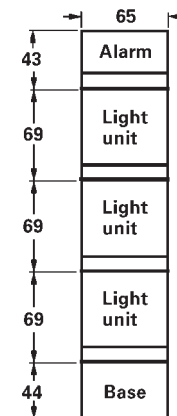

With Xenon flasher

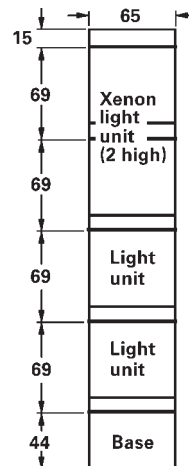



Eaton's Electrical business is a global leader in electrical control, power distribution, and industrial automation products and services. Through advanced product development, world-class manufacturing methods, and global engineering services and support, Eaton's Electrical business provides customer-driven solutions under brand names such as Cutler-Hammer®, Durant®, Heinemann®, Holec® and MEM®, which globally serve the changing needs of the industrial, utility, light commercial, residential, and OEM markets. For more information, visit [www.EatonElectrical.com](http://www.EatonElectrical.com).

Eaton Corporation is a diversified industrial manufacturer with 2003 sales of \$8.1 billion. Eaton is a global leader in fluid power systems and services for industrial, mobile and aircraft equipment; electrical systems and components for power quality, distribution and control; automotive engine air management systems and powertrain controls for fuel economy; and intelligent drivetrain systems for fuel economy and safety in trucks. Eaton has 55,000 employees and sells products to customers in more than 100 countries. For more information, visit [www.eaton.com](http://www.eaton.com).

**Eaton Electric Limited**

Reddings Lane  
Birmingham B11 3EZ  
United Kingdom

**Customer Support Centre**

Tel: +44 (0)8700 545 333  
Fax: +44 (0)8700 540 333  
email: [ukcommorders@eaton.com](mailto:ukcommorders@eaton.com)

**Eaton Electric NV**

PO Box 23  
7550 AA Hengelo  
The Netherlands

**Customer Support Centre**

Tel: +31 (0)74 246 7066  
Fax: +31 (0)74 246 7070  
email: [c-heuropesupport@eaton.com](mailto:c-heuropesupport@eaton.com)

