

## Usable dimensions

### Fixing

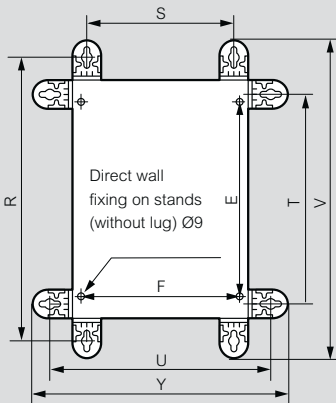

Cat. No. 0364 01

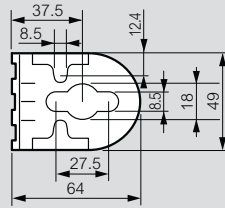

Cat. No. 0364 04

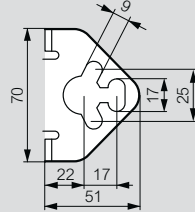

| Enclosures |        | Vertical lugs |                       | Mounting centres |                       | Horizontal lugs |        | Mounting centres |        | Overall 0364 01 |        | Overall 0364 04 |        |
|------------|--------|---------------|-----------------------|------------------|-----------------------|-----------------|--------|------------------|--------|-----------------|--------|-----------------|--------|
| H (mm)     | W (mm) | R (mm)        | S <sup>(1)</sup> (mm) | E (mm)           | T <sup>(1)</sup> (mm) | U (mm)          | F (mm) | V (mm)           | Y (mm) | V (mm)          | Y (mm) | V (mm)          | Y (mm) |
| 300        | 200    | 375           | 150                   | 225              | 250                   | 275             | 169    | 430              | 330    | 402             | 302    |                 |        |
| 300        | 300    | 375           | 250                   | 225              | 250                   | 375             | 269    | 430              | 430    | 402             | 402    |                 |        |
| 300        | 400    | 375           | 350                   | 225              | 250                   | 475             | 369    | 430              | 530    | 402             | 502    |                 |        |
| 400        | 300    | 475           | 250                   | 325              | 350                   | 375             | 269    | 530              | 430    | 502             | 402    |                 |        |
| 400        | 400    | 475           | 350                   | 325              | 350                   | 475             | 369    | 530              | 530    | 502             | 502    |                 |        |
| 400        | 600    | 475           | 550                   | 325              | 350                   | 675             | 569    | 530              | 730    | 502             | 702    |                 |        |
| 500        | 400    | 575           | 350                   | 425              | 450                   | 475             | 369    | 630              | 530    | 602             | 502    |                 |        |
| 500        | 500    | 575           | 450                   | 425              | 450                   | 575             | 469    | 630              | 630    | 602             | 602    |                 |        |
| 600        | 400    | 675           | 350                   | 525              | 550                   | 475             | 369    | 730              | 530    | 702             | 502    |                 |        |
| 600        | 500    | 675           | 450                   | 525              | 550                   | 575             | 469    | 730              | 630    | 702             | 602    |                 |        |
| 600        | 600    | 675           | 550                   | 525              | 550                   | 675             | 569    | 730              | 730    | 702             | 702    |                 |        |
| 600        | 800    | 675           | 750                   | 525              | 550                   | 875             | 769    | 730              | 930    | 702             | 902    |                 |        |
| 600        | 1000   | 675           | 950                   | 525              | 550                   | 1075            | 969    | 730              | 1130   | 702             | 1102   |                 |        |
| 700        | 500    | 775           | 450                   | 625              | 650                   | 575             | 469    | 830              | 630    | 802             | 602    |                 |        |
| 800        | 600    | 875           | 550                   | 725              | 750                   | 675             | 569    | 930              | 730    | 902             | 702    |                 |        |
| 800        | 800    | 875           | 750                   | 725              | 750                   | 875             | 769    | 930              | 930    | 902             | 902    |                 |        |
| 800        | 1000   | 875           | 950                   | 725              | 750                   | 1075            | 969    | 930              | 1130   | 902             | 1102   |                 |        |
| 1000       | 600    | 1075          | 550                   | 925              | 950                   | 675             | 569    | 1130             | 730    | 1102            | 702    |                 |        |
| 1000       | 800    | 1075          | 750                   | 925              | 950                   | 875             | 769    | 1130             | 930    | 1102            | 902    |                 |        |
| 1000       | 1200   | 1075          | 1150                  | 925              | 950                   | 1275            | 1169   | 1130             | 1330   | 1102            | 1302   |                 |        |
| 1200       | 800    | 1275          | 750                   | 1125             | 1150                  | 875             | 769    | 1330             | 930    | 1302            | 902    |                 |        |
| 1400       | 800    | 1475          | 750                   | 1325             | 1350                  | 875             | 769    | 1530             | 930    | 1502            | 902    |                 |        |

1: Same mounting centres for Cat. Nos. 0364 01 and 0364 04

## Assembly kit on plane surface for Cabstop plate

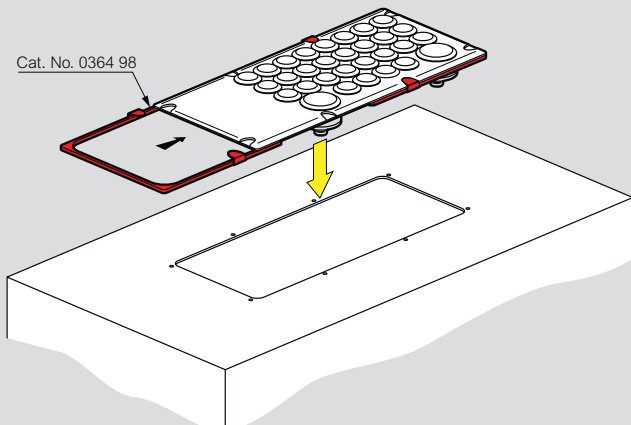

## Cabstop plate

- Tensile resistance: 15 kg minimum
- Operating temperature: - 20 °C to + 65 °C
- ASTM No 3 resistance to cutting oil
- Resistance to incandescent wire: 750 °C according to IEC EN 60695-2-11

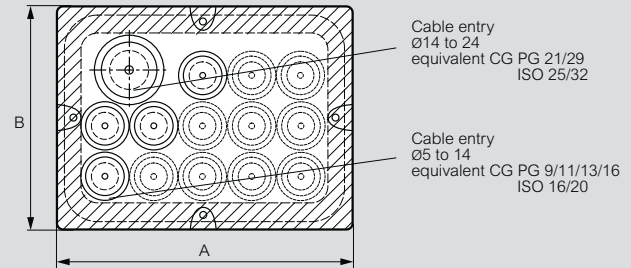

## Dimensions

Cat. No. 0364 94

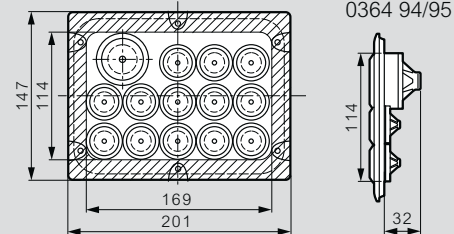

Cat. No. 0364 95

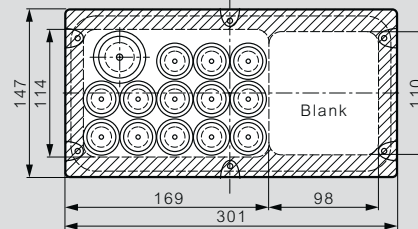

Cat. No. 0364 96

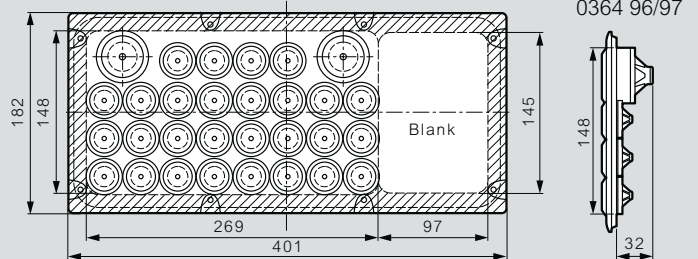

Cat. No. 0364 97

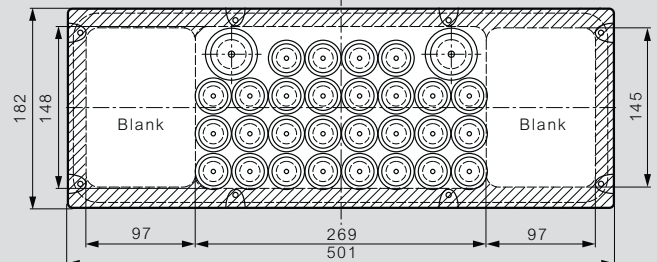

# Atlantic stainless steel enclosures

304 L and 316 L



Wall mounting lugs, horizontal or vertical installation



0352 01 + 0364 06



Enclosure and equipment selection chart p. 8-9

IP 66 according to standards IEC/EN 60529  
 IK 10 according to standards IEC/EN 62262 (EN 50102)  
 Approvals: cULus: type 4x  
 Bureau Veritas, LCIE N° 80257-575296  
 Suitable for harsh environments. Brushed stainless steel finish  
 Door with rounded vertical edges  
 Double bar lock. Upper and lower protective hoods  
 Reversible enclosure  
 Self-centering positioning system for the equipment  
 Excellent resistance to corrosion and weather conditions  
 Compatible with all Atlantic and Atlantic stainless steel accessories

| Pack | Cat. Nos.            | Stainless steel enclosures 304L (1 door) |            |            | Weight (kg) |
|------|----------------------|--|------------|------------|-------------|
|      |                      | External dimensions                      |            |            |             |
|      | Metal door           | Height (mm)                              | Width (mm) | Depth (mm) |             |
| 1    | 0352 00 <sup>1</sup> | 300                                      | 200        | 160        | 4           |
| 1    | 0352 01              | 400                                      | 300        | 200        | 5.8         |
| 1    | 0352 02              | 500                                      | 400        | 200        | 8.3         |
| 1    | 0352 03              | 600                                      | 400        | 200        | 10.8        |
| 1    | 0352 05              | 600                                      | 400        | 250        | 12          |
| 1    | 0352 06              | 700                                      | 500        | 250        | 15          |
| 1    | 0352 11              | 800                                      | 600        | 300        | 22          |
| 1    | 0352 13              | 1000                                     | 800        | 300        | 38          |

## Stainless steel enclosures 316L (1 door)

Supplied with non-interchangeable double bar lock  
 Epoxy finish. Steel coated  
 Locking points :  
 1 lock for heights ≤ 400 mm  
 2 locks for heights ≥ 500 mm

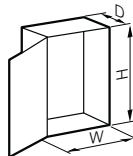

|   |                      | External dimensions |            |            | Weight (kg) |
|---|----------------------|---------------------|------------|------------|-------------|
|   |                      | Height (mm)         | Width (mm) | Depth (mm) |             |
| 1 | 0352 40 <sup>1</sup> | 300                 | 200        | 160        | 4           |
| 1 | 0352 41              | 400                 | 300        | 200        | 5.8         |
| 1 | 0352 42              | 500                 | 400        | 200        | 8.3         |
| 1 | 0352 45              | 600                 | 400        | 250        | 12          |
| 1 | 0352 46              | 700                 | 500        | 250        | 15          |
| 1 | 0352 47              | 800                 | 600        | 300        | 22          |
| 1 | 0352 53              | 1000                | 800        | 300        | 38          |

## Stainless steel wall mounting lugs

For load up to 300 kg  
 Horizontal or vertical installation  
 Supplied with stainless steel screws  
 Set of 4

|   |         |       |
|---|---------|-------|
| 1 | 0364 06 | 304 L |
| 1 | 0364 16 | 316 L |

1: Supplied with plain plate

# Atlantic stainless steel enclosures

technical characteristics

## Usable dimensions

### Doors

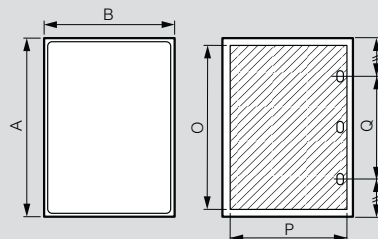

| Cat. Nos.  | Enclosures    |              |            | Door usable dimensions |        | Lock position |
|------------|---------------|--------------|------------|------------------------|--------|---------------|
|            | Height A (mm) | Width B (mm) | Depth (mm) | O (mm)                 | P (mm) | Q (mm)        |
| 0352 00/40 | 301.6         | 199.6        | 161.5      | 250                    | 150    | -             |
| 0352 01/41 | 401.6         | 299.6        | 201.5      | 350                    | 250    | -             |
| 0352 02/42 | 501.6         | 399.6        | 201.5      | 450                    | 350    | 250           |
| 0352 03    | 601.6         | 399.6        | 201.5      | 550                    | 350    | 380           |
| 0352 05/45 | 601.6         | 399.6        | 251.5      | 550                    | 350    | 380           |
| 0352 06/46 | 702.4         | 500          | 251.5      | 650                    | 450    | 400           |
| 0352 11/47 | 802.4         | 600          | 301.5      | 750                    | 550    | 400           |
| 0352 13/53 | 1003.6        | 800.6        | 301.5      | 950                    | 750    | 600           |

## Usable depth

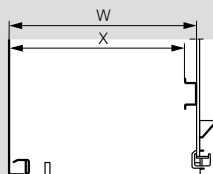

| Enclosures | Back of enclosure |     |
|------------|-------------------|-----|
|            | Depth (mm)        | W   |
| 160        | 140               | 125 |
| 200        | 180               | 165 |
| 250        | 230               | 215 |
| 300        | 280               | 265 |
| 400        | 380               | 365 |

## Fixing

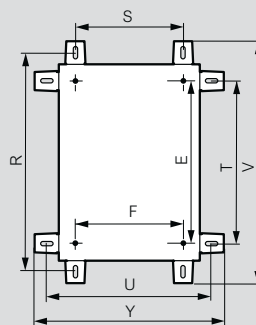

Cat. Nos. 0364 06/16

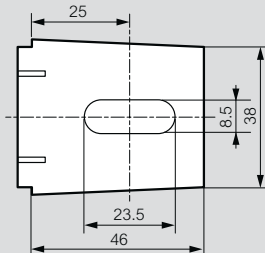

| Cat. Nos.  | Vertical position |     | Horizontal position |     | V    | Y   | E   | F   |
|------------|-------------------|-----|---------------------|-----|------|-----|-----|-----|
|            | R                 | S   | T                   | U   |      |     |     |     |
| 0352 00/40 | 350               | 150 | 250                 | 250 | 392  | 292 | 225 | 169 |
| 0352 01/41 | 450               | 250 | 350                 | 350 | 492  | 392 | 325 | 269 |
| 0352 02/42 | 550               | 350 | 450                 | 450 | 592  | 492 | 425 | 369 |
| 0352 03    | 650               | 350 | 550                 | 450 | 692  | 492 | 525 | 369 |
| 0352 05/45 | 650               | 350 | 550                 | 450 | 692  | 492 | 525 | 369 |
| 0352 06/46 | 750               | 450 | 650                 | 550 | 792  | 592 | 625 | 469 |
| 0352 11/47 | 850               | 550 | 750                 | 650 | 892  | 692 | 725 | 569 |
| 0352 13/53 | 1050              | 750 | 950                 | 850 | 1092 | 892 | 925 | 769 |

Download the full file at

<http://assets.kempstoncontrols.com/doc/Atlantic%20New%20IP66%20Metal%20Enclosures.pdf>



**KEMPSTON**  
CONTROLS