

## Smart solutions for electrical distribution in residential and commercial applications



**EATON**

*Powering Business Worldwide*



Aerospace



Truck



# Powering business worldwide

## Discover Eaton – a leader in the power management field

Since 1911, when our company began trading as a small truck parts supplier, Eaton® Corporation has come a long way. Today, as a diversified power management company, Eaton has sales of \$11.9 billion USD (FY 2009), employs 70,000 people and has customers in more than 150 countries. Everyday, we help companies across the world to manage power, and do more, while consuming less energy.

Eaton's innovative products, solutions and technologies are designed to help customers to manage power and conserve resources while working more productively, safely and sustainably. Our integrated and diversified business strategy ensures that we remain at the forefront of our industry, decade after decade.

### Aerospace

A leading global supplier to commercial and military aviation and aerospace industries. An extensive technology portfolio includes hydraulic systems, fuel systems, motion control systems, propulsion sub-systems, cockpit controls and displays and fluid health monitoring systems. Our products improve fuel economy, aircraft performance, reliability and safety.

### Truck

A leader in the design, manufacture and marketing of complete line of drivetrain systems and components for medium- and heavy-duty commercial vehicles. Under the "Roadranger" brand, Eaton also markets lubricants, safety products and service tools. Eaton's hybrid power systems have earned the company recognition as a global leader in alternative power for commercial vehicles.

### Electrical

A global leader in electrical control, power distribution, uninterruptible power supply and industrial automation products and services. Our products provide customer-driven PowerChain Management® solutions to serve the power system needs of the industrial, institutional, government, utility, commercial, residential, IT, mission critical and OEM markets worldwide.



Powering Business Worldwide





Electrical



Automotive



Hydraulics

# Powering business more sustainably

## Sustainability – smaller footprint in the world

The principle of sustainability means meeting the current needs of our own society without compromising the needs or options of future generations. It is a principle, which forms the very core of our design and production philosophy and guides all our activities across the world. Our commitment to reducing our own ecological footprint covers a wide range of green technologies, products and services that help our customers utilise electrical power more efficiently, while improving environmental performance.

Eaton has been recognised throughout the world for its uncompromising business ethics. For example, it was listed as one of the 'World's Most Ethical Companies' on the Ethisphere Institute's annual list for three consecutive years (2007, 2008 and 2009).



An Eaton Green Solution

Learn more about Eaton Green Solutions at [www.eaton.com/greensolutions](http://www.eaton.com/greensolutions)

When you see this symbol, you know the solution represents an Eaton benchmark for environmental performance.

## Automotive

A supplier of critical components that reduce emissions and fuel consumption and improve stability and performance of cars, light trucks and commercial vehicles. Principal products include engine valves and valve train components, transmission and engine controls, supercharger, locking and limited slip differentials, cylinder heads, fluid conveyance components, body mouldings and spoilers.

## Hydraulics

A worldwide leader in reliable, high-efficiency hydraulic systems and components for use in mobile and industrial applications. Markets include agriculture, construction, mining, forestry, utility, material handling, earth moving, truck and bus, machine tools, moulding, primary metals, automotive, power generation, port machinery and entertainment.

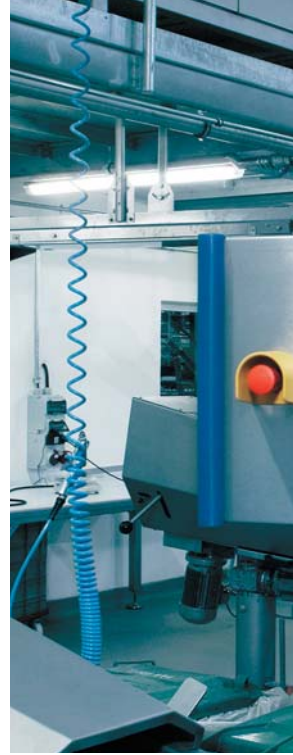
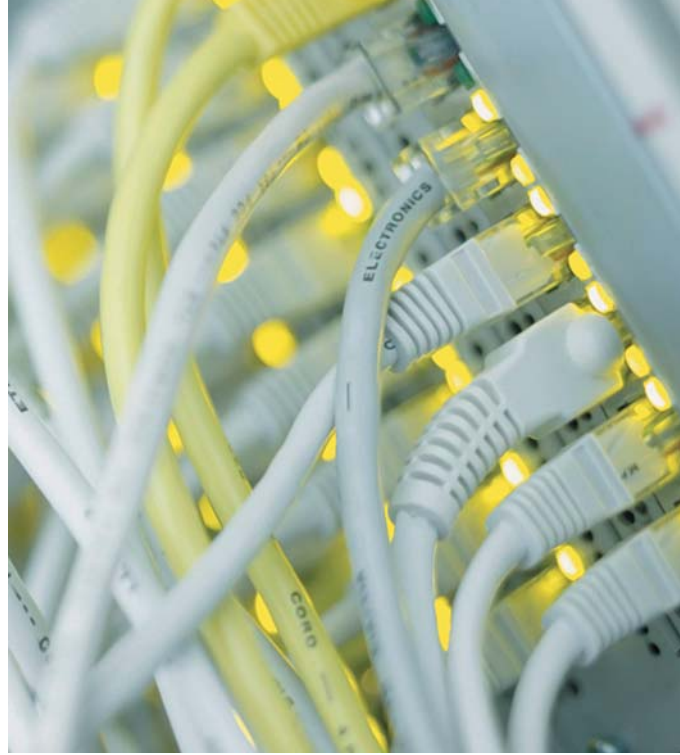

# Powering electrical systems worldwide

## Buildings

- Residential
- Healthcare
- Education
- Commercial offices
- Retail
- Public sector
- Airports
  
- Electrical distribution solutions for safe and efficient power delivery
- Power quality systems for uptime and reliability
- Power metering and monitoring to add intelligence and save costs
- Industrial control products for HVAC applications

## Information Technology

- Data centers
- Telecommunication
- Networks
- Computer rooms
  
- World's most efficient line of UPSs to reduce footprint and save energy
- Reliable power systems with inherent redundancy to improve availability
- Power metering and monitoring to diagnose problems and lower costs
- Local service and support for quick response





### Public and private sectors

Buildings, Information Technology, Industrial & Machinery, Energy & Utilities  
We provide reliable, efficient and safe power management.

## Industrial & Machinery

- Manufacturing
- Agriculture
- Construction
- Mining and metals
- Processing:
  - Petrochemicals
  - Pharmaceuticals
  - Pulp and paper
- Material handling
  
- Electrical distribution equipment to deliver power throughout the enterprise
- Control & automation and power quality equipment for process control
- Power metering and monitoring to manage energy costs and uptime
- Power and motion control products to optimize productivity, reliability, safety and operator comfort

## Energy & Utilities

- Renewable energy:
  - Solar
  - Wind
  - Hydropower
- Traditional energy:
  - Oil
  - Gas
- Smart grid
- Water and waste water
  
- Electrical balance of system and turnkey services for residential, utility and commercial solar installations
- Power distribution equipment, control components and system installations services
- Network power grid technology for intelligent data, lower costs and crew/public safety



# Complete coverage of the market – worldwide in all standards

## Local market leader with global competence

Eaton's product series are distinguished by their strong presence in all regions of the world. In markets that adhere to IEC standards, Eaton's Moeller line is very well established, and in the world of UL/CSA, Eaton is a key player, for example with its Cutler-Hammer line. Now all customers are benefiting from first-rate engineering and the combined know-how in research and development – no matter which standards they use.

In electrical engineering, it was less continents and regions but rather standards that drew boundaries. Historically grown in the U.S. market, Eaton focused on product series according to UL/CSA standards. Consequently, Eaton's Electrical Sector was always strongly geared towards the markets in North and South America, the Middle East, Benelux as well as the United Kingdom.

Moeller series products from Eaton are the customers' first choice in markets adhering to IEC standards for innovative switchgear and control circuit devices, control, drive and operating systems as well as sophisticated visualization and communication.



## Contents

1	Product overview	9
2	PREMERA white moulded	33
3	PREMERA mix	45
4	PREMERA proof	59
5	COPA clip-on plate	61
6	COPA fix	73
7	XTRA surface metalclad	81
8	CIRCA ceiling range	87
9	LSC plug-in lighting system	93
10	xComfort system overview	97
11	MEMERA consumer units	107
12	Technical data	125
	Index	157







Eaton’s comprehensive range of wiring accessories and single phase distribution solutions have been developed to meet today’s challenging electrical applications in residential and light commercial projects and applications. Through a proven competency in electrical distribution, Eaton delivers an innovative and flexible approach to aid compliance with the regulatory requirements associated with modern buildings.

<b>1.1</b>	<b>PREMERA WIRING ACCESSORIES</b>	
	PREMERA white moulded .....	10
	PREMERA mix .....	10–11
	PREMERA proof .....	13
	COPA clip-on plate .....	11
	COPA fix .....	12
	XTRA surface metalclad .....	13
	Wall mounted range options .....	14–17
<b>1.2</b>	<b>CIRCA CEILING RANGE</b> .....	18
<b>1.3</b>	<b>LSC PLUG-IN LIGHTING SYSTEM</b> .....	19
<b>1.4</b>	<b>MEMERA CONSUMER UNITS AND DEVICES</b> .....	20
	Moulded consumer units .....	21
	Metalclad consumer units .....	22
	Consumer unit solutions .....	28
	Switch and protection devices .....	29
	Control and switching devices .....	30
<b>1.5</b>	<b>RF BUILDING AUTOMATION AND CONTROLS</b> .....	32

# 1.1

## Product overview PREMERA wiring accessories

### PREMERA white moulded range

PREMERA offers a new consistent range of white accessories combining good aesthetics and high quality material

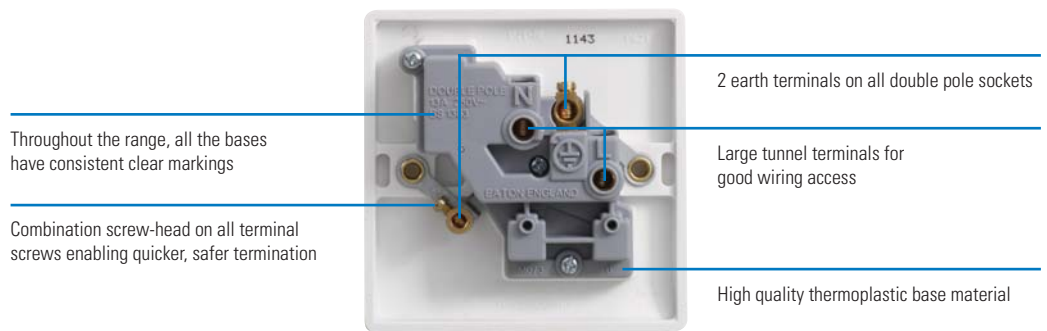

### PREMERA mix modular range



Quick, easy removal of modules via clip release

1-4 gang mounting plates come complete with integral earth strap avoiding the need to order separate grid

Large terminals for good wiring access

Bottom terminals angled in slightly to aid access to screws from the top



Module plates up to 12 gang in urea material and 24 gang in COPA 'clip-on' or 'screw fix' versions

Top facing terminals for easy access and quicker installation

High quality thermoplastic material on bases

Wiring diagram shown on each module

Totally modular system incorporating;

- Power switches, standard & broad rocker options
- Power sockets in various worldwide styles
- Power indicators, fuses units, cable outlets
- Dimmer modules
- Communication modules including RJ45 Cat 6, isolated co-axial/satellite outlets, standard telephone outlets, including RJ11
- xComfort radio frequency switch modules
- 6-24 gang mounting plates comes with all the frames/mounts/screws required – just order the modules you need
- 6-24 gang mounting plates have individual removable banks for ease of installation and future changes. Banks removed via quarter turn fasteners offering quick release/fitting



### PREMERA mix combinations

Various socket options to offer a wide choice of worldwide applications;

- Standard 13A sockets BS1363
- Non standard 13A
- 5 and 15 Amp round pin
- US standard 15A 3 pin sockets
- European Schuko sockets
- Key switched socket with power indicator
- Unique key switch with integral neon indicator





## COPA clip-on plate range

Eaton's COPA range is strengthened with the introduction of the PREMERA mix range.

- Includes new modular plate options up to 24 gang
- Plates available in decorative plastic finishes and high quality metal finishes
- Plates can be affixed by either clip-on or screw on option depending on the clients' requirements



The following key aspects need to be considered to comply with Part M – Building Regulations.

Eaton's clip-on plate accessory range provides a very easy way to meet the requirements under the Electrical Installations section for switches, outlets and controls.

### Design considerations – Part M:

**4.28** Controls that **contrast visually with their surroundings are more convenient for visually impaired people**, as are light switches that are activated by a large push pad.

### Eaton's solutions:

A range of 10 standard colours/finishes will ensure a suitable contrast is maintained between wall and plate switch/socket.

It is recommended that a 30-point difference in the light reflective value (LRV) be achieved between the two surfaces. The LRV scale runs from 0, which is a perfectly absorbing surface that could be assumed to be totally black, up to 100, which is a perfectly reflective surface that could be considered to be the perfect white.

With COPA, the switch/socket plate colour can be left to the last minute due to its simple clip-on facility. This allows for late confirmation or unknown wall colour. It also avoids any damage to the front plate during wall preparation/painting.

- Choice of 10 contrasting colour/finish plates.
- Final colour of plate can be left to the last minute and clipped on once the wall surround colour is known.

### Design considerations – Part M:

**4.28** Controls that contrast visually with their surroundings are more convenient for visually impaired people, **as are light switches that are activated by a large push pad**.

### Eaton's solutions:

A comprehensive range of broad rocker switches with contrasting coverplates is available including:

- 1 and 2 gang large rocker 2 way switches
- Intermediate switches
- Double pole switches
- Push switches

## Light Reflective Value (LRV) plate guide

Plate finish	Approx. LRV
<b>BM</b> BLACK MATT	26
<b>GY</b> GREY	39
<b>BL</b> BLUE METALLIC	59
<b>SB</b> SATIN BRONZE	62
<b>SV</b> SILVER METALLIC	65
<b>SS</b> STAINLESS STEEL	70
<b>GL</b> GOLD METALLIC	77
<b>HP</b> HIGHLY POLISHED	82
<b>PB</b> POLISHED BRASS	83
<b>WH</b> WHITE	89

### Design considerations – Part M:

**4.29** It is also an advantage if individual switches on panels and on multiple socket outlets are well separated, or in the form of large touch plates, to avoid the inadvertent selection of an adjacent control by visually impaired people and individuals with limited dexterity.

### Eaton's solutions:

Eaton offers a comprehensive range of sockets with outboard (separated) rockers. Coloured plates can be selected to provide suitable visual contrast.

### In Summary:

Eaton's clip-on plate accessory range offers simple solutions;

- Broad rocker range throughout the range finishes.
- Outboard rockers on sockets.
- Contrasting clip-on plates for all products.

**Easy installation – COPA (Clip-on Plate Accessory) range**



- STEP 1**  
Fit interior electrically safe and can be tested to IET Regulations at this stage.
- STEP 2**  
Determine the colour of the wall then decorate.
- STEP 3**  
Choose finish to meet 30 point LRV criteria.



COPA – clip-on plate version

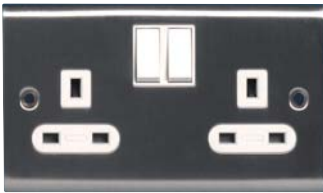

COPA fix – fixed plate version

**COPA fix range**

The COPA style of plate is being extended to now offer an alternative to the 'Clip on' plate by offering the same plate profile with it's stylish good looks but with a fixed plate.

COPA fix:

- offers a solution in situations where it is more desirable to have screw fixed plates. It is appreciated not every application is suitable for clip-on plates and in situations such as prisons, schools, public places, it offers the consultant a choice dependant on the clients requirements
- will also benefit from the PREMERA mix range of modular components up to 24 gang size offering many modular solutions
- will be available in the two most popular finishes, Stainless Steel and Highly Polished

**XTRA surface metalclad range**

- A subtle change has been made to the front plate style to bring the range more in line with the latest plate style offered in the new look MEM® series of wiring accessories
- Will also benefit from the PREMERA mix range of modular components up to 24 gang size offering many modular solutions



**PREMERA proof**

- Provides an extensive range of combinations by utilising the 1 and 2 gang IP66 enclosures making a wide variety of combinations
- A new range of weatherproof accessories offering protection up to IP66





## Wall mounted range

Description	PREMERA range	COPA c/w cover	COPA interior	COPA black interior	COPA decorative plates <sup>1)</sup>	COPA metal plates <sup>2)</sup>	COPA fix stainless steel	COPA fix highly polished	XTRA surface metal
<b>10A switches – 1 way</b>									
10A 1G 1 way	P011	C011WH	C011	C011B	CP011 <sup>1)</sup>	CM011 <sup>2)</sup>	–	–	–
10A 2G 1 way	P012	C012WH	C012	C012B	CP012 <sup>1)</sup>	CM012 <sup>2)</sup>	–	–	–
10A 3G 1 way	P013	C013WH	C013	C013B	CP013 <sup>1)</sup>	CM013 <sup>2)</sup>	–	–	–
10A 4G 1 way	P014	C014WH	C014	C014B	CP014 <sup>1)</sup>	CM014 <sup>2)</sup>	–	–	–
10A 1G 1 way bell push	P015	C015WH	C015	C015B	CP015 <sup>1)</sup>	CM015 <sup>2)</sup>	B015SS	B015HP	–
10A 1G 1 way light symbol push	P015L	C015LWH	–	–	CP015L <sup>1)</sup>	CM015L <sup>2)</sup>	–	–	–
10A 1G 1 way push	P015P	–	–	–	–	–	–	–	–
10A 1G intermediate	P017	C017WH	C017	C017B	CP011 <sup>1)</sup>	CM011 <sup>2)</sup>	B017SS	B017HP	X017MG
<b>10A switches – 2 way</b>									
10A 1G 2 way	P021	C021WH	C021	C021B	CP011 <sup>1)</sup>	CM011 <sup>2)</sup>	B021SS	B021HP	X021MG
10A 1G 2 way push	P021P	–	–	–	–	–	–	–	–
10A 2G 2 way	P022	C022WH	C022	C022B	CP012 <sup>1)</sup>	CM012 <sup>2)</sup>	B022SS	B022HP	X022MG
10A 3G 2 way	P023	C023WH	C023	C023B	CP013 <sup>1)</sup>	CM013 <sup>2)</sup>	B023SS	B023HP	X023MG
10A 4G 2 way	P024	C024WH	C024	C024B	CP014 <sup>1)</sup>	CM014 <sup>2)</sup>	–	–	–
10A 6G 2 way	P026	C026WH	C026	C026B	CP026 <sup>1)</sup>	CM026 <sup>2)</sup>	–	–	–
<b>10A fan isolator</b>									
10A 3-pole fan isolator + fan symbol	P048	C048WH	C048	C048B	CP048 <sup>1)</sup>	CM048 <sup>2)</sup>	B048SS	B048HP	X048MG
10A 3-pole isolator	P049	C049WH	–	–	CP049 <sup>1)</sup>	CM049 <sup>2)</sup>	–	–	X049MG
<b>10A broad rocker switches</b>									
10A 2G 2 way half broad	P032	C032WH	C032	C032B	CP013 <sup>1)</sup>	CM013 <sup>2)</sup>	–	–	–
10A 1G 2 way broad	P041	C041WH	C041	C041B	CP013 <sup>1)</sup>	CM013 <sup>2)</sup>	–	–	X041MG
10A 1G 2 way broad push	P041P	–	–	–	–	–	–	–	–
10A 2G 2 way broad	P042	–	–	–	–	–	–	–	–
10A 1G 1 way broad bell push	P045	C045WH	C045	C045B	CP045 <sup>1)</sup>	CM045 <sup>2)</sup>	–	–	–
10A 1G 1 way broad push	P045P	–	–	–	–	–	–	–	–
10A 1G intermediate broad	P047	C047WH	C047	C047B	CP013 <sup>1)</sup>	CM013 <sup>2)</sup>	–	–	–
10A 1G DP broad + neon	P043N	–	–	–	–	–	–	–	–
<b>16A hotel switch</b>									
16A hotel switch	P450	–	–	–	–	–	–	–	–
<b>Dimmers</b>									
250W 1G 2 way push tungsten	P9131	C9131WH	C9131	–	CP351 <sup>1)</sup>	CM351 <sup>2)</sup>	–	–	–
250W 2G 2 way push tungsten	P9132	C9132WH	C9132	–	CP9132 <sup>1)</sup>	CM9132 <sup>2)</sup>	–	–	–
400W 1G 2 way push tungsten	P9141	C9141WH	C9141	–	CP351 <sup>1)</sup>	CM351 <sup>2)</sup>	–	–	–
400W 2G 2 way push tungsten	P9142	–	–	–	–	–	–	–	–
1000W 1G 2 way push tungsten (2G plate size)	P9111	–	C9111	–	CP9111 <sup>1)</sup>	CM9111 <sup>2)</sup>	–	–	–
1–10V 1G 1 way analogue	P9101	–	–	–	–	–	–	–	–
500W 1G 1 way tungsten non-european	P9551	C9551WH	C9551	–	CP351 <sup>1)</sup>	CM351 <sup>2)</sup>	–	–	–
500W 2G 1 way tungsten non-european	P9552	C9552WH	C9552	–	CP9132 <sup>1)</sup>	CM9132 <sup>2)</sup>	–	–	–
1000W 1G 1 way tungsten non-european	P9511	C9511WH	C9511	–	CP351 <sup>1)</sup>	CM351 <sup>2)</sup>	–	–	–
60–500W fan controller non-european	P9751	C9751WH	C9751	–	CP351 <sup>1)</sup>	CM351 <sup>2)</sup>	–	–	–
<b>13A switched sockets – single pole</b>									
13A 1G	P611	–	–	–	–	–	–	–	–
13A 2G	P612	–	–	–	–	–	–	–	–
<b>13A switched sockets – double pole</b>									
13A 1G DP 2E terminals	P621	C621WH	C621	C621B	CP621 <sup>1)</sup>	CM621 <sup>2)</sup>	B621SS	B621HP	X621MG
13A 1G DP 2E terminals – grey cover	P621GY	–	C621	–	CP621GY	–	–	–	–
13A 1G DP 2E terminals + neon	P621N	C621NWH	C621N	C621NB	CP621N <sup>1)</sup>	CM621N <sup>2)</sup>	B621NSS	B621NHP	X621NMG
13A 1G DP 2E terminals – red cover	P621RED	–	–	–	–	–	–	–	–
13A 1G DP 2E terminals + red rockers	P621RR	–	–	–	–	–	B621RRSS	–	X621RRMG
13A 2G DP 2E terminals	P622	C622WH	C622	C622B	CP622 <sup>1)</sup>	CM622 <sup>2)</sup>	B622SS	B622HP	X622MG
13A 2G DP 2E terminals + neon	P622N	C622NWH	C622N	C622NB	CP622N <sup>1)</sup>	CM622N <sup>2)</sup>	B622NSS	B622NHP	X622NMG
13A 2G DP 2E terminals + red rockers	P622RR	–	–	–	–	–	B622RRSS	–	X622RRMG



Wall mounted range (contd)



Description	PREMERA range	COPA c/w cover	COPA interior	COPA black interior	COPA decorative plates <sup>1)</sup>	COPA metal plates <sup>2)</sup>	COPA fix stainless steel	COPA fix highly polished	XTRA surface metal
<b>13A switched sockets – double pole, outboard rockers</b>									
13A 2G DP 2E terminals	P632	C632WH	C632	C632B	CP632 <sup>1)</sup>	CM632 <sup>2)</sup>	B632SS	–	X632MG
13A 2G DP 2E terminals – grey cover	P632GY	–	C632	–	CP632GY	–	–	–	–
13A 2G DP 2E terminals – red cover	P632RED	–	–	–	–	–	–	–	–
13A 2G DP 2E terminals – red rockers	P632RR	–	–	–	–	–	–	–	X632RRMG
13A 2G DP 2E terminals + neon	P632N	–	–	–	–	–	–	–	–
<b>13A switched sockets – double pole, non-standard</b>									
13A 1G DP 2E terminals	P651	C651WH	C651	C651B	CP621 <sup>1)</sup>	CM621 <sup>2)</sup>	B651SS	–	X651MG
13A 1G DP 2E terminals + neon	P651N	–	–	–	–	–	–	–	X651NMG
13A 2G DP 2E terminals – outboard rockers	P652	C652WH	C652	C652B	CP632 <sup>1)</sup>	CM632 <sup>2)</sup>	B652SS	–	X652MG
13A 2G DP 2E terminals – outboard red rockers	P652RR	–	–	–	–	–	–	–	–
<b>13A switched sockets – double pole, outboard rockers, clean earth</b>									
13A 2G with 2E terminals	P672	–	–	–	–	–	–	–	–
<b>13A RCD socket</b>									
13A 2G RCD 30mA – passive	P686	–	–	–	–	–	–	–	X686MG
<b>13A unswitched sockets</b>									
13A 1G	P111	C111WH	C111	C111B	CP111 <sup>1)</sup>	CM111 <sup>2)</sup>	B111SS	–	X111MG
13A 2G	P112	C112WH	C112	C112B	CP112 <sup>1)</sup>	CM112 <sup>2)</sup>	B112SS	–	X112MG
<b>5A sockets</b>									
5A 1G	–	C305WH	C305	C305B	CP305 <sup>1)</sup>	CM305 <sup>2)</sup>	B305SS	–	X305MG
<b>16A sockets</b>									
16A 2 pin universal	–	C461WH	C461	C461B	CP011 <sup>1)</sup>	CM011 <sup>2)</sup>	–	–	–
<b>15A switched sockets</b>									
15A 1G	P415	C415WH	C415	C415B	CP415 <sup>1)</sup>	CM415 <sup>2)</sup>	B415SS	–	X415MG
<b>Shaver supply unit</b>									
Dual voltage 230V/115V AC	P370	C370WH	C370	C370B	CP370 <sup>1)</sup>	CM370 <sup>2)</sup>	B370SS	–	–
<b>13A connection units – double pole switched with optional cable outlets</b>									
13A connection unit	P221	C221WH	C221	C221B	CP221 <sup>1)</sup>	CM221 <sup>2)</sup>	B221SS	B221HP	X221MG
13A connection unit – grey cover	P221GY	–	C221	–	CP221 <sup>1)</sup>	–	–	–	–
13A connection unit ‘boiler’	P221BO	–	–	–	–	–	–	–	–
13A connection unit ‘central heating’	P221CH	–	–	–	–	–	–	–	–
13A connection unit ‘cooker hood’	P221CKH	–	–	–	–	–	–	–	–
13A connection unit ‘dishwasher’	P221DW	–	–	–	–	–	–	–	–
13A connection unit ‘extract fan’	P221EF	–	–	–	–	–	–	–	–
13A connection unit ‘refrigerator’	P221R	–	–	–	CP221RWH	–	–	–	–
13A connection unit + red rocker	P221RR	–	–	–	–	–	–	–	X221RRMG
13A connection unit ‘washing machine’	P221WM	–	–	–	CP221WMMWH	–	–	–	–
13A connection unit fitted with 3A fuse	P223	–	–	–	–	–	–	–	–
<b>13A connection units – double pole switched + neon with optional cable outlets</b>									
13A connection unit	P221N	C221NWH	C221N	C221NB	CP221N <sup>1)</sup>	CM221N <sup>2)</sup>	B221NSS	B221NHP	X221NMG
13A connection unit – grey cover	P221NGY	–	C221N	–	CP221NGY	–	–	–	–
13A connection unit ‘refrigerator’	P221NR	–	–	–	CP221NRWH	–	–	–	–
13A connection unit + red rocker	P221NRR	–	–	–	–	–	–	–	X221NRRMG
13A connection unit ‘water heater’	P221NWH	–	–	–	–	–	–	–	–
13A connection unit ‘washing machine’	P221NWM	–	–	–	CP221NMMWH	–	–	–	–
13A connection unit ‘boiler’	P221NBO	–	–	–	–	–	–	–	–
13A connection unit ‘dishwasher’	P221NDW	–	–	–	–	–	–	–	–
13A connection unit ‘fridge freezer’	P221NFF	–	–	–	–	–	–	–	–
13A connection unit ‘hob’	P221NHO	–	–	–	–	–	–	–	–
13A connection unit ‘tumble dryer’	P221NTD	–	–	–	–	–	–	–	–



## Wall mounted range (contd)

Description	PREMERA range	COPA c/w cover	COPA interior	COPA black interior	COPA decorative plates <sup>1)</sup>	COPA metal plates <sup>2)</sup>	COPA fix stainless steel	COPA fix highly polished	XTRA surface metal
<b>13A connection units – unswitched with optional cable outlets</b>									
13A connection unit	P220	C220WH	C220	C220B	CP220 <sup>1)</sup>	CM220 <sup>2)</sup>	B220SS	–	X220MG
13A connection unit + red fuse drawer	P220RR	–	–	–	–	–	–	–	X220RRMG
13A connection unit fitted with 3A fuse	P224	–	–	–	–	–	–	–	–
<b>13A connection units – unswitched + neon with optional cable outlets</b>									
13A connection unit	P220N	C220NWH	C220N	C220NB	CP220N <sup>1)</sup>	CM220N <sup>2)</sup>	B220NSS	–	X220NMG
13A connection unit fitted with 3A fuse	P223N	–	–	–	–	–	–	–	–
<b>20A double pole switches with optional cable outlet</b>									
20A switch	P401	C401WH	C401	C401B	CP401 <sup>1)</sup>	CM401 <sup>2)</sup>	B401SS	–	X401MG
20A switch marked 'water heater'	P403	C403WH	–	–	–	CM403 <sup>2)</sup>	–	–	–
<b>20A double pole switches + neon with optional cable outlets</b>									
20A switch	P401N	C401NWH	C401N	C401NB	CP401N <sup>1)</sup>	CM401N <sup>2)</sup>	B401NSS	–	X401NMG
20A switch marked 'water heater'	P403N	C403NWH	–	–	CP403N <sup>1)</sup>	CM403N <sup>2)</sup>	B403NSS	–	–
20A switch marked 'air conditioner'	P404N	–	–	–	–	–	B404NSS	–	–
<b>45A double pole switches – cooker control units</b>									
45A DP cooker control unit	P425	C425WH	C425	C425B	CP425 <sup>1)</sup>	CM425 <sup>2)</sup>	–	–	–
45A DP cooker control unit + neon	P425N	C425NWH	C425N	C425NB	CP425N <sup>1)</sup>	CM425N <sup>2)</sup>	B425NSS	–	–
<b>50A double pole switches – 2 gang plate size</b>									
50A DP switch	P421	–	–	–	–	–	–	–	X421MG
50A DP switch + neon	P421N	C421NWH	C421N	C421NB	CP421N <sup>1)</sup>	CM421N <sup>2)</sup>	B421NSS	–	X421NMG
50A DP switch marked 'cooker'	P423	–	–	–	–	–	–	–	–
50A DP switch + neon marked 'cooker'	P423N	C423NWH	–	–	CP423N <sup>1)</sup>	CM423N <sup>2)</sup>	–	–	–
50A DP switch + neon marked 'air conditioner'	P424N	C424NWH	–	–	CP424N <sup>1)</sup>	CM424N <sup>2)</sup>	–	–	–
<b>50A double pole switches – 1 gang plate size</b>									
50A DP switch + neon	P422N	C422NWH	C422N	C422NB	CP422N <sup>1)</sup>	CM422N <sup>2)</sup>	B422NSS	–	–
50A DP switch + neon – grey cover	P422NGY	–	C422N	–	CP422NGY	–	–	–	–
50A DP switch + neon marked 'cooker'	P426N	C426NWH	–	–	–	–	B426NSS	–	–
50A DP switch + neon marked 'air conditioner'	P427N	–	–	–	–	–	–	–	–
<b>Cable/cooker outlet/cable outlet adaptor plate</b>									
20A flex outlet plate	P210	–	–	–	–	–	–	–	–
Cable outlet adaptor plate for 20A switch/3A fused connection unit	P212	C212	–	–	–	–	–	–	–
45A DP cable outlet with terminal block	P345	–	–	–	–	–	–	–	–
<b>Phone outlets</b>									
1G telephone outlet master	P360	C360WH	C360	C360B	CP360 <sup>1)</sup>	CM360 <sup>2)</sup>	B360SS	–	X360MG
1G telephone outlet secondary	P361	C361WH	C361	C361B	CP360 <sup>1)</sup>	CM360 <sup>2)</sup>	B361SS	–	X361MG
1G american telephone outlet RJ11	P362	C362WH	C362	C362B	CP360 <sup>1)</sup>	CM360 <sup>2)</sup>	–	–	–
<b>Data outlets</b>									
1G RJ45 CAT 6 outlet interior	–	C363WH	C363	C363B	CP360 <sup>1)</sup>	CM360 <sup>2)</sup>	–	–	–
<b>Communication outlets</b>									
1G TV co-axial	P351	C351WH	C351	C351B	CP351 <sup>1)</sup>	CM351 <sup>2)</sup>	B351SS	–	–
1G TV co-axial dual clamp	P351D	–	–	–	–	–	–	–	–
2G TV co-axial outlet	P352	C352WH	C352	C352B	CP352 <sup>1)</sup>	CM352 <sup>2)</sup>	–	–	–
1G TV/FM isolated co-axial	P353	C353WH	C353	C353B	CP351 <sup>1)</sup>	CM351 <sup>2)</sup>	–	–	–
2G TV/FM diplexer co-axial	P354	C354WH	C354	C354B	CP352 <sup>1)</sup>	CM352 <sup>2)</sup>	B354SS	–	–
1G satellite	P355	C355WH	C355	C355B	CP351 <sup>1)</sup>	CM351 <sup>2)</sup>	B355SS	–	–
2G TV/satellite	P356	C356WH	C356	C356B	CP352 <sup>1)</sup>	CM352 <sup>2)</sup>	B356SS	–	–
2G TV/radio	P357	–	–	–	–	–	–	–	–
1G TV/radio/satellite return	–	C359WH	C359	C359B	CP359 <sup>1)</sup>	CM359 <sup>2)</sup>	–	–	–
<b>Blank plates</b>									
1G blank plate	P391	C391WH	C391	C391	CP391 <sup>1)</sup>	CM391 <sup>2)</sup>	B391SS	–	X391MG
2G blank plate	P392	C392WH	C392	C392	CP392 <sup>1)</sup>	CM392 <sup>2)</sup>	B392SS	–	X392MG

Wall mounted range (contd)



Description	PREMERA range	COPA c/w cover	COPA interior	COPA black interior	COPA decorative plates <sup>1)</sup>	COPA metal plates <sup>2)</sup>	COPA fix stainless steel	COPA fix highly polished	XTRA surface metal
<b>Spare screw caps</b>									
Spare screw caps – PREMERA range	<b>P999</b>	–	–	–	–	–	–	–	–
<b>PREMERA mix module cover plates</b>									
1G module plate moulded	<b>P901</b>	<b>C901WH</b>	<b>C901</b>	<b>C901B</b>	<b>CP901<sup>1)</sup></b>	<b>CM901<sup>2)</sup></b>	<b>B901SS</b>	<b>B901HP</b>	<b>X901MG</b>
2G module plate moulded	<b>P902</b>	<b>C902WH</b>	<b>C902</b>	<b>C902B</b>	<b>CP902<sup>1)</sup></b>	<b>CM902<sup>2)</sup></b>	<b>B902SS</b>	<b>B902HP</b>	<b>X902MG</b>
3G module plate moulded	<b>P903</b>	<b>C903WH</b>	<b>C903</b>	<b>C903B</b>	<b>CP903<sup>1)</sup></b>	<b>CM903<sup>2)</sup></b>	<b>B903SS</b>	<b>B903HP</b>	<b>X903MG</b>
4G module plate moulded	<b>P904</b>	<b>C904WH</b>	<b>C904</b>	<b>C904B</b>	<b>CP904<sup>1)</sup></b>	<b>CM904<sup>2)</sup></b>	<b>B904SS</b>	<b>B904HP</b>	<b>X904MG</b>
6G module plate assembly moulded	<b>P906</b>	–	<b>C906</b>	<b>C906B</b>	<b>CP906<sup>1)</sup></b>	<b>CM906<sup>2)</sup></b>	<b>B906SS</b>	<b>B906HP</b>	<b>X906MG</b>
8G module plate assembly moulded	<b>P908</b>	–	<b>C908</b>	<b>C908B</b>	<b>CP908<sup>1)</sup></b>	<b>CM908<sup>2)</sup></b>	<b>B908SS</b>	<b>B908HP</b>	<b>X908MG</b>
12G module plate assembly moulded	<b>P912</b>	–	<b>C912</b>	<b>C912B</b>	<b>CP912<sup>1)</sup></b>	<b>CM912<sup>2)</sup></b>	<b>B912SS</b>	–	<b>X912MG</b>
18G module plate assembly	–	–	<b>C918</b>	<b>C918B</b>	<b>CP918<sup>1)</sup></b>	<b>CM918<sup>2)</sup></b>	<b>B918SS</b>	–	<b>X918MG</b>
24G module plate assembly	–	–	<b>C924</b>	<b>C924B</b>	<b>CP924<sup>1)</sup></b>	<b>CM924<sup>2)</sup></b>	<b>B924SS</b>	–	<b>X924MG</b>
1G module plate moulded grey cover	<b>P901GY</b>	–	<b>C901</b>	–	<b>CP901GY</b>	–	–	–	–
2G module plate moulded grey cover	<b>P902GY</b>	–	<b>C902</b>	–	<b>CP902GY</b>	–	–	–	–
3G module plate moulded grey cover	<b>P903GY</b>	–	<b>C903</b>	–	<b>CP903GY</b>	–	–	–	–
4G module plate moulded grey cover	<b>P904GY</b>	–	<b>C904</b>	–	<b>CP904GY</b>	–	–	–	–
6G module plate assembly moulded grey cover	<b>P906GY</b>	–	<b>C906</b>	–	<b>CP906GY</b>	–	–	–	–
8G module plate assembly moulded grey cover	<b>P908GY</b>	–	<b>C908</b>	–	<b>CP908GY</b>	–	–	–	–

<sup>1)</sup>Plastic covers available in the following finishes

Finish	add suffix to end of part number	Example of product code
White	<b>WH</b>	<b>CP904WH</b>
Metallic silver	<b>SV</b>	<b>CP904SV</b>
Gold metallic	<b>GL</b>	<b>CP904GL</b>
Black matt	<b>BM</b>	<b>CP904BM</b>
Blue metallic	<b>BL</b>	<b>CP904BL</b>
Grey	<b>GY</b>	<b>CP904GY</b>

<sup>2)</sup>Metal plates available in the following finishes

Finish	add suffix to end of part number	Example of product code
Stainless steel	<b>SS</b>	<b>CM904SS</b>
Highly polished	<b>HP</b>	<b>CM904HP</b>
Satin bronze	<b>SB</b>	<b>CM904SB</b>
Polished brass	<b>PB</b>	<b>CM904PB</b>





### CIRCA ceiling range

Lamp activated products offer a comprehensive range for applications such as schools, nurseries, children's bedrooms and public buildings where an extra degree of protection may be required.

Technical characteristics:

- T2 rated
- Full range of lampholders and battenholders
- Each item incorporates DP switching mechanism
- No live parts accessible when lamp is removed
- Tool required to access terminals



BC3 Low Energy CFL (compact fluorescent lamp) range is a dedicated lampholder range for use with low energy lamps.

This range covers the most commonly used items within the home.

Using CFLs means that the benefits of energy efficient lighting are available in the home. They are appropriate to areas where lights are left on for long periods of time such as hallways, staircases, entrances, kitchens, bedrooms and bathrooms.

The most versatile option is to use a pendant or battenholder, a direct substitute for a normal BC lampholder. There is no extra installation time and is safe and easy to do.

Why use the BC3 range?

- The range will accept standard UK size lampshades and require no adjustment.
- The house owner is not restricted to the wattage of lamp by the lampholder. The same BC3 lampholder will accept a range of wattages to suit the customers needs.
- BC3 offers a cost effective solution to the developer and contractor.
- The range of lampholders offered meets all the normal requirements for housing - pendant sets, battenholders and angled battenholders.
- Reduced wattage and heat generated by CFL means a wider choice of decorative lampshades for the home.
- Lamps are CE marked and meet latest standards – IEC 60969 and IEC 60901.
- Dedicated 3 pin 'J' slot lampholders and 3 pin BC lamp bases.



### LSC plug-in lighting system

The BS 7001 LSC (Luminaire Supporting Coupler) system is recognised as the industry standard interface, offering complete changeability with other manufacturers' products. To meet the increasing industry demand for LSF cable, Eaton now offers both 3 and 4 pin versions with low smoke and fume cable.

Both versions provide considerable benefits for the specifier, contractor and end user. Litelink represents a significant advance in the safety and ease of installation of lighting points.

- A range for all Commercial, Industrial and Domestic projects
- Designed for ease of installation
- Cable available in 1, 2 and 3m lengths with HR (Heat Resistant) and LSF (Low Smoke and Fume) options
- Pre-flexed 3 and 4 pin products with either 0.75mm<sup>2</sup> or 1.00mm<sup>2</sup> cable
- High quality, reliable, safe range of products



### 3 pin system

This version has a wide range of applications in many commercial and industrial environments. Its technical and design features are supplemented with a full range of plug, outlets, assemblies, pendants and mounting boxes. In use, it provides flexibility for the specifier, easy installation for the contractor and convenience for the end users.

- 3 pin plugs can be used safely in 4 pin outlets
- LSC pre-wired ceiling assembly with 2 or 3m of cable, ideal for suspended ceiling lighting
- Spacious easy wire plug with quick cover release screws
- Bases will take up to 2 x 4.00mm<sup>2</sup> cables



### 4 pin system

This version has been specifically designed for applications where an extra live conductor is required i.e. emergency lighting. It has all the benefits of the 3 pin system, but the auxiliary live conductor gives greater flexibility in switching capabilities. It can also be used as a time delay trigger mechanism and offers greater control over multi-lamp luminaires.

- Red plug top and cover ensures easy identification of 4 pin circuit
- The first 4 pin system to comply with BS 7001
- Large outlet terminals will take up to 2 x 4.00mm<sup>2</sup> cable
- Terminal access designed to aid cable installation on outlet and plug



### LDU Multi-outlet Box

The LDU Multi-outlet boxes utilise the LSC 'plug-in' lighting interface allowing luminaires to be plugged in, providing safety without isolation of the circuit. The LDU (Lighting Distribution Unit) incorporates LSC outlets which accept both Eaton's 3 and 4 pin plugs.

The 4 pin plug uses the fourth auxiliary socket contact for emergency lighting requirements.

- 6, 8 and 10 outlet units available
- Will accommodate 3 or 4 pin applications
- Separate back box to enable first fix with simple plug connectors for front cover
- Complies with the recognised industry interface BS 7001
- Extensive range of pre-wired plugs available in both HR (Heat Resistant) and LSF (Low Smoke and Fume) cable
- Mounting options – wall, ceiling, trunking or suspension
- Makes life easy – no need for on-site wiring of individual fittings
- Steel box for harsh environments
- Interchangeable front covers (6, 8 and 10) to enable, if required, expansion at a later date

**MEM® series Memera consumer units**

The Memera range of consumer units provide a broad scope of products to meet the requirements of the 17th edition of the wiring regulations. This well established range offers moulded and metalclad units for both surface and flush mounting applications.

All units have the ability to accommodate a wide range of ancillary and comfort function devices.

The moulded range provides a suite of boards with 1–19 outgoing ways which can be coupled together to make multi rail configurations. With a flexible design that enables speedy on-site configurations this installer friendly unit ensures speed and ease of installation.

All Memera consumer units comply to BSEN 60439 and are IP30 rated.

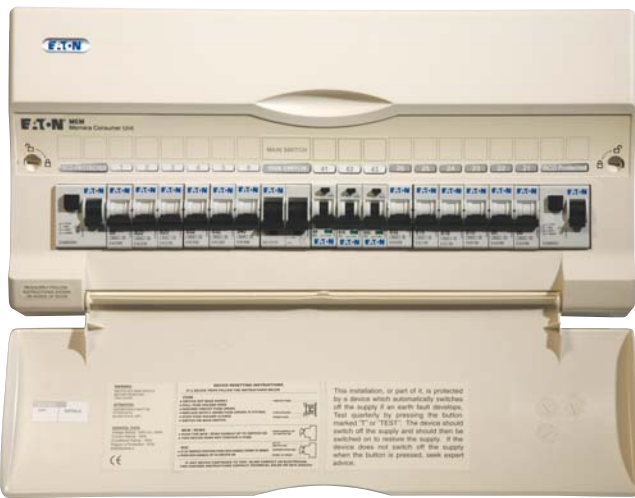
**Moulded unit features:**

- A solid base which can be fitted to all surfaces without the need for a separate back plate.
- Elongated keyhole fixings and optional flexing points compensate for irregularities in the surface and simplify alignment of the box.
- Quick release pan assembly including all neutral links and terminals.
- Quarter turn quick release cover screws.
- Base and cover provided with ample 'cut outs' which can be easily removed.
- A clip-in earth bar can be removed to give full access to the base.
- Snappable busbar enabling easy configuration on site.

All moulded consumer units are supplied with a combined pictorial installation guide and a high quality circuit identification way label which is easy to use and gives the finishing touch to a professional job.

**Metalclad unit features:**

- Sturdy steel enclosure with ample circular knock outs to allow the mounting of conduit or cable glands.
- Large removable apertures in back of enclosure to allow cable access from the rear.
- Snappable busbar enabling easy configuration on site.
- Twin rail units available with up to 38 outgoing ways.

All metalclad consumer units are supplied with a comprehensive label kit to complete the installation.

**Factory Built Assemblies (FBA) features:**

- Moulded or metal case construction, single rail or dual rail metal.
- Configured with outgoing protective devices to customer requirements.
- Can be fitted with other modular devices including timers, contactors and relays.
- Can also be fitted with additional components including kWh meters, sensors, other devices and internal wiring as required.



Memera moulded consumer units – features and benefits

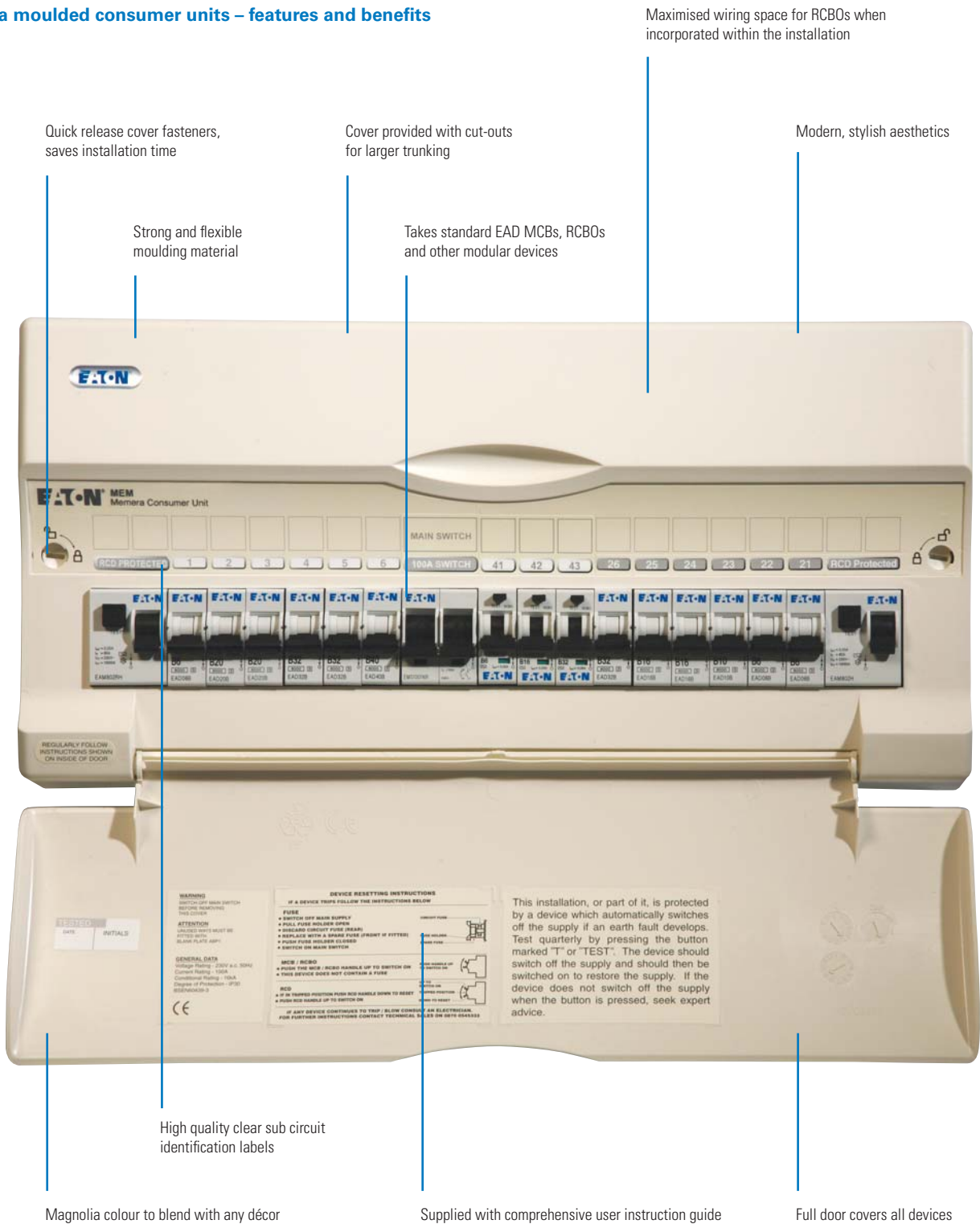

- Memera consumer units are factory assembled and include the main controlling devices. All that's required is the fitting of the MCBs etc, and the busbar which is provided in every unit securely held in it's transit carrier.
- The compact Memera range is ideal for domestic and light commercial applications.
- The range of units provides various solutions to the 17th edition wiring regulations, with grouped RCD outgoing sections as well as accommodating multiple RCBO devices.
- Dual tariff units with multiple incoming devices are also available.
- Manufactured to BSEN 60439-3.
- Degree of protection IP30.

# 1.4

## Product overview

Memera consumer units and devices

### Memera moulded consumer units – features and benefits (continued)

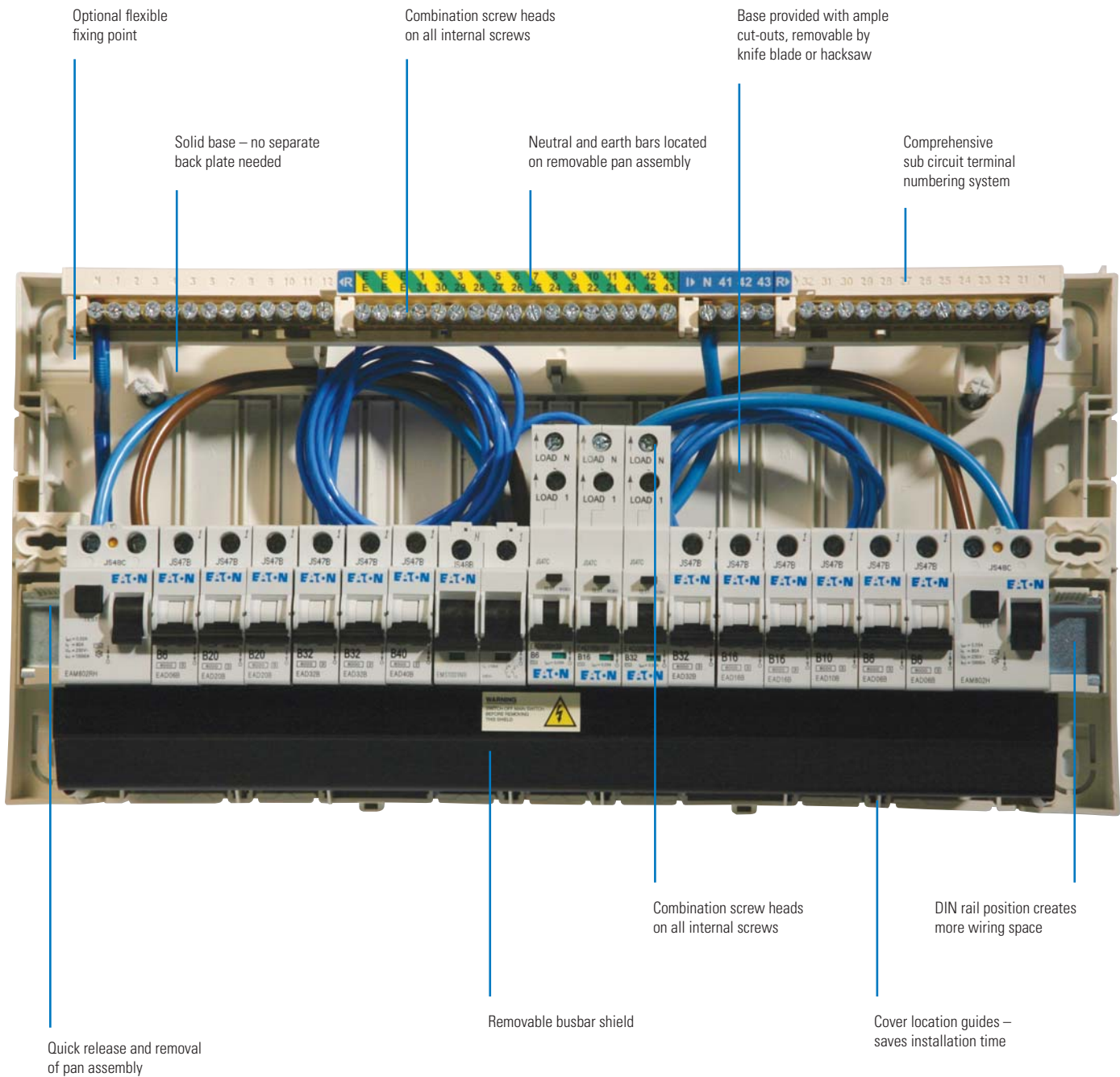

- All Memera consumer units use MCBs and RCBOs for final sub-circuit protection and some also feature the variable split load design which allows on-site configuration of the number of ways allocated to each main section.
- The units are supplied with a combined pictorial installation guide and a high quality circuit identification way label which is easy to use and gives the finishing touch to a professional job.
- Dual RCD isolator controlled units offer grouped 30mA protection on all circuits with the ability to also connect RCBOs directly off the main switch.
- Comprehensive sub circuit terminal numbering system. This easy, but clever way to distinguish individual circuit wiring terminations is as simple as 1,2,3. Typically, all isolator circuits utilise numbers from 1–16 whilst RCD controlled circuits use 21–36. Therefore, no need for last minute re-numbering of circuits. All numbers work away from the main or secondary controlling devices in conjunction with the MCB etc. All variations of split load units are catered for ensuring each circuit has its own unique circuit number.

Memera metalclad consumer units – features and benefits

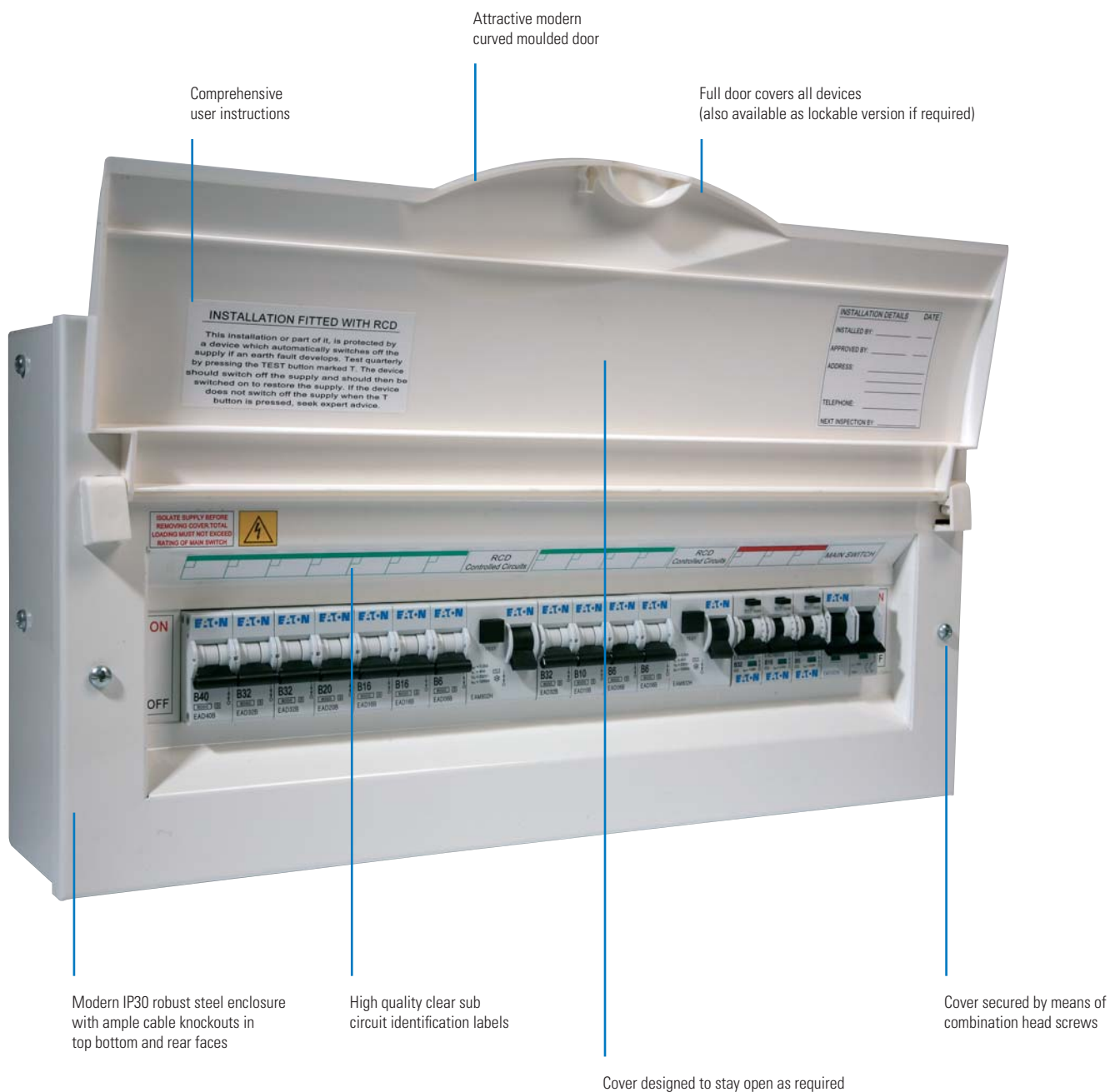

- Modern stylish appearance fully assembled with ample knock-outs in steel enclosure to suit all applications. The units are delivered factory assembled and fully equipped with all main controlling devices and interconnections. All that is required is to remove and install the busbar which is secured in the rear of the unit and fit the outgoing devices.
- The Memera metalclad consumer units are ideal for both domestic and light commercial applications where a more robust metal enclosure is needed.
- The units are available with single or multiple incoming device options as well as the various dual RCD combinations widely used to enable compliance with the 17th Edition wiring regulations.
- Manufactured to BSEN 60439-3.
- Degree of protection IP 30.

## Memera metalclad consumer units – features and benefits (continued)

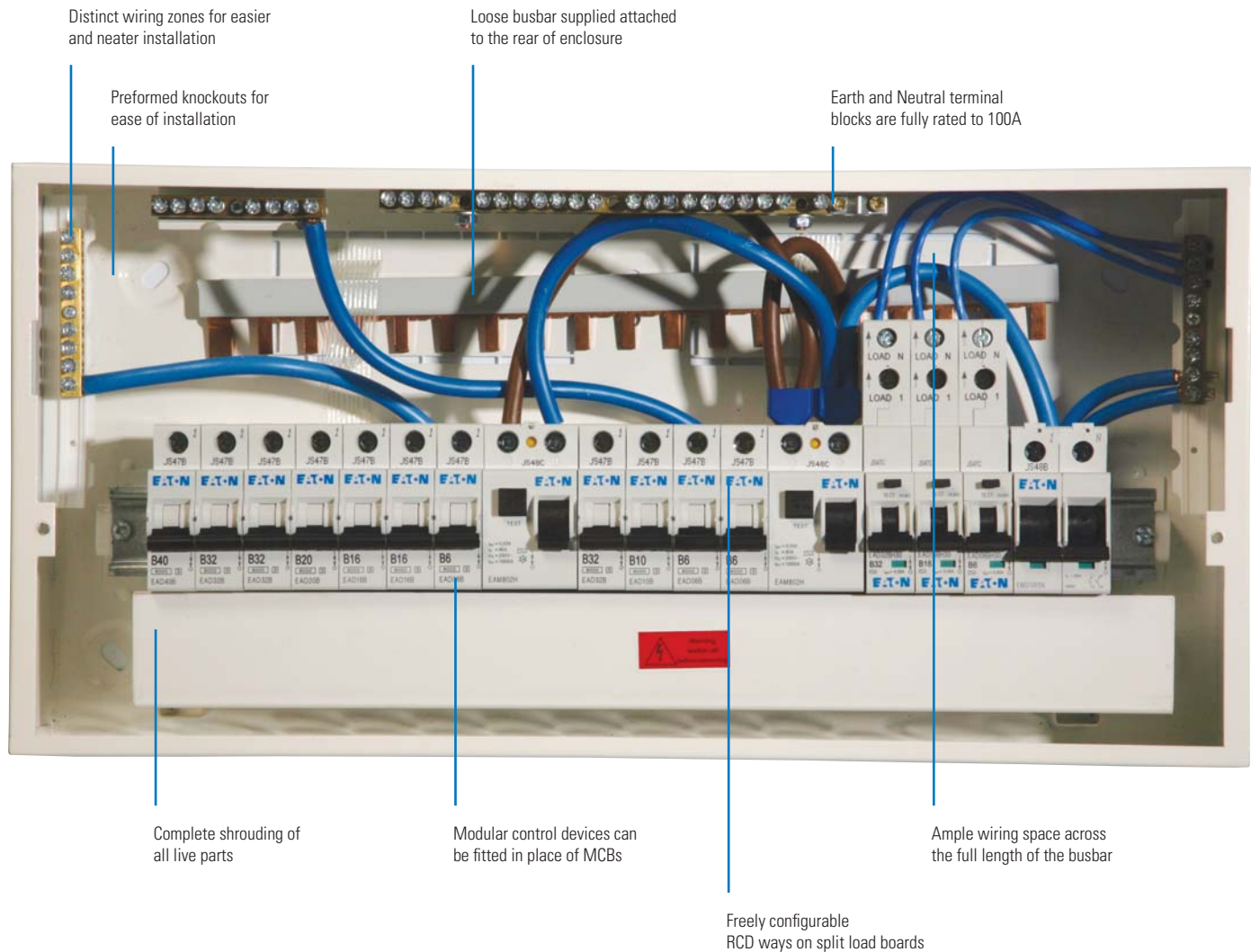

- The Memera metalclad consumer units use MCBs and RCBOs for final sub circuit protection, and can also accommodate a wide range of other modular devices such as timers, contactors and relays.
- The split load and multiple RCD units all feature a variable split design with busbars that can be simply split on site to enable the exact configuration to be achieved.
- Dual RCD units incorporating an isolator main switch and providing grouped 30mA RCD protection in two zones, can also be configured with some high integrity ways fed directly off the isolator. Ideal for protecting selected circuits with independent RCBOs.
- Full instructions and a comprehensive labelling kit enable the installation to be completed professionally with all the appropriate internal warning and circuit identification labels.



**Memera moulded consumer units – quick and easy installation**



**Step 1 – Prepare for base installation**

On removal of the main cover using the quick release cover fasteners, the complete pan assembly can be withdrawn from the base by means of the unique clip feature. The busbar is then removed from its retaining clip.

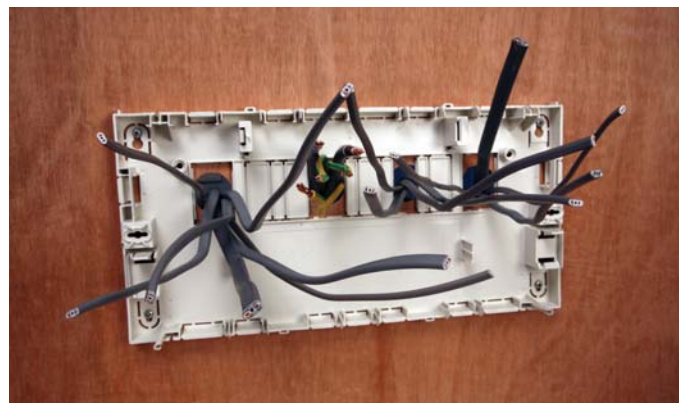

**Step 2 – Cut-out and cable preparation**

Using any of the easily removable cut out sections, the cables may be prepared. The empty base is then fitted to the wall without obstruction to the cable bunch..

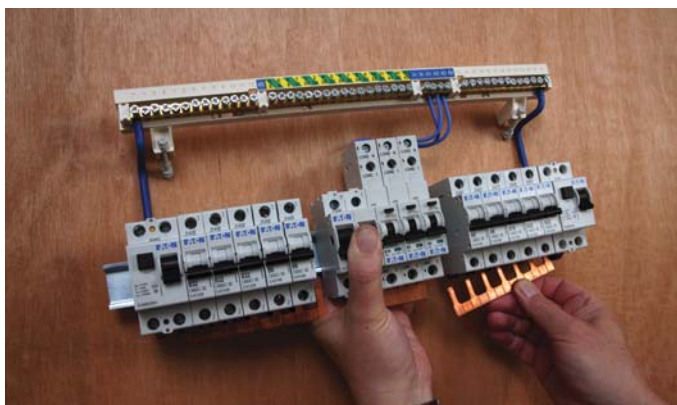

**Step 3 – Pan assembly preparation**

MCBs and RCBOs are fitted to the pan assembly in the appropriate positions. The busbar is then snapped to the required length (split load units only) and fixed to the device terminals. On completion the pan assembly is clipped into position.

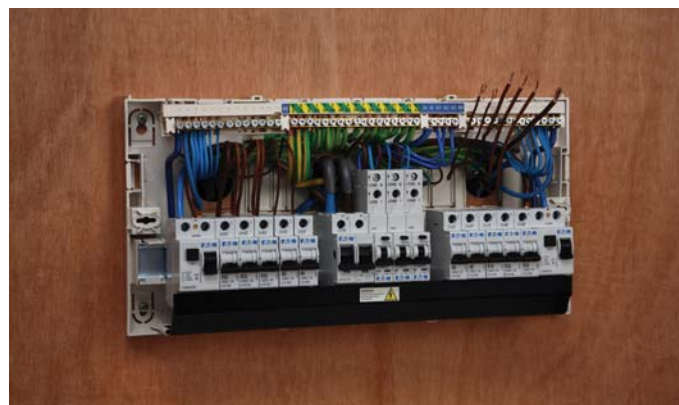

**Step 4 – Internal wiring**

On re-fitting of the pan assembly, the pre-prepared cables can be wired to the devices. Circuit testing can then be carried out at the appropriate time.



**Step 5 – Completion of internal wiring and labelling**

Once all wiring is completed, the push-fit busbar cover is slotted into position and the internal labels can be applied.



**Step 6 – External identification labels and fitting of main cover**

The external circuit identification labels are now applied. The cover is then replaced easily and quickly using the quarter turn fasteners.

### 17th Edition regulations and consumer units

The advent of the 17th Edition of the Wiring regulations brought with it new challenges for installers and manufacturers alike, one such challenge involves the much greater use of RCDs within the electrical installation. The regulations BS 7671:2008 now incorporate amendment No.1 2011.

#### Regulation 411.3.3.

States that additional protection by means of a 30mA RCD is to be provided for all socket outlets with a rated current not exceeding 20A for use by ordinary persons. The only exceptions allowed are for socket outlets for use under the supervision of "skilled" or "instructed persons" e.g. some commercial / industrial locations, or a specific labelled socket provided for connection of a particular item of equipment, e.g. a freezer circuit.

#### Regulation 701.411.3.3

In specific locations such as those containing a bath or shower there is a requirement now to provide RCD protection on all circuits, including the lighting and shower circuits.

#### Regulation 314.1 & 2

Requires that every installation shall be divided into circuits as necessary to avoid danger and minimise inconvenience, in the event of a fault. Also reducing the possibility of unwanted RCD tripping, due to excessive protective conductor currents but not due to an Earth fault. Separate circuits may be required for parts of the installation, which need to be separately controlled in such a way that they are not affected by the failure of other circuits. The appropriate subdivision should take account of any danger arising from the failure of a single circuit eg. an RCD trip on a socket outlet causing the unwanted failure of a lighting circuit and its associated hazards.

#### Regulation 522.6.102

Now requires a much greater use of RCDs to protect the wiring concealed in walls or partitions even where installed in previously defined "Safe Zones". These regulations effectively mean that all concealed wiring at a depth of less than 50mm from the surface now requires protection by a 30mA RCD unless provided with earthed mechanical protection.

### Application of RCDs

The 17th Edition of the IEE wiring regulations ( BS7671 ), detail a number of regulations relating to protection against electric shock, including the need for additional protection.

The use of RCDs (Residual Current Devices) with a residual operating current not exceeding 30mA is the recognised means of providing this additional protection in the event of failure of the provision for basic protection and or the provision for fault protection or carelessness by users.

Such RCDs should not be used to provide the sole means of protection and do not obviate the need to apply one or more of the recognised protective measure as detailed in the regulations.

Under the new regulations an installation is required to incorporate one or more RCDs, depending upon the circumstances. Such instances include:-

- All socket outlets not exceeding 20A, but with certain exceptions. One such exception would be permitted for a specific labelled or otherwise suitably identified socket outlet for connection of a particular piece of equipment.
- Mobile equipment with a current rating not exceeding 32A for use outdoors
- Electrical circuits installed under "Special installations and locations" as defined in Part 7 of the regulations e.g. Swimming Pools / Saunas.
- All electrical circuits, including shower and lighting circuits etc. in rooms with a fixed bath or shower e.g. bedrooms and en-suite bathrooms.

In addition to the protection requirements of the outgoing circuits / loads, the requirements of the installed cabling also must be taken into account.

Where a cable is concealed in a wall or partition at a depth of less than 50mm from the surface, even if installed in the "safe zone", if not provided with earthed mechanical protection e.g. Metal trunking or conduit, it must be provided with additional protection by means of a 30mA RCD.

Whilst it may be desirable to have one or two circuits fed via an unprotected circuit e.g. an identified / dedicated freezer circuit, the installation of the wiring may still dictate that the circuit must be RCD protected. The protection of a circuit by means of a 30mA RCD is also required where cables are concealed in walls constructed with metal stud partitions which are common in modern buildings, irrespective of the depth from the surface, unless provided with protection in the form of earthed metallic covering, trunking, conduit or other mechanical protection so as to avoid damage to the cable during installation or construction of the wall.

IEE Regulations and British Standards are subject to amendments. This Eaton guide to consumer unit solutions is not a substitute for the regulations which should always be used for all types of electrical installations and design work.

## In summary

Regulations	Relating to	Example	Additional Protection
411.3.3	All socket outlets up to 20A rating for general use by ordinary persons	<ul style="list-style-type: none"> <li>– Upstairs sockets</li> <li>– Downstairs sockets</li> <li>– Kitchen sockets</li> <li>– Cooker outlet with integral 13A socket outlet</li> <li>– Plus any other sockets rated up to 20A including garage sockets</li> </ul>	30mA RCD
701.411.3.3	All electrical circuits in a room with a fixed bath or shower	<ul style="list-style-type: none"> <li>– Shower circuit</li> <li>– Lighting circuit</li> <li>– Heating circuit</li> <li>– Ventilation circuit</li> <li>– Shaver socket</li> <li>– Socket outlets</li> </ul>	30mA RCD
522.6.100 522.6.101 522.6.103	All electrical circuits buried in a wall or partition at less than 50mm and without mechanical protection	<p><b>All concealed wiring</b></p> <ul style="list-style-type: none"> <li>– Socket outlets</li> <li>– Lighting circuits</li> <li>– Smoke alarm</li> <li>– Burglar alarm</li> </ul>	30mA RCD

## Installation design

The 17th edition wiring regulations BS7671 applies to all new installations designed after 30th June 2008, and there are various options that must be considered in order to satisfy these requirements. Starting with the wiring scheme and the building design, consideration must be given to the purpose of the building, and to the persons who will be using the installation, as different regulations will be applicable, e.g. is the installation under the control of skilled or instructed persons, or ordinary persons, or perhaps the installed location contains a bath or shower. Answers to these points will start to focus in on the regulations that need to be followed.

Consideration must be given to the way cables will be fitted within the installation, either on the surface in trunking or conduit, or else concealed beneath the surface of the wall either buried within the plaster or inside the cavity of a hollow partition wall. The chosen installation methods and wiring accessories or loads being fed, will also dictate whether additional protection by means of 30mA RCDs is required on those circuits or not.

The wiring regulations are open to interpretation in some areas, where reference is made to “minimise inconvenience in the event of a fault”, acceptable levels of inconvenience can be somewhat subjective.

In most circumstances the regulations now dictate that a consumer unit will be required to have two or more 30mA RCDs, enabling the load circuits to be spread over a number of RCD protected zones or outgoing ways.

However, the most comprehensive and effective solution, and one that is guaranteed to fully meet the requirements of the regulations is to equip each and every circuit with it’s own individual 30mA RCBO.

The examples shown on the next page illustrate just some of the many options available, to a contractor, to achieve a 17th Edition compliant installation. Some options provide a much higher level of circuit integrity than others. The final choice of which may well be made based on this and the cost/ease of the installation.

#### Consumer unit solutions

There are many ways of providing RCD circuit protection to meet the demands of the new regulations.

The most comprehensive solution would be to provide individual RCBO protection on each and every out going circuit from a consumer unit. Hence the use of a consumer unit such as a 12 way isolator controlled board. eg. **EAD12** fitted with up to **12 x RCBOs** or the **EAD11R** 11 way unit with additional cabling space to accommodate the RCBOs.



The next level down would be to provide an isolator controlled dual RCD consumer unit feeding two RCD board sections. eg. **EAD12H80H80D** or **EAD12H80H63D** fitted with up to **12 x MCBs**

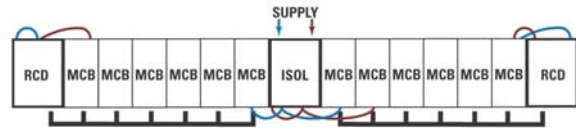

Such a dual RCD board could also be provided with some unprotected ways controlled by the main switch to enable a supply to any individual circuits that don't require RCD protection or else require individual RCBO circuit protection. eg. **EAD12H80H803D** or **EAD12H80H633D** fitted with up to **15 x MCBs**

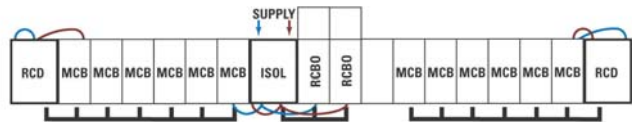

A conventional split load board such as an **EAD14H80D** could have additional RCBOs fitted to the non protected side allowing a mixture of Group RCD protected circuits and Individual RCBO protected circuits.

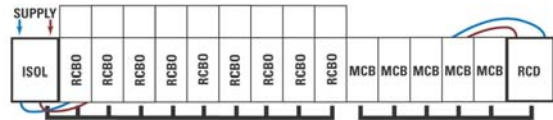

Consumer units are already available with RCD incomers of 30mA sensitivity such as **EAD12H80**, **EAD12H100**. However, single RCD controlled units on their own are unlikely to satisfy regulation 314.1 and 2.

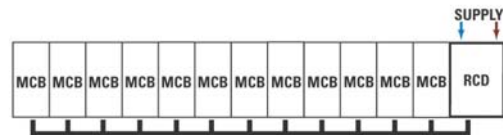



## Switch and protection devices



### Miniature Circuit Breakers (MCBs)

The Eaton range of 6kA high performance Miniature Circuit Breakers (MCBs) has been designed to meet the latest UK, European and International standards, with ratings from 2A up to 63A as standard.

The Eaton 6kA miniature circuit breakers are designed and tested in accordance with IEC/EN 60898 and are available in both B and C characteristic curve as standard

Technical characteristics

- Modular design, DIN rail mountable, one module wide.
- Single pole MCB for commercial and residential applications.
- Rated Braking Capacity 6kA to IEC/EN 60898
- 2–63A in both type B and C characteristics
- Positive contact indication
- Box clamp barrier to prevent incorrect cable insertion
- Calibrated at 40°C
- Can be used with both pin and comb type busbars
- Suitable for use in Eaton consumer units and a wide range of other applications



### Residual Current Circuit Breakers (RCCBs)

The Eaton range of Residual Current Circuit Breakers without integral overload protection (RCCBs), provide protection solutions to a wide range of applications.

The Eaton range of double pole RCDs are available with 10mA, 30mA, 100mA and 300mA sensitivities.

Technical characteristics

- Modular design, DIN rail mountable, two modules wide.
- Double pole RCD for commercial and residential applications
- Rated short circuit capacity 10kA with fuse back up
- Manufactured and tested to IEC/EN 61008
- Trip sensitivities 10, 30, 100 and 300mA
- Positive contact indication
- Test button



### Compact Residual Current Circuit Breakers with Overcurrent protection (RCBOs)

The Eaton range of combined Residual Current Circuit Breakers with integral Overload protection (RCBOs), combine the highest level of protection for both people and circuits in a single one module device.

The Eaton range of 6kA RCBOs are available from 6A to 45A in both B and C curve with 30mA trip sensitivity and fully comply to IEC/EN 61009

Technical characteristics

- New compact modular design, DIN rail mountable, one module wide. Providing significant wiring space above the module.
- Single module combined MCB/RCD unit
- Solid neutral
- Positive contact indication
- Rated currents from 6–45A in both B and C characteristic
- Trip sensitivity 30mA (others available)
- Rated breaking capacity 6kA
- Test button



### Main load disconnect switch (isolator)

The Eaton range of modular Isolators are available in single pole, double pole and single pole with switched neutral arrangements.

Technical characteristics

- Compact modular design, DIN rail mountable, one or two modules wide.
- Positive contact indication
- Rated at up to 12.5kA these switches are fully tested to IEC 60947-3 for AC23 duty at 240VAC
- Terminal capacity 2.5–50 mm<sup>2</sup>



### Single pole & neutral switchfuse

The Eaton wall mounted switchfuse **800KMF** is a fully moulded, compact wall mounted, SP&N unit rated at up to 80A, complying with EN 60947-3 for duty AC22B, 240v AC. The unit is fitted with a fully insulated pull out fuse carrier, which will accommodate HRC fuse links complying with BS 88-3 (formerly BS 1361) and rated between 45–80A.

### Control and Switching Devices



#### Timers

The Eaton range comprises of a wide variety of different products which include analogue timers, digital timers, twilight switches and staircase timers. Timers are available either with 50Hz net-synchronisation or quartz control. Except for net-synchronised timers all units do have self power reserve to secure the time setting and program storage in case a power interruption does occur. Twilight Switches are supplied with a remote light sensor, which can be easily installed on the outside wall where the required light intensity threshold can be simply adjusted on the modular device itself. The multifunctional staircase timer TE1 with many advanced switching facilities completes our range of timer products.

Technical characteristics (depending on type)

- Modular design.
- Analogue and digital timers.
- Time adjustment by 50 Hz net, quartz.
- Maximum 2 channel output.
- Manual override switching function.
- Power reserve for all quartz, analogue and digital controlled timers.
- Remote Light Sensor for Twilight Switching.

Advantages of Eaton timers

- Easily programmable on front of device.
- Computer aided programming software available.
- Compact 18 mm design for restricted space opportunities.
- Separate IP40 covers are available for direct wall mounting.
- High level of accuracy.
- Maximum lamp load test data is available for reference.
- Automatic summer and winter time adjustment.
- Holiday & Random program settings.
- High power reserve up to 10 years.

#### Contactors and impulse switches



Contactors are frequently applied for switching of lamp loads, fans, heaters or pumps in both utility as well as industrial areas. All contactors with ac/dc coils ensure silent operation which is further enhanced by a low power consumption. Optimal contacts and low heat dissipation guarantee a long lifetime of the contactor which is available in a wide range of characteristics.

Technical characteristics

- Designed according to IEC 60947-4-1 and IEC 61095 standards.
- Suitable for applications in general control, heating & lighting applications.
- Available in 20, 25, 40 & 63 A ratings with up to 4-pole contacts.
- Coil voltages: 12 Vac/dc, 24 Vac/dc, 48 Vac/dc, 230 Vac, 220 Vdc.
- Optional add-on auxiliary contact available.
- DIN modular profile.
- Spacers available to extend lifetime (it is recommended to use 1 spacer between every 2 contactors installed).
- Day / night contactors available with manual override function.

Advantages of Eaton contactors

- Low inrush power for all ac/dc types.
- Availability of combined ac/dc type contactors ensure silent operation.
- Contactors of ac/dc coil type are operable on both ac and dc voltage. The 20A and 25A versions are also available with ac coil. All combined ac/dc type versions are equipped with surge protection on the operating coil.
- Equipped with contact indication.
- Optimal quality of contacts and low heat dissipation ensure a long life time.

---

**Transformers**



The Eaton bell transformer is a simple two module unit providing a dual voltage output (12V, 0.6A and 8V, 1.0A) and can be used with most commercially available door bells.

---

**Wireless electricity monitor**



Take control of your energy use by using the efergy wireless electricity monitor. It displays instant power, costs, historical and average data and estimated CO2 emissions. Discover and reduce the size of your carbon footprint by monitoring the cost of using your home appliances and lighting. It's also fun and educational for all the family.





Suitable for residential and commercial applications, Eaton's Moeller xComfort range of building automation products has been specifically designed to provide centralised control of all the electrical equipment in order to maximise energy savings, comfort, safety and security.

### System components include sensors, actuators and control/communication devices

See chapter 10 for more information.



#### Switching actuator

switches lights, pumps, ventilation and heating systems, saunas, ... any electrical consumer product.



#### Shutter actuator

for controlling blinds, shutters, mixing valves, etc.



#### Dimming actuator

switches and dims lights and light environments.



#### Analogue actuator

controls devices such as mixers, dimmers and fluorescent lamps.



#### Temperature input unit

measures temperature and controls shading and heating.



#### Home manager

the universal genius for centralised building management, operation, and display.



#### Room manager

the operating and display unit – easy to handle and easy to read.



#### Room controller

regulates and controls heating and shading.



#### Binary input unit

for integrating conventional switches, window contacts, and signal contacts.



#### Push-button unit

for lighting, shading, etc.



#### PIR motion sensor

controls lights depending on movement and brightness.



#### Adaptor plug

switches and dims living room fountains, aquaria, etc.





The PREMERA White Moulded range offers a modern aesthetically edged styled appearance whilst utilising the well established UREA material with its inherent MRSA germ protection properties ideal for kitchens, bedrooms and living rooms.

Each product is supplied with an optional screw cap facility to hide unsightly screws.

Essential supply products are offered enabling circuits to be highlighted effectively with unmistakable red rockers and fuse drawers without compromising their suiting with other standard accessories. Grey covers are offered to provide solutions to the latest Building Regulations.

<b>2.1</b>	<b>10A WALL SWITCHES</b>	
	10A standard switches .....	35
	3 Pole fan isolator switches .....	35
	10A broad rocker switches .....	35
	16A hotel switch .....	35
	Dimmer switches .....	36
<b>2.2</b>	<b>SOCKET OUTLETS</b>	
	13A switched sockets.....	37
	13A RCD socket.....	38
	Unswitched sockets .....	38
	15A sockets .....	38
	Shaver socket .....	38
<b>2.3</b>	<b>FUSED CONNECTION UNITS</b>	
	13A connection units – unswitched.....	39
	13A connection units – switched.....	39
<b>2.4</b>	<b>POWER SWITCHES</b>	
	20A switches .....	40
	45A/50A switches.....	40
<b>2.5</b>	<b>CABLE OUTLETS AND BLANK PLATES</b>	
	Cable outlets.....	41
	Blank plates .....	41

Continued overleaf

<b>2.6</b>	<b>COMMUNICATION OUTLETS</b>	
	Phone/data outlets .....	42
	Communication outlets .....	42
<b>2.7</b>	<b>PATRASSES AND ANCILLARY ITEMS</b>	
	Pattresses .....	43
	Junction boxes and plugs .....	43
<b>2.8</b>	<b>PREMERA MIX MODULE PLATES</b>	
	Modular plates/grids .....	44

P021



### 10A switches

- To BSEN 60669-1.
- Supplied with M3.5 fixing screws and caps. Each terminal is capable of accepting up to 3 x 1.5mm<sup>2</sup> conductors. All terminals are backed off, ready to accept cable.
- X-rated for fluorescent or inductive loads.

Description	Eaton list number
10A 1G 1 way	P011
10A 2G 1 way	P012
10A 3G 1 way	P013
10A 4G 1 way	P014
10A 1 way bell push	P015
10A 1 way light symbol push	P015L
10A 1G 1 way push	P015P
10A 1G intermediate	P017
10A 1G 2 way	P021
10A 1G 2 way push	P021P
10A 2G 2 way	P022
10A 3G 2 way	P023
10A 4G 2 way	P024
10A 6G 2 way	P026

P048



### 3 Pole isolator switches

- To BSEN 60669-1.

Description	Eaton list number
10A fan isolator + fan symbol	P048
10A 3 pole isolator	P049

P041



### 10A broad rocker switches

- To BSEN 60669-1.
- Broad rocker individual modules can be removed for replacement/ maintenance. X-rated for fluorescent or inductive loads.

Description	Eaton list number
10A 2G 2 way half broad switch	P032
10A 1G 2 way broad switch	P041
10A 1G 2 way push switch	P041P
10A 2G 2 way broad switch	P042
10A 1G 1 way bell push	P045
10A 1G 1W broad switch push	P045P
10A 1G intermediate broad switch	P047
10A 1G DP broad switch + neon	P043N

P450



### 16A hotel switch

- To BS 60669-1.
- Each terminal is capable of accepting up to 3 x 1.5mm<sup>2</sup> conductors. Suitable for surface mounting.
- Time delay.

Description	Eaton list number
16A hotel switch	P450

# 2.1

## PREMERA white moulded

Wall switches

P9131



### Push on/push off action dimmers

- To BSEN 60669-1.

Description	Eaton list number
250W 1G 2W push tungsten	<b>P9131</b>
250W 2G 2W push tungsten	<b>P9132</b>
400W 1G 2W push tungsten	<b>P9141</b>
400W 2G 2W push tungsten	<b>P9142</b>
1000W 1G 2W push tungsten (2 gang plate size)	<b>P9111</b>
1–10V 1G 1W analogue	<b>P9101</b>

P9551



### Non-european rotary dimmers

Description	Eaton list number
500W 1G 1W tungsten non-european	<b>P9551</b>
500W 2G 1W tungsten non-european	<b>P9552</b>
1000W 1G 1W tungsten non-european	<b>P9511</b>
60–500W fan controller non-european	<b>P9751</b>

P611



### 13A single pole switched sockets

- To BS 1363: Part 2.
- Terminals capable of accepting up to 3 x 4mm<sup>2</sup> or 2 x 6mm<sup>2</sup> conductors.

Description	Eaton list number
13A 1G SP switched socket	P611
13A 2G SP switched socket	P612

P622



### 13A double pole switched sockets inboard rockers

- To BS 1363: Part 2.
- 2 earth terminals and inboard rockers.
- Terminals capable of accepting up to 3 x 4mm<sup>2</sup> or 2 x 6mm<sup>2</sup> conductors.

Description	Eaton list number
13A 1G DP switched socket	P621
13A 1G DP switched socket – grey	P621GY
13A 1G DP switched socket + neon	P621N
13A 1G DP switched socket + red rockers	P621RR
13A 1G DP switched socket red plate cover	P621RED
13A 2G DP switched socket	P622
13A 2G DP switched socket + neon	P622N
13A 2G DP switched socket + red rockers	P622RR

P632N



### 13A double pole switched sockets outboard rockers

- To BS 1363: Part 2.
- 2 earth terminals and outboard rockers.
- Terminals capable of accepting up to 3 x 4mm<sup>2</sup> or 2 x 6mm<sup>2</sup> conductors.

Description	Eaton list number
13A 2G DP switched socket	P632
13A 2G DP switched socket – grey	P632GY
13A 2G DP switched socket + neon	P632N
13A 2G DP switched socket + red rockers	P632RR
13A 2G DP switched socket – red coverplate	P632RED

P651



### 13A 1G double pole non-standard/clean earth switched sockets

- Non-standard socket interface to BS 5733 with clean earth facility.
- 2 clean earth terminals and 2 standard earth terminals on each product.

Description	Eaton list number
13A 1G DP switched socket	P651
13A 1G DP switched socket + neon	P651N

P652



### 13A 2G double pole non-standard/clean earth switched sockets

- Outboard rockers.
- Non-standard socket interface to BS 5733 with clean earth facility.
- 2 clean earth terminals and 2 standard earth terminals on each product.

Description	Eaton list number
13A 2G DP switched socket with 2E terminals	P652
13A 2G DP switched socket + red rockers with 2E terminals	P652RR



# 2.2

## PREMERA white moulded

### Socket outlets

P672



#### 13A 2G double pole clean earth switched sockets

- Outboard rockers.
- Standard socket interface to BS 1363 with clean earth facility.
- 2 clean earth terminals and 2 standard earth terminals on each product.

##### Description

Eaton list number

13A 2G DP switched socket with 2E terminals

**P672**

P686



#### 13A double pole RCD socket outlet – passive

- Added protection against electrocution.
- 30mA protection.
- Passive – The contacts on the passive device remain closed when the mains supply is interrupted – this type is suitable for applications such as fridge freezers etc.
- To BS 7288

##### Description

Eaton list number

13A 2G RCD protected socket passive 30mA

**P686**

P111



#### 13A socket outlets

- To BS 1363: Part 2.
- Terminals capable of accepting up to 3 x 4mm<sup>2</sup> or 2 x 6mm<sup>2</sup> conductors.
- 2 earth terminals on P112.

##### Description

Eaton list number

13A 1G unswitched socket

**P111**

13A 2G unswitched socket

**P112**

P415



#### 15A socket outlet

- To BS 546.

##### Description

Eaton list number

15A 1G switched socket

**P415**

P370



#### Shaver supply unit

- To BSEN 61558-2-5.
- Mounting box – **F4530** (46mm deep).

##### Description

Eaton list number

Shaver socket dual voltage 230V/110V AC

**P370**

P221N



### 13A double pole fused connection units with optional cable outlets – switched

- To BS 1363: Part 4.
- Live and Neutral accept 2 x 2.5mm<sup>2</sup> cables. Suitable for surface mounting.
- P212 adaptor plate for use with bottom entry cable outlet.

Description	Eaton list number
13A DP switched connection unit	P221
13A DP switched connection unit marked 'boiler'	P221BO
13A DP switched connection unit marked 'central heating'	P221CH
13A DP switched connection unit marked 'cooker hood'	P221CKH
13A DP switched connection unit marked 'dishwasher'	P221DW
13A DP switched connection unit – grey	P221GY
13A DP switched connection unit marked 'extract fan'	P221EF
13A DP switched connection unit marked 'refrigerator'	P221R
13A DP switched connection unit + red rocker	P221RR
13A DP switched connection unit marked 'washing machine'	P221WM
13A DP switched connection unit + neon	P221N
13A DP switched connection unit + neon – grey	P221NGY
13A DP switched connection unit + neon + red fuse drawer	P221NRR
13A DP switched connection unit + neon marked 'water heater'	P221NWH
13A DP switched connection unit + neon marked 'boiler'	P221NBO
13A DP switched connection unit + neon marked 'dishwasher'	P221NDW
13A DP switched connection unit + neon marked 'fridge freezer'	P221NFF
13A DP switched connection unit + neon marked 'hob'	P221NHO
13A DP switched connection unit + neon marked 'tumble dryer'	P221NTD
13A DP switched connection unit + neon marked 'washing machine'	P221NWM
13A DP switched connection unit fitted with 3A fuse	P224

P220



### 13A fused connection units with optional cable outlets – unswitched

- To BS 1363: Part 4.
- Live and Neutral accept 2 x 2.5mm<sup>2</sup> cables. Suitable for surface mounting.
- P212 adaptor plate for use with bottom entry cable outlet.

Description	Eaton list number
13A unswitched connection unit	P220
13A unswitched connection unit + red fuse drawer	P220RR
13A unswitched connection unit + neon	P220N
13A unswitched connection unit fitted + 3A fuse	P223
13A unswitched connection unit + neon fitted with 3A fuse	P223N

# 2.4

## PREMERA white moulded

### Power switches

P401N



#### 20A double pole switches with optional cable outlet

- To BSEN 60669-1.
- Supply terminals accept 3 x 2.5mm<sup>2</sup> conductors. Load terminals accept 2 x 2.5mm<sup>2</sup> conductors.
- P212 adaptor plate for use with bottom entry cable outlet.

Description	Eaton list number
20A DP switch	<b>P401</b>
20A DP switch marked 'water heater'	<b>P403</b>
20A DP switch + neon	<b>P401N</b>
20A DP switch + neon marked 'water heater'	<b>P403N</b>
20A DP switch + neon marked 'air conditioner'	<b>P404N</b>

P425N



#### 45A double pole cooker control unit

- To BS 4177.

Description	Eaton list number
45A DP cooker control unit	<b>P425</b>
45A DP cooker control unit + neon	<b>P425N</b>

P421N



#### 50A double pole switches

- To BSEN 60669-1.

Description	Eaton list number
50A DP switch 2G plate	<b>P421</b>
50A DP switch + neon 2G plate	<b>P421N</b>
50A DP switch marked 'cooker' 2G plate	<b>P423</b>
50A DP switch + neon marked 'cooker' 2G plate	<b>P423N</b>
50A DP switch + neon marked 'air conditioner' 2G plate	<b>P424N</b>
50A DP switch + neon 1G plate size	<b>P422N</b>
50A DP switch + neon 1G plate size – grey	<b>P422NGY</b>
50A DP switch + neon 1G plate size marked 'cooker'	<b>P426N</b>
50A DP switch + neon 1G plate size marked 'air conditioner'	<b>P427N</b>

P345



### Cable/cooker outlet plates

- To BS 5733.

#### Description

Eaton list  
number

45A DP cable outlet with terminal block

**P345**

20A flex outlet plate

**P210**

Cable outlet adaptor plate for 20A switch/3A fused connection unit

**P212**

P212



P392



### Blank plates

#### Description

Eaton list  
number

1 gang blank plate

**P391**

2 gang blank plate

**P392**

### Accessories

#### Description

Eaton list  
number

Spare screw caps – PREMERA

**P999**

# 2.6

## PREMERA white moulded

### Communication outlets

P362



#### Telephone outlets

##### Description

##### Eaton list number

1G telephone outlet single master

**P360**

1G telephone outlet single secondary

**P361**

1G telephone outlet single RJ11

**P362**

P352



#### TV/FM co-axial outlets

- **P353** and **P354** isolated outlets for use in multi-outlet aerial systems. Suitable for full band width 40–860MHz. Single outlet TV/FM isolated co-axial socket suitable for 'T' box use with a single co-axial lead. Isolated 2 gang TV/FM diplexer socket double resistive outlet suitable for TV/FM and 'T' box use with a single co-axial down lead.

##### Description

##### Eaton list number

1G TV co-axial outlet

**P351**

1G TV co-axial outlet dual clamp

**P351D**

2G TV co-axial outlet

**P352**

1G TV/FM isolated co-axial outlet

**P353**

2G TV/FM diplexer co-axial outlet

**P354**

P356



#### TV and satellite co-axial outlets

- Suitable for full band width 40–860MHz.

##### Description

##### Eaton list number

1G SAT outlet

**P355**

2G TV/SAT outlet

**P356**

P357



#### Screened TV/FM/radio/satellite co-axial outlets

- Suitable for full band width 40-860MHz. Will accept digital IR return signal through TV point.

##### Description

##### Eaton list number

2G TV/radio outlet screened

**P357**



F4501



### Mounting boxes

Description	Eaton list number
1G pattress 16mm deep	F4500
1G pattress 28mm deep	F4501
2G pattress 28mm deep	F4502
2G conversion pattress 25mm deep	F4510
2G pattress 40mm deep with cable clamp	F4511
2G pattress 46mm deep for shaver supply unit	F4530
1G pattress 45mm deep	F4570

F3368



### Ancillary products

Description	Eaton list number
13A non-standard plug	F3368
10W connection box	F5099

# 2.8

## PREMERA white moulded

### PREMERA mix module coverplates

P903



#### Modular coverplates

- Suitable for use with PREMERA mix module range.
- Dimensions: 1–2G: 86mm x 86mm      3–4G: 86mm x 146mm      6–8G: 146mm x 150mm  
12G: 150mm x 210mm      18G: 210mm x 210mm      24G: 210mm x 270mm
- Supplied complete with mounting frames/earth straps.

Description	Eaton list number
1G module coverplate moulded c/w earth strap	<b>P901</b>
2G module coverplate moulded c/w earth strap	<b>P902</b>
3G module coverplate moulded c/w earth strap	<b>P903</b>
4G module coverplate moulded c/w earth strap	<b>P904</b>
6G module coverplate moulded c/w mounting frame	<b>P906</b>
8G module coverplate moulded c/w mounting frame	<b>P908</b>
12G module coverplate moulded c/w mounting frame	<b>P912</b>
18G module coverplate c/w mounting frame – clip-on cover	<b>C918 + CP918WH</b>
24G module coverplate c/w mounting frame – clip-on cover	<b>C924 + CP924WH</b>
1G modular coverplate moulded – grey c/w earth strap	<b>P901GY</b>
2G modular coverplate moulded – grey c/w earth strap	<b>P902GY</b>
3G modular coverplate moulded – grey c/w earth strap	<b>P903GY</b>
4G modular coverplate moulded – grey c/w earth strap	<b>P904GY</b>
6G modular coverplate assembly moulded – grey c/w mounting frame	<b>P906GY</b>
8G modular coverplate assembly moulded – grey c/w mounting frame	<b>P908GY</b>



PREMERA mix is a modular interface grid system combining the benefits of a traditional grid range, a voice and data range, power sockets, broad switches and intelligent RF switch modules.

Offering up to 24 module size plates with endless combinations, PREMERA mix also includes radio frequency switching capabilities as part of Eaton's xComfort range enabling one product platform to fit all.

<b>3.1</b>	<b>SWITCHES</b>	
	10A switches .....	48
	20A switches .....	48–49
	20A DP legend switches .....	48
<b>3.2</b>	<b>BROAD SWITCHES</b>	
	10A switches .....	50
	20A switches .....	50
<b>3.3</b>	<b>KEY SWITCHES</b>	
	20A key switches .....	51
	20A DP key switches.....	51
<b>3.4</b>	<b>ANCILLARY PRODUCTS</b>	
	Neons .....	52
	Fuse modules .....	52
	Cable outlets, buzzers, blanks .....	52
<b>3.5</b>	<b>DIMMERS</b>	
	250W/400W/VA Universal dimmers .....	53
	500W/1000W dimmers .....	53
	Fan controller .....	53
<b>3.6</b>	<b>SOCKET MODULES</b>	
	13A sockets/13A non-standard socket.....	54
	5A/15A sockets.....	54
	Schuko and American sockets.....	54

Continued overleaf

<b>3.7</b>	<b>COMMUNICATION MODULES</b>	
	TV/FM sockets.....	55
	Satellite outlets.....	55
	Phone outlets .....	55
	Data and voice outlets.....	55
<b>3.8</b>	<b>RF SWITCHES AND ACTUATORS</b>	
	Switches .....	56
	Dimmers.....	56
	Actuators .....	56
<b>3.9</b>	<b>BACK BOXES</b>	
	Surface and flush.....	57

## PREMERA mix specification guide

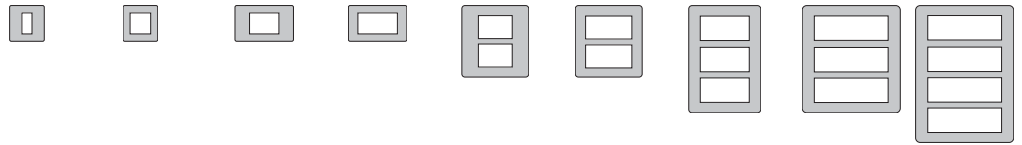

Range/finish	Eaton list number								
	1 module	2 module	3 module	4 module	6 module	8 module	12 module	18 module	24 module
PREMERA white	P901	P902	P903	P904	P906	P908	P912	C918WH	C924WH
PREMERA grey	P901GY	P902GY	P903GY	P904GY	P906GY	P908GY	–	–	–
COPA c/w white cover	C901WH	C902WH	C903WH	C904WH	–	–	–	–	–
COPA interior	C901	C902	C903	C904	C906	C908	C912	C918	C924
COPA interior black	C901B	C902B	C903B	C904B	C906B	C908B	C912B	C918B	C924B
COPA plastic covers <sup>1)</sup>	CP901*	CP902*	CP903*	CP904*	CP906*	CP908*	CP912*	CP918*	CP924*
COPA metal covers <sup>2)</sup>	CM901*	CM902*	CM903*	CM904*	CM906*	CM908*	CM912*	CM918*	CM924*
COPA fix plates – SS	B901SS	B902SS	B903SS	B904SS	B906SS*	B908SS*	B912SS*	B918SS*	B924SS*
COPA fix plates – HP	B901HP	B902HP	B903HP	B904HP	B906HP*	B908HP*	–	–	–
XTRA surface range	X901MG	X902MG	X903MG	X904MG	X906MG	X908MG	X912MG	X918MG	X924MG
<b>Back boxes</b>									
Flush boxes – Metal	35mm deep	35mm deep	35mm deep	35mm deep	F8342	F8342	F8343	F8344	F8345
Surface metal boxes for Xtra plates									
– with knockouts	FM8340	FM8340	FM8341	FM8341	F8342	F8342	F8343	F8344	F8345
– without knockouts	FM8349	FM8349	FM8350	FM8350	F8351	F8351	F8352	–	–
Surface moulded boxes	F4501	F4501	F4502	F4502	–	–	–	–	–

Notes: Items supplied complete with all the mounting frames unless stated.

\*Covers only – need to order interior – white or black (eg C901 or C901B).

<sup>1)</sup>Plastic covers available in the following finishes

Finish	add suffix to end of part number	Example of product code
White	WH	CP904WH
Metallic silver	SV	CP904SV
Gold metallic	GL	CP904GL
Black matt	BM	CP904BM
Blue metallic	BL	CP904BL
Grey	GY	CP904GY

<sup>2)</sup>Metal plates available in the following finishes

Finish	add suffix to end of part number	Example of product code
Stainless steel	SS	CM904SS
Highly polished	HP	CM904HP
Satin bronze	SB	CM904SB
Polished brass	PB	CM904PB



F9004

**10A switches**

- To BSEN60669-1.

**Description**

Description	Eaton list number		
	White module	Black module	Red rocker
10A 1 way	F9000	–	–
10A 2 way	F9001	F9001B	F9001RR
10A 2 way push to make	F9004	F9004B	–

F9021RR

**20A switches**

- To BSEN60669-1.

**Description**

Description	Eaton list number		
	White module	Black module	Red rocker
20A 1 way	F9020	F9020B	F9020RR
20A 2 way	F9021	F9021B	F9021RR
20A intermediate switch	F9022	F9022B	–

F9023

**20A double pole switches**

- To BSEN60669-1.

**Description**

Description	Eaton list number		
	White module	Black module	Red rocker
20A double pole	F9023	F9023B	F9023RR
20A double pole push to break	F9029	–	F9029RR
20A double pole push to make	F9030	F9030B	F9030RR
20A 2 way centre off	F9024	F9024B	F9024RR
20A 2 way centre off bias	F9033	F9033B	F9033RR

F9023WM

**20A double pole switches – legends**

- To BSEN60669-1.

**Description**

Description	Eaton list number		
	White module	Black module	Red rocker
20A double pole marked 'boiler'	F9023BO	F9023BBO	–
20A double pole marked 'central heating'	F9023CH	F9023BCH	–
20A double pole marked 'dishwasher'	F9023DW	F9023BDW	–
20A double pole marked 'extract fan'	F9023EF	F9023BEF	–
20A double pole marked 'fridge freezer'	F9023FF	F9023BFF	–
20A double pole marked 'fridge'	F9023FG	F9023BFG	–
20A double pole marked 'freezer'	F9023FZ	F9023BFZ	–
20A double pole marked 'hob'	F9023HB	F9023BHB	–
20A double pole marked 'hob hood'	F9023HH	F9023BHH	–
20A double pole marked 'light'	F9023LI	F9023BLI	–
20A double pole marked 'microwave'	F9023MW	F9023BMW	–
20A double pole marked 'oven'	F9023OV	F9023BOV	–
20A double pole marked 'plinth heater'	F9023PH	F9023BPH	–
20A double pole marked 'pilot light'	F9023PL	F9023BPL	–
20A double pole marked 'tumble dryer'	F9023TD	F9023BTD	–
20A double pole marked 'towel rail'	F9023TR	F9023BTR	–
20A double pole marked 'washer dryer'	F9023WDR	F9023BWDR	–
20A double pole marked 'water heater'	F9023WH	F9023BWH	–
20A double pole marked 'washing machine'	F9023WM	F9023BWM	–

F9025



### 20A double pole switches with neon

- To BSEN60669-1.

**Description**

Description	Eaton list number		
	White module	Black module	Red rocker
20A double pole with indicator	<b>F9025</b>	<b>F9025B</b>	–

F9025HE



### 20A double pole switches with neon – legends

- To BSEN60669-1.

**Description**

Description	Eaton list number		
	White module	Black module	Red rocker
20A double pole + neon marked 'boiler'	<b>F9025BO</b>	–	–
20A double pole + neon marked 'central heating'	<b>F9025CH</b>	–	–
20A double pole + neon marked 'dishwasher'	<b>F9025DW</b>	–	–
20A double pole + neon marked 'extract fan'	<b>F9025EF</b>	–	–
20A double pole + neon marked 'fridge freezer'	<b>F9025FF</b>	–	–
20A double pole + neon marked 'fridge'	<b>F9025FG</b>	–	–
20A double pole + neon marked 'hob'	<b>F9025HB</b>	–	–
20A double pole + neon marked 'heater'	<b>F9025HE</b>	–	–
20A double pole + neon marked 'microwave'	<b>F9025MW</b>	–	–
20A double pole + neon marked 'plinth heater'	<b>F9025PH</b>	–	–
20A double pole + neon marked 'tumble dryer'	<b>F9025TD</b>	–	–
20A double pole + neon marked 'washer dryer'	<b>F9025WDR</b>	–	–
20A double pole + neon marked 'water heater'	<b>F9025WH</b>	–	–
20A double pole + neon marked 'wachine machine'	<b>F9025WM</b>	–	–

F9032



### 16A twin switches

- To BSEN60669-1.

**Description**

Description	Eaton list number		
	White module	Black module	Red rocker
16A 1 way twin switch module	<b>F9032</b>	–	–

F9201B

**10A broad rocker switches**

- 50mm x 50mm modules.
- To BSEN60669-1.

**Description**

Eaton list number  
White module    Black module    Red rocker

Description	White module	Black module	Red rocker
10A 2 way broad rocker	F9201	F9201B	–
10A 2 way broad rocker push to make	F9204	F9204B	–

F9225

**20A broad rocker switches**

- 50mm x 50mm modules.
- To BSEN60669-1.

**Description**

Eaton list number  
White module    Black module    Red rocker

Description	White module	Black module	Red rocker
20A 2 way broad rocker	F9221	F9221B	–
20A intermediate broad rocker switch	F9222	F9222B	–
20A double pole broad rocker	F9223	F9223B	–
20A double pole broad rocker indicator	F9225	F9225B	–
20A 2 way centre off broad rocker	F9224	F9224B	–
20A 2 way centre off bias broad rocker	F9233	F9233B	–

F9027RR



### 20A key switches

- To BSEN60669-1.

**Description**

Description	Eaton list number		
	White module	Black module	Red rocker
20A key switch 2 way	<b>F9026</b>	<b>F9026B</b>	–
20A key switch 2 way printed with 'emergency lighting test charge'	<b>F9026EL</b>	<b>F9026BEL</b>	–
20A key switch double pole	<b>F9027</b>	<b>F9027B</b>	<b>F9027RR</b>
20A key switch double pole printed with 'emergency lighting test charge'	<b>F9027EL</b>	<b>F9027BEL</b>	–
20A key switch double pole with indicator	<b>F9027N</b>	<b>F9027NB</b>	–
20A key switch 2 way centre off bias	<b>F9028</b>	<b>F9028B</b>	–
20A key switch intermediate	<b>F9031</b>	<b>F9031B</b>	–

# 3.4

## PREMERA mix

### Ancillary items

F9063



F9072



#### Ancillary items

Description	Eaton list number		
	White module	Black module	Red rocker
Red neon 230V	<b>F9061</b>	<b>F9061B</b>	–
Red filament lamp 24V	<b>F9061/24V</b>	–	–
Amber neon 230V	<b>F9062</b>	–	–
Amber neon 24V	<b>F9062/24V</b>	–	–
Green neon 230V	<b>F9063</b>	–	–
Green neon 24V	<b>F9063/24V</b>	–	–
13A fuse module <sup>1)</sup>	<b>F9072</b>	<b>F9072B</b>	<b>F9072RR</b>
Cable outlet <sup>2)</sup>	<b>F9073</b>	<b>F9073B</b>	–
Buzzer	<b>F9076</b>	–	–
Replacement key	<b>F9099</b>	–	–
Blank <sup>2)</sup>	<b>F9060</b>	<b>F9060B</b>	–

<sup>1)</sup>To BS1363 Part 2

<sup>2)</sup>To BS5733



F9064



### Dimmer modules

Description	Eaton list number	
	White module	Black module
250W dimmer universal push on/off 2 way <sup>1)</sup>	F9064	F9064B
400W dimmer universal push on/off 2 way <sup>1)</sup>	F9065	F9065B
500W dimmer (50mm x 50mm) push on/off 2 way <sup>1)</sup>	F9066	F9066B
1000W dimmer non-european (50mm x 50mm) push on/off 2 way	F9077	F9077B
1–10V dimmer push on/off 1 way <sup>1)</sup>	F9078	F9078B
60–500W fan controller – non-euro rotary 1 way	F9079	F9079B

<sup>1)</sup>To BSEN60991-2-1

F9313

**Socket modules**

- 50mm x 50mm modules.

**Description**

Description	Eaton list number	
	White module	Black module
5A 3 pin shuttered socket <sup>1)</sup>	<b>F9306</b>	<b>F9306B</b>
13A 3 pin socket module 2 earth terminals <sup>2)</sup>	<b>F9313</b>	<b>F9313B</b>
13A 3 pin non standard socket 2 earth terminals	<b>F9314</b>	<b>F9314B</b>
15A 3 pin shuttered socket <sup>1)</sup>	<b>F9315</b>	<b>F9315B</b>
16A Schuko socket <sup>3)</sup>	<b>F9317</b>	<b>F9317B</b>
15A 3 pin 127v SASO socket <sup>4)</sup>	<b>F9318</b>	<b>F9318B</b>

<sup>1)</sup>To BS546

<sup>2)</sup>To BS1363 Part 2

<sup>3)</sup>To IEC60884-1

<sup>4)</sup>To SASO 444

F3784



### Communication modules

Description	Eaton list number	
	White module	Black module
Single IEC co-axial (female) screened	<b>F3780</b>	<b>F3780B</b>
Single IEC co-axial (male) screened	<b>F3781</b>	<b>F3781B</b>
Single satellite (female) connection screened	<b>F3782</b>	<b>F3782B</b>
TV/radio/satellite/return module screened	<b>F3783</b>	<b>F3783B</b>
Telephone (BT secondary)	<b>F3784</b>	<b>F3784B</b>
Telephone (BT master)	<b>F3785</b>	<b>F3785B</b>
RJ11 outlet	<b>F3786</b>	<b>F3786B</b>
RJ45 CAT 6	<b>F3787</b>	<b>F3787B</b>
2 x RCA socket	<b>F3788</b>	<b>F3788B</b>
2 x loudspeaker socket	<b>F3789</b>	<b>F3789B</b>
1G module blank <sup>1)</sup>	<b>F3790</b>	<b>F3790B</b>

<sup>1)</sup>To BS5733

F9401

**Premera xComfort RF switch modules**

- See xComfort section for more information.

**Description****Eaton list number  
White module**

Description	Eaton list number White module
xComfort RF module surface mounting plate (will accept any CP902 type of plate – not supplied)	<b>F9400</b>
xComfort 1G RF switch module	<b>F9401</b>
xComfort 2G RF switch module	<b>F9402</b>
xComfort 4G RF switch module	<b>F9404</b>

CSAU-01/01

**xComfort actuators: examples**

- See xComfort section for details of actuators and other RF devices for use with Premera RF switch modules.

**Description****Eaton list number  
White module**

Description	Eaton list number White module
xComfort 8A SP switching actuator	<b>CSAU-01/01</b>
xComfort 250W dimming actuator	<b>CDAU-01/02</b>

F8344



### Grid boxes

- To BS5733.

Description	Eaton list number
1 and 2 gang grid box surface	<b>FM8340</b>
3 and 4 gang grid box surface	<b>FM8341</b>
6 and 8 gang grid box flush or surface	<b>F8342</b>
9 and 12 gang grid box flush or surface	<b>F8343</b>
18G grid box flush or surface	<b>F8344</b>
24G grid box flush or surface	<b>F8345</b>
1 and 2 gang grid box no knockouts surface	<b>FM8349</b>
3 and 4 gang grid box no knockouts surface	<b>FM8350</b>
Gridswitch box 6 & 8 gang – no knockouts flush or surface	<b>F8351</b>
9 and 12 gang grid box no knockouts flush or surface	<b>F8352</b>

Note: PREMERA Mix modules/plates (1–4 gang) fit industry standard 35mm standard flush metal boxes







PREMERA PROOF is a range of weatherproof accessories offering IP66 protection for outdoor or more arduous environments.

The range provides extensive combinations by utilising the 1 and 2 gang IP66 enclosures whilst delivering on aesthetic appeal.

## 4.1

### IP66 SWITCHES AND ENCLOSURES

60

# 4.1

## PREMERA proof IP66 switches and enclosures

P722



### IP66 switches

#### Description

#### Eaton list number

1G 10A 2W bell push + neon IP66

**P715**

1G 16A 2W switch + neon IP66

**P721**

2G 16A 2W switch + neon IP66

**P722**

1G 20A DP + neon IP66

**P741**

2G 20A DP switch + neon IP66

**P742**

P762



### IP66 enclosures

- Will accept most standard PREMERA 1 gang or 2 gang products.
- Enclosures must be ordered with equivalent number of PREMERA products.

#### Description

#### Eaton list number

1G IP66 enclosure

**P761**

2G IP66 enclosure

**P762**

P771



### IP56 switch socket

#### Description

#### Eaton list number

13A 1G switched socket IP56

**P771**



COPA is Eaton's flexible 'Clip On' Plate Accessory range designed with innovative, slim and stylish 'clip-on' face plates that conceal the screw fixing holes to give a superior elegance to the finish of the product. The decorative face plates are available in a selection of styles available in both high quality decorative plastic and luxury metal finishes.

## 5.1 SWITCHES

10A switches/architrave .....	63
3 Pole fan isolator switches .....	63
10A broad rocker switches .....	63
Dimmer switches .....	63
Alternative dimmer knobs .....	64

## 5.2 SOCKET OUTLETS

13A switched sockets .....	65
Unswitched sockets .....	65
5A sockets .....	65
15A sockets .....	66
Shaver sockets .....	66

## 5.3 FUSED CONNECTION UNITS

13A connection units – unswitched .....	67
13A connection units – switched .....	67

## 5.4 POWER SWITCHES

20A switches .....	68
45A/50A switches .....	68

## 5.5 BLANK PLATES

Blank plates .....	69
--------------------	----

Continued overleaf

<b>5.6</b>	<b>COMMUNICATION OUTLETS</b>	
	Phone/data outlets .....	70
	Communication outlets .....	70
<b>5.7</b>	<b>PREMERA MIX MODULE PLATES</b>	
	Modular plates/grids .....	71

C012



### 10A switches

- To BSEN 60669-1.
- Minimum back box depth = 25mm.

#### Description

Description	Eaton list number					
	White interior c/w white cover	White interior	Black interior	Decorative plate option	Metallic plate option	White cover
10A 1G 1 way	<b>C011WH</b>	<b>C011</b>	<b>C011B</b>	<b>CP011<sup>(1)</sup></b>	<b>CM011<sup>(2)</sup></b>	<b>CP011WH</b>
10A 2G 1 way	<b>C012WH</b>	<b>C012</b>	<b>C012B</b>	<b>CP012<sup>(1)</sup></b>	<b>CM012<sup>(2)</sup></b>	<b>CP012WH</b>
10A 3G 1 way	<b>C013WH</b>	<b>C013</b>	<b>C013B</b>	<b>CP013<sup>(1)</sup></b>	<b>CM013<sup>(2)</sup></b>	<b>CP013WH</b>
10A 4G 1 way	<b>C014WH</b>	<b>C014</b>	<b>C014B</b>	<b>CP014<sup>(1)</sup></b>	<b>CM014<sup>(2)</sup></b>	<b>CP014WH</b>
10A 1G 1 way retractive switch with light symbol	<b>C015LWH</b>	<b>C015</b>	<b>C015B</b>	<b>CP015L<sup>(1)</sup></b>	<b>CM015L<sup>(2)</sup></b>	<b>CP015LWH</b>
10A 1G 1 way retractive switch with bellpush symbol	<b>C015WH</b>	<b>C015</b>	<b>C015B</b>	<b>CP015<sup>(1)</sup></b>	<b>CM015<sup>(2)</sup></b>	<b>CP015WH</b>
10A intermediate switch	<b>C017WH</b>	<b>C017</b>	<b>C017B</b>	<b>CP011<sup>(1)</sup></b>	<b>CM011<sup>(2)</sup></b>	<b>CP011WH</b>
10A 1G 2 way	<b>C021WH</b>	<b>C021</b>	<b>C021B</b>	<b>CP011<sup>(1)</sup></b>	<b>CM011<sup>(2)</sup></b>	<b>CP011WH</b>
10A 2G 2 way	<b>C022WH</b>	<b>C022</b>	<b>C022B</b>	<b>CP012<sup>(1)</sup></b>	<b>CM012<sup>(2)</sup></b>	<b>CP012WH</b>
10A 3G 2 way	<b>C023WH</b>	<b>C023</b>	<b>C023B</b>	<b>CP013<sup>(1)</sup></b>	<b>CM013<sup>(2)</sup></b>	<b>CP013WH</b>
10A 4G 2 way	<b>C024WH</b>	<b>C024</b>	<b>C024B</b>	<b>CP014<sup>(1)</sup></b>	<b>CM014<sup>(2)</sup></b>	<b>CP014WH</b>
10A 6G 2 way	<b>C026WH</b>	<b>C026</b>	<b>C026B</b>	<b>CP026<sup>(1)</sup></b>	<b>CM026<sup>(2)</sup></b>	<b>CP026WH</b>

CM012SS



C012 + CM012SS



C041



### 10A broad rocker switches

- To BSEN 60669-1.
- Minimum back box depth = 25mm.

#### Description

Description	Eaton list number					
	White interior c/w white cover	White interior	Black interior	Decorative plate option	Metallic plate option	White cover
10A 2G 2 way half broad switch	<b>C032WH</b>	<b>C032</b>	<b>C032B</b>	<b>CP013<sup>(1)</sup></b>	<b>CM013<sup>(2)</sup></b>	<b>CP013WH</b>
10A 1G 2 way broad switch	<b>C041WH</b>	<b>C041</b>	<b>C041B</b>	<b>CP013<sup>(1)</sup></b>	<b>CM013<sup>(2)</sup></b>	<b>CP013WH</b>
10A 1G 1 way broad switch bellpush	<b>C045WH</b>	<b>C045</b>	<b>C045B</b>	<b>CP045<sup>(1)</sup></b>	<b>CM045<sup>(2)</sup></b>	<b>CP045WH</b>
10A intermediate broad switch	<b>C047WH</b>	<b>C047</b>	<b>C047B</b>	<b>CP013<sup>(1)</sup></b>	<b>CM013<sup>(2)</sup></b>	<b>CP013WH</b>
10A 3 pole broad rocker fan isolator	<b>C048WH</b>	<b>C048</b>	<b>C048B</b>	<b>CP048<sup>(1)</sup></b>	<b>CM048<sup>(2)</sup></b>	<b>CP048WH</b>
10A 3 pole broad rocker isolator	<b>C049WH</b>	<b>C048</b>	<b>C048B</b>	<b>CP049<sup>(1)</sup></b>	<b>CM049<sup>(2)</sup></b>	<b>CP049WH</b>

C9132WH



### Push on/push off action dimmers

- To BSEN 60669-1-1.
- Minimum back box depth = 35mm.
- Supplied with white and black knobs

#### Description

Description	Eaton list number					
	White interior c/w white cover	White interior	Decorative plate option	Metallic plate option	White cover	
250W 1G 2 way	<b>C9131WH</b>	<b>C9131</b>	<b>CP351<sup>(1)</sup></b>	<b>CM351<sup>(2)</sup></b>	<b>CP351WH</b>	
250W 2G 2 way	<b>C9132WH</b>	<b>C9132</b>	<b>CP9132<sup>(1)</sup></b>	<b>CM9132<sup>(2)</sup></b>	<b>CP9132WH</b>	
400W 1G 2 way	<b>C9141WH</b>	<b>C9141</b>	<b>CP351<sup>(1)</sup></b>	<b>CM351<sup>(2)</sup></b>	<b>CP351WH</b>	
1000W 1G 2way – 2 gang size coverplate	<b>C9111WH</b>	<b>C9111</b>	<b>CP9111<sup>(1)</sup></b>	<b>CM9111<sup>(2)</sup></b>	<b>CP9111WH</b>	

### <sup>1</sup>Plastic covers available in the following finishes

Finish	add suffix to end of part number	Example of product code
White	<b>WH</b>	<b>CP011WH</b>
Metallic silver	<b>SV</b>	<b>CP011SV</b>
Gold metallic	<b>GL</b>	<b>CP011GL</b>
Black matt	<b>BM</b>	<b>CP011BM</b>
Blue metallic	<b>BL</b>	<b>CP011BL</b>
Grey	<b>GY</b>	<b>CP011GY</b>

### <sup>2</sup>Metal plates available in the following finishes

Finish	add suffix to end of part number	Example of product code
Stainless steel	<b>SS</b>	<b>CM011SS</b>
Highly polished	<b>HP</b>	<b>CM011HP</b>
Satin bronze	<b>SB</b>	<b>CM011SB</b>
Polished brass	<b>PB</b>	<b>CM011PB</b>



# 5.1

## COPA clip-on plate accessory range

### Switches

C9551WH



#### Rotary tungsten dimmers

- These dimmers are produced for **non-european countries**.
- Minimum back box depth = 35mm.
- Supplied with white and black knobs.

Description	Eaton list number		Decorative plate option	Metallic plate option	White cover
	White interior c/w white cover	White interior			
500W 1G 1 way	<b>C9551WH</b>	<b>C9551</b>	<b>CP351<sup>1)</sup></b>	<b>CM351<sup>2)</sup></b>	<b>CP351WH</b>
500W 2G 1 way	<b>C9552WH</b>	<b>C9552</b>	<b>CP9132<sup>1)</sup></b>	<b>CM9132<sup>2)</sup></b>	<b>CP9132WH</b>
500W 1G 1 way fan controller	<b>C9751WH</b>	<b>C9751</b>	<b>CP351<sup>1)</sup></b>	<b>CM351<sup>2)</sup></b>	<b>CP351WH</b>
1000W 1G 1way	<b>C9511WH</b>	<b>C9511</b>	<b>CP351<sup>1)</sup></b>	<b>CM351<sup>2)</sup></b>	<b>CP351WH</b>

A9900PB



#### Alternative dimmer knobs

Description	Eaton list number
Dimmer knob – highly polished	<b>A9900HP</b>
Dimmer knob – polished brass	<b>A9900PB</b>
Dimmer knob – stainless steel	<b>A9900SS</b>

A9900SS



#### <sup>1)</sup>Plastic covers available in the following finishes

Finish	add suffix to end of part number	Example of product code
White	<b>WH</b>	<b>CP351WH</b>
Metallic silver	<b>SV</b>	<b>CP351SV</b>
Gold metallic	<b>GL</b>	<b>CP351GL</b>
Black matt	<b>BM</b>	<b>CP351BM</b>
Blue metallic	<b>BL</b>	<b>CP351BL</b>
Grey	<b>GY</b>	<b>CP351GY</b>

#### <sup>2)</sup>Metal plates available in the following finishes

Finish	add suffix to end of part number	Example of product code
Stainless steel	<b>SS</b>	<b>CM621NSS</b>
Highly polished	<b>HP</b>	<b>CM621NHP</b>
Satin bronze	<b>SB</b>	<b>CM621NSB</b>
Polished brass	<b>PB</b>	<b>CM621NPB</b>

C622WH



### 13A switched socket outlets

- To BS 1363: Part 2.
- Minimum back box depth = 25mm.
- Terminals capable of accepting up to 3 x 4mm<sup>2</sup> or 2 x 6mm<sup>2</sup> conductors.
- Double pole with 2 earth terminals

Description	Eaton list number			Decorative plate option <sup>1)</sup>	Metallic plate option <sup>2)</sup>	White cover
	White interior c/w white cover	White interior	Black interior			
13A 1G DP switched socket 2E term	<b>C621WH</b>	<b>C621</b>	<b>C621B</b>	<b>CP621N<sup>1)</sup></b>	<b>CM621<sup>2)</sup></b>	<b>CP621WH</b>
13A 1G DP switched socket 2E term + neon	<b>C621NWH</b>	<b>C621N</b>	<b>C621NB</b>	<b>CP621N<sup>1)</sup></b>	<b>CM621N<sup>2)</sup></b>	<b>CP621NWH</b>
13A 2G DP switched socket 2E term	<b>C622WH</b>	<b>C622</b>	<b>C622B</b>	<b>CP622<sup>1)</sup></b>	<b>CM622<sup>2)</sup></b>	<b>CP622WH</b>
13A 2G DP switched socket 2E term + neon	<b>C622NWH</b>	<b>C622N</b>	<b>C622NB</b>	<b>CP622N<sup>1)</sup></b>	<b>CM622N<sup>2)</sup></b>	<b>CP622NWH</b>
13A 2G DP switched socket 2E term	<b>C622WH</b>	<b>C622</b>	<b>C622B</b>	<b>CP622<sup>1)</sup></b>	<b>CM622<sup>2)</sup></b>	<b>CP622WH</b>
13A 2G DP switched socket 2E term outboard rockers	<b>C632WH</b>	<b>C632</b>	<b>C632B</b>	<b>CP632<sup>1)</sup></b>	<b>CM632<sup>2)</sup></b>	<b>CP632WH</b>
13A 1G DP switched socket 2E term non standard	<b>C651WH</b>	<b>C651</b>	<b>C651B</b>	<b>CP621<sup>1)</sup></b>	<b>CM621<sup>2)</sup></b>	<b>CP621WH</b>
13A 2G DP switched socket 2E term non standard	<b>C652WH</b>	<b>C652</b>	<b>C652B</b>	<b>CP632<sup>1)</sup></b>	<b>CM632<sup>2)</sup></b>	<b>CP652WH</b>

C111WHa



### 13A unswitched socket outlets

- To BS 1363: Part 2.
- Minimum back box depth = 25mm.
- Terminals capable of accepting up to 3 x 4mm<sup>2</sup> or 2 x 6mm<sup>2</sup> conductors.
- CP and CM coverplate on C111 item all end with an 'a'

Description	Eaton list number			Decorative plate option <sup>1)</sup>	Metallic plate option <sup>2)</sup>	White cover
	White interior c/w white cover	White interior	Black interior			
13A 1G unswitched socket	<b>C111WHa</b>	<b>C111a</b>	<b>C111ba</b>	<b>CP111<sup>1)</sup></b>	<b>CM111<sup>2)</sup></b>	<b>CP111WHa</b>
13A 2G unswitched socket	<b>C112WH</b>	<b>C112</b>	<b>C112B</b>	<b>CP112<sup>1)</sup></b>	<b>CM112<sup>2)</sup></b>	<b>CP112WH</b>

C305WH



### 5A socket outlets

- Minimum back box depth = 25mm.
- To BS 546.

Description	Eaton list number			Decorative plate option <sup>1)</sup>	Metallic plate option <sup>2)</sup>	White cover
	White interior c/w white cover	White interior	Black interior			
5A 1G unswitched socket	<b>C305WH</b>	<b>C305</b>	<b>C305B</b>	<b>CP305<sup>1)</sup></b>	<b>CM305<sup>2)</sup></b>	<b>CP305WH</b>

#### <sup>1)</sup>Plastic covers available in the following finishes

Finish	add suffix to end of part number	Example of product code
White	<b>WH</b>	<b>CP621NWH</b>
Metallic silver	<b>SV</b>	<b>CP621NSV</b>
Gold metallic	<b>GL</b>	<b>CP621NGL</b>
Black matt	<b>BM</b>	<b>CP621NBM</b>
Blue metallic	<b>BL</b>	<b>CP621NBL</b>
Grey	<b>GY</b>	<b>CP621NGY</b>

#### <sup>2)</sup>Metal plates available in the following finishes

Finish	add suffix to end of part number	Example of product code
Stainless steel	<b>SS</b>	<b>CM621NSS</b>
Highly polished	<b>HP</b>	<b>CM621NHP</b>
Satin bronze	<b>SB</b>	<b>CM621NSB</b>
Polished brass	<b>PB</b>	<b>CM621NPB</b>

# 5.2

## COPA clip-on plate accessory range

### Socket outlets

C415WH



#### 15A socket outlets

- To BS 546.
- Minimum back box depth = 35mm.
- Terminals capable of accepting up to 3 x 4mm<sup>2</sup> or 2 x 6mm<sup>2</sup> conductors.

Description	Eaton list number			Decorative plate option	Metallic plate option	White cover
	White interior c/w white cover	White interior	Black interior			
15A 1G SP switched socket	<b>C415WH</b>	<b>C415</b>	<b>C415B</b>	<b>CP415<sup>(1)</sup></b>	<b>CM415<sup>(2)</sup></b>	<b>CP415WH</b>

C461WH



#### 16A socket outlets

- Minimum back box depth = 35mm.

Description	Eaton list number			Decorative plate option	Metallic plate option	White cover
	White interior c/w white cover	White interior	Black interior			
16A 1G universal 2 pin socket	<b>C461WH</b>	<b>C461</b>	<b>C461B</b>	<b>CP011<sup>(1)</sup></b>	<b>CM011<sup>(2)</sup></b>	<b>CP461WH</b>

C370B



#### 230V/115V AC shaver socket

- To BSEN 61558-2-5.
- Minimum back box depth = 47mm.

Description	Eaton list number			Decorative plate option	Metallic plate option	White cover
	White interior c/w white cover	White interior	Black interior			
Shaver socket dual voltage	<b>C370WH</b>	<b>C370</b>	<b>C370B</b>	<b>CP370<sup>(1)</sup></b>	<b>CM370<sup>(2)</sup></b>	<b>CP370WH</b>

#### <sup>1</sup>Plastic covers available in the following finishes

Finish	add suffix to end of part number	Example of product code
White	<b>WH</b>	<b>CP415WH</b>
Metallic silver	<b>SV</b>	<b>CP415SV</b>
Gold metallic	<b>GL</b>	<b>CP415GL</b>
Black matt	<b>BM</b>	<b>CP415BM</b>
Blue metallic	<b>BL</b>	<b>CP415BL</b>
Grey	<b>GY</b>	<b>CP415GY</b>

#### <sup>2</sup>Metal plates available in the following finishes

Finish	add suffix to end of part number	Example of product code
Stainless steel	<b>SS</b>	<b>CM415SS</b>
Highly polished	<b>HP</b>	<b>CM415HP</b>
Satin bronze	<b>SB</b>	<b>CM415SB</b>
Polished brass	<b>PB</b>	<b>CM415PB</b>

C221NWH



## 13A fused connection units

- To BS 1363: Part 4.
- Minimum back box depth = 25mm.
- Terminals capable of accepting up to 3 x 4mm<sup>2</sup> or 2 x 6mm<sup>2</sup> conductors. Use **C212** for bottom entry cable outlet.

Description	Eaton list number White interior c/w white cover	White interior	Black interior	Decorative plate option	Metallic plate option	White cover
13A fused connection unit	<b>C220WH</b>	<b>C220</b>	<b>C220B</b>	<b>CP220<sup>1)</sup></b>	<b>CM220<sup>2)</sup></b>	<b>CP220WH</b>
13A fused connection unit + neon	<b>C220NWH</b>	<b>C220N</b>	<b>C220NB</b>	<b>CP220N<sup>1)</sup></b>	<b>CM220N<sup>2)</sup></b>	<b>CP220NWH</b>
13A fused switched connection unit	<b>C221WH</b>	<b>C221</b>	<b>C221B</b>	<b>CP221<sup>1)</sup></b>	<b>CM221<sup>2)</sup></b>	<b>CP221WH</b>
13A fused switched connection unit 'refrigerator'	–	<b>C221</b>	–	–	–	<b>CP221RWH</b>
13A fused switched connection unit 'washing machine'	–	<b>C221</b>	–	–	–	<b>CP221WMWH</b>
13A fused switched connection unit + neon	<b>C221NWH</b>	<b>C221N</b>	–	–	–	<b>CP221NWH</b>
13A fused switched connection unit + neon 'refrigerator'	–	<b>C221N</b>	<b>C221NB</b>	<b>CP221NR<sup>1)</sup></b>	<b>CM221NR<sup>2)</sup></b>	<b>CP221NRWH</b>
13A fused switched connection unit + neon 'washing machine'–	–	<b>C221N</b>	<b>C221NB</b>	<b>CP221NWM<sup>1)</sup></b>	<b>CM221NWM<sup>2)</sup></b>	<b>CP221NWMWH</b>

C212



## Adaptor plate

Description	Eaton list number
Cable outlet adaptor plate	<b>C212</b>

### <sup>1)</sup>Plastic covers available in the following finishes

Finish	add suffix to end of part number	Example of product code
White	<b>WH</b>	<b>CP220WH</b>
Metallic silver	<b>SV</b>	<b>CP220SV</b>
Gold metallic	<b>GL</b>	<b>CP220GL</b>
Black matt	<b>BM</b>	<b>CP220BM</b>
Blue metallic	<b>BL</b>	<b>CP220BL</b>
Grey	<b>GY</b>	<b>CP220GY</b>

### <sup>2)</sup>Metal plates available in the following finishes

Finish	add suffix to end of part number	Example of product code
Stainless steel	<b>SS</b>	<b>CM220SS</b>
Highly polished	<b>HP</b>	<b>CM220HP</b>
Satin bronze	<b>SB</b>	<b>CM220SB</b>
Polished brass	<b>PB</b>	<b>CM220PB</b>

# 5.4

## COPA clip-on plate accessory range

### Power switches

C401NWH



#### 20A switches

- To BSEN 60669-1.
- Minimum back box depth = 25mm.
- Use cable adaptor plate C212 for bottom entry cable outlet.

Description	Eaton list number					
	White interior c/w white cover	White interior	Black interior	Decorative plate option	Metallic plate option	White cover
20A DP switch + neon	<b>C401NWH</b>	<b>C401N</b>	<b>C401NB</b>	<b>CP401N<sup>1)</sup></b>	<b>CM401N<sup>2)</sup></b>	<b>CP401NWH</b>
20A DP control switch	<b>C401WH</b>	<b>C401</b>	<b>C401B</b>	<b>CP401<sup>1)</sup></b>	<b>CM401<sup>2)</sup></b>	<b>CP401WH</b>
20A DP switch + neon marked 'water heater'	<b>C403NWH</b>	<b>C401N</b>	<b>C401NB</b>	<b>CP403N<sup>1)</sup></b>	<b>CM403N<sup>2)</sup></b>	<b>CP403NWH</b>
20A DP switch marked 'water heater'	<b>C403WH</b>	<b>C401</b>	<b>C401B</b>	<b>CP403<sup>1)</sup></b>	<b>CM403<sup>2)</sup></b>	<b>CP403WH</b>

C422NWH



#### 50A switches

- Minimum back box depth = 47mm.
- To BSEN 60669-1.

Description	Eaton list number					
	White interior c/w white cover	White interior	Black interior	Decorative plate option	Metallic plate option	White cover
50A DP switch + neon	<b>C421NWH</b>	<b>C421N</b>	<b>C421NB</b>	<b>CP421N<sup>1)</sup></b>	<b>CM421N<sup>2)</sup></b>	<b>CP421NWH</b>
50A DP switch + neon 1G plate size	<b>C422NWH</b>	<b>C422N</b>	<b>C422NB</b>	<b>CP422N<sup>1)</sup></b>	<b>CM422N<sup>2)</sup></b>	<b>CP422NWH</b>
50A DP switch + neon 'cooker'	<b>C423NWH</b>	<b>C421N</b>	<b>C421NB</b>	<b>CP423N<sup>1)</sup></b>	<b>CM423N<sup>2)</sup></b>	<b>CP423NWH</b>
50A DP switch + neon 'air conditioner'	<b>C424NWH</b>	<b>C421N</b>	<b>C421NB</b>	<b>CP424N<sup>1)</sup></b>	<b>CM424N<sup>2)</sup></b>	<b>CP424NWH</b>
50A DP switch + neon 'cooker' 1G plate size	<b>C426NWH</b>	–	–	–	–	–

C425NWH



#### 45A switches

- Minimum back box depth = 47mm.
- To BS 4177.

Description	Eaton list number					
	White interior c/w white cover	White interior	Black interior	Decorative plate option	Metallic plate option	White cover
45A DP cooker control unit	<b>C425WH</b>	<b>C425</b>	<b>C425B</b>	<b>CP425<sup>1)</sup></b>	<b>CM425<sup>2)</sup></b>	<b>CP425WH</b>
45A DP cooker control unit + neon	<b>C425NWH</b>	<b>C425N</b>	<b>C425NB</b>	<b>CP425N<sup>1)</sup></b>	<b>CM425N<sup>2)</sup></b>	<b>CP425NWH</b>

#### <sup>1)</sup>Plastic covers available in the following finishes

Finish	add suffix to end of part number	Example of product code
White	<b>WH</b>	<b>CP401WH</b>
Metallic silver	<b>SV</b>	<b>CP401SV</b>
Gold metallic	<b>GL</b>	<b>CP401GL</b>
Black matt	<b>BM</b>	<b>CP401BM</b>
Blue metallic	<b>BL</b>	<b>CP401BL</b>
Grey	<b>GY</b>	<b>CP401GY</b>

#### <sup>2)</sup>Metal plates available in the following finishes

Finish	add suffix to end of part number	Example of product code
Stainless steel	<b>SS</b>	<b>CM401SS</b>
Highly polished	<b>HP</b>	<b>CM401HP</b>
Satin bronze	<b>SB</b>	<b>CM401SB</b>
Polished brass	<b>PB</b>	<b>CM401PB</b>

CP392SV



## Blank plates

- Minimum back box depth = 16mm.

Description	Eaton list number			Decorative plate option	Metallic plate option	White cover
	White interior c/w white cover	White interior	Black interior			
1G blank plate	<b>C391WH</b>	<b>C391</b>	–	<b>CP391</b> <sup>1)</sup>	<b>CM391</b> <sup>2)</sup>	<b>CP391WH</b>
2G blank plate	<b>C392WH</b>	<b>C392</b>	–	<b>CP392</b> <sup>1)</sup>	<b>CM392</b> <sup>2)</sup>	<b>CP392WH</b>

### <sup>1)</sup>Plastic covers available in the following finishes

Finish	add suffix to end of part number	Example of product code
White	<b>WH</b>	<b>CP391WH</b>
Metallic silver	<b>SV</b>	<b>CP391SV</b>
Gold metallic	<b>GL</b>	<b>CP391GL</b>
Black matt	<b>BM</b>	<b>CP391BM</b>
Blue metallic	<b>BL</b>	<b>CP391BL</b>
Grey	<b>GY</b>	<b>CP391GY</b>

### <sup>2)</sup>Metal plates available in the following finishes

Finish	add suffix to end of part number	Example of product code
Stainless steel	<b>SS</b>	<b>CM391SS</b>
Highly polished	<b>HP</b>	<b>CM391HP</b>
Satin bronze	<b>SB</b>	<b>CM391SB</b>
Polished brass	<b>PB</b>	<b>CM391PB</b>



# 5.6

## COPA clip-on plate accessory range

Communication outlets

C362WH



### Telephone outlets

- Minimum back box depth = 25mm.

#### Description

Description	Eaton list number			Decorative plate option	Metallic plate option	White cover
	White interior c/w white cover	White interior	Black interior			
1G telephone outlet master	<b>C360WH</b>	<b>C360</b>	<b>C360B</b>	<b>CP360<sup>(1)</sup></b>	<b>CM360<sup>(2)</sup></b>	<b>CP360WH</b>
1G telephone outlet secondary	<b>C361WH</b>	<b>C361</b>	<b>C361B</b>	<b>CP360<sup>(1)</sup></b>	<b>CM360<sup>(2)</sup></b>	<b>CP360WH</b>
1G telephone outlet RJ11	<b>C362WH</b>	<b>C362</b>	<b>C362B</b>	<b>CP360<sup>(1)</sup></b>	<b>CM360<sup>(2)</sup></b>	<b>CP360WH</b>
1G RJ45 CAT 6 outlet	<b>C363WH</b>	<b>C363</b>	<b>C363B</b>	<b>CP360<sup>(1)</sup></b>	<b>CM360<sup>(2)</sup></b>	<b>CP360WH</b>

C351B



### TV co-axial outlets

- To BS3041-2.
- Minimum back box depth = 25mm.

#### Description

Description	Eaton list number			Decorative plate option	Metallic plate option	White cover
	White interior c/w white cover	White interior	Black interior			
1G TV co-axial outlet	<b>C351WH</b>	<b>C351</b>	<b>C351B</b>	<b>CP351<sup>(1)</sup></b>	<b>CM351<sup>(2)</sup></b>	<b>CP351WH</b>
2G TV co-axial outlet	<b>C352WH</b>	<b>C352</b>	<b>C352B</b>	<b>CP352<sup>(1)</sup></b>	<b>CM352<sup>(2)</sup></b>	<b>CP352WH</b>

CP351GL



C351B + CP351GL



C359WH



### TV/FM/radio and satellite outlets

- To BS 6312: 2.2.
- Minimum back box depth = 25mm.

#### Description

Description	Eaton list number			Decorative plate option	Metallic plate option	White cover
	White interior c/w white cover	White interior	Black interior			
1G TV/FM isolated co-axial outlet	<b>C353WH</b>	<b>C353</b>	<b>C353B</b>	<b>CP351<sup>(1)</sup></b>	<b>CM351<sup>(2)</sup></b>	<b>CP351WH</b>
2G TV/FM diplexer co-axial outlet	<b>C354WH</b>	<b>C354</b>	<b>C354B</b>	<b>CP352<sup>(1)</sup></b>	<b>CM352<sup>(2)</sup></b>	<b>CP352WH</b>
1G Satellite outlet	<b>C355WH</b>	<b>C355</b>	<b>C355B</b>	<b>CP351<sup>(1)</sup></b>	<b>CM351<sup>(2)</sup></b>	<b>CP351WH</b>
2G TV/Satellite outlet	<b>C356WH</b>	<b>C356</b>	<b>C356B</b>	<b>CP352<sup>(1)</sup></b>	<b>CM352<sup>(2)</sup></b>	<b>CP352WH</b>
1G TV/Radio/Satellite/return outlet	<b>C359WH</b>	<b>C359</b>	<b>C359B</b>	<b>CP359<sup>(1)</sup></b>	<b>CM359<sup>(2)</sup></b>	<b>CP359WH</b>

### <sup>1</sup>Plastic covers available in the following finishes

Finish	add suffix to end of part number	Example of product code
White	<b>WH</b>	<b>CP360WH</b>
Metallic silver	<b>SV</b>	<b>CP360SV</b>
Gold metallic	<b>GL</b>	<b>CP360GL</b>
Black matt	<b>BM</b>	<b>CP360BM</b>
Blue metallic	<b>BL</b>	<b>CP360BL</b>
Grey	<b>GY</b>	<b>CP360GY</b>

### <sup>2</sup>Metal plates available in the following finishes

Finish	add suffix to end of part number	Example of product code
Stainless steel	<b>SS</b>	<b>CM360SS</b>
Highly polished	<b>HP</b>	<b>CM360HP</b>
Satin bronze	<b>SB</b>	<b>CM360SB</b>
Polished brass	<b>PB</b>	<b>CM360PB</b>

C903WH



## Modular plates

- Minimum back box depth = 35mm.
- For modules, please refer to PREMERA mix section – see page 45.

Description	Eaton list number					
	White interior c/w white cover <sup>3)</sup>	White interior <sup>3)</sup>	Black interior <sup>3)</sup>	Decorative plate option <sup>4)</sup>	Metallic plate option <sup>4)</sup>	White cover <sup>4)</sup>
1 module plate	<b>C901WH</b>	<b>C901</b>	<b>C901B</b>	<b>CP901<sup>1)</sup></b>	<b>CM901<sup>2)</sup></b>	<b>CP901WH</b>
2 module plate	<b>C902WH</b>	<b>C902</b>	<b>C902B</b>	<b>CP902<sup>1)</sup></b>	<b>CM902<sup>2)</sup></b>	<b>CP902WH</b>
3 module plate	<b>C903WH</b>	<b>C903</b>	<b>C903B</b>	<b>CP903<sup>1)</sup></b>	<b>CM903<sup>2)</sup></b>	<b>CP903WH</b>
4 module plate	<b>C904WH</b>	<b>C904</b>	<b>C904B</b>	<b>CP904<sup>1)</sup></b>	<b>CM904<sup>2)</sup></b>	<b>CP904WH</b>
6 module plate	<b>C906WH</b>	<b>C906</b>	<b>C906B</b>	<b>CP906<sup>1)</sup></b>	<b>CM906<sup>2)</sup></b>	<b>CP906WH</b>
8 module plate	<b>C908WH</b>	<b>C908</b>	<b>C908B</b>	<b>CP908<sup>1)</sup></b>	<b>CM908<sup>2)</sup></b>	<b>CP908WH</b>
12 module plate	–	<b>C912</b>	<b>C912B</b>	<b>CP912<sup>1)</sup></b>	<b>CM912<sup>2)</sup></b>	<b>CP912WH</b>
18 module plate	–	<b>C918</b>	<b>C918B</b>	<b>CP918<sup>1)</sup></b>	<b>CM918<sup>2)</sup></b>	<b>CP918WH</b>
24 module plate	–	<b>C924</b>	<b>C924B</b>	<b>CP924<sup>1)</sup></b>	<b>CM924<sup>2)</sup></b>	<b>CP924WH</b>

<sup>3)</sup> Supplied with mounting frames/earth bars

<sup>4)</sup> Covers only

### <sup>1)</sup>Plastic covers available in the following finishes

Finish	add suffix to end of part number	Example of product code
White	<b>WH</b>	<b>CP901WH</b>
Metallic silver	<b>SV</b>	<b>CP901SV</b>
Gold metallic	<b>GL</b>	<b>CP901GL</b>
Black matt	<b>BM</b>	<b>CP901BM</b>
Blue metallic	<b>BL</b>	<b>CP901BL</b>
Grey	<b>GY</b>	<b>CP901GY</b>

### <sup>2)</sup>Metal plates available in the following finishes

Finish	add suffix to end of part number	Example of product code
Stainless steel	<b>SS</b>	<b>CM901SS</b>
Highly polished	<b>HP</b>	<b>CM901HP</b>
Satin bronze	<b>SB</b>	<b>CM901SB</b>
Polished brass	<b>PB</b>	<b>CM901PB</b>





The COPA style of plate has been extended to offer an alternative to the 'clip-on' plate by offering the same plate profile with its stylish good looks but with a fixed plate, rather than just a 'clip-on' option.

COPA fix offers a solution in situations where it is more desirable to have screw fixed plates in applications such as schools and public places.

<b>6.1</b>	<b>SWITCHES</b>	
	10A switches/architrave .....	74
	3 Pole fan isolator switches .....	74
<b>6.2</b>	<b>SOCKET OUTLETS</b>	
	13A switched sockets .....	75
	Unswitched sockets .....	75
	5A sockets/15A sockets/shaver socket .....	75
<b>6.3</b>	<b>CONNECTION UNITS</b>	
	13A connection units – unswitched/switched .....	76
<b>6.4</b>	<b>POWER SWITCHES</b>	
	20A switches .....	77
	45A/50A switches .....	77
<b>6.5</b>	<b>BLANK PLATES</b>	
	Blank plates .....	78
<b>6.6</b>	<b>COMMUNICATION OUTLETS</b>	
	Phone/data outlets .....	79
	Communication outlets .....	79
<b>6.7</b>	<b>PREMERA MIX MODULE PLATES</b>	
	Modular plates/grids .....	80

B022SS

**10A switches**

- To BSEN60669-1.

**Description**

10A 1G 1W retractable switch bell push symbol

10A intermediate switch

10A 1G 2W switch

10A 2G 2W switch

10A 3G 2W switch

**Eaton list number**  
 Stainless steel Highly polished
**B015SS B015HP****B017SS B017HP****B021SS B021HP****B022SS B022HP****B023SS B023HP**

B048SS

**10A broad rocker switches**

- To BSEN60669-1.

**Description**

10A 3-pole broad fan isolator + fan symbol

**Eaton list number**  
 Stainless steel Highly polished
**B048SS B048HP**

B621SS



### 13A switched sockets

- To BS1363 Part 2.

Description	Eaton list number	
	Stainless steel	Highly polished
13A 1G DP switched socket 2E terminals	<b>B621SS</b>	<b>B621HP</b>
13A 2G DP switched socket 2E terminals	<b>B622SS</b>	<b>B622HP</b>
13A 1G DP switched socket 2E terminals + neon	<b>B621NSS</b>	<b>B621NHP</b>
13A 2G DP switched socket 2E terminals + neon	<b>B622NSS</b>	<b>B622NHP</b>

B621RRSS



### 13A switched sockets – red rockers

- To BS1363 Part 2.

Description	Eaton list number	
	Stainless steel	Highly polished
13A 1G DP switched socket 2E terminals – red rockers	<b>B621RRSS</b>	–
13A 2G DP switched socket 2E terminals – red rockers	<b>B622RRSS</b>	–

B632SS



### 13A switched sockets outboard rockers

- To BS1363 Part 2.

Description	Eaton list number	
	Stainless steel	Highly polished
13A 2G DP switched socket 2E terminals – outboard rockers	<b>B632SS</b>	–

B652SS



### 13A switched sockets outboard rockers non-standard

- To BS 5733.
- With clean earth facility.

Description	Eaton list number	
	Stainless steel	Highly polished
13A 1G DP switched socket 2E terminals – non-standard outboard rockers	<b>B651SS</b>	–
13A 2G DP switched socket 2E terminals – non-standard outboard rockers	<b>B652SS</b>	–

B111SS



### 13A unswitched sockets

- To BS1363 Part 2.

Description	Eaton list number	
	Stainless steel	Highly polished
13A 1G unswitched socket	<b>B111SS</b>	–
13A 2G unswitched socket	<b>B112SS</b>	–

B305SS



### 5A/15A sockets

- To BS546.

Description	Eaton list number	
	Stainless steel	Highly polished
5A 1G socket	<b>B305SS</b>	–
15A 1G SP switched socket	<b>B415SS</b>	–

B370SS



### Shaver socket

- To BSEN61558-2-5.

Description	Eaton list number	
	Stainless steel	Highly polished
Shaver socket dual voltage 230V 115AC	<b>B370SS</b>	–



B221NSS

**13A connection units**

- To BS1363 Part 4.

**Description**

Description	Eaton list number	
	Stainless steel	Highly polished
13A unswitched connection unit + neon	<b>B220NSS</b>	–
13A unswitched connection unit	<b>B220SS</b>	–
13A switched fused connection unit + neon	<b>B221NSS</b>	<b>B221NHP</b>
13A switched fused connection unit	<b>B221SS</b>	<b>B221HP</b>

B401NSS



### 20A switches

- To BSEN60669-1.

#### Description

Description	Eaton list number	
	Stainless steel	Highly polished
20A DP switch + neon	<b>B401NSS</b>	–
20A DP switch	<b>B401SS</b>	–
20A DP switch + neon marked 'water heater'	<b>B403NSS</b>	–
20A DP switch + neon marked 'air conditioner'	<b>B404NSS</b>	–

B422NSS



### 45A/50A switches

#### Description

Description	Eaton list number	
	Stainless steel	Highly polished
50A DP switch + neon – 1 gang plate size	<b>B421NSS<sup>1)</sup></b>	–
50A DP switch + neon	<b>B422NSS<sup>1)</sup></b>	–
45A DP cooker control unit + neon	<b>B425NSS<sup>2)</sup></b>	–
50A DP switch + neon marked 'cooker'	<b>B426NSS<sup>2)</sup></b>	–

<sup>1)</sup> To BSEN60669-1.

<sup>2)</sup> To BS 4177:1992 (2004).

B392SS

**Blank plates****Description****Eaton list number**  
**Stainless steel Highly polished**1G blank plate  
2G blank plate**B391SS** –  
**B392SS** –

B351SS



### Communication outlets

Description	Eaton list number	
	Stainless steel	Highly polished
1G TV co-axial outlet	<b>B351SS</b>	–
2G TV/FM diplex co-axial outlet	<b>B354SS</b>	–
1G Satellite outlet	<b>B355SS</b>	–
2G TV/Satellite co-axial outlet	<b>B356SS</b>	–

B360SS



### Phone outlets

Description	Eaton list number	
	Stainless steel	Highly polished
1G telephone outlet – master	<b>B360SS</b>	–
1G telephone outlet – secondary	<b>B361SS</b>	–

B902SS

**PREMERA mix module plates**

- To BS5733.
- **B906–B924** are plates only. **C906–C924** interior frames are also required.

**Description**

Eaton list number  
Stainless steel Highly polished

Description	Eaton list number	
	Stainless steel	Highly polished
1 module cover plate c/w mounting frame	<b>B901SS</b>	<b>B901HP</b>
2 module cover plate c/w mounting frame	<b>B902SS</b>	<b>B902HP</b>
3 module cover plate c/w mounting frame	<b>B903SS</b>	<b>B903HP</b>
4 module cover plate c/w mounting frame	<b>B904SS</b>	<b>B904HP</b>
6 module cover plate (2 banks)	<b>B906SS</b>	<b>B906HP</b>
8 module cover plate (2 banks)	<b>B908SS</b>	<b>B908HP</b>
12 module cover plate (3 banks)	<b>B912SS</b>	–
18 module cover plate (3 banks)	<b>B918SS</b>	–
24 module cover plate (4 banks)	<b>B924SS</b>	–



The perfect choice for a variety of industrial and commercial projects. The Xtra range of rugged and tough surface metalclad accessories are produced from high quality steel with an epoxy powder coating for corrosion resistance.

<b>7.1</b>	<b>SWITCHES</b>	
	10A switches .....	82
	3 Pole isolator switches .....	82
	10A broad rocker switches .....	82
	20A/50A double pole switches .....	82
<b>7.2</b>	<b>SOCKET OUTLETS</b>	
	13A unswitched sockets .....	83
	13A double pole switched sockets inboard rockers .....	83
	13A 2G double pole switched sockets outboard rockers .....	83
	13A 1G/2G double pole non-standard/clean earth switched sockets .....	83
	13A RCD socket .....	83
	5A/15A sockets .....	84
	13A lockable outlet .....	84
<b>7.3</b>	<b>FUSED CONNECTION UNITS</b>	
	13A fused connection units – unswitched .....	85
	13A fused connection units – switched .....	85
	13A fused connection units with red rockers/fuse drawers with optional cable outlets .....	85
<b>7.4</b>	<b>PREMERA MIX MODULE PLATES AND BLANK PLATES</b>	
	Modular plates/grids .....	86
	Blank plates .....	86

X022MG

**10A switches**

- To BSEN 60669-1.
- Supplied with M3.5 fixing screws. Each terminal is capable of accepting up to 3 x 1.5mm<sup>2</sup> conductors. All terminals are backed off, ready to accept cable. X-rated for fluorescent or inductive loads.

Description	Eaton list number
10A 1G 2 way	<b>X021MG</b>
10A 2G 2 way	<b>X022MG</b>
10A 3G 2 way	<b>X023MG</b>
10A 1G intermediate	<b>X017MG</b>

X048MG

**3 pole isolator switches**

- To BSEN 60669-1.
- Supplied with M3.5 fixing screws. Each terminal is capable of accepting up to 3 x 1.5mm<sup>2</sup> conductors. All terminals are backed off, ready to accept cable. X-rated for fluorescent or inductive loads.

Description	Eaton list number
10A broad fan isolator + fan symbol	<b>X048MG</b>
10A broad fan isolator	<b>X049MG</b>

X401NMG

**20A double pole switches**

- To BSEN 60669-1.
- Supply terminals accept 3 x 2.5mm<sup>2</sup> conductors. Load terminals accept 2 x 2.5mm<sup>2</sup> conductors.

Description	Eaton list number
20A DP switch	<b>X401MG</b>
20A DP switch + neon	<b>X401NMG</b>

X421NMG

**50A double pole switch**

- To BSEN 60669-1.

Description	Eaton list number
50A DP switch + neon	<b>X421NMG</b>



X111MG



### 13A unswitched socket outlets

- To BS 1363:Part 2.
- Terminals capable of accepting up to 3 x 4mm<sup>2</sup> or 2 x 6mm<sup>2</sup> conductors.

Description	Eaton list number
13A 1G unswitched socket	X111MG
13A 2G unswitched socket	X112MG

X621MG



### 13A double pole switched sockets

- To BS 1363: Part 2.
- 2 earth terminals and inboard rockers.

Description	Eaton list number
13A 1G DP switched socket with 2E terminals	X621MG
13A 1G DP switched socket with 2E terminals + neon	X621NMG
13A 1G DP switched socket with 2E terminals + red rocker	X621RRMG
13A 2G DP switched socket with 2E terminals	X622MG
13A 2G DP switched socket with 2E terminals + neon	X622NMG
13A 2G DP switched socket with 2E terminals + red rocker	X622RRMG

X632MG



### 13A 2G double pole switched sockets outboard rockers

- To BS 1363: Part 2.
- Terminals capable of accepting up to 3 x 4mm<sup>2</sup> or 2 x 6mm<sup>2</sup> conductors.
- 2 earth terminals and outboard rockers.

Description	Eaton list number
13A 2G DP switched socket with 2E terminals	X632MG
13A 2G DP switched socket with 2E terminals + red rockers	X632RRMG

X651MG



### 13A 1G double pole non-standard/clean earth switched sockets

- Non-standard socket interface to BS 5733 with clean earth facility.

Description	Eaton list number
13A 1G DP switched socket	X651MG
Non-standard plug top	F3368

X652MG



### 13A 2G double pole non-standard/clean earth switched sockets

- Non-standard socket interface to BS 5733 with clean earth facility.
- Outboard rockers.

Description	Eaton list number
13A 2G DP switched socket with 2E terminals	X652MG

X686MG



### 13A double pole RCD socket outlet – passive

- To BS 7288.
- Added protection against electrocution.
- Passive – the contacts on the passive device remain closed when the mains supply is interrupted – this type is suitable for applications such as fridge freezers etc.

Description	Eaton list number
13A 2G RCD protected socket passive 30mA	X686MG

X105MG

**13A lockable socket**

- To BS 1363 Part 2.

**Description**

13A 1G socket 2G plate size with common key

Eaton list  
number**X105MG**

X305MG

**5A socket outlet**

- To BS 546.

**Description**

5A 1G unswitched socket

Eaton list  
number**X305MG**

X415MG

**15A socket outlet**

- To BS 546.

**Description**

15A 1G switched socket

Eaton list  
number**X415MG**

X220MG



**13A fused connection units – unswitched**

- To BS 1363: Part 4: 1995.
- Live and neutral terminals accept 2 x 4mm<sup>2</sup> cables.

Description	Eaton list number
13A unswitched connection unit	<b>X220MG</b>
13A unswitched connection unit + neon	<b>X220NMG</b>

X221MG



**13A fused connection units**

- To BS 1363: Part 4: 1995.
- Live and neutral terminals accept 2 x 4mm<sup>2</sup>.

Description	Eaton list number
13A switched connection unit	<b>X221MG</b>
13A switched connection unit + neon	<b>X221NMG</b>

X220RRMG



**13A fused connection units with red rockers/fuse drawers**

- To BS 1363: Part 4: 1995.
- Live and neutral terminals accept up to 2 x 2.5mm<sup>2</sup> cables.
- Highlights essential supply circuits where extra safety is a vital consideration.
  - Hospitals
  - Hospitals
  - Computer installations
- Circuits can be quickly and easily identified.

Description	Eaton list number
13A DP unswitched connection unit – red fuse drawer	<b>X220RRMG</b>
13A DP switched connection unit – red rocker	<b>X221RRMG</b>
13A DP switched connection unit – red rocker + neon	<b>X221NRRMG</b>

X901MG



### Modular coverplates – surface metalclad

- Suitable for use with PREMERA mix modules – see page 45.
- Dimensions: 1G–2G: 86mm x 86mm    3G–4G: 86mm x 146mm    6G–8G: 134mm x 134mm  
9G–12G: 134mm x 195mm    18G: 195mm x 195mm    24G: 195mm x 256mm
- Surface mounting box:  
1G–2G: **FM8340**    3G–4G: **FM8341**    6G–8G: **FM8342**    9G–12G: **FM8341**    (41mm deep with earth terminal).  
18G: **FM8344**    24G: **FM8345**    (56mm deep with earth terminal).

Description	Eaton list number
1G module coverplate c/w earth bar	<b>X901MG</b>
2G module coverplate c/w earth bar	<b>X902MG</b>
3G module coverplate c/w earth bar	<b>X903MG</b>
4G module coverplate c/w earth bar	<b>X904MG</b>
6G module coverplate c/w mounting frame	<b>X906MG</b>
8G module coverplate c/w mounting frame	<b>X908MG</b>
9G module coverplate c/w mounting frame	<b>X909MG</b>
12G module coverplate c/w mounting frame	<b>X912MG</b>
18G module coverplate c/w mounting frame	<b>X918MG</b>
24G module coverplate c/w mounting frame	<b>X924MG</b>

X391MG



### Blank plates

Description	Eaton list number
1G blank plate	<b>X391MG</b>
2G blank plate	<b>X392MG</b>



CIRCA is a comprehensive range of white ceiling accessories, ideal for all project requirements. Tortuous path lampholders enable simple, speedier installation and pre-assembled pendant sets ensure maximum convenience.

## 8.1 CEILING RANGE

Lampholders.....	88
Battenholders .....	88
Ceiling roses.....	88
Pendant sets.....	88
Lampholder accessories.....	88

## 8.2 LAMP ACTIVATED RANGE

Lamp activated lampholder .....	89
Lamp activated pendant set .....	89
Lamp activated battenholders .....	89

## 8.3 BC3 LOW ENERGY RANGE

BC3 low energy pendant sets .....	90
BC3 low energy lampholders .....	90
BC3 low energy battenholders .....	90
BC3 low energy lamps 15W and 20W.....	90

## 8.4 CEILING SWITCHES

Ceiling switches.....	91
-----------------------	----

F1000

**Lampholders**

- To BSEN 61184-T2.
- 2A rated.
- Meets the T2 ratings requirements of specification which tests at 210°C lamp cap temperature.

Description	Eaton list number
Lampholder short skirt	<b>F1000</b>
Lampholder home office skirt	<b>F1001</b>

F1091

**Battenholders**

- To BSEN 61184-T2

Description	Eaton list number
Batten lampholder 2T short skirt	<b>F1025</b>
Batten lampholder 2T home office skirt	<b>F1026</b>
Batten lampholder 3T short skirt	<b>F1030</b>
Batten lampholder 3T home office skirt	<b>F1031</b>
Angled batten lampholder 3T short skirt	<b>F1045</b>
Angled batten lampholder 3T home office skirt	<b>F1046</b>
Batten lampholder 3T&E HR leads home office skirt	<b>F1091</b>

F1200

**Ceiling roses**

- To BS 67
- 6A rated.
- Supplied with 332 terminal arrangement + 1 x 2 hole pillar terminal for earth conductors. Each pillar terminal will accept up to 3 x 1 x 1.5mm<sup>2</sup> conductors. Screw fixings are positioned to allow joist fixing with the central rear cable knock out accessible at the side of the joist or for use with a small circular BESA box.

Description	Eaton list number
Ceiling rose with 332 terminal block and E	<b>F1200</b>

F1250

**Pendant set with F1000 lampholder**

Description	Eaton list number
6" pendant assembly <b>F1000</b> and <b>F1200</b>	<b>F1250</b>
9" pendant assembly <b>F1000</b> and <b>F1200</b>	<b>F1251</b>

F5002

**Lampholder accessories**

Description	Eaton list number
Lampholder home office skirt	<b>F5002</b>
Lampholder short skirt	<b>F5006</b>

F1530

**Lampholder accessories**

Description	Eaton list number
Flange ring 105mm (41/8") outer diameter, 50mm (2") centres	<b>F1530</b>

F1400



**Lamp activated lampholder**

- To BSEN 61184-T2
- T2 rated. Plungers remain isolated until lamp is fully inserted. Live parts only accessible with tool. Incorporates switching mechanism.

**Description**

**Eaton list number**

Lampholder short skirt

**F1400**

F1451



**Lamp activated pendant set with F1400 lampholder**

- T2 rated. Plungers remain isolated until lamp is fully inserted. Live parts only accessible with tool. Incorporates switching mechanism.

**Description**

**Eaton list number**

6" lamp activated pendant set **F1400** and **F1200**

**F1450**

9" lamp activated pendant set **F1400** and **F1200**

**F1451**

F1491



**Lamp activated battenholders**

- To BSEN 61184-T2.
- T2 rated. Plungers remain isolated until lamp is fully inserted. Live parts only accessible with tool. Incorporates switching mechanism.
- 332 + 6 terminal arrangement.

**Description**

**Eaton list number**

Lamp activated batten lampholder HR leads

**F1491**

# 8.3

## CIRCA ceiling range

### BC3 low energy range

F1260



#### BC3 low energy pendant sets

- Lampholders tested to BS 5733 and relevant parts of BSEN 61184-T2.
- Will accept standard UK 29mm diameter shade ring and require no adjustment.
- Will accept different wattage lamps. Based on 3 pin 'J' slot configuration to ensure restriction to low energy lamps.

Description	Eaton list number
BC3 pendant set for low energy lamps 4" drop	<b>F1260</b>
BC3 pendant set for low energy lamps 6" drop	<b>F1261</b>

F1262



#### BC3 low energy lampholders

- Lampholders tested to BS 5733 and relevant parts of BSEN 61184-T2.

Description	Eaton list number
BC3 lampholder for low energy lamps	<b>F1262</b>

F1264



#### BC3 low energy battenholders

- Lampholders tested to BS 5733 and relevant parts of BSEN 61184-T2.

Description	Eaton list number
BC3 battenholder for low energy lamps	<b>F1263</b>
BC3 angled battenholder for low energy lamps	<b>F1264</b>

F1269



#### BC3 low energy lamps 15W and 20W

- Lamps to IEC 60969.

Description	Eaton list number
BC3 15W TT low energy CFL lamp 'warm white'	<b>F1266</b>
BC3 20W TT low energy CFL lamp 'warm white'	<b>F1267</b>
BC3 15W TT low energy CFL lamp 'cool white'	<b>F1268</b>
BC3 20W TT low energy CFL lamp 'cool white'	<b>F1269</b>

#### Product specification

Eaton list number	Lamp life (hrs)	Lumens	Lumens per Watt	Energy category
<b>F1266</b>	8000	900	60	A
<b>F1267</b>	8000	1200	60	A
<b>F1268</b>	8000	900	60	A
<b>F1269</b>	8000	1200	60	A
<b>F1273</b>	8000	900	69	A
<b>F1274</b>	8000	1200	67	A
<b>F1275</b>	8000	900	69	A
<b>F1276</b>	8000	1200	67	A



F1340



### Ceiling switches

- To BSEN 60669-1.
- Dimensions: **F1340** – 86mm x 86mm, Fixing centres – 60.3mm – **F1350/F1351** – 85mm diameter.
- Mounting box: **F4570**.
- 6A ceiling switches, each terminal is capable of accepting up to 3 x 1.5mm<sup>2</sup> conductors.

Description	Eaton list number
50A DP ceiling pull switch c/w neon and flag indicator	<b>F1340</b>
6A 1 way ceiling switch	<b>F1350</b>
6A 2 way ceiling switch	<b>F1351</b>
Pull cord and acorn for <b>F1350, F1351, F1340</b>	<b>F1350PC</b>





The BS 7001 LSC (Luminaire Supporting Coupler) system is recognised as the industry standard interface, offering complete changeability with other manufacturers' products. Both the 3 and 4 pin LSC systems provide considerable benefits for the specifier, contractor and end user.

## 9.1 LSC PLUG-IN LIGHTING SYSTEM

LSC ceiling assembly.....	94
LSC ceiling outlet.....	94
3 pin system LSC plug.....	94
LSC ceiling rose covers .....	94
4 pin LSC ceiling outlets .....	95
4 pin system LSC plugs .....	95

## 9.2 LDU SYSTEM

6G/8G/10G/12G LDU multi-outlet boxes.....	96
3 pin and 4 pin plugs.....	96

F8501



### LSC ceiling assembly

- BS 6972: 1988 and BS 7001: 1998.
- Rated 6A with outlets capable of installation on a 16A lighting circuit.
- Coupler supports loads up to 5kg.
- Base terminals will accept 2 x 4.0mm<sup>2</sup> incoming cables.
- Heat resisting cable is to BS 6141.
- Fixing centres 50.8mm.

F8570



#### Description

#### Eaton list number

3 pin LSC ceiling assembly (ceiling outlet, plug, cover)	<b>F8501</b>
3 pin assembly c/w 2 mtrs 0.75mm <sup>2</sup> HR (heat resistant) cable	<b>F8570</b>
3 pin assembly c/w 2 mtrs 1.00mm <sup>2</sup> HR (heat resistant) cable	<b>F8571</b>
3 pin assembly c/w 3 mtrs 0.75mm <sup>2</sup> HR (heat resistant) cable	<b>F8572</b>
3 pin assembly c/w 3 mtrs 1.00mm <sup>2</sup> HR (heat resistant) cable	<b>F8573</b>
3 pin assembly c/w 2 mtrs 0.75mm <sup>2</sup> LSF (low smoke and fume) cable	<b>F8580</b>
3 pin assembly c/w 2 mtrs 1.00mm <sup>2</sup> LSF (low smoke and fume) cable	<b>F8581</b>
3 pin assembly c/w 3 mtrs 0.75mm <sup>2</sup> LSF (low smoke and fume) cable	<b>F8582</b>
3 pin assembly c/w 3 mtrs 1.00mm <sup>2</sup> LSF (low smoke and fume) cable	<b>F8583</b>
3 pin assembly c/w 1 mtr 1.00mm <sup>2</sup> LSF (low smoke and fume) cable	<b>F8584</b>

F8502



### LSC ceiling outlet

- To BS 6972: 1988 and BS 7001: 1988.
- Large outlet terminals will take up to 2 x 4.0mm<sup>2</sup> cable.
- Flush mounting box for F8502 is a standard BESA circular box (27mm deep).

#### Description

#### Eaton list number

3 pin LSC ceiling outlet	<b>F8502</b>
--------------------------	--------------

F8540



### 3 pin system LSC plug

- To BS 6972: 1988 and BS 7001: 1988.

#### Description

#### Eaton list number

3 pin LSC re-wireable plug	<b>F8540</b>
----------------------------	--------------

F8534



### Ceiling LSC covers

- Ceiling cover provide extra protection for the outlets.
- Red covers allow for easy identification of a 4 pin circuit.

#### Description

#### Eaton list number

Ceiling rose cover – white	<b>F8534</b>
Ceiling rose cover – red	<b>F8535</b>

F8602



#### 4 pin LSC ceiling outlets

- Red plug allows easy identification of a 4 pin circuit.
- Height: 46mm, diameter 85mm.
- Rated 6A with outlets capable of installation on a 16A lighting circuit.
- Coupler supports loads up to 5kg.

F8671



- Outlet terminals will accept 2 x 4.0mm<sup>2</sup> incoming cables.
- Heat resisting cable attached is to BS 6141.
- Fixing centres 50.8mm.

Description	Eaton list number
4 pin LSC ceiling assembly (ceiling outlet, plug, cover)	F8601
4 pin LSC ceiling outlet	F8602
4 pin LSC ceiling assembly with red ceiling rose cover	F8603
4 pin assembly c/w 2 mtrs 1.00mm <sup>2</sup> HR (heat resistant) cable	F8671
4 pin assembly c/w 3 mtrs 1.00mm <sup>2</sup> HR (heat resistant) cable	F8672
4 pin assembly c/w 2 mtrs 1.00mm <sup>2</sup> LSF (low smoke and fume) cable	F8681
4 pin assembly c/w 3 mtrs 1.00mm <sup>2</sup> LSF (low smoke and fume) cable	F8682
4 pin assembly c/w 1 mtr 1.00mm <sup>2</sup> LSF (low smoke and fume) cable	F8684

F8641



#### 4 pin system LSC plugs

- To BS 6972: 1988 and BS 7001: 1988.

Description	Eaton list number
4 pin LSC re-wireable plug – white cover	F8641
4 pin LSC re-wireable plug – red cover	F8640

F8640



LDU6



### LDU multi-outlet boxes

- To BS 5733.
- Large outlet terminals will take up to 2 x 2.5mm<sup>2</sup> incoming cables.
- Dimensions: 6/8 LDU Length: 255mm, width: 168mm, depth: 58mm.  
10/12 LDU Length: 255mm, width: 247mm, depth: 58mm.
- Removable links allow each row to be switched separately.

Description	Eaton list number
6G LSC outlet unit – 4 pin	LDU6
8G LSC outlet unit – 4 pin	LDU8
10G LSC outlet unit – 4 pin	LDU10
12G LSC outlet unit – 4 pin	LDU12

FP320



### 3 pin plugs c/w cable

- 3 pin = live, neutral and earth.

Description	Eaton list number
3 pin plug c/w 2 mtrs HR (heat resistant) 0.75mm <sup>2</sup> cable	FP320
3 pin plug c/w 3 mtrs HR (heat resistant) 0.75mm <sup>2</sup> cable	FP330
3 pin plug c/w 4 mtrs HR (heat resistant) 0.75mm <sup>2</sup> cable	FP340
3 pin plug c/w 2 mtrs HR (heat resistant) 1.00mm <sup>2</sup> cable	FP321
3 pin plug c/w 3 mtrs HR (heat resistant) 1.00mm <sup>2</sup> cable	FP331
3 pin plug c/w 4 mtrs HR (heat resistant) 1.00mm <sup>2</sup> cable	FP341
3 pin plug c/w 5 mtrs HR (heat resistant) 1.00mm <sup>2</sup> cable	FP351
3 pin plug c/w 2 mtrs LSF (low smoke and fume) 1.00mm <sup>2</sup> cable	FL321
3 pin plug c/w 3 mtrs LSF (low smoke and fume) 1.00mm <sup>2</sup> cable	FL331
3 pin plug c/w 4 mtrs LSF (low smoke and fume) 1.00mm <sup>2</sup> cable	FL341
3 pin plug c/w 5 mtrs LSF (low smoke and fume) 1.00mm <sup>2</sup> cable	FL351

FP421



### 4 pin plugs c/w cable

- 4 pin = live, neutral, earth and separate live connection for emergency pack equipped luminaires.

Description	Eaton list number
4 pin plug c/w 2 mtrs HR (heat resistant) 1.00mm <sup>2</sup> cable	FP421
4 pin plug c/w 3 mtrs HR (heat resistant) 1.00mm <sup>2</sup> cable	FP431
4 pin plug c/w 4 mtrs HR (heat resistant) 1.00mm <sup>2</sup> cable	FP441
4 pin plug c/w 5 mtrs HR (heat resistant) 1.00mm <sup>2</sup> cable	FP451
4 pin plug c/w 2 mtrs LSF (low smoke and fume) 1.00mm <sup>2</sup> cable	FL421
4 pin plug c/w 3 mtrs LSF (low smoke and fume) 1.00mm <sup>2</sup> cable	FL431
4 pin plug c/w 4 mtrs LSF (low smoke and fume) 1.00mm <sup>2</sup> cable	FL441
4 pin plug c/w 5 mtrs LSF (low smoke and fume) 1.00mm <sup>2</sup> cable	FL451



Suitable for residential and commercial applications, Eaton's Moeller xComfort range of building automation products has been specifically designed to provide centralised control of all the electrical equipment in order to maximise energy savings, comfort, safety and security.

10.1	<b>PRODUCT OVERVIEW</b> .....	98
10.2	<b>SYSTEM OVERVIEW</b> .....	99
10.3	<b>BASIC MODE COMPONENTS</b>	
	Sensors.....	100
	Actuators .....	100
10.4	<b>COMFORT MODE OVERVIEW AND COMPONENTS</b>	
	Sensors.....	104
	Actuators .....	105
	Complimentary products.....	105

System components include sensors, actuators and control/communication devices.



#### Switching actuator

switches lights, pumps, ventilation and heating systems, saunas, ... any electrical consumer product.



#### Shutter actuator

for controlling blinds, shutters, mixing valves, etc.



#### Dimming actuator

switches and dims lights and light environments.



#### Analogue actuator

controls devices such as mixers, dimmers and fluorescent lamps.



#### Temperature input unit

measures temperature and controls shading and heating.



#### Home manager

the universal genius for centralised building management, operation, and display.



#### Room manager

the operating and display unit – easy to handle and easy to read.



#### Room controller

regulates and controls heating and shading.



#### Binary input unit

for integrating conventional switches, window contacts, and signal contacts.



#### Push-button unit

for lighting, shading, etc.



#### PIR motion sensor

controls lights depending on movement and brightness.



#### Adaptor plug

switches and dims living room fountains, aquaria, etc.



#### Remote control

controls lights, shading and other electrical consumer products.



#### Router

redirects information when direct transmission is not possible.



#### Analogue input

receives data from universal sensors for further processing.



#### Diagnostic device

is used by the installer for assessing the reception quality.



#### Sensors

receive different information, with alarm option.



xComfort's flexibility and intelligence makes it a powerful tool... particularly when it comes to saving energy. All the key influences, such as interior and exterior temperatures, light levels and room occupancy, can be taken into account automatically to provide exceptionally efficient and sophisticated control over lighting, heating and air-conditioning.

As well as having a wide range of applications for commercial premises, xComfort can be used to provide a high degree of home automation, including pre-programmed lighting schemes for living areas and bedrooms, timed operation of television and lights to deter burglars, and automatic operation of window blinds.

**xComfort bi-directional technology:**

Making it significantly more reliable than uni-directional communication.

**Without battery (uni-directional)**

The switch will work on a self-powered basis, only sending a signal when the switch is pushed. The actuator can receive a command, but it cannot send one back to say that the command has been obeyed. Therefore, if errors occur, or a signal is poor, there is nothing in place to ensure that the commands are always completed.

**With battery (bi-directional)**

- The switch uses the battery power to send a command to the actuator; the actuator receives the signal and carries out the command; it then sends confirmation to the switch.
- If for any reason (for instance, technical error or poor signal) the command is not received by the actuator, the intelligence of the bi-directional system allows the switch to automatically resend the command twice more within a split second.
- If the actuator has still not completed the command after three attempts, the mesh network enables other actuators within the building to route and complete the task, ensuring that all commands are always fulfilled as long as the installation was done in comfort mode.

**The Xcomfort system can be set up in two main ways – "basic mode" or "comfort mode":**

**Basic mode**

This is ideal for straightforward installations. The functions of the devices can be assigned by just activating the programming key and the corresponding push-button, a simple procedure that requires no complicated tools – all that is needed is a small screwdriver.

**Four simple steps**

1. Press the configuration pushbutton with a screwdriver for less than 0.5 seconds. Actuator enters teach-in mode. LED in the actuator is on.
2. Press the selected pushbutton for less than 0.5 sec.
3. The LED in the actuator flashes twice for confirmation.
4. Press the configuration pushbutton with a screwdriver for less than 0.5 seconds. Actuator leaves teach-in mode.

- Ideal for new construction and renovation.
- Numerous functions, such as controlling lights, blinds, heating, ventilation, etc. including status display.
- Control by wireless switch, remote control and mobile phone.
- Simple installation within an existing installation system, no chiselling, no mess, no additional wiring.
- Suitable for a wide range of applications, can easily be expanded.
- Matches a wide range of accessories and switches.
- Little wiring required.

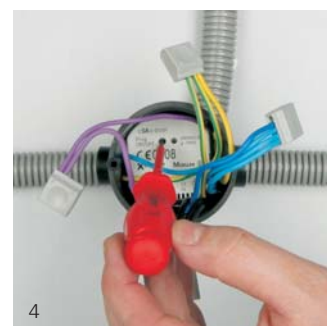
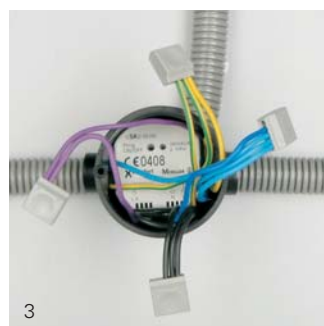
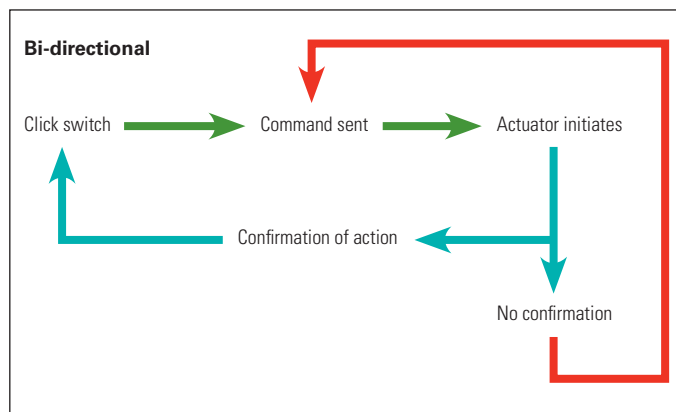
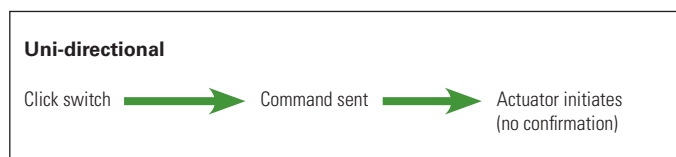

# 10.3

## xComfort system overview

### Basic mode components

F9401



#### RF pushbuttons – 1, 2, & 4 channel

When pressed, the RF push-button sends signals to the actuators of the xComfort system. No distinction is required between a shutter, dimmer, etc. or a two-way, intermediate or shutters/blinds switch. The device is powered by a coin cell. Therefore it can be conveniently attached (screw-mounted or glued) wherever needed. Thanks to the very flat design NO switch or installation box is required, although may be used for convenience..

Frames are available in a wide variety of designs and finishes (see PREMERA mix section).

F9402



The battery is included in the scope of delivery.

#### Description

#### Eaton list number

1 gang PREMERA RF push button module

**F9401**

2 gang PREMERA RF push button module

**F9402**

4 gang PREMERA RF push button module

**F9404**

PREMERA surface mounting RF module plate

**F9400**

Spare battery for module 3V **CR2430**

**CBTZ-00/01**

F9404



F9400



CSAU-01/01



#### RF switching actuator

RF receiver for switching power devices (lighting, heating, etc) rated at 8A/230VAC – 1 pole switching

#### Description

#### Eaton list number

8A/230VAC

**CSAU-01/01**

CSAU-01/02



#### RF switching actuator – potential-free

RF receiver for switching power devices (lighting, heating, etc) rated at 8A/230VAC/24VDC – potential free 2 pole switching

#### Description

#### Eaton list number

8A/230VAC

**CSAU-01/02**

CSAU-01/03



#### RF switching actuator – all-pole

RF receiver for switching power devices (lighting, heating, etc) rated at 8A/230VAC – 2 pole switching

#### Description

#### Eaton list number

8A/230VAC

**CSAU-01/03**

CSAE-01/01



#### RF switching actuator – enclosed

RF receiver for switching power devices (lighting, heating, etc.) rated at 8A/230V – 1 pole switching

#### Description

#### Eaton list number

8A/230VAC

**CSAE-01/01**

CSAP-01/03



**RF switching actuator adaptor plug**

The “Switching Actuator” adaptor plug receives signals and controls devices such as floor-standing lamps, fans, audio and video appliances, living room fountains, aquaria, etc. It is mains-supplied, can be plugged into an existing wall outlet and does not require any wiring work.

Description	Eaton list number
8A/230VAC	CSAP-01/03

CDAU-01/02



**RF dimming actuator**

The dimming actuator receives signals and switches/dims incandescent lamps and electronic transformers for low-voltage halogen lamps (DO NOT USE inductive loads!).

Description	Eaton list number
250W/230VAC	CDAU-01/02

CDAE-01/01



**RF dimming actuator – enclosed**

The dimming actuator receives signals and switches/dims incandescent lamps and electronic transformers for low-voltage halogen lamps (DO NOT USE inductive loads!). Power supply is from the mains. The device can be mounted in branch-off boxes, standard installation boxes or directly in an intermediate ceiling. The dimming actuator is also equipped with a last-value memory.

Description	Eaton list number
40–500W/230VAC	CDAE-01/01

CDAE-01/02



**RF dimming actuator – enclosed**

The dimming actuator receives signals and switches/dims incandescent lamps and electronic transformers for low-voltage halogen lamps (DO NOT USE inductive loads!). Power supply is from the mains. The device can be mounted in branch-off boxes, standard installation boxes or directly in an intermediate ceiling. The dimming actuator is also equipped with a last-value memory.

Description	Eaton list number
250W/230VAC (pre set dimming range 20–99%)	CDAE-01/02
250W (pre set dimming range 0–55%)	CDAE-01/03

CDAP-01/13



**RF dimming actuator adaptor plug**

The “Dimming Actuator” adaptor plug receives signals and controls and dims devices such as floor-standing lamps. It is mains-supplied, can be plugged into an existing wall outlet and does not require any wiring work.

Description	Eaton list number
40–250VA/230VAC	CDAP-01/13

CHSZ-02/02

**2-channel remote control**

The 2-channel remote control sends signals to the xComfort system when it is operated. This mobile device is powered by a coin cell battery (CR2430). The functions can be individually assigned, with no distinction to be made between blinds control, dimming, switching etc. A LED indicates whether the signal has actually been sent, correctly interpreted and re-confirmed. The remote control can simply be fixed at the key ring (included in the scope of delivery). Optionally, wall-mounting via a magnet is possible too (CMMZ-00/11 - to be ordered separately). Battery included in the scope of delivery.

**Description****Eaton list number**

2 channels (mini)

**CHSZ-02/02**

CHSZ-12/03

**12-channel remote control**

The 12-channel remote control sends signals to xComfort system when it is operated. This mobile device is powered by two AAA batteries. The functions can be individually assigned, with no distinction to be made between blinds control, dimming, switching etc. Pushing the pre-selection key (1-6) once will take you to level 1 (channels 1 to 6), (short) pushing the pre-selection key (1-6) twice will take you to level 2 (channel 7-12). The two LEDs indicate the level and whether the signal has actually be sent, correctly interpreted and re-confirmed. Optionally, wall-mounting via a magnet is possible too (CMMZ-00/11 – to be ordered separately). Battery included in the scope of delivery.

**Description****Eaton list number**

12 channels

**CHSZ-12/03**

CBMA-02/01

**RF PIR Motion sensor**

This PIR motion sensor is designed to sense movement inside a building. Power supply is provided either through two AAA-batteries (included in the scope of delivery) or through a power supply unit (CMMZ – 00/08), not included in the scope of delivery), therefore it is easy to fix (screw or glue) it wherever you need it. To make it easy for you to do setting, we provide an adjustable "mounting support" (CMMZ – 00/09). Channel A (for lighting) transmits a switching command depending on the movement that has been detected, on the brightness and on the time-setting for the light to shut off again. Channel B (for alarm functions) transmits a switching command when movement is detected, irrespective of brightness and time-setting for switch-off (channel B is activated for approx. 145 seconds). The setting for the number of impulses to be analysed before triggering an alarm or transmitting a switching command can be done for both channels at the same time. All the settings can be carried out directly on the device, with the front cover removed. A light emitting diode (LED) makes the job of setting the sensor easier.

**Description****Eaton list number**

110°, covers 12m when mounted at a height of h=2.2m

**CBMA-02/01**

CMMZ-00/09

**Mounting set for the motion sensor**

The mounting set for the motion sensor is used where the sensor needs to be adjusted to different directions in order to guarantee an optimal area covered by the motion sensor (CBMA-02/01). (Two fixing screws are included).

**Description****Colour number****Eaton list**

Mounting set

white

**CMMZ-00/09**

CBEU-02/01

**RF binary input unit 2 x 230VAC**

The binary input unit transmits input signals e.g. from window contacts, motion sensors or other signal contacts (relays, switches, pushbutton units, etc.) to the xComfort installation system. Power supply is from the mains. The device can be mounted in installation boxes for switches, branch-off boxes or standard installation boxes.

**Description****Eaton list number**

2 x 230VAC

**CBEU-02/01**

CBEU-02/02



**RF binary input unit, 2 x signal contact**

The binary input unit transmits input signals e.g. from window contacts, glass breakage sensors or other signal contacts (relays, switches, pushbutton units, etc) to the convenient electrical installation system. The device is powered by a coin cell (**CR2477N**). Therefore it can be conveniently attached (screw-mounted or glued) in any place. Placing it in installation boxes for switches, branch-off boxes or standard installation boxes is also possible.

Battery included.

Description	Eaton list number
2 x signal contact	<b>CBEU-02/02</b>

CAAE-01/02



**RF analogue actuator 0–10VDC + 1–10VDC**

The analogue actuator receives signals, switches a relay and actuates a control voltage of 1–10VDC for dimmers and electronic ballasts of fluorescent lamps. It is mains-supplied and can be incorporated into an installation box, an intermediate ceiling or directly into fluorescent lamps.

Description	Eaton list number
8A/230VAC, 20mA/0–10VDC	<b>CAAE-01/01</b>
8A/230VAC, 20mA/1–10VDC	<b>CAAE-01/02</b>

#### Comfort mode overview – using MRF software

Using an RS232 interface, the software scans for all devices within a building. Simply right clicking on any actuator can then allow access to other program and setting commands.

Once set, the pre-determined scenes, times, temperatures, light levels and commands are then loaded and the system is now programmed.

Once in this mode, the system becomes a Mesh network – much more reliable than any other, as it allows the actuators to act as routers.

Comfort mode allows for much greater manipulation, maximising the system's full potential.

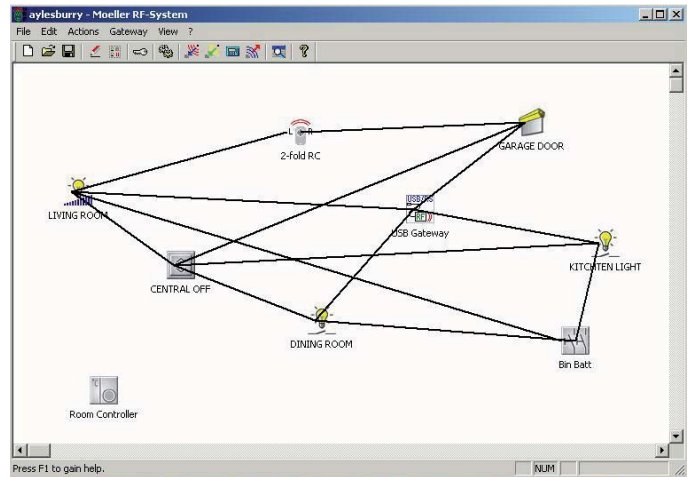

#### Comfort mode components

The devices listed below can all be incorporated along with the basic mode components to form a completely integrated home automation system, providing full building control, including the control of heating, lighting, blinds/shutters as well as energy and security functions.

All you need is a computer/laptop and the free MRF software, which is easy to understand, along with the xComfort RF configuration interface which will allow the MRF software to configure the system components via the PC or laptop.

If the system has been previously configured in "Basic mode", the software will read all the existing functional links and display these as single lines on the screen. This configuration is then available for editing along with a host of additional settings and

features only available in "Comfort mode". If no functions have previously been assigned to the system devices the MRF software in "Comfort mode" will allow you to assign links between devices simply by drawing lines between actuators and sensors on the screen as well as allowing the addition of unique names/identifiers to the devices and access to the internal settings function.

Central control functions can be provided by incorporating a room manager or home manager within the system, or else allowing external control by a GSM link or a PC or PLC via the appropriate control and communication interfaces.

Eaton Systems Integrators fully trained on the application of xComfort will be pleased to assist with the full integration of a building system.

CSEZ-01/12



#### Sensors

##### Description

RF analogue input unit 2-channel	<b>CAEE-02/01</b>
RF energy measuring module	<b>CEMU-01/02</b>
RF energy measuring module with sensor (up to 23kW)	<b>CEMU-01/03</b>
RF temperature input unit 2-channel	<b>CTEU-02/01</b>
Temperature sensor – range -50 to 180°C	<b>CSEZ-01/01</b>
Temperature sensor – range -50 to 100°C	<b>CSEZ-01/05</b>
Window contact, surface mounted	<b>CSEZ-01/06</b>
Window contact, flush mounted	<b>CSEZ-01/07</b>
Motion detector, 200° – outdoor 16A 230VAC	<b>CSEZ-01/12</b>
Presence detector, 360° – ceiling 10A 230VAC	<b>CSEZ-01/13</b>
Air quality sensor 0–10VDC	<b>CSEZ-01/16</b>
Water leakage sensor 9V use with <b>CBEU-02/02</b>	<b>CSEZ-01/18</b>
Smoke detector (9V battery supplied) use with <b>CBEU-02/02</b>	<b>CSEZ-01/19</b>
Wind rain sensor, rain heated	<b>CSEZ-02/08</b>
Wind rain sensor, wind + rain heated	<b>CSEZ-02/09</b>
Mounting unit for wind rain sensor	<b>CSEZ-00/10</b>
Power adaptor for RF PIR motion detector	<b>CMMZ-00/08</b>
Brightness sensor – indoor	<b>CSEZ-01/14</b>
Brightness sensor – outdoor	<b>CSEZ-01/15</b>

##### Eaton list number

CHVZ-01/03



### Actuators

Description	Eaton list number
Mains powered radiator valve actuator 230VAC (must be used with RF switching actuator)	<b>CHVZ-01/01</b>
RF battery powered radiator valve actuator	<b>CHVZ-01/03</b>
RF radiator valve actuator adaptor set	<b>CMMZ-00/36</b>

CHMU-00/02



### Control & communication

Description	Eaton list number
RF ethernet coms interface – LAN	<b>CCIA-02/01</b>
RF ethernet coms interface – LAN power over internet	<b>CCIA-03/01</b>
Power adaptor – 5V mini USB	<b>CMMZ-00/33</b>
Power adaptor – 12VDC ECI and RS232 configuration interface	<b>CMMZ-00/15</b>
RF home manager	<b>CHMU-00/02</b>
RF communication interface	<b>CKOZ-00/03</b>
RF room controller switch/night time reduction	<b>CRCA-00/04</b>
RF room controller with night time reduction and humidity sensor	<b>CRCA-00/05</b>
RF room manager – white	<b>CRMA-00/03</b>
RF room manager – silver	<b>CRMA-00/07</b>
RF room manager + bluetooth – white	<b>CRMA-00/11</b>
RF room manager + bluetooth – silver	<b>CRMA-00/15</b>
RF router	<b>CROU-00/01</b>
RF diagnostic device	<b>CSEZ-01/11</b>
RF USB configuration stick	<b>CKOZ-00/13</b>







Stylish and easy to fit, the Memera range of moulded and metalclad Consumer Units has been designed in accordance with BSEN 60439-3. A full and extensive range of outgoing devices are available to meet all possible application needs from MCBs, RCBOs, RCDs to DIN rail mountable control and switching devices.

<b>11.1</b>	<b>MOULDED</b> .....	109
	Isolator controlled surface mounting units .....	109
	RCD controlled surface mounting units.....	109
	Split load surface mounting units – variable configuration.....	110
	Dual RCD isolator controlled 17th Edition surface mounting units .....	110
	High integrity 17th Edition compliant units.....	110
	Dual tariff surface mounting units .....	110
	Accessories .....	110
<b>11.2</b>	<b>METALCLAD</b> .....	111
	Isolator controlled surface mounting units .....	111
	RCD controlled surface mounting units.....	111
	Split load units .....	111–112
	Dual tariff surface mounting units .....	112
	Accessories .....	112
<b>11.3</b>	<b>PRE-CONFIGURED</b> .....	113–114
	Factory built assemblies.....	113–114
	Energy monitoring .....	114
<b>11.4</b>	<b>ENCLOSURES</b> .....	115
	Moulded enclosures .....	115

continued overleaf

<b>11.5</b>	<b>SWITCH AND PROTECTION DEVICES</b> .....	116–118
	Miniature Circuit Breakers (MCBs) .....	116
	Isolators .....	116
	Residual Current Circuit Breakers (RCCBs /RCDS) .....	117
	Residual Current Circuit Breaker with Overcurrent Protection (RCBOs) .....	117
	Accessories .....	118
	Single pole and neutral switchfuses .....	118
<b>11.6</b>	<b>CONTROL AND SWITCHING DEVICES</b> .....	119
	Timers.....	119
	Contactors and impulse switches .....	120–121
	Bell transformers .....	121
<b>11.7</b>	<b>ENERGY MONITORING</b> .....	123
	Wireless electricity monitor .....	123

See pages 116–118 for switch and protection devices selection.  
See pages 119–121 for control and switching devices selection.  
See pages 130–155 for consumer unit technical data and overall dimensions

EAD2/3

**Isolator controlled surface mounting consumer units**

Description	Total no. of outgoing ways	Isolator rating (A)	Eaton list number
1 way moulded consumer unit 63A isolator	1	63	<b>EAD1</b>
2–3 way moulded consumer unit 100A isolator	2–3	100	<b>EAD2/3</b>
4 way moulded consumer unit 100A isolator	4	100	<b>EAD4</b>
6 way moulded consumer unit 100A isolator	6	100	<b>EAD6</b>
8 way moulded consumer unit 100A isolator	8	100	<b>EAD8</b>
12 way moulded consumer unit 100A isolator	12	100	<b>EAD12</b>
16 way moulded consumer unit 100A isolator	16	100	<b>EAD16</b>
19 way moulded consumer unit 100A isolator	19	100	<b>EAD19</b>

EAD6H63

**RCD controlled surface mounting consumer units – 30mA sensitivity**

Description	Total no. of outgoing ways	RCD rating (A)	RCD sensitivity (mA)	Eaton list number
1 way moulded consumer unit 63A 30mA RCD	1	63	30	<b>EAD1H63</b>
2–3 way moulded consumer unit 63A 30mA RCD	2–3	63	30	<b>EAD2/3H63</b>
2–3 way moulded consumer unit 80A 30mA RCD	2–3	80	30	<b>EAD2/3H80</b>
4 way moulded consumer unit 63A 30mA RCD	4	63	30	<b>EAD4H63</b>
4 way moulded consumer unit 80A 30mA RCD	4	80	30	<b>EAD4H80</b>
6 way moulded consumer unit 63A 30mA RCD	6	63	30	<b>EAD6H63</b>
6 way moulded consumer unit 80A 30mA RCD	6	80	30	<b>EAD6H80</b>
8 way moulded consumer unit 63A 30mA RCD	8	63	30	<b>EAD8H63</b>
8 way moulded consumer unit 80A 30mA RCD	8	80	30	<b>EAD8H80</b>
12 way moulded consumer unit 80A 30mA RCD	12	80	30	<b>EAD12H80</b>
12 way moulded consumer unit 100A 30mA RCD	12	100	30	<b>EAD12H100</b>
16 way moulded consumer unit 80A 30mA RCD	16	80	30	<b>EAD16H80</b>
16 way moulded consumer unit 100A 30mA RCD	16	100	30	<b>EAD16H100</b>
19 way moulded consumer unit 80A 30mA RCD	19	80	30	<b>EAD19H80</b>
19 way moulded consumer unit 100A 30mA RCD	19	100	30	<b>EAD19H100</b>

EAD8M80

**RCD controlled surface mounting consumer units – 100mA sensitivity**

Description	Total no. of outgoing ways	RCD rating (A)	RCD sensitivity (mA)	Eaton list number
2–3 way moulded consumer unit 63A 100mA RCD	2–3	63	100	<b>EAD2/3M63</b>
2–3 way moulded consumer unit 80A 100mA RCD	2–3	80	100	<b>EAD2/3M80</b>
4 way moulded consumer unit 63A 100mA RCD	4	63	100	<b>EAD4M63</b>
4 way moulded consumer unit 80A 100mA RCD	4	80	100	<b>EAD4M80</b>
6 way moulded consumer unit 63A 100mA RCD	6	63	100	<b>EAD6M63</b>
6 way moulded consumer unit 80A 100mA RCD	6	80	100	<b>EAD6M80</b>
8 way moulded consumer unit 63A 100mA RCD	8	63	100	<b>EAD8M63</b>
8 way moulded consumer unit 80A 100mA RCD	8	80	100	<b>EAD8M80</b>
12 way moulded consumer unit 80A 100mA RCD	12	80	100	<b>EAD12M80</b>
12 way moulded consumer unit 100A 100mA RCD	12	100	100	<b>EAD12M100</b>
16 way moulded consumer unit 80A 100mA RCD	16	80	100	<b>EAD16M80</b>
16 way moulded consumer unit 100A 100mA RCD	16	100	100	<b>EAD16M100</b>
19 way moulded consumer unit 80A 100mA RCD	19	80	100	<b>EAD19M80</b>
19 way moulded consumer unit 100A 100mA RCD	19	100	100	<b>EAD19M100</b>

EAD14H80D



### Split load surface mounting consumer units – variable configuration

Description	Total no. of outgoing ways	RCD ways available	RCD rating (A)	RCD sensitivity (mA)	Eaton list number
10 way variable split load moulded consumer unit	10	1–9	80	30	EAD10H80D
14 way variable split load moulded consumer unit	14	1–10	80	30	EAD14H80D
17 way variable split load moulded consumer unit	17	1–10	80	30	EAD17H80D

EAD12H80H80D



### Dual RCD isolator controlled 17th edition surface mounting consumer units

Description	Total no. of outgoing ways	RCD ways available	RCD rating (A)	RCD rating (A)	RCD sensitivity (mA)	Eaton list number
8 way variable split dual RCD moulded consumer unit	8	8 variable	80	80	30	EAD8H80H80D
8 way variable split dual RCD moulded consumer unit	8	8 variable	80	63	30	EAD8H80H63D
12 way variable split dual RCD moulded consumer unit	12	12 variable	80	80	30	EAD12H80H80D
12 way variable split dual RCD moulded consumer unit	12	12 variable	80	63	30	EAD12H80H63D
15 way variable split dual RCD moulded consumer unit	15	15 variable	80	80	30	EAD15H80H80D
15 way variable split dual RCD moulded consumer unit	15	15 variable	80	63	30	EAD15H80H63D

EADH80H803D



### High integrity 17th edition compliant consumer units

Description	Total no. of outgoing ways	RCD ways available	RCD rating (A)	RCD rating (A)	RCD sensitivity (mA)	Eaton list number
6+2 way variable split dual RCD moulded consumer unit	8	6 variable	80	80	30	EAD6H80H802D
6+2 way variable split dual RCD moulded consumer unit	8	6 variable	80	63	30	EAD6H80H632D
12+3 way variable split dual RCD moulded consumer unit	15	12 variable	80	80	30	EAD12H80H803D
12+3 way variable split dual RCD moulded consumer unit	15	12 variable	80	63	30	EAD12H80H633D

EAD11R



### High integrity RCBO consumer unit

Description	Total no. of outgoing ways	Isolator Rating (A)	Pole	Eaton list number
11 way moulded RCBO consumer unit 100A isolator	11	100	DP	EAD11R

EAD10DD



### Dual Tariff surface mounting consumer units

Description	Total no. of outgoing ways	Isolator Rating (A)	Pole	Eaton list number
10 way dual tariff moulded consumer unit 2 x 100A	10	100	DP	EAD10DD
14 way dual tariff moulded consumer unit 2 x 100A	14	100	DP	EAD14DD

ABP1



### Accessories

Description	Eaton list number
Coupling kit for joining 2 x 6 module enclosures together	ADC6
Coupling kit for joining 2 x 8 module enclosures together	ADC8
Coupling kit for joining 2 x 10 module enclosures together	ADC10
Coupling kit for joining 2 x 14 module enclosures together	ADC14
Coupling kit for joining 2 x 18/21 module enclosures together	ADC18
Flexible interconnection links for coupling 2 standard consumer units	ADCSL
1 way blanking plate	ABP1
6 module blanking strip	EABP6

See pages 116–118 for switch and protection devices selection.  
See pages 119–121 for control and switching devices selection.  
See pages 130–155 for consumer unit technical data and overall dimensions.

- For flush mounted units – add **F** to the end of the reference number e.g. **EAS12F**
- For lockable units – add **L** to the end of the reference number e.g. **EAS38L**
- For flush mounted lockable units – add **FL** to the end of the reference number e.g. **EAS18FL**

## EAS2



## Isolator controlled surface mounting consumer units

Description	Total no. of outgoing ways	Isolator (A)	Pole	Eaton list number
2 way metal consumer unit 63A isolator	2	63	DP	<b>EAS2</b>
6 way metal consumer unit 100A isolator	6	100	DP	<b>EAS6</b>
10 way metal consumer unit 100A isolator	10	100	DP	<b>EAS10</b>
12 way metal consumer unit 100A isolator	12	100	DP	<b>EAS12</b>
18 way metal consumer unit 100A isolator	18	100	DP	<b>EAS18</b>
26 way metal consumer unit 100A isolator 2 rail	26	100	DP	<b>EAS26</b>
38 way metal consumer unit 100A isolator 2 rail	38	100	DP	<b>EAS38</b>

## EAS6H63



## RCD controlled metalclad surface mounting consumer units

Description	Total no. of outgoing ways	RCD rating (A)	RCD sensitivity (mA)	Pole	Eaton list number
2 way metal consumer unit 40A 30mA RCD	2	40	30	DP	<b>EAS2H40</b>
2 way metal consumer unit 63A 30mA RCD	2	63	30	DP	<b>EAS2H63</b>
6 way metal consumer unit 63A 30mA RCD	6	63	30	DP	<b>EAS6H63</b>
6 way metal consumer unit 80A 30mA RCD	6	80	30	DP	<b>EAS6H80</b>
6 way metal consumer unit 100A 30mA RCD	6	100	30	DP	<b>EAS6H100</b>
10 way metal consumer unit 100A 30mA RCD	10	100	30	DP	<b>EAS10H100</b>
12 way metal consumer unit 100A 30mA RCD	12	100	30	DP	<b>EAS12H100</b>
18 way metal consumer unit 100A 30mA RCD	18	100	30	DP	<b>EAS18H100</b>

## EAS1080D



## Split load metalclad surface mounting consumer units

Description	Total no. of outgoing ways	RCD ways available	RCD (A)	RCD sensitivity (mA)	Isolator rating (A)	Pole	Eaton list number
8 way split load metal consumer unit 63A 30mA RCD	8	1–7	63	30	100	DP	<b>EAS8H63D</b>
8 way split load metal consumer unit 80A 30mA RCD	8	1–7	80	30	100	DP	<b>EAS8H80D</b>
10 way split load metal consumer unit 63A 30mA RCD	10	1–9	63	30	100	DP	<b>EAS10H63D</b>
10 way split load metal consumer unit 80A 30mA RCD	10	1–9	80	30	100	DP	<b>EAS10H80D</b>
16 way split load metal consumer unit 80A 30mA RCD	16	1–15	80	30	100	DP	<b>EAS16H80D</b>

## EAS24H80D



## Split load dual rail metalclad surface mounting consumer unit

Description	Total no. of outgoing ways	RCD ways available	RCD (A)	RCD sensitivity (mA)	Isolator rating (A)	Pole	Eaton list number
24 way split load metal consumer unit 100A isolator controlled 80A 30mA RCD	24	16	80	30	100	DP	<b>EAS24H80D</b>
36 way split load metal consumer unit 100A isolator controlled 80A 30mA RCD	36	24	80	30	100	DP	<b>EAS36H80D</b>

EAS14H80H80D

**Split load dual RCD metalclad surface mounting consumer units**

Description	Total no. of outgoing ways	RCD ways available	RCD (A)	RCD (A)	RCD sensitivity (mA)	Isolator rating (A)	Pole	Eaton list number
14 way split load dual RCD metal consumer unit	14	up to 14	63	63	30	100	DP	<b>EAS14H63H63D</b>
14 way split load dual RCD metal consumer unit	14	up to 14	80	63	30	100	DP	<b>EAS14H80H63D</b>
14 way split load dual RCD metal consumer unit	14	up to 14	80	80	30	100	DP	<b>EAS14H80H80D</b>

EAS22H80H80D

**Split load dual rail dual RCD metalclad surface mounting consumer unit**

Description	Total no. of outgoing ways	RCD ways available	RCD (A)	RCD (A)	RCD (A)	Isolator rating (A)	Pole	Eaton list number
22 way split load dual RCD metal consumer unit	22	22	80	80	30	100	DP	<b>EAS22H80H80D</b>
22 way split load dual RCD metal consumer unit	22	22	80	63	30	100	DP	<b>EAS22H80H63D</b>
34 way split load dual RCD metal consumer unit	34	34	80	80	30	100	DP	<b>EAS34H80H80D</b>
34 way split load dual RCD metal consumer unit	34	34	80	63	30	100	DP	<b>EAS34H80H63D</b>

EAS10DD

**Dual tariff metalclad surface mounting consumer units**

Description	Total no. of outgoing ways	Isolator rating (A)	Pole	Eaton list number
10 way dual tariff metal consumer unit + 2 x 100A isolators	10	100	DP	<b>EAS10DD</b>
16 way dual tariff metal consumer unit + 2 x 100A isolators	16	100	DP	<b>EAS16DD</b>

ABP1

**Accessories**

Description	Eaton list number
6 module blanking strip	<b>EABP6</b>
1 way blanking plate	<b>ABP1</b>

All standard Memera consumer units can be pre-configured as factory built assemblies for specific project applications for one time use or indeed for continued application as a customised product.

Customisation can include the following features:

- Fitting of outgoing MCB's and RCBO's
- Fitting of timers, contactors and transformers
- Fitting of customised labelling and end user logos
- Fitting of wireless energy monitors with remote LCD display
- Fitting of MID and non-MID approved digital kWh meters
- Fitting of secondary 2 pole RCBO's for connection of renewable energy sources such as PV installations.
- Non-standard enclosure configurations.
- Any combination of the above features.



Typical pre-configured EAD consumer unit – fitted and labelled to customer specific requirements.

Example shown – **EAD11R** fitted with RCBO's and bespoke labelling.



Example EAD consumer unit fitted with DIN rail mounted wireless energy monitoring transmitter and LCD display.

Example shown – **EAD12** fitted with efergy wireless DIN rail mounted energy monitor and remote display.



Example of EAS metal clad consumer unit fitted with MID approved kWh meter equipped with LCD display and pulsed output.

Example shown – **EAS14H80H80D** fitted with digital MID approved kWh meter.

# 11.3 MEMERA consumer units

Pre-configured



Example of **PVSSUKV4** Photovoltaic combination switch and surge device unit, fitted with AC and DC isolators and surge suppressors with MC4 connectors for dc connection to the solar array.



Example of Compact garage consumer unit which can be built using the standard EAD enclosure or alternatively a **BC-MP65** high IP enclosure with DP RCD and one or two MCB's fitted (as shown).



BC-MP65

**Enclosures moulded – IP65**

Description	Additional features	Finish	Number of modules	IP rating	Eaton list number
DIN rail enclosure 3 way	Transparent door	Moulded	1–3	65	<b>BC-MP65-1/3</b>
DIN rail enclosure 5 way	Transparent door	Moulded	1–5	65	<b>BC-MP65-1/5</b>
DIN rail enclosure 9 way	Transparent door	Moulded	1–9	65	<b>BC-MP65-1/9</b>

Note: A typical application for a 5 way unit would be as a 'garage consumer unit' when fitted with a DP RCD and one or two MCB's

AN2EBD

**Enclosures moulded – IP40**

Description	Additional features	Finish	Number of modules	IP rating	Eaton list number
DIN rail enclosure 2 module	Sealable terminal access	Moulded	2	40	<b>AN2</b>
DIN rail enclosure 2 module	Fitted 100A SPSN isolator	Moulded	2	40	<b>AN2D</b>
DIN rail enclosure 2 module	Sealable access with earth bar	Moulded	2	40	<b>AN25</b>
Service isolator 2 module	Fitted 100A SPSN isolator	Moulded	2	40	<b>AN2EBD<sup>1)</sup></b>
Service isolator 4 module	Sealable front access	Moulded	4	40	<b>AN4EBLS<sup>1)</sup></b>

<sup>1)</sup>Independently sealable supply and load terminal covers.

See pages 138–139 for technical data and overall dimensions.

EAD20B



#### Miniature circuit breakers – 6kA, trip type B, 1P

Description	Rating (A)	Trip type	Short circuit rating (kA)	Pole configuration	Width (mm)	Eaton list number
MCB	2	B	6	1P	18	EAD02B
MCB	4	B	6	1P	18	EAD04B
MCB	6	B	6	1P	18	EAD06B
MCB	10	B	6	1P	18	EAD10B
MCB	13	B	6	1P	18	EAD13B
MCB	16	B	6	1P	18	EAD16B
MCB	20	B	6	1P	18	EAD20B
MCB	25	B	6	1P	18	EAD25B
MCB	32	B	6	1P	18	EAD32B
MCB	40	B	6	1P	18	EAD40B
MCB	50	B	6	1P	18	EAD50B
MCB	63	B	6	1P	18	EAD63B

EAD20C



#### Miniature circuit breakers – 6kA, trip type C, 1P

Description	Rating (A)	Trip type	Short circuit rating (kA)	Pole configuration	Width (mm)	Eaton list number
MCB	2	C	6	1P	18	EAD02C
MCB	4	C	6	1P	18	EAD04C
MCB	6	C	6	1P	18	EAD06C
MCB	10	C	6	1P	18	EAD10C
MCB	13	C	6	1P	18	EAD13C
MCB	16	C	6	1P	18	EAD16C
MCB	20	C	6	1P	18	EAD20C
MCB	25	C	6	1P	18	EAD25C
MCB	32	C	6	1P	18	EAD32C
MCB	40	C	6	1P	18	EAD40C
MCB	50	C	6	1P	18	EAD50C
MCB	63	C	6	1P	18	EAD63C

EMS1001N



#### Main load disconnect switch (isolator)

Description	Rating (A)	Short circuit rating (kA)	Width	Eaton list number
EMS 100A SP isolator	100	10	1 module	EMS1001
EMS 100A SPN isolator	100	10	2 module	EMS1001N
EMS 100A SPN isolator reversed pole	100	10	2 module	EMS1001NR
EMS 100A DP isolator	100	10	2 module	EMS1002

EAM632H

**RCCBs – 2-pole double module – 10mA–30mA sensitivity**

Description	Rating (A)	Sensitivity (mA)	Eaton list number
EAM 16A 2 Pole RCCB 10mA	16	10	<b>EAM162V</b>
EAM 16A 2 Pole RCCB 30mA	16	30	<b>EAM162H</b>
EAM 25A 2 Pole RCCB 30mA	25	30	<b>EAM252H</b>
EAM 40A 2 Pole RCCB 30mA	40	30	<b>EAM402H</b>
EAM 63A 2 Pole RCCB 30mA	63	30	<b>EAM632H</b>
EAM 80A 2 Pole RCCB 30mA	80	30	<b>EAM802H</b>
EAM 80A 2 Pole RCCB 30mA reversed pole	80	30	<b>EAM802RH</b>
EAM 100A 2 Pole RCCB 30mA	100	30	<b>EAM1002H</b>
EAM 100A 2 Pole RCCB 30mA reversed pole	100	30	<b>EAM1002RH</b>

EAM252M

**RCCBs – 2-pole double module – 100mA sensitivity**

Description	Rating (A)	Sensitivity (mA)	Eaton list number
EAM 25A 2 Pole RCCB 100mA	25	100	<b>EAM252M</b>
EAM 40A 2 Pole RCCB 100mA	40	100	<b>EAM402M</b>
EAM 63A 2 Pole RCCB 100mA	63	100	<b>EAM632M</b>
EAM 80A 2 Pole RCCB 100mA	80	100	<b>EAM802M</b>
EAM 100A 2 Pole RCCB 100mA	100	100	<b>EAM1002M</b>
EAM 100A 2 Pole RCCB 100mA reversed pole	100	100	<b>EAM1002RM</b>

EAM802M

**RCCBs – 2-pole double module – 300mA sensitivity**

Description	Rating (A)	Sensitivity (mA)	Eaton list number
EAM 80A 2 Pole RCCB 300mA	80	300	<b>EAM802L</b>
EAM 80A 2 Pole RCCB 300mA reversed pole	80	300	<b>EAM802RL</b>
EAM 100A 2 Pole RCCB 300mA	100	300	<b>EAM1002L</b>
EAM 100A 2 Pole RCCB 300mA reversed pole	100	300	<b>EAM1002RL</b>

EAD16BH30C

**RCBOs – compact single pole single module – trip type B – 30mA sensitivity**

Description	Rating (A)	Trip type	Sensitivity (mA)	Eaton list number
EAD 6A 6kA type B SP 30mA RCBO	6	B	30	<b>EAD06BH30C</b>
EAD 10A 6kA type B SP 30mA RCBO	10	B	30	<b>EAD10BH30C</b>
EAD 16A 6kA type B SP 30mA RCBO	16	B	30	<b>EAD16BH30C</b>
EAD 20A 6kA type B SP 30mA RCBO	20	B	30	<b>EAD20BH30C</b>
EAD 25A 6kA type B SP 30mA RCBO	25	B	30	<b>EAD25BH30C</b>
EAD 32A 6kA type B SP 30mA RCBO	32	B	30	<b>EAD32BH30C</b>
EAD 40A 6kA type B SP 30mA RCBO	40	B	30	<b>EAD40BH30C</b>
EAD 45A 6kA type B SP 30mA RCBO	45	B	30	<b>EAD45BH30C</b>

EAD16CH30C

**RCBOs – compact single pole single module – trip type C – 30mA sensitivity**

Description	Rating (A)	Trip type	Sensitivity (mA)	Eaton list number
EAD 6A 6kA type C SP 30mA RCBO	6	C	30	<b>EAD06CH30C</b>
EAD 10A 6kA type C SP 30mA RCBO	10	C	30	<b>EAD10CH30C</b>
EAD 16A 6kA type C SP 30mA RCBO	16	C	30	<b>EAD16CH30C</b>
EAD 20A 6kA type C SP 30mA RCBO	20	C	30	<b>EAD20CH30C</b>
EAD 25A 6kA type C SP 30mA RCBO	25	C	30	<b>EAD25CH30C</b>
EAD 32A 6kA type C SP 30mA RCBO	32	C	30	<b>EAD32CH30C</b>
EAD 40A 6kA type C SP 30mA RCBO	40	C	30	<b>EAD40CH30C</b>
EAD 45A 6kA type C SP 30mA RCBO	45	C	30	<b>EAD45CH30C</b>

# 11.5

## MEMERA consumer units

Switch and protection devices

ASPDL

### Padlocking devices



#### Description

Universal device lockout attachment – fits EAD MCBs/RCBOs, EAM RCCBs and EMS isolators.

Eaton list  
number

**ASPDL**

800KMF

### Single pole and neutral switchfuses



#### Description

80A SPN switchfuse (fuse fitted)

Fuse rating  
(A)

80

Fuse type

BS 88-3 (BS1361)

Eaton list  
number

**800KMF**

80A SPN Switchfuse (no fuse fitted)

–

BS 88-3 (BS1361)

**800KMFNF**

80A Switchfuse cable gland

–

–

**1MGL**

See pages 144–150 for timers technical data and overall dimensions.

TAD1NC



**Analogue day timers – 50Hz net synchronised**

Program range	Type	Channels	Contact configuration	Power reserve	Min. cycling time	Width (mm)	Eaton list number
Day	50Hz Net	1	CO	–	30 min.	54	<b>TAD1NC</b>
Day	50Hz Net, 18mm	1	NO	–	15 min	18	<b>TAD1NCS</b>

TAD1



**Analogue day timers – quartz controlled**

Program range	Type	Channels	Contact configuration	Power reserve	Min. cycling time	Width (mm)	Eaton list number
Day	Quartz	1	CO	72 hrs.	30 min.	54	<b>TAD1</b>
Day	Quartz, 18 mm	1	NO	72 hrs.	15 min	18	<b>TAD1S</b>

TAW1



**Analogue week timers – quartz controlled**

Program range	Type	Channels	Contact configuration	Power reserve	Min. cycling time	Width (mm)	Eaton list number
Week	Quartz	1	CO	72 hrs.	3 hrs.	54	<b>TAW1</b>
Week	Quartz, 18 mm	1	NO	72 hrs.	2 hrs.	18	<b>TAW1S</b>

TDW1S



**Digital week timers – 1 & 2 channel**

Program range	Type	Channels	Contact configuration	Power reserve	Min. cycling time	Program steps	Width (mm)	Eaton list number
Week	Quartz	1	CO	10 yrs.	1 min.	28	36	<b>TDW1</b>
Week	Quartz, 18 mm	1	CO	3 yrs.	1 min.	28	18	<b>TDW1S</b>
Week	Quartz	2	2 CO	10 yrs.	1 min.	42	36	<b>TDW2</b>
Week	Quartz, advanced	2	2 CO	10 yrs.	1 min.	42	36	<b>TDW2E</b>

TE7



**Staircase timer – standard version**

Description	Delay off time adjustment	Contact configuration	Width (mm)	Eaton list number
Staircase timer basic function	0.5–20 min	NO	18	<b>TE7</b>

TE1



**Staircase timer – multifunctional version**

Description	Delay off time adjustment	Contact configuration	Width (mm)	Eaton list number
Staircase timer multi function	0.5–20 min	NO	18	<b>TE1</b>

See pages 151–155 for Contactors technical data and overall dimensions.

CR2011230A

### Contactors, 20 A – ac coil

When several contactors are mounted it is advisable to fit a blanking module, List number MBP, every two contactors.



Description	Rating (A)	Coil voltage (Vac)	Coil voltage (Vdc)	Width (mm)	Contacts	Eaton list number
Contactors	20	230	–	18	1 NO + 1 NC	CR2011230A
Contactors	20	230	–	18	2 NC	CR2002230A
Contactors	20	230	–	18	2 NO	CR2020230A

CR2020024

### Contactors, 20 A – ac/dc coil

When several contactors are mounted it is advisable to fit a blanking module, List number MBP, every two contactors.



Description	Rating (A)	Coil voltage (Vac)	Coil voltage (Vdc)	Width (mm)	Contacts	Eaton list number
Contactors	20	230	220	18	1 NO + 1 NC	CR2011230
Contactors	20	230	220	18	2 NC	CR2002230
Contactors	20	230	220	18	2 NO	CR2020230

CR2540230A

### Contactors, 25 A – ac coil

When several contactors are mounted it is advisable to fit a blanking module, List number MBP, every two contactors.



Description	Rating (A)	Coil voltage (Vac)	Coil voltage (Vdc)	Width (mm)	Contacts	Eaton list number
Contactors	25	230	–	36	2 NO + 2 NC	CR2522230A
Contactors	25	230	–	36	3 NO	CR2530230A
Contactors	25	230	–	36	4 NC	CR2504230A
Contactors	25	230	–	36	4 NO	CR2540230A

CR2504024

### Contactors, 25 A – ac/dc coil

When several contactors are mounted it is advisable to fit a blanking module, List number MBP, every two contactors.



Description	Rating (A)	Coil voltage (Vac)	Coil voltage (Vdc)	Width (mm)	Contacts	Eaton list number
Contactors	25	230	220	36	2 NO + 2 NC	CR2522230
Contactors	25	230	220	36	3 NO	CR2530230
Contactors	25	230	220	36	4 NC	CR2504230
Contactors	25	230	220	36	4 NO	CR2540230

CR4030024

### Contactors, 40 A – ac/dc coil

When several contactors are mounted it is advisable to fit a blanking module, List number MBP, every two contactors.



Description	Rating (A)	Coil voltage (Vac)	Coil voltage (Vdc)	Width (mm)	Contacts	Eaton list number
Contactors	40	230	220	54	2 NC	CR4002230
Contactors	40	230	220	54	2 NO	CR4020230
Contactors	40	230	220	54	3 NO	CR4030230
Contactors	40	230	220	54	4 NO	CR4040230

CR6320230

**Contactors, 63 A – ac/dc coil**

When several contactors are mounted it is advisable to fit a blanking module, List number MBP, every two contactors.

Description	Rating (A)	Coil voltage (Vac)	Coil voltage (Vdc)	Width (mm)	Contacts	Eaton list number
Contactor	63	230	220	54	2 NO	<b>CR6320230</b>
Contactor	63	230	220	54	4 NO	<b>CR6340230</b>

CRM2540230A

**Day/night contactors, 20–25 A – ac coil**

When several contactors are mounted it is advisable to fit a blanking module or spacer every two contactors. Day/night contactors do have a manual override function, which enables the user to bring the contactor in either a forced “ON” or “OFF” position. The contactor can only be brought into the forced “ON” position when it is de-energised. When the contactor is energised the operation will return into the normal/automatic position.

Description	Rating (A)	Coil voltage (Vac)	Width (mm)	Contacts	Eaton list number
Contactor	20	230	18	2 NO	<b>CRM2020230A</b>
Contactor	25	230	36	4 NO	<b>CRM2540230A</b>

CRA611

**Auxiliary contacts**

Can be connected at the right-side of the contactor.

Description	Rating (A)	Width (mm)	Contacts	Eaton list number
Auxiliary	6	9	1 NO + 1 NC	<b>CRA611</b>
Auxiliary	6	9	2 NO	<b>CRA620</b>

CRC63

**Terminal covers (sealable)**

Description	Rating (A)	Width (mm)	Eaton list number
Terminal cover	For 20	18	<b>CRC20</b>
Terminal cover	For 25	36	<b>CRC25</b>
Terminal cover	For 40/63	54	<b>CRC63</b>

CRS

**Spacer**

Description	Mounting	Width (mm)	Eaton list number
Spacer	DIN rail	9	<b>CRS</b>
Spacer	DIN rail	18	<b>MBP</b>

Z-S230

**Impulse switches/relays**

Description	Rating (A)	Coil Voltage (Vac)	Poles	Width (mm)	Contacts	Eaton list number
Impulse relay	16	230	1P	18	1 NO	<b>Z-S230/S</b>
Impulse relay	16	230	1P	18	1 NO / 1 NC	<b>Z-S230/SO</b>

TR-G3/8

**Transformers**

Description	Volts	Amps	Width (mm)	Module	Eaton list number
Bell Transformer 2 module	4/8/12	0.6 1.0	36	2	<b>TR-G3/8</b>





**Wireless electricity monitor**

Wireless electricity monitor displaying instant power, costs and estimated CO<sub>2</sub> emissions. It can also show historical and average data.

- Take control of your energy use
- Monitor the cost of using appliances and lights
- Discover and reduce the size of your carbon footprint

- Visual alarm
- Wireless transmitter
- Advanced sensor
- Heavy duty 140A sensor



**Features**

Compatible

- Suitable for use with clip-on sensor

Flexible

- Valid for single and dual tariff

Easy to understand

- Clear and simple graphical display
- Simultaneous information
- Average daily (energy and costs),
- Instant information (power and costs)
- Historical consumption (energy, costs and CO<sub>2</sub>)

History

- Stores data for 7 days, 4 weeks and 24 months

Discover

- How much electricity is being used at a any given moment
- The total amount of money being spent on electricity
- The difference in electricity consumption by turning various appliances on or off
- How much money can be saved by reducing usage

Understand

- Daily average consumption
- Savings of 5–20% off typical energy consumption
- Consumption history
- Carbon footprint

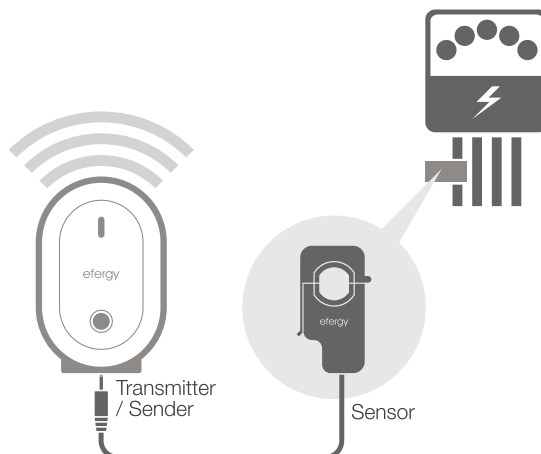

**efergy wireless electricity monitor**

Description	Eaton list number
efergy elite electricity monitor	70040468
efergy e2 energy monitor (USB)	70040465
Additional CT	70040466



With dimensional drawings and specification data, this chapter provides indepth information for all our customers on all products displayed in this product guide.

<b>12.1</b>	<b>PREMERA/COPA/XTRA TECHNICAL DATA</b>	
	Switch details and terminal conductors specification tables .....	126
<b>12.2</b>	<b>CIRCA TECHNICAL DATA</b>	
	Ceiling roses and pendants specifications/BC3 lamp information .....	127
<b>12.3</b>	<b>XCOMFORT TECHNICAL DATA</b>	
	Basic mode setting .....	128
<b>12.4</b>	<b>CONSUMER UNITS AND ENCLOSURES DIMENSIONS AND DATA</b>	129
	Moulded – surface mounted .....	129–130
	Metalclad – surface mounted .....	131–132
	Metalclad – flush mounted .....	133–134
	Enclosures – moulded and metalclad, dimensions and technical data .....	135
	Combination DC & AC isolator switching enclosure with integrated surge protection .....	136–137
<b>12.5</b>	<b>SWITCH AND PROTECTION DEVICES DIMENSIONS AND DATA</b>	138
	MCBs .....	138–139
	Isolators .....	140
	RCCBs .....	141
	RCBOs .....	142
	Single Pole and Neutral Switchfuses .....	143
<b>12.6</b>	<b>CONTROL AND SWITCHING DEVICES DIMENSIONS AND DATA</b>	144
	Analogue timers .....	144
	Digital timers .....	145–147
	Staircase timers .....	148–149
	Multifunctional staircase timers .....	150
	Contactors .....	151–155

### 10A switches

- Supplied with M3.5 fixing screws.
- Switch contact – silver/nickel.
- Shallow depth for maximum wiring space, containing back entry terminal with top and bottom access to terminal screws.
- Rocker operated, quick positive movement, enclosed to minimise dust penetration.
- All screws backed off, ready to accept cable.
- X-rated for fluorescent or inductive loads.
- Modular construction to enable individual replacement of modules.

### 13A switched sockets

- Supplied with M3.5 fixing screws.
- Switch contact – silver/nickel.
- Shutter is operated by the earth pin.
- Shallow depth for maximum wiring space with back entry tunnel terminal and top access for terminal screws.
- Terminals accept up to 3 x 4mm<sup>2</sup> or 2 x 6mm<sup>2</sup> conductors.
- Accidental penetration by “foreign bodies” through the earth aperture is prevented by the rear of the earth contacts.
- Rocker, operated either double pole or single pole switch, quick, positive movement, enclosed to minimise dust penetration.
- Suitable for use with flush or surface mounting box minimum 25mm depth.

### 20A switches

- Shallow depth, for maximum wiring space with back entry tunnel terminals.
- Separate earth terminals are provided for supply and load cable.
- Rocker operated, quick, positive movement, enclosed to minimise dust penetration.
- Switch contact surfaces – silver/nickel.
- Suitable for use with flush mounting box minimum 35mm deep and upwards.

### Flat twin and earth insulated pvc sheathed cable to BS6004: 1984 Table 5 (a)

C.S.A. of Live and Neutral conductors	C.S.A. of associated Earth conductor
1.0mm <sup>2</sup>	1.0mm <sup>2</sup>
1.5mm <sup>2</sup>	1.0mm <sup>2</sup>
2.5mm <sup>2</sup>	1.5mm <sup>2</sup>
4.0mm <sup>2</sup>	1.5mm <sup>2</sup>
6.0mm <sup>2</sup>	2.5mm <sup>2</sup>
10.0mm <sup>2</sup>	4.0mm <sup>2</sup>

#### Note:

Terminal hole capacities for earth conductors refer to the actual cross sectional area of individual earth conductors.

When using flat twin and earth insulated pvc sheathed cable in accordance with table 5 (a) of BS 6004: 1984 the size of the earth conductor is shown here.

### 13A connection units

- Supplied with M3.5 fixing screws.
- Shallow depth for maximum wiring space with back entry tunnel terminals and top and right side access for terminal screws.
- Live and Neutral terminals accept up to 3 x 4 mm<sup>2</sup> or 2 x 6mm<sup>2</sup> conductors.
- Rocker operated, double pole switched, quick positive movement, enclosed to minimise dust penetration.
- Separate earth terminals are provided for standard and hard wiring connections.
- Suitable for use with flush mounting box 25mm minimum depth.

### 45A and 50A Switches

- Supplied with M3.5 fixing screws.
- Shallow depth for maximum wiring space, with back entry tunnel terminals giving top and bottom access for terminal screws.
- Separate earth terminals provided for supply and load cables.
- Rocker operated, quick, positive movements, enclosed to minimise dust penetration.
- Switch contacts silver/nickel.

### Maximum number of conductors per terminal hole

Product		1.0mm <sup>2</sup>	1.5mm <sup>2</sup>	2.5mm <sup>2</sup>	4.0mm <sup>2</sup>	6.0mm <sup>2</sup>	10.0mm <sup>2</sup>
13A socket outlets	L+N	–	–	3	2	1	–
	E	–	6	3	2	1	–
RCD socket outlets	L+N	–	–	5	3	2	–
	E	–	7	3	2	1	–
15A socket outlets	L+N	–	–	3	2	1	–
	E	–	6	3	–	–	–
5A socket outlets	L+N	5	3	1	–	–	–
	E	6	3	1	–	–	–
15A 127V socket outlets	L+N	–	–	4	2	1	–
	E	–	7	3	1	–	–
10A switch range		5	3	–	–	–	–
15A switch range		–	–	1	–	–	–
250W/400W dimmer switches		4	3	1	–	–	–
20A switch range	L+N	–	–	2	2	1	–
	2 x E	–	7	3	–	–	–
13A connection units	L+N	–	–	4	3	2	–
	E	–	7	3	–	–	–
50A switches	L+N	–	–	–	2	2	1
	2 x E	–	9	5	2	–	–
45A cooker units	L+N	–	–	–	3	2	1
	2 x E	–	10	5	2	–	–
Shaver units	L+N	3	2	1	–	–	–
	E	6	4	–	–	–	–
Cooker outlet plate	2 x (L+N)	–	–	–	3	3	2
	2 x E	–	14	6	3	–	–
Surface mounting boxes, moulded		7	4	2	1	–	–
Surface mounting box for shaver unit		8	5	3	1	–	–

Ceiling roses and pendants

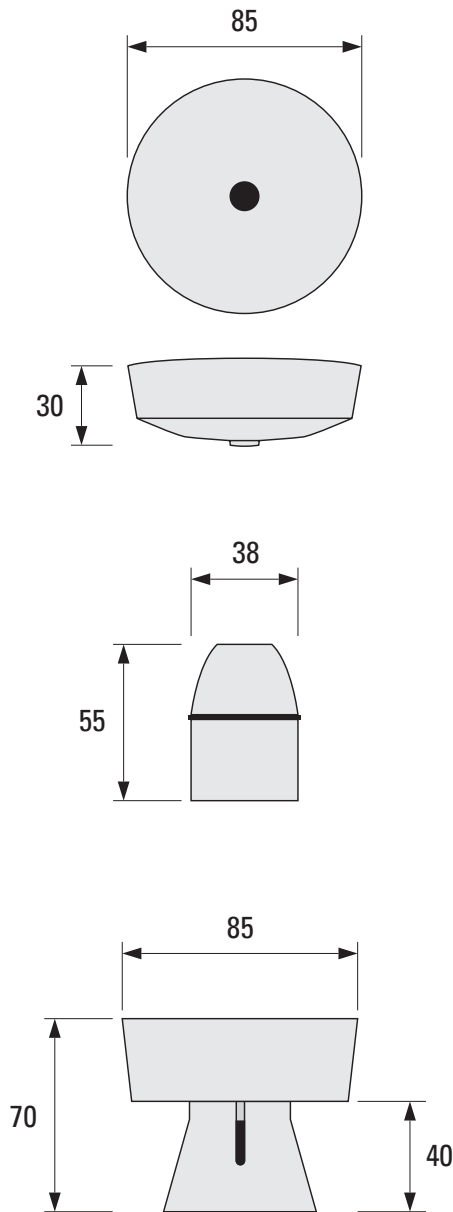

**Standards and approvals**

- Lampholders comply with BS EN 611841-T2.
- All lamp activated lampholders comply with BS 7895.
- Ceiling roses comply with BS 67.

**Technical specifications – electrical**

- Lampholders and batten lampholders.
  - Voltage rating: 250V a.c.
  - Maximum rating: 150 watts.
  - Terminal capacity: Live, neutral and earth, 3 x 1.0mm<sup>2</sup>, 2 x 1.5mm<sup>2</sup>
- Ceiling roses and base of pre-wired batten lampholders.
  - Voltage rating: 250V a.c.
  - Maximum rating: 6 amps.
  - Terminal capacity: Live, neutral and earth, 4 x 1.0mm<sup>2</sup>, 3 x 1.5mm<sup>2</sup>, 1 x 1.5mm<sup>2</sup>
  - Ambient operating temperature -5°C to +40°C
- Ceiling switches.
  - Terminal capacity: 3 x 1.5mm<sup>2</sup> conductors.
  - Maximum rating: 6 amps.

**Features**

- Lamp activated range.
- Plungers remain isolated until lamp is fully inserted.
- Live parts only accessible with tool.
- Incorporates double pole switching mechanism.
- T2 rated - meets the T2 ratings requirements of specification which test at 210°C lamp cap temperature.

**Ceiling roses.**

- Clear markings.
- Terminal layout allows cables to be cut to even length.
- Earth terminal point used for easier cable access.

**BC3 lamp information**

Eaton list number	Lamp life hours	Lumens	Lumens per watt	Energy category
F1266	8000	900	60	A
F1267	8000	1200	60	A
F1268	8000	900	60	A
F1269	8000	1200	60	A
F1273	8000	900	69	A
F1274	8000	1200	67	A
F1275	8000	900	69	A
F1276	8000	1200	67	A

# 12.3

## Technical data xComfort technical data

### Technical specification

#### Eaton RF software

Frequency:	868.300 MHz
Type of transmission:	Bi directional via encoded telegrams

#### Mains powered devices/actuators

Back up protection:	By means of a type C miniature circuit breaker (MCB) rated at no more than 16A
---------------------	--

#### Switching and dimming actuators

Rated Voltage:	230VAC, 50Hz		
Protection:	IP20		
Wired connections:	1.5mm single core x 150mm		
Dimensions mm	H	W	D
Wired type	50	46	27
Enclosed type	150	34	28

#### Battery powered devices

RF Range:	Typically 30–50m = 2 walls and 1 ceiling dependent on wall thickness and material
Battery life:	Depending on usage and type of battery RF pushbutton battery – approx 10 years RF remote control battery – approx 3–5 years Room controller battery – approx 5–7 years

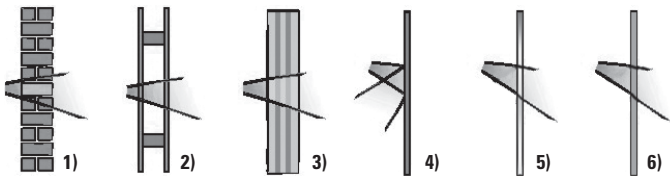

### RF System Basic Mode Card

	CTAA-01/0X CTAA-02/0X		CSAU-01/0X CSAP-01/0X
	CBEU-02/0X		CJAU-01/0X
	M1 M2 M3 M4 1x 2x 3x 4x		CDAU-01/0X CDAP-01/0X
	CRCA-00/0X		0-10V OUT CAAE-01/0X
	CHSZ-00/0X		

- 1) Brick-type wall approx. 60–90%
  - 2) Wood and wood frames with sandwich-type plaster board approx. 80–95%
  - 3) Concrete with steel reinforcement approx. 20–60%
  - 4) Metal walls approx. 0–10%
  - 5) Ordinary glass approx. 70–90%. Insulating glass (metalized) approx. 30 - 60%
  - 6) Synthetic material approx. 80–95%
- Important: The percentages given are guideline values only. They may vary subject to the respective conditions.

### Allocate functions

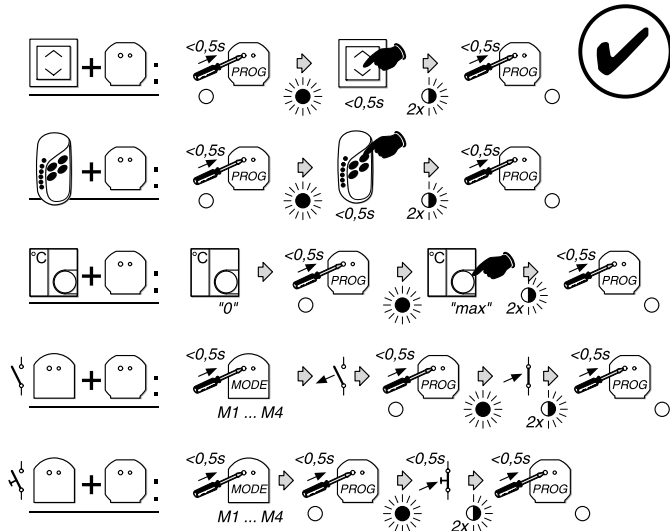

### Delete individual sensors

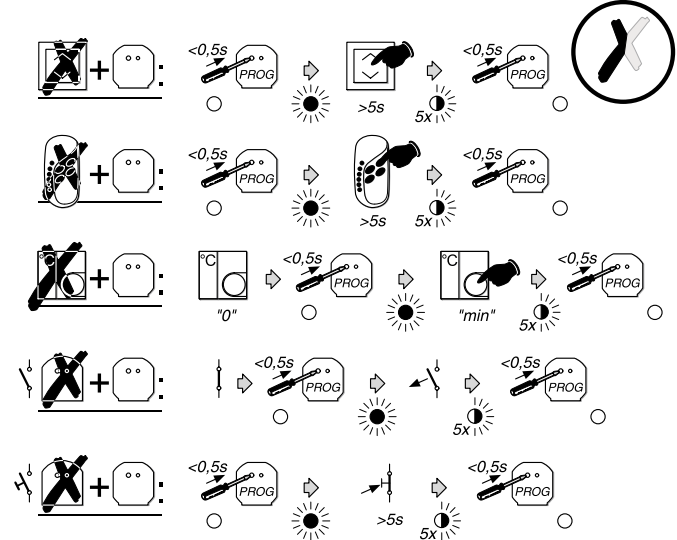

### Totally delete an actuator

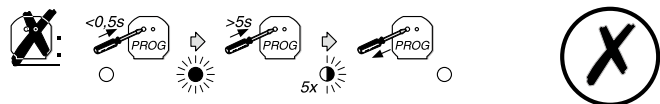

### Manual operation

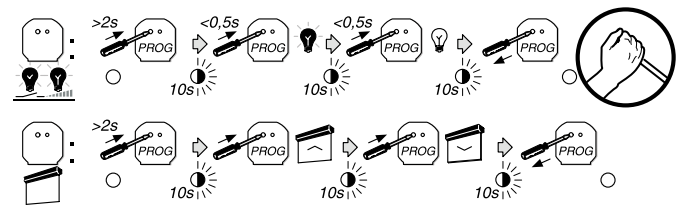

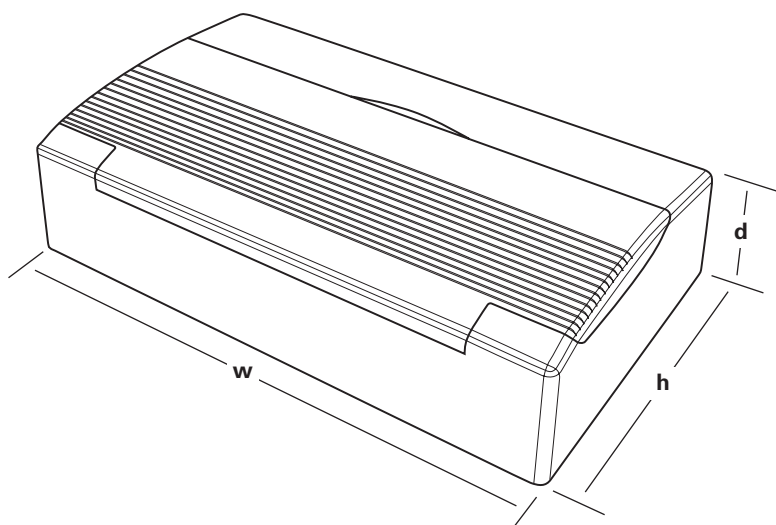

**Isolator controlled surface mounting consumer units**

Eaton list number	Dimensions (mm)		
	w	h	d
<b>EAD1</b>	98	153	94
<b>EAD2/3</b>	154	223	101
<b>EAD4</b>	235	223	120
<b>EAD6</b>	271	223	120
<b>EAD8</b>	307	223	120
<b>EAD12</b>	379	223	120
<b>EAD16</b>	450	223	120
<b>EAD19</b>	450	223	120

Note: **EAD1** depth dimension takes into account the fitted device's handle and its movement arc when operated

**RCCB controlled surface mounting consumer units**

Eaton list number	Dimensions (mm)		
	w	h	d
<b>EAD1H63</b>	98	153	94
<b>EAD2/3H63</b> <b>EAD2/3H80</b>	154	223	101
<b>EAD4H63</b> <b>EAD4H80</b>	235	223	120
<b>EAD6H63</b> <b>EAD6H80</b>	271	223	120
<b>EAD8H63</b> <b>EAD8H80</b>	307	223	120
<b>EAD12H80</b> <b>EAD12H100</b>	379	223	120
<b>EAD16H80</b> <b>EAD16H100</b>	450	223	120
<b>EAD19H80</b> <b>EAD19H100</b>	450	223	120

## RCCB controlled surface mounting consumer units

Eaton list number	Dimensions (mm)		
	w	h	d
EAD2/3M63 EAD2/3M80	154	223	101
EAD4M63 EAD4M80	235	223	120
EAD6M63 EAD6M80	271	223	120
EAD8M63 EAD8M80	307	223	120
EAD12M80 EAD12M100	379	223	120
EAD16M80 EAD16M100	450	223	120
EAD19M80 EAD19M100	450	223	120

## Split load surface mounting consumer units – variable configuration

Eaton list number	Dimensions (mm)		
	w	h	d
EAD10H80D	379	223	120
EAD14H80D	450	223	120
EAD17H80D	450	223	120

## Dual RCD isolator controlled 17th Edition surface mounting consumer units

Eaton list number	Dimensions (mm)		
	w	h	d
EAD8H80H80D EAD8H80H63D	379	223	120
EAD12H80H80D EAD12H80H63D	450	223	120
EAD15H80H80D EAD15H80H63D	450	223	120

## High integrity dual RCD 17th edition compliant consumer units

Eaton list number	Dimensions (mm)		
	w	h	d
EAD6H80H802D EAD6H80H632D	379	223	120
EAD12H80H803D EAD12H80H633D	450	223	120

## High integrity RCBO consumer unit

Eaton list number	Dimensions (mm)		
	w	h	d
EAD11R	379	223	120

## Dual tariff surface mounting consumer units

Eaton list number	Dimensions (mm)		
	w	h	d
EAD10DD	379	223	120
EAD14DD	450	223	120



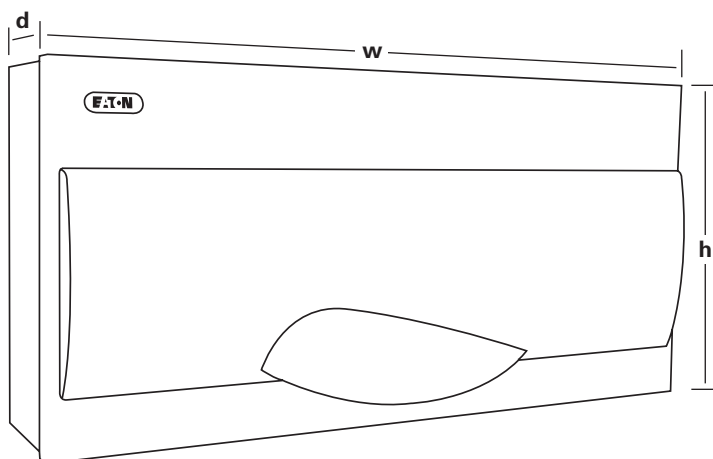

**Note:** For lockable versions - add letter 'L' to end of list number, e.g. **EAS16DDFL**

#### Isolator controlled metalclad surface mounting consumer units

Eaton list number		Dimensions (mm)		
		w	h	d
<b>EAS2</b>		180	223	113
<b>EAS6</b>		252	223	113
<b>EAS10</b>		324	223	113
<b>EAS12</b>		359	223	113
<b>EAS18</b>		465	223	113
<b>EAS26</b>	Dual rail	359	420	113
<b>EAS38</b>	Dual rail	465	420	113

#### RCD controlled metalclad surface mounting consumer units

Eaton list number		Dimensions (mm)		
		w	h	d
<b>EAS2H40</b>		180	223	113
<b>EAS2H63</b>		180	223	113
<b>EAS6H63</b>		252	223	113
<b>EAS6H80</b>				
<b>EAS6H100</b>				
<b>EAS10H100</b>		324	223	113
<b>EAS12H100</b>		359	223	113
<b>EAS18H100</b>		465	223	113

#### Split load metalclad surface mounting consumer units

Eaton list number		Dimensions (mm)		
		w	h	d
<b>EAS8H63D</b>		324	223	113
<b>EAS8H80D</b>		324	223	113
<b>EAS10H63D</b>		359	223	113
<b>EAS10H80D</b>		359	223	113
<b>EAS16H80D</b>		465	223	113
<b>EAS24H80D</b>	Dual rail	359	420	113
<b>EAS36H80D</b>	Dual rail	465	420	113

# 12.4

## Technical data

Consumer units and enclosures dimensions and data

### Split load dual rail dual RCD metalclad surface mounting consumer unit

Eaton list number		Dimensions (mm)		
		w	h	d
EAS14H63H63D		465	223	113
EAS14H80H63D		465	223	113
EAS14H80H80D		465	223	113
EAS22H80H80D	Dual rail	359	420	113
EAS22H80H63D	Dual rail	359	420	113
EAS34H80H80D	Dual rail	465	420	113
EAS34H80H63D	Dual rail	465	420	113

### Dual tariff metalclad surface mounting consumer units

Eaton list number		Dimensions (mm)		
		w	h	d
EAS10DD		359	223	113
EAS16DD		465	223	113

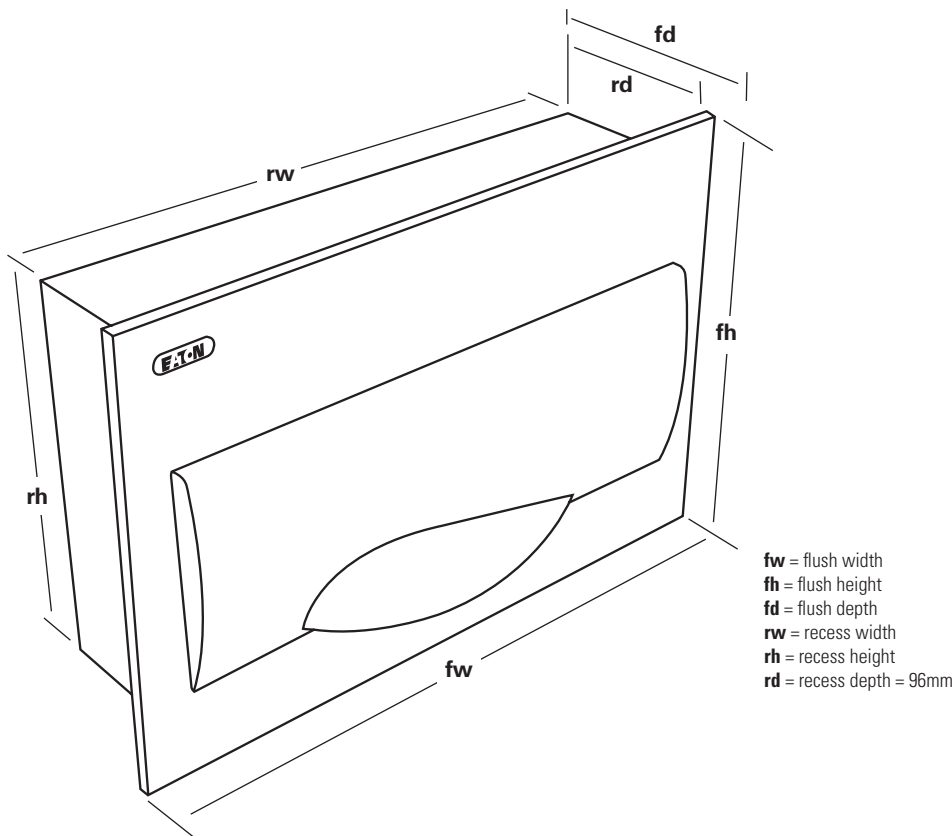

**Note:** For lockable versions - add letter 'L' to end of list number, e.g. **EAS16DDFL**

**Isolator controlled metalclad flush mounting consumer units**

Eaton list number		Recess Dimensions (mm)		Front Dimensions (mm)		
		rw	rh	fw	fh	fd
<b>EAS2F</b>		180	223	215	264	113
<b>EAS6F</b>		252	223	287	264	113
<b>EAS10F</b>		324	223	359	264	113
<b>EAS12F</b>		359	223	394	264	113
<b>EAS18F</b>		465	223	500	264	113
<b>EAS26F</b>	Dual rail	359	420	394	460	113
<b>EAS38F</b>	Dual rail	465	420	500	460	113

**RCD controlled metalclad flush mounting consumer units**

Eaton list number		Recess Dimensions (mm)		Front Dimensions (mm)		
		rw	rh	fw	fh	fd
<b>EAS2H40F</b>		180	223	215	264	113
<b>EAS2H63F</b>		180	223	215	264	113
<b>EAS6H63F</b>		252	223	287	264	113
<b>EAS6H80F</b>		252	223	287	264	113
<b>EAS6H100F</b>		252	223	287	264	113
<b>EAS10H100F</b>		324	223	359	264	113
<b>EAS12H100F</b>		359	223	394	264	113
<b>EAS18H100F</b>		465	223	500	264	113

# 12.4

## Technical data

Consumer units and enclosures dimensions and data

### Split load RCD and isolator controlled flush mounting consumer units

Eaton list number		Recess Dimensions (mm)		Front Dimensions (mm)		
		rw	rh	fw	fh	fd
EAS8H63DF		324	223	359	264	113
EAS8H80DF		324	223	359	264	113
EAS10H63DF		359	223	394	264	113
EAS10H80DF		359	223	394	264	113
EAS16H80DF		465	223	500	264	113
EAS24H80DF	Dual rail	359	420	394	460	113
EAS36H80DF	Dual rail	465	420	500	460	113

### Split load dual RCD metalclad flush mounting consumer units

Eaton list number		Recess Dimensions (mm)		Front Dimensions (mm)		
		rw	rh	fw	fh	fd
EAS14H63H63DF		465	223	500	264	113
EAS14H80H63DF		465	223	500	264	113
EAS14H80H80DF		465	223	500	264	113
EAS22H80H80DF	Dual rail	359	420	394	460	113
EAS22H80H63DF	Dual rail	359	420	394	460	113
EAS34H80H80DF	Dual rail	465	420	500	460	113
EAS34H80H63DF	Dual rail	465	420	500	460	113

### Dual tariff metalclad flush mounting consumer units

Eaton list number		Recess Dimensions (mm)		Front Dimensions (mm)		
		rw	rh	fw	fh	fd
EAS10DDF		359	223	394	264	113
EAS16DDF		465	223	500	264	113

Enclosures, dimensional drawings IP65

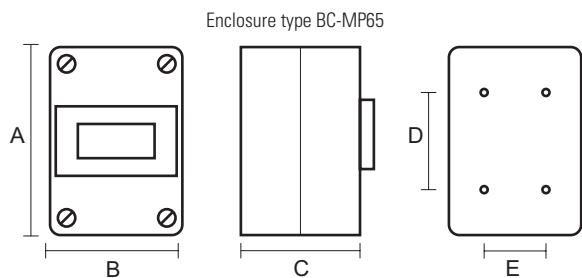

Eaton list number	Finish	No of modules	A	B	C	D	E
BC-MP65-1/3	Moulded	1-3	150	100	100	84	50
BC-MP65-1/5	Moulded	1-5	200	126	125	120	50
BC-MP65-1/9	Moulded	1-9	200	200	125	120	120

Enclosures dimensions IP40

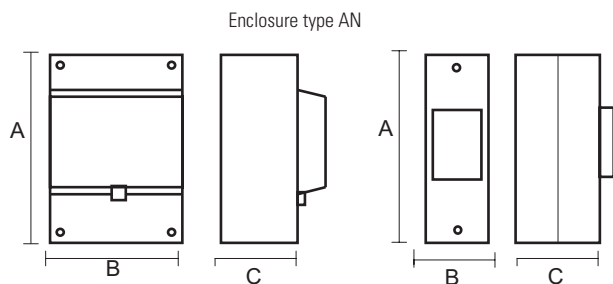

Eaton list number	Finish	Number of modules	A	B	C
AN2	Moulded	2	135	40	65
AN2D <sup>1)</sup>	Moulded	2	135	40	65
AN25	Moulded	2	135	50	65
AN2EBD <sup>1,2)</sup>	Moulded	2	135	40	65
AN4EBLS <sup>2)</sup>	Moulded	4	135	110	88

<sup>1)</sup> Isolator fitted.

<sup>2)</sup> Sealable supply terminal access, independent access to load terminals.

Consumer units and enclosures technical data

	Earth	Neutral	Isolator	RCCB	RCBO	MCB
Connection type	Pinch screw	Pinch screw	Box clamp	Box clamp	Box clamp	Box clamp
Screw type	Combination	Combination	Combination	Combination	Combination	Combination
Size	M5	M5	M6	M5	M5	M5
Min cable size	1mm <sup>2</sup>	1mm <sup>2</sup>	2.5mm <sup>2</sup>	1mm <sup>2</sup>	1mm <sup>2</sup>	1mm <sup>2</sup>
Max cable size	16mm <sup>2</sup>	16mm <sup>2</sup>	50mm <sup>2</sup>	35mm <sup>2</sup>	25mm <sup>2</sup> /16mm <sup>2</sup>	25mm <sup>2</sup>
Recommended torque	Note 1	Note 1	2.5Nm	2.0Nm	2.0Nm	2.0Nm
Maximum torque	Note 1	Note 1	5.0Nm	2.4Nm	2.4Nm	2.4Nm

Note: As terminal is pinch screw, the torque will depend upon cable size and type and should be sufficient to secure termination without damaging conductor strands.

# 12.4

## Technical data

Consumer units and enclosures dimensions and data

### PVSS Photovoltaic Switch and Surge Unit

#### Combination DC & AC isolator switching enclosure with integrated surge protection

The Switch & Surge Unit is a combined DC & AC Isolator Switching enclosure with integrated surge protection. It is compact and robust, and safely houses the electrical Components in a single unit. It provides the ideal solution For both new builds, retrofit, and other small scale PV Installations. Eaton offers 4 versions of the unit to suit different requirements, for connecting 1 and 2 strings with and without DC surge protection. All units include AC surge protection as standard.



- Lockable DC isolator and AC isolator in a single IP65 enclosure.
- AC surge protection included in all versions.
- Option to include DC surge protection.
- Single enclosure – no need to install multiple separate devices.
- MC4 DC input connections, with the option to connect up to 2 strings or more using branch connectors.
- Screw terminals for the AC and DC output cables, ensure that connecting is simple and fast.
- All regulatory labelling is pre-fitted.
- Enclosure can be installed in a range of operating environments (IP65).
- Factory assembled, to give fault-free compliance with all local regulations and best practice.
- Exclusive warranty for the complete unit, with all devices from a single manufacturer.
- Designed in accordance with BS EN61439.
- Technical standards – tested in accordance with EN 61643-11:2007 Surge protection and IEC 60364-7-712:2002 PV power supply systems.

Description	DC inputs	DC surge protection	AC input cable	AC cable (internal)	Eaton list number
Isolator DC 30A 600V ; AC 25A 1 x input MC4 AC SPD UK V1	1 string	n/a	3C x 2.5mm <sup>2</sup> 1.5m LSF flex M20 gland	4.0mm <sup>2</sup> Tri-rated	<b>PVSSUKV1</b>
Isolator DC 30A 600V ; AC 32A 2 x input MC4 AC SPD UK V2	2 string	n/a	3C x 4.0mm <sup>2</sup> 1.5m LSF flex M20 gland	4.0mm <sup>2</sup> Tri-rated	<b>PVSSUKV2</b>
Isolator DC 30A 600V ; AC 25A 1 x input MC4 AC+DC SPD UK V3	1 string	Type T2 (Class C), 600V, 15KA nominal discharge	3C x 2.5mm <sup>2</sup> 1.5m LSF flex M20 gland	4.0mm <sup>2</sup> Tri-rated	<b>PVSSUKV3</b>
Isolator DC 30A 600V ; AC 32A 2 x input MC4 AC+DC SPD UK V4	2 string	Type T2 (Class C), 600V, 15KA nominal discharge	3C x 4.0mm <sup>2</sup> 1.5m LSF flex M20 gland	4.0mm <sup>2</sup> Tri-rated	<b>PVSSUKV4</b>

Enclosure – IP65, Polystyrene , polycarbonate transparent access door, polypropylene separation plate between AC and DC components

Dimensions (H x W x D): 260 x 275 x 140mm

DC Input Connectors – MC4 Panel Mount.

DC Cable (internal) – 4mm<sup>2</sup> double insulated solar cable, TUV certified.

DC Isolator – 30A, 600V, 2 Pole, Rotary type, lockable with padlock.

DC Output – Screw terminal, M25 gland with 2 cable insert (2.5–6.0mm<sup>2</sup> DC cable).

AC Isolator – 63A, 230V, 2 Pole, Toggle type, lockable with additional clip.

AC Surge Protection – Type T2 (Class C), 280V, 20kA nominal discharge.

AC Outputs – Screw terminal, M20 gland (2.5 - 10mm<sup>2</sup> AC cable).

Earth Connections – Screw terminal, 2 x M12 glands (4–16mm<sup>2</sup> cable).

Maximum power rating – typically single string units are suitable for systems up to 5.7kW, and 2 string units suitable for up to 7.3kWp, assuming PF = 1.

### Quick installation guide

1. Remove the front cover by removing the 4 screws.
2. Consider the position of the unit on the wall in relation to the inverter and cables.
3. Fix onto a vertical wall surface, use the fixings through the 4 knock-out fixing holes in the rear of the enclosure.
4. To maintain the IP65 rating, clip the 4 sealing caps supplied with the enclosure over the fixing holes.
5. Make the DC connections to the inverter using the screw terminals at the left end of the unit (labelled below).  
DC terminal colours: Brown = positive, Grey = negative.
6. Cut the pre-fitted flex to the length required and make the AC connection to the inverter, refer to your inverter manual for further guidance with this step.
7. Connect the AC cable from the consumer unit to the screw terminals at the right of the unit.  
AC terminal colours: Grey = live, Blue = neutral.
8. Ensure all cable glands are fully tightened around the cables to maintain the IP rating and provide adequate retention.
9. Refit the front cover and replace screws.
10. To complete the installation, make the DC connections from the PV array field cables to the MC 4 connectors to the left of the unit.



**WARNING:** DC cables from the PV array are always live. Ensure both AC and DC supplies are isolated before removing front cover of switch and surge unit.

### Notes to designers and installers

- Installation to be in accordance with the latest revision of BS7671, IET Wiring Regulations.
- Enclosure is IP65, installation is recommended indoors or in a sheltered outdoor location.
- Glands supplied are intended for circular section cables, use of flat twin and earth cables may compromise IP rating.
- Cables should be stripped to 12mm to suit all screw terminals.
- Ensure all screw connections are adequately tightened. A torque of 3Nm is recommended for all the factory made connections and 1.3Nm for the installer accessible terminal blocks.
- Cable to consumer unit can be up to 10mm<sup>2</sup>, care should be taken in specifying this cable to prevent excessive losses (recommended at not more than 1%).
- Unit is supplied configured for a TN-C-S supply system. If the system is TT, wiring should be modified in accordance with the schematic shown below. No additional wiring is required to make this change.
- For a TN-C-S installation  $Z_e$  should not exceed 0.35Ω at the consumer unit, for a TT it should not exceed 200Ω.
- Additional glands at left and right of the unit are provided for earth connections if required (up to 16mm<sup>2</sup>).
- Take care to ensure internal wiring or devices are not damaged or disturbed during installation. Damage during installation may invalidate product warranty. No adjustment to device connections is required other than the option to accommodate a change in system earthing requirements from TN-C-S to TT.
- Eaton data sheets for all individual components are available upon request.

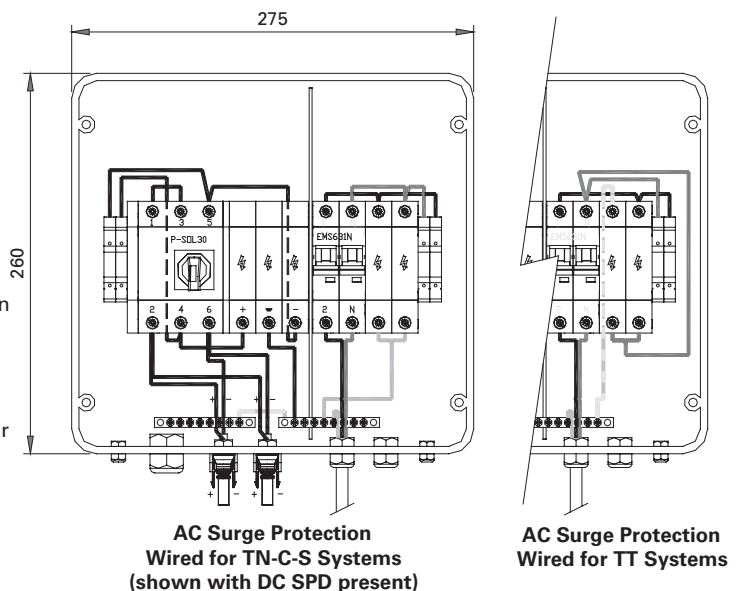
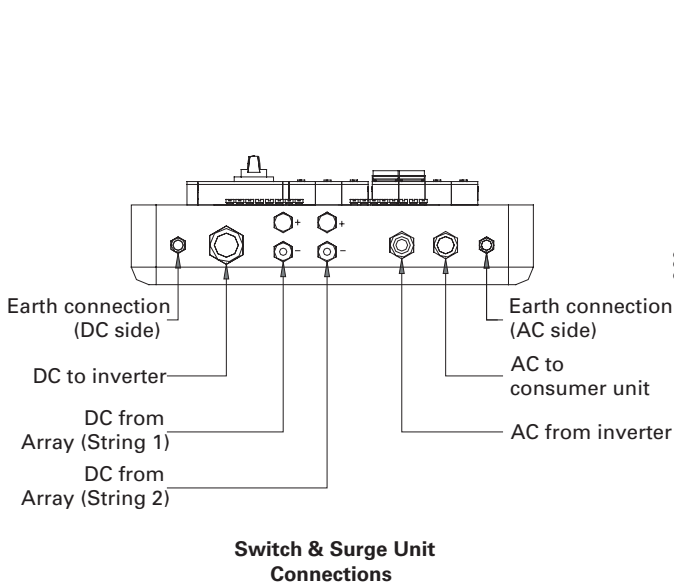

#### 6kA Miniature Circuit Breakers (MCBs) technical Data

Eaton's range of 6kA high performance Miniature Circuit Breakers (MCBs) are manufactured to IEC/EN 60898, meeting the latest UK, European and International standards, with ratings from 2A to 63A as standard.

DIN rail mountable and suitable for use with both pin and comb type busbar systems, Eaton's MCBs are suitable for use on 230/240 V, AC systems and are calibrated for use at 40°C. These devices suite with the other modular devices including RCBOs, RCCBs and Isolators, for use within Eaton's MEM consumer units and a wide range of other applications.

The Eaton 6kA MCBs are fitted with box clamp terminals suitable for use with cables up to 25mm<sup>2</sup>.

The Eaton 6kA miniature circuit breakers are available with both B and C characteristic curves as standard. Type B MCBs are most commonly used in domestic applications, however the use of type C devices may be desirable e.g. on lighting circuits where high switching surges are involved. Type D devices are not commonly used in other than industrial applications.

IEC/EN 60898 Type	Instantaneous Trip Current (x I <sub>n</sub> )	Typical Application	Eaton 6kA MCB Type
B	3 to 5	Domestic	EAD B
C	5 to 10	Commercial Light Industrial	EAD C
D	10 to 20	General Industrial	—

**Type B:** Suitable for general, domestic and commercial installations having little or no switching surges

**Type C:** Suitable for general use in commercial or industrial applications where the greater use of fluorescent lighting and small motors can produce switching surges, which may cause nuisance tripping of type B breakers.

**Type D:** Suitable for General Industrial applications where there are a lot of high inrush switching surges associated with equipment such as transformers, large motors, welding and X ray equipment.

#### Earth fault loop impedance's (Zs) to provide compliance with BS 7671

The wiring regulations BS 7671 makes specific reference to MCB types and the maximum earth loop impedance allowable to meet the required disconnection times.

It can be seen that it is much easier to achieve adequate disconnection times with type B devices than it is with types C and indeed type D devices.

Maximum earth fault loop impedance i.e. Zs ohms for final circuits fed from Miniature Circuit Breakers MCBs or RCBOs with U<sub>o</sub> of 230V, for instantaneous operation giving compliance with 0.4s disconnection time of Reg 411.3.2.2 and 5s disconnection time of 411.3.2.3

**Table Zs Ohms**

Device	Standard	2A	4A	6A	10A	13A	16A	20A	25A	32A	40A	45A	50A	63A
Type B MCB	BS EN 60898	23.00	11.50	7.67	4.60	3.54	2.88	2.30	1.84	1.44	1.15	—	0.92	0.73
Type C MCB	BS EN 60898	11.50	5.75	3.83	2.30	1.77	1.44	1.15	0.92	0.72	0.58	—	0.46	0.37
Type B RCBO	BS EN 61009	—	—	7.67	4.60	—	2.88	2.30	1.84	1.44	1.15	1.02	—	—
Type C RCBO	BS EN 61009	—	—	3.83	2.30	—	1.44	1.15	0.92	0.72	0.58	0.51	—	—

#### Tripping characteristic type B and C

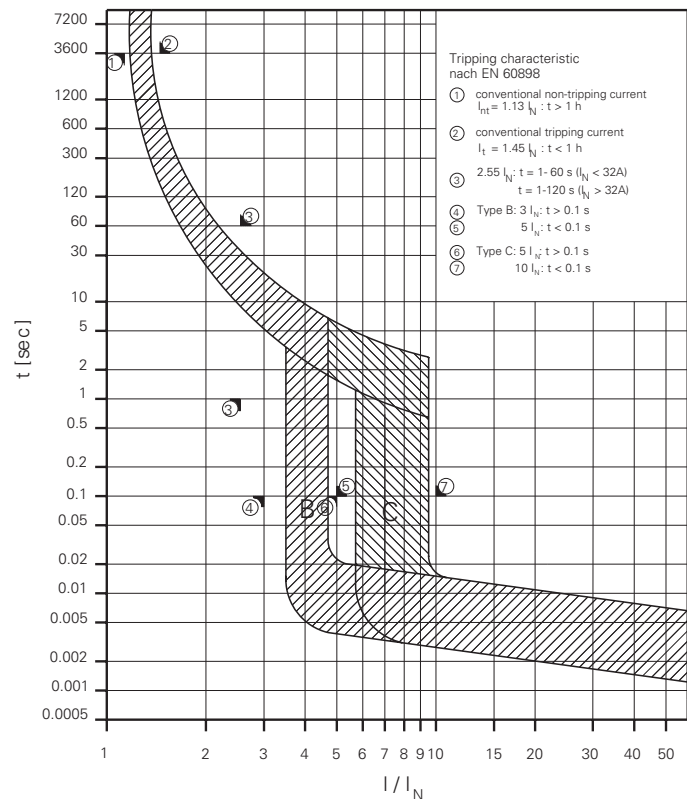



6kA MCB dimensional drawings

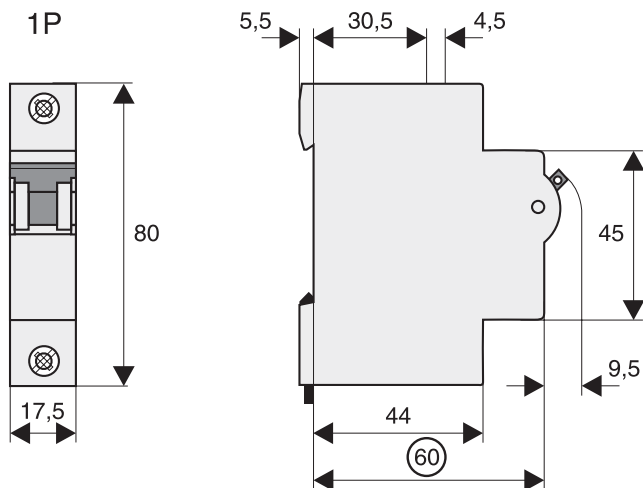

6kA MCB technical data

Product standard	IEC/EN 60898
No of poles	1P
<b>Mechanical specification</b>	
Device width	17.7mm
Terminal type	Box clamp
Terminal capacity	1 – 25mm <sup>2</sup>
Terminal Screw	M5 combination
Terminal torque recommended	2.0Nm - max 2.4Nm
Mounting	DIN rail
Degree of protection	IP 20
Positive contact indication	Yes (Toggle position)
<b>Electrical specification</b>	
Rated voltage	230/240 V AC
Current ratings	2, 4, 6, 10, 13, 16, 20, 25, 32, 40, 50, 63 A
Rated impulse and withstand voltage	4kV (1.2/50 μ sec)
Rated short circuit capacity	6kA
Selectivity class	3 to IEC/ EN 60898
<b>Tripping characteristic</b>	
Instantaneous Tripping current I <sub>mt</sub>	Type B: 3 I <sub>n</sub> < I <sub>mt</sub> < 5 I <sub>n</sub> Type C: 5 I <sub>n</sub> < I <sub>mt</sub> < 10 I <sub>n</sub>
Conventional non tripping current	I <sub>nt</sub> = 1.13 I <sub>n</sub>
Conventional tripping current	I <sub>t</sub> = 1.45 I <sub>n</sub>
Ref/calibration temp	40° C
Number of operating cycles elec	>4000
Number of operating cycles mech	>20000

# 12.5

## Technical data

Switch and protection devices dimensions and data

### Main load disconnecter switch (Isolators)

The Eaton range of compact modular Isolators are available in Single Pole, Double Pole and Single Pole with Switched Neutral arrangements. Manufactured and tested in accordance with IEC/EN 60947-3 to meet the latest European and International standards.

DIN rail mountable in one or 2 modules width these Isolators are available in 63A and 100A ratings. Suiting with the complete range of Eaton's modular devices, providing positive contact position indication and terminal capacity up to 50 mm<sup>2</sup>, these devices are the ideal choice as a Main switch in Eaton's MEM Memera consumer units and other applications.

With rated short circuit capacity at up to 12.5kA these switches are fully rated and tested to IEC/EN 60947-3 for AC23 duty at 240VAC

### Connection diagram

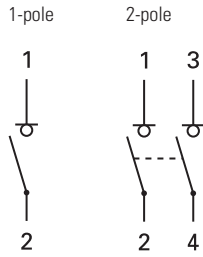

### Main load disconnecter switch (Isolators) technical data

#### Specifications

Product standard	IEC/EN 60947-3
No of poles	1P, 2P, 1P+N

#### Mechanical specification

Device width	
1p	17.7mm
2p	35mm
Terminal type	Box clamp
Terminal capacity	2.5 – 50mm <sup>2</sup>
Terminal Screw	M6 combination
Terminal torque recommended	2.5Nm - max 5.0Nm
Mounting	DIN rail
Degree of protection	IP 10
Positive contact indication	Yes (Red/Green)

#### Electrical specification

Rated voltage	230/240 V AC
Rated Current AC23	63A, 100A (240V)
Rated peak withstand voltage	6kV
Rated insulation Voltage	690V
Rated short circuit capacity	
63A	12.5kA (fuse backup 125A gG max.)
100A	6kA (fuse backup 125A gG max.)
Rated short time withstand Icw	2kA
Rated short circuit making Icm	2.8kA

#### Endurance

Number of operating cycles elec	>3000
Number of operating cycles mech	>16000

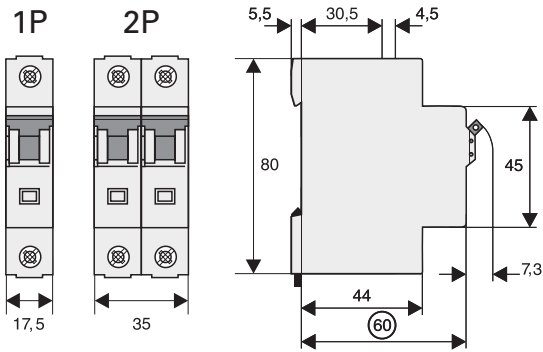

### Residual Current Circuit Breakers (RCCBs) technical data

Eaton's range of Residual Current Circuit Breakers without integral Overload protection (RCCBs), are manufactured to IEC/EN 61008 and meet the latest European and International standards.

DIN rail mountable in 2 module width these RCCBs provide protection solutions to a wide range of applications. With standard thermal ratings of 16A to 100A and trip sensitivities of 10mA, 30mA, 100mA and 300mA, these devices can be equipped with a range of modular accessories.

The Eaton RCCBs suite with the complete range of modular devices, and are for use within Eaton's MEM Memera consumer units and other applications.

These devices will accommodate cables up to 35mm<sup>2</sup>.

### Terminology

**RCD** – Residual Current Device:- This is the generic term covering a range of devices that are able to detect residual currents sometimes also referred to as earth leakage current. The residual current is measured by detecting the difference between the current flowing in the live and neutral conductors of a circuit and where the residual current is above a predefined level, the RCD will trip. RCDs are available in a range of sensitivities for different applications.

**RCCB** – Residual Current Circuit Breaker is an RCD which will cause disconnection of the electrical supply should it detect a residual current passing through the device, above a specified tripping current limit e.g. 30mA. This device does not provide over current protection and is therefore also referred to as an RCCB without integral over current protection.

**RCCBO** – Residual Current Circuit Breaker, with Overload protection, is an RCD which will cause disconnection of the electrical supply should it detect a residual current above a specified tripping current limit, combined with integral overload, overcurrent, and shortcircuit protection associated with a miniature circuit breaker.

The 17th Edition of the IEE wiring regulations BS7671 now places much greater emphasis on the use of 30mA RCDs to provide "additional protection" in many areas covered by the regulations, such as circuits feeding socket outlets and for the protection of concealed wiring.

### Trip sensitivities

**10mA** – Provides the highest degree of RCD protection in hazardous environments where supplementary protection against electric shock is required. This very high sensitivity should only be applied to final circuits where a high degree of risk exists

**30mA** – Provides a high degree of protection against electric shock due to direct and indirect contact. A 30mA RCD will trip within 40mS when a fault current of 150mA is detected.

This type of RCD is required to satisfy the requirements for "Additional Protection" in accordance with BS7671 (IEE wiring regs.)

**100mA** – Provides a degree of protection against electric shock resulting from indirect contact, and is generally used to protect a group of circuits as well as providing overall protection against Fire risk.

**300mA** – Provides a lower level of RCD protection in the form of an overall protection against the risk of fire resulting from faults in electrical wiring etc.

### RCCB dimensions (mm)

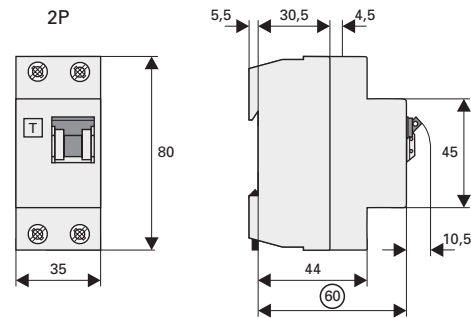

### RCCB technical data

#### Specifications

Product standard	IEC/EN 61008
No of poles	2P

#### Mechanical specification

Device width	35 mm
Terminal type	Box clamp
Terminal capacity	1.5 – 35mm <sup>2</sup>
Terminal Screw	M5 combination
Terminal torque recommended	2.0Nm - max 2.4Nm
Mounting	DIN rail
Degree of protection	IP 20
Positive contact indication	Yes (Toggle position)

#### Electrical specification

Rated voltage	230/240 V AC
Current ratings	16, 40, 63, 80, 100 A
Rated impulse and withstand voltage	4kV (1.2/50 μ sec)
Rated short circuit capacity	10kA
Sensitivity	AC

#### Tripping characteristic

Rated tripping currents	10, 30, 100, 300 mA
Tripping type	Instantaneous
Number of operating cycles elec	>4000
Number of operating cycles mech	>20000

# 12.5

## Technical data

### Switch and protection devices dimensions and data

#### Compact Residual Current Circuit Breakers – with Overload protection (RCBOs) technical data

Eaton's range of new compact Residual Current Circuit Breakers with integral Overload protection (RCBOs), are manufactured to IEC/EN 61009 and meet the latest European and International standards.

DIN rail mountable in a single module width these RCBOs provide a comprehensive protection solution to a wide range of applications. With standard current ratings from 6A to 45A, in both B and C Type characteristics and a trip sensitivity of 30mA, these devices are the ideal choice for domestic applications.

The Eaton RCBOs suite with the complete range of modular devices, and are for use within Eaton's MEM Memera consumer units and other applications.

These devices will accommodate cables up to 16mm<sup>2</sup>.

Trip Sensitivity 30mA Standard

Provides a high degree of protection against electric shock due to direct and indirect contact. A 30mA RCD will trip within 40mS when a fault current of 150mA is detected.

This type of RCD is required to satisfy the requirements for "Additional Protection" in accordance with BS7671 (IEE wiring regs.) Other sensitivities are available on request.

#### RCBOs technical data

##### Specifications

Product standard	IEC/EN 61009
No of poles	1P & solid N

##### Mechanical specification

Device width	17.7 mm
Terminal type	Box clamp
Mounting	DIN rail
Degree of protection	IP 20
Positive contact indication	Yes (red/green)

##### Electrical specification

Rated voltage	230/240 V AC
Current ratings	6, 10, 16, 20, 25, 32, 40, 45A
Rated impulse and withstand voltage	4kV (1.2/50 μ sec)
Rated short circuit capacity	6kA
Sensitivity	AC

##### Tripping characteristic

Instantaneous Tripping current I <sub>mt</sub>	Type B: 3 I <sub>n</sub> < I <sub>mt</sub> < 5 I <sub>n</sub>
	Type C: 5 I <sub>n</sub> < I <sub>mt</sub> < 10 I <sub>n</sub>
Conventional non tripping current I <sub>nt</sub>	1.13 I <sub>n</sub>
Conventional tripping current I <sub>t</sub>	1.45 I <sub>n</sub>
Ref / Calibration temp	40° C
Rated residual tripping current	30mA
Residual tripping type	Instantaneous
Number of operating cycles elec	>4000
Number of operating cycles mech	>20000

	LOAD	LINE
Terminal capacity	1–16mm <sup>2</sup>	1–25mm <sup>2</sup>
Terminal screw	M4	M5
Terminal torque recommended	1.2–1.5Nm	2.0–2.5Nm

#### RCBOs dimensions (mm)

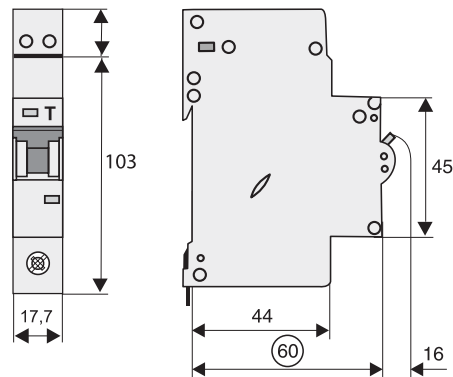

### Single pole & neutral switchfuse

The **800KMF** is a fully moulded, compact wall mounted, SP&N switchfuse rated at up to 80A, complying with BS EN 60947-3 for duty AC22B, 240v AC. The unit is fitted with a fully insulated pull out fuse carrier, which will accommodate HRC fuse links complying with BS 88-3 (BS1361) and rated between 45 -80A.

### Wall mounted switch fuses technical data

#### Specification

<b>Product standard</b>	<b>IEC/EN 60947-3</b>		
No of poles	1P+N		
Rated Voltage	230/240VAC		
Terminal capacity:			
800KMF	Main Terminals	25 mm <sup>2</sup>	(Maximum)
	Earth terminals	16 mm <sup>2</sup>	(Maximum)

#### Rated current and fuse details

Type	Rating (A)	Class	Finish	IP rating	Fuse (A)	Standard
800KMF	80	AC22	Moulded	40	80	BS 88-3 (BS1361)
800KMFNF	80	AC22	Moulded	40	Not fitted	BS 88-3 (BS1361)

#### Replacement fuse-links

Switch	Standard	Rating (A)	Ordering reference
800KMF	BS 88-3 (BS1361)	80	804R
800KMF	BS 88-3 (BS1361)	60	604R
800KMF	BS 88-3 (BS1361)	50	504R
800KMF	BS 88-3 (BS1361)	45A	454R

### 800KMF dimensions (mm)

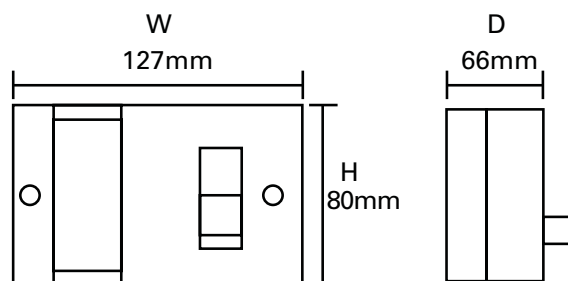

## Analogue timers, technical details

Analogue Timers	TAD1NC	TAD1NCS	TAW1	TAD1	TAD1S	TAW1S
<b>General</b>						
Standards	EN 60730-2-7, EN 60730-1					
Nominal operating voltage & tolerance	230 Vac ± 10 %	230 Vac ± 10 %	230 Vac ± 10%	230 Vac ± 10 %	230 Vac ± 10 %	230 Vac ± 10 %
Frequency	50 Hz	50 Hz	50-60 Hz	50-60 Hz	50-60 Hz	50-60 Hz
Power consumption	max. 2.5 VA	max. 2.5 VA	max. 2.5 VA	max. 2.5 VA	max. 2.5 VA	max. 2.5 VA
Time base control	Net	Net	Quartz	Quartz	Quartz	Quartz
Accuracy at 20 °C	acc. Net	acc. Net	£ <sub>-</sub> ± 1 sec. / day	£ <sub>-</sub> ± 1 sec. / day	£ <sub>-</sub> ± 1 sec. / day	£ <sub>-</sub> ± 1 sec. / day
Power reserve at 20 °C	-	-	±3 days	±3 days	±3 days	±3 days
Type of battery	-	-	NiMH	NiMH	NiMH	NiMH
Mechanical endurance (switching cycles)	> 30.000	> 30.000	> 30.000	> 30.000	> 30.000	> 30.000
Electrical endurance (switching cycles)	> 10.000	> 10.000	> 10.000	> 10.000	> 10.000	> 10.000
Protection class (acc. EN 60529)	IP20	IP20	IP20	IP20	IP20	IP20
Permissible ambient temperature	-20 °C...+50 °C	-25 °C...+50 °C	-20 °C...+50 °C	-20 °C...+50 °C	-10 °C...+50 °C	-10 °C...+50 °C
Storage temperature	-20 °C...+50 °C	-25 °C...+50 °C	-20 °C...+50 °C	-20 °C...+50 °C	-10 °C...+50 °C	-10 °C...+50 °C
Protection class (acc. EN 60 730-1) at proper installation	II	II	II	II	II	II
<b>Switching contact(s)</b>						
Type of switching contact	1 x CO	1 x NO	1 x CO	1 x CO	1 x NO	1 x NO
Contact material	Hard silver	Hard silver	Hard silver	Hard silver	Hard silver	Hard silver
Switching capacity at 250 Vac, cos j = 1	16 A	16 A	16 A	16 A	16 A	16 A
Switching capacity at 250 Vac, cos j = 0,6	4A	4A	4A	4A	4A	4A
<b>Programming features</b>						
Period of program	Day	Day	Week	Day	Day	Week
Number of channels	1	1	1	1	1	1
Minimum cycle time	30 min.	15 min.	4 hours	30 min.	15 min.	2 hours
Maximum programming steps in memory	48	96	42	48	96	84
Manual / Hand / Permanent switching 1)	ON, OFF,					
Hand, Auto	ON, Auto	ON, OFF,				
Hand, Auto	ON, OFF,					
Hand, Auto	ON, Auto	ON, Auto				
<b>Dimensions &amp; weight</b>						
Number of module width	3	1	3	3	1	1
Dimensions	Width	52.5 mm	17.5 mm	52.5 mm	52.5 mm	17.5 mm
17.5 mm	Height	90 mm	90 mm	90 mm	90 mm	90 mm
	Depth	65.5 mm	65.5 mm	65.5 mm	65.5 mm	65.5 mm
Weight	135 gr.	120 gr.	175 gr.	150 gr.	120 gr.	120 gr.
<b>Terminals</b>						
Terminal capacity – fine stranded wire	1.....2.5 mm <sup>2</sup>	1.....2.5 mm <sup>2</sup>	1.....2.5 mm <sup>2</sup>	1.....2.5 mm <sup>2</sup>	1.....2.5 mm <sup>2</sup>	1.....2.5 mm <sup>2</sup>
Terminal capacity – solid wire	1.....4 mm <sup>2</sup>	1.....4 mm <sup>2</sup>	1.....4 mm <sup>2</sup>	1.....4 mm <sup>2</sup>	1.....4 mm <sup>2</sup>	1.....4 mm <sup>2</sup>
Terminal screw size	M3.5	M3.5	M3.5	M3.5	M3.5	M3.5
Terminal screw head type (Pozidrive)	PZ Size 1	PZ Size 1	PZ Size 1	PZ Size 1	PZ Size 1	PZ Size 1
Maximum torque	0.8 Nm	0.8 Nm	0.8 Nm	0.8 Nm	0.8 Nm	0.8 Nm

1) Remark

ON = Permanent ON

OFF = Permanent OFF

Hand = ON or OFF, valid until next program cycle overrules

Auto = According program

Analogue timers, technical drawings

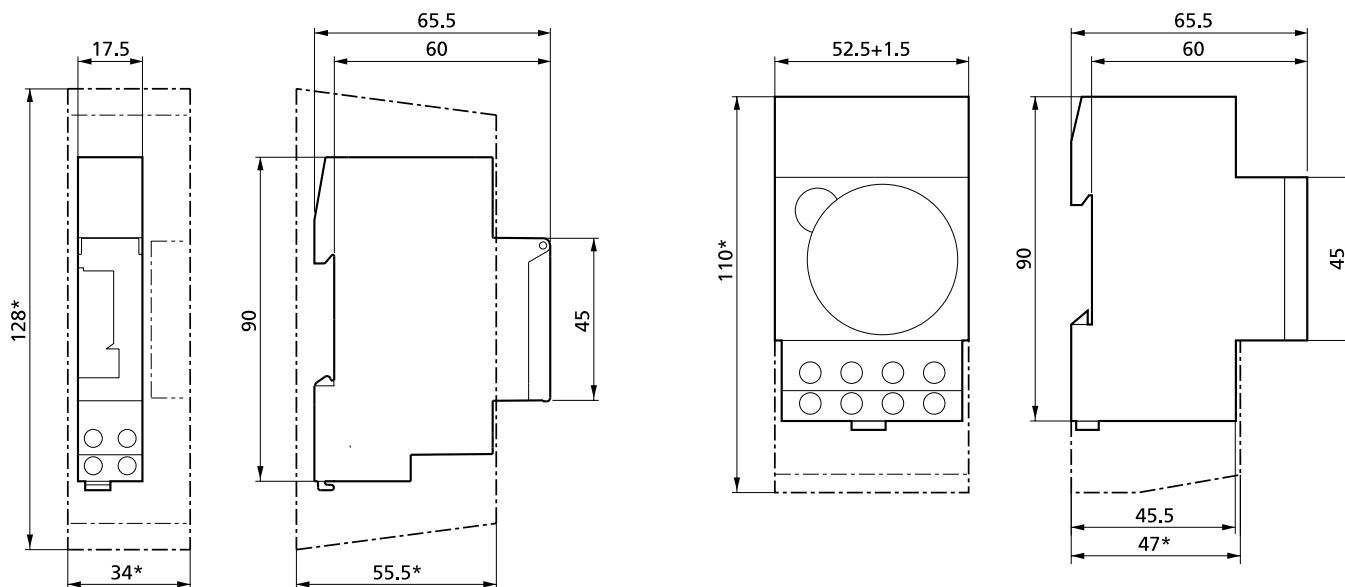

Analogue day and week timers,  
type TAD1NCS, TAD1S and TAW1S.

\*) Dimensions are applicable when  
using terminal covers.

Analogue day and week Timers,  
types TAD1NC, TAD1 and TAW 1.

\*) Dimensions are applicable when  
using terminal covers.

Digital week timers, technical details

Digital timers – week program	TDW1	TDW1S	TDW2	TDW2E
<b>General</b>				
Standards	EN 60730-2-7, EN 60730-1			
Nominal operating voltage	230...240 Vac	230 Vac	230...240 Vac	230...240 Vac
Nominal operating voltage tolerance	-10%...+6%	-10%...+10%	-10%...+6%	-10%...+6%
Frequency	50...60 Hz	50...60 Hz	50...60 Hz	50...60 Hz
Power consumption	max. 6 VA	± 2.5 VA	max. 6 VA	max. 6 VA
Time base control	Quartz	Quartz	Quartz	Quartz
Accuracy at 20 °C	£ <sub>-</sub> ± 1 sec. / day	£ <sub>-</sub> ± 1 sec. / day	£ <sub>-</sub> ± 1 sec. / day	£ <sub>-</sub> ± 1 sec. / day
Power reserve at 20 °C	10 years	3 years	10 years	10 years
Type of battery	Lithium	Lithium (CR2032)	Lithium	Lithium
Mechanical endurance (switching cycles)	> 100.000	> 100.000	> 100.000	> 100.000
Electrical endurance (switching cycles)	> 40.000	> 40.000	> 40.000	> 40.000
Protection class (acc. EN 60529)	IP20	IP20	IP20	IP20
Permissible ambient temperature	-10 °C...+50 °C	-10 °C...+50 °C	-10 °C...+50 °C	-10 °C...+50 °C
Storage temperature	-25 °C...+50 °C	-25 °C...+50 °C	-25 °C...+50 °C	-25 °C...+50 °C
Protection class at proper installation	II (acc. EN 60730-1)	II (acc. EN 60355-1)	II (acc. EN 60730-1)	II (acc. EN 60730-1)

**Digital week timers, technical details (continued)**

Digital Timers – week program	TDW1	TDW1S	TDW2	TDW2E
<b>Switching contact(s)</b>				
Type of switching contact	1 x CO	1 x CO	2 x CO	2 x CO
Contact material	Ag Sn O2	Ag Sn O2	Ag Sn O2	Ag Sn O2
Switching capacity at 250 Vac, cosj = 1	16 A	16 A	16 A	16 A
Switching capacity at 250 Vac, cosj = 0,6	10:00 AM	6:00 AM	10:00 AM	10:00 AM
Digital Timers – week program	TDW1	TDW1S	TDW2	TDW2E
Switching capacity for lighting :				
-Incandescent lamp	2300 W	1000 W	2300 W	2300 W
-Halogen lamp	2300 W	1000 W	2300 W	2300 W
– Fluorescent lamp :				
single fitting uncompensated (inductive)	1000 W	800 W	1000 W	1000 W
single fitting compensated (capacitive 42mF)	400 W	200 W	400 W	400 W
double fitting series compensated	1000 W	800 W	1000 W	1000 W
– Compact fluorescent lamp electronic				
7 W	9 x	7 x	9 x	9 x
11 W	7 x	6 x	7 x	7 x
15 W	7 x	5 x	7 x	7 x
20 W	7 x	5 x	7 x	7 x
23 W	7 x	5 x	7 x	7 x
<b>Programming features</b>				
Period of program	Week	Week	Week	Week
Number of channels	1	1	2	2
Minimum cycle time	1 min.	1 min.	1 min.	1 min.
Maximum programming steps in memory	28	28	42	42
Summer – / wintertime automatic (or manual on/off)	Yes	Yes	Yes	Yes
Random program	No	No	No	Yes
Holiday program	No	No	No	Yes
Cycle program	No	No	No	Yes
Pulse switching	No	No	No	Yes
Manual / Hand / Permanent switching 1)	ON, OFF, Hand, Auto	ON, OFF, Hand, Auto	ON, OFF, Hand, Auto	ON, OFF, Hand, Auto
LCD backlighting	No	No	No	Yes
<b>Dimensions &amp; Weight</b>				
Number of module width	2	1	2	2
Width	35 mm	17.9 mm	35 mm	35 mm
Height	86 mm	85.5 mm	86 mm	86 mm
Depth	65.5 mm	65.5 mm	65.5 mm	65.5 mm
Weight	170 gr.	85 gr.	170 gr.	170 gr.
<b>Terminals</b>				
Terminal capacity – fine stranded wire	1.....2.5 mm <sup>2</sup>	1.....2.5 mm <sup>2</sup>	1.....2.5 mm <sup>2</sup>	1.....2.5 mm <sup>2</sup>
Terminal capacity – solid wire	1.....4 mm <sup>2</sup>	1.....4 mm <sup>2</sup>	1.....4 mm <sup>2</sup>	1.....4 mm <sup>2</sup>
Terminal screw size	M3.5	M3.5	M3.5	M3.5
Terminal screw head type (Pozidrive)	PZ Size 1	PZ Size 1	PZ Size 1	PZ Size 1
Maximum torque	0.8 Nm	0.8 Nm	0.8 Nm	0.8 Nm

1) Remark

ON = Permanent ON

OFF = Permanent OFF

Hand = ON or OFF, valid until next program cycle overrules

Auto = According program



Digital week Timers, technical drawings

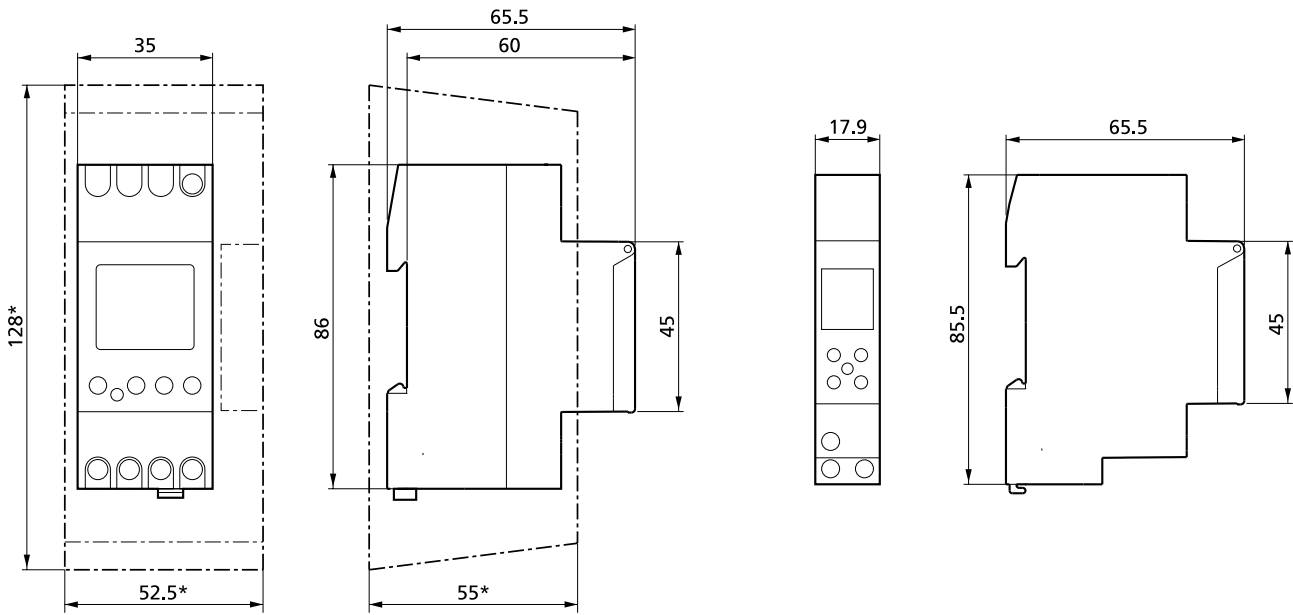

Digital week Timers, types TDW1, TDW2 and TDW2E.

\*) Dimensions are applicable when using terminal covers.

Digital week Timers, type TDW1S.

## Staircase Timers, technical details

Staircase Timer	TE7	TE1
<b>General</b>		
Standards	EN 60669-2-3, EN 60669-2-1, EN 60669-1	
Nominal operating voltage	220...240 Vac	220...240 Vac
Nominal operating voltage tolerance	-15%...+10%	-15%...+10%
Frequency	50...60 Hz	50...60 Hz
Power consumption	± 6 VA	± 6 VA
Time setting	0.5 – 20 min.	0.5 – 20 min.
Mechanical endurance (switching cycles)	> 100.000	> 100.000
Electrical endurance (switching cycles)	> 40.000	> 40.000
Protection class (acc. EN 60529)	IP20	IP20
Permissible ambient temperature	-10 °C...+50 °C	-25 °C...+50 °C
Storage temperature	-25 °C...+50 °C	-25 °C...+50 °C
Protection class at proper installation	II	II
<b>Switching contact(s)</b>		
Type of switching contact	1 x NO (not potential free)	1 x NO (not potential free)
Contact material	Ag Sn O2	Ag Sn O2
Switching capacity at 250 Vac, cos φ =1	16 A	16 A
Switching capacity for lighting :		
-	2300 W	3600 W
-	2300 W	3600 W
-		
single fitting uncompensated (inductive)	2300 W	3600 W *
single fitting compensated (capacitive 120 mF)	400 W	1200 W *
double fitting series compensated	2300 W	3600 W *
single / double fitting electronic supply	300 W	1000 W
7 W	9 x	34 x
9 W	7 x	27 x
11 W	7 x	27 x
15 W	7 x	24 x
20 W	7 x	22 x
23 W	7 x	22 x
<b>Features</b>		
Maximum load for push button illumination (incandescent lamp)	150 mA	150 mA
Automatic 3/4 wire detection	Yes	Yes
Separate control input 8 – 240 Vac/dc	No	Yes
galvanic separated (e.g. for intercom)		
Permanent on function	Yes	Yes
Warning before switching off (2 times flashing) *	No	Yes
Time extension (1 hour)	No	Yes
Pulse switching (on & off)	No	Yes
<b>Dimensions &amp; Weight</b>		
Number of module width	1	1
Dimensions	17.5 mm	17.5 mm
	90 mm	90 mm
	65.5 mm	65.5 mm
Weight	99 gr.	99 gr.
Staircase Timer	TE7	TE1
<b>Terminals</b>		
Terminal capacity – fine stranded wire	1.....2.5 mm <sup>2</sup>	1.....2.5 mm <sup>2</sup>
Terminal capacity – solid wire	1.....4 mm <sup>2</sup>	1.....4 mm <sup>2</sup>
Terminal screw size	M3.5	M3.5
Terminal screw head type (Pozidrive)	PZ Size 1	PZ Size 1
Maximum torque	0.8 Nm	0.8 Nm

Note : Lamp load marked with \* may not be used in combination with 'warning function'

**Staircase Timers, technical drawings**

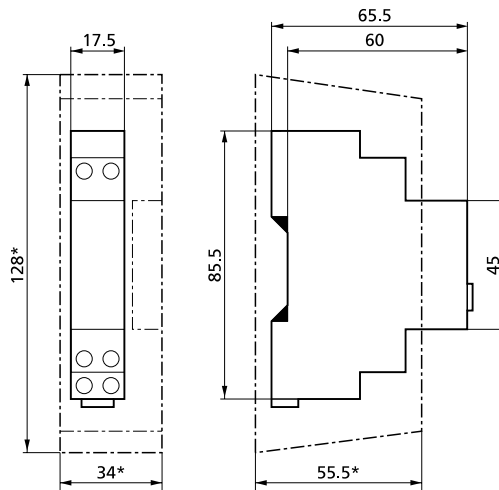

Staircase Timer, type TE7 and TE1.

\*) Dimension applicable when using terminal covers.

**Staircase Timer TE7, example wiring diagrams**

The Staircase Timers can be wired utilising either the 3-wire or 4-wire configuration as shown in the wiring diagrams below.

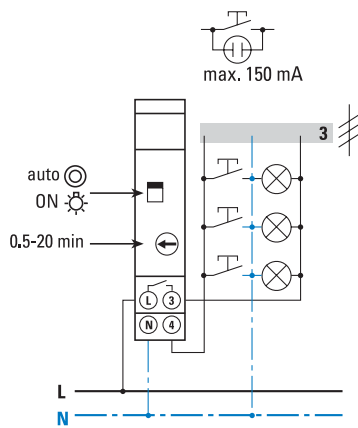

3-wire configuration

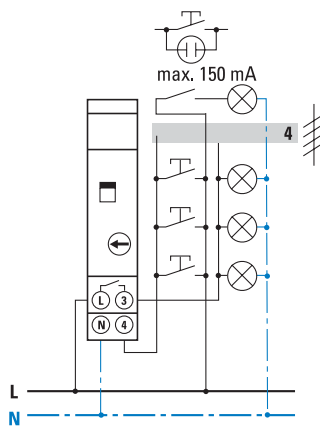

4-wire configuration

**Multifunctional Staircase Timer TE1, example wiring diagram**

The Staircase Timers can be wired utilising either the 3-wire or 4-wire configuration as shown in the wiring diagrams below.

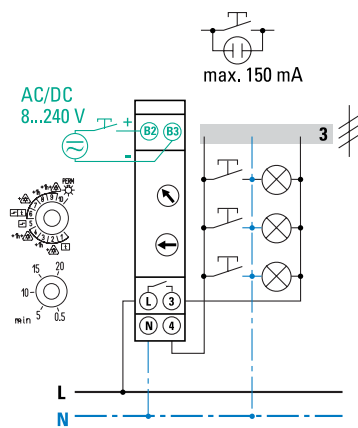

3-wire configuration

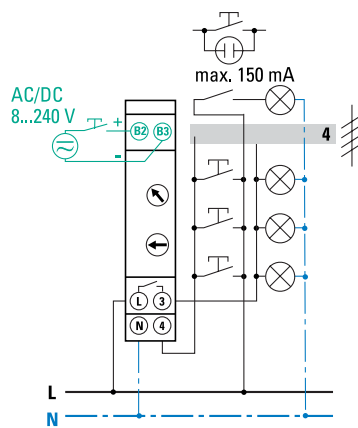

4-wire configuration

# 12.6

## Technical data

Control and switching devices dimensions and data

### Multifunctional Staircase Timer TE1, available functions

Following functions can be set on the Multifunctional Staircase Timer

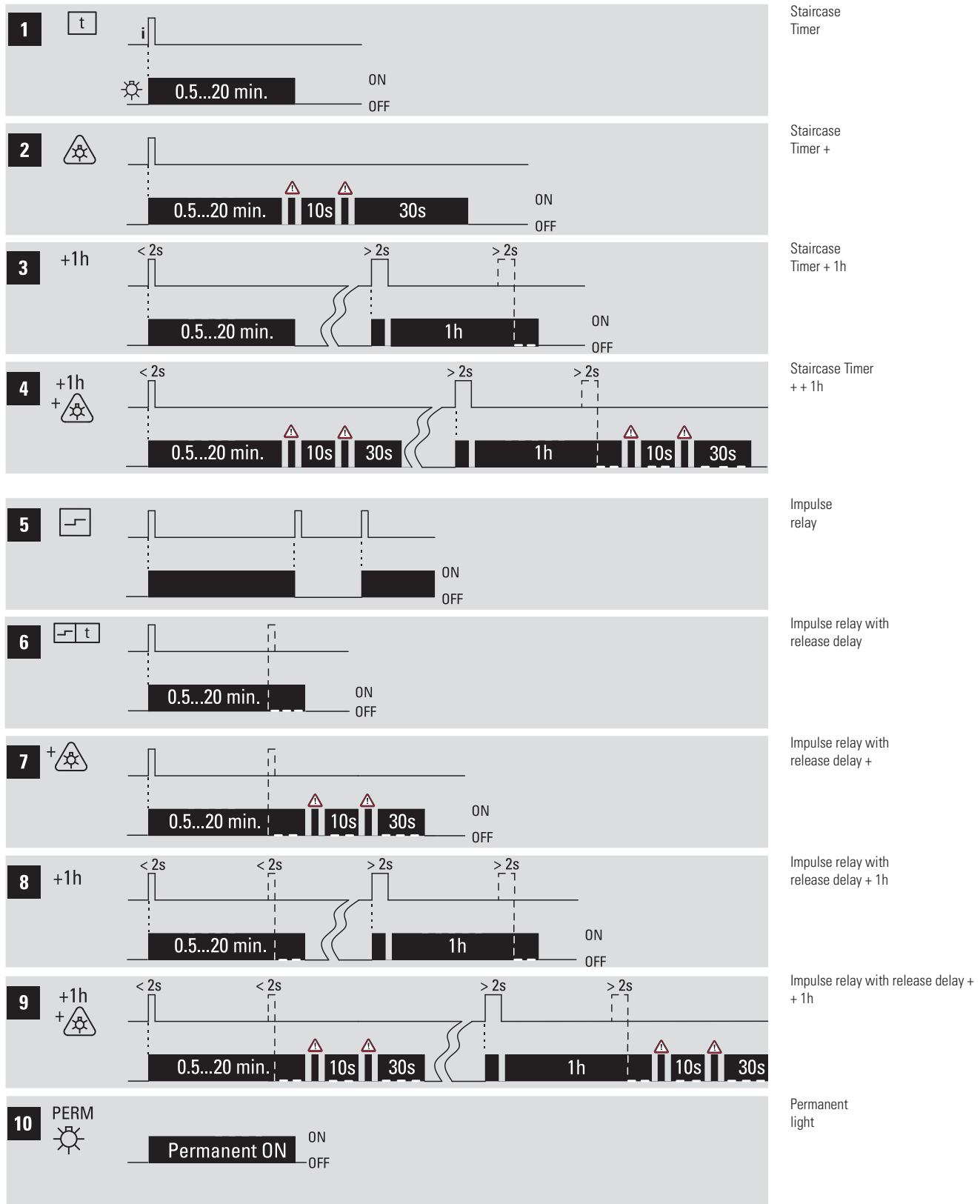

**Contactors type CR, technical data**

Products	Contactors				Aux. contact
Rating	20 A	25 A	40 A	63 A	6A
<b>General</b>					
Standards	IEC 60947-4-1, IEC 61095				IEC 60947-5-1
Nominal operating voltage 1-phase U <sub>e</sub> 1-ph.	230 V	230 V	230 V	230 V	230 V
Nominal operating voltage 3-phase U <sub>e</sub> 3-ph.	400 V	400 V	400 V	-	-
Overvoltage protection on coil	430 V (*5)	430 V (*5)	430 V	430 V	
Mechanical endurance (switching cycles)	3.000.000	3.000.000	3.000.000	3.000.000	3.000.000
Protection class (acc. DIN 40 050, IEC 529)	IP20	IP20	IP20	IP20	IP20
Permissible ambient temperature	-5...+55 °C	-5...+55 °C	-5...+55 °C	-5...+40 °C	-5...+55 °C
Storage temperature	-30...+80 °C	-30...+80 °C	-30...+80 °C	-30...+80 °C	-30...+80 °C
<b>Contact rating</b>					
Rated insulation voltage U <sub>i</sub>	440 V	440 V	500 V	500 V	500 V
Frequency	50/60 Hz	50/60 Hz	50/60 Hz	50/60 Hz	50/60 Hz
Rated impulse withstand voltage U <sub>imp</sub>	4 kV	4 kV	4 kV	4 kV	4 kV
Rated thermal current I <sub>th</sub>	20 A	25 A	40 A	63 A	6 A
AC1 / AC7a Rated operational current I <sub>e</sub>	20 A	25 A	40 A	63 A	-
AC1 / AC7a Operational power rating at U <sub>e</sub> = 230 Vac P <sub>max</sub>	4 kW	9 kW	16 kW	24 kW	-
AC1 / AC7a Operational power rating at U <sub>e</sub> = 400 Vac P <sub>max</sub>	16 kW	26 kW	40 kW	-	-
AC3 / AC7b Operational power rating at U <sub>e</sub> = 230 Vac P <sub>max</sub>	1,3 kW (*1)	2,2 kW	5,5 kW	8,5 kW	-
AC3 / AC7b Operational power rating at U <sub>e</sub> = 400 Vac P <sub>max</sub>	4 kW	11 kW	15 kW	-	-
DC1 Rated thermal current at U <sub>e</sub> = 24 Vdc I <sub>e</sub>	20 A	25 A	40 A	63 A	-
DC1 Rated thermal current at U <sub>e</sub> = 110 Vdc I <sub>e</sub>	1A	2A	4A	4A	-
DC1 Rated thermal current at U <sub>e</sub> = 220 Vdc I <sub>e</sub>	0,5 A	0,5 A	0,8 A	0,8 A	-
DC1 Rated thermal current at U <sub>e</sub> = 24 Vdc (2-poles in series) I <sub>e</sub>	20 A	25 A	40 A	63 A	-
DC1 Rated thermal current at U <sub>e</sub> = 110 Vdc (2-poles in series) I <sub>e</sub>	3 A	4 A	10 A	10 A	-
DC1 Rated thermal current at U <sub>e</sub> = 220 Vdc (2-poles in series) I <sub>e</sub>	1,5 A	1,5 A	6 A	6 A	-
DC1 Rated thermal current at U <sub>e</sub> = 24 Vdc (3-poles in series)	-	25 A	40 A	63 A	-
DC1 Rated thermal current at U <sub>e</sub> = 110 Vdc (3-poles in series)	-	6:00 AM	30 A	35 A	-
DC1 Rated thermal current at U <sub>e</sub> = 220 Vdc (3-poles in series)	-	2,5 A	20 A	30 A	-
<b>Electrical endurance</b>					
Maximum operating cycles at AC1 / AC7a application	200.000 x	200.000 x	100.000 x	100.000 x	-
Maximum operating cycles at AC3 / AC7b application	300.000 x	500.000 x	150.000 x	150.000 x	-
Maximum operating cycles at AC5a application	100.000 x	100.000 x	100.000 x	100.000 x	-
Maximum operating cycles at AC5b application	100.000 x (*2)	100.000 x (*2)	100.000 x (*3)	100.000 x (*4)	-
Maximum operating cycles per hour	600 x	600 x	600 x	600 x	600 x
Power dissipation per contact at I <sub>n</sub>	1,7 W	2,2 W	4 W	8 W	-
Maximum back-up fuse	25 A gL	35 A gL	63 A gL	80 A gL	-
Rating	20 A	25 A	40 A	63 A	6 A
<b>Operating coil (for combined ac/dc types only – CR.....)</b>					
Coil inrush power (for all voltage ratings)	2,5 W	3 W	5 W	5 W	-
Coil consumption (for all voltage ratings)	2,5 W	3 W	5 W	5 W	-
Closing delay	15-25 ms	15-30 ms	15-20 ms	15-20 ms	-
Opening delay	35-45 ms	50-80 ms	35-45 ms	35-45 ms	-
<b>Operating coil (for ac types only – CR.....A)</b>					
Coil inrush power (for all voltage ratings)	13 W / 15 VA	17 W / 27 VA	-	-	-
Coil consumption (for all voltage ratings)	2 W / 5 VA	1 W / 2.7 VA	-	-	-
Closing delay	15 ms	15-25 ms	-	-	-
Opening delay	10 ms	35-45 ms	-	-	-

**Contactors type CR, technical data (continued)**

Products	Contactors				Aux. contact
<b>Dimensions</b>					
Width	18 mm	35 mm	54 mm	54 mm	9 mm
Height	85 mm	85 mm	85 mm	85 mm	85 mm
Depth	60 mm	60 mm	60 mm	60 mm	60 mm
<b>Terminals for main &amp; auxiliary contacts</b>					
Terminal capacity – fine stranded wire	1.....6 mm <sup>2</sup>	1.....6 mm <sup>2</sup>	1.....16 mm <sup>2</sup>	1.....16 mm <sup>2</sup>	1....2,5 mm <sup>2</sup>
Terminal capacity – solid wire	1.....10 mm <sup>2</sup>	1.....10 mm <sup>2</sup>	1.....25 mm <sup>2</sup>	1.....25 mm <sup>2</sup>	1....2,5 mm <sup>2</sup>
Terminal screw size	M3,5	M3,5	M5	M5	M3
Terminal screw head type (Pozidrive)	PZ Size 1	PZ Size 1	PZ Size 2	PZ Size 2	PZ Size 1
Maximum torque	1,2 Nm	1,2 Nm	2,0 Nm	2,0 Nm	0,8 Nm
<b>Terminals for operating coils</b>					
Terminal capacity – fine stranded wire	1.....2,5 mm <sup>2</sup>	1.....2,5 mm <sup>2</sup>	1.....2,5 mm <sup>2</sup>	1.....2,5 mm <sup>2</sup>	
Terminal capacity – solid wire	1.....2,5 mm <sup>2</sup>	1.....2,5 mm <sup>2</sup>	1.....2,5 mm <sup>2</sup>	1.....2,5 mm <sup>2</sup>	
Terminal screw size	M3	M3	M3	M3	
Terminal screw head type (Pozidrive)	PZ Size 1	PZ Size 1	PZ Size 1	PZ Size 1	
Maximum torque	0,6 Nm	0,6 Nm	0,6 Nm	0,6 Nm	

## Remarks:

\*1) Only applicable for normally open contact(s)

\*2) At 1,5 kW

\*3) At 3 kW

\*4) At 5 kW

\*5) For CR.... types only (combined ac/dc types), NOT for CR...A types

**Contactors type CR, lamp load table**

Lighting Type	Lamp load (Watt)				Maximum number of fittings per contactor type
	CR 20	CR 25	CR 40	CR 63	
<b>Incandescent lamp</b>					
	15	86	110	228	480
	25	52	72	180	290
	40	32	50	122	195
	60	21	33	86	130
	75	17	26	69	104
	100	13	20	52	78
	150	8	13	34	52
	200	6	10	26	39
	250	5	8	20	31
	300	4	6	17	26
	500	2	4	10	15
	1000	1	2	5	7
<b>Energy saving lamp</b>					
	3	42	52	83	120
	5	42	52	83	120
	7	42	52	83	120
	9	36	45	72	104
	11	33	41	65	94
	15	30	37	59	85
	20	29	36	57	82
	23	28	35	56	81

**Contactors type CR, lamp load table (continued)**

Lighting Type	Lamp load (Watt)				Maximum number of fittings per contactor type
	CR 20	CR 25	CR 40	CR 63	
<b>Fluorescent lamp – conventional supply</b>					
Single fitting – Uncompensated (inductive)	18	22	24	90	140
	24	22	24	90	140
	36	17	20	65	95
	58	14	17	45	70
Single fitting – Compensated (capacitive)	18	7	8	48	73
	24	7	8	48	73
	36	7	8	48	73
	58	4	5	31	47
Double fitting – Series compensated	2 x 18	30	40	100	150
	2 x 24	24	31	78	118
	2 x 36	17	24	65	95
	2 x 58	10	14	40	60
<b>Fluorescent lamp – HF electronic</b>					
Single fitting – HF Electronic	18	25	31	49	71
	24	18	22	35	50
	36	14	17	27	39
	58	8	10	16	23
Double fitting – HF Electronic	2 x 18	12	15	24	35
	2 x 24	9	11	17	25
	2 x 36	7	8	13	19
	2 x 58	4	5	8	11
<b>Compact fluorescent lamp</b>					
Conventional supply	5	38	48	77	121
	7	27	34	54	86
	9	21	26	42	67
	11	17	21	35	55
Electronic supply	5	39	49	78	124
	7	39	49	78	124
	9	30	38	61	96
	11	25	31	50	79
<b>High pressure mercury vapour lamp</b>					
Uncompensated	50	14	18	38	55
	80	10	13	29	42
	125	7	9	20	29
	250	4	5	10	15
	400	2	3	7	10
Parallel compensated	50	4	5	31	47
	80	4	5	27	41
	125	3	4	22	33
	250	1	2	12	18
	400	1	1	9	13
<b>Halogen metal vapour lamp</b>					
Uncompensated	35	18	22	43	60
	70	10	12	23	32
	150	5	7	12	18
	250	3	4	7	10
	400	3	3	6	9
Parallel compensated	35	5	6	36	50
	70	2	3	18	25
	150	1	1	11	15
	250	-	1	6	9
	400	-	1	6	8

# 12.6

## Technical data

Control and switching devices dimensions and data

### Contactors type CR, lamp load table (continued)

Lighting Type	Lamp load (Watt)				Maximum number of fittings per contactor type
	CR 20	CR 25	CR 40	CR 63	
<b>Low pressure sodium vapour lamp</b>					
Uncompensated	18	22	27	71	90
	35	7	9	23	30
	55	7	9	23	30
	90	4	5	14	19
	135	3	4	10	13
	180	3	4	10	13
Parallel compensated	18	6	7	44	66
	35	1	1	11	16
	55	1	1	11	16
	90	1	1	8	12
	135	-	-	4	7
	180	-	-	4	7
<b>High pressure sodium vapour lamp</b>					
Uncompensated	150	5	6	17	22
	250	3	4	10	13
	400	2	2	6	8
	1000	-	1	3	3
Parallel compensated	150	1	1	11	16
	250	-	1	6	10
	400	-	-	4	6
	1000	-	-	2	3

**General remarks:**

- 1) In case a 4-pole contactor is used (3 ph. + neutral) the above mentioned quantity of lamps need to be multiplied by 1,5 to obtain the maximum quantity of fittings for the contactor. The total quantity of fitting need to be split equally across the 3 poles.
- 2) In case multiple contactors are installed in one panel it is required to multiply the above mentioned fittings by the applicable load factor according the IEC 60439-1.
- 3) It is recommended to install one spacer between each 2 contactors installed (eg contactor, contactor, spacer, contactor, etc.)



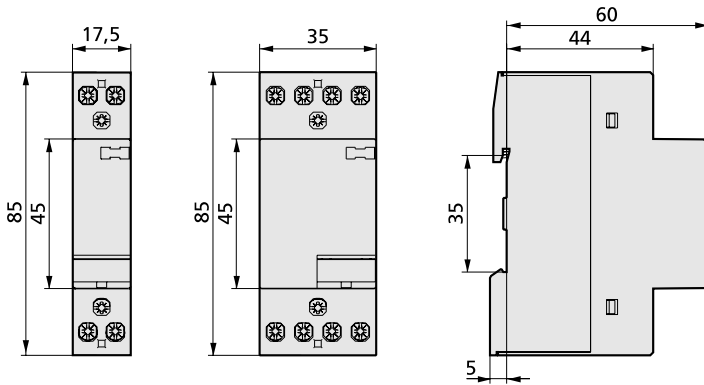

Contactors, type CR20, CR25

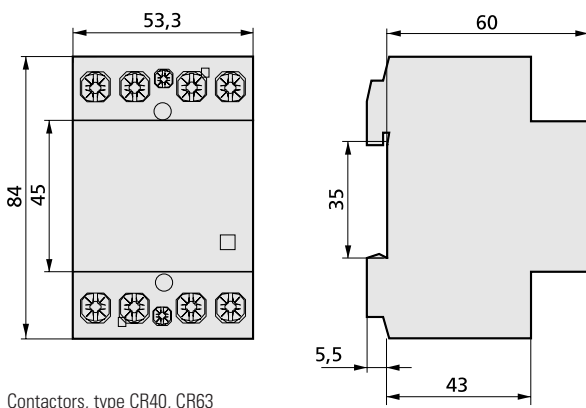

Contactors, type CR40, CR63

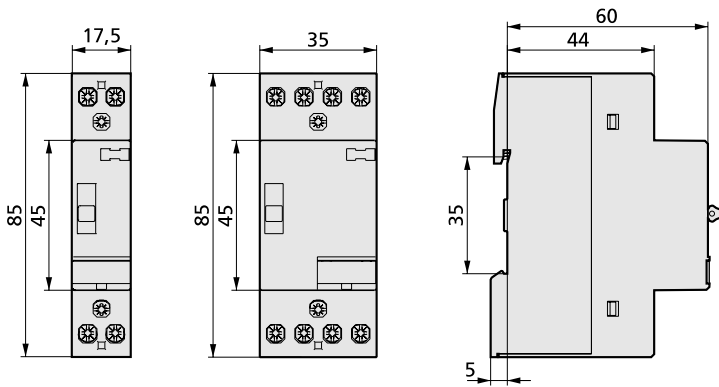

Day/Night contactors, type CRM20, CRM25

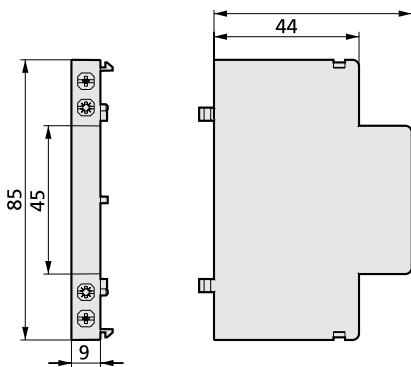

Auxiliary contact

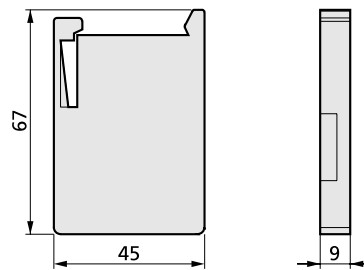

Spacer

# Index

## Eaton list number index

70040465.....	123	B621SS.....	14, 75	C9141.....	14, 63	C401NB.....	16, 68
70040466.....	123	B622SS.....	14, 75	C9511.....	14, 64	C421NB.....	16, 68
70040468.....	123	B632SS.....	15, 75	C9551.....	14, 64	C422NB.....	16, 68
800KMF.....	29, 143	B651SS.....	15, 75	C9552.....	14, 64	C425NB.....	16, 68
		B652SS.....	15, 75	C9751.....	14, 64	C621NB.....	14, 65
A9900HP.....	64	B901SS.....	17, 47, 80	C9111WH.....	63	C622NB.....	14, 65
A9900PB.....	64	B902SS.....	17, 47, 80	C9131WH.....	14, 63	C220NWH.....	16, 67
A9900SS.....	64	B903SS.....	17, 47, 80	C9132WH.....	14, 63	C221NWH.....	15, 67
ABP1.....	110, 112	B904SS.....	17, 47, 80	C9141WH.....	14, 63	C401NWH.....	16, 68
ADC6.....	110	B906SS.....	17, 80, 47	C9511WH.....	14, 64	C403NWH.....	16, 68
ADC8.....	110	B908SS.....	17, 80, 47	C9551WH.....	14, 64	C421NWH.....	16, 68
ADC10.....	110	B912SS.....	17, 80, 47	C9552WH.....	14, 64	C422NWH.....	16, 68
ADC14.....	110	B918SS.....	17, 80, 47	C9751WH.....	14, 64	C423NWH.....	16, 68
ADC18.....	110	B924SS.....	17, 80, 47	C111a.....	65	C424NWH.....	16, 68
ADCSL.....	110	BC-MP65.....	114	C011B.....	14, 63	C425NWH.....	16, 68
AN2.....	115, 135	BC-MP65-1/3.....	115, 135	C012B.....	14, 63	C426NWH.....	16, 68
AN25.....	115, 135	BC-MP65-1/5.....	115, 135	C013B.....	14, 63	C621NWH.....	14, 65
AN2D.....	115, 135	BC-MP65-1/9.....	115, 135	C014B.....	14, 63	C622NWH.....	14, 65
AN2EBD.....	115, 135	BL.....	17, 47, 63-71	C015B.....	14, 63	C011WH.....	14, 63
AN4EBLS.....	115, 135	BM.....	17, 47, 63-71	C017B.....	14, 63	C012WH.....	14, 63
				C021B.....	14, 63	C013WH.....	14, 63
B906.....	80	C011.....	14, 63	C022B.....	14, 63	C014WH.....	14, 63
B924.....	80	C012.....	14, 63	C023B.....	14, 63	C015WH.....	14, 63
B015HP.....	14, 74	C013.....	14, 63	C024B.....	14, 63	C017WH.....	14, 63
B017HP.....	14, 74	C014.....	14, 63	C026B.....	14, 63	C021WH.....	14, 63
B021HP.....	14, 74	C015.....	14, 63	C032B.....	14, 63	C022WH.....	14, 63
B022HP.....	14, 74	C017.....	14, 63	C041B.....	14, 63	C023WH.....	14, 63
B023HP.....	14, 74	C021.....	14, 63	C045B.....	14, 63	C024WH.....	14, 63
B048HP.....	14, 74	C022.....	14, 63	C047B.....	14, 63	C026WH.....	14, 63
B221HP.....	15, 76	C023.....	14, 63	C048B.....	14, 63	C032WH.....	14, 63
B621HP.....	14, 75	C024.....	14, 63	C111B.....	15	C041WH.....	14, 63
B622HP.....	14, 75	C026.....	14, 63	C112B.....	15, 65	C045WH.....	14, 63
B901HP.....	17, 47, 80	C032.....	14, 63	C220B.....	16, 67	C047WH.....	14, 63
B902HP.....	17, 47, 80	C041.....	14, 63	C221B.....	15, 67	C048WH.....	14, 63
B903HP.....	17, 47, 80	C045.....	14, 63	C305B.....	15, 65	C049WH.....	14, 63
B904HP.....	17, 47, 80	C047.....	14, 63	C351B.....	16, 70	C111WH.....	15
B906HP.....	17, 80	C048.....	14, 63	C352B.....	16, 70	C112WH.....	15, 65
B906HP*.....	47	C111.....	15	C353B.....	16, 70	C220WH.....	16, 67
B908HP.....	17, 80	C112.....	15, 65	C354B.....	16, 70	C221WH.....	15, 67
B908HP*.....	47	C212.....	16, 67	C355B.....	16, 70	C305WH.....	15, 65
B221NHP.....	15, 76	C220.....	16, 67	C356B.....	16, 70	C351WH.....	16, 70
B621NHP.....	14, 75	C221.....	15, 67	C359B.....	16, 70	C352WH.....	16, 70
B622NHP.....	14, 75	C305.....	15, 65	C360B.....	16, 70	C353WH.....	16, 70
B220NSS.....	16, 76	C351.....	16, 70	C361B.....	16, 70	C354WH.....	16, 70
B221NSS.....	15, 76	C352.....	16, 70	C362B.....	16, 70	C355WH.....	16, 70
B401NSS.....	16, 77	C353.....	16, 70	C363B.....	16, 70	C356WH.....	16, 70
B403NSS.....	16, 77	C354.....	16, 70	C370B.....	15, 66	C359WH.....	16, 70
B404NSS.....	16, 77	C355.....	16, 70	C401B.....	16, 68	C360WH.....	16, 70
B421NSS.....	16, 77	C356.....	16, 70	C415B.....	15, 66	C361WH.....	16, 70
B422NSS.....	16, 77	C359.....	16, 70	C425B.....	16, 68	C362WH.....	16, 70
B425NSS.....	16, 77	C360.....	16, 70	C461B.....	15, 66	C363WH.....	16, 70
B426NSS.....	16, 77	C361.....	16, 70	C621B.....	14, 65	C370WH.....	15, 66
B621NSS.....	14, 75	C362.....	16, 70	C622B.....	14, 65	C391WH.....	16, 69
B622NSS.....	14, 75	C363.....	16, 70	C632B.....	15, 65	C392WH.....	16, 69
B621RRSS.....	14, 75	C370.....	15, 66	C651B.....	15, 65	C401WH.....	16, 68
B622RRSS.....	14, 75	C391.....	16, 69	C652B.....	15, 65	C403WH.....	16, 68
B015SS.....	14, 74	C392.....	16, 69	C901B.....	17, 47, 71	C415WH.....	15, 66
B017SS.....	14, 74	C401.....	16, 68	C902B.....	17, 47, 71	C425WH.....	16, 68
B021SS.....	14, 74	C415.....	15, 66	C903B.....	17, 47, 71	C461WH.....	15, 66
B022SS.....	14, 74	C425.....	16, 68	C904B.....	17, 47, 71	C621WH.....	14, 65
B023SS.....	14, 74	C461.....	15, 66	C906B.....	17, 47, 71	C622WH.....	14, 65
B048SS.....	14, 74	C621.....	14, 65	C908B.....	17, 47, 71	C632WH.....	15, 65
B111SS.....	15, 75	C622.....	14, 65	C912B.....	17, 47, 71	C651WH.....	15, 65
B112SS.....	15, 75	C632.....	15, 65	C918B.....	17, 47, 71	C652WH.....	15, 65
B220SS.....	16, 76	C651.....	15, 65	C924B.....	17, 47, 71	C901WH.....	17, 47, 71
B221SS.....	15, 76	C652.....	15, 65	C111ba.....	65	C902WH.....	17, 47, 71
B305SS.....	15, 75	C901.....	17, 47, 71	C924 + CP924WH.....	44	C903WH.....	17, 47, 71
B351SS.....	16, 79	C902.....	17, 47, 71	C015LWH.....	14, 63	C904WH.....	17, 47, 71
B354SS.....	16, 79	C903.....	17, 47, 71	C220N.....	16, 67	C906WH.....	71
B355SS.....	16, 79	C904.....	17, 47, 71	C221N.....	15, 67	C908WH.....	71
B356SS.....	16, 79	C906.....	17, 47, 71, 80	C401N.....	16, 68	C918WH.....	47
B360SS.....	16, 79	C908.....	17, 47, 71	C421N.....	16, 68	C924WH.....	47
B361SS.....	16, 79	C912.....	17, 47, 71	C422N.....	16, 68	C111WHa.....	65
B370SS.....	15, 75	C918.....	17, 44, 47, 71	C425N.....	16, 68	CAAE-01/01.....	103
B391SS.....	16, 78	C924.....	17, 47, 71, 80	C621N.....	14, 65	CAAE-01/02.....	103
B392SS.....	16, 78	C9111.....	14, 63	C622N.....	14, 65	CBEU-02/01.....	102
B401SS.....	16, 77	C9131.....	14, 63	C220NB.....	16, 67	CBEU-02/02.....	103
B415SS.....	15, 75	C9132.....	14, 63	C221NB.....	15, 67	CBMA-02/01.....	102

CBTZ-00/01.....	100	CM221NR.....	67	CP011BM.....	63	CP011WH.....	63
CDAE-01/01.....	101	CM621NSB.....	64–65	CP220BM.....	67	CP012WH.....	63
CDAE-01/02.....	101	CM621NSS.....	64–65	CP351BM.....	64	CP013WH.....	63
CDAE-01/03.....	101	CM221NWM.....	67	CP360BM.....	70	CP014WH.....	63
CDAP-01/13.....	101	CM011PB.....	63	CP391BM.....	69	CP015WH.....	63
CDAU-01/02.....	56, 101	CM220PB.....	67	CP401BM.....	68	CP026WH.....	63
CHSZ-02/02.....	102	CM360PB.....	70	CP415BM.....	66	CP045WH.....	63
CHSZ-12/03.....	102	CM391PB.....	69	CP901BM.....	71	CP048WH.....	63
CM011.....	14–15, 63, 66	CM401PB.....	68	CP904BM.....	17, 47	CP049WH.....	63
CM012.....	14, 63	CM415PB.....	66	CP011GL.....	63	CP112WH.....	65
CM013.....	14, 63	CM901PB.....	71	CP220GL.....	67	CP220WH.....	67
CM014.....	14, 63	CM904PB.....	17, 47	CP351GL.....	64	CP221WH.....	67
CM015.....	14, 63	CM011SB.....	63	CP360GL.....	70	CP305WH.....	65
CM026.....	14, 63	CM220SB.....	67	CP391GL.....	69	CP351WH.....	63–64, 70
CM045.....	14, 63	CM360SB.....	70	CP401GL.....	68	CP352WH.....	70
CM048.....	14, 63	CM391SB.....	69	CP415GL.....	66	CP359WH.....	70
CM049.....	14, 63	CM401SB.....	68	CP901GL.....	71	CP360WH.....	70
CM111.....	15, 65	CM415SB.....	66	CP904GL.....	17, 47	CP370WH.....	66
CM112.....	15, 65	CM901SB.....	71	CP011GY.....	63	CP391WH.....	69
CM220.....	16, 67	CM904SB.....	17, 47	CP220GY.....	67	CP392WH.....	69
CM221.....	15, 67	CM011SS.....	63	CP351GY.....	64	CP401WH.....	68
CM305.....	15, 65	CM220SS.....	67	CP360GY.....	70	CP403WH.....	68
CM351.....	14, 16, 63–64, 70	CM360SS.....	70	CP391GY.....	69	CP415WH.....	66
CM352.....	16, 70	CM391SS.....	69	CP401GY.....	68	CP425WH.....	68
CM359.....	16, 70	CM401SS.....	68	CP415GY.....	66	CP461WH.....	66
CM360.....	16, 70	CM415SS.....	66	CP621GY.....	14	CP621WH.....	65
CM370.....	15, 66	CM901SS.....	71	CP632GY.....	15	CP622WH.....	65
CM391.....	16, 69	CM904SS.....	17, 47	CP901GY.....	17, 71	CP632WH.....	65
CM392.....	16, 69	CP011.....	14–15, 63, 66	CP902GY.....	17	CP652WH.....	65
CM401.....	16, 68	CP012.....	14, 63	CP903GY.....	17	CP901WH.....	71
CM403.....	16, 68	CP013.....	14, 63	CP904GY.....	17, 47	CP902WH.....	71
CM415.....	15, 66	CP014.....	14, 63	CP906GY.....	17	CP903WH.....	71
CM425.....	16, 68	CP015.....	14, 63	CP908GY.....	17	CP904WH.....	17, 47, 71
CM621.....	14–15, 65	CP026.....	14, 63	CP015L.....	14, 63	CP906WH.....	71
CM622.....	14, 65	CP045.....	14, 63	CP015LWH.....	63	CP908WH.....	71
CM632.....	15, 65	CP048.....	14, 63	CP220N.....	16, 67	CP912WH.....	71
CM901.....	17, 71	CP049.....	14, 63	CP221N.....	15	CP918WH.....	44, 71
CM901*.....	47	CP111.....	15, 65	CP401N.....	16, 68	CP924WH.....	71
CM902.....	17, 71	CP112.....	15, 65	CP403N.....	16, 68	CP111WHa.....	65
CM902*.....	47	CP220.....	16, 67	CP421N.....	16, 68	CP221WMWH.....	15, 67
CM903.....	17, 71	CP221.....	15, 67	CP422N.....	16, 68	CR2430.....	100
CM903*.....	47	CP305.....	15, 65	CP423N.....	16, 68	CR2002230.....	120
CM904.....	17, 71	CP351.....	14, 16, 63–64, 70	CP424N.....	16, 68	CR2011230.....	120
CM904*.....	47	CP352.....	16, 70	CP425N.....	16, 68	CR2020230.....	120
CM906.....	17, 71	CP359.....	16, 70	CP621N.....	14, 65	CR2504230.....	120
CM906*.....	47	CP360.....	16, 70	CP622N.....	14, 65	CR2522230.....	120
CM908.....	17, 71	CP370.....	15, 66	CP621NBL.....	65	CR2530230.....	120
CM908*.....	47	CP391.....	16, 69	CP621NBM.....	65	CR2540230.....	120
CM912.....	17, 71	CP392.....	16, 69	CP621NGL.....	65	CR4002230.....	120
CM912*.....	47	CP401.....	16, 68	CP221NGY.....	15	CR4020230.....	120
CM918.....	17, 71	CP403.....	68	CP422NGY.....	16	CR4030230.....	120
CM918*.....	47	CP415.....	15, 66	CP621NGY.....	65	CR4040230.....	120
CM924.....	17, 71	CP425.....	16, 68	CP221NR.....	67	CR6320230.....	121
CM924*.....	47	CP621.....	14–15, 65	CP221NRWH.....	15, 67	CR6340230.....	121
CM9111.....	14, 63	CP622.....	14, 65	CP621NSV.....	65	CR2002230A.....	120
CM9132.....	14, 63–64	CP632.....	15, 65	CP220NWH.....	67	CR2011230A.....	120
CM011HP.....	63	CP901.....	17, 71, 47	CP221NWH.....	67	CR2020230A.....	120
CM220HP.....	67	CP902.....	17, 71, 47	CP401NWH.....	68	CR2504230A.....	120
CM360HP.....	70	CP903.....	17, 71, 47	CP403NWH.....	68	CR2522230A.....	120
CM391HP.....	69	CP904.....	17, 71, 47	CP421NWH.....	68	CR2530230A.....	120
CM401HP.....	68	CP906.....	17, 71, 47	CP422NWH.....	68	CR2540230A.....	120
CM415HP.....	66	CP908.....	17, 71, 47	CP423NWH.....	68	CR2477N.....	103
CM901HP.....	71	CP912.....	17, 71, 47	CP424NWH.....	68	CRA611.....	121
CM904HP.....	17, 47	CP918.....	17, 71, 47	CP425NWH.....	68	CRA620.....	121
CM015L.....	14, 63	CP924.....	17, 71, 47	CP621NWH.....	65	CRC20.....	121
CM220N.....	16, 67	CP9111.....	14, 63	CP622NWH.....	65	CRC25.....	121
CM221N.....	15	CP9132.....	14, 63–64	CP221NWM.....	67	CRC63.....	121
CM401N.....	16, 68	CP9111WH.....	63	CP221NWMWH.....	15, 67	CRM2020230A.....	121
CM403N.....	16, 68	CP9132WH.....	63–64	CP221RW.....	15, 67	CRM2540230A.....	121
CM421N.....	16, 68	CP011BL.....	63	CP011SV.....	63	CRS.....	121
CM422N.....	16, 68	CP220BL.....	67	CP220SV.....	67	CSAE-01/01.....	100
CM423N.....	16, 68	CP351BL.....	64	CP351SV.....	64	CSAU-01/01.....	56, 100
CM424N.....	16, 68	CP360BL.....	70	CP360SV.....	70	CSAU-01/02.....	100
CM425N.....	16, 68	CP391BL.....	69	CP391SV.....	69	CSAU-01/03.....	100
CM621N.....	14, 65	CP401BL.....	68	CP401SV.....	68	EABP6.....	110, 112
CM622N.....	14, 65	CP415BL.....	66	CP415SV.....	66	EAD1.....	109, 129
CM621NHP.....	64–65	CP901BL.....	71	CP901SV.....	71	EAD4.....	109, 129
CM621NPB.....	64–65	CP904BL.....	17, 47	CP904SV.....	17, 47		

EAD6.....	109, 129	EAD6H80.....	129	EAS14H63H63DF.....	134	F4510.....	43
EAD8.....	109, 129	EAD8H63.....	129	EAS14H80H63DF.....	134	F4511.....	43
EAD12.....	109, 113, 129	EAD8H80.....	129	EAS14H80H80DF.....	134	F4530.....	38, 43
EAD16.....	109, 129	EAD6H80H632D.....	110, 130	EAS22H80H63DF.....	134	F4570.....	43, 91
EAD19.....	109, 129	EAD6H80H802D.....	110, 130	EAS22H80H80DF.....	134	F5002.....	88
EAD2/3.....	109, 129	EAD8H80H63D.....	110, 130	EAS34H80H63DF.....	134	F5006.....	88
EAD02B.....	116	EAD8H80H80D.....	110, 130	EAS34H80H80DF.....	134	F5099.....	43
EAD04B.....	116	EAD4M63.....	109, 130	EAS38L.....	111	F8342.....	47, 57
EAD06B.....	116	EAD4M80.....	109, 130	EAS2F.....	133	F8343.....	47, 57
EAD10B.....	116	EAD6M63.....	109, 130	EAS6F.....	133	F8344.....	47, 57
EAD13B.....	116	EAD6M80.....	109, 130	EAS2H40.....	111, 131	F8345.....	47, 57
EAD16B.....	116	EAD8M63.....	109, 130	EAS2H63.....	111, 131	F8351.....	47, 57
EAD20B.....	116	EAD8M80.....	109, 130	EAS6H63.....	111, 131	F8352.....	47, 57
EAD25B.....	116	EAM1002H.....	117	EAS6H80.....	111, 131	F8501.....	94
EAD32B.....	116	EAM1002L.....	117	EAS6H100.....	111, 131	F8502.....	94
EAD40B.....	116	EAM1002M.....	117	EAS6H100F.....	133	F8534.....	94
EAD50B.....	116	EAM1002RH.....	117	EAS8H63D.....	111, 131	F8540.....	94
EAD63B.....	116	EAM1002RL.....	117	EAS8H80D.....	111, 131	F8570.....	94
EAD06BH30C.....	117	EAM1002RM.....	117	EAS8H63DF.....	134	F8571.....	94
EAD10BH30C.....	117	EAM162H.....	117	EAS8H80DF.....	134	F8572.....	94
EAD16BH30C.....	117	EAM252H.....	117	EAS2H40F.....	133	F8573.....	94
EAD20BH30C.....	117	EAM402H.....	117	EAS2H63F.....	133	F8580.....	94
EAD25BH30C.....	117	EAM632H.....	117	EAS6H63F.....	133	F8581.....	94
EAD32BH30C.....	117	EAM802H.....	117	EAS6H80F.....	133	F8582.....	94
EAD40BH30C.....	117	EAM802L.....	117	EMS1001.....	116	F8583.....	94
EAD45BH30C.....	117	EAM252M.....	117	EMS1002.....	116	F8584.....	94
EAD02C.....	116	EAM402M.....	117	EMS1001N.....	116	F8601.....	95
EAD04C.....	116	EAM632M.....	117	EMS1001NR.....	116	F8602.....	95
EAD06C.....	116	EAM802M.....	117	F.....	111	F8603.....	95
EAD10C.....	116	EAM802RH.....	117	F1000.....	88	F8635.....	94
EAD13C.....	116	EAM802RL.....	117	F1001.....	88	F8640.....	95
EAD16C.....	116	EAM162V.....	117	F1025.....	88	F8641.....	95
EAD20C.....	116	EAS2.....	111, 131	F1026.....	88	F8671.....	95
EAD25C.....	116	EAS6.....	111, 131	F1030.....	88	F8672.....	95
EAD32C.....	116	EAS10.....	111, 131	F1031.....	88	F8681.....	95
EAD40C.....	116	EAS12.....	111, 131	F1045.....	88	F8682.....	95
EAD50C.....	116	EAS18.....	111, 131	F1046.....	88	F8684.....	95
EAD63C.....	116	EAS26.....	111, 131	F1091.....	88	F9000.....	48
EAD06CH30C.....	117	EAS38.....	111, 131	F1200.....	88-89	F9001.....	48
EAD10CH30C.....	117	EAS10DD.....	112, 132	F1250.....	88	F9004.....	48
EAD16CH30C.....	117	EAS16DD.....	112, 132	F1251.....	88	F9020.....	48
EAD20CH30C.....	117	EAS10DDF.....	134	F1260.....	90	F9021.....	48
EAD25CH30C.....	117	EAS16DDF.....	134	F1261.....	90	F9022.....	48
EAD32CH30C.....	117	EAS10F.....	133	F1262.....	90	F9023.....	48
EAD40CH30C.....	117	EAS12F.....	111, 133	F1263.....	90	F9024.....	48
EAD45CH30C.....	117	EAS18F.....	133	F1264.....	90	F9025.....	49
EAD10DD.....	130	EAS26F.....	133	F1266.....	90, 127	F9026.....	51
EAD14DD.....	130	EAS38F.....	133	F1267.....	90, 127	F9027.....	51
EAD12H80.....	129	EAS18FL.....	111	F1268.....	90, 127	F9028.....	51
EAD16H80.....	129	EAS10H100.....	111, 131	F1269.....	90, 127	F9029.....	48
EAD19H80.....	129	EAS12H100.....	111, 131	F1273.....	90, 127	F9030.....	48
EAD2/3H63.....	129	EAS18H100.....	111, 131	F1274.....	90, 127	F9031.....	51
EAD2/3H80.....	129	EAS10H100F.....	133	F1275.....	90, 127	F9032.....	49
EAD12H100.....	129	EAS12H100F.....	133	F1276.....	90, 127	F9033.....	48
EAD16H100.....	129	EAS18H100F.....	133	F1340.....	91	F9060.....	52
EAD19H100.....	129	EAS10H63D.....	111, 131	F1350.....	91	F9061.....	52
EAD10H80D.....	110, 130	EAS10H80D.....	111, 131	F1351.....	91	F9062.....	52
EAD14H80D.....	110, 130	EAS16H80D.....	111, 131	F1400.....	89	F9063.....	52
EAD17H80D.....	110, 130	EAS24H80D.....	111	F1450.....	89	F9064.....	53
EAD12H80H633D.....	110, 130	EAS24H80D.....	131	F1451.....	89	F9065.....	53
EAD12H80H803D.....	110, 130	EAS36H80D.....	111	F1491.....	89	F9066.....	53
EAD12H80H63D.....	110, 130	EAS36H80D.....	131	F1530.....	88	F9072.....	52
EAD12H80H80D.....	110, 130	EAS10H63DF.....	134	F3368.....	43, 83	F9073.....	52
EAD15H80H63D.....	110, 130	EAS10H80DF.....	134	F3780.....	55	F9076.....	52
EAD15H80H80D.....	110, 130	EAS16H80DF.....	134	F3781.....	55	F9077.....	53
EAD12M80.....	109, 130	EAS24H80DF.....	134	F3782.....	55	F9078.....	53
EAD16M80.....	109, 130	EAS36H80DF.....	134	F3783.....	55	F9079.....	53
EAD19M80.....	109, 130	EAS14H63H63D.....	112, 132	F3784.....	55	F9099.....	52
EAD2/3M63.....	109, 130	EAS14H80H63D.....	112, 132	F3785.....	55	F9201.....	50
EAD2/3M80.....	109, 130	EAS14H80H80D.....	112-113, 132	F3786.....	55	F9204.....	50
EAD12M100.....	109, 130	EAS22H80H63D.....	112	F3787.....	55	F9221.....	50
EAD16M100.....	109, 130	EAS22H80H63D.....	132	F3788.....	55	F9222.....	50
EAD19M100.....	109, 130	EAS22H80H80D.....	112	F3789.....	55	F9223.....	50
EAD11R.....	113, 130	EAS22H80H80D.....	132	F3790.....	55	F9224.....	50
EAD1H63.....	129	EAS34H80H63D.....	112	F4500.....	43	F9225.....	50
EAD4H63.....	129	EAS34H80H63D.....	132	F4501.....	43, 47	F9233.....	50
EAD4H80.....	129	EAS34H80H80D.....	112	F4502.....	43, 47	F9306.....	54
EAD6H63.....	129	EAS34H80H80D.....	132			F9313.....	54

F9314.....	54	F9023BTD.....	48	GL.....	17, 47, 63–71	P902.....	17, 44, 47
F9315.....	54	F9023BTR.....	48	GY.....	17, 47, 63–71	P903.....	17, 44, 47
F9317.....	54	F9023BWDR.....	48			P904.....	17, 44, 47
F9318.....	54	F9023BWH.....	48	HP.....	17, 47, 63–71	P906.....	17, 44, 47
F9400.....	56, 100	F9023BWM.....	48			P908.....	17, 44, 47
F9401.....	56, 100	F9023CH.....	48	L.....	111	P912.....	17, 44, 47
F9402.....	56, 100	F9025CH.....	49	LDU6.....	96	P999.....	17, 41
F9404.....	56, 100	F9023DW.....	48	LDU8.....	96	P9101.....	14, 36
F9061/24V.....	52	F9025DW.....	49	LDU10.....	96	P9111.....	14, 36
F9062/24V.....	52	F9023EF.....	48	LDU12.....	96	P9131.....	14, 36
F9063/24V.....	52	F9025EF.....	49			P9132.....	14, 36
F3780B.....	55	F9026EL.....	51	MBP.....	121	P9141.....	14, 36
F3781B.....	55	F9027EL.....	51			P9142.....	14, 36
F3782B.....	55	F9023FF.....	48	P011.....	14, 35	P9511.....	14, 36
F3783B.....	55	F9025FF.....	49	P012.....	14, 35	P9551.....	14, 36
F3784B.....	55	F9023FG.....	48	P013.....	14, 35	P9552.....	14, 36
F3785B.....	55	F9025FG.....	49	P014.....	14, 35	P9751.....	14, 36
F3786B.....	55	F9023FZ.....	48	P015.....	14, 35	P221BO.....	15, 39
F3787B.....	55	F9023HB.....	48	P017.....	14, 35	P221CH.....	15, 39
F3788B.....	55	F9025HB.....	49	P021.....	14, 35	P221CKH.....	15, 39
F3789B.....	55	F9025HE.....	49	P022.....	14, 35	P351D.....	16, 42
F3790B.....	55	F9023HH.....	48	P023.....	14, 35	P221DW.....	15, 39
F9001B.....	48	F9023LJ.....	48	P024.....	14, 35	P221EF.....	15, 39
F9004B.....	48	F9023MW.....	48	P026.....	14, 35	P221GY.....	15, 39
F9020B.....	48	F9025MW.....	49	P032.....	14, 35	P621GY.....	14, 37
F9021B.....	48	F9027N.....	51	P041.....	14, 35	P632GY.....	15, 37
F9022B.....	48	F9027NB.....	51	P042.....	14, 35	P901GY.....	17, 44, 47
F9023B.....	48	F9023OV.....	48	P045.....	14, 35	P902GY.....	17, 44, 47
F9024B.....	48	F1350PC.....	91	P047.....	14, 35	P903GY.....	17, 44, 47
F9025B.....	49	F9023PH.....	48	P048.....	14, 35	P904GY.....	17, 44, 47
F9026B.....	51	F9025PH.....	49	P049.....	14, 35	P906GY.....	17, 44, 47
F9027B.....	51	F9023PL.....	48	P111.....	15, 38	P908GY.....	17, 44, 47
F9028B.....	51	F9001RR.....	48	P112.....	15, 38	P015L.....	14, 35
F9030B.....	48	F9020RR.....	48	P210.....	16, 41	P043N.....	14, 35
F9031B.....	51	F9021RR.....	48	P212.....	16, 41	P220N.....	16, 39
F9033B.....	48	F9023RR.....	48	P220.....	16, 39	P221N.....	15, 39
F9060B.....	52	F9024RR.....	48	P221.....	15, 39	P223N.....	16, 39
F9061B.....	52	F9027RR.....	51	P223.....	15, 39	P401N.....	16, 40
F9064B.....	53	F9029RR.....	48	P224.....	16, 39	P403N.....	16, 40
F9065B.....	53	F9030RR.....	48	P345.....	16, 41	P404N.....	16, 40
F9066B.....	53	F9033RR.....	48	P351.....	16, 42	P421N.....	16, 40
F9072B.....	52	F9072RR.....	52	P352.....	16, 42	P422N.....	16, 40
F9073B.....	52	F9023TD.....	48	P353.....	16, 42	P423N.....	16, 40
F9077B.....	53	F9025TD.....	49	P354.....	16, 42	P424N.....	16, 40
F9078B.....	53	F9023TR.....	48	P355.....	16, 42	P425N.....	16, 40
F9079B.....	53	F9023WDR.....	48	P356.....	16, 42	P426N.....	16, 40
F9201B.....	50	F9025WDR.....	49	P357.....	16, 42	P427N.....	16, 40
F9204B.....	50	F9023WH.....	48	P360.....	16, 42	P621N.....	14, 37
F9221B.....	50	F9025WH.....	49	P361.....	16, 42	P622N.....	14, 37
F9222B.....	50	F9023WM.....	48	P362.....	16, 42	P632N.....	15, 37
F9223B.....	50	F9025WM.....	49	P370.....	15, 38	P651N.....	15, 37
F9224B.....	50	FL.....	111	P391.....	16, 41	P221NBO.....	15, 39
F9225B.....	50	FL321.....	96	P392.....	16, 41	P221NDW.....	15, 39
F9233B.....	50	FL331.....	96	P401.....	16, 40	P221NFF.....	15, 39
F9306B.....	54	FL341.....	96	P403.....	16, 40	P221NGY.....	15, 39
F9313B.....	54	FL351.....	96	P415.....	15, 38	P422NGY.....	16, 40
F9314B.....	54	FL421.....	96	P421.....	16, 40	P221NHO.....	15, 39
F9315B.....	54	FL431.....	96	P423.....	16, 40	P221NR.....	15
F9317B.....	54	FL441.....	96	P425.....	16, 40	P221NRR.....	15, 39
F9318B.....	54	FL451.....	96	P450.....	14, 35	P221NTD.....	15, 39
F9023BBB.....	48	FM8340.....	47, 57, 86	P611.....	14, 37	P221NWH.....	15, 39
F9023BCH.....	48	FM8341.....	47, 57, 86	P612.....	14, 37	P221NWM.....	15, 39
F9023BDW.....	48	FM8342.....	86	P621.....	14, 37	P015P.....	14, 35
F9023BEF.....	48	FM8344.....	86	P622.....	14, 37	P021P.....	14, 35
F9026BEL.....	51	FM8345.....	86	P632.....	15, 37	P041P.....	14, 35
F9027BEL.....	51	FM8349.....	47, 57	P651.....	15, 37	P045P.....	14, 35
F9023BFF.....	48	FM8350.....	47, 57	P652.....	15, 37	P221R.....	15, 39
F9023BFG.....	48	FP320.....	96	P672.....	15, 38	P621RED.....	14, 37
F9023BFZ.....	48	FP321.....	96	P686.....	15, 38	P632RED.....	15, 37
F9023BHB.....	48	FP330.....	96	P715.....	60	P220RR.....	16, 39
F9023BHH.....	48	FP331.....	96	P721.....	60	P221RR.....	15, 39
F9023BLI.....	48	FP340.....	96	P722.....	60	P621RR.....	14, 37
F9023BMW.....	48	FP341.....	96	P741.....	60	P622RR.....	14, 37
F9023BO.....	48	FP351.....	96	P742.....	60	P632RR.....	15, 37
F9025BO.....	49	FP421.....	96	P761.....	60	P652RR.....	15, 37
F9023BOV.....	48	FP431.....	96	P762.....	60	P221WM.....	15, 39
F9023BPH.....	48	FP441.....	96	P771.....	60	PB.....	17, 47, 63–71
F9023BPL.....	48	FP451.....	96	P901.....	17, 44, 47	PVSSUKV1.....	136

# Index

## Eaton list number index

PVSSUKV2.....	136	TE7.....	119	X361MG.....	16	X912MG.....	17, 47, 86
PVSSUKV3.....	136	TR-G3/8.....	121	X391MG.....	16, 86	X918MG.....	17, 47, 86
PVSSUKV4.....	114, 136			X392MG.....	16, 86	X924MG.....	17, 47, 86
SB.....	17, 47, 63–71	WH.....	17, 47, 63–71	X401MG.....	16, 82	X220NMG.....	16, 85
SS.....	17, 47, 63–71	X017MG.....	14, 82	X415MG.....	15, 84	X221NMG.....	15, 85
SV.....	17, 47, 63–71	X021MG.....	14, 82	X421MG.....	16	X401NMG.....	16, 82
TAD1.....	119	X022MG.....	14, 82	X621MG.....	14, 83	X421NMG.....	16, 82
TAD1NC.....	119	X023MG.....	14, 82	X622MG.....	14, 83	X621NMG.....	14, 83
TAD1NCS.....	119	X041MG.....	14	X632MG.....	15, 83	X622NMG.....	14, 83
TAD1S.....	119	X048MG.....	14, 82	X651MG.....	15, 83	X651NMG.....	15
TAW1.....	119	X049MG.....	14, 82	X652MG.....	15, 83	X221NRRMG.....	15, 85
TAW1S.....	119	X105MG.....	84	X686MG.....	15, 83	X220RRMG.....	16, 85
TDW1.....	119	X111MG.....	15, 83	X901MG.....	17, 47, 86	X221RRMG.....	15, 85
TDW2.....	119	X112MG.....	15, 83	X902MG.....	17, 47, 86	X621RRMG.....	14, 83
TDW2E.....	119	X220MG.....	16, 85	X903MG.....	17, 47, 86	X622RRMG.....	14
TDW1S.....	119	X221MG.....	15, 85	X904MG.....	17, 47, 86	X632RRMG.....	15, 83
TE1.....	119	X305MG.....	15, 84	X906MG.....	17, 47, 86	Z-S230/S.....	121
		X360MG.....	16	X908MG.....	17, 47, 86	Z-S230/S0.....	121
				X909MG.....	86		









# EAT•N

## The power of fusion.

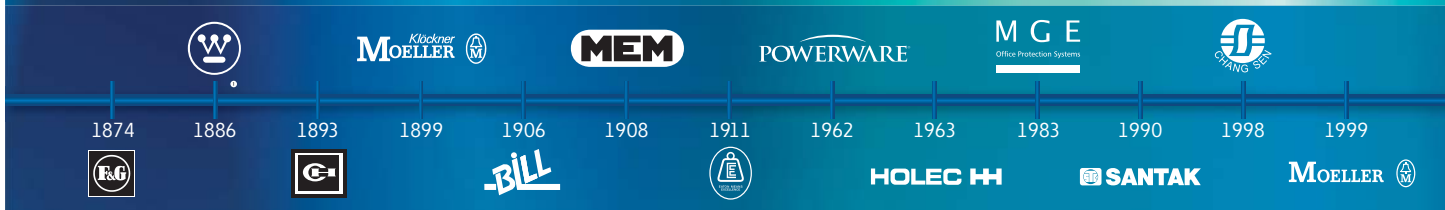

# EAT•N

Powering Business Worldwide

There's a certain energy at Eaton. It's the power of uniting some of the world's most respected names to build a brand you can trust to meet every power management need. The energy created supports our commitment to powering business worldwide.

From power distribution to power quality and control, Eaton allows you to proactively manage your complete power system by providing electrical solutions that make your applications safer, more reliable, and highly efficient. Visit [www.eaton.com/electrical](http://www.eaton.com/electrical).

All of the above are trademarks of Eaton Corporation or its affiliates. • Eaton has a license to use the Westinghouse brand name in Asia Pacific. ©2009 Eaton Corporation.

Eaton's Electrical Sector is a global leader in power distribution, power quality, control and automation, and monitoring products. When combined with Eaton's full-scale engineering services, these products provide customer-driven PowerChain Management® solutions to serve the power system needs of the data center, industrial, institutional, public sector, utility, commercial, residential, IT, mission critical, alternative energy and OEM markets worldwide.

PowerChain Management solutions help enterprises achieve sustainable and competitive advantages through proactive management of the power system as a strategic, integrated asset throughout its life cycle, resulting in enhanced safety, greater reliability and energy efficiency. For more information, visit [www.eaton.com/electrical](http://www.eaton.com/electrical).

**Eaton Electric Limited**  
Grimshaw Lane  
Middleton  
Manchester M24 1GQ  
United Kingdom  
Customer Support Centre  
Tel: +44 (0)8700 545 333  
Fax: +44 (0)8700 540 333  
email: [ukcommorders@eaton.com](mailto:ukcommorders@eaton.com)

© 2012 Eaton Corporation  
All Rights Reserved  
Printed in UK  
Form No. PG00400018U  
March 2012



*Powering Business Worldwide*

[www.eaton.com/uk](http://www.eaton.com/uk)