

Indicator light, 22mm, round, metal, red, lens with concentric rings with holder !!! Phased-out product !!! SIRIUS ACT 3SU1 is successor Preferred successor type is >>3SU1051-6AA20-0AA0 + 3SU1550-0AA10-0AA0<< !!! Phased-out product !!! SIRIUS ACT 3SU1 is suc Preferred successor ty >>3SU1051-6AA20-0AA0 + 3SU1550-0AA10-0AA0<<

Design of the product	Single device round
Enclosure	
Number of command points	0
Actuator	
Design of the operating mechanism	indicator light
Product extension optional Light source	Yes
Color	
• of the actuating element	red
Material of the actuating element	plastic
Shape of the actuating element	Concentric rings
Outer diameter of the actuating element	28 mm
Number of switching positions	0
Front ring	
Product component front ring	No
Holder	
Material of the holder	Metal
General technical data	

Product function	
• EMERGENCY OFF function	No
• EMERGENCY STOP function	No
Protection class IP	IP67
Vibration resistance	
• acc. to IEC 60068-2-6	20 ... 200 Hz: 5g
Reference code acc. to DIN 40719 extended according to IEC 204-2 acc. to IEC 750	H
Reference code acc. to DIN EN 81346-2	P
Reference code acc. to DIN EN 61346-2	P

Connections/ Terminals

Tightening torque of the screws in the bracket	1.4 ... 1.6 N·m
---	-----------------





Ambient conditions





Ambient temperature	
• during operation	-25 ... +70 °C
• during storage	-40 ... +80 °C
Environmental category during operation acc. to IEC 60721	3K6

Installation/ mounting/ dimensions

Mounting type	front mounting
Shape of the installation opening	round
Mounting diameter	22 mm
Mounting height	11 mm
Installation width	28 mm
Installation depth	29 mm

Certificates/ approvals

General Product Approval			Declaration of Conformity	Marine / Shipping
 CSA	 UL		 EG-Konf.	Miscellaneous  ABS

Marine / Shipping				other	
 LRS	 PRS	 RINA	 DNVGL.COM/AF	Miscellaneous	Confirmation

Railway
Special Test Certificate

Further information

Information- and Downloadcenter (Catalogs, Brochures,...)
<https://www.siemens.com/ic10>

Industry Mall (Online ordering system)
<https://mall.industry.siemens.com/mall/en/en/Catalog/product?mlfb=3SB3501-6BA20>

Cax online generator
<http://support.automation.siemens.com/WW/CAXorder/default.aspx?lang=en&mlfb=3SB3501-6BA20>

Service&Support (Manuals, Certificates, Characteristics, FAQs,...)
<https://support.industry.siemens.com/cs/ww/en/ps/3SB3501-6BA20>

Image database (product images, 2D dimension drawings, 3D models, device circuit diagrams, EPLAN macros, ...)
http://www.automation.siemens.com/bilddb/cax_de.aspx?mlfb=3SB3501-6BA20&lang=en

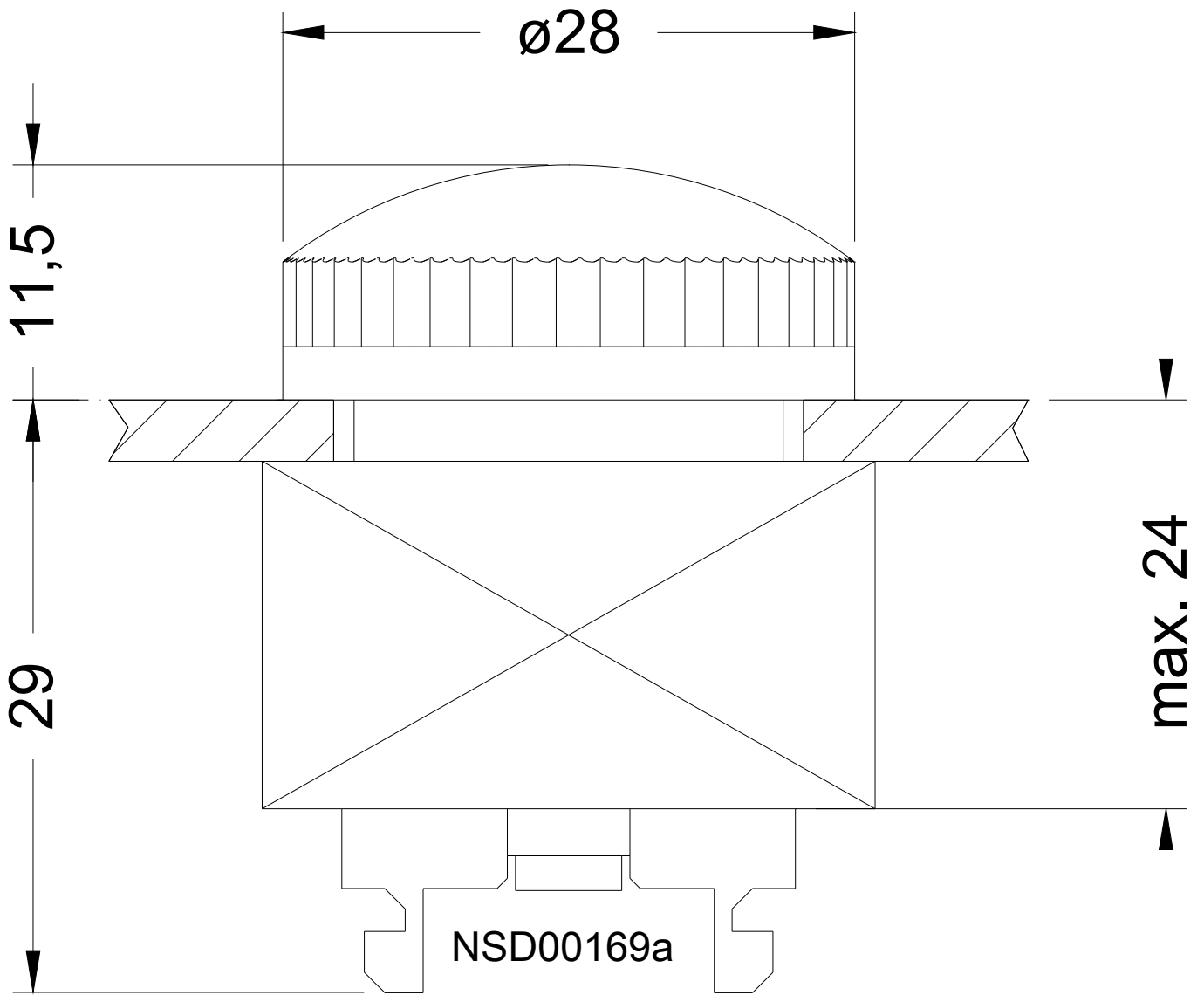

last modified:

05/15/2020