

# control, signalling and safety isolation transformers

## open type single phase (continued)

### ■ Dimensions

Fig. 1 : 40 to 400 VA

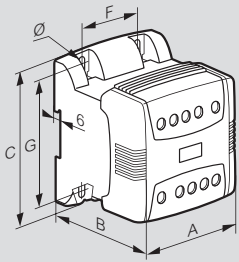

Fig. 2 : 630 to 1 000 VA

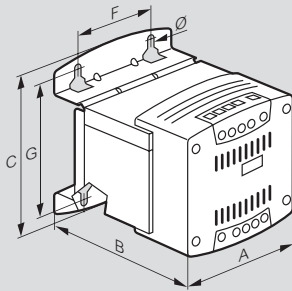

Fig. 3 : 1 600 to 2 500 VA

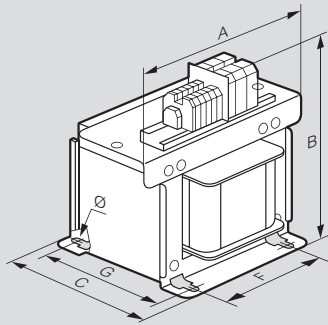
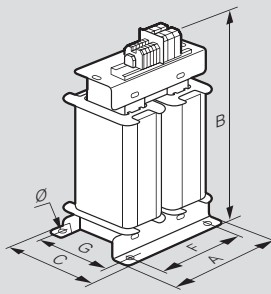

Fig. 4 : 4 000 to 8 000 VA



### ■ Electrical characteristics

Single phase 50-60 Hz - Class 1

Insulation voltage between windings : 4 510 V

Maximum ambient operating temperatures : 50 °C without derating

#### Voltage adjustment

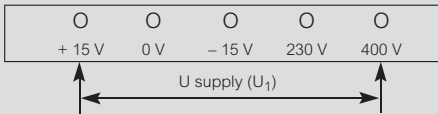

- 1) if  $U_1 > 230$  or  $400$  V
- 2) if  $I_2 < I_{2n}$  (if the load is less than the nominal load reduce the secondary voltage)

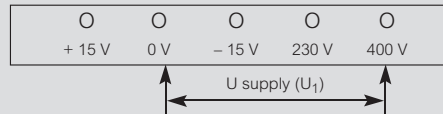

if  $U_1 = 230$  or  $400$  V with load  $I_2 = I_{2n}$

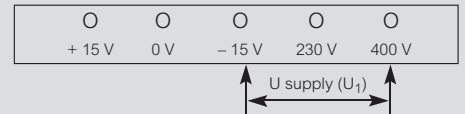

if  $U_1 < 230$  or  $400$  V with load  $I_2 = I_{2n}$

Cat. Nos.	Power (VA)	Admissible instantaneous power (VA) at cos φ of :									No-load loss (W)	On-load loss <sup>1</sup> (W)	Voltage drop as (%) with cos φ :			Efficiency (%) with cos φ :			Ucc (%)	Connection capacity			
		0.2	0.3	0.4	0.5	0.6	0.7	0.8	0.9	1			0.3	0.6	1	0.3	0.6	1		Primary cable (mm <sup>2</sup> ) flexible	Primary cable (mm <sup>2</sup> ) rigid	Secondary cable (mm <sup>2</sup> ) flexible	Secondary cable (mm <sup>2</sup> ) rigid
<b>Primary 230-400 V ± 15 V - Secondary 24-48 V</b>																							
0442 31	40	63	58	55	52	50	48	48	49	60	3.9	7.3	8.7	10.5	8.5	62	77	84	10.0	1 to 4	1 to 4	1 to 4	1 to 4
0442 32	63	110	102	94	87	83	79	77	78	91	6.0	14.2	7.5	9.4	8.5	57	73	82	9.0	1 to 4	1 to 4	1 to 4	1 to 4
0442 33	100	200	180	160	150	140	130	130	130	150	8.2	15.1	7.3	9.3	8.9	66	80	87	8.9	1 to 4	1 to 4	1 to 4	1 to 4
0442 34	160	340	300	270	250	230	220	210	210	230	11.2	24.6	5.8	7.6	7.7	66	80	87	7.2	1 to 4	1 to 4	1 to 4	1 to 4
0442 35	250	550	490	450	420	400	380	370	370	430	14.9	31.4	5.2	6.6	6.2	70	83	89	6.1	1 to 4	1 to 4	1 to 4	1 to 4
0442 36	400	1800	1300	1100	900	800	700	600	600	500	18.3	46.3	2.1	3.7	5.6	72	84	90	4.2	1 to 4	1 to 4	1 to 4	1 to 4
0442 37	630	2700	2200	1900	1700	1500	1300	1200	1200	1200	24.1	49.4	2.0	3.0	3.9	79	88	93	3.3	1 to 16	1 to 16	1 to 16	1 to 16
0442 38	1000	3400	2800	2300	2000	1800	1600	1500	1400	1300	44.2	74.4	1.3	1.9	2.9	80	89	93	2.4	1 to 16	1 to 16	1 to 16	1 to 16
0442 39	1600	12800	10900	9500	8500	7700	7100	6700	6400	6600	65.5	94.7	1.1	1.6	1.9	84	91	94	1.7	2.5 to 10	1.5 to 16	4 to 16	1.5 to 25
0442 40	2500	4300	3900	3600	3300	3100	3000	2900	2900	3400	86.5	143.4	1.8	2.2	2.0	84	91	95	1.9	4 to 16	1.5 to 25	4 to 35	2.5 to 50
<b>Primary 230-400 V ± 15 V - Secondary 115-230 V</b>																							
0442 61	40	62	57	53	50	48	47	46	47	57	3.9	7.4	8.7	10.5	8.8	62	76	84	10.1	1 to 4	1 to 4	1 to 4	1 to 4
0442 62	63	110	100	93	86	82	78	76	76	90	6.0	11.8	7.6	9.6	8.9	62	76	84	9.2	1 to 4	1 to 4	1 to 4	1 to 4
0442 63	100	200	180	160	150	140	140	130	130	150	8.2	17.3	7.2	9.2	8.6	63	78	85	8.7	1 to 4	1 to 4	1 to 4	1 to 4
0442 64	160	330	300	270	250	240	230	220	220	250	11.2	23.4	5.8	7.4	7.1	67	80	87	6.9	1 to 4	1 to 4	1 to 4	1 to 4
0442 65	250	560	510	460	430	410	390	380	370	430	14.9	31.7	5.2	6.6	6.2	70	83	89	6.1	1 to 4	1 to 4	1 to 4	1 to 4
0442 66	400	2200	1700	1400	1200	1000	910	830	760	730	18.3	43.9	2.1	3.6	5.2	73	85	90	4.1	1 to 4	1 to 4	1 to 4	1 to 4
0442 67	630	2700	2200	1800	1600	1400	1200	1100	1000	1000	24.1	53.2	2.1	3.3	4.5	78	88	92	3.6	1 to 16	1 to 16	1 to 16	1 to 16
0442 68	1000	3400	2800	2300	2000	1800	1600	1500	1400	1300	44.2	73.6	1.3	2.0	2.7	80	89	93	2.2	1 to 16	1 to 16	1 to 16	1 to 16
0442 69	1600	8700	7500	6600	6100	5400	5000	4700	4500	4700	65.5	95.3	1.1	1.5	1.8	83	91	94	1.5	2.5 to 10	1.5 to 16	2.5 to 10	1.5 to 16
0442 70	2500	9200	8300	7600	7100	6700	6300	6200	6100	7100	86.5	150.1	1.8	2.3	2.2	83	91	94	2.0	4 to 16	1.5 to 25	4 to 16	1.5 to 25
0442 71	4000	16500	14300	12700	11400	10500	9800	9200	8900	9500	87.4	234.8	2.1	2.9	3.3	84	91	94	2.7	4 to 16	1.5 to 25	4 to 16	1.5 to 25

1 : Total losses at nominal load

### ■ Fixing

On perforated plates Lina 25 and on Lina 12.5 plates **p. 23**

On symmetrical rail up to 250 VA

fixing centres pitch 25 mm up to 1000 VA

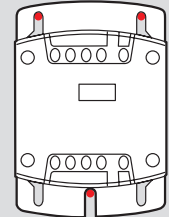
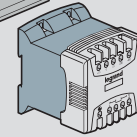
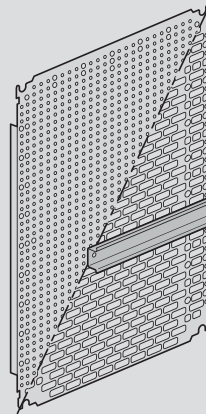

Oblong fixings : Attachment at 3 points possible

Cat. Nos.	Power (VA)	Fig.	Dimensions (mm)			Fixing <sup>1</sup> (mm)			Weight (Kg)
			A	B	C	F	G	Ø	
0442 31/61	40	1	94	78	113	50	100	5.2	1.23
0442 32/62	63	1	94	85	113	50	100	5.2	1.56
0442 33/63	100	1	94	94	113	50	100	5.2	1.95
0442 34/64	160	1	94	112	113	50	100	5.2	2.6
0442 35/65	250	1	106	123	115	50	100	5.2	3.82
0442 36/66	400	1	120	140	140	62.5	125	5.2	5.62
0442 37/67	630	2	150	158	206	100	175	7	9.9
0442 38/68	1000	2	150	199	206	100	175	7	14.9
0442 39/69	1600	3	220	245	191	150	153	9	25.6
0442 40/70	2500	3	300	292	171	200	114	9	33.1
0442 71	4000	4	230	340	205	180	130	11	31

Note : 40-250 VA transformers have juxtaposed windings with an insulated barrier to provide insulation and interference filtering. Higher ratings have an electrostatic screen between windings

1 : Up to 250 VA may be fixed to symmetrical DIN rail

# compact transformers

## open type single phase

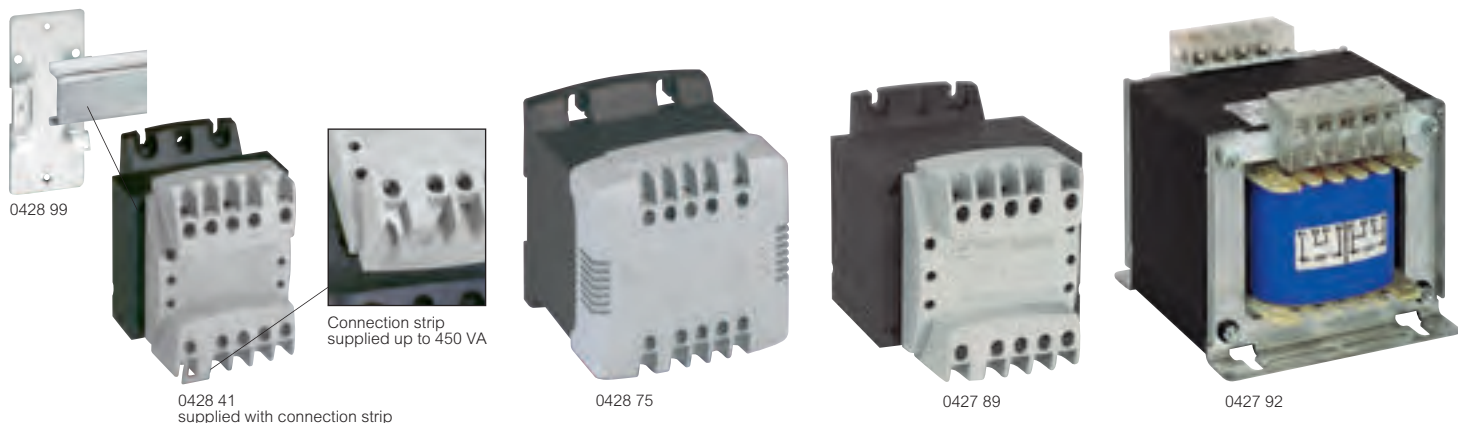

Technical information and dimensions p. 93  
Transformer protection p. 95

Isolating and safety isolating <math>< 50\text{ V}</math> transformers  
Designed to meet the needs of users with specific VA ratings such as original equipment manufacturers  
The terminals are designed to provide easy and quick connections  
Transformers up to 160 VA can be clipped to rail using accessory or directly fixed using screws through the easily accessible fixing points  
Multiple fixing possibilities :  
- clip to DIN rail using Cat. No. 0044 16 or 0428 99 ( $\leq 160\text{ VA}$ )  
- screw directly on to Lina 12.5 or Lina 25 mounting plate ( $\geq 220\text{ VA}$ )  
Recommended protection :  
• for 40 and 63 VA : Type T fuses (5x20) time delay fuse to IEC 60127  
• for  $>100\text{ VA}$  use MCB Type C

Pack	Cat. Nos.	Single phase	
		<b>Safety isolating transformers</b>	
		<b>Primary : 230-400 V Secondary : 12-24 V</b>	
		Power in VA according to IEC/EN	Admissible instantaneous power at $\cos \varphi 0.5$
1	0428 40	40 VA	55
1	0428 41	63 VA	91
1	0428 42	100 VA	140
1	0428 43	160 VA	205
1	0428 44	220 VA	290
1	0428 45	310 VA	345
1	0428 47	630 VA	1 520
		<b>Primary : 230-400 V Secondary : 24 V</b>	
		Power in VA according to IEC/EN	Admissible instantaneous power at $\cos \varphi 0.5$
1	0428 55	40 VA	55
1	0428 56	63 VA	91
1	0428 57	100 VA	140
1	0428 58	160 VA	205
1	0428 59	220 VA	290
1	0428 60	310 VA	345
1	0428 61	450 VA	1 100
1	0428 62	630 VA	1 520
		<b>Safety isolating transformers</b>	
		<b>Primary : 230-400 V Secondary : 24-48 V</b>	
		Power in VA according to IEC/EN	Admissible instantaneous power at $\cos \varphi 0.5$
1	0428 70	40 VA	55
1	0428 71	63 VA	80
1	0428 72	100 VA	150
1	0428 73	160 VA	160
1	0428 74	220 VA	290
1	0428 75	310 VA	345
1	0428 77	630 VA	1 520

Pack	Cat. Nos.	Single phase	
		<b>Isolating transformers</b>	
		<b>Primary : 230-400 V Secondary : 115 V With centre tap</b>	
		Power in VA according to IEC/EN	Admissible instantaneous power at $\cos \varphi 0.5$
1	6423 62	63 VA	91
1	6423 63	100 VA	140
1	6423 64	160 VA	205
1	6423 65	220 VA	290
1	6423 66	310 VA	345
1	6423 68	630 VA	1 520
		<b>Isolating transformers</b>	
		<b>Primary : 230-400 V Secondary : 115-230 V</b>	
		Power in VA according to IEC/EN	Admissible instantaneous power at $\cos \varphi 0.5$
1	0427 85	40 VA	55
1	0427 86	63 VA	91
1	0427 87	100 VA	140
1	0427 88	160 VA	205
1	0427 89	220 VA	290
1	0427 90	310 VA	345
1	0427 92	630 VA	1 520

Pack	Cat. Nos.	Accessories
10	0044 16	<b>Clips for fixing up to 160 VA on to rail EN 60715</b>
		Claw width 10 mm Threaded hole for M4 screws (Use two clips per transformer)
5	0428 99	<b>Mounting bracket</b> DIN rail mounting bracket

Modular transformers p. 102



Protection devices p. 56-64



Download the full file at

<http://assets.kempstoncontrols.com/doc/Legrand%20Industrial%20and%20power%20protection%20catalogue.pdf>



**KEMPSTON**  
CONTROLS