

R-SERIES REFLECTORS

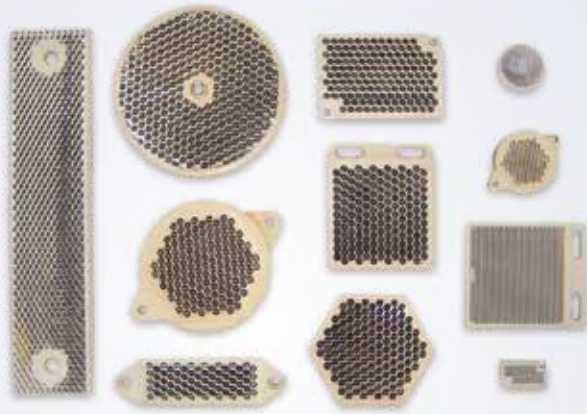

EXCELLENT PERFORMANCE WITH INFRARED, RED LIGHT AND POLARIZED EMISSION

- Prismatic reflectors for retroreflective sensors
- High efficiency models for long operating distances
- Microprism reflectors for sensors with LASER emission
- Self-adhesive reflectors and reflector tape

APPLICATIONS

- Automated warehousing
- Processing and Packaging machinery
- Industrial vehicles
- Automotive



REFLECTORS

Prismatic reflector material	Reflector in PMMA plastic
Support material	Support in ABS
Reflective tape	Polyester
Mechanical protection	IP67, IP69K (R4K)
Operating temperature	-30 ... +70°C

MODELS	DESCRIPTION	ORDER No.
R1	Ø 23 mm with Ø 31 mm support	S940700023
R2	Ø 48 mm with Ø 63 mm support	S940700048
R3	18 x 54 mm with 22 x 82 mm support	S940700972
R4	47x 47 mm with 51.5 x 61 mm support	95A151340
R4K	51X61 mm IP69K protection	95A151220
R5	Ø 75 mm with Ø 82 mm support	S940700075
R6	36 x 55 mm with 40.5 x 60 mm support	95A151350
R7	47x47 mm microprism reflector with 51 x 61 mm support	95A151360
R8	9.7 x 19 mm microprism reflector with 13.8 x 23 mm support	95A151370
R9	Ø 23 mm with Ø 25 mm self-adhesive support	95A151080
R10	36 x 176 mm with 41 x 181 mm support	S19120000
R11	146 x 15 mm with 150 x 18 mm support	95A155050
R12	R12 PRISMATIC REFLECTOR-100 X 100 mm	95A155060
R13	R13 PLASTIC REFLECTOR 20x32 mm	95A151300
R14	Ø 24 mm with Ø 25 mm support	95A151310
R15	REFLECTOR 60x19,2m M142-20	95A151290
R16	9.7 x 19 mm reflector with 14 x 23 mm support	95A151330
R20	Ø 48 mm microprism reflector with Ø 63 mm support	95A151090
R35	Ø 33 mm with Ø 35 mm support	95A151530
R100	19 x 35 mm reflector with 24 x 48 mm support	95ACC7990
RT3870	200 x 300 mm self-adhesive reflective tape	S940000600
RT3970	200 x 300 mm self-adhesive reflective tape for polarized light	S940000900
RT3970	60 x 40 mm self-adhesive reflective tape for polarized light	S940000604

DIMENSIONS

R1

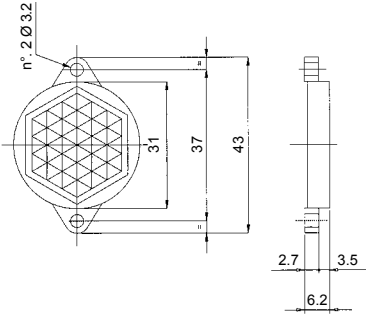

R2 / R20

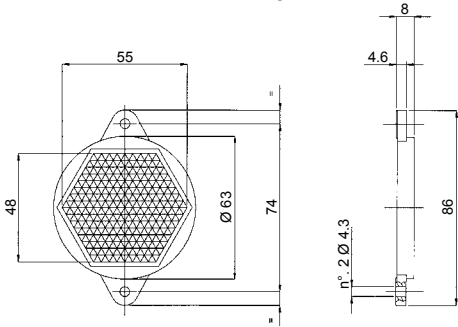

R3

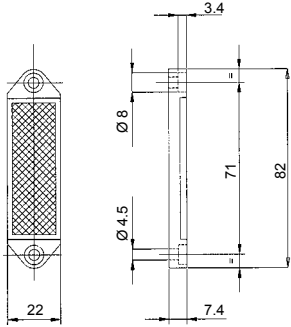

R4

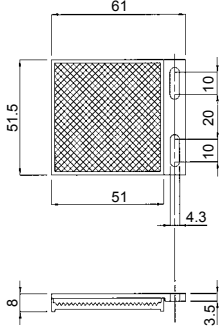

R5

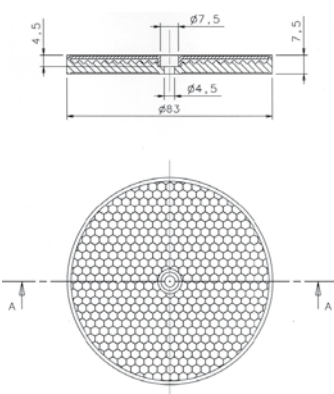

R6

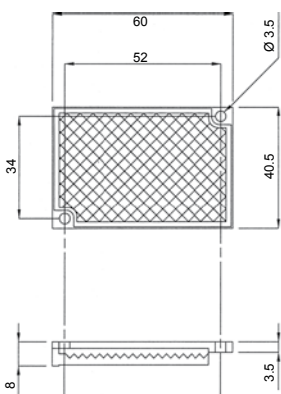

R7

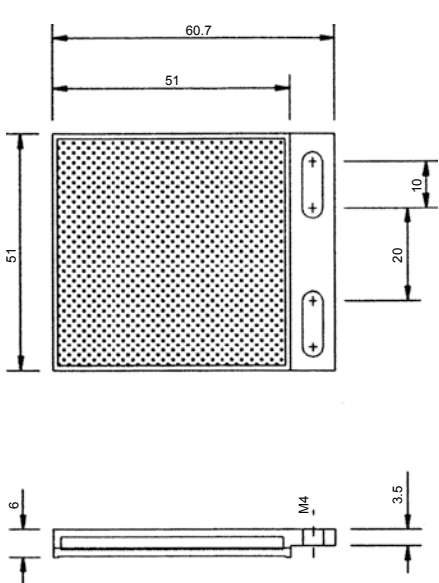

R8

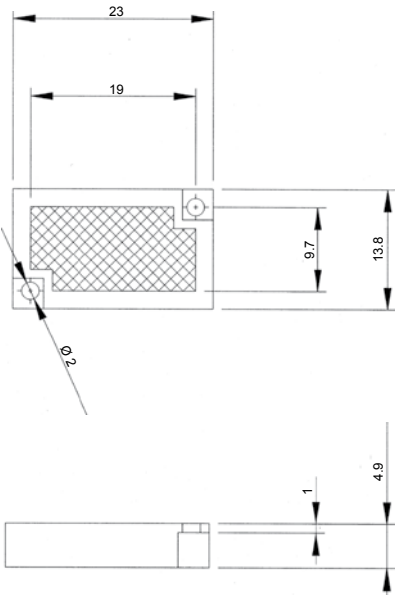

R9

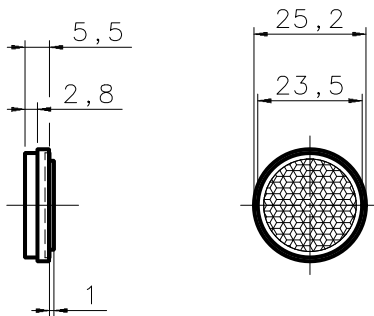

mm

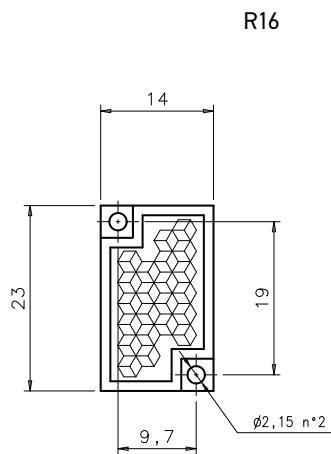
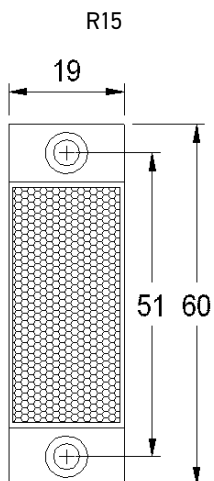
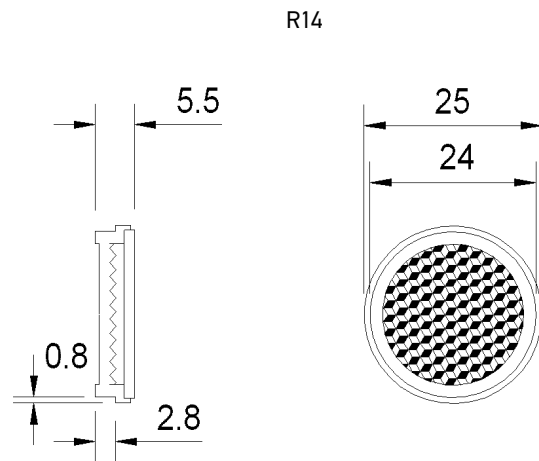
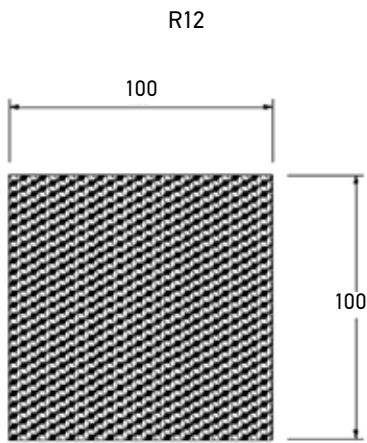
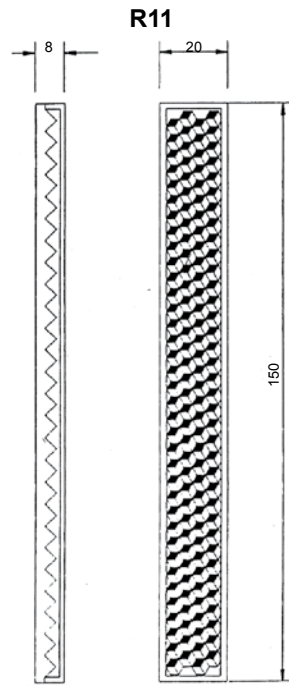
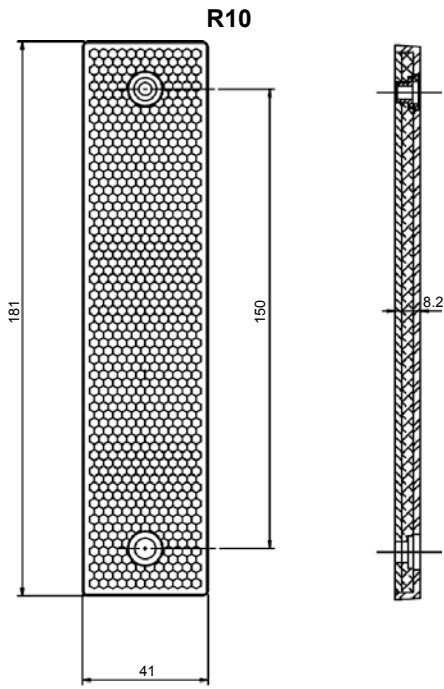

R35

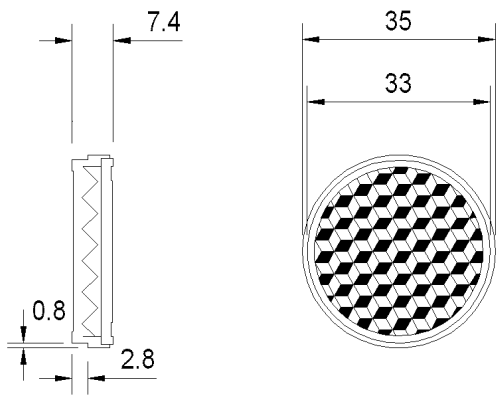

R100

