

Square Body DC Fuses — 750Vdc: 63-500A

750Vdc 63-500A

Specifications

Description: High speed fuses, for the protection of DC circuits in equipment.

Dimensions: See dimensions illustration.

Ratings:

Volts: — 750Vdc

Amps: — 63-500A

IR: — 750Vdc IR: 100kA, L/R = 100 ms.

— 1000Vdc IR: 100kA, L/R = 40 ms

Agency Information: Consult Cooper Bussmann.

Electrical Characteristics

Arc Voltage

This curve gives the peak arc voltage, U_L , which may appear across the fuse during its operation as a function of the applied working voltage E_g .

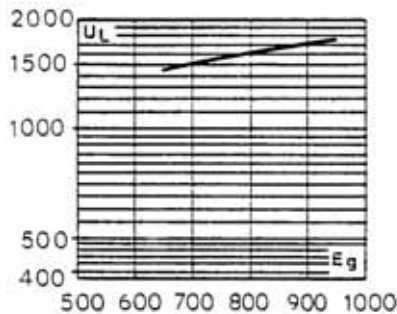

Power Losses

Watts loss at rated current is given in the electrical characteristics. The curve allows the calculation of the power losses at load currents lower than the rated current. The correction factor, K_p , is given as a function of the RMS load current, I_b , in % of the rated current.

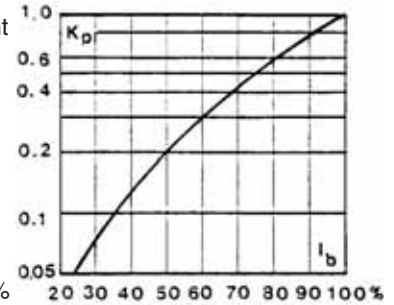

Features and Benefits

- Excellent DC performance
- Low arc voltage and low energy let-through (I^2t)
- Low watts loss
- Superior cycling capability

Typical Applications

- DC common bus
- DC drives
- Power converters/rectifiers
- Reduced voltage starters

Catalog Numbers

Fuse Size	Catalog Numbers		Electrical Characteristics		
	-BK/130	-EK/-	Rated Voltage (Vdc)	Rated Current RMS-Amp	Watt Loss (W)
1*	170E3577	170E3583	750	63	10.0
	170E3578	170E3584		80	13.0
	170E3579	170E3585		100	16.0
	170E3580	170E3586		125	21.0
	170E3581	170E3587		160	26.0
1	170E5417	170E5420		200	37.0
	170E5418	170E5421		250	46.0
2	170E8335	170E8345		250	47.0
	170E8336	170E8346		315	57.0
	170E8337	170E8347		400	73.0
3	170E9681	170E9685		500	91.0

Data Sheet: Size 1*: 170K3620
 Size 1: 170K3622
 Size 2: 170K3624
 Size 3: 170K3626
 Microswitch: 170H0069, 170H3027 (gold)

Square Body DC Fuses — 750Vdc: 63-500A

Square Body DC Fuses 750Vdc / 63 - 500A

(mm):

Type -BK/130

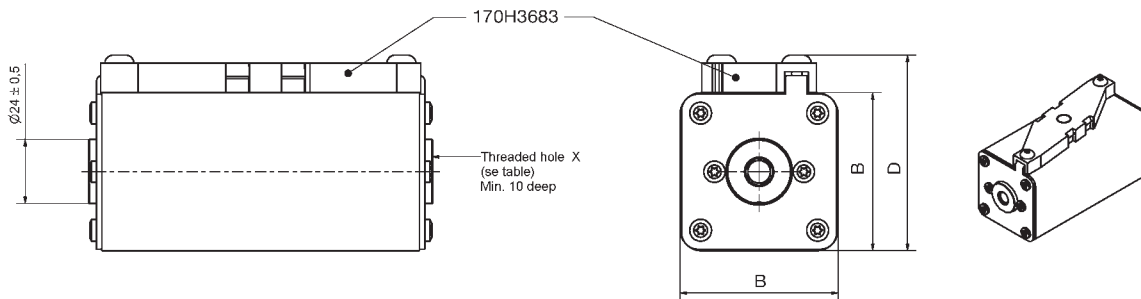

Size/Type	A	B	D
1* BK/130	129	43	61
1 BK/130	130	51	69
2 BK/130	130	59	77
3 BK/130	131	74	90

Type -EK/-

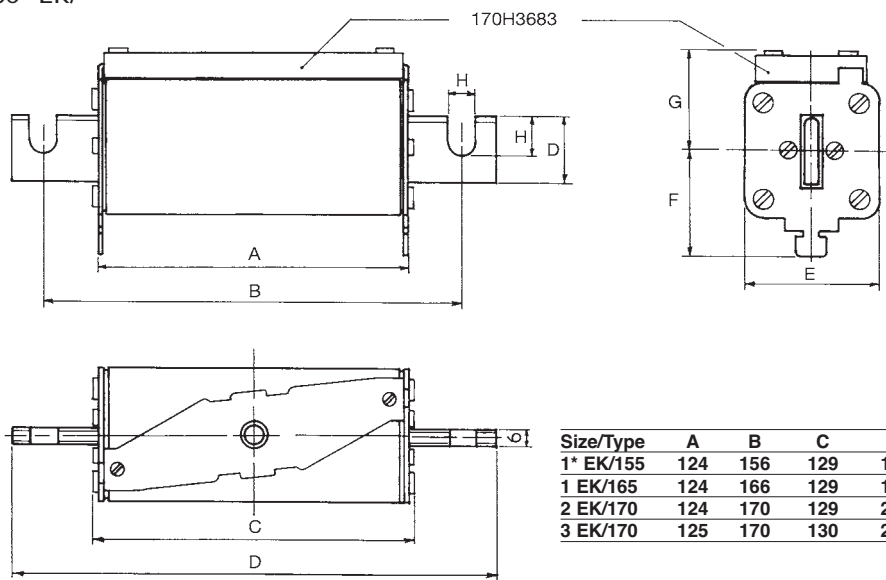

Size/Type	A	B	C	D	E	F	G	H	I	J
1* EK/155	124	156	129	180	43	36	41	9	9	18
1 EK/165	124	166	129	191	51	37	41	11	14	25
2 EK/170	124	170	129	205	59	42	48	13	21	30
3 EK/170	125	170	130	206	74	51	56	13	20	36

High Speed Fuses

Square Body DC Fuses — 750Vdc: 63-500A

Square Body DC Fuse — 63-160A: 750V
Time-Current Curve

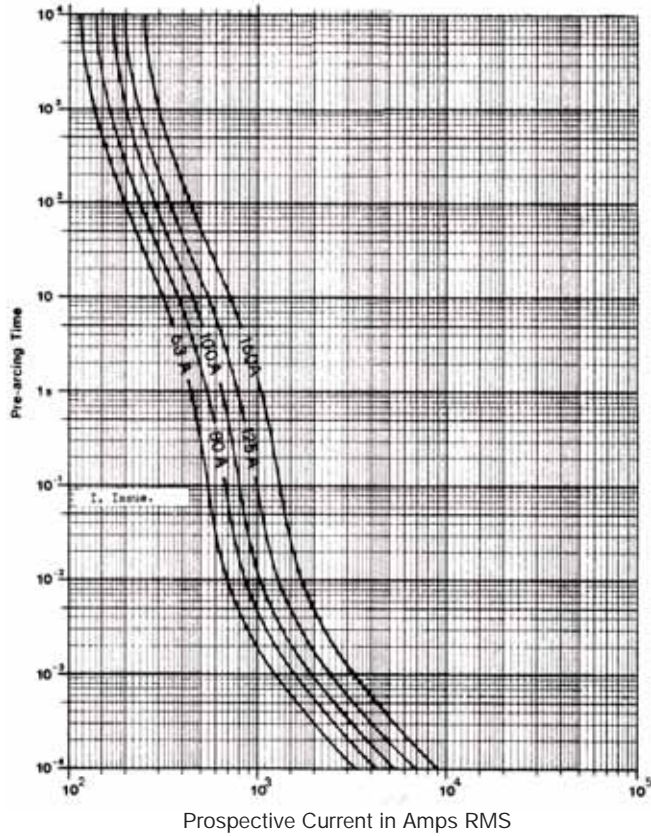

Square Body DC Fuse — 200-250A: 750V
Time-Current Curve

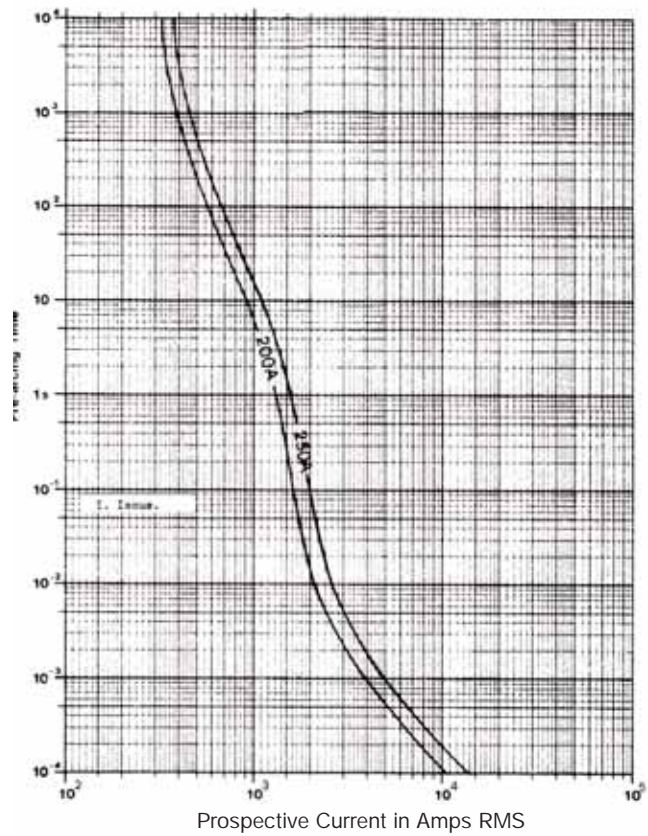

Peak Let-Through Curve

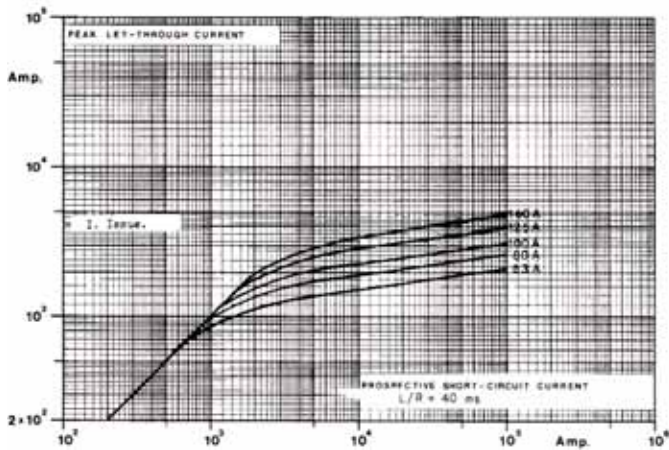

Peak Let-Through Curve

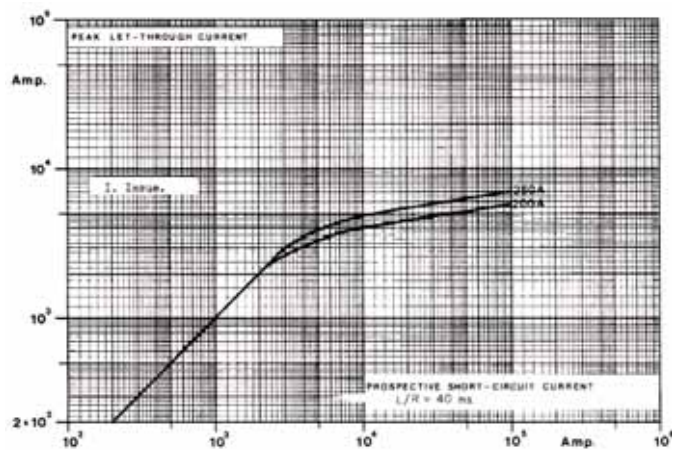

Data Sheet: Available upon request

Data Sheet: Available upon request

Square Body DC Fuses — 750Vdc: 63-500A

Square Body DC Fuse — 250-400A: 750V
Time-Current Curve

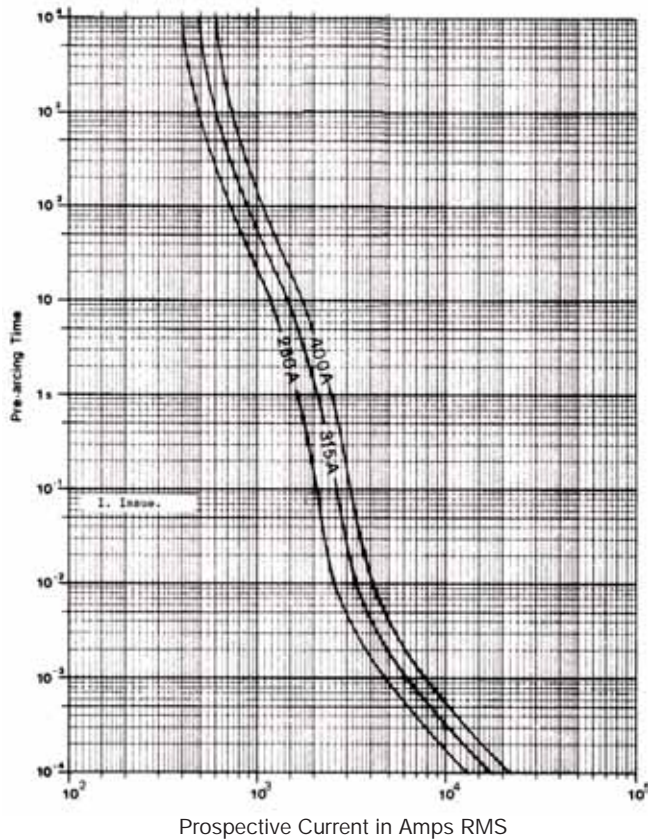

Square Body DC Fuse — 500A: 750V
Time-Current Curve

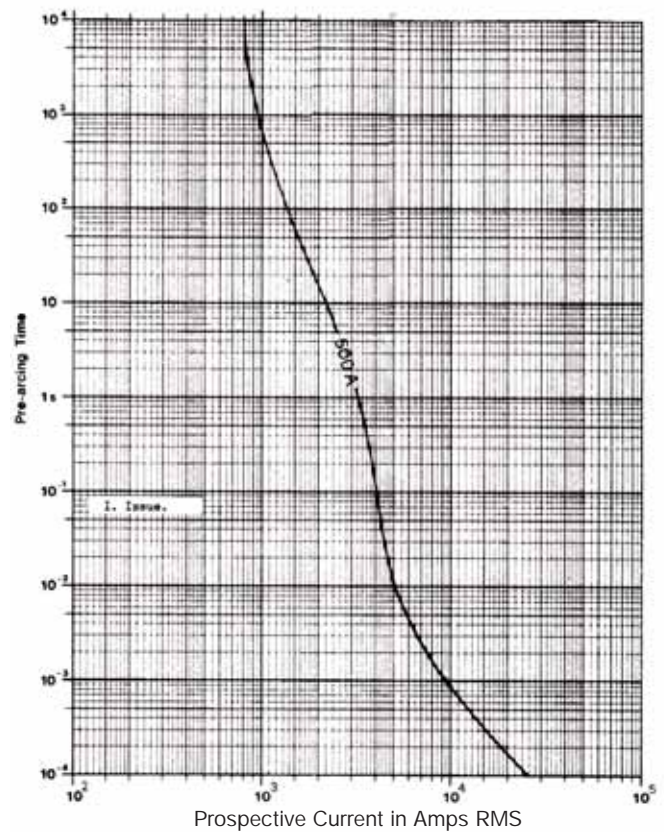

High Speed Fuses

Peak Let-Through Curve

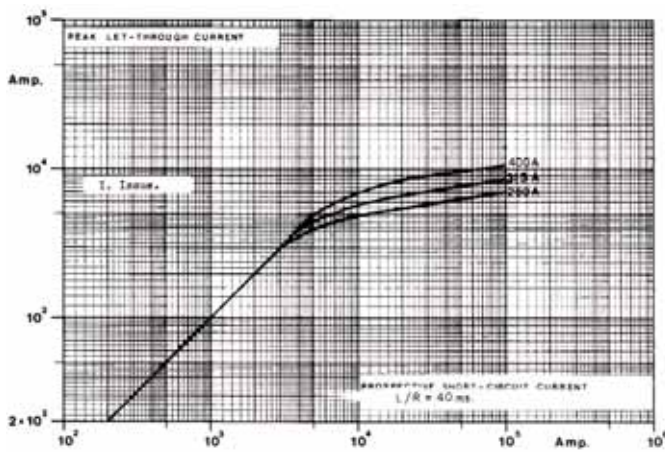

Peak Let-Through Curve

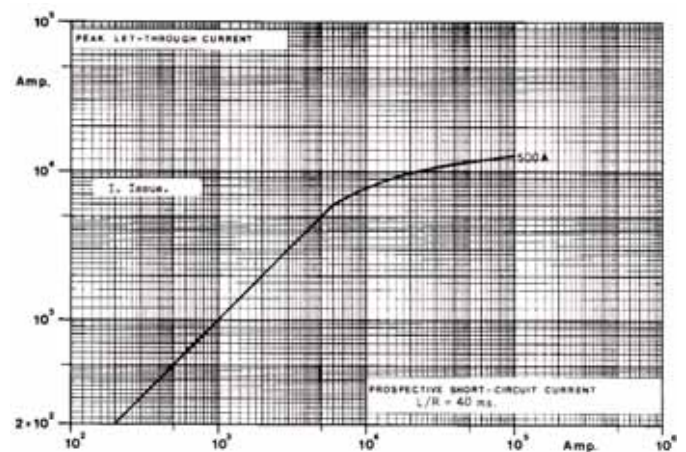

Data Sheet: Available upon request

Data Sheet: Available upon request