

Safety momentary-contact foot switch 1-pedal, with protective cover, IP65, with interlock function, 2 NO+2 NC, NO contact, closes as pushbutton, NC contact, opens with simultaneous latching (safety function), cable entry M20 x 1.5



Product designation	safety foot switch
Suitability for use safety switch	Yes

General technical data	
Protection class IP	IP65
Reference code acc. to DIN EN 81346-2	S
Reference code acc. to DIN EN 61346-2	S
Number of switching steps	2
Number of the actuation pedals	1
Minimum actuating force in activation direction	240 N
Number of NC contacts for auxiliary contacts	2
Number of NO contacts for auxiliary contacts	2
Operating current at AC-15	
• at 230 V rated value	16 A
• at 400 V rated value	16 A
Operating current at DC-13	
• at 24 V rated value	3 A
• at 250 V rated value	0.25 A

Enclosure

Material of the enclosure	metal
Color	
• of the enclosure	black
• of top part of the enclosure	grey

Actuator

Product feature	
• interlock	Yes
• Latching	No

Safety related data

B10 value	
• with high demand rate acc. to SN 31920	100 000
Proportion of dangerous failures	
• with low demand rate acc. to SN 31920	50 %
• with high demand rate acc. to SN 31920	50 %
Failure rate [FIT]	
• with low demand rate acc. to SN 31920	100 FIT
T1 value for proof test interval or service life acc. to IEC 61508	20 y
Cable entry type	M20 x 1.5

Installation/ mounting/ dimensions

Height	138 mm
Width	156 mm
Depth	265 mm

Certificates/ approvals

General Product Approval	Declaration of Conformity
---------------------------------	----------------------------------



[Miscellaneous](#)

Test Certificates	Marine / Shipping	other
--------------------------	--------------------------	--------------

[Miscellaneous](#)



[Confirmation](#)

Further information

Information- and Downloadcenter (Catalogs, Brochures,...)

www.siemens.com/sirius/catalogs

Industry Mall (Online ordering system)

<https://mall.industry.siemens.com/mall/en/en/Catalog/product?mlfb=3SE2924-3AA20>

Cax online generator

<http://support.automation.siemens.com/WW/CAXorder/default.aspx?lang=en&mlfb=3SE2924-3AA20>

Service&Support (Manuals, Certificates, Characteristics, FAQs,...)

<https://support.industry.siemens.com/cs/ww/en/ps/3SE2924-3AA20>

Image database (product images, 2D dimension drawings, 3D models, device circuit diagrams, EPLAN macros, ...)

http://www.automation.siemens.com/bilddb/cax_de.aspx?mlfb=3SE2924-3AA20&lang=en

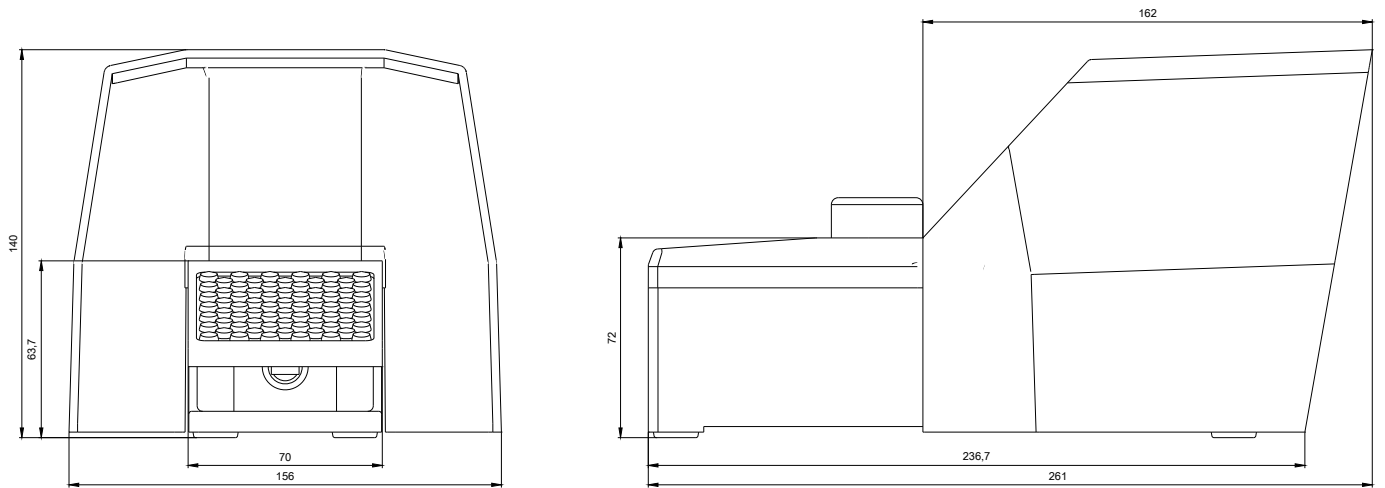

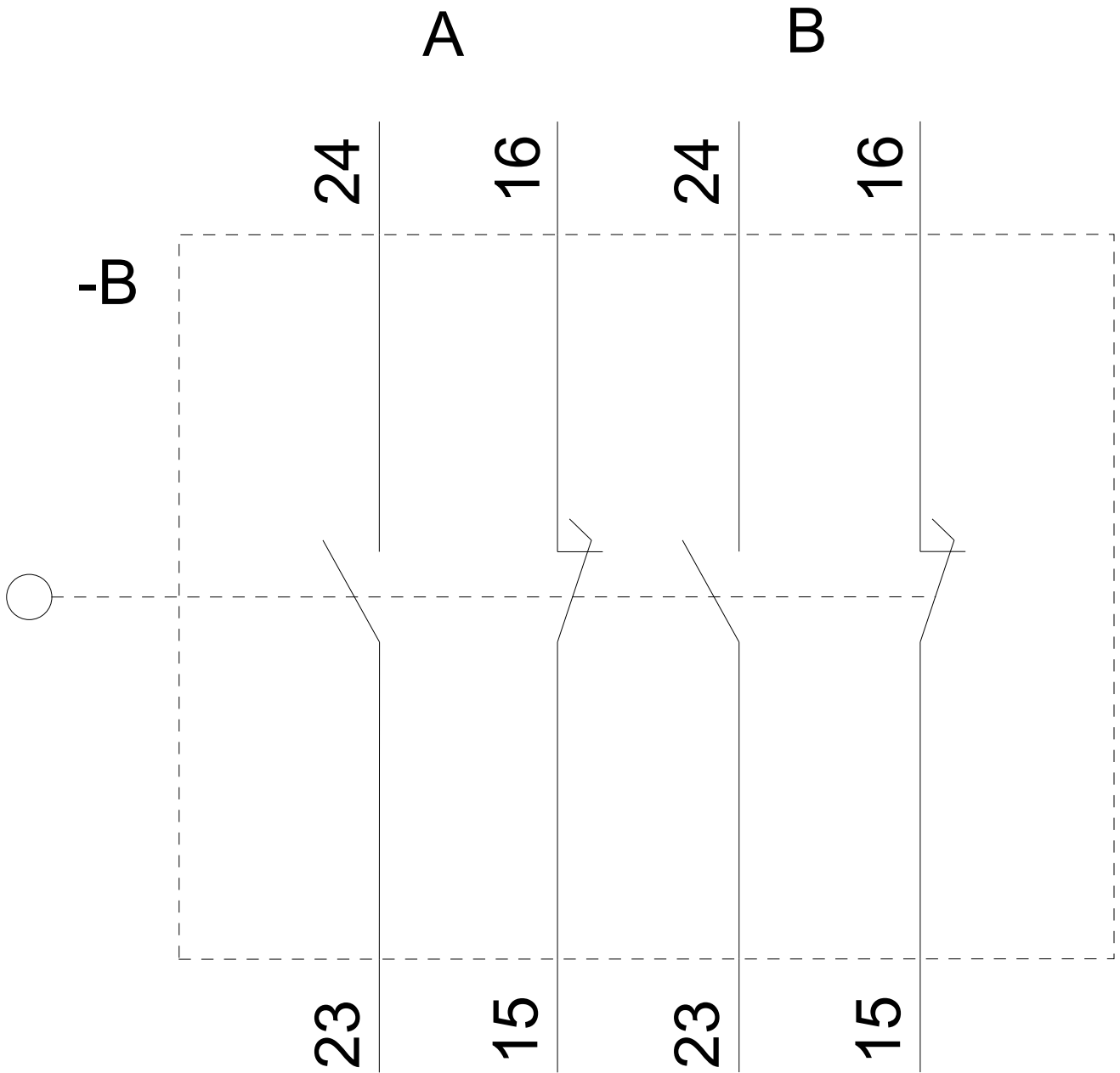

last modified:

09/24/2019