



LUT2-2N1116

LUT2

LUMINESCENCE SENSORS

SICK
Sensor Intelligence.



Ordering information

Type	Part no.
LUT2-2N1116	1048506

Other models and accessories → www.sick.com/LUT2



Detailed technical data

Features

Dimensions (W x H x D)	12 mm x 40 mm x 22 mm
Sensing distance	12.5 mm ¹⁾
Housing design (light emission)	Rectangular
Working range	8 mm ... 20 mm
Light source	LED, Ultraviolet light ²⁾
Wave length	370 nm
Light emission	Long side
Light spot size	2 mm x 2.5 mm ³⁾
Light spot direction	Vertical
Receiving filters	KV 418 (standard)
Receiving range	450 nm ... 750 nm
Adjustment	Teach-in button
Teach-in mode	Static 2-point teach-in
Output function	Light/dark switching ⁴⁾

¹⁾ From front edge of lens.

²⁾ Average service life: 100,000 h at T_U = +25 °C.

³⁾ At sensing distance.

⁴⁾ L/D switching via teach-in.

Mechanics/electronics

Supply voltage	12 V DC ... 24 V DC ¹⁾
Ripple	≤ 5 V _{pp} ²⁾

¹⁾ Limit values: DC 12 V (-10 %) ... DC 24 V (+20 %). Operation in short-circuit protected network max. 8 A.

²⁾ May not exceed or fall below U_v tolerances.

³⁾ Without load.

⁴⁾ With light/dark ratio 1:1.

⁵⁾ Signal transit time with resistive load.

⁶⁾ Reference voltage DC 50 V.

Power consumption	≤ 30 mA ³⁾
Switching frequency	0.5 kHz ⁴⁾ 2 kHz Depending on the mark intensity
Response time	1 ms, 250 μs ⁵⁾
Switching output	NPN
Switching output (voltage)	NPN: HIGH = approx. V_S / LOW ≤ 2 V
Switching output	Light/dark switching
Output current I_{max}	≤ 100 mA
Input, teach-in (ET)	NPN Teach: U < 2 V Run: U = 10 V ... < U_V
Connection type	Male connector M12, 4-pin
Protection class	II ⁶⁾
Circuit protection	U_V connections, reverse polarity protected Output Q short-circuit protected Interference pulse suppression
Enclosure rating	IP67
Weight	11 g
Housing material	ABS

¹⁾ Limit values: DC 12 V (-10 %) ... DC 24 V (+20 %). Operation in short-circuit protected network max. 8 A.

²⁾ May not exceed or fall below U_V tolerances.

³⁾ Without load.

⁴⁾ With light/dark ratio 1:1.

⁵⁾ Signal transit time with resistive load.

⁶⁾ Reference voltage DC 50 V.

Ambient data

Ambient operating temperature	-10 °C ... +55 °C
Ambient storage temperature	-25 °C ... +75 °C
Shock load	According to IEC 60068
UL File No.	NRKH.E181493 & NRKH7.E181493

Classifications

ECl@ss 5.0	27270908
ECl@ss 5.1.4	27270908
ECl@ss 6.0	27270908
ECl@ss 6.2	27270908
ECl@ss 7.0	27270908
ECl@ss 8.0	27270908
ECl@ss 8.1	27270908
ECl@ss 9.0	27270908
ETIM 5.0	EC001822
ETIM 6.0	EC001822
UNSPSC 16.0901	39121528

Dimensional drawing (Dimensions in mm (inch))

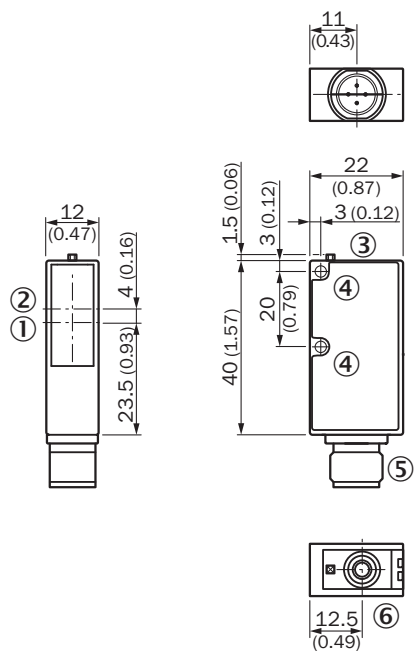

- ① Center of optical axis, sender
- ② Center of optical axis, receiver
- ③ LED signal strength indicator
- ④ Mounting hole, Ø 3 mm
- ⑤ Male connector M12
- ⑥ Teach-in button

Adjustments

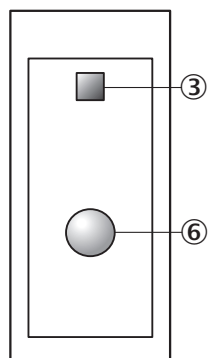

- ③ LED signal strength indicator
- ⑥ Teach-in button

Connection type

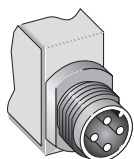

Connection diagram

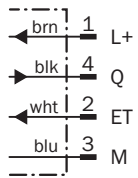

Concept of operation

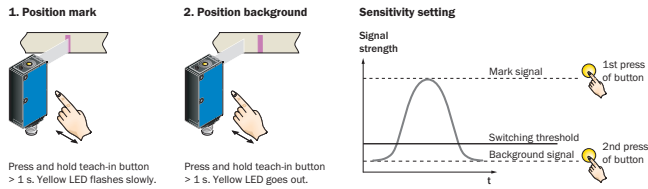

Note
 Adjustments are intended for luminescence background suppression.

Characteristic curve

Sensing distance

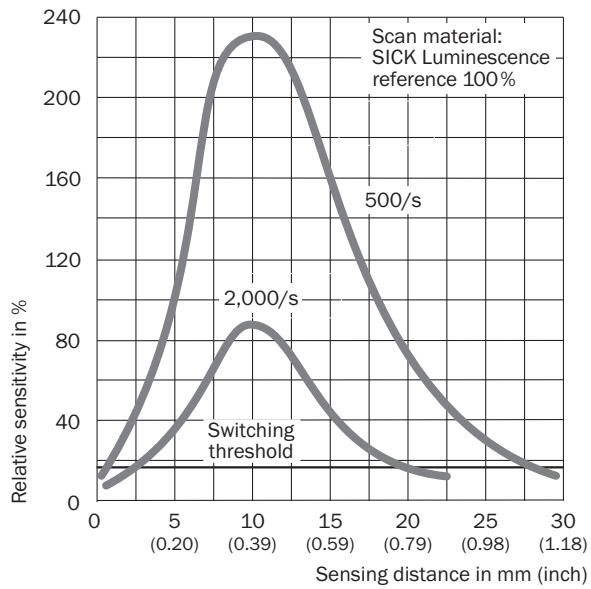

Light spot size



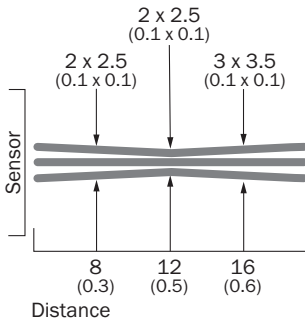



Sensing distance 12 mm





All dimensions in mm (inch)

Recommended accessories

Other models and accessories → www.sick.com/LUT2

	Brief description	Type	Part no.
Universal bar clamp systems			
	Universal clamp bracket for rod mounting, steel, zinc coated, without mounting hardware	BEF-KHS-KH1	2022726
	Plate L for universal clamp bracket, steel, zinc coated, Universal clamp (2022726), mounting hardware	BEF-KHS-L01	2023057
	Mounting bar, straight, 200 mm, steel, steel, zinc coated, without mounting hardware	BEF-MS12G-A	4056054
	Mounting bar, straight, 300 mm, steel, steel, zinc coated, without mounting hardware	BEF-MS12G-B	4056055
	Mounting bar, L-shaped, 150 mm x 150 mm, steel, steel, zinc coated, without mounting hardware	BEF-MS12L-A	4056052
	Mounting bar, L-shaped, 250 x 250 mm, steel, steel, zinc coated, without mounting hardware	BEF-MS12L-B	4056053
Mounting brackets and plates			
	Mounting bracket, steel, zinc coated, mounting hardware included	BEF-WN-W9-2	2022855
Plug connectors and cables			
	Head A: female connector, M12, 4-pin, straight, A-coded Head B: Flying leads Cable: Sensor/actuator cable, PVC, unshielded, 2 m	YF2A14-020VB3XLEAX	2096234
	Head A: female connector, M12, 4-pin, straight, A-coded Head B: Flying leads Cable: Sensor/actuator cable, PVC, unshielded, 5 m	YF2A14-050VB3XLEAX	2096235
	Head A: female connector, M12, 4-pin, straight, A-coded Head B: Flying leads Cable: Sensor/actuator cable, PVC, unshielded, 10 m	YF2A14-100VB3XLEAX	2096236

	Brief description	Type	Part no.
	Head A: female connector, M12, 4-pin, straight, A-coded Head B: Flying leads Cable: Sensor/actuator cable, PVC, unshielded, 15 m	YF2A14-150VB3XLEAX	2096237
	Head A: female connector, M12, 4-pin, angled, A-coded Head B: Flying leads Cable: Sensor/actuator cable, PVC, unshielded, 2 m	YG2A14-020VB3XLEAX	2095895
	Head A: female connector, M12, 4-pin, angled, A-coded Head B: Flying leads Cable: Sensor/actuator cable, PVC, unshielded, 5 m	YG2A14-050VB3XLEAX	2095897
	Head A: female connector, M12, 4-pin, angled, A-coded Head B: Flying leads Cable: Sensor/actuator cable, PVC, unshielded, 10 m	YG2A14-100VB3XLEAX	2095898
	Head A: female connector, M12, 4-pin, straight Head B: - Cable: unshielded	DOS-1204-G	6007302
	 Head A: female connector, M12, 4-pin, angled Head B: - Cable: unshielded	DOS-1204-W	6007303
Reference materials			
	Crayon, red fluorescence	LUM-FT	1004460
	Writing chalk, red fluorescence	LUM-KLK	1002959

SICK AT A GLANCE

SICK is one of the leading manufacturers of intelligent sensors and sensor solutions for industrial applications. A unique range of products and services creates the perfect basis for controlling processes securely and efficiently, protecting individuals from accidents and preventing damage to the environment.

We have extensive experience in a wide range of industries and understand their processes and requirements. With intelligent sensors, we can deliver exactly what our customers need. In application centers in Europe, Asia and North America, system solutions are tested and optimized in accordance with customer specifications. All this makes us a reliable supplier and development partner.

Comprehensive services complete our offering: SICK LifeTime Services provide support throughout the machine life cycle and ensure safety and productivity.

For us, that is “Sensor Intelligence.”

WORLDWIDE PRESENCE:

Contacts and other locations –www.sick.com