

Solid State Relays 1-Phase with Integrated Heatsink Zero Cross or Instant On Switching Types RGC Solid State Contactor 'E' Connection



- Product Width ranging from 17.5mm up to 70mm
- Rated Operational voltage: Up to 600VAC
- Rated Operational current: Up to 85AAC @ 40°C
- Up to 18,000A²s for I²t and 1200Vp blocking voltage
- Control voltages: 3-32 VDC, 20-275 VAC (24-190 VDC)
- IP20 protection
- Design according to EN/IEC60947-4-2, EN/IEC60947-4-3, EN/IEC62314, UL508, CSA 22-2 No. 14-10
- Integrated voltage transient protection with varistor
- RoHS compliant
- Short circuit current rating: 100kA
- VDE approval
- Germanischer Lloyd approval¹

Product Description

This new range of solid state contactors presents a unique opportunity to maximize efficiency in panel space and is an evolution of solid state switches for which Carlo Gavazzi is very well known.

The nominal current ratings are at 40°C. The smallest width is 17.5mm and is rated at 20 AAC. Power and control terminals allow for safe looping of cables.

Voltage transient protection is standard across the output with a varistor. Specifications are stated at 25°C unless otherwise noted.

1. Germanischer Lloyd approval applicable only to models RGC1...15.KE, RGC1...20.KE, RGC1..25..KE and RGC1....30.KE

Ordering Key **RGC 1 A 60 A 30 K K E**

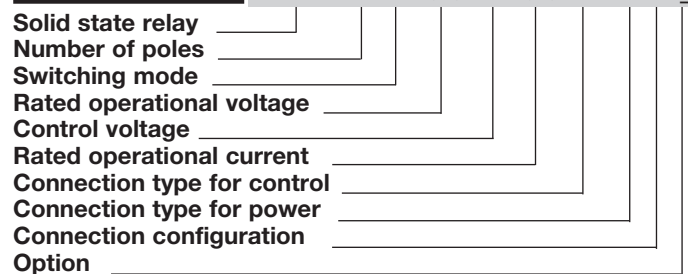

Ordering Key (Refer to page 2 and 3 for available part numbers)

1Phase SSR with heatsink	Rated Voltage, Blocking Voltage	Control Voltage	Rated Current at 40°C ²	Connection Control	Connection Power	Connection Configuration	Option
RGC1A: ZC⁴	23: 230V +10% - 15%, 800Vp	D: 3 or 4-32VDC	15: 20AAC, 525A ² s	K: Screw	K: Screw	E: Contactor	P: Overtemperature protection (OTP) ³
RGC1B: IO⁴	60: 600V +10% -15%, 1200Vp	A: 20 - 275VAC, 24-190 VDC	20: 23AAC, 525A ² s 25: 25AAC, 1800A ² s 30: 30AAC, 1800A ² s 40: 40AAC, 3200A ² s 42: 43AAC, 18000A ² s 60: 60AAC, 3200A ² s 62: 65AAC, 18000A ² s 90: 85AAC, 6600A ² s 92: 85AAC, 18000A ² s	G: Box clamp M: Pluggable spring-loaded	G: Box Clamp		

2. Refer to derating curves

3. Default control connection for RGC...P is Box Clamp. See connections specifications

4. ZC= Zero Cross Switching, IO= Instant ON Switching

Selection Guide

Rated voltage, Blocking voltage, Switching mode	Control voltage	Connection Control/ Power	Rated operational current @ 40°C (I _{2t} value)				
			Product width 20 AAC (525A ² s) 17.5mm, low depth	23 AAC (525A ² s) 17.5mm	25 AAC (1800A ² s) 17.5mm, low depth	30 AAC (1800A ² s) 22.5mm	
230V, 800Vp ZC	3-32VDC	Screw/Screw Spring/Screw	RGC1A23D15KKE	RGC1A23D20KKE	RGC1A23D25KKE	RGC1A23D30KKE	
			RGC1A23D15MKE	RGC1A23D20MKE	RGC1A23D25MKE	RGC1A23D30MKE	
	20-275VAC, 24-190VDC	Screw/Screw Spring/Screw	RGC1A23A15KKE	RGC1A23A20KKE	RGC1A23A25KKE	RGC1A23A30KKE	
			RGC1A23A15MKE	RGC1A23A20MKE	RGC1A23A25MKE	RGC1A23A30MKE	
				40 AAC (3200A²s) 35mm	43 AAC (18000A²s) 35mm	60 AAC (3200A²s) 70mm	65 AAC (18000A²s) 70mm
	3-32VDC	Screw/Box Spring/Box	RGC1A23D40KGE	RGC1A23D42KGE	RGC1A23D60KGE	RGC1A23D62KGE	
			RGC1A23D40MGE	RGC1A23D42MGE	-	RGC1A23D62MGE	
	20-275VAC, 24-190VDC	Screw/Box Spring/Box	RGC1A23A40KGE	RGC1A23A42KGE	RGC1A23A60KGE	RGC1A23A62KGE	
			RGC1A23A40MGE	RGC1A23A42MGE	-	RGC1A23A62MGE	
				20 AAC (525A²s) 17.5mm, low depth	23 AAC (525A²s) 17.5mm	25 AAC (1800A²s) 17.5mm, low depth	30 AAC (1800A²s) 22.5mm
	600V, 1200Vp ZC	4-32VDC	Screw/Screw Spring/Screw	RGC1A60D15KKE	RGC1A60D20KKE	RGC1A60D25KKE	RGC1A60D30KKE
				RGC1A60D15MKE	RGC1A60D20MKE	RGC1A60D25MKE	RGC1A60D30MKE
20-275VAC, 24-190VDC		Screw/Screw Spring/Screw	RGC1A60A15KKE	RGC1A60A20KKE	RGC1A60A25KKE	RGC1A60A30KKE	
			RGC1A60A15MKE	RGC1A60A20MKE	RGC1A60A25MKE	RGC1A60A30MKE	
			40 AAC (3200A²s) 35mm	43 AAC (18000A²s) 35mm	60 AAC (3200A²s) 70mm	65 AAC (18000A²s) 70mm	
4-32VDC		Screw/Box Spring/Box	RGC1A60D40KGE	RGC1A60D42KGE	RGC1A60D60KGE	RGC1A60D62KGE	
			RGC1A60D40MGE	RGC1A60D42MGE	-	RGC1A60D62MGE	
20-275VAC, 24-190VDC		Screw/Box Spring/Box	RGC1A60A40KGE	RGC1A60A42KGE	RGC1A60A60KGE	RGC1A60A62KGE	
			RGC1A60A40MGE	RGC1A60A42MGE	-	RGC1A60A62MGE	
			20 AAC (525A²s) 17.5mm, low depth	23 AAC (525A²s) 17.5mm	25 AAC (1800A²s) 17.5mm, low depth	30 AAC (1800A²s) 22.5mm	
600V, 1200Vp IO		4-32VDC	Screw/Screw	RGC1B60D15KKE	RGC1B60D20KKE	RGC1B60D25KKE	RGC1B60D30KKE
							40 AAC (3200A²s) 35mm
	4-32VDC	Screw/Box	RGC1B60D40KGE	RGC1B60D42KGE	RGC1B60D60KGE	RGC1B60D62KGE	

Selection Guide - RGC..P (Integrated Overtemperature Protection)

Rated voltage, Blocking voltage, Switching mode	Control voltage	Connection Control/ Power	Rated operational current @ 40°C (I ² t value)			
			Product width	23 AAC (525A ² s) 22.5mm	25 AAC (1800A ² s) 22.5mm, low depth	30 AAC (1800A ² s) 22.5mm
230V, 800Vp ZC	5-32VDC	Screw/Screw	RGC1A23D20GKEP	-	RGC1A23D30GKEP	RGC1A23D90GGEP
			23 AAC (525A ² s) 22.5mm	25 AAC (1800A ² s) 22.5mm, low depth	30 AAC (1800A ² s) 22.5mm	85AAC (6600A ² s) 70mm + fan
600V, 1200Vp ZC	5-32VDC	Box/Screw	RGC1A60D20GKEP	RGC1A60D25GKEP	RGC1A60D30GKEP	
		20-275VAC, 24-190VDC	Box/Screw	RGC1A60A20GKEP	RGC1A60A25GKEP	RGC1A60A30GKEP
	5-32VDC	Box/Box	RGC1A60D40GGEP	RGC1A60D42GGEP	RGC1A60D60GGEP	RGC1A60D62GGEP
		20-275VAC, 24-190VDC	Box/Box	RGC1A60A40GGEP	RGC1A60A42GGEP	RGC1A60A60GGEP
5-32VDC	20-275VAC, 24-190VDC	Box/Box	85AAC (6600A ² s) 70mm + fan		85AAC (18000A ² s) 70mm + fan	
			RGC1A60D90GGEP	RGC1A60D92GGEP	RGC1A60A90GGEP	RGC1A60A92GGEP

Output Voltage Specifications

	RGC..23..	RGC..60..
Operational Voltage Range	24-240 VAC, +10%, -15% on max	42-600 VAC, +10% -15% on max
Blocking Voltage	800Vp	1200 Vp
Internal Varistor	275V	625V

General Specifications

Latching voltage (across L1-T1)	20V	Over-voltage category	III (fixed installations)
Operational frequency range	45 to 65Hz	Isolation	
Power factor	> 0.5 @ Vrated	Input to Output RGC... RGC...D..P RGC...A..P	4000 Vrms 2500 Vrms 4000 Vrms
Touch Protection	IP20	Input and Output RGC... to case RGC...D..P RGC...A..P	4000 Vrms 4000 Vrms 4000 Vrms
Control input status	continuously ON Green LED, when control input is applied	Input to Fan/ Alarm Output RGC...A..P	2500 Vrms
Pollution degree	2 (non-conductive pollution with possibilities of condensation)		

Output Specifications (@ 25°C unless otherwise specified)

	RGC..15..	RGC..20..	RGC..25..	RGC..30..
Rated operational current ⁶ AC-51 rating @ Ta=25°C	20 AAC	25.5 AAC	30 AAC	30 AAC
AC-51 rating @ Ta=40°C	20 AAC	23 AAC	25 AAC	30 AAC
AC-53a rating @ Ta=40°C	5 AAC	5 AAC	5 AAC	8 AAC
Number of motor starts (x:6, Tx:6s, F:50%) at 40°C ⁵	30	30	30	30
Min. operational current	150 mAAC	150 mAAC	250 mAAC	250 mAAC
Rep. overload current - (Motor Rating) PF = 0.4 - 0.5 UL508: T _{AMB} =40°C, t _{ON} =1s, t _{OFF} =9s, 50cycles	51 AAC	60 AAC	51 AAC	84 AAC
Maximum transient surge current (I _{TSM}), t=10ms	325 Ap	325 Ap	600 Ap	600Ap
Maximum off-state leakage current at rated voltage	3 mAAC	3 mAAC	3 mAAC	3 mAAC
I ² t for fusing (t=10ms) Minimum	525 A ² s	525 A ² s	1800 A ² s	1800 A ² s
Critical dv/dt (@ T _j init = 40°C)	1000 V/us	1000 V/us	1000 V/us	1000 V/us

	RGC..40..	RGC..42..	RGC..60..	RGC..62..	RGC..90..	RGC..92..
Rated operational current ⁶ AC-51 rating @ Ta=25°C	47 AAC	50 AAC	70 AAC	75 AAC	85 AAC	85 AAC
AC-51 rating @ Ta=40°C	40 AAC	43 AAC	60 AAC	65 AAC	85 AAC	85 AAC
AC-53a rating @ Ta=40°C	13 AAC	16 AAC	14.8 AAC	20 AAC	18 AAC	20 AAC
Number of motor starts (x:6, Tx:6s, F:50%) at 40°C ⁵	30	30	30	30	30	30
Min. operational current	400 mAAC	500 mAAC	400 mAAC	500 mAAC	400 mAAC	500 mAAC
Rep. overload current - (Motor Rating) PF = 0.4 - 0.5 UL508: T _{AMB} =40°C, t _{ON} =1s, t _{OFF} =9s, 50cycles	126 AAC	126 AAC	126 AAC	168 AAC	168 ACC	168 AAC
Maximum transient surge current (I _{TSM}), t=10ms	800 Ap	1900 Ap	800 Ap	1900 Ap	1150 Ap	1900 Ap
Maximum off-state leakage current at rated voltage	3 mAAC	3 mAAC	3 mAAC	3 mAAC	3 mAAC	3 mAAC
I ² t for fusing (t=10ms) Minimum	3200 A ² s	18000 A ² s	3200 A ² s	18000 A ² s	6600 A ² s	18000 A ² s
Critical dv/dt (@ T _j init = 40°C)	1000 V/us	1000 V/us	1000 V/us	1000 V/us	1000 V/us	1000 V/us

5. Overload current profile definition: x: multiple of AC53a rating, Tx: duration of current surge, F: duty cycle

6. See derating curves

Overtemperature Alarm Specifications for RGC...P

	RGC..D..P	RGC..A..P
Output type	PNP open collector	Potential Free
Normal state	Closed	Closed
Maximum current rating	50 mADC	50 mADC
Rated voltage (EN61131-2: 2003) ^{8,7} , U _a	24VDC -15%, +20%	24VDC -15%, +20%
Rated voltage, U _s	RGC...D9xGGEP 24VDC ± 10%	N/A
Fan rating, U _f	RGC...A9xGGEP N/A	24VDC ±10%, 50mA nominal
Alarm voltage drop	Typical Maximum 2.8VDC 4VDC	1.8VDC 3.5VDC
Visual Indication	Continous Red LED	Continous Red LED
Reverse polarity protection	24VDC	24VDC

7. DC supply for alarm signal should be supplied from a Class 2 power source

8. Maximum voltage to be applied between 11+ and 12- (U_a) terminals should be 35VDC maximum with reference to A2-

Input specifications

		RGC..D..	RGC..A..
Control voltage range ^{9,10}	RGC..23..	3 - 32 VDC	20 - 275 VAC, 24 (-10%) - 190 VDC
	RGC..60..	4 - 32 VDC	20-275 VAC, 24 (-10%) - 190 VDC
	RGC...P (Uc)	5 - 32 VDC	20-275 VAC, 24 (-10%) - 190 VDC
Pick-up voltage	RGC..23..	3.0 VDC	20 VAC/DC
	RGC..60..	3.8 VDC	
	RGC...P	5 VDC	20 VAC/ 24VDC
Drop-out voltage		1 VDC	5 VAC/DC
Maximum Reverse voltage		32 VDC	-
Response time pick-up ZC (RGC1A..)		0.5 cycle + 500µs @ 24VDC	2 cycles @ 230VAC/110VDC
Response time pick-up IO (RGC1B..)		350µs @ 24 VDC	N/A
Response time drop-out		0.5 cycle + 500µs @ 24VDC	0.5 cycle + 40ms @ 230VAC/110VDC
Input current @ 40°C		See diagrams below	See diagrams below

9. DC control to be supplied by class 2 power source according to UL1310

10. For GL approved models control range for RGC1.23... is 4-32VDC and for RGC1.60... 5-32VDC

RG..A..

RGC1 .. A : Input current vs input voltage

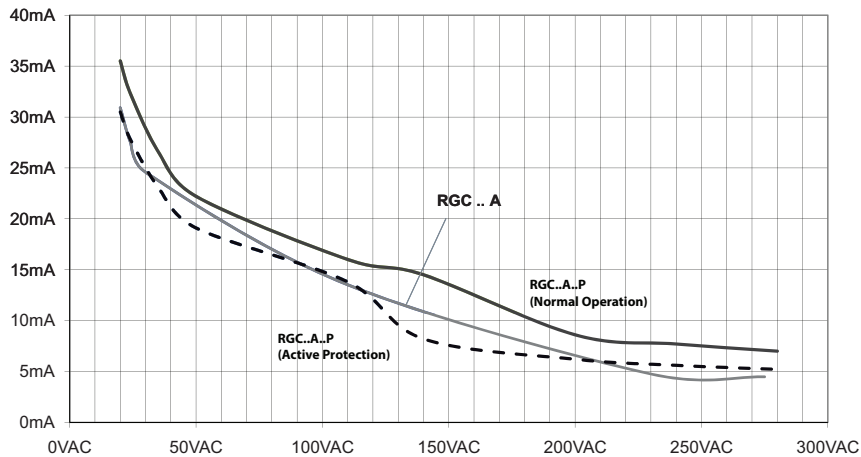

RGC1 .. A : Input current vs input voltage

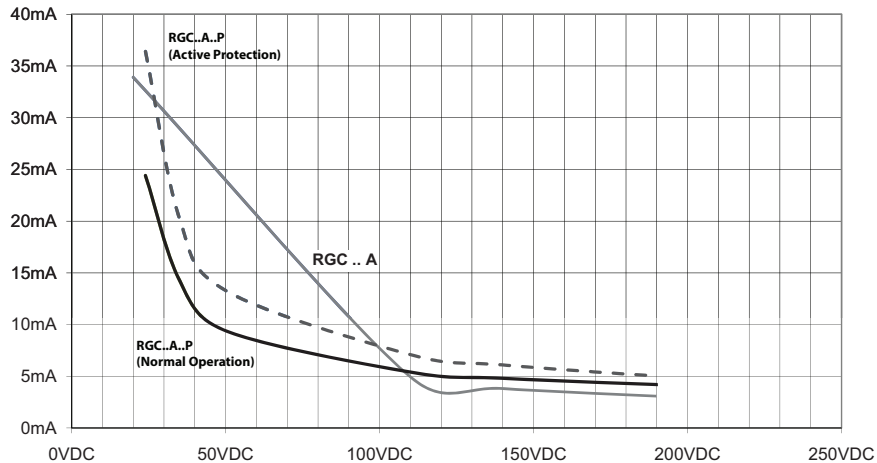

Input specifications (cont.)

RG..D..

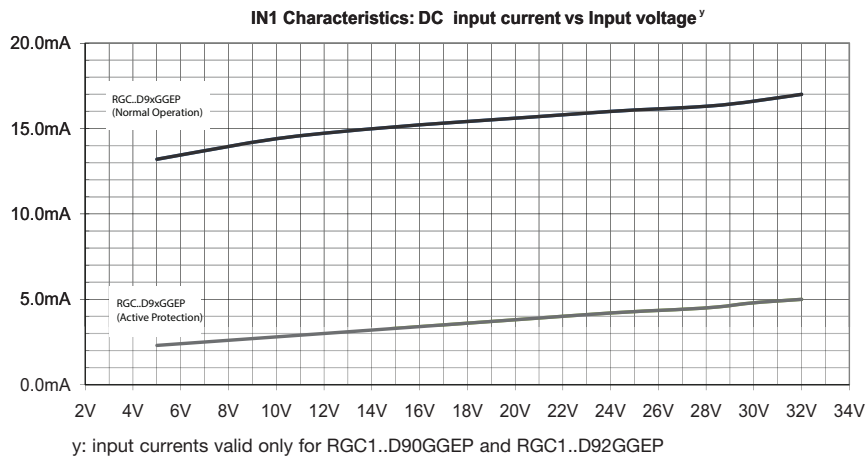
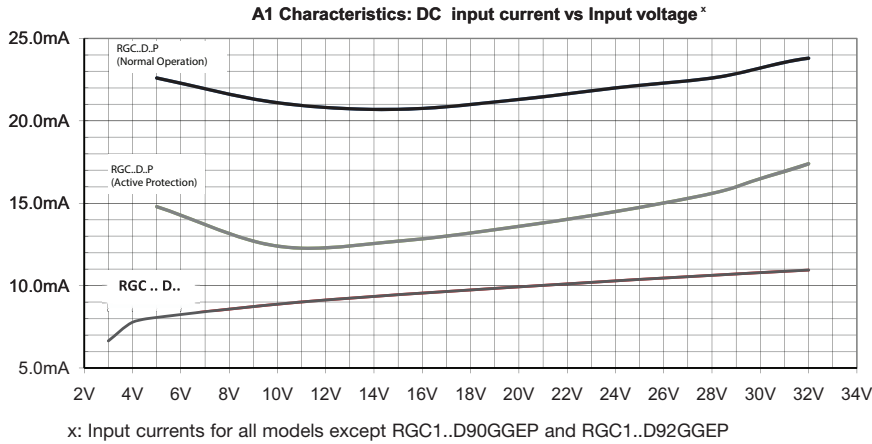

Motor Ratings: HP (UL508) / kW (EN/IEC60947-4-2) @ 40°C

	115 VAC	230 VAC	400 VAC	480 VAC	600 VAC
RG..15	1/3HP / 0.18kW	1HP / 0.37kW	2HP / 0.75kW	3HP / 1.1kW	3HP / 1.5kW
RG..20	1/2HP / 0.18kW	1 1/2HP / 0.37kW	2HP / 0.75kW	3HP / 1.1kW	3HP / 1.5kW
RG..25	1/3HP / 0.18kW	1HP / 0.37kW	2HP / 0.75kW	3HP / 1.1kW	3HP / 1.5kW
RG..30	3/4HP / 0.37kW	2HP / 1.1kW	3HP / 1.5kW	5HP / 2.2kW	5HP / 3.7kW
RG..40	1HP / 0.56kW	3HP / 1.5kW	5HP / 2.2kW	5HP / 3.7kW	7 1/2HP / 4kW
RG..42	1 1/2HP / 0.56kW	3HP / 1.5kW	5HP / 2.2kW	7 1/2HP / 3.7kW	10HP / 4kW
RG..60	1 1/2HP / 0.56kW	3HP / 1.5kW	5HP / 3kW	7 1/2HP / 4kW	10HP / 4kW
RG..62	2HP / 0.75kW	5HP / 1.5kW	7 1/2HP / 4kW	10HP / 4kW	15HP / 5.5kW
RG..90	2HP / 0.75kW	5HP / 1.5kW	7 1/2HP / 4kW	10HP / 4kW	15HP / 5.5kW
RG..92	2HP / 0.75kW	5HP / 1.5kW	7 1/2HP / 4kW	10HP / 4kW	15HP / 5.5kW

Detailed Over temperature Alarm Procedure (for RGC...P)

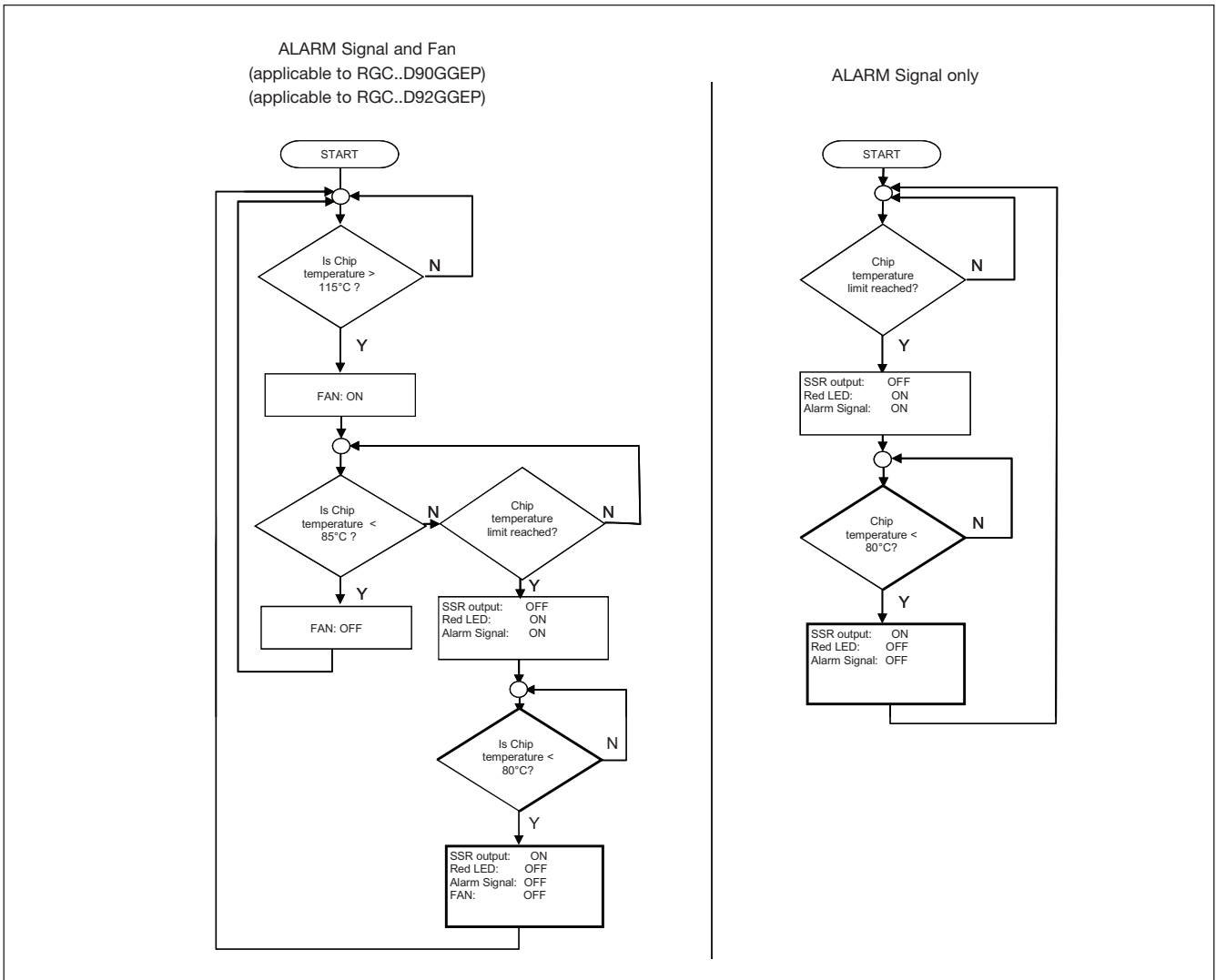

CAUTION

- Alarm condition resets whenever the voltage signal is removed from terminal A1 (+)
- In the case of RGC...D9xGGEP, if the voltage signal is not applied across A1(+) and A2 (-) terminals, the overtemperature detection and functionality is lost (including fan operation and alarm signalling)
- In the case of RGC1A60A9xGGEP it is necessary to supply IN2 and IN3 with 24VDC for fan operation.
- Alarm procedure for RGC1A60A9xGGEP follows 'Alarm signal only' flow since fan is continuously operating.
- Alarm condition automatically resets ONLY when power semiconductor temperature < 80°C
- Temperatures indicated are typical figures.

Output Power Dissipation

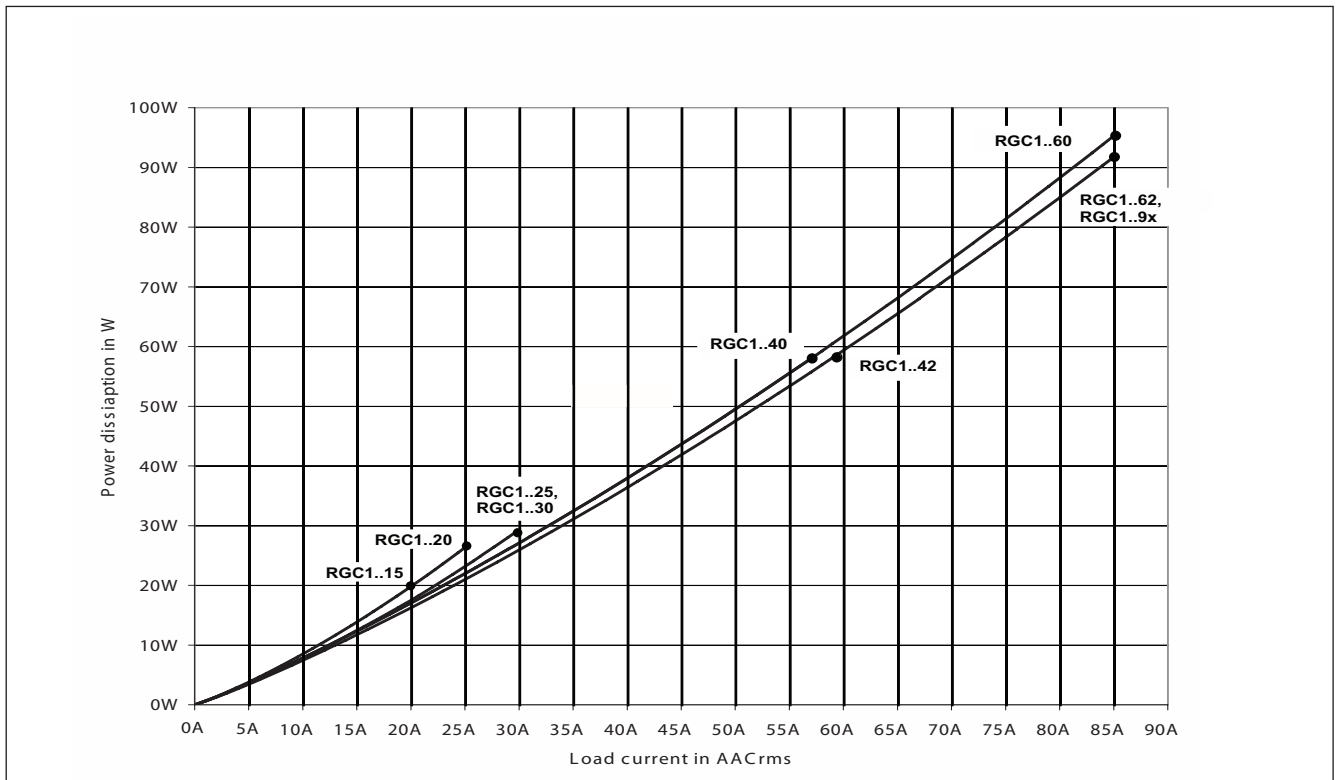

Current Derating (UL508)

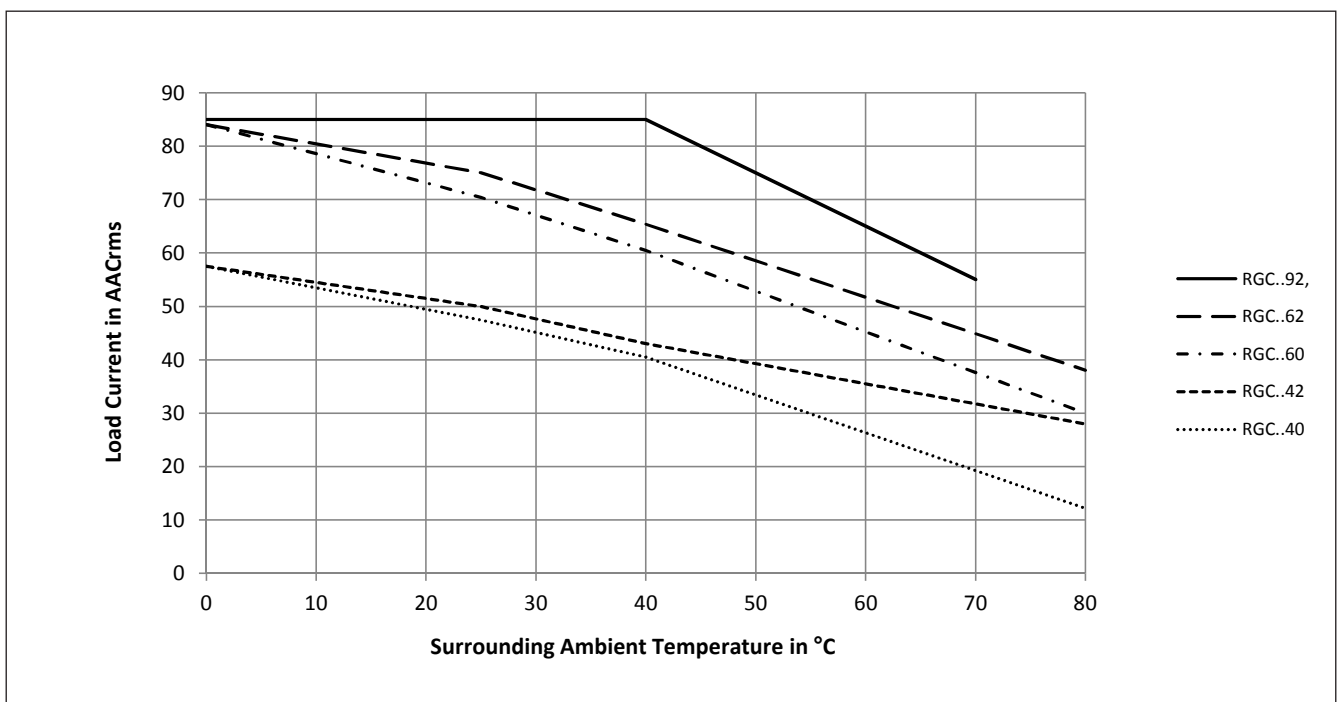
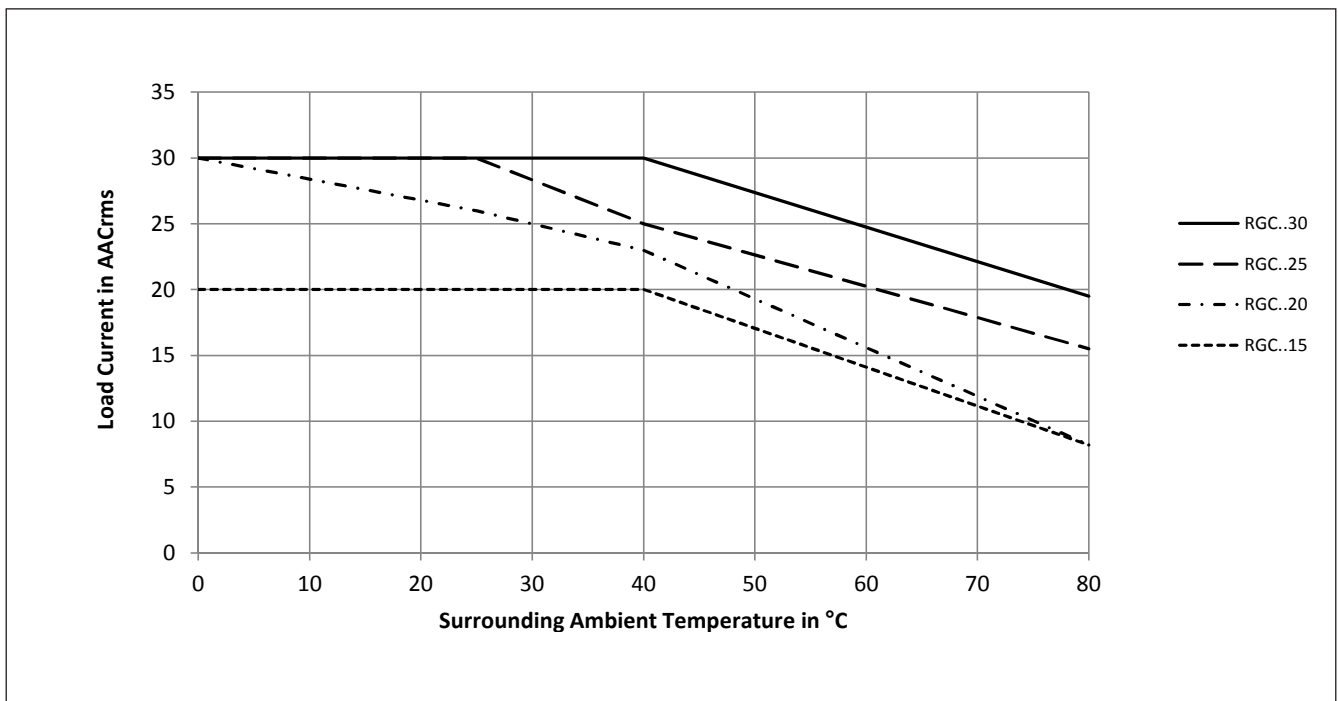

RGC...P models max. operating temperature is + 70°C



Derating vs. Spacing Curves

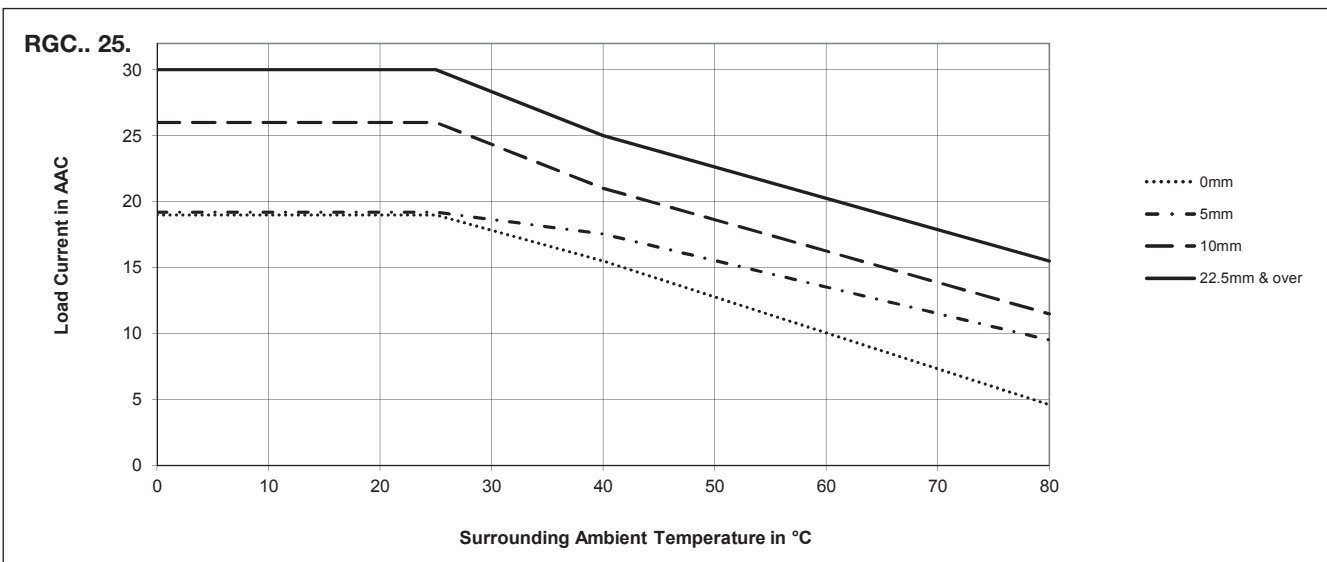
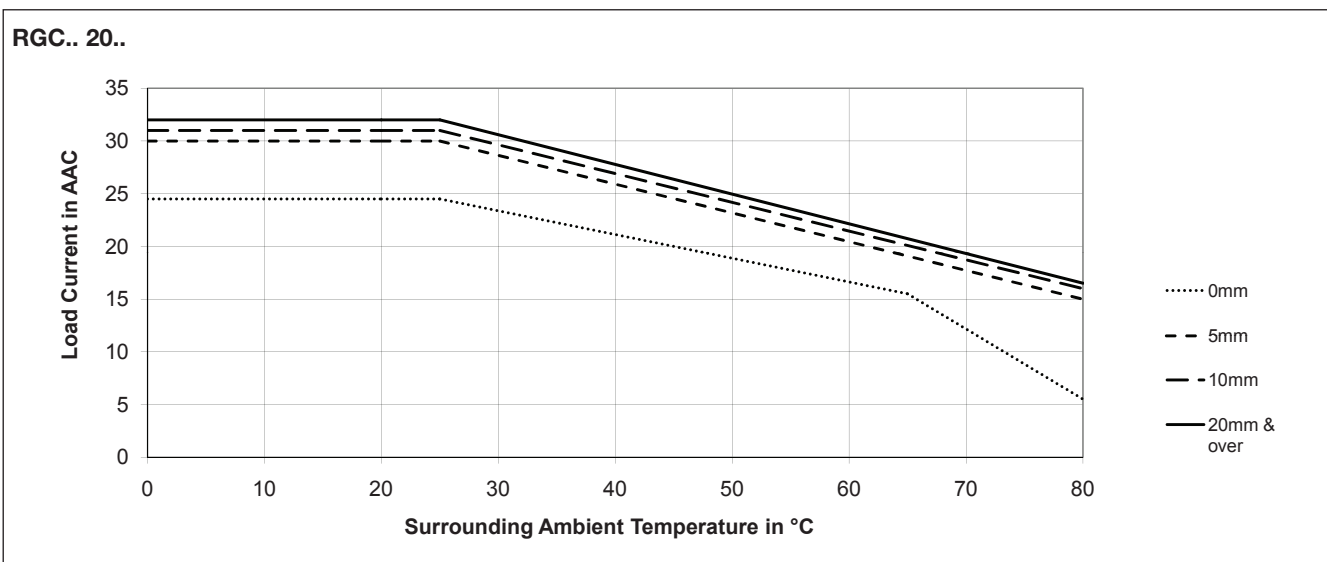
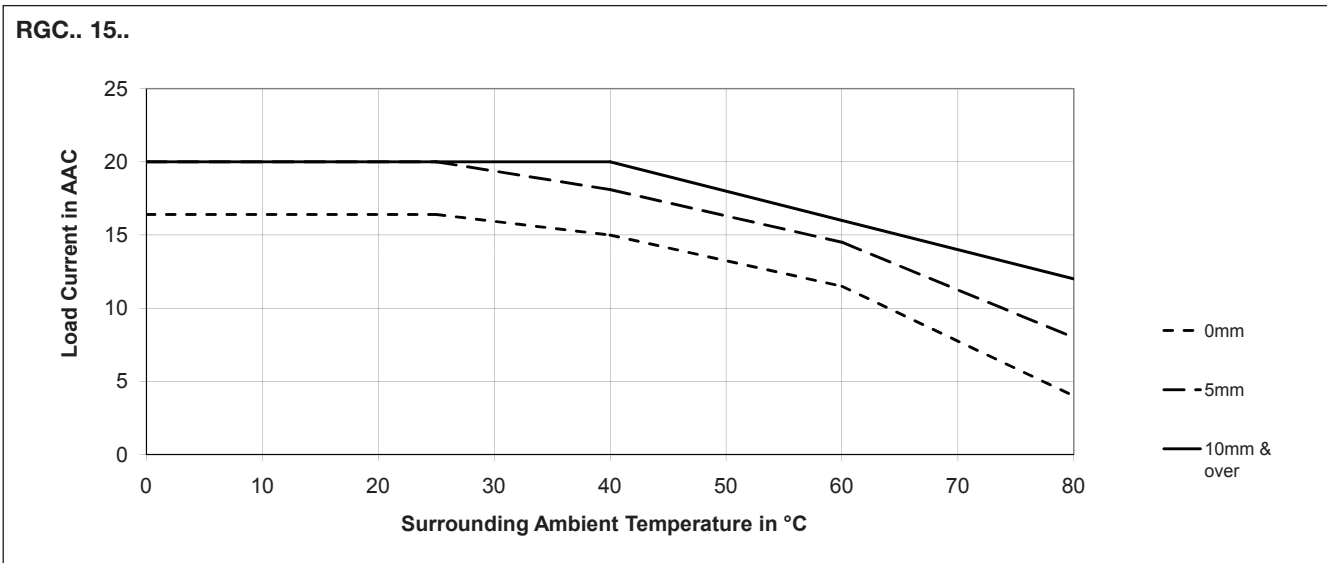

Derating vs. Spacing Curves

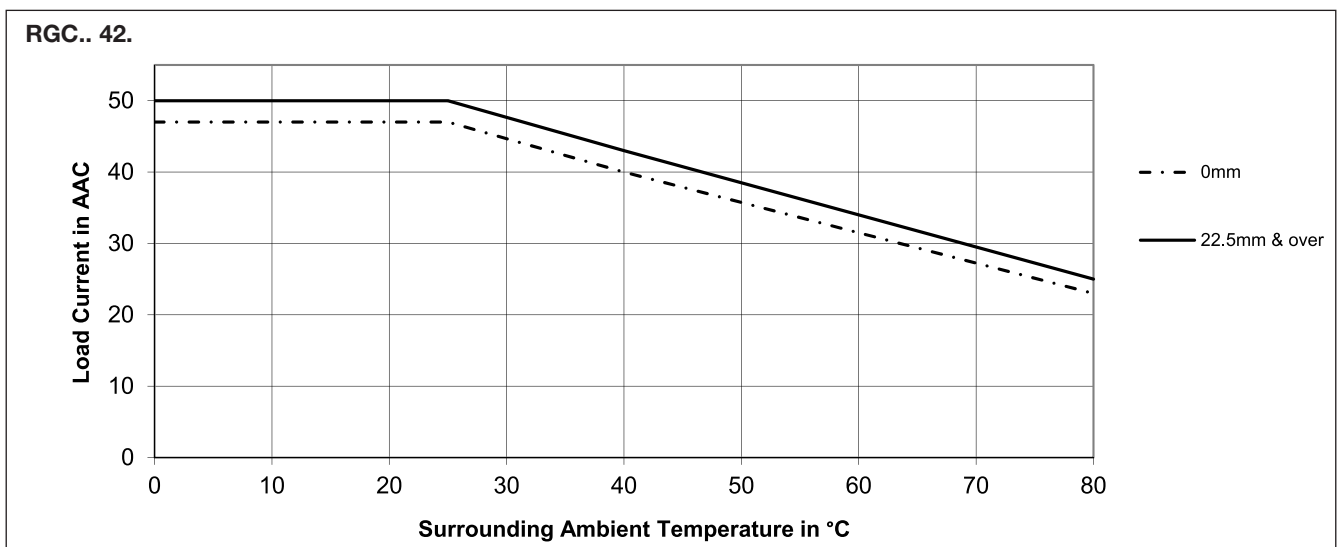
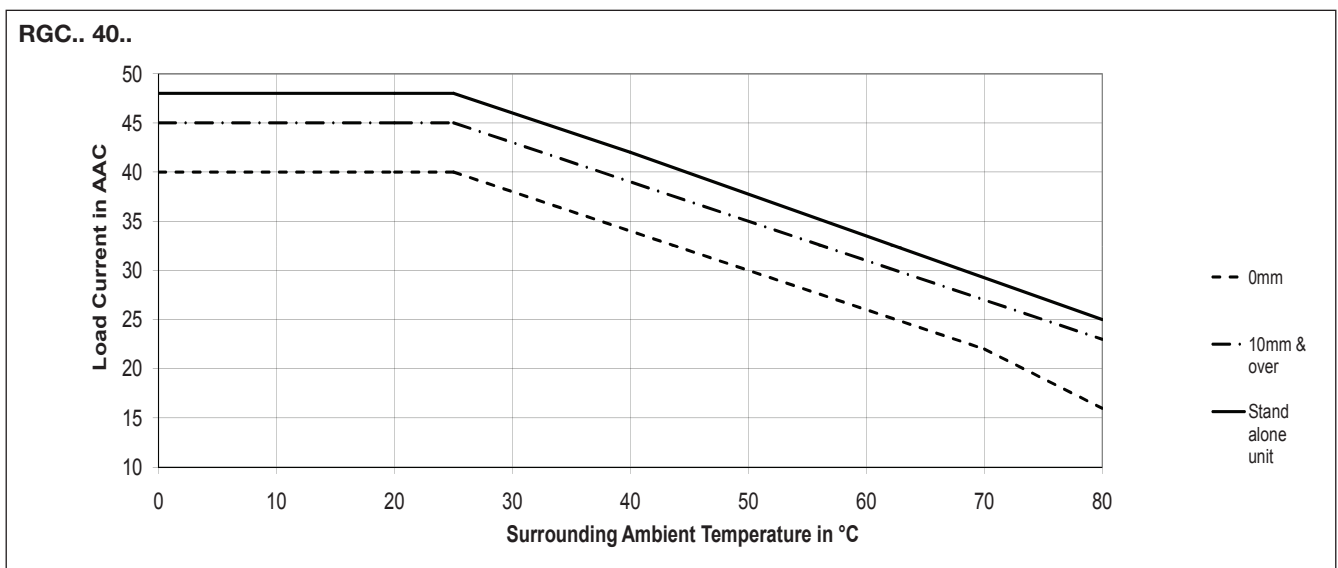
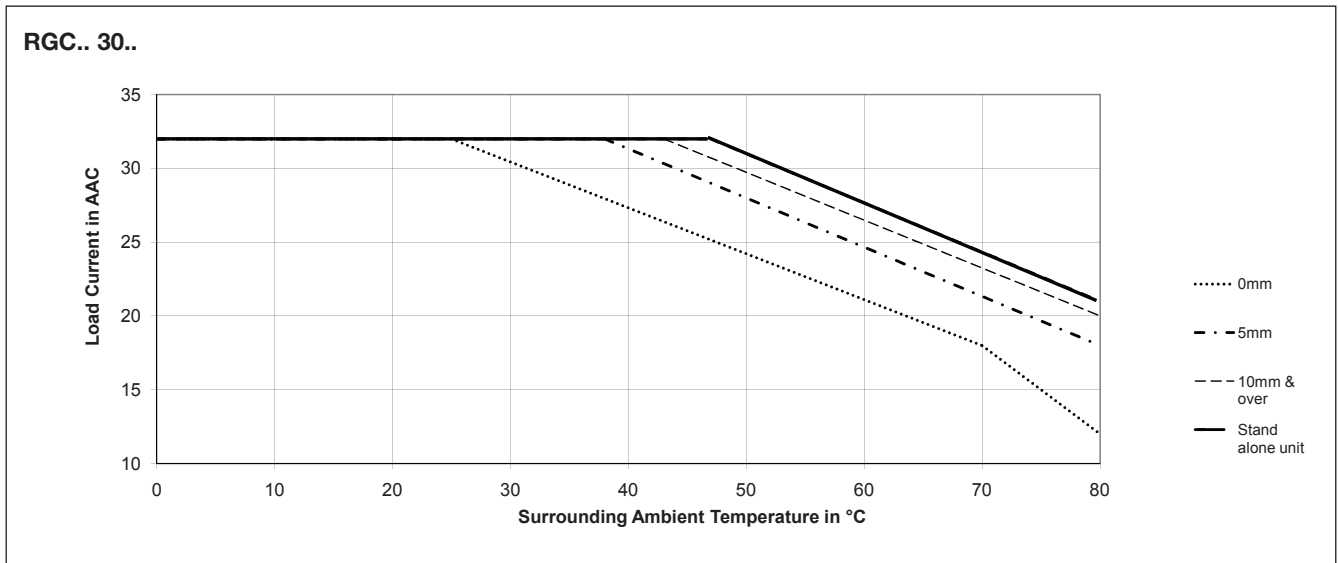

Derating vs. Spacing Curves

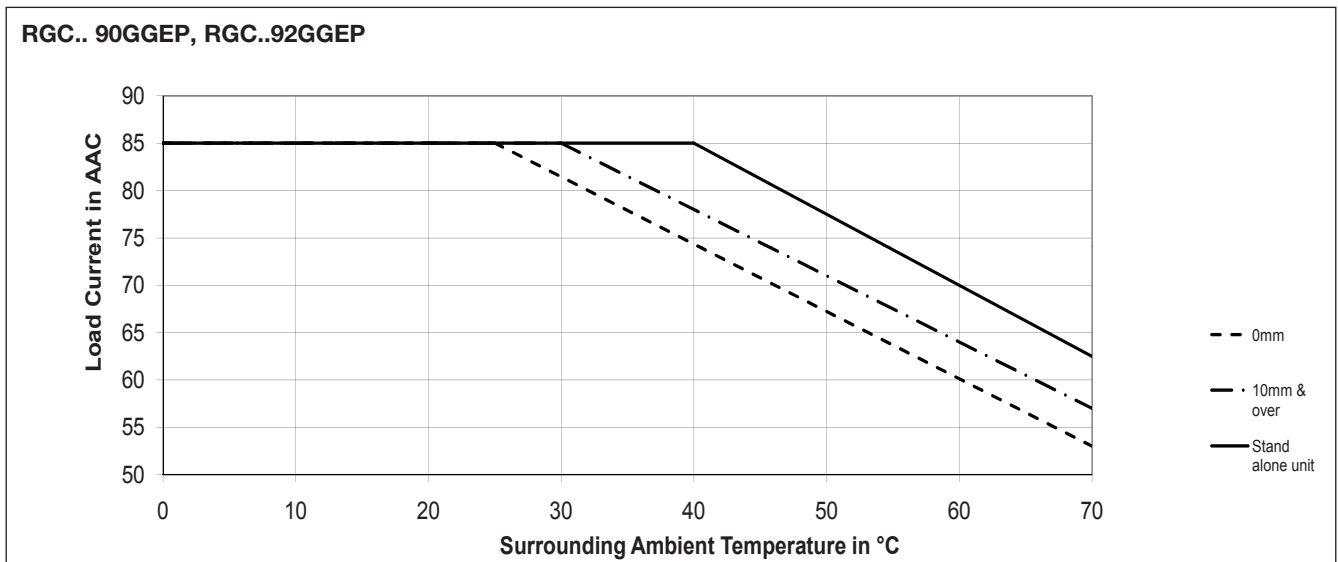
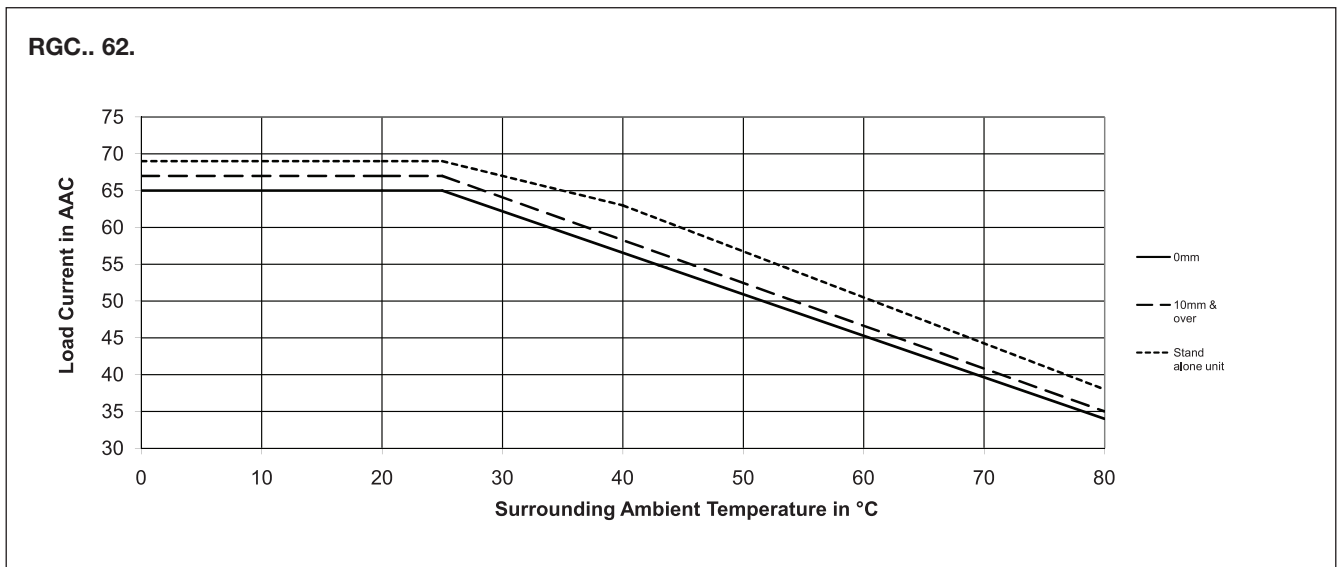
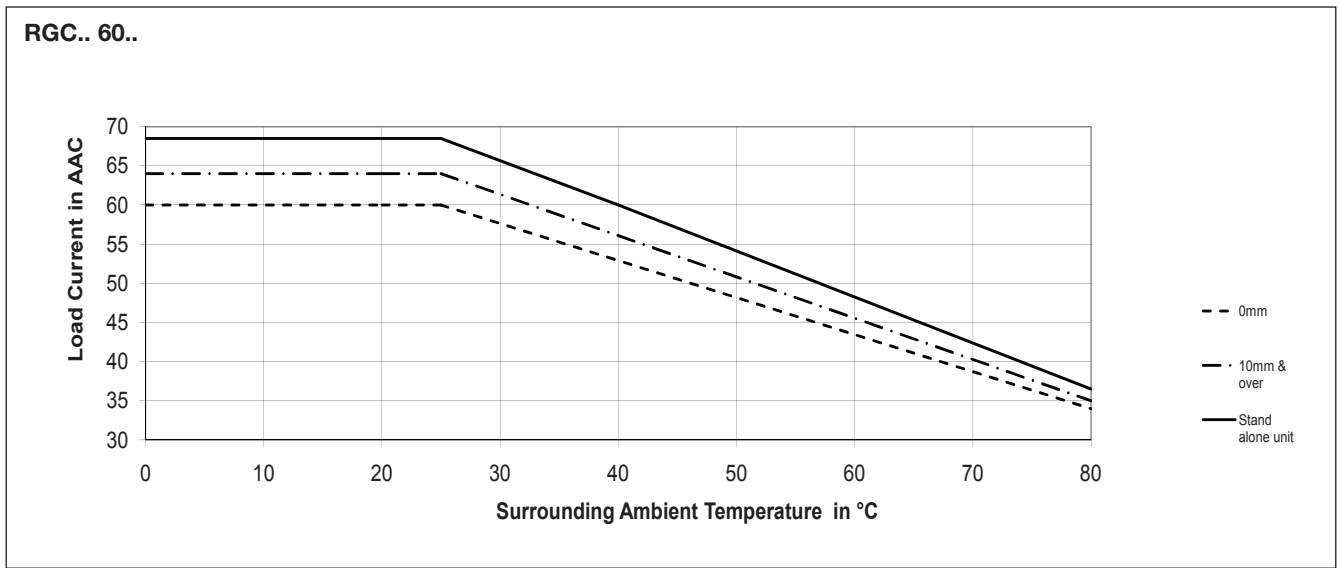

Agency Approvals and Conformances

Conformance	IEC/EN 62314 IEC/EN 60947-4-2 IEC/EN 60947-4-3	Agency Approvals	UL508 Listed (E172877) cUL Listed (E172877) VDE 0660-109 GL ¹²
		Short Circuit Current Rating	100kA, UL508



Electromagnetic Compatibility

EMC Immunity	EN 60947-4-3	Electrical Surge Immunity (for RGC...EP)	IEC/EN 61000-4-5
Electrostatic Discharge (ESD) Immunity Air discharge, 8kV Contact, 4kV	IEC/EN 61000-4-2 Performance Criteria 1 Performance Criteria 1	Output, line to line, 1kV Output, line to earth, 2kV DC lines, line to line, 500V DC lines, line to earth, 500V Signal lines, line to earth, 1kV	Performance Criteria 1 Performance Criteria 1 Performance Criteria 2 Performance Criteria 2 Performance Criteria 2
Electrical Fast Transient (Burst) Immunity Output: 2kV, 5kHz Input: 1kV, 5kHz	IEC/EN 61000-4-4 Performance Criteria 1 Performance Criteria 1	Radiated Radio Frequency Immunity 10V/m, 80 - 1000 MHz 10V/m, 1.4 - 2 GHz 3V/m, 2 - 2.7 GHz	IEC/EN 61000-4-3 Performance Criteria 1 Performance Criteria 1 Performance Criteria 1
Electrical Surge Immunity (for RGC...E) Output, line to line, 1kV Output, line to earth, 2kV Input, line to line, 1kV Input, line to earth, 2kV	IEC/EN 61000-4-5 Performance Criteria 1 Performance Criteria 1 Performance Criteria 2 Performance Criteria 2	Conducted Radio Frequency Immunity 10V/m, 0.15 - 80 MHz	IEC/EN 61000-4-6 Performance Criteria 1
		Voltage Dips Immunity 0% for 0.5, 1 cycle 40% for 10 cycles 70% for 25 cycles 80% for 250 cycles	IEC/EN 61000-4-11 Performance Criteria 2 Performance Criteria 2 Performance Criteria 2 Performance Criteria 2
		Voltage Interruptions Immunity 0% for 5000ms	IEC/EN 61000-4-11 Performance Criteria 2
EMC Emission	EN 60947-4-3	Radio Interference Field Emission (Radiated) 30 - 1000MHz	IEC/EN 55011 Class A (industrial)
Radio Interference Voltage Emission (Conducted) 0.15 - 30MHz	IEC/EN 60947-4-3 Class A (no filtering needed) IEC/EN 55011 Class A (industrial) with filters - see filter information		

Environmental Specifications

Operating Temperature ¹¹	-40°C to 80°C (-40°F to +176°F)	Vibration resistance (2-100Hz, IEC60068-2-6, EN50155, EN61373)	2g per axis
Storage Temperature	-40°C to 100°C (-40°F to +212°F)	Relative humidity	95% non-condensing @ 40°C
RoHS (2002/95/EC)	Compliant	UL flammability rating (housing)	UL 94 V0
Impact resistance (EN50155, EN61373)	15/11 g/ms	GWIT & GWFI	conforms to EN 60335-1 requirements
Weight		RGC..30 (P)	approx. 375g (412g)
RGC..15	approx. 260g	RGC..4x (P)	approx. 515g (581g)
RGC..20 (P)	approx. 315g (360g)	RGC..6x (P)	approx. 972g (1020g)
RGC..25 (P)	approx. 260g (307g)	RGC..9x (P)	approx. 1100g

11. Operating temperature range for RGC..P (overtemperature protection) is -30°C to 70°C (-22°F to 158°F)

12. Applicable to models RGC1...15.KE, RGC1...20.KE, RGC1..25..KE and RGC1...30.KE

Filtering - EN / IEC 55011 Class A compliance (for class B compliance contact us)

Part Number	Suggested filter for compliance	Maximum Heater current
RGC1A23..15	68nF / 275 V / X1	20A
RGC1A23..20	68nF / 275 V / X1	20A
RGC1A23..25, RGC1A23..30	220 nF / 275V / X1	30A
RGC1A23..40	220 nF / 275V / X1 330 nF / 275V / X1	30A 45A
RGC1A23..60	220 nF / 275V / X1 330 nF / 275V / X1	30A 45A
RGC1A23..42, RGC1A23..62, RGC1A23..9x	330 nF / 275V / X1 470 nF / 275V / X1	35A 65A
RGC1A60..15	100 nF / 760V / X1	20A
RGC1A60..20	100 nF / 760V / X1	20A
RGC1A60..25, RGC1A60..30	220 nF / 760V / X1	30A
RGC1A60..40	220 nF / 760V / X1 330 nF / 760V / X1	25A 45A
RGC1A60..60	220 nF / 760V / X1 330 nF / 760V / X1	25A 45A
RGC1A60..42, RGC1A60..62, RGC1A23..9x	330 nF / 760V / X1 470 nF / 760V / X1	40A 65A

Note:

- Control input lines must be installed together to maintain products' susceptibility to Radio Frequency interference.
- Use of AC solid state relays may, according to the application and the load current, cause conducted radio interferences. Use of mains filters may be necessary for cases where the user must meet E.M.C requirements. The capacitor values given inside the filtering specification tables should be taken only as indications, the filter attenuation will depend on the final application.
- Performance Criteria 1: No degradation of performance or loss of function is allowed when the product is operated as intended.
- Performance Criteria 2: During the test, degradation of performance or partial loss of function is allowed. However when the test is complete the product should return operating as intended by itself.
- Performance Criteria 3: Temporary loss of function is allowed, provided the function can be restored by manual operation of the controls.

Filter Connection Diagrams

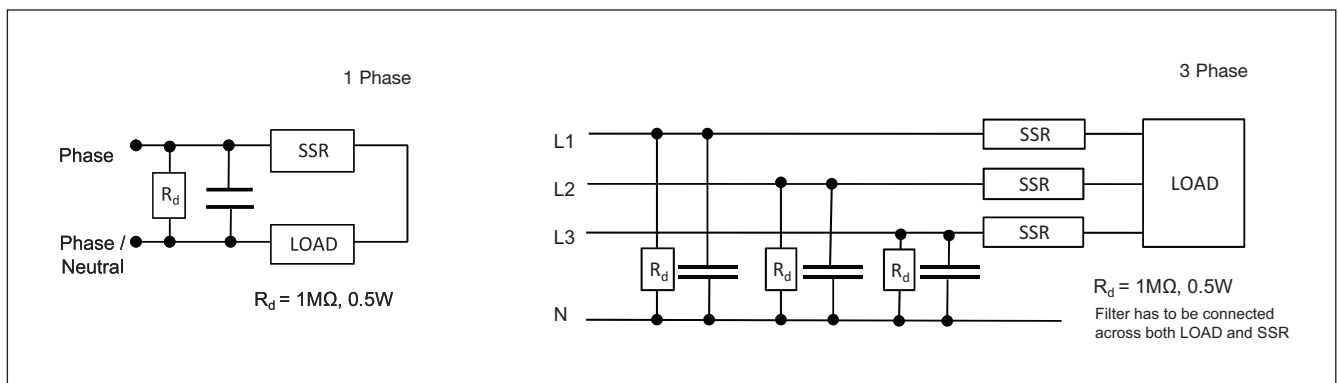

Connection Diagram (No OTP)

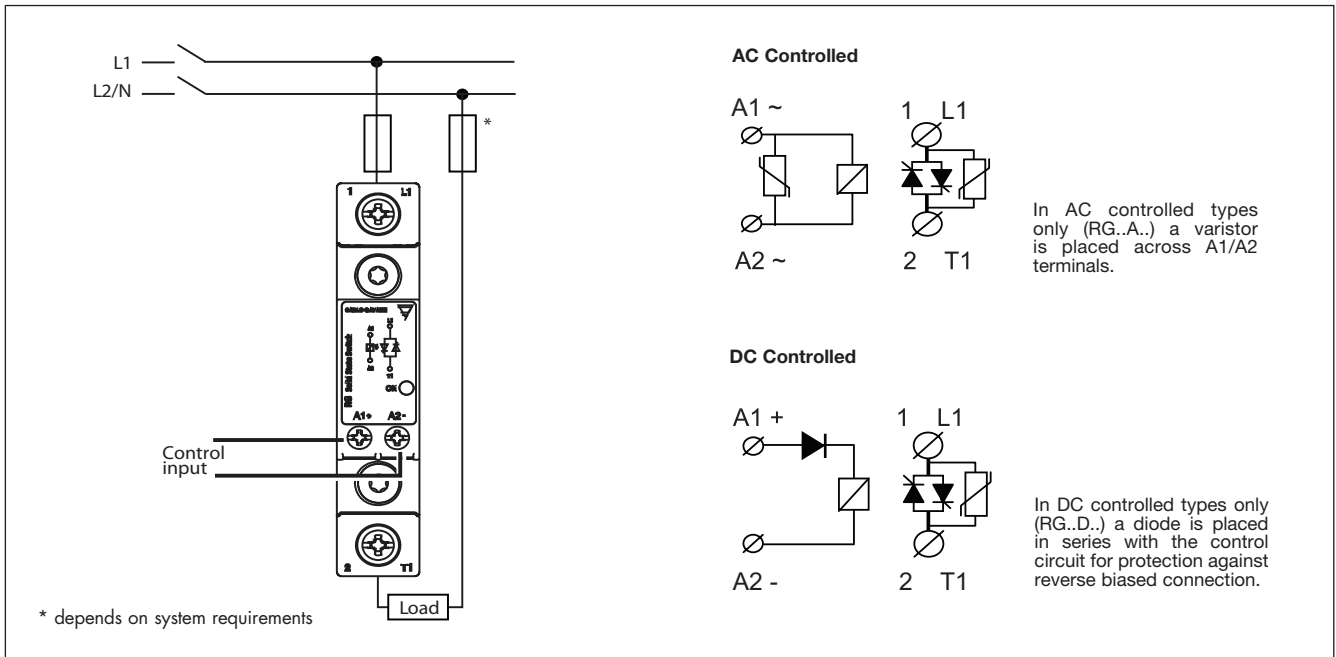

Connection Diagram (with OTP)

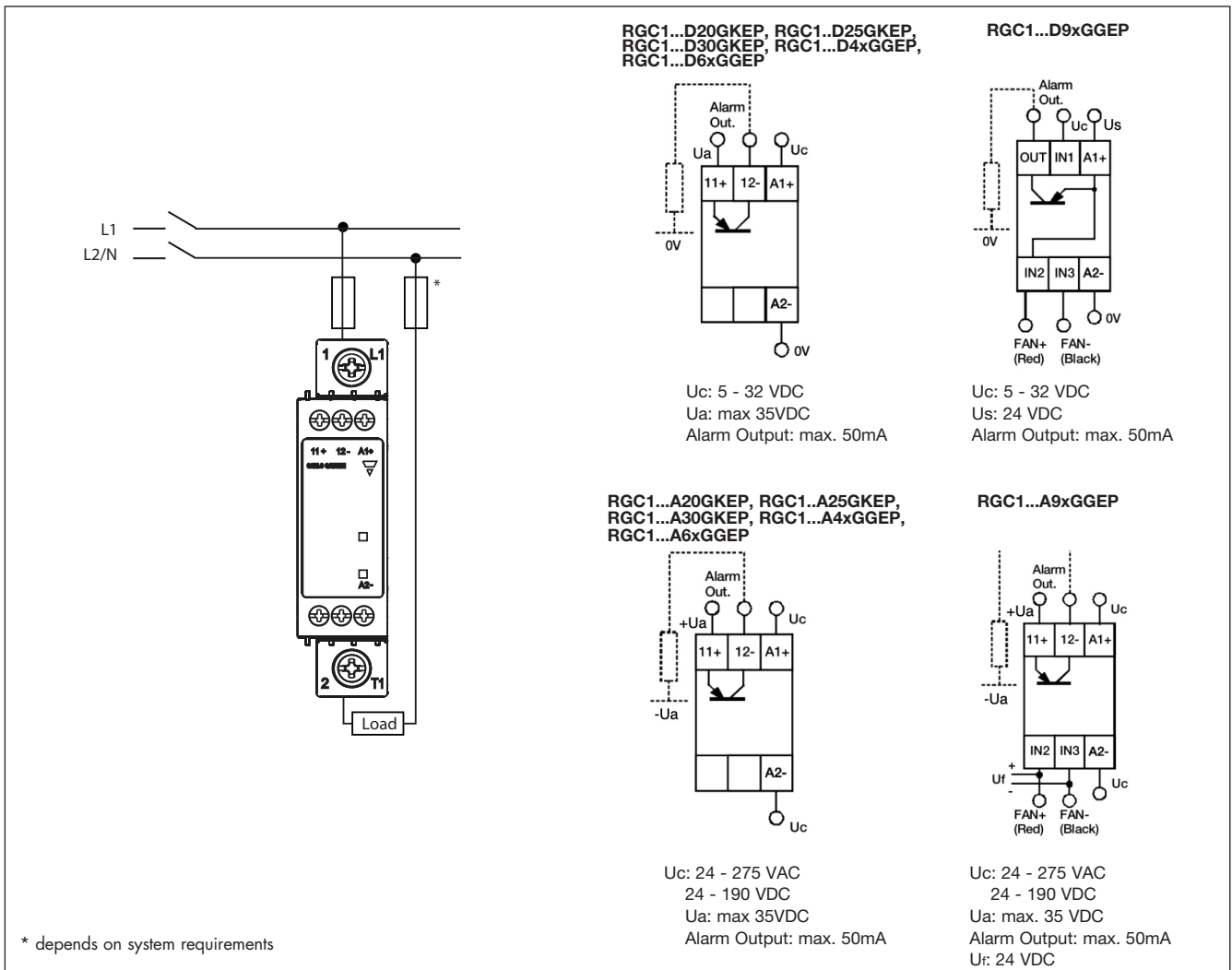

Terminal Layout and Dimensions

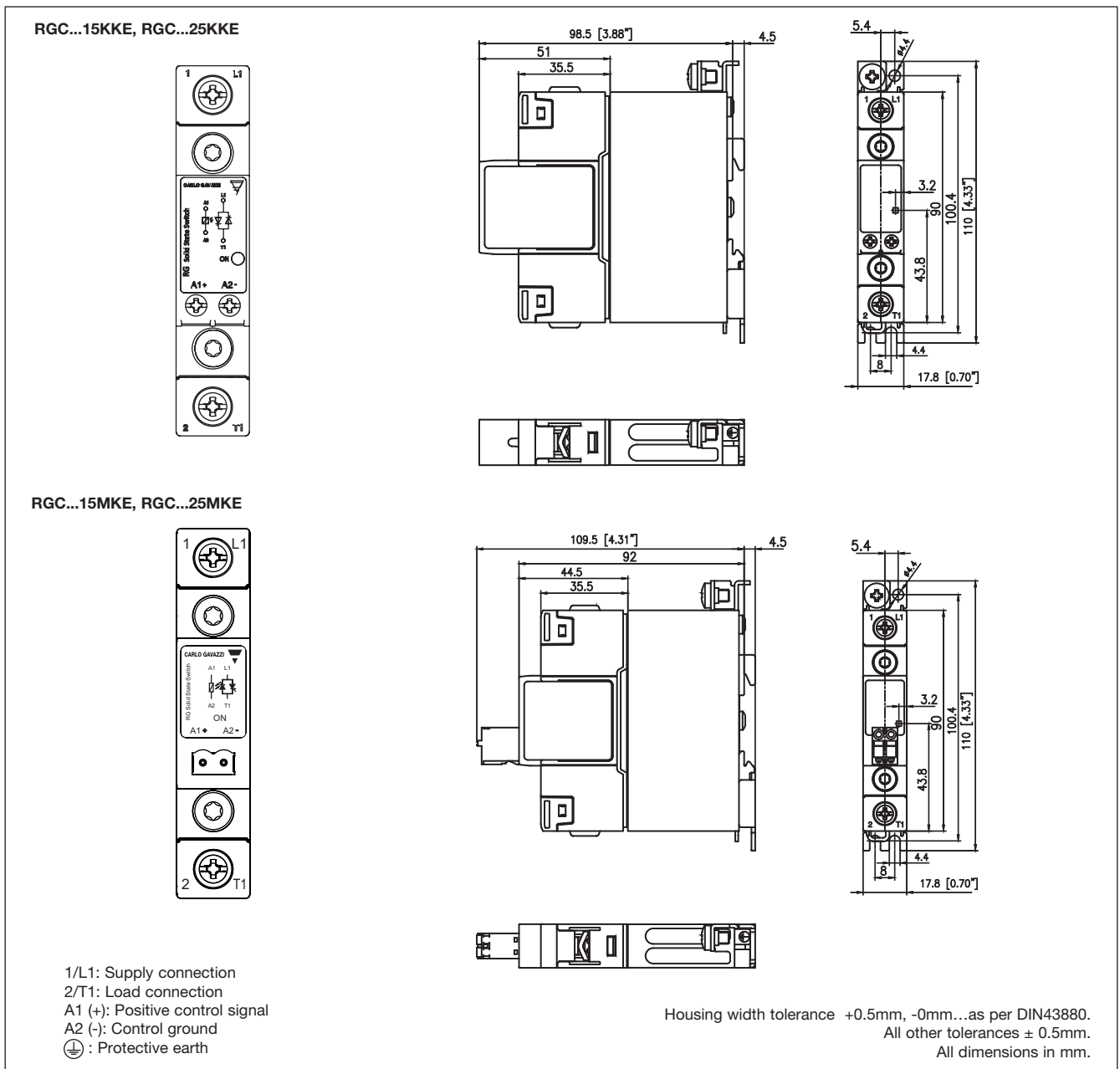

Terminal Layout and Dimensions (cont.)

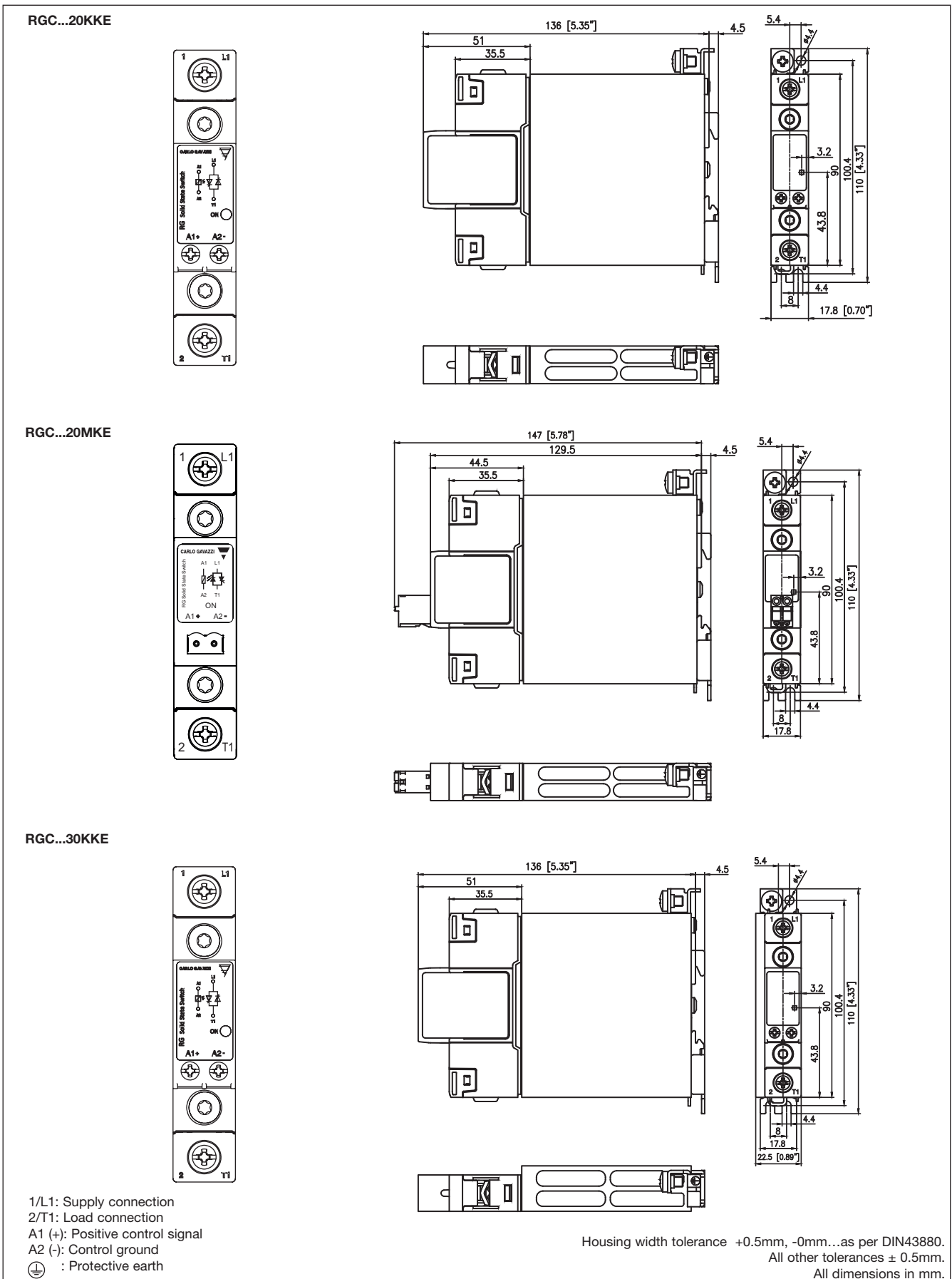

Terminal Layout and Dimensions (cont.)

RGC...30MKE

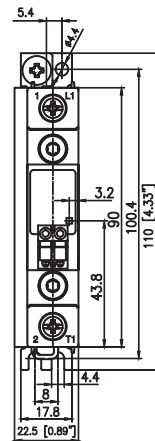
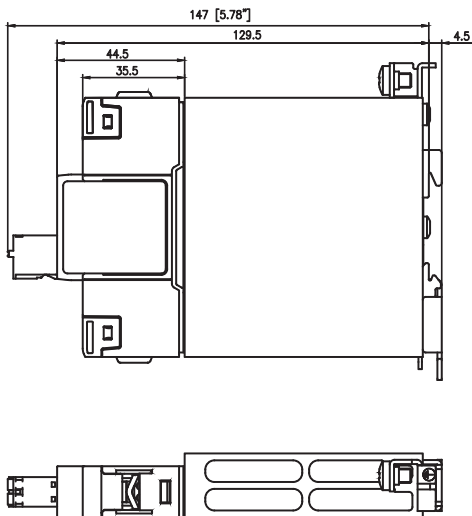
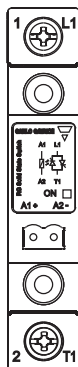

RGC...40KGE, RGC...42KGE

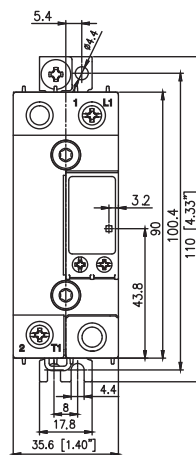
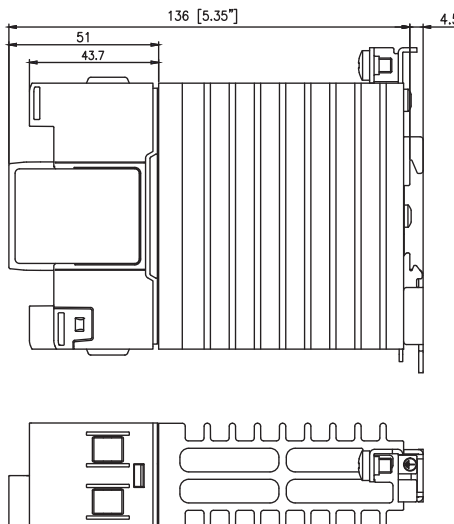
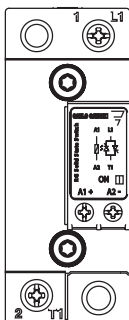

RGC...40MGE, RGC...42MGE

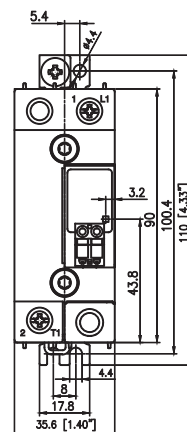
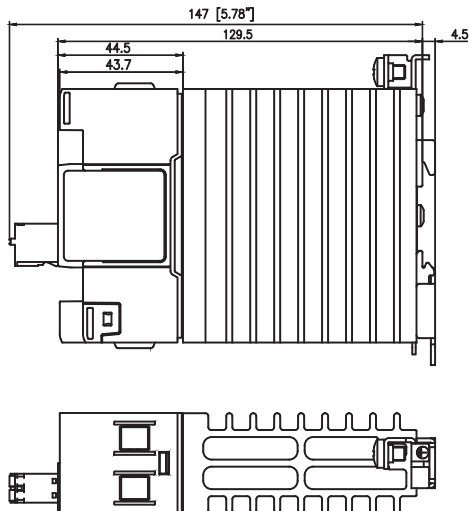
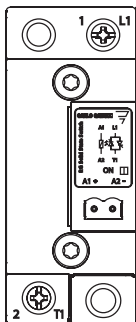

- 1/L1: Supply connection
- 2/T1: Load connection
- A1 (+): Positive control signal
- A2 (-): Control ground
- ⊕ : Protective earth

Housing width tolerance +0.5mm, -0mm...as per DIN43880.
All other tolerances ± 0.5mm. All dimensions in mm.

Terminal Layout and Dimensions (cont.)

RGC...60KGE, RGC...62KGE

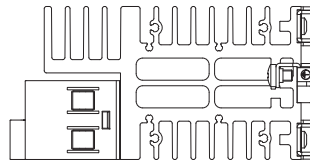
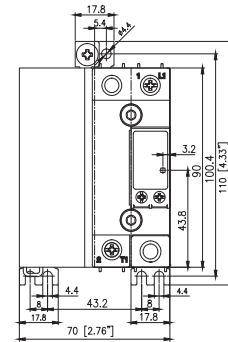
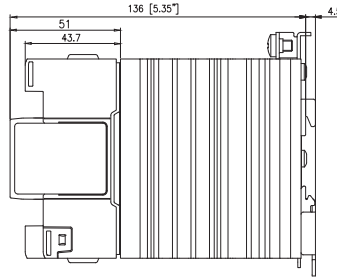
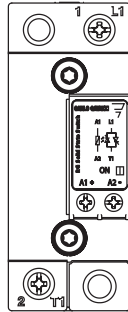

RGC...62MGE

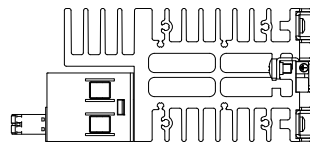
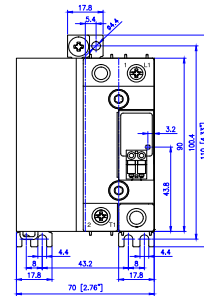
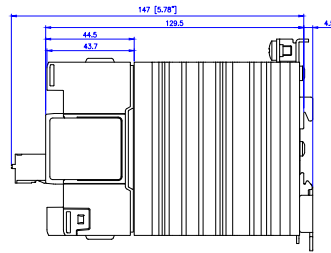
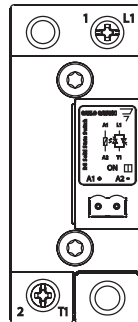

RGC...20GKEP

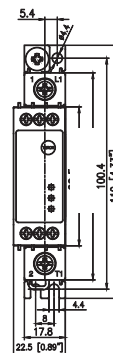
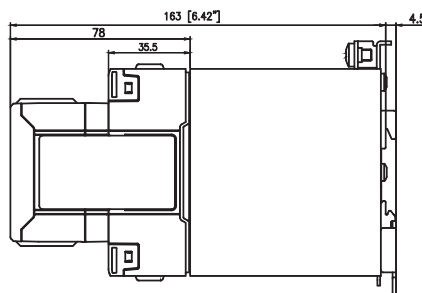
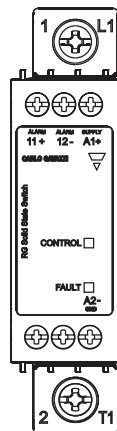

- 1/L1: Supply connection
- 2/T1: Load connection
- A1 (+): Positive control signal
(Positive supply in case of RGC1A..D9xGGEP)
- A2 (-): Control ground
- IN1: Control signal (only for RGC1A.. D 9xGGEP)
- IN2: Fan + supply (only for RGC1A60A9xGGEP)
- IN3: Fan - supply (only for RGC1A60A9xGGEP)
- 11 + : Alarm output (+)
- OUT, 12 - : Alarm output (-)
- ⊕ : Protective earth

Housing width tolerance +0.5mm, -0mm...as per DIN43880.
All other tolerances ± 0.5mm.
All dimensions in mm.

Terminal Layout and Dimensions (cont.)

RGC...25GKEP

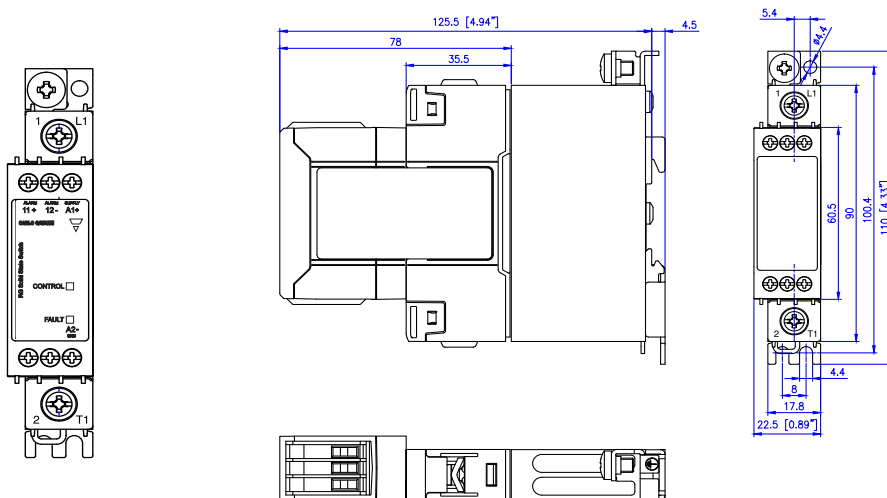

RGC...30GKEP

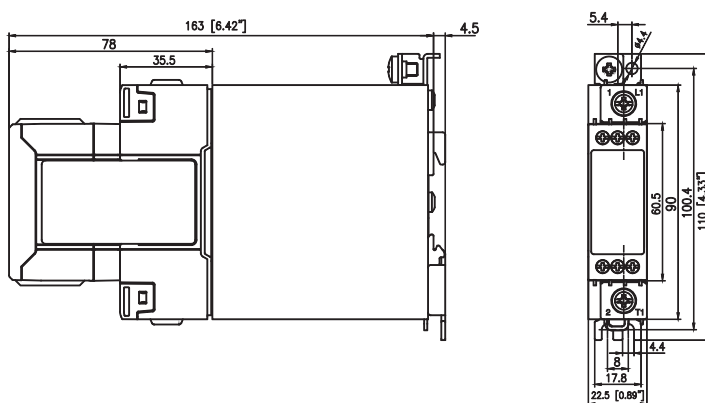

- 1/L1: Supply connection
- 2/T1: Load connection
- A1 (+): Positive control signal
(Positive supply in case of RGC1A..D9xGGEP)
- A2 (-): Control ground
- IN1: Control signal (only for RGC1A.. D 9xGGEP)
- IN2: Fan + supply (only for RGC1A60A9xGGEP)
- IN3: Fan - supply (only for RGC1A60A9xGGEP)
- 11 + : Alarm output (+)
- OUT, 12 - : Alarm output (-)
- ⊕ : Protective earth

Housing width tolerance +0.5mm, -0mm...as per DIN43880.
 All other tolerances ± 0.5mm.
 All dimensions in mm.

Terminal Layout and Dimensions (cont.)

RGC...40GGEP, RGC...42GGEP

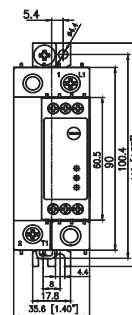
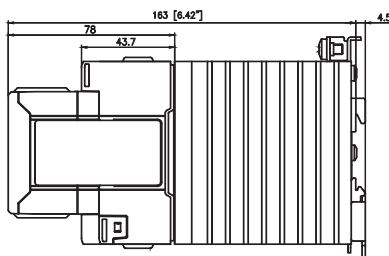
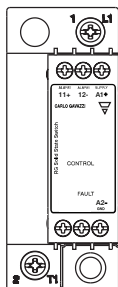

RGC...60GGEP, RGC...62GGEP

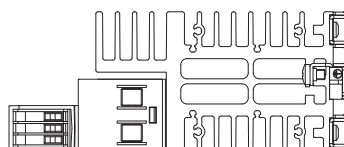
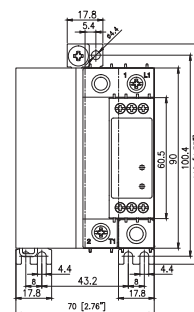
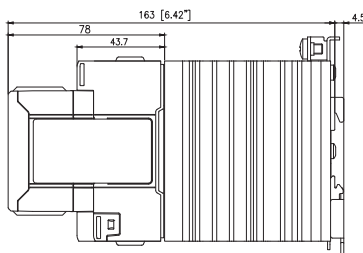
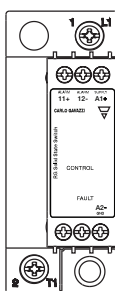

RGC...90GGEP, RGC...92GGEP

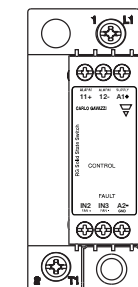
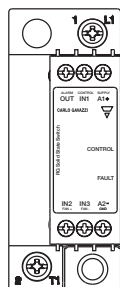

RGC...D9xGGEP

RGC...A9xGGEP

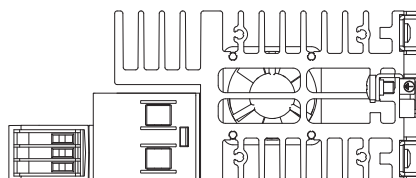
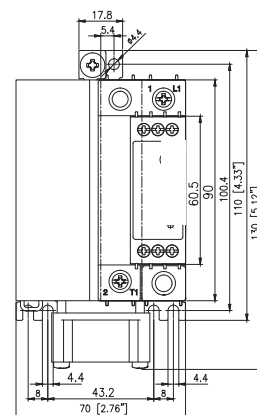
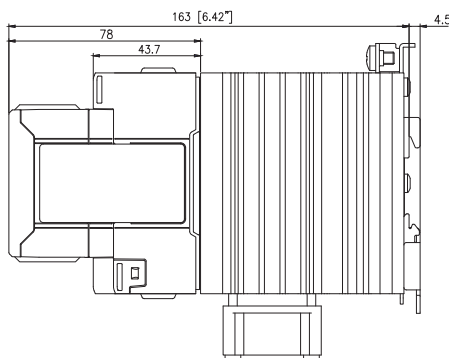







- 1/L1: Supply connection
- 2/T1: Load connection
- A1 (+): Positive control signal
(Positive supply in case of RGC1A..D9xGGEP)
- A2 (-): Control ground
- IN1: Control signal (only for RGC1A..D9xGGEP)
- IN2: Fan + supply (only for RGC1A60A9xGGEP)
- IN3: Fan - supply (only for RGC1A60A9xGGEP)
- 11 + : Alarm output (+)
- OUT, 12 - : Alarm output (-)
- ⊕ : Protective earth

Housing width tolerance +0.5mm, -0mm...as per DIN43880.
All other tolerances ± 0.5mm. All dimensions in mm.

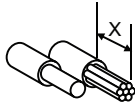
Connection Specifications

POWER CONNECTIONS: 1/L1, 2 /T1





Use 75°C copper (Cu) conductors

	RG...KKE ; RG..GKEP. ; RG...MKE		RG...KGE ; RG...GGEP ; RG...MGE
Stripping Length (X)	12mm		11mm
Connection type	M4 screw with captivated washer		M5 screw with box clamp
Rigid (Solid & Stranded) UL/ cUL rated data		 2 x 2.5..6 mm ² 2 x 14.. 10 AWG	 1 x 2.5..6 mm ² 1 x 14.. 10 AWG
Flexible with end sleeve		2 x 1.0 ... 2.5mm ² 2 x 2.5..4mm ² 2 x 18.. 14 AWG 2 x 14.. 12 AWG	1 x 2.5..16mm ² 1 x 14.. 6 AWG
Flexible without end sleeve		2 x 1.0 ... 2.5mm ² 2 x 2.5.. 6mm ² 2 x 18.. 14 AWG 2 x 14.. 10 AWG	1 x 4.. 25mm ² 1 x 12.. 3 AWG
Torque specifications		Pozidriv 2 UL: 2Nm (17.7lb-in) IEC: 1.5 - 2.0Nm (13.3 - 17.7lb-in)	Posidriv 2 UL: 2.5Nm (22lb-in) IEC: 2.5 - 3.0Nm (22-26.6lb-in)
Aperture for termination lug	12.3mm		N/A
Protective Earth (PE) Connection		M5, 1.5Nm (13.3 in-lb)	

Note: M5 PE screw not provided with SSR. PE connection required when product is intended to be used in Class 1 applications according to EN/IEC 61140.

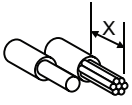

CONTROL CONNECTIONS: A1(+), A2(-)

Use 60/75°C copper (Cu) conductors

	RG...KKE, RG..KGE		RG...MKE, RG...MGE
Torque specifications		M3, Pozidriv 1 UL: 0.5Nm (4.4lb-in) IEC: 0.5 - 0.6Nm (4.4 - 5.3lb-in)	
Stripping Length (X)	8mm		12 - 13mm
Rigid (Solid & Stranded) UL/ cUL rated data		 2 x 0.5..2.5mm ² 2 x 18..12 AWG	 1 x 0.5..2.5mm ² 1 x 18..12 AWG
Flexible with end sleeve		2 x 0.5..2.5mm ² 2 x 18..12AWG	1 x 0.5..2.5mm ² 1 x 18..12AWG

CONTROL CONNECTIONS: A1(+), A2(-), IN1, IN2, IN3, 11 (+), 12(-), OUT

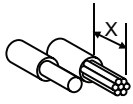
Use 60/75°C copper (Cu) conductors

	RG...GGEP	
Torque specifications		M3, Pozidriv 1 UL: 0.5Nm (4.4lb-in) IEC: 0.4 - 0.5Nm (3.5 - 4.4lb-in)
Stripping Length (X)	6mm	6mm
Rigid (Solid & Stranded) UL/ cUL rated data		 2 x 1.0..2.5mm ² 2 x 18..14 AWG
Flexible with end sleeve		2 x 1.0..2.5mm ² 2 x 18..14 AWG

Installation Instructions

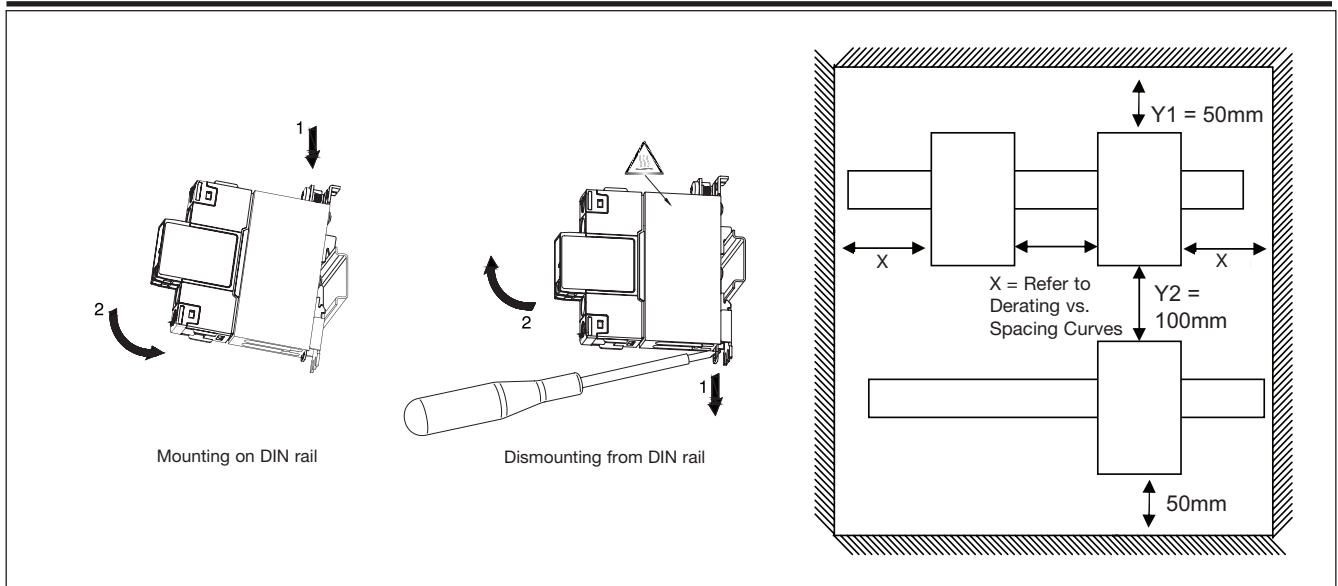

Short Circuit Protection

Protection Co-ordination, Type 1 vs Type 2:

Type 1 protection implies that after a short circuit, the device under test will no longer be in a functioning state. In type 2 co-ordination the device under test will still be functional after the short circuit. In both cases, however the short circuit has to be interrupted. The fuse between enclosure and supply shall not open. The door or cover of the enclosure shall not be blown open. There shall be no damage to conductors or terminals and the conductors shall not separate from terminals. There shall be no breakage or cracking of insulating bases to the extent that the integrity of the mounting of live parts is impaired. Discharge of parts or any risk of fire shall not occur.

The product variants listed in the table hereunder are suitable for use on a circuit capable of delivering not more than 100,000A rms Symmetrical Amperes, 600 Volts maximum when protected by fuses. Tests at 100,000A were performed with Class J fuses, fast acting; please refer to the table below for maximum allowed ampere rating of the fuse. Use fuses only.

Tests with Class J fuses are representative of Class CC fuses.

Co-ordination type 1 (UL508)

Part No.	Prospective short circuit current [kArms]	Max. fuse size [A]	Class	Voltage [VAC]
RGC..15	100	30	J or CC	max. 600
RGC..20	100	30	J or CC	max. 600
RGC..25	100	30	J or CC	max. 600
RGC..30	100	30	J or CC	max. 600
RGC..40	100	40	J	max. 600
RGC..42	100	90	J	max. 600
RGC..60	100	40	J	max. 600
RGC..62	100	90	J	max. 600
RGC..90	100	40	J	max. 600
RGC..92	100	90	J	max. 600

Co-ordination type 2 (IEC/EN 60947-4-2/ -4-3)

Part No.	Prospective short circuit current [kArms]	Ferraz Shawmut		Siba		Voltage [VAC]
		Max fuse size [A]	Part number	Max fuse size [A]	Part number	
RGC..15	10	25	6.9xx CP GRC 14x51 /25	32	50 142 06.32	max. 600
	100	25	6.9xx CP GRC 14x51 /25	32	50 142 06.32	max. 600
RGC..20	10	40	6.6xx CP URD 22x58 /40	32	50 142 06.32	max. 600
	100	40	6.6xx CP URD 22x58 /40	32	50 142 06.32	max. 600
RGC..25	10	40	6.9xx CP GRC 22x58 /40	32	50 142 06.32	max. 600
	100	40	6.6xx CP URD 22x58 /40	32	50 142 06.32	max. 600
RGC..30	10	40	6.9xx CP GRC 22x58 /40	32	50 142 06.32	max. 600
	100	40	6.6xx CP URD 22x58 /40	32	50 142 06.32	max. 600
RGC..40	10	63	6.621 CP URGD 27x60 /63	63	50 194 20.63	max. 600
	10	70	A70QS70-4	63	50 194 20.63	max. 600
	100	63	6.621 CP URQ 27x60 /63	63	50 194 20.63	max. 600
RGC..42	10	63	6.9xx CP URC 14x51 /63	80	50 194 20.80	max. 600
	10	70	A70QS70-4	80	50 194 20.80	max. 600
	100	63	6.9xx CP URC 14x51 /63	80	50 194 20.80	max. 600
	100	70	A70QS70-4	80	50 194 20.80	max. 600
RGC..60 up to 65AAC	10	80	6.621 CP URQ 27x60 /80	80	50 194 20.80	max. 600
	100	n/a	n/a	80	50 194 20.80	max. 600
RGC..62	10	100	6.9xx CP GRC 22x58 /100	100	50 194 20.100	max. 600
	10	100	A70QS100-4	100	50 194 20.100	max. 600
	100	100	6.621 CP URGD 27x60 /100	100	50 194 20.100	max. 600
	100	100	A70QS100-4	100	50 194 20.100	max. 600
RGC..90 up to 80AAC	10	100	6.621 CP URQ 27x60 /100	100	50 194 20.100	max. 600
	10	100	A70QS100-4	100	50 194 20.100	max. 600
	100	n/a	n/a	100	50 194 20.100	max. 600
RGC..92	10	125	6.621 CP URQ 27x60 /125	125	50 194 20.125	max. 600
	10	125	A70QS125-4	125	50 194 20.125	max. 600
	100	125	6.621 CP URQ 27x60 /125	125	50 194 20.125	max. 600
	100	125	A70QS125-4	125	50 194 20.125	max. 600

Type 2 Protection with Miniature Circuit Breakers (M.C.B.s)

Solid State Relay type	ABB Model no. for Z - type M. C. B. (rated current)	ABB Model no. for B - type M. C. B. (rated current)	Wire cross sectional area [mm ²]	Minimum length of Cu wire conductor [m] ¹³	
RGC..15, RGC..20	1 pole S201 - Z4 (4A) S201 - Z6 UC (6A)	S201 - B2 (2A) S201 - B2 (2A)	1.0	21.0	
			1.0	21.0	
			1.5	31.5	
RGC..25, RGC..30	1 pole S201 - Z10 (10A)	S201-B4 (4A)	1.0	7.6	
			1.5	11.4	
			2.5	19.0	
	S201 - Z16 (16A)	S201-B6 (6A)	1.0	5.2	
			1.5	7.8	
			2.5	13.0	
			4.0	20.8	
	S201 - Z20 (20A)	S201-B10 (10A)	1.5	12.6	
			2.5	21.0	
	S201 - Z25 (25A)	S201-B13 (13A)	2.5	25.0	
			4.0	40.0	
	2 pole S202 - Z25 (25A)	S202-B13 (13A)	2.5	19.0	
			4.0	30.4	
	RGC..40	1 pole S201 - Z25 (25A)	S201-B13 (13A)	2.5	7.0
				4.0	11.2
6.0				16.8	
RGC..60	1 pole S201 - Z25 (25A)	S201-B13 (13A)	2.5	7.0	
			4.0	11.2	
			6.0	16.8	
RGC..90GGEP	1 pole S201 - Z20 (20A)	S201-B10 (10A)	1.5	4.2	
			2.5	7.0	
			4.0	11.2	
	S201 - Z32 (32A)	S201-B16 (16A)	2.5	13.0	
			4.0	20.8	
			6.0	31.2	
	2 pole S202 - Z20 (20A)	S202-B10 (10A)	1.5	1.8	
			2.5	3.0	
			4.0	4.8	
	S202 - Z32 (32A)	S202-B16 (16A)	2.5	5.0	
			4.0	8.0	
			6.0	12.0	
			10.0	20.0	
	S202 - Z50 (50A)	S202-B25 (25A)	4.0	14.8	
			6.0	22.2	
10.0			37.0		
RGC..42, RGC..62, RGC..92	1 pole S201-Z32 (32A)	S201-B16 (16A)	2.5	3.0	
			4.0	4.8	
			6.0	7.2	
	S201-Z50 (50A)	S201-B25 (25A)	4.0	4.8	
			6.0	7.2	
			10.0	12.0	
			16.0	19.2	
	S201-Z63 (63A)	S201-B32 (32A)	6.0	7.2	
			10.0	12.0	
			16.0	19.2	

13. Between MCB and Load (including return path which goes back to the mains).

Note: A prospective current of 6kA and a 230/400V power supply system is assumed for the above suggested specifications. For cables with different cross section than those mentioned above please consult Carlo Gavazzi's Technical Support Group.

Accessories

Control Plugs



Ordering Key

Pack of 10 spring
loaded control plugs

RGM25

* Refer to 'Connection Specifications' section for further details.