

## Ignition transformers TZI, TGI

Technical Information · GB  
8 Edition 06.16

- Electrical ignition of gas burners
- Ignition and burner control with a single electrode possible
- TZI 7,5-20/33R complies with CSA



---

# Contents

Ignition transformers TZI, TGI .....	1
Contents .....	2
<b>1 Application .....</b>	<b>3</b>
1.1 Examples of application .....	5
1.1.1 Double-electrode operation .....	5
1.1.2 Single-electrode operation .....	5
<b>2 Certification .....</b>	<b>6</b>
<b>3 Function .....</b>	<b>7</b>
3.1 Connection diagrams .....	7
<b>4 Selection .....</b>	<b>8</b>
4.1 Selection table .....	8
4.1.1 Type code .....	8
<b>5 Project planning information .....</b>	<b>9</b>
5.1 Operation .....	9
5.2 Installation .....	9
5.3 Cable selection .....	9
5.3.1 Ignition cable .....	9
5.4 Reduction of EMC, wiring .....	10
5.5 Single-electrode operation .....	10
5.6 Intermittent operation/Star electrodes .....	10
5.7 Duty cycle .....	11
<b>6 Accessories .....</b>	<b>12</b>
6.1 High-voltage cable .....	12
6.2 Radio interference suppressed electrode adapters .....	12
<b>7 Technical data .....</b>	<b>13</b>
7.1 Dimensions .....	14
<b>Feedback .....</b>	<b>15</b>
<b>Contact .....</b>	<b>15</b>

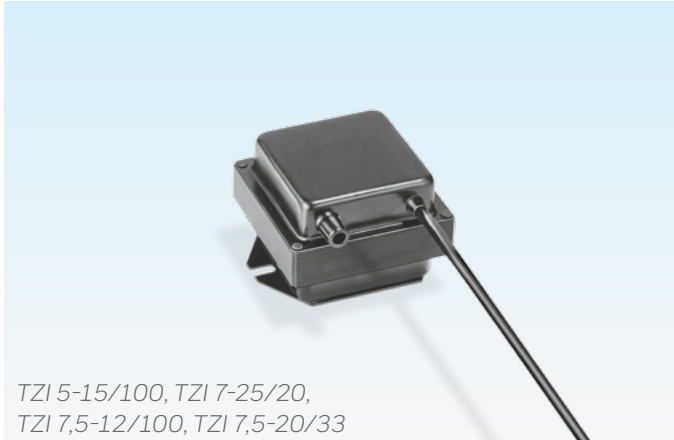

*TZI 5-15/100, TZI 7-25/20,  
TZI 7,5-12/100, TZI 7,5-20/33*



*TGI*

### **1 Application**

Ignition transformers TZI and TGI are designed for high-voltage spark ignition of gas burners and gas-ignited or directly ignited oil burners. The ignition transformers can also be used on burners with single-electrode operation; the ignition current and ionization current flow over a common electrode. The ignition transformer TZI must be mounted in a housing, e.g. in a control cabinet. It fulfils the requirements for enclosure IP 00. Ignition transformer TGI in its die-cast aluminium housing meets the requirements for enclosure IP 54. It is suitable for on-site mounting near to the burner.



*Bogie hearth forging furnace  
in the metallurgical industry*

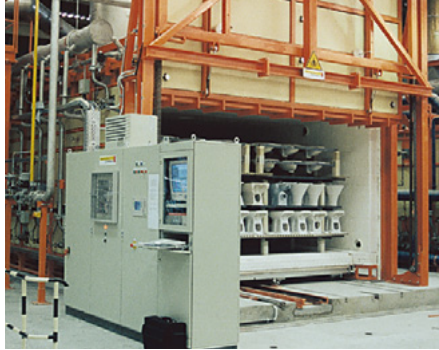

*Intermittent shuttle kiln  
in the ceramics industry*



*Walking beam furnace  
with overhead firing*

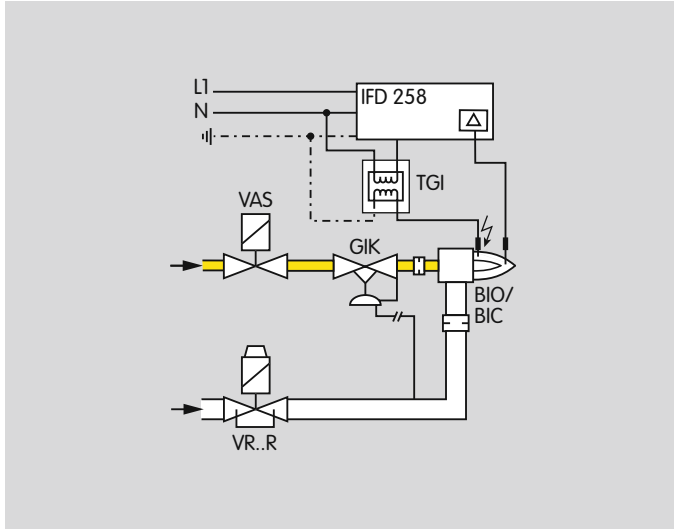

## 1.1 Examples of application

### 1.1.1 Double-electrode operation

Ignition using ignition electrode

Ignition transformer TGI is supplied with voltage via the automatic burner control unit IFD 258. The ignition transformer generates a high voltage. This high voltage creates ignition sparks between the ignition electrode and burner ground. After the burner start, a current flows via the ionization electrode for flame control.

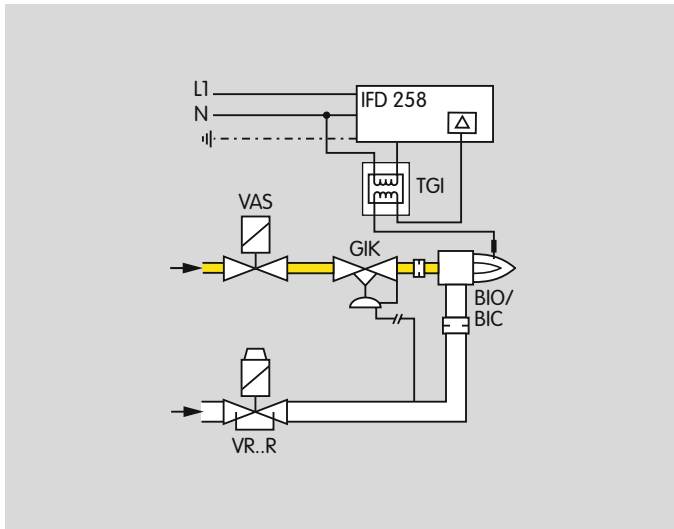

### 1.1.2 Single-electrode operation

Ignition using an ignition and ionization electrode.

After burner start, a flame control current flows via the same electrode that is also used for ignition.

## **2 Certification**

Ignition transformers TZI and TGI are built for applications pursuant to the Machinery Directive 2006/42/EC.

### **TZI 7,5-20/33R**

Complies with Canadian Standards Association  
CSA C22.2 No. 13-1962.



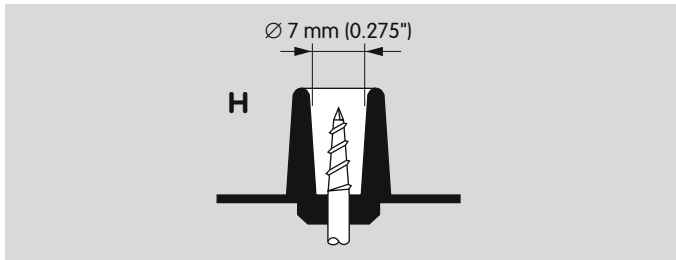
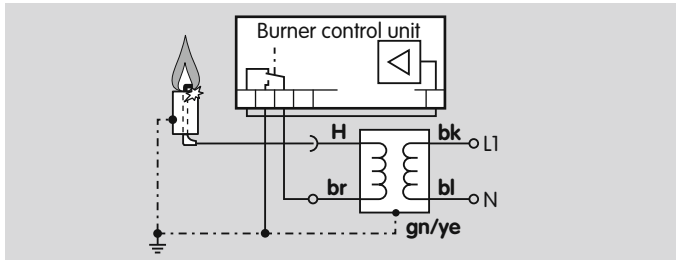
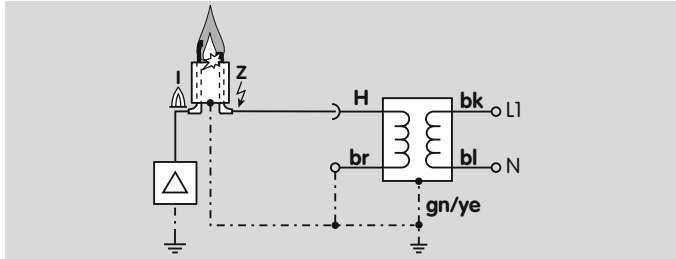

**Legend**

<b>H</b>	High-voltage connection
<b>br</b>	Connection cable brown
<b>bk</b>	Connection cable black
<b>bl</b>	Connection cable blue
<b>gn/ye</b>	Connection cable green/yellow

**3 Function**

**3.1 Connection diagrams**

Ignition: double-electrode operation

**Ignition: single-electrode operation**

Single-electrode operation is possible only in conjunction with suitable automatic burner control units. The switchover between ignition and monitoring is performed by the automatic burner control unit.

**High-voltage connection**

Cut end of high-voltage cable is inserted into the shroud and screwed onto the wood screw (**H**).

## 4 Selection

### 4.1 Selection table

	R	W
TZI 5-15/100	●	●
TZI 7-25/20	●	●
TZI 7,5-12/100	●	●
TZI 7,5-20/33	●	●
TGI 5-15/100	●	●
TGI 7-25/20	●	●
TGI 7,5-12/100	●	●
TGI 7,5-20/33	●	●

#### Order example

TZI 5-15/100W

● = standard, ○ = available

#### 4.1.1 Type code

Code	Description
TZI	Ignition transformer
TGI	Ignition transformer, enclosed
5	High voltage: 5 kV
7	7 kV
7,5	7.5 kV
-12	Output current: 12 mA at 50 Hz (9 mA at 60 Hz)
-15	15 mA at 50 Hz (11 mA at 60 Hz)
-20	20 mA at 50 Hz (15 mA at 60 Hz)
-25	25 mA at 50 Hz (18 mA at 60 Hz)
/20	Duty cycle: 20%
/33	33%
/100	100%
R	Mains voltage: 115 V
W	230 V



## 5 Project planning information

### 5.1 Operation

The ignition transformers are suitable only for applications for igniting gas burners and gas-ignited or directly ignited oil burners. An automatic burner control unit with integrated fuse (max. 4 A) must be provided to activate the ignition transformers. Do not operate the transformers when no ignition sparks are created (distance between spark electrode and burner ground =  $2 \pm 0.5$  mm). The duty cycle and the ambient temperature must not exceed the permissible limits.

### 5.2 Installation

Installation position for TZI and TGI: install with the connections facing down. Position the ignition transformer right next to the burner (recommended ignition cable length: max. 5 m, recommended  $< 1$  m).

#### TZI

The length of the mains cable is approx. 410 mm.  
Fix the ignition transformer in a housing or control cabinet.

### 5.3 Cable selection

Use mains cable suitable for the type of operation and complying with local regulations.

Install an equipotential bond (4 mm<sup>2</sup>, compliant with local regulations) between burner and ignition transformer.

#### TGI

The TGI housing has two A/F 27 cable glands with double seal inserts for two cables up to 7 mm in diameter. A seal insert for 10 to 14 mm is enclosed and can be used in the A/F 27 cable gland, see page 14 (Dimensions).

#### 5.3.1 Ignition cable

Use unscreened high-voltage cable for the ignition cable, see page 12 (Accessories). The ignition capacity is lower when using a screened ignition cable.

Ignition cable length:

Recommended  $< 1$  m, max. 5 m. The longer the ignition cable, the lower the ignition capacity.

Use radio interference suppressed terminal boots only on the burner (with 1 k $\Omega$  resistor), see page 12 (Accessories).

### **5.4 Reduction of EMC, wiring**

Avoid external electrical interference.

Lay cables individually and, if possible, not in a metal conduit.

Do not lay UV/ionization cable and ignition cables together and lay them as far apart as possible.

Screw the ignition cable securely into the high-voltage connection on the ignition transformer and run to the burner by the shortest possible route, see page 7 (High-voltage connection).

Use radio interference suppressed terminal boots only on the burner (with 1 k $\Omega$  resistor), see page 12 (Accessories).

### **5.5 Single-electrode operation**

Single-electrode operation is possible only in conjunction with suitable automatic burner control units.

For single-electrode operation, wire an equipotential bond between the burner and the automatic burner control unit, see page 7 (Ignition: single-electrode operation). Ensure that the wiring has been done correctly, otherwise the connected units will be damaged.

### **5.6 Intermittent operation/Star electrodes**

We recommend using 7.5 kV ignition transformers for On/Off intermittent operation or when using burners with star electrodes.

## 5.7 Duty cycle

The duty cycle indicates for how long the ignition transformer can be switched on within 180 s, without it being overloaded.

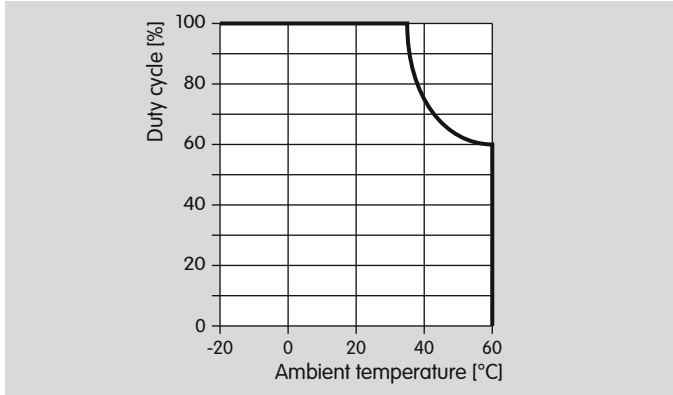

For ignition transformers, the duty cycle is dependent on the ambient temperature.

TZI/TGI duty cycle in % – see page 13 (Technical data).

Converting the duty cycle into seconds:

$$\text{Duty cycle [s]} = \frac{\text{Duty cycle [\%]} \times 180 \text{ s}}{100\%}$$

Example

Ignition transformer TZI 7-25/20W with a duty cycle of 20% for an ambient temperature of -20 to +35°C.

$$\text{Duty cycle} = \frac{20 [\%] \times 180 \text{ s}}{100\%} = 36 \text{ s}$$

In an ambient temperature of -20 to +35°C, this results in a maximum duty cycle of 36 s within 180 s for the ignition transformer.

For an automatic burner control unit with an ignition time  $t_z = 6 \text{ s}$ , for example, the resultant timing cycle is a maximum of 2 ignitions per minute.

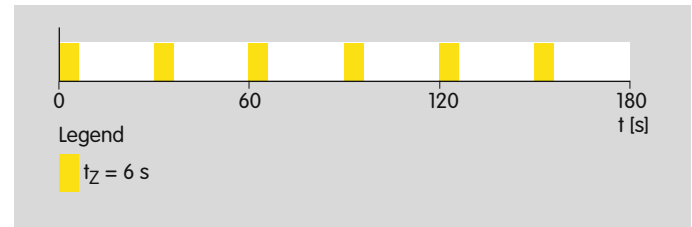

## 6 Accessories

### 6.1 High-voltage cable

FZLSi 1/7 -50°C (-58°F) to 180°C (356°F),

Order No. 04250410,

FZLK 1/7 -5°C (23°F) to 80°C (176°F),

Order No. 04250409.

### 6.2 Radio interference suppressed electrode adapters

Plug cap, 4 mm (0.16 inch), interference-suppressed,

Order No. 04115308.

Straight adapter, 4 mm (0.16 inch), interference-suppressed,

Order No. 04115307.

Straight adapter, 6 mm (0.2 inch), interference-suppressed,

Order No. 04115306.

## 7 Technical data

Type	Input			Output			Duty cycle**	Enclosure	Weight
	V AC	Hz*	A*	V	mA*				
TZI 5-15/100W	230	50 (60)	0.45 (0.35)	5000	15 (11)		100	IP 00	1.5
TZI 7-25/20W	230	50 (60)	1.1 (0.8)	7000	25 (18)		20	IP 00	1.5
TZI 7,5-12/100W	230	50 (60)	0.6 (0.45)	7500	12 (9)		100	IP 00	2
TZI 7,5-20/33W	230	50 (60)	0.9 (0.7)	7500	20 (15)		33	IP 00	2
TZI 5-15/20R	115	50 (60)	1 (0.7)	5000	15 (11)		20	IP 00	0.9
TZI 5-15/100R	115	50 (60)	0.9 (0.7)	5000	15 (11)		100	IP 00	1.5
TZI 7-25/20R	115	50 (60)	2.2 (1.6)	7000	25 (18)		20	IP 00	1.5
TZI 7,5-12/100R	115	50 (60)	1.2 (0.9)	7500	12 (9)		100	IP 00	2
TZI 7,5-20/33R	115	50 (60)	1.8 (1.35)	7500	20 (15)		33	IP 00	2
TGI 5-15/100W	230	50 (60)	0.45 (0.35)	5000	15 (11)		100	IP 54	3
TGI 7-25/20W	230	50 (60)	1.1 (0.8)	7000	25 (18)		20	IP 54	3
TGI 7,5-12/100W	230	50 (60)	0.6 (0.45)	7500	12 (9)		100	IP 54	3.5
TGI 7,5-20/33W	230	50 (60)	0.9 (0.7)	7500	20 (15)		33	IP 54	3.5
TGI 5-15/100R	115	50 (60)	0.9 (0.7)	5000	15 (11)		100	IP 54	3
TGI 7-25/20R	115	50 (60)	2.2 (1.6)	7000	25 (18)		20	IP 54	3
TGI 7,5-12/100R	115	50 (60)	1.2 (0.9)	7500	12 (9)		100	IP 54	3.5
TGI 7,5-20/33R	115	50 (60)	1.8 (1.35)	7500	20 (15)		33	IP 54	3.5

\* Values in brackets apply to 60 Hz.

\*\* For temperatures between -20 and +35°C.

Converting the duty cycle into seconds, see page 11

(Duty cycle).

Ambient temperature:

-20 to +60°C.

## 7.1 Dimensions

### TZI

Length of connection cable: approx. 410 mm

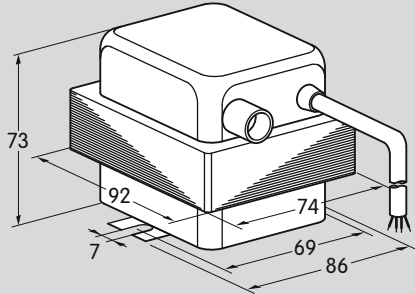

TZI 5-15/100, TZI 7-25/20

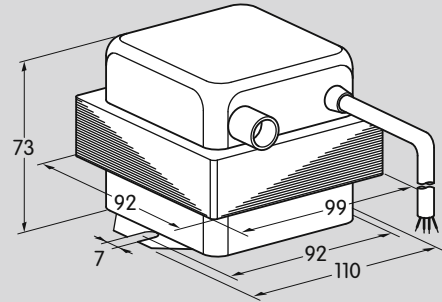

TZI 7,5-12/100, TZI 7,5-20/33

### TGI

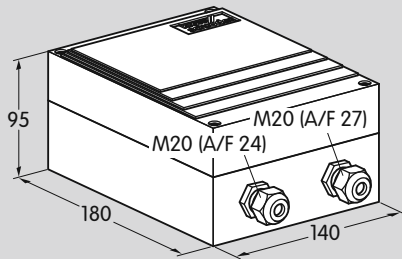

TGI

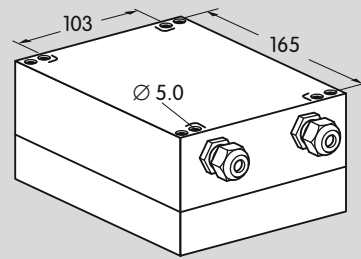

## Feedback

Finally, we are offering you the opportunity to assess this “Technical Information (TI)” and to give us your opinion, so that we can improve our documents further and suit them to your needs.

### Clarity

- Found information quickly
- Searched for a long time
- Didn't find information
- What is missing?
- No answer

### Comprehension

- Coherent
- Too complicated
- No answer

### Scope

- Too little
- Sufficient
- Too wide
- No answer



### Use

- To get to know the product
- To choose a product
- Planning
- To look for information

### Navigation

- I can find my way around
- I got “lost”
- No answer

### My scope of functions

- Technical department
- Sales
- No answer

### Remarks

## Contact

Elster GmbH  
Postfach 2809 · 49018 Osnabrück  
Strothweg 1 · 49504 Lotte (Büren)  
Germany

Tel +49 541 1214-0  
Fax +49 541 1214-370  
info@kromschroeder.com  
www.kromschroeder.com

The current addresses of our international agents are available on the Internet:  
[www.kromschroeder.de/Weltweit.20.0.html?&L=1](http://www.kromschroeder.de/Weltweit.20.0.html?&L=1)

We reserve the right to make technical modifications in the interests of progress.  
Copyright © 2016 Elster GmbH  
All rights reserved.

**Honeywell**  
krom  
schroeder

03250846