



SICK – laser competence in photoelectric switches



WT27L

Laser sensors with high beam quality at distances of up to 1 m.

W12L-2

Best performance in a metal housing. The original – proven in thousands of installations.

W190L Standard

Easy adjustment and light-/dark-switching using potentiometers.

W190L High

With display and configurable. As a photoelectric reflex switch, best in class for transparent objects.

W9L

Laser competence for performance and safety in a compact housing.

W100L

One of the smallest laser photoelectric switches on the market.

W130L

Configurable evaluation unit with external laser heads, analogue output and parallel laser line.

V18L

Family of cylindrical laser photoelectric switches. Laser Class 1 provides safest eye protection.

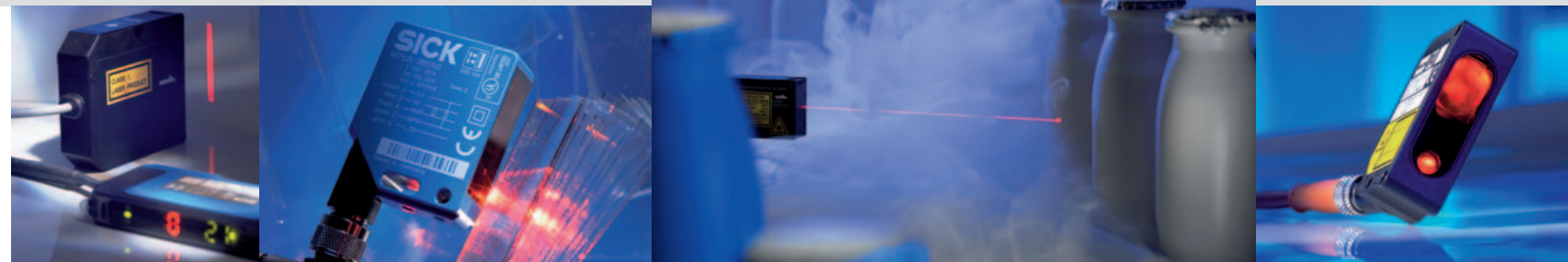
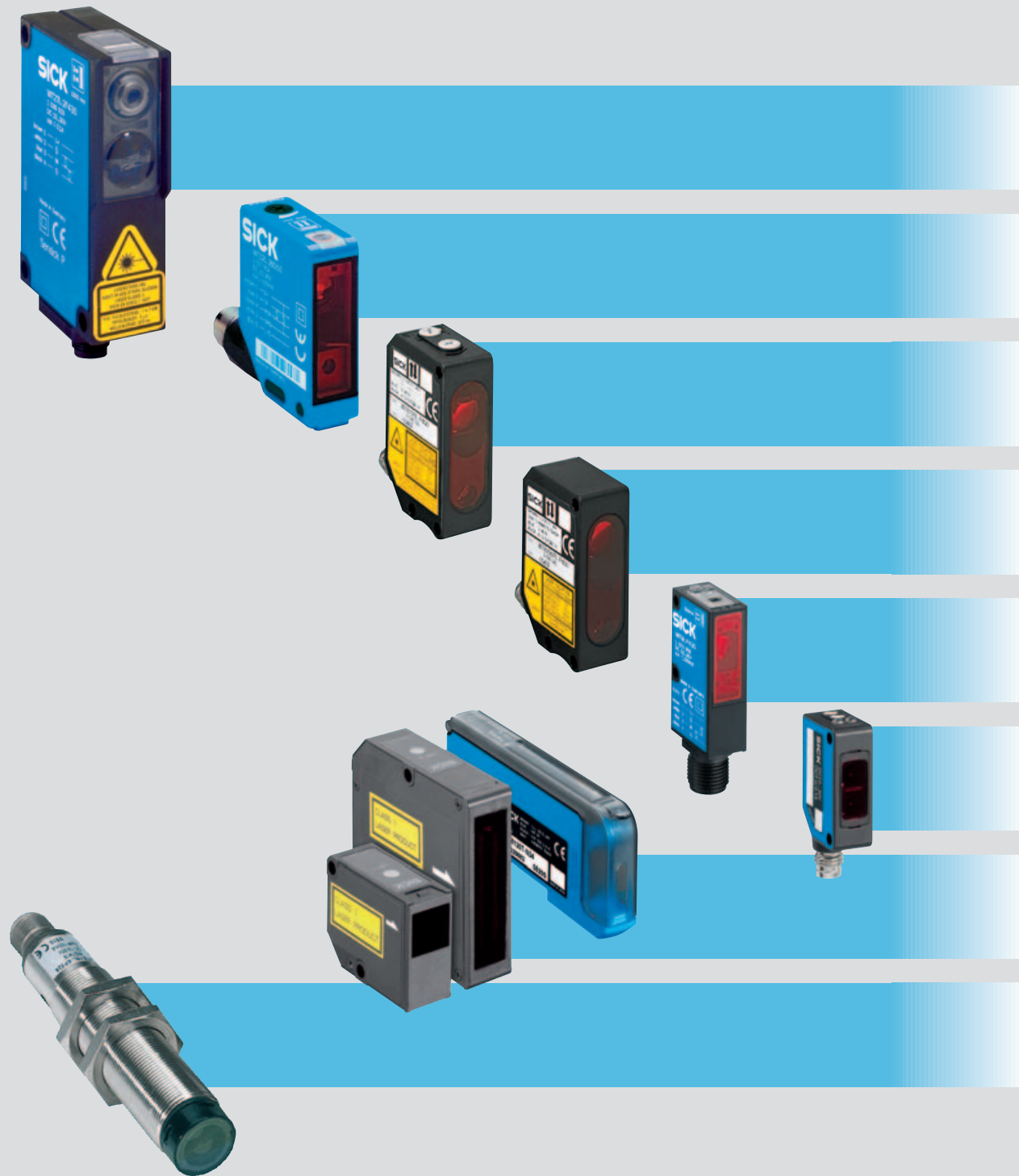



Scanning distance
 100...800 mm
 Photoelectric proximity switches

- Laser LED, red light
- Adjustable background suppression

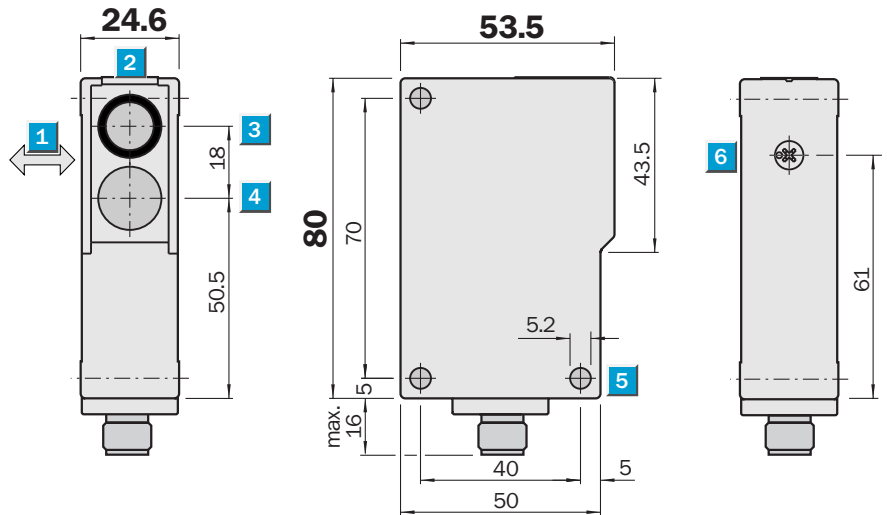

Dimensional drawing



Adjustments possible

WT 27L-2F 430

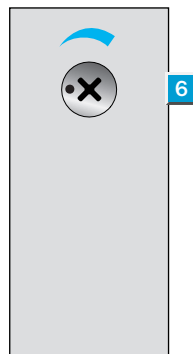

- 1 Standard direction of the material being scanned
- 2 LED signal strength indicator
- 3 Optical axis, sender
- 4 Optical axis, receiver
- 5 Mounting hole \varnothing 5.2 mm
- 6 Sensitivity adjustment

Connection type

WT 27L-2F 430

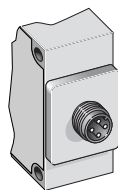

4-pin, M12

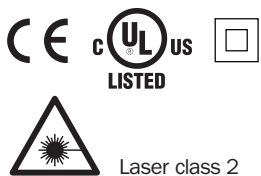
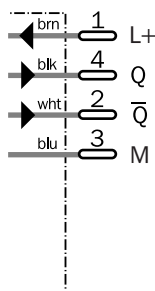

See chapter Accessories

Cables and connectors

Mounting systems

Technical data		WT 27L-2	F 430											
Scanning distance	100...800 mm, adjustable													
Light source¹⁾, light type	LED laser, red light													
Light spot diameter	Approx. 2 mm at 400 mm													
Supply voltage V_S	10...30 V DC ²⁾													
Residual ripple ³⁾	$\leq 5 V_{PP}$													
Current consumption ⁴⁾	$\leq 35 \text{ mA}$													
Switching outputs	PNP, Q and \bar{Q}													
Output current I_A max.	100 mA													
Response time ⁵⁾	500 μs													
Max. switching frequency ⁶⁾	1000/s													
Connection type	Plug													
VDE protection class⁷⁾	<input type="checkbox"/>													
Laser class⁸⁾	2 (IEC 825/VDE 0837)													
Circuit protection⁹⁾	A, B, C													
Enclosure rating	IP 67													
Ambient temperature T_A	Operation $-10 \text{ }^\circ\text{C} \dots +45 \text{ }^\circ\text{C}$ Storage $-10 \text{ }^\circ\text{C} \dots +75 \text{ }^\circ\text{C}$													
Weight	Approx. 100 g													
Housing material	ABS													

1) Average service life 50,000 h at $T_A = +25 \text{ }^\circ\text{C}$
 2) Limit values
 3) May not exceed or fall short of V_S tolerances

4) Without load
 5) Signal flight time with ohmic load
 6) With light/dark ratio 1:1
 7) Reference voltage 50 V DC

8) Low power. Eyes normally protected by averting reaction and eyelid closing reflex.

9) A = V_S connections reverse-polarity protected
 B = Output Q and \bar{Q} short-circuit protected
 C = Interference pulse suppression

Scanning distance

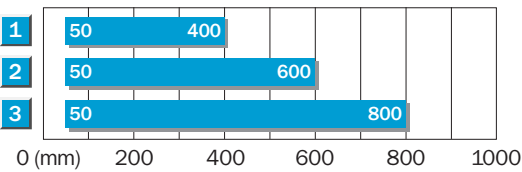

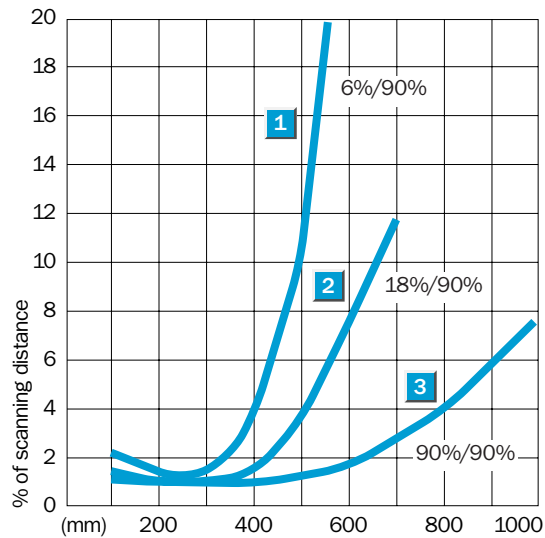

- 1 Scanning distance on black, 6 % remission
- 2 Scanning distance on grey, 18 % remission
- 3 Scanning distance on white, 90 % remission



Order information

Type	Order no.
WT 27L-2F 430	1 016 019

W100L: Laser Sensor in Mini-Format

	Photoelectric proximity switch energ.
	Photoelectric reflex switch
	Through-beam photoelectric switch

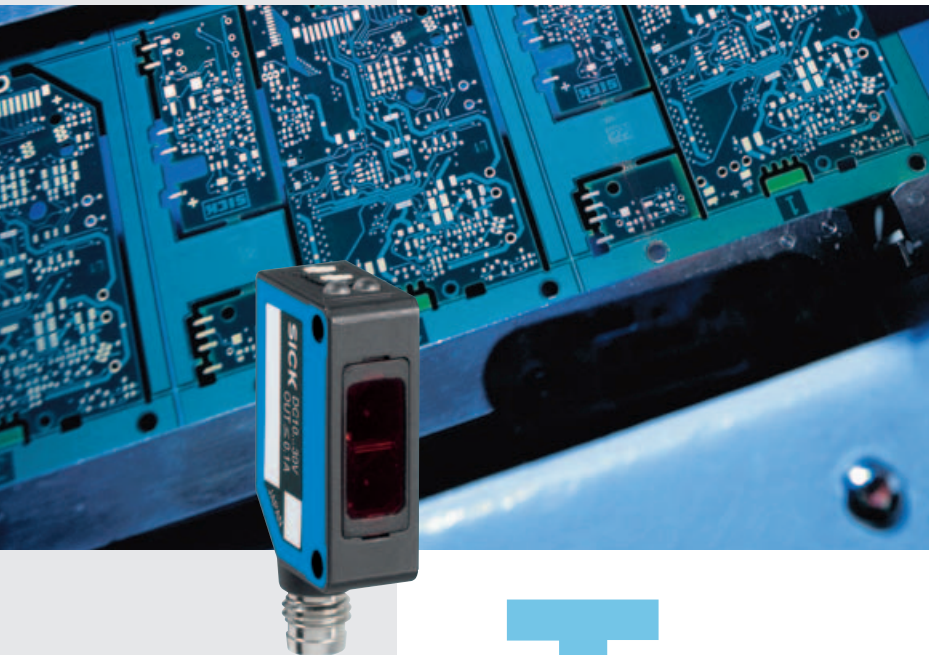

The compact housing creates new applications for laser photoelectric switches where mounting space is at a premium and thus complements the development trend towards ever more compact machines. Where applications demand it, the sensor can be adapted for light or dark switching by the use of a rotary switch.

The W100L photoelectric switch series comprises:

- Photoelectric proximity switch WT (energetic) with up to 450 mm scanning distance,
- Photoelectric reflex switch WL with up to 12 m scanning range,
- Through-beam photoelectric switch WS/WE with up to 35 m scanning range.

The W100L photoelectric switch series offers laser sensors in a miniature housing. In upgrading the successful W100 series with laser technology, an even wider spectrum of applications can be economically implemented. The small laser light spot and the high switching frequency enable the detection of small objects in highspeed processes. Apart from the benefit to the application, the small and easily visible laser light spot enables easy alignment during installation.

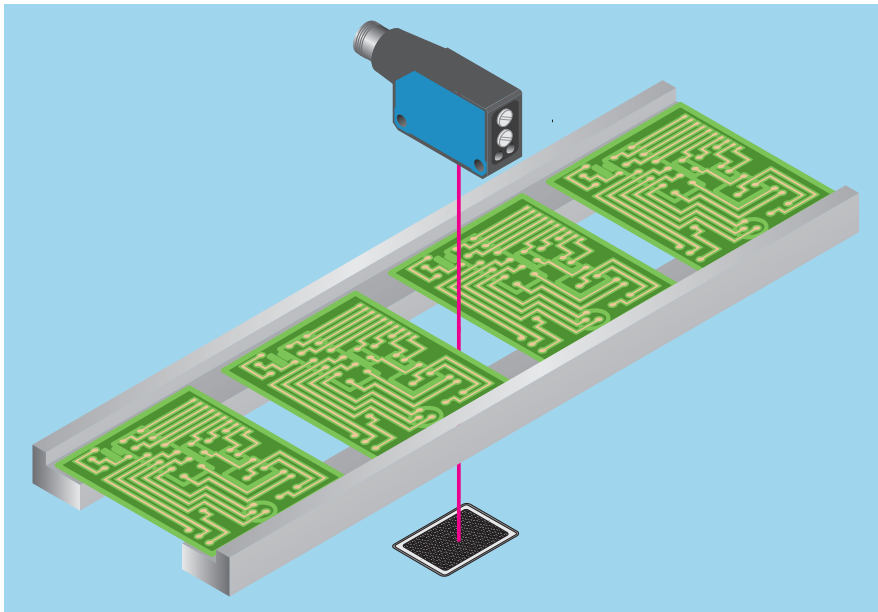

◀ The small beam diameter enables high-precision edge detection.

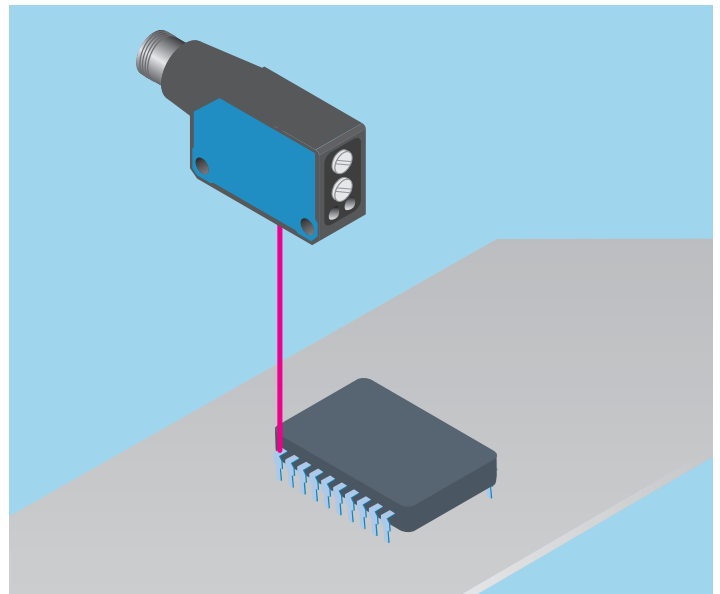

▶ Even the smallest objects or features can be reliably detected with the precise light spot.

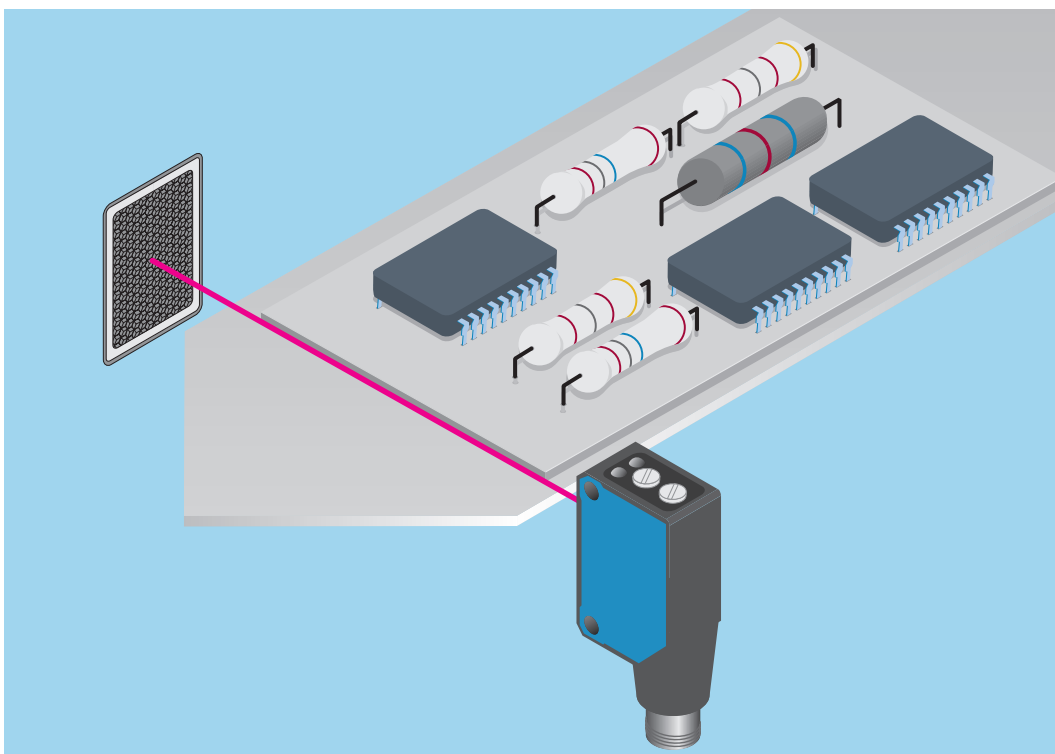

◀ Using the fine laser beam, edge detection can be implemented even with very low object heights.

Photoelectric proximity switch, WT100 Laser, energetic



Scanning distance
0 ... 450 mm
Photoelectric proximity switch

- Laser sensor in mini-format
- Easy alignment by Class 2 red light laser
- Switching frequency 2000 Hz

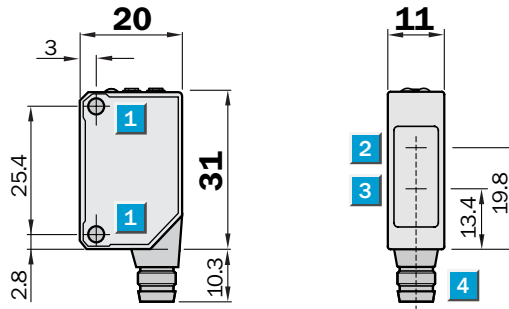
Dimensional drawing

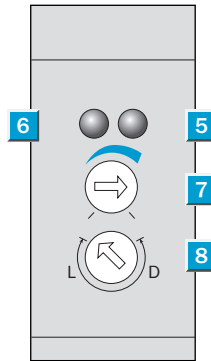

Adjustments possible



- 1 Mounting hole M3
- 2 Centre of optical axis, receiver
- 3 Centre of optical axis, sender
- 4 Connector
- 5 LED signal strength indicator orange: switching output active
- 6 LED signal strength indicator green: power on
- 7 Sensitivity adjustment (270°)
- 8 Light/dark rotary switch :
L = light-switching, D = dark-switching



Connection type

WT100L-E1141
WT100L-F1141

WT100L-E2141
WT100L-F2141

WT100L-E2241
WT100L-F2241

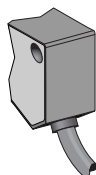

3 x 0.18 mm²

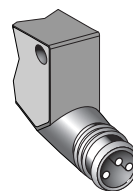

M8, 3-pin

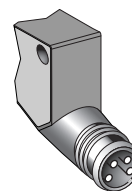
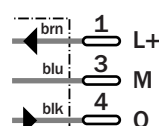

M8, 4-pin

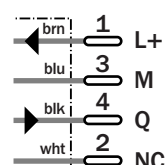

See chapter Accessories

- Connector, M8, 3-pin
- Connector, M8, 4-pin
- Mounting systems

Technical specifications		WT100L-	E1141	E2141	E2241	F1141	F2141	F2241				
Scanning distance typ. max.	0 ... 450 mm ¹⁾											
Operating distance	0 ... 400 mm ¹⁾											
Adjustment of operating distance	Potentiometer											
Light source, light type	Laser diode, Laser, 650 nm ²⁾											
Laser protection class	2 (IEC 60 825-1/C.D.R.H)											
Light spot diameter	2 mm at 400 mm distance											
Supply voltage V _s	DC 10 ... 30 V ³⁾											
Ripple	± 10 % ⁴⁾											
Power consumption	≤ 30 mA ⁵⁾											
Switching outputs	NPN, Q											
	PNP, Q											
Switching mode	Light-/dark-switching via rotary switch											
Output current I _{a,max}	≤ 100 mA											
Response time	< 0.25 ms ⁶⁾											
Switching frequency	2,000 Hz ⁷⁾											
Connection type	Cable, PVC, 2 m ⁸⁾											
	Connector, M8, 3-pin											
	Connector, M8, 4-pin											
Circuit protection	V _s connections reverse-polarity protected / In-/outputs short-circuit protected / Outputs overcurrent and short-circuit protected											
Enclosure rating	IP 65											
Ambient temperature operation	-10 °C ... +50 °C											
Ambient temperature storage	-40 °C ... +70 °C											
Weight	Approx. 50 g											
	Approx. 10 g											
Housing material	ABS, PMMA											
Included with delivery	Mounting bracket											

¹⁾ Object with 90 % remission (based on standard white to DIN 5033)
²⁾ Average service life 50,000 h

at T_a = +25 °C
³⁾ Limit values
⁴⁾ may not exceed or fall short of

V_s tolerances
⁵⁾ without load
⁶⁾ Signal transit time with resistive load

⁷⁾ with light/dark ratio 1:1
⁸⁾ do not bend below 0 °C

Scanning distance

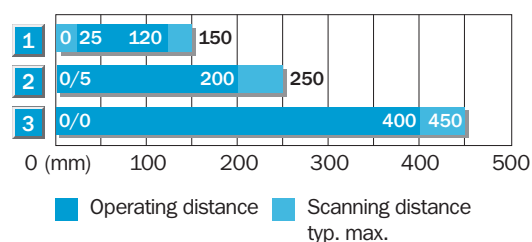

- 1 Scanning range on black, 6 % remission
- 2 Scanning range on grey, 18 % remission
- 3 Scanning range on white, 90 % remission

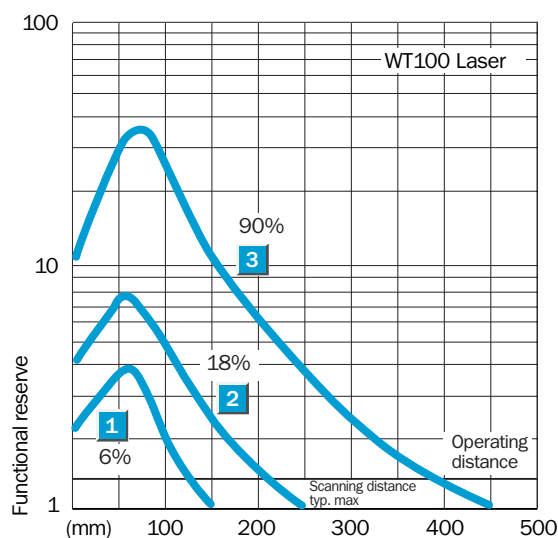

Light spot diameter

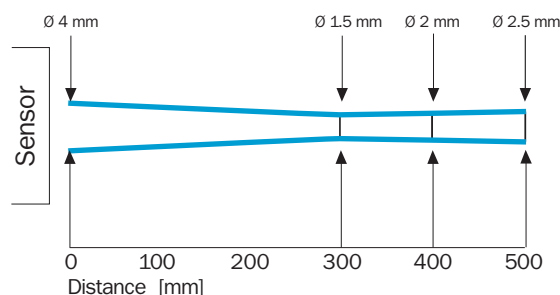

Ordering information

Type	Order no.
WT100L-E1141	6 030 705
WT100L-E2141	6 030 706
WT100L-E2241	6 030 707
WT100L-F1141	6 030 702
WT100L-F2141	6 030 703
WT100L-F2241	6 030 704

Photoelectric reflex switch, WL100 Laser

Scanning range
 0.01 ... 12 m

Photoelectric reflex switch

- Laser sensor in mini-format
- Easy alignment by Class 2 red light laser
- Switching frequency 2000 Hz
- Polarisation filter for secure detection of reflective objects

Dimensional drawing

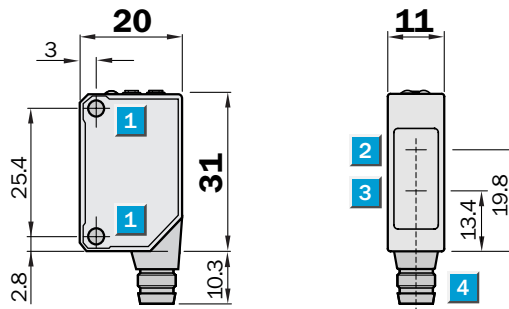

Adjustments possible

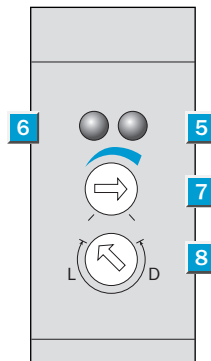

- 1** Mounting hole M3
- 2** Centre of optical axis, receiver
- 3** Centre of optical axis, sender
- 4** Connector
- 5** LED signal strength indicator orange: switching output active
- 6** LED signal strength indicator green: power on
- 7** Sensitivity adjustment (270°)
- 8** Light/dark rotary switch :
L = light-switching, D = dark-switching



Connection type

WL100L-E1131	WL100L-E2131	WL100L-E2231
WL100L-F2241	WL100L-F2131	WL100L-F2231

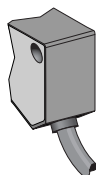

3 x 0.18 mm²

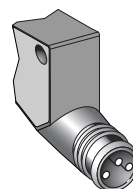

M8, 3-pin

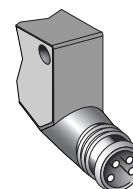
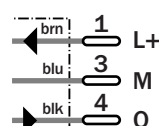

M8, 4-pin

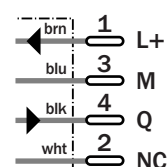

See chapter Accessories

- Connector, M8, 3-pin
- Connector, M8, 4-pin
- Mounting systems
- Reflectors

Technical specifications		WL100L-	E1131	E2131	E2231	F2241	F2131	F2231				
Scanning range typ. max.	0.01 ... 12 m											
Scanning range, recommended	0.01 ... 10 m											
Relating to	Reflector P250 F											
Sensitivity adjustment	Potentiometer											
Light source, light type	Laser diode, Laser, 650 nm ¹⁾											
Laser protection class	2 (IEC 60 825-1/C.D.R.H)											
Light spot diameter	12 mm at 10 m distance											
Supply voltage V _s	DC 10 ... 30 V ²⁾											
Ripple	± 10 % ³⁾											
Power consumption	≤ 30 mA ⁴⁾											
Switching outputs	NPN, Q											
	PNP, Q											
Switching mode	Light-/dark-switching via rotary switch											
Output current I _a max	≤ 100 mA											
Response time	< 0.25 ms ⁵⁾											
Switching frequency	2,000 Hz ⁶⁾											
Connection type	Cable, PVC, 2 m ⁷⁾											
	Connector, M8, 3-pin											
	Connector, M8, 4-pin											
Circuit protection	V _s connections reverse-polarity protected / In-/outputs short-circuit protected / Outputs overcurrent and short-circuit protected											
Enclosure rating	IP 65											
Ambient temperature operation	-10 °C ... +50 °C											
Ambient temperature storage	-40 °C ... +70 °C											
Weight	Approx. 50 g											
	Approx. 10 g											
Housing material	ABS, PMMA											
Included with delivery	Reflector P250F + mounting brackets											

¹⁾ Average service life 50,000 h at T_a = +25 °C

²⁾ Limit values may not exceed or fall short of

V_s tolerances without load

⁵⁾ Signal transit time with resistive load
⁶⁾ with light/dark ratio 1:1
⁷⁾ do not bend below 0 °C

Scanning range and functional reserve

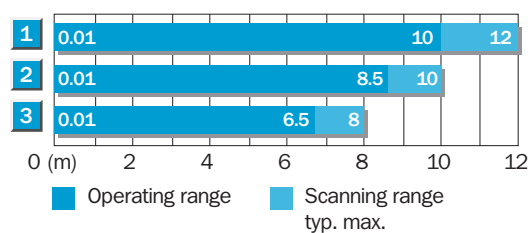

Reflector type	Operating range
1 P250F	0.01 ... 10 m
2 PL20F	0.01 ... 8.5 m
3 PL10F	0.01 ... 6.5 m

Light spot diameter

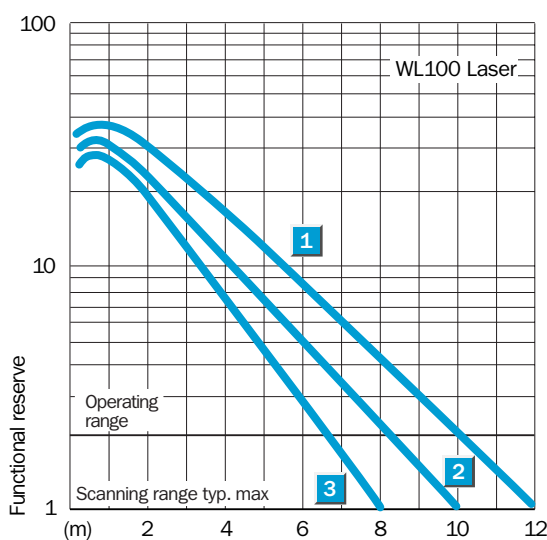
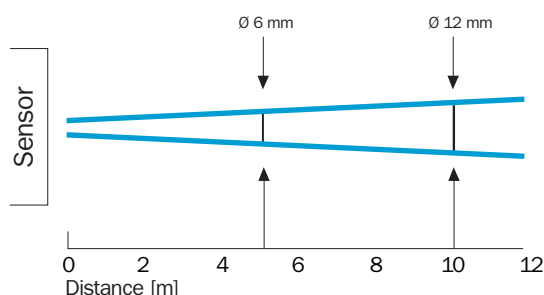

Ordering information

Type	Order no.
WL100L-E1131	6 030 711
WL100L-E2131	6 030 712
WL100L-E2231	6 030 713
WL100L-F2241	6 030 708
WL100L-F2131	6 030 709
WL100L-F2231	6 030 710

Through-beam photoelectric switch, WS/WE100 Laser

Scanning range
0 ... 35 m

Through-beam photoelectric switch

- Laser sensor in mini-format
- High degree of eye protection by Class 1 red light laser
- Switching frequency 2000 Hz

Dimensional drawing

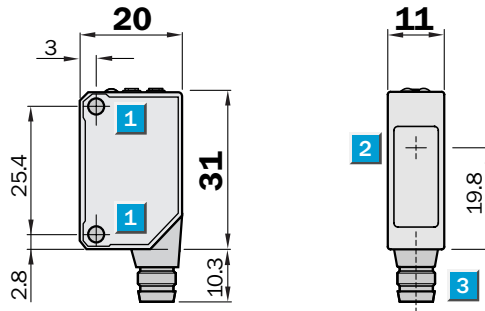

Adjustments possible

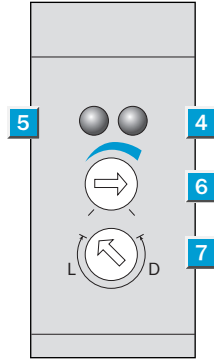

- 1 Mounting hole M3
- 2 Centre of optical axis
- 3 Connector
- 4 LED signal strength indicator orange: switching output active
- 5 LED signal strength indicator green: power on
- 6 Sensitivity adjustment (270 °)
- 7 Light/dark rotary switch:
L = light-switching, D = dark-switching



Connection type

WS/WE100L-E1131	WS/WE100L-E2131	WS/WE100L-E2231
WS/WE100L-F1131	WS/WE100L-F2131	WS/WE100L-F2231

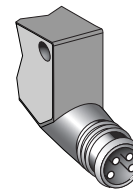
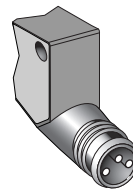
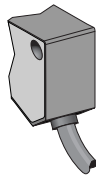

Sender	2 x 0.18 mm ²	M8, 3-pin	M8, 4-pin
Receiver	3 x 0.18 mm ²	M8, 3-pin	M8, 4-pin

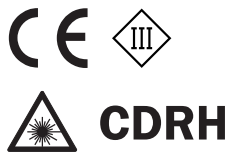

See chapter Accessories

Connector, M8, 3-pin
Connector, M8, 4-pin
Mounting systems

Technical specifications		WS/WE100L-	E1131	E2131	E2231	F1131	F2131	F2231				
Scanning range typ. max.	0 ... 35 m											
Scanning range, recommended	0 ... 30 m											
Sensitivity adjustment	Potentiometer											
Light source, light type	Laser diode, Laser, 650 nm ¹⁾											
Laser protection class	1 (EN 60 825-1)											
Light spot diameter	30 mm at 30 m distance											
Supply voltage V _s	DC 10 ... 30 V ²⁾											
Ripple	± 10 % ³⁾											
Power consumption	≤ 30 mA ⁴⁾											
Switching outputs	NPN, Q											
	PNP, Q											
Switching mode	Light-/dark-switching via rotary switch											
Output current I _a max	≤ 100 mA											
Response time	< 0.25 ms ⁵⁾											
Switching frequency	2,000 Hz ⁶⁾											
Connection type	Cable, PVC, 2 m ⁷⁾											
	Connector, M8, 3-pin											
	Connector, M8, 4-pin											
Circuit protection	V _s connections reverse-polarity protected / In-/outputs short-circuit protected / Outputs overcurrent and short-circuit protected											
Enclosure rating	IP 65											
Ambient temperature operation	-10 °C ... +50 °C											
Ambient temperature storage	-40 °C ... +70 °C											
Weight	Approx. 50 g											
	Approx. 10 g											
Housing material	ABS, PMMA											
Included with delivery	Mounting bracket											

¹⁾ Average service life 50,000 h at T_a = +25 °C

²⁾ Limit values may not exceed or fall short of

³⁾ V_s tolerances without load

⁵⁾ Signal transit time with resistive load
⁶⁾ with light/dark ratio 1:1
⁷⁾ do not bend below 0 °C

Scanning range and functional reserve

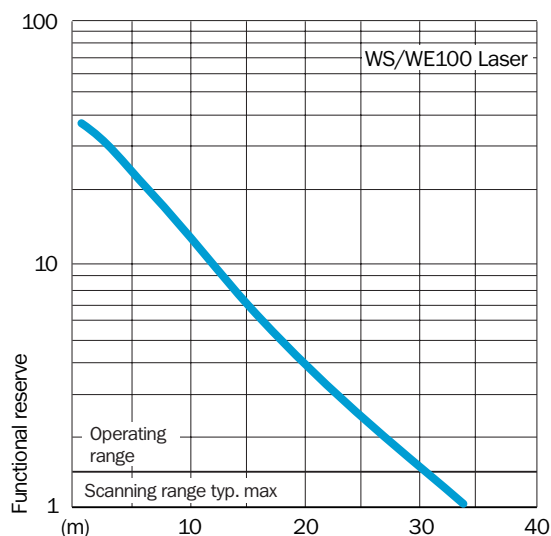
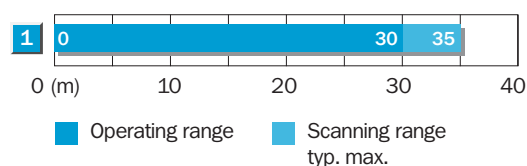

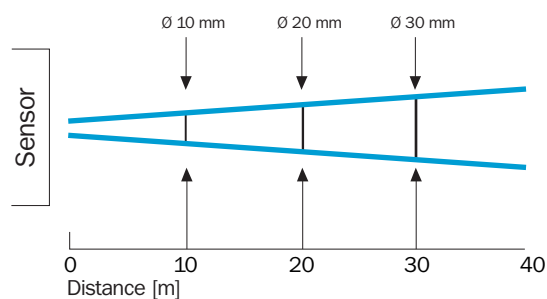

Light spot diameter



Ordering information

Type	Order no.
WS/WE100L-E1131	6 030 717
WS/WE100L-E2131	6 030 718
WS/WE100L-E2231	6 030 719
WS/WE100L-F1131	6 030 714
WS/WE100L-F2131	6 030 715
WS/WE100L-F2231	6 030 716

	Photoelectric proximity switches, BGS
	Photoelectric reflex switches
	Through-beam photoelectric switches

W 9 L: Laser photoelectric switches: small, light and reliable



- Temperature-compensated laser-protection electronics make constant performance of the laser possible in laser protection class 2.

Objects as small as hairs are detected just as reliably as fast operations are processed. Interference from external light sources is ignored, and cell phones are not detected. Innovative Teach-in technology means a simple push of a button for operating the W 9 Laser series.

To ensure that the W 9 Laser series can be used without problems in the whole world, we have complied with all regulations and fulfilled all standards, for example, CE and CDRH.

The W 9 Laser series provides a complete series with innovative laser technology in compact plastic housing.

Because our devices are controlled using the most modern μ P technology, we can provide a laser series that has excellent performance data in addition to its small size and slight weight.

- Proximity switch with background suppression, which can be set very precisely,
- Photoelectric switch with simple Teach-in operation,
- Through-beam photoelectric switch with simple Teach-in operation,

▼ ► Precise positioning of stacker cranes using the holes in the carriers.



▲ Detection of the leading edge of PCBs. Safely implemented using the small light spot and a precise switching point.



▲ Lid closed or open. An important issue for automatic wrapping. Two WL 9 lasers provide a reliable solution.

Scanning distance
150 mm

Photoelectric proximity switches

- Laser red light, class 2
- Background suppression adjustable
- Switching frequency 1000/s
- Compact housing made of ABS

Dimensional drawing

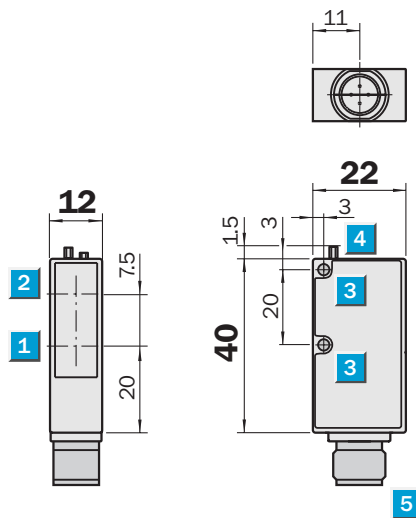

Adjustments possible

WT 9L-P330
WT 9L-P430
WT 9L-N330
WT 9L-N430

- 1 Centre of optical axis, sender
- 2 Centre of optical axis, receiver
- 3 Mounting hole \varnothing 3.2 mm
- 4 Power indicator green; LED signal strength indicator yellow
- 5 Plug M12 or M8, 4-pin
- 6 Scanning distance adjustment

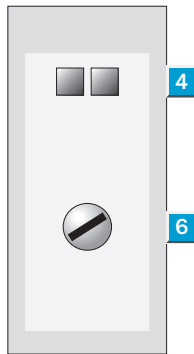

Connection types

WT 9L-P330	WT 9L-P430
WT 9L-N330	WT 9L-N430

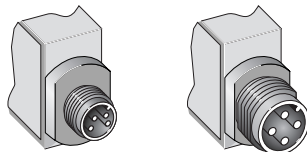

4-pin, M8

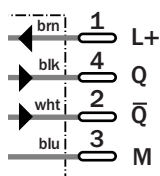

4-pin, M12

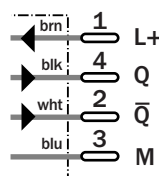

See chapter Accessories

- Cables and connectors
- Mounting systems

Technical data		WT 9L-	P330	P430	N330	N430						
Scanning distance ¹⁾	30 ... 150 mm, adjustable											
Supply voltage V_S	10 ... 30 V DC ²⁾											
Ripple ³⁾	< 5 V _{pp}											
Current consumption ⁴⁾	< 35 mA											
Light source ⁵⁾ , light type	Laser, red light; class 2											
Focusing position/light spot diameter	60 mm/< 0.5 mm											
Switching outputs Q and \bar{Q}	PNP											
	NPN											
PNP; signal voltage HIGH	$V_S - 2 V$											
PNP; signal voltage LOW	Approx. 0 V											
NPN; signal voltage HIGH	V_S											
NPN; signal voltage LOW ⁶⁾	$V_S < 2 V$											
Output current I_A max.	< 100 mA											
Response time ⁷⁾	< 0.6 ms											
Max. switching frequency ⁸⁾	1000/s											
Connection types	Plug M12, 4-pin											
	Plug M8, 4-pin											
VDE protection class ⁹⁾	□ (plug M12)											
	III (plug M8)											
Enclosure rating	IP 67											
Circuit protection ¹⁰⁾	A, B, C											
Ambient temperature T_A ¹¹⁾	Operation - 10 ... + 50 °C											
	Storage - 25 ... + 70 °C											
Weight with plug	Approx. 20 g											
Housing material	ABS											

- 1) Object with 90 % remission (based on standard white DIN 5033)
- 2) Limit values
- 3) May not exceed or fall short of V_S tolerances
- 4) Without load
- 5) Average service life 50,000 h at $T_A = + 25 °C$
- 6) At $T_A = + 25 °C$ and 100 mA output current
- 7) Signal transit time with resistive load
- 8) With light/dark ratio 1:1
- 9) Reference voltage 50 V
- 10) A = V_S connections reverse-polarity protected
B = Outputs reverse-polarity protected
C = Interference pulse suppression
- 11) Do not stack devices

Laser protection

EN 60825-1, class 2
CDRH 1040.10, class 2

Scanning distance

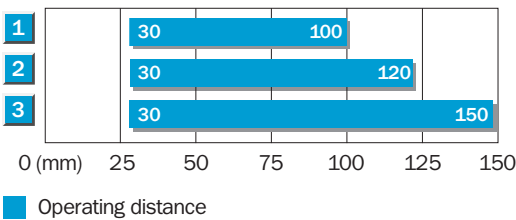

- 1 Scanning range on black, 6 % remission
- 2 Scanning range on grey, 18 % remission
- 3 Scanning range on white, 90 % remission

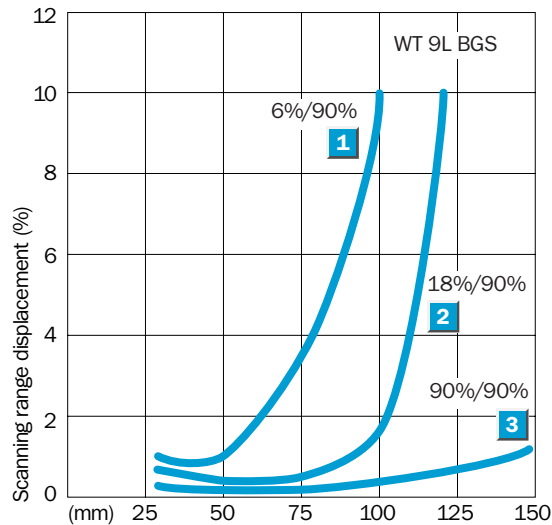

Order information

Type	Order no.
WT 9L-P330	1 023 977
WT 9L-P430	1 023 959
WT 9L-N330	1 023 991
WT 9L-N430	1 023 990

Scanning range
12 m

Photoelectric reflex switches

- Laser red light, class 2
- Teach-in
- Switching frequency 1000/s
- Polarising filter
- Compact housing made of ABS

Dimensional drawing

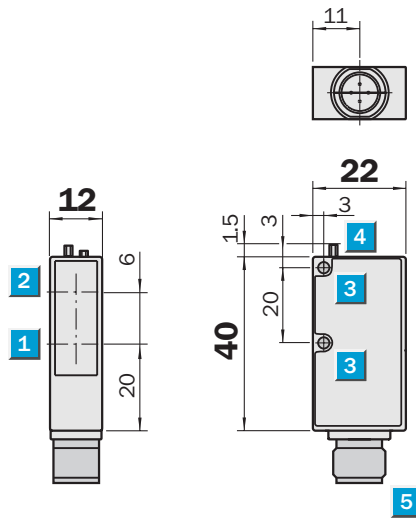

Adjustments possible

- WL 9L-P330
- WL 9L-P430
- WL 9L-N330
- WL 9L-N430

- 1 Centre of optical axis, sender
- 2 Centre of optical axis, receiver
- 3 Mounting hole \varnothing 3.2 mm
- 4 Power indicator green;
LED signal strength indicator yellow
- 5 Plug M12 or M8, 4-pin
- 6 Teach-in button

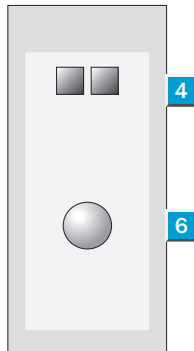

Connection types

- | | |
|------------|------------|
| WL 9L-P330 | WL 9L-P430 |
| WL 9L-N330 | WL 9L-N430 |

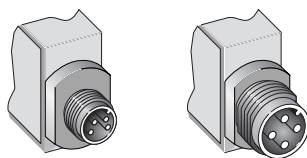

4-pin, M8

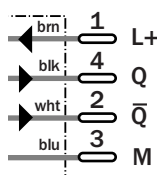

4-pin, M12

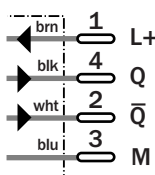

See chapter Accessories

- Cables and connectors
- Mounting systems

Technical data	WL 9L-	P330	P430	N330	N430						
Scanning range, max. typ./on Reflector	0.1–12 m/PL 80 A										
Supply voltage V_S	10 ... 30 V DC ⁴⁾										
Ripple ²⁾	< 5 V _{pp}										
Current consumption ³⁾	< 35 mA										
Light source ⁴⁾ , light type	Laser 650 nm, red, class 2										
Focusing position/light spot diameter	∞/min. < 1 mm										
Switching outputs Q and \bar{Q}	PNP										
	NPN										
PNP; signal voltage HIGH	$V_S - 2$ V										
PNP; signal voltage LOW	Approx. 0 V										
NPN; signal voltage HIGH	V_S										
NPN; signal voltage LOW ⁵⁾	$V_S - 2$ V										
Output current I_A max.	< 100 mA										
Response time ⁶⁾	< 0.6 ms										
Max. switching frequency ⁷⁾	1000/s										
Connection types	Plug M12, 4-pin										
	Plug M8, 4-pin										
VDE protection class ⁸⁾	□ (plug M12)										
	III (plug M8)										
Enclosure rating	IP 67, IP 69 K										
Circuit protection ⁹⁾	A, B, C										
Ambient temperature T_A ¹⁰⁾	Operation - 10 ... + 50 °C										
	Storage - 25 ... + 75 °C										
Weight with plug	Approx. 20 g										
Housing material	ABS										

- 1) Limit values
- 2) May not exceed or fall short of V_S tolerances
- 3) Without load

- 4) Average service life 50,000 h at $T_A = + 25$ °C
- 5) At $T_A = + 25$ °C and 100 mA output current

- 6) Signal transit time with resistive load
- 7) With light/dark ratio 1:1
- 8) Reference voltage 50 V

- 9) A = V_S connections reverse-polarity protected
- B = Outputs reverse-polarity protected
- C = Interference pulse suppression
- 10) Do not stack devices

Teach-in function standard

1. Align the photoelectric switch with the reflector. LED yellow/green = on.
2. Press Teach-in button > 2 s. LED green = off/on. Teach-in is initiated. LED yellow/green = blinking.
3. The signal is stored permanently after you release the button. The switching threshold is set to standard sensitivity.

Precise setting:

1. Align the photoelectric switch with the reflector. LED yellow/green = on.
2. Press Teach-in button > 5 s. LED green = off/on. Teach-in is initiated. LED yellow/green = blinking.
3. The signal is stored permanently after you release the button. The switching threshold is set to a low degree of sensitivity (detection of transparent objects is possible).

Laser protection

EN 60825-1, class 2
CDRH 1040.10, class 2

Scanning range

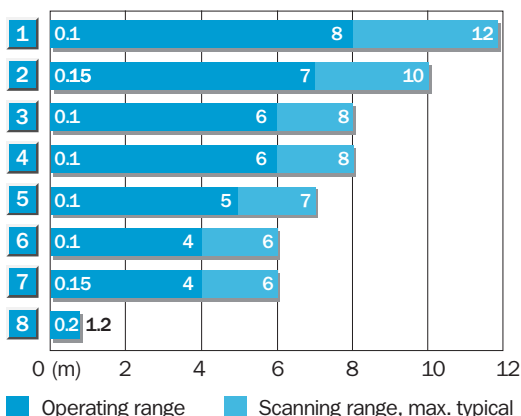

Reflector type	Operating range	
1	PL 80 A	0 – 8.0 m
2	PL 250 F	0 – 7.0 m
3	PL 50 A	0 – 6.0 m
4	PL 40 A	0 – 6.0 m
5	PL 30 A	0 – 5.0 m
6	PL 20 A	0 – 4.0 m
7	PL 20 F	0 – 4.0 m
8	Reflective tape	0 – 1.2 m

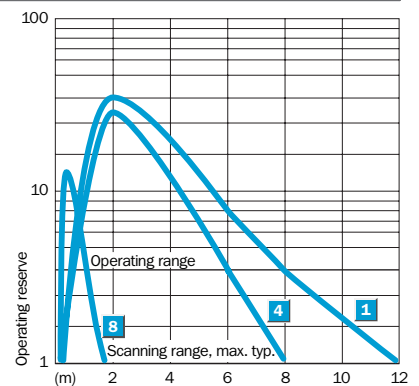

Order information

Type	Order no.
WL 9L-P330	1 023 976
WL 9L-P430	1 023 958
WL 9L-N330	1 023 989
WL 9L-N430	1 023 988

Scanning range
0 ... 50 m

Through-beam photoelectric switches

- Laser red light, class 2
- Teach-in
- Switching frequency 1000/s
- Compact housing made of ABS

Dimensional drawing

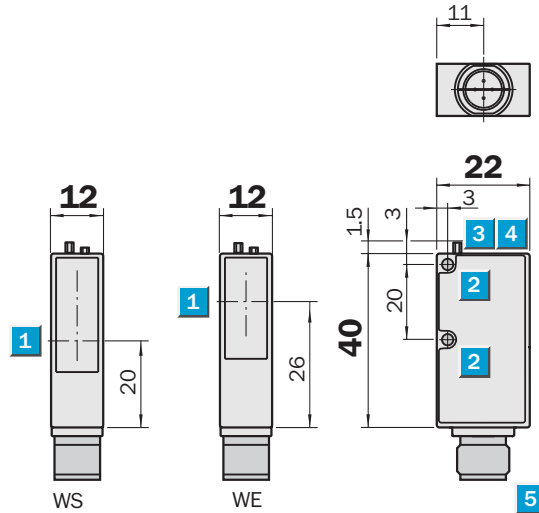

Adjustments possible

WS/WE 9L-P330	WS/WE 9L-N330
WS/WE 9L-P430	WS/WE 9L-N430

- 1 Centre of optical axis
- 2 Mounting hole \varnothing 3.2 mm
- 3 Power indicator green, WS in operation
- 4 LED signal strength indicator yellow
- 5 Plug M12 or M8, 4-pin
- 6 Teach-in button

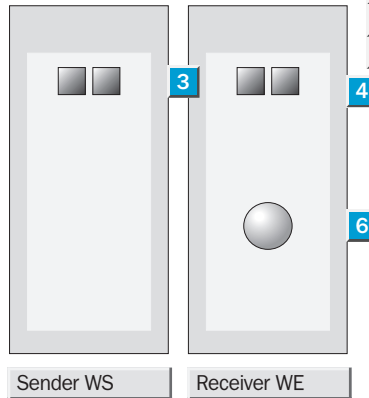

Connection types

WS/WE 9L-P330	WS/WE 9L-P430
WS/WE 9L-N330	WS/WE 9L-N430

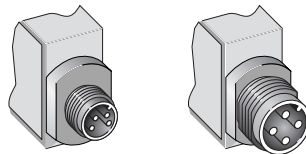

4-pin, M8

4-pin, M12

Sender

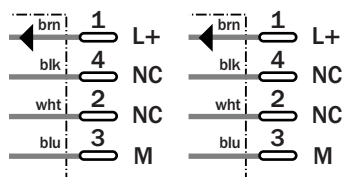

Receiver

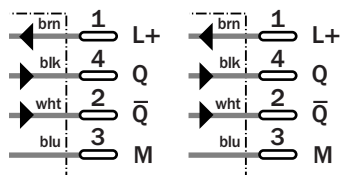

See chapter Accessories
Cables and connectors
Mounting systems



Technical data		WS/WE 9L-	P330	P430	N330	N430						
Scanning range, max. typ.	50 m											
Supply voltage V_S	10 ... 30 V DC ¹⁾											
Ripple ²⁾	< 5 V _{pp}											
Current consumption ³⁾	< 25 mA (WE), < 35 mA (WS)											
Light source ⁴⁾ , light type	Laser, red, class 2											
Focusing position/light spot diameter	500 mm/< 0.5 mm											
Switching outputs Q and \bar{Q}	PNP											
	NPN											
PNP; signal voltage HIGH	$V_S - 2$ V											
PNP; signal voltage LOW	Approx. 0 V											
NPN; signal voltage HIGH	V_S											
NPN; signal voltage LOW ⁵⁾	$V_S - 2$ V											
Output current I_A max.	< 100 mA											
Response time ⁶⁾	< 0.6 ms											
Max. switching frequency ⁷⁾	1000/s											
Connection types	Plug M12, 4-pin											
	Plug M8, 4-pin											
VDE protection class ⁸⁾	II (plug M12)											
	III (plug M8)											
Enclosure rating	IP 67											
Circuit protection ⁹⁾	A, B, C											
Ambient temperature T_A ¹⁰⁾	Operation - 10 ... + 50 °C											
	Storage - 25 ... + 70 °C											
Weight with plug	Approx. 20 g											
Housing material	ABS											

1) Limit values
 2) May not exceed or fall short of V_S tolerances
 3) Without load

4) Average service life 50,000 h at $T_A = + 25$ °C
 5) At $T_A = + 25$ °C and 100 mA output current

6) Signal transit time with resistive load
 7) With light/dark ratio 1:1
 8) Reference voltage 50 V

9) A = V_S connections reverse-polarity protected
 B = Outputs reverse-polarity protected
 C = Interference pulse suppression
 10) Do not stack devices

Teach-in function standard

- Align the sender and receiver with respect to each other. Receiver LED yellow/green = on.
- Press Teach-in button > 2 s. LED green = off/on. Teach-in is initiated. LED yellow/green = blinking.
- The signal is stored permanently after you release the button. The switching threshold is set to standard sensitivity.

Precise setting:

- Align the sender and receiver with respect to each other. Receiver LED yellow/green = on.
- Press Teach-in button > 5 s. LED green = off/on. Teach-in is initiated. LED yellow/green = blinking.
- The signal is stored permanently after you release the button. The switching threshold is set to a low degree of sensitivity (detection of transparent objects is possible).

Laser protection

EN 60825-1, class 2
 CDRH 1040.10, class 2

Scanning range

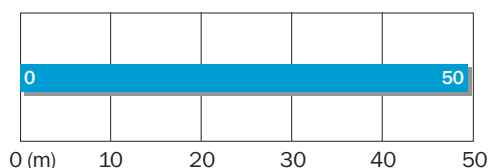



■ Operating range/Scanning range, max. typical

Order information

Type	Order no.
WS/WE 9L-P330	1 023 993
WS/WE 9L-P430	1 023 992
WS/WE 9L-N330	1 023 995
WS/WE 9L-N430	1 023 994

W130 Laser - Customised through configuration, and small format through external laser heads

	Photoelectric proximity switch energ.
	Photoelectric reflex switch
	Through-beam photoelectric switch

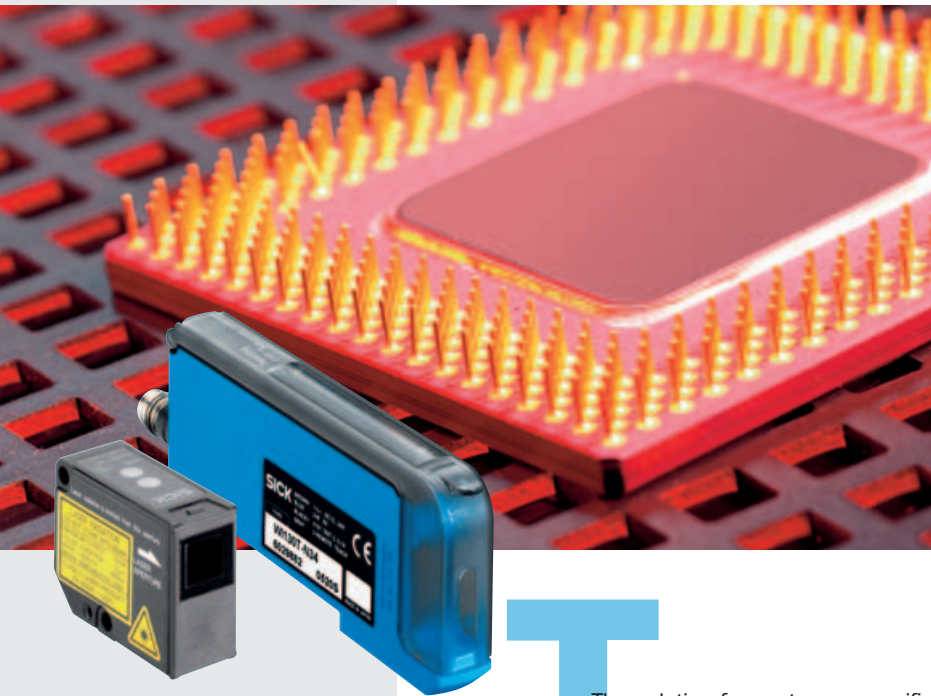

Included in the system

The sensor heads offered, comprise a photoelectric proximity switch, a photoelectric reflex switch and two through-beam photoelectric switches with small laser spot or a parallel laser line 30 mm in width. The combination of the analogue output and two switching outputs is the basis for a variety of application solutions, such as edge control or sorting parts.

Application-oriented, easy commissioning

The solution for customer-specific requirements: configurable evaluation units with digital and analogue outputs and external laser heads. By separating optics and evaluation, the W130L offers compact laser sensors with extensive functionality, allowing the configuration-based setup of application-specific sensor functions. Fast and easy commissioning is implemented by clear Teach-in functions.

- 1 or 2 point Teach-in: for the safe Teach-in of switching points,
- Auto Teach-in: for Teach-in during a running process,
- Zone Teach-in: for the Teach-in of an upper and lower switching threshold,
- Transparent Teach-in: for transparent objects such as bottles or films.

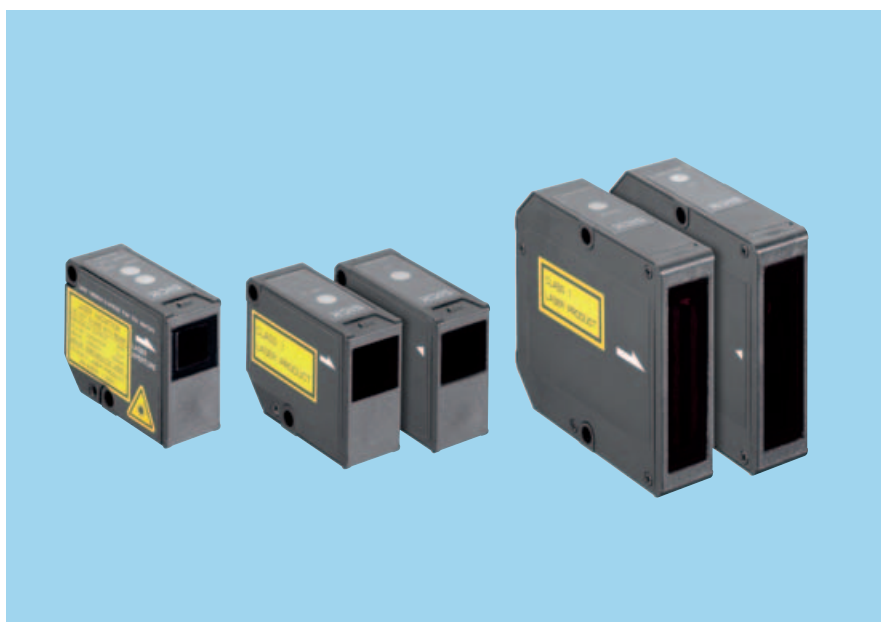

◀ Extensive choice of sensor heads for versatile applications, amongst others with parallel laser line 30 mm wide.

▼ Reliable detection of small objects and features, respectively, with W130 Laser.

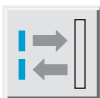

Photoelectric proximity switch, WT130L, energetic

Scanning distance
0 ... 1,200 mm
Photoelectric proximity switch

- Laser sensor in a compact housing
- Easy alignment through red light laser Class 2
- Coaxial light path
- Configuration via amplifier unit

Dimensional drawing

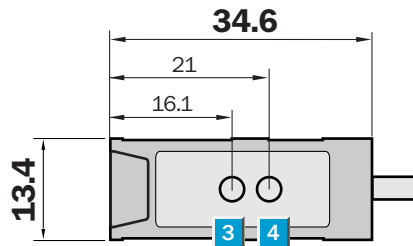
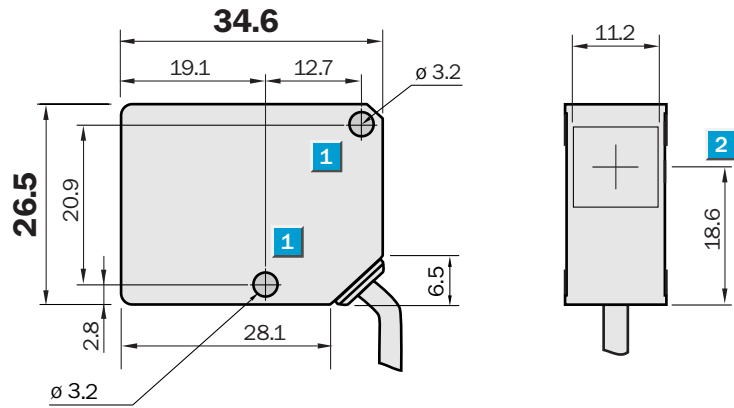

- 1 Through-hole \varnothing 3.2 mm
- 2 Optical axis
- 3 Indicator LED green: operational status indicator
- 4 Indicator LED orange: switching output



Connection type

WT130L-32

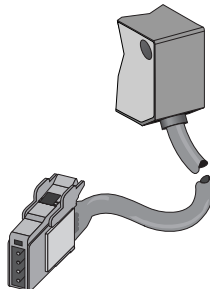

Technical specifications WT130L- 32

Sensor head	Operation in combination with amplifier unit W130	
Scanning distance typ. max.	0 ... 1,200 mm ¹⁾	
Operating distance	30 ... 1,000 mm ¹⁾	
Light source, light type	Laser, red light ²⁾	
Laser protection class	2 (IEC 60 825-1/C.D.R.H)	
Light spot diameter	1 mm at 1 m distance	
Supply voltage V_s	See amplifier unit W130	
Switching outputs	See amplifier unit W130	
Connection type	Cable with plug, PVC/PBT, 2 m ³⁾	
VDE protection class	◆	
Enclosure rating	IP 67	
Ambient temperature operation	-10 °C ... +55 °C	
Ambient temperature storage	-25 °C ... +70 °C	
Weight	Approx. 35 g	
Housing material	PC, polycarbonate, glass	

¹⁾ Object with 90 % remission (based on standard white to DIN 5033). Scanning

distance depends on chosen operating mode

²⁾ Average service life 50,000 h at T_a = +25 °C

³⁾ Connection between sensor head and amplifier unit with system specific plug. Do not bend cable below 0 °C

Scanning distance and operating reserve

Mode: Long

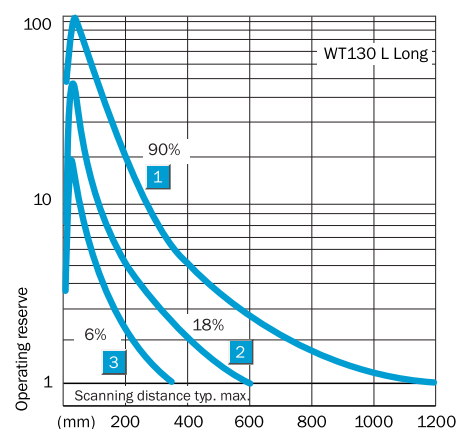

1	0	30	1000	1200
2	0	30	550	600
3	0	30	300	350

Operating distance Scanning distance typ. max.

- 1 Scanning distance on white, 90 % remission
- 2 Scanning distance on grey, 18 % remission
- 3 Scanning distance on black, 6 % remission

Mode: Standard

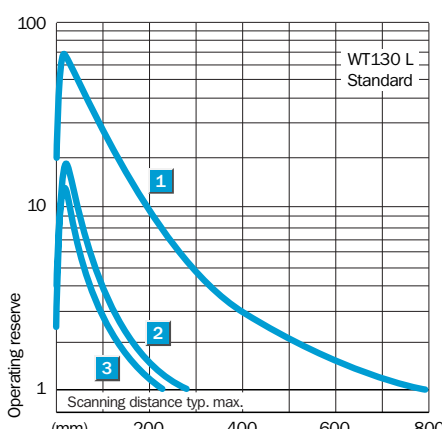

1	0	30	700	800
2	0	30	240	280
3	0	30	200	230

Operating distance Scanning distance typ. max.

- 1 Scanning distance on white, 90 % remission
- 2 Scanning distance on grey, 18 % remission
- 3 Scanning distance on black, 6 % remission

Mode: Fast

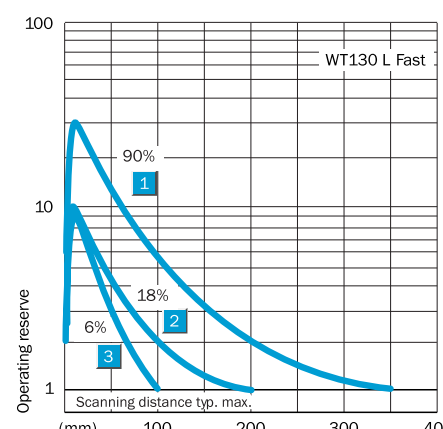

1	0	30	250	350
2	0	30	180	200
3	0	30	90	100

Operating distance Scanning distance typ. max.

- 1 Scanning distance on white, 90 % remission
- 2 Scanning distance on grey, 18 % remission
- 3 Scanning distance on black, 6 % remission

Light spot diameter

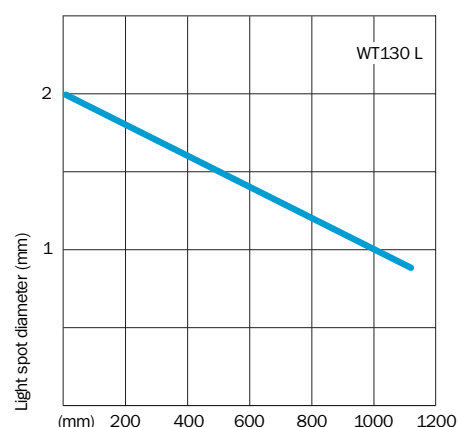

Ordering information

Type	Order no.
WT130L-32	6 029 861

Photoelectric reflex switch, WL130L

Scanning range
0 ... 10 m

Photoelectric reflex switch

- Laser sensor in a compact housing
- Easy alignment through red light laser Class 2
- Coaxial light path
- Configuration via amplifier unit
- Line laser through line attachment

Dimensional drawing

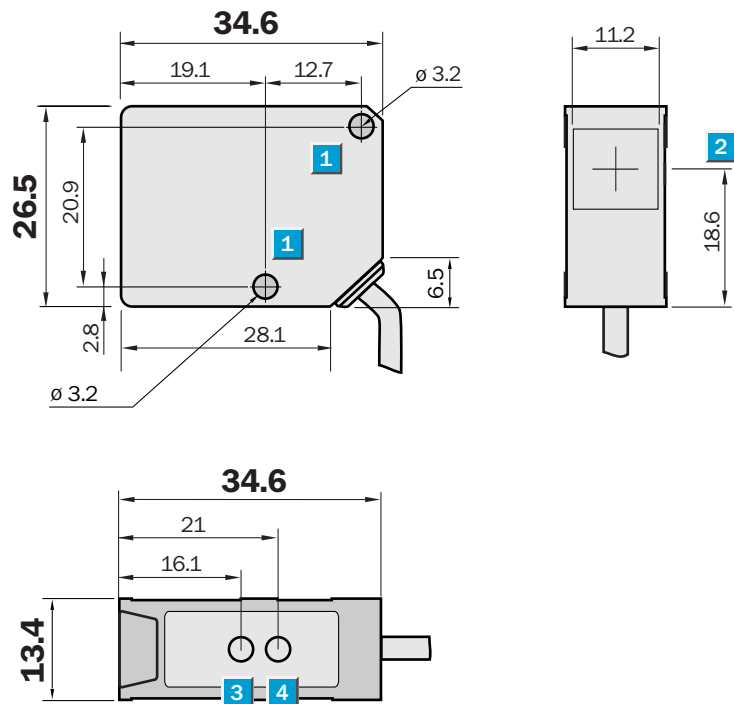

- 1 Through-hole Ø 3.2 mm
- 2 Optical axis
- 3 Indicator LED green: operational status indicator
- 4 Indicator LED orange: switching output



Connection type

WL130L-32

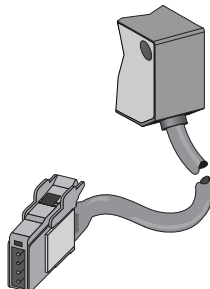

See chapter Accessories

Masks

Reflectors

Technical specifications WL130L- 32

Sensor head	Operation in combination with amplifier unit W130
Scanning range typ. max.	0 ... 10 m
Scanning range, recommended	0 ... 7 m
Laser line through lens	✓
Laser line dimension	26 x 0.5 mm at 200 mm distance
Light source, light type	Laser, red light ¹⁾
Laser protection class	2 (IEC 60 825-1/C.D.R.H)
Light spot diameter	2 mm in 2m Entfernung
Polarisation filter	✓
Supply voltage V_s	See amplifier unit W130
Switching outputs	See amplifier unit W130
Connection type	Cable with plug, PVC/PBT, 2 m ²⁾
VDE protection class	◆
Enclosure rating	IP 67
Ambient temperature operation	-10 °C ... +55 °C
Ambient temperature storage	-25 °C ... +70 °C
Weight	Approx. 35 g
Housing material	PC, polycarbonate, PMMA
Included with delivery	Reflector P41F

¹⁾ Average service life 50,000 h at T_a = +25 °C

²⁾ Connection between sensor head and amplifier unit with system specific plug. do not bend cable below 0 °C

Scanning range and operating reserve

Mode: Long

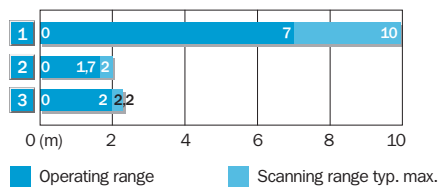
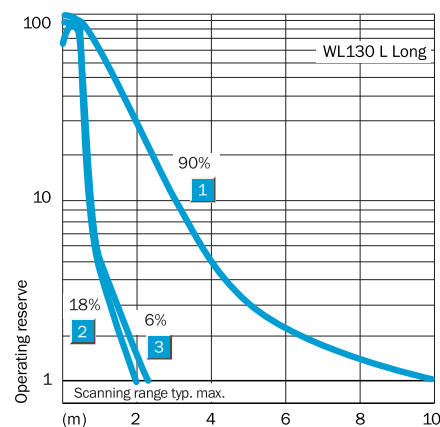

Reflector type	Operating range
1 P41F (without tip adapter lens)	0 ... 7 m
2 P41F (with area tip adapter lens)	0 ... 1.7 m
3 P41F (with line tip adapter lens)	0 ... 2 m

Mode: Standard

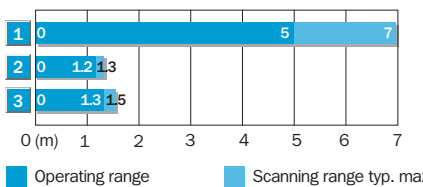
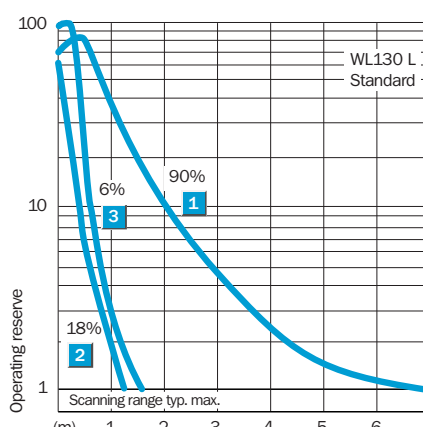

Reflector type	Operating range
1 P41F (without tip adapter lens)	0 ... 5 m
2 P41F (with area tip adapter lens)	0 ... 1.2 m
3 P41F (with line tip adapter lens)	0 ... 1.5 m

Mode: Fast

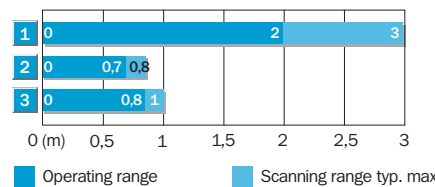
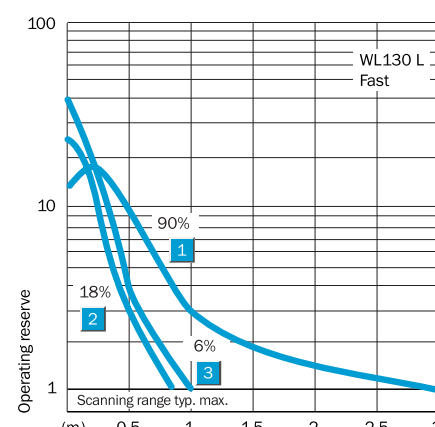

Reflector type	Operating range
1 P41F (without tip adapter lens)	0 ... 2 m
2 P41F (with area tip adapter lens)	0 ... 0.7 m
3 P41F (with line tip adapter lens)	0 ... 0.8 m

Light spot diameter

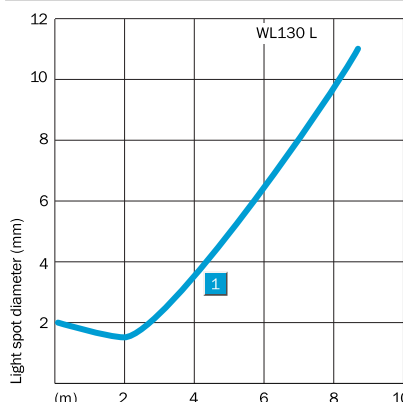

Ordering information	
Type	Order no.
WL130L-32	6 029 862

Through-beam photoelectric switch, WS/WE130L "SPOT"

Scanning range
0 ... 3.5 m

Through-beam photoelectric switch

- Laser sensor in a compact housing
- "Eye safe" (Class 1) red light laser
- Configuration via amplifier unit

Dimensional drawing

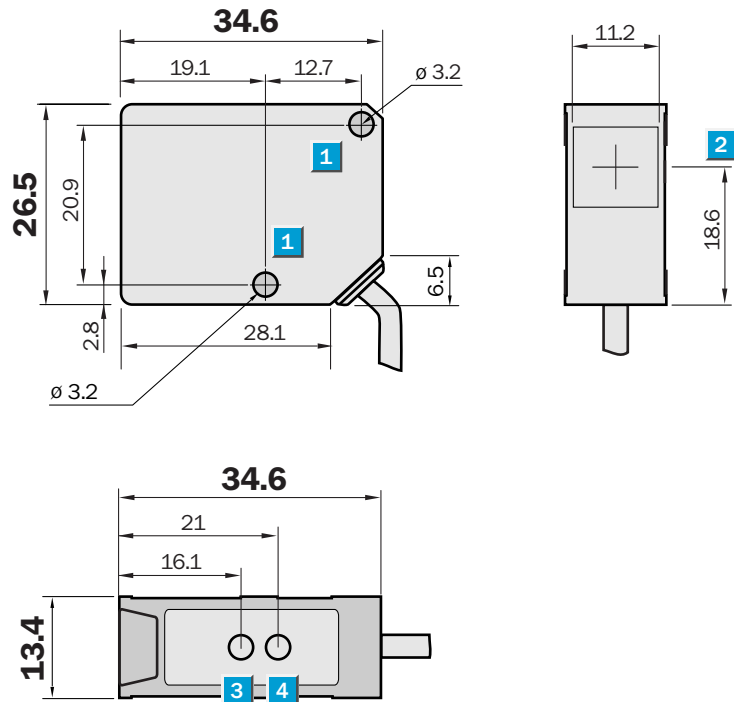

- 1 Through-hole \varnothing 3.2 mm
- 2 Optical axis
- 3 Indicator LED green: operational status indicator
- 4 Indicator LED orange: switching output



Connection type

WS/WE130L-32

WS/WE130L-34

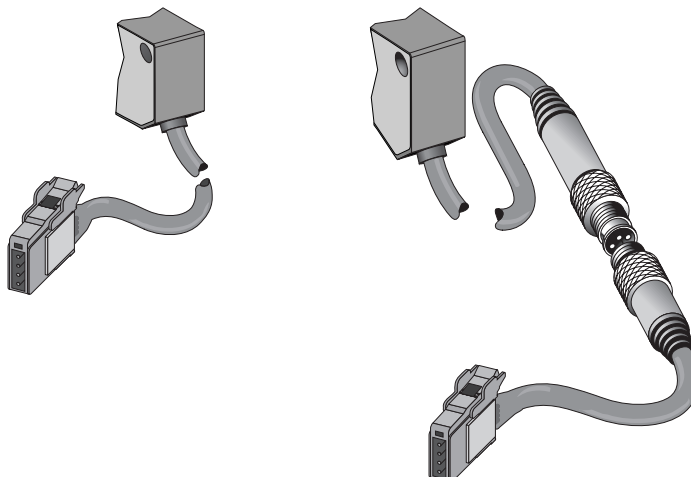

Technical specifications		WS/WE130L-	32	34								
Sensor head	Operation in combination with amplifier unit W130											
Scanning range typ. max.	0 ... 3.5 m											
Scanning range, recommended	0 ... 2 m											
Light source, light type	Laser, red light ¹⁾											
Laser protection class	1 (EN 60 825-1)											
Light spot diameter	2 mm at 2 m distance											
Supply voltage V_s	See amplifier unit W130											
Switching outputs	See amplifier unit W130											
Connection type	Cable with plug, PVC/PBT, 2 m ²⁾											
	Cable with plug and coupling, PVC/PBT, 2 m ³⁾											
VDE protection class	◆											
Enclosure rating	IP 67											
Ambient temperature operation	-10 °C ... +55 °C											
Ambient temperature storage	-25 °C ... +70 °C											
Weight	Approx. 70 g											
Housing material	PC, polycarbonate, PMMA											

¹⁾ Average service life 50,000 h at T_a = +25 °C

²⁾ Connection between sensor head and amplifier unit with system specific plug.

Do not bend cable below 0 °C
³⁾ System cable M8, 2 m necessary for

connection. Included with delivery. Do not bend cable below 0 °C

Scanning range and operating reserve

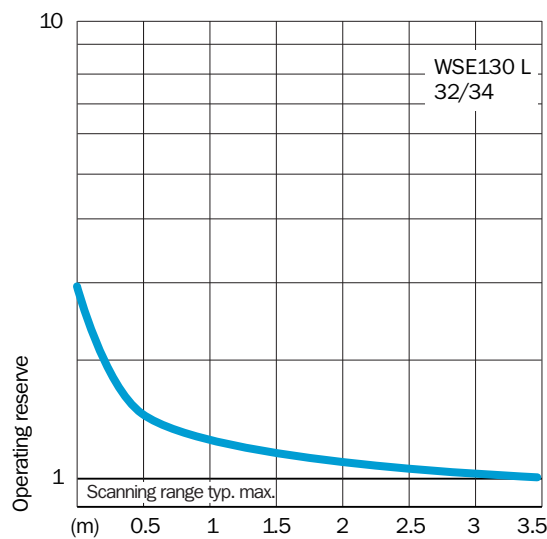
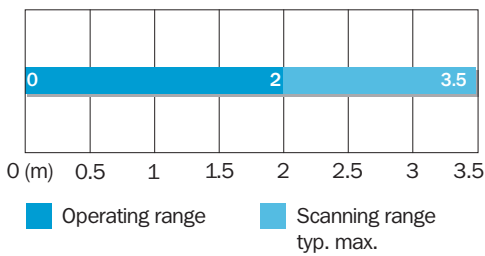

Light spot diameter

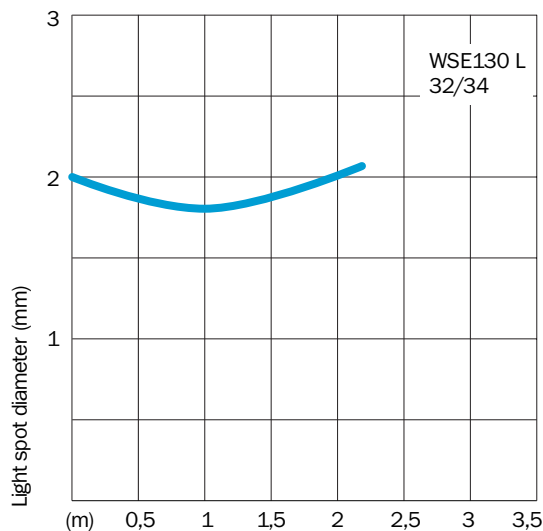

Ordering information

Type	Order no.
WS/WE130L-32	6 029 863
WS/WE130L-34	6 029 866

Through-beam photoelectric switch, WS/WE130L "LINE"

Scanning range
0 ... 3.5 m

Through-beam photoelectric switch

- Parallel laser line 30 mm wide
- Range up to 2 m
- "Eye safe" (Class 1) red light laser
- Configuration via amplifier unit enables application solutions such as edge control and detection of objects with position tolerance

Dimensional drawing

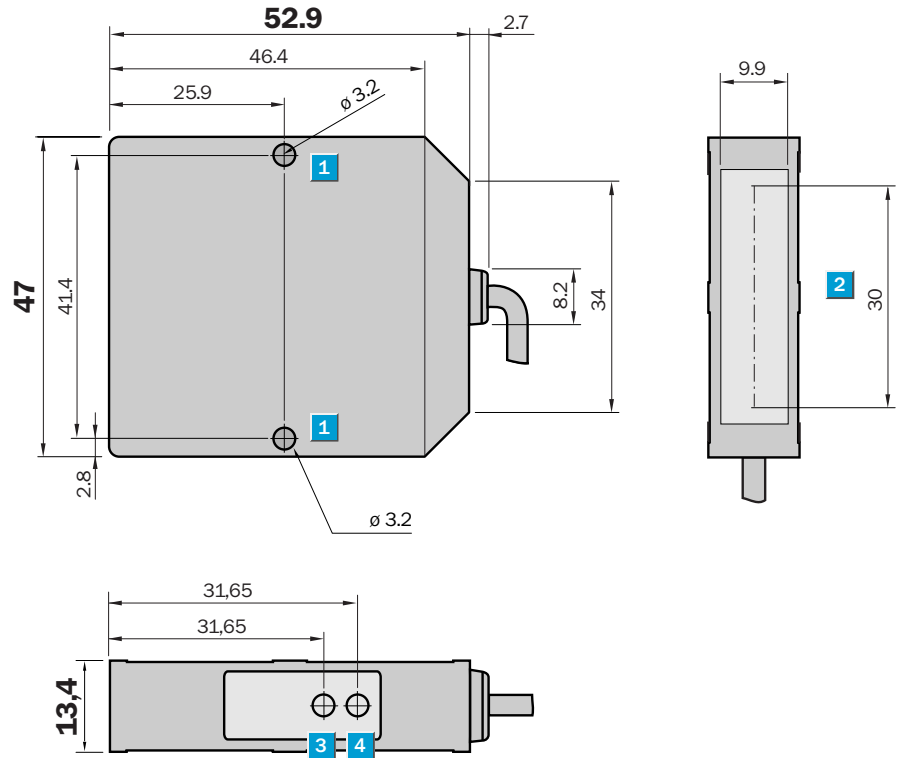

- 1 Through-hole \varnothing 3.2 mm
- 2 Parallel laser line
- 3 Indicator LED green: operational status indicator
- 4 Indicator LED orange: switching output

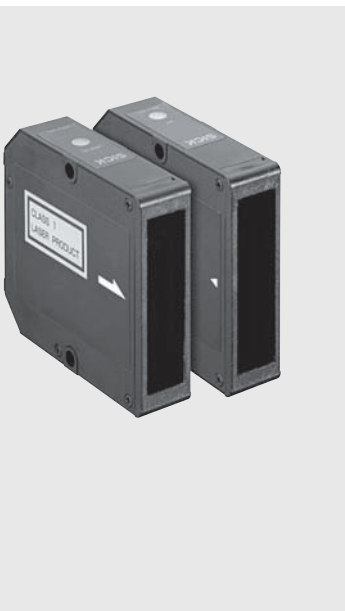

Connection type

WS/WE130L-52

WS/WE130L-54

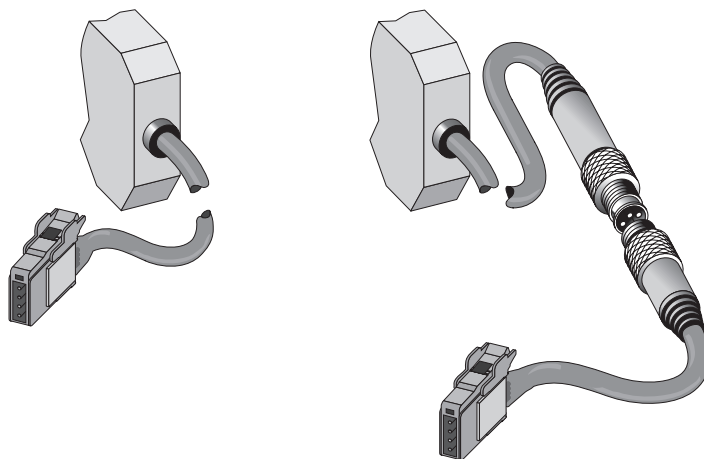

Technical specifications		WS/WE130L-	52	54								
Sensor head	Operation in combination with amplifier unit W130											
Scanning range typ. max.	0 ... 3.5 m											
Scanning range, recommended	0 ... 2 m											
Laser line dimension	30 x 2.5 mm parallel											
Light source, light type	Laser, red light ¹⁾											
Laser protection class	1 (EN 60 825-1)											
Supply voltage V_s	See amplifier unit W130											
Switching outputs	See amplifier unit W130											
Connection type	Cable with plug, PVC/PBT, 2 m ²⁾											
	Cable with plug and coupling, PVC/PBT, 2 m ³⁾											
VDE protection class	◇											
Enclosure rating	IP 67											
Ambient temperature operation	-10 °C ... +55 °C											
Ambient temperature storage	-25 °C ... +70 °C											
Weight	Approx. 100 g											
Housing material	PC, polycarbonate, PMMA											

¹⁾ Average service life 50,000 h at T_a = +25 °C

²⁾ Connection between sensor head and amplifier unit with system specific plug.

Do not bend cable below 0 °C
³⁾ System cable M8, 2 m necessary for

connection. Included with delivery. Do not bend cable below 0 °C

Scanning range and operating reserve

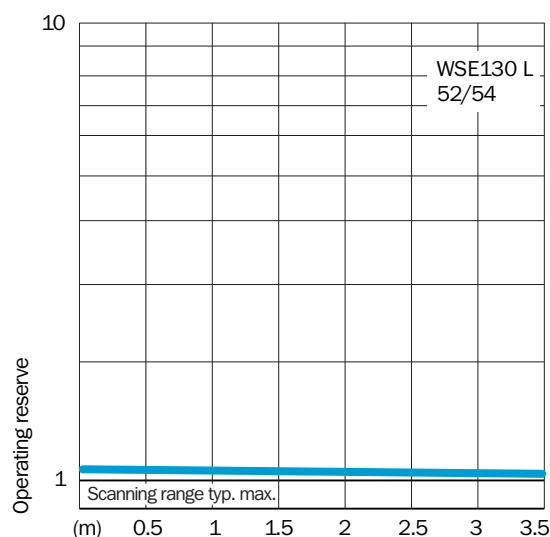
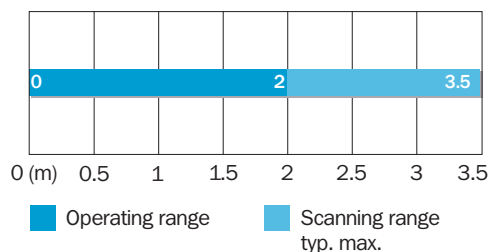

Light spot diameter

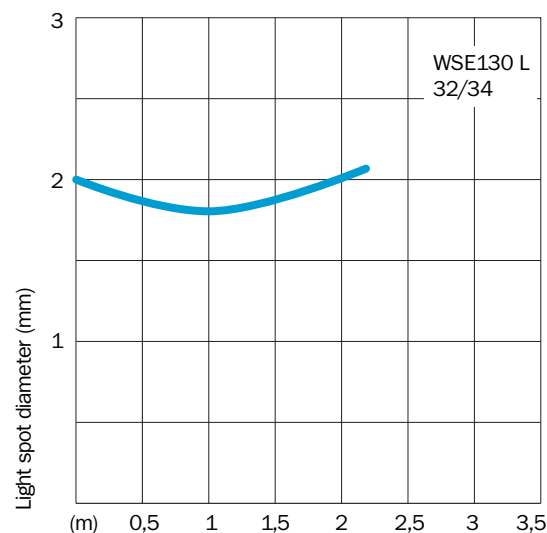

Ordering information	
Type	Order no.
WS/WE130L-52	6 029 865
WS/WE130L-54	6 029 868

Amplifier unit, WI130T, with switching output

Dimensional drawing

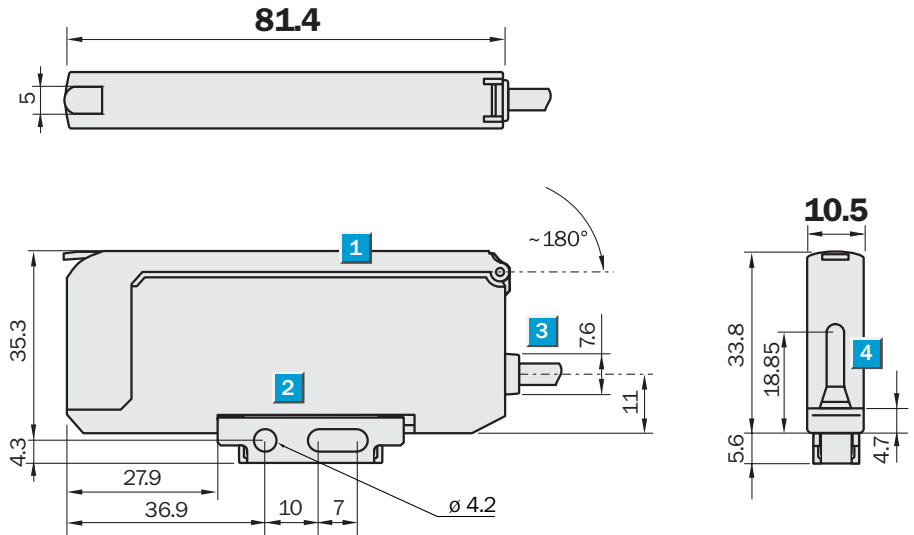

- Provision of varied functions for configuration
- Easy commissioning
- Display for operational status indicator and operator guidance
- Switching and analogue outputs
- Switching frequency up to 8.3 kHz

Adjustments possible

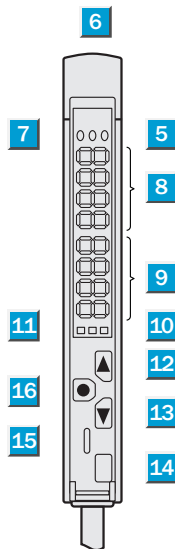

- 1 Protective hood; can be folded open (180° approx.)
- 2 Mounting bracket (included with delivery)
- 3 Connection
- 4 Connection for sensor heads
- 5 Indicator LED: output 1
- 6 Indicator LED: laser active
- 7 Indicator LED: output 2
- 8 Display: measurement value
- 9 Display: switching point
- 10 Indicator: SET active
- 11 Indicator LED: output 1 or 2 activated
- 12 Function key
- 13 Function key
- 14 Teach-in key
- 15 Set/Run selector switch
- 16 Operating key



Connection type

- WI130T-P340
- WI130T-N340

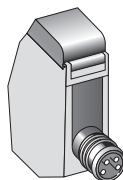

M8, 4-pin

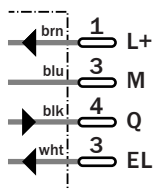

See chapter Accessories

- Connector, M8, 4-pin
- Male bus connector for mounting systems



Technical specifications		W130T-	P340	N340										
Amplifier unit	Operation in combination with sensor heads from the W130L series													
Adjustment of operating distance	Teach-in: teach button & cable (ET)													
Supply voltage V_s	DC 12 ... 24 V ¹⁾													
Power consumption	≤ 50 mA													
Switching outputs	PNP, Q													
	NPN, Q													
Switching mode	Programmable/configurable													
Output current I_a max	≤ 100 mA													
Response time	60 μs / 500 μs / 5 ms													
Time delay	On / Off Delay, 0 ... 9 s													
Connection type	Connector, M8, 4-pin													
VDE protection class	◆													
Circuit protection	V_s connections reverse-polarity protected / Output Q short-circuit protected													
Enclosure rating	IP 50													
Ambient temperature operation	-25 °C ... +55 °C ²⁾													
Ambient temperature storage	-40 °C ... +70 °C													
Weight	Approx. 20 g													
Housing material	PPE / PC													
Included with delivery	Mounting bracket													

¹⁾ ± 10 %

²⁾ more than 2 devices mounted as a block
max 50° C

Ordering information

Type	Order no.
W130T-P340	6 032 851
W130T-N340	6 032 852

Dimensional drawing

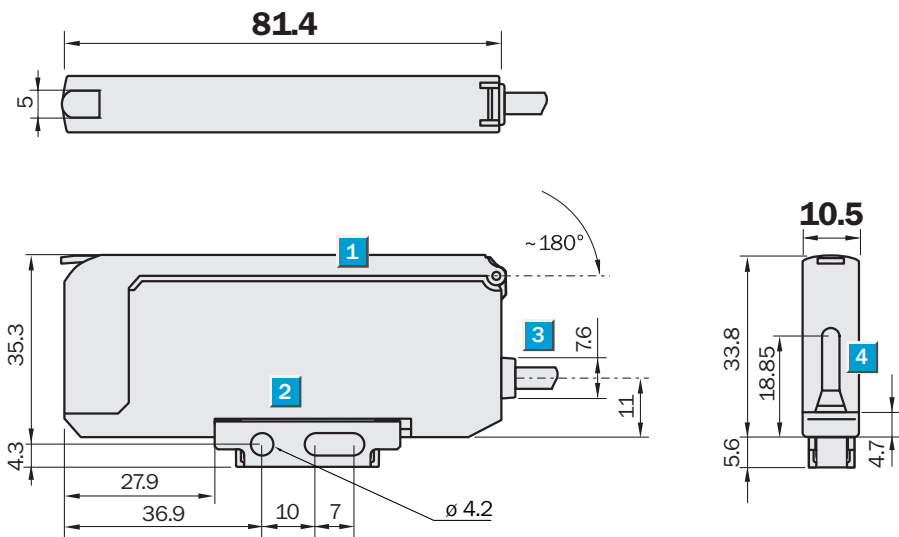

- Provision of varied functions for configuration
- Easy commissioning
- Display for operational status indicator and operator guidance
- Switching and analogue outputs
- Switching frequency up to 8.3 kHz

Adjustments possible

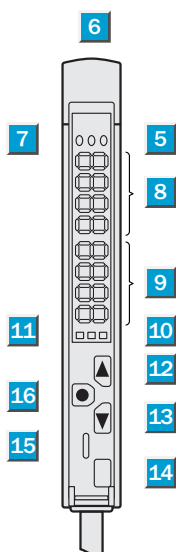

- 1 Protective hood; can be folded open (180° approx.)
- 2 Mounting bracket (included with delivery)
- 3 Connection
- 4 Connection for sensor heads
- 5 Indicator LED: output 1
- 6 Indicator LED: laser active
- 7 Indicator LED: output 2
- 8 Display: measurement value
- 9 Display: switching point
- 10 Indicator: SET active
- 11 Indicator LED: output 1 or 2 activated
- 12 Function key
- 13 Function key
- 14 Teach-in key
- 15 Set/Run selector switch
- 16 Operating key

Connection type

WI130T-N720

WI130T-P720

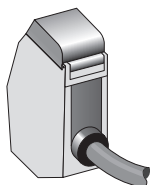

7 wire

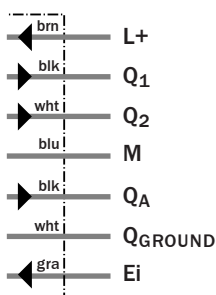

See chapter Accessories

Male bus connector

Mounting systems

Technical specifications		W130T-	N720	P720										
Amplifier unit	Operation in combination with sensor heads from the W130L series													
Adjustment of operating distance	Teach-in: teach button & cable (ET)													
Supply voltage V_s	DC 12 ... 24 V ¹⁾													
Power consumption	≤ 50 mA													
Switching outputs	NPN, Q1, Q2 and analogue output													
	PNP, Q1, Q2 and analogue output													
Switching mode	Programmable/configurable													
Output current I_a max	≤ 100 mA													
Response time	60 μs / 500 μs / 5 ms													
Time delay	On / Off Delay, 0 ... 9 s													
Connection type	Cable, PVC/PBT, 2 m													
VDE protection class	◆													
Circuit protection	V_s connections reverse-polarity protected / Output Q short-circuit protected													
Enclosure rating	IP 50													
Ambient temperature operation	-25 °C ... +55 °C ²⁾													
Ambient temperature storage	-40 °C ... +70 °C													
Weight	Approx. 80 g													
Housing material	PPE / PC													
Included with delivery	Mounting bracket													

¹⁾ ± 10 %

²⁾ more than 2 devices mounted as a block
max 50° C

Ordering information

Type	Order no.
W130T-N720	6 032 854
W130T-P720	6 032 853

W 190 L Standard Series: Laser Technology at economical prices

	BGS Photoelectric proximity switches
	Photoelectric reflex switches
	Through-beam photoelectric switches



The sensors' fast response times make them ideal for most high-speed applications.

A standard feature is the light/dark selector switch, providing great flexibility and allowing the W 190 L to be adapted to a wide variety of applications.

The option of a rotating M8 connector or 2 m cable version is available as standard, and yellow and green LEDs provide practical and user friendly assistance with commissioning and calibration.

The compact, industry-standard plastic housing permits the use of the device even in harsh environments.

Do your customers require reliable, economical Laser Technology for standard applications? The photoelectric switches W 190 L series with laser technology are reliable, user friendly and economical.

All sensors have red-light laser diodes, which conform to Protection Class 2. The precise visible light spot allows fast and accurate alignment of the sensors to the target. The small light spot allows the reliable detection of even the smallest objects.

WTB 190 L, with precise, adjustable background suppression (BGS), is available with two different scanning ranges.

WL 190 L, with precision auto-collimated optics, enables the reliable detection of small objects, even at close range.

WS/WE 190 L, ideal for applications requiring a large system reserve.

► WS/WE 190 L: Detection of over-height sheet metal parts.
Sector: Metal working.

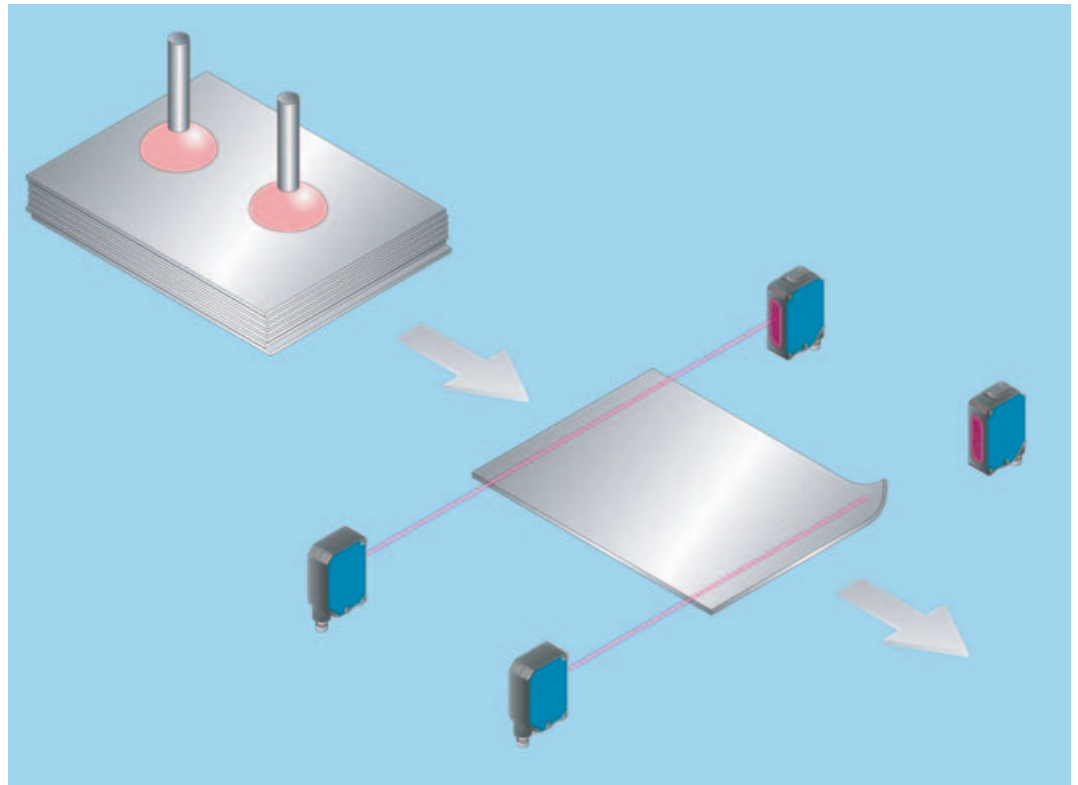

▼ WTB 190 T: Wire break test.
Sector: Assembly technology.

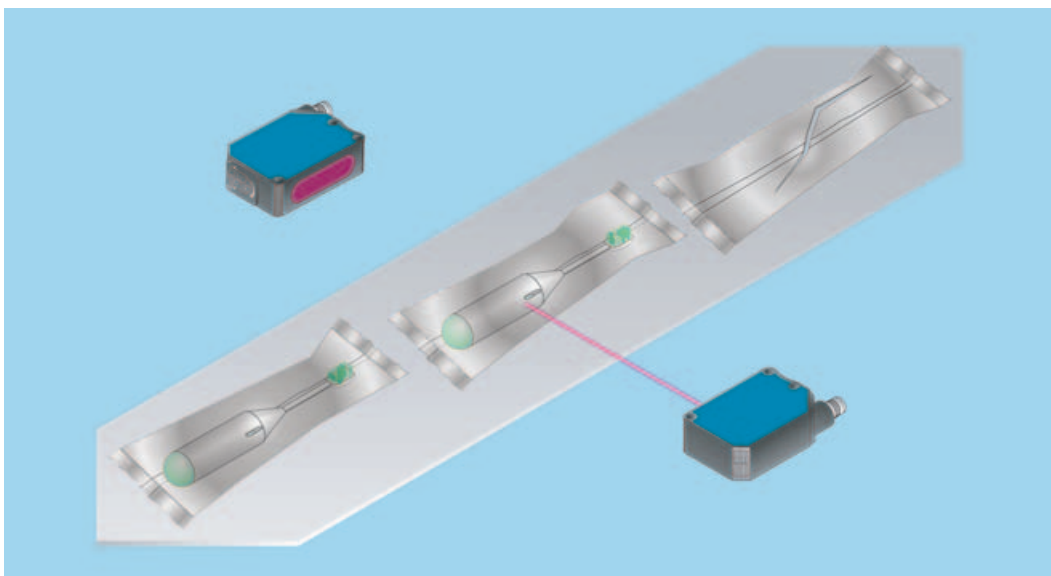
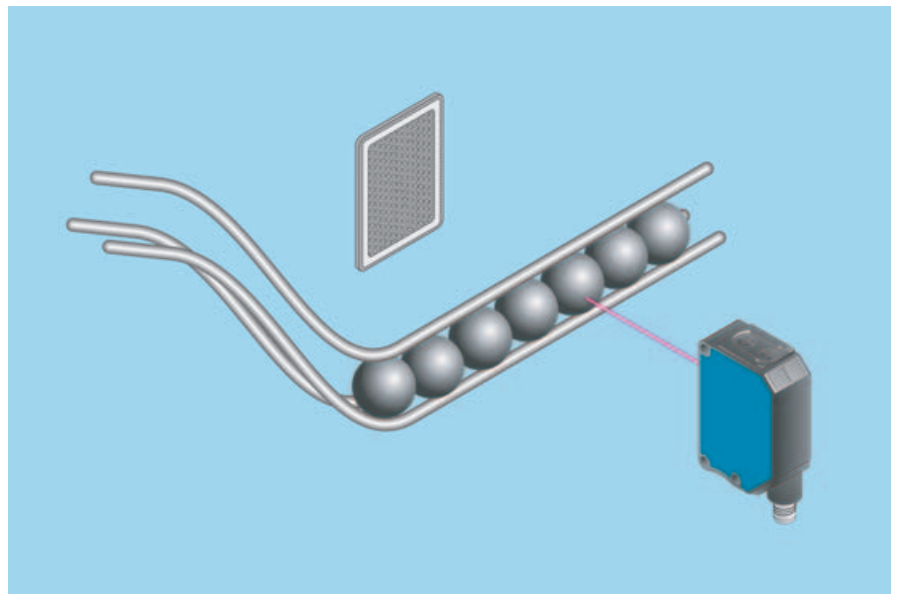
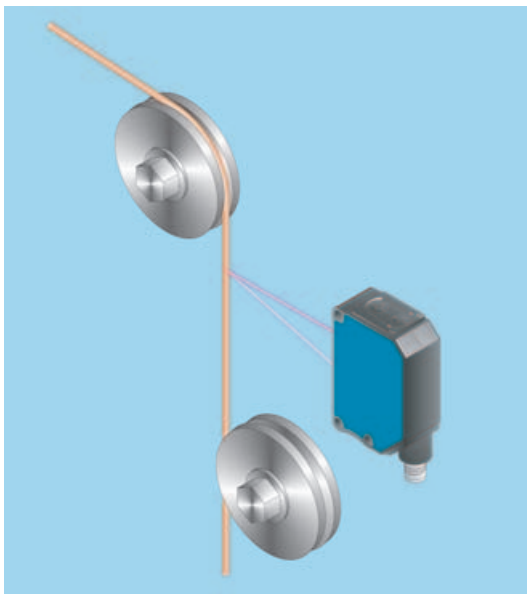

▲ WL 190 L: Component detection, e.g. components for bearings.
Sector: Assembly technology.

◄ WS/WE 190 L: Completeness check. In this example: Is the product in the outer packaging?
Sector: Packaging industry.

Scanning distance
100 ... 300 mm

Photoelectric proximity switches

- Laser LED, visible red light, Class 2
- User friendly sensor, easily aligned and set up
- Precise background suppression
- Set via rotary switch
- Selectable output: Light/dark switching

Dimension illustration

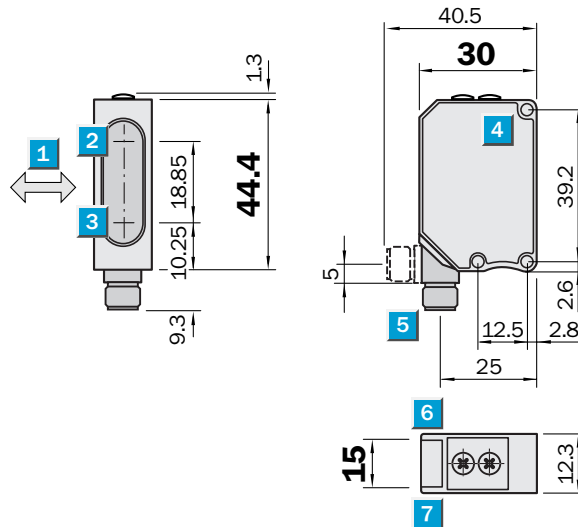

Setting options

All types

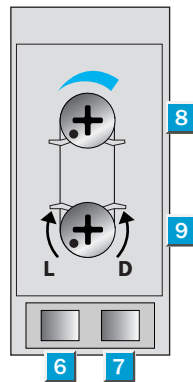

- 1 Standard direction of the material being scanned
- 2 Centre of optical axis, sender
- 3 Centre of optical axis, receiver
- 4 Mounting holes, Ø approx. 3.1 mm
- 5 Plug 4-pin, M8, 90° rotatable or cable 2 m, 3-wire
- 6 Status indicator LED, yellow: Output active
- 7 Status indicator LED, green: Laser on
- 8 Scanning range adjustment
- 9 L.ON/D.ON selection switch

Connection types

WTB 190L-P 162	WTB 190L-P 460
WTB 190L-N 162	WTB 190L-N 460

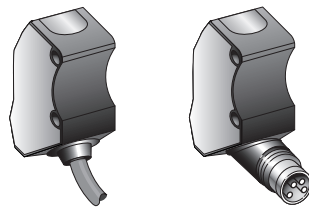

3 x 0.18 mm²

4-pin, M8

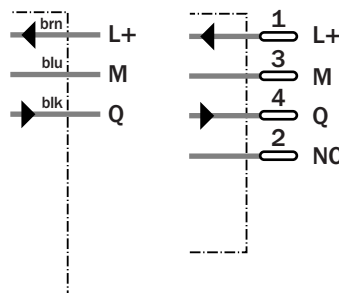

CE III CDRH
Accession Number
0 31 22 45

Laser class 2



See chapter Accessories

- Cables and connectors
- Mounting systems

Technical data		WTB 190 L-	P 162	P 460	N 162	N 460
Scanning distance, adjustable	100 ... 300 mm ¹⁾					
Adjustment	Potentiometer, 4 turns volume					
Light source²⁾	Laser, red light; class 2					
Light spot diameter	2.5 mm at distance of 200 mm					
Supply voltage V_S	10 ... 30 V DC ³⁾					
Ripple ⁴⁾	± 10 %					
Current consumption ⁵⁾	Max. 40 mA					
Switching outputs	PNP					
	NPN					
Output current I _A max.	< 100 mA					
Switching mode	Light/dark mode ⁶⁾ , selectable					
Response time ⁷⁾	0.7 ms					
Switching frequency max. ⁸⁾	700/s					
Connection types Cable	3-wire ⁹⁾					
Plug	4-pin, M8					
VDE protection class¹⁰⁾	⊕					
Circuit protection¹¹⁾	A, B					
Enclosure rating	IP 67					
Ambient temperature	Operation -10 ... +40 °C					
	Storage -20 ... +60 °C					
Weight	With cable 2 m approx. 200 g					
	With plug approx. 120 g					
Housing material	Housing: ABS; optic: PMMA					

1) Object with 90 % reflectance (with reference to standard white according to DIN 5033)
 2) Average service life 50,000 h at T_A = + 25 °C

3) Limit values
 4) Must be within V_S tolerances
 5) Without load
 6) Via "select button"

7) With resistive load
 8) With light/dark ratio 1:1
 9) Do not bend below 0 °C
 10) Reference voltage 50 V DC

11) A = V_S connections reverse-polarity protected
 B = Output Q short-circuit protected

Scanning distance

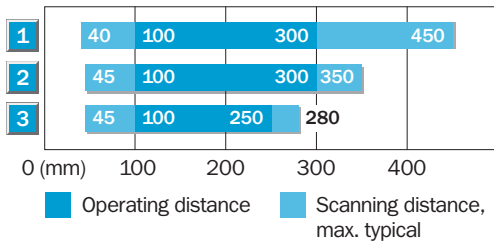

- 1 Scanning range on white, 90 % remission
- 2 Scanning range on grey, 18 % remission
- 3 Scanning range on black, 6 % remission

Light spot diameter

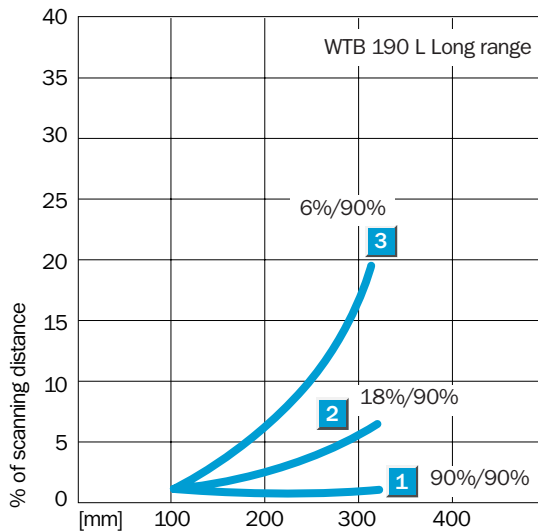
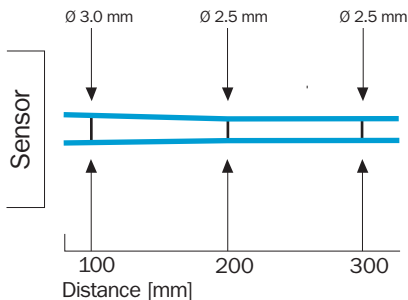

Order information *)

Type	Order no.
WTB 190L-P 162	6 026 553
WTB 190L-P 460	6 026 554
WTB 190L-N 162	6 026 551
WTB 190L-N 460	6 026 552

*) Equipment model with 5 m PVC cable or M8 plug, 3-pin on request

Scanning distance
40 ... 100 mm

Photoelectric proximity switch

- Laser LED, visible red light, Class 2
- User friendly sensor, easily aligned and set up
- Precise background suppression
- Set via rotary switch
- Selectable output: Light/dark switching

Dimension illustration

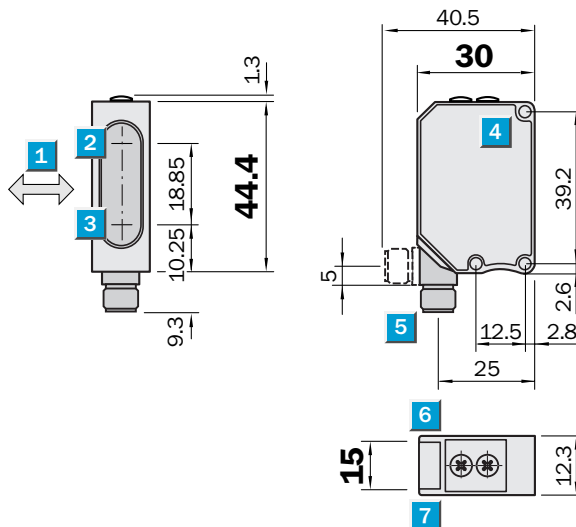

Setting options

All types

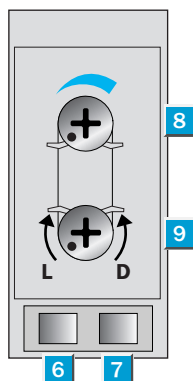

- 1 Standard direction of the material being scanned
- 2 Centre of optical axis, sender
- 3 Centre of optical axis, receiver
- 4 Mounting holes, Ø approx. 3.1 mm
- 5 Plug 4-pin, M8, 90° rotatable or cable 2 m, 3-wirer
- 6 Status indicator LED, yellow: Output active
- 7 Status indicator LED, green: Laser on
- 8 Scanning range adjustment
- 9 L.ON/D.ON selection switch

Connection types

WTB 190L-P 132	WTB 190L-P 430
WTB 190L-N 132	WTB 190L-N 430

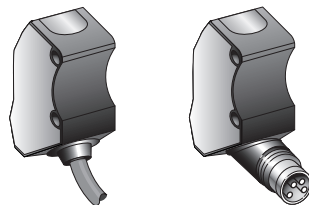

3 x 0.18 mm ²	4-pin, M8
--------------------------	-----------

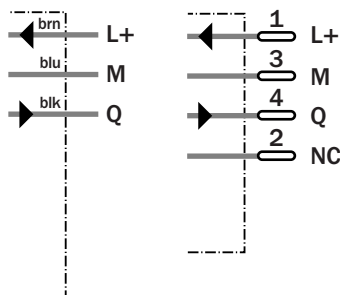

CE III CDRH
Accession Number
0 31 22 45

Laser class 2



See chapter Accessories

- Cables and connectors
- Mounting systems

Technical data		WTB 190 L-	P 132	P 430	N 132	N 430						
Scanning distance, adjustable	40 ... 100 mm ¹⁾											
Adjustment	Potentiometer, 4 turns volume											
Light source²⁾	Laser, red light; class 2											
Light spot diameter	2 mm at distance of 80 mm											
Supply voltage V_S	10 ... 30 V DC ³⁾											
Ripple ⁴⁾	± 10 %											
Current consumption ⁵⁾	Max. 40 mA											
Switching outputs	PNP											
	NPN											
Output current I _A max.	< 100 mA											
Switching mode	Light/dark mode ⁶⁾ , selectable											
Response time ⁷⁾	0.7 ms											
Switching frequency max. ⁸⁾	700/s											
Connection types Cable	3-wire ⁹⁾											
Plug	4-pin, M8											
VDE protection class¹⁰⁾	⊕											
Circuit protection¹¹⁾	A, B											
Enclosure rating	IP 67											
Ambient temperature	Operation -10 ... +40 °C											
	Storage -20 ... +60 °C											
Weight	With cable 2 m approx. 200 g											
	With plug approx. 120 g											
Housing material	Housing: ABS; optic: PMMA											

- 1) Object with 90 % reflectance (with reference to standard white according to DIN 5033)
- 2) Average service life 50,000 h at T_A = + 25 °C
- 3) Limit values
- 4) Must be within V_S tolerances
- 5) Without load
- 6) Via „select button“
- 7) With resistive load
- 8) With light/dark ratio 1:1
- 9) Do not bend below 0 °C
- 10) Reference voltage 50 V DC
- 11) A = V_S connections reverse-polarity protected
B = Output Q short-circuit protected

Scanning distance

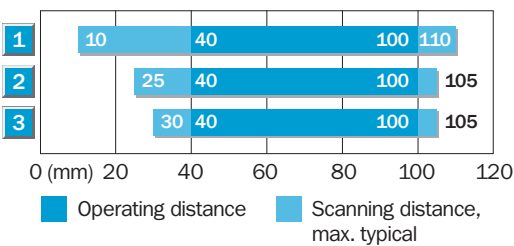

- 1 Scanning range on white, 90 % remission
- 2 Scanning range on grey, 18 % remission
- 3 Scanning range on black, 6 % remission

Light spot diameter

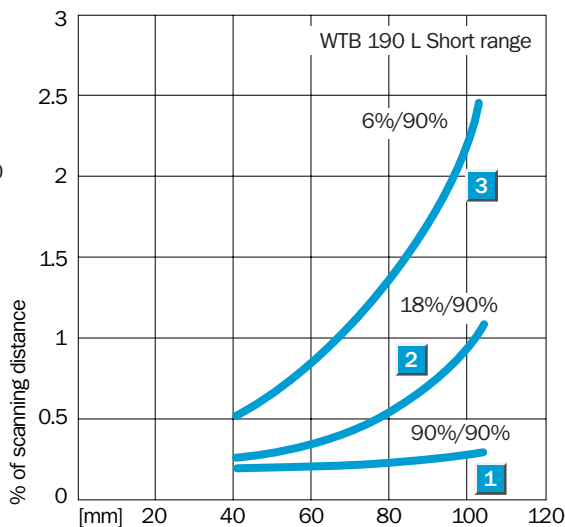
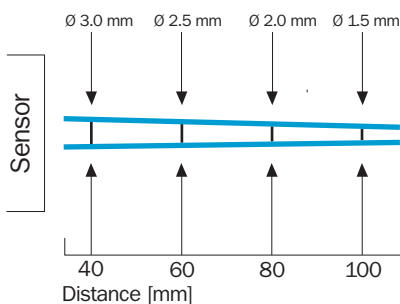

Order information *)

Type	Order no.
WTB 190L-P 132	6 026 549
WTB 190L-P 430	6 026 550
WTB 190L-N 132	6 026 547
WTB 190L-N 430	6 026 548

*) Equipment model with 5 m PVC cable or M8 plug, 3-pin on request

Scanning range
0.01 ... 5.5 m

Photoelectric reflex switches

- Laser LED, visible red light, Class 2
- User friendly sensor, easily aligned and set up
- Sensitivity setting via rotary switch
- Precision auto-collimated optics
- Selectable output: Light/dark switching

Dimension illustration

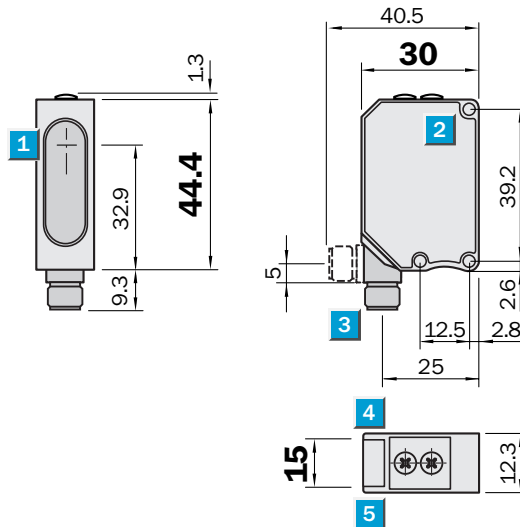

Setting options

All types

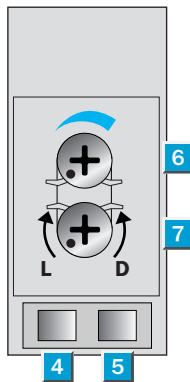

- 1 Centre of optical axis
- 2 Mounting holes, Ø approx. 3.1 mm
- 3 Plug 4-pin, M8, 90° rotatable or cable 2 m, 3-wire
- 4 Status indicator LED, yellow: Output active
- 5 Status indicator LED, green: Laser on
- 6 Sensitivity control
- 7 L.ON/D.ON selection switch

Connection types

WL 190L-P 132	WL 190L-P 430
WL 190L-N 132	WL 190L-N 430

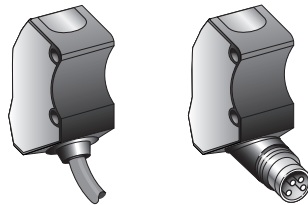

3 x 0.18 mm²

4-pin, M8

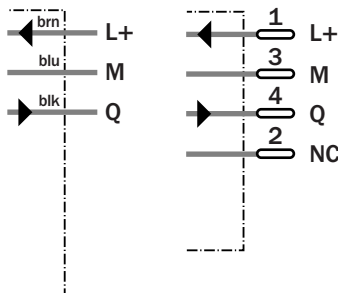

CE III CDRH
Accession Number
0 31 22 45

Laser class 2



See chapter Accessories

- Cables and connectors
- Mounting systems
- Reflectors

Technical data		WL 190L-	P 132	P 430	N 132	N 430						
Scanning range , max. typical/on refl. ¹⁾	0.01 ... 5.5 m/P 250 F											
Sensitivity, adjustable	Potentiometer, 1 turn volume											
Light source ²⁾	Laser, red light; class 2											
Light spot diameter	45 mm at distance of 5 m											
Supply voltage V _S	10 ... 30 V DC ³⁾											
Ripple ⁴⁾	± 10 %											
Current consumption ⁵⁾	Max. 40 mA											
Switching outputs	PNP											
	NPN											
Output current I _A max.	< 100 mA											
Switching mode	Light/dark mode ⁶⁾ , selectable											
Response time ⁷⁾	< 0.5 ms											
Switching frequency max. ⁸⁾	1000/s											
Connection types Cable	3-wire ⁹⁾											
	Plug	4-pin, M8										
VDE protection class ¹⁰⁾	⊕											
Circuit protection ¹¹⁾	A, B											
Enclosure rating	IP 67											
Ambient temperature	Operation -10 ... +40 °C											
	Storage -20 ... +60 °C											
Weight	With cable 2 m approx. 200 g											
	With plug approx. 120 g											
Housing material	Housing: ABS; optic: PMMA											

- 1) Reflector P 250 F included with delivery
- 2) Average service life 50,000 h at T_A = + 25 °C
- 3) Limit values
- 4) Must be within V_S tolerances
- 5) Without load
- 6) Via "select button"
- 7) With resistive load
- 8) With light/dark ratio 1:1
- 9) Do not bend below 0 °C
- 10) Reference voltage 50 V DC
- 11) A = V_S connections reverse-polarity protected
B = Output Q short-circuit protected

Scanning range

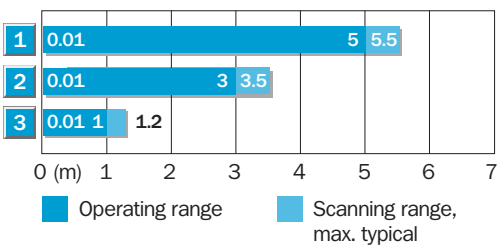

Reflector type	Operating range
1 P 250 F	0.01 ... 5 m
2 PL 20 F	0.01 ... 3 m
3 PL 10 F	0.01 ... 1 m

Light spot diameter

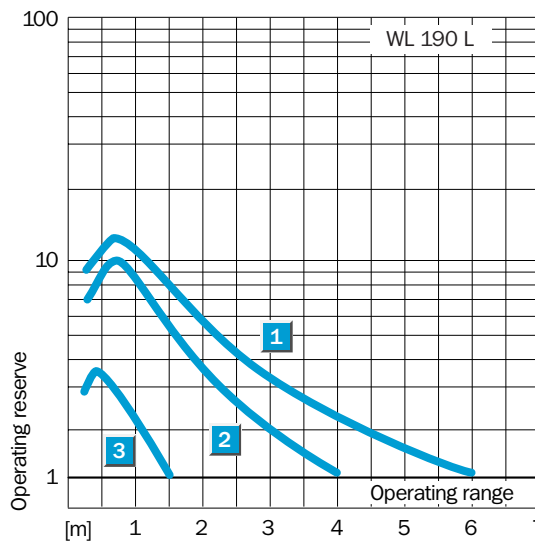
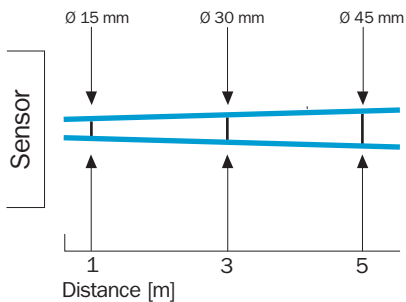

Order information *)

Type	Order no.
WL 190L-P 132	6 026 557
WL 190L-P 430	6 026 558
WL 190L-N 132	6 026 555
WL 190L-N 430	6 026 556

*) Equipment model with 5 m PVC cable or M8 plug, 3-pin on request

Scanning range
0 ... 50 m

Through-beam photoelectric switches

- Laser LED, visible red light, Class 2
- User friendly sensor, easily aligned and set up
- Sensitivity setting via rotary switch
- Precision auto-collimated optics
- Selectable output: Light/dark switching

Dimension illustration

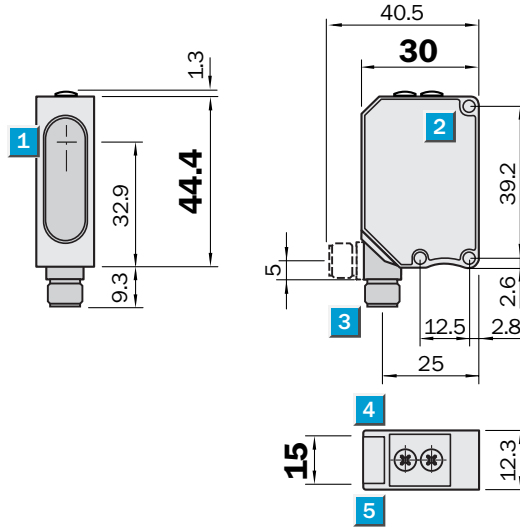

Setting options

All types

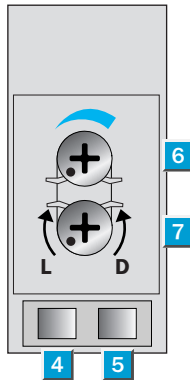

- 1 Centre of optical axis
- 2 Mounting holes, Ø approx. 3.1 mm
- 3 Plug 4-pin, M8, 90° rotatable or cable 2 m, 3-wire
- 4 Status indicator LED, yellow: Output active
- 5 Status indicator LED, green: Laser on
- 6 Sensitivity control
- 7 L.ON/D.ON selection switch

Connection types

WS/WE 190L-P 132
WS/WE 190L-N 132

WS/WE 190L-P 430
WS/WE 190L-N 430

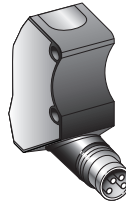
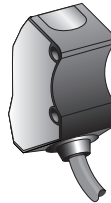

2 x 0.18 mm²

3 x 0.18 mm²

4-pin, M8

4-pin, M8

Sender

Receiver

Sender

Receiver

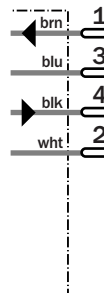
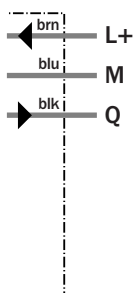
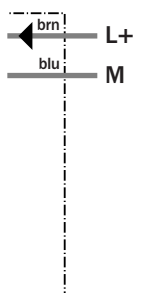

CE III CDRH
Accession Number
0 31 22 45

Laser class 2



See chapter Accessories

Cables and connectors

Mounting systems

Technical data		WS/WE 190L-	P 132	P 430	N 132	N 430						
Scanning range , max. typical	50 m, adjustable											
Sensitivity, adjustable	Potentiometer, 1 turn volume											
Light source ¹⁾	Laser, red light; class 2											
Light spot diameter	40 mm at distance of 10 m											
Supply voltage V _S	10 ... 30 V DC ²⁾											
Ripple ³⁾	± 10 %											
Current consumption ⁴⁾	Max. 40 mA											
Switching outputs	PNP											
	NPN											
Output current I _A max.	< 100 mA											
Switching mode	Light/dark mode ⁵⁾ , selectable											
Response time ⁶⁾	< 0.5 ms											
Switching frequency max. ⁷⁾	1000/s											
Connection types Cable	3-wire ⁸⁾											
	Plug	4-pin, M8										
VDE protection class ⁹⁾	⊕											
Circuit protection ¹⁰⁾	A, B											
Enclosure rating	IP 67											
Ambient temperature	Operation -10 ... +40 °C											
	Storage -20 ... +60 °C											
Weight	With cable 2 m approx. 200 g											
	With plug approx. 120 g											
Housing material	Housing: ABS; optic: PMMA											

1) Average service life 50,000 h at T_A = +25 °C
 2) Limit values

3) Must be within V_S tolerances
 4) Without load
 5) Via "select button"

6) With resistive load
 7) With light/dark ratio 1:1
 8) Do not bend cable below 0 °C
 9) Reference voltage 50 V DC

10) A = V_S connections reverse-polarity protected
 B = Output Q short-circuit protected

Scanning range and operating reserve

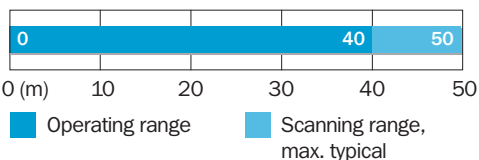

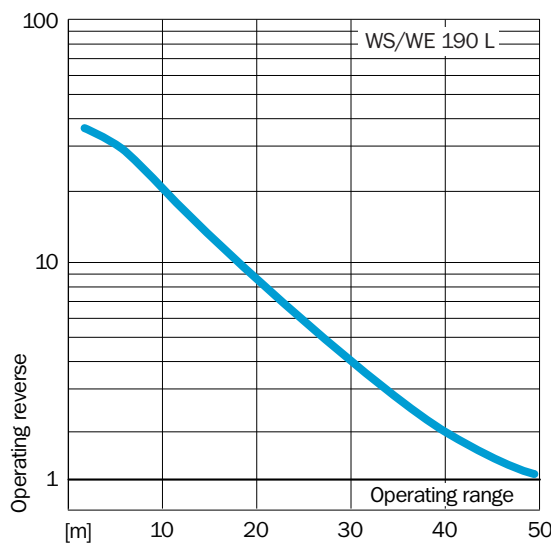
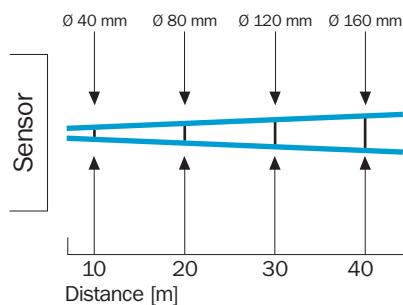

Light spot diameter



Order information *)

Type	Order no.
WS/WE 190L-P132	6 026 561
WS/WE 190L-P430	6 026 562
WS/WE 190L-N132	6 026 559
WS/WE 190L-N430	6 026 560

*) Equipment model with 5 m PVC cable or M8 plug, 3-pin on request

	Photoelectric proximity switches BGS/FGS
	Photoelectric reflex switches

W 190 L High Grade: Application-based Laser Technology, the optimum solution for demanding applications



objects or foils provide a secure switching signal. Automatic switching threshold tracking ensures high availability and long maintenance intervals in industrial environments.

Through the configuration menu, the **WTB 190TL photoelectric proximity switch** with CMOS receiver line enables flexible selection of the operating and Teach-in modes. Foreground and background suppression modes are available.

Demanding tasks with customised functionality of the sensor are typical requirements. With the W 190TL series of laser sensors, we have a convincing answer.

The sensors can be configured via a function menu with display and have a red light laser of protection class 2. This ensures a precise, clearly visible light spot which enables fast and exact alignment even for smallest objects.

The **WLG 190T photoelectric reflex switch** is one of the most powerful sensors for transparent objects. Even highly transparent

Further configurable functions of the W 190L High Grade series:

- On/off delay up to 10 s;
- one shot signal,
- light-/dark switching,
- External Teach-in or Teach-in by keystroke,
- Exact adjustment of the switching threshold down to the last digit,
- keylock.

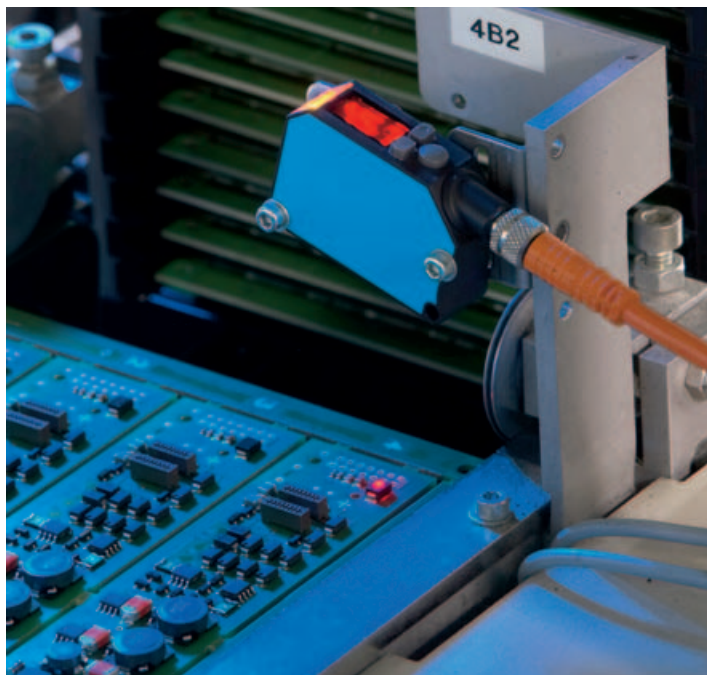

▲ WTB 190TL: Precise presence check for small components.

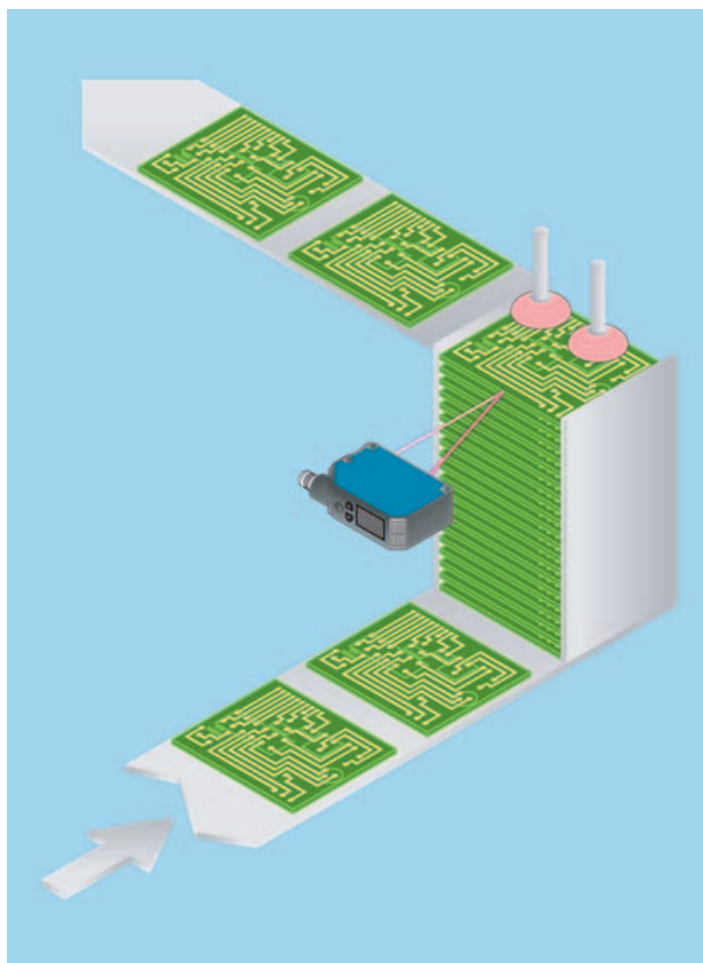

▲ WTB 190TL: Position Teach-in, BGS mode, checking presence.
Sector: Electronic and semiconductor industry.

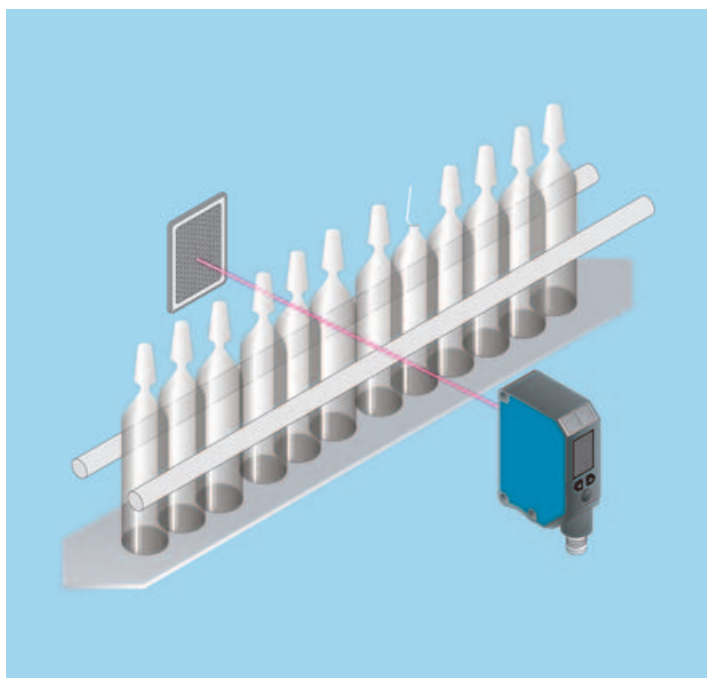

▲ WLG 190T: Ampoule syringes and breakage test.
Sector: Pharmaceutical industry.

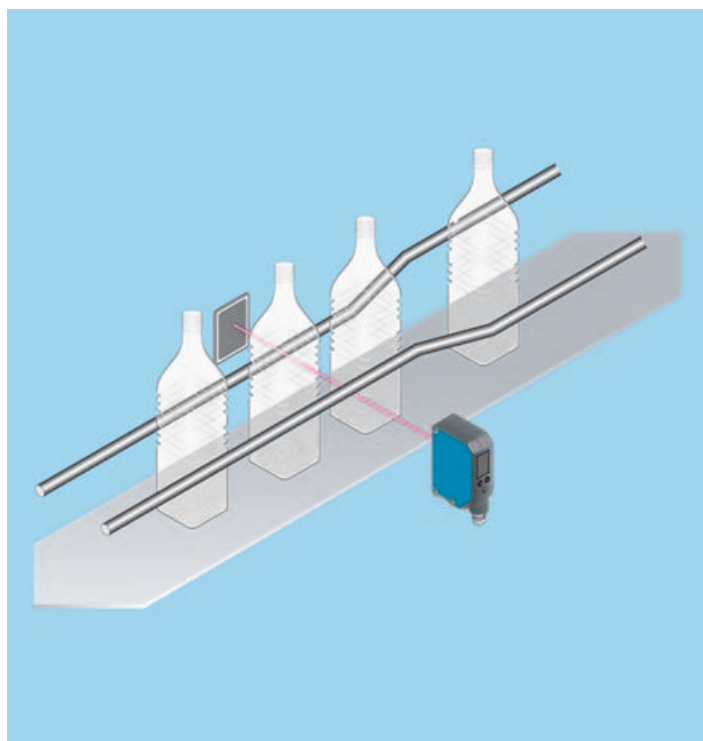

▲ WLG 190T: Transparent bottles.
Sector: Bottling.

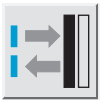

Scanning distance
100 ... 270 mm

Photoelectric proximity switches

- Laser LED, visible red light, Class 2
- Scanning distance adjustment by Teach-in function
- Programmable background or foreground suppression
- Programmable output: light/dark switching
- Numeric display with menu prompts

Dimensional drawing

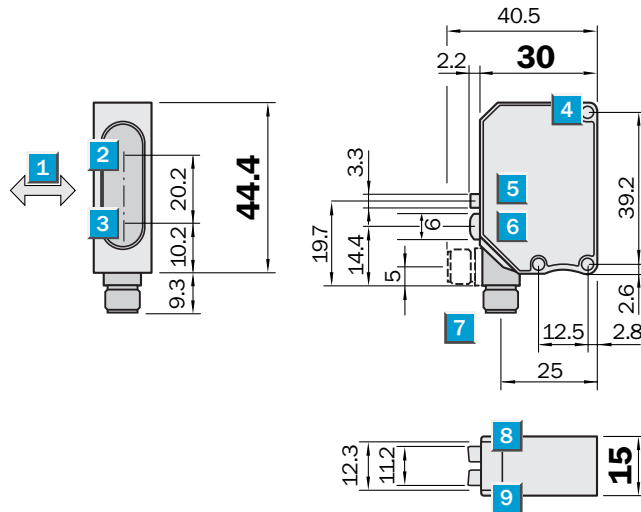

Adjustments possible

All types

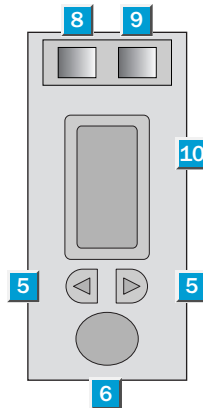

- 1 Standard direction of the material being scanned
- 2 Centre of optical axis, sender
- 3 Centre of optical axis, receiver
- 4 Mounting holes, Ø approx. 3.1 mm
- 5 +/- button; select mode button
- 6 Teach-in button
- 7 Plug 4-pin, M8, 90° rotatable or cable 2 m, 4-wire
- 8 Status indicator LED, green: Laser on
- 9 Status indicator LED, yellow: output active
- 10 Numerical display

Connection types

WTB 190TL-P 162	WTB 190TL-P 460
WTB 190TL-N 162	WTB 190TL-N 460

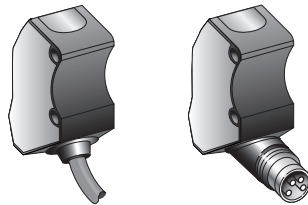

4 x 0.18 mm²

4-pin, M8

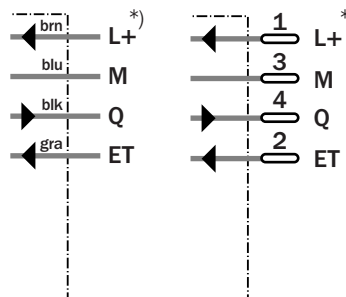

*) Adjustment via External Teach (ET)

PNP → L+

NPN → M

CE III CDRH
Accession Number
0 31 22 45

Laser class 2



See chapter Accessories

Cables and connectors

Mounting systems

Technical data		WTB 190TL-	P 162	P 460	N 162	N 460
Scanning distance, adjustable	100 ... 270 mm ¹⁾					
Device function mode	BGS ²⁾ or FGS ³⁾ , programmable					
Scanning distance, adjustable	Teach-in, External Teach (ET)					
	Teach-in via button, menu guided					
Threshold, precise setting	Manually adjustable					
Light source⁴⁾	Laser, red light; class 2					
Light spot diameter	1.5 mm at distance of 200 mm					
Supply voltage V_S	10 ... 30 V DC ⁵⁾					
Ripple ⁶⁾	± 10 %					
Current consumption ⁷⁾	Max. 40 mA					
Switching outputs	PNP					
	NPN					
Output current I _A max.	< 100 mA					
Switching type	Light-/dark-switching, programmable					
Response time ⁸⁾	1.5 ms					
Switching frequency max. ⁹⁾	300/s					
Timer mode (dLY)	0 ... 10 s, programmable					
Timer function	Nor: normal Mode					
	Ond: On Delay Mode, on delay					
	OFd: Off Delay Mode, off delay					
	OnE: One Shot Mode, one shot					
Numerical display monitoring	Threshold, distance, mode selection					
Connection types Cable	4-wire ¹⁰⁾					
Plug	4-pin, M8					
VDE protection class¹¹⁾	⚡					
Circuit protection¹²⁾	A, B					
Enclosure rating	IP 67					
Ambient temperature	Operation -10 ... +40 °C					
	Storage -20 ... +60 °C					
Weight	With cable 2 m approx. 200 g					
	With plug approx. 120 g					
Housing material	Housing: ABS; optic: PMMA					

1) Object with 90 % reflectance (with reference to standard white according to DIN 5033)
 2) Background suppression
 3) Foreground suppression

4) Average service life 50,000 h at T_A = + 25 °C
 5) Limit values
 6) Must be within V_S tolerances
 7) Without load

8) With resistive load
 9) With light/dark ratio 1:1
 10) Do not bend below 0 °C
 11) Reference voltage 50 V DC

12) A = V_S connections reverse-polarity protected
 B = Output Q short-circuit protected

Scanning distance

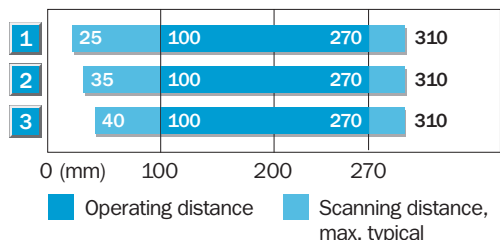

- 1 Scanning range on white, 90 % remission
- 2 Scanning range on grey, 18 % remission
- 3 Scanning range on black, 6 % remission

Light spot diameter

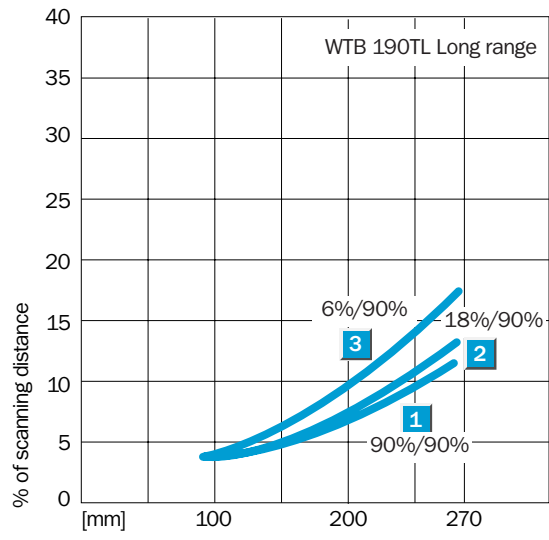
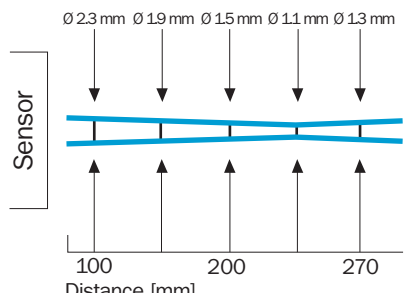

Order information*)

Type	Order no.
WTB 190TL-P 162	6 026 545
WTB 190TL-P 460	6 026 546
WTB 190TL-N 162	6 026 543
WTB 190TL-N 460	6 026 544

*) Equipment model with 5 m PVC cable or M8 plug, 3-pin on request



Scanning distance
40 ... 100 mm

Photoelectric proximity switches

- Laser LED, visible red light, Class 2
- Scanning distance adjustment by Teach-in function
- Programmable background or foreground suppression
- Programmable output: light/dark switching
- Numeric display with menu prompts

Dimensional drawing

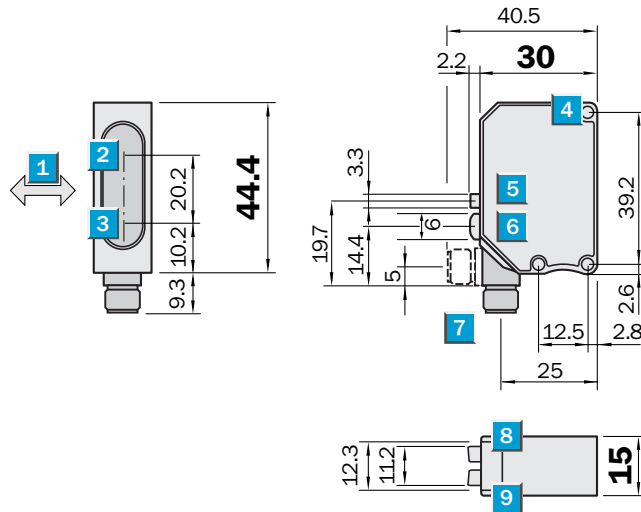

Adjustments possible

All types

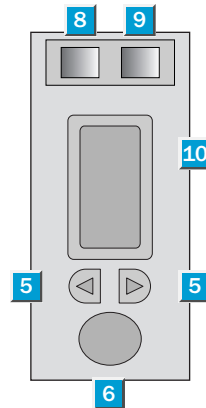

- 1 Standard direction of the material being scanned
- 2 Centre of optical axis, sender
- 3 Centre of optical axis, receiver
- 4 Mounting holes, Ø approx. 3.1 mm
- 5 +/- button; select mode button
- 6 Teach-in button
- 7 Plug 4-pin, M8, 90° rotatable or cable 2 m, 4-wire
- 8 Status indicator LED, green: Laser on
- 9 Status indicator LED, yellow: output active
- 10 Numerical display

Connection types

WTB 190TL-P 132	WTB 190TL-P 430
WTB 190TL-N 132	WTB 190TL-N 430

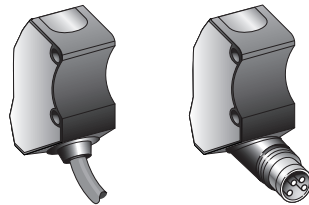

4 x 0.18 mm²

4-pin, M8

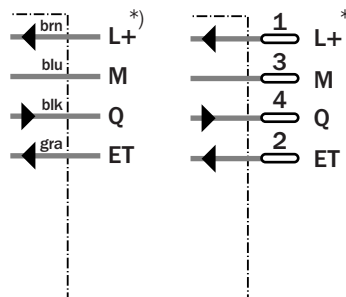

*) Adjustment via External Teach (ET)

PNP → L+

NPN → M



CE III CDRH
Accession Number
0 31 22 45

Laser class 2



See chapter Accessories

Cables and connectors

Mounting systems

Technical data		WTB 190TL-	P 132	P 430	N 132	N 430
Scanning distance, adjustable	40 ... 100 mm ¹⁾					
Device function mode	BGS ²⁾ or FGS ³⁾ , programmable					
Scanning distance, adjustable	Teach-in, External Teach (ET)					
	Teach-in via button, menu guided					
Threshold, precise setting	Manually adjustable					
Light source⁴⁾	Laser, red light; class 2					
Light spot diameter	0.8 mm at distance of 80 mm					
Supply voltage V_S	10 ... 30 V DC ⁵⁾					
Ripple ⁶⁾	± 10 %					
Current consumption ⁷⁾	Max. 40 mA					
Switching outputs	PNP					
	NPN					
Output current I _A max.	< 100 mA					
Switching type	Light-/dark-switching, programmable					
Response time ⁸⁾	1.5 ms					
Switching frequency max. ⁹⁾	300/s					
Timer mode (dLY)	0 ... 10 s, programmable					
Timer function	Nor: normal Mode					
	OnD: On Delay Mode, on delay					
	OFd: Off Delay Mode, off delay					
	OnE: One Shot Mode, one shot					
Numerical display monitoring	Threshold, distance, mode selection					
Connection types Cable	4-wire ¹⁰⁾					
Plug	4-pin, M8					
VDE protection class¹¹⁾	⚡					
Circuit protection¹²⁾	A, B					
Enclosure rating	IP 67					
Ambient temperature	Operation -10 ... +40 °C					
	Storage -20 ... +60 °C					
Weight	With cable 2 m approx. 200 g					
	With plug approx. 120 g					
Housing material	Housing: ABS; optic: PMMA					

1) Object with 90 % reflectance (with reference to standard white according to DIN 5033)
 2) Background suppression
 3) Foreground suppression

4) Average service life 50,000 h at T_A = +25 °C
 5) Limit values
 6) Must be within V_S tolerances
 7) Without load

8) With resistive load
 9) With light/dark ratio 1:1
 10) Do not bend below 0 °C
 11) Reference voltage 50 V DC

12) A = V_S connections reverse-polarity protected
 B = Output Q short-circuit protected

Scanning distance

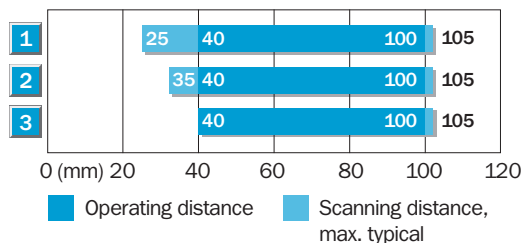

- 1 Scanning range on white, 90 % remission
- 2 Scanning range on grey, 18 % remission
- 3 Scanning range on black, 6 % remission

Light spot diameter

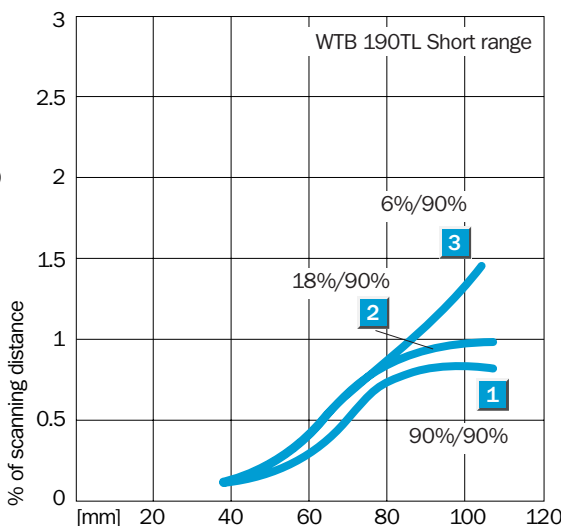
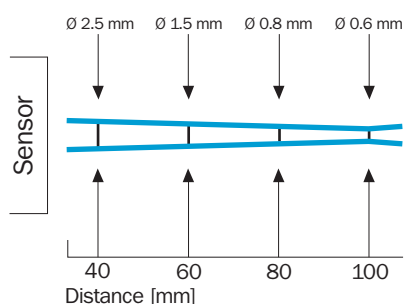

Order information*)

Type	Order no.
WTB 190TL-P 132	6 026 541
WTB 190TL-P 430	6 026 542
WTB 190TL-N 132	6 026 539
WTB 190TL-N 430	6 026 540

*) Equipment model with 5 m PVC cable or M8 plug, 3-pin on request

Scanning range
0.01 ... 5.5 m

Photoelectric reflex switches

- Laser LED, visible red light, Class 2
- Sensitivity setting by Teach-in
- Precision auto-collimated optics
- Programmable output: light/dark switching
- Numeric display with menu prompts

Dimensional drawing

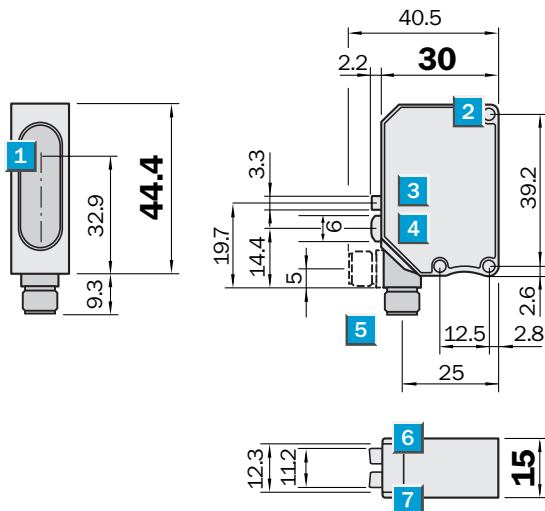

Adjustments possible

All types

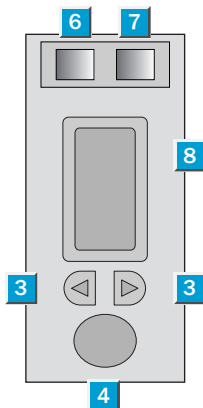

- 1 Centre of optical axis
- 2 Mounting holes, Ø approx. 3.1 mm
- 3 +/- button; select mode button
- 4 Teach-in button
- 5 Plug 4-pin, M8, 90° rotatable or cable 2 m, 4-wire
- 6 Status indicator LED, green: Laser on
- 7 Status indicator LED, yellow: output active
- 8 Numerical display

Connection types

WLG 190T-P 112	WLG 190T-P 410
WLG 190T-N 112	WLG 190T-N 410

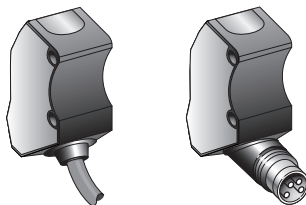

4 x 0.18 mm ²	4-pin, M8
--------------------------	-----------

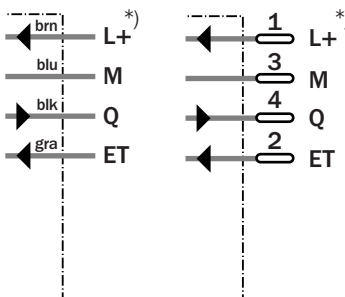

*) Sensitivity control via External Teach (ET)

PNP → L+

NPN → M



CE III CDRH
Accession Number
0 31 22 45

Laser class 2



See chapter Accessories

Cables and connectors

Mounting systems

Reflectors

Technical data		WLG 190T-	P 112	P 410	N 112	N 410
Scanning range , max. typ. on reflector ¹⁾	0.01 ... 5.5 m/P 250 F, adjustable					
Sensitivity control	Teach-in, External Teach (ET) Teach-in via button, menu guided					
Fine adjustment	Manually adjustable					
Light source ²⁾	Laser, red light; class 2					
Light spot diameter	15 mm at distance of 1 m					
Supply voltage V _S	10 ... 30 V DC ³⁾					
Ripple ⁴⁾	± 10 %					
Current consumption ⁵⁾	Max. 40 mA					
Switching outputs	PNP NPN					
Output current I _A max.	< 100 mA					
Switching type	Light-/dark-switching, programmable					
Response time ⁶⁾	0.7; 2; 5 ms, programmable					
Switching frequency max. ⁷⁾	700; 200; 100/s, programmable					
Timer mode (dLY)	0 ... 10 s, programmable					
Timer function	Nor: normal Mode Ond: On Delay Mode, on delay OFd: Off Delay Mode, off delay OnE: One Shot Mode, one shot					
Numerical display monitoring	Transmission, remission, threshold, distance, mode selection					
Connection types Cable	4-wire ⁸⁾					
Plug	4-pin, M8					
VDE protection class ⁹⁾	⚡					
Circuit protection ¹⁰⁾	A, B					
Enclosure rating	IP 67					
Ambient temperature	Operation -10 ... +40 °C Storage -20 ... +60 °C					
Weight	With cable 2 m approx. 200 g With plug approx. 120 g					
Housing material	Housing: ABS; optic: PMMA					

1) Reflector P 250 F included with delivery
2) Average service life 50,000 h at T_A = + 25 °C
3) Limit values

4) Must be within V_S tolerances
5) Without load
6) With resistive load

7) With light/dark ratio 1:1
8) Do not bend below 0 °C
9) Reference voltage 50 V DC

10) A = V_S connections reverse-polarity protected
B = Output Q short-circuit protected

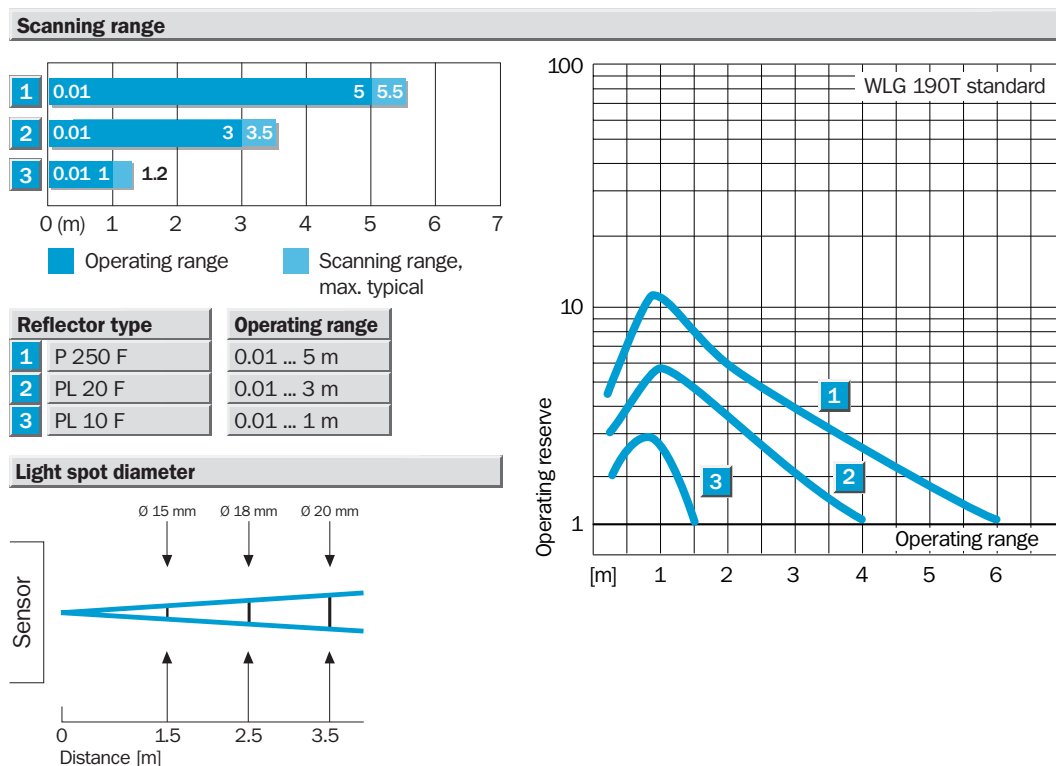

Order information *)

Type	Order no.
WLG 190T-P 112	6 026 537
WLG 190T-P 410	6 026 538
WLG 190T-N 112	6 026 535
WLG 190T-N 410	6 026 536

*) Equipment model with 5 m PVC cable or M8 plug, 3-pin on request

Scanning range
0.01 ... 1.8 m

Photoelectric reflex switches

- Laser LED, visible red light, Class 2
- Sensitivity setting by Teach-in
- Precision auto-collimated optics
- Programmable output: light/dark switching
- Numeric display with menu prompts

Dimensional drawing

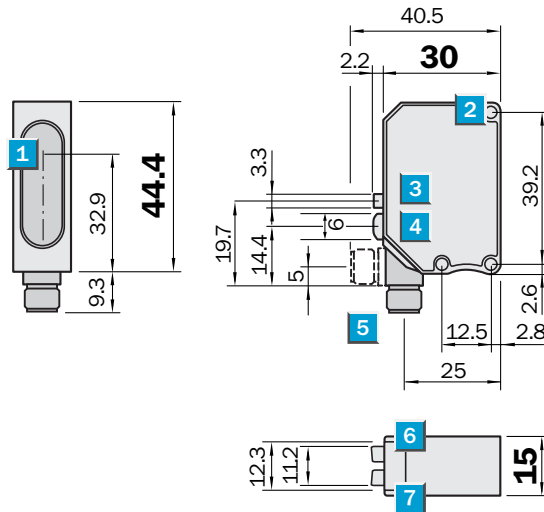

Adjustments possible

All types

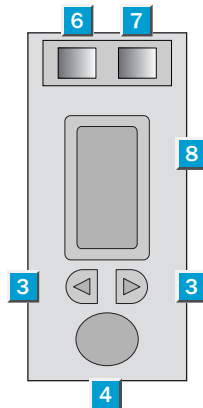

- 1 Centre of optical axis
- 2 Mounting holes, Ø approx. 3.1 mm
- 3 +/- button; select mode button
- 4 Teach-in button
- 5 Plug 4-pin, M8, 90° rotatable or cable 2 m, 4-wire
- 6 Status indicator LED, green: Laser on
- 7 Status indicator LED, yellow: output active
- 8 Numerical display

Connection types

WLG 190T-P 122	WLG 190T-P 420
WLG 190T-N 122	WLG 190T-N 420

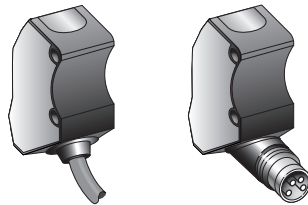

4 x 0.18 mm²

4-pin, M8

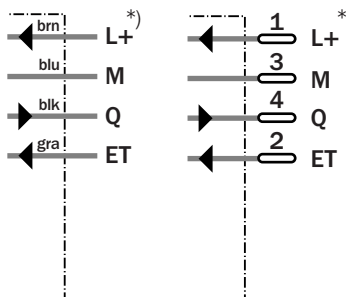

*) Sensitivity control via External Teach (ET)

PNP → L+

NPN → M



CE III CDRH
Accession Number
0 31 22 45



See chapter Accessories

Cables and connectors

Mounting systems

Reflectors

Technical data		WLG 190T-	P 122	P 420	N 122	N 420
Scanning range , max. typ. on reflector ¹⁾	0.01 ... 1.8 m/PL 80 A, adjustable					
Scanning range , max. typ. on reflector ¹⁾	0.01 ... 1.2 m/P 250, adjustable					
Sensitivity control	Teach-in, External Teach (ET) Teach-in via button, menu guided					
Fine adjustment	Manually adjustable					
Light source ²⁾	Laser, red light; class 2					
Light spot diameter	15 mm at distance of 1 m					
Supply voltage V _S	10 ... 30 V DC ³⁾					
Ripple ⁴⁾	± 10 %					
Current consumption ⁵⁾	Max. 40 mA					
Switching outputs	PNP NPN					
Output current I _A max.	< 100 mA					
Switching type	Light-/dark-switching, programmable					
Response time ⁶⁾	0.7; 2; 5 ms, programmable					
Switching frequency max. ⁷⁾	700; 200; 100/s					
Timer mode (dLY)	0 ... 10 s, programmable					
Timer function	Nor: normal Mode Ond: On Delay Mode, on delay OFd: Off Delay Mode, off delay OnE: One Shot Mode, one shot					
Numerical display monitoring	Transmission, remission, threshold, distance, mode selection					
Connection types Cable	4-wire ⁸⁾					
Plug	4-pin, M8					
VDE protection class ⁹⁾	⚡					
Circuit protection ¹⁰⁾	A, B					
Enclosure rating	IP 67					
Ambient temperature	Operation -10 ... +40 °C Storage -20 ... +60 °C					
Weight	With cable 2 m approx. 200 g With plug approx. 120 g					
Housing material	Housing: ABS; optic: PMMA					

- 1) Reflector P 250 included with delivery
- 2) Average service life 50,000 h at T_A = + 25 °C
- 3) Limit values
- 4) Must be within V_S tolerances
- 5) Without load
- 6) With resistive load
- 7) With light/dark ratio 1:1
- 8) Do not bend below 0 °C
- 9) Reference voltage 50 V DC
- 10) A = V_S connections reverse-polarity protected
B = Output Q short-circuit protected

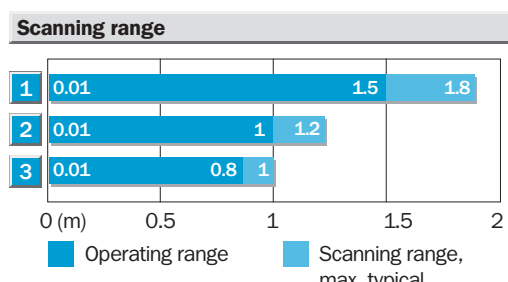

Reflector type	Operating range
1 PL 80 A	0.01 ... 1.5 m
2 P 250/PL 40 A/PL 50 A	0.01 ... 1 m
3 PL 30 A/PL 31 A	0.01 ... 0.8 m

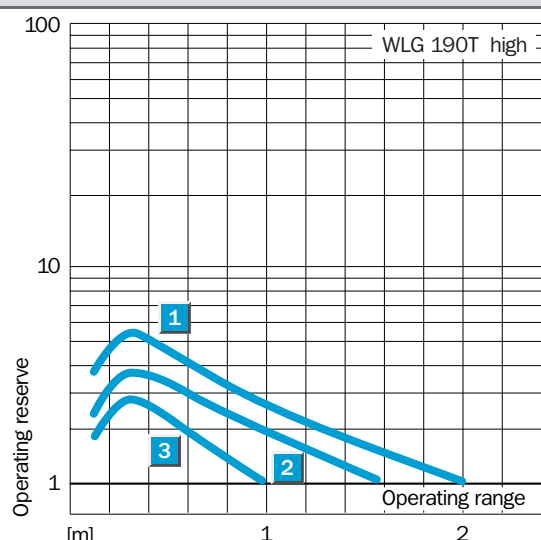
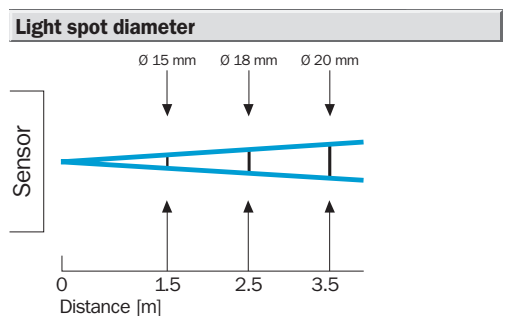

Order information *)

Type	Order no.
WLG 190T-P 122	6 022 827
WLG 190T-P 420	6 022 830
WLG 190T-N 122	6 022 823
WLG 190T-N 420	6 022 826

*) Equipment model with 5 m PVC cable or M8 plug, 3-pin on request

W 12 L-2: Laser photoelectric switches – long-sighted, certainly, and no need for extra safety precautions

	Photoelectric proximity switches, BGS
	Photoelectric reflex switches
	Through-beam photoelectric switches



All the devices in this series are particularly "long-sighted": the WS/WE 12 L-2 through-beam photoelectric switch covers distances up to 80 m, while the WL 12 L-2 reflex photoelectric switch can reach up to 18 m. Their integrated polarisation filter makes it possible to reliably detect shiny surfaces. The WT 12 L-2 photoelectric proximity switch also covers a relatively long range: it is the right choice for scanning fixed distances of 20...50 mm, or offers precise background suppression that can be adjusted between 30 and 200 mm.

The W 12 L-2 series offers a complete range of photoelectric switches using innovative laser technology, contained in a rugged metal housing. Pulsed lasers are used to transmit light. Because they have in protection class 2, the machine operator does not need to take any extra safety or protective measures when using the sensors.

In addition to the scanning range, the small dimensions of the light spot generated on the object is a further advantage of laser technology. This makes it possible to detect even minute items of just 0.5 mm at maximum switching frequencies of 2,500/s.

W 12 L-2 laser photoelectric switches – the best solution for millimetre precision, or even smaller!

► The laser photoelectric proximity switch detects minimal differences in height, such as overlapping metal sheets, during continuous metal production processes.

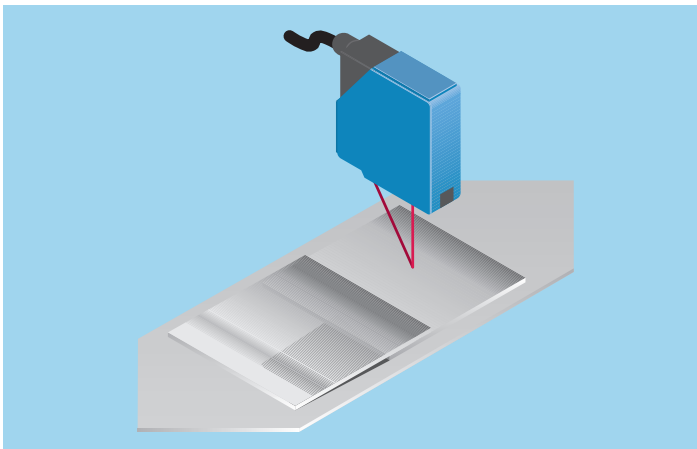

► The W 12 L-2 with laser technology detects the smallest electronic components with precision even at high switching frequencies.

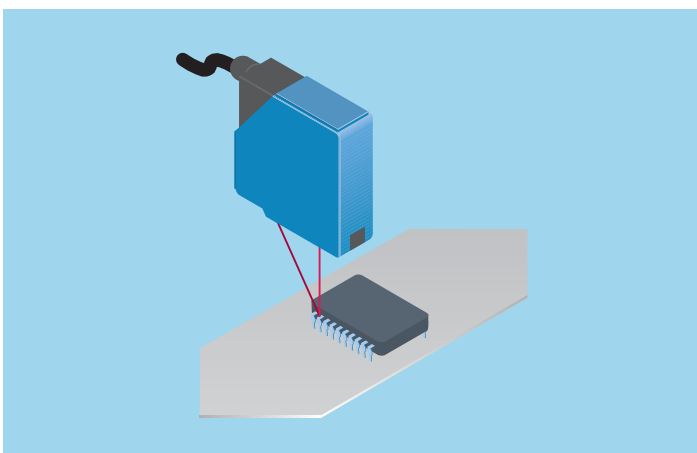

▼ Moulded sheet-metal parts used for the production of automobiles are detected with millimetre accuracy by WL 12 L-2 laser photoelectric switches so they can then be picked up and mounted with precision by a robot.

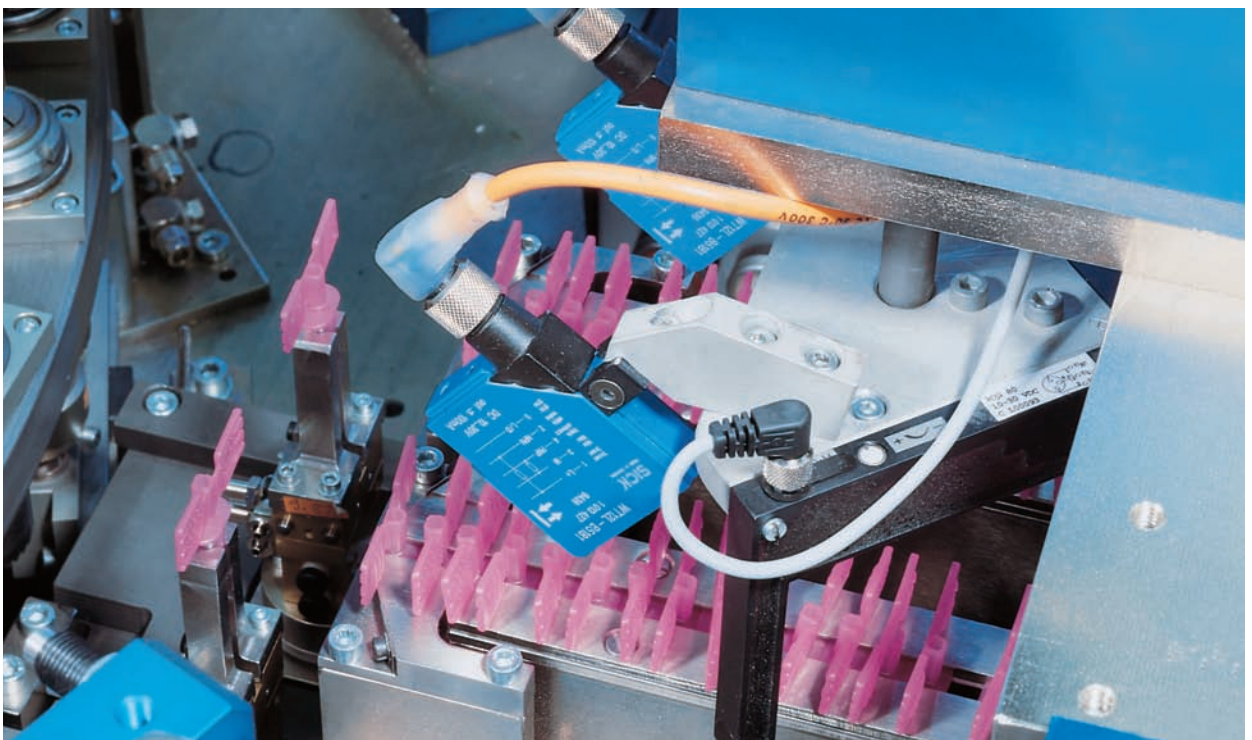

▲ Thanks to their small light spot, laser sensors such as the WT 12 L-2 photoelectric proximity switch can also reliably detect the smallest objects such as packaging units in the pharmaceutical industry.

Scanning distance
30 ... 200 mm
Photoelectric proximity switches

- Laser class 2
- 90° rotatable M12 plug
- Adjustable and fixed background suppression

Dimensional drawing

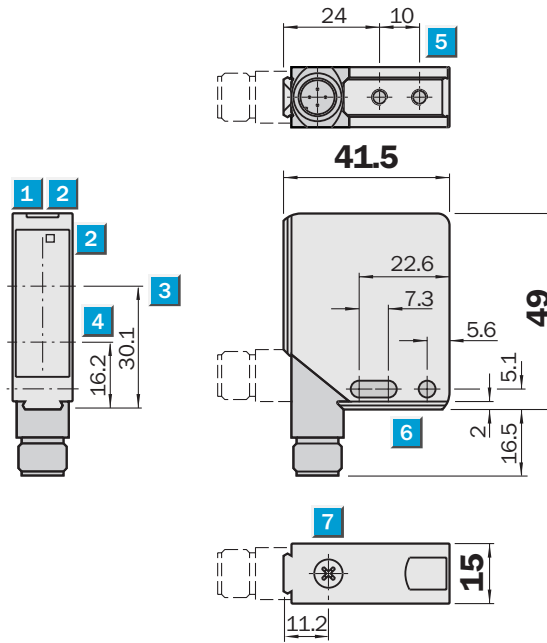

Adjustments possible

- WT 12L-2B 510*
- WT 12L-2B 530
- WT 12L-2B 540
- WT 12L-2B 550

- 1 LED operating indicator, green
- 2 LED reception indicator, yellow
- 3 Optical axis, receiver
- 4 Optical axis, sender
- 5 M4 threaded mounting hole – 4 mm deep
- 6 Mounting hole \varnothing 4.2 mm
- 7 Scanning distance control
* (not for fixed scanning distances)

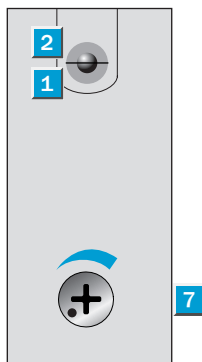

Connection type

- WT 12L-2B 510
- WT 12L-2B 530
- WT 12L-2B 540
- WT 12L-2B 550

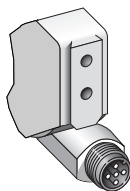

5-pin, M12

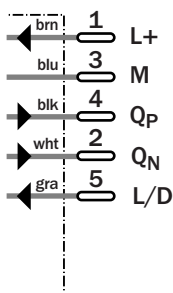

See chapter Accessories

Mounting systems

Technical data		WT 12L-2	B510	B530	B540	B550							
Scanning distance, adjustable	30...200 mm, 18 % remission												
	Focus 45 mm												
	Focus 80 mm												
	Focus 100 mm												
Scanning range, fixed, 6 % remission	20... 50 mm, focus 45 mm												
Light source¹⁾	Laser 650 nm, pulsed												
Light spot diameter focal point	0.1 mm												
	0.2 mm												
Supply voltage V_S	10...30 V DC ²⁾												
Ripple ³⁾	$\leq 5 V_{SS}$												
Current consumption ⁴⁾	≤ 55 mA												
Switching output Q_N and Q_P	PNP, NPN												
Signal voltage HIGH	$V_S - < 2$ V, V_S												
Signal voltage LOW ⁵⁾	0 V, ≤ 1.5 V												
Output current I_A max.	100 mA												
Operating mode	Light- or dark-switching ⁶⁾												
Control input L/D	0 V or open, light-switching												
Control input L/D	V_S , dark-switching												
Response time max. ⁷⁾	Typ. 200 μ s												
Max. switching frequency ⁸⁾	2500/s												
Laser class	2 (IEC 825-1; EN 60825-1:97)												
VDE protection class⁹⁾	<input type="checkbox"/>												
Enclosure rating	IP 67, IP 69K												
Circuit protection¹⁰⁾	A, B, C												
Ambient temperature T_A	Operation -10 °C...+ 50 °C												
	Storage -25 °C...+ 75 °C												
Connection type	M12 plug, 5-pin												
Weight	Approx. 130 g with plug												

1) Average service life 50,000 h at $T_A = +25$ °C
 2) Limit values

3) May not exceed or fall short of V_S tolerances
 4) Without load
 5) At $T_A = +25$ °C and 100 mA output current

6) Reversible via control input L/D
 7) Signal transit time with resistive load
 8) At light/dark ratio 1:1
 9) Reference voltage 50 V DC

10) A = V_S connections reverse-polarity protected
 B = Outputs protected against short-circuiting
 C = Interference pulse suppression

Scanning distance and light spot size

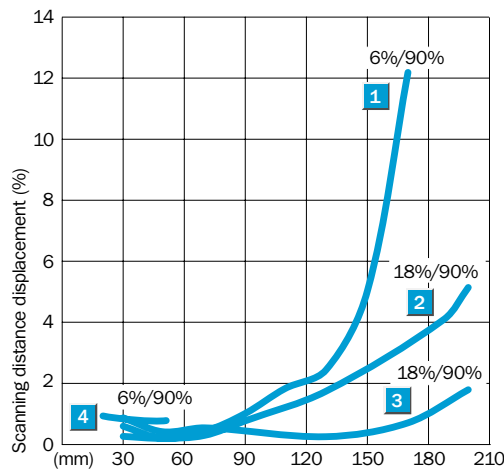
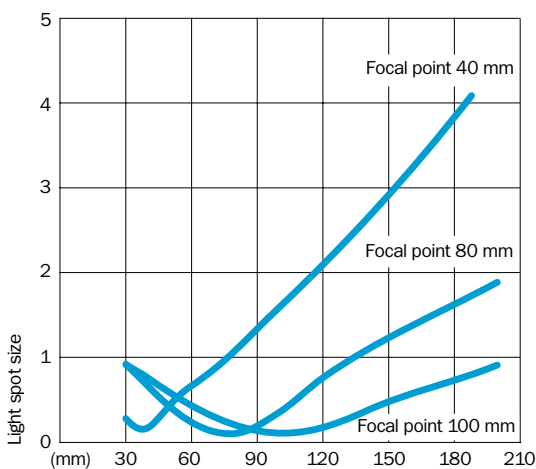

Order information

Type	Order no.
WT 12L-2B 510	1 017 959
WT 12L-2B 530	1 018 250
WT 12L-2B 540	1 018 251
WT 12L-2B 550	1 017 904

1	30	170
2	30	200
3	30	200
4	20	50

1	Scanning distance on black, 6 % remission
2	Scanning distance on grey, 18 % remission
3	Scanning distance on white, 90 % remission
4	Scanning distance on black, 6 % remission, fixed

Scanning range
18 m
 Reflexions-Lichtschranke

- Laser class 2
- Adjustable focus and sensitivity
- 90° rotatable M12 plug



Dimensional drawing

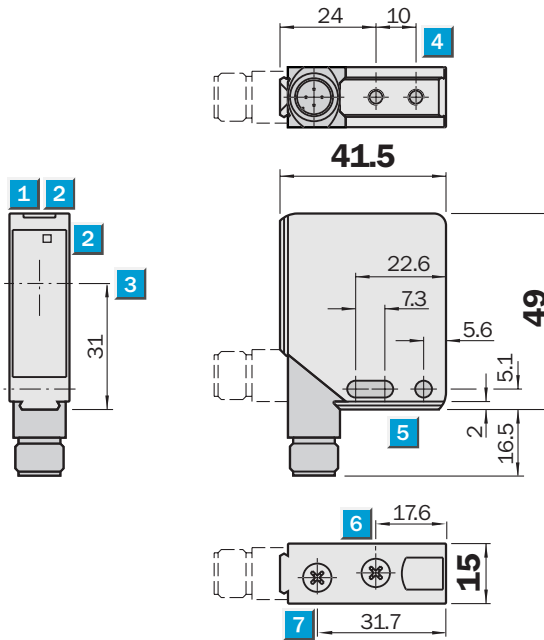

Adjustments possible

- WL 12L-2B 530
- WL 12L-2B 520

- 1 LED operating indicator, green
- 2 LED reception indicator, yellow
- 3 Centre of optical axis
- 4 M4 threaded mounting hole – 4 mm deep
- 5 Mounting hole \varnothing 4.2 mm
- 6 Focal adjustment
- 7 Sensitivity adjustment

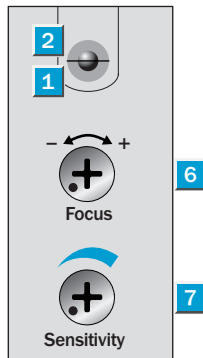

Connection type

- WL 12L-2B 530
- WL 12L-2B 520

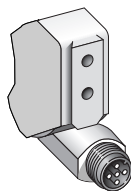

5-pin, M12

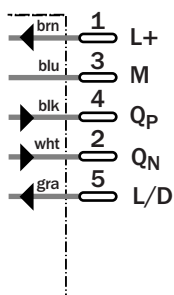

See chapter Accessories

- Cables and connectors
- Mounting systems
- Reflectors

Technical data		WL 12L-2	B530	B520								
Scanning range,	18 m/PL 80 A											
max. typical/on reflector	15 m/PL 80 A											
Light source¹⁾	Laser 650 nm, pulsed											
Light spot diameter	min. 0.8 mm											
in focal range	300 mm to ∞											
	150 mm to 450 mm											
Supply voltage V_S	10...30 V DC ²⁾											
Ripple ³⁾	≤ 5 V _{SS}											
Current consumption ⁴⁾	≤ 55 mA											
Switching output Q_N and Q_P	PNP, NPN											
Signal voltage HIGH	V _S - < 2.9 V, V _S											
Signal voltage LOW ⁵⁾	0 V, ≤ 1.5 V											
Output current I _A max.	100 mA											
Operating mode	Light- or dark-switching ⁶⁾											
Control input L/D	0 V or open, light-switching											
Control input L/D	V _S , dark-switching											
Response time max. ⁷⁾	Typ. 200 μs											
Max. switching frequency ⁸⁾	2500/s											
Laser class	2 (IEC 825-1; EN 60825-1:97)											
VDE protection class⁹⁾	□											
Enclosure rating	IP 67, IP 69K											
Circuit protection¹⁰⁾	A, B, C											
Ambient temperature T_A	Operation - 10 °C...+ 50 °C											
	Storage - 25 °C...+ 75 °C											
Connection type	M12 plug, 5-pin											
Weight	Approx. 130 g with plug											

1) Average service life 50,000 h at T_A = + 25 °C
2) Limit values

3) May not exceed or fall short of V_S tolerances
4) Without load
5) At T_A = + 25 °C and 100 mA output current

6) Reversible via control input L/D
7) Signal transit time with resistive load
8) At light/dark ratio 1:1
9) Reference voltage 50 V DC

10) A = V_S connections reverse-polarity protected
B = Outputs protected against short-circuiting
C = Interference pulse suppression

Scanning range and operating reserve

WL 12L-2 B530

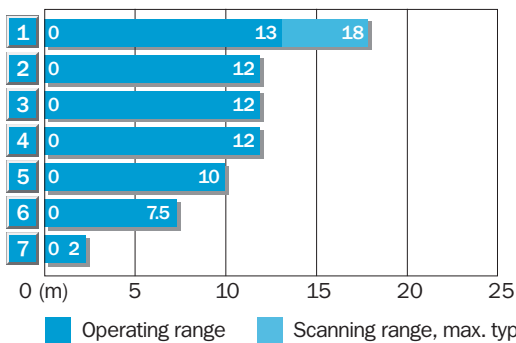

Reflector type	Operating range
1	PL 80 A 0 ... 13.0 m
2	PL 50 A 0 ... 12.0 m
3	PL 40 A 0 ... 12.0 m
4	P 250 0 ... 12.0 m
5	PL 30 A 0 ... 10.0 m
6	PL 20 A 0 ... 7.5 m
7	Reflective tape «Diamond Grade» 0 ... 2.0 m

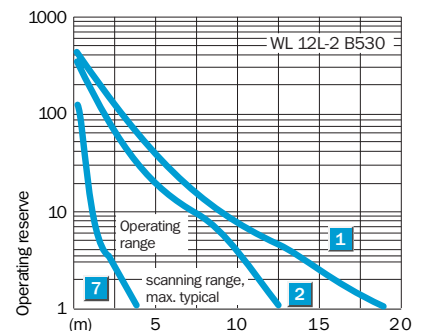

WL 12L-2 B520

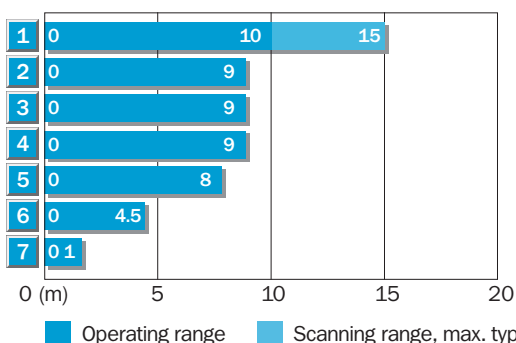

Reflector type	Operating range
1	PL 80 A 0 ... 10.0 m
2	PL 50 A 0 ... 9.0 m
3	PL 40 A 0 ... 9.0 m
4	P 250 0 ... 9.0 m
5	PL 30 A 0 ... 8.0 m
6	PL 20 A 0 ... 4.5 m
7	Reflective tape «Diamond Grade» 0 ... 1.0 m

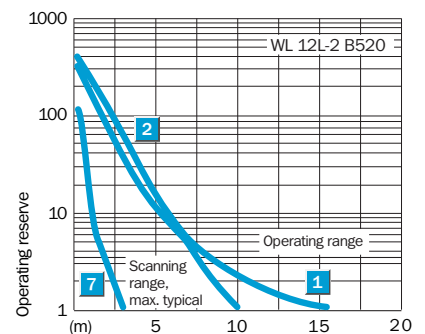

Order information

Type	Order no.
WL 12L-2B 530	1 018 252
WL 12L-2B 520	1 018 253

Scanning range
80 m

Through-beam photoelectric switches

- Laser class 2
- Adjustable focus and sensitivity
- 90° rotatable M12 plug

Dimensional drawing

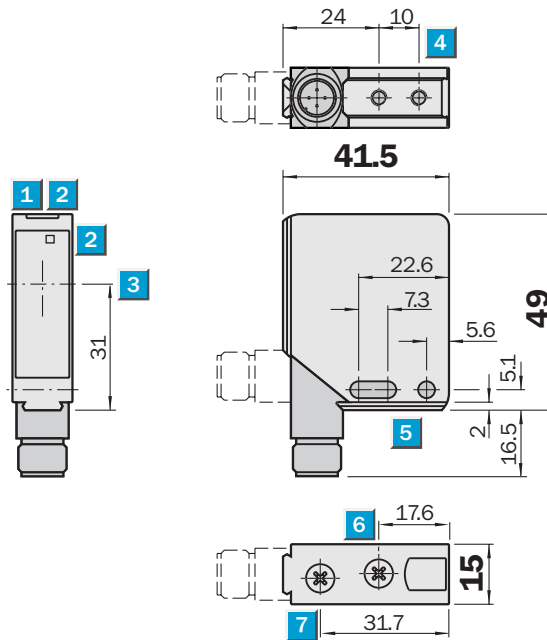

Adjustments possible

WS/WE 12L-2P430	WS/WE 12L-2P410
WS/WE 12L-2N430	WS/WE 12L-2N410

Sender WS

Receiver WE

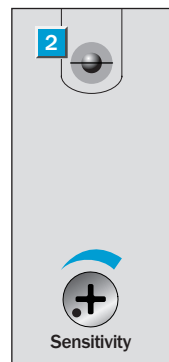
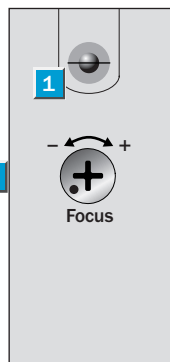

- LED operating indicator (WS above only)
- LED reception indicator (WE)
- Centre of optical axis
- M4 threaded mounting hole – 4 mm deep
- Mounting drill hole \varnothing 4.2 mm
- Focal adjustment (WS)
- Sensitivity adjustment (WE)



CE CDRH



ECOLAB®

Connection type

WS/WE 12L-2P430	WS/WE 12L-2P410
WS/WE 12L-2N430	WS/WE 12L-2N410

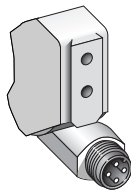

4-pin, M12

See chapter Accessories

- Cables and connectors
- Mounting systems

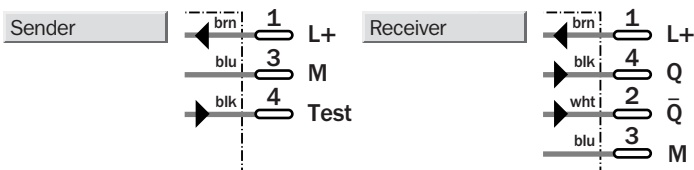

Technical data		WS/WE 12L-2	P430	N430	P410	N410						
Scanning range, max. typical	80 m											
	10 m											
Recommended operating range	80 m											
	10 m											
Focus adjustable	300 mm...∞											
	Fixed parallel light beam											
Light source ¹⁾	Laser 650 nm, pulsed											
Light spot diameter	150 mm at 60 m											
	1.0 mm at 1 m											
Supply voltage V_S	10...30 V DC ²⁾											
Ripple ³⁾	$\leq 5 V_{SS}$											
Current consumption ⁴⁾	WS ≤ 45 mA, WE ≤ 15 mA											
Switching outputs Q and \bar{Q}	PNP											
	NPN											
Signal voltage HIGH	$V_S - < 2.9 V, V_S$											
Signal voltage LOW ⁵⁾	Approx. 0 V, $\leq 1.5 V$											
Output current I_A max.	100 mA											
Response time max. ⁶⁾	Typ. 200 μ s											
Max. switching frequency ⁷⁾	2500/s											
Input "TE" system test	V_S or open: sender active											
	0 V: sender inactive											
VDE protection class ⁸⁾	<input type="checkbox"/>											
Laser class	2 (IEC 825-1; EN 60825-1:97)											
Enclosure rating	IP 67, IP 69K											
Circuit protection ⁹⁾	A, B, C											
Ambient temperature T_A	Operation -10 °C... $+50$ °C											
	Storage -25 °C... $+75$ °C											
Connection type	M12 plug, 4-pin											
Weight (WS + WE)	Approx. 260 g											

1) Average service life 50,000 h at $T_A = +25$ °C
 2) Limit values
 3) May not exceed or fall short of V_S tolerances

4) Without load
 5) At $T_A = +25$ °C and 100 mA output current
 6) Signal transit time with resistive load
 7) At light/dark ratio 1:1

8) Reference voltage 50 V DC
 9) A = V_S connections reverse-polarity protected
 B = Outputs protected against short-circuiting
 C = Interference pulse suppression

Scanning range

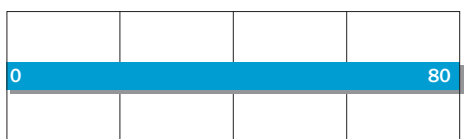

0 (m) 20 40 60 80

Operating range/scanning range, max. typical

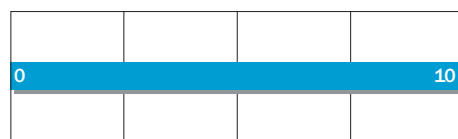

0 (m) 2.5 5 7.5 10



Operating range/scanning range, max. typical

Order information

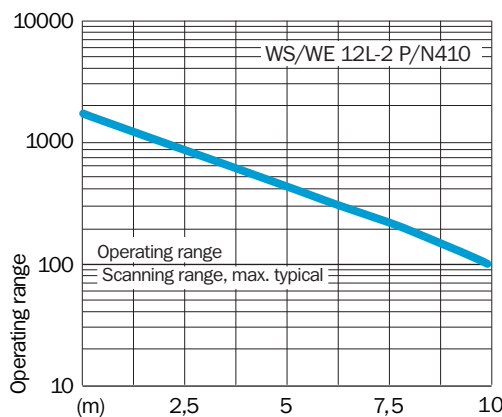
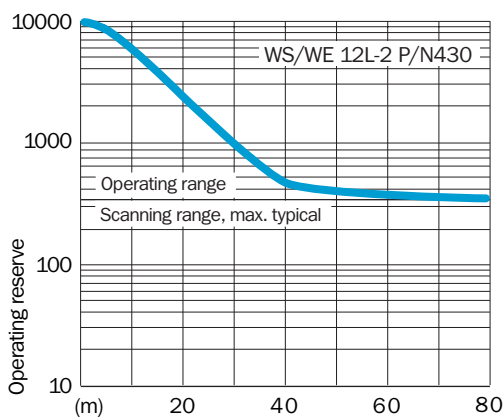
Type	Order no.
WS/WE 12L-2P430	1 018 254
WS/WE 12L-2N430	1 018 255
WS/WE 12L-2P410	1 018 256
WS/WE 12L-2N410	1 018 257



V 18 Laser – No frills performance: long ranges, high speeds with precision

	Photoelectric proximity switches
	Photoelectric reflex switches
	Through-beam photoelectric switches



Laser class 1
(IEC 60825-1)

The photoelectric switch series V 18 L utilising the latest technology laser diodes, allies many years of sensor and applications know-how, with customer oriented features.

The strengths of our V 18 Laser:

- Laser class 1 (IEC 60825-1),
- extremely long ranges,
- smallest, visible light spots,
- very short response times.

The V 18 L and its ranges in overview:

- VSE 18 L through-beam photoelectric switches: 60 m;
- VL 18 L photoelectric reflex switches: 35 m (P 250 F), polarizing filter;

- VTE 18 L photoelectric proximity switches: energetic type, scr. 400 mm (90 % remission).

Additional standard features:

very short response time $f = 800/s$ (1,000/s); manual sensitivity adjustment (VSE 18 L), or Teach-in (VL 18 L and VTE 18 L). The Teach-in provides easy handling and additional flexibility. Select:

- substantial operating reserve for standard applications,
- precise switching point and small hysteresis for special tasks.

High flexibility and functionality is available from a small number of variants as a result of: programmable switching type L.ON or D.ON by control line. $V_S = 10 \dots 30 \text{ V DC}$; switching output Q either in PNP or NPN; M12 plug connector, IP 67 and sturdy metal housing (straight or 90 degree body styles) ...

Yellow and green LED indicators provide support during installation, operation startup, alignment and maintenance.

Whilst the V 18 L is suitable for any general purpose application, it will be of particular interest for applications in mechanical handling and logistics engineering, special mechanical engineering tasks, the packaging industry and conveyor engineering.

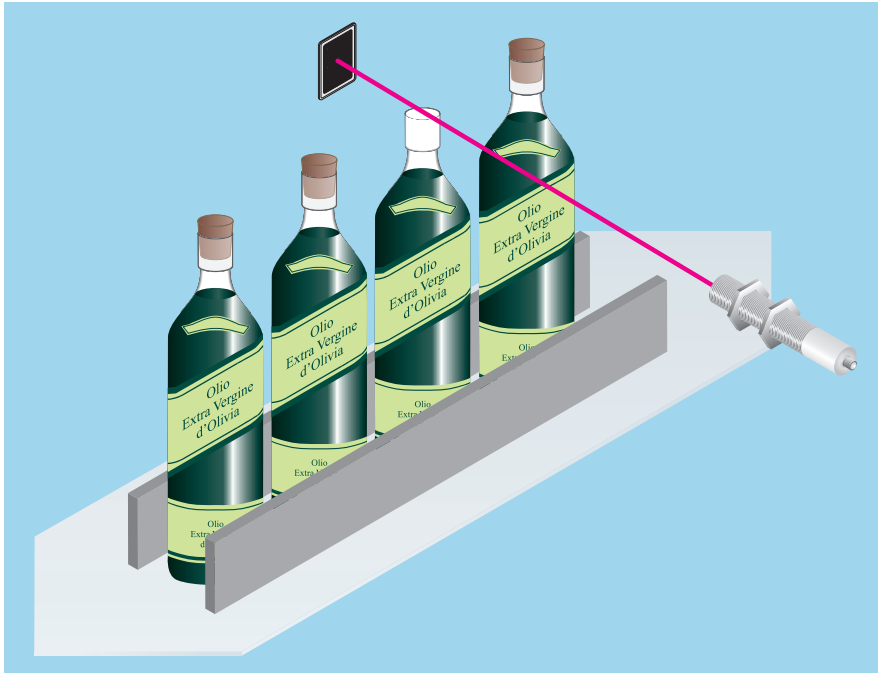

◀ The photoelectric reflex switch VL 18 L checks the presence of cork stoppers.

▶ The photoelectric proximity switch VTE 18 L detects marks and ensures precise positioning of circuit boards.

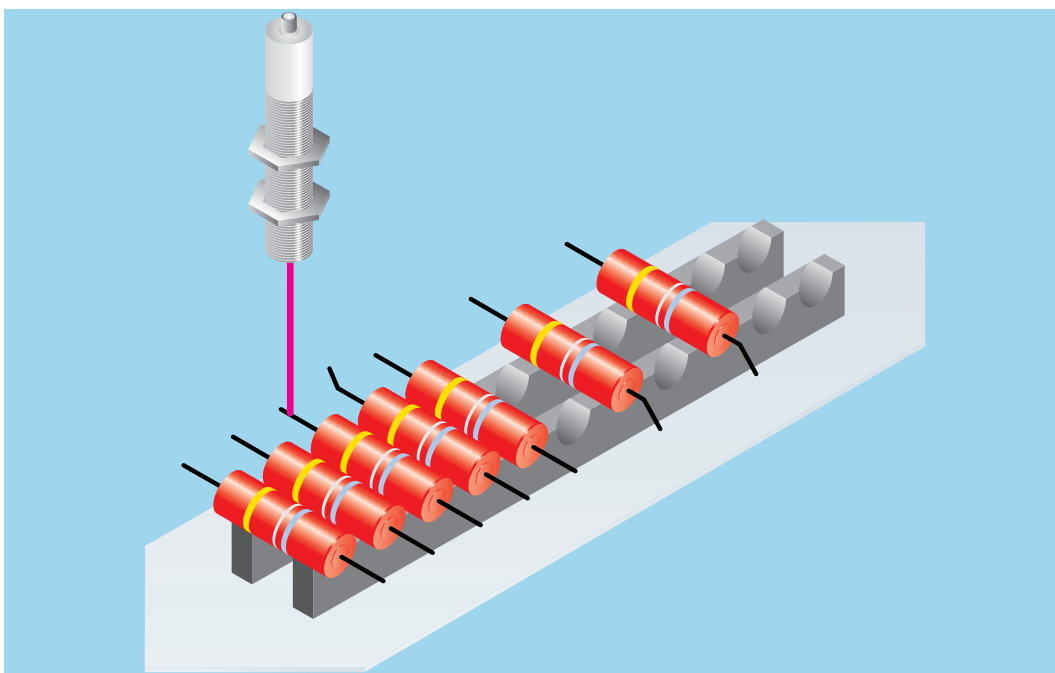
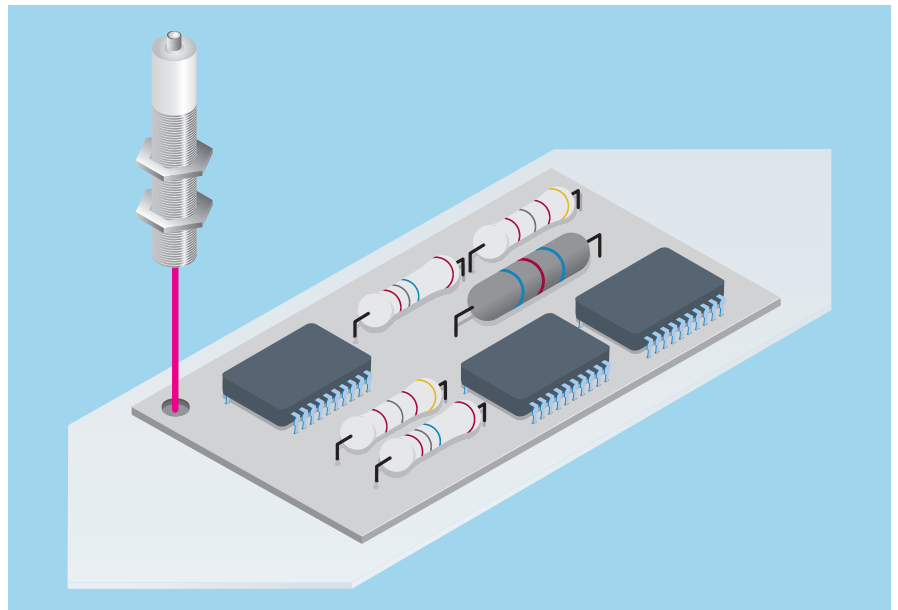

◀ The VTE 18 L detects thin wires on resistors prior to insertion.

	Scanning distance
	0 ... 400 mm
	2 ... 250 mm
Photoelectric proximity switches	

- Detects small parts and switches precisely thank to small laser spot
- Laser class 1
- Adjustable sensitivity

Dimensional drawing

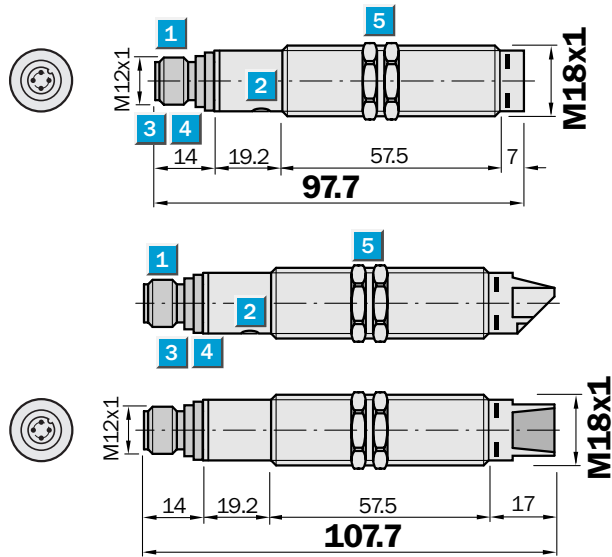

Adjustments possible

VTE 18 L-4P344	VTE 18 L-4P324
VTE 18 L-4N344	VTE 18 L-4N324

- 1** Plug M12, 4-pin
- 2** Sensitivity adjustment (Teach-in button)
- 3** Green LED indicator: V_S supply voltage feed
- 4** Yellow LED indicator:
 - lights continuously: reception signal > reserve factor 2
 - blinks: Reception signal < reserve factor 2 but > switching threshold 1
- 5** Mounting nuts (2x), SW 24, metal (included with delivery)

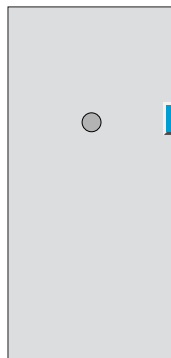

Connection types

VTE 18 L-4P344	VTE 18 L-4P324
VTE 18 L-4N344	VTE 18 L-4N324

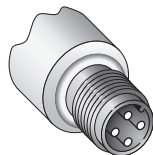

4-pin, M12

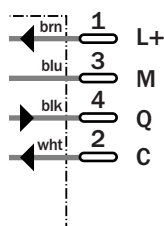

- * Control input C, programming:
- Switching type L.ON/D.ON and External Teach-in
 - C = open (not assigned) light-switching L.ON
 - C = + V_S : dark-switching D.ON
 - C = 0 V: sensitivity setting per "external Teach-in" active



Laser class 1
(IEC 60825-1)

See chapter Accessories

- Cables and connectors
- Mounting systems

Technical data		VTE 18 L-	4P324	4P344	4N324	4N344							
Scanning distance, max. typical ¹⁾	0 ... 400 mm												
	2 ... 250 mm												
Operating distance ¹⁾	5 ... 300 mm												
	5 ... 200 mm												
Minimum object diameter ¹⁾	= Light spot diameter												
Light spot diameter	Approx. 0.1 mm in 100 mm (= Focus)												
	Approx. 5.0 mm in 200 mm												
	Approx. 8.0 mm in 300 mm (only axial)												
Angle of dispersion of sender	Focused, focus at 100 mm												
Light source ²⁾ , Light type	Red laser LED, 650 nm												
Laser class	Laser class 1 (IEC 60825-1)												
Laser sender output capacity	Max. 0.4 mW												
Housing	Axial optics												
	Radial optics												
Sensitivity setting	Manual, per Teach-in button												
	Electronic, per control input C (0 V) ³⁾												
Status indicators	Yellow LED: switching output active, reserve												
	LED green: supply voltage V _S = ON												
Supply voltage V _S	10 ... 30 V DC ⁴⁾												
Ripple ⁵⁾	≤ 10 %												
Current consumption ⁶⁾	≤ 30 mA												
Switching outputs	Q: PNP												
	Q: NPN												
Output current I _A max.	≤ 100 mA												
Switching mode	Light-/Dark-switching selectable ³⁾												
Response time ⁷⁾	≤ 0.625 ms												
Switching frequency max. ⁸⁾	800/s												
Connection types	Plug M12, 4-pin												
VDE protection class ⁹⁾	□												
Enclosure rating	IP 67												
Circuit protection ¹⁰⁾	A, B, C, D												
Ambient temperature	Operation -15 °C ... +55 °C												
	Storage -25 °C ... +70 °C												
Weight with plug	Approx. 60 g												
Housing material	Housing: Nickel-coated brass/PC												
	Optics: PC with protective glass pane												

1) Object to be detected with 90 % emission (to standard white in acc. with DIN 5033); 100 x 100 mm
 2) Average service life 100,000 h at T_A = +25 °C

3) Control input C
 - L.ON/D.ON and
 - external Teach-in
 C = open: light-switching L.ON
 C = + V_S: dark-switching D.ON
 C = 0 V: Sensitivity setting per "external Teach-in"

4) Limit values
 5) May not exceed or fall short of V_S tolerances
 6) Without load
 7) Signal transit time with resistive load
 8) With light/dark ratio 1:1
 9) Reference voltage 50 V

10) A = V_S connections reverse-polarity protected
 B = Inputs and outputs reverse-polarity protected
 C = Interference pulse suppression
 D = Outputs overload and short-circuit protected

VTE 18 L operating diagrams

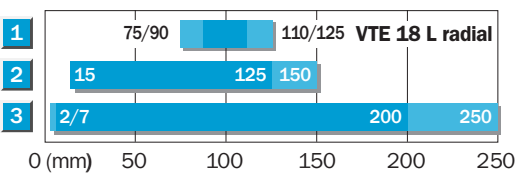
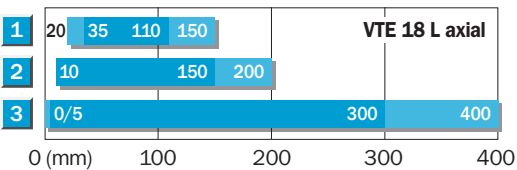

■ Operating distance ■ Scanning distance, max. typ.

1	Scanning distance on black, 6% remission
2	Scanning distance on grey, 18% remission
3	Scanning distance on white, 90% remission

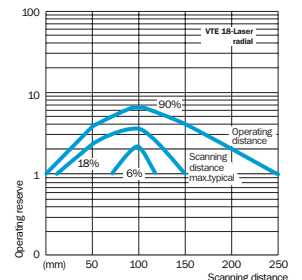
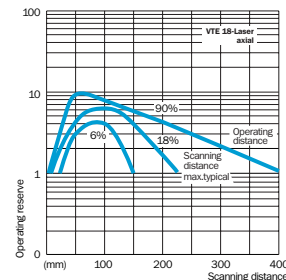
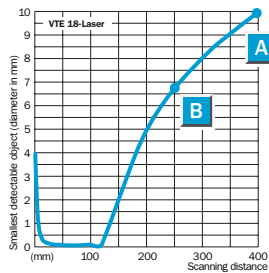

A	Axial optics
B	Radial optics

Order information	
Type	Order no.
VTE 18 L-4P324	6 027 418
VTE 18 L-4N324	6 027 420
VTE 18 L-4P344	6 027 422
VTE 18 L-4N344	6 027 424

Scanning range
 0.1 ... 35 m (P 250F)

Photoelectric reflex switches

- Longest ranges
- Detects small parts and switches precisely thank to small laser spot
- Laser class 1
- A polarisation filter ensures reliable switching even with shiny objects

Dimensional drawing

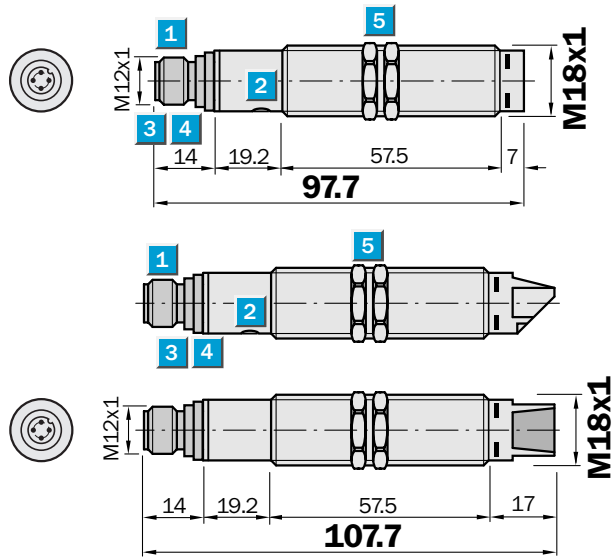

Adjustments possible

VL 18 L-4P344	VL 18 L-4P324
VL 18 L-4N344	VL 18 L-4N324

- 1** Plug M12, 4-pin
- 2** Sensitivity adjustment (Teach-in button)
- 3** Green LED indicator: V_S supply voltage feed
- 4** Yellow LED indicator:
 - lights continuously: reception signal > reserve factor 2
 - blinks: Reception signal < reserve factor 2 but > switching threshold 1
- 5** Mounting nuts (2x), SW 24, metal (included with delivery)

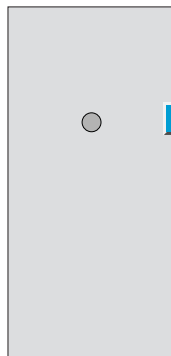

Connection types

VL 18 L-4P344	VL 18 L-4P324
VL 18 L-4N344	VL 18 L-4N324

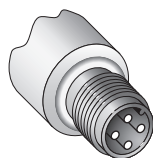

4-pin, M12

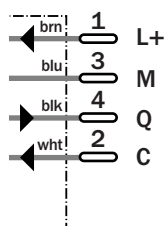

- * Control input C, programming:
- Switching type L.ON/D.ON and
 - External Teach-in
 - C = open (not assigned) dark-switching D.ON
 - C = + V_S : light-switching L.ON
 - C = 0 V: sensitivity setting per "external Teach-in" active



Laser class 1
(IEC 60825-1)

See chapter Accessories

- Cables and connectors
- Mounting systems
- Reflectors

Technical data		VL 18 L-	4P324	4P344	4N324	4N344							
Scanning range , max. typical/Reflector	0.1 m ... 35 m/P 250 F												
Operating range ¹⁾	0.1 m ... 30 m/P 250 F												
Smallest detectable object ¹⁾	Approx. 0.7 mm Ø at 1 m												
	Approx. 25 mm Ø at 35 m												
Light spot diameter	Approx. 9 mm at 35 m												
Angle of dispersion of sender	Approx. 0.04° (SR = max.)												
	Approx. 0.02° (SR = 1/2 max.)												
Light source ²⁾, Light type	Red laser light, 650 nm												
Laser class	Laser class 1 (IEC 60825-1)												
Laser sender output capacity	Max. 0.4 mW												
Housing	Axial optics												
	Radial optics												
Sensitivity setting	Manual, per Teach-in button												
	Electronic, per control input C (0 V) ³⁾												
Status indicators	Yellow LED:												
	Switching output active, reserve												
	LED green: supply voltage V _S = ON												
Supply voltage V_S	10 ... 30 V DC ⁴⁾												
Ripple ⁵⁾	≤ 10 %												
Current consumption ⁶⁾	≤ 20 mA												
Switching outputs	Q: PNP												
	Q: NPN												
Output current I_A max.	≤ 100 mA												
Switching mode	Light-/Dark-switching selectable ³⁾												
Response time ⁷⁾	≤ 0.625 ms												
Switching frequency max. ⁸⁾	800/s												
Connection types	Plug M12, 4-pin												
VDE protection class ⁹⁾	□												
Enclosure rating	IP 67												
Circuit protection ¹⁰⁾	A, B, C, D												
Ambient temperature	Operation -15 °C ... +55 °C												
	Storage -25 °C ... +70 °C												
Weight	with plug												
	Approx. 60 g												
Housing material	Housing: Nickel-coated brass/PC												
	Optics: PC with protective glass pane												

- ¹⁾ Suitable reflectors for laser photoelectric reflex switches: We recommend our "F" reflectors with micro triple structure or DG reflector tape for short distances up to 5 m and our standard reflectors for ranges > 5 m (also see the accessories; reflectors for VL 18 L)
- ²⁾ Average service life 100,000 h at T_A = +25 °C
- ³⁾ Control input C
 - L.ON/D.ON and - external Teach-in
 - C = open: dark-switching D.ON
 - C = + V_S: light-switching L.ON
- C = 0 V: Sensitivity setting per "external Teach-in"
- ⁴⁾ Limit values
- ⁵⁾ May not exceed or fall short of V_S tolerances
- ⁶⁾ Without load
- ⁷⁾ Signal transit time with resistive load
- ⁸⁾ With light/dark ratio 1:1
- ⁹⁾ Reference voltage 50 V
- ¹⁰⁾ A = V_S connections reverse-polarity protected
 B = Inputs and outputs reverse-polarity protected
 C = Interference pulse suppression
 D = Outputs overload and short-circuit protected

Operating range and operating reserve

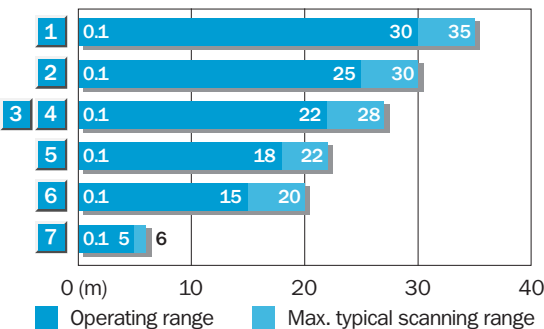

Reflector type	Operating range
1 P 250 F	0.1 – 30 m
2 PL 10 F	0.1 – 25 m
3 4 PL 80 A/P 250	0.1 – 22 m
5 C 110	0.1 – 18 m
6 PL 20 F	0.1 – 15 m
Reflective tape "Diamond Grade"	0.1 – 5 m

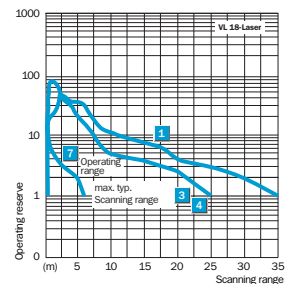
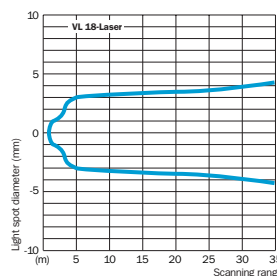
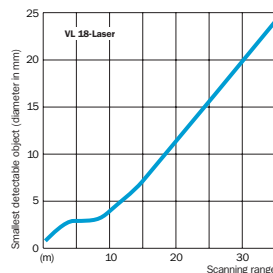

Order information

Type	Order no.
VL 18 L-4P324	6 027 430
VL 18 L-4N324	6 027 432
VL 18 L-4P344	6 027 434
VL 18 L-4N344	6 027 436

Scanning range
0 ... 60 m

Through-beam photoelectric switches

- Longest ranges
- Detects small parts and switches precisely thanks to small laser spot
- Laser class 1
- Optionally (integrated) horizontal and radial optic axes

Dimensional drawing

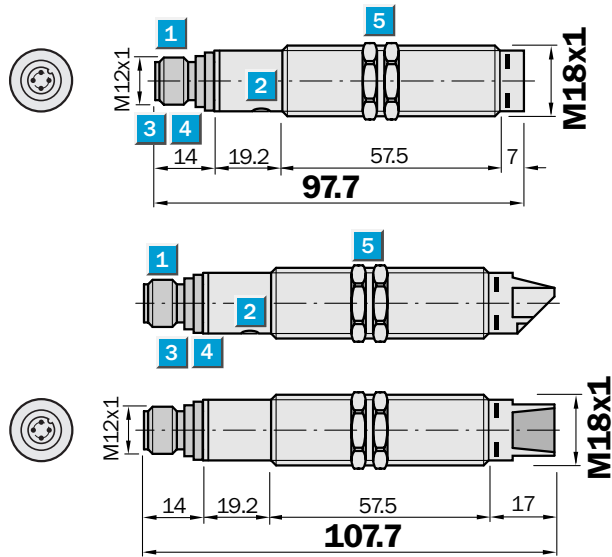

Adjustments possible

VE 18 L-4P324	VE 18 L-4P344
VE 18 L-4N324	VE 18 L-4N344

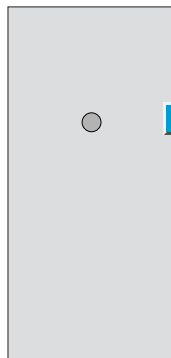

- 1** Plug M12, 4-pin
- 2** Sensitivity adjustment, trimmer 270° (only receiver VE 18 L)
- 3** Green LED indicator: V_S supply voltage feed
- 4** Yellow LED indicator (only receiver VE 18 L),
 - lights continuously: reception signal > reserve factor 2
 - blinks: Reception signal < reserve factor 2 but > switching threshold 1
- Yellow LED indicator (only sender VS 18 L),
 - lights continuously: Sender active
 - does not light: Sender off
- 5** Mounting nuts (2x), SW 24, metal (included with delivery)

Connection types

VS 18 L-0D314	VE 18 L-4P324
VS 18 L-0D334	VE 18 L-4N324
	VE 18 L-4P344
	VE 18 L-4N344

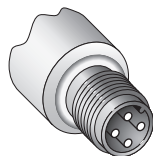

Sender VS	Receiver VE
3-pin, M12	4-pin, M12

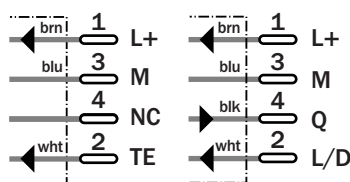

Laser class 1
(IEC 60825-1)

See chapter Accessories

Cables and connectors
Mounting systems

Technical data		VS 18 L-/VE 18 L-	0D314	0D334		4P324	4P344	4N324	4N344			
Scanning range SR, max. typical	0 ... 60 m											
Operating range SR	0 ... 50 m											
Smallest detectable object	Approx. 0.5 mm Ø at 1 m											
	Approx. 0.8 mm Ø at 2 m											
	Approx. 10 mm Ø at 50 m											
Light spot diameter	Approx. 40 mm at 50 m											
Angle of dispersion of sender	Approx. 0.06° (SR = max.)											
	Approx. 0.04° (SR = 1/2max.)											
Receiver reception angle	Approx. 0.08° (SR = max.)											
	Approx. 0.06° (SR = 1/2max.)											
Light source ¹⁾ Light type	Red laser light, 650 nm											
Laser class	Laser class 1 (IEC 60825-1)											
Laser sender output capacity	Max. 0.4 mW											
Housing	Axial optics											
	Radial optics											
Sensitivity setting	Trimmer 270° (only receiver VE 18 L)											
Status indicators	Yellow LED:											
	Switching output/sender active											
	LED green: supply voltage V _S = ON											
Supply voltage V _S	10 ... 30 V DC ²⁾											
Ripple ³⁾	≤ 10 %											
Current consumption ⁴⁾	≤ 25 mA											
Switching outputs	Q: PNP											
	Q: NPN											
Output current I _A max.	≤ 100 mA											
Switching mode	Light-/Dark-switching selectable ⁵⁾											
Response time ⁶⁾	≤ 0.5 ms											
Switching frequency max. ⁷⁾	1000/s											
Test input »TE«	0 V = Sender not active											
Connection types	Plug M12											
VDE protection class ⁸⁾	□											
Enclosure rating	IP 67											
Circuit protection ⁹⁾	A, B, C, D											
Ambient temperature	Operation -15 °C ... +55 °C											
	Storage -25 °C ... +70 °C											
Weight with plug	Approx. 60 g											
Housing material	Housing: Nickel-coated brass/PC											
	Optics: PC with protective glass pane											

¹⁾ Average service life 100,000 h at T_A = +25 °C

²⁾ Limit values

³⁾ May not exceed or fall short of V_S tolerances

⁴⁾ Without load

⁵⁾ L/D switching type control line
L/D = open (not assigned)
dark-switching D.ON
L/D = + V_S: light-switching L.ON
L/D = 0 V: dark-switching D.ON

⁶⁾ Signal transit time with resistive load

⁷⁾ With light/dark ratio 1:1

⁸⁾ Reference voltage 50 V

⁹⁾ A = V_S connections reverse-polarity protected
B = Inputs and output reverse-polarity protected
C = Interference pulse suppression
D = Outputs overload and short-circuit protected

Operating range and operating reserve

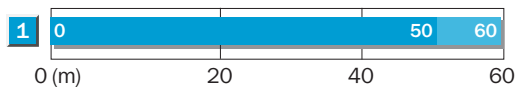

■ Operating range ■ Max. typical scanning range

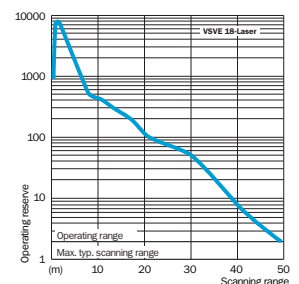
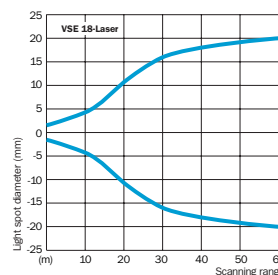

Order information (packaging unit VSE 18 L = VS 18 L + VE 18 L)

Type	Order no.	Type	Order no.
VSE 18 L-4P324	6 027 931	VSE 18 L-4P344	6 027 935
VSE 18 L-4N324	6 027 933	VSE 18 L-4N344	6 027 937