

Automation

Pushbuttons and Pilot Lights - CSW Line

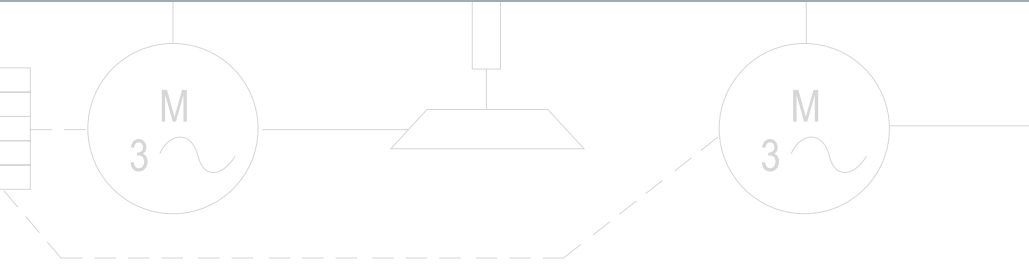

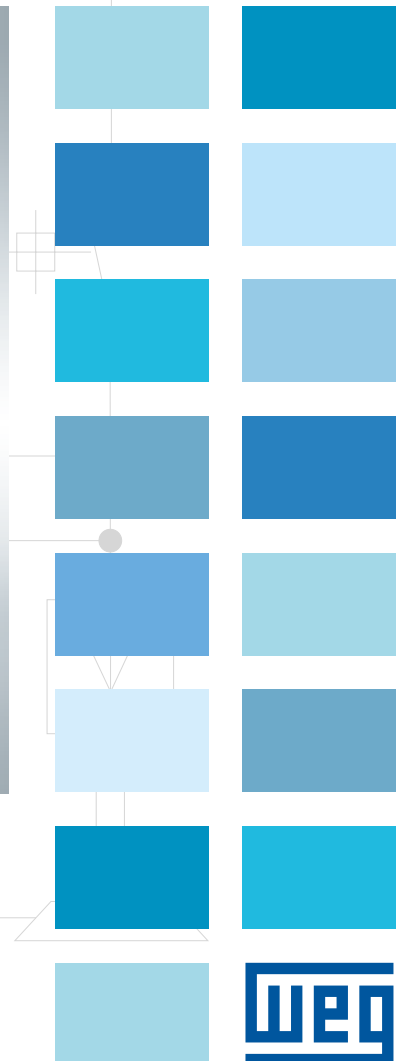
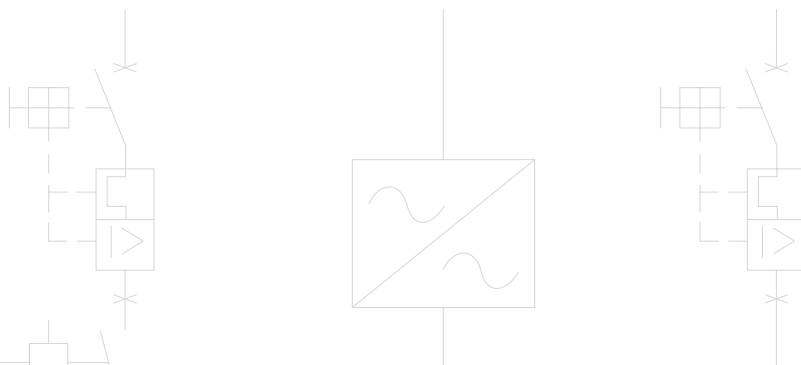

CSW Pushbuttons and Pilot Lights Line

Index

Introduction	04
Pushbuttons and Pilot Lights - CSW Line (Ø22 mm) - IP66	06
Overview	12
Pushbuttons - Ø22 mm - IP66	14
Pushbuttons with Latch - Ø22 mm - IP66	20
Illuminated Pushbuttons - Ø22 mm - IP66	23
Illuminated Pushbuttons - Ø22 mm - IP40	26
Pilot Lights - Ø22 mm - IP66	26
2 Positions Selectors - Ø22 mm - IP66	27
3 Positions Selectors - Ø22 mm - IP66	28
Illuminated Selectors - Ø22 mm - IP66	29
Accessories - Mounting in Flanges - Blue	30
Accessories - Mounting in Flanges	33
Decentralized Control Stations and Accessories	35
Accessories - Mounting in Control Stations	35
Common Accessories - Mounting in Flanges or Control Stations	37
Assembled Units - Ø22 mm	40
Coding	42
Technical Data	44
Assembly Configurations	46
Installation and Mounting	47
Dimensions	49

Variety and functionality in pushbuttons and pilot lights



WEG line of Pushbuttons and Pilot Lights (CSW) was **carefully developed** to meet the **operation and signaling** requirements in a wide range of industrial applications.

All items of the CSW line have been designed and present performance **according to the IEC 60947-5-1** and **UL 508** standards, allowing their **application on machines** and **electrical panels**, intended for **the most demanding markets of the world**.



Pushbuttons and Pilot Lights - CSW Line (Ø22 mm) - IP66

Design and Construction

In order to ensure a high quality standard and provide reliable performance for the control and signaling circuits, the products of the CSW line are made with high-end materials.

Their anatomical design allows easy understanding and operation.

The CSW line is also characterized by the robustness, reliability and excellent cost effectiveness. 100% produced in Brazil, the CSW line is a world-class WEG product available for its customers worldwide.



Safety and Reliability

The CSW line offers IP66 protection rating, according to IEC 60529 and Type 4X as per UL 50, providing proper performance even in environments where contaminants such as dust and humidity are present.

All the CSW line is manufactured with non-flammable and UV-ray-protected materials to ensure safety and reliability in applications outdoors and in aggressive environments.



Non-flammable



UV protected

IP66
(Type 4X)

Protected against
dust and water jets

Easy Assembly

The coupling system of WEG contact or illumination blocks to frontal parts (pushbuttons, selector switches or pilot lights) is made by quick assembly using a dedicated mounting flange with 3 or 5 positions, without requiring any tools. The quick-connecting flanges are installed on the frontal parts with just a click, and they can also be uninstalled from the frontal parts without any tools.

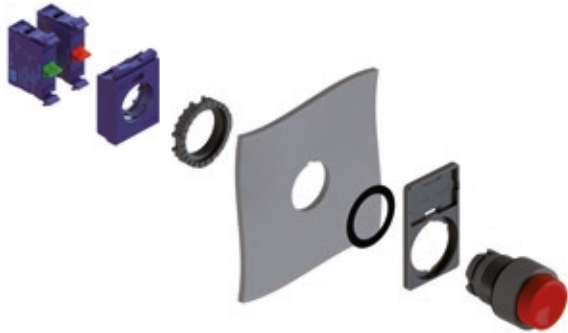

Self-Cleaning and High-Performance Contact Blocks

The contacts of the CSW line are manufactured with special silver alloys, ensuring high reliability and performance to the control circuits, with low current and voltage levels (5 mA / 17 V dc). WEG contact blocks are self-cleaning, which prevents the internal oxidation of the contacts and ensures better electric conductivity to the circuit. In compliance with the requirements of international occupational safety standards, the NC contact blocks feature positive opening, which ensures the opening of the contact by means of direct action, regardless of any event, such as contact welding.

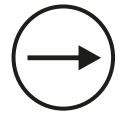
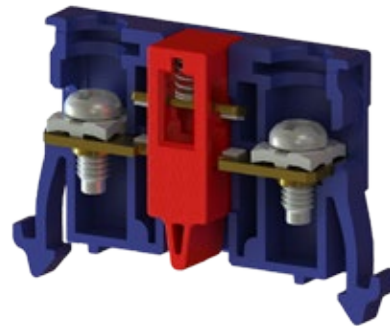

Positive opening

Different Applications

WEG has a full line of solutions in order to solve challenging industrial applications. The Pushbuttons and Pilot Lights portfolio includes different types of buttons: double, triple and illuminated (LED technology) pushbuttons, emergency-stop pushbuttons and many other options, together with a wide range of accessories. There are several function and options.



Front-Back Assembly Systems and the New Contact Blocks

By means of special snap fits, the contact blocks can be front-back assembled. This new mounting system allows greater flexibility on contact combination resulting in inventory reduction, since the old double contact blocks are no longer necessary. The AF3F or AF5F flange models must be used for the front-back assembly of contact blocks. The new contact blocks that allow front-back assembly are easily distinguished from traditional blocks due to their new shape and blue color. The AF3F and AF5F flanges are distinguished by the blue color.

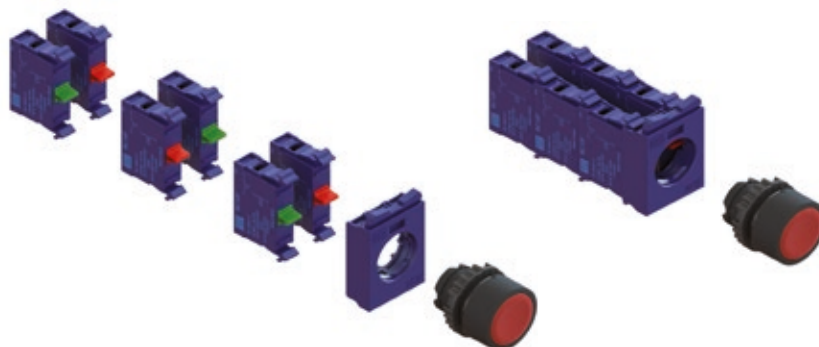

Pushbuttons and Pilot Lights - CSW Line (Ø22 mm) - IP66

Decentralized Control Stations - PBW

With a modern design, the PBW control stations are compact and solve a great variety of challenging applications. Manufactured with high-end materials, ensure excellent performance to applications that require great resistance against impact and bad weather. Their use with frontal parts of the CSW pushbuttons and pilot lights line allows different functions, such as: emergency stop, signaling, starts, stops, among others.



Main Features and Benefits

- IP66/Type 4X degree of protection: accurate design combined with a special sealing gasket assures the degree of protection throughout product life cycle
- Several cable entries: knock-out type entries on the top, base and side, meeting different cable glands with different threads
- Exclusive ID plate holding system: integrated to the construction, allows for standard CSW legend
- Anti-loosening fixing screws: ensures safe and easy operations
- Robustness: manufactured in high-performance, non-flammable and UV-protected polycarbonate. Due to their mechanical construction, they offer outstanding resistance to aggressive environments and impacts
- Special base-mount contact and illumination blocks provide easy installation
- Safety against electric shocks: manufactured with materials that provide full insulation of live parts, they ensure greater safety to the user without the risk of electric shocks



Anti-loosening fixing screw



Exclusive ID plate holding system



IP66 (Type 4X) *Protected against **dust** and **water jets***



UV-protected



Totally insulated



Resistant to impacts



Non-flammable

Pushbuttons and Pilot Lights - CSW Line (Ø22 mm) - IP66

Self-Monitoring of Emergency-Stop Buttons

- Emergency-stop pushbuttons are one of the most common and important devices to actuate the emergency stop and indicate dangerous situations on machine and equipment panels. However, if this device is not properly installed, its function will be compromised, and it may put users at risk.
- The BCM01F-CSW monitoring block was developed so as to ensure greater safety to those applications. Its application with the emergency-stop pushbuttons of the BESG/P/Y line ensures proper installation and provides greater reliability for emergency stop systems. When properly fit, WEG emergency-stop pushbutton prevents inadvertent start or stop.
- Developed according to the international IEC 60947-5-5 and UL 508 standards and the Brazilian NR12 standard.

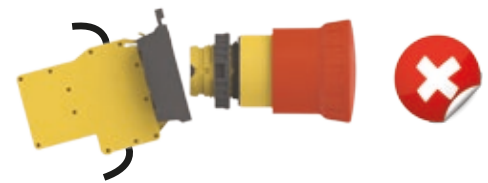

Flange **NOT** properly assembled on the pushbutton.

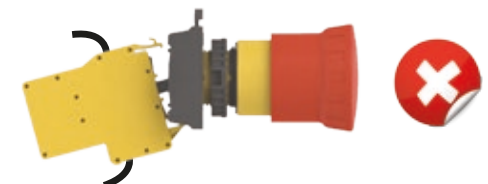

Block **NOT** properly assembled on the flange.

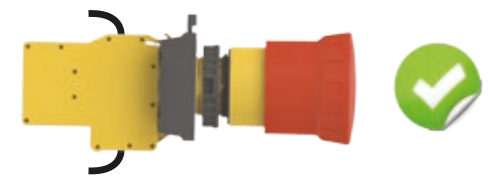

Correct assembly.



Electric Diagram

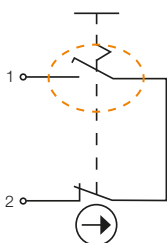

When the button is actuated or removed from its position, the NO contact opens and interrupts the electric circuit.

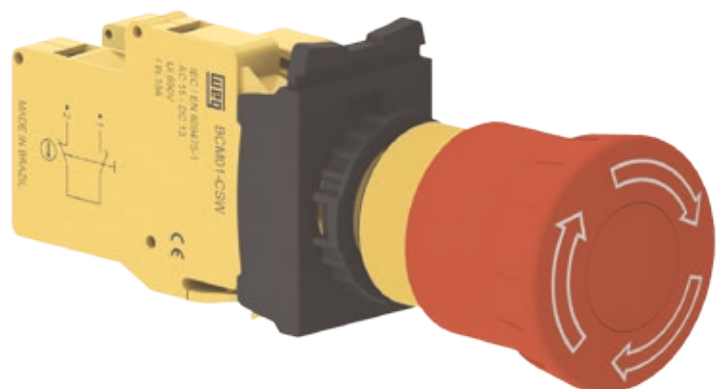

Pushbuttons and Pilot Lights - CSW Line (Ø22 mm) - IP66

Self-Monitoring of Emergency-Stop Buttons

BESGM, BESPM and BESYM emergency-stop pushbuttons allow monitoring the mechanical assembly using single contact blocks in flange or PBW control station mounting. The CBCSW contact block tie enables turning all the items into a single set, ensuring greater safety and reducing the possibility of operation fault. The only national manufacturer with emergency-stop pushbutton monitoring system mounted in plastic control stations with base-mount contact blocks, ensuring more compact and efficient solutions to your application.

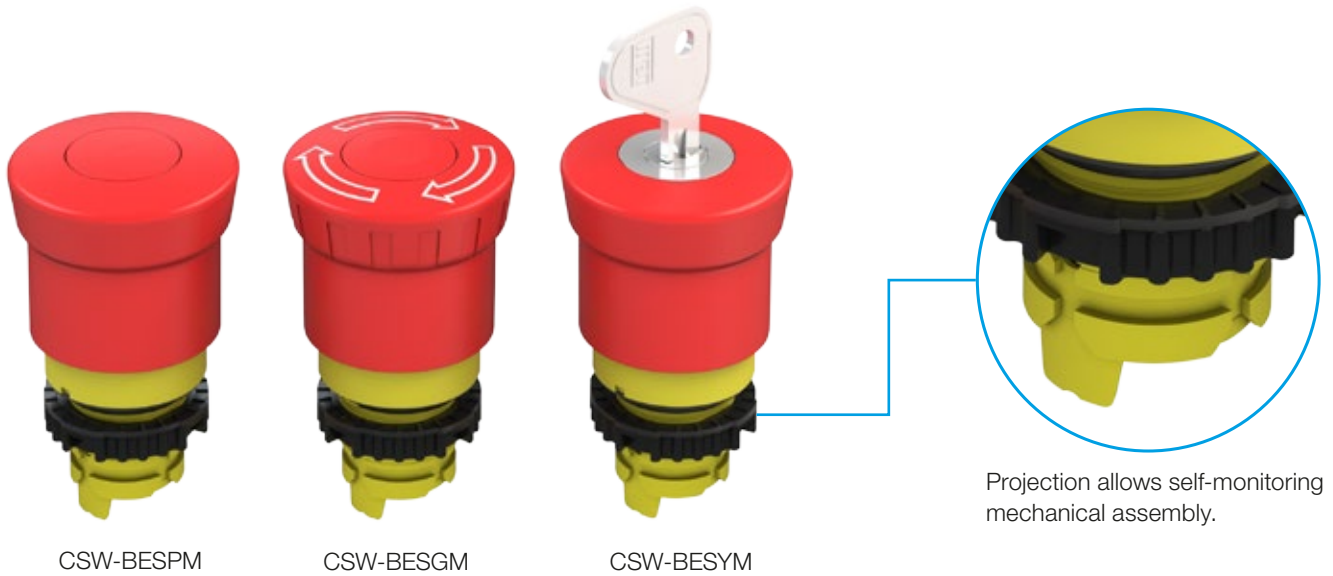

Mounting of the Self-Monitoring System in Flange with Front-Back System

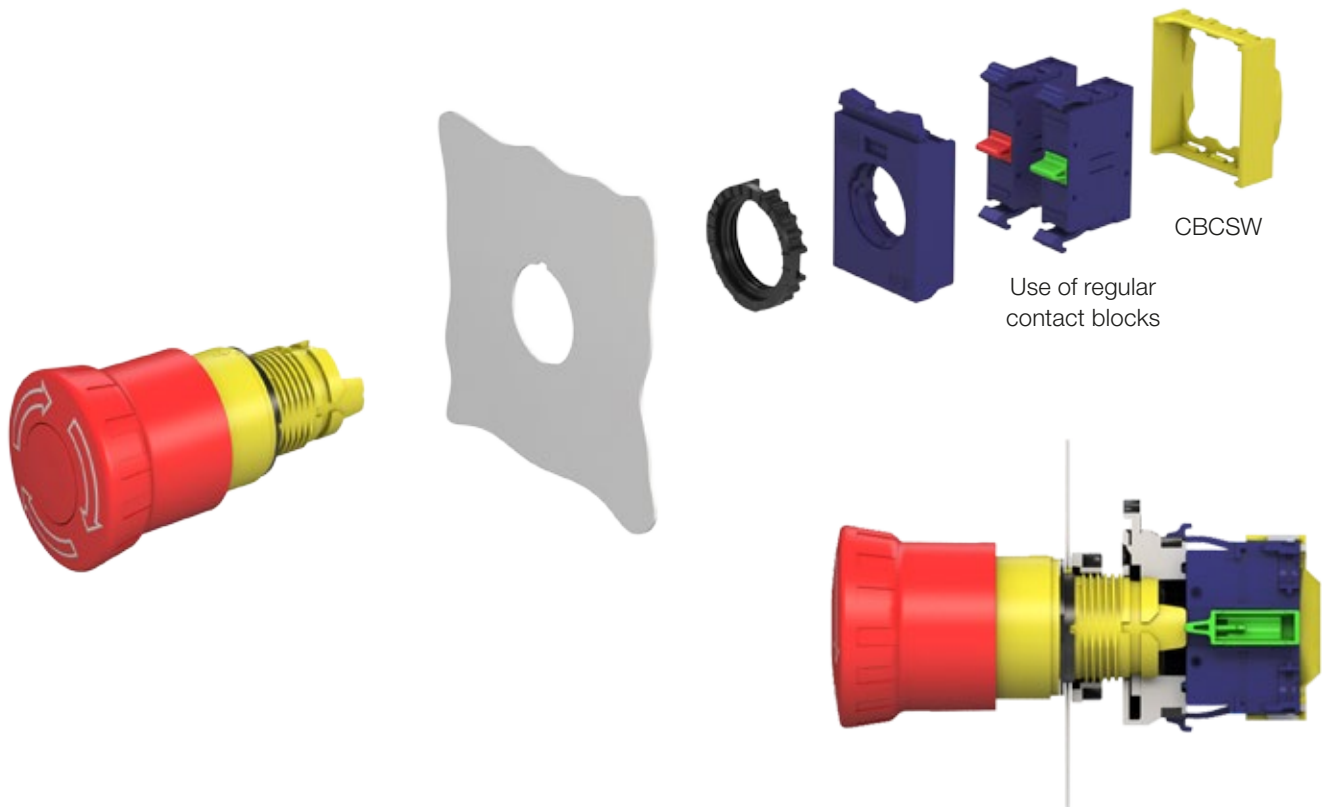

Pushbuttons and Pilot Lights - CSW Line (Ø22 mm) - IP66

Mounting of the Self-Monitoring System in PBW Control Stations



Electric Diagram

NO contact closes when the mechanical mounting is correct

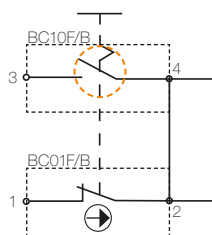

Assembly

Monitored

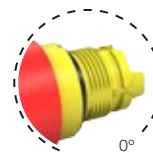

Non-monitored

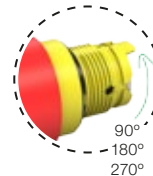

According to the installation of the emergency-stop pushbutton, it allows choosing the monitoring of the mechanical assembly

High Performance Illumination Blocks

High brightness LEDs ensure illumination and efficiency (lumens/Watt), with low heat dissipation and energy consumption. Its integrated construction provides high mechanical resistance to vibrations and maintenance-free operation. Its useful life is much longer than illumination by Ba9s-type conventional incandescent lamps.



Certifications

- The products of the CSW line bear several certifications for a great variety of markets and applications.



Overview

N°	Description
1	Double pushbutton
2	Protection cover for double pushbutton
3	Illuminated single pushbutton
4	Single pushbutton
5	Protection cover for single pushbutton
6	Selector switch knob
7	Lever selector switch
8	Illuminated selector switch
9	Selector switch - key release
10	Pilot light
11	Mushroom selector switch
12	Emergency - stop button - twist release
13	Emergency - stop button - key release
14	Plate holder
15	Plate
16	Double contact block
17	Illumination block
18	Single contact block
19	NC late - break single contact block
20	Push-on/push-off block
21	NO early - make single contact block
22	3 - position flange
23	5 - position flange
24	Illuminated extended pushbutton
25	Illuminated mushroom selector switch
26	Guarded pushbutton
27	Protection cover for the single pushbutton illumination and extended
28	Plate holder double pushbutton
29	Sealing ring
30	Protection
31	Emergency- stop - twist release (BESG)
32	Emergency - stop pull release (BESP)
33	Emergency - stop key release (BESY)
34	Self - monitoring block
35	Double pushbutton IP66
36	Reset pushbutton with shaft BH

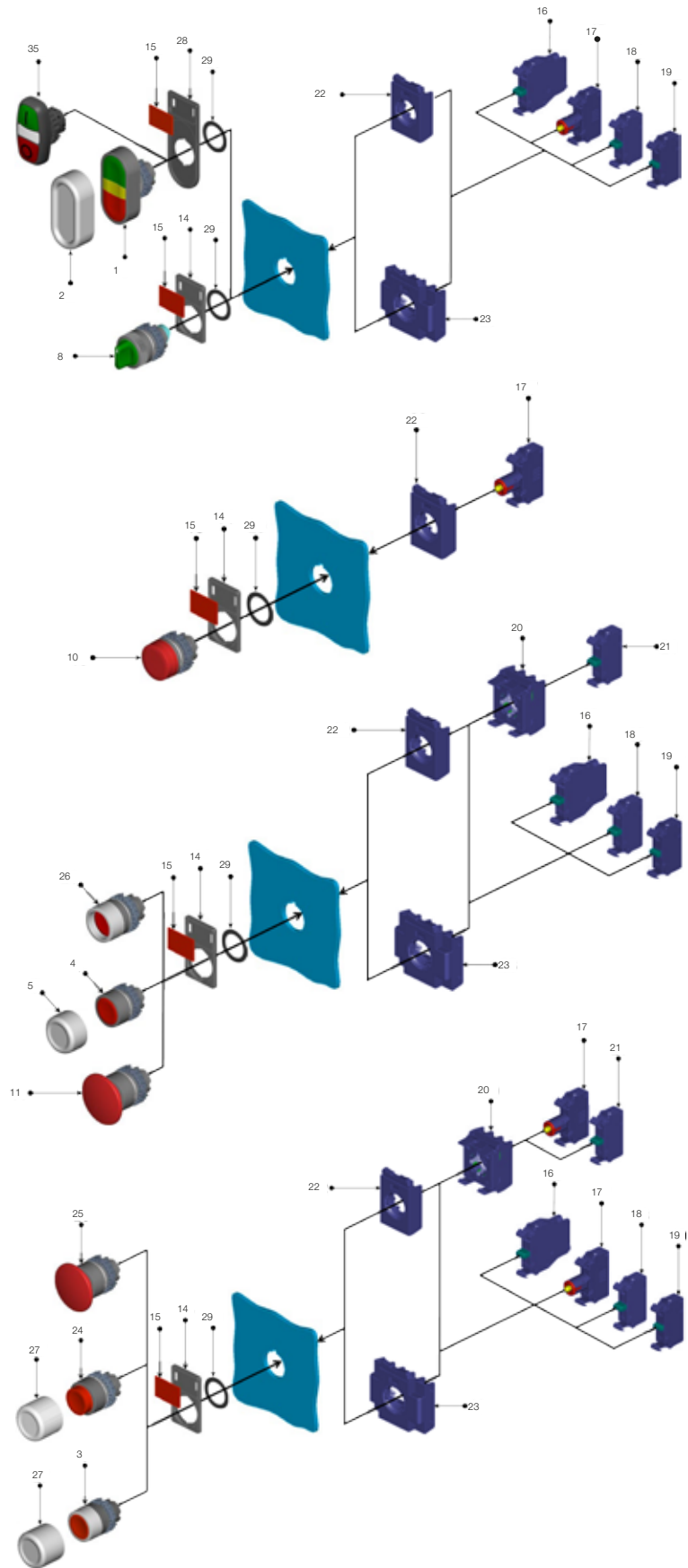

Overview

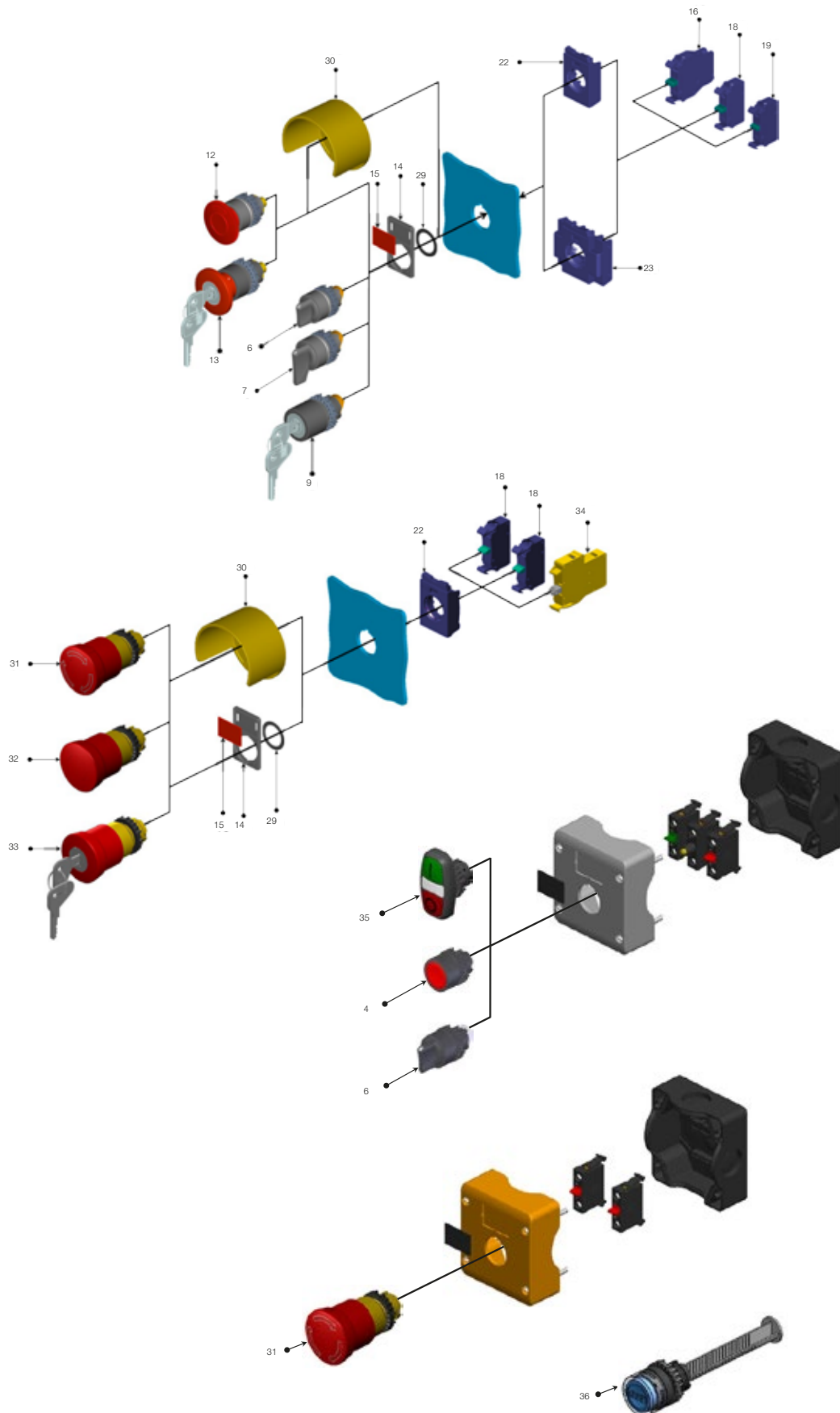

Pushbuttons - Ø22 mm - IP66

Flush¹⁾

Illustrative image	Color	Reference	Code	Weight (kg)
	○	White	CSW-BF0 WH	12880559
	●	Red	CSW-BF1 WH	12881927
	●	Green	CSW-BF2 WH	12882149
	●	Yellow	CSW-BF3 WH	12882150
	●	Blue	CSW-BF4 WH	12882151
	●	Black	CSW-BF5 WH	12882152

Guarded¹⁾

Illustrative image	Color	Reference	Code	Weight (kg)
	○	White	CSW-BGA0 WH	12882154
	●	Red	CSW-BGA1 WH	12882155
	●	Green	CSW-BGA2 WH	12882156
	●	Yellow	CSW-BGA3 WH	12882157
	●	Blue	CSW-BGA4 WH	12882158
	●	Black	CSW-BGA5 WH	12882159

Extended¹⁾

Illustrative image	Color	Reference	Code	Weight (kg)
	○	White	CSW-BS0 WH	12882167
	●	Red	CSW-BS1 WH	12882208
	●	Green	CSW-BS2 WH	12882210
	●	Yellow	CSW-BS3 WH	12882211
	●	Blue	CSW-BS4 WH	12882212
	●	Black	CSW-BS5 WH	12882213

Mushroom - External Diameter: Ø40 mm¹⁾

Illustrative image	Color	Reference	Code	Weight (kg)
	○	White	CSW-BC0 WH	12882160
	●	Red	CSW-BC1 WH	12882161
	●	Green	CSW-BC2 WH	12882162
	●	Yellow	CSW-BC3 WH	12882163
	●	Blue	CSW-BC4 WH	12882164
	●	Black	CSW-BC5 WH	12882166

How to order²⁾



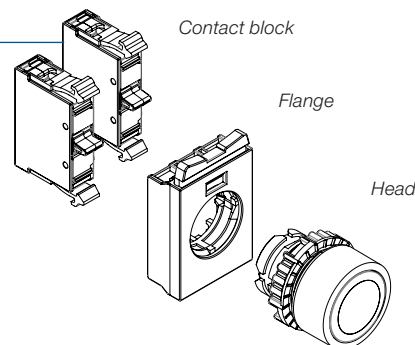













- Head
- + Flange
- + Contact block















Notes: 1) Does not allow the use of contact blocks in the central position of the mounting flanges;
2) Check the maximum of recommended blocks for each head on page 46.

Pushbuttons - Ø22 mm - IP66

Double Pushbutton¹⁾

Illustrative image	Frontal part	Color	Engraving	Reference	Code	Weight (kg)
	Flush		Green	I	CSW2-BDF2110 WH	12724261
	Flush		Red	0		
	Flush		Green	START	CSW2-BDF21SS WH	12905152
	Flush		Red	STOP		
	Flush		Green	Without engraved	CSW2-BDF21 WH	12905153
	Flush		Red	Without engraved		
	Flush		White	I	CSW2-BDF0510 WH	12905154
	Flush		Black	0		
	Flush		White	START	CSW2-BDF05SS WH	12905156
	Flush		Black	STOP		
	Flush		White	Without engraved	CSW2-BDF05 WH	12905157
	Flush		Black	Without engraved		
	Flush		Black	+	CSW2-BDF55PN WH	12905179
	Flush		Black	-		
	Flush		Black	↑	CSW2-BDF55FR WH	12905181
	Flush		Black	↓		

Extended Double Pushbutton¹⁾

Illustrative image	Frontal part	Color	Engraving	Reference	Code	Weight (kg)
	Flush		Green	I	CSW2-BDS21 WH	12905208
	Extended		Red	0		
	Flush		Green	START	CSW2-BDS2110 WH	12724178
	Extended		Red	STOP		
	Flush		Green	Without engraved	CSW2-BDS21 WH	12905208
	Extended		Red	Without engraved		
	Flush		White	I	CSW2-BDS0510 WH	12905209
	Extended		Black	0		
	Flush		White	START	CSW2-BDS05SS WH	12905210
	Extended		Black	STOP		
	Flush		White	Without engraved	CSW2-BDS05 WH	12905211
	Extended		Black	Without engraved		

How to order²⁾

- Head
- + Flange
- + Contact block

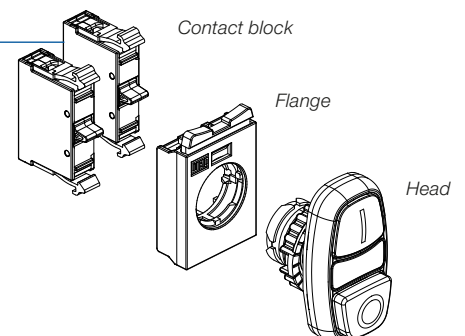

Notes: 1) Does not allow the use of contact blocks in the central position of the mounting flanges;
2) Check the maximum of recommended blocks for each head on page 46.

Pushbuttons - Ø22 mm - IP66

Flush Double with Metallic Appearance¹⁾

Illustrative image	Frontal part	Color	Engraving	Reference	Code	Weight (kg)
	Flush		Green	I	CSW2-BDFC2110 WH	13184929
	Flush		Red	O		
	Flush		Green	START	CSW2-BDFC21SS WH	13184932
	Flush		Red	STOP		
	Flush		Green	Without engraved	CSW2-BDFC21 WH	13184933
	Flush		Red	Without engraved		
	Flush		White	I	CSW2-BDFC0510 WH	13184934
	Flush		Black	O		
	Flush		White	START	CSW2-BDFC05SS WH	13184936
	Flush		Black	STOP		
	Flush		White	Without engraved	CSW2-BDFC05 WH	13184937
	Flush		Black	Without engraved		
	Flush		Black	+	CSW2-BDFC55PN WH	13184988
	Flush		Black	-		
	Flush		Black	↑	CSW2-BDFC55FR WH	13184989
	Flush		Black	↓		

Double Extended with Metal-Coated Frame¹⁾

Illustrative image	Frontal part	Color	Engraving	Reference	Code	Weight (kg)
	Flush		Green	I	CSW2-BDSC21 WH	13184993
	Extended		Red	O		
	Flush		Green	START	CSW2-BDSC2110 WH	13184990
	Extended		Red	STOP		
	Flush		Green	Without engraved	CSW2-BDSC21 WH	13184993
	Extended		Red	Without engraved		
	Flush		White	I	CSW2-BDSC0510 WH	13184994
	Extended		Black	O		
	Flush		White	START	CSW2-BDSC05SS WH	13184995
	Extended		Black	STOP		
	Flush		White	Without engraved	CSW2-BDSC05 WH	13184996
	Extended		Black	Without engraved		

How to order²⁾



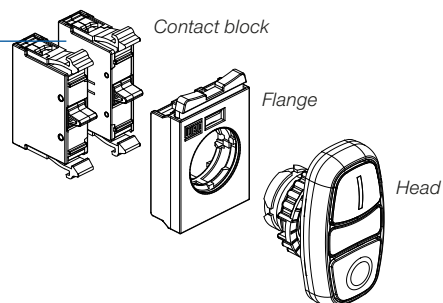





- Head
- + Flange
- + Contact block



Notes: 1) Does not allow the use of contact blocks in the central position of the mounting flanges;
2) Check the maximum of recommended blocks for each head on page 46.

Pushbuttons - Ø22 mm - IP66

Triple Pushbutton

Illustrative image	Frontal part	Color	Engraving	Reference	Code	Weight (kg)
	Flush		Green		CSW2-BTF212IIS WH	13120276
	Extended		Red	STOP		
	Flush		Green	0	CSW2-BTF212RSL WH	13120358
	Flush		Green	→		
	Extended		Red	STOP	CSW2-BTF212FRS WH	13120359
	Flush		Green	←		
	Flush		Green	↑	CSW2-BTF515FRS WH	13120360
	Extended		Red	STOP		
	Flush		Black	↑	CSW2-BTF015FRS WH	13120362
	Extended		Red	STOP		
	Flush		White	↑	CSW2-BTF015RSL WH	13120365
	Extended		Red	STOP		
	Flush		Black	↓	CSW2-BTF515PNS WH	13120367
	Flush		Black	-		
	Extended		Red	STOP	CSW2-BTF2411ORM WH	13120411
	Flush		Green			
	Flush		Green	+	CSW2-BTF2411OR WH	13120530
	Extended		Blue	RESET		
	Flush		Red	0	CSW2-BTF045IOR WH	13120531
	Flush		White			
	Extended		Blue	RESET	CSW2-BTF045SSR WH	13120532
	Flush		Black	0		
	Flush		White	START		
	Extended		Blue	RESET		
	Flush		Blue	RESET		
	Flush		Black	STOP		

0.034

How to order¹⁾



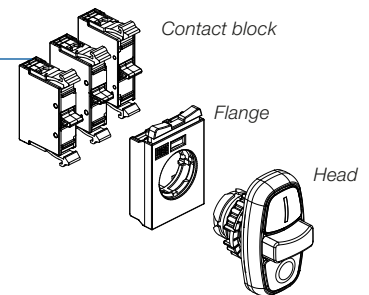













- Head
- + Flange
- + Contact block



Notes: 1) Check the maximum of recommended blocks for each head on page 46.

Pushbuttons - Ø22 mm - IP66

Triple Pushbuttons with Metallic Appearance¹⁾

Illustrative image	Frontal part	Color	Engraving	Reference	Code	Weight (kg)
	Flush		Green	I	CSW2-BTFC212IIS WH	13185098
	Extended		Red	STOP		
	Flush		Green	II	CSW2-BTFC212RLS WH	13185099
	Flush		Green	→		
	Extended		Red	STOP	CSW2-BTFC212FRS WH	13185100
	Flush		Green	←		
	Flush		Green	↑	CSW2-BTFC215FRS WH	13185102
	Extended		Red	STOP		
	Flush		Black	↑	CSW2-BTFC015FRS WH	13185107
	Extended		Red	STOP		
	Flush		Black	↓	CSW2-BTFC015RLS WH	13185158
	Flush		White	↑		
	Extended		Red	STOP	CSW2-BTFC015PNS WH	13185162
	Flush		Black	-		
	Flush		Black	+	CSW2-BTFC241IORM WH	13185164
	Extended		Red	STOP		
	Flush		Black	-	CSW2-BTFC241IOR WH	13185165
	Flush		Green	I		
	Extended		Blue	REARME	CSW2-BTFC045IOR WH	13185167
	Flush		Red	0		
	Flush		Green	I	CSW2-BTFC045SSR WH	13185239
	Extended		Blue	RESET		
	Flush		Red	0	CSW2-BTFC045IOR WH	13185167
	Flush		White	I		
	Extended		Blue	RESET	CSW2-BTFC045IOR WH	13185167
	Flush		Black	0		
	Flush		White	START	CSW2-BTFC045SSR WH	13185239
	Extended		Blue	RESET		
	Flush		Black	STOP	CSW2-BTFC045SSR WH	13185239
	Flush		Black	STOP		

0.034

How to order²⁾

- Head
- + Flange
- + Contact block

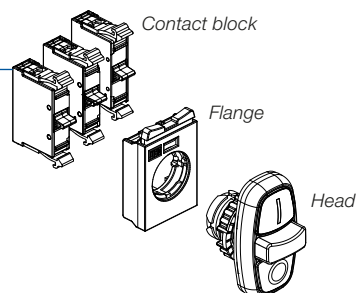

Notes: 1) Other colors and function are available under request;
 2) Check the maximum of recommended blocks for each head on page 46.

Pushbuttons - Ø22 mm - IP66

Extended Triple Pushbuttons¹⁾

Illustrative image	Frontal part	Color		Engraving	Reference	Code	Weight (kg)
	Flush		Green	I	CSW2-BTSC241IORM WH	13120536	0.034
	Extended		Blue	REARME			
	Extended		Red	0			
	Flush		Green	I	CSW2-BTSC241IOR WH	13120537	
	Extended		Blue	RESET			
	Extended		Red	0			
	Flush		Green	LIGA	CSW2-BTSC241LDRM WH	13120559	
	Extended		Blue	REARME			
	Extended		Red	DESLIGA			
	Flush		Green	LIGA	CSW2-BTSC241LDR WH	13120561	
	Extended		Blue	RESET			
	Extended		Red	DESLIGA			

Extended Triple with Metallic Appearance¹⁾

Illustrative image	Frontal part	Color		Engraving	Reference	Code	Weight (kg)
	Flush		Green	I	CSW2-BTSC241IORM WH	13185244	0.034
	Extended		Blue	REARME			
	Extended		Red	0			
	Flush		Green	I	CSW2-BTSC241IOR WH	13185245	
	Extended		Blue	RESET			
	Extended		Red	0			

How to order²⁾

- Head
- + Flange
- + Contact block

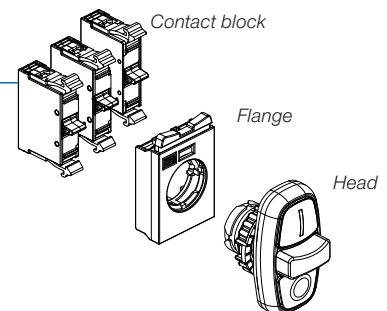

Notes: 1) Other colors and function are available under request;
2) Check the maximum of recommended blocks for each head on page 46.

Pushbuttons with Latch - Ø22 mm - IP66

Emergency Pushbuttons With Latch (EN 419 and IEC 60947-5-5) - External Diameter: 42 mm

Illustrative image	Description	Signalling	Color		Reference	Code	Weight (kg)
	Pull to release	-		Red	CSW-BESP WH	12882459	0.049
	Twist to release	-		Red	CSW-BESG WH	12882447	
	Key to release ¹⁾	-		Red	CSW-BESY WH	12882461	0.114
	Pull to release	Side		Red	CSW-BESPS WH	12882463	0.049
	Twist to release	Side		Red	CSW-BESGS WH	12882462	
	Key to release ¹⁾	Side		Red	CSW-BESYS WH	12882464	0.114

How to order²⁾

- Head
- + Flange
- + Contact block

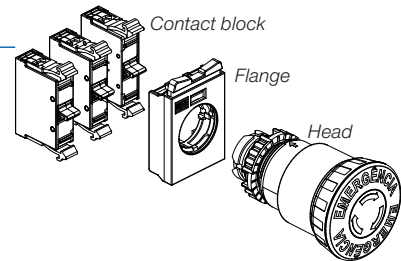

Notes: 1) Keys with different codes are available under request;
 2) Check the maximum of recommended blocks for each head on page 46.

Pushbuttons with Latch - Ø22 mm - IP66

Emergency Pushbuttons With Latch (EN 419 and IEC 60947-5-5) - External Diameter: 42 mm - Self-Monitoring

Illustrative image	Description	Signalling	Color		Reference	Code	Weight (kg)
	Pull to release	-		Red	CSW-BESPM WH	13268409	0.049
	Twist to release	-		Red	CSW-BESGM WH	13268381	
	Key to release ¹⁾	-		Red	CSW-BESYM WH	13274097	0.114
	Pull to release	Side		Red	CSW-BESPSM WH	13277427	0.049
	Twist to release	Side		Red	CSW-BESGSM WH	13277423	
	Key to release ¹⁾	Side		Red	CSW-BESYSM WH	13277425	0.114

How to order²⁾

- Head
- + Flange
- + Contact block

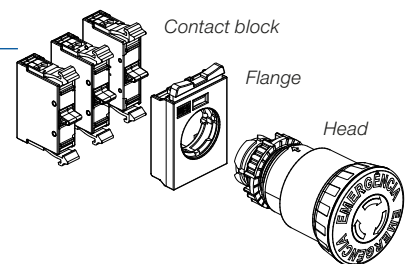

Notes: 1) Keys with different codes are available under request;
 2) Check the maximum of recommended blocks for each head on page 46.

Pushbuttons with Latch - Ø22 mm - IP66

Mushroom Twist Release - External Diameter: Ø40 mm¹⁾

Illustrative image	Color		Reference	Code	Weight (kg)
	○	White	CSW-BCT0 WH	12882214	0.027
	●	Red	CSW-BCT1 WH	12882215	
	●	Green	CSW-BCT2 WH	12882216	
	●	Yellow	CSW-BCT3 WH	12882217	
	●	Blue	CSW-BCT4 WH	12882249	
	●	Black	CSW-BCT5 WH	12882250	

Mushroom Key to Release - External Diameter: Ø40 mm¹⁾

Illustrative image	Color		Reference	Code	Weight (kg)
	○	White	CSW-BCY0 WH	12882251	0.090
	●	Red	CSW-BCY1 WH	12882252	
	●	Green	CSW-BCY2 WH	12882253	
	●	Yellow	CSW-BCY3 WH	12882255	
	●	Blue	CSW-BCY4 WH	12882256	
	●	Black	CSW-BCY5 WH	12882257	

How to order²⁾

- Head
- + Flange
- + Contact block

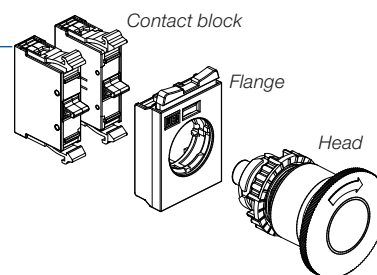

Notes: 1) Does not allow the use of contact blocks in the central position of the mounting flanges;
 2) Check the maximum of recommended blocks for each head on page 46.

Illuminated Pushbuttons - Ø22 mm - IP66





Flush¹⁾²⁾

Illustrative image	Color		Reference	Code	Weight (kg)
		White	CSW-BF10 WH	12882258	0.021
		Red	CSW-BF11 WH	12882259	
		Green	CSW-BF12 WH	12882260	
		Yellow	CSW-BF13 WH	12882261	
		Blue	CSW-BF14 WH	12882262	
		Orange	CSW-BF16 WH ⁴⁾	12882264	

Extended¹⁾²⁾

Illustrative image	Color		Reference	Code	Weight (kg)
		White	CSW-BS10 WH	12882265	0.021
		Red	CSW-BS11 WH	12882266	
		Green	CSW-BS12 WH	12882267	
		Yellow	CSW-BS13 WH	12882298	
		Blue	CSW-BS14 WH	12882299	
		Orange	CSW-BS16 WH ⁴⁾	12882300	

Mushroom - External Diameter: Ø40 mm¹⁾²⁾

Illustrative image	Color		Reference	Code	Weight (kg)
		White	CSW-BC10 WH	12882301	0.026
		Red	CSW-BC11 WH	12882302	
		Green	CSW-BC12 WH	12882303	
		Yellow	CSW-BC13 WH	12882304	
		Blue	CSW-BC14 WH	12882305	
		Orange	CSW-BC16 WH ⁴⁾	12882306	

How to order³⁾

- Head
- + Flange
- + Contact block
- + Illumination block

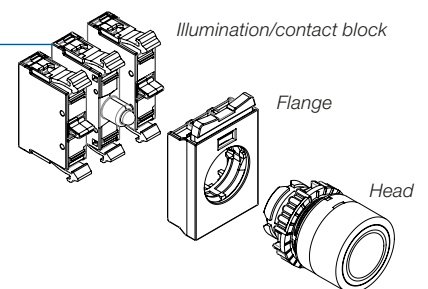

- Notes: 1) Does not allow the use of contact blocks in the central position of the mounting flanges;
 2) It allows the use of illumination contact block in the center of the flange;
 3) Check the maximum of recommended blocks for each head on page 46;
 4) For a better lighting performance, it is recommended the use of yellow LED blocks.

Illuminated Pushbuttons - Ø22 mm - IP66

Flush Double Pushbutton¹⁾²⁾

Illustrative image	Frontal part	Color	Engraving	Reference	Code	Weight (kg)
	Flush		Green	I	CSW2-BDFI2110 WH	12756258
	Flush		Red	0		
	Flush		Green	START	CSW2-BDFI21SS WH	12904803
	Flush		Red	STOP		
	Flush		Green	Without engraved	CSW2-BDFI21 WH	12904818
	Flush		Red	Without engraved		
	Flush		White	I	CSW2-BDFI0510 WH	12904819
	Flush		Black	0		
	Flush		White	START	CSW2-BDFI05SS WH	12904822
	Flush		Black	STOP		
	Flush		White	Without engraved	CSW2-BDFI05 WH	12904824
	Flush		Black	Without engraved		
	Flush		Black	+	CSW2-BDFI55PN WH	12904825
	Flush		Black	-		
	Flush		Black	↑	CSW2-BDFI55FR WH	12904827
	Flush		Black	↓		

Extended Double Pushbutton¹⁾²⁾

Illustrative image	Frontal part	Color	Engraving	Reference	Code	Weight (kg)
	Flush		Green	I	CSW2-BDSI2110 WH	12904828
	Extended		Red	0		
	Flush		Green	START	CSW2-BDSI21SS WH	12904831
	Extended		Red	STOP		
	Flush		Green	Without engraved	CSW2-BDSI21 WH	12904834
	Extended		Red	Without engraved		
	Flush		White	I	CSW2-BDSI0510 WH	12904837
	Extended		Black	0		
	Flush		White	START	CSW2-BDSI05SS WH	12904848
	Extended		Black	STOP		

How to order³⁾



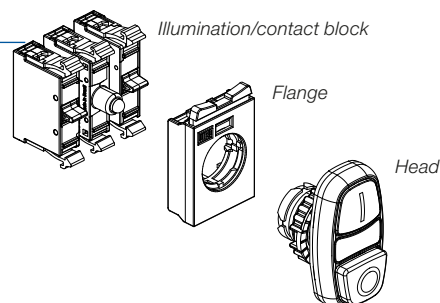





- Head
- + Flange
- + Contact block
- + Illumination block









Notes: 1) Does not allow the use of contact blocks in the central position of the mounting flanges;
 2) It allows the use of illumination contact block in the center of the flange;
 3) Check the maximum of recommended blocks for each head on page 46.

Illuminated Pushbuttons - Ø22 mm - IP66

Flush Double with Metal-Coated Frame¹⁾²⁾

Illustrative image	Frontal part	Color	Engraving	Reference	Code	Weight (kg)
	Flush		Green	I	CSW2-BDFIC2110 WH	13185008
	Flush		Red	0		
	Flush		Green	START	CSW2-BDFIC21SS WH	13185011
	Flush		Red	STOP		
	Flush		Green	Without engraved	CSW2-BDFIC21 WH	13185012
	Flush		Red	Without engraved		
	Flush		White	I	CSW2-BDFIC0510 WH	13185013
	Flush		Black	0		
	Flush		White	START	CSW2-BDFIC05SS WH	13185014
	Flush		Black	STOP		
	Flush		White	Without engraved	CSW2-BDFIC05 WH	13185015
	Flush		Black	Without engraved		
	Flush		Black	+	CSW2-BDFIC55PN WH	13185016
	Flush		Black	-		
	Flush		Black	↑	CSW2-BDFIC55FR WH	13185017
	Flush		Black	↓		

Double Extended with Metal-Coated Frame¹⁾²⁾

Illustrative image	Frontal part	Color	Engraving	Reference	Code	Weight (kg)
	Flush		Green	I	CSW2-BDSIC2110 WH	13185059
	Extended		Red	0		
	Flush		Green	START	CSW2-BDSIC21SS WH	13185061
	Extended		Red	STOP		
	Flush		Green	Without engraved	CSW2-BDSIC21 WH	13185062
	Extended		Red	Without engraved		
	Flush		White	I	CSW2-BDSIC0510 WH	13185063
	Extended		Black	0		
	Flush		White	START	CSW2-BDSIC05SS WH	13185065
	Extended		Black	STOP		
	Flush		White	Without engraved	CSW2-BDSIC05 WH	13185067
	Extended		Black	Without engraved		

How to order³⁾

- Head
- + Flange
- + Contact block
- + Illumination block

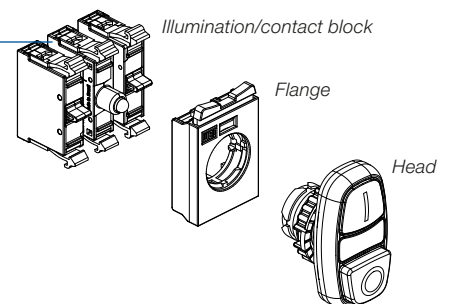

Notes: 1) Does not allow the use of contact blocks in the central position of the mounting flanges;
 2) It allows the use of illumination contact block in the center of the flange;
 3) Check the maximum of recommended blocks for each head on page 46.

Illuminated Pushbuttons - Ø22 mm - IP40

Flush Double Pushbutton - Degree of Protection IP40¹⁾²⁾³⁾

Illustrative image	Color	Engraving	Reference	Code	Weight (kg)
		Green	I	CSW-BD WH	12884105
		Red	O		
		Green	START	CSW-BD21SS WH	12884106
		Red	STOP		
		Green	Without engraved	CSW-BD21 WH	12884108
		Red	Without engraved		
		White	I	CSW-BD05IO WH	12884109
		Black	O		
		White	START	CSW-BD05SS WH	12884110
		Black	STOP		
		White	Without engraved	CSW-BD05 WH	12884112
		Black	Without engraved		
		Black	+	CSW-BD55PN WH	12884114
		Black	-		
	Black	↑	CSW-BD55FR WH	12884115	
	Black	↓			

How to order

- Head
- + Flange
- + Contact block
- + Illumination block

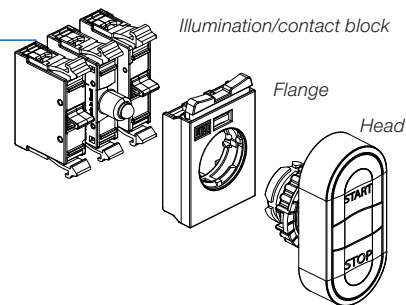

Pilot Lights - Ø22 mm - IP66

Pilot Lights¹⁾²⁾

Illustrative image	Color	Reference	Code	Weight (kg)
		White	CSW-SD0 WH	0.016
		Red	CSW-SD1 WH	
		Green	CSW-SD2 WH	
		Yellow	CSW-SD3 WH	
		Blue	CSW-SD4 WH	
		Orange	CSW-SD6 WH ⁵⁾	

How to order⁴⁾



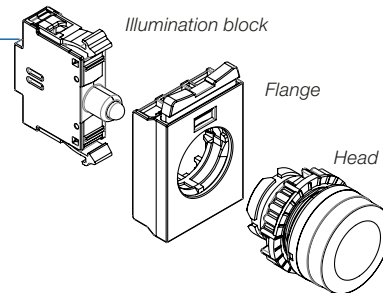

- Head
- + Flange
- + Illumination block







- Notes: 1) It allows illumination by means of lamp block and LED block;
 2) Does not allow the use of contact blocks in the central position of the mounting flanges;
 3) To increase the protection rating to IP66, use the APBD accessory;
 4) Check the maximum of recommended blocks for each head on page 46;
 5) For a better lighting performance, it is recommended the use of yellow LED blocks.

2 Positions Selectors - Ø22 mm - IP66

Knob¹⁾

Illustrative image	Position	Diagram	Selector angle	Color ¹⁾		Reference	Code	Weight (kg)
		Fixed	1	45°	●	Black	CSW-CK2F45 WH	0.025
		Return	1	45°	●	Black	CSW-CK2R45 WH	
		Fixed	1	90°	●	Black	CSW-CK2F90 WH	
			2	90°	●	Black	CSW-CK2F90W WH	
		Return	1	90°	●	Black	CSW-CK2R90 WH	

Lever¹⁾

Illustrative image	Position	Diagram	Selector angle	Color ¹⁾		Reference	Code	Weight (kg)
		Fixed	1	45°	●	Black	CSW-CA2F45 WH	0.025
		Return	1	45°	●	Black	CSW-CA2R45 WH	
		Fixed	1	90°	●	Black	CSW-CA2F90 WH	
			2	90°	●	Black	CSW-CA2F90W WH	
		Return	1	90°	●	Black	CSW-CA2R90 WH	

Key Release²⁾³⁾







Illustrative image	Position	Diagram	Selector angle	Color ¹⁾		Reference	Code	Weight (kg)
		Fixed	1	45°	●	Black	CSW-CY2F45 WH	0.087
		Return	1	45°	●	Black	CSW-CY2R45 WH	
		Fixed	1	90°	●	Black	CSW-CY2F90 WH	
			2	90°	●	Black	CSW-CY2F90W WH	
		Return	1	90°	●	Black	CSW-CY2R90 WH	

Diagram 1				Diagram 2						Flanges			
	Handle position	Mounting position in the flange						Mounting position in the flange					
				-	2	3		1	-		-	2	3
		4	2	5	1	3		4	2	5	1	3	5P
	0	□	□	-	□	□		■	■	-	□	□	
	I	■	■	-	■	■		□	□	-	■	■	

Legend

- Contacts in the rest position.
- Contacts operated.

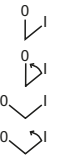
How to order⁴⁾

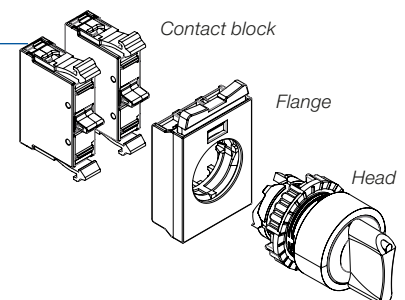

- Head
- + Flange
- + Contact block







- Notes: 1) Selector switches in other colors are available under request;
 2) Keys with different codes are available under request;
 3) Key is released in any position. For key release in specific positions, replace CY by: CYD (only from the right),
 CYE (only from the left) and CYC (only from the center);
 4) Check the maximum of recommended blocks for each head on page 46.

3 Positions Selectors - Ø22 mm - IP66

Knob¹⁾

Illustrative image	Position	Diagram	Selector angle	Color ¹⁾		Reference	Code	Weight (kg)
	 Fixed	1	45°	●	Black	CSW-CK3F45 WH	12882311	0.025
	 Return	1	45°	●	Black	CSW-CK3R45 WH	12882312	
	 Return from the right	1	45°	●	Black	CSW-CK3RD45 WH	12882315	
	 Return from the left	1	45°	●	Black	CSW-CK3RE45 WH	12882314	

Lever¹⁾

Illustrative image	Position	Diagram	Selector angle	Color ¹⁾		Reference	Code	Weight (kg)
	 Fixed	1	45°	●	Black	CSW-CA3F45 WH	12882340	0.025
	 Return	1	45°	●	Black	CSW-CA3R45 WH	12882341	
	 Return from the right	1	45°	●	Black	CSW-CA3RD45 WH	12882343	
	 Return from the left	1	45°	●	Black	CSW-CA3RE45 WH	12882342	

With Key²⁾³⁾







Illustrative image	Position	Diagram	Selector angle	Color ¹⁾		Reference	Code	Weight (kg)
	 Fixed	1	45°	●	Black	CSW-CY3F45 WH	12882347	0.087
	 Return	1	45°	●	Black	CSW-CY3R45 WH	12882368	
	 Return from the right	1	45°	●	Black	CSW-CY3RD45 WH	12882373	
	 Return from the left	1	45°	●	Black	CSW-CY3RE45 WH	12882372	

Diagram 1			Flanges					
	Handle position	Mounting position in the flange	-	2	3	1	-	3P
			4	2	5	1	3	5P
	I		■	■		□	□	
	0		□	□	-	□	□	
	II		□	□		■	■	

Legend

- Contacts in the rest position.
- Contacts operated.

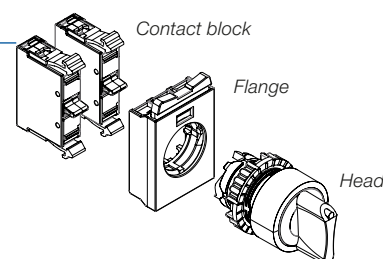

How to order⁴⁾

- Head
- + Flange
- + Contact block



Notes: 1) Selector switches in other colors are available under request;
 2) Keys with different codes are available under request;
 3) Key is released in any position. For key release in specific positions, replace CY by: CYD (only from the right),
 CYE (only from the left) and CYC (only from the center);
 4) Check the maximum of recommended blocks for each head on page 46.

Illuminated Selectors - Ø22 mm - IP66

Illustrative image	Position		Diagram	Selector angle	Color		Reference	Code	Weight (kg)
		Fixed	1	90°	○	White	CSW-CKI2F900 WH	12882374	0.020
					●	Red	CSW-CKI2F901 WH	12882375	
					●	Green	CSW-CKI2F902 WH	12882376	
					●	Yellow	CSW-CKI2F903 WH	12882377	
					●	Blue	CSW-CKI2F904 WH	12882388	

3 Positions Illuminated Selectors







Illustrative image	Position		Diagram	Selector angle	Color		Reference	Code	Weight (kg)
		Fixed	2	45°	○	White	CSW-CKI3F450 WH	12882391	0.020
					●	Red	CSW-CKI3F451 WH	12882392	
					●	Green	CSW-CKI3F452 WH	12882393	
					●	Yellow	CSW-CKI3F453 WH	12882394	
					●	Blue	CSW-CKI3F454 WH	12882395	
		Return	2	45°	○	White	CSW-CKI3R450 WH	12882397	
					●	Red	CSW-CKI3R451 WH	12882408	
					●	Green	CSW-CKI3R452 WH	12882409	
					●	Yellow	CSW-CKI3R453 WH	12882410	
					●	Blue	CSW-CKI3R454 WH	12882411	
		Return from the right	2	45°	○	White	CSW-CKI3RD450 WH	12882413	
					●	Red	CSW-CKI3RD451 WH	12882414	
					●	Green	CSW-CKI3RD452 WH	12882415	
					●	Yellow	CSW-CKI3RD453 WH	12882416	
					●	Blue	CSW-CKI3RD454 WH	12882417	
		Return from the left	2	45°	○	White	CSW-CKI3RE450 WH	12882439	
●					Red	CSW-CKI3RE451 WH	12882440		
●					Green	CSW-CKI3RE452 WH	12882441		
●					Yellow	CSW-CKI3RE453 WH	12882442		
●					Blue	CSW-CKI3RE454 WH	12882443		

Diagram 1					Diagram 2					Flanges			
	Handle position	Mounting position in the flange						Handle position	Mounting position in the flange				
		-	2	3	1	-			-	2	3	1	-
0	0	□	□	☼	□	□	I	■	■	□	□	3P	
I	I	■	■	☼	■	■	0	□	□	☼	□	5P	
							II	□	□	■	■		

Legend

- Contacts in the rest position.
- Contacts operated.
- ☼ Mounting position for LED blocks in illuminated switches.

How to order¹⁾

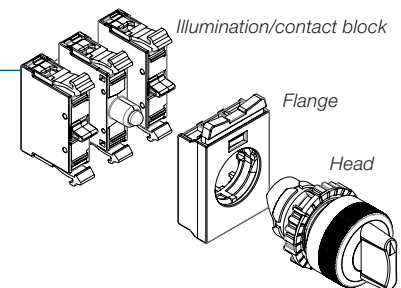

- Head
- + Flange
- + Contact block
- + Illumination block



Note: 1) Check the maximum of recommended contact blocks for each head on page 46.



Accessories - Mounting in Flanges - Blue

Blue Flange¹⁾

Illustrative image	Description	Standard packing	Reference	Code
 0.010 kg	3 position mounting flange for blue contact blocks Front-back assembly system	1 piece	AF3F	12670264
		10 pieces	AF3FX10 ²⁾	12918902
 0.015 kg	5 position mounting flange for blue contact blocks Front-back assembly system	1 piece	AF5F	13268324
		5 pieces	AF5FX5 ²⁾	13275324

Front-back
system

Contact Blocks¹⁾

Illustrative image	Contacts	Diagram	Standard packing	Compatible flange	Reference	Code
 0.015	1NO		1 piece	AF3F AF5F	BC10F-CSW	12891184
			10 pieces		BC10F-CSWX10 ²⁾	12174912
	1NC		1 piece		BC01F-CSW	12891186
			10 pieces		BC01F-CSWX10 ²⁾	12174913

Self-Monitoring Contact Block for CSW-BES Emergency Pushbuttons¹⁾³⁾⁴⁾

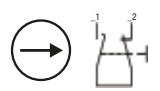
Illustrative image	Contacts	Diagram	Standard packing	Compatible flange	Reference	Code
 0.015 kg	1NC		1 piece	AF3F	BCM01F-CSW	13262011

Push-On/Push-Off Block¹⁾³⁾

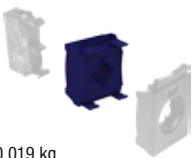
Illustrative image	Description	Standard packing	Compatible flange	Reference	Code
 0.019 kg	Mechanical push-on/push-off block for contact blocks mounted on buttons: CSW-BF, CSW-BFI, CSW-BS, CSW-BSI, CSW-BGA, CSW-BC, CSW-BCI Note: use only with the following contact blocks: - BC01F (1NC) - BCA10F (1NOa - advanced)	1 piece	AF3F	BR-3PF-CSW	13270966

Notes: 1) Not compatible with the PBW control stations line. For control stations, please refer to the page 36 and 37 of this catalogue;

































2) Unitary weights;

3) It does not allow front-back assembly;



4) The NO contact close when assembled correctly in the flange.

Accessories - Mounting in Flanges - Blue

Illumination Blocks with Integrated LED¹⁾²⁾

Illustrative image	Voltage	Color	Diagram	Standard packing	Compatible flange	Reference	Code	
 0.016 kg	12 V ac/dc		Colorless		1 piece	AF3F AF5F	CSW-BIDLF-0E25	12640012
			Red				CSW-BIDLF-1E25	12640013
			Green				CSW-BIDLF-2E25	12640014
			Yellow				CSW-BIDLF-3E25	12640015
			Blue				CSW-BIDLF-4E25	12640016
	24 V ac/dc		Colorless				CSW-BIDLF-0E26	12640017
			Red				CSW-BIDLF-1E26	12640038
			Green				CSW-BIDLF-2E26	12640039
			Yellow				CSW-BIDLF-3E26	12640040
			Blue				CSW-BIDLF-4E26	12640041
	48 V ac/dc		Colorless				CSW-BIDLF-0E27	12640042
			Red				CSW-BIDLF-1E27	12640043
			Green				CSW-BIDLF-2E27	12640044
			Yellow				CSW-BIDLF-3E27	12640046
			Blue				CSW-BIDLF-4E27	12640047
	110-130 V ac		Colorless				CSW-BIDLF-0D61	12640048
			Red				CSW-BIDLF-1D61	12640049
			Green				CSW-BIDLF-2D61	12640050
			Yellow				CSW-BIDLF-3D61	12640051
			Blue				CSW-BIDLF-4D61	12640052
	220-240 V ac		Colorless				CSW-BIDLF-0D66	12640053
			Red				CSW-BIDLF-1D66	12640054
			Green				CSW-BIDLF-2D66	12640055
			Yellow				CSW-BIDLF-3D66	12640056
		Blue	CSW-BIDLF-4D66	12640057				
125 V dc		Colorless	CSW-BIDLF-0C13	12640058				
		Red	CSW-BIDLF-1C13	12640059				
		Green	CSW-BIDLF-2C13	12640060				
		Yellow	CSW-BIDLF-3C13	12640061				
		Blue	CSW-BIDLF-4C13	12640062				

Ba9s Socket Lamp Block¹⁾²⁾

Illustrative image	Description	Diagram	Standard packing	Compatible flange	Reference	Code
 0.013 kg	<ul style="list-style-type: none"> - For lamps with Ba9s socket - Maximum voltage 380 V (2 W) - Direct power supply V ac/V dc - Lamp not included <p>Note: Not compatible with CSW double pushbutton2-BD.</p>		1 piece	AF3F AF5F	CSW-BIDF	13262009

Illumination Block with Lamp + Resistor + Diode¹⁾²⁾

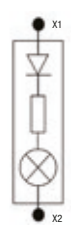
Illustrative image	Description	Diagram	Standard packing	Compatible flange	Reference	Code
 0.016 kg	<ul style="list-style-type: none"> - Block voltage: 220 - 240 Vac - Includes 120/130 V incandescent lamp - Ba9s Socket <p>Note: Not compatible with double pushbutton CSW2-BD.</p>		1 piece	AF3F AF5F	CSW-BIRDF-D66	13262010

Notes: 1) Not compatible with the PBW control stations. Accessories for base or control stations, see pages 36 and 37 of this catalog;
2) It does not allow front-back assembly.

Accessories - Mounting in Flanges - Blue

Voltage Reduction Blocks¹⁾³⁾

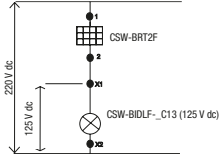
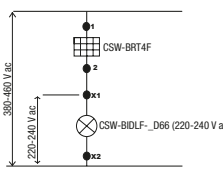
Illustrative image	Description	U _e	Diagram	Standard packing	Compatible flange	Reference	Code
 0.016 kg	For use with integrated LED blocks models: CSW-BIDL-F_C13 (125 V dc)	220 V dc		1 piece	AF3F AF5F	CSW-BRT2F	13275624
	For use with integrated LED blocks models: CSW-BIDL-F_D66 (220-240 V ac)	380-460 V ac				CSW-BRT4F	13275625

Lamps Ba9s





Illustrative image	Voltage	Standard packing	Reference	Code
 0.005 kg	6 V ac/dc	25 pieces	L6VI-E48-0.6 W ²⁾	10045241
	12 V ac/dc	25 pieces	L12VI-E25-1.8 W ²⁾	10046387
	24 V ac/dc	25 pieces	L24VI-E26-2 W ²⁾	10045243
	48 V ac/dc	25 pieces	L48VI-E27-2 W ²⁾	10046462
	60 V ac/dc	25 pieces	L60VI-E28-1.2 W ²⁾	10045244
	130 V ac/dc	25 pieces	L130VI-E30-2 W ²⁾	10409537
	220 V ac/dc	25 pieces	L220VI-E31-2 W ²⁾	10409538

Plate Holder and Plastic Legend Plate Set¹⁾

Illustrative image	Description	Standard packing	Reference	Code
 0.004 kg	Plate holder and plastic legend plate set 27 x 18 mm, no engraved, in black and red for pilot lights, single pushbuttons and selector switches.	5 pieces	APP30 ²⁾	10185880
	Plate holder and plastic legend plate set 27 x 18 mm, no engraved, in black and red for double pushbuttons CSW-BD. Not compatible with CSW2-BD.	5 pieces	APP60 ²⁾	10643837
 0.004 kg	Plate holder and plastic legend plate set 27 x 18 mm, no engraved, colorless for pilot lights, single pushbuttons and selector switches.	5 pieces	APP30T ²⁾	10185886
	Plate holder and plastic legend plate set 27 x 18 mm, no engraved, colorless for double pushbuttons CSW-BD. Not compatible with CSW2-BD.	5 pieces	APP60T ²⁾	10583832
 0.004 kg	Plate holder 27 x 18 mm for pilot lights, single pushbuttons and selector switches.	5 pieces	PP30-CSW ²⁾	11427388
	Plate holder 27 x 18 mm for double pushbutton CSW-BD. Not compatible with CSW2-BD/BT.	5 pieces	PP60-CSW ²⁾	11427391

DIN Rail Adaptor

Illustrative image	Description	Standard packing	Reference	Code
 0.033 kg	Allows 1 pushbutton/pilot light/selector switch to be mounted in a 35 mm DIN Rail. Note: does not allow the use of the following accessories: - Self-monitored contact block (BCM01F-CSW); - Push-on/push-off block (CSW-BRF-3P); - 5 positions mounting flange.	1 piece	DRCSWA	12846896

Notes: 1) Not compatible with the PBW control stations. Accessories for base or control stations, see pages 36 and 37 of this catalog;

2) Unitary weights;

3) It allow front-back assembly.

Accessories - Mounting in Flanges

Emergency - Stop Plate¹⁾

Illustrative image	Description	Standard packing	Reference	Code
 0.009 kg	Legend plate for emergency pushbutton: portuguese - english	5 pieces	APE ²⁾	10045238
	Legend plate for emergency pushbutton: english	5 pieces	APE-02 ²⁾	11315980
	Legend plate for emergency pushbutton: spanish - english	5 pieces	APE-03 ²⁾	10077414

Reduction Ring¹⁾

Illustrative image	Description	Standard packing	Reference	Code
 0.030 kg	Reduction ring from Ø30 mm to Ø22 mm	1 piece	AR30	10187807

Lamp Extraction Tool¹⁾

Illustrative image	Description	Standard packing	Reference	Code
 0.008 kg	Ba9s Lamp Extraction Tool	1 piece	ACEF	10046256

Plastic Shaft¹⁾

Illustrative image	Description	Standard packing	Reference	Code
 0.018 kg	Plastic shaft with length of 250 mm	1 piece	SH250	12470467

Silicone Cover¹⁾

Illustrative image	Description	Standard packing	Reference	Code
 0.010 kg	Additional protection cover for CSW-BD double pushbuttons (IP40) so as to ensure IP66	5 pieces	APBD ²⁾	10046217
	Additional protection cover against solid particles for CSW2-BD double pushbuttons		AP2BD ²⁾	13253639
	Additional protection cover against solid particles for triple CSW2-BT pushbuttons		AP2BT ²⁾	13253640

Notes: 1) Not compatible with the PBW control stations. Accessories for base or control stations, see pages 36 and 37 of this catalog;
2) Unitary weights.

Accessories - Mounting in Flanges

APP30 Plate Holder and 27 x 18 mm Engraved Plastic Legend Plate Set¹⁾²⁾³⁾

For use with single pushbuttons, pilot lights and selector switches



+



Standard packing 5 pieces

0.015 kg

Single pushbuttons and pilot lights											
Reference	Code	Engraving	Reference	Code	Engraving	Reference	Code	Engraving	Reference	Code	Engraving
APP30-204	11654290	HAND	APP30-208	11654721	RIGHT	APP30-215	11654738	AVANÇO	APP30-229	11654747	SUBIR
APP30-205	11654292	AUTO	APP30-209	11654722	LEFT	APP30-216	11654739	RECUO	APP30-230	11654746	BAJAR
APP30-18 ³⁾	10186656	STOP	APP30-210	11654724	INCH	APP30-125	10212524	LIGA	APP30-231	11654745	ADELANTE
APP30-11	10211995	OPEN	APP30-03 ³⁾	10186652	EMERGENCY STOP	APP30-120	10212519	DESLIGA	APP30-232	11654744	REGRESO
APP30-01	10211988	CLOSE	APP30-05	10186653	JOG	APP30-123	10212522	EM OPERAÇÃO	APP30-233	11654743	PARO
APP30-19	10211999	UP	APP30-06	10211991	JOG FORWARD	APP30-217	11654740	INICIAR	APP30-234	11654742	MARCHA
APP30-02	10211989	DOWN	APP30-07	10211992	JOG REVERSE	APP30-218	11654748	RÁPIDO	APP30-218	11654748	RÁPIDO
APP30-04	10211990	FORWARD	APP30-08	10211993	LOWER	APP30-219	11654751	DEVAGAR	APP30-235	11654741	DESPACIO
APP30-15	10186654	REVERSE	APP30-13	10211997	RAISE	APP30-220	11654755	DIREITA	APP30-236	11654758	DERECHA
APP30-10	10212532	ON	APP30-147	10186991	FAULT	APP30-221	11654757	ESQUERDA	APP30-237	11654760	IZQUIERDA
APP30-132	10212531	OFF	APP30-129	10212528	MANUAL	APP30-222	11654756	PARADA DE EMERGÊNCIA	APP30-238	11654761	BAJADA
APP30-12	10211996	POWER ON	APP30-52	10652903	AUTOMÁTICO	APP30-223	11654754	ABAIXAR	APP30-239	11654762	SUBIDA
APP30-14	10212533	RESET	APP30-134	10186620	PARADA	APP30-224	11654753	LEVANTAR	APP30-240	11654765	FALLA
APP30-17	10186655	START	APP30-211	11654725	ABRIR	APP30-225	11654752	FALHA	APP30-201	11654226	O
APP30-16	10211998	RUN	APP30-212	11654723	FECHAR	APP30-226	11654750	AUTOMÁTICA	APP30-202	11654227	I
APP30-206	11654293	FAST	APP30-213	11654726	ACIMA	APP30-211	11654725	ABRIR	APP30-203	11654289	II
APP30-207	11654294	SLOW	APP30-214	11654759	ABAIXO	APP30-228	11654749	CERRAR			

2 - position selector switch											
Reference	Code	Engraving	Reference	Code	Engraving	Reference	Code	Engraving	Reference	Code	Engraving
APP30-21	10212001	HAND AUTO	APP30-24	10212004	OFF ON	APP30-28	10212006	UP DOWN	APP30-244	11654909	AVANÇO RECUO
APP30-27	10186658	START STOP	APP30-25	10186657	OPEN CLOSE	APP30-23	10212003	MAN AUTO	APP30-39	10212589	DES LIG
APP30-20	10212000	FOR REV	APP30-26	10212005	RUN JOG	APP30-243	11654908	LIGA DESLIGA	APP30-250	11654914	PARO ARRANQUE
APP30-22	10212002	JOG RUN									







3 - position selector switch											
Reference	Code	Engraving	Reference	Code	Engraving	Reference	Code	Engraving	Reference	Code	Engraving
APP30-30	10186660	FOR OFF REV	APP30-35	10212010	UP OFF DOWN	APP30-257	11654901	ABERTO 0 AUTO	APP30-261	11654903	SUBIR 0 REGRESSO
APP30-32	10212007	MAN OFF AUTO	APP30-149	10647576	AUTO 0 REV	APP30-258	11654902	ABERTO 0 FECHADO	APP30-262	11654917	AUTO 0 REGRESSO
APP30-33	10212008	OPEN OFF AUTO	APP30-255	11654864	AVANÇO 0 RECUO	APP30-190	10289211	SOBE 0 DESCE	APP30-253	11654898	I 0 II
APP30-34	10212009	OPEN OFF CLOSE	APP30-256	11654865	MANUAL 0 AUTO	APP30-260	11654916	AUTO 0 REVERSO			

Pushbuttons with double											
Reference	Code	Engraving	Reference	Code	Engraving	Reference	Code	Engraving	Reference	Code	Engraving
APP30-36	10186554	ON/OFF	APP30-38	10212012	UP/DOWN	APP30-247	11654911	ACIMA/ABAIXO	APP30-251	11654899	ABRIR/CERRAR
APP30-37	10212011	OPEN/CLOSE	APP30-246	11654863	ABRIR/FECHAR	APP30-248	11654912	LIGA/PARO	APP30-252	11654900	SUBIR/BAJAR

Notes: 1) Other engraving and colors on request. APP60 legend plates are also available under request;
 2) Not compatible with the PBW control stations. Accessories for base or control stations, see pages 36 and 37 of this catalog;
 3) Unitary weights.



Decentralized Control Stations and Accessories

Decentralized Control Stations - Hole Ø22 mm¹⁾

Illustrative image	Number of holes	Color		Standard packing	Reference	Code
		Cover	Base			
 0.114 kg	1	Yellow	Black	1 piece	PBW-1Y	12204334
 0.114 kg					PBW-1	12204335
 0.152 kg	2	Gray			PBW-2	12204336
 0.185 kg	3				PBW-3	12204337
 0.215 kg	4				PBW-4	12204388
 0.276 kg	6				PBW-6	12204389

Accessories - Mounting in Control Stations

Contact Blocks²⁾

Illustrative image	Description	Contacts	Diagram	Standard packing	Reference	Code
 0.015 kg	Base or DIN rail 35mm mounted single contact blocks	1NC		1 piece	BC01B-CSW	12174857
				10 pieces	BC01B-CSWX10 ³⁾	13163056
		1NO		1 piece	BC10B-CSW	12174856
				10 pieces	BC10B-CSWX10 ³⁾	13163057

How to order





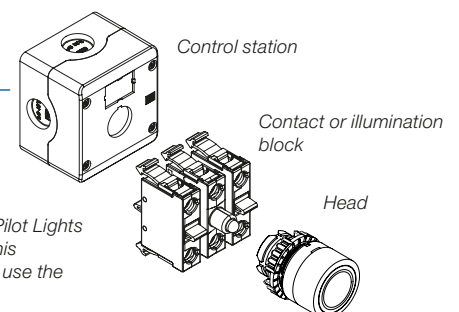



























- Head
- + Contact or illumination blocks
- + Control station

Notes: 1) Compatible with all single pushbuttons, selector switches and pilot lights of the Pushbuttons and Pilot Lights line. It does not allow mounting mushroom pushbuttons side by side with other frontal parts. For this mounting, close hole next to the mushroom button using the ATR accessory. It is not necessary to use the mounting flange for the proper mounting of the frontal parts in the PBW control stations;
2) Specific blocks for base mounting or mounting in PBW control stations or DIN rail 35 mm;
3) Unitary weights.



Accessories - Mounting in Control Stations





Illumination Blocks with Integrated LED¹⁾

Illustrative image	Voltage	Color	Diagram	Standard packing	Reference	Code	
	12 V ac/dc		White		1 piece	CSW-BIDLB-0E25	12195732
			Red			CSW-BIDLB-1E25	12195737
			Green			CSW-BIDLB-2E25	12195839
			Yellow			CSW-BIDLB-3E25	12195840
			Blue			CSW-BIDLB-4E25	12195842
	24 V ac/dc		White			CSW-BIDLB-0E26	12195847
			Red			CSW-BIDLB-1E26	12195918
			Green			CSW-BIDLB-2E26	12195919
			Yellow			CSW-BIDLB-3E26	12195920
			Blue			CSW-BIDLB-4E26	12195921
	48 V ac/dc		White			CSW-BIDLB-0E27	12195922
			Red			CSW-BIDLB-1E27	12195923
			Green			CSW-BIDLB-2E27	12195924
			Yellow			CSW-BIDLB-3E27	12195926
			Blue			CSW-BIDLB-4E27	12195948
	110-130 V ac		White			CSW-BIDLB-0D61	12195949
			Red			CSW-BIDLB-1D61	12195950
			Green			CSW-BIDLB-2D61	12195951
			Yellow			CSW-BIDLB-3D61	12195956
			Blue			CSW-BIDLB-4D61	12195957
	220-240 V ac		White			CSW-BIDLB-0D66	12196008
			Red			CSW-BIDLB-1D66	12196009
			Green			CSW-BIDLB-2D66	12196010
			Yellow			CSW-BIDLB-3D66	12196011
			Blue			CSW-BIDLB-4D66	12196012
	125 V dc		White			CSW-BIDLB-0C13	12196013
			Red			CSW-BIDLB-1C13	12196014
			Green			CSW-BIDLB-2C13	12196015
			Yellow			CSW-BIDLB-3C13	12196016
			Blue			CSW-BIDLB-4C13	12196017

Note: 1) Blocks specific for mounting in base or PBW control stations.

Common Accessories - Mounting in Flanges or Control Stations

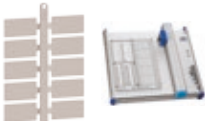





Plastic Legend Plates

Illustrative image	Description	Standard packing	Reference	Code
 0.006 kg	Black and red legend plates 27 x 18 mm, without engraved	5 pieces	AP30 ²⁾	10045237
 0.006 kg	Translucent legend plates 27 x 18 mm without engraved	5 pieces	AP30T ²⁾	10045240
 0.081 kg	White legend plates 27x18 mm, mounted on APP30/60 plate holders or on PBW control stations. It allows engraving by means of WEG plotter. Note: Compatible edition software from version: SB-PW_setup5.0.0056_121012.	15 charts with 10 plates	CAP30 ²⁾	12439346
 0.009 kg	Legend plate for emergency pushbutton Text: portuguese	5 pieces	APEC ²⁾	13050396
	Legend plate for emergency pushbutton Text: english	5 pieces	APEC-02 ²⁾	13050413
	Legend plate for emergency pushbutton Text: spanish	5 pieces	APEC-03 ²⁾	13050408







Fixing Ring Tool

Illustrative image	Description	Standard packing	Reference	Code
 0.017 kg	Fixing ring tool of the fastening ring of the CSW line	1 piece	CAF22	13218642

Lenses for Diffuse Pilot Lights

Illustrative image	Color	Description	Standard packing	Reference	Code
 0.004 kg		Lens to replace the pilot lights color	5 pieces	ALSD0 ²⁾	10185885
				ALSD1 ²⁾	10185881
				ALSD2 ²⁾	10185882
				ALSD3 ²⁾	10185883
				ALSD4 ²⁾	10185884
				ALSD6 ²⁾	12916460

Engraved Illuminated Pushbutton Caps¹⁾

Illustrative image	Description	Function	Standard packing	Reference	Code
 0.006 kg	Engraved internal caps for flush illuminated and extended illuminated pushbutton	 Stop	5 pieces	ALBI30 ²⁾	10211962
		 Start		ALBI31 ²⁾	10211963
		 Rectilinear movement		ALBI32 ²⁾	10211964
		 Clockwise rotation		ALBI33 ²⁾	10211965
		 Counterclockwise rotation		ALBI34 ²⁾	10211966
		 Feed		ALBI35 ²⁾	10211967

Round Plug

Illustrative image	Description	Standard packing	Reference	Code
 0.010 kg	Round plug for unused Ø22 mm holes	5 pieces	ATR ²⁾	10185878







Notes: 1) Other engraving options under request.
2) Unitary weights.

Common Accessories - Mounting in Flanges or Control Stations







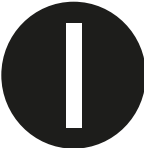

Single Pushbutton Protection

Illustrative image	Description	Standard packing	Reference	Code
 0.010 kg	Silicon additional protective cover for flush pushbuttons (BF) and pilot lights (SD)	5 pieces	APBF ²⁾	10185879
	Silicon additional protective cover for illuminated flush pushbuttons (BF), illuminated extended pushbuttons (BSI) and extended pushbuttons (BS)		APBI ²⁾	10075605

Pushbutton Caps

Illustrative image	Description	Color	Standard packing	Reference	Code
 0.005 kg	Caps to replace the flush pushbuttons colors		5 pieces	ACB0 ²⁾	10071881
				ACB1 ²⁾	10045227
				ACB2 ²⁾	10045228
				ACB3 ²⁾	10045229
				ACB4 ²⁾	10045230
				ACB5 ²⁾	10045226
		All 6 colors	6 pieces	ACB ²⁾	12916461

Engraved Pushbutton Caps¹⁾

Illustrative image	Description	Function	Standard packing	Reference	Code
 0.005 kg	Engraved caps for flush and guarded pushbuttons ¹⁾		5 pieces	ACB1-30 ²⁾	10045231
				ACB5-31 ²⁾	10045232
				ACB5-32 ²⁾	10045233
				ACB5-33 ²⁾	10045234
				ACB5-34 ²⁾	10045235
				ACB5-35 ²⁾	10045236
				ACB4-37 ²⁾	13526353
				ACB4-47 ²⁾	13526354

Contact Blocks Tie

Illustrative image	Description	Standard packing	Compatible blocks	Reference	Code
 0.002 kg	Contact blocks tie to monitor the mechanical assembly together with the CSW-BESGM, CSW-BESPM and CSW-BESYM buttons. Maximum number of contact blocks: 3 BC_F/BC_B blocks Note: - In does not allow overlapping the contacts	1 piece	BC10F BC01F BC10B BC01B	CBCSW	13275381

Emergency Pushbutton Protection³⁾

Illustrative image	Description	Standard packing	Reference	Code
 0.025 kg	Guard to avoid inadvertent touch on the emergency-stop pushbutton.	1 piece	GBES	13263711

Notes: 1) Other engraving on request;

2) Unitary weights;

3) Don't use the emergency pushbutton protection with emergency-stop plate.

Common Accessories - Mounting in Flanges or Control Stations

Plastic Plates 27x18 mm Already Engraved for Use in Empty Control Stations or Plate Holders¹⁾²⁾

START

MANUAL

AUTO

Standard packing 5 piece

0.020 kg

Single pushbuttons and pilot lights											
Reference	Code	Engraving	Reference	Code	Engraving	Reference	Code	Engraving	Reference	Code	Engraving
AP30-204	On request	HAND	AP30-208	On request	RIGHT	AP30-215	On request	AVANÇO	AP30-229	On request	SUBIR
AP30-205	On request	AUTO	AP30-209	On request	LEFT	AP30-216	On request	RECUO	AP30-230	On request	BAJAR
AP30-18 ²⁾	On request	STOP	AP30-210	On request	INCH	AP30-125	12642939	LIGA	AP30-231	On request	ADELANTE
AP30-11	On request	OPEN	AP30-03 ²⁾	On request	EMERGENCY STOP	AP30-120	12642429	DESLIGA	AP30-232	On request	REGRESO
AP30-01	On request	CLOSE	AP30-05	On request	JOG	AP30-123	On request	EM OPERAÇÃO	AP30-233	On request	PARO
AP30-19	On request	UP	AP30-06	On request	JOG FORWARD	AP30-217	On request	INICIAR	AP30-234	On request	MARCHA
AP30-02	On request	DOWN	AP30-07	On request	JOG REVERSE	AP30-218	On request	RÁPIDO	AP30-218	On request	RÁPIDO
AP30-04	On request	FORWARD	AP30-08	On request	LOWER	AP30-219	On request	DEVAGAR	AP30-235	On request	DESPACIO
AP30-15	On request	REVERSE	AP30-13	On request	RAISE	AP30-220	On request	DIREITA	AP30-236	On request	DERECHA
AP30-10	On request	ON	AP30-147	On request	FAULT	AP30-221	On request	ESQUERDA	AP30-237	On request	IZQUIERDA
AP30-132	13724248	OFF	AP30-129	On request	MANUAL	AP30-222	12622820	PARADA DE EMERGENCIA	AP30-238	On request	BAJADA
AP30-12	On request	POWER ON	AP30-52	On request	AUTOMÁTICO	AP30-223	On request	ABAIXAR	AP30-239	On request	SUBIDA
AP30-14	On request	RESET	AP30-134	On request	PARADA	AP30-224	On request	LEVANTAR	AP30-240	On request	FALLA
AP30-17	On request	START	AP30-211	13718112	ABRIR	AP30-225	On request	FALHA	AP30-201	On request	0
AP30-16	On request	RUN	AP30-212	On request	FECHAR	AP30-226	On request	AUTOMÁTICA	AP30-202	On request	I
AP30-206	On request	FAST	AP30-213	On request	ACIMA	AP30-211	On request	ABRIR	AP30-203	On request	II
AP30-207	On request	SLOW	AP30-214	On request	ABAIXO	AP30-228	On request	CERRAR			

2 - position selector switch											
Reference	Code	Engraving	Reference	Code	Engraving	Reference	Code	Engraving	Reference	Code	Engraving
AP30-21	13724250	HAND AUTO	AP30-24	On request	OFF ON	AP30-28	On request	UP DOWN	AP30-244	On request	AVANÇO RECUO
AP30-27	On request	START STOP	AP30-25	On request	OPEN CLOSE	AP30-23	On request	MAN AUTO	AP30-39	On request	DES LIG
AP30-20	On request	FOR REV	AP30-26	On request	RUN JOG	AP30-243	12720641	LIGA DESLIGA	AP30-250	On request	PARO ARRANQUE
AP30-22	On request	JOG RUN									

3 - position selector switch											
Reference	Code	Engraving	Reference	Code	Engraving	Reference	Code	Engraving	Reference	Code	Engraving
AP30-30	On request	FOR OFF REV	AP30-35	On request	UP OFF DOWN	AP30-257	On request	ABERTO 0 AUTO	AP30-261	On request	SUBIR 0 REGRESSO
AP30-32	On request	MAN OFF AUTO	AP30-149	On request	AUTO 0 REV	AP30-258	On request	ABERTO 0 FECHADO	AP30-262	On request	AUTO 0 REGRESSO
AP30-33	On request	OPEN OFF AUTO	AP30-255	On request	AVANÇO 0 RECUO	AP30-190	On request	SOBE 0 DESCE	AP30-253	On request	I 0 II
AP30-34	On request	OPEN OFF CLOSE	AP30-256	On request	MANUAL 0 AUTO	AP30-260	On request	AUTO 0 REVERSO			

Notes: 1) Other engraving on request;
2) Unitary weights.

Assembled Units - Ø22 mm

Button with Shaft

Illustrative image	Description	Reference	Code	Weight (kg)
	Flush pushbutton - Blue - "RESET" Engraved - With 22.5 mm to 250 mm long shaft	CSW-BHF437	12471376	0.045

Non-Illuminated Pushbuttons

Illustrative image	Description	Reference	Code	Weight (kg)
	Flush pushbutton - Black - 1 NO	CSW-BF5-10000000-3VF	12923176	0.041
	Flush pushbutton - Blue - Engraving: "RESET" - 1 NO	CSW-BF437-10000000-3VF	12922280	
	Flush pushbutton - Blue - 1 NO	CSW-BF4-10000000-3VF	12923199	
	Flush pushbutton - Yellow - 1 NO	CSW-BF3-10000000-3VF	12930986	
	Flush pushbutton - Green - 1 NO	CSW-BF2-10000000-3VF	12923177	
	Flush pushbutton - Red - 1 NC	CSW-BF1-01000000-3VF	12922955	
	Mushroom pushbutton - Green - 1 NO	CSW-BC2-10000000-3VF	12930987	0.044
	Mushroom pushbutton - Red - 1 NO	CSW-BC1-01000000-3VF	12931019	
	Emergency-stop pushbutton - Twist Release - 3 NC monitored	CSW-BESG-00000003-3VF	13312574	0.277
	Emergency-stop pushbutton - Twist Release - 2 NC monitored	CSW-BESG-00000002-3VF	13312575	0.204
	Emergency-stop pushbutton - Twist Release - 1 NC monitored	CSW-BESG-00000001-3VF	13278311	0.077
	Emergency-stop pushbutton - Pull Release - 3 NC monitored	CSW-BESP-00000001-3VF	13278309	
	Flush Double pushbutton IP40 - Green (Engraved:"I") and Red (Engraved:"O") - 1 NO + 1 NC	CSW-BD-11000000-3VF	12923175	0.055
	Flush Double pushbutton IP66 - Green (Engraved:"I") and Red (Engraved:"O") - 1 NO + 1 NC	CSW2-BDF2110-11000000-3VF	12756198	

Illuminated Pushbuttons

Illustrative image	Description	Reference	Code	Weight (kg)
	Illuminated flush double pushbutton IP40 - Green (Engraved:"I") and Red (Engraved:"O") - 220-240 V ac - 1 NO + 1 NC	CSW-BD-11000000-FD661-3VF	12923174	0.055
	Illuminated flush double pushbutton IP40 - Green (Engraved:"I") and Red (Engraved:"O") - 110-130 V ac - 1 NO + 1 NC	CSW-BD-11000000-FD611-3VF	12931024	
	Illuminated flush double pushbutton IP40 - Green (Engraved:"I") and Red (Engraved:"O") - 125 V dc - 1 NO + 1 NC	CSW-BD-11000000-FC131-3VF	12931026	
	Illuminated flush double pushbutton IP40 - Green (Engraved:"I") and Red (Engraved:"O") - 24 V ac/dc - 1 NO + 1 NC	CSW-BD-11000000-FE261-3VF	12931058	
	Illuminated flush double pushbutton IP66 - Green (Engraved:"I") and Red (Engraved:"O") - 220-240 V ac - 1 NO + 1 NC	CSW2-BDF2110-11000000-FD661-3VF	12931201	0.054
	Illuminated flush pushbutton - Red - 220-240 V ac - 1 NC	CSW-BF11-01000000-FD66-3VF	12931064	
	Illuminated flush pushbutton - Red - 24 V ac/dc - 1 NC	CSW-BF11-01000000-FE26-3VF	12931066	
	Illuminated flush pushbutton - Green - 220-240 V ac - 1 NO	CSW-BF12-10000000-FD66-3VF	12931067	
	Illuminated flush pushbutton - Green - 24 V ac/dc - 1 NO	CSW-BF12-10000000-FE26-3VF	12931090	
	Illuminated flush pushbutton - Yellow - 24 V ac/dc - 1 NO	CSW-BF13-10000000-FE26-3VF	12931092	
	Illuminated flush pushbutton - Blue - 24 V ac/dc - 1 NO	CSW-BF14-10000000-FE26-3VF	12931093	
	Extended flush pushbutton - Green - 220-240 V ac - 1 NO	CSW-BSI2-10000000-FD66-3VF	12931094	

Non-Illuminated Selector Switch

Illustrative image	Description	Reference	Code	Weight (kg)
	Selector switch knob - Black - 2 fixed positions - 45° - 1 NO	CSW-CK2F45-10000000-3VF	12923170	0.046
	Selector switch knob - Black - 2 fixed positions - 90° - 1 NO + 1 NC	CSW-CK2F90-11000000-3VF	12923198	0.057
	Selector switch knob - Black - 2 fixed positions - 90° - 1 NO	CSW-CK2F90-10000000-3VF	12923253	0.046
	Selector switch knob - Black - 2 fixed positions - 90° - 2 NO	CSW-CK2F90-20000000-3VF	12931095	0.057
	Selector switch knob - Black - 2 fixed positions - 45° - 1 NO + 1 NC	CSW-CK2F45-11000000-3VF	12931096	
	Selector switch knob - Black - 3 positions return - 45° - 2 NO	CSW-CK3R45-20000000-3VF	12923020	
	Selector switch knob - Black - 3 fixed positions - 45° - 2 NO	CSW-CK3F45-20000000-3VF	12923168	

Assembled Units - Ø22 mm

Illuminated Selector Switch

Illustrative image	Description	Reference	Code	Weight (kg)
	Illuminated selector switch - Red - 2 fixed positions - 90° - 1 NO - 220-240 V ac	CSW-CKI2F901-10000000-FD66-3VF	12930906	0.053
	Illuminated selector switch - Green - 2 fixed positions - 90° - 1 NO - 220-240 V ac	CSW-CKI2F902-10000000-FD66-3VF	12930907	
	Illuminated selector switch - Green - 2 fixed positions - 90° - 1 NO - 110-130 V ac	CSW-CKI2F902-10000000-FD61-3VF	12930958	
	Illuminated selector switch - Red - 2 fixed positions - 90° - 1 NO - 110-130 V ac	CSW-CKI2F901-10000000-FD61-3VF	12930960	
	Illuminated selector switch - Red - 2 fixed positions - 90° - 2 NO - 220-240 V ac	CSW-CKI2F901-20000000-FD66-3VF	12930961	0.063
	Illuminated selector switch - Red - 2 fixed positions - 90° - 1 NO - 24 V ac/dc	CSW-CKI2F901-10000000-FE26-3VF	12930962	0.053
	Illuminated selector switch - Red - 2 fixed positions - 90° - 1 NC - 220-240 V ac	CSW-CKI2F901-10000000-FD66-3VF	12930906	
	Illuminated selector switch - Green - 2 fixed positions - 90° - 1 NO - 24 V ac/dc	CSW-CKI2F902-10000000-FE26-3VF	12930965	
	Illuminated selector switch - Red - 3 fixed positions - 45° - 2 NO - 110-130 V ac	CSW-CKI3F451-20000000-FD61-3VF	12930980	
	Illuminated selector switch - Green - 3 fixed positions - 45° - 2 NO - 110-130 V ac	CSW-CKI3F452-20000000-FD61-3VF	12930981	0.063
	Illuminated selector switch - Green - 3 fixed positions - 45° - 2 NO - 24 V ac/dc	CSW-CKI3F452-20000000-FE26-3VF	12930982	
	Illuminated selector switch - Red - 3 positions return - 45° - 1 NO + 1 NC - 220-240 V ac	CSW-CKI3R451-11000000-FD66-3VF	12930983	
	Illuminated selector switch - Red - 3 fixed positions - 45° - 2 NO - 220-240 V ac	CSW-CKI3F451-20000000-FD66-3VF	12930984	
	Illuminated selector switch - Green - 3 fixed positions - 45° - 2 NO - 220-240 V ac	CSW-CKI3F452-20000000-FD66-3VF	12930985	

Modular Pilot Lights with LED Blocks

Illustrative image	Description	Reference	Code	Weight (kg)
	White diffuse pilot light - LED Block 24 V ac/dc - White	CSW-SD0-FE26-3VF	12930828	0.039
	Red diffuse pilot light - LED Block 24 V ac/dc - Red	CSW-SD1-FE26-3VF	12930829	
	Green diffuse pilot light - LED Block 24 V ac/dc - Green	CSW-SD2-FE26-3VF	12930830	
	Yellow diffuse pilot light - LED Block 24 V ac/dc - Yellow	CSW-SD3-FE26-3VF	12930831	
	Blue diffuse pilot light - LED Block 24 V ac/dc - Blue	CSW-SD4-FE26-3VF	12930832	
	Orange diffuse pilot light - LED Block 24 V ac/dc - Orange	CSW-SD6-FE26-3VF	12930833	
	White diffuse pilot light - LED Block 48 V ac/dc - White	CSW-SD0-FE27-3VF	12930834	
	Red diffuse pilot light - LED Block 48 V ac/dc - Red	CSW-SD1-FE27-3VF	12930835	
	Green diffuse pilot light - LED Block 48 V ac/dc - Green	CSW-SD2-FE27-3VF	12930836	
	Yellow diffuse pilot light - LED Block 48 V ac/dc - Yellow	CSW-SD3-FE27-3VF	12930837	
	Blue diffuse pilot light - LED Block 48 V ac/dc - Blue	CSW-SD4-FE27-3VF	12930878	
	Orange diffuse pilot light - LED Block 48 V ac/dc - Orange	CSW-SD6-FE27-3VF	12930879	
	White diffuse pilot light - LED Block 110-130 V ac - White	CSW-SD0-FD61-3VF	12930880	
	Red diffuse pilot light - LED Block 110-130 V ac - Red	CSW-SD1-FD61-3VF	12930881	
	Green diffuse pilot light - LED Block 110-130 V ac - Green	CSW-SD2-FD61-3VF	12930882	
	Yellow diffuse pilot light - LED Block 110-130 V ac - Yellow	CSW-SD3-FD61-3VF	12930883	
	Blue diffuse pilot light - LED Block 110-130 V ac - Blue	CSW-SD4-FD61-3VF	12930884	
	Orange diffuse pilot light - LED Block 110-130 V ac - Orange	CSW-SD6-FD61-3VF	12930885	
	White diffuse pilot light - LED Block 125 V dc - White	CSW-SD0-FC13-3VF	12930886	
	Red diffuse pilot light - LED Block 125 V dc - Red	CSW-SD1-FC13-3VF	12930887	
	Green diffuse pilot light - LED Block 125 V dc - Green	CSW-SD2-FC13-3VF	12930898	
	Yellow diffuse pilot light - LED Block 125 V dc - Yellow	CSW-SD3-FC13-3VF	12930899	
	Blue diffuse pilot light - LED Block 125 V dc - Blue	CSW-SD4-FC13-3VF	12930900	
	Orange diffuse pilot light - LED Block 125 V dc - Orange	CSW-SD6-FC13-3VF	12930901	
	White diffuse pilot light - LED Block 220-240 V ac - White	CSW-SD0-FD66-3VF	12930902	
	Red diffuse pilot light - LED Block 220-240 V ac - Red	CSW-SD1-FD66-3VF	12923060	
	Green diffuse pilot light - LED Block 220-240 V ac - Green	CSW-SD2-FD66-3VF	12923059	
	Yellow diffuse pilot light - LED Block 220-240 V ac - Yellow	CSW-SD3-FD66-3VF	12930903	
	Blue diffuse pilot light - LED Block 220-240 V ac - Blue	CSW-SD4-FD66-3VF	12930904	
	Orange diffuse pilot light - LED Block 220-240 V ac - Orange	CSW-SD6-FD66-3VF	12930905	

Emergency-Stop Pushbuttons on Decentralized Control Station¹⁾

Illustrative image	Control station	Emergency-stop pushbutton	Contact blocks	Engraved plate	Reference	Code	Weight
	PBW-1Y	CSW-BESGM	1NA + 1NF	"EMERGENCY STOP"	PBW1Y-GM11P03	13232101	0.212
	PBW-1Y	CSW-BESGM	1NA + 2NF	"EMERGENCY STOP"	PBW1Y-GM12P03	13232498	0.212

Note: 1) Other configurations on request.

Coding

Set With Head Type Selector

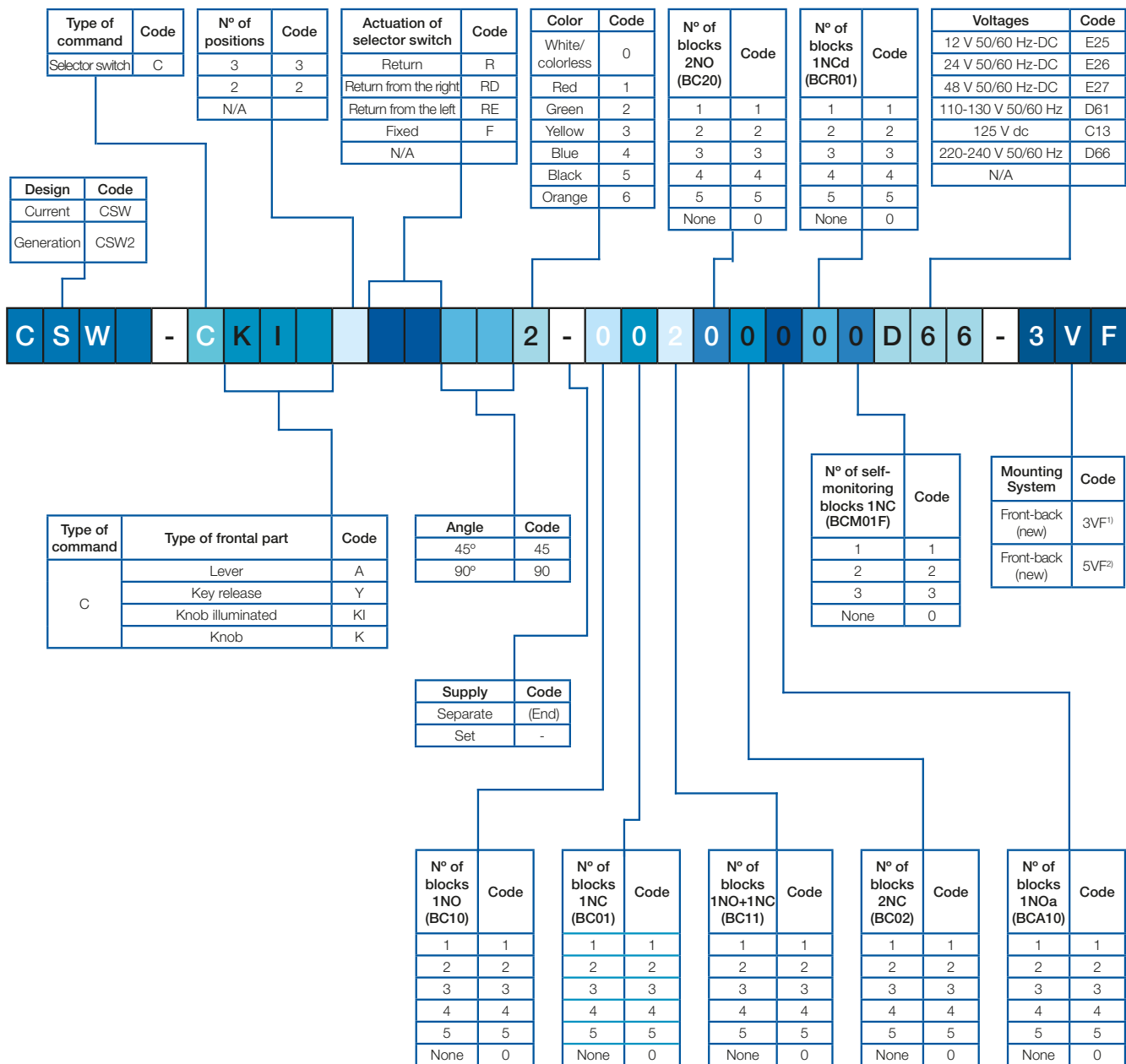

Notes: 1) Flange AF3F (3 positions).
2) Flange AF5F (5 positions).

Coding

Set With Head Type Button and Diffuse

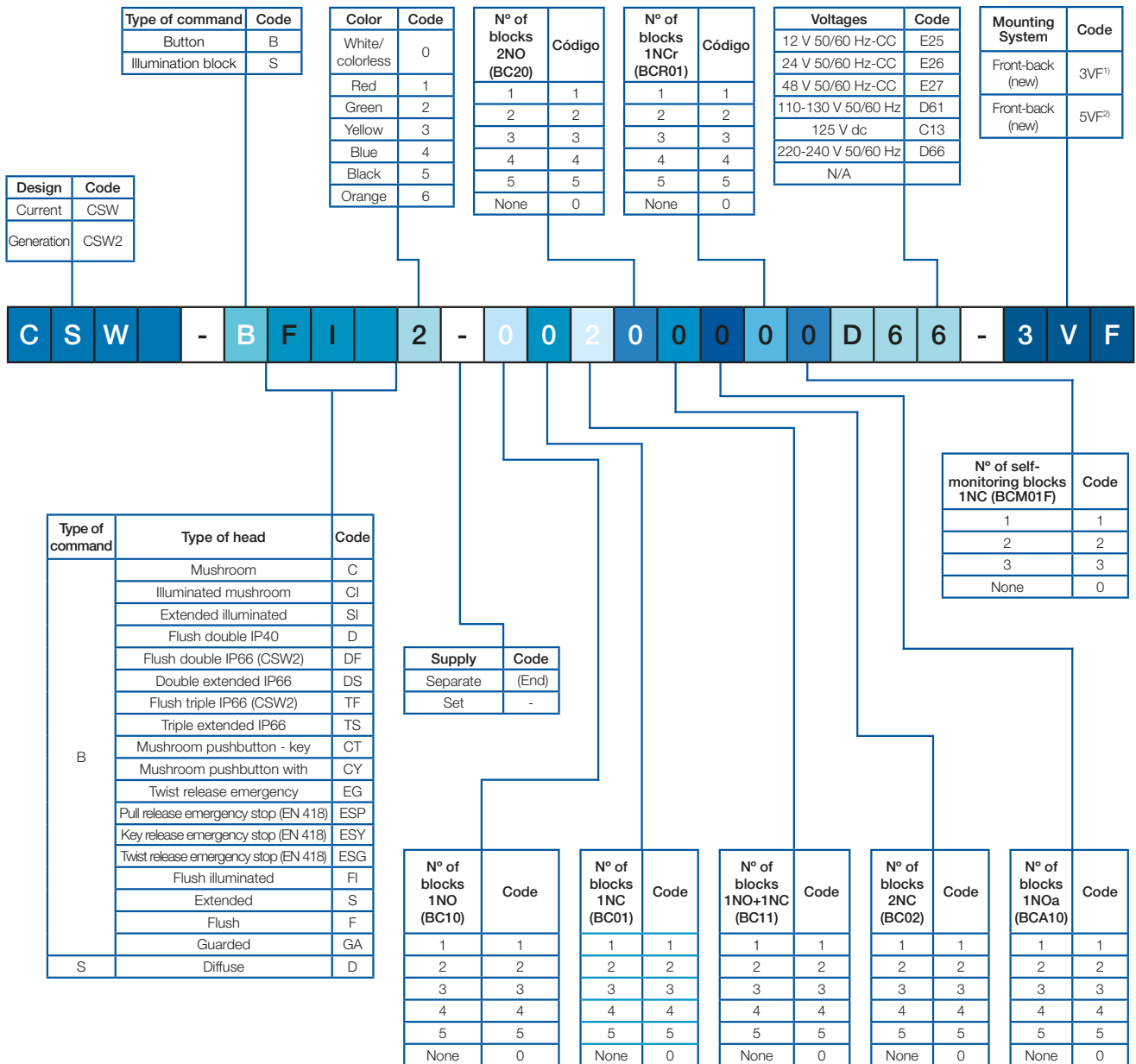

Notes: 1) Flange AF3F (3 positions).
 2) Flange AF5F (5 positions).
 This table is not allow to head type selector.

Technical Data

Buttons, Commutators and Signal Lights

Applicable standards	IEC 60947-5-1, VDE 0660, UL 508, CENELEC EN 50007, ISO 13850 (EN 418), IEC 60947-5-5
Certifications	CE, cULus, BV, IRAM, PCT, RCC, ICONTEC
Degree of protection	IP66 and IP40 (CSW-BD) according to IEC 60529 NEMA1, 2, 3, 3R, 3S, 4, 4X, 5, 12, 12K and 13 according to UL 508
Materials of the frontal parts	Polyamide (PA66) or Polycarbonate (PC)
Mechanical life	
Pushbuttons	3 x 10 ⁶ operations
CSW2-BD e CSW2-BT pushbuttons	2 x 10 ⁶ operations
CSW-BEG/EY/CT/CY pushbuttons	3 x 10 ⁵ operations
CSW-BESG/P/Y emergency-stop pushbuttons	1 x 10 ⁵ operations
Selector switches	1 x 10 ⁶ operations
Use in environments	Outdoors (UV rays) or indoors

Contact Blocks

Applicable standards	IEC 60947-5-1, VDE 0660, UL 508, CENELEC EN 50007, ISO 13850 (EN 418), IEC 60947-5-5			
Certifications	CE, cULus, BV, IRAM, PCT, RCC, ICONTEC			
Rated insulation voltage U _i	690 V			
Rated impulse withstand voltage U _{imp}	4 kV			
Degree of protection (IEC 60529)	IP20			
Conventional thermal current I _{th}	10 A			
Electrical performance according to IEC 60947-5-1				
Utilization category AC-15	BC...-CSW		BCM01-CSW	
	U _e (V ac)	I _e (A)	U _e (V ac)	I _e (A)
	24	10	24	6
	48	10	48	6
	60	10	60	6
	110	6	110	6
	220	3	220	3
	380	2	380	2
Utilization category DC-13	BC...-CSW		BCM01-CSW	
	U _e (V dc)	I _e (A)	U _e (V dc)	I _e (A)
	24	2.5	24	2.5
	48	1.4	48	1.4
	60	1	60	1
	110	0.55	110	0.55
	220	0.27	220	0.27
	300	0.2	300	0.2
600	0.1	600	0.1	
Performance according to UL and CSA	AC / Heavy Duty (A600) e DC / Standard Duty (Q600)		-	
Resistance of the contacts (IEC 60255)	≤ 25m Ω			
Protection against short circuit (IEC 60269-1 / IEC 60269-3)	BC...-CSW: Fuse of 16 A / 690 V gL/gG (1 kA) Mini-circuit breaker of 16 A (MDW-B16)		Fuse of 6 A / 500 V gL/gG (0.5 kA) Mini-circuit breaker of 6 A (MDW-B6)	
	BC...F-CSW (Front-back) and BC...B-CSW (Control Stations): Fuse of 10 A / 690 V gL/gG (1 kA) Mini-circuit breaker of 10 A (MDW-B10)			
Protection against electric shock (IEC 60536)	Class II			
Section of the conductors (wire/cable with or without terminal)	Minimum (1 x 0.5 mm ²) and maximum (2 x 2.5 mm ²)			
Tightening torque	0.8 N.m			
Working temperature range	-25 °C...+70 °C			
Resistance to mechanical shock	Without damages or disassembly 100 g (1/2 sinusoidal 11ms, according to MIL 202 B method 202 A)			
Resistance to vibration (IEC 60068-2-6)	16 g for a frequency range from 40 to 500 Hz. Maximum displacement 0.75 mm (peak to peak)			
Mechanical endurance of contact blocks BC10F / BC01F / BCA10F / BCR01F	1 x 10 ⁶ operating cycles			

Technical Data

Illumination Blocks with Integrated LED BIDL

Applicable standards	IEC 60947-5-1, UL 508
Voltage range for operation	0.85...1.10 x U _e
Degree of protection (IEC 60529)	IP20
Consumption (V ac/V dc)	10 mA
Rated impulse withstand voltage U _i (IEC 60947-1)	2.5 kV
Working temperature range	- 25 °C...+70 °C
Average useful life	100.000 hours
Brightness	Red 70 mcd
	Yellow 115 mcd
	White 275 mcd
	Blue 64 mcd
	Green 150 mcd
Section of the conductors (wire/cable with or without terminal)	Minimum (1 x 0.5 mm ²) and maximum (2 x 2.5 mm ²)
Tightening torque	0.8 N.m

Special Blocks (Illumination, Sockets, Voltage Reduction)

Applicable standards	IEC 60947-5-1, UL 508
Degree of protection (IEC 60529)	IP20
Rated impulse withstand voltage U _i (IEC 60947-1)	4 kV
Working temperature range	- 25 °C...+70 °C
Section of the conductors (wire/cable with or without terminal)	Minimum (1 x 0.5 mm ²) and maximum (2 x 2.5 mm ²)
Tightening torque	0.8 N.m

Empty Plastic Control Station

Applicable standards	IEC 60947-5-1, IEC 50102, IEC 60529, UL 508, UL 50
Certifications	CE
Degree of protection (IEC 60529)	IP66 (NEMA 4X)
Working temperature range	-25 °C...+70 °C
Material	Polycarbonate (cover and base)
Color of the cover	Grey (RAL 7035) or yellow (RAL 1003)
Color of the base	Black (RAL 9005)
Cable gland inputs	ØM20 / PG13.5 / 1/2" e ØM16 / 3/8"
Use in environments	Outdoors (UV rays) or indoors

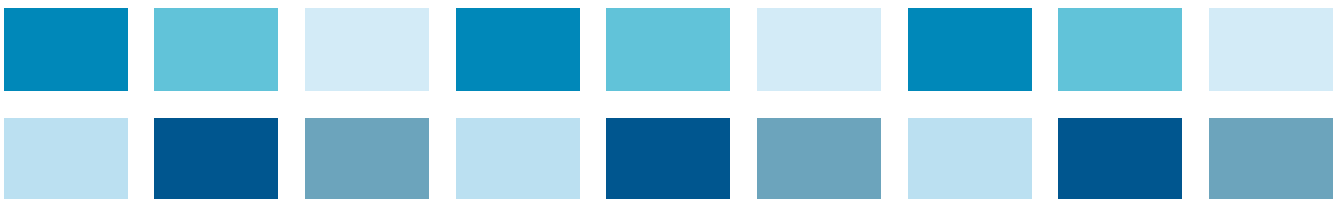

Assembly Configurations

Maximum Recommended Configuration of Contact Blocks for Each Type of Head and Flange

Type of head	Illuminated selector	Selectors	Illuminated pushbuttons	
Reference	CSW-CKI	CSW-CK, CSW-CA, CSW-CY	CSW2-BDFI, CSW2-BDSI	CSW-BCI, CSW-BD, CSW-BFI, CSW-BSI
Maximum number of contacts	Max 4	Max 6	Max 4	Max 6
AF3F flange (3 positions)				
Maximum number of contacts	Max	Max 6	Max 4	Max 6
AF5 flange (5 positions) ¹⁾				

Type of head	Non-illuminated						
Reference	CSW-BESGM, CSW-BESPM, CSW-BESYM	CSW-BESG, CSW-BESP, CSW-BESY	CSW2-BDF, CSW2-BDS	CSW-BF, CSW-BGA	CSW-BC, CSW-BS	CSW-BEG, CSW-BEY, CSW-BCT, CSW-BCY	CSW2-BT
Maximum number of contacts	Max 3	Max 4	Max 4	Max 6	Max 6	Max 6	Max 7
AF3F flange (3 positions)							
Maximum number of contacts	-	Max 4	Max 4	Max 6	Max 6	Max 6	-
AF5 flange (5 positions) ²⁾	-	-					-

Contact blocks BC10F-CSW
 Contact blocks BC01F-CSW

Self-monitoring contact blocks BCM01-CSW

Location not permitted

Illumination blocks BIDL

CBCSW contact blocks tie

Notes: 1) In the central position of flange AF5F use only illumination block;
 2) Not use self-monitoring contact block with flange AF5F;
 Not use emergency pushbuttons with flange AF5F.

Installation and Mounting

Installation on Flange

Fitting and Positioning

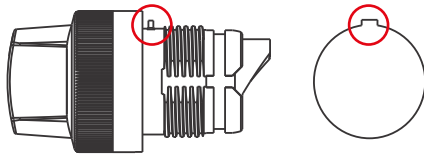

Latch on the body of the frontal part and holes with slot will prevent the rotation of the frontal part during its mounting or operation.

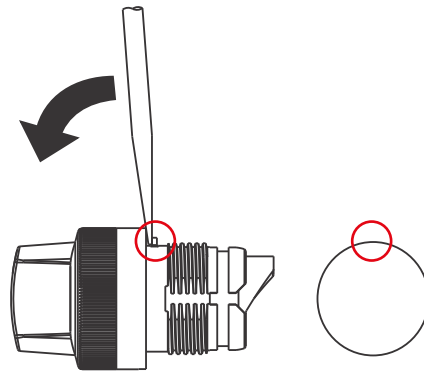

Latch on the body of the frontal part can be removed for installation in round hole, but it may rotate.

Mounting

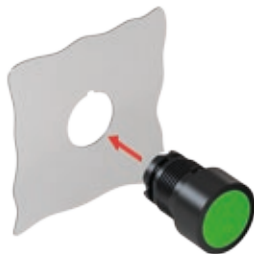

Install the frontal part without fastening nut.



Screw the fastening nut.



Tighten with the fastening wrench.

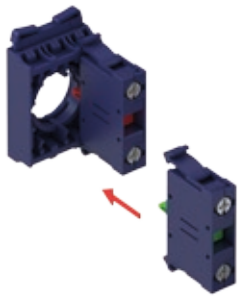

Fit the blocks onto the flange.

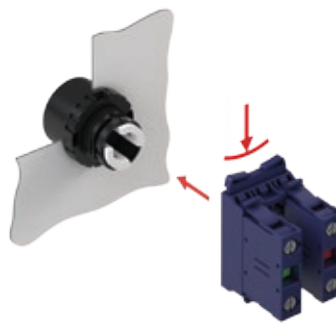

Press the snap fit to connect the flange to the frontal part.

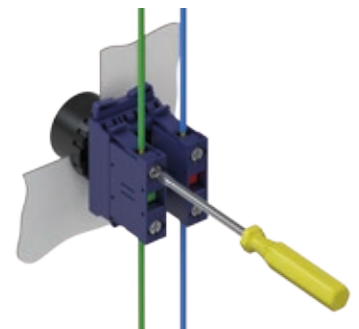

Make electric wiring.

Disassembly

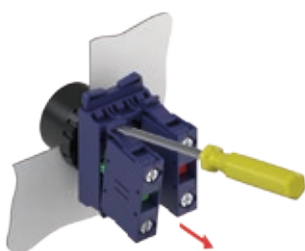

Place the screwdriver at the ends of the block so as to disconnect it from the flange.



Press the snap fit to remove the flange from the frontal part.

Installation and Mounting

Installation in PBW Control Stations

Fitting and Positioning

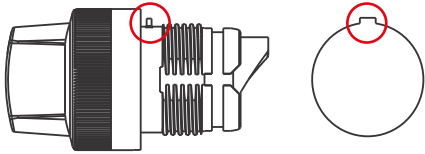

Latch on the body of the frontal part and slot on the holes of the PBW control stations will prevent the rotation of the frontal part during its mounting or operation.

Mounting



Install the frontal part without fastening nut.



Screw the fastening nut.

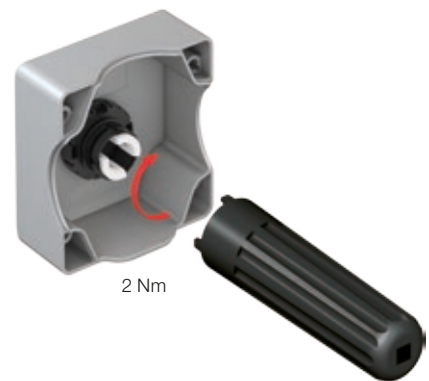

Tighten with the fastening wrench.

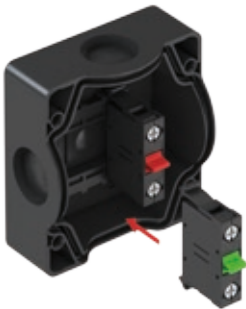

Fit the blocks on the control station base.

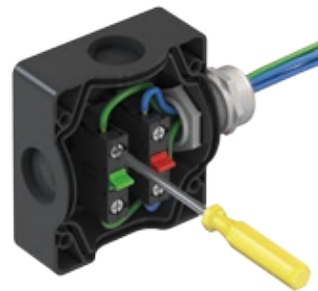

Make electric wiring.

Disassembly



Place the screwdriver at the ends of the block so as to disconnect it from the flange.

Dimensions (mm)

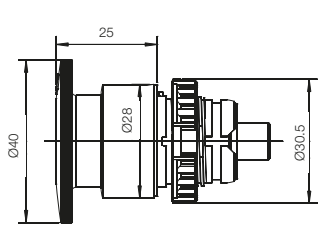

BEG
BCT

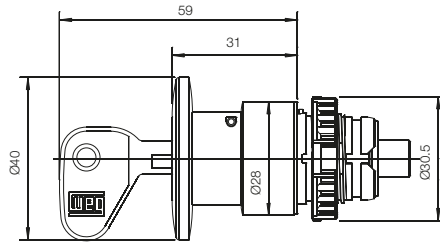

BEY
BCY

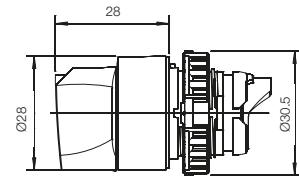

CK

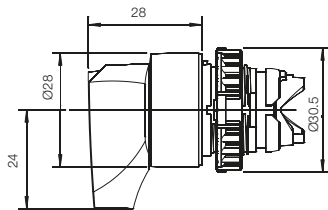

CA

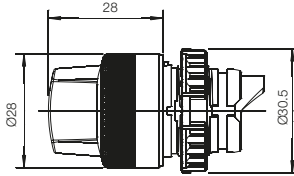

CKI

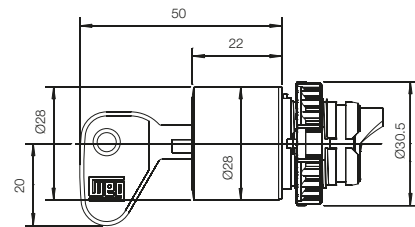

CY

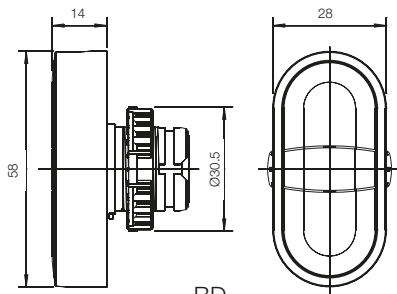

BD

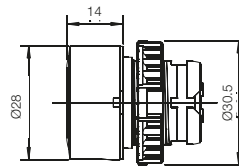

BF

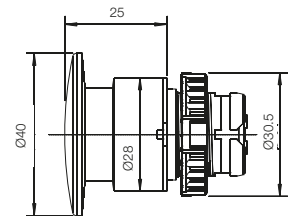

BC
BCI

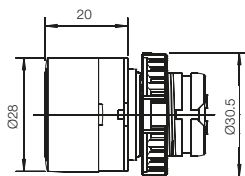

BFI
BGA

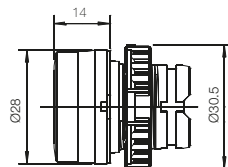

SD

Dimensions (mm)

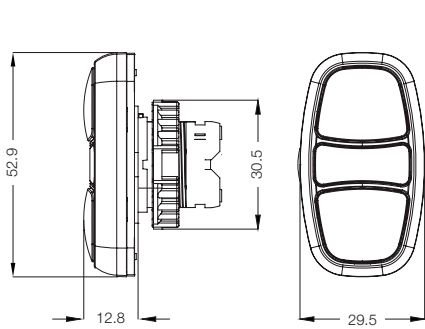

CSW2-BDF

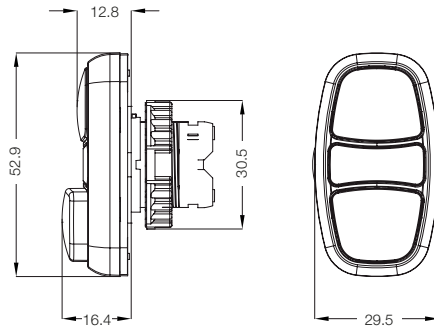

CSW2-BDS

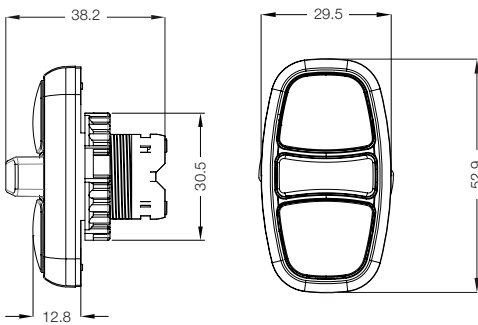

CSW2-BTF

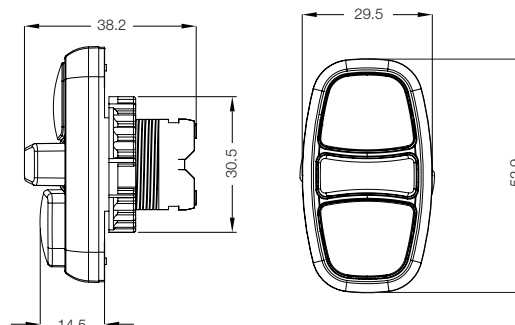

CSW2-BTS

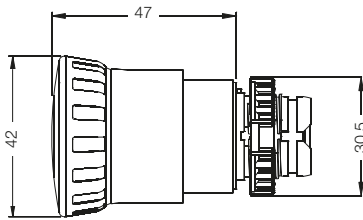

BESG

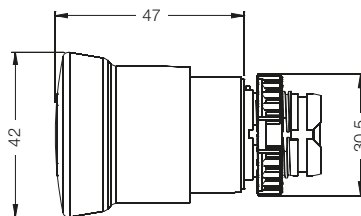

BESP

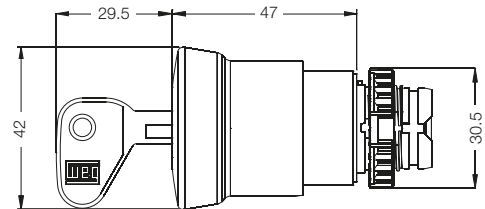

BESY

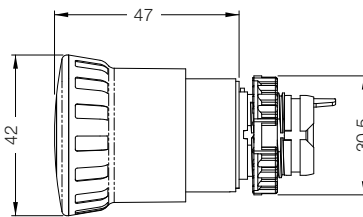

BESGM

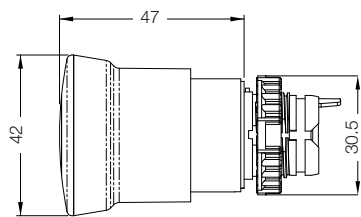

BESPM

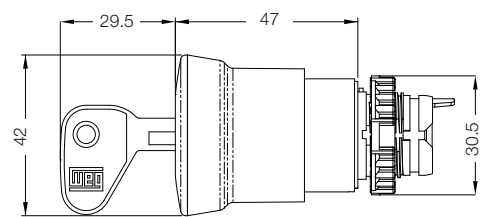

BESYM

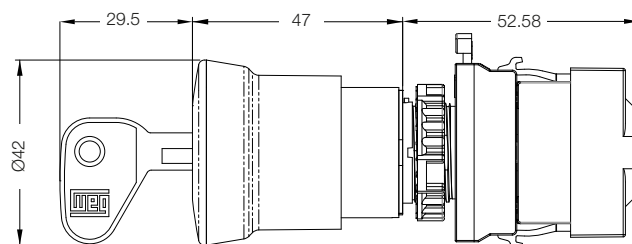

ES_M + Contact blocks BC10F/BC01F + CBCSW Tie

Dimensions (mm)

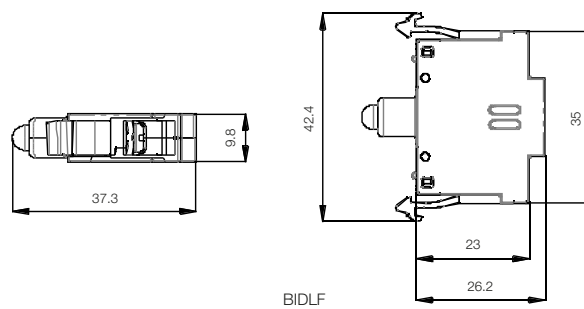
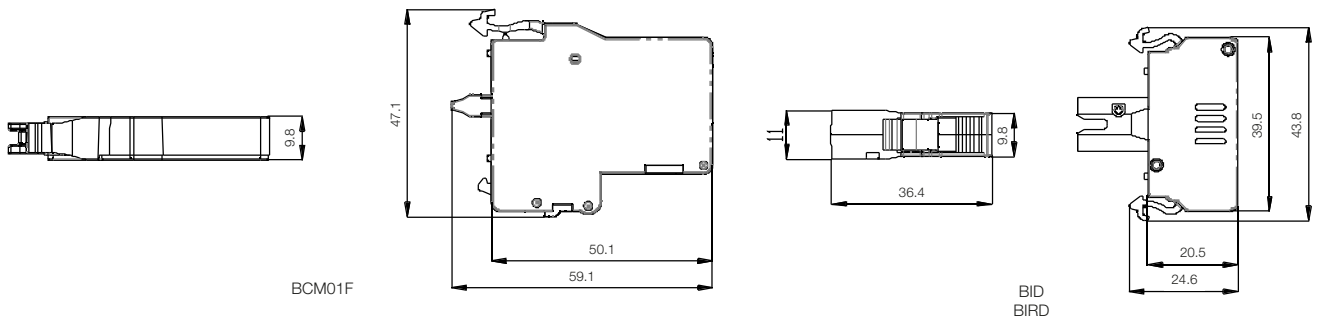
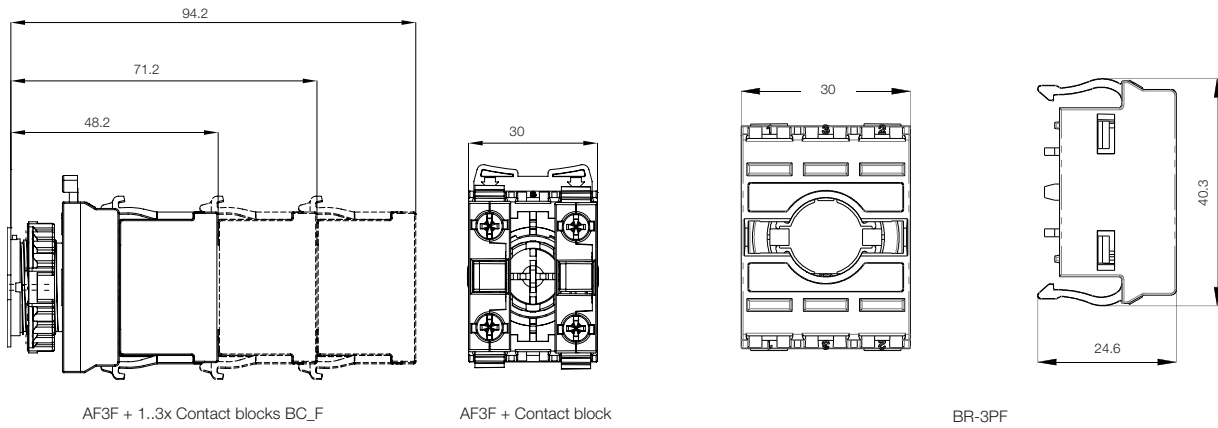
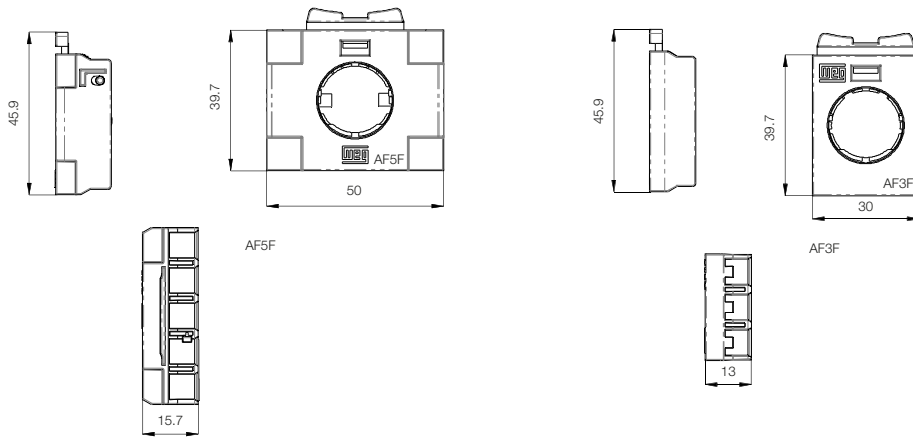

Dimensions (mm)

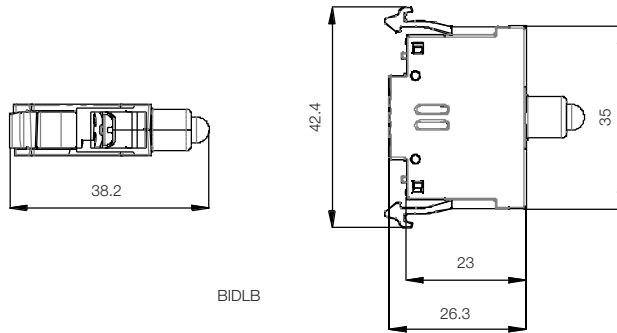

BIDLB

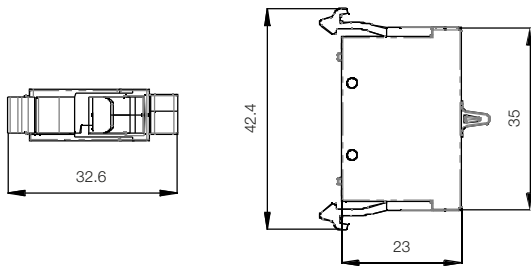

BC10B
BC01B

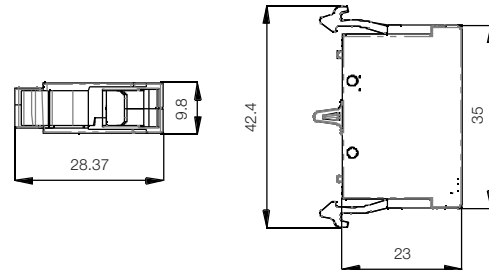

BC10F
BC01F

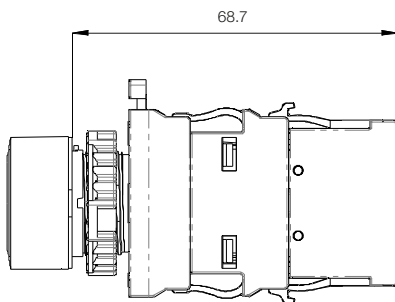

AF3F + BR - 3PF + BIDLF + BCA10F

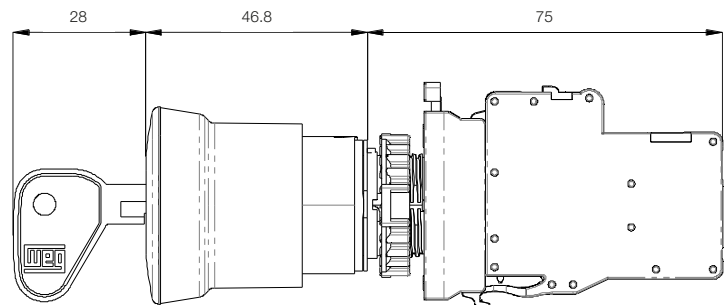

BESY + BCM01 - CSW

Dimensions (mm)

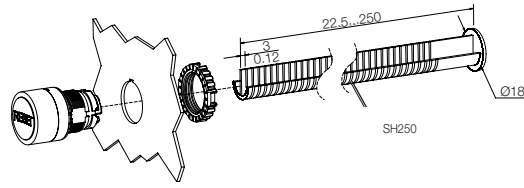

CSW-BHF437

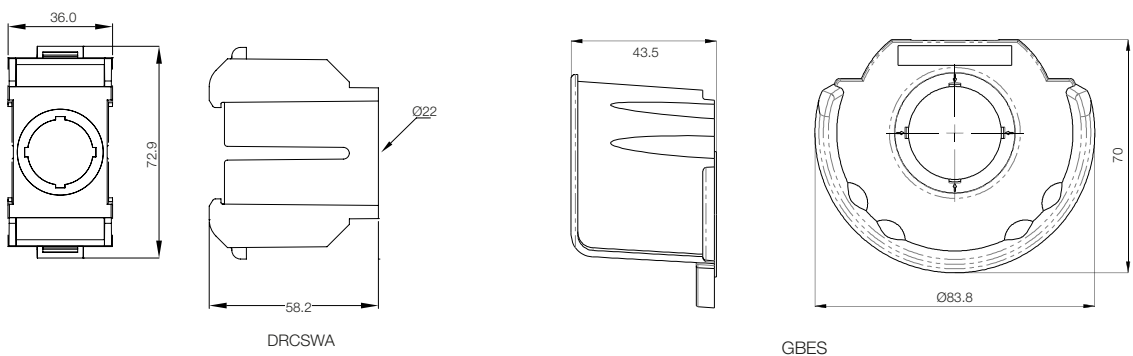
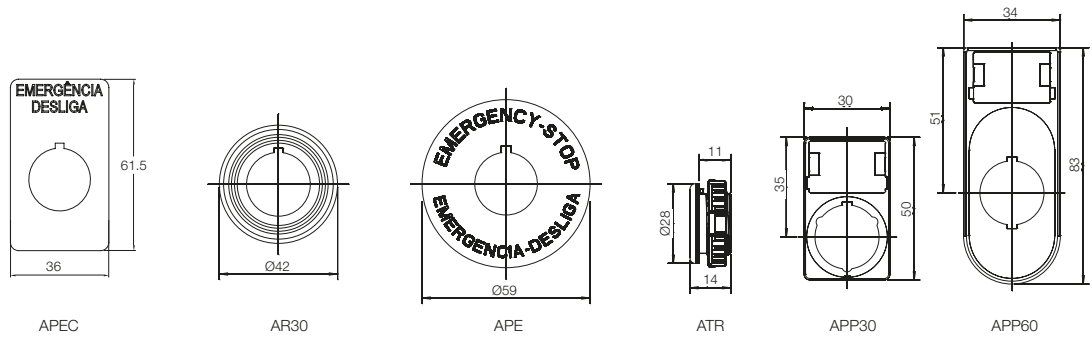
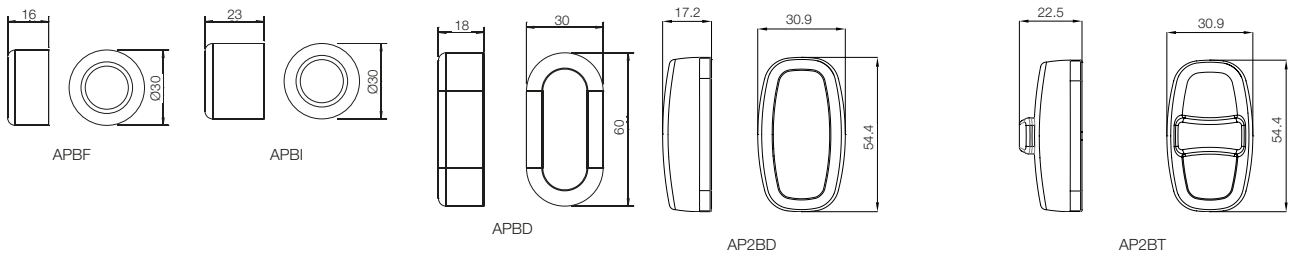

Dimensions (mm)

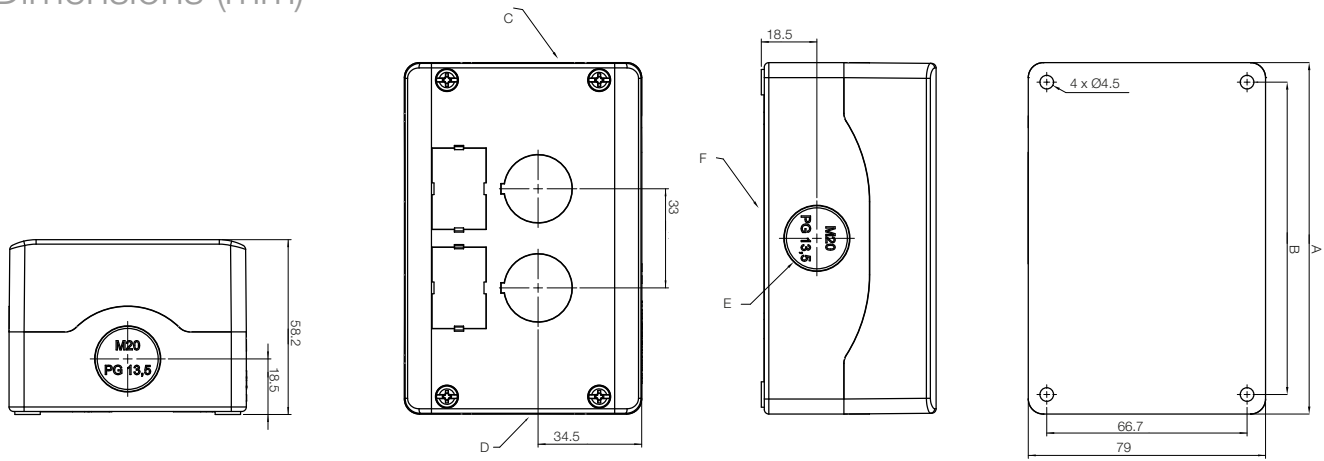

PBW empty control stations

Number of holes	A	B	Cable gland input			
			C (lower)	D (upper)	E (side)	F (base)
1	74	66.7	1x ØM20/PG13.5	1x ØM20/PG13.5	1x ØM20/PG13.5	2x ØM16
2	117	104	1x ØM20/PG13.5	1x ØM20/PG13.5	1x ØM20/PG13.5	2x ØM16
3	150	137	1x ØM20/PG13.5	1x ØM20/PG13.5	2x ØM20/PG13.5	2x ØM16
4	183	170	1x ØM20/PG13.5	1x ØM20/PG13.5	2x ØM20/PG13.5	2x ØM16
6	249	236	1x ØM20/PG13.5	1x ØM20/PG13.5	2x ØM20/PG13.5	2x ØM16

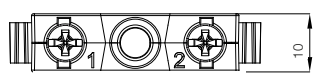
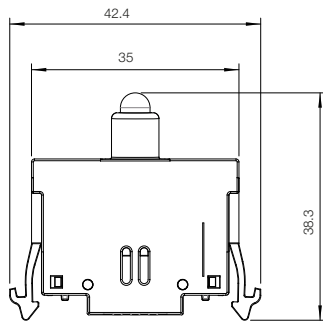

BIDLB - CSW

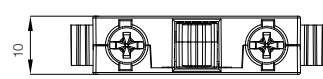
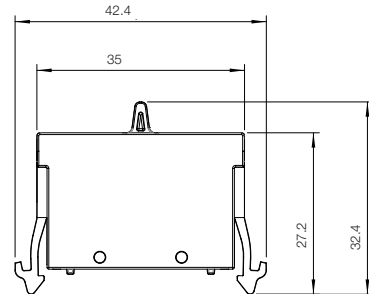

BC**B - CSW

Installation Distances (mm)

AF3F 3-Position Flange

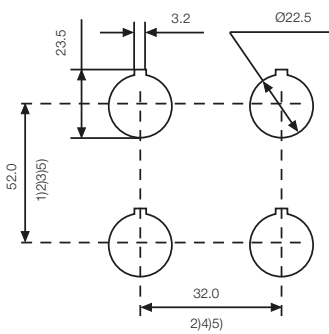

AF5F 5-Position Flange

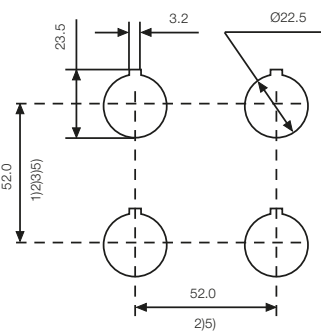

PBW Control Stations

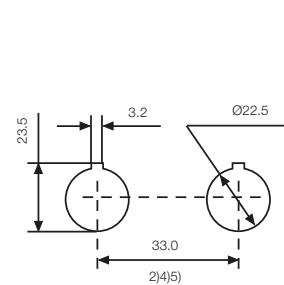

- Notes: 1) 60.0 - BD
 2) 100.0 - BESG/BESP/BESY/GBES
 3) 85.0
 4) 35.0 - APPT60
 5) 60.0 - APE

Global presence is essential,
as much as understanding your needs.

Global Presence

With more than 30,000 employees worldwide, WEG is one of the largest electric motors, electronic equipments and systems manufacturers. We are constantly expanding our portfolio of products and services with expertise and market knowledge. We create integrated and customized solutions ranging from innovative products to complete after-sales service.

WEG's know-how guarantees our **pushbuttons and pilot lights line** is the right choice for your application and business, assuring safety, efficiency and reliability.



Availability is to have a global support network



Partnership is to create solutions that suits your needs



Competitive edge is to unite technology and innovation

Know More

High performance and reliable products to improve your production process.

Excellence is to provide a whole solution in industrial automation that improves our customers productivity.



Visit:

www.weg.net



youtube.com/wegvideos

WEG Worldwide Operations

ARGENTINA

San Francisco - Cordoba
Phone: +54 3564 421484
info-ar@weg.net

Cordoba - Cordoba
Phone: +54 351 4641366
weg-morbe@weg.com.ar

Buenos Aires
Phone: +54 11 42998000
ventas@pulverlux.com.ar

AUSTRALIA

Scoresby - Victoria
Phone: +61 3 97654600
info-au@weg.net

AUSTRIA

Markt Piesting - Wiener
Neustadt-Land
Phone: +43 2633 4040
watt@wattdrive.com

BELGIUM

Nivelles - Belgium
Phone: +32 67 888420
info-be@weg.net

BRAZIL

Jaraguá do Sul - Santa Catarina
Phone: +55 47 32764000
info-br@weg.net

CHILE

La Reina - Santiago
Phone: +56 2 27848900
info-cl@weg.net

CHINA

Nantong - Jiangsu
Phone: +86 513 85989333
info-cn@weg.net

Changzhou - Jiangsu
Phone: +86 519 88067692
info-cn@weg.net

COLOMBIA

San Cayetano - Bogota
Phone: +57 1 4160166
info-co@weg.net

ECUADOR

El Batan - Quito
Phone: +593 2 5144339
ceccato@weg.net

FRANCE

Saint-Quentin-Fallavier - Isère
Phone: +33 4 74991135
info-fr@weg.net

GERMANY

Türnich - Kerpen
Phone: +49 2237 92910
info-de@weg.net

Balingen - Baden-Württemberg

Phone: +49 7433 90410
info@weg-antriebe.de

Homburg (Efze) - Hesse
Phone: +49 5681 99520
info@akh-antriebstechnik.de

GHANA

Accra
Phone: +233 30 2766490
info@zestghana.com.gh

INDIA

Bangalore - Karnataka
Phone: +91 80 41282007
info-in@weg.net

Hosur - Tamil Nadu
Phone: +91 4344 301577
info-in@weg.net

ITALY

Cinisello Balsamo - Milano
Phone: +39 2 61293535
info-it@weg.net

JAPAN

Yokohama - Kanagawa
Phone: +81 45 5503030
info-jp@weg.net

MALAYSIA

Shah Alam - Selangor
Phone: +60 3 78591626
info@wattdrive.com.my

MEXICO

Huehuetoca - Mexico
Phone: +52 55 53214275
info-mx@weg.net

Tizayuca - Hidalgo
Phone: +52 77 97963790

NETHERLANDS

Oldenzaal - Overijssel
Phone: +31 541 571080
info-nl@weg.net

PERU

La Victoria - Lima
Phone: +51 1 2097600
info-pe@weg.net

PORTUGAL

Maia - Porto
Phone: +351 22 9477700
info-pt@weg.net

RUSSIA and CIS

Saint Petersburg
Phone: +7 812 363 2172
sales-wes@weg.net

SOUTH AFRICA

Johannesburg
Phone: +27 11 7236000
info@zest.co.za

SPAIN

Coslada - Madrid
Phone: +34 91 6553008
wegiberia@wegiberia.es

SINGAPORE

Singapore
Phone: +65 68589081
info-sg@weg.net

Singapore
Phone: +65 68622220
watteuro@watteuro.com.sg

SCANDINAVIA

Mölnlycke - Sweden
Phone: +46 31 888000
info-se@weg.net

UK

Redditch - Worcestershire
Phone: +44 1527 513800
info-uk@weg.net

UNITED ARAB EMIRATES

Jebel Ali - Dubai
Phone: +971 4 8130800
info-ae@weg.net

USA

Duluth - Georgia
Phone: +1 678 2492000
info-us@weg.net

Minneapolis - Minnesota
Phone: +1 612 3788000

VENEZUELA

Valencia - Carabobo
Phone: +58 241 8210582
info-ve@weg.net

For those countries where there is not a WEG own operation, find our local distributor at www.weg.net.



WEG Group - Automation Business Unit
Jaraguá do Sul - SC - Brazil
Phone: +55 47 3276 4000
automacao@weg.net
www.weg.net

