

# S5N

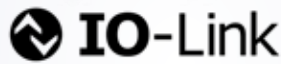

## EXTENDED RANGE OF STANDARD “ONE FOR ALL” PHOTOELECTRIC TUBULAR M18 SENSORS

- All optic functions
- Improved EMI immunity
- Improved ambient light immunity
- Improved laser safety level
- M18 flat plastic with universal mounting
- Available in M18 metal housing
- Axial or radial optics, cable or connector
- Standard 4-wire NO-NC NPN or PNP output
- IO-Link connectivity V1.1 with double channel

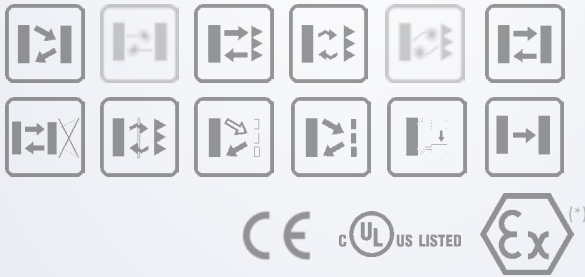

### APPLICATIONS

- Processing and Packaging machinery
- Conveyor lines, material handling
- Ceramics intralogistics
- Automated warehousing

### S5N

<b>Through beam</b>		0...20 m
		0...60 m (class 1 LASER)
<b>Retroreflective (on R2 reflector)</b>		0,1...4 m
<b>Polarized retroreflective</b>		0,1...4 m
		0,1...16 m (class 1 LASER)
<b>Retroreflective for transparent (on R2 reflector)</b>		0,1...1,3 m
<b>Diffuse proximity</b>		short distance 0...100 mm
		medium distance 0...400 mm
		long distance 0...700 mm
		long distance LASER 0...350 mm
<b>Fixed focus</b>		100 mm
<b>Background suppression</b>		50...150 mm
<b>Through beam with fiber optic</b>		0...100 mm
<b>Diffuse proximity with fiber optic</b>		0...30 mm
<b>Contrast sensor</b>		10 ±2 mm
<b>Luminescence sensor</b>		0...20 mm
<b>Power supply</b>	Vdc	10...30 V
	Vac	
	Vac/dc	
<b>Output</b>	PNP	•
	NPN	•
	NPN/PNP	
	relay	
	other	IO-Link v 1.1
<b>Connection</b>	cable	•
	connector	•
	pig-tail	
<b>Approximate dimensions (mm)</b>		M18x 55/68
<b>Housing material</b>		PBT, nickel plated brass
<b>Mechanical protection</b>		IP67

# TECHNICAL DATA

<b>Power supply</b>	10 ... 30 Vdc (limit values)
<b>Ripple</b>	2 Vpp max.
<b>Consumption (output current excluded)</b>	35 mA max. (mod. S5N...A00/B01/C01/C10/C21/D00/E01/T01)
	30 mA max. (mod. S5N...F01/M03)
	25 mA max. (mod. S5N...W03/U03)
<b>Light emission</b>	red LED 630 nm (mod. S5N...D00/E01, S5N-PA/MA...M03)
	red LED 660 nm (mod. S5N...B01/T01)
	red LED 670 nm (mod. S5N-PS/MS...M03)
	IR LED 880 nm (mod. S5N...A00/C01/C10/C21/G00)
	white LED 400-700 nm (mod. S5N...W03)
	UV LED 370 nm (mod. S5N...U03)
	red Laser 650 nm (mod. S5N...G00/F01/B01/C01)
<b>Setting</b>	sensitivity trimmer (mod. B01/C01/C21/E01/F01/T01)
	teach-in push-button (mod. M03/W03/U03)
<b>Operating mode</b>	LIGHT mode on N.O. output / DARK mode on N.C. output (mod.S5N...C01/C10/C21/D00/M03/U03)
	DARK mode on N.O. output / LIGHT mode on N.C. output (mod.S5N...A00/B01/E01/F01/T01/W03)
<b>Indicators</b>	yellow OUTPUT LED (S5N, excl. mod. G00)
	green STABILITY LED (mod. S5N...B01/C01/C21/E01/F01), POWER LED (mod. S5N...G00)
	green/red READY/ERROR LED (mod. S5N...M03/W03/U03)
<b>Output</b>	PNP or NPN; NO; NC (mod. S5N) IO-Link v 1.1 (mod.S5N...OZ)
<b>IO-Link interface</b>	(mod.S5N...OZ) v 1.1, com 2, 38,4 kBaud, 32 bit process data, 5 ms cycle time LED emission model, 8 ms cycle time LASER emission model
<b>Output current</b>	100 mA max.
<b>Saturation voltage</b>	2 V max.
<b>Response time</b>	0,5 ms (mod. S5N...A00/B01/T01/C10/C21/C01/D00/E01/U03)
	2 ms (mod. S5N...F01/G00)
	1 ms (mod. S5N...M03)
	100 µs (mod. S5N...W03)
	333 µs (Laser mod. S5N)
<b>Switching frequency</b>	1 kHz (mod. S5N...A00/B01/T01/C10/C21/C01/D00/E01/U03)
	250 Hz (mod. S5N...F01/G00)
	500 Hz (mod. S5N...M03)
	5 kHz (mod. S5N...W03)
	1,5 kHz (Laser mod. S5N)
<b>Connection</b>	2 m cable Ø- 4 mm, M12 4-pole connector
<b>Dielectric strength</b>	500 Vac, 1 min between electronics and housing
<b>Insulating resistance</b>	>20 MΩ, 500 Vdc between electronics and housing
<b>Electrical protection</b>	class 2
<b>Mechanical protection</b>	IP67
<b>Ambient light rejection</b>	according to EN 60947-5-2
<b>Vibrations</b>	0,5 mm amplitude, 10 ... 55 Hz frequency, for every axis (EN60068-2-6)
<b>Shock resistance</b>	11 ms (30 G) 6 shock for every axis (EN60068-2-27)
<b>Housing material</b>	Plastic version PBT
	Metal version nickel plated brass
<b>Lens material</b>	PMMA
<b>Operating temperature</b>	-25 ... 55 °C
	(Laser mod.) -10 ... 50 °C
<b>Storage temperature</b>	-25 ... 70 °C
<b>Weight</b>	Plastic version 75 g max. cable vers. (90 g max. mod. M03), 25 g max. conn. vers. (40 g max. mod. M03)
	Metal version 110 g max. cable vers. (125 g max. mod. M03), 60 g max. conn. vers. (75 g max. mod. M03)

# DIMENSIONS

## PLASTIC

### AXIAL VERSION

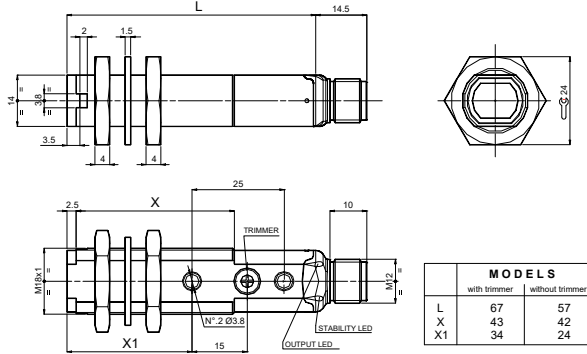

### RADIAL VERSION

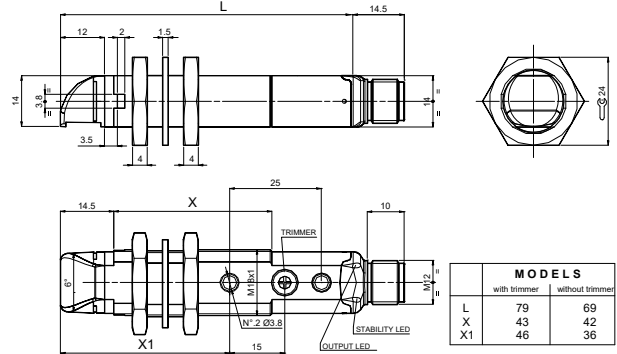

### FIBRE OPTIC VERSION

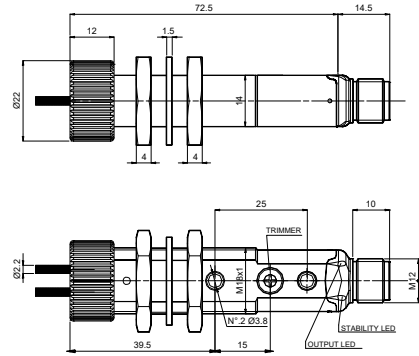

## METAL

### AXIAL VERSION

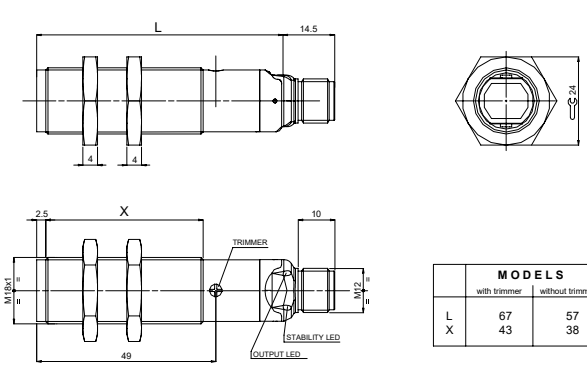

### RADIAL VERSION

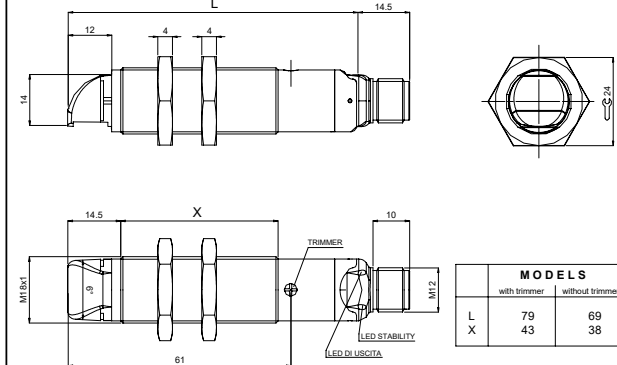

### FIBRE OPTIC VERSION

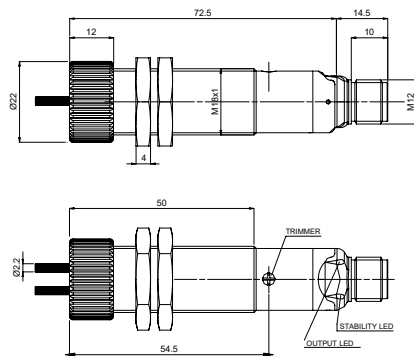



# CONNECTIONS

## CABLE

Through beam emitter

BROWN	1	+	10 ... 30 Vdc
WHITE	2		N.C. OUTPUT
BLACK	4		N.O. OUTPUT
BLUE	3	-	0 V

BROWN	1	+	10 ... 30 Vdc
WHITE	2		TEST +
BLACK	4		TEST / NOT USED (Laser version)
BLUE	3	-	0 V

## M12 CONNECTOR

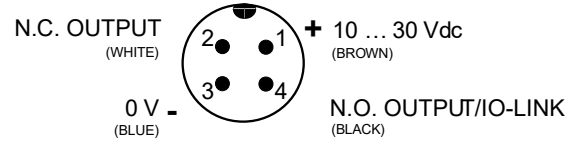
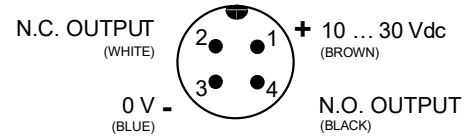

# INDICATORS AND SETTINGS

## S5N-XX...A00/B01/C01/C21/E01/F01/T01



- A** OUTPUT status LED Yellow  
STABILITY LED Green (Only Receiver)  
POWER ON LED Green (Only Emitter)
- B** Adjustment trimmer (receiver)

Single-turn trimmer for sensitivity adjustment. Rotate in a clockwise direction to increase the operating distance.

## S5N-XX-U03

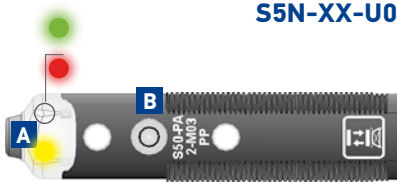

- A** OUTPUT status LED Yellow  
READY LED Green  
LED Red error
- B** Teach-in push-button

## S5N-XX-M03/W03



- A** OUTPUT status LED Yellow  
READY LED Green
- B** Teach-in push-button

Teach-in button for setting. EASYtouch™ provides two setting modes: standard or fine, both obtained by pressing the push-button only once. Please refer to instructions manual for operating details.

## S5N-XX-A00/C10/D00



- A00/C10
- A** OUTPUT status LED Yellow

G00  
OUTPUT status LED yellow (Only Emitter G00)

# S5N DETECTION DIAGRAMS

## THROUGH BEAM (G/F) INFRARED EMISSION

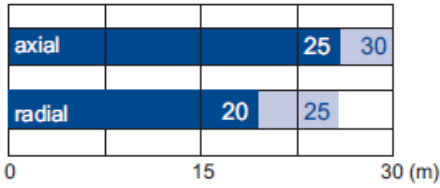

■ Recommended operating distance  
 ■ Maximum operating distance

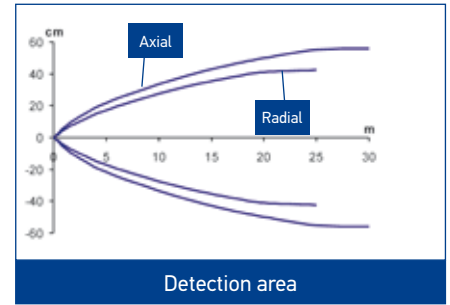
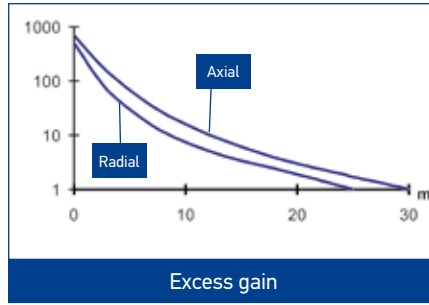

## THROUGH BEAM (G/F) LASER RED EMISSION

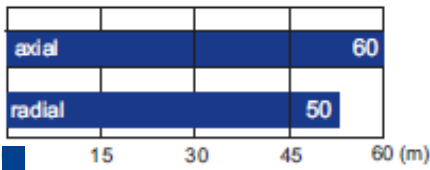

Operating distance

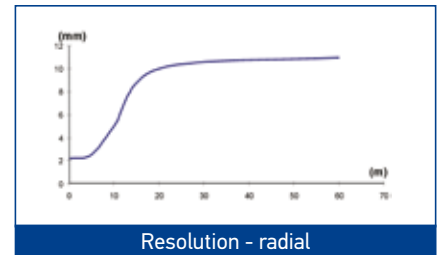
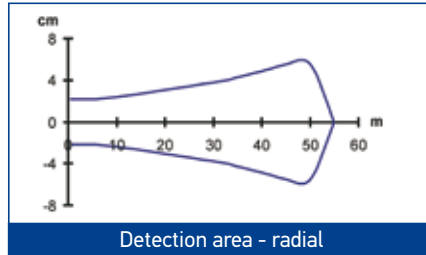
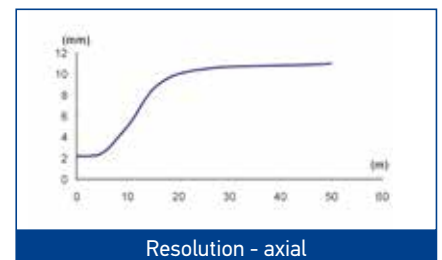
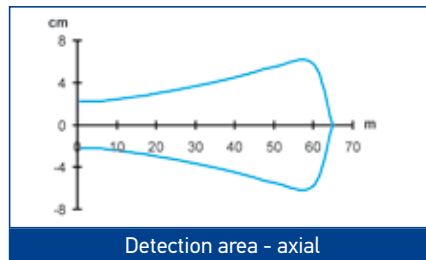

## RETROREFLECTIVE (A) INFRARED EMISSION

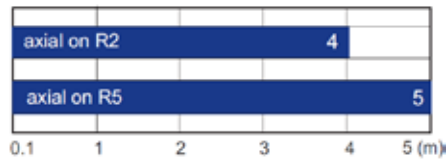

■ Operating distance

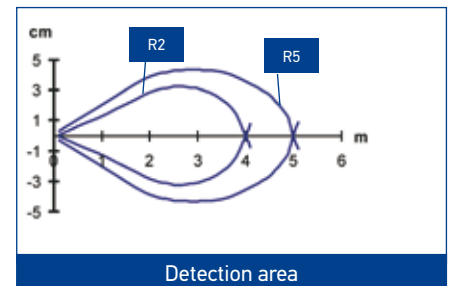
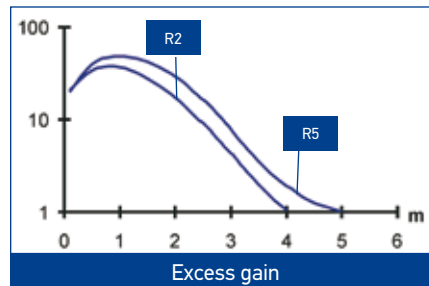

## RETROREFLECTIVE POLARIZED (B) RED EMISSION

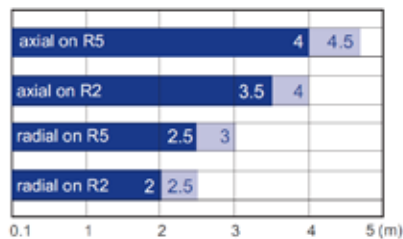

■ Recommended operating distance  
 ■ Maximum operating distance

High efficiency reflectors can be used to obtain larger operating distances. Refer to **Reflectors** (A.01).

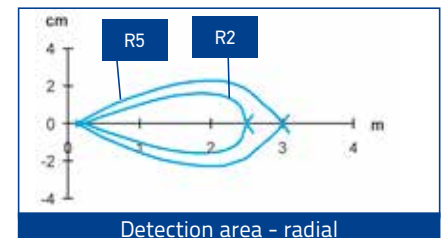
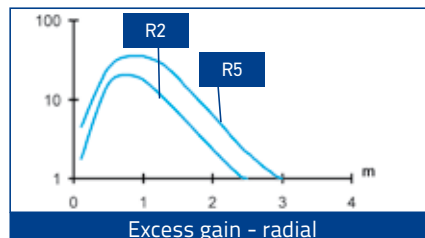
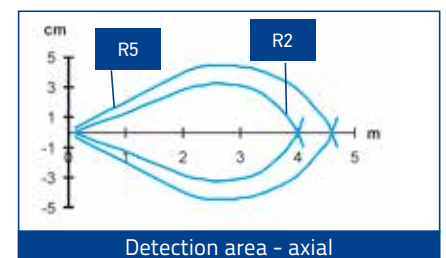
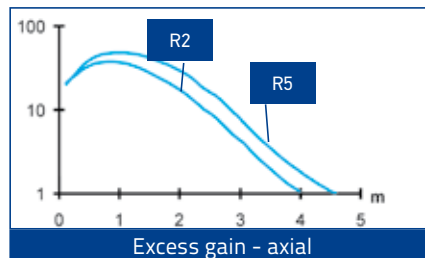

## RETROREFLECTIVE POLARIZED (B) LASER RED EMISSION

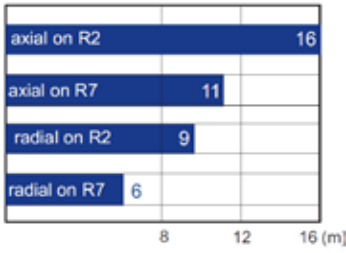

■ Operating distance

High efficiency reflectors can be used to obtain larger operating distances. Refer to **Reflectors** (A.01).

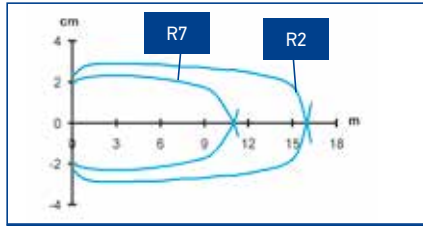

Detection area - axial

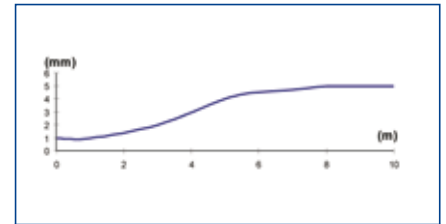

Resolution on R7 reflector - axial

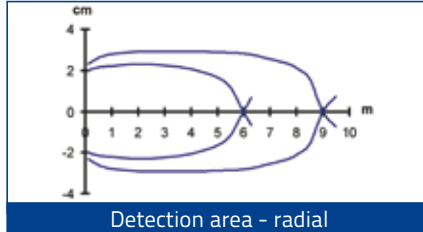

Detection area - radial

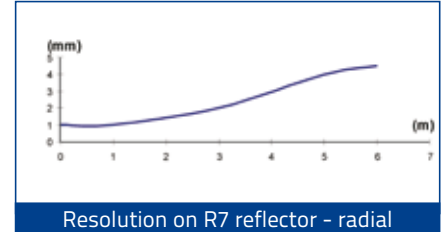

Resolution on R7 reflector - radial

## RETROREFLECTIVE TRANSPARENT (T) RED EMISSION

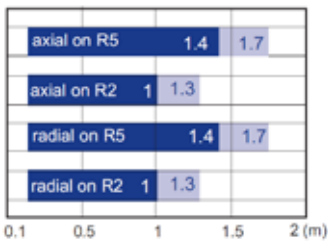

■ Recommended operating distance  
 ■ Maximum operating distance

High efficiency reflectors can be used to obtain larger operating distances. Refer to **Reflectors**.

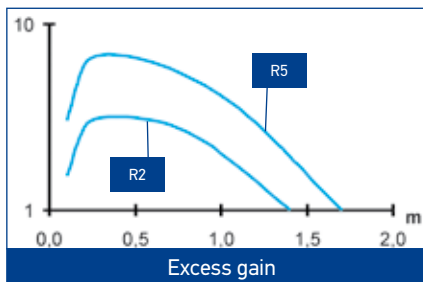

Excess gain

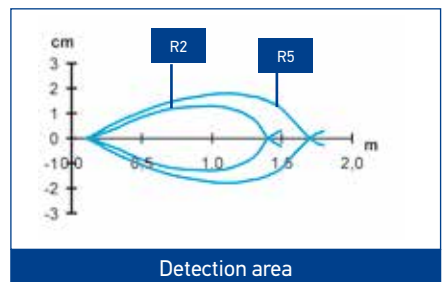

Detection area

## ENERGETIC DIFFUSED (C) SHORT INFRARED EMISSION

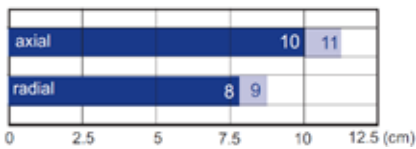

■ Recommended operating distance  
 ■ Maximum operating distance

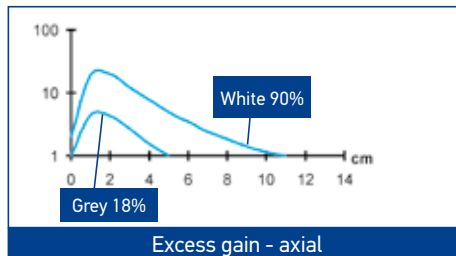

Excess gain - axial

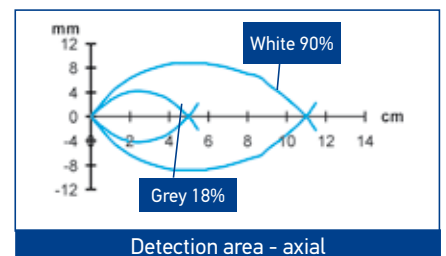

Detection area - axial

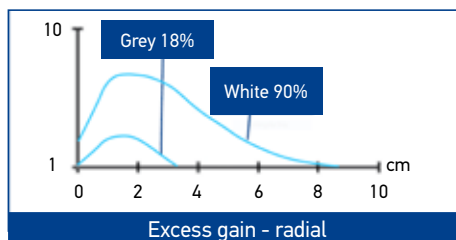

Excess gain - radial

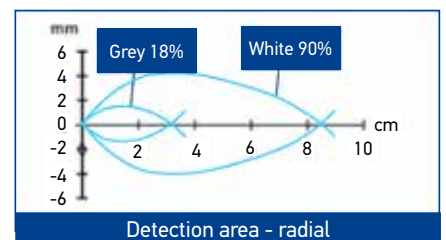

Detection area - radial

### ENERGETIC DIFFUSED (C) MID INFRARED EMISSION

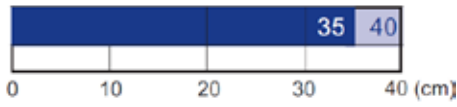

Recommended operating distance  
 Maximum operating distance

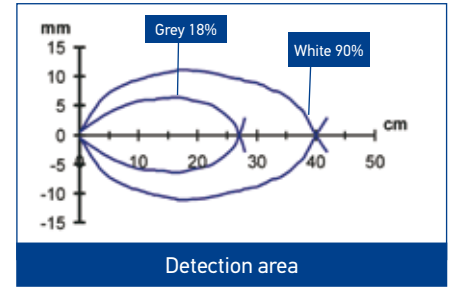
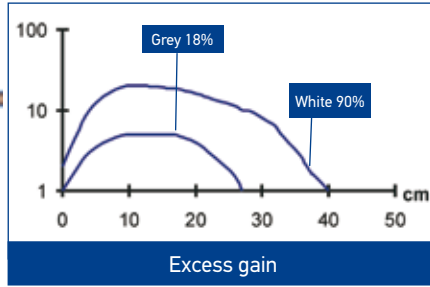

### ENERGETIC DIFFUSED (C) LONG INFRARED EMISSION

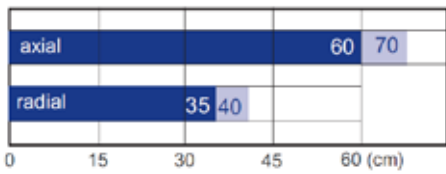

Recommended operating distance  
 Maximum operating distance

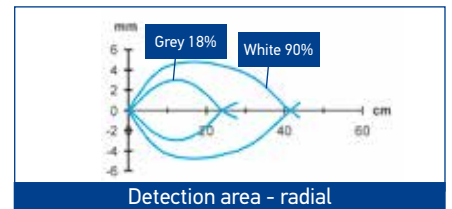
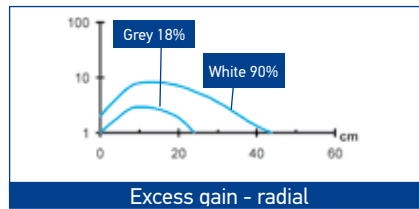
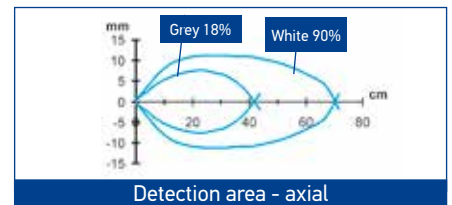
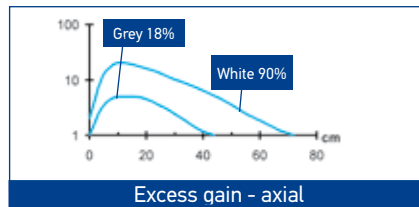

### FIXED FOCUS (D) RED EMISSION

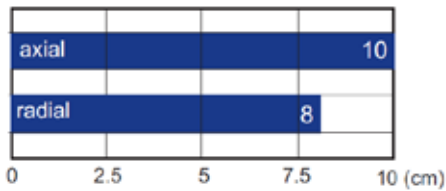

Operating distance

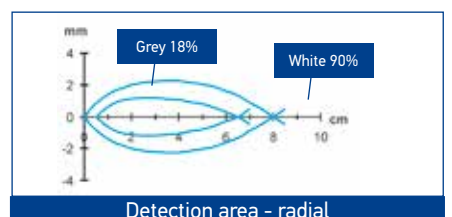
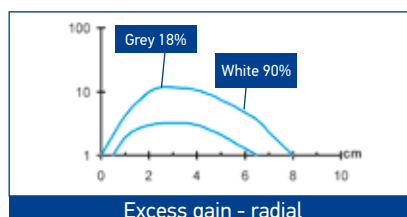
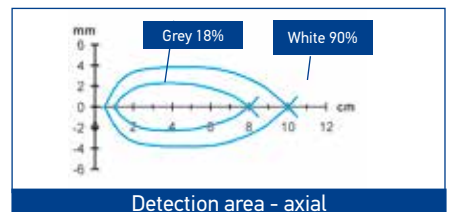
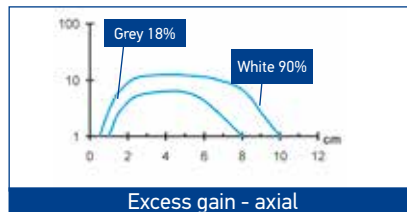



## DIFFUSED (C) LASER RED EMISSION



Operating distance

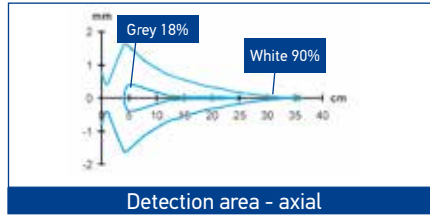

Detection area - axial

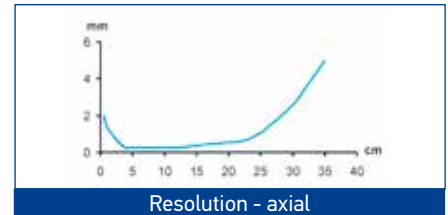

Resolution - axial

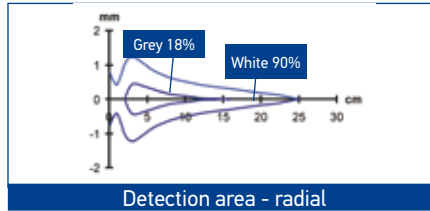

Detection area - radial

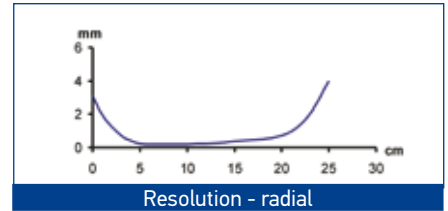

Resolution - radial

## BACKGROUND SUPPRESSOR (M) AXIAL RED EMISSION



Operating distance

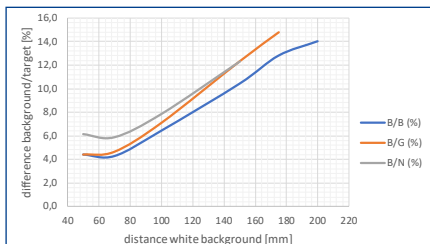

Detection difference with EASYtouch™ acquisition

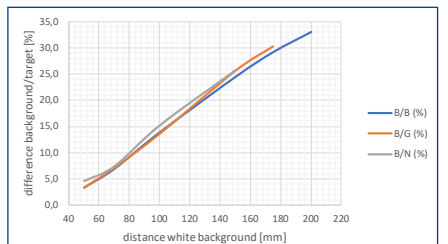

Detection difference with EASYtouch™ fine acquisition

## BACKGROUND SUPPRESSOR (M) RADIAL RED EMISSION

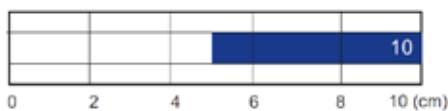

Operating distance

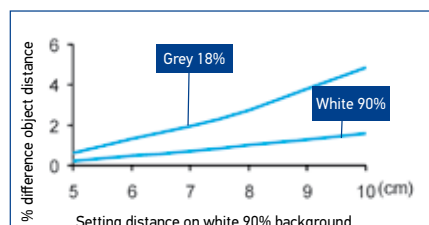

Detection difference with EASYtouch™ acquisition

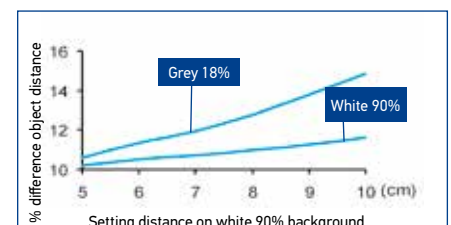

Detection difference with fine acquisition

## FIBER OPTIC (E) RED EMISSION

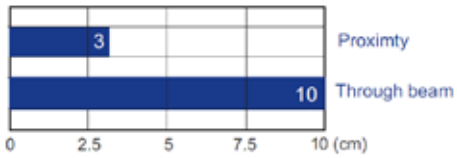

Operating distance with standard fibers

Standard Fiber-optics:  
OF-42-ST-20 proximity  
OF-43-ST-20 through beam

High efficiency fiber-optics or accessory lenses can be used to obtain larger operating distances.

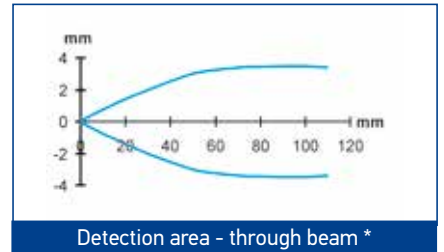
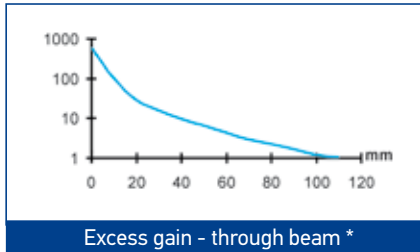
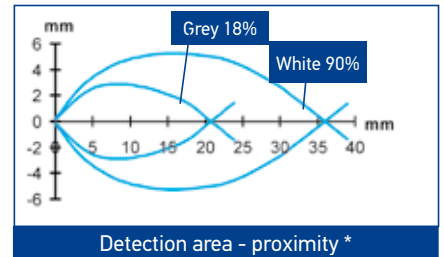
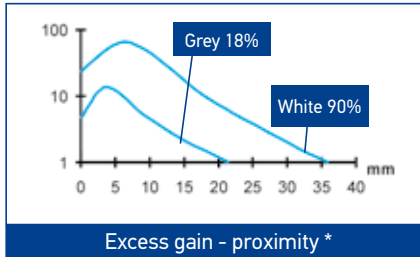

\* standard Fiber-optics

## MARK READER (W) WHITE EMISSION

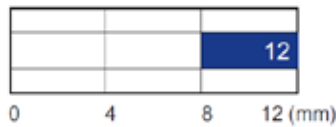

Operating distance

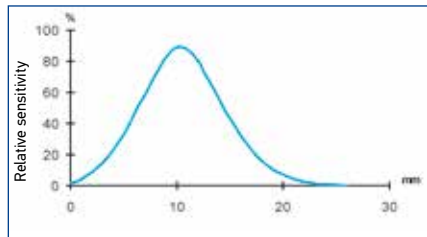



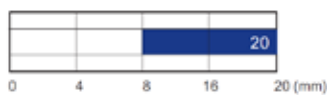

## LUMINESCENCE (U) UV EMISSION

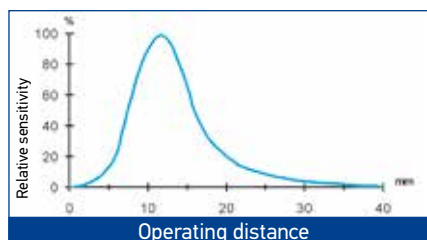



Operating distance





# MODEL SELECTION AND ORDER INFORMATION

S5N PLASTIC MODELS					
OPTIC FUNCTION	EMISSION	CONNECTION	OUTPUT	MODEL	ORDER No.
Retroreflective	LED, Axial optic	2m Cable	NPN	S5N-PA-2-A00-NN	952002091
			PNP	S5N-PA-2-A00-PP	952002081
		M12 Connector	NPN	S5N-PA-5-A00-NN	952002111
			PNP	S5N-PA-5-A00-PP	952002101
Polarized retroreflective	LED, Axial optic	2m Cable	NPN	S5N-PA-2-B01-NN	952001611
			PNP	S5N-PA-2-B01-PP	952001011
		M12 Connector	NPN	S5N-PA-5-B01-NN	952001501
			PNP	S5N-PA-5-B01-PP	952001021
			 IO-Link	S5N-PA-5-B01-OZ	952002200
	LED, Radial optic	2m Cable	NPN	S5N-PR-2-B01-NN	952001781
			PNP	S5N-PR-2-B01-PP	952001031
		M12 Connector	NPN	S5N-PR-5-B01-NN	952001721
			PNP	S5N-PR-5-B01-PP	952001041
	LASER, Axial optic	2m Cable	NPN	S5N-PL-2-B01-NN	952001871
			PNP	S5N-PL-2-B01-PP	952001361
		M12 Connector	NPN	S5N-PL-5-B01-NN	952001841
			PNP	S5N-PL-5-B01-PP	952001371
			 IO-Link	S5N-PL-5-B01-OZ	952002250
	LASER, Radial optic	2m Cable	NPN	S5N-PH-2-B01-NN	952001951
			PNP	S5N-PH-2-B01-PP	952001941
		M12 Connector	NPN	S5N-PH-5-B01-NN	952001971
			PNP	S5N-PH-5-B01-PP	952001961
Long Diffuse proximity	LED, Axial optic	2m Cable	NPN	S5N-PA-2-C01-NN	952001621
			PNP	S5N-PA-2-C01-PP	952001051
		M12 Connector	NPN	S5N-PA-5-C01-NN	952001511
			PNP	S5N-PA-5-C01-PP	952001061
			 IO-Link	S5N-PA-5-C01-OZ	952002210
	LED, Radial optic	2m Cable	NPN	S5N-PR-2-C01-NN	952001791
			PNP	S5N-PR-2-C01-PP	952001071
		M12 Connector	NPN	S5N-PR-5-C01-NN	952001731
			PNP	S5N-PR-5-C01-PP	952001081
	LASER, Axial optic	2m Cable	NPN	S5N-PL-2-C01-NN	952001881
			PNP	S5N-PL-2-C01-PP	952001381
		M12 Connector	NPN	S5N-PL-5-C01-NN	952001851
			PNP	S5N-PL-5-C01-PP	952001391
			 IO-Link	S5N-PL-5-C01-OZ	952002260
	LASER, Radial optic	2m Cable	NPN	S5N-PH-2-C01-NN	952001991
			PNP	S5N-PH-2-C01-PP	952001981
		M12 Connector	NPN	S5N-PH-5-C01-NN	952002011
			PNP	S5N-PH-5-C01-PP	952002001
Short Diffuse proximity	LED, Axial optic	2m Cable	NPN	S5N-PA-2-C10-NN	952001631
			PNP	S5N-PA-2-C10-PP	952001241
		M12 Connector	NPN	S5N-PA-5-C10-NN	952001521
			PNP	S5N-PA-5-C10-PP	952001251
	LED, Radial optic	2m Cable	NPN	S5N-PR-2-C10-NN	952001801
			PNP	S5N-PR-2-C10-PP	952001491
		M12 Connector	NPN	S5N-PR-5-C10-NN	952001741
			PNP	S5N-PR-5-C10-PP	952001481
Medium Diffuse proximity	LED, Axial optic	2m Cable	NPN	S5N-PA-2-C21-NN	952002171
			PNP	S5N-PA-2-C21-PP	952002161
		M12 Connector	NPN	S5N-PA-5-C21-NN	952002191
			PNP	S5N-PA-5-C21-PP	952002181
	LED, Axial optic	2m Cable	NPN	S5N-PA-2-D00-NN	952001641
			PNP	S5N-PA-2-D00-PP	952001091
Fixed focus	M12 Connector	NPN	S5N-PA-5-D00-NN	952001531	
		PNP	S5N-PA-5-D00-PP	952001101	
	LED, Radial optic	2m Cable	NPN	S5N-PR-2-D00-NN	952001811
			PNP	S5N-PR-2-D00-PP	952001111
M12 Connector	NPN	S5N-PR-5-D00-NN	952001751		
	PNP	S5N-PR-5-D00-PP	952001121		

S5N PLASTIC MODELS

Fiber optic	LED, Axial optic	2m Cable	NPN	S5N-PA-2-E01-NN	952001651
			PNP	S5N-PA-2-E01-PP	952001131
		M12 Connector	NPN	S5N-PA-5-E01-NN	952001541
			PNP	S5N-PA-5-E01-PP	952001141
Through beam receiver	LED, Axial optic	2m Cable	NPN	S5N-PA-2-F01-NN	952001661
			PNP	S5N-PA-2-F01-PP	952001151
	M12 Connector	NPN	S5N-PA-5-F01-NN	952001551	
		PNP	S5N-PA-5-F01-PP	952001161	
	LED, Radial optic	2m Cable	NPN	S5N-PR-2-F01-NN	952001821
			PNP	S5N-PR-2-F01-PP	952001171
	M12 Connector	NPN	S5N-PR-5-F01-NN	952001761	
		PNP	S5N-PR-5-F01-PP	952001181	
	LASER, Axial optic	2m Cable	NPN	S5N-PL-2-F01-NN	952001891
			PNP	S5N-PL-2-F01-PP	952001401
	M12 Connector	NPN	S5N-PL-5-F01-NN	952001861	
		PNP	S5N-PL-5-F01-PP	952001411	
LASER, Radial optic	2m Cable	NPN	S5N-PH-2-F01-NN	952002031	
		PNP	S5N-PH-2-F01-PP	952002021	
M12 Connector	NPN	S5N-PH-5-F01-NN	952002051		
	PNP	S5N-PH-5-F01-PP	952002041		
Through beam emitter	LED, Axial optic	2m Cable	-	S5N-PA-2-G00-XG	952001191
		M12 Connector	-	S5N-PA-5-G00-XG	952001201
	LED, Radial optic	2m Cable	-	S5N-PR-2-G00-XG	952001211
		M12 Connector	-	S5N-PR-5-G00-XG	952001221
	LASER, Axial optic	2m Cable	-	S5N-PL-2-G00-XG	952001421
		M12 Connector	-	S5N-PL-5-G00-XG	952001431
	LASER, Radial optic	2m Cable	-	S5N-PH-2-G00-XG	952002061
		M12 Connector	-	S5N-PH-5-G00-XG	952002071
Background suppression	LED, Axial optic	2m Cable	NPN	S5N-PA-2-M03-NN	952001671
			PNP	S5N-PA-2-M03-PP	952001231
		M12 Connector	NPN	S5N-PA-5-M03-NN	952001561
			PNP	S5N-PA-5-M03-PP	952001001
	LED, Radial optic	M12 Connector	 IO-Link	S5N-PA-5-M03-OZ	952002230
			PNP	S5N-PS-5-M03-PP	952001931
		2m Cable	NPN	S5N-PS-5-M03-NN	952001921
			PNP	S5N-PS-2-M03-PP	952001911
Retroreflective for transparent	LED, Axial optic	2m Cable	NPN	S5N-PA-2-T01-NN	952001691
			PNP	S5N-PA-2-T01-PP	952001261
		M12 Connector	NPN	S5N-PA-5-T01-NN	952001581
			PNP	S5N-PA-5-T01-PP	952001271
	LED, Radial optic	2m Cable	 IO-Link	S5N-PA-5-T01-OZ	952002220
			NPN	S5N-PR-2-T01-NN	952001831
		M12 Connector	PNP	S5N-PR-2-T01-PP	952001281
			NPN	S5N-PR-5-T01-NN	952001771
		2m Cable	PNP	S5N-PR-5-T01-PP	952001291
			NPN	S5N-PA-2-U03-NN	952001701
Luminescence	LED, Axial optic	2m Cable	PNP	S5N-PA-2-U03-PP	952001301
			NPN	S5N-PA-5-U03-NN	952001591
Contrast	LED, Axial optic	2m Cable	PNP	S5N-PA-5-U03-PP	952001311
			NPN	S5N-PA-2-W03-NN	952001711
		M12 Connector	PNP	S5N-PA-2-W03-PP	952001321
			NPN	S5N-PA-5-W03-NN	952001601
			PNP	S5N-PA-5-W03-PP	952001331
			 IO-Link	S5N-PA-5-W03-OZ	952002240

S5N METAL MODELS

OPTIC FUNCTION	EMISSION	CONNECTION	OUTPUT	MODEL	ORDER No.
Retroreflective	LED, Axial optic	2m Cable	NPN	S5N-MA-2-A00-NN	952022091
			PNP	S5N-MA-2-A00-PP	952022081
		M12 Connector	NPN	S5N-MA-5-A00-NN	952022111
			PNP	S5N-MA-5-A00-PP	952022101
Polarized retroreflective	LED, Axial optic	2m Cable	NPN	S5N-MA-2-B01-NN	952021501
			PNP	S5N-MA-2-B01-PP	952021001
		M12 Connector	NPN	S5N-MA-5-B01-NN	952021661
			PNP	S5N-MA-5-B01-PP	952021201
	LED, Radial optic	2m Cable	 IO-Link	S5N-MA-5-B01-OZ	952022160
			NPN	S5N-MR-2-B01-NN	952021601
		M12 Connector	PNP	S5N-MR-2-B01-PP	952021141
			NPN	S5N-MR-5-B01-NN	952021761
	LASER, Axial optic	2m Cable	PNP	S5N-MR-5-B01-PP	952021341
			NPN	S5N-ML-2-B01-NN	952021821
		M12 Connector	PNP	S5N-ML-2-B01-PP	952021401
			NPN	S5N-ML-5-B01-NN	952021851
	LASER, Radial optic	2m Cable	PNP	S5N-ML-5-B01-PP	952021441
			 IO-Link	S5N-ML-5-B01-OZ	952022180
		M12 Connector	NPN	S5N-MH-2-B01-NN	952021951
			PNP	S5N-MH-2-B01-PP	952021941
Long Diffuse proximity	LED, Axial optic	2m Cable	NPN	S5N-MH-5-B01-NN	952021971
			PNP	S5N-MH-5-B01-PP	952021961
		M12 Connector	NPN	S5N-MA-2-C01-NN	952021511
			PNP	S5N-MA-2-C01-PP	952021011
	LED, Radial optic	2m Cable	NPN	S5N-MA-5-C01-NN	952021671
			PNP	S5N-MA-5-C01-PP	952021211
		M12 Connector	 IO-Link	S5N-MA-5-C01-OZ	952022200
			NPN	S5N-MR-2-C01-NN	952021611
	LASER, Axial optic	2m Cable	PNP	S5N-MR-2-C01-PP	952021151
			NPN	S5N-MR-5-C01-NN	952021771
		M12 Connector	PNP	S5N-MR-5-C01-PP	952021351
			NPN	S5N-ML-2-C01-NN	952021831
	LASER, Radial optic	2m Cable	PNP	S5N-ML-2-C01-PP	952021411
			NPN	S5N-ML-5-C01-NN	952021861
		M12 Connector	PNP	S5N-ML-5-C01-PP	952021451
			 IO-Link	S5N-ML-5-C01-OZ	952022190
Short Diffuse proximity	LED, Axial optic	2m Cable	NPN	S5N-MH-2-C01-NN	952021991
			PNP	S5N-MH-2-C01-PP	952021981
		M12 Connector	NPN	S5N-MH-5-C01-NN	952022011
			PNP	S5N-MH-5-C01-PP	952022001
	LED, Radial optic	2m Cable	NPN	S5N-MA-2-C10-NN	952021521
			PNP	S5N-MA-2-C10-PP	952021021
		M12 Connector	NPN	S5N-MA-5-C10-NN	952021681
			PNP	S5N-MA-5-C10-PP	952021221
	Medium Diffuse proximity	2m Cable	NPN	S5N-MR-2-C10-NN	952021621
			PNP	S5N-MR-2-C10-PP	952021491
		M12 Connector	NPN	S5N-MR-5-C10-NN	952021781
			PNP	S5N-MR-5-C10-PP	952021481
	Medium Diffuse proximity	2m Cable	NPN	S5N-MA-2-C21-NN	952022131
			PNP	S5N-MA-2-C21-PP	952022121
		M12 Connector	NPN	S5N-MA-5-C21-NN	952022151
			PNP	S5N-MA-5-C21-PP	952022141

S5N METAL MODELS

Fixed focus	LED, Axial optic	2m Cable	NPN	S5N-MA-2-D00-NN	952021531	
			PNP	S5N-MA-2-D00-PP	952021031	
	M12 Connector		NPN	S5N-MA-5-D00-NN	952021691	
			PNP	S5N-MA-5-D00-PP	952021231	
	LED, Radial optic	2m Cable	NPN	S5N-MR-2-D00-NN	952021631	
			PNP	S5N-MR-2-D00-PP	952021161	
	M12 Connector	NPN	S5N-MR-5-D00-NN	952021791		
Fiber optic	LED, Axial optic	2m Cable	PNP	S5N-MR-5-D00-PP	952021361	
			NPN	S5N-MA-2-E01-NN	952021881	
	M12 Connector		PNP	S5N-MA-2-E01-PP	952021041	
			NPN	S5N-MA-5-E01-NN	952021891	
			PNP	S5N-MA-5-E01-PP	952021241	
	Through beam receiver	LED, Axial optic	2m Cable	NPN	S5N-MA-2-F01-NN	952021541
			PNP	S5N-MA-2-F01-PP	952021051	
M12 Connector				NPN	S5N-MA-5-F01-NN	952021701
				PNP	S5N-MA-5-F01-PP	952021251
LED, Radial optic		2m Cable	NPN	S5N-MR-2-F01-NN	952021641	
			PNP	S5N-MR-2-F01-PP	952021171	
		M12 Connector		NPN	S5N-MR-5-F01-NN	952021801
				PNP	S5N-MR-5-F01-PP	952021371
LASER, Axial optic		2m Cable	NPN	S5N-ML-2-F01-NN	952021841	
			PNP	S5N-ML-2-F01-PP	952021421	
		M12 Connector		NPN	S5N-ML-5-F01-NN	952021871
				PNP	S5N-ML-5-F01-PP	952021461
LASER, Radial optic		2m Cable	NPN	S5N-MH-2-F01-NN	952022031	
			PNP	S5N-MH-2-F01-PP	952022021	
		M12 Connector		NPN	S5N-MH-5-F01-NN	952022051
				PNP	S5N-MH-5-F01-PP	952022041
Through beam emitter		LED, Axial optic	2m Cable	-	S5N-MA-2-G00-XG	952021061
			M12 Connector	-	S5N-MA-5-G00-XG	952021261
	LED, Radial optic	2m Cable	-	S5N-MR-2-G00-XG	952021181	
		M12 Connector	-	S5N-MR-5-G00-XG	952021381	
	LASER, Axial optic	2m Cable	-	S5N-ML-2-G00-XG	952021431	
		M12 Connector	-	S5N-ML-5-G00-XG	952021471	
	LASER, Radial optic	2m Cable	-	S5N-MH-2-G00-XG	952022061	
		M12 Connector	-	S5N-MH-5-G00-XG	952022071	
Background suppression	LED, Axial optic	2m Cable	NPN	S5N-MA-2-M03-NN	952021551	
			PNP	S5N-MA-2-M03-PP	952021071	
		M12 Connector		PNP	S5N-MA-5-M03-PP	952021271
			 IO-Link	S5N-MA-5-M03-OZ	952022170	
	LED, Radial optic	M12 Connector	PNP	S5N-MS-5-M03-PP	952021931	
		2m Cable	PNP	S5N-MS-2-M03-PP	952021911	
Retroreflective for transparent	LED, Axial optic	2m Cable	NPN	S5N-MA-2-T01-NN	952021571	
			PNP	S5N-MA-2-T01-PP	952021091	
		M12 Connector		NPN	S5N-MA-5-T01-NN	952021731
				PNP	S5N-MA-5-T01-PP	952021291
	LED, Radial optic	2m Cable	NPN	S5N-MR-2-T01-NN	952021651	
			PNP	S5N-MR-2-T01-PP	952021191	
		M12 Connector		NPN	S5N-MR-5-T01-NN	952021811
				PNP	S5N-MR-5-T01-PP	952021391
Luminescence	LED, Axial optic	M12 Connector	PNP	S5N-MA-5-U03-PP	952021301	
Contrast	LED, Axial optic	2m Cable	PNP	S5N-MA-2-W03-PP	952021111	
		M12 Connector		NPN	S5N-MA-5-W03-NN	952021751
				PNP	S5N-MA-5-W03-PP	952021311

# ACCESSORIES

ST-5010

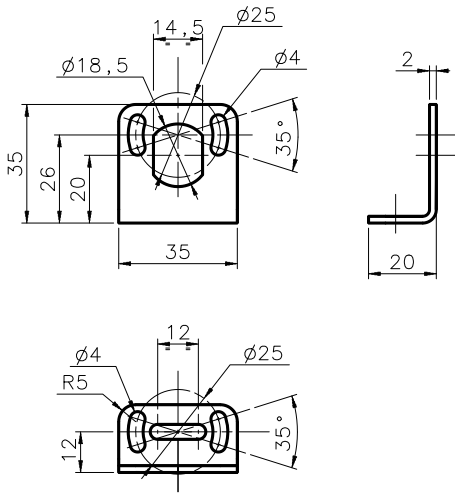

ST-5011

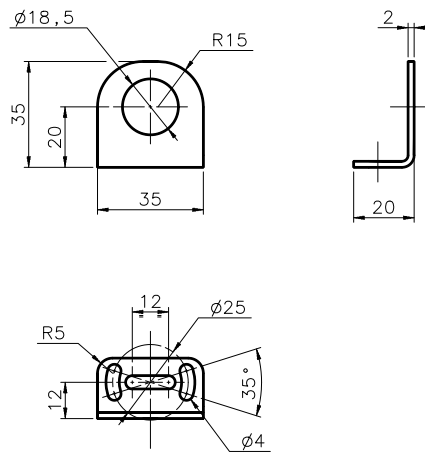

ST-5012

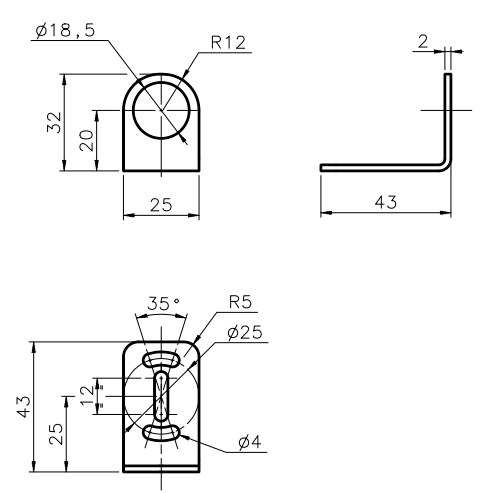

ST-5017

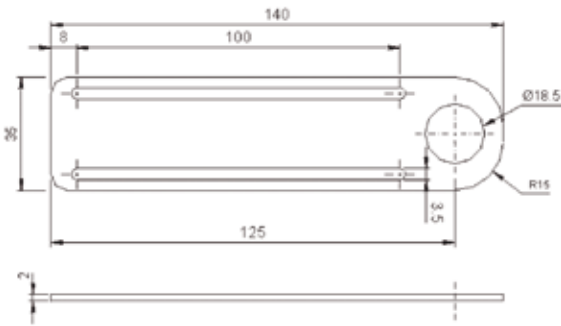

SWING-18

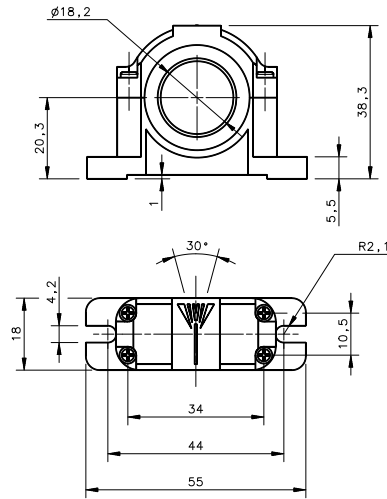

SP-40

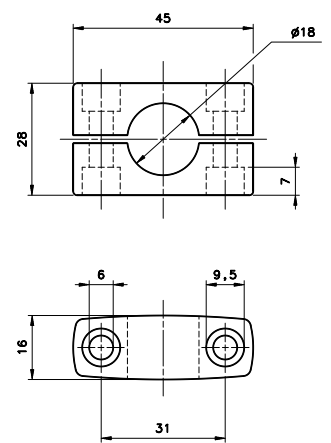

JOINT 18

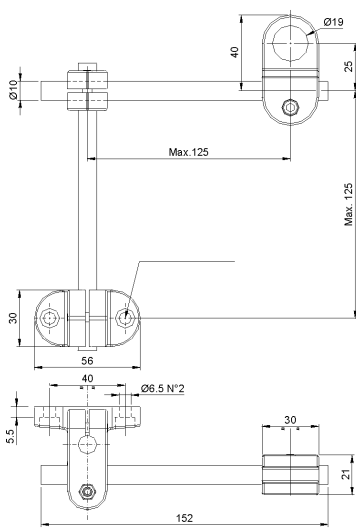

MICRO 18

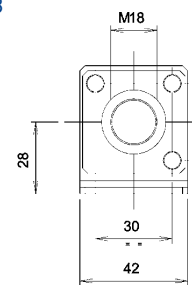
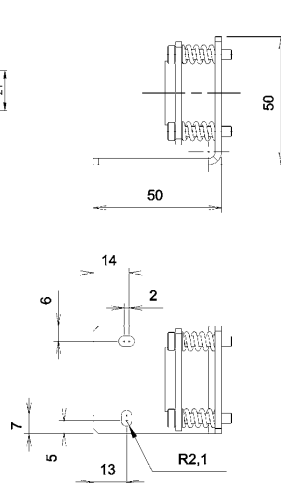

M18 FLARED PLASTIC NUT

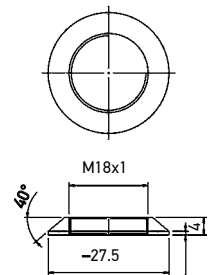

mm

MODEL	DESCRIPTION	ORDER No.
ST-5010	M18/14 mounting bracket	95ACC5230
ST-5011	M18 mounting bracket short	95ACC5240
ST-5012	M18 mounting bracket long	95ACC5250
ST-5017	M18 mounting bracket	95ACC5270
S50 EASY -IN	M18/14 EASY in™ adjustable mounting support	95ACC 5300
JOINT -18	M18 jointed support	95ACC 5220
MICRO -18	support with micrometric regulation for tubular M18 sensors	95ACC 1380
SP-40	mounting bracket tubular	95ACC1370
SWING-18	adjustable support for M18 tubular sensors	895000006
PLASTIC NUT	flared mounting nut	95ACC2630
M18 FLARED NUT	S5N mounting nut M18 flared nut (1 pc)	95ACC2630
M18 METAL NUT	S5N mounting nut M18 nut (1 pc)	G602000017
M18 PLASTIC NUT KIT	S5N mounting nut M18 nuts kit (100 pcs)	G602000008
MEK -PROOF	front protection (only for metal models)	G5000001

## IO-LINK CONNECTIVITY

MODEL	DESCRIPTION	ORDER No.
CBX-8IOL-EIP	CBX-8IOL-EIP 8P IOL M12 EIP MASTER	95ACC8180
CBX-8IOL-PNIO	CBX-8IOL-PNIO 8P IOL M12 PROFINET MASTER	95ACC8190

## CABLES

TYPE	DESCRIPTION	LENGTH	MODEL	ORDER No.
Axial M12 Connector	4-pole, grey, P.V.C.	3 m	CS-A1-02-G-03	95A251380
		5 m	CS-A1-02-G-05	95A251270
		7 m	CS-A1-02-G-07	95A251280
		10 m	CS-A1-02-G-10	95A251390
	4-pole, P.U.R.	2 m	CS-A1-02-R-02	95A251540
		5 m	CS-A1-02-R-05	95A251560
Radial M12 Connector	4-pole, grey, P.V.C.	3 m	CS-A2-02-G-03	95A251360
		5 m	CS-A2-02-G-05	95A251240
		7 m	CS-A2-02-G-07	95A251245
		10 m	CS-A2-02-G-10	95A251260
	4-pole, P.U.R.	2 m	CS-A2-02-R-02	95A251550
		5 m	CS-A2-02-R-05	95A251570
Radial M12 Connector with LED (for PNP N.O. sensors)	4-pole, grey, P.V.C.	3 m	CS-A2-12-G-03	95A251400
		5 m	CS-A2-12-G-05	95A251350
		10 m	CS-A2-12-G-10	95A251370
Axial M12 Connector	4-pole, shielded, black, P.V.C.	3 m	CV-A1-22-B-03	95ACC1480
		5 m	CV-A1-22-B-05	95ACC1490
		10 m	CV-A1-22-B-10	95ACC1500
		15 m	CV-A1-22-B-15	95ACC2070
		25 m	CV-A1-22-B-25	95ACC2090
Radial M12 Connector	4-pole, shielded, black, P.V.C.	3 m	CV-A2-22-B-03	95ACC1540
		5 m	CV-A2-22-B-05	95ACC1550
		10 m	CV-A2-22-B-10	95ACC1560
Axial M12 Connector	4-pole, U.L., black, P.V.C.	3 m	CS-A1-02-U-03	95ASE1120
		5 m	CS-A1-02-U-05	95ASE1130
		10 m	CS-A1-02-U-10	95ASE1140
		15 m	CS-A1-02-U-15	95ASE1150
		25 m	CS-A1-02-U-25	95ASE1160
Radial M12 Connector	4-pole, black	Connector- not cabled	CS-A1-02-B-NC	G5085002
Axial M12 Connector	4-pole, black	Connector- not cabled	CS-A2-02-B-NC	G5085003
Axial M12 Connector	5-pole, L coded power cable	3 m	CS-M1-02-B-03	95ACC0007
Axial M12 F/M8 M Connector	4-pole, double headed	3 m	CS-H1-02-B-03	95ACC0008
Axial M12 F/M12 M Connector	4-pole, double headed	3 m	CS-11-02-B-03	95ACC0009

Rev. 01, 04/2019

## DATALOGIC PRODUCT OFFERING



Sensors



Hand Held scanners



Mobile Computers



Laser Marking Systems



Safety Laser Scanner



Vision Systems



Stationary Industrial Scanners



Safety Light Curtains