

VARISTOR, AC 127...240 V,DC 150...250 V, SURGE SUPPRESSOR, FOR MOUNTING ONTO CONTACTORS SIZES00







Figure similar

General technical data:		
product brandname		SIRIUS
Product designation		surge suppressor
Size of contactor		S00
Design of the surge suppressor		with varistor
Control circuit/ Control:		
Type of voltage of the control supply voltage		AC/DC
Control supply voltage frequency		
• 1 rated value	Hz	50
• 2 rated value	Hz	60
Control supply voltage 1		
• at DC		
— Initial rated value	V	150
— Final rated value	V	250
• at AC		
— at 50 Hz Initial rated value	V	127
— at 50 Hz Final rated value	V	240

— at 60 Hz Final rated value  
 — at 60 Hz Initial rated value

V	240
V	127

Certificates/ approvals:

General Product Approval			Functional Safety/Safety of Machinery	Declaration of Conformity	Test Certificates
 CSA	 UR		<a href="#">Type Examination Certificate</a>	 EG-Konf.	<a href="#">Special Test Certificate</a>

Shipping Approval



Shipping Approval

other



Further information

Information- and Downloadcenter (Catalogs, Brochures,...)

<http://www.siemens.com/industrial-controls/catalogs>

Industry Mall (Online ordering system)

<http://www.siemens.com/industrymall>

Cax online generator

<http://support.automation.siemens.com/WW/CAXorder/default.aspx?lang=en&mlfb=3RT1916-1BD00>

Service&Support (Manuals, Certificates, Characteristics, FAQs,...)

<https://support.industry.siemens.com/cs/ww/en/ps/3RT1916-1BD00>

Image database (product images, 2D dimension drawings, 3D models, device circuit diagrams, EPLAN macros, ...)

[http://www.automation.siemens.com/bilddb/cax\\_de.aspx?mlfb=3RT1916-1BD00&lang=en](http://www.automation.siemens.com/bilddb/cax_de.aspx?mlfb=3RT1916-1BD00&lang=en)

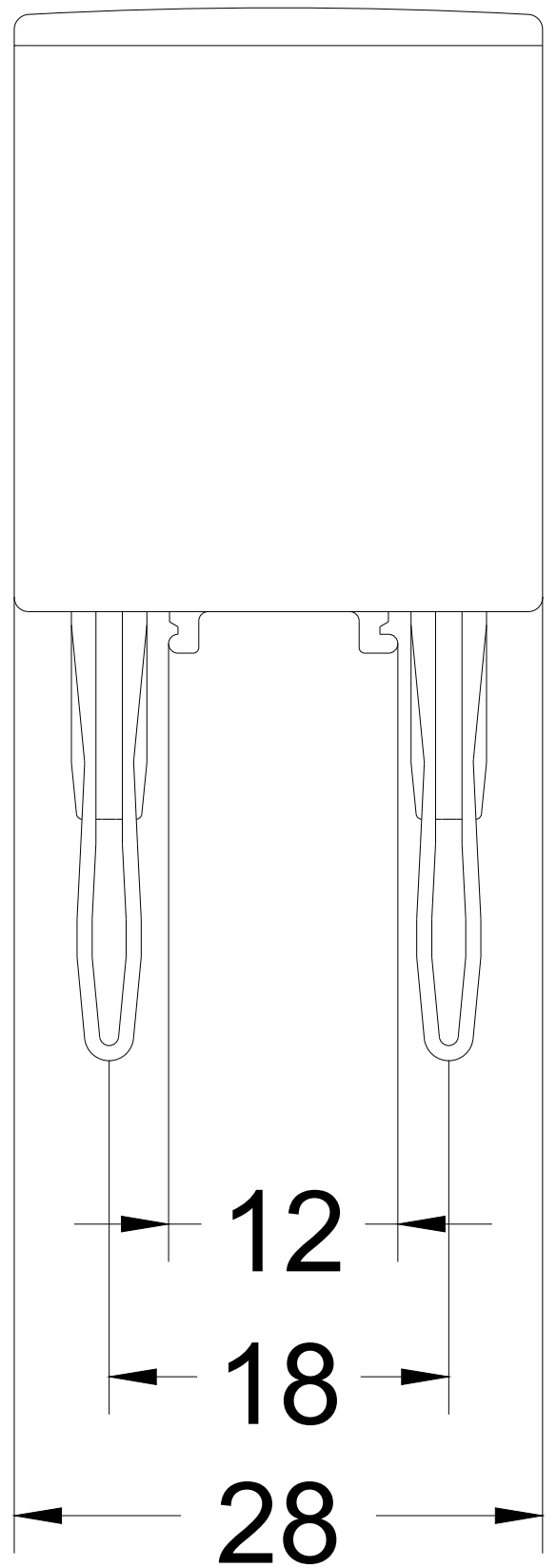
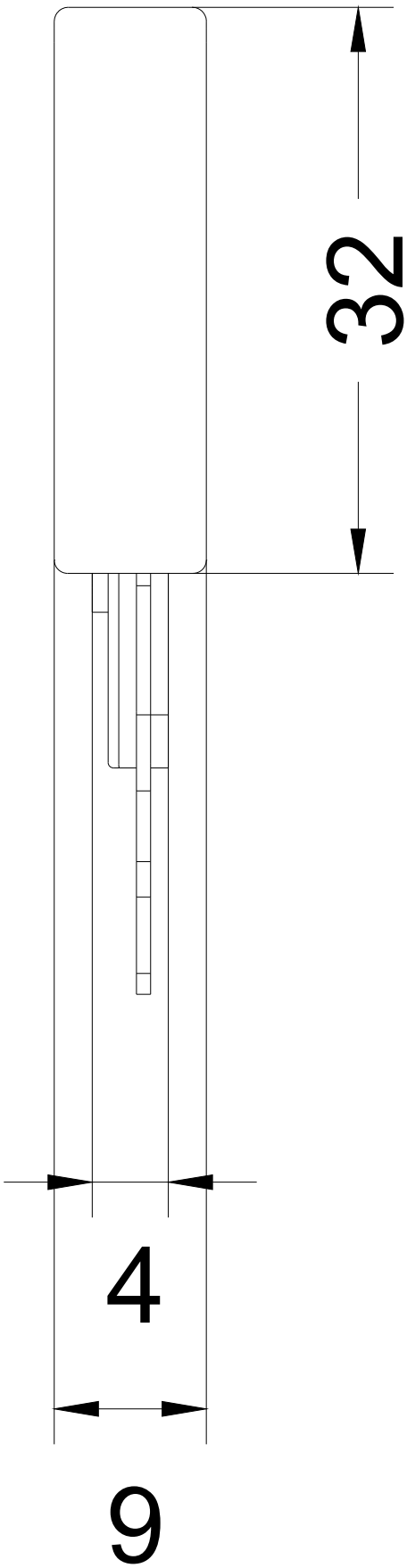

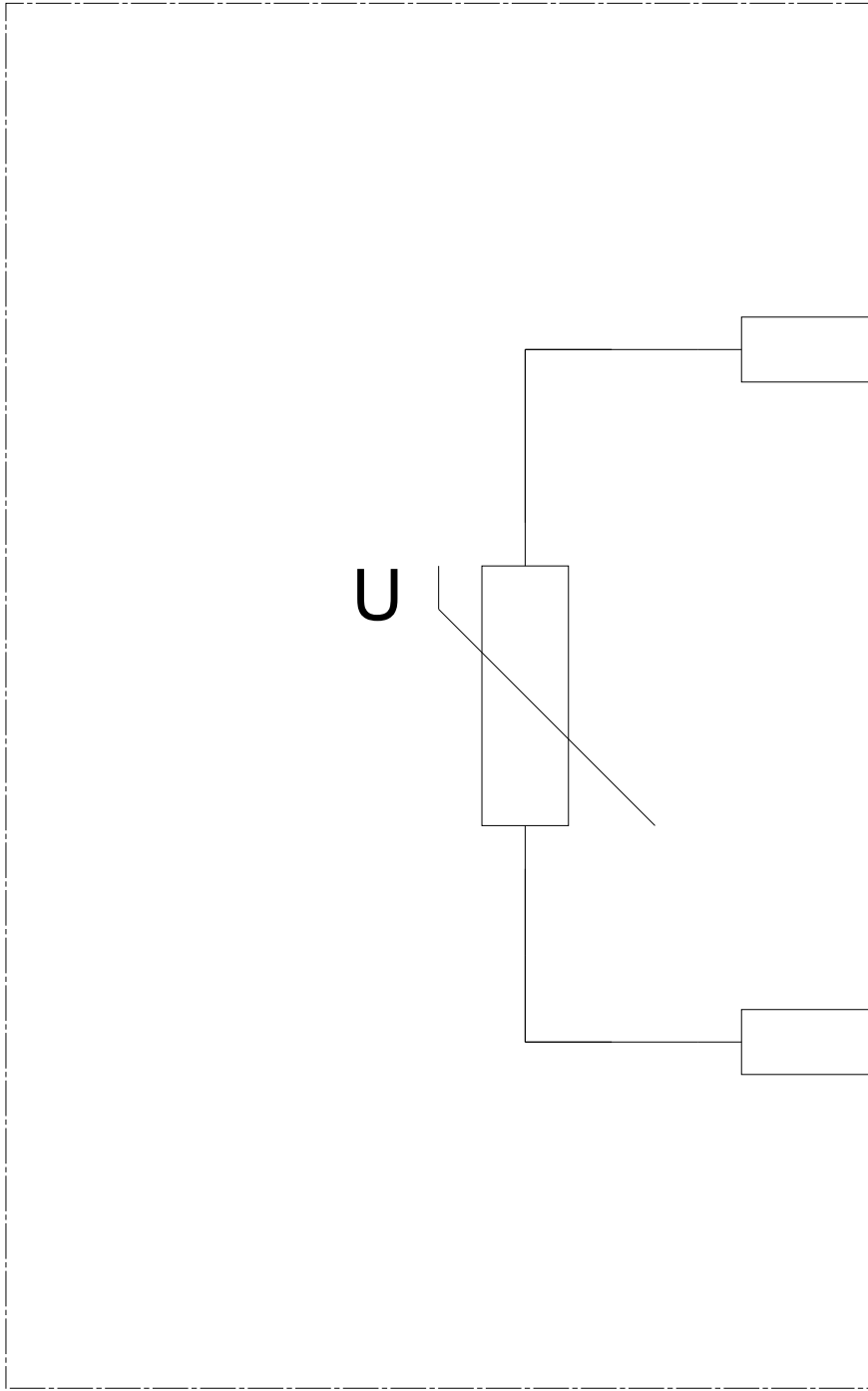

last modified:

08/10/2017