

Plexo weatherproof boxes

increased depth PVC range (continued)

■ Dimensions (mm)

Cat. No. 0922 84

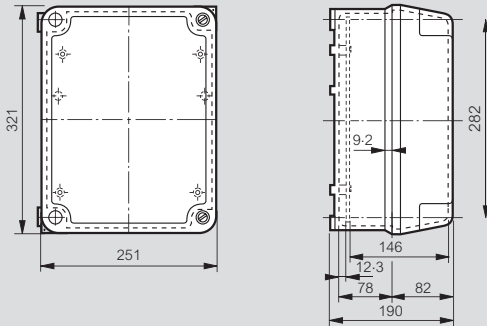

Fixing dimensions

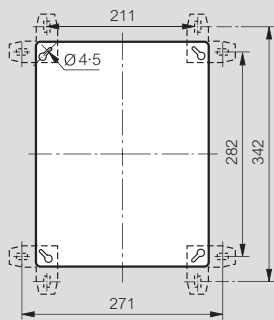

■ Mounting plates for PVC boxes

Cat. No. 0350 90

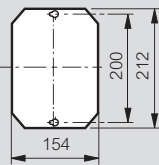

Cat. No. 0350 92

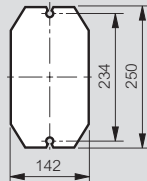

Cat. No. 0350 93

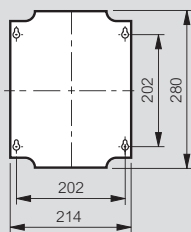

Cat. No. 0350 94

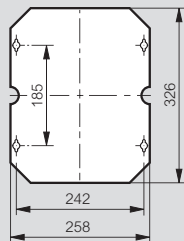

Nylbloc™ terminal strips

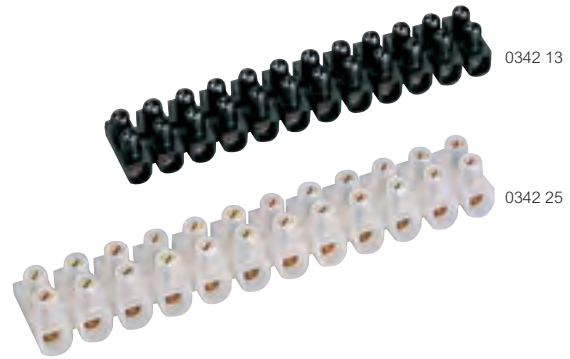

Pack	Cat. Nos.	Nylbloc terminal strips			
		According to EN 60998-2-1, the rated insulation voltage of Nylbloc terminal strips is 250 V			
		They may be used under 400 V nominal voltage supply when integrated in equipment designed according to EN 60664-1 with pollution degree 2 and overvoltage category III			
		12 way strips with captive screws			
		Supplied with screws undone			
		Flame retardent polypropylene (-25 °C to +100 °C)			
		Ambient temperature from -25 °C to +55 °C			
		Rated capacity (mm ²)	Diameter Ø	Current max. (A)	Dimensions (mm)
	Black				
10	0342 11	2.5	2.5	24	15.6 x 94 x 12.3
10	0342 13	6	3.5	41	18 x 107 x 14.7
10	0342 15	10	4.5	57	20.8 x 136 x 17.4
10	0342 17	16	5.5	76	24.2 x 157 x 22.6
10	0342 19	25	7	101	33.2 x 214 x 27.8
	White				
10	0342 21	2.5	2.5	24	15.6 x 94 x 12.3
10	0342 23	6	3.5	41	18 x 107 x 14.7
10	0342 25	10	4.5	57	20.8 x 136 x 17.4
10	0342 27	16	5.5	76	24.2 x 157 x 22.6



Plexo weatherproof boxes p. 36-40



distribution terminal blocks



Conform to standard IEC 60998-2-1
 Supplied ready for use (screws captive and backed-off)
 100 A max. - 400 V~ with 25 mm² incoming
 80 A max. - 400 V~ with 16 mm² incoming
 Ipk (kA) 60 : Icw (kA) 3-5

Pack	Cat. Nos.	Unshrouded terminal blocks		
		Fix using M4 dia. screw		
		Incoming capacity	Outgoing capacity	Terminal length (mm)
10	0048 01	1 x 6 to 25 mm ²	4 x 1.5 to 16 mm ²	45
10	0048 03	1 x 6 to 25 mm ²	8 x 1.5 to 16 mm ²	73
10	0048 05	1 x 6 to 25 mm ²	14 x 1.5 to 16 mm ²	122
10	0048 06	1 x 6 to 25 mm ²	19 x 1.5 to 16 mm ²	157
10	0048 07	1 x 6 to 25 mm ²	24 x 1.5 to 16 mm ²	192

		Fully shrouded terminal blocks		
		Terminal blocks on support		
		Mounting on or rail with universal terminal rail support Cat. No. 0048 11 or on 12 x 2 mm rail		
		Supplied with Duplix markers ¹		
		Incoming capacity	Outgoing capacity	Terminal length (mm)
10	0048 20 ¹	-	4 x 1.5 to 16 mm ²	47
10	0048 22 ¹	-	8 x 1.5 to 16 mm ²	75
10	0048 24 ¹	1 x 6 to 25 mm ²	12 x 1.5 to 16 mm ²	113
10	0048 25 ¹	1 x 6 to 25 mm ²	16 x 1.5 to 16 mm ²	141

		IP 2X terminal blocks on support		
		For fixing to 12 x 2 mm rail		
		Incoming capacity	Outgoing capacity	Terminal length (mm)
10	Phase (black) 0048 50	-	4 x 1.5 to 16 mm ²	47
10	0048 52	-	8 x 1.5 to 16 mm ²	75
10	0048 54	1 x 6 to 25 mm ²	12 x 1.5 to 16 mm ²	113
10	0048 55	1 x 6 to 25 mm ²	16 x 1.5 to 16 mm ²	141
10	0048 56	1 x 6 to 25 mm ²	21 x 1.5 to 16 mm ²	176
10	0048 58	2 x 6 to 25 mm ²	33 x 1.5 to 16 mm ²	276
		Neutral (blue)		
10	0048 30	-	4 x 1.5 to 16 mm ²	47
10	0048 32	-	8 x 1.5 to 16 mm ²	75
10	0048 34	1 x 6 to 25 mm ²	12 x 1.5 to 16 mm ²	113
10	0048 35	1 x 6 to 25 mm ²	16 x 1.5 to 16 mm ²	141
10	0048 36	1 x 6 to 25 mm ²	21 x 1.5 to 16 mm ²	176
10	0048 38	2 x 6 to 25 mm ²	33 x 1.5 to 16 mm ²	276
		Earth (green)		

		Supports for terminal blocks	
		Terminal side support	
1	0048 10	Consists of two side supports for positioning of up to 4 x IP 2X terminal blocks with the same dimensions to create a 2, 3 or 4 pole distribution block	
		Terminal rail support	
5	0048 11	Adaptor support for or rail. Provides a firm fixing allowing IP 2X terminal blocks to be side or top mounted on to adaptor	
		35 hole empty support	
5	0048 17	For screw terminal blocks Length : 276 mm	
		Rail	
10	0048 19	1 metre length of 12 x 2 mm terminal mounting rail - accepts partly and fully shrouded terminals	

■ Connection protection

Fixes into side supports to construct a distribution block

■ Use of terminal supports Cat. No. 0048 10

Terminal supports Cat. No. 0048 10 fitted with fully shrouded terminals providing custom made distribution

Adaptor support Cat. No. 0048 11 showing method of fixing terminals

+++ Plexo weatherproof boxes p. 36-40

¹ : Each terminal supplied with :
 - 2 green Duplix markers (+) - 2 blue Duplix markers (N) - 2 red Duplix markers (L)

Download the full file at

<http://assets.kempstoncontrols.com/doc/Legrand%20Industrial%20and%20power%20Protection%20catalogue.pdf>

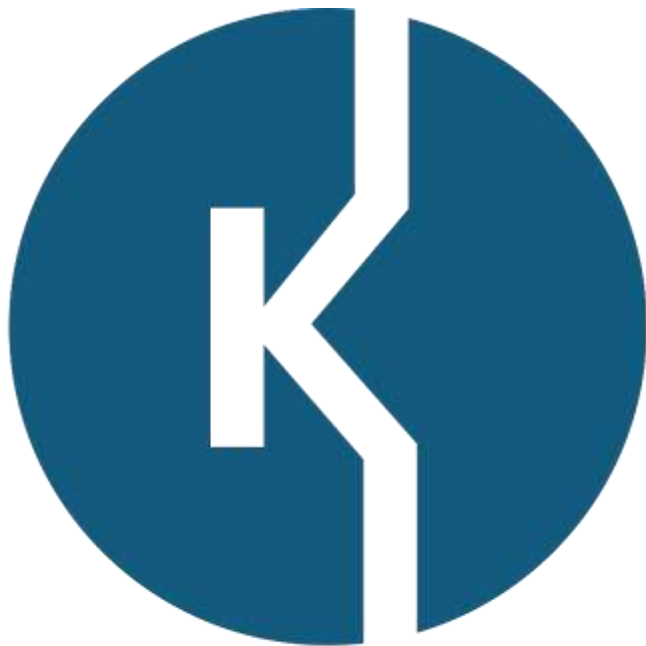

KEMPSTON
CONTROLS