

# 2200 Series / 2600 Series – General Purpose Industrial Pressure Transducers

- ▶ Gauge, Absolute, Vacuum and Compound Pressure Models Available
- ▶ Submersible, General Purpose and Wash Down Enclosures
- ▶ High Stability Achieved by CVD Sensing Element
- ▶ Millivolt, Voltage and Current Output Models

The 2200 series features stability and accuracy in a variety of enclosure options. The 2600 series extends the packaging options via an all welded stainless steel back end for demanding submersible and industrial applications. The 2200 and the 2600 feature proven CVD sensing technology, an ASIC (amplified units), and modular packaging to provide a sensor line that can easily accommodate specials while not sacrificing high performance.

## Specifications

Input	
<b>Pressure Range</b>	Vacuum to 6000 psi (400 bar)
<b>Proof Pressure</b>	2 x Full Scale (FS) (1.5 x Fs for 400 bar, ≥ 5000 psi)
<b>Burst Pressure</b>	>35 x FS <= 100 psi (6 bar); >20 x FS >= 1000 psi (60 bar); >5 x FS <= 6000 psi (400 bar)
<b>Fatigue Life</b>	Designed for more than 100 million FS cycles
Performance	
<b>Long Term Drift</b>	0.2% FS/year (non-cumulative)
<b>Accuracy</b>	0.25 % FS typical (optional 0.15% FS)
<b>Thermal Error</b>	1.5% FS typical (optional 1% FS)
<b>Compensated Temperatures</b>	-5°F to +180°F (-20°C to +80°C)
<b>Operating Temperatures</b>	-40°F to +260°F (-40°C to +125°C) for elec. codes A, B, C, 1 -5°F to +180°F (-20°C to +80°C) for elec. codes 2, D, G, 3 -5°F to +125°F (-20°C to +50°C) for elec. codes F,M, P Amplified units >100°C maximum 24 VDC supply
<b>Zero Tolerance</b>	1% of span
<b>Span Tolerance</b>	1% of span
<b>Response Time</b>	0.5 ms
Mechanical Configuration	
<b>Pressure Port</b>	See ordering chart
<b>Wetted Parts</b>	17-4 PH Stainless Steel
<b>Electrical Connection</b>	See ordering chart
<b>Enclosure</b>	316 ss, 17-4 PH ss IP65 NEMA 4 for elec. codes A, B, C, D, G, 1, 2, 3 IP67 for elec. code "F" IP68 for elec. codes M, (max depth 200 meters H <sub>2</sub> O) IP30 for elec. code "3" with flying leads
<b>Vibration</b>	70g, peak to peak sinusoidal, 5 to 2000 Hz (Random Vibration: 20 to 2000 Hz @ ≈20g Peak per MIL-STD.-810E Method 514.4)
<b>Acceleration</b>	100g steady acceleration in any direction 0.032% FS/g for 15 psi (1 bar) range decreasing logarithmically to 0.0007% FS/g for 6000 psi (400 bar) range.
<b>Shock</b>	20g, 11 ms, per MIL-STD.-810E Method 516.4 Procedure I
<b>Approvals</b>	CE, UR (221C, 261C, 22CS, 26CS)
<b>Weight</b>	Approx. 100 grams (additional cable; 75 g/m)

Series 2200



Series 2600



PRESSURE TRANSDUCERS

## Individual Specifications

<b>Millivolt Output units</b>	
Output	100 mV (10 mv/v)
Supply Voltage (Vs)	10 VDC (15 VDC max.) Regulated
Bridge resistance	2600-6000 ohms
<b>Voltage Output units</b>	
Output	see ordering chart
Supply Voltage (Vs)	1.5 VDC above span to 35 VDC @ 6 mA
Supply Voltage Sensitivity	0.01% FS/Volt
Min. Load Resistance	(FS output / 2) Kohms
Current Consumption	approx 6 mA at 7.5V output
<b>Current Output units</b>	
Output	4-20 mA (2 wire)
Supply Voltage (Vs)	24 VDC, (7-35 VDC)
Supply Voltage Sensitivity	0.01% FS/Volt
Max. Loop Resistance	(Vs-7) x 50 ohms

## Electromagnetic Capability

Meets the requirement for CE marking of EN50081-2 for emissions and EN50082-2 for susceptibility.

Test Data:

- EN61000-4-2 Electrostatic Discharge. 8kV air discharge, 4kV contact discharge. Unit survived.
- ENV50140 Radiated RF Susceptibility. 10V/m, 80MHz-1GHz, 1kHz mod. Maximum recorded output error was  $<\pm 1\%$
- ENV50204 Radiated RF Susceptibility to Mobile Telephones. 10V/m, 900MHz. Maximum recorded output error was  $<\pm 1\%$ .
- EN61000-4-4 Fast Burst Transient. 2kV, 5/50ns, 5kHz for 1 minute. Unit survived.
- ENV50141 Conducted RF Susceptibility. 10Vms, 1kHz mod, 150kHz - 80MHz. Maximum recorded output error was  $<\pm 1\%$

Connection Code		mV units				Voltage units				Current units (4-20mA)		
		IN+	OUT+	OUT-	IN-	IN+	COM	OUT+	EARTH	(+)	(-)	EARTH
A, B, G	"DIN" PIN	1	2	3	E	1	2	3	4	1	2	4
C	"10-6 Bayonet" PIN	A	B	C	D	A	C	B	E	A	B	E
D	"cable"	R	Y	BL	G	R	BK	W	DRAIN	R	BK	DRAIN
F	"IP 67 cable"	R	Y	BL	G	R	BK	W	DRAIN	R	BK	DRAIN
M	"Immersible"	R	Y	BL	W	R	W	Y	DRAIN	R	BL	DRAIN
1	"8-4 Bayonet" PIN	A	B	C	D	A	C	B	D	A	B	D
2	"cable"	R	W	G	BK	R	BK	W	DRAIN	R	BK	DRAIN
3	"conduit & cable"	R	W	G	BK	R	BK	W	DRAIN	R	BK	DRAIN

### Cable Legend:

R = Red  
BL = Blue  
BK = Black  
W = White  
Y = Yellow

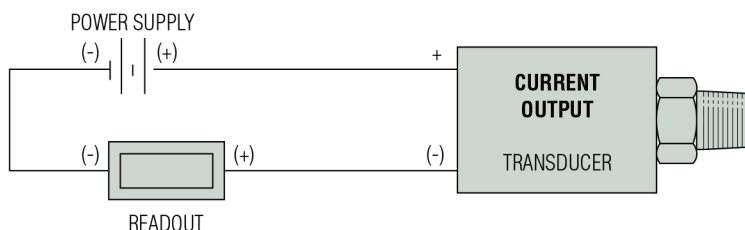
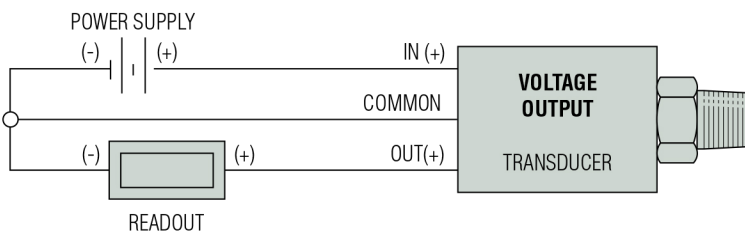
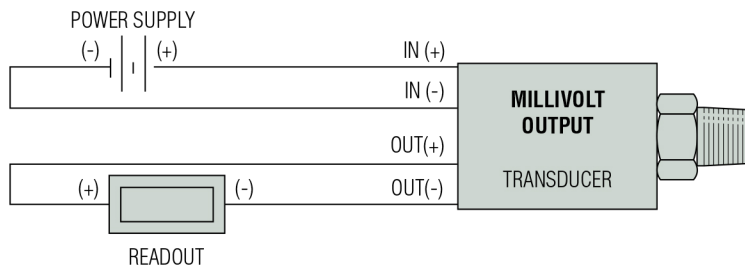



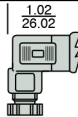
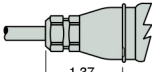
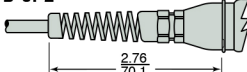

## Dimensions

### 2200 Series

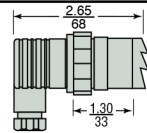
<b>Mini 4 Pin - No Connector</b>
<b>Code B</b> 
<b>Mini 4 Pin - With Connector</b>
<b>Code A</b>  1.02 26.02
<b>IP67 Cable (Waterproof)</b>
<b>Code F</b>  1.37 35.0
24 AWG Shielded PVC
<b>IP65 or NEMA4 Cable</b>
<b>Code D or 2</b>  2.76 70.1
24 AWG Shielded PVC

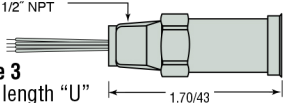
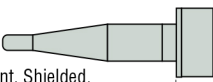
### 2600 Series







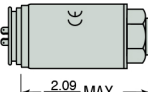
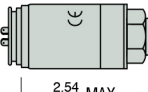



<b>10-6 or 8-4 Mil-C Connector</b>
<b>10-6 Code C</b>  0.87 22
8-4 Code 1
<b>Large DIN 43650 Plug</b>
<b>Code G</b>  2.65 68 1.30 33
<b>Conduit Connector with Cable</b>
<b>Code 3</b> 1/2" NPT  43 1.70
24 AWG Shielded PVC
<b>Conduit Connector with Flying Leads</b>
1/2" NPT <b>Code 3</b> with length "U"  1.70/43
<b>Moulded, Immersible Cable</b>
<b>Code M</b>  0.90 23
24 AWG, Vent, Shielded, Polyurethane

<b>mV Gauge/Absolute Amplified Gauge</b>  2.43 61.60 MAX
<b>Amplified Absolute</b>  2.48 65.7 MAX

Maximum diameter 1.07" (27.3 mm)

<b>mV Gauge/Absolute Amplified Gauge</b>  2.09 53.2 MAX
<b>Amplified Absolute</b>  2.54 64.4 MAX

Maximum diameter 1.07" (27.3 mm)

<b>1/8-27 NPT</b>
<b>Code 08</b>  0.59 15
<b>1/4 - 18 NPT</b>
<b>Code 02 with snubber</b> 
<b>Code OJ with snubber</b>  0.79 20
<b>1/4-18 NPT Internal</b>
<b>Code OE</b>  0.95 24
<b>1/2-14 NPT</b>
<b>Code OH</b>  1.02 26.0
<b>7/16-20 UNF-2A</b>
<b>Code 04</b>  0.75 19
<b>9/16-18 UNF-2A</b>
<b>Code 1P</b>  0.67 17
<b>G 1/8 Internal</b>
<b>Code 09</b> 
<b>G 1/4 External</b>
<b>Code 01</b>  0.67 17
<b>R 1/4</b>
<b>Code 0A</b>  0.79 20

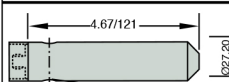
<b>Nose Cone - Black Acetal</b>
<b>Code 19</b>  0.75 19
<b>Nose Cone Sink Weight</b>
 4.67/121 0.27/20
<b>Code 29</b> Through hole Ø 10.0

inch  
mm

## How to Order

Use the **bold** characters from the chart below to construct a product code

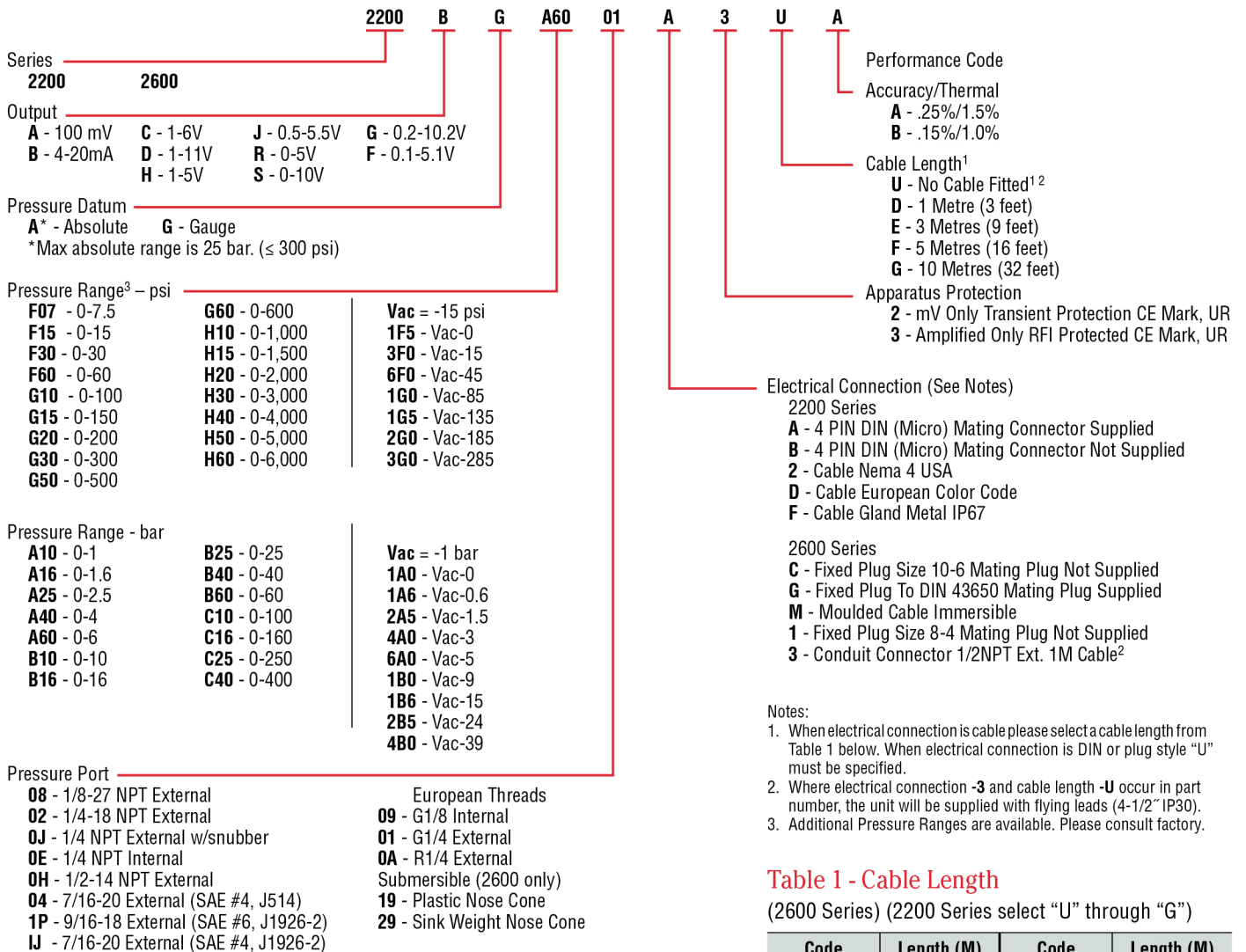

### Table 1 - Cable Length

(2600 Series) (2200 Series select "U" through "G")

Code	Length (M)	Code	Length (M)
<b>U</b>	No Cable Fitted	<b>M</b>	40
<b>D</b>	1	<b>N</b>	50
<b>E</b>	3	<b>P</b>	75
<b>F</b>	5	<b>Q</b>	100
<b>G</b>	10	<b>R</b>	125
<b>H</b>	15	<b>S</b>	150
<b>J</b>	20	<b>4</b>	170
<b>K</b>	25	<b>5</b>	200
<b>L</b>	30	<b>6</b>	225

Note: Maximum cable length on a 2200 is 10 meters.