



QMX3.P37 QMX3.P34 / P74 QMX3.P02 QMX3.P70 QMX3.P30 / P40

Desigo™ TRA











Wall-mounted sensors and room operator units for KNX PL-Link, KNX S-mode and KNX LTE-Mode

QMX3.P30
QMX3.P40
QMX3.P70
QMX3.P02
QMX3.P34
QMX3.P74
QMX3.P37

Communicative sensors, switches and room operator units with KNX (S-mode, LTE-Mode) or KNX PL-Link (for Desigo™ Total Room Automation)

Functions (depending on type):

- Energy efficiency function ("Green Leaf )
- Room temperature, CO₂, and humidity measurement
- Control of light, blinds, and scenes
- PID controller for room temperature or ventilation (KNX S-mode)
- LCD Display for room temperature, operating mode, etc.
- Label for light, blinds and scenes (exchangeable, created with Word template)
- Operation via 8 or 16 touchkeys
- Interface KNX (S-mode, LTE-Mode) and KNX PL-Link (for TRA, with plug & play functionality)
- Powered over KNX PL-Link / KNX bus
- LEDs to indicate the switch state or the position of the device in dark rooms

			Product number	Stock number	Features								
					Temperature sensor	Humidity sensor	CO ₂ sensor	Air quality indicator with LED	Segmented backlit display and	"Green Leaf" LED	Configurable touch-keys with LED	Window for labels	
Sensors			QMX3.P30	S55624-H103	X								
			QMX3.P30-1BSC	S55624-H123									
			QMX3.P40	S55624-H116	X	X							
			QMX3.P40-1BSC	S55624-H124									
			QMX3.P70	S55624-H104	X	X	X	X					
			QMX3.P70-1BSC	S55624-H125									
Room operator units			QMX3.P02	S55624-H107	X						X	X	
			QMX3.P02-1BSC	S55624-H128									
			QMX3.P34	S55624-H105	X				X	X			
			QMX3.P34-1BSC	S55624-H126									
			QMX3.P74	S55624-H106	X	X	X		X	X			
			QMX3.P74-1BSC	S55624-H127									
		QMX3.P37	S55624-H108	X				X	X	X	X		
		QMX3.P37-1BSC	S55624-H129										
Accessories		QMX3.MP1	S55624-H110	Base plate for conduit box / cavity wall box for 68 mm diameter hole 20 pcs. per package									

Use / compatibility

Use with KNX PL-Link

The room automation station determines the functions of both LCD display and keys.

- **Measure and indicate** the room temperature, humidity and CO₂.
- **Operate** the room functions.
- **Indicate external information** (outdoor temp., outdoor humidity, state of a window switch).

Use with KNX S-mode

Measure and indicate

- the room temperature
- the relative humidity
- the CO₂ concentration

Control (threshold value switch)

- of the relative humidity
- of the CO₂ concentration

Indicate external information

- outdoor temperature
- outdoor humidity
- state of a window switch

Control (with a PID controller)

- of the room temperature

Use with KNX S-mode
(continued)

Switches

- switching and dimming of lights
- control of blinds
- selecting and saving of scenes

**Use with
KNX LTE-Mode**

LTE can only use the sensor information of the types QMX3.P30, QMX3.P40, and QMX3.P70.

NOTICE

Devices with CO₂ measurement are not suitable for safety applications such as gas or smoke alarm.

Mechanical design

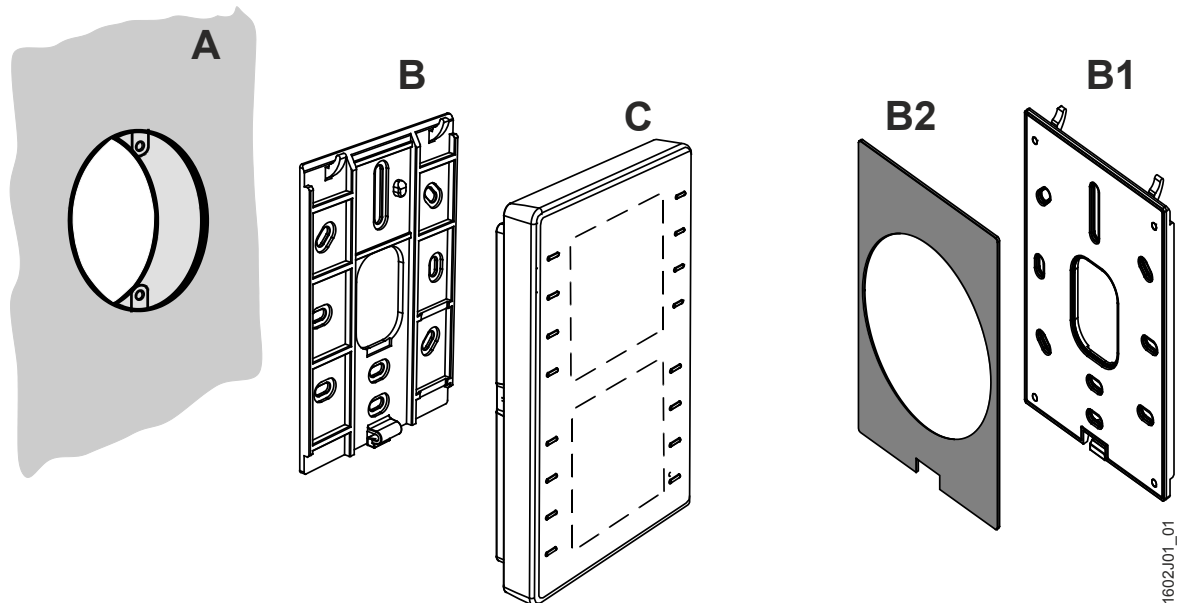

- The devices are designed for **wall-mounting (A)**. A conduit box is optional.
 - **Conduit box:** Keep in mind the dimensions of the conduit box!
 - **Cable conduits on the wall:** Keep a distance of 30 mm (from above) / 20 mm (from below) to the base plate (B), so that the device (C) can be snapped onto the base plate.
- The **base plate (B)** has screw holes for all common flush-mount boxes. **The screw head height must not exceed 3 mm.**
- The **device (C)** incorporates a KNX / PL-Link plug, a tool plug, and, depending on the type, sensor element, keys, LCD panel, window for the label. The cable can be pushed into channels on the rear.
- A KNX plug is enclosed with the devices

The optional metal-reinforced base plate **QMX3.MP1 (B1)** serves for two purposes:

- It is more rigid so that it does not bend when fixed in the middle with two screws only (directly over a conduit box or a cavity wall box).
- It has a removable gray foam plate (B2) for mounting on a 68 mm diameter cavity wall box. The plate compensates for the jutting edge of the box (see mounting, page 5).

Note QMX3.MP1 is supplied in boxes with 20 pcs.

KNX PL-Link

- The room operator units offer plug & play functionality.
- The room operator units receive their power from the connected room automation station via the KNX PL-Link interface.
- KNX PL-Link supports plug & play functionality for pre-configured devices out of the library
- For KNX PL-Link wiring (topology, allowed cables and cable length), see the Desigo installation guide, CM111043.
- Normally, electrical installers only install the base plate and the KNX PL-Link plug.
- Use the tear-off label with the barcode on the packaging / on the display and stick it on the floor plan to prepare commissioning for several room operator units per room automation station.
The same barcode label with unique identifier is available on the device.

KNX S-mode

Engineering and commissioning is done using the ETS tool
For detail information see Technical basics, P1602.

KNX LTE-Mode

Engineering and commissioning is done using the ACS tool.
For detail information see Technical basics, P1602.

Labels for switches (QMX3.P02, P37)

- The ABT provides a list of the devices, their function and their location
- Create the labels using a Word template (M1602.1)
- Print the labels on commercially available overhead transparency film
- Cut out the labels
- Insert or exchange the labels as described in the mounting instructions, M1602.

Mounting and installation

Location (sensors, room operator units)

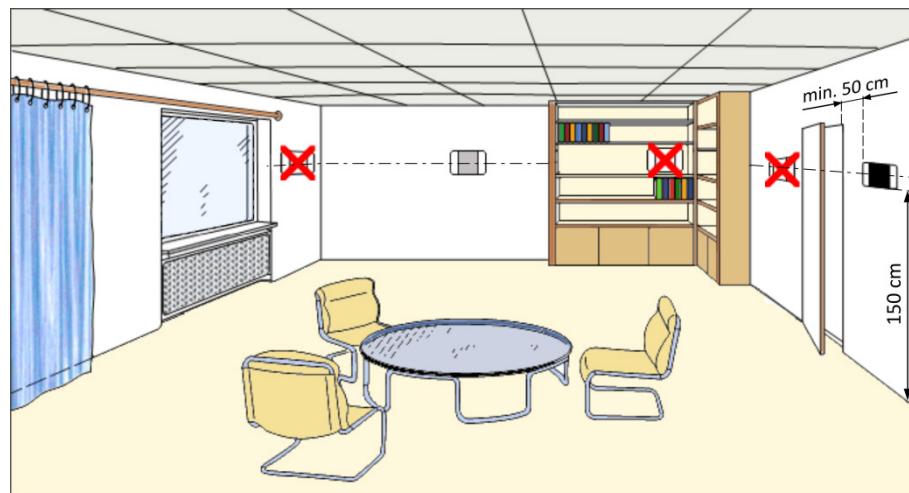

- The devices are suitable for wall mounting.
- Recommended height: 1.50 m above floor.
- Do not mount the devices in recesses, shelves, behind curtains or doors, or above or near heat sources.
- Avoid direct solar radiation and drafts.
- Seal the conduit box or the installation tube, as air currents can affect sensor readings.
- Adhere to allowed ambient conditions.

Mounting instructions

- Mounting instructions M1602 are enclosed with the devices.

Mounting over a conduit box

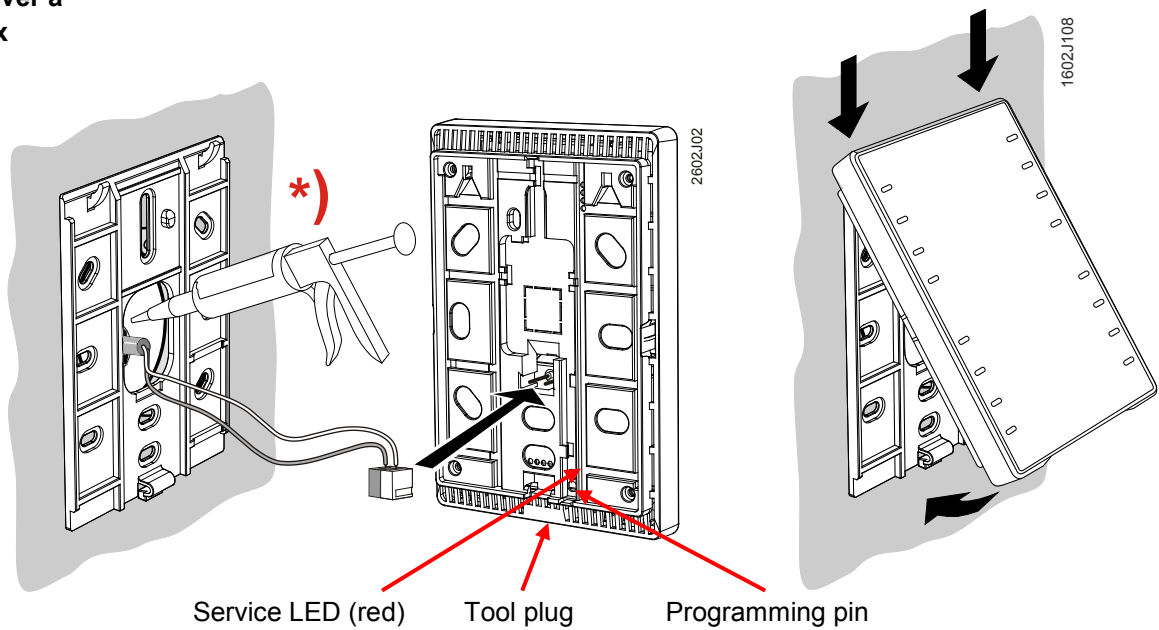

***)** The installing tube must be sealed or cold or warm air may enter the device and cause faulty temperature readings by the internal sensor.

Mounting over a cavity wall box

Use a metal-reinforced base plate QMX3.MP1 instead of the standard base plate delivered with the room operator unit.

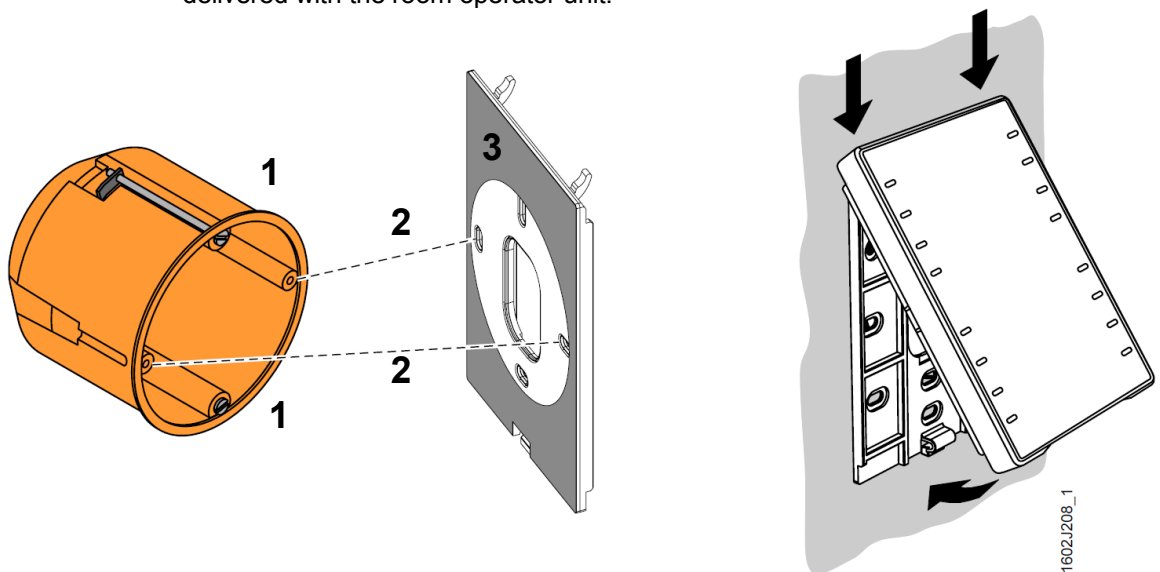

The installing tube must be sealed or cold or warm air may enter the device and cause faulty temperature readings by the internal sensor.

- 1 Fixing the box on the cavity wall.
- 2 Fixing the QMX3.MP1 base plate on the box using 2 screws.
- 3 The gray foam plate (removable) compensates for the jutting edge of the box so that the plate is aligned with the wall.

Wall mounting

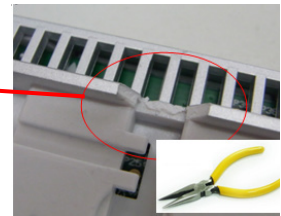
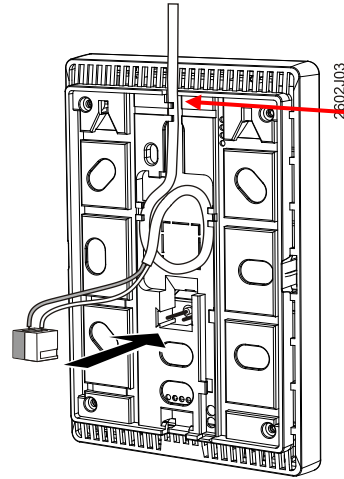
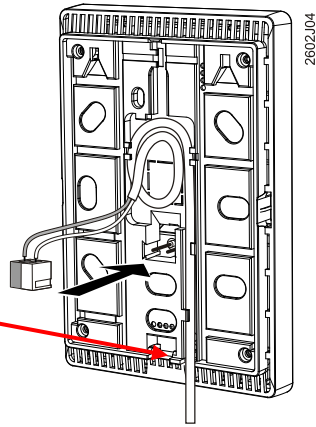
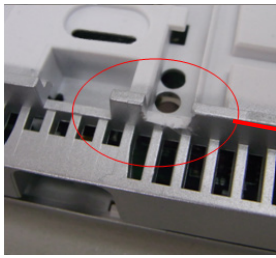

Remove the breakout on the housing before putting the cable into the gaining channel.

4-wire cables (daisy chain wiring)

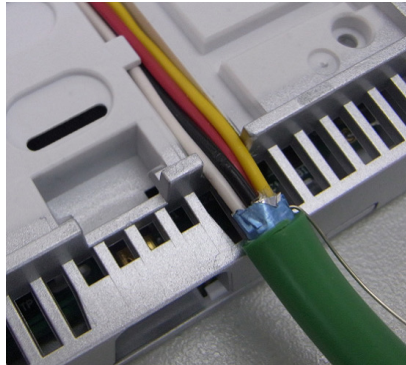

Remove the cable coating, as it will not fit in the gaining channel.

Cable ducts on the wall

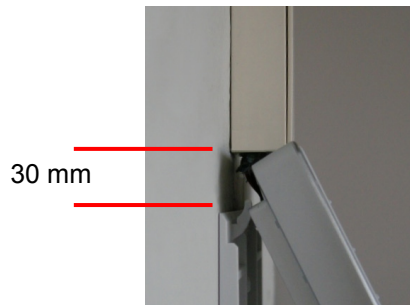

Keep a distance of 30 mm (from above) / 20 mm (from below) to the base plate, so that the device can be snapped onto the base plate.

Dismounting / service:

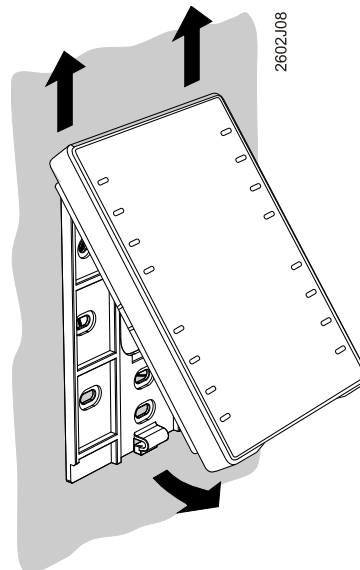
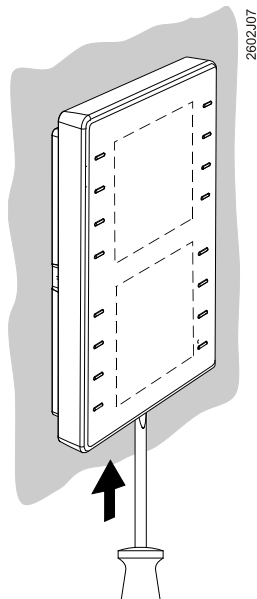

**Labels for QMX3.P02,
QMX3.P37**

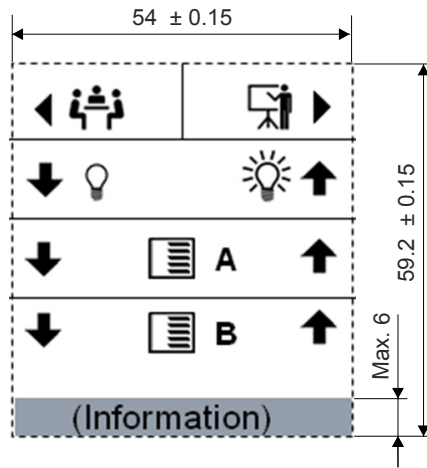

Sample icons are available in the label template M1602.1

Information. e.g. on room operator unit location or on room type (free text)

Insert label

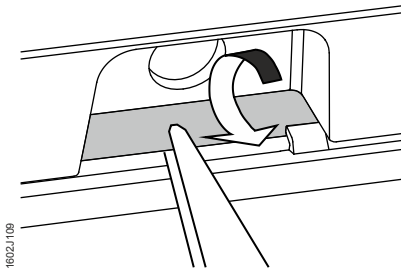
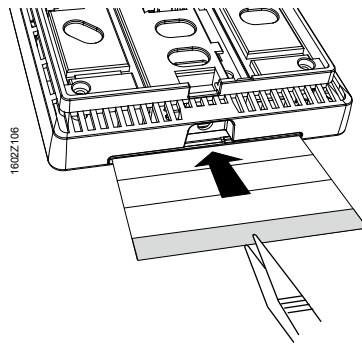

Remove label

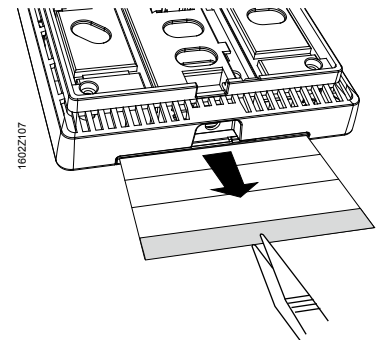
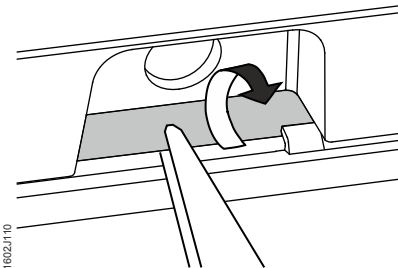

Installation

- For KNX PL-Link wiring (topology, allowed cables and cable length), see the Designo TRA installation guide, CM111043.
- Use the correct cables for the KNX PL-Link bus
- Do not interchange the wires of the KNX PL-Link cable.
 - The red terminal is for KNX PL-Link +
 - The gray terminal is for KNX PL-Link –
- For KNX S-mode follow the KNX regulations
- Observe all local installation regulations.

⚠ Caution! • The devices are not protected against accidental connection to AC 230 V.

Prerequisite for commissioning (KNX PL-Link)

Load application on the room automation station

The room automation station must be running and an application must be loaded.

The application is not loaded on the room operator unit, but the room automation station.

Download of the application is done using the SSA-DNT (Pack & Go) or the ABT. For this purpose (or for service), connect the ABT to the room automation station (USB or Ethernet).

Manual commissioning (KNX PL-Link)

All commissioning work is done via the room automation station, using the SSA-DNT or the ABT.

The ABT is never connected directly to a room operator unit.

When more than one QXM3.P... room operator unit is on the same trunk of the KNX PL-Link bus, manual commissioning is done as follows:

1. Connect the SSA-DNT or the ABT to the room automation station and activate the online commissioning function.
2. Load the web page "KNX PL-Link identification".
Activate the identification function.
The room automation station now waits for a signal from the room operator unit.
3. On the room operator unit, simultaneously press the upper left and bottom right button for at least 5 seconds (keys 1 and 8).
4. The "Engineering" page  is displayed.
5. Press "Prog. Mode" (Key 2).
The display changes from "DISA" to "EnAB".
The tool identifies the current room operator unit that is operated and assigns it.
6. After the device is commissioned, reset the device to programming mode to "disabled" by pressing key 2.

Addressing

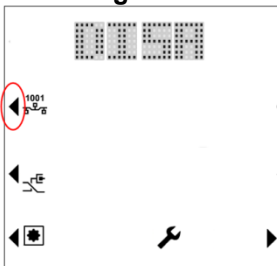

Note: Programming mode resets to "disabled" each time the device restarts.

Connection test

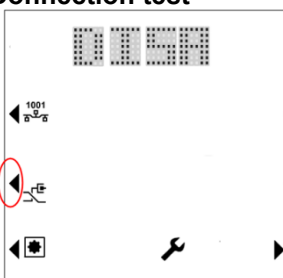

1. Press "Conn. Test" (key 3) to test the KNX PL-Link connection.
The display shows the result of the connection test:

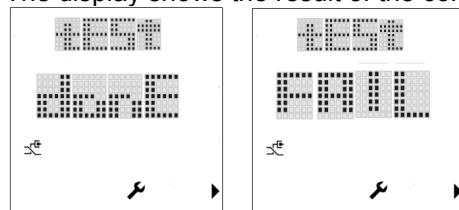

2. Press key 8 to return to the engineering page.

Reset to factory setting

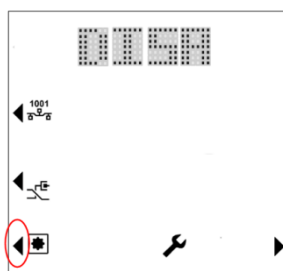

Press "Fact. Reset" (Key 4). The device is locked and reboots within 10 seconds. The room automation station deletes it from its device list. During this time, it is safe to remove the device from the network.

If the bus plug remains connected, the device acts like a newly inserted device requiring again automated or manual configuration.



Note! This operation resets all user preference data and configuration settings to factory default. This operation is irreversible.

Manual commissioning (KNX PL-Link, without display)

The devices are equipped with a programming pin and a red service LED on the back side (see page 4)

Addressing

1. Short press the programming pin (<0.5 s).
The device goes into programming mode; the service LED is continuously on. The tool identifies the current room operator unit that is operated and assigns it.
2. After the device is commissioned, deactivate the programming mode by shortly pressing the programming pin (<0.5 s). The service LED goes off.

Note: Programming mode resets to “disabled” each time the device restarts.

Connection test

1. Medium press the programming pin (>2 s and <20 s) to test the KNX PL-Link connection. After releasing the programming pin, the test of the KNX PL-Link connection starts; the service LED flashes (1/4 s on, 7/4 s off).
After approx. 10 s, the test result is displayed:
 - If the test is positive, the LED goes on continuously.
 - If the test fails, it flashes (1 s on, 1 s off).
2. Short press the programming pin (<0.5 s) to stop displaying the result of the connection test. The service LED goes off.

Reset to factory setting

Long press the programming pin (>20 s). The device is locked and reboots within 10 seconds. The room automation station deletes it from its device list. During this time, it is safe to remove the device from the network.

Note: there is no LED activity during this operation.

If the bus plug remains connected, the device acts like a newly inserted device requiring again automated or manual configuration.

NOTICE



This operation resets all user preference data and configuration settings to factory default.

This operation is irreversible.

Commissioning (plug & play, KNX PL-Link)

When **only one device** is connected to the KNX PL-Link bus, the room operator unit automatically establishes communications with the room automation station, from where the functions are downloaded to the room operator unit (plug & play).

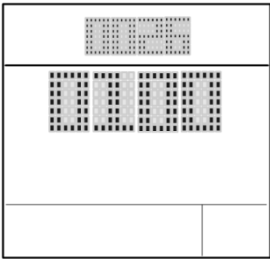
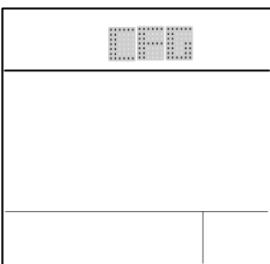
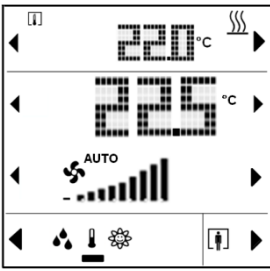
The following routine is executed:

Step	With display	Description
1		The Build number and the version number of the device are displayed.
2		The Individual Address (IA) is downloaded to the device via KNX PL-Link. This step is skipped if the device is already configured. Note: The configuration file can be downloaded any time; as a result, these characters are displayed every time the room automation station initializes download.
3a		After startup, the device goes to normal operation (example view; picture depends on application in room automation station).
3b		When configuration is faulty, "UCFG" is displayed, along with the temperature that is measured by the local temperature sensor. In this case, manual commissioning must be performed (see above).

Commissioning (KNX)

The devices are equipped with a programming pin and a red service LED for KNX commissioning (see page 4).

Addressing

1. Short press the programming pin (<0.5 s).
The device goes into programming mode; the service LED is continuously on.
The tool identifies the current room operator unit that is operated and assigns it.
2. After the device is commissioned, deactivate the programming mode by shortly pressing the programming pin (<0.5 s). The service LED goes off.

Note: Programming mode resets to “disabled” each time the device restarts.

Reset to factory setting

Long press the programming pin (>20 s). The device is locked and reboots within 10 seconds. The room automation station deletes it from its device list. During this time, it is safe to remove the device from the network.

If the bus plug remains connected, the device acts like a newly inserted device requiring again automated or manual configuration.

NOTICE

This operation resets all user preference data and configuration settings to factory default.

This operation is irreversible.

Display and operation

NOTICE

Operation and display of the room operator unit depend on the control program running on the room automation station.

Numbering of the keys

1	-	-	5
2	-	-	6
3	-	-	7
4	-	-	8





9	-	-	13
10	-	-	14
11	-	-	15
12	-	-	16

Keys 1...8 for room operator units

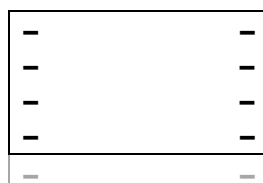
Keys 9...16 for switches

LED display (upper right corner)



-  /  Green Leaf (green, red: Indicates the Energy efficiency (room operator units))
-    green, orange, red: Indicates the air quality (multi sensor QMX3.P70)

Switches / keys

9	-	•	-	13
10	-	•	-	14

11	-	•	-	15
12	-	•	-	16

- Each line can be a pair of keys or two separate keys (Light *), blinds **), scenes ***)
- Each key is equipped with an LED (green)

- *) Light
- The activity of the LEDs depends on the application running on the room automation station
- ***) Scenes
- Selecting a predefined scene (short press, <0.5.s). LED is on for 3 s.
 - Saving a changed scene (long press > 5s). LED flashes during 3 s. When it goes off, the user can release the key.

Display layout of room operator units

A	
B	
C	
D	E

- A Display (temp., AQ, r.h.)
- B Setpoint adjustment (temperature) ****)
- C Operation (fan, operating mode)
- D Navigation
- E Presence / Comfort prolongation (display, operation)





****) Setpoint adjustment :

- Absolute value (23.5 °C) or relative value (+2 °C)

Function of the display elements and keys

Key		Key
1		5
2		6
3		7
4		8

	<ul style="list-style-type: none"> • An arrow indicates that an element can be operated
	<ul style="list-style-type: none"> • Temperature display in °C or °F / humidity in % r.H. / air quality in text, symbol, or ppm of CO₂
	<ul style="list-style-type: none"> • Toggling (key 1) between indoor and outdoor measurement (temperature, humidity, CO₂)
	<ul style="list-style-type: none"> • Indication that a window is open (connected window switch is active)
	<ul style="list-style-type: none"> • Display of the plant state (Heating or Cooling / inactive) Note: No manual switchover! Key 5 is used for Green Leaf
	<ul style="list-style-type: none"> • Green Leaf function: Pressing key 5 activates the RoomOptiControl function.
	<ul style="list-style-type: none"> • Display of the relative or absolute setpoint for temperature • Adjusting the setpoint using keys 2 and 6
	<ul style="list-style-type: none"> • Display of the present fan speed (when automatic) • Adjusting the fan speed using key 3 (or keys 3 and 7 if operation of room operating mode is disabled)
	<ul style="list-style-type: none"> • Display of the room operating mode (when automatic) • Adjusting the room operating mode using key 7
	<ul style="list-style-type: none"> • Navigation: toggle the display / setpoint setting between temperature / humidity / CO₂ , using key 4. The black bar points to the displayed information.
	<ul style="list-style-type: none"> • Operation of the occupancy state (presence switch, Comfort prolongation) • Activate the Comfort prolongation using key 8 (only available if enabled)

   	<ul style="list-style-type: none"> Engineering functions (press keys 1 and 8 simultaneously during 5 s) <ul style="list-style-type: none"> – Programming mode (key 2), same function as programming pin – Connection test (Key 3) – Reset device to factory settings (key 4) <p>Note: This operation is irreversible!</p>
	<ul style="list-style-type: none"> Indicates that the room operator unit is locked by the system. <ul style="list-style-type: none"> – Operation is disabled – The display in line 1 shows the temperature from bus

Maintenance

NOTICE



The device can be cleaned with off-the shelf, solvent-free cleaning agents. Do not use mechanical aids (rough sponge or similar materials) – only a soft, damp cloth.

Technical data

Supply voltage	Operating voltage range	KNX / PL-Link DC 21...30 V
Power consumption (from room automation station)	The device receives its power from the connected room automation station via the KNX / PL-Link interface	
	QMX3.P02	Max 7.5mA at DC 24 V
	QMX3.P30	Max 7.5mA at DC 24 V
	QMX3.P34	Max 7.5mA at DC 24 V
	QMX3.P40	Max 7.5mA at DC 24 V
	QMX3.P37	Max 10mA at DC 24 V
	QMX3.P70	Max 15mA at DC 24 V
	QMX3.P74	Max 15mA at DC 24 V
Operating data	Temperature sensor (all types)	
	Measuring element	NTC resistance sensor
	Measuring range	0...50 °C
	Measuring accuracy (5...30 °C)	±0.8 K
	Measuring accuracy (25 °C)	±0.5 K
	Relative Humidity Sensor (r.h.) (QMX3.P40; QMX3.P74; QMX3.P70)	
	Measuring range	10%...95% r.h.
	Accuracy (20%...80%)	±4% at 25°C
	Accuracy (0%...20%, 80%...95%)	±6% at 25°C
	CO ₂ Sensor (QMX3.P74; QMX3.P70) *)	
	Measuring range	400..10000 ppm
	Measuring accuracy at 23 °C and 1013 hPa	±(30 ppm +4% of measured value)
	for measured value 400...2000 ppm	degraded accuracy.
	for measured value >2000 ppm	
	Temperature dependency	±2 ppm / °C typical
	Pressure dependency	0.14% of measured value / hPa
	Long-term drift	±20 ppm per year
	Service life	15 years

*) Notes on CO₂ sensor

- Function:** The sensor determines the CO₂ concentration via infrared absorption measurement (NDIR). The sensor is maintenance free in normal environments, thanks to the built-in self-correcting ABC (Automatic Baseline Correction) algorithm. This algorithm keeps track of the sensor's lowest reading within 8 days and corrects for any drift detected. The sensor also contains self-diagnostics to assure proper operation during lifetime.
- Use:** Normal environments, such as offices, class rooms, hotel rooms, or other non-permanently occupied areas, typically reach at least once a week the CO₂ concentration of fresh air of 400 ppm. However, exposure to a lowest CO₂ concentration other than fresh air, or incorrect altitude parameter setting, might result in reduced accuracy and incorrect operation.
- Rough handling during **transport, storage or mounting** might adversely affect accuracy during the first days of operation.
- The specified **accuracy** is reached after 25 days of continuous operation.

Display	Type	Information displayed depends on the application in the room automation station.		Segment LCD	<ul style="list-style-type: none"> – Room temperature, humidity, CO₂ – Setpoint adjustment – Control mode – Manually selected fan speed – Control sequence – Scenes (LED next to the button) – etc. 					
	Ports/interfaces	Type of port between room automation station and room operator unit	KNX / PL-Link							
	Baud rate	9.6 kbps								
	Standard KNX plug	Wire diameter 0.8 mm, max. 1.0 mm (solid conductors only)								
	Cable type	Solid conductors 2-core, twisted pair								
	Single cable length (from room automation station to room operator unit)	<1000 m								
	Cables must comply with KNX specifications, see TRA Install. manual, CM111043 ¹⁾									
Housing protection	Protection standard as per EN 60529	IP 30								
Protection class	Insulation protection class	III								
Ambient conditions	IEC 721	Normal operation	Transport							
	Environmental conditions	Class 3K5	Class 2K3							
	Temperature	0...50 °C	– 25...70 °C							
	Humidity	< 85 % rh	< 95 % rh							
	Mechanical conditions	Class 3M2	Class 2M2							
Standards and directives	EU conformity (CE)	CM2T1602xx ¹⁾								
	 compliance	UL916								
	 compliance	Part 15 of the FCC rules								
	CSA compliance	C22.2 No 205 – Signal equipment C22.2 No 0 – General Requirements								
	 RCM Mark conformity (EMC)	AS/NZS 61000-6-3								
	The product environmental declaration CM2E1602 ¹⁾ contains data on environmentally compatible product design and assessments (RoHS compliance, materials composition, packaging, environmental benefit, disposal)									
Color	Front housing	Models QMX3.Pxx Models QMX3.Pxx-1BSC	Titanium white similar to RAL9010 Black similar to RAL9005							
	Weight [g]		QMX3.	P02	P30	P34	P37	P40	P70	P74
	Operator unit		91	84	122	124	85	97	132	
	Base plate		20	20	20	20	20	20	20	
	Packaging		64	64	64	64	64	64	64	
	Total		175	168	206	208	169	181	216	

¹⁾ The documents can be downloaded from <http://siemens.com/bt/download>.

Notes on FCC rules

NOTICE

This device complies with Part 15 of the FCC Rules. Operation is subject to the following two conditions: (1) this device may not cause harmful interference, and (2) this device must accept any interference received, including interference that may cause undesired operation.

FCC warning

This equipment has been tested and found to comply with the limits for a Class B digital device, pursuant to part 15 of the FCC Rules. These limits are designed to provide reasonable protection against harmful interference in a residential installation. This equipment generates, uses and can radiate radio frequency energy and, if not installed and used in accordance with the instructions, may cause harmful interference to radio communications. However, there is no guarantee that interference will not occur in a particular installation. If this equipment does cause harmful interference to radio or television reception, which can be determined by turning the equipment off and on, the user is encouraged to try to correct the interference by one or more of the following measures:

- Reorient or relocate the receiving antenna.
- Increase the separation between the equipment and receiver.
- Connect the equipment into an outlet on a circuit different from that to which the receiver is connected.
- Consult the dealer or an experienced radio/TV technician for help.

Connection

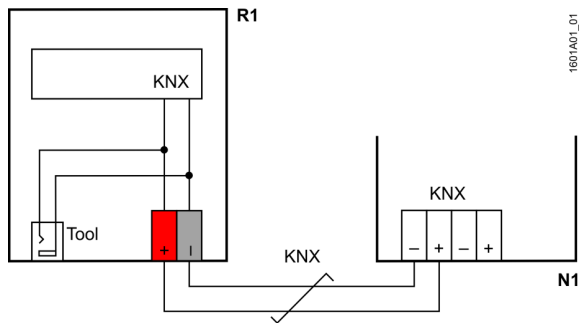

R1 QMX3... room operator unit
 N1 Controller, actuator
 ✓ = Twisted pair

KNX / PL-Link plug

+	Red	KNX PL-Link (positive)
-	Gray	KNX PL-Link (negative)

NOTICE

- **Wires are NOT interchangeable.**
The device is protected against faulty wiring, but communications does not work on interchanged wires.
- **The KNX / KNX PL-Link bus MUST NOT be connected to the tool plug, only the tool.**

Tool plug
(2.5 mm Jack)

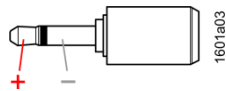

RJ45 plug of the tool cable

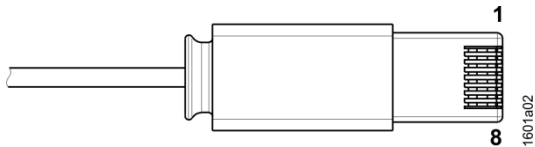

1	CE+, KNX	5	Spannung 16 V
2	CE-, KNX	6	N.C.
3	N.C.	7	Ident'pin
4	N.C.	8	GND

Connect the tool

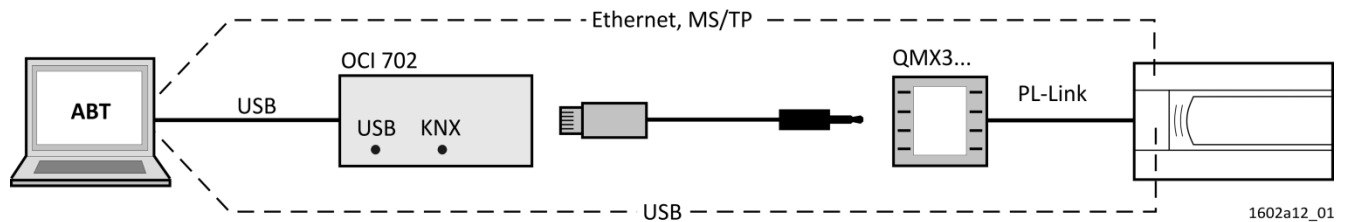

Connect the ABT to load the application in the room automation station, or for service purposes:

- Directly to the room automation station.
- To the room unit using the tool cable and the OCI702 service interface (see data sheet A6V10438951).

Dimensions

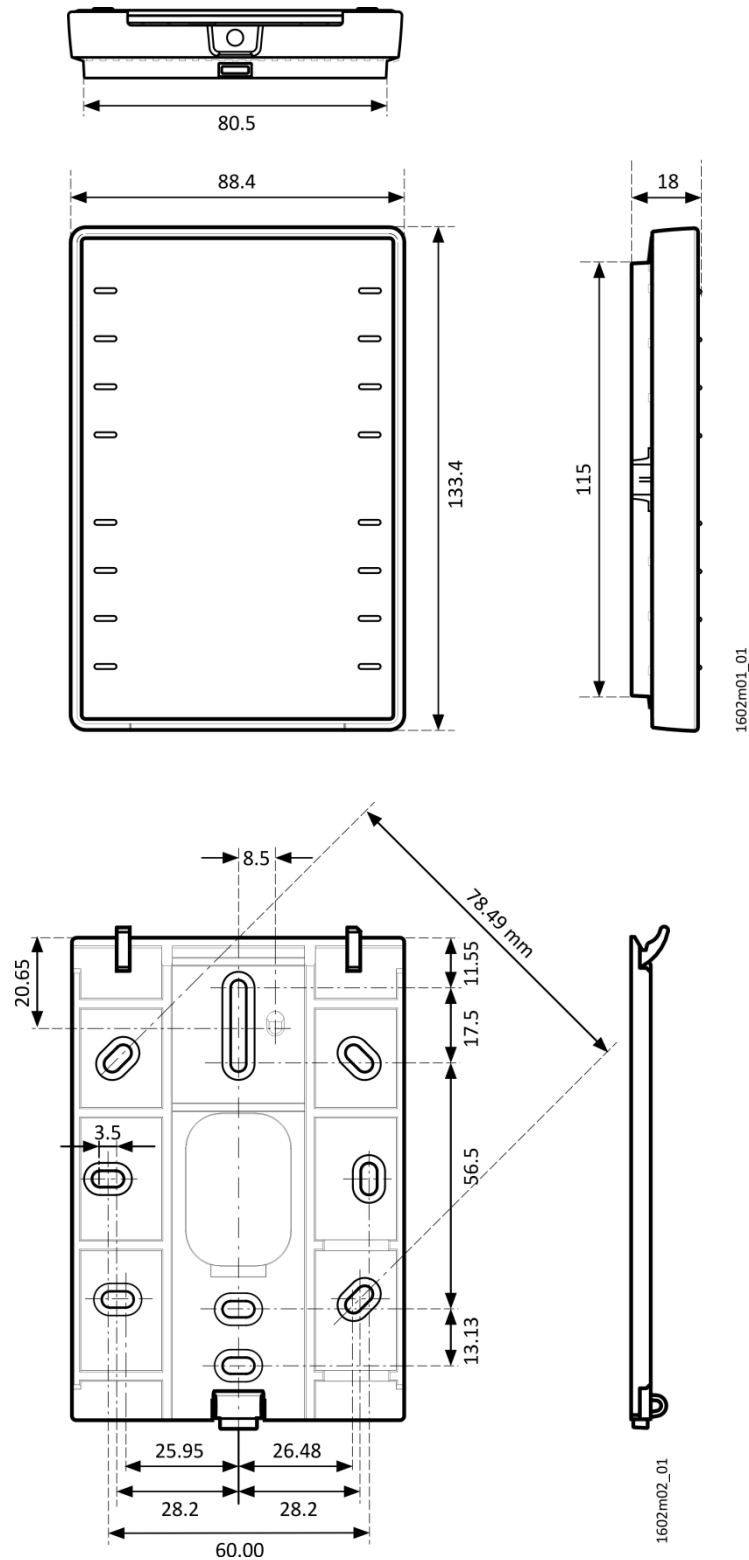

Disposal



The device is considered an electronics device for disposal in terms of European Directive 2012/19/EU and may not be disposed of as domestic garbage.

- Dispose of the device through channels provided for this purpose.
- Comply with all local and currently applicable laws and regulations.