

## Usable dimensions

### Fixing

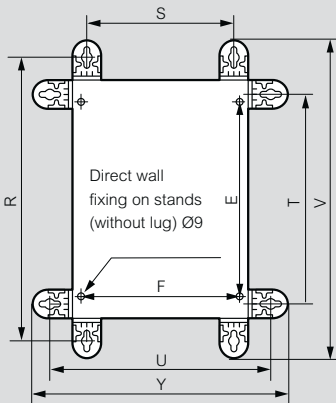

Cat. No. 0364 01

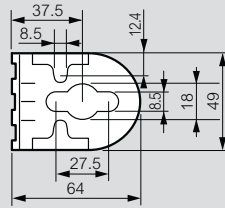

Cat. No. 0364 04

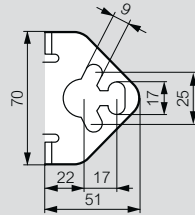

Enclosures		Vertical lugs		Mounting centres		Horizontal lugs		Mounting centres		Overall 0364 01		Overall 0364 04	
H (mm)	W (mm)	R (mm)	S <sup>(1)</sup> (mm)	E (mm)	T <sup>(1)</sup> (mm)	U (mm)	F (mm)	V (mm)	Y (mm)	V (mm)	Y (mm)	V (mm)	Y (mm)
300	200	375	150	225	250	275	169	430	330	402	302		
300	300	375	250	225	250	375	269	430	430	402	402		
300	400	375	350	225	250	475	369	430	530	402	502		
400	300	475	250	325	350	375	269	530	430	502	402		
400	400	475	350	325	350	475	369	530	530	502	502		
400	600	475	550	325	350	675	569	530	730	502	702		
500	400	575	350	425	450	475	369	630	530	602	502		
500	500	575	450	425	450	575	469	630	630	602	602		
600	400	675	350	525	550	475	369	730	530	702	502		
600	500	675	450	525	550	575	469	730	630	702	602		
600	600	675	550	525	550	675	569	730	730	702	702		
600	800	675	750	525	550	875	769	730	930	702	902		
600	1000	675	950	525	550	1075	969	730	1130	702	1102		
700	500	775	450	625	650	575	469	830	630	802	602		
800	600	875	550	725	750	675	569	930	730	902	702		
800	800	875	750	725	750	875	769	930	930	902	902		
800	1000	875	950	725	750	1075	969	930	1130	902	1102		
1000	600	1075	550	925	950	675	569	1130	730	1102	702		
1000	800	1075	750	925	950	875	769	1130	930	1102	902		
1000	1200	1075	1150	925	950	1275	1169	1130	1330	1102	1302		
1200	800	1275	750	1125	1150	875	769	1330	930	1302	902		
1400	800	1475	750	1325	1350	875	769	1530	930	1502	902		

1: Same mounting centres for Cat. Nos. 0364 01 and 0364 04

## Assembly kit on plane surface for Cabstop plate

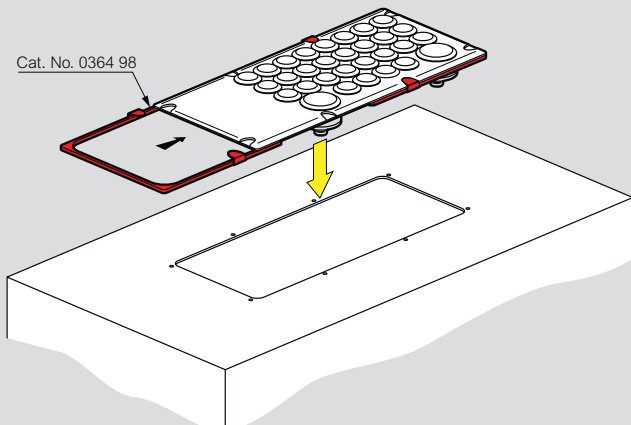

## Cabstop plate

- Tensile resistance: 15 kg minimum
- Operating temperature: - 20 °C to + 65 °C
- ASTM No 3 resistance to cutting oil
- Resistance to incandescent wire: 750 °C according to IEC EN 60695-2-11

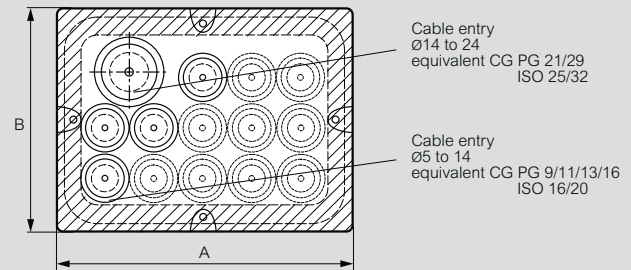

## Dimensions

Cat. No. 0364 94

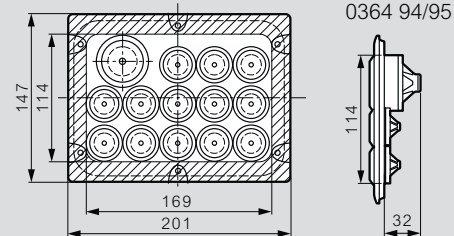

Cat. No. 0364 95

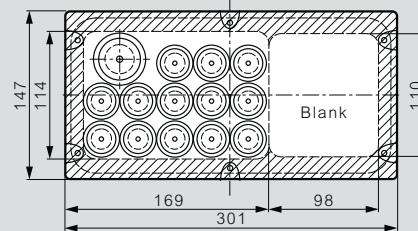

Cat. No. 0364 96

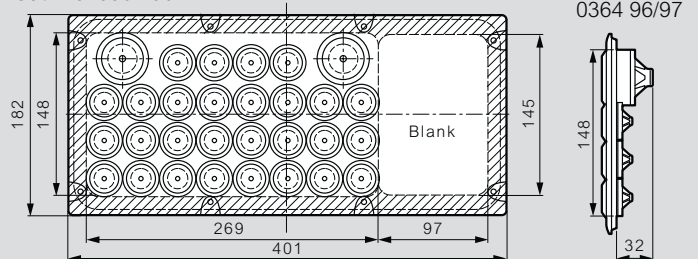

Cat. No. 0364 97

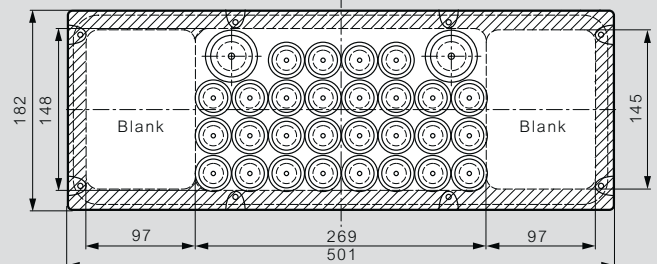

# Atlantic stainless steel enclosures

304 L and 316 L



Wall mounting lugs, horizontal or vertical installation



0352 01 + 0364 06



Enclosure and equipment selection chart p. 8-9

IP 66 according to standards IEC/EN 60529  
 IK 10 according to standards IEC/EN 62262 (EN 50102)  
 Approvals: cULus: type 4x  
 Bureau Veritas, LCIE N° 80257-575296  
 Suitable for harsh environments. Brushed stainless steel finish  
 Door with rounded vertical edges  
 Double bar lock. Upper and lower protective hoods  
 Reversible enclosure  
 Self-centering positioning system for the equipment  
 Excellent resistance to corrosion and weather conditions  
 Compatible with all Atlantic and Atlantic stainless steel accessories

Pack	Cat. Nos.	Stainless steel enclosures 304L (1 door)			Weight (kg)
		External dimensions			
	Metal door	Height (mm)	Width (mm)	Depth (mm)	
1	0352 00 <sup>1</sup>	300	200	160	4
1	0352 01	400	300	200	5.8
1	0352 02	500	400	200	8.3
1	0352 03	600	400	200	10.8
1	0352 05	600	400	250	12
1	0352 06	700	500	250	15
1	0352 11	800	600	300	22
1	0352 13	1000	800	300	38

## Stainless steel enclosures 316L (1 door)

Supplied with non-interchangeable double bar lock  
 Epoxy finish. Steel coated  
 Locking points :  
 1 lock for heights ≤ 400 mm  
 2 locks for heights ≥ 500 mm

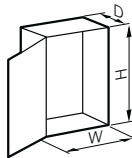

		External dimensions			Weight (kg)
		Height (mm)	Width (mm)	Depth (mm)	
1	0352 40 <sup>1</sup>	300	200	160	4
1	0352 41	400	300	200	5.8
1	0352 42	500	400	200	8.3
1	0352 45	600	400	250	12
1	0352 46	700	500	250	15
1	0352 47	800	600	300	22
1	0352 53	1000	800	300	38

## Stainless steel wall mounting lugs

For load up to 300 kg  
 Horizontal or vertical installation  
 Supplied with stainless steel screws  
 Set of 4

1	0364 06	304 L
1	0364 16	316 L

1: Supplied with plain plate

# Atlantic stainless steel enclosures

technical characteristics

## Usable dimensions

### Doors

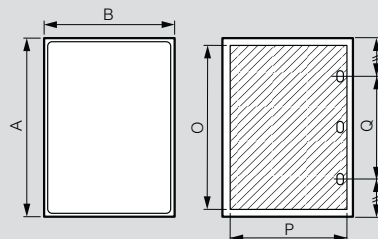

Cat. Nos.	Enclosures			Door usable dimensions		Lock position
	Height A (mm)	Width B (mm)	Depth (mm)	O (mm)	P (mm)	Q (mm)
0352 00/40	301.6	199.6	161.5	250	150	-
0352 01/41	401.6	299.6	201.5	350	250	-
0352 02/42	501.6	399.6	201.5	450	350	250
0352 03	601.6	399.6	201.5	550	350	380
0352 05/45	601.6	399.6	251.5	550	350	380
0352 06/46	702.4	500	251.5	650	450	400
0352 11/47	802.4	600	301.5	750	550	400
0352 13/53	1003.6	800.6	301.5	950	750	600

## Usable depth

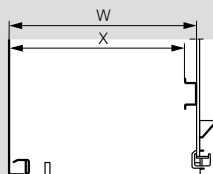

Enclosures	Back of enclosure	
	Depth (mm)	W
160	140	125
200	180	165
250	230	215
300	280	265
400	380	365

## Fixing

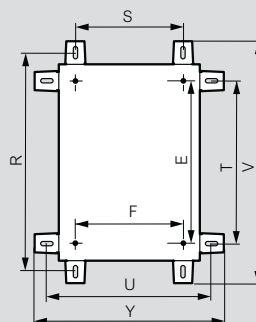

Cat. Nos. 0364 06/16

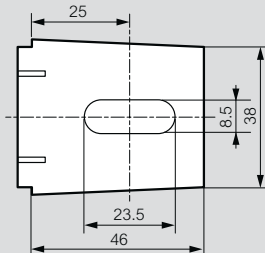

Cat. Nos.	Vertical position		Horizontal position		V	Y	E	F
	R	S	T	U				
0352 00/40	350	150	250	250	392	292	225	169
0352 01/41	450	250	350	350	492	392	325	269
0352 02/42	550	350	450	450	592	492	425	369
0352 03	650	350	550	450	692	492	525	369
0352 05/45	650	350	550	450	692	492	525	369
0352 06/46	750	450	650	550	792	592	625	469
0352 11/47	850	550	750	650	892	692	725	569
0352 13/53	1050	750	950	850	1092	892	925	769

Download the full file at

<http://assets.kempstoncontrols.com/doc/Atlantic%20New%20IP66%20Metal%20Enclosures.pdf>



**KEMPSTON**  
CONTROLS