

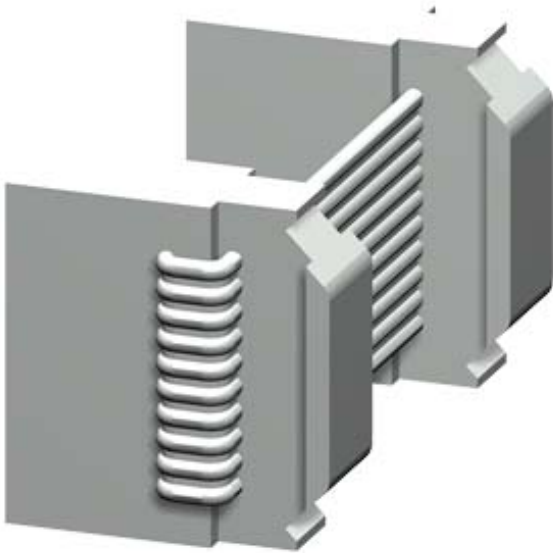



Connecting cable Length 0.3 m, flat, for connection of basic unit, current measuring module, current/voltage measuring module, operator panel or extension modules via the system interface







#### General technical data:

<b>Product brand name</b>	SIRIUS
<b>Product designation</b>	connecting cable
<b>Design of the product</b>	Length 0.3 m, flat
<b>Ambient temperature</b>	
• during storage	-40 ... +80 °C
• during operation	-25 ... +60 °C
• during transport	-40 ... +80 °C

#### Certificates/ approvals:

General Product Approval	EMC	Test Certificates		Shipping Approval
 UL		 C-Tick	<a href="#">Type Test Certificates/Test Report</a>	<a href="#">Special Test Certificate</a>  ABS

Shipping Approval					other
 BUREAU VERITAS	 GL	 LRS	 PRS	 RMRS	<a href="#">Confirmation</a>

other		
<a href="#">PROFIsafe-Certification</a>	<a href="#">PROFINET-Certification</a>	 Profibus

### Further information

**Information- and Downloadcenter (Catalogs, Brochures,...)**

<http://www.siemens.com/industrial-controls/catalogs>

**Industry Mall (Online ordering system)**

<https://mall.industry.siemens.com/mall/en/en/Catalog/product?mlfb=3UF7935-0AA00-0>

**Cax online generator**

<http://support.automation.siemens.com/WW/CAXorder/default.aspx?lang=en&mlfb=3UF7935-0AA00-0>

**Service&Support (Manuals, Certificates, Characteristics, FAQs,...)**

<https://support.industry.siemens.com/cs/ww/en/ps/3UF7935-0AA00-0>

**Image database (product images, 2D dimension drawings, 3D models, device circuit diagrams, EPLAN macros, ...)**

[http://www.automation.siemens.com/bilddb/cax\\_de.aspx?mlfb=3UF7935-0AA00-0&lang=en](http://www.automation.siemens.com/bilddb/cax_de.aspx?mlfb=3UF7935-0AA00-0&lang=en)

