

ISO 9001
Certified

M4 line

User manual • M.I.U.M4 -6/05.06 • Cod. J30-478-1AM4 IE



Ascon Tecnologic srl
via Indipendenza 56,
27029 Vigevano (PV)
Tel.: +39-0381 69 871
Fax: +39-0381 69 8730
Internet site:

www.ascontecnologic.com

E-Mail address:

sales@ascontecnologic.com



Temperature Controller

1/16 DIN - 48 x 48

M4 line

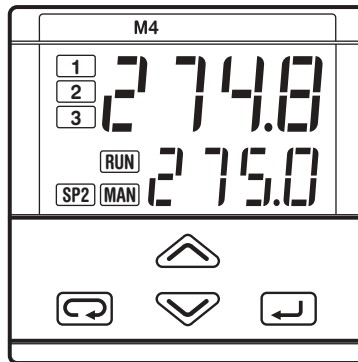



NOTES

ON ELECTRIC SAFETY AND ELECTROMAGNETIC COMPATIBILITY.

Please, read carefully these instructions before proceeding with the installation of the controller.

Class II instrument, real panel mounting.

This controller has been designed with compliance to:

Regulations on electrical apparatus (appliance, systems and installations) according to the European Community directive 73/23/EEC amended by the European Community directive 93/68/EEC and the Regulations on the essential protection requirements in electrical apparatus EN61010-1 : 93 + A2:95.

Regulations on Electromagnetic Compatibility according to the European Community directive n089/336/EEC, amended by the European Community directive n° 92/31/EEC, 93/68/EEC, 98/13/EEC and the following regulations:

Regulations on RF emissions

EN61000-6-3 : 2001 residential environments

EN61000-6-4 : 2001 industrial environments

Regulation on RF immunity

EN61000-6-2 : 2001 industrial equipment and system

It is important to understand that it's responsibility of the installer to ensure the compliance of the regulations on safety requirements and EMC.

The device has no user serviceable parts and requires special equipment and specialised engineers. Therefore, a repair can be hardly carried on directly by the user. For this purpose, the manufacturer provides technical assistance and the repair service for its Customers.

Please, contact your nearest Agent for further information.

All the information and warnings about safety and electromagnetic compatibility are marked with the  sign, at the side of the note.

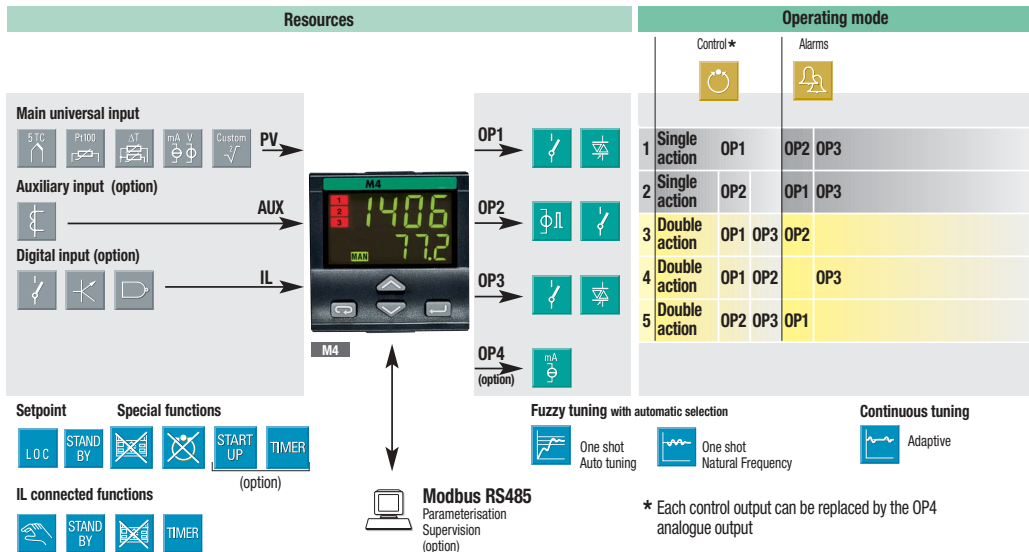

TABLE OF CONTENTS

1	INSTALLATION	Page	4
2	ELECTRICAL CONNECTIONS	Page	8
3	PRODUCT CODING	Page	16
4	OPERATIONS	Page	20
5	AUTOMATIC TUNING	Page	38
6	SPECIAL FUNCTIONS	Page	40
7	TECHNICAL SPECIFICATIONS	Page	46



INSTALLATION

Installation must only be carried out by qualified personnel.

Before proceeding with the installation of this controller, follow the instructions illustrated in this manual and, particularly the installation precautions marked with the   symbol, related to the European Community directive on electrical protection and electromagnetic compatibility.



To prevent hands or metal touching parts that may be electrically live, **the controllers must be installed in an enclosure and/or in a cubicle.**

1.1 GENERAL DESCRIPTION

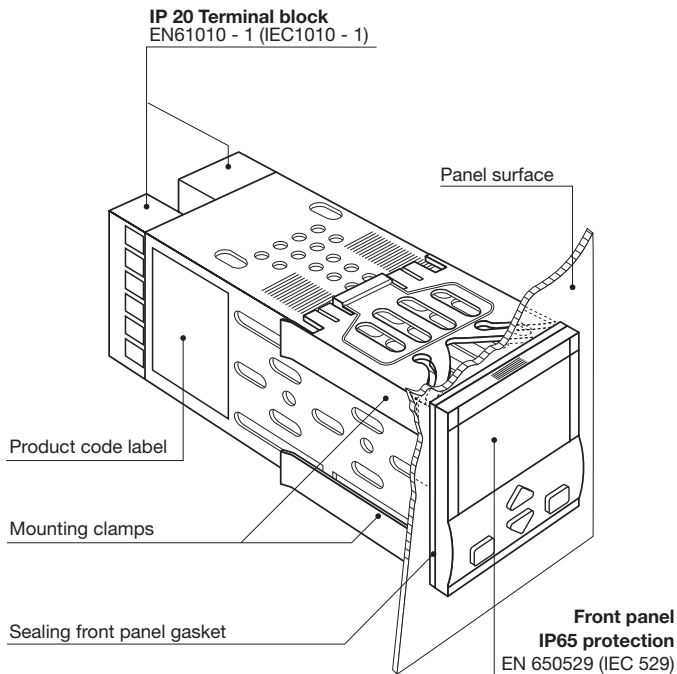

1.2 DIMENSIONAL DETAILS

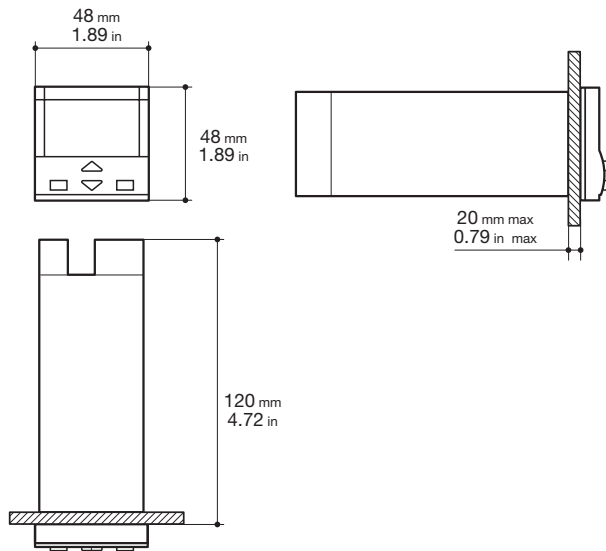

1.3 PANEL CUT-OUT

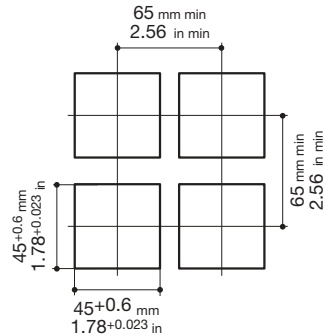

1.4 ENVIRONMENTAL RATINGS



Operating conditions



Altitude up to 2000 m



Temperature 0...50°C

%Rh

Relative humidity 5...95 % non-condensing

Special conditions

Suggestions



Altitude > 2000 m

Use 24Vac supply version



Temperature >50°C

Use forced air ventilation

%Rh

Humidity > 95 %

Warm up



Conducting atmosphere

Use filter

Forbidden Conditions



Corrosive atmosphere



Explosive atmosphere

1.5 PANEL MOUNTING [1]

1.5.1 INSERT THE INSTRUMENT

- 1 Prepare panel cut-out
- 2 Check front panel gasket position
- 3 Insert the instrument through the cut-out

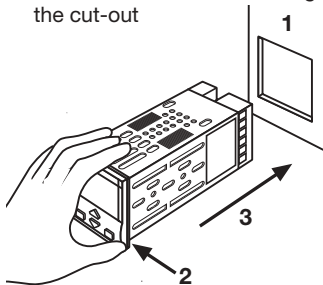

UL note

- [1] For Use on a Flat Surface of a Type 2 and Type 3 'raintight' Enclosure.

1.5.2 INSTALLATION SECURING

- 1 Fit the mounting clamps
- 2 Push the mounting clamps towards the panel surface to secure the instrument

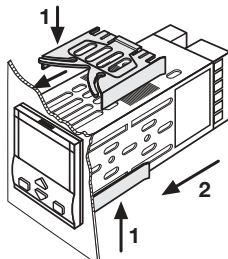

1.5.3 CLAMPS REMOVING

- 1 Insert the screwdriver in the clips of the clamps
- 2 Rotate the screwdriver

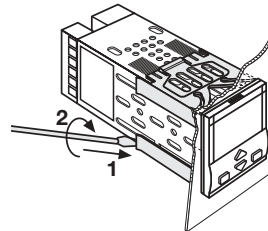

1.5.4 INSTRUMENT UNPLUGGING



- 1 Push and
- 2 pull to remove the instrument

Electrostatic discharges can damage the instrument

Before removing the instrument the operator must discharge himself to ground

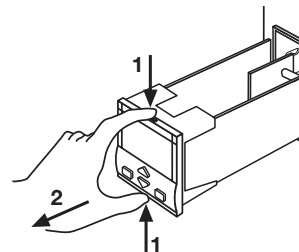

ELECTRICAL CONNECTIONS

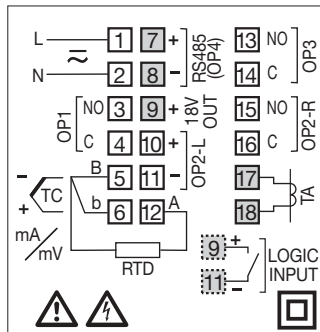

2.1 TERMINAL BLOCK [1]

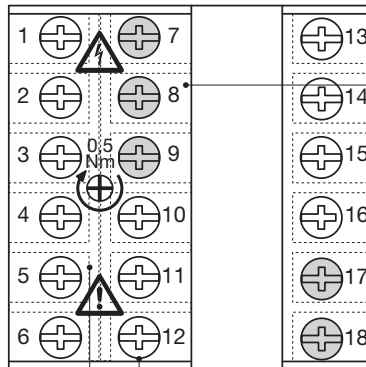

Rear terminal cover

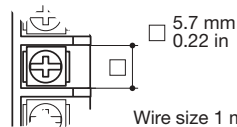

Wire size 1 mm²
(18 AWG
Solid/Stranded)

UL note

[1] Use 60/70 °C copper (Cu) conductors only.

[2] Wire size 1 mm²
(18 AWG Solid/Stranded)



18 M3 screw terminals



Option terminals



Holding screw 0.5 Nm



Positive screw driver PH1



Negative screw driver 0,8 x 4 mm

Terminals

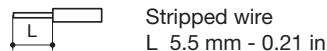
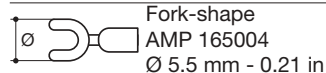
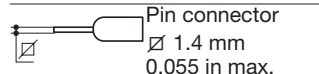

PRECAUTIONS

Despite the fact that the instrument has been designed to work in an harsh and noisy environmental (level IV of the industrial standard IEC 801-4), it is recommended to follow the following suggestions.



All the wiring must comply with the local regulations.

The supply wiring should be routed away from the power cables. Avoid to use electromagnetic contactors, power Relays and high power motors nearby. Avoid power units nearby, especially if controlled in phase angle

Keep the low level sensor input wires away from the power lines and the output cables. If this is not achievable, use shielded cables on the sensor input, with the shield connected to earth.

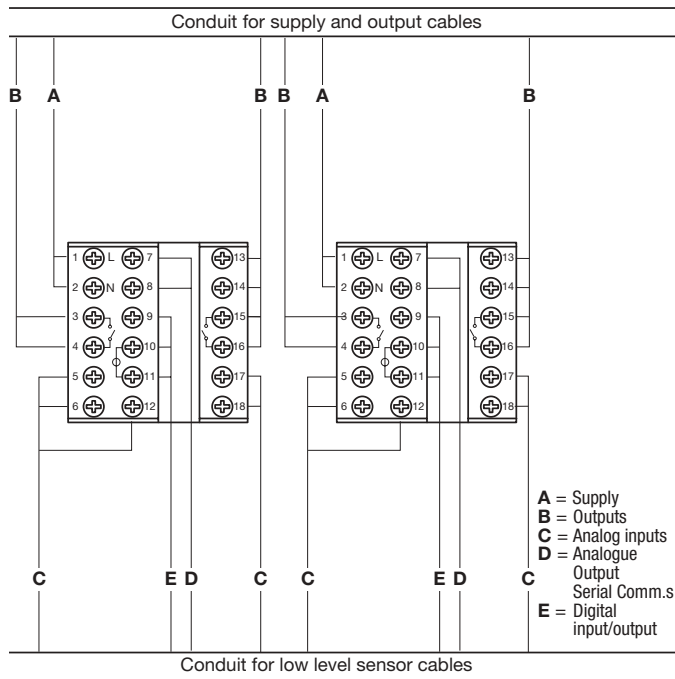
2.2 PRECAUTIONS AND ADVISED CONDUCTOR COURSE

2.3 EXAMPLE OF WIRING DIAGRAM (HEAT COOL CONTROL)

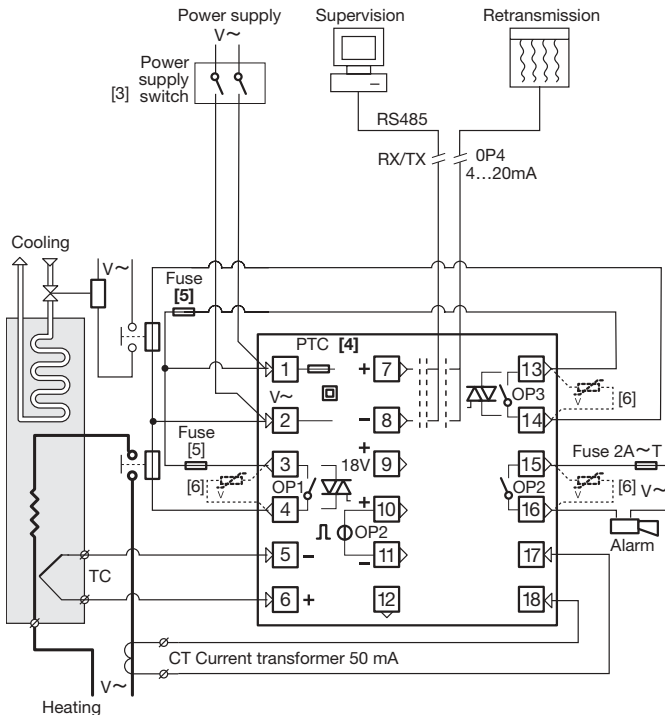
**Notes:**

- 1] Make sure that the power supply voltage is the same indicated on the instrument.
 - 2] Switch on the power supply only after that all the electrical connections have been completed.
 - 3] In accordance with the safety regulations, the power supply switch shall bring the identification of the relevant instrument. The power supply switch shall be easily accessible from the operator.
 - 4] The instrument is PTC protected. In case of failure it is suggested to return the instrument to the manufacturer for repair.
 - 5] To protect the instrument internal circuits use:
 - 2AT fuse for 220Vac relay outputs;
 - 4 AT fuse for 110vac relay outputs;
 - 1 AacT fuse for Triac outputs.6]
- Relay contacts are already protected with varistors.

Only in case of 24 Vac inductive loads, use model A51-065-30D7 varistors (on request)

2.3.1 POWER SUPPLY



Switching power supply with multiple isolation and internal PTC

- Standard version:
nominal voltage:
100...240Vac (-15...+10%)
Frequency 50/60Hz
- Low Voltage version:
Nominal voltage:
24Vac (-25...+12%)
Frequency 50/60Hz or
24Vdc (-15...+25%)
- Power consumption 2.6W max.

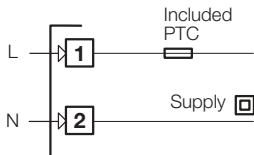

2.3.2 PV CONTROL INPUT

**A For L-J-K-S-T thermocouple type**

- Connect the wires with the polarity as shown
- Use always compensation cable of the correct type for the thermocouple used
- The shield, if present, must be connected to a proper earth.

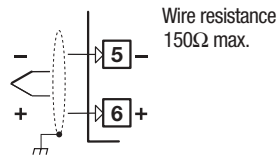
**B For Pt100 resistance thermometer**

- If a 3 wires system is used, use always cables of the same diameter (1mm² min.) (line 20 Ω/lead maximum resistance)
- When using a 2 wires system, use always cables of the same diameter (1.5mm² min.) and put a jumper between terminals 5 and 6

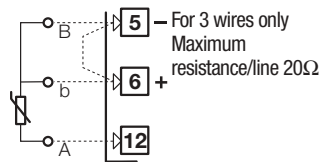
**C For ΔT (2x RTD Pt100) Special**

- ⚠ When the distance between the controller and the sensor is 15 m. using a cable of 1.5 mm² diameter, produces an error on the measure of 1°C (1°F).

R1 + R2 must be <320Ω

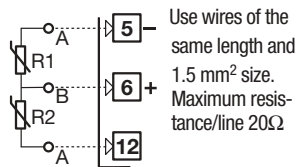

2.3.2 PV CONTROL INPUT



D For mA, mV

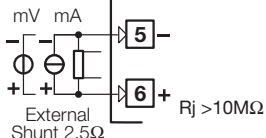

D1 With 2 wires transducer

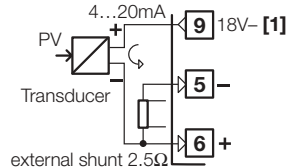

D2 With 3 wires transducer

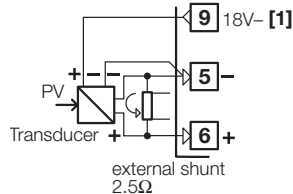

[1] Auxiliary power supply for external transmitter 18Vdc $\pm 20\%$ /30mA max. without short circuit protection

2.3.3 AUXILIARY INPUT

(option)



For current transformer CT

Not isolated

For the measure of the load current (see page 34)

- Primary coil 10A...100A
- Secondary coil 50mA default 100mA jumper selectable

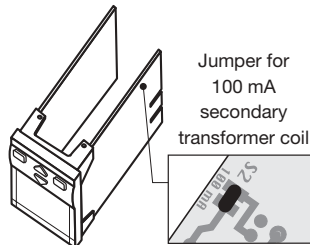
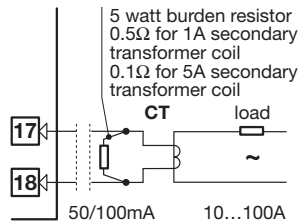

2.3.4 DIGITAL INPUT

(option) (page 37)



- The input is active when the logic state is ON, corresponding to the contact closed
- The input is inactive when the logic state is OFF, corresponding to the contact open

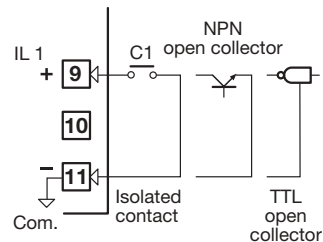

2.3.5 OP1 - OP2 - OP3 OUTPUTS



The functionality associated to each of the OP1, OP2 and OP3 input is defined during the configuration of the instrument index **L** (see page 18).

The suggested combinations are:

	Control outputs [1]			Alarms	
				AL2	AL3
A	Single action	OP1 Heat		OP2-R	OP3
B	Single action	OP2-L Heat		OP1	OP3
C	Double action	OP1 Heat	OP3 Cool	OP2-R [2]	
D	Double action	OP1 Heat	OP2-L Cool		OP3 [2]
E	Double action	OP2-L Heat	OP3 Cool	OP1 [2]	

OP1 - OP3	Relay or Triac output
OP2 - L	Logic output
OP2 - R	Relay output

Notes

[1] Each control output can be replaced by the OP4 analogue output.

The replaced output is not yet available.

[2] With heat / cool control AL2 and AL3 share in or mode the same output (the free one).

OP2 output can be Relay (Std) or logic .

The “jumper” on the auxiliary board selects the output type:

Link Pins 1-2 for OP2-Relay

Link Pins 2-3 for OP2-Logic

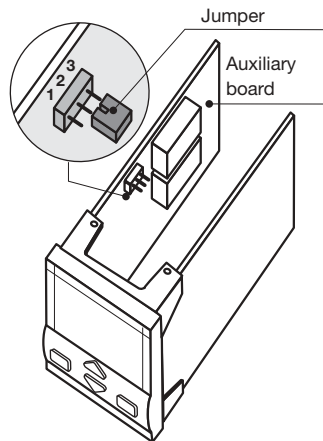

2.3.5-A SINGLE ACTION RELAY (TRIAC) CONTROL OUTPUT

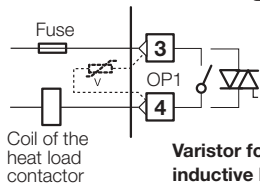

**Varistor for inductive load
24Vac only**

2.3.5-B SINGLE ACTION LOGIC CONTROL OUTPUT

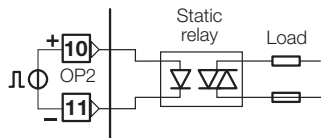

Relay output

- SPST Relay N.O., 2A/250Vac for resistive load, fuse 2AT

Triac output

- N.O. contact for resistive load of up to 1A/250 Vac max., fuse 1A T

Logic output not isolated

- 0...5Vdc, ±20%, 30 mA max.

2.3.5-C DOUBLE ACTION RELAY (TRIAC)/RELAY (TRIAC) CONTROL OUTPUT

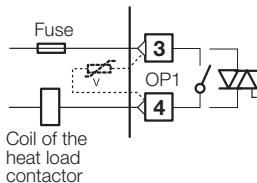

Coil of the heat load contactor

**Varistor for inductive load
24Vac only**

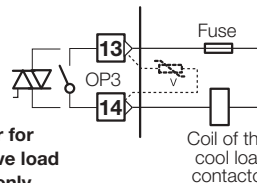

Coil of the cool load contactor

2.3.5-D DOUBLE ACTION RELAY (TRIAC)/LOGIC CONTROL OUTPUT

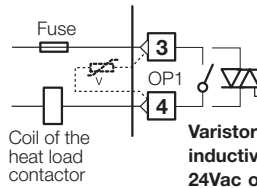

Coil of the heat load contactor

**Varistor for inductive load
24Vac only**

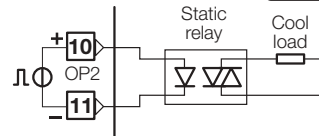

2.3.5-E DOUBLE ACTION LOGIC/RELAY (TRIAC) CONTROL OUTPUT

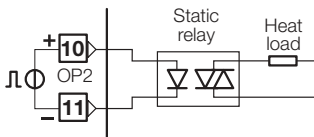

Static relay
Heat load

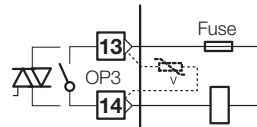

**Varistor for inductive load
24Vac only**

Coil of the cool load contactor

2.3.6 ALARMS OUTPUTS

 The outputs OP1, OP2 and OP3, can be used as alarm outputs only if they are not configured as control outputs.

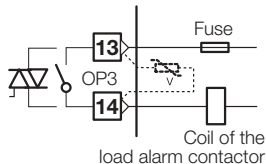
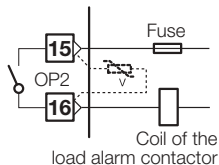
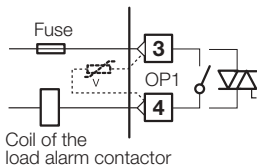

**Varistor for inductive load
24Vac only**

2.3.7 OP4 ANALOGUE CONTROL OUTPUT (option)

- Galvanic isolation 500Vac/1 min
- 0/4...20mA, (750Ω or 15Vdc max.)

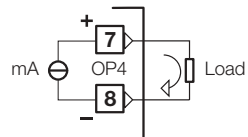

2.3.8 SERIAL COMMUNICATIONS (option)

- Galvanic isolation 500Vac/1 min
- Compliance to the EIA RS485 standard for Modbus/Jbus

 Please, read:
gamma^{due}[®] and **delta^{due}**[®]
controller series serial communication and configuration

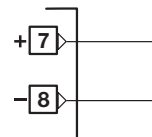

3 PRODUCT CODING

The complete code is shown on the instrument label. The informations about product coding are accessible from the front panel by mean of a particular procedure described at section 4.2.2 page 21

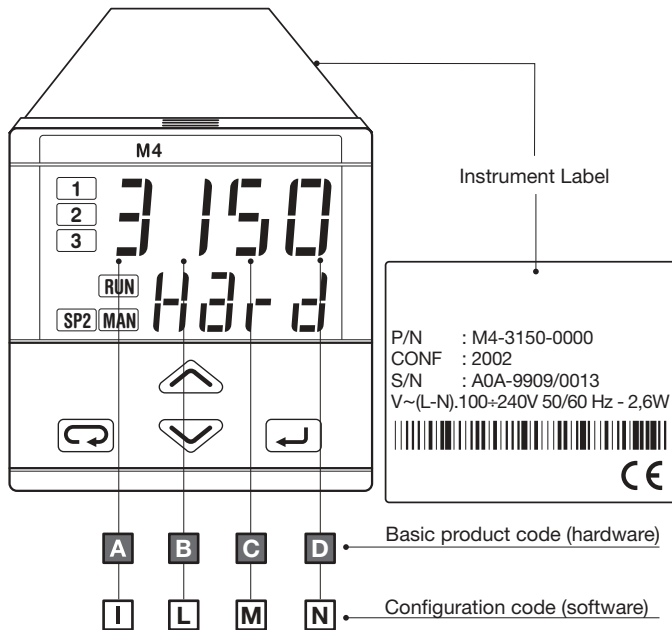

3.1 MODEL CODE

The product code indicates the specific hardware configuration of the instrument, that can be modified, by specialized engineers only.

Model: **Line** **Basic** **Accessories** **Configur.**
M 4 **A B C D** - **E F G 0** / **I L M N**

Line **M 4**

Power supply	A
100...240Vac (-15...+10%)	3
24Vac (-25...+12%) or 24Vdc (-15...+25%)	5

OP1 - OP3 Outputs	B
Relay - Relay	1
Relay - Triac	2
Triac - Relay	4
Triac - Triac	5

Serial Communications	Options	C	D
Not fitted	None	0	0
	Current transformer input (CT)	0	3
	Transmitter Power Supply (P.S.)	0	6
	Transmitter P.S. + Cont. control output	0	7
	Transmitter P.S. + CT	0	8
	Transmitter P.S. + Cont. control + CT	0	9
RS485 Modbus/Jbus protocol	None	5	0
	Transmitter Power Supply	5	6
	Transmitter P.S. + CT	5	8
Digital input	None	9	0
	CT	9	3
	Analogue control output	9	7
	Analogue control output + CT	9	9

Special functions	E
Not fitted	0
Start up + Timer	2

User manual	F
Italian/English (std)	0
French/English	1
German/English	2
Spanish/English	3

Front panel colour	G
Dark (std)	0
Beige	1

3.2 CONFIGURATION CODING

The configuration code consists of 4 digits that identify the operating characteristic of the controller, as chosen by the user.

Section 4.6 at page 35 reports the instructions how to set a new configuration code.

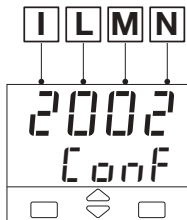

The configuration code can be displayed on the front panel, following the instructions at page 21 section 4.2.2.

Input type and range			I
TR Pt100 IEC751	-99.9...300.0 °C	-99.9...572.0 °F	0
TR Pt100 IEC751	-200...600 °C	-328...1112 °F	1
TC L Fe-Const DIN43710	0...600 °C	32...1112 °F	2
TC J Fe-Cu45% Ni IEC584	0...600 °C	32...1112 °F	3
TC T Cu-CuNi	-200 ...400 °C	-328...752 °F	4
TC K Chromel -Alumel IEC584	0...1200 °C	32...2192 °F	5
TC S Pt10%Rh-Pt IEC584	0...1600 °C	32...2912 °F	6
DC input 0...50 mV, linear	Engineering units		7
DC input 10...50 mV, linear	Engineering units		8
Custom input and range	[1]		9

[1] For instance, other thermocouples types, ΔT (with 2 PT 100), custom linearisation etc.

Control mode	Output configuration [2]	L
PID	Control OP1 / alarm AL2 on OP2	0
	Control OP2 / alarm AL2 on OP1	1
On - Off	Control OP1 / alarm AL2 on OP2	2
	Control OP2 / alarm AL2 on OP1	3
Heat/Cool action	Control OP1- OP3 / alarm AL2 on OP2	6
	Control OP1- OP2 / alarm AL2 on OP3	7
	Control OP2- OP3 / alarm AL2 on OP1	8

[2] Each control output can be replaced by the OP4 analogue output. The replaced output is not more available (see page 34).

Control action type		M
Reverse (single action)	Linear Cool (Heat/Cool double action)	0
Direct (single action)	On-Off Cool (Heat/Cool double action)	1



If, when the controller is powered up for the first time, the display shows the following message

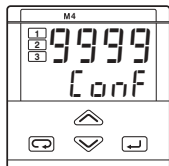

it means that the controller has not been configured yet.

The controller remain in stand-by until the configuration code is set correctly (see chapter 4.6 page 35).

Alarm 2 type and function		N
Not active		0
Sensor break alarm / Loop Break Alarm		1
Absolute	active high	2
	active low	3
Deviation	active high	4
	active low	5
Band	active out	6
	active in	7
Heater break by CT [3]	active during ON output state	8
	active during OFF output state	9

Alarm 3 type and function		O
Disabled or used by Timer		0
Sensor break alarm / Loop Break Alarm		1
Absolute	active high	2
	active low	3
Deviation	active high	4
	active low	5
Band	active out	6
	active in	7
Heater break by CT [3]	active during ON output state	8
	active during OFF output state	9

For alarm 3 type and function see page 34

Note

[3] Only with CT options.

4 OPERATIONS

4.1.A KEYS FUNCTIONS AND DISPLAY IN OPERATOR MODE

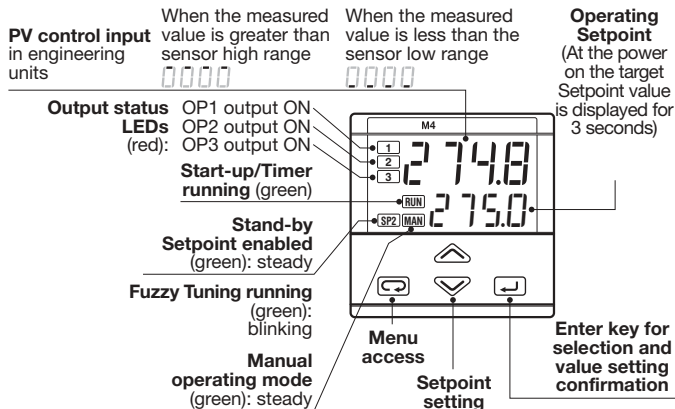

4.1.B KEYS FUNCTIONS AND DISPLAY IN PROGRAMMING MODE

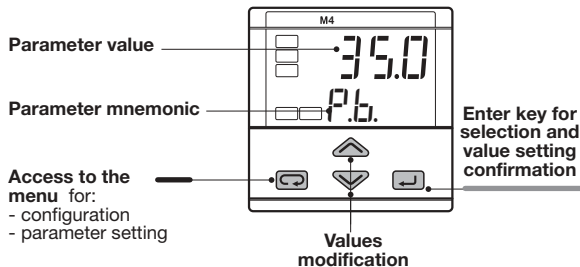

4.2 DISPLAY

During the operation, the parameters values cannot be modified by the user

Note

[1] See table page 37

[2] This display is not presented if the instrument has been configured as an On - Off controller

[3] Value in Ampere. Only with CT option (see page 34)

[4] Only with Timer option selected (see page 42)

4.2.1 OF THE PROCESS VARIABLES

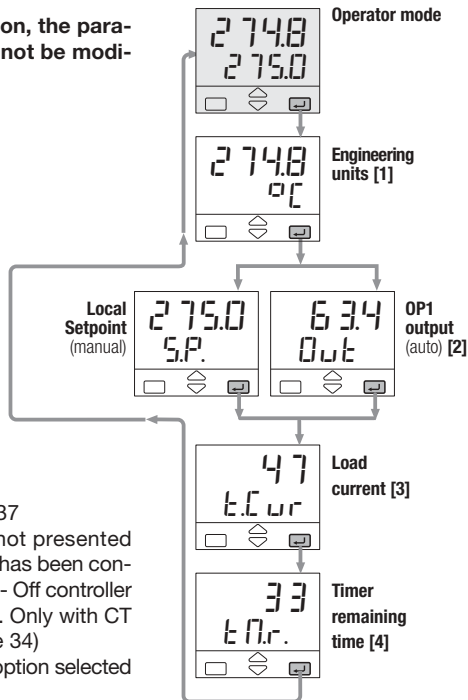

4.2.2 OF THE CONFIGURATION CODES

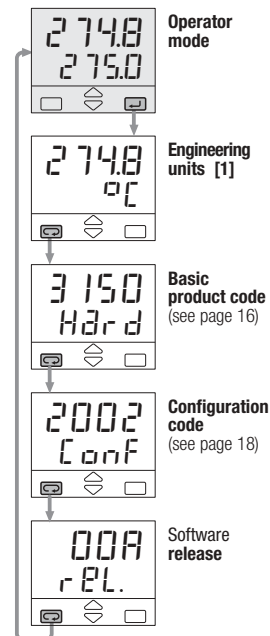



Example:



M4 - 3150 - 2002 / Release 00A

4.3 PARAMETER SETTING



4.3.1 NUMERIC ENTRY

(i.e. the modification of the Setpoint value from 275.0 to 240.0)

Press  or  momentarily to change the value of 1 unit every push

Continued pressing of  or  changes the value, at rate that doubles every second. Releasing the button the rate of change decreases.

In any case the change of the value stops when it has reached the max./min limit set for the parameter.



In case of Setpoint modification: press  or  once to display the local Setpoint instead of working Setpoint.

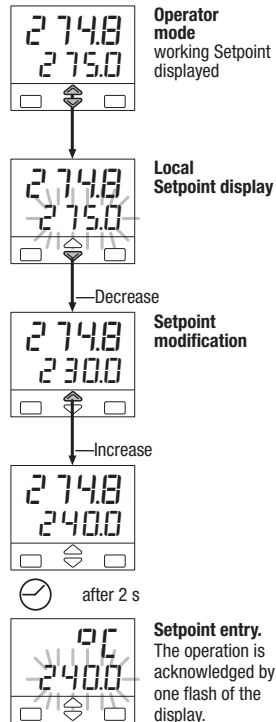

To evidence this change the display flashes once. Then the Setpoint can be modified



4.3.2 MNEMONIC CODES SETTING



(e.g. configuration see page 35)

Press the  or  to display the next or previous mnemonic for the selected parameter.

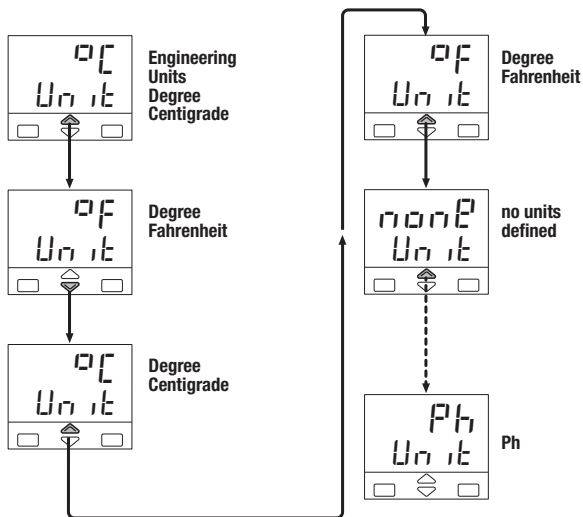
Continued pressing of  or  will display further mnemonics at a rate of one mnemonic every 0.5 s. The mnemonic displayed at the time the next parameter is selected, is the one stored in the parameter.



4.3.3 KEYPAD LOCK

To lock/unlock the keypad press the keys  and  simultaneously for 2 seconds.

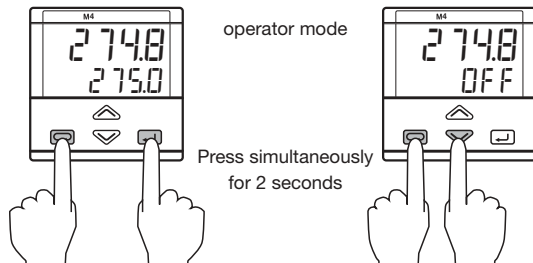

To confirm the keypad lock/unlock the display flashes once.



The keypad lock/unlock can be achieved by serial communications too.

⚠ The keypad lock is maintained in case of power failure.

4.3.4 OUTPUTS LOCK

The outputs are switched to the OFF status by pressing the keys  and  together.

When the outputs are locked, the message  is displayed instead of the Setpoint value.

To unlock the outputs press again the keys simultaneously (the Soft-start will be enabled).

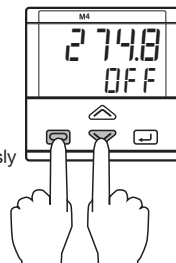



The outputs lock/unlock can be achieved by serial communications too

⚠ The outputs lock/unlock is maintained in case of power failure.

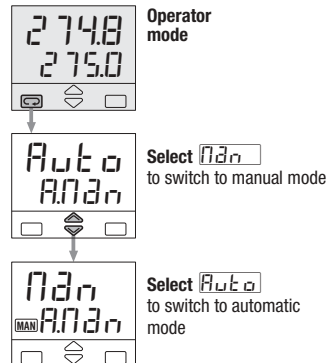
4.3.5 AUTO / MAN



- Press  to confirm. Back to operator mode.
- The **MAN** led shows the manual mode status.
- When manual mode is active, the Setpoint display shows the output value, that can be modified by  .

4.4 PARAMETERISATION

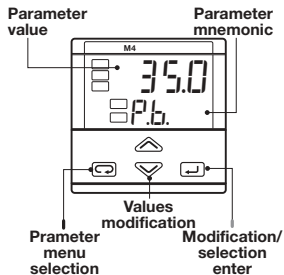

The parameter setting procedure has a timeout. If no keys are pressed for, at least, 30 seconds, the controller switches back, automatically, to the operator mode.

After having selected the parameter or the code, press and to display or modify the value (see page 22). The value is entered when the next parameter is selected, by pressing the key.

Pressing the key, the next group of parameters is presented on the display.

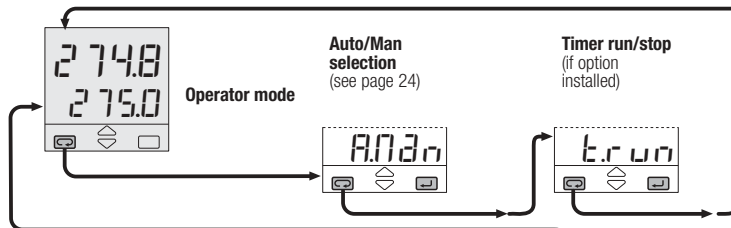
**Note**

- [1] It is not presented if the controller has been configured with alarm n° 2 not active or of sensor break type. Digit N/M of the configuration code is assigned to 0 or 1.
- [2] These values are not automatically stored on the PID menu parameters P_b , t_i , t_d .

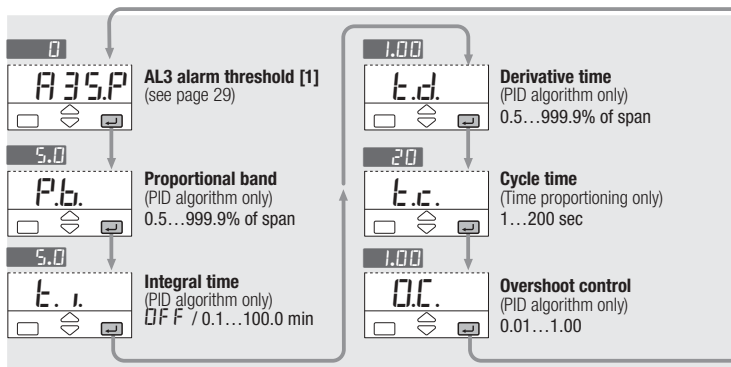

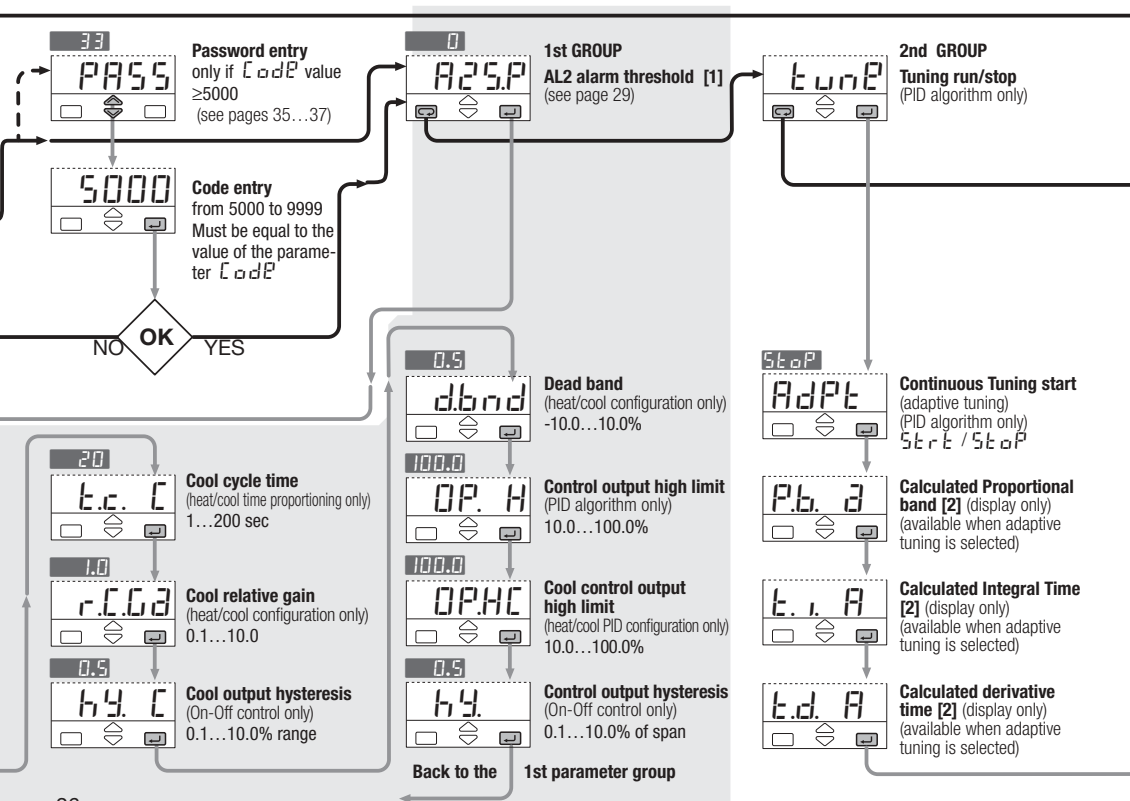

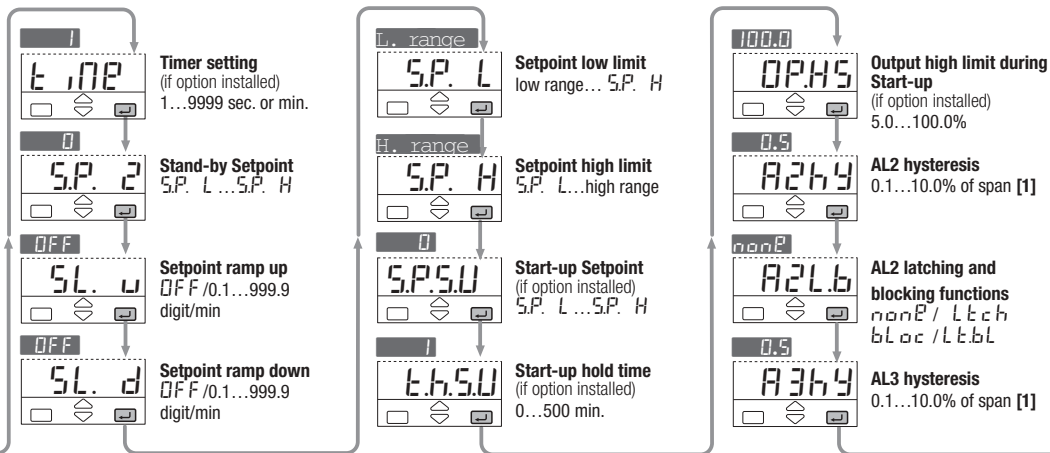

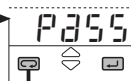
**Password entry**

only if *LoDE* value
<5000 (see pages 35...37)

Direct access
to the configuration
(pages 35 ... 37)

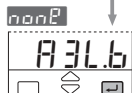

**AL3 latching and
blocking functions**
nonP / *Ltch*
bLoc / *Lt.bL*

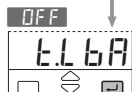

LBA delay
(see page 31)
OFF = sensor break
1...9999 sec LBA



Filter time constant
OFF / 1...30 sec



Input shift
OFF / -60...60 digit



Error dead band
(PID algorithm only)
OFF / 0.1...10.0 digits



Soft-start output value
(PID algorithm and
L.Mod = *OFF*)
OFF / 0.1...100.0%



**Soft-start
activation time**
(only if *St.OP* different than
OFF) 1...9999 sec.

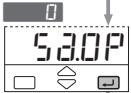

Output safety value
0.0...100.0%
(-100.0...100.0% for
heat/cool)



Communication address
(if option installed)
OFF / 1...247

Back to the 2nd parameter group

4.5 PARAMETERS

FIRST GROUP

The controller parameters have been organised in group, according to their functionality area.

A25.P

AL2 alarm threshold

A35.P

AL3 alarm threshold

The alarm occurrences handle the OP1, OP2 and OP3 outputs, in different ways, according to the configured types of alarms, as illustrated.

With double action control output, AL2 and AL3 share in or mode the same output (the free one) (see table on page 13)

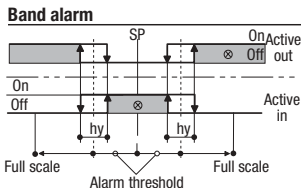
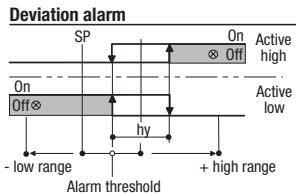
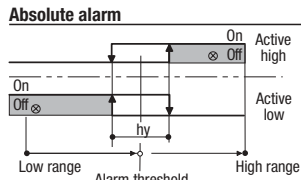
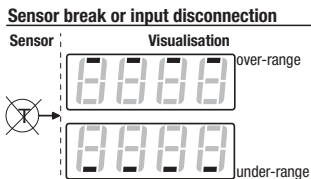

P.b.

Proportional band

This parameter specifies the proportional band coefficient that multiplies the error ($SP - PV$)

E. I.

Integral time

It is the integral time value, that specifies the time required by the integral term to generate an output equivalent to the proportional term. When OFF the integral term is not included in the control algorithm.

E.d.

Derivative time

It is the time required by the proportional term P to repeat the output provided by the derivative term D. When OFF the derivative term is not included in the control algorithm.

E.c.

Control output cycle time

E.c. C

Cycle time cool

It's the cycle time of the logic control output. The PID time proportional control output is provided through the pulse width modulation of the digital waveform.

OC.

Overshoot control

(Automatically disabled when the adaptive tuning is running).

This parameter specifies the span of action of the overshoot control. Setting lower values (0.99 → 0.01) the overshoot generated by a Setpoint change is reduced. The overshoot control doesn't affect the effectiveness of the PID algorithm. Setting 1, the overshoot control is disabled.

dbnd

Heat/Cool dead band

This parameter specifies the width of the deadband between the Cool and the Heat channel.

OP.H

Control output high limit

OP.HC

Cool output high limit

It specifies the maximum value the control output can be set

hy.

Control output hysteresis

hy.C

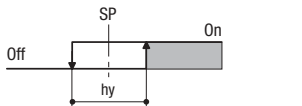
Cool output hysteresis**Hysteresis of the threshold**

Control or alarm output hysteresis span, set in % of the full scale.

SECOND GROUP

SP.2

Stand-by Setpoint

Used by Timer function too.

SL.u

Setpoint ramp up

SL.d

Setpoint ramp down

This parameter specifies the maximum rate of change of the Setpoint in digit/min. When the parameter is OFF, this function is disabled.

SECOND GROUP

A2hy

AL2 alarm hysteresis

A3hy

AL3 alarm hysteresis

Hysteresis of the threshold of both the alarms, that activate OP1 and OP2 control output. It is specified as a % of the full scale.

SP.L

Setpoint low limit

SP.H

Setpoint high limit

Low / high limit of the Setpoint value.

A2Lb

AL2, AL3 latching

A3Lb

and blocking functions

For each alarm it is possible to select the following functions

nonE none

LtcH latching

blOc blocking

Ltcbl both latching and blocking

ALARM ACKNOWLEDGE FUNCTION

The alarm, once occurred, is presented on the display until the time of acknowledge.

The acknowledge operation consists in pressing any key.

After this operation, the alarm leaves the alarm state only when the alarm condition is no longer present.

START-UP DISABLING

Ramp down

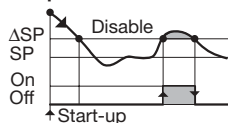

Ramp up

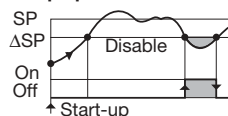

ΔSP Threshold = $SP \pm \text{range}$

ALARMS WITH LBA (LOOP BREAK ALARM) AND SENSOR BREAK OPERATION

Select the code 1 on **N** or **O** configuration indexes (see pages 18 or 19). The following parameter is then available:

LBA delay

Setting a value between 1 and 9999 sec the alarm works as LBA+Sensor break with delay [1]

This condition is shown by means a red led as well as the blinking PV display.

Setting OFF the alarm works as Sensor break with immediate action.

This condition is shown by means the red led of the selected alarm as well as:

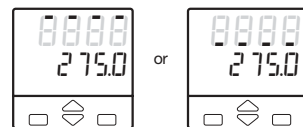
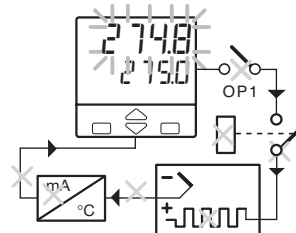

Note [1] In case of sensor break, condition, the alarm action is immediate.

When the cause of the alarm disappears, the alarm status stops.

SECOND GROUP

t.Fil Input filter time constant

Time constant, in seconds, of the RC input filter applied to the PV input. When this parameter is set to **0FF** the filter is bypassed.

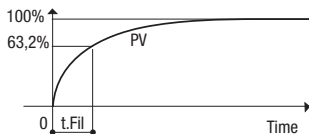
Filter response**1n.5h** Input shift

This value is added to the measured PV input value. Its effect is to shift the whole PV scale of up to ± 60 digits.

d.Err Error Dead Band

Inside this band for $(PV - SP)$, the control output does not change to protect the actuator (output Stand-by)

5t.OP Soft-start control output value

Value of the control output during the Soft-start activation time.

5t.tn Soft-start activation time

Time duration (starting from the power on) of the Soft-start function.

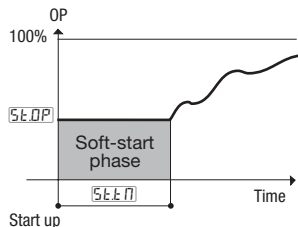
**5a.OP** Output Safety Value

Output Value in case of input anomaly

Addr Controller address

the address range is from 1 to 247 and must be unique for each controller on the communication bus to the supervisor.

When set to **0FF** the controller is not communicating

HEAT COOL CONTROL

By a sole PID control algorithm, the controller handles two different outputs, one of these performs the Heat action, the other one the Cool action.

It is possible to overlap the outputs.

The dead band parameter \boxed{dbnd} is the zone where it is possible to separate or overlap the Heat and Cool actions.

The Cool action can be adjusted using the relative cool gain parameter $\boxed{r.c.g.a.}$

To limit the Heat and Cool outputs the parameters $\boxed{OP.H}$ and \boxed{OPHC} can be used.

When there is an overlap, the displayed output \boxed{OUE} shows the algebraic sum of the Heat and Cool outputs.

A Heat /Cool actions separated

Insert positive \boxed{dbnd} value (0...10%)

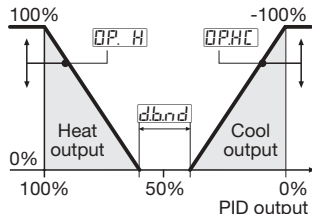

B Heat /Cool actions overlapped

Insert negative \boxed{dbnd} value (-10...0%)

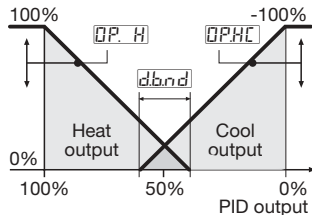

C Cool action adjusting

Example with different relative cool gains

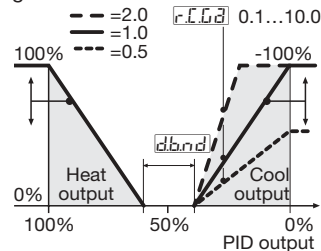

D On-Off Cool action

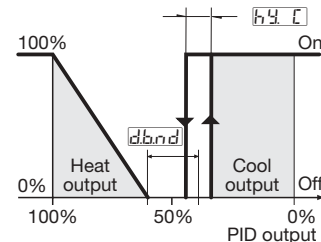

ANALOGUE CONTROL OUTPUT OP4

When configured, the analogue control output excludes the corresponding time proportioning control output automatically. (see page 18)
(e.g. if code $L = 0$ and $rEtH = NU.$ the OP1 is not yet available)

$rEtH$ Analogue control output range

0-20 / 4-20

$rEtH$ Control output selection

nonE Not used
NU. Heat (single action)
NU. C. Cool

With analogue control output EtC or EtC are not present.

CURRENT TRANSFORMER INPUT

With CT option it is possible to display the load current and set an alarm threshold.

It is possible to set AL2 or AL3 (index 8 and 9) to have an alarm when, during the ON time of the time proportional output, the load current is less then the specified threshold or, during the OFF time, there is at least 3% of full scale

load current

The alarm condition must be longer than 120 ms to set the alarm. During the OFF time the parameter $tEur$ latches the last on time current value

Example:

CT input on OP1, alarm on AL2 during on time (configuration digit N = 8)

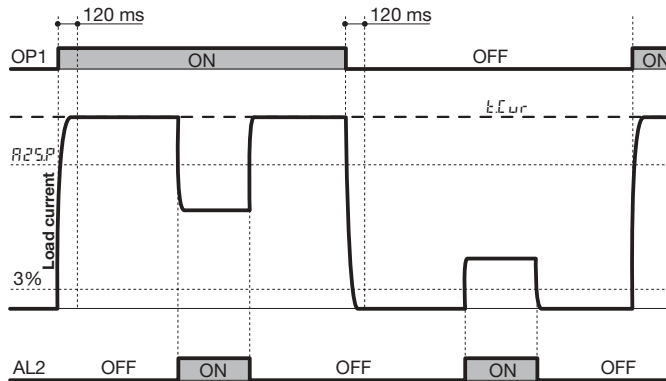

4.6 CONFIGURATION

The configuration of the controller is specified through a 4 digit code that defines the type of input, of control output and of the alarms. (sect. 3.2 page 18)

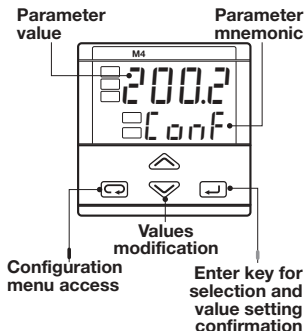

Press or to display the next parameter or the next code and change its value.

The new value entered is stored into the controller when the next parameter is selected by pressing . Pressing the the next group of parameters is displayed.

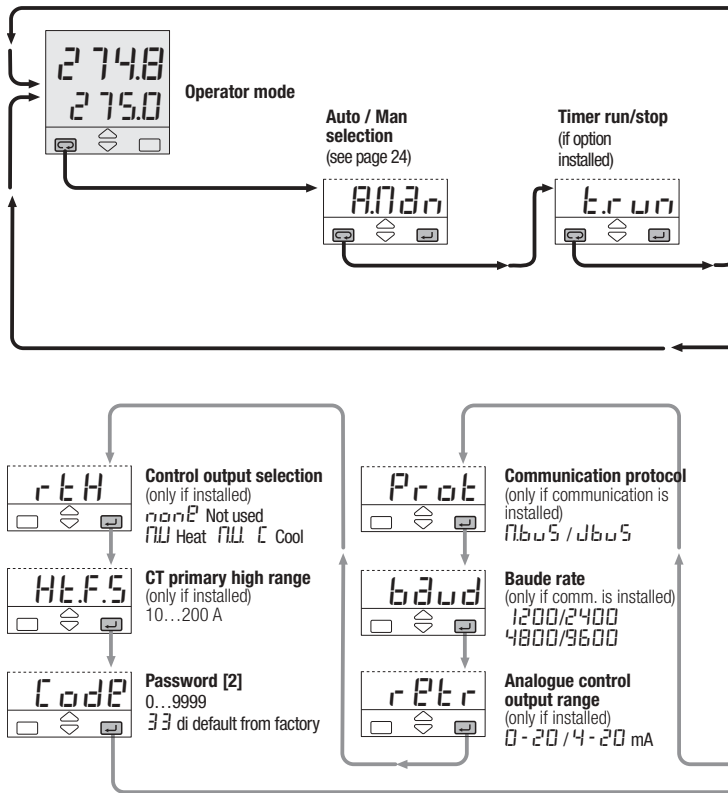

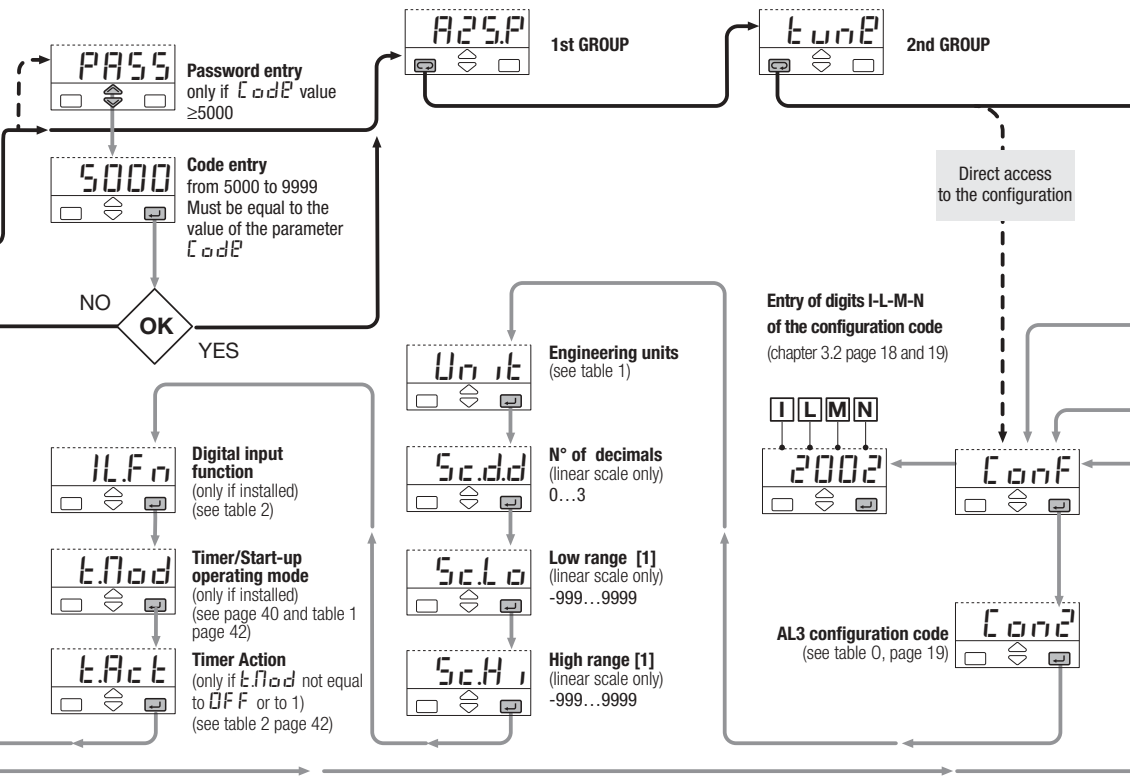

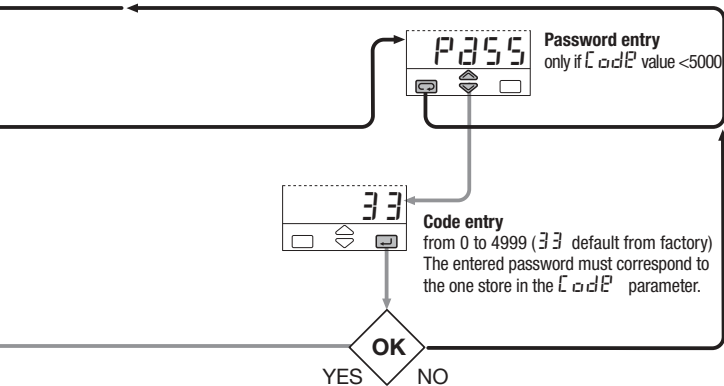

Direct access to the configuration

A From parameterisation (see page 28).

B At the first power on when the controller is not configured:

In this situation, the controller has its outputs and inputs not active.
This situation ends when a correct configuration code is entered.

Table 1 - Supported Engineering Units.

Centigrade degrees*	°C
Fahrenheit degrees *	°F
nessuna	none
mV	mV
Volt	V
mA	mA
Ampere	A
Bar	bar
PSI	PSI
Rh	rh
pH	pH

* For inputs from thermocouple or resistance thermometer, the choice is between °C and °F only.

Table 2- Digital input functions

Not used	OFF
Keypad lock	EEP.1
Auto/Man	MAN
Stand-by Setpoint	SP. 2
Timer launch	Start

Notes

[1] Minimum Range 100 digits.

[2] To avoid free parameter access insert 5000...9999

5 AUTOMATIC TUNING

Two tuning methods are provided:

- Initial one shoot **Fuzzy-tuning**
- Continuous, self learning **Adaptive Tuning**

The Fuzzy-Tuning allows the calculation of the optimal PID terms parameters, monitoring the response of the process to disturbances.

The controller provides 2 types of “one shot” tuning algorithm, that are selected automatically according to the process condition when the operation is started.

Step response

This type is selected when, at the start of the autotune operation, the PV is far from the Setpoint of more than 5% of the span.

This method has the big advantage of fast calculation, with a reasonable accuracy in the term calculation.

Natural frequency

This type is selected when the PV is close to the SP Setpoint.

This method has the advantage of

a better accuracy in the term calculation with a reasonable speed calculation.

The Fuzzy Tuning determines automatically the best method to use to calculate the PID term, according the process conditions.

Step response

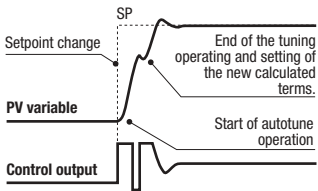

Natural frequency

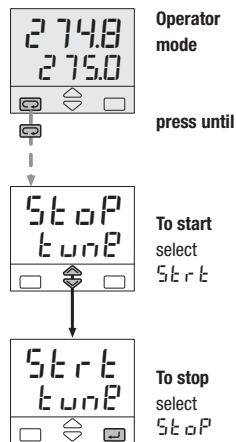
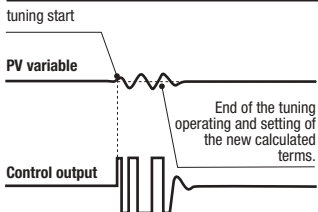

The green led **MAN** blinking goes on when the Fuzzy Tuning is in progress. At the end of this operation, the calculated PID terms parameter are stored and used by the control algorithm and the controller goes back to the operator mode. The green led **MAN** becomes off.

The self-learning **Adaptive Tuning** is not intrusive. It doesn't affect the process, at all, during the phase of calculation of the optimal terms parameters.

Continuous Adaptive Tuning

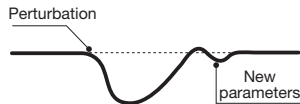

It is particularly suitable for controlling process whose control characteristics change with time or are not linear in relation to the Setpoint values.

It doesn't require any operation by the user. It is simple and works fine: it samples continuously the process response to the various perturbations, determining the frequency and the amplitude of the signals. On the basis of this data and their statistical values, stored in the instrument, it modifies automatically the PID term parameters. It is the ideal for all applications where it is required to change con-

tinuously the PID terms parameters, in order to adjust the PID to the changes of the process dynamic conditions.

In case of power off with the Adaptive Tuning enabled, the values of the PID terms parameters are lost. At the power on the Adaptive Tuning starts automatically and computes again the values of the PID terms parameters.

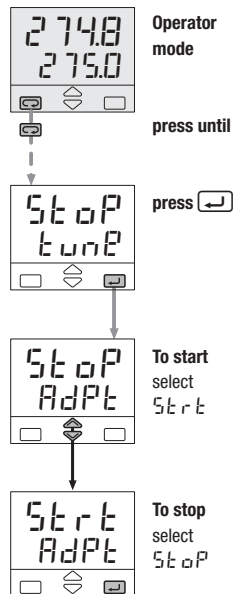

6 SPECIAL FUNCTIONS

Two special functions are available:

6.1 Start-up

6.2 Timer

In order to have the above functions the product code digit **E** must be **2** (see page 17)

For example: M4 3100-2000

To select these functions use the parameter:

t.Mod

Timer/Start-up operator mode

(see page 36).

⚠ Selecting Timer or Start-up, the Soft-start function is disabled, therefore the parameters

s.e.d.p and **s.e.t.n** will not be shown. (see page 27)

6.1 START-UP FUNCTION

By means of this function it is possible to manipulate the control output when the controller is switched on.



To configure Start-up function the parameter “Timer/Start-up operating

mode” must be set to .

Three parameters are associated to the Start-up function, they appear on the second group. (see page 27)

s.p.s.u

Start-up Setpoint

(s.p. L...s.p. H)

t.h.s.u

Start-up hold time

(0...500 min.)

o.p.h.s

Output high limit

(5.0%...100.0% min)

The Start-up function includes three phases:

1st “Limy” - The control output is limited to the **o.p.h.s**

2nd “Hold” - The process variable is maintained to the Start-up Setpoint for the time fixed by the parameter **t.h.s.u**

3rd “Off” - When the **t.h.s.u** time is elapsed the process variable is maintained to the working Setpoint.

Whether the process variable, for any reason (e.g. load change), decreases at a value lower than (**s.p.s.u** - 40 digits), the Start-up function starts again from the “Limy” phase.

When the Start-up is in Hold phase, if the local Setpoint becomes lower than the Start-up Setpoint or if the operating mode changes to manual, the Start-up function passes to the “Off” phase.

There are two possibilities:

A Start-up Setpoint SP_{PSU} lower than the local Setpoint.

The “Hold” phase starts when the process variable PV achieves the SP_{PSU} (with a tolerance of 1 digit).

B Start-up Setpoint SP_{PSU} greater than or equal to the local Setpoint.

When the process variable PV achieves the local Setpoint (with a tolerance of 1 digit), the Start-up function passes directly to the “Off” phase.

If, at the controller power-on, the process variable PV is greater than the lowest between the SP_{PSU} and the working Setpoint, the next phase (“Hold” or “Off”) will be executed instead of the “Limy” phase.

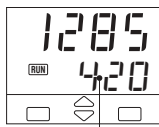

Start-up
Setpoint

During the “Limy” and “Hold” phases the **RUN** led is on.

A $SP_{PSU} < \text{local Setpoint SP}$

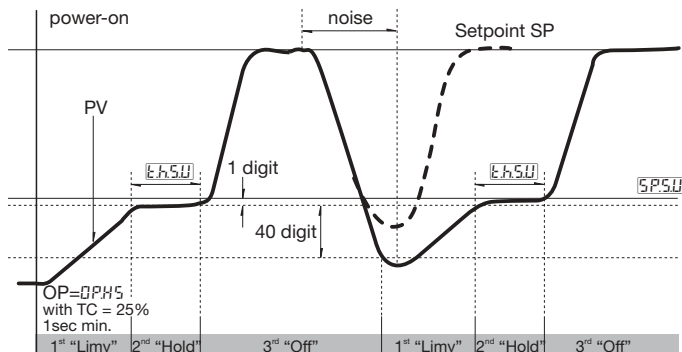

B $SP_{PSU} < \text{local Setpoint SP}$

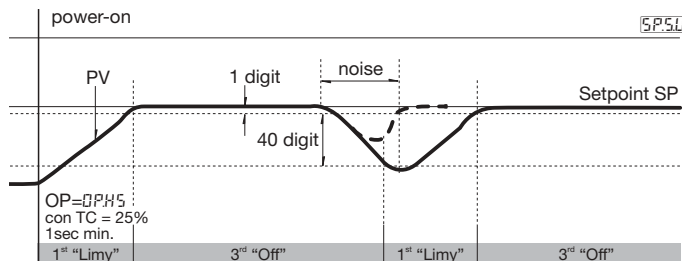

6.2 TIMER FUNCTION

To use AL3 in addition to this function, set the parameter $\boxed{\text{AL3}}$ (AL3 configuration code) is set to $\boxed{0..}$

⚠ The Timer can't be enabled with Heat/Cool control.

The two following parameters (see page 36) must be set to select one of the six possible types of Timer.

$\boxed{t.Nod}$ **Timer/Start-up operating mode**

By this parameter can be defined:

- the counting start time
- the control output status at the end of the counting

Table 1

Timer counting mode	Value
Counting start time	End mode
When inside the band	Control mode $\boxed{2}$ Output to 0 $\boxed{3}$
When launched	Control mode $\boxed{4}$ Output to 0 $\boxed{5}$
When launched. Control disabled	Control mode $\boxed{6}$
When launched stand-by Setpoint	Control mode $\boxed{7}$

$\boxed{t.Action}$ **Timer Action**

By this parameter can be defined:

- the time units
- the starting mode
- the OP3 status when the timer is running.

When the timer is not running, the OP3 takes the opposite status.

Table 2

Time units	Starting mode	[1]OP3 status	Value
Seconds	Manual by keypad	Off	$\boxed{0}$
		On	$\boxed{1}$
	Auto at the power on [2]	Off	$\boxed{2}$
		On	$\boxed{3}$
Minutes	Manual by keypad	Off	$\boxed{4}$
		On	$\boxed{5}$
	Auto at the power on [2]	Off	$\boxed{6}$
		On	$\boxed{7}$

[1] If used by Timer

[2] Using this selection, manual starting mode is possible too.

After the Timer configuration the following parameters will be shown on the second parameters group. (see page 26)

$\boxed{t.time}$ **Timer setting**
(1...9999 s/min)

$\boxed{S.P. 2}$ **Stand-by Setpoint**
(only for $t.Nod = 7$) (SP: L...SP: H)

6.2.1. DISPLAY



When the Timer is running, the led $\boxed{\text{RUN}}$ is on.

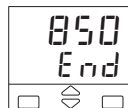

When the Timer ends, the Setpoint display shows alternatively the message $\boxed{\text{End}}$ and the Setpoint value until a key is pressed.

When the timer is running it is always possible to see the remaining time and to modify it.

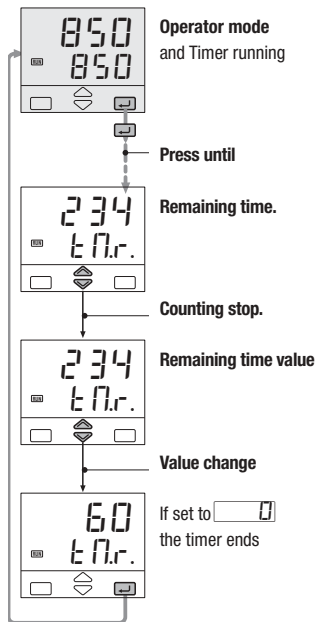

6.2.2 TIMER STARTING

Depending on the Timer action `[E.a.c.t]` selection, there can be two different starting ways:

- Automatic at the power on
- Manual by keypad, serial communications or digital input.

To start/stop the Timer:

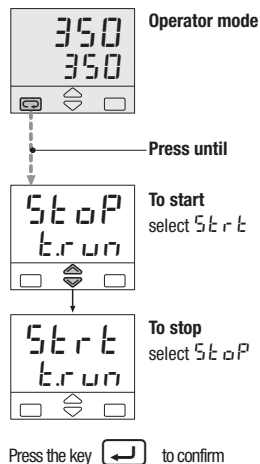

6.2.3 POWER FAILURE

If there is a power failure during the Timer execution, the value of the elapsed time is lost.

Depending on Timer action `[E.a.c.t]` selection, when the controller restarts you can have two different situations:

- with automatic mode (`[E.a.c.t] = 2, 3, 6, 7`), the Timer function starts again and the counting time is reinitialised.
- with manual mode (`[E.a.c.t] = 0, 1, 4, 5`), the control output is forced to if `[t.n.od] = 3 e 5`; otherwise the control action restarts using the working Setpoint

6.2.4 TIMER COUNTING MODES

A Counting start time inside the band, end in control mode.

The time counting starts only when the error is inside a ± 1 digit band. The control action is not affected by the Timer function.

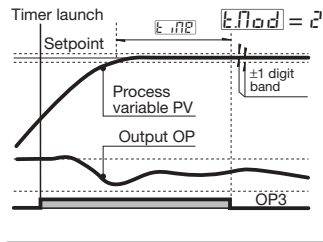
**B Counting start time inside the band, end with control output forced to zero.**

The time counting starts only when the error is inside a ± 1 digit band. At the end, the control output is forced to zero. [1]

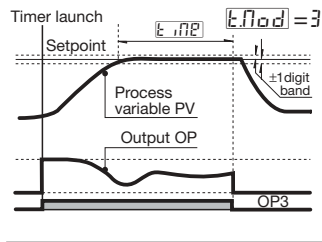
**C Counting start time = timer launch time, end in control mode.**

The time counting starts when the timer is launched. The control action is not affected by the Timer function.

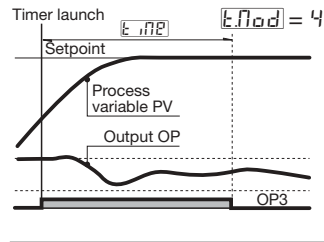

[1] When the Timer is not running the control output is forced to zero, also before the Timer launch

D Counting start time = timer launch time, end with control output forced to zero.

The time counting starts when the timer is launched. At the end, the control output is forced to zero. [1]

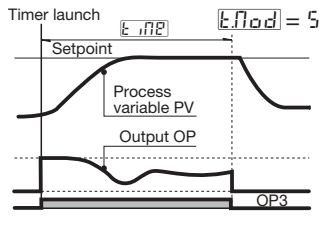

E No control action during the counting time.

The time counting starts when the timer is launched and the control output is forced to zero. At the end, the control action starts.

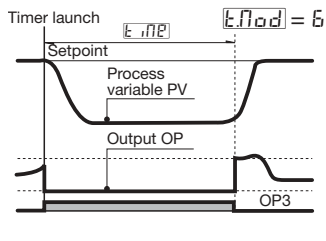

F Control action with stand-by Setpoint during the counting time

The time counting starts when the timer is launched and the control action use the Stand-by Setpoint. At the end, the control action use the working Setpoint.

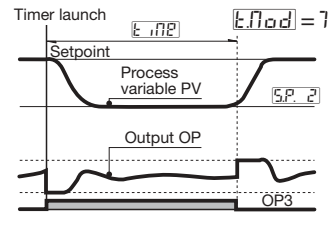

[1] When the Timer is not running the control output is forced to zero, also before the Timer launch

7 TECHNICAL SPECIFICATIONS

Features (at 25°C environmental temp.)	Description			
Total configurability (see par. 3.2 page 18 par. 4.6 page 35)	From keypad or serial communication the user selects: <ul style="list-style-type: none"> - the type of input - the type of control algorithm - the type and functionality of the alarms - the associated functions and the corresponding outputs - the type of output and the safe conditions - the values of all the control parameters. 			
PV Input (see page 11, 12 and page 18)	Common characteristics	A/D converter with resolution of 50,000 points Update measurement time: 0.2 seconds Sampling time: 0.5 seconds Input bias: -60...+60 digit Input filter with enable/disable: 1...30 seconds		
	Accuracy	0.25% ±1 digits for temperature sensors 0.1% ±1 digits (for mV and mA)	Between 100...240Vac the error is minimal	
	Resistance thermometer (for ΔT : R1+R2 must be <320 Ω)	Pt100 Ω at 0°C (IEC 751) °C/°F selectable	2 or 3 wires connection Burnout (with any combination)	Wire Res: 20 Ω max. (3 wires) Sensitivity: 0.35°C/10° E. T. <0.35°C/10 Ω Wire Res.
	Thermocouple	L, J, T, K, S (IEC 584) Rj >10M Ω °C/°F selectable	Internal cold junction compensation con NTC Error 1°C/20°C ±0.5°C Burnout	Line: 150 Ω max. Input drift: <2 μ V/°C. Env. Temp <5 μ V/10 Ω Wire Res.
	DC input (current)	4...20mA, 0...20mA with external shunt 2.5 Ω Rj >10M Ω	Engineering units Conf. decimal point position Init. Sc -999...9999	Input drift: <0.1%/20°C Env. Temp.
	DC input (voltage)	10...50mV, 0...50mV Rj >10M Ω	Full Sc. -999...9999 (min. range of 100 digits)	

Features (at 25°C environmental temp.)	Description					
CT auxiliary input (option)	Current transformer (see page 12)	50 or 100 mA input hardware selectable	Current visualisation 10...200A With 1A resolution and HeaterBreak Alarm			
Digital input (option)	The closure of the external contact produces any of the following actions: Auto/Man mode change, Stored Setpoint activation, Keypad lock, Timer launch					
Operating mode and Outputs	1 double action PID loop or On/Off with 1 or 2 alarms	Single action	Control output		AL2 alarm	AL3 alarm
		OP1-Relay /Triac OP2 -Logic	OP2-Relay or logic	OP3-Relay/Triac		
	Double action Heat/cool	OP1-Relay /Triac	OP3-Relay /Triac	OP1-Relay /Triac	OP3-Relay/Triac	
		OP1-Relay /Triac	OP2 Logic	OP2-Relay or logic	OP3-Relay/Triac	
		OP2 Logic	OP3-Relay /Triac	OP1-Relay /Triac		
Control mode	Algorithm		PID with overshoot control or On-off			
	Proportional band (P)		0.5...999.9%			
	Integral time (I)		0.1...100.0 min		OFF = 0	PID algorithm
	Derivative time (D)		0.01...10.00 min			
	Error band		0.1...10.0 digit			
	Cycle time		1...200 s			
	Dead band		-10.0...10.0%			
	Cool relative gain		0.1...10.0		Heat / cool control action	
	Cool cycle time		1...200 s			
	Overshoot control		0.01...1.00			
	High limit		100.0...10.0% (heat) -100.0...-10.0%(cool)			PID algorithm
Hysteresis		0.1...10.0%			On-Off algorithm	

Features (at 25°C environmental temp.)	Description		
OP1 output	SPST Relay N.O., 2A/250Vac (4A/120Vac) for resistive load Triac, 1A/250Vac for resistive load		Protection by varistor for 220Vac and capacitor
OP2 output	Logic not isolated: 5Vdc, ±10%, 30mA max SPST Relay N.O., 2A/250Vac (4A/120Vac) for resistive load	Jumper selectable (page 13)	
OP3 output	SPST Relay N.O., 2A/250Vac (4A/120Vac) for resistive load Triac, 1A/250Vac for resistive load		
OP4 continuous control output (option)	Galvanic isolation: 500 Vac/1 min Resolution: 12bit (0.025%) Accuracy: 0.1 %		In current: 0/4...20mA 750Ω/15V max.
AL2 - AL3 alarms	Hysteresis 0.1...10.0% c.s.		
	Action	Active high	Action type
		Active low	
	Band threshold 0...range	Sensor break, heater break alarm, Latching/Blocking, Loop Break Alarm	Absolute threshold whole range
Setpoint	Local and stand-by digital input or serial communications		
	Ramp up and down. User inhibited		0.1...999.9 digit/min
	Low limit		from low range to high limit
	High limit		from low limit to high range
Tuning	Fuzzy-Tuning The controller selects automatically the best method according to the process conditions		Step response
	Adaptive Tuning self-learning, not intrusive, analysis of the process response to perturbations and continuously calculation of the PID parameters		Natural frequency
Auto/Man station	Standard with bumpless function, by keypad, digital input or serial communications		
Serial comm. (option)	RS485 isolated, Modbus/Jbus protocol, 1200, 2400, 4800, 9600 bit/s, two wires		
Auxiliary Supply	+18Vdc ±20%, 30mA max. for external transmitter supply		











Features (at 25°C environmental temp.)	Description		
Operational safety	Measure input	Detection of out of range, short circuit or sensor break with automatic activation of the safety strategies and alerts on display	
	Control output	Safety value: -100...100%	
	Parameters	Parameter and configuration data are stored in a non volatile memory for an unlimited time	
	Access protection	Password to access the configuration and parameters data, keypad lock, output lock	
General characteristics	Power supply (PTC protected)	100...240Vac (-15...+10%) 50/60 Hz or 24Vac (-25...+12%), 50/60 Hz and 24Vdc (-15...+25%)	Power consumption 2.6W max.
	Safety	Compliance to EN61010-1 (IEC 1010 – 1), installation class 2 (2500V) pollution class 2, instrument class II	
	Electromagnetic compatibility	Compliance to the CE standards (see page 2)	
	Protection EN60529 (IEC 529)	IP65 front panel	
	UL and cUL approval	File 176452	
	Dimensions	1 ¹ / ₁₆ DIN - 48 x 48, depth 120 mm, weight 130 g approx.	













■ WARRANTY











We warrant that the products will be free from defects in material and workmanship for 18 months from the date of delivery.

The warranty above shall not apply for any failure caused by the use of the product not in accordance with the instructions contained in this manual.

ICONS TABLE

Main universal input	
	Thermocouple
	RTD (Pt100)
	Delta Temp (2x RTD)
	mA and mV
	Custom
	Frequency
Auxiliary input	
	Current transformer
	mA Remote setpoint
	Volt Remote setpoint
	Feedback potentiometer

Digital input	
	Isolated contact
	NPN open collector
	TTL open collector
Setpoint	
	Local
	Stand-by
	Keypad lock
	Outputs lock
	Start-up function
	Timer function
	Memorized
	Remote
	Setpoint programmer

Digital input connected functions	
	Auto/Manual
	Run, Hold, Reset and program selection
	PV hold
	Setpoint slopes inhibition
Output	
	SPST Relay
	Triac
	SPDT Relay
	mA
	mA mV
	SSR Drive