

Operator Interface

Cable Pull Switches

Lifeline™ 3



Description

The Lifeline 3 is a cable (rope) operated emergency stop device designed to meet the stringent requirements of ISO 13850 (Safety of Machinery—Emergency Stop Equipment). The Lifeline 3 system can be installed along or around awkward machinery such as conveyors and provides a constant-access emergency-stop facility.

1. The positive-mode mechanism helps ensure that the contacts are immediately latched open on actuation and can only be reset by the intentional action of turning the blue reset knob. The design also protects against nuisance tripping and the effects of thermal expansion.
2. The cable-status indicator makes the system easy to set up and maintain for spans up to 30 m (98 ft).
3. Four sets of contacts are provided: 2 N.C. + 2 N.O., or 3 N.C. + 1 N.O. contacts.
4. Sealed to IP 67 with rugged construction using die-cast alloy and stainless steel to withstand harsh conditions.

Features

- Switches up to 30 m (98 ft) span
- Universal mounting and operation
- Switch lockout on cable pulled and cable slack
- Cable-status indicator on switch lid
- Industry standard fixing centers to DIN/EN 50041
- Quick disconnect styles available

Specifications

Safety Ratings					
Standards	ISO 13850, EN ISO 12100, IEC 60947-5-1, IEC 60947-5-5				
Safety Classification	Cat. 1 device per EN 954-1 May be suitable for use in Cat 3 or Cat 4 systems depending on the architecture and application characteristics				
Functional Safety Data *	B10d: > 2 x 10 ⁶ operations at min. load PFH _D : < 3 x 10 ⁻⁷ MTTF _d : > 385 years May be suitable for use in performance levels Pl _e or Pl _d systems (according to ISO 13849-1:2006) and for use in SIL2 or SIL3 systems (according to IEC 62061) depending on the architecture and application characteristics				
Certifications	CE Marked for all applicable directives, cULus, TÜV, and CCC				
Outputs					
Safety Contacts *	2 N.C. direct-opening action	3 N.C. direct-opening action			
Auxiliary Contacts	2 N.O. direct-opening action	1 N.O. direct-opening action			
Thermal Current/I _{th}	10 A				
Rated Insulation Voltage	(U _i) 500V				
Switching Current @ Voltage, Min.	5 mA @ 5V DC				
Utilization Category					
A600/AC-15	(U _e)	600V	500V	240V	120V
	(I _e)	1.2 A	1.4 A	3 A	6 A
DC-13	(U _e)	24V			
	(I _e)	2 A			
Operating Characteristics					
Cable Span Between Switches, Max.	30 m (98 ft)				
Tensioning Force to Run Position	103 N (23.17 lbf) typical				
Tensioning Force to Lockout	188 N (42.3 lbf) typical				
Operating Force, Min.	<125 N (28.1 lb) at 300 mm deflection				
Actuation Frequency, Max.	1 cycle/s				
Operating Life @ 100 mA load	1 x 10 ⁶				
Environmental					
Enclosure Type Rating	IP67				
Operating Temperature [C (F)]	-25...80° (-13...176°)				
Physical Characteristics					
Housing Material	Heavy-duty painted zinc-based die-cast alloy				
Indicator Material	Glass-filled nylon				
Eye Nut Material	Stainless steel				
Weight [g (lb)]	610 (1.34)				
Color	Yellow body, blue reset button				

* Usable for ISO 13849-1:2006 and IEC 62061. Data is based on the B10d value given and:
 - Usage rate of 1op/10 mins., 24 hrs/day, 360 days/year, representing 51840 operations per year
 - Mission time/Proof test interval of 38 years

* The safety contacts are described as normally closed (N.C.) i.e., with the guard closed, actuator in place (where relevant) and the machine able to be started.

Note: It is recommended that the LRTS (Lifeline Rope Tensioning System) should be used with the Lifeline 3 cable rope switch.

Product Selection

Contacts		Cat. No.				
Safety	Auxiliary	Conduits		Connectors*		
		M20	1/2 inch NPT	12-Pin M23	8-Pin Micro (M12)*	Connect to ArmorBlock Guard I/O 5-Pin Micro (M12)‡
2 N.C.	2 N.O.	440E-D13118	440E-D13120	440E-D13132	440E-D21BNYH	440E-D2NNNYS
3 N.C.	1 N.O.	440E-D13112	440E-D13114	440E-D13124	—	—

* For connector ratings, see page 3-9.

* With an 8-pin micro (M12) connector, not all contacts are connected. See *Typical Wiring Diagram* on page 4-9 for wiring details.

‡ For connection to ArmorBlock Guard I/O. With a 5-pin micro (M12) connector, not all contacts are connected. See *Typical Wiring Diagram* on page 4-9 for wiring details.

Recommended Logic Interfaces

Description	Safety Outputs	Auxiliary Outputs	Terminals	Reset Type	Power Supply	Cat. Page No.	Cat. No.
Single-Function Safety Relays for 2 N.C. Contact Switch							
MSR127RP	3 N.O.	1 N.C.	Removable (Screw)	Monitored Manual	24V AC/DC	5-26	440R-N23135
MSR127TP	3 N.O.	1 N.C.	Removable (Screw)	Auto./Manual	24V AC/DC	5-26	440R-N23132
MSR126T	2 N.O.	None	Fixed	Auto./Manual	24V AC/DC	5-24	440R-N23117
MSR30RT	2 N.O. Solid State	1 N.O. Solid State	Removable	Auto./Manual or Monitored Manual	24V DC	5-16	440R-N23198
Modular Safety Relays							
MSR210P Base 2 N.C. only	2 N.O.	1 N.C. and 2 PNP Solid State	Removable	Auto./Manual or Monitored Manual	24V DC from the base unit	5-82	440R-H23176
MSR220P Input Module	—	—	Removable	—	24V DC	5-86	440R-H23178
MSR310P Base	MSR300 Series Output Modules	3 PNP Solid State	Removable	Auto./Manual Monitored Manual	24V DC	5-102	440R-W23219
MSR320P Input Module	—	2 PNP Solid State	Removable	—	24V DC from the base unit	5-106	440R-W23218

Note: For additional Safety Relays connectivity, see the Safety Relays section (page 5-8) of this catalog.

For additional Safety I/O and Safety PLC connectivity, see the Programmable Safety System section (page 5-115) of this catalog.

For application and wiring diagrams, see the Safety Applications section (page 10-1) of this catalog.

Connection Systems

Description	5-Pin Micro (M12)*	8-Pin Micro (M12)	12-Pin M23
Cordset	—	889D-F8AB-§	889M-FX9AE-§
Patchcord	889D-F5ACDM-♣	889D-F8ABDM-♣	889M-F12AHMU->

§ Replace symbol with 2 (2 m), 5 (5 m), or 10 (10 m) for standard cable lengths.





♣ Replace symbol with 1 (1 m), 2 (2 m), 3 (3 m), 5 (5 m), or 10 (10 m) for standard cable lengths.

> Replace symbol with 0M3 (0.3 m), 0M6 (0.6 m), 1 (1 m), 2 (2 m) or 3 (3 m) for standard lengths.

* To connect to ArmorBlock Guard I/O.

Operator Interface
Cable Pull Switches
 Lifeline™ 3

Accessories

	Description	Cat. No.
	Lifeline P. bolt M8 x 1.25 thread size, 58 mm (2.28 in.) threaded length, 12 mm (0.47 in.) dia. eye, 95 mm (3.74 in.) overall length	440E-A17003
	Lifeline tensioner spring 19 mm (0.75 in.) diameter, 210 mm (8.27 in.) overall length, 50 N force	440E-A13078
	Lifeline inside corner pulley Internal diameter 16 mm (0.64 in.) zinc-plated mild steel	440A-A17101
	Lifeline outside corner pulley Outside diameter 38 mm (1.5 in.) zinc-plated mild steel	440A-A17102
	Blanking plug, M20 conduit	440A-A07265
	Cable grip, M20 conduit, accommodates cable diameter 7...10.5 mm (0.27...0.41 in.)	440A-A09028
	Adaptor, conduit, M20 to 1/2 inch NPT, plastic	440A-A09042
	Screwdriver including security bit	440A-A09018

Approximate Dimensions

Dimensions are shown in mm (in.). Dimensions are not intended to be used for installation purposes.

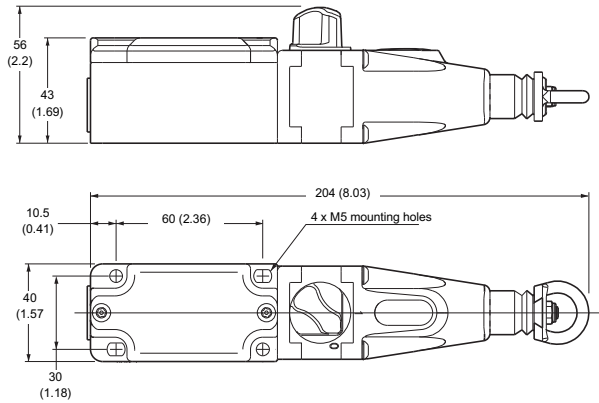

Note: 2D, 3D and electrical drawings are available on www.ab.com.

4-Emergency Stop Devices

Typical Wiring Diagrams

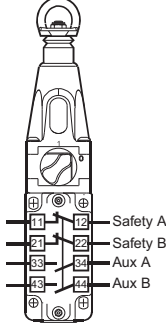
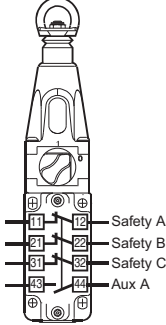
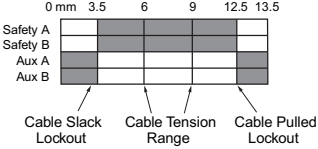
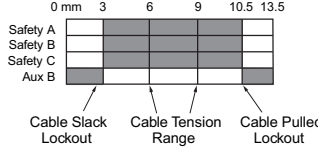
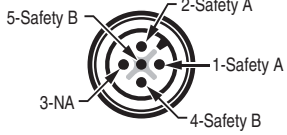
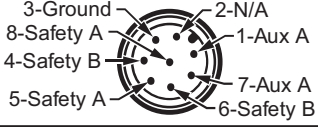
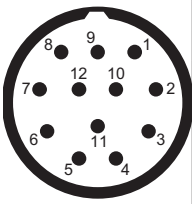
Description		2 N.C. & 2 N.O.	3 N.C. & 1 N.O.
Contact Configuration			
Contact Action □ Open ■ Closed			
5-Pin Micro (M12) for ArmorBlock Guard I/O			—
8-Pin Micro (M12)			—
 Pins 2, 5, 11 not connected	1-3	Safety A	Safety A
	4-6	Safety B	Safety B
	7-8	Aux A	Safety C
	9-10	Aux B	Aux A
	12	Ground	Ground
8-Pin Cordset 889D-F8AB-*	Grey Red	Safety A	
	Yellow Pink	Safety B	
	White Blue	Aux A	
	Green	Ground	
	Brown	Not Used	
12-Pin Cordset 889M-FX9AE-*	Brown Blue	Safety A	Safety A
	White Green	Safety B	Safety B
	Yellow Grey	Aux A	Safety C
	Pink Red	Aux B	Aux A
	Green Yellow	Ground	Ground

* Replace symbol with 2 (2 m), 5 (5 m), or 10 (10 m) for standard cable lengths.
 * Replace symbol with 0F5 (0.5 ft) or 1F (1 ft) for standard cable lengths.

4-Emergency Stop Devices