

Operator Interface

Cable Pull Switches

Lifeline™ 4 Stainless Steel



Description

The stainless steel Lifeline 4 cable/push button operated system can be installed along or around awkward machinery such as conveyors and provide a constant emergency stop access. This switch is made from stainless steel 316 and is suitable for external use, applications where there are hygiene requirements and other situations where a level of corrosion resistance is required.

The Lifeline 4 is the only device of its kind to incorporate the following features in one unit making it the most versatile cable switch on the market.

1. The positive mode mechanism helps ensure that the contacts are immediately latched open on actuation and can only be reset by the intentional action of turning the blue reset knob. The design also protects against nuisance tripping and the effects of thermal expansion.
2. A mushroom head emergency stop button is included on the unit to provide E-Stop access even at the extreme ends of the span.
3. The cable status indicator makes the system easy to set up and maintain for spans up to 75 meters.
4. Four sets of contacts are provided: 2 N.C. + 2 N.O.
5. Sealed to IP66 and IP69K with rugged construction using stainless steel 316 to withstand harsh conditions.

Features

- Switches up to 75 m (246 ft) span
- Universal mounting and operation
- Lid mounted emergency stop button, designed to conform to ISO 850
- Switch lockout on cable pulled and cable slack
- Cable status indicator on switch lid
- Made from stainless steel 316

Lid mounted E-Stop button

A mushroom head emergency stop button is included on the unit to provide total E-Stop access even at the extreme ends of the span.



Cable status indicator on lid

The cable status indicator makes the system easy to setup and maintain for spans up to 75 m (246 ft).

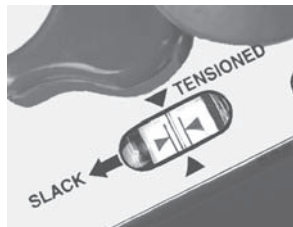

Specifications

Safety Ratings	
Standards	EN 60947-5-5, ISO 13850, EN ISO 12100, IEC 60947-5-1
Safety Classification	Cat. 1 device per EN 954-1 May be suitable for use in Cat 3 or Cat 4 systems depending on the architecture and application characteristics
Functional Safety Data *	B10d: > 2 x 10 ⁶ operations at min. load PFH _D : < 3 x 10 ⁻⁷ MTTF _d : > 385 years May be suitable for use in performance levels Ple or Pld systems (according to ISO 13849-1:2006) and for use in SIL2 or SIL3 systems (according to IEC 62061) depending on the architecture and application characteristics
Note: For up-to-date information, visit http://www.ab.com/Safety/	
Certifications	CE Marked for all applicable directives, cULus Certified and TÜV

Outputs	
Safety Contacts *	2 N.C. direct opening action
Auxiliary Contacts	2 N.O.
Thermal Current I_{th}	10 A
Rated Insulation Voltage	(Ui) 500V
Switching Current @ Voltage, Min.	5 mA @ 5V DC

Utilization Category					
A600/AC-15	(Ue)	600V	500V	240V	120V
	(Ie)	1.2 A	1.4 A	3 A	6 A
DC-13	(Ue)	24V			
	(Ie)	2 A			

Operating Characteristics	
Cable Span Between Switches, Max.	75 m (246 ft)
Tensioning Force to Run Position	103 N (23.17 lbf) typical
Tensioning Force to Lockout	188 N (42.3 lbf) typical
Operating Force, Min.	<125 N (28.1 lbf) at 300 mm deflection
Actuation Frequency, Max.	1 cycle/s
Operating Life @ 100 mA load	1 x 10 ⁶

Environmental	
Enclosure Type Rating	IP66, IP67, IP69K
Operating Temperature [C (F)]	-25...80° (-13...176°)

Physical Characteristics	
Housing Material	Stainless steel 316
Indicator Material	Acetal
Eye Nut Material	Stainless steel
Weight [g (lb)]	1442 (3.17)
Color	Unpainted metal

* Usable for ISO 13849-1:2006 and IEC 62061. Data is based on the B10d value given and:

- Usage rate of 1op/10 mins., 24 hrs/day, 360 days/year, representing 51840 operations per year
- Mission time/Proof test interval of 38 years

* The safety contacts are described as normally closed (N.C.) i.e., with the guard closed, actuator in place (where relevant) and the machine able to be started.

Note: It is recommended that the stainless steel installation kit should be used with the stainless steel Lifeline 4 as it is made of suitable materials for harsh conditions.

Product Selection

Cable Span	Safety Contacts	Auxiliary Contacts	Cat. No.		
			Conduits		Connectors§
			M20	1/2 inch NPT	12-Pin M23
Up to 75 m (246 ft)	2 N.C.	2 N.O.	440E-L22BNSM	440E-L22BNST	440E-L22BNSL

§ For connector ratings, see 3-9.

Recommended Logic Interfaces

Description	Safety Outputs	Auxiliary Outputs	Terminals	Reset Type	Power Supply	Cat. Page No.	Cat. No.
Single-Function Safety Relays for 2 N.C. Contact Switch							
MSR127RP	3 N.O.	1 N.C.	Removable (Screw)	Monitored Manual	24V AC/DC	5-26	440R-N23135
MSR127TP	3 N.O.	1 N.C.	Removable (Screw)	Auto./Manual	24V AC/DC	5-26	440R-N23132
MSR126T	2 N.O.	None	Fixed	Auto./Manual	24V AC/DC	5-24	440R-N23117
MSR30RT	2 N.O. Solid State	1 N.O. Solid State	Removable	Auto./Manual or Monitored Manual	24V DC	5-16	440R-N23198
Modular Safety Relays							
MSR210P Base 2 N.C. only	2 N.O.	1 N.C. and 2 PNP Solid State	Removable	Auto./Manual or Monitored Manual	24V DC from the base unit	5-82	440R-H23176
MSR220P Input Module	—	—	Removable	—	24V DC	5-86	440R-H23178
MSR310P Base	MSR300 Series Output Modules	3 PNP Solid State	Removable	Auto./Manual Monitored Manual	24V DC	5-102	440R-W23219
MSR320P Input Module	—	2 PNP Solid State	Removable	—	24V DC from the base unit	5-106	440R-W23218

Note: For additional Safety Relays connectivity, see page 5-4.
 For additional Safety I/O and Safety PLC connectivity, see page 5-116.
 For application and wiring diagrams, see page 10-1.









Connection Systems

Description	12-Pin M23
Cordset	889M-FX9AE-*
Patchcord	889M-F12AHMU-*

* Replace symbol with 2 (2 m), 5 (5 m), or 10 (10 m) for standard cable lengths.
 * Replace symbol with 0M3 (0.3 m), 0M6 (0.6 m), 1 (1 m), 2 (2 m) or 3 (3 m) for standard length.

Operator Interface
Cable Pull Switches
 Lifeline™ 4 Stainless Steel

Accessories

	Description	Eye Bolts	Cat. No.
	Stainless steel installation kit—5 m (16.4 ft)—polypropylene	4	440E-A13194
	Stainless steel installation kit—10 m (32.8 ft)—polypropylene	4	440E-A13195
	Stainless steel installation kit—15 m (49.2 ft)—polypropylene	7	440E-A13196
	Stainless steel installation kit—20 m (65.6 ft)—polypropylene	8	440E-A13197
	Stainless steel installation kit—30 m (98.4 ft)—polypropylene	12	440E-A13198
	Stainless steel installation kit—50 m (164 ft)—polypropylene	20	440E-A13199
Polypropylene Covered Steel Cable	Stainless steel installation kit—75 m (246 ft)—polypropylene	30	440E-A13200
	Stainless steel installation kit—5 m (16.4 ft)—UV resistant	4	440E-A13220
	Stainless steel installation kit—10 m (32.8 ft)—UV resistant	4	440E-A13221
	Stainless steel installation kit—15 m (49.2 ft)—UV resistant	7	440E-A13222
	Stainless steel installation kit—20 m (65.6 ft)—UV resistant	8	440E-A13223
	Stainless steel installation kit—30 m (98.4 ft)—UV resistant	12	440E-A13224
	Stainless steel installation kit—50 m (164 ft)—UV resistant	20	440E-A13225
UV Resistant Polypropylene-Covered Steel Cable	Stainless steel installation kit—75 m (246 ft)—UV resistant	30	440E-A13226
	Stainless steel turn buckle kit (no cable)		440E-A13227
	Stainless steel 304 eyebolt complete M8 x 1.25 thread size, 58 mm (2.28 in) threaded length, 12 mm (0.47 in) dia. eye 95 mm (3.74 in) overall length		440E-A13201
	Stainless steel 316 tensioner spring, 19 mm (0.75 in) dia. 210 mm (8.27 in) overall length		440E-A13202
	Replacement Cover		440E-A13203
	Replacement cover no E-Stop		440E-A13204
	Stainless steel 316 inside corner pulley		440E-A13205
	Stainless steel outside corner pulley		440E-A13206

Note: Installation Kits include the following parts: one rope, one turnbuckle tensioner, four thimbles, eight rope grips and eyebolts, nuts and washers depending on the length of the rope.

Approximate Dimensions

Dimensions are shown in mm (in.). Dimensions are not intended to be used for installation purposes.

Standard Model

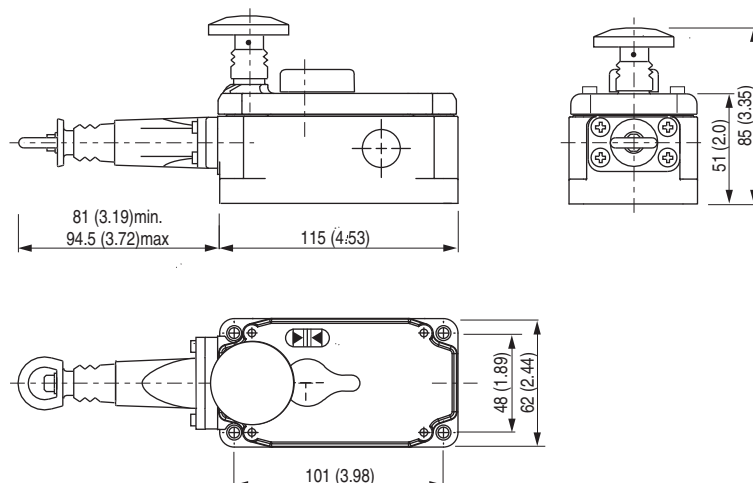

Note: 2D, 3D and electrical drawings are available on www.ab.com.

Typical Wiring Diagrams

Description		2 N.C. & 2 N.O.
Contact Configuration		
Contact Action	<input type="checkbox"/> Open <input checked="" type="checkbox"/> Closed	
12-Pin M23	1-3	Safety A
	4-6	Safety B
	7-8	Aux A
	9-10	Aux B
	12	Ground
	Brown Blue	Safety A
	White Green	Safety B
	Yellow Grey	Aux A
	Pink Red	Aux B
	Green Yellow	Ground

* Replace symbol with 0F5 (0.5 ft) or 1F (1 ft) for standard cable lengths.

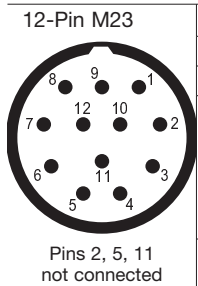

4-Emergency
Stop Devices